

TELEVISION



CONTENTS INCLUDE

Special Message from
the Marchese Marconi

B.B.C. and Television :
Official Announcement

Watching the Derby
by Television!

How to Construct
a Television Receiver

*To get the best out of your Set—
get the best Components and Wires*



GLAZITE WIRE

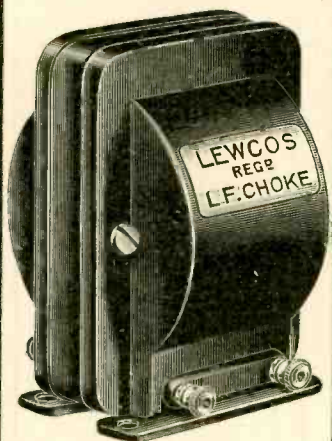

L.F. CHOKE

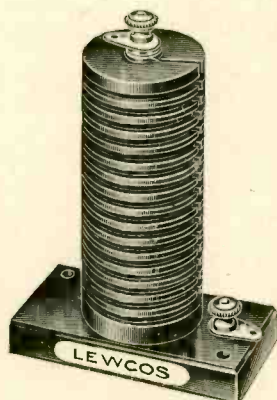

H.F. CHOKE

LEWCOS

For many years the expert constructors of the most popular wireless journals have expressed their recognition of the supreme quality of LEWCOS COMPONENTS AND WIRES by continually specifying them for their most highly successful Receivers. And now in the Television field experimenters have conclusively proved that LEWCOS PRODUCTS are equally successful. ONLY A TEST—and not mere words—WILL PROVE TO YOU THAT LEWCOS PRODUCTS ARE YOUR GUARD AGAINST INDIFFERENT REPRODUCTION.

Try all, or some, of the following when reconstructing your present receiver, or building a new one.

Intermediate Frequency Transformer Coil Set, comprising, 1 Oscillator Coil, 2 I.F. Coils with Pigtails and 1 I.F. Coil without Pigtail, price 50/- per set.

The LEWCOS L.F. Transformer, Reference L.F.T. 6, price 10/-.

The LEWCOS L.F. Choke, reduced price 12/6.

The LEWCODENSER, manufactured in two types, Reference Type W. and Type O., price 2/6 each.

The LEWCOS Super H.F. Choke, price 6/-.

The LEWCOS Spaghetti Resistances, manufactured in Resistance Values from 300 to 100,000 ohms, at 9d. to 1/6.

Glazite Wire, 6d. per 10 ft. coil.

Beware of imitations. Look for the "Glazite" label on each coil.

LEWCOS Twin Flex.

GLAZITE WIRE AND LEWCOS TWIN FLEX WERE EXCLUSIVELY SPECIFIED FOR THE "VISIONETTE" DESCRIBED IN THIS JOURNAL



F.T.

LEWCOS RADIO PRODUCTS FOR BETTER RECEPTION

THE LONDON ELECTRIC WIRE COMPANY AND SMITHS LIMITED, CHURCH ROAD, LEYTON, LONDON, E.10

2ND EDITION
REVISED

223 PAGES FULLY
ILLUSTRATED

PRACTICAL TELEVISION

BY
E. T. LARNER AND J. L. BAIRD

10/6

In this book the history and development of the attempts to transmit sight by radio are collected and discussed, with descriptions of all the principal apparatus, including, by special arrangement with the inventor, the most recent research work of Mr. J. L. Baird.

FREE LIST OF WIRELESS BOOKS ON REQUEST
FROM

ERNEST BENN LTD.
TECHNICAL DEPT., BOUVERIE HOUSE, FLEET ST., E.C.4

PHONE
HOLBORN
8638

DOSSSET STUDIO

TECHNICAL DRAWINGS/
RADIO DIAGRAMS/
MODERN IDEAS/
ILLUSTRATIONS

HAZLITT H/5 SOUTHAMPTON BLDG/
CHANCERY LANE LONDON W.C. 2

ONE SHILLING — MONTHLY

ARMCHAIR SCIENCE

A POPULAR ILLUSTRATED
MAGAZINE FOR THE
AVERAGE MAN &
WOMAN

YOU will enjoy reading this popular, brightly illustrated magazine dealing with curious and interesting discoveries and events throughout the world. Each month there is interest and instruction for every member of the family.

"Profitable and delightful reading."—*Alnwick City Gazette*.

"Well worth a monthly shilling."—*Derbyshire Advertiser*.

"Full of good things, fully and attractively illustrated."—*Northants Evening Telegraph*.

"Deserves a front place. Every copy sold will find a permanent reader."—*National Newsagent*.

- ★ Send 3d. in Stamps for
- ★ Free Specimen Copy to
- ★ address below

JUNE ISSUE NOW ON SALE

ARMCHAIR SCIENCE LTD.
SUBSCRIPTION DEPT.
56 Victoria St., LONDON, S.W.1

*Bailey The Wireless
Foton Rd 3.*

THE FOLLOWING DEALERS ARE WILLING TO DEMONSTRATE TELEVISION

"TELEVISORS" • KIT SETS • COMPONENTS

| | | |
|----------------------|-------------------------------------|--------------------------------|
| AMERSFOORT (Holland) | WILLEN VAN LOON | Stationsstraat 32B |
| BAGSHOT | LINDFIELDS GARAGE | Surrey |
| BEDFORD | JEAKINGS & SON | Mill Street |
| BEDWORTH | T. H. RUSSELL | Tram Terminus, Coventry Rd. |
| BEXLEY HEATH | J. SPENCER (LONDON) LTD. | 127 The Broadway |
| BIGGESTER | LAMBOURNE BROS. | 47 Market Square |
| BIRMINGHAM | C. WEBB LTD. | 41 Carts Lane |
| BIRMINGHAM | SHANNON & CAPENER | 13 Aston Road North |
| BISHOPS STORTFORD | H. R. MOORE LTD. | Northgate End |
| BOURNEMOUTH | J. E. BEALE LTD. | Hants |
| BRACKNELL | DRAKE & MOUNT LTD. | Berks |
| BRAINTREE | COX'S GARAGE | Rayne Road |
| BRIDGEND | WRIGHT & ASHWORTH | Kings Bldgs., Adair Street |
| BURTON-ON-TRENT | RADIO & CY-KAR MART | Cross Street |
| CAERPHILLY | L. PRITCHARD | 73 Princes Avenue |
| CHALVEY | J. D. HALLIDAY | Nr. Slough |
| CHESTERFIELD | G. KENNINGTON (CHESTERFIELD) LTD. | Victor Lane |
| CHIPPERFIELD | A. C. GEORGE | The Common |
| COLCHESTER | SHROSBURY & BAKEWELL CO., LTD. | 73 Crouch Street |
| COULSDON | THE "VIC" WIRELESS STORES | 21 Chipstead Valley Road |
| COVENTRY | MAX. A. BUCH | 143 Lower Ford Street |
| COVENTRY | PARKER'S RADIO SERVICES | 3 Holyhead Road |
| DARLINGTON | C. SHARP | 321 North Street |
| DEAL | G. CLOUT | Electrical Engrs. |
| DEWSBURY | BICKERS LTD. | The Galleries |
| DOVER | DOVER RADIO STORES | 4 Townwall Street |
| EASTBOURNE | A. BODKIN & CO., LTD. | 11 Cornfield Road |
| EASTBOURNE | OWEN H. RELLY | "Gavinwood," Willingdon |
| ERDINGTON | STANLEY'S RADIO | 191 High Street |
| FELIXSTOWE | L. E. PULFORD | 141 Hamilton Road |
| FOLKESTONE | BOBBY & CO. LTD. | 48 Sandgate Road |
| GERRARDS CROSS | R. F. CHIPPS | 6 Oak End Way |
| GODALMING | H. J. CHALLEN | 12 Church Street |
| GRAYS (ESSEX) | GRAYS WIRELESS CO. (H. W. FRANKLIN) | Clarence Road |
| KIRKCALDY | GIBB & WATSON | 270 High Street |
| LEIGHTON BUZZARD | GRIFFIN BROS. | 11 High Street |
| LLANDUDNO | EVANS & EVANS | 29 Mostyn Ave., Craig-y-Don |
| LONDON: | | |
| BATTERSEA | E. F. KELLY | 5 Park Road |
| BAYSWATER | HOPE, NORMAN & CO. | 85 Westbourne Grove |
| BRIXTON | QUIN & AXTENS | Brixton Road |
| BROMLEY | UNIVERSAL ENGINEERS | 1 Chatterton Road |
| CLAPHAM COMMON | DEMPSEY & CO. | 69 South Side |
| CRICKLEWOOD BROADWAY | HARDEN & CO. | 99 Cricklewood Broadway |
| EALING | KEEN WIRELESS CO. | 1 Dare Road |
| EALING (WEST) | L. LEAMAN | 97 Northfield Avenue |
| EARLSFIELD | H. HOLLIER & SONS | 422 Garratt Lane |
| EAST BARNET | EAST BARNET WIRELESS STORES | 3 Park Parade |
| EDGWARE | A. ALDERTON | 8 Bank Parade, High Street |
| EDGWARE | J. F. WISSON | 2 Cheapside, Deans Lane |
| FULHAM PALACE ROAD | "ECONOMIC" | 24 Fulham Palace Road |
| HAMMERSMITH | W. H. OATES | 195 Hammersmith Road |
| HOLLOWAY | JONES BROS. (HOLLOWAY) LTD. | Holloway Road |
| HOUNSLOW | SANDERS ELECTRIC & RADIO SUPPLIES | 110 Staines Road |
| KINGSTON | BENTALLS LTD. | Surrey |
| KNIGHTSBRIDGE | BROMPTON RADIO CO. | 20 Brompton Arcade |
| KNIGHTSBRIDGE | HARRODS LTD. | S.W. |
| MUSWELL HILL | VICTOR RADIO SERVICES | 8 Firs Parade |
| NEW BOND STREET | KEITH PROWSE LTD. | 150 New Bond Street |
| OXFORD STREET | SELFRIDGE & CO., LTD. | W.1. |
| PECKHAM | HAVIL RADIO | 30 High Street |
| PIMLICO | F. DOVE & SONS | 77 Pimlico Road |
| WEST NORWOOD | E. SHELDRIK | 493 Norwood Road |
| WIGMORE STREET, W. | WIGMORE RADIO SERVICE | 39/38 Wigmore Street |
| WOOD GREEN | DISTRICT SUPPLIES LTD. | 43 High Road |
| LUTON | R. J. STEARN & CO. | 7 Manchester Street |
| NEWCASTLE | PAYNE & HORNSBY LTD. | 7 St. Andrew's Buildings |
| NEW MALDEN (SURREY) | ACORN SERVICE STATION LTD. | Kingston By-pass Road |
| NORWICH | E. A. PRIEST & CO. | 28 St. George's Road |
| PERRY BAR | WELLINGTON RADIO & ELECTRICAL DEPOT | 303 Birchfield Road |
| PLYMOUTH | W. H. AXWORTHY & CO. | 106 Tavistock Road |
| RAMSGATE | J. CARMAN | 65 King Street |
| RAMSGATE | E. COVENEY & SONS | 20 Belle Vue Road |
| ROCHDALE | BANNISTER & FITTON | 27 Milnrow Road |
| ROCHESTER | A. F. SMITH & SONS, LTD. | 215 High Street |
| SLOUGH | G. CASE & SONS | 27 High Street, High Street |
| STAINES | V. & D. KEALE | Kingston Road |
| TONBRIDGE | A. T. LANGTON | High Street |
| WALLINGTON | W. BELDING | 9 The Parade, 320 Stafford Rd. |
| WALLINGTON | BULLOUGH BROS. | 346 Woodcote Road |
| WEST BYFLEET | A. LONG | 1 Byfleet Corner |
| WEST DRAYTON | SPRATLEY BROS. | Station Road |
| WITLEY (SURREY) | G. WOOTON | Northfields |
| WORTHING | E. LAMB | Franklin Road, Durrington |

• GIVE YOUR LOCAL DEALER A CALL TO-DAY •

GENEROUS HIGH-TENSION NEVER FAILING, NEVER FLUCTUATING

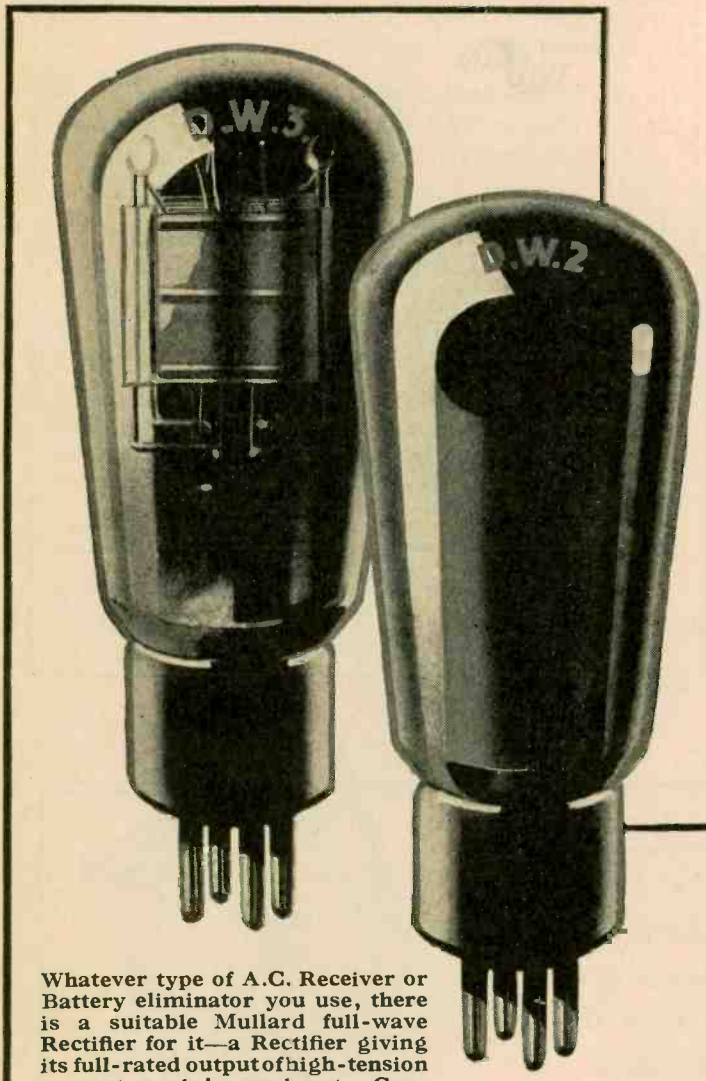

Whatever type of A.C. Receiver or Battery eliminator you use, there is a suitable Mullard full-wave Rectifier for it—a Rectifier giving its full-rated output of high-tension current, week in, week out. Constant voltage, generous ever-available output—and that consistent performance which you have learnt to expect from every Mullard valve.

The D.W.4 is specified for the eliminator for the "Tele-Radio" receiver described in this issue.

from

MULLARD FULL-WAVE RECTIFIERS

| | |
|---|------|
| Type D.W.2. Output 60 mA. at 250 volts | 12/6 |
| Reduced price | |
| Type D.W.3. Output 120 mA. at 350 volts | 15/- |
| Reduced price | |
| Type D.W.4. Output 120 mA. at 500 volts | 20/- |
| Reduced price | |

MADE IN ENGLAND

Mullard

THE · MASTER · VALVE

Advt. The Mullard Wireless Service Co., Ltd., Mullard House, Charing Cross Road, London, W.C.2.
TELEVISION for June, 1932

ARKS
121



"Undoubtedly the finest in its Price class"—TRUE moving coil reproduction. Write for FREE folder.

THE NEW P.M.4 PERMANENT MAGNET Moving Coil Speaker.

42! Complete with output transformer.

Made by the makers of the famous W.B. Valveholders.

Whiteley Electrical Radio Co., Ltd., Nottingham Road, Mansfield, Notts.



Irish Free State Distributors: Kelly & Shiel, Ltd., 47 Fleet Street, Dublin.

L. LEAMAN

97, NORTHFIELD AVENUE
WEST EALING, LONDON, W.13

For Radio and Television

DEMONSTRATIONS DURING TELEVISION TRANSMISSIONS

Baird Components Supplied

PHONE: EALING 5394 (MEMBER, TELEVISION SOCIETY)

MISCELLANEOUS ANNOUNCEMENTS

Readers wishing to sell secondhand apparatus and components, books, etc., are invited to make use of this advertisement section at the rate of 3d. per word (minimum, 36 words).

Announcements should be written on one side of the paper only, and accompanied by a postal order made payable to Benn Brothers, Ltd.

BARGAIN.—Exact model of W. J. Richardson's "Crystal" Three described in March, 1932, issue. Complete in cabinet with valves. First three guineas secures.—Write Box 100, TELEVISION.

RADIO Vision Receptors (Television). Parts for Experimenters supplied by JOHN SALTER (Established 1896), Experimental and Radio Engineer, 13 Featherstone Buildings, High Holborn, London, W.C.1. Telephone—Chancery 7408.

BACK issues of TELEVISION from No. 1 can be obtained at the published price from the publishers, 154 Fleet Street, London, E.C.4.

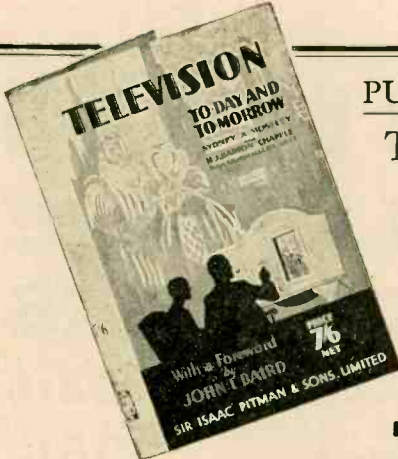

PUBLISHED BY PITMAN'S

These two books are
the leading Works
on these great
features of
modern
Life

**TELEVISION
TO-DAY AND TO-MORROW**

By SYDNEY A. MOSELEY and H. J. BARTON CHAPPLE, Wh.Sch., B.Sc. (Hons.), etc., with a Foreword by JOHN L. BAIRD. Should be read by all who realise the tremendous possibilities of this development of radio.
190 pages, illustrated, Second Edition, 7/6 net

TALKING PICTURES

By BERNARD BROWN, B.Sc. (Eng.). Gives a detailed insight into the production of talking pictures, and explains clearly the scientific facts and mechanical methods.
304 pages, illustrated, Second Edition, 12/6 net

Order from your local bookseller, or

SIR ISAAC PITMAN & SONS LTD., PARKER ST., KINGSWAY, W.C.2



Telegrams :
Benbrolish Fleet
London

TELEVISION

Telephone :
City 0244
(10 lines)

Proprietors : BENN BROTHERS LTD.

Established 1880

Editorial, Advertisement and Publishing Offices :

Bouverie House, Fleet Street, London, E.C.4

(Closed on Saturdays)

SUBSCRIPTION RATES
13/6 PER ANNUM, POST FREE.
6/9 SIX MONTHS, POST FREE.
AMERICAN RATE:
\$4.50 PER ANNUM, POST FREE.
\$2.25 SIX MONTHS, POST FREE.

MS.S. AND OTHER MATERIAL
FOR EDITORIAL CONSIDERATION
SHOULD BE ACCOMPANIED BY A
STAMPED ADDRESSED ENVELOPE,
AND SHOULD PREFERABLY BE
TYPEWRITTEN.

Contents June 1932

| | PAGE |
|---|------|
| NOTES OF THE MONTH | 125 |
| DERBY THRILLS BY TELEVISION | 127 |
| B.B.C. AND TELEVISION: OFFICIAL STATEMENT OF POLICY | 131 |
| TELEVISION BY ULTRA-SHORT WAVES | 132 |
| MESSAGE FROM H.E. MARCHESE MARCONI | 133 |
| MR. BELLOC LOOKS AHEAD | 133 |
| TELEVISION SOCIETY | 134 |
| POWER FOR THE TELE-RADIO RECEIVER | 135 |
| NEWS FROM ABROAD: FRANCE AND THE UNITED STATES | 138 |
| ONLY SEVEN YEARS AGO! AN EDITOR'S FORESIGHT | 140 |
| FROM MY NOTEBOOK | 142 |
| THE ENTHUSIAST SEES IT THROUGH | 144 |
| BROADCASTING HOUSE: THE TECHNICAL EQUIPMENT | 150 |
| REPORTS ON APPARATUS TESTED | 153 |

Index to Advertisements

(Where no page number is given, announcement appears in a previous issue)

| | PAGE | | PAGE |
|---|------|---|------|
| "Armchair Science" | iii | Microfuses, Ltd. | — |
| Baird Television Ltd. | 124 | Miscellaneous Announcements | 122 |
| Bapty, S. Lee | — | Mullard Wireless Service Co., Ltd. | 121 |
| Belling & Lee, Ltd. | — | Oates, W. H. | — |
| Benn Ltd., Ernest | iii | Partridge & Mee, Ltd. | 155 |
| British Institute of Engineering Technology | — | Pitman & Sons Ltd., Sir Isaac | 122 |
| Dossett Studio | iii | Psychology Foundation, S.A. | 156 |
| Dubilier Condenser Co. (1925) Ltd. | — | Salter, J. | 122 |
| "Irish Radio News" | 156 | Westinghouse Brake & Saxby Signal Co. | 155 |
| Leaman, L. | 122 | Whiteley Electrical Radio Co., Ltd. | 122 |
| London Electric Wire Co. & Smiths Ltd. | ii | | |

BAIRD TELEVISION LTD.

Take This
Opportunity
of Wishing

“TELEVISION”

EVERY SUCCESS
UNDER ITS
NEW
PROPRIETORSHIP

BAIRD TELEVISION LTD.

133 Long Acre, London
W.C.2

Temple Bar 5401

TELEVISION

The First Television Journal in the World

Publishers : BENN BROTHERS, LTD. Technical Editor : H. J. BARTON CHAPPLE, WH.SCH., B.Sc.

Offices : BOUVERIE HOUSE, FLEET STREET, LONDON, E.C.4

VOL. V. No. 52]

JUNE 1932

[IS. NET

Notes of the Month

LORD NORTHCLIFFE used to say that a newspaper should never "complain or explain." But an exception may be made on a change of proprietorship, when it is usual to say a word or two about "policy." This issue of TELEVISION appears with the imprint of Benn Brothers, Limited, who have specialised in publishing trade and technical journals since 1880. All the resources of a large organisation will now be at the disposal of TELEVISION, just at the moment when the science itself is to have the full support of the B.B.C. In place of the intermittent transmissions of recent months, television broadcasts will now be a regular feature of the programmes four evenings every week. As announced on another page, the B.B.C. are co-operating with the Baird engineers in the new service, which will be provided from Broadcasting House and is expected to begin on July 15th.

* * *

Now that this arrangement has been made, we may look back for a moment at the steps by which it was achieved. Five years ago Mr. Baird and his colleagues felt that propaganda was necessary to introduce television to the public. They therefore founded this journal, which had a remarkable reception from the outset and played a prominent part in bringing the science to the notice of the broadcasting authorities. Unfortunately, however, the case for television was not well presented in some quarters, and was considerably hindered by statements which gave an altogether exaggerated impression of the progress of the science. Gradually improvements were made, and



H.E. Marchese Marconi, whose special message to TELEVISION appears on page 133.

the Baird system reached a point where the Post Office and the B.B.C. authorities could no longer ignore its possibilities. After a period of trial, they have decided to develop television as a part of the broadcasting service, and the science will now have the energy and resources of the B.B.C. behind it. Special credit is due to Mr. Sydney Moseley for his prominent part in putting television "on the map."

* * * * *

Most of this is past history, but it has an obvious bearing on the policy of TELEVISION. Under the new publishers the journal will be, before everything else, independent. This has always been the keynote of the Benn publications, such as the *Electrician* and the *Chemical Age*, which have become the recognised authorities on science and industry in this country. The progress of television as a whole will be our aim, and every system, whatever its origin or nationality, will receive impartial treatment in these columns. Readers will notice that "News from Abroad" is the title of a new feature this month, and we propose to develop foreign news in future issues, giving special attention to the United States.

* * *

Fortunately for British science, the first and most successful system of television was invented in this country, which undoubtedly leads the world in this new activity. The Baird system is therefore engaging the major attention of television researchers, and will do so to an increasing extent under the auspices of the

B.B.C. Benn Brothers, Limited, were the first publishers to recognise the importance of the invention; as explained on another page, they printed the inventor's first article in 1925, and therefore take special pride in the success since achieved. Consistently with complete impartiality, we shall continue to give the strongest support to the British system of television that has now been adopted by the broadcasting authorities.

* * * * *

In an official statement of the B.B.C. policy, published on another page, it is suggested that television will not revolutionise the wireless programmes of the future. We disagree entirely with this view. Sight and sound have always been kindred senses, and nearly every speaker or singer expresses with his facial gestures a good deal which is otherwise lost by the audience. We admit that there would be no advantage in watching as well as listening to the news announcer or a brass band, but these items occupy only a small part of the broadcast programmes. The B.B.C. has succeeded in enlisting some of the most distinguished critics in the country as regular contributors, and in such cases television would be of enormous advantage. Those who know Mr. H. G. Wells, for example, are aware that when he talks his remarkable personality is reflected in his face quite as much as in the voice. The public which at present has only heard him, has a treat in store when television becomes a normal part of the broadcasting service. The same applies, of course, to statesmen, musicians, and singers, and not least to actors and preachers.

* * * * *

As for the new broadcasts, we shall publish regular criticisms of the programmes both from a technical and dramatic standpoint, providing an indispensable guide to all who are adopting this new form of entertainment. In order to make the criticisms as comprehensive as possible, we shall welcome the co-operation of readers, who are invited to submit their comments on the new programmes. A number of these letters will be published, and each month the correspondent who sends the best criticism will receive a year's subscription to TELEVISION free of charge. Where a prizewinner is already a subscriber, his existing subscription will be extended for a further year. The knowledge that television broadcasts are now to be transmitted regularly will enable listeners in all parts of the country to become "lookers" as well. Our articles on the construction of apparatus from the amateur's standpoint will continue to keep pace with the latest developments.

* * * * *

The event of the month was, of course, the televising of the Derby. Even the most sanguine supporters of television hardly expected such excellent results as were actually obtained, and the clerk of the weather must be thanked for providing an ideal day for the experiment, which was accomplished in the face of conditions largely outside the control of the television engineers. Although Epsom is only fourteen miles from London, the signals had to be

sent over about thirty miles of public telephone cable, at a time when all the lines were fully occupied. Not long before the race a breakdown occurred and a dozen Post Office engineers were rushed to the rescue. Another difficulty was presented by the position of the television apparatus. The best sites on the course were secured by the cinema and Press photographers, and Mr. John Thorne, who directed the broadcast, had to work under very crowded conditions. The real triumph of the Derby experiment was in proving that a transmission can now be carried out under practical conditions of the most severe kind.

* * * * *

From a technical standpoint the two-way transmission achieved in Paris last month was even more notable. It was the first of its kind on this side of the Atlantic, and was as successful as the two-way system used by Bell Telephone Laboratories Inc. in 1930. On another page our American correspondent recalls this earlier research, which was not carried beyond the experimental stage owing to the depression in the United States. The manufacturers hoped that the opportunity of seeing as well as speaking over the long-distance telephone would appeal to business men and also to newly-wed husbands absent from home! It is not hard to imagine the kind of literature issued to attract this new public for television. The Americans are the most sentimental people in the world, as those who have received their Christmas cables will be aware. We have never seen anything to beat a certain telegraph company's form which stated that Greeting No. 4 was to be recommended—"it's more sincere"!

* * * * *

Broadcasting House has been described as the world's largest "entertainment factory." Its capacity is indicated by the control room, which is capable of handling eight rehearsal programmes and six transmission programmes simultaneously without inconvenience. There are twenty-two studios, complete with separate waiting-rooms for the artists, and each is adjoined by a small announcing room, sound-proofed from the studio itself, with windows through which the announcer can see the artists at work. In the same way, each studio has a listening-room from which the performance can be watched. The arrangements for the television broadcasts are not yet complete, but it is clear that the transmissions will be conducted under ideal conditions, which will contribute a great deal to their successful development.

* * * * *

A period of progress is beginning in which television is likely to follow the remarkable progress of "sightless" broadcasting. When we remember how the talkie supplanted the silent film almost overnight, we may predict a similar development in the realm of wireless. As the first television journal in the world, TELEVISION will continue to lead the way towards this latest and most ambitious goal of modern science.

JOHN A. BENN.

Derby Thrills by Television

An Historic Transmission

“LOOK—there are the horses!” This exclamation and a burst of applause released the pent-up feelings of 2,000 people who watched the Derby from the Metropole Cinema, London. The finish of the race was shown on a large screen at the same instant as it was being watched by the enormous crowds on Epsom Downs. The experiment was the first of its kind attempted in any part of the world, and its success will make June 1st, 1932, an outstanding date in the history of television.

At 2.45 p.m. the manager of the Metropole, Mr. Sowden, addressed the audience from the stage, drawing an analogy between the development of cinema films and television, and emphasising that while it was about thirty-five years ago that Lumière first showed his flickering pictures, it was only six years ago that Mr. Baird gave his first demonstrations of real television. The image was then the size of a postage stamp, but to-day it was large and bright enough to be seen on a cinema screen about 10 ft. high by 8 ft. wide.

Anxious Engineers

After this introduction the audience was switched over to Epsom and through the loud speaker heard the announcer, Mr. John Thorne, who provided a running commentary throughout the transmission. He was able to report that the conditions at Epsom were perfect, and though rain had fallen in London during the morning none had occurred on the race-course. Nevertheless, the anxiety of the engineers as to whether the experiment would succeed was shown by the extremely cautious remarks of the announcer before the race took place. He drew attention to the fact that the television apparatus was situated in a crowded stand on which the cinema photographers had pride of place and “rather obscured the view.” He also mentioned that a breakdown in the telephone lines between Epsom and London reserved for the experiment had only been rectified a few hours before the race. Though the distance was only fourteen miles as the crow flies, the transmission had to be made over about thirty miles of telephone cable. After a rather lengthy description of the ground and the crowds, the audience began to wonder whether the television pictures would appear at all. But a few minutes before 3 p.m., when the horses came within range of the transmitter, the screen was illuminated, and it was possible to distinguish the grand-stand and a section of the course in the flickering images which flashed across the screen. Then the famous parade began,

and horse after horse was clearly seen as it passed in front of the television apparatus. It was difficult to distinguish details, and someone was heard to remark that the horses looked more like camels! Each jockey and horse appeared as a single moving object, but the general impression was excellent. At one moment three or four horses were seen on the screen together, and showed the greater range covered by this open-air transmission compared with the usual studio images.

An interval of some minutes followed, during which the announcer again described the scene, and then a great shout went up from the crowd, which was being heard faintly all the time as a background to the speaker's remarks. The race had begun! Immediately the screen was exposed again, and the audience was rewarded by seeing the winning horses flash neck to neck across the screen. A few seconds later the runners-up followed in twos and threes, these being more distinct than the winners, as they passed at a more leisurely speed. After the race it was possible to see the crowd moving on to the course, rather like a swarm of ants, and the winners were led past by their owners, though this was the least satisfactory part of the transmission.

Everyone agreed that it was a very remarkable achievement, and when Mr. Baird was persuaded to show himself on the stage afterwards, he was greeted with tremendous applause. He smiled but did not say a word; he had scored a triumph and left it at that.

Inside the Caravan

The diagram and photographs overleaf will enable the reader to visualise how the experiment was carried out. The Baird daylight television apparatus was housed in a trailer caravan opposite the grandstand at Epsom and adjacent to the winning-post. Inside could be seen a large drum with thirty mirrors arranged round its periphery. This was revolved at a speed of 750 revolutions per minute, and since each mirror was set at a slightly different angle to the preceding one, the whole scene was in effect split up into thirty strips. A succession of images thrown by a lens on to the drum was thereby made to move over three apertures, which admitted the different degrees of light and shade comprising the scene to three separate photo-electric cells.

Each of these cells in its turn converted these light and shade effects into electrical variations of equivalent intensity. In this way the scene was split up into three adjacent zones and the separate signals

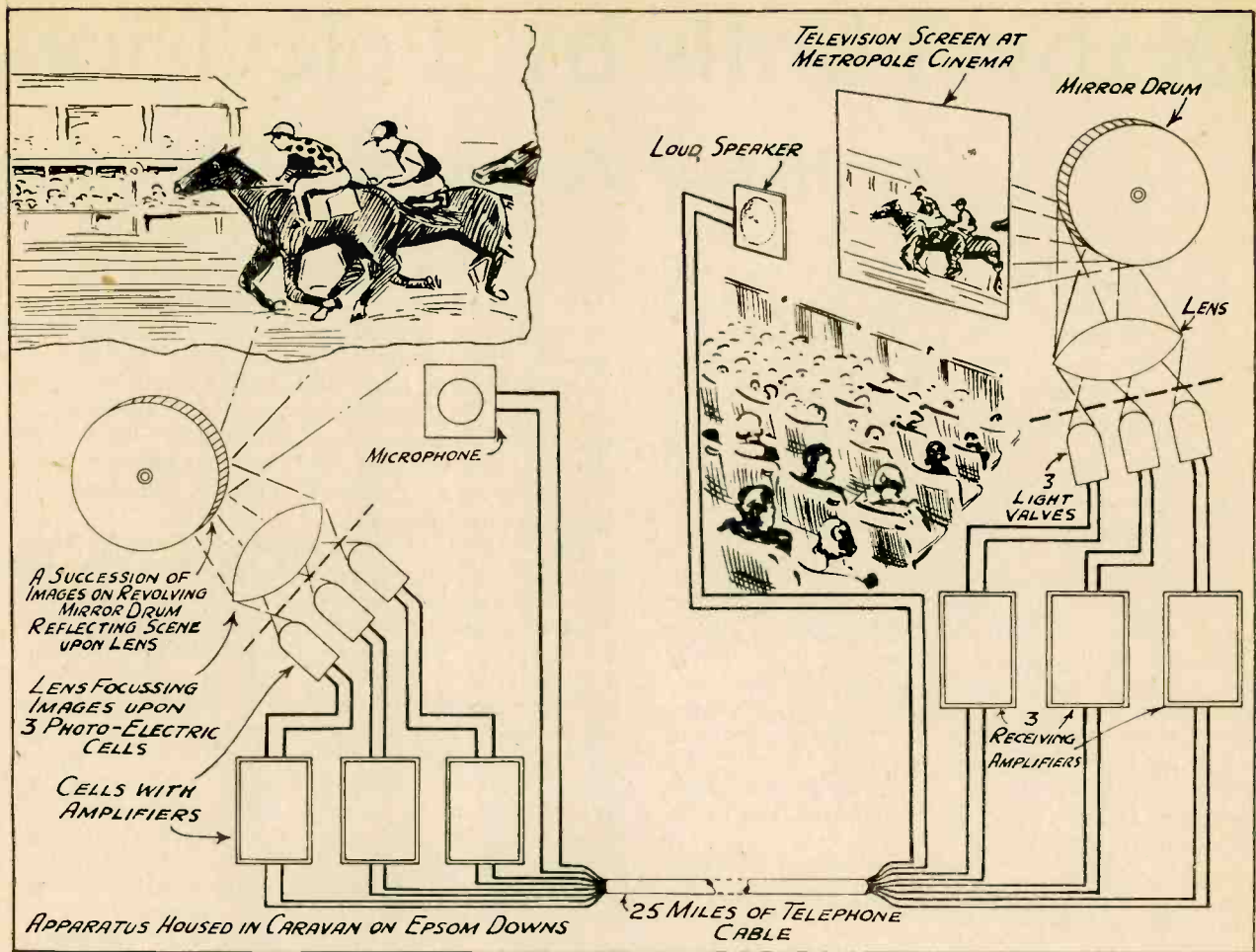

Pictorial diagram showing the general arrangement of the apparatus by which the images were transmitted from the race-course to the cinema screen in London.

passed to amplifiers, from whence they passed to telephone lines laid under the course for transmission to the Company's control room at Long Acre. From here they were relayed to the stage at the Metropole Cinema, and after being further amplified were passed to the receiver.

The receiving apparatus was most ingeniously designed, and a reference to the photograph should make this part of the scheme quite clear. Three small arc lights were set at the three points of a compass, each being responsible for one zone of the resultant picture. Three light valves (each a specially developed form of Kerr cell) modulated the beams from the arcs, and the resultant modulated light was thrown on to a single mirror drum geometrically identical to that at the transmitting end, and automatically synchronised. One of the light beams, namely the centre zone, passed direct to the drum, but the other two, since they were situated at right angles, were bent in their path by means of small mirrors. The three beams of light were then reflected from the revolving mirror drum to a large plate-glass mirror set at an angle of 45 degrees, and in this way the beams were once more turned

through an angle of 90 degrees to be projected on to the translucent screen situated on the Metropole Cinema stage.

It was necessary to include this large mirror, owing to the absence of adequate depth in the back of the stage, and in consequence the mirror drum, instead of being at right angles to the screen, revolved in a plane parallel to the screen.

It may be asked why the picture ratio of each zone was maintained at the Baird standard of 7 vertical to 3 horizontal, together with the speed of $12\frac{1}{2}$ pictures per second, with only a 30-line picture. This was done so that the centre zone of the picture could be broadcast on Derby Day by the B.B.C., and this wireless transmission was effected through the medium of the National transmitter on a wavelength of 261 metres. In this way it was possible for anyone in possession of a "Televisor" and a suitable wireless receiver to be able to watch the Derby in the comfort of their own home and, according to the many reports since received, this side of the transmission was a great success.

Reverting to the cinema, the three adjacent zones were carefully phased so that they would build them-

selves into a composite picture, and it was by this means that it was possible to make the screen so large. The simultaneous effect of sound and vision made a vivid impression and indicated the enormous progress recently made in television transmissions by wire and wireless. The experiment was repeated with the Oaks Race on June 3rd, and although the visibility was not so good as that on Derby Day, it was attended with equal success. The finish of the race was not so close, with the result that the horses were seen to better advantage as each passed the winning-post.

The opinions of the Press representatives who attended the theatre varied considerably, some being enthusiastic, others taking a very cautious view of the results. For example, the *News-Chronicle* regarded the images as "big enough and clear enough to see the points of the horse's ears, its hooves and so on," while the *Daily Telegraph* thought them "too small and too indistinct to convey much information."

In view of the historic nature of the experiment, we reprint the following reports from the leading newspapers of June 2nd, which will be particularly interesting to look back on in years to come.

The Times

The television of the finish of the Derby was witnessed yesterday afternoon by a large and enthusiastic audience at the Metropole Cinema, Victoria. The experiment was reasonably successful considering the great technical difficulties involved. The parade of horses before the race was televised, as well as the actual finish, when the bunch

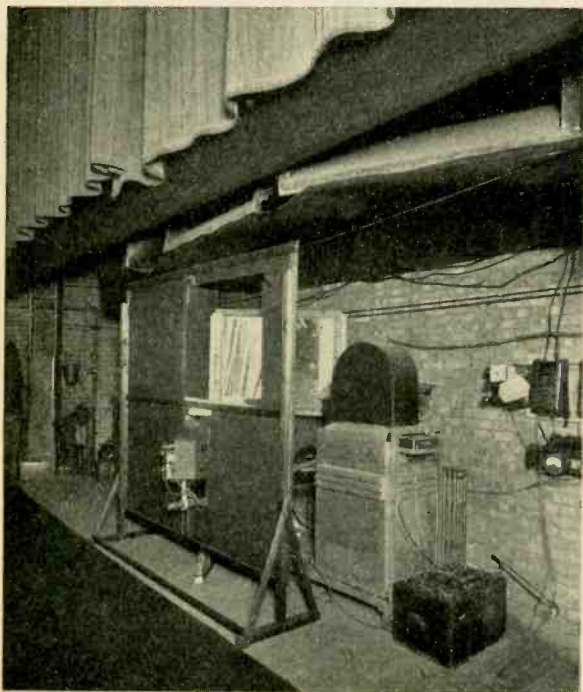

Behind the screen at the Metropole, showing the receiving apparatus on the stage. Notice the large plate-glass mirror.



Transmitting apparatus in the caravan opposite the grandstand at Epsom. The announcer described the race from the roof.

of horses which included the winner was clearly seen as it flashed past the television camera. A lively running commentary by Mr. John Thorne was also simultaneously relayed to the audience.

The Morning Post

The general level of reproduction was of a standard which a few years ago could have been achieved only under laboratory conditions.

The Daily Telegraph

Yesterday, for the first time in history, it was possible to sit in a chair in Victoria and see the running of the Derby fifteen miles away.

Film records shown the day of the race are familiar to us all; but what we saw yesterday was very different. We actually saw the race, we watched the horses flash past the judges' box at the very instant they were in motion.

Up to a point, therefore, the television demonstration arranged by the Baird Company was a success. But if the experiment is any guide, the stage has not yet been reached when television can be employed for public entertainment. The screen used was only a fraction of the size of the ordinary film screen, and the images projected on to it were too small and too indistinct to convey much information. The background might have been almost anything; and the horses were too small and blurred to be individually recognisable.

But at least people sitting miles away saw the Derby, and it needs little imagination to visualise

the new marvels and fields of entertainment that this achievement opens up.

The Daily Express

It was thrilling because one felt that it was an historic occasion, when a new page in the history of science was being revealed. It was like seeing the first automobile, or the first motion picture film, or watching the first telephone experiment. The cinema was inky black. Suddenly curtains drew back on the stage, and we saw a screen about nine feet by seven in size, brilliantly illuminated with a moving, flickering picture of the Epsom grandstand.

It was difficult at first to distinguish what was on the screen. Then gradually, as we got used to the rain-like effect, we made out the blurred figures of the horses filing past in parade.

We saw the finish: the horses flashed past us quite close to the camera. We were unable to pick them out, but the announcer from the course called their names. Then the cinema audience burst into applause.

Television in the cinema is the greatest thrill since the birth of the movies. There is a flicker about it, too, that is reminiscent of the "rain" that appeared to pour continually down those early screens.

The News-Chronicle

Probably the audience witnessed more of the race than 50 per cent. of the people on the course. . . . We sat in a London cinema. The curtains drew aside and a murmur of amazement went up from the audience. There, on a flickering screen before us, was the grandstand at Epsom with the people walking about, waving to each other and their voices and the cries of the bookmakers coming over in perfect realism. Admittedly the vision was crude and with two black lines down the centre just as if the picture were pasted up on three strips. But it was the real thing.

Then the horses moved into view. "They're coming . . . here they are," shouts the commentator, and like a flash April the Fifth whizzes by within a few yards, so it seemed, of the televisor, his thudding hooves sounding distinctly. We could not tell what had won—the numbers were too indistinct—but we had seen the Derby won.

The images were big enough and clear enough for us to see the points of the horse's ears, its hooves, and so on, but at the same time I could not tell you whether the owner or his jockey were smiling. Expressions on a man's face at that distance are a little beyond the science of television as it now is. But think of the possibilities!

The Daily Herald

It was the most thrilling demonstration of the possibilities of television yet witnessed. It made history. So distinct was the scene shown on a screen, nine feet by seven feet, that the watchers forgot the race in face of the miracle that brought it before their eyes.

Many of us can remember the thrill of those first "moving pictures." They flickered and spluttered, but out of the haze we saw men move about. Television, as we saw it yesterday, is in that stage, although the "flicker" is not so bad as those early films. We saw the horses quite distinctly as they came up the straight, April the Fifth ahead, with Dastur and Miracle close behind. We could discern the black and white figures of the crouching jockeys and distinguish them by the shapes of the colours they wore!

As we sat in that darkened theatre distance was annihilated. We were the first people in the world to see such a spectacle on a cinema screen. "Marvellous! Marvellous!" shouted men and women around me.

While the excitement still raged on the Downs we were cheering Tom Walls's success, and then we came back to earth. Mr. J. L. Baird, the inventor who made the marvel possible, stepped on the stage and received a bigger cheer than April the Fifth. He was too thrilled to say a word.

The Daily Sketch

Seated in comfort at Westminster yesterday afternoon I had a clearer view of the finish of the Derby than I have frequently had on Epsom Downs. Two thousand other people in the Metropole Cinema had the same astonishing experience. . . .

"It's a wonderful finish," the announcer was exclaiming excitedly, and then in a bunch the horses flashed by. The figure of the winning owner coming down towards the jockeys was discernible, though it was impossible, of course, to pick out individual horses. The general "scene," however, was recognisable all through.

From the Studio

In support of these two outdoor events, transmissions were effected from the studios in Long Acre to the Metropole Cinema three times a day throughout Derby week. In addition to ordinary artists, many celebrities appeared before the transmitter and addressed the audience from the screen, including Lord Amptill, Sir Richard Gregory, Sir Ambrose Fleming, Sir Ian Hamilton, Lt.-Col. Moore-Brabazon, Mr. Gordon Selfridge, Mr. H. W. Austin, and Miss Amy Johnson.

These transmissions were introduced from the stage by Mr. Sowden, and then the Baird Company's announcer appeared on the screen, speaking from Long Acre. After saying a few words, he was asked by Mr. Sowden from the stage, through the medium of a telephone line to the studio, to perform one or two simple things in order to convince any sceptics in the audience who may have felt that the television image was a projected film.

For the purpose of these transmissions both the standard disc and mirror-drum transmitters normally employed for the daily broadcasts of television were brought into service, and it is interesting to record that not a single hitch occurred during the whole week.

B.B.C. and Television

Official Statement of Policy

We print below the first official statement of the British Broadcasting Corporation's policy on television. This exclusive article has exceptional interest at the present time, as television transmissions are to be a regular feature of the programmes from Broadcasting House. Editorial comment appears on page 126.

THE attitude of the B.B.C. towards television has been the subject of a good deal of misunderstanding. The B.B.C. has to bear in mind always the priority of its normal service to listeners, the derangement or mutilation of which



Sir John Reith, Director-General of the B.B.C.

in the interests of a small minority would be unjustifiable. The listening constituency is certainly not less than 20,000,000, and probably a good deal bigger. It has been said truthfully that broadcasting has become part of the essential machinery of our civilisation. Accordingly, all the greater vigilance is necessary to maintain an uninterrupted service.

Some of the earlier advocates of television sharply criticised the B.B.C. for not including television transmissions in normal programme hours, even at the risk of withdrawing wavelengths from the ordinary service. The attitude of the B.B.C. was that this course would be wrong; that before television could be included in the programmes, even experimentally, it must be developed considerably beyond the stage of five years ago. When, however, some progress was noted in the Baird laboratories, it was decided to arrange with the Baird Company for a limited series of transmissions outside programme hours. These began about two and a half years ago. They were supplemented from time to time by feature transmissions, such as that of the Derby last year and this year.

Recently sufficient further progress was recorded to make possible an extension of facilities. Beginning at an early date, there will be a new series of half-hour transmissions on four nights a week at eleven o'clock. The present experimental series will close down for about a month, and it is expected that the regular transmissions will begin between July 15th and 20th. The programmes, hitherto provided by the Baird Company, will be taken over and adapted by the B.B.C. The Baird Company, for its part, will concentrate on research, and on perfecting the apparatus of reception. To give reasonable security to purchasers of Baird sets, the B.B.C. has agreed not to discontinue transmissions by this process sooner than March 1934.

Until experience has been gained with the new series of transmissions, it would be rash to offer definite conclusions; but it is not the opinion of those concerned that television, if and when developed to a service stage, will revolutionise programmes. For one thing, there would not be the automatic televising of every broadcast programme; even if the scarcity of wavelengths did not preclude this, it would not be appropriate, for the reason that only some programmes lend themselves to vision as well as sound. It would be undoubtedly thrilling to see the finish of the Grand National as well as to hear it, but it does not follow that it would be advantageous always to see a band performing or an announcer reading the news. As television progresses, it will be incorporated here and there, illustrating only those programmes which would be improved thereby.

There are, of course, technical difficulties in broadcasting television. One of these is the need of more elbow-room for the operating channel. Another, of course, is that two channels are required, one for vision and one for sound.

In a letter to the publishers of TELEVISION, Sir John Reith writes:

"The association of an independent publishing house with television coincides with the development of B.B.C. experimental work in the same connection. While it is impossible as yet to determine when television will become of general practical value, there is no doubt that it has already reached a stage at which it merits serious consideration. The B.B.C. wishes your journal the success which your enterprise deserves."

Television

by Ultra-short Waves

THE first public demonstration of ultra-short wave television was given in London by Mr. J. L. Baird recently. The transmission took place between the Baird Company's premises in Long Acre, where the ultra-short wave transmitting apparatus had been installed, and a wireless receiver on the roof of Selfridges.

The demonstration not only represented an important development at the transmitting end, but an advance was marked by the entirely new experimental receiver upon which the images were seen. The image was shown on a screen instead of in a lens, as in the "Televisor" at present sold to the public. The size of the image was considerably larger, thus a number of people were able to see the image simultaneously.

The accompanying photograph shows the ultra-short wave aerial itself. In the experiment a wavelength of 6.1 metres was used, and the aerial consisted of two copper rods with a meter registering aerial current in the centre, the total length of the rods being one-half of a wavelength. This was supported by a well-stayed wooden pole, mounted on the roof of a small brick hut erected on the flat roof at Long Acre.

The transmission lines from the aerial made separate connections to the copper rods in such a way that it was split into three divisions. The parallel wires then passed through insulators, and were joined to the extremities of a coil inductively coupled to the main oscillator drive. For the purpose of the demonstration, the vision signals were supplied from the standard Baird transmitters,

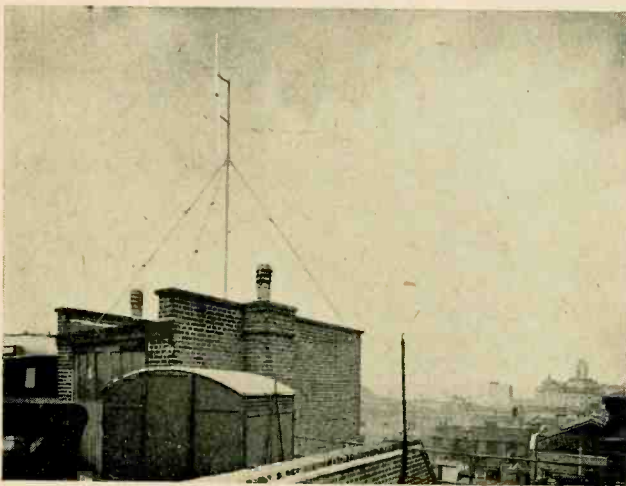

The ultra-short wave aerial erected on the roof at Long Acre.

which are in daily use for the morning transmissions sent out by the B.B.C. stations at Brookman's Park; that is to say, thirty scanning strips were used and $12\frac{1}{2}$ pictures were transmitted per second. At this juncture no attempt had been made to exploit fully the advantages offered by ultra-short wave working, namely an image of much greater detail which can be displayed with an absence of flicker.

At the receiving end a simple super-regenerative wireless receiver was connected to a short length of aerial wire. The set consisted of a back-coupled detector valve, linked to a resistance-capacity coupled low-frequency amplifier fed from the mains. The signals then passed to the vision apparatus, where they were reconstituted from electrical currents into the resultant image. This appeared on the screen as black and white instead of the more familiar glowing neon colour.

From 11.45 a.m. until 12.15 p.m., Press reporters and technical experts, including a representative of TELEVISION, were given a programme which was divided up into two separate sections. The first section was identical with the latter half of the normal television morning programme, which was being transmitted from the Brookman's Park station on a wavelength of 356 metres.

The signals from the studio at Long Acre, in addition to being passed through to the B.B.C., were handed on to the ultra-short wave transmitter, sent into space and received at Selfridges. The onlookers saw first of all a dance by Miss Eileen du Barry, the vision being fully extended. This was followed by a semi-extended image of Rupert Harvey drawing his popular cartoons, and finally there was a character song by John Rorke in "close-up."

Mr. Sydney A. Moseley then appeared in front of the transmitter, and his image was seen at the receiving end. After he had closed the morning programme in the usual way, his image remained instead of disappearing, thus showing that the signals were being transmitted by means of the ultra-short waves. For the first quarter of an hour also the sound section of the dual television programme was received through the medium of a pair of portable wireless receivers, and as soon as the sound from these ceased, direct telephonic communication was established between the transmitting and receiving ends.

The speaker conducted a short conversation from the transmitting end, his movements and the telephone used being clearly seen on the screen. The images throughout were distinct and steady; the synchronising system functioned perfectly without "image hunting."

Message from H.E. Marchese Marconi

At the moment of going to press the Editor of TELEVISION has received the following message from H.E. the Marchese Marconi, G.C.V.O., LL.D., D.Sc., expressing the greatest confidence in the future of this science, and wishing success to the journal under its new auspices.

Television is a particularly fascinating branch of the science and art of wireless, and I have every confidence that it has ^{a vast} ~~an~~ important future.

Every effort made to assist the technical progress of television and to foster public interest in the subject is a contribution towards its ultimate triumph over every difficulty, and I therefore welcome the further development of the "Television" magazine.



Mr. Baird, who addressed the onlookers, explained that the ultra-short waves—that is to say, those below a length of 10 metres—formed an alternative method of broadcasting which did not in any way interfere with the present B.B.C.'s service. Advantage had been taken of this to erect an ultra-short-wave station in order that transmissions might eventually be made at any hour of the day.

The ultra-short wave transmissions had the additional advantages that they allowed television pictures of much finer detail to be transmitted, and they provided a reliable local service absolutely free from fading and atmospheric disturbances. The present transmitter had a radius of five to ten miles, and although this was restricted at the present time, it was hoped in due course, with the collaboration of the B.B.C., to extend the system so that a wide service area would be covered.

Mr. Baird added that an interesting feature of this type of transmission was that although it was sent out on ultra-short waves it could still be received easily by those possessing "Televisors" and wireless sets of normal type designed for the present B.B.C. transmissions. To do this the only extra apparatus required was an ultra-short wave adapter, which virtually converted any ordinary receiver into a super-heterodyne. The ultra-short waves opened

up a new vista in the television field, and he anticipated that development would be very rapid.

While for some time experiments had been conducted on ultra-short wave television, that was the first public demonstration to be given anywhere in the world. The present apparatus could be adapted, not only to receive ultra-short wave television, but also the transmissions which were sent out regularly through the B.B.C.

Mr. Belloc Looks Ahead

A SATIRE on English public life in 1960, which concerns a television contract, has been published by Mr. Hilaire Belloc under the title *The Postmaster-General* (Arrowsmith, 7s. 6d.). The book opens with the P.M.G.—the Rt. Hon. Wilfrid Delescue Halterton—sitting in front of his "wireless electric heater" in a house overlooking Hyde Park, awaiting the visit of James McAuley, the financier behind the Durrant Imperial Television Company, one of the two successful firms operating television systems. The other—the Reynier Company—took its name from the late Hector Reynier, "an admitted genius who has died in great poverty."

Each is anxious to get its system adopted for the public service, and Mr. Belloc depicts a series of intrigues and political log rolling, such as are often supposed to occur in the United States, but which will not, let us hope, be at all likely in this country, even in 1960. *The Postmaster-General* is illustrated by Mr. G. K. Chesterton, whose well-known antipathy to monopoly and officialdom inspires many piquant sketches of the ministers, financiers, and political hostesses who are dealt with so severely by Mr. Belloc.

For the purposes of his story the author might have taken any new invention of public interest, but in choosing television he has evidently not studied the position of the science to-day before talking about its development. Or if he has, Mr. Belloc takes a very cautious view of its possibilities. "Television, which had long been an expectation"—he is writing of thirty years hence—"then an experiment, then a toy, had approached more and more during the past ten years to a commercial proposition. Television was already working at short ranges. It seemed just at the stage of being practicable over very long distances and having high commercial value."

A Public Monopoly

The time was ripe for the chartering of a television monopoly under public control, which, according to Mr. Belloc, entails the granting of a subsidy, "the right to enforce rates fixed by themselves, to let out private machines at their own price, and to make whatever charges they thought fit for installation: with a guarantee from the Treasury against loss!" As for the rival television companies, both had manufactured short-range private instruments for domestic use since 1953, each was well established and their shares stood at a premium. But when long-range television was a fact—"already arrived at experimentally over nearly a hundred miles and with prospects of indefinite expansion"—much larger developments were in prospect. The political and City interest centred on which of the two rivals should obtain the contract and charter.

The difficulty that stood in the way of a decision, we are told, was a technical one. There was not much to choose between the Reynier system and Durrant's, so far as the sending and receiving were concerned. The difficulty in deciding lay in who should ultimately prove possessor of a gadget called "Dow's Intensifier." Mr. Belloc enjoys himself hugely in dealing with this imaginary factor. "Dow's patent was the only Intensifier which had been found to work satisfactorily. With it you got tolerably clear reproductions. None of the other very numerous competing types had successfully solved what is, as everybody knows, the chief difficulty in the practical use of television at long range; for with the experimental and unsatisfactory Intensifiers that were in use, though the picture was then all right, it was all but invisible. Durrant's used, and talked a lot about, a certain Murray's Intensifier; but that was bluff (said people in the

know). It didn't work and it couldn't ever: it was on a false principle."

With the flimsiest basis, Mr. Belloc succeeds in giving a plausible technical atmosphere to this part of the story, which, though chiefly political, is the first work of fiction that deals with television. Jules Verne and Mr. H. G. Wells were certainly nearer the mark in their prophecies of the submarine and flying, but Mr. Belloc has made an original use of a scientific theme in this book which will offend a good many people, but will amuse an even larger number.

TELEVISION SOCIETY

AMONG the exhibits at the Royal Academy this summer is a portrait bust in bronze of Sir Ambrose Fleming, F.R.S., President of the Television Society. It is carried out in bronze and is the work of Mr. G. H. Paulin.

The recent meeting of the Society held at Univer-



Sir Ambrose Fleming, F.R.S.

sity College, London, was well attended, when Mr. R. W. Corking, F.P.S., A.M.I.R.E., read a paper on "Seven Years' Experimental Research and Investigation of Television." After tracing the work of early pioneers, the lecturer indicated the principles that have recently given much promise of success, and cited experiments that he had himself carried out. Among the various devices mentioned was a disc having a spiral of hexagonal holes to facilitate the avoidance of overlap and underlap which occur with a disc not well made with square holes.

Many members took part in the discussion which followed, and the secretary announced three visits to places of special interest during the summer, notice of which will be sent to members.

Power for the Tele-Radio Receiver

By

H. J. Barton Chapple,
Wh.Sch., B.Sc. (Hons.), A.C.G.I.,
D.I.C., A.M.I.E.E.



LAST month we discussed at fair length the question of the power unit or eliminator for supplying the high-tension and low-tension voltages to the Tele-Radio receiver. Having spoken about the use of a valve rectifier in an earlier number, I made reference to the new Westinghouse metal rectifier which has been designated the H.T.II.

The matter has been thought over very carefully, and I came to the conclusion that it would meet the needs of all experimenters if I built up and described two versions, one of which could include the metal rectifier and the second the valve rectifier. This plan has accordingly been followed, and in this issue I have pleasure in presenting details for building up the power units. Since they both give the same rated output, the reader can make his own choice, according to his preference for metal or valve rectifiers.

The First Unit

Dealing with the former, Fig. 1 shows the theoretical arrangement adopted. The A.C. mains input is fed into a special transformer (T_1 , T_2 , T_3 , and T_4) built up to my specification by Partridge & Mee, Ltd. On the primary side it is tapped for 200, 220, and 240 volts, but if your own house mains voltage is not covered by these figures, it will be necessary for you to specify the correct voltage and frequency when ordering from the makers.

A pair of 1-amp. fuses are included on this side, these being actually part of a combined twin fuseholder and mains plug made by A. F. Bulgin & Co., Ltd.

Three secondaries are included, and taking them in turn, we have T_2 , giving an output of 300 volts, 400 milliamperes, to feed the metal rectifier. This last named is connected up as a voltage doubler, one end of T_2 going to the junction of the pair of

rectifiers included in the rectifier, $M.R.$, and the other end to the junction of two 8-mfd. fixed condensers, C_2 and C_3 , which are joined in series and together placed in parallel across $M.R.$

Smoothing

This makes the familiar bridge formation, and the rectified A.C. now passes through a heavy-duty smoothing choke ($L.F.C.$), and this component, together with the 2-mfd. reservoir condenser, C_1 , results in a smoothed D.C. source of voltage being available at the terminals marked output + and output -. This will feed the anodes of the valves in the wireless set, and also supply power to the vision apparatus itself.

The next secondary winding, T_3 , is centre tapped, the tap passing to output -, while the extremities of the winding go to terminals $L.T.A.C._1$ and $L.T.A.C._2$, giving an output of 4 volts, 6 amps. to feed the filaments of six of the receiver's valves.

The last secondary, T_4 , is also centre tapped and gives an output of 6 volts, 2 amps. to the filament of the LS6A output valve. It is also centre tapped,

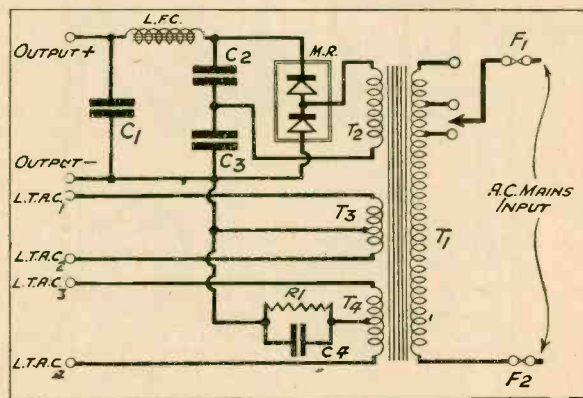

Fig. 1.—Theoretical diagram showing how the metal rectifier is connected up as a voltage doubler.

but before passing to output — has a resistance, R_1 (3,000 ohms), and a fixed condenser, C_4 (2-mfd.), interposed, and in this way automatic grid bias is given to the grid of the LS6A.

Components Required

We now come to the components necessary for building up this section of our apparatus. A complete list is given below, together with the manufacturers' names and the symbol used in the theoretical diagram of Fig. 1, to enable constructors to see exactly where the components are used.

Two 8-mfd. Type LSB fixed condensers (C_2 and C_3) (Dubilier Condenser Co. (1925), Ltd.).

One 2-mfd. Type LSC fixed condenser (C_1) (Dubilier Condenser Co. (1925), Ltd.).

One 2-mfd. Type BB fixed condenser (C_4) (Dubilier Condenser Co. (1925), Ltd.).

One heavy-duty smoothing choke, Type No. 3 (L.F.C.) (Partridge & Mee, Ltd.).

One 3,000-ohm 10-watt power resistance with holder (R_1) (Varley, Ltd.).

One special mains transformer to specification, see text (T_1 , T_2 , T_3 , and T_4) (Partridge & Mee, Ltd.).

Six insulated terminals (4 L.T.A.C., 1 output + and 1 output -) (Belling & Lee, Ltd.).

Three terminal mounts (Belling & Lee, Ltd.).

One Westinghouse metal rectifier, Type H.T.11

(M.R.) (Westinghouse Brake & Saxby Signal Co., Ltd.).

One wooden baseboard 14 in. by 13 in. by $\frac{5}{8}$ in. Sundry screws and a quantity of Lewcos Glazite wire and heavy-duty flex.

The accompanying photographs and wiring diagram of Fig. 2 indicate in a very comprehensive manner how the components are laid out and the wiring effected. I advise you first of all to run the short flex leads, keeping these as short as possible to avoid any unnecessary voltage drop. The completed unit is very heavy, but the wiring is quite simple once you have positioned and screwed down the components on the baseboard. Make all the wiring runs as straight and as neat as possible, and where a soldering iron can be handled efficiently, I strongly recommend that each junction should be soldered.

The Second Unit

Attention must now be directed to the second power unit, using in this case a Mullard DW4 valve rectifier. Data concerning this valve has been given in an earlier article of this series (see April 1932 issue). Unfortunately it has been found impossible to complete and test this power unit thoroughly in time to describe it fully in this article, owing to a late delivery of some of the components. These

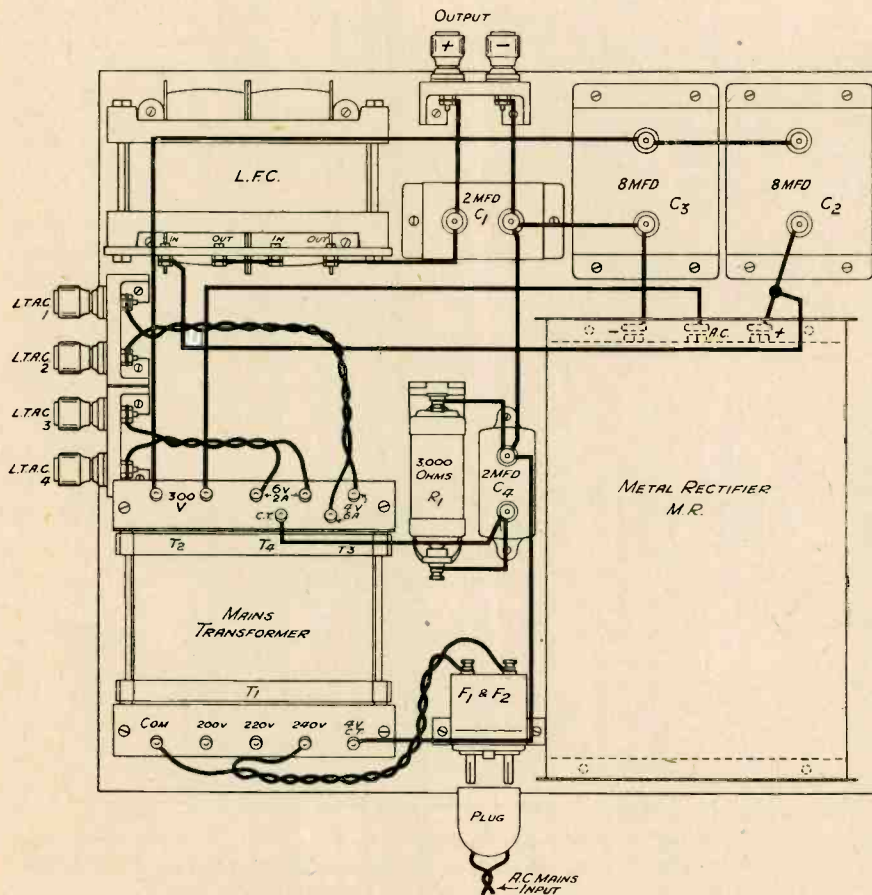
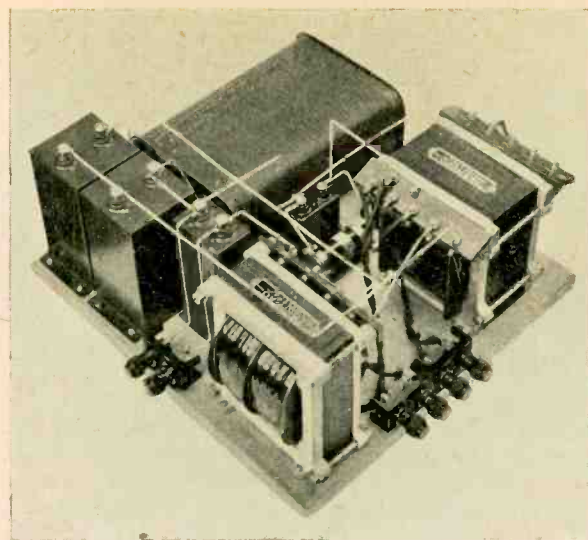
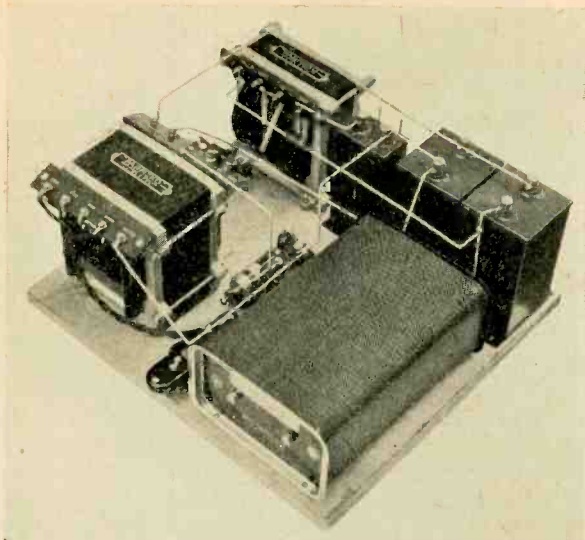

Fig. 2.—It is advisable to run the short flex leads first, keeping these as short as possible to avoid any unnecessary voltage drop.



Photographs of the power unit specially designed by the Technical Editor of TELEVISION. The compact arrangement of the parts is clearly shown, and the wiring is indicated in Fig. 2.

have all come to hand now, however, and are listed below in a manner identical to the previous design, Fig. 3 being the theoretical diagram.

Second Set of Components

Further explanation is unnecessary, so we may now give the components to be used in building up the power unit.

Two 2-mfd. Type LSC fixed condensers (C_1 and C_2) (Dubilier Condenser Co. (1925), Ltd.).

One 2-mfd. Type BB fixed condenser (C_3) (Dubilier Condenser Co. (1925), Ltd.).

One heavy-duty smoothing choke, Type No. 3 (L.F.C.) (Partridge & Mee, Ltd.).

One DW4 rectifying valve (Mullard Wireless Service Co., Ltd.).

One 3,000-ohm 10-watt power resistance with holder (R_1) (Varley, Ltd.).

One special mains transformer to specification, see text (T_1 , T_2 , T_3 , T_4 , and T_5) (Wright & Weaire, Ltd.).

One 5-pin universal valveholder (Whiteley Electrical Radio Co., Ltd.).

Six insulated terminals (4 L.T.A.C., 1 output +, 1 output -) (Belling & Lee, Ltd.).

Three terminal mounts (Belling & Lee, Ltd.).

One twin fuseholder and combined mains plug (F_1 and F_2) (A. F. Bulgin & Co., Ltd.).

One wooden baseboard 12 in. by 10 in. by $\frac{5}{8}$ in.

Sundry screws and a quantity of Lewcos Glazite wire and heavy-duty flex.

The potential constructor can collect together all the components so as to be ready to complete the construction which will be described in the July issue of TELEVISION.

[Owing to pressure on our space Mr. William J. Richardson's further article on the "Visionette" is unavoidably held over until next month.]

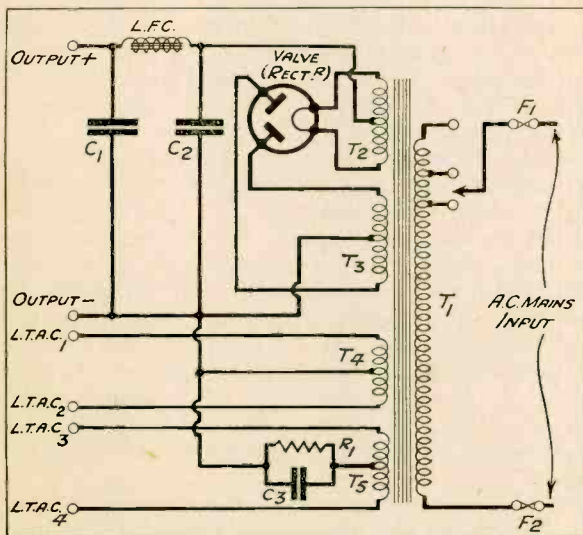

Fig. 3.—Theoretical lay-out of the second power unit, using a valve rectifier.

SUCCESS TO "TELEVISION"

Captain S. R. Mullard, M.B.E., M.I.E.E., Chairman of the Mullard Wireless Service Co., Ltd., has sent the following message to the Editor:—

"The technical advances which have been made in the art of television during recent years will undoubtedly proceed without interruption and with increased speed. Ample scope is thus assured for your interesting magazine. I wish TELEVISION every success under its new administration."

Mr. E. M. Lee, B.Sc., of Belling & Lee, Ltd., writes as follows:—

"We wish TELEVISION every possible success in this new phase of its existence."

Similar messages of appreciation have been received from Mr. John Salter and from Mr. J. G. Wright, of Wright & Weaire, Ltd.

News from Abroad

From Our Own Correspondents

FRANCE

THE first combined two-way vision and sound system that has been shown in Europe was inaugurated in Paris on May 19th. Under the direction of Messrs. Lyon et Stoyanowsky, representatives of the Baird Company in France, an official demonstration of this system was held between the offices of the French newspaper *Le Matin* and a studio at the Galeries Lafayette.

M. Louis Rollin, Minister of Commerce and P.T.T., accepted an invitation to be present, and the Technical Editor of TELEVISION flew over to Paris on the morning of the 19th, in order to take part in this historic experiment. After a short address, M. Rollin entered the booth at *Le Matin* and talked to the Galeries Lafayette, being able to see the person to whom he was speaking. Numerous distinguished people, technical experts, and representatives of the French and foreign Press succeeded the Minister, and all testified to the excellence of the image and the general scheme adopted.

The image was projected on to a small screen 10 in. high by 5 in. wide, on which the head and shoulders of the speaker were clearly shown. It is interesting to note that at this transmission, Noctovision was for the first time applied to two-way television. There was no question of a flickering light playing on the sitter's face, and it is largely due to this innovation that the new system was rendered practicable. For conversation an ordinary telephone was used.

Commenting on the occasion, the Paris correspondent of *The Times* paid an independent tribute to the success of the transmission. "Although the

image was fairly coarse," he said, "the features of the sitter were clearly recognisable, while the movements of the lips could easily be followed. The whole play of expression on the face of the speaker at the other end was remarkably clear, and when he obeyed a request to put out his tongue the organ in question duly popped out from the face on the screen. It required a considerable effort to remember that one's own face was appearing on the screen at the other end, since the screening light from the transmitter had been deprived of all but the infra-red rays, which are invisible to the human eye."

Remarking that one-way television transmission with sound is, of course, already in operation over the B.B.C. system to-day, *The Times* added that "ultimately two-way transmission, subject to the limitations governing ordinary wireless telephony, will become commercially possible."

A full account of the apparatus used in Paris for this notable demonstration will be given in TELEVISION next month.

UNITED STATES

An important announcement is expected shortly regarding a new system of television that is being studied by American engineers. Actually the method was invented in France, and has been taken up by an important financial group here that is interested in radio and television projects. The experiments are at present confidential, but from advance information we understand that the results are likely to revolutionise television technique.

Meanwhile television engineers in the United States were greatly interested in the reports of the demonstration of two-way television in Paris, because it is hoped to develop two-way television on a commercial scale here.

Some of the English newspapers referred to the experiment as the first of its kind, but that is not the case. Over two years ago, in April 1930, Bell Telephone Laboratories Inc. demonstrated two-way television between their premises in West Street and the American Telephone and Telegraph Co. building at 195 Broadway, two miles away. At each end were two discs, one 21 in. in diameter to direct the scanning beam, and the other, below, 30 in. in diameter, revolving before a neon lamp. Three banks of photo-electric cells, twelve in all, were arranged at each side of and above the "sitter's" face.

The apparatus was arranged so that the "sitter" was in a booth like a telephone kiosk. In front of him he saw a disc of blue, which was the filtered scanning beam, and below, appearing about 12 in.

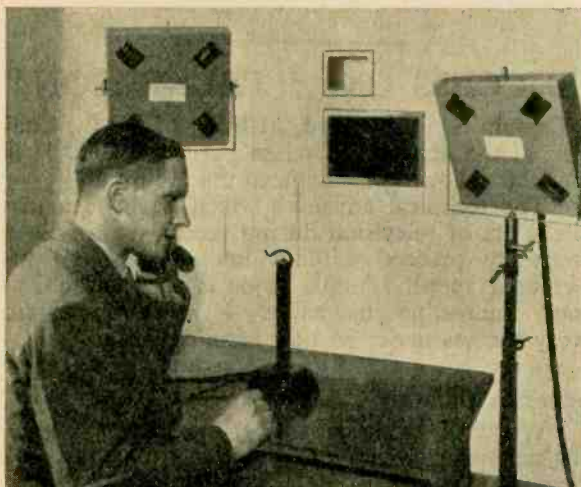

The image of the person at the other end of the telephone line appeared in the centre aperture. On either side of the speaker are banks of photo-electric cells.

square, was the detailed image of the face of the "sitter" two miles away. Speech was picked up by a hidden microphone. Landlines were used; the transmission band for the television encompassed a range of from 10 cycles to 40,000 cycles a second. An alternating current of an effective value of a ten-thousand-billionth ampere (American billion = 1,000,000,000) given by the photo-electric cells was amplified to the one-tenth ampere necessary for the neon lamp. The discs were maintained in synchronism at 18 revolutions a second by a vacuum-tube oscillator delivering a frequency of 1,275 cycles a second. Mechanically damping couplings were used between the discs and the motor shafts to steady the image, and an electrical phase shifter was used to frame the image.

For "Newly-weds"

When the writer saw this apparatus in operation, Dr. Herbert E. Ives, Bell Laboratories' director of television research, and Dr. Frank Gray, one of his chief assistants, emphasised that this was merely experimental apparatus. But arrangements were made later to fit it up between two cities, such as New York and Cleveland, to determine whether there was any demand from business leaders (or newly-wed husbands on business trips!) for the luxury of seeing as well as talking by long-distance telephone. It was thought that two-way television

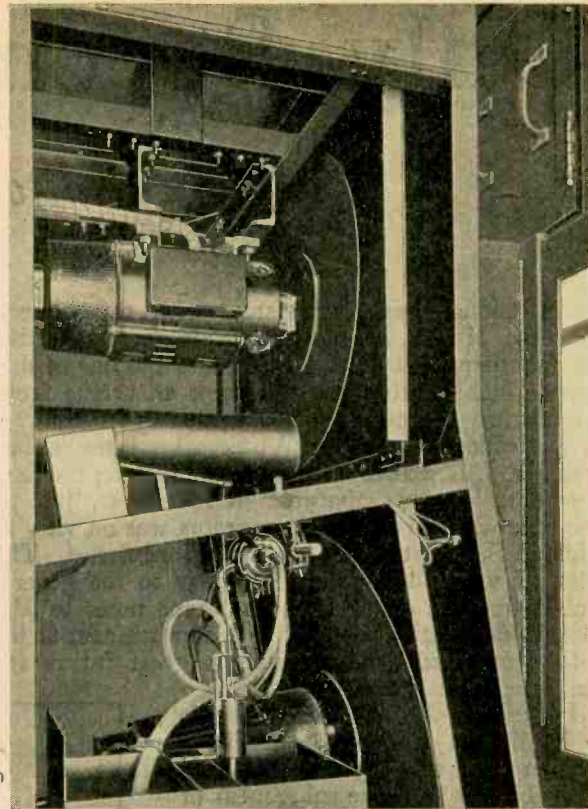

A view of the transmission apparatus employed by the American Telephone & Telegraph Co. for two-way experiments.



In this kiosk used at the Bell Laboratories, the photo-electric cells can be seen behind the glass plates surrounding the sitter.

might even be useful for urgent demonstrations of goods to be sold or articles to be manufactured; but the trade depression has lasted, and the thorough testing of the commercial possibilities of two-way television in the United States must await the return of prosperity.

While most television research in the United States is being carried out with discs—perforated discs, lens discs, mirror discs—much work is now being done with cathode rays. An ultra-short-wave station, using cathode rays both for scanning and receiving, has been opened in Los Angeles. Images 10 in. square are obtained. Frames of 80 lines are scanned 15 times a second. Instead of a cathode-ray receiver, a disc revolving 15 times a second, with 80 holes, may be used. The frequency of the station, which is called W6XAO, is 44,500 kilocycles.

Amateurs in several cities report receiving disc-scanned television broadcasts on home-made cathode-ray receivers. Amateur interest in television is growing steadily in the United States. There are now several stations broadcasting television, and some daily newspapers are including television items as part of their ordinary radio programmes. "Bigger and Better" is still the slogan in America. Mr. U. A. Sanabria, a young Chicago man who first became prominent about five years ago with a cathode-ray system, now promises a television screen that will give an image 24 ft. square, using disc scanning. Further news of this development is awaited with interest.

Only Seven Years Ago!

An Editor's Foresight

IN taking over TELEVISION with the present issue, Messrs. Benn Brothers are not new to this fascinating subject. Seven years ago one of our editors had the foresight to accept an article from an obscure inventor for publication in *Discovery*. It was called "Seeing by Wireless," and the author was Mr. J. L. Baird. This was, we believe, the first signed article that appeared in the Press, just at the time when his original apparatus was on view at Messrs. Selfridges' premises in Oxford Street. The idea of television was then so new to the general public that the editor appended some notes to Mr. Baird's description, expressing his amazement at the results achieved and predicting a great future for the invention.

In reading this early article to-day, it is difficult to realise that it was written only seven years ago, so remarkable has been the subsequent progress. Readers will be interested to compare the diagram and photograph here reproduced from *Discovery* for April 1925 with those of the "Tele-Radio" receiver and other apparatus described in this issue of TELEVISION. With the author's permission we reprint the following paragraphs exactly as they appeared at the time, together with the editorial comments which provided the first link of the House of Benn with this new science. The encouragement extended to the inventor of the first successful system of television was consistent with our policy during half a century of publishing enterprise and experience, which will now be at the service of TELEVISION and its readers throughout the world.

"The subject of television," Mr. Baird wrote (April 1925), "is often confused with the sending of photographs by wire or by wireless. This is perhaps a readily understood confusion. Television, however, is quite distinct from photo-telegraphy. It is the instantaneous transmission of the living and moving object so that the person at the receiver may actually see and watch the movements of the person at the transmitter or, if the transmitter is directed at a scene, such as a racecourse, the spectators at the

receiver may actually see the race at the moment it is occurring.

"Very many attempts have been made to solve the problem of television, one of the first devices, the 'Telectroscope' of Senlac dating as far back as 1872; yet, while telephony and telegraphy have made vast strides since those days, television for many years remained, as far as practical results were concerned, at a complete standstill. Nevertheless, a great number of schemes were put forward as attempts to solve the problem.

"The theory is simple. The image of the object to be transmitted is broken up into a great number of little areas, each area having its own value of

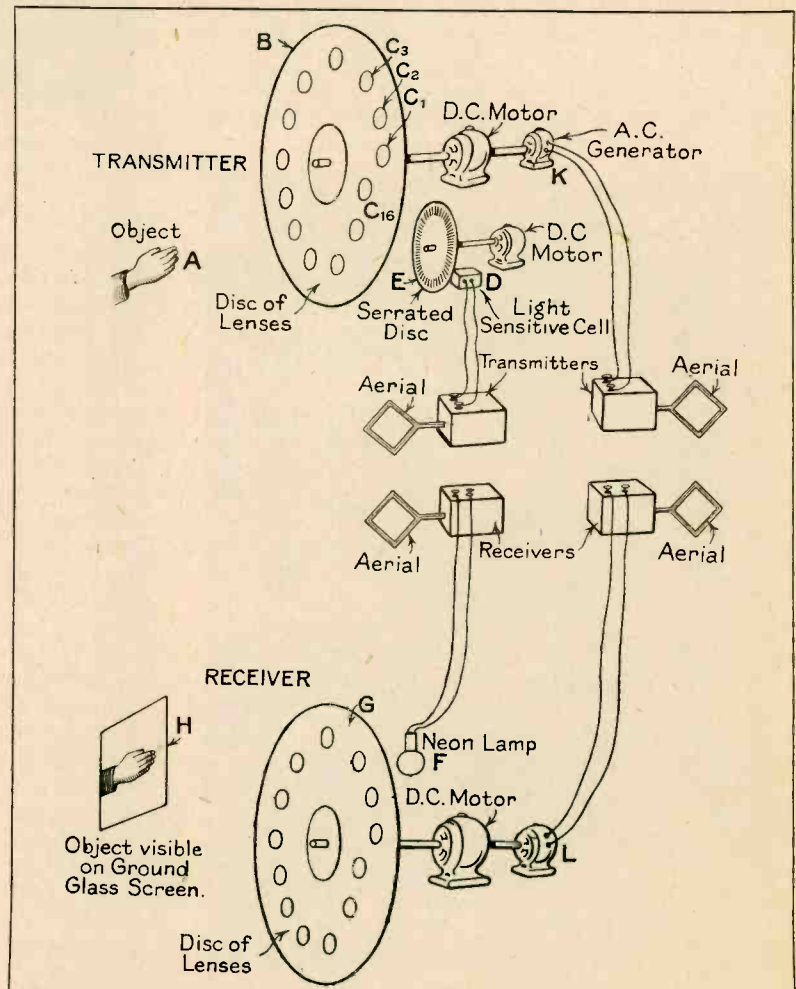

Diagram of the original apparatus employed in the Baird system, reproduced from "Discovery," April 1925.

light or shade, and signals are sent along the line corresponding to the light intensity and position of each area, so that a similar mosaic is built up at the receiver, the complete operation being performed many times per second so that a cinematograph effect is produced. Although, however, the theory is simple, the practice is exceedingly difficult owing to the immense speed of signalling involved.

"In my system the object to be transmitted (*A*) is focused by each of the lenses, *C*1, etc., in the disc *B* on to the light-sensitive cell *D*. The lenses are arranged in a spiral or in a staggered formation and, as the disc revolves, each lens causes a single strip of the image to traverse the cell. Before reaching the cell the light is interrupted at high frequency by the serrated disc *E*. This interrupted light causes a pulsating current to flow through the cell circuit, and this current is transmitted to the receiving station, where it lights the lamp *F* behind the disc *G* which is similar to the transmitting disc *B*. As these discs revolve in synchronism the varying light from *F* traverses the screen *H* and reproduces the image.

"Isochronism is obtained by coupling an alternating current generator *K* to the transmitter and sending an A.C. current from there to the receiver where, after amplification, it controls the speed of the alternating-current synchronous motor *L*. Synchronism is simply and effectively obtained by rotating the driving mechanism about the spindle of the receiving machine until the image comes correctly into view.

"The present models, which are purely experimental, are capable of transmitting only coarse images. Simple objects, such as letters of the alphabet, are perfectly clear. The hand appears only as a blurred outline, the human face only as a white oval with dark patches for the eyes and mouth. The mouth, however, can be clearly discerned opening and closing, and it is possible to detect a wink.

"Many prophecies and promises have been made with regard to this subject. I shall add no more to their number, but certainly it can be said that we are now actually 'seeing by wireless'—very crude and very imperfect vision, but a man even with acute myopia and astigmatism is not called blind."

Here follow the notes by the editor of *Discovery*, who attended a demonstration of Mr. Baird's apparatus and was very favourably impressed.

"The machinery," he commented, "is astonishingly crude, and the apparatus in general is built out of derelict odds and ends. The optical system is composed of lenses out of bicycle lamps. The framework is an unimpressive erection of old sugar

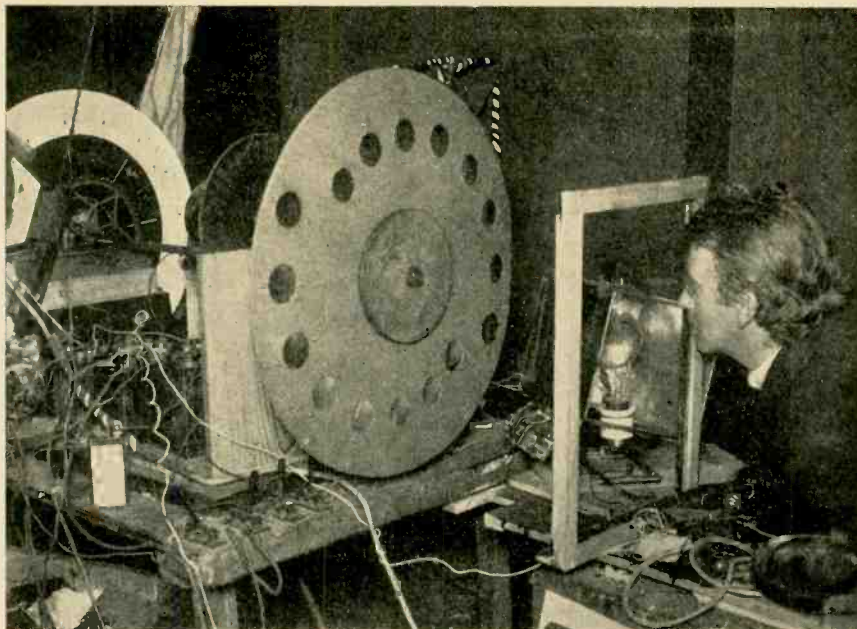

The transmitter of the first television apparatus, which was described as an "unimpressive erection of old sugar boxes"!

boxes, and the electrical wiring a nightmare cobweb of improvisations. The outstanding miracle is that he has been able to produce any result at all with the very indifferent material at his disposal.

"The invention has now reached a stage when it should be properly developed and an adequate instrument built. In its present form it reminds one of some of the earliest rudimentary attempts to produce a cinematograph. These were then looked on as scientific novelties of no practical value, but have since developed into an enormous industry. Mr. Baird is anxious to secure adequate financial backing for the development of the invention, and it is possible that the importance of the invention may appeal to some big industrial concern interested in its possibilities.

"Whether this particular invention or some other inventor's system will eventually develop into a commercial success is, however, not the main point. The outstanding fact remains that rudimentary transmission of visual images by wireless is now possible and that it is only a question of time, refinement, and improvement before we reach the point where reception screens will be normally attached to wireless receiving apparatus.

"In the not too distant future we may expect not the rather wearying 'travel talk' from a broadcasting station, but direct wireless speech and vision transmitted from the ends of the earth and relayed to our firesides. We shall see on our screens the reproduction of distant events and hear them explained as they take place.

"It is a devastating outlook, for eventually it will probably be applied to the ordinary telephone service and prevarication will be even more difficult than it is to-day. On the other hand, when it arrives, we shall find so many conveniences in it that we shall wonder how we ever got on without it in the past."

From My Notebook

By *H. J. Barton Chapple*,
Wh.Sch., B.Sc.(Hons.), A.C.G.I.,
D.I.C., A.M.I.E.E.



Microphonic Noises in Mains Sets

WHEN receivers operated entirely from the A.C. electric-light mains were first introduced, they generally followed closely the design of the ordinary battery-operated set; that is to say, they were cabinet instruments of moderate power, intended to work in conjunction with separate speakers.

To-day, however, mains sets are usually self-contained, being fitted with built-in speakers, often of the moving-coil type, and driven by large output valves. The vibrations produced by loud speakers are very powerful, and some of them may be transmitted through the chassis of the receiver or through the air to the valves, with the result that the electrodes of the valves, and particularly the grid and cathode, may in turn be set vibrating.

Vibration of the electrodes has the effect of setting up rhythmic variations in the characteristics of the valve, causing it to become hyper-sensitive to some particular frequency. Signals at that frequency will therefore be abnormally amplified and re-amplified, and will be made manifest as a musical note which grows in volume as this "microphonic" energy is built up. This effect, of course, is not due in any inherent fault in valve design, but is the outcome of changed conditions of service.

In this connection I see that the Mullard Company are making a special feature of a new form of construction they have adopted in order to obviate the risk of this microphony in their new range of indirectly heated A.C. mains valves. This is to be known as the "rigid-unit construction." The heater-cathode system has been redesigned, the clearance between the electrodes has been increased, and the mechanical assembly is made much stiffer.

"Dry" Rectifiers for the Grid

The value of the dry rectifier has been mentioned on several occasions in these columns, and, in addition, wireless receivers and amplifiers have been built up and described in which this unit has been incorporated. We are apt to lose sight of the fact, however, that these rectifiers have many other appli-

cations than in radio, and I was therefore interested to see that the Westinghouse Company are to supply the Central Electricity Board with rectifier sets for trickle-charging tripping batteries for the 132-kV sub-stations.

These sets include a double-wound transformer of a special design, by means of which the trickle-charge rate may be adjusted within very fine limits. A "bridge"-connected metal rectifier giving full-wave rectification is fitted inside the framework, which carries a steel panel with meters, fuses, and switches, the whole being arranged for wall mounting. Two sizes, viz. .75 and 1.5 amps., are used, depending on the capacity of the sub-station, the operating battery being 110 volts. This battery supplies the power for operating the closing mechanism for the 132-kV switchgear, in addition to various indicating and interlocking circuits.

Many of the sub-stations are unattended, being remotely controlled.

An Improved S.G. Valve

We are always on the look-out for new valves or improved models of old favourites, and I was therefore pleased to hear that there is in production, for early release, a new highly efficient "P.M." battery-operated screened-grid valve, which will be known as Type PM12A for use with a 2-volt low-tension supply.

Full details are not yet available, but I understand that the amplification factor is in the neighbourhood of 500, with a "slope" of 1.5 milliamperes per volt.

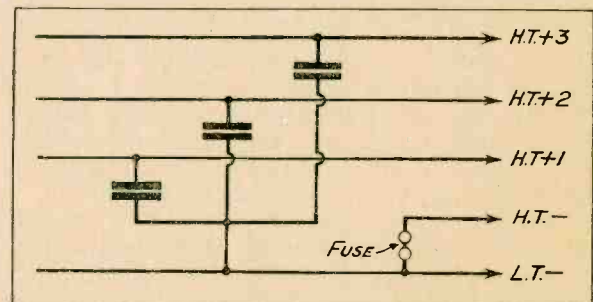

See "Curing a Fuse Fault."

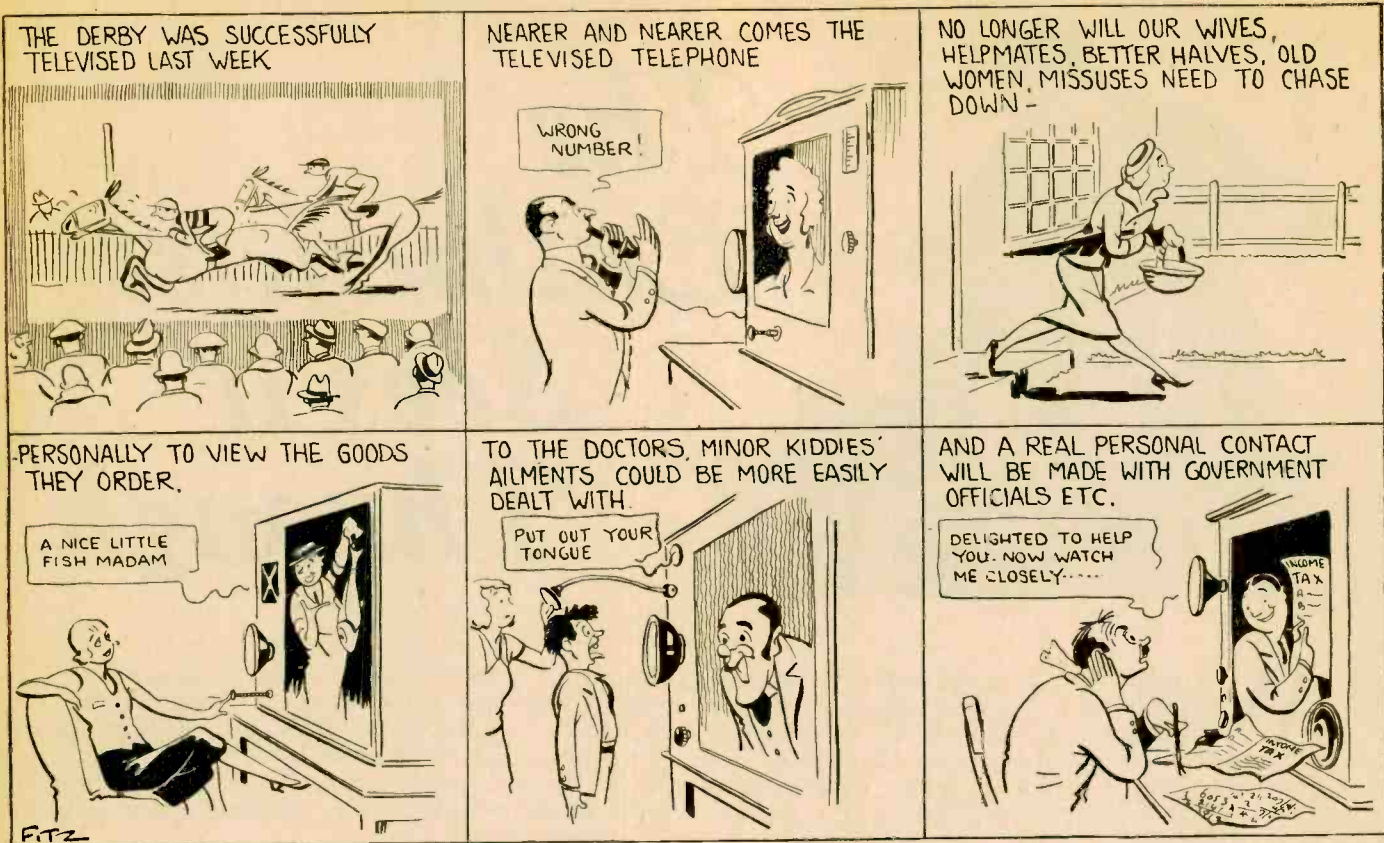

By Courtesy of "The Daily Mirror."

How television appears to a popular cartoonist, who asks, "Will it be a help or a hindrance to life?"

It is stated that the valve has been designed to give a high stage gain at an anode voltage of 100 and a screen voltage of 70, and under circuit conditions such as obtain in present-day portable receivers.

While these characteristics, combined with very economical low-tension and high-tension current consumption, render the PM12A an extremely good high-frequency amplifier for use in portable sets, careful attention has also been given to the performance of the valve in the somewhat different conditions existing in non-portable sets. In this connection it is claimed that the valve opens up entirely new possibilities in highly sensitive high-frequency amplification, the valve being perfectly stable in operation when used with the most efficient types of high-impedance coupling.

Curing a Fuse Fault

A short time ago I was carrying out some routine tests on a powerful multi-valve wireless receiver fed from H.T. batteries and an accumulator. When all the connections were made and the set switched on via the appropriate control, no signals could be heard. It was confirmed that the valve filaments were operative, but the set still appeared quite "dead," so a few quick tests were made with a voltmeter.

It was soon found that an H.T. fuse—in this case a low-consumption bulb filament, rated at 60

milliamperes—located between the H.T.— and L.T.— terminal connections, was burnt out. A replacement was effected immediately, and the set once more switched on. Still nothing happened, and on re-examining the fuse it was noticed that the bulb filament had burnt out again.

Attention was therefore turned to the set itself, and although everything appeared in perfect order, it was noticed that the 2-mfd. fixed condensers were shunted between each H.T.+ tapping and L.T.— as indicated in the accompanying diagram. If it happened that any of these condensers had developed a short circuit, this would obviously cause a short circuit between the H.T.+ tapping and H.T.—, since H.T.— was joined to L.T.— through the fuse and in consequence this lamp was in circuit.

The abnormal current under these conditions would naturally be sufficient to blow the fuse lamp filament, and in consequence each condenser was tested separately but found to be in perfect condition. Another solution had to be forthcoming, and since it is known that when a large-capacity fixed condenser is charged initially there is a momentary heavy current rush, it was felt that this in itself may have been sufficient to cause the burn-out.

To safeguard the fuse from this, therefore, the common ends of the existing 2-mfd. condensers were joined to H.T.— instead of to L.T.—. The fuse was in this way removed from the "charging current" circuit, and on switching on the receiver again all went well.

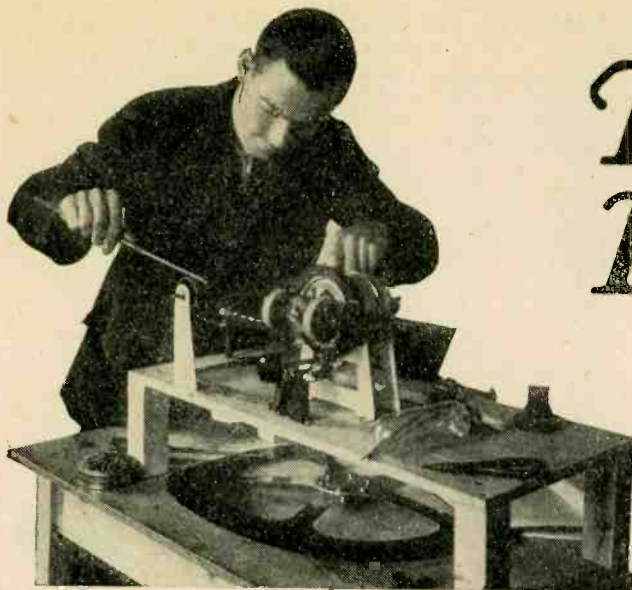

The Enthusiast Sees it Through

WE have been delighted with the response already made to our invitation to readers to supply details of their own experimental work in connection with television. During the last few weeks we have received letters from readers who have taken in TELEVISION since No. 1, and yet their modesty has prevented them from writing to us until now.

Rapid Strides

With the unbounded enthusiasm of youth on his side, Mr. D. Parsons, of "Cartref," Shenstone Court Drive, near Lichfield, has made rapid strides in his television experiments. Once again we meet a reader since No. 1, and, although only a student, he would appear to have graduated with full honours in the television sphere. He has written a very long and detailed report of his work, and points out how he has been able to achieve really good results at a cost well within the pocket of everyone. We congratulate our correspondent on his work, and feel sure that he will always look back on these pioneering days with great pride. In the course of his letter, he writes:

"Although I have been a reader for four years, it was not until last September that I decided to make a television receiver. I should like to say that it was entirely due to the reports which other amateurs had sent to your paper that I started. The sets most of your readers used were by no means high-quality receivers, and I thought that if they could do it, I could! And so it all began. Fortunately I am a student at the Technical College at Birmingham, taking a three-year course in electrical engineering, and I am now on my last year and do not have to go in the mornings, so I can tune-in the morning transmissions regularly.

"In September last, I had a set which I knew was

not perfect by any means. For one thing, the transformer only cost 10s. 6d., and I expect it has a frequency response curve like a parabola with all the main output round about 1,000 cycles! Fig. 1 shows the set, from which you will notice that it is the common or garden I-v-I set used by thousands of listeners to-day.

"I want to stress this point—and that is why I have shown the circuit diagram—because I know that it is the most popular circuit on the market to-day. If any reader has one of the sets, well place a 'Televisor' on the output side!

"It will be seen that band-pass tuning is not employed, the tapping in each stage making the coils auto-transformers. The MS4, working with 200 volts on its plate, is coupled to the detector stage by the tuned-grid method, which I used because tuned anode and transformer coupling involves complicated switching from one frequency range to another. Power-grid detection is preferred with the customary grid leak and condenser of the usual values.

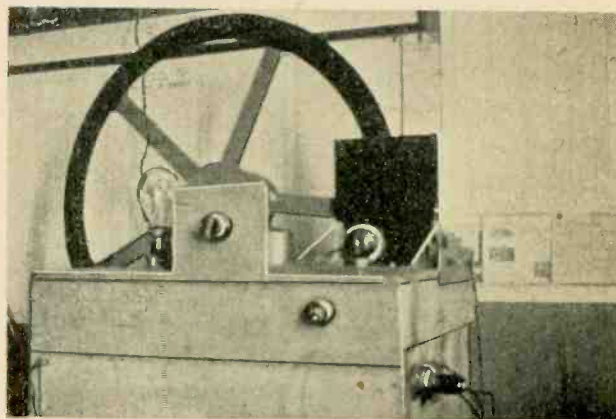

General view of the apparatus constructed by Mr. Parsons, who describes his experiences in the accompanying letter.

"As the AC/HL takes 10 milliamperes at 150 volts, the mains voltage being 250 volts after smoothing, 100 volts has to be dropped across the anode resistance, which gives the value 10,000 ohms. Due to this fact, decoupling cannot be carried out in the detector stage, but there is no tendency towards 'motor-boating,' and hum is not in evidence. A differential reaction condenser is used to keep the by-pass capacity between plate and earth constant, but for the reception of the London Regional Station it is not used.

"Due to the 10 milliamperes passed by the detector valve direct transformer coupling cannot be used, as the inductance of the primary would fall enormously, saturation occur, and probably burn out the winding. Hence an auto-transformer coupling is used, the blocking condenser being 1 mfd. This value resonating with the inductance of the primary ensures a rise in bass notes.

"The AC/PI passes 16 milliamperes at 200 volts, the 32 volts grid bias, being obtained by the volts dropped across the 2,000-ohm bias resistance. Choke coupling is used in the output stage, together with a step-down transformer to match the impedance of the moving coil.

"So much for the receiver. Now, how was I to alter it for television signals? Well, I should have

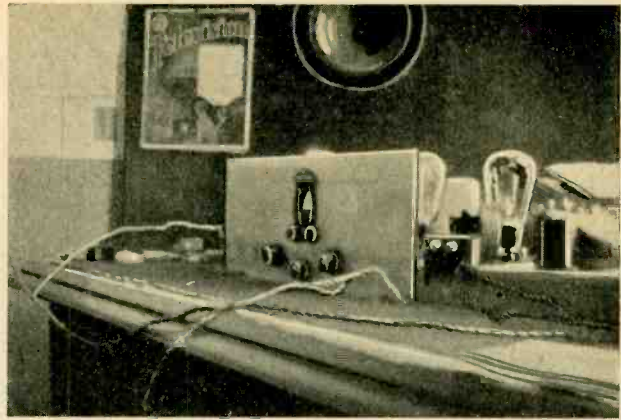

Another aspect of our correspondent's set, showing the vision apparatus.

were made by a sewing needle .033 diameter, and squared with a rat-tail file.

"A neon was purchased for 3s. 1d., and placed in the anode circuit of the valve. The next item was the motor, which hit me badly until I saw a man advertising old vacuum-cleaner motors at 10s. each for 50-volt A.C. mains.

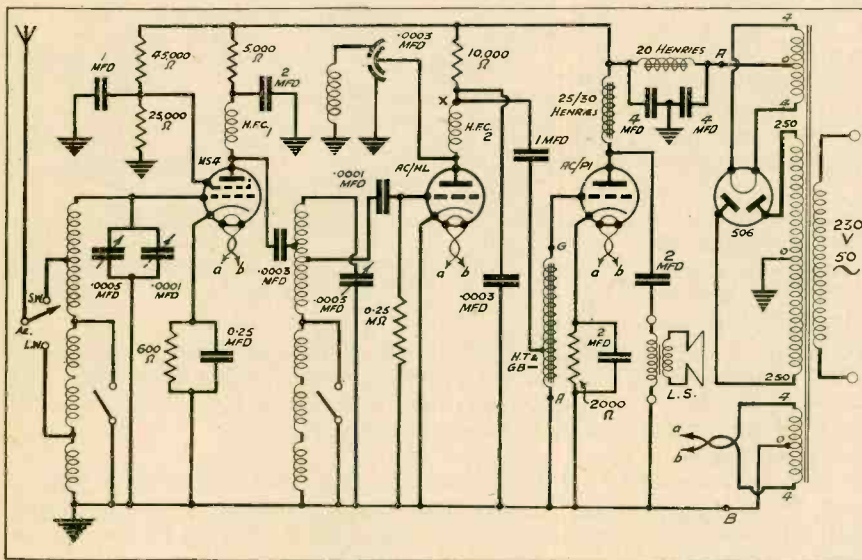

Fig. 1.—Complete circuit diagram of the wireless receiver used for vision signals. Note the simplicity of the circuit.

liked to have put an AF5 in place of the transformer used, but my student's pocket did not seem able to stand such an item, and so I left it as it was, and waited to see what I could get.

"First of all the disc. I obtained a piece of 28-gauge aluminium 24 in. by 24 in. for 2s., and started to make the disc. I decided to have the picture exactly 7 in. by 3 in., so making the width 1 in., this gave me the larger side of image 2.33 in. 2.33 in. by 30 in. = 66.6 in. in circumference. Diameter = $\frac{66.6}{\pi} = 21.2$ in., say 22.5 in. Thus the radius of the outer hole was 11.25 in. Allowing $\frac{1}{4}$ in. extra at the end of the last hole, this gave me a 23-in. disc. The holes

"This was just the thing! I bought one, and soon saw my images for the first time. Total cost, 15s.! This was January 1st this year. At first I got two images side by side, and of course I was running at 375 r.p.m. instead of the required 750. So I bought another neon, and the Meccano wheel which was used to fasten disc to shaft of motor and had 8 holes in it. Since the neon lamp on 50 volts goes out 100 times a second, this was an ideal stroboscope disc ($\frac{100}{8} = 12.5$ revs./sec. = 750 r.p.m.). And so I got fairly good images on January 4th, although at the end of the half-hour the motor was so hot, armature and laminations, that

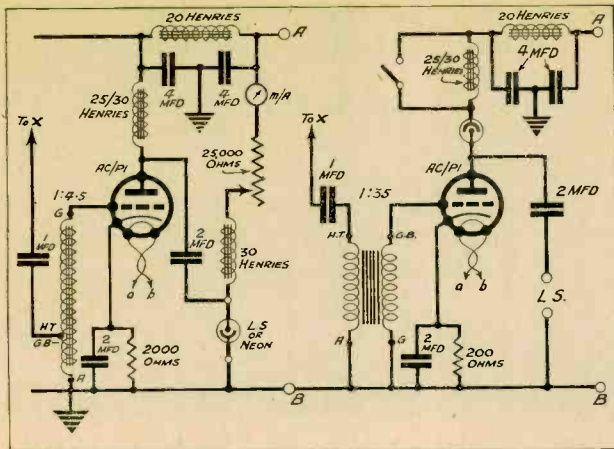

Fig. 2.—Diagram showing the connections for positive signal with set for (A) choke-fed neon, (B) series connected.

I could not put my hand on it! This was obviously hopeless, so just before Easter I purchased a $\frac{1}{10}$ -h.p. G.E.C. motor, which runs beautifully.

"The final piece of vision apparatus will be seen in one of the photographs on its own, and another photograph shows the complete equipment in my bedroom. It is mounted on a soap-box cut with a slit as shown in Fig. 3, the lay-out being quite neat and convenient for operating. The neon for synchronising will be seen clearly in front of the disc, as well as the series resistance for regulating the current passing through the neon when series fed, and another small resistance in front of image which is a vernier resistance. The latter works in series with a large resistance to obtain the required speed.

"This large series resistance is interesting. It consists of two pieces of wood with nichrome resistance wire wound on each and a crocodile clip to tap off at various points. Two clips are used on adjacent turns, as seen in the photographs, to save the motor stopping if an adjustment has to be made. The small series resistance is of such a value that its resistance is equal to two turns on the piece resistance. With this control I can keep the image quite steady, except when the mains fluctuate.

"Living in the country as I do, the amount of copper in our transmission lines is, I am afraid, rather small, and if my mother puts the cooker on between 11.30 a.m. and noon you can see our lights go dim, so you can imagine that I have got over the difficulty by making her shut off the cooker or keep it on all the time. This certainly gets over the difficulty, but being a three-phase balanced load the lady three doors away does affect our mains a bit when she cooks her dinner and I cannot control her affairs!

"However, for quite a long time I can keep the image constant, and the results are really very satisfactory. Incidentally, at night I can keep the motor speed very constant, and so when the evening transmissions begin from Broadcasting House it will be fine for me, although I understand that vision will be given from the 261-metre station, which does not give us satisfactory results here as the

indirect ray is in evidence, and is of course no good for a service.

"Fig. 2 will be of interest to readers with r-v-r receivers and grid rectification, as it shows the connections of the transformer for series- and choke-fed neon connections. In Fig. 2 (a) the variable resistance is adjustable and is adjusted until about 8 milliamperes flow through the neon, which I find the best current for modulating. Fig. 2 (b) gives the connection for series feed, the L.S. being connected across the loud-speaker terminals to hear the vision signals first, and then the switch across the choke is closed to bring the neon in circuit.

"Although the voltage drop across the neon is about 100 volts this gives the best results. Only 6 milliamperes are then passed by the neon, and the AC/PI gives 12 volts grid bias across the bias resistance, which is just right for the plate voltage on the anode of AC/PI. This is about 100 volts.

"I get far better definition with the latter method, although the former is, of course, better theoretically. Perhaps my chokes have a high self-capacity, thus by-passing the higher frequencies.

"I hope I have not written too much, but I am sure you will be interested in reception which is carried out with simple apparatus. The disc is

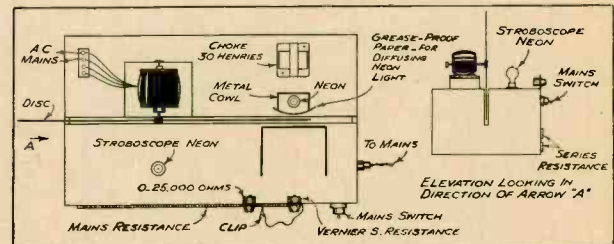

Fig. 3.—Plan of apparatus, with sketch showing its arrangement on a soap-box!

perfect radially, but the last holes are not quite right angularly, so I shall have to get another disc. The reporter of our local paper has given two good reports of my reception here.

Subsequent to Mr. D. Parsons' original letter to us, he has been carrying out some further experiments with the object of improving his images, and he adds:

"In my last letter to you I said that I was getting better results with a series-fed neon, so I thought I would experiment in this direction. I may add that I have got beyond the stage when I only want to see something, and I am trying to improve results just as when I started wireless; volume not quality was required.

"I knew that results could not be at all as good as they might be with about 100 volts dropped across the neon impedance, so I decided to overcome this difficulty with an extra source of voltage in the anode circuit of my power valve. I had a spare transformer with secondaries giving 200 volts at 20 mA. and 4 volts at .8 amperes. With the help of a spare

choke and two 2-mfd. condensers I had an eliminator. For the rectifying valve I had an old 4-volt power valve of about 4,000 ohms impedance, so I decided to use this, although I should loose about 80 volts in the valve impedance with a 20 mA. load, but I should still have 120 volts to play with. A filament resistance was placed in the filament circuit to regulate the current to the filament and hence the output emission, as shown in Fig. 4.

"This eliminator was connected in the anode circuit as shown in Fig. 5 (a). The filament resistance was adjusted until the milliammeter indicated the correct anode current at 200 volts, when I knew that the initial conditions were being applied to the valve. It so happened that this eliminator just supplied this need.

"Signals were received beautifully, but the images had no background at all and resembled the quality of an ordinary photograph on the close-up views.

"Results, however, did not appear to be so strong as I had expected, so I thought that the current through the neon was not quite at the most sensitive value. I therefore placed two elements across the output valve, as shown in Fig. 5 (b), which, however, did not give better results than the series method, although the current could be regulated beautifully by the series resistance *R*.

"In both cases the switch *S* is for hearing the vision signals. In Fig. 5 (a), *S* is open for loud-speaker signals and closed for neon working, whilst in Fig. 5 (b) the opposite occurs.

"There must be many of your readers who, like myself, have a spare eliminator giving an output of 120 volts at 20 mA., which they used when doing away with H.T. batteries, and here is a useful application for the idle components.

"Before I close I should like to thank the Baird Company for the excellent programmes they give us, mention being made particularly of the cricket and golf demonstrators, xylophonist, demonstration of model aeroplanes, native dances, and Mr. Rupert Harvey's cartoons.

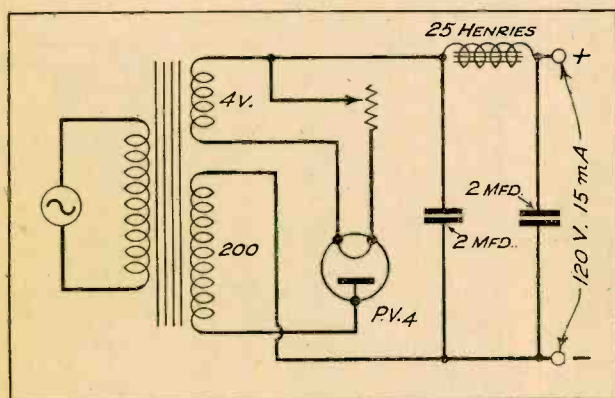

Fig. 4.—Showing filament resistance placed in the filament circuit to regulate the current and hence the output emission.

"Please use your influence to see that when the B.B.C. transmit from Broadcasting House at night we get the vision on a transmitter which is well

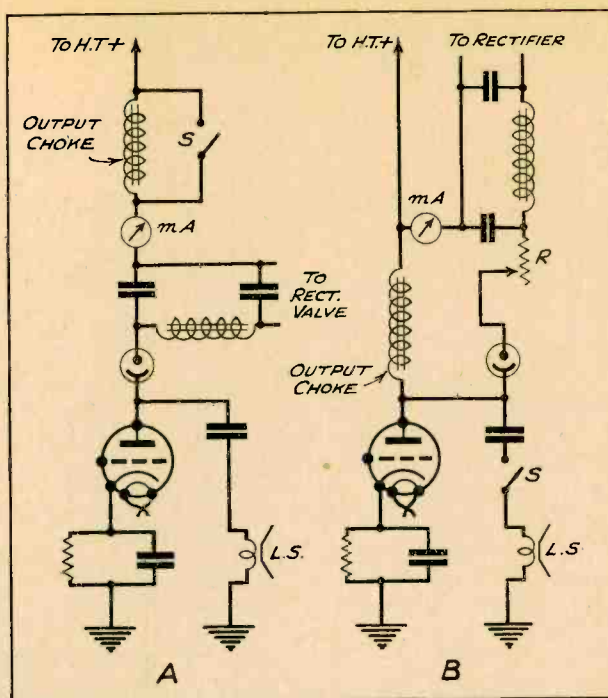

Fig. 5.—(A) How the eliminator is connected in the anode circuit. (B) Two elements placed across the output valve.

received all over England, for many of your readers only receive the vision signals as I do at present, and it is essential that we have the vision from the best received transmitter. Put, say, vision on London Regional and sound on London National, but not *vice versa* or many amateurs will be deprived of their television, and television in every home will be an impossibility except round London."

In Far-off Madeira

To be able to receive British television transmissions in far-off Madeira, so many hundreds of miles away, is a feat of no mean achievement. We should therefore like to extend our congratulations to Mr. W. L. Wraight, of Campo do Almirante Reis, Funchal, Madeira, who has not only sent along a description of his apparatus, but has furnished also some most interesting sketches and photographs. On more than one occasion the work of Mr. Wraight has been mentioned in these columns, but he does not believe in letting the grass grow under his feet, and he is now at work building up vision apparatus so that he can project images on to a screen, and in addition he has been carrying out some experiments on daylight television, and has agreed to furnish us with details of same at an early date. During the course of his letter he says:

"As promised in my recent letter, I am now sending you some details and photograph of the new receivers in use here in Madeira.

"The complete machine comprises two radio receivers for combined sound and vision work, an electrical gramophone and pick-up reproducer, Baird standard scanning receiver, lens enlarging system,

the actual lay-out of the different components, no trouble will be encountered.

"The diagrams enclosed show the cabinet panel lay-out and the circuits employed in the vision and sound receivers. These may be of interest to other distant workers. Naturally, such flatly tuned amplifiers as these would not be suitable for reception in England for obvious reasons, but at this distance such circuits are to be preferred, both from a signal strength and frequency response point of view. The selectivity problem does not effect Madeira, as the nearest 'local station' is Radio Algiers, situated 600 miles away. This station, although very powerful in the winter months, is quite sharply tuned at this distance, and 2 degrees separated from the London Regional transmitter. It may interest readers to know that the latter station only occupies one-tenth of a degree, even with the flatly tuned amplifier employed.

"On the other hand, of course, such circuits tend to bring in every particle of static interference at large in the heavens. This is a particular problem in Madeira. Statics in these latitudes can be extremely annoying. However, there are two ways which the writer has employed with fair success in minimising this type of interference. The first is to lower the aerial from its ordinary height of 30 ft. to 15 ft. This naturally reduces the signal strength, but not nearly to the same extent as the interference. Incidentally, in this respect high aerials are not advocated in these latitudes. The second method employed when conditions are really bad and signal strength will allow, is to use a large directional and shielded frame aerial situated on top of the house. Quite workable results may be obtained with this arrangement.

"Referring to the vision apparatus. This is composed of a standard Baird scanning disc and 6-volt motor and the usual flat-plate type neon. No synchronising gear is used beyond a variable resistance in series with the motor. At great distances from the transmitter it cannot be expected to hold the images steady with any form of automatic apparatus which is governed by the transmitter itself, owing to the great variations of signal strength and

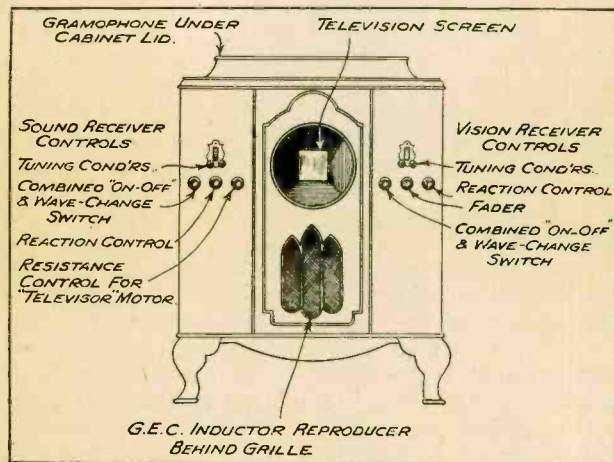

Sketch indicating lay-out of controls, etc., on the cabinet.

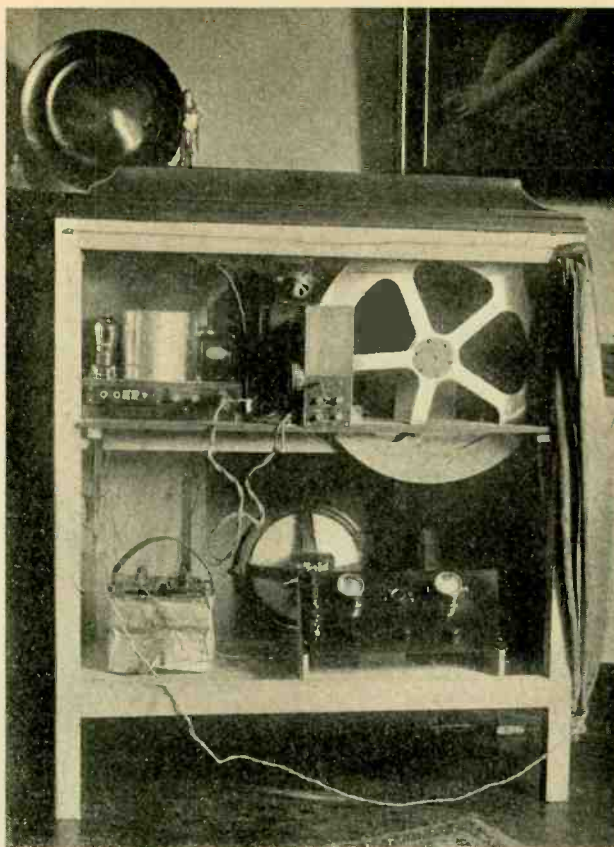

Rear view showing the two radio receivers, electrical gramophone, etc., for combined sound and vision reception.

the many forms of interference which are to be encountered. The signal strength may vary in rapid pulsations from minute to minute, or hour to hour, from a whisper to full loud-speaker strength. On the other hand, nothing might be heard of the station for nights on end. However, it will be found that a properly constructed little 6-volt motor (such as the Baird motor), once warmed up to its work, will run with remarkable steadiness. On the last midnight transmissions received from London, it was only necessary to phase the image twice during the whole of the half-hour.

"The apparent size of the image received with the lens system shown is approximately 7 in. by 3 in. Provision has been made in the cabinet design, however, for fitting a ground-glass screen, to enable images 12 by 5 in. to be received."

COMPETITION RESULTS

OVER 5,000 entries were received by the School for the Blind, Swiss Cottage, for the word-building competition recently announced in TELEVISION and other journals. The list containing the greatest number of correct words (546) was submitted by Mr. Charles Carr, of Stowmarket, who wins the first prize of £60. The second prize of £25 goes to Mrs. Furbisher, Wakefield, with 541 correct words.

Broadcasting House

Finest Technical Equipment in the World

AS television is the latest and most ambitious branch of wireless, it is appropriate that the first regular broadcasts of television should be made from the most up-to-date radio building in the world. There is little doubt that in deciding to develop television, the B.B.C. was influenced by the fact that it would have at its disposal the latest and most perfect equipment yet devised for dealing with the new transmissions. Both for technical purposes and from the standpoint of the artists, Broadcasting House will provide unrivalled facilities for the development of television, which should make rapid progress under these ideal conditions.

The popular features of Broadcasting House are by now familiar to the public—the central tower containing the studios insulated from the rest of the building, the elaborate accommodation for the artists, and so on. But readers of TELEVISION will be interested in its technical aspects, more especially the machinery which forms the "heart" of this giant undertaking.

There are three floors below and eight above the level of the street, and the sound-insulated tower contains twenty-two separate studios in self-contained suites. The outer shell of the building provides accommodation for 750 people, in addition to the control rooms, ventilating plant, and so on.

Broadcasting House is supplied by the St. Marylebone Borough Council's Electricity Department by means of six separate feeders (3-phase), three of which are at H.T. 6,600 volts, the other three at 415 volts between each phase and neutral. As the supply is fed on six separate feeders, there is little likelihood of failure, but to guard against the possibility, an emergency lighting system from a 240-volt storage battery of 1,000 Ah capacity in the basement, has been supplied to all the studios and dependent accommodation. Should the public supply fail, the emergency lighting which is permanently switched on during the hours of darkness in addition to the regular lighting, will provide suffi-

cient illumination for the continuation of the performance. In normal circumstances a motor generator floats the storage battery so that it is kept fully charged. If the breakdown is of long duration, a 100-kW. Diesel-driven generator, which is about to be installed, will be capable of carrying indefinitely all the absolutely essential lighting and ventilation load which the building requires. The storage battery, without assistance from the Diesel set, will carry all the essential lighting load for a period of approximately one hour. The anticipated peak load demanded by all the electrical equipment at Broadcasting House, when the building is in full use, will be about 500 kW.

The larger part of the power load is due to the ventilating and air-conditioning plant in the sub-basement, which is served by a ring main from the distribution switchgear already mentioned. The supply to the rest of the building, including the ventilating plant on the roof, is fed to the various floors through cables arranged in vertical ducts, formed in each side of the brick tower and continuing from the sub-basement

to the top of the building. These ducts have steel doors opening on to each corridor, thus providing easy access to all cables. All power cables are run in ducts separate from those allotted for studio microphone and signalling circuit wiring, to avoid any possibility of interference being induced into the microphone circuits.

Loud-speaker Units

Each of the twenty-two studios has an adjacent listening room with a double window through which the studio can be seen. Loud-speaker units are provided in each of these rooms, which are acoustically treated to be suitable for high-quality loud-speaker reproduction. The loud-speaker units are self-contained, and consist of a two-stage mains-driven amplifier, and a loud speaker housed in a box baffle. The use of loud-speaker amplifiers at all



Broadcasting House from which television transmissions will commence next month.

loud-speaker points enables the programmes to be fed round the building at low volume levels, and in this way avoids the possibility of cross talk on to microphone circuits, which might occur if the loud speakers were fed from some central point at high volume levels. These loud-speaker amplifiers have resistance-capacity interstage coupling, and an undistorted speech output of 1 watt. The box baffle in which the loud speakers are housed is built up in the form of a logarithmic flare, and is treated with sound-absorbing wool.

The acoustic treatment of the studios has been given most careful consideration.

In recent years the B.B.C. has used the carbon-type microphone, but a change is now gradually being made to the condenser type. Provision is made in each studio so that either type of microphone can be used at will. The condenser microphone embodies a single-stage microphone amplifier, as part of the microphone unit, but no amplification for carbon-type microphones is necessary until the output reaches the control room.

A number of microphone plug points are installed in all the large studios, and the output of each microphone is fed to a microphone mixing unit in the listening room adjacent to the studio. Thus the output of a number of microphones can be mixed in the studio listening room, and the combined output is passed on a single pair of wires to the input of the first or "A" amplifier in the control room.

The control room is situated at the top of the building, and is divided functionally into two halves, i.e. rehearsal and transmission. The control-room equipment consists essentially of all amplifiers and auxiliary equipment required in the chain of transmission between any studio (or outside broadcast point) and the lines feeding the transmitters. It also contains the necessary control positions or desks, from which any studio can be brought into circuit and the out-going transmission can be checked.

There are three amplifiers: a microphone or "A" amplifier, a variable gain or "B" amplifier, and a

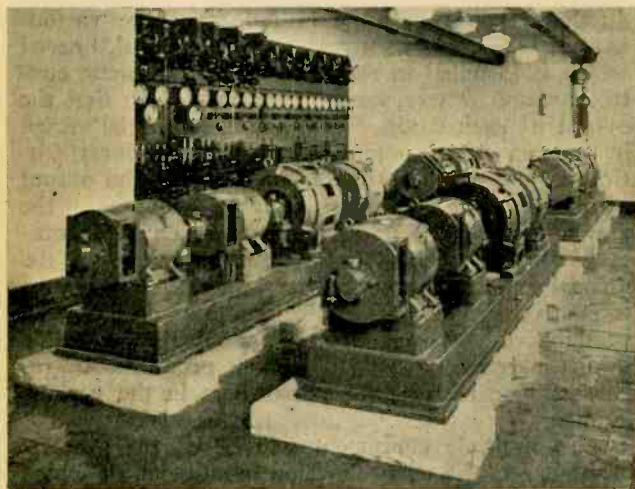

Fig. 1.—Motor generators for control-room battery charging and control switchgear in Broadcasting House.

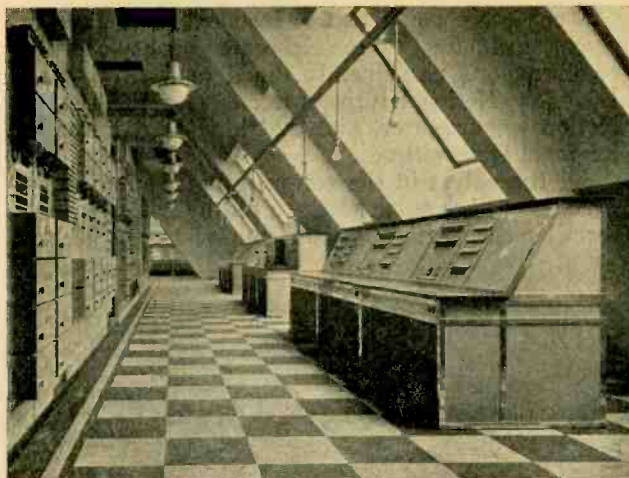

Fig. 2.—Transmission control positions and amplifiers in the control room, typical of the fine equipment at the new B.B.C. headquarters.

land line or "C" amplifier. In addition, there is also a fourth type of amplifier which is used when an incoming transmission from some distant point, such as a provincial studio centre or an O.B. point, is received in the control room.

Avoidance of Local Interference

Trap-valve amplifiers are provided in the control room to avoid the possibility of any fault on a local circuit affecting the outgoing transmission. The trap-valve amplifiers are arranged with their inputs across the chain of transmission, their outputs feeding loud speakers in listening rooms, house phone circuits, etc., in the building. Thus if a short circuit occurs on the house wiring, it does not affect the outgoing transmission.

All amplifiers are rack-mounted in groups. Each amplifier has a removable metal cover at the front and back, so that easy access is possible to the components, and maintenance work is thus facilitated. In addition, each amplifier can be removed from the rack without disturbing the other amplifiers. All are designed to give a sensibly flat response curve over a band of frequencies of 30 to 8,000 cycles per second. Elaborate decoupling arrangements are incorporated to ensure that there shall be no mutual interference between amplifiers, and that switching operations on one bank shall not cause noises in another chain already in use.

Another important development in the design of control positions is the use of a visible indication of the audible strength of the programme. This is a special device known as a programme meter. It is calibrated in equally spaced divisions, and each division represents a change in sound intensity of 4 decibels. During transmission the meter reading is maintained between divisions 1 and 7 on the scale, and this represents a difference in intensity of 24 decibels. If allowed to go below division 1, the transmission would be lost below the noise level of the chain, while if it exceeded division 7 the distant transmitter would be over-modulated.

Much other equipment is installed in the control room, including three elaborate quality-checking receivers, one permanently tuned to the long-wave Daventry National transmitter, one to the London National transmitter, and the third to the London Regional transmitter.

All the valves in the control-room equipment, of which there are some 400, are fed by batteries, both for filament heating, anode supply, and grid bias.

of batteries can be on charge while the other is on load. The charging is carried out by means of motor generators situated in a room immediately adjacent to the battery room.

Mixing Panels

The Broadcasting House control room is capable of handling eight rehearsal programmes simul-

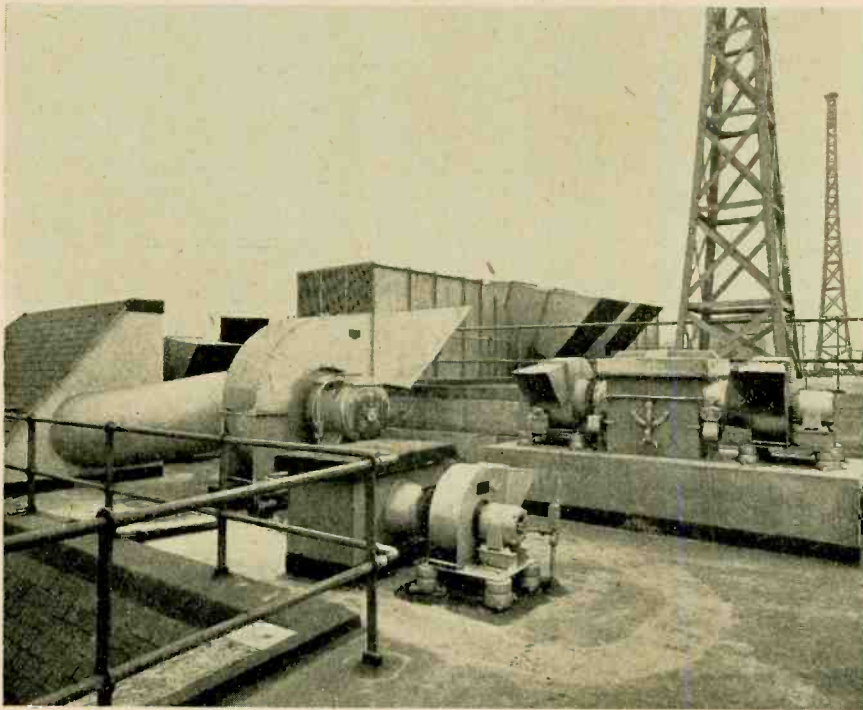

General extract fans on roof, with water coolers in distance, which operate in conjunction with the centrifugal refrigerating machine.

This method was considered preferable to the direct use of machines where a large number of studios have to be handled through one control room. In the central battery room there are installed the following banks of batteries, all in duplicate:

| Type of Battery | Voltage. | Capacity in Ampere-hours. |
|---|----------|------------------------------|
| "A" amplifier, filament heating | 6 | 1,050 |
| Filament heating for all other amplifiers | 6 | 2,100 |
| H.T. supply for all amplifiers | 300 | 50 |
| Polarising for carbon-type micro-phones | 8 | 500 |
| Relay operating coils | 24 | 600 |

It will be noted that separate batteries are provided for heating the filaments of the "A" amplifiers. This precaution was taken to avoid "clicks" in the transmission, which would result if there were any variation in the filament voltage of the valves in the early stages of amplification. The grid-bias batteries are also of the secondary type, but are situated in a room adjoining the control room, to avoid lengthy leads in grid circuits. The banks of batteries are duplicated so that one complete set

taneously with six transmission programmes. Most types of dramatic production involve the simultaneous use of at least four or five different studios, such as an effects room, a studio for incidental music, a studio for principals, etc. In such productions the programme is fed from the various studios which are in use to a mixing panel, one of which is installed in each of the two dramatic control rooms. These panels are arranged so that the output of each studio "A" amplifier can be varied by means of a potentiometer. A producer sitting at one of these desks can "fade" the output of any studio up to the required volume at the psychological moment in the score. Thus the outputs of the various studios can be mixed at the dramatic control panel and the "mixed" programme is then passed into the control room as a completed production. Arrangements are made at these dramatic control panels by which producers at rehearsals can address the performers in the various studios.

This multiple equipment will be of the greatest assistance in the new television broadcasts, of which the arrangements will be described in a later issue, as soon as information is available.

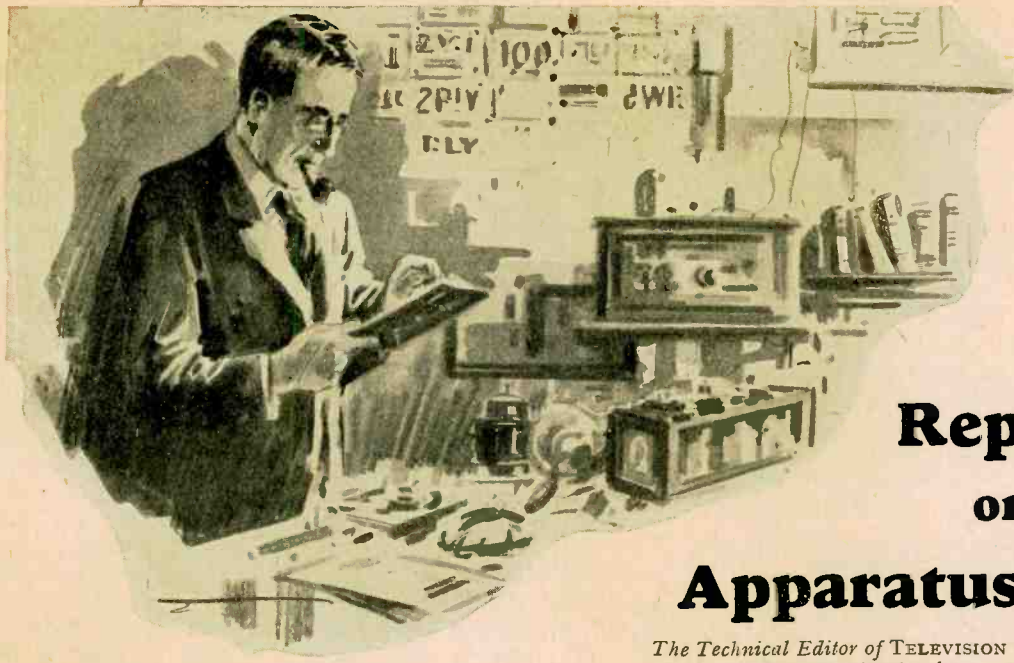

Reports

on

Apparatus Tested

The Technical Editor of TELEVISION will be pleased to receive apparatus, components, etc., from manufacturers for test and, if found suitable, for review in these columns.

Wates' Three-valve Transportable

SINCE with the dual transmissions of sound and vision it is necessary to have two wireless receivers, one to handle the vision signals and the second to deal with the sound side, it often is very advisable to employ a simple portable receiver in order to deal with the latter type of reception. A receiver which we have found to be very suitable

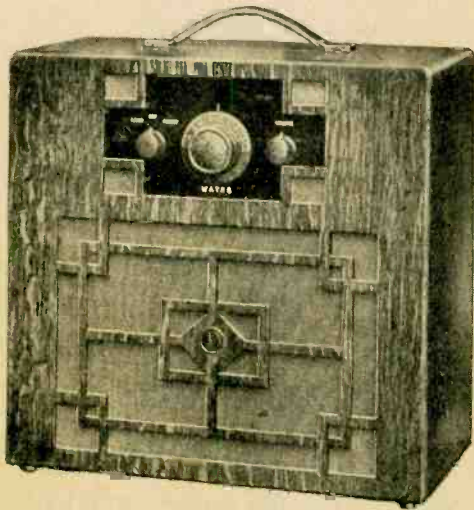

A compact receiver for use with or without aerial.

for this purpose is the new Wates' Three-valve Transportable, marketed by the Standard Battery Company.

Its general appearance is most pleasing, the cabinet being made of solid oak, with a central control panel. The three controls consist of a com-

bined on/off and wave-change switch, tuning-dial, and reaction knob. On test we confirmed that this receiver, although only consisting of a straightforward three-valve circuit, was quite sensitive and enabled the powerful wireless broadcast stations to be tuned-in quite easily. The quality of reproduction was really good when it is borne in mind that the price of the set, complete with the loud speaker and valves, is only £5 5s. A 120-volt H.T. battery and a 2-volt L.T. accumulator must be purchased separately.

The frame aerial is fitted inside the case, but aerial and earth connections are provided, so that to increase the range of the receiver it is possible to attach an aerial and thus make available at good loud-speaker strength the most powerful of the foreign stations. For those readers desiring an economical receiver, that is to say, economical not only in cost but in that the H.T. consumption is quite low, namely 7 milliamperes, this receiver will foot the bill admirably.

Interference Elimination

It sometimes happens that when using the vision apparatus in connection with a wireless receiver the motor driving the disc causes a certain amount of interference, which is noticed on the vision screen. This is not only objectionable but is often sufficient to mar the whole programme.

We were therefore interested to test out a new Weedon Power-link Compensator, Model A, which is designed for use in conjunction with all types of domestic motors up to and including 1 b.h.p.

The case of the model forms one connection, and is clamped to the motor housing at some convenient position, while the two leads coming from the body of the Power-link Compensator should be connected

directly across the input terminals of the motor. In those cases where there are separate terminals for providing current to the motor brushes, the two leads should be connected to these two latter terminals.

If this is done it will be found that any extraneous interference that may previously have been present is considerably reduced, and if the interference is not too heavy it will disappear entirely. There are three separate condensers inside the case, one of which is joined across the two flexible leads, while the remaining two condensers are connected in series across the first condenser, the centre connection being taken to the case on the model. We have tried out this model with marked success, and since the price of the component is only 7s. 6d., suitable for a maximum working voltage for either D.C. or A.C. of 240 volts, the scheme is one which should have a direct appeal to all television enthusiasts.

Three-way Wall-plug Adapter

Experimenters who are using the mains for the supply of power to their wireless receivers and to their vision apparatus often find themselves in difficulties owing to the fact that there is only one power-point available into which they can make their connections.

A simple way of overcoming this difficulty is to make use of the "Goltone" Three-way Wall-plug Adapter, manufactured by Ward & Goldstone, Limited. It consists of a well-made and highly finished bakelite moulding, in which there are three pairs of sockets and one pair of split brass pins, the last named being used in the normal electric light or power sockets.

In this way it is possible to use at this one junction three separate two-pin plugs, and thus overcome the previous difficulty. The component in question, which by the way only costs 1s. 3d., is strongly made and the pins make excellent contact into the usual twin sockets which are available in the home lighting system.

A Rotary Double-pole Radio-gram Switch

Messrs. A. F. Bulgin & Company, Limited, have now put on the market a radio-off-gramo. switch, which in effect is a double-pole, double-throw switch with a central off position. This has been designated the "S.110 Switch," and is primarily for use in all battery-operated receivers. Owing to the nature of the construction of this component, it should not be employed to switch mains current. The switch itself is supplied complete with an engraved bakelite plate and has three definite positions marked, "Gramo.," "Off," and "Radio."

A well-moulded bakelite housing protects the switch contacts, and the appropriate connections are brought out to six terminals at the back of the moulding. When regarded as a straightforward D.P.D.T. switch, terminals 2 and 5 are "centre points," and with anti-clockwise rotation of the knob 2 connects to 3, and 5 to 6; while with clockwise rotation 2 connects to 1 and 5 to 4.

It is interesting to note that the two poles of the switch are insulated from each other and from the fixing bush, and, in consequence, insulating washers

This switch is designed primarily for use in battery-operated receivers.



are not required for a metal panel. Complete instructions for the use of this switch are included in the carton, and the sample which we examined and tested was fully up to the high standard of past Bulgin products. One feels a definite snap action as each position is made with the switch, and a large number of uses will occur to the reader where this new product may be employed. At a cost of 2s. 6d. this switch represents remarkably good value for the money, and whenever in need for such a piece of apparatus we would strongly recommend our readers to bear this component in mind.

FREE INQUIRY SERVICE

THE new publishers of TELEVISION, Benn Brothers, Limited, have pleasure in announcing that a free inquiry service is now at the service of readers. Previously a nominal charge of 1s. was made, but in view of the increasing interest in this science and the need for making technical information available to every amateur, the publishers have now decided to provide this service without charge.

Inquiries should be stated as concisely as possible and written on one side of the paper only, and **MUST be accompanied by the coupon** which appears below, together with a stamped addressed envelope for the reply; readers writing from abroad should use the Universal Stamp Coupon, which can be obtained from most post offices.

The Editor cannot at the moment undertake to supply circuit diagrams, blue prints, etc., in this free service.

" TELEVISION "

COUPON

FOR FREE INQUIRY SERVICE

Name

Address

Enclose with this coupon a stamped addressed envelope. Readers writing from abroad should use the Universal Stamp Coupon, obtainable from most post offices.

June 1932

THE BEST HAS THE PARMEKO DIAMOND

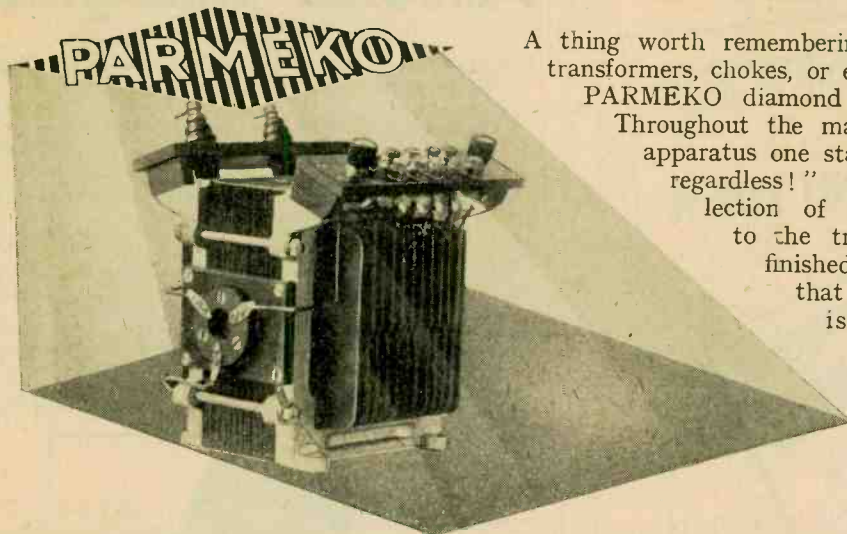

A thing worth remembering when you are buying transformers, chokes, or eliminators—"look for the PARMEKO diamond if you want the best." Throughout the manufacture of PARMEKO apparatus one standard rule—"the best—regardless!" This holds from the selection of the finest raw materials to the triumphant testing of the finished job. The result is that PARMEKO apparatus is used extensively in every field of wireless research as well as by the serious amateur throughout the country.

Lists from:

PARTRIDGE & MEE, LTD.

LEICESTER, and 74 New Oxford Street, LONDON

AYLESTONE 487

MUSEUM 5070

THE NEW WESTINGHOUSE METAL RECTIFIERS

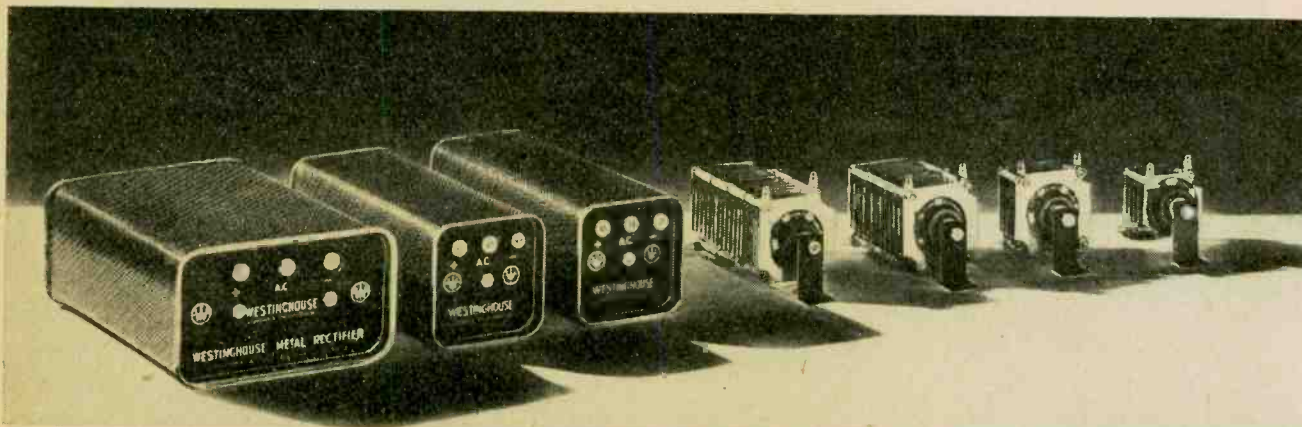

for constructors' use, as detailed below, are now available; and the price of the H.T.8 is reduced to 18s. 6d.

| H.T. | | | | L.T. | | | |
|--------|-------------|-----|-------|-------|-------------|-------|-------|
| Type | D.C. Output | | Price | Type | D.C. Output | | Price |
| | Volts | mA. | | | Volts | Amps. | |
| H.T.9 | 300 | 60 | 21/- | L.T.1 | 6'0 | 0'25 | 10/6 |
| H.T.10 | 200 | 100 | 21/- | L.T.2 | 6'0 | 0'5 | 11/- |
| H.T.11 | 500 | 120 | 35/- | L.T.4 | 6'0 | 1'0 | 13/- |
| | 400 | 150 | | L.T.5 | 12'0 | 1'0 | 15/- |

Details of these new units are given in our booklet "THE ALL METAL WAY." Send a 3d. stamp for a copy, marking your application "Dept.T.V."

THE WESTINGHOUSE BRAKE & SAXBY SIGNAL CO. LTD., 82, YORK ROAD, KING'S CROSS, LONDON, N.1

An unusual

FREE OFFER

MAY WE SEND YOU A COPY OF



Ireland's National Radio Journal

We are anxious for you to see a copy of our paper, and therefore we should like you to fill in the coupon at the bottom of the page. Place it in an unsealed envelope and post it to us WITHOUT A STAMP. We will gladly pay the postage this end and will send you free and without obligation a complimentary copy of "Irish Radio News." If you do not wish to send the coupon, a post card will serve the same purpose and we will pay the postage on it.

To "IRISH RADIO NEWS"
RICHMOND HOUSE,
NORTHBROOK ROAD,
LONDON, S.E.13

PLEASE SEND ME WITHOUT OBLIGATION A SPECIMEN COPY OF "IRISH RADIO NEWS"

NAME

ADDRESS

Reveals Secret of Personal Influence

Simple Method that Anyone Can Use to Develop the Powers of Personal Magnetism, Memory, Concentration, Will-Power and to correct Undesirable Habits through the wonder-science of Suggestion. 80-page Book Fully Describing this Unique Method and a Psycho-Analysis Character Delineation FREE to all who write at once.

"The wonderful power of Personal Influence, Magnetism, Fascination, Mind-Control, call it what you will, can surely be acquired by everyone no matter how unattractive or unsuccessful," says Mr. Elmer E. Knowles, author of the new book entitled: *The Key to the Development of the Inner Forces*. The book lays bare many astounding facts concerning the practices of the Eastern Yoghis and explains a unique system for the Development of Personal Magnetism,

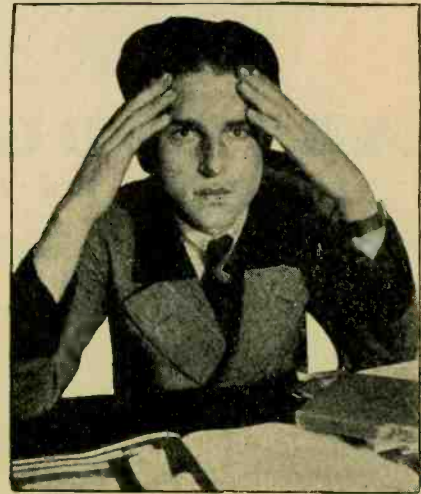

Mr. Martin Goldhardt.

Hypnotic and Telepathic powers, Memory, Concentration, Will-Power and the correction of undesirable habits through the wonder-power of Suggestion.

Mr. Martin Goldhardt writes: "My own success with the Knowles System justifies my belief that it does more for the advancement of people than any other existing method." The book, which is being distributed broadcast free of charge, is full of photographic reproductions showing how these unseen forces are being used all over the world and how thousands upon thousands have developed powers which they little dreamed they possessed. The free distribution of 10,000 copies is being conducted by a large Brussels Institution, and a copy will be sent post free to anyone interested.

In addition to supplying the book free, each person who writes at once will also receive a psycho-analysis character delineation of from 400 to 500 words as prepared by Prof. Knowles. If you wish a copy of Prof. Knowles' book and a Character Delineation, simply copy the following verse in your own handwriting:

"I want power of mind,
Force and strength in my look,
Please read my character,
And send me your book."

Also send your full name and address plainly printed (state whether Mr., Mrs. or Miss), and address your letter to: PSYCHOLOGY FOUNDATION, S.A. (Dept. 569-A), No. 18 rue de Londres, Brussels, Belgium. If you wish you may enclose 4d. (stamps of your own country) to pay postage, etc. Be sure to put sufficient postage on your letter. Postage to Belgium is 2½d.