

Vol. 4 MARCH 1931 No. 37

SIXPENCE MONTHLY

TELEVISION

**OUR
THIRD
BIRTHDAY**



THE WORLD'S FIRST TELEVISION JOURNAL.

“**TELEVISION**”
IS MORE THAN
AN ORDINARY PERIODICAL

Being entirely unique, and dealing exclusively with an ever-growing subject, “Television” forms a valuable medium for reference purposes. Readers who take the wise course of having within reach the back numbers of “Television” are advised either to purchase Bound Volumes or Binding Cases, both of these methods ensuring copies being kept in a clean, handy form.

BOUND VOLUMES

Handsomely bound in rich brown imitation leather, Morocco finish, lettered in gold on front and spine, complete with Index. Permanent records of the World's First Television Journal.

VOLS. **12/6** EACH
1 and 2 POST FREE

BINDING CASES

Available for those who wish to have their own copies bound. In brown cloth, lettered in gold on front and spine, with Index.

EACH **4/6** POST FREE

(Indexes to Vols. 1 and 2—6d. each, postage 2d.)

TELEVISION PRESS LTD.
505, CECIL CHAMBERS, STRAND, LONDON, W.C.2.

TEMPLE BAR 8169

TELEVISION

TELEVISION PRESS, LTD.

Editorial, Advertisement and Publishing Offices :
505, CECIL CHAMBERS, STRAND, LONDON, W.C.2.
Telephone: TEMPLE BAR 8169

SUBSCRIPTION RATE :
7/6 PER ANNUM, POST FREE.
AMERICAN RATE :
\$2.50 PER ANNUM, POST FREE.

MS. AND OTHER MATERIAL FOR EDITORIAL
CONSIDERATION SHOULD BE ACCOMPANIED
BY A STAMPED ADDRESSED ENVELOPE, AND
SHOULD BE TYPEWRITTEN.

PRINCIPAL CONTENTS

	PAGE
THIS MONTH'S CAUSERIE	3
WHAT IS AMERICA'S GAME?	4
FROM MY NOTEBOOK	7
THE ENTHUSIAST SEES IT THROUGH	10
WITH THE TELEVISION LAMP SCREEN IN STOCKHOLM	14
MEASURE YOUR SIGNAL VOLTS	15
THE CAPACIMETER	18
TELEVISION IN FRANCE	22
"TELEVISION'S" THIRD BIRTHDAY	23
ATTENTION TO THE HIGH TENSION.—PART III.	24
RECENT DEVELOPMENTS IN PHOTO-ELECTRICITY.—PART II.	29
REDUCING THE STRIKING VOLTAGE OF NEON LAMPS	33
TRADE NOTES OF THE MONTH AND APPARATUS TESTED	34
LETTERS TO THE EDITOR	37

INDEX TO ADVERTISERS

	PAGE
Bapty, S. Lee	23
Baird Television Ltd.	iv (Cover) and 35
Belling & Lee, Ltd.	21
"Irish Radio News"	17

OUR NEW
"SMALL AD."
SECTION
APPEARS ON PAGE 39.

Leaman, L.	33
M-L Magneto Syndicate Ltd.	9
Mullard Wireless Service Co., Ltd.	2
Oates, W. H.	31

ORDER FORM

CUT THIS OUT AND HAND IT TO YOUR NEWSAGENT.

To Mr. , Newsagent

Address

Please deliver to me at the address given below a
copy of TELEVISION for April, and monthly
thereafter until countermanded.

Name

Address

P.M.1HL

P.M.2A

2 new Mullard types for Television receivers

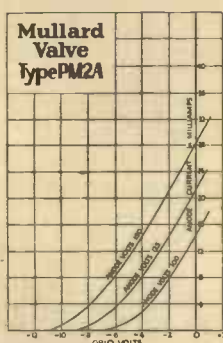
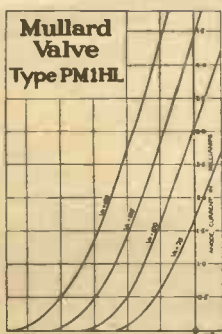
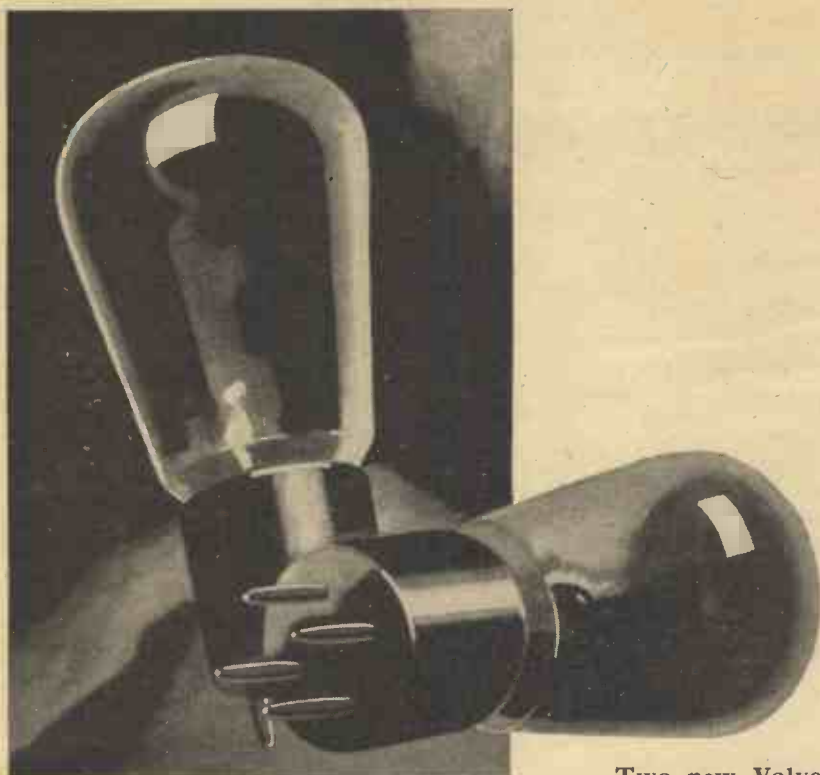

CHARACTERISTICS.

	P.M. 1HL.	P.M. 2A.
Max. Filament Voltage	2.0 volts	2.0 volts
Filament Current	0.1 amp.	0.2 amp.
Max. Anode Voltage	150 volts	150 volts
*Anode Impedance	18,500 ohms	3,600 ohms
*Amplification Factor	28	12.5
*Mutual Conductance	1.5mA/volt	3.5mA/volt
	Price 8/6	Price 10/6

* At Anode Volts 100; Grid Volts Zero.

Two new Valves in the Mullard 2-volt range of great interest to television enthusiasts. Type P.M.1HL is particularly suitable for use in aperiodic choke-coupled H.F. stages, but is also very efficient as a neutralised H.F. amplifier in tuned stages, and as a detector when followed either by a medium or high impedance transformer or by a resistance-capacity coupling.

Type P.M. 2A is a highly efficient and economical output valve for use in the speech receiving portion of a television equipment, and may also be employed in the picture receiver as an L.F. amplifier immediately preceding a large output valve.

Mullard

THE MASTER VALVE

The Mullard Wireless Service Co., Ltd., Mullard House, Charing Cross Road, London, W.C.2.

Arks

TELEVISION for March, 1931

TELEVISION



THE OFFICIAL ORGAN OF THE TELEVISION SOCIETY

SYDNEY A. MOSELEY, *Managing Editor.*

Consultants { H. J. BARTON CHAPPLE, Wh.Sch.,
B.Sc.(Hons.), A.C.G.I., D.I.C., A.M.I.E.E.
C. TIERNEY, D.Sc., F.R.M.S.
W. J. JARRARD, B.Sc., A.R.C.S., A.I.C.

VOL. IV] MARCH 1931 [No. 37

THIS MONTH'S CAUSERIE

THERE are two important matters on which we should like to touch this month—our birthday and developments in France.

The first year in the life of any journal or newspaper is always one of doubt and uncertainty. Will it meet with the approval of the particular section of the public to whom it is desired to appeal? Will those readers who *do* like it take the trouble to recommend it to their friends and thus build up a sufficiently wide circle of regular supporters?

There are bound to be some readers who lose interest in a particular subject, and others who became readers at the start merely out of curiosity. Will sufficient new readers be found during the second year to replace those who drop out? If so, then the journal may enter upon its third year with every confidence.

During the third year of TELEVISION'S life we have spared no effort not only to maintain but to improve upon the standard we set ourselves at the outset. The steady growth in the number of our readers during the year just ended, and the letters of encouragement we have received from so many supporters, both old and new, convince us that our efforts have not been in vain, and we are able to celebrate our third birthday in the happy knowledge that our readers are also our friends.

Both these matters—our birthday and the developments in France—are dealt with elsewhere in this issue.

* * * * *

The advent of talking pictures brought the cinema directly under the control of a stupendous American organisation known as the Radio Trust. This Trust controls, directly and indirectly, many of the leading activities in the cinema industry, and its hold on this vast branch of the entertainment world is being steadily extended.

Now the Trust is making a bid to acquire a complete monopoly of the art of television. Television, while still young, undoubtedly will be the biggest factor in the entertainment world of the future. The Radio Corporation is, to quote from that remarkable book *America Conquers Britain*, "to-day the head of what independents in the industry call the 'radio trust,' by which is meant the patent pools and trade agreements linking R.C.A., General Electric, Westinghouse, United Fruit, and A.T.T."

We are now faced with a position in which individual British enterprise has to combat this gigantic trust with a capital of five thousand millions. The activities of these trusts, even when they are operating in their native land, are fraught with the greatest dangers to the welfare of the general public. Such trusts create monopolies, with all their attendant evils. The action of such monopolies, when controlled by foreign syndicates, may well have the worst possible results to the country in which they operate. Not only can such a trust destroy British prestige, but, what is worse, it can strangle British enterprise.

*Entire Contents of this Journal copyright in the U.S.A., 1931, by Television Press, Ltd.
Foreign Translation Rights Reserved.*



What is America's Game?

By Sydney
A. Moseley

recognition of television in this country. The average reader has no idea of the machinations of foreign interests in the British commercial world. He is crying out all the time for "Britain first" (since, of course, Americans insist on "America first"), and yet at the same time he is unconsciously supporting foreign interests by purchasing goods which he *believes* are British, but which are actually of foreign origin. He

FOR a good many moons now, these articles of mine have been written not in ink but with the milk of human kindness. The hatchets were buried; friends were welcomed to the bosom of the television family, and the most stupid of so-called "experts" were shown the errors of their ways with courtesy, reasonableness, and patience.

But it looks to me as if we must take off the gloves again. The battle for British television, it seems, is not completely won; within sight of the goal it seems that efforts are being made to wrest the laurels from the British Company, and once more the slick Americans are endeavouring to reap what we have sown. We need only recall the last example in the realm of the sister science, cinematography, to show what we are up against.

I have never hidden the fact, in giving news of television wherever I have found it, that this magazine was a British magazine, and that it stood for the rights of British television as represented by Mr. Baird. If another British inventor had entered the field at the same time as Mr. Baird, or even since, I should have espoused his cause with the same wholeheartedness.

The fact remains, however, that Mr. Baird in England has kept the flag a-flying, has contrived under every conceivable difficulty to maintain his lead, while his Company has spent several hundred thousands of pounds to make the position secure for television so far as the British side of it was concerned.

The news, therefore, that is conveyed to me that American interests are endeavouring to enter the British field under various subterfuges makes it necessary for me to mobilise the same forces as did yeoman service in the earlier stages of the fight for



The smaller caravan made to house the Baird Lamp Screen and enable it to be more mobile than the original model.

buys wireless sets, gramophones and gramophone records, fully believing that he is supporting the British market, when as a matter of fact he is doing nothing of the sort.

If, in those industries, America is able to put it across the unsuspecting British customer, that is the look-out of British radio interests.

So far as it affects television, it is another matter. I consider that any attempt to wrest the fruits of our toil from us is the immediate interest of every reader of this journal, and I take it upon myself to warn those interests abroad that they will have to reckon with me and many powerful readers who are supporting me, if any attempt is made to foist a foreign system of television in this country by means of the usual back door.

If any of my readers doubt the magnitude of the menace of invasion into the television field by American interests as represented by the Radio Corporation of America, I would refer them to a book by Ludwell Denny, entitled "America Conquers Britain." On page 388 of that work will be found the following:—

"To-day it [the R.C.A.] is the head of what independents in the industry call the 'radio

trust,' by which is meant the patent pools and trade agreements linking R.C.A., General Electric, Westinghouse, United Fruit, and A.T.T.

"A resolution adopted in 1929 by the Radio Protective Association, representing independent manufacturers, petitioned President Hoover to hasten prosecution of the alleged trust. It states the case of critics of R.C.A.: 'Whereas the Radio Corporation of America, the American Telephone and Telegraph Company, the General Electric Company, the Westinghouse Electric and Manufacturing Company, and the United Fruit Company, with aggregate resources of \$5,000,000,000 have undertaken to create an unlawful monopoly in the radio industry, and: Whereas, said radio trust has sought to destroy its competitors and to control every phase of the art of radio, including communications, broadcasting, manufacture, television, and the talking movies, and: Whereas, this attempted monopoly of the greatest means of mass communications known to man is a menace to the safety of the republic, and: Whereas, the unpunished violations of the anti-trust laws by such a combination of rich and powerful corporations, and their offences against independent

competitors, tend to bring all laws into disrepute and to encourage law-breaking by less wealthy and less powerful individuals and corporations: Therefore, be it resolved by the Radio Protective Association as the representative of the independent radio industry of America, assembled in annual convention in Chicago, that it respectfully petition the Honourable Herbert Hoover, President of the United States, to direct the Law Enforcement Commission recently appointed by him to investigate the apparent immunity from prosecution enjoyed by the 'radio trust.'

"R.C.A. is based upon the electrical trust. It in effect represents the manufacturing and hydro-electric power capital of the Morgan-General Electric interests, which control in whole or in part a score of national and international trusts in Europe, Latin America, and the Far East, and which hold with other American interests majority stock in British General Electric. It has great political as well as industrial and financial power—it has escaped the sweeping



One of the many laboratories of the Baird Company where television research is going on daily.

anti-trust prosecution demanded of the Government by independent companies. Mr. Owen D. Young, whose leadership in the experts' committees formulating the two German reparation plans has made him one of the most powerful figures in international finance, is chairman of General Electric and of R.C.A. Mr. Frank L. Polk, President Wilson's Secretary of State, is R.C.A.'s counsel; its former counsel is Under-Secretary of State Cotton. One of its directors is Mr. James R. Sheffield, former Ambassador to Mexico. Major-General James G. Harbord, former Chief of Staff of the American Expeditionary Force, is its president.

"No longer merely an international communications concern, R.C.A. has absorbed manufacturing, telegraph, phonograph, theatre and motion picture producing companies, and is now trying to acquire a cable system. At the same time it has perfected a manufacturing and merchandising alliance with General Motors; it holds with General Electric and Westinghouse 49 per cent. of stock in the new General Motors Radio Corporation, whose supporting companies represent assets of \$2,000,000,000.

"Wholly owned subsidiaries include Radio Real

Estate Corporation, organised in 1922; Radiomarine Corporation of America, 1927; R.C.A. Communications, and Radio-Victor Corporation, 1929. Other affiliated companies in which it has large stock-holdings include Federal Telegraph Company of Delaware, organised in 1922; National Broadcasting Company, 1926; R.C.A. Photophone, 1928; Radio-Keith-Orpheum Corporation, 1928. Other subsidiaries include Marconi Telegraph-Cable Company of New York, Marconi Telegraph-Cable Company of New Jersey, R.C.A. of Massachusetts, and United States Radio Supply Company. These are in addition to its foreign subsidiaries, such as R.C. of the Philippines, R.C. of Argentina, and R.C. of Brazil. Its international operating subsidiary, R.C.A. Communications, conducts a system extending from the

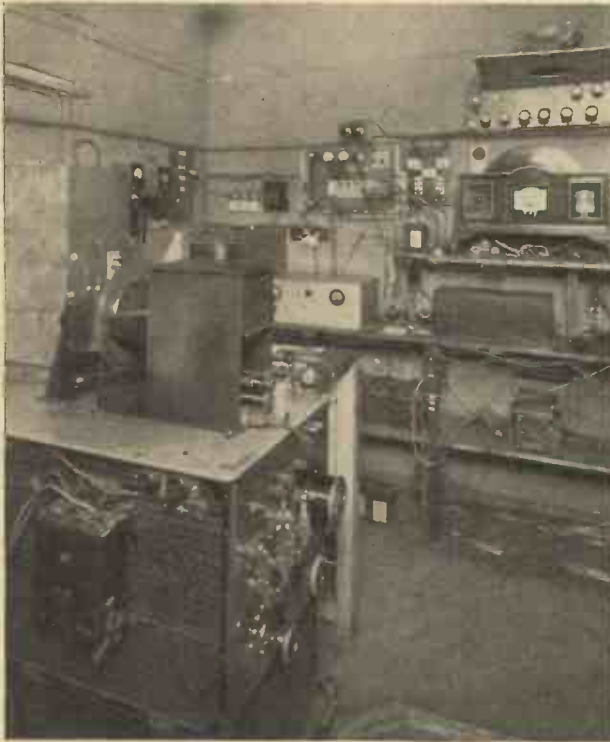

This is the control room from which the daily broadcasts of Baird television are sent through to the B.B.C.

United States to Britain, Scandinavian countries, France, Germany, Poland, Italy, The Netherlands, Belgium, Portugal, Turkey, Liberia, Brazil, Argentina, Venezuela, Colombia, Dutch Guiana, Dutch West Indies, Porto Rico, Cuba, Hawaii, Japan, Philippines, French Indo-China, Hong-Kong, Dutch East Indies."

An Absorbing Lecture

THE Golders Green and Hendon Radio and Scientific Society held a most interesting evening recently when Mr. G. G. Blake, M.I.R.E., F.Inst.P., the well-known author, read a very absorbing paper entitled "A Journey into the World of Science."

The great interest shown in this meeting may be gathered from the fact that the president, vice-president, honorary secretary for the Radio Society of Great Britain, together with representatives of seven radio and scientific societies, and the press were present.

Space will only permit us to touch on a few of the many and varied theories dealt with and experiments shown. The lecturer admitted quite frankly that the scientist considers his theories to be only working hypothesis—approximating to the truth after which he is always searching. It was pointed out that the only difference between solids, liquids, and gases was that the molecules of a solid mass were more tightly packed.

These facts were illustrated by means of experiments the first of which was to prove that, however solid a body may appear, it was possible to penetrate it by means of a ray of suitable wave-length.

A Philips portable X-ray outfit was called into service, and in the darkened hall a part of the human body was clearly shown on the screen.

To show that the air is composed of groups of oxygen and nitrogen molecules, small tubes of radium were exposed to the air, and the α particles flew out from the radium, disturbing the air groups in a most astonishing manner. Several experiments were then shown illustrating the electron theory.

Light was also considered, it being pointed out that all colours were conveyed by means of the white light from the sun. Only a minute number of the known octaves of vibration could be seen, and various reasons for this were advanced by the lecturer.

Finally, the lecturer arrived at what he very artistically called the "Physicists' Mental Gymnasium," namely, relativity.

At the conclusion of the lecture Mr. Maurice Child proposed a vote of thanks to the lecturer in a most amusing and witty speech, while Mr. Leslie McMichael, F.I.R.E., F.R.S.A., said he had the greatest pleasure in seconding the vote of thanks.

Mr. G. G. Blake made a suitable reply, thanking his many assistants for their valuable help, specially Mr. Maurice Child and Lieut.-Colonel H. Ashley-Scarlett.

Mr. Bevan Swift, A.M.I.E.E., President of the Radio Society of Great Britain, added his words of thanks to the Golders Green and Hendon Radio and Scientific Society on behalf of the radio societies and visitors present.

Mr. H. J. Barton Chapple, Wh.Sch., B.Sc., A.C.G.I. D.I.C., A.M.I.E.E., thanked those responsible for arranging the lecture, and was pleased to note that the Golders Green and Hendon Radio Society had again shown that they were a very active body, and were exerting every effort to bring the latest ideas and inventions before their members.

After the meeting was closed a large number of the audience availed themselves of the very unique opportunity of being televised, their friends observing the results in the Baird "Televisors" located in Messrs. Garsubil's premises, where the lecture was held. Needless to say, this relaxation was an excellent antidote to the rather strenuous mental exercises of the learned lecturer.

From My Notebook

By *H. J. Barton Chapple*
Wh.Sch., B.Sc.(Hons.), A.C.G.I.,
D.I.C., A.M.I.E.E.

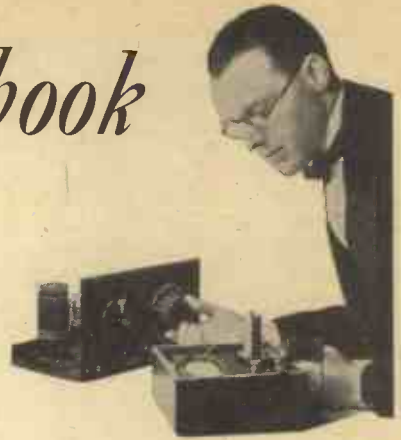

Meeting Meters

I HAVE always been a strong advocate of the employment of measuring instruments by all wireless set users, this being especially important in the cases of those who are displaying the keenest of interest in television reception. In this matter, however, it is necessary to exercise due care in the choice of the instruments, because one can be so easily lead astray by meter readings, and thus be put on a false track in assessing faults which have occurred in the wireless set.

Let me illustrate these remarks by recounting the facts of a case which occurred recently. A friend of mine had a wireless receiver incorporating the familiar Reinartz type of reaction, but which failed to give proper oscillation over the whole of the range for both long and short waves. The set in question comprised a detector valve followed by two stages of low-frequency coupling, and this, under normal

valves of both high and low impedance in the detector position, but still failed to secure that smooth control of volume which should have been apparent in a set of this character. A new accumulator was purchased since, for some reason, he suspected his other model of being in rather poor condition, but, when a further test was undertaken, it produced no better results.

A False Scent

Someone then told him that he ought to find out whether his H.T. battery had run down, and suggested measuring the voltage with a meter. With this idea in mind my friend bought an instrument of the cheap pocket variety and, reaching home that night, he immediately measured the voltage of his H.T. battery. Here was the fault! The instrument registered only 60 volts instead of the 100 marked against the sockets.

Feeling somewhat pleased with his discovery, he at once purchased a new H.T. battery and, in a state of great expectation, connected it to the set in lieu of his old one, and listened for the glorious burst of volume he felt sure would come. Disappointment was his, however, for although in turn he tried every H.T. tapping, he failed to achieve the object he had in mind. He was now in desperation, and coupled the old and new H.T. batteries in series, and made a further assault on the set, but the only effect was to bring about very impure reproduction, while the failure of the set to oscillate was still apparent.

Naturally, I found my friend in rather a low state of mind when I arrived on the scene, and his remarks about wireless in general were very uncomplimentary, so I at once offered to lend him a hand. As far as his voltage measurements were concerned, a glance at the meter he had employed was sufficient to show that he had been led to an erroneous conclusion on this score. I brought along a reliable high-resistance voltmeter and found that his original H.T. battery registered 90 volts, as against his reading of 60, so the trouble did not lie in that direction.

Make a Careful Choice

After a short investigation, I traced the defect to very long and high resistance lead-in and earth wires, and the proper reaction effects were brought about

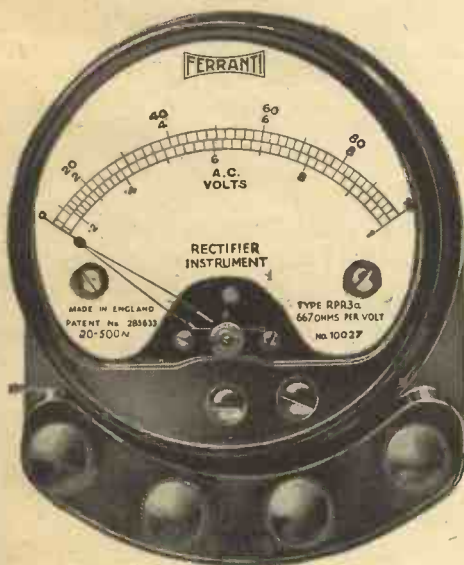

* * *

Always employ a reliable meter when making any measurements on a radio receiver otherwise you may be led to wrong conclusions.

* * *

circumstances, should have been capable of giving him at least half-a-dozen stations on the loud-speaker.

In an effort to overcome his trouble he had tried various H.T. voltages, and substituted a number of

by the insertion of a fixed condenser in series with the aerial lead. Of course, the best solution would have been the shortening of these leads and the substitution of a more efficient earth, but conditions of environment precluded this. In any case, the set functioned quite satisfactorily with the expedient I adopted, and my friend was a sadder and wiser man.

His low-resistance voltmeter had taken such a heavy current from the battery when making the measurements that the readings were false ones, whereas if he had taken the trouble to secure a reliable high-resistance instrument in the first place he would have been spared the expense of a new accumulator and a new H.T. battery.

The illustration I have given should serve to impress upon readers that although measuring instruments serve a very useful purpose and are really indispensable in many directions, they must, in the case of voltmeters, be of sufficiently high resistance to cause no undue drain on the battery when measurements are being made. Furthermore, in the case of ammeters or milliammeters they should possess a low resistance, so that the constants of a circuit do not alter when the meter is inserted in series for taking readings and, if desired, may be left in as a permanent connection.

My Reply to Mr. Davies

Readers will notice in the correspondence columns that Mr. Davies has taken me to task over my remarks concerning the "dot theory" in the January issue. I am led to the conclusion that he has never seen a television image as broadcast over the ether. If such is the case he should avail himself of the first opportunity to see one, and then, like many others, he will be converted from scepticism to enthusiasm, and from enthusiasm to an earnest worker in the cause of the science. It is quite possible that the general public (a much abused term) ultimately will judge television reproduction by comparing it with the talking picture as at present being shown

in the cinema theatres. It is very premature, however, for Mr. Davies to suggest that this should be the case now. Television gives you vision *in your own home*, but the talking film is seen and heard in a place of public entertainment, and makes no pretence at being suitable for home displays, which of course it is not.

I appreciate Mr. Davies' sincerity, but feel that he is making comparisons between standards which, in the terms of the chairman, "are out of order." I am one of the last to decry the need for mathematics, in fact I glory in their use, but always endeavour to make sure that my initial conditions are correct before voicing a definite opinion. In this way one does not tend to lead others astray by false conclusions.

Helping the Science

If Mr. Davies again reads through the paragraphs to which he takes exception he will see that I was joining issue with the supporters of the "dot theory." This theory was torn to shreds a long time ago by reputable scientists, and should really need no further comment, but since writers are still using it to show that recognisable detail is impossible with

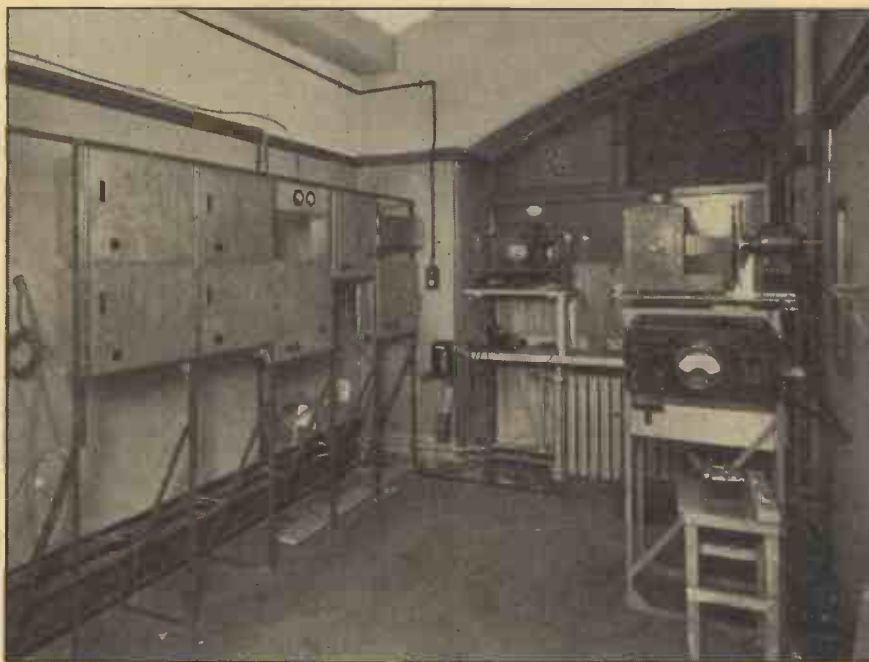

A peep inside the new control room of the Baird Company. Many experiments are being conducted to find circuits and apparatus best suited for the demands of television, and undoubtedly this new control room will bring about many improvements.

a televised image as now sent over the ether by the Baird Company, then it is only natural that one should return to the attack.

For example, with the 7 by 3 ratio picture of the Baird Company's transmissions, and working with $12\frac{1}{2}$ pictures per second, then the alternate square scheme means a frequency of 13,125 cycles per second. In practice, however, this figure is not needed for the reasons I advanced before and which require no further reiteration. These images, while limited in scope and size of scene, are easily recognisable, and appear to suffer little "damage" through being broadcast within the 9,000 cycle waveband.

No one is attempting to belittle the magnitude of the problems still to be solved, and the difficulties that have to be overcome. What is wanted, however, is a little more of the constructive criticism and a little less of the destructive class. *Television is here*, and is progressing steadily, and this fact must be kept

well to the fore. If this is done, and somewhat more careful thought is given to the subject, then we shall be in the happy position of being able to say that we have done our bit to *further* its progress and not be accused of *retarding* it.

"Pulling the Strings"

A few days ago I took advantage of an opportunity to go into the Baird Company's studio at Long Acre during the half hour's morning broadcast. On several occasions I had seen the "figures" of the London Marionettes as television images on the screen of a "Televisor," and the programme had always fascinated me. What I was anxious to find out was how "the strings were pulled," and on the morning in question my desire was satisfied. A special stage had been erected complete with front curtains, and behind this was a white screen backed by a platform on which stood a man manipulating the figures. These were most ingeniously contrived, having a minimum of seven or eight strings to work the arms, legs, and body.

The strings terminate in a kind of wooden crosspiece standard for every model, and in this way the performer instinctively handled the right string at the right moment. All the movements were most realistic and, of course, there was the accompanying patter, song or music to make this performance complete. I could not help being impressed with the wonderful way in which the show was carried out, and during the same half-hour I looked in and saw the television images as received by wireless. They came over very well indeed, and served to show that even within the present broadcasting limitations "seeing-in" has a wonderful fascination.

Broadcasting without a Microphone

Experiments are being conducted in Hamburg in connection with the transmission of piano music without using a microphone. The string vibrations are immediately converted to electrical vibrations and fed to the transmitter. Tests are also being made to ascertain whether the principle can be applied to other musical instruments.

Close Co-ordination

I think we are justified in stating that the development of television will not only be the result of true invention, but will, in addition, embrace sound engineering in the form of the wide co-ordination of ideas and the endless refinement of principles already well established. There are times when we find it rather difficult to discriminate between the finish of true invention and the beginning of development, but, undoubtedly, the present stage of television affords similar opportunities to the individual as that provided by wireless some years ago.

The subject is in no way dependent upon one definite line of thought, for in its solution we must bear in mind the combined problems of wireless electricity, optics, physics, chemistry and mechanics. Added to that there is the time factor looming, all important, in the background when we realise that such a tremendous amount of work has to be handled in the minutest fraction of a second.

The Interchange of Ideas

That being the case, the evolution of the science will call for the close co-ordination of trained engineers and amateurs alike, while the interchange of ideas through the columns of the press and via the medium of television societies cannot fail to be productive of useful information. Unfortunately there are still sceptics who pour scorn on the present day achievements, but I cannot help feeling that they have failed to keep pace with the progress which materialises week by week and month by month in the laboratories specialising in the work.

The columns of this magazine quite recently have borne witness to the many new demonstrations conducted by the Baird Company, and we can look forward to the future with the hope that this is only the forerunner of many other ideas and developments.

A RELIABLE H-T SUPPLY is required for TELEVISION



ROTARY TRANSFORMERS

are used by the

BAIRD TELEVISION CO. and many experimenters

Send for the "Book of the M-L Rotary Transformer."
THE M-L MAGNETO SYND. LTD., Radio Dept. K, COVENTRY
Telephone 5001.



Godbolds

PLEASE MENTION TELEVISION WHEN REPLYING TO ADVERTISERS



The Enthusiast Sees it Through

RECRUIITS to the cause of television, who are introduced to the fascinations of looking-in to the broadcasts sent out by the Baird Company through the Brookman's Park stations, continue to send us descriptions of their apparatus and the methods they have adopted in order to overcome certain difficulties. These communications are most welcome and interesting, and are indicative of the fact that amateurs, both in this country and abroad, are slowly but surely awakening to the fact that television offers to them unlimited scope for their ingenuity. Difficulties are there to be overcome, and the methods adopted to effect a solution to the problems should serve as a spur to others to go and do likewise, and then send us descriptions of their work.

Easy, Cheap and Interesting

According to the words of Mr. J. Milnes, of 76A, Grange Park Road, Thornton Heath, Surrey, he found that the making of his own vision apparatus was easy, cheap, and very interesting. Making use of the resources at his disposal, he pressed into service a domestic motor for driving his disc (which by the way was made up according to information supplied in our columns), and, using this in conjunction with a beehive neon, was successful in obtaining clear although small images on his first trial. Mr. Milnes deserves congratulations for his work, and we are sure that readers will be glad to see his own comments in the extracts from the letter which we print below:—

"Having been interested in television for some time, I decided about two weeks ago to build my own vision apparatus, and judge for myself what results could be obtained with rough and ready material.

"The scanning disc is constructed as recommended in TELEVISION some time ago, and works very well indeed. The motor is an old vacuum cleaner motor, running on ball bearings. This runs so smoothly that synchronising is very easily obtained with a

small resistance in parallel with the large one. An ordinary beehive lamp serves for the neon, and this is connected in series with the last valve which is working on 200 volts.

"My radio set is a three-valver using anode bend rectification, which I find gives the best results on vision work. I only tried the apparatus out last Tuesday night, and after about fifteen minutes spent in getting correct motor speed, I saw for the first time in my life television pictures. These images, although small, were very clear indeed.

"As I have never seen or worked this type of appa-

* * *

With simple apparatus, including a disc made from drawing paper, Mr. Halket was able to make his first experiments in television.

* * *

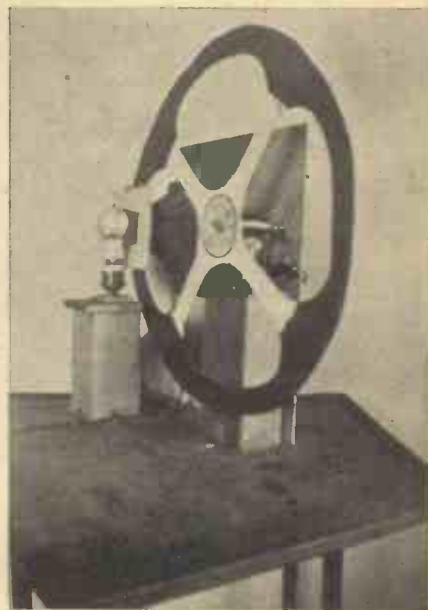

ratus before I think I am right in saying that it is easy, cheap, and very interesting to construct.

"Wishing your journal all the best."

The Enthusiasm of Youth

We could not help smiling at the way Mr. Halket Jnr., of "Ozanam," Roman Road, Duntcher, Dumbar-tonshire described his initiation into the thrills of watching his first television image. He writes an illuminating letter and shows how keenness and energy are capable of overcoming any obstacles which might at first appear to bar successful television working. We appreciate Mr. Halket's comments on our magazine and can assure him that we are losing no time in our efforts to further the ideals of "television for all," especially as far as England is concerned.

We shall look forward to further comments by Mr. Halket when he has had other opportunities of looking-in to the television broadcasts received on his home-made apparatus, and would point out that it was through reading this popular series, which we have included in our journal, that Mr. Halket first realised that he could do the job himself. He writes as follows:

"I did not intend to write so soon, but after trying to pick up the television transmission from the London Regional station half an hour ago, I just cannot wait any longer. The Regional never comes in very well here, but this morning it was so weak that I could scarcely hear it on a S.G., Det. and 2 L.F., R.C. coupled. When shall we get television broadcasts from the Glasgow station; even at midnight it fades terribly? No doubt you or your readers will be interested in the apparatus I am using. I have been a constant reader since No. 1, so it is not for want of knowledge that I have delayed constructing apparatus. To tell the truth, I was afraid to start making my apparatus because, after reading the reports of other readers, I was lead to believe that I should require a very powerful receiver and extremely high voltages, and since we have no electric mains in the

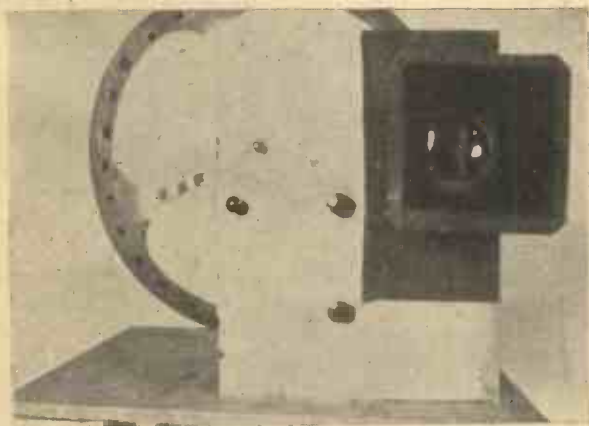

A front view of the vision apparatus used in Dumbar-tonshire.

house I sighed for the time when they would be available. Also, being an apprentice, I thought I would wait until my time was up, when I would have more spare cash.

"Imagine my surprise when I opened this month's TELEVISION and read Mr. G. E. G. Graham's letter saying that he received good images with only a total

of 7 milliamps consumption for his whole set, and a 4-volt motor to drive the disc. That got me going! So last Tuesday, when I came in, I fished out an old 6-volt motor I have had since I was a boy. The

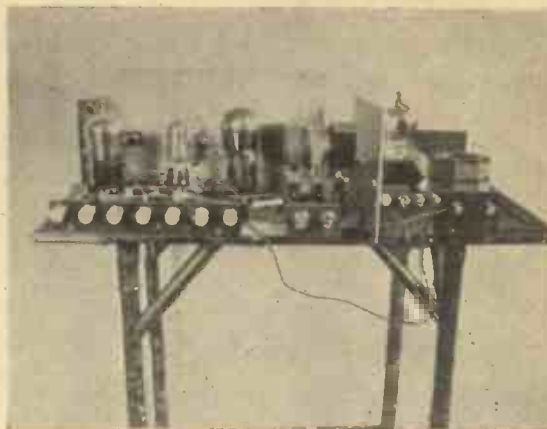

The four-valve set employed by Mr. Halket to receive the vision signals from Brookman's Park.

shaft was bent and the whole motor rattled like a 1914 Ford, and I'm sure consumed a couple of amps. I put a new shaft in it (a 6-in. 2BA bolt), rewound the armature with the wire from an old No. 200 coil, and wound some more turns over the field winding. It now ran freely on 2 volts.

"I then bought an Osglim beehive neon (with the resistance already removed) and holder, 3s. for the neon and 8d. for the holder, and a piece of thin ground glass for 2d. and a 4-in. lens for 1s. 6d. I made the disc from drawing paper, 30 holes, 20 in. dia., the holes being made with a needle about .038 in. in dia., and squared with the end of a file ground to the size. I fitted the whole up and ran the motor on 6 volts; but I was not getting enough speed, so I changed it to a shunt wound. Still I did not expect to get the speed, so I lightened the disc as much as possible, by cutting a half-inch off the diameter. The neon was covered with tinfoil and a ground glass screen scotined into the cardboard window. Zebo was used to blacken the disc and tunnel.

"At last came the great night, Friday, 9th January. I bought three cheap high-tension batteries, and I had another, so all together I had about 240 volts. At 12 o'clock we turned on the television signal but could get nothing but red dots. After five valuable minutes had gone my chum thought the disc was running too fast; so we put 4 volts on the motor. Then we saw something like a face (what a thrill!). But there was something wrong; it was negative. I told my father to look at the time, my mother to turn on the gas, my chum to pull out the H.T. and I fell over the output wires in my hurry to change round the anode-coupling coil. Out came the coil, wires were changed round, gas on, H.T., in, time 12.15, but now the screen was a blank. Five minutes later I found I hadn't replaced the coil; tried again, still blank; condenser dial was displaced, got it right and then I saw what I thought was a pair of heads just

for a second or two, but it suddenly jumped up and disappeared, and I could get nothing but odd black and red dots.

"Well, I'm afraid I have written rather a long letter, but then I've got it badly like many other amateurs. Why don't you start a queries page where readers could write in and get problems cleared up?"

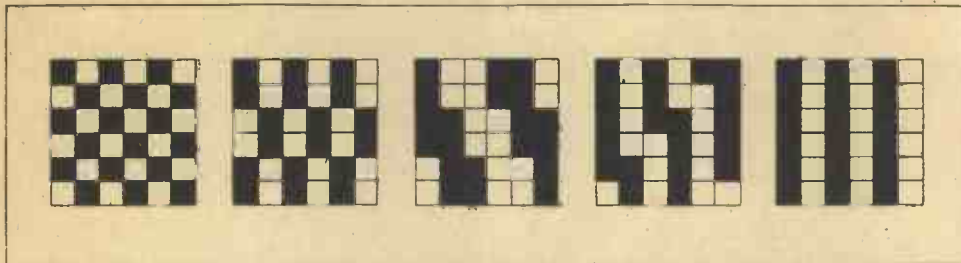

* * * *
 Fig. 1.—Patterns obtained
 for different scanning
 disc speeds.

* * * *

I've dozens. Well, once again, is nothing going to be done about Glasgow broadcasting television and letting us have more time? A miserable half-hour is positively ridiculous.

"Being my first letter to you, I take the opportunity to thank you for the TELEVISION magazine, and admire the way you stick up for British television, especially Mr. Sydney A. Moseley. We are keen up here; after all, we are only about 15 miles from J.L.'s place, Helensburgh! Again wishing you every success."

A Simple Model for Demonstration Purposes

Shown during a lecture on "Television," given by Mr. E. G. Bowen, to the Physical Society of Swansea University College.

During the lecture a model television receiver was shown, made up of a disc, motor, and neon supplied from 50-cycle mains.

Since the frequency applied to the neon was so low, a standard 30-hole disc could not be used, and a smaller one was made, only 12 in. in diameter, having six holes, each $\frac{1}{2}$ in. square. The images were formed on a ground glass screen some 3 in. square, mounted just in front of the disc (Fig. 2). An ordinary neon, connected to 220-volt 50-cycle mains, was fixed about 3 ft. from this screen with a large lens bringing the light, not to a focus, but to a smudge just large enough to cover the screen.

The disc was driven by a fairly powerful motor, having a variable resistance of 300 ohms in series, to give variations in speed from a couple of revolutions per second to the maximum possible for the motor. As the speed of the disc increased, a number of interesting geometric images were obtained, and could be held by critical adjustment of the speed. (Perhaps a small rheostat of from 10 to 20 ohms resistance, in series with the larger one, would have been helpful in holding the images.) When adjustment was rough, they showed the "hunting" common to television images when synchronising is poor.

The images obtained varied from a draught-board design to alternate black and pink strips as shown here. (Fig. 1.)

With the room in complete darkness, and the neon roughly focussed on the screen, the patterns could be seen clearly up to a distance of 30 ft., when standing immediately in front of the screen.

Looking-In

An account of a visit paid by the *Birkenhead News* representative to see Mr. Piggott's television apparatus. Mr. Piggott is one of our enthusiastic readers, and his apparatus was described in last month's issue. (Extract from *Birkenhead News*, January 14th.)

"I have had my first peep at television. This pleasure was afforded by being allowed to 'look-in' to an apparatus constructed by a young Prenton man who has already devoted much time to the subject. Although the equipment of the set is by no means up-to-date, the demonstration was wholly satisfactory and convincing.

"The sensations were much the same as on hearing one's first 'talkie,' except that they were more emphasised. The simplicity of the actual apparatus surprised me. Except for the familiar up-to-date five-valve wireless set which reposed in a corner, I saw nothing of wires, valves, switchboards, and the like, but instead, resting on the table, was what appeared at first glance to be a large disc about 15 inches in diameter. It was constructed of some thin metal and was mounted upon an obviously home-made wooden superstructure. Apart from an energetic little electric motor to revolve this disc at a high speed, there was nothing—nothing, that is, of what I had at first expected.

"My friend then began a necessarily abridged instruction in the art of television, but unfortunately technicalities crept in and I soon found myself hopelessly involved in the intricacies of a section of modern science that has become a science in itself.

"The disc had minute holes drilled through it at varying distances from the outer edge. At a certain point behind the disc was a neon lamp and immediately in front was a wide cardboard tunnel into which one had to look and in which there were fitted two magnifying glasses.

"All was ready. The apparatus was then connected up, the motor was switched into motion, the

PLEASE MENTION TELEVISION WHEN REPLYING TO ADVERTISERS

room was plunged into darkness, and the disc began to whirr rapidly, causing a number of lines of light to pass through the cardboard tunnel. As the disc revolved more and more rapidly the lines began to take more definite form, until the figures of the performers somewhere in London could be seen quite distinctly, their movements synchronising with the sound from the wireless loud-speaker.

"Certain minor imperfections were noticeable, but nevertheless television was there right in front of me. Sound and light, perfectly synchronised, were being transmitted over hundreds of miles through all kinds of obstacles, and by a home-made apparatus."

Bringing England Nearer to Madeira

The communication we have received from Mr. W. L. Wraight, c/o The Madeira Electric Lighting Co., Ltd., Campo do Almirante Reis, Funchal, Madeira, should serve to dispel any pessimistic thoughts which might be held concerning the value of the Baird Television transmissions. It is brimful of enthusiasm and we take this opportunity of heartily congratulating Mr. Wraight, who, by the way, is an Associate of the Television Society, on the good work he is doing and "wish more power to his television reception" during the months to come. He writes as follows:—

"With your desire to be kept in touch with reception results of the Baird television transmissions, you may be interested to learn that "looking-in on London" has become a very matter-of-fact procedure here during the past five months. On many occasions the transmissions have been extremely good and have never yet failed to fill my audience with excitement and enthusiasm. Some ninety odd people of English, German, French, Portuguese and Spanish nationalities have witnessed the transmissions on my receivers during these months. In every case, whether they have been lucky in being able to see really well, or seeing only a faint glimpse, the impression left on all has been intense enthusiasm for the new science. No person in England, I think, will quite have the same appreciation for television as the lonely exile abroad. At the present time my main problem is not concerned with Low Frequency Amplifiers or with fractious signals, so much as trying to control the number of my visitors.

"My apparatus in general has been altered slightly since I last sent to you a description, and the vision apparatus and the two wireless receivers are now combined to make one complete unit. In appearance the complete apparatus resembles the early Baird Olympia model. Beyond being adapted for long distance work the wireless receivers are similar in every respect to standard practice.

"The actual vision apparatus, being home made leaves much to be desired, and I hope to replace most of this when I go to England this August.

"Reverting to the transmissions, the greater depth of vision recently introduced is naturally more difficult to receive really well owing to the lack of sufficient signal strength to show up the details. The best transmissions are those of the head and shoulder type.

Incidentally, Mr. Announcer of the Baird Company is a very well-known personality here and we are always very pleased to see him.

"Double images have not been apparent for some considerable time although fading is extremely bad on occasions. Recent experimenting has shown that fading can be greatly minimised on the short waves by employing "Zero beat" reception methods and I have had quite promising results on the medium waveband with an automatic volume control. The greatest signal strength obtainable here using one S.G. H.F. Anode Bend Det. and three R.C.C. on the London Regional Station is never greater than weak L.S. Strength. This will give you a very good idea of conditions under which work is done in Madeira. The use of Multi-H.F. circuits is not warranted as what is not obtained with one efficient S.G. amplifier is certainly not worth having on two or three. Nevertheless, providing the circuit in use is efficient, with

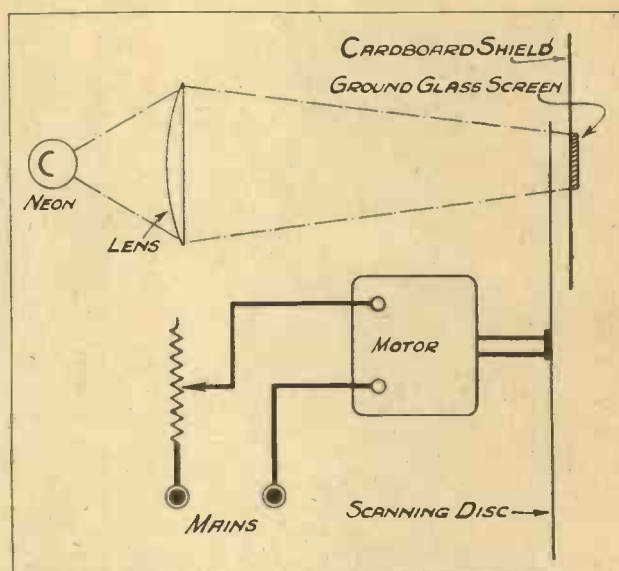

Fig. 2.—Simple details of Mr Bowen's model receiver which he used during the course of his lecture on "Television."

signal strength as mentioned and the room in darkness, very good images can be seen three to four feet away from the screen. The use of Low Frequency transformers and Power Grid Detection would of course greatly increase the signal input but these have proved sadly inferior to the Anode Bend and R.C.C. method.

"However, looking back over the past year it has been a very successful television one, and has helped to bring England very much nearer to Madeira.

"With best wishes to TELEVISION in 1931."

**STOP PRESS FOR THE
ENTHUSIAST.**

**ADVERTISE YOUR NEEDS
IN A "TELEVISION SMALL."**

With the Television Lamp Screen in Stockholm

By G. B. Banks, B.Sc.

DURING the past few months I have travelled many thousands of miles about the north of Europe in the cause of screen television, but up to the moment I have no pleasanter recollections than those of Stockholm.

Stockholm is built on a large number of islands linked by innumerable bridges, and hundreds of quays and waterways, thronged with shipping, thread their way through the old town. Not without reason is Stockholm called the "Venice of the North."

The Swedish people are a very go-ahead type. Everywhere we found the most up-to-date ideas very much in evidence, and it was only to be expected that the debut of television in Stockholm would be looked upon as an auspicious occasion.

The demonstration was given under the auspices of the Aktiebolag Svensk Filmindustri, a large concern manufacturing films, and owning and renting more than 200 cinemas in Sweden, and was staged at the Roda Kvarn (Red Mill) Theatre. As this was

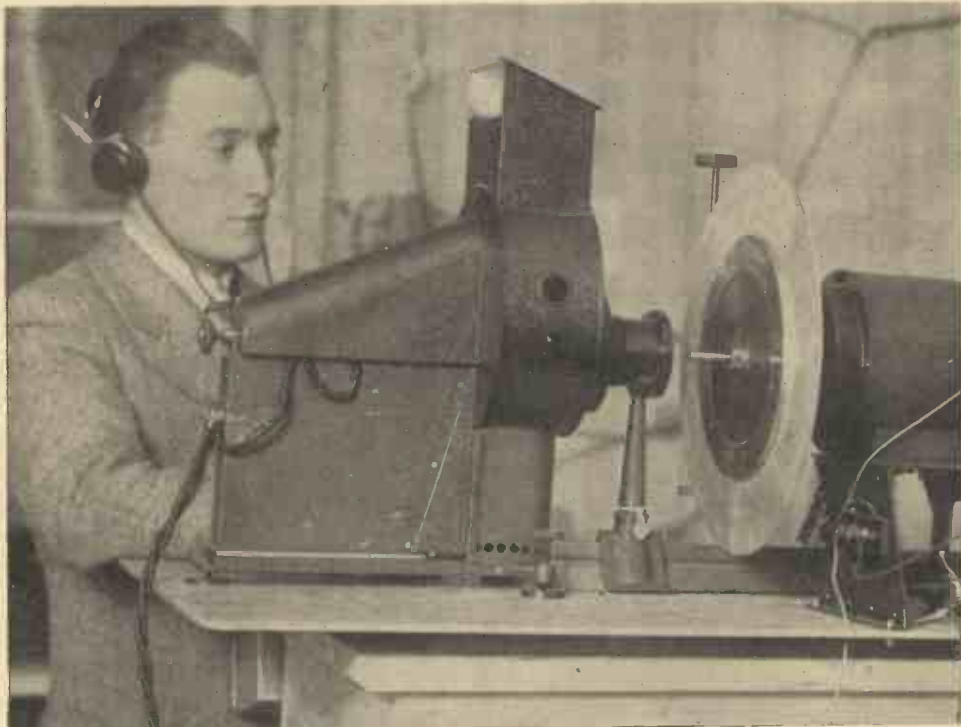

* *
Mr. Banks
working at
the
transmitting
end of the
Baird
apparatus.
* *

Picturesque Streets

In the main the streets are very narrow even in the busy shopping centres, but the shops and buildings themselves are very fine. In the more modern part of the town there are a few wider streets, including the beautiful Kungsgatan, which is built in the American style, even possessing two skyscrapers.

We were fortunate enough to be in Stockholm during the Yuletide celebrations, which, by the way, commence early in December, and the streets were simply covered with electric lanterns of every conceivable shape and colour. Each street seemed to vie with the other in putting up the best display, transforming the town into a veritable fairyland.

a cinema theatre, the stage was extremely small, and it was very fortunate that the caravan containing the screen "Televisor" and its amplifiers had been reduced to about a quarter of its original size previous to the Paris demonstration, otherwise it would have been quite impossible to have found accommodation for it on the stage.

Excellent Studio

On this occasion the studio was erected in the foyer of the cinema itself, instead of sending the pictures from a distance as had been done in the case of the London Coliseum (400 yards) and the Berlin Scala (10 kilometres). In some ways this may not be so demonstrative to the man in the street,

(Continued on page 31.)

Measure Your Signal Volts

An Explanation of the Valve Voltmeter

By *D. R. Campbell*

WIRELESS experimenters from the earliest days of broadcasting have realised that a voltmeter is a necessity, but it is only in the last year or so that the milliammeter has made its general appearance in the really serious-minded enthusiast's equipment. Both these types of meters, however, except in very isolated cases, are suitable only for recording direct current. The signals proper, in the form of alternating currents, are, even to-day, frequently neglected.

Their effect, after being converted to sound, is described as R_1 to R_{10} , a form of nomenclature used to describe the sound intensity of a signal by radio "fans." This form of measurement is certainly simple, but hardly suitable for the exacting requirements of modern radio apparatus, especially when applied to television.

A. C. Voltages

It is now some years since E. B. Moullin introduced the valve voltmeter for the measurement of A.C. voltages, both at radio and audio frequencies. In operation this instrument makes use of the rectifying

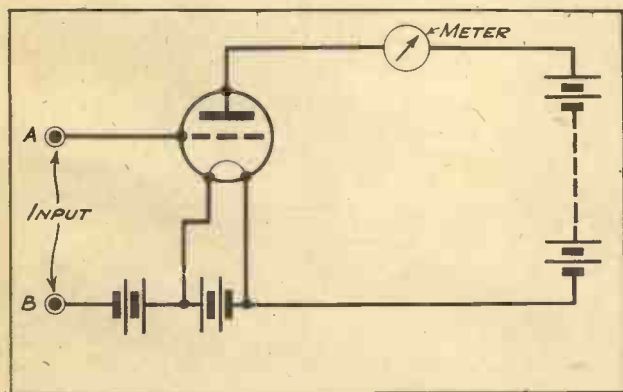

Fig. 1.—In its simplest form the valve voltmeter is connected as shown in this diagram.

properties of the thermionic valve. An A.C. voltage is applied to the grid, and the corresponding plate current is registered on a direct current meter. The instrument, therefore, virtually converts pressure units to current units. The valve being a voltage-operated device the input power load of the valve voltmeter is of an extremely low order compared with any other A.C. measuring instrument. Primarily the valve voltmeter is for measuring the voltages

such as are found in a valve amplifier, to which it can be coupled with practically no loss to the A.C. signal component.

In its simplest form the instrument consists of a valve, a suitable meter for registering the valve plate current, and the necessary batteries, connected up as in Fig. 1. In Fig. 2 is a grid volt/plate current

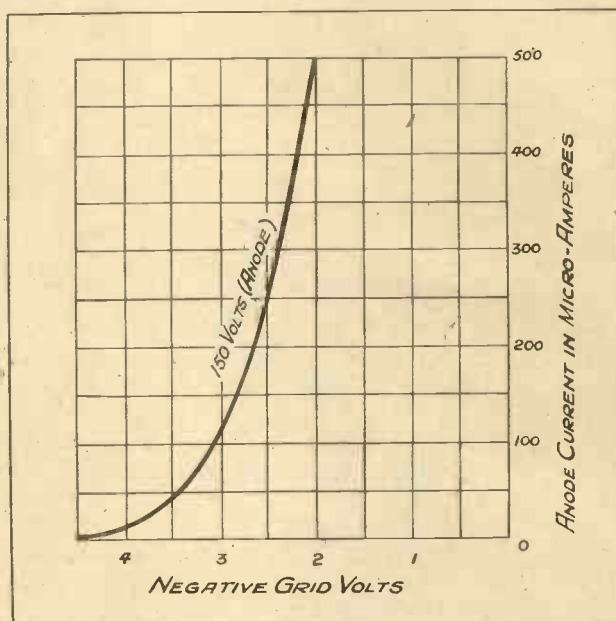

Fig. 2.—The characteristic (grid volts/plate current) curve of a valve used in the instrument described in this article.

characteristic curve of a valve used in this type of instrument. It will be noted that the anode current is recorded in microamperes instead of the more generally used milliamperes, as the microampere is the more suitable unit for the type of valve under consideration, and has been used, therefore, throughout this article.

The Valve Characteristic

Studying the curve, it will be observed that no plate current will flow if the valve is biased to -4.5 volts. If an A.C. voltage is applied across the input AB (Fig. 1) through a transformer, or in such a way that the grid remains biased to -4.5 volts, while the peak value of this A.C. voltage is 1.5 volts, on the positive cycle, then the plate current will rise from zero to a maximum of 120 microamperes,

falling again to zero, and remaining at zero during the negative cycle. This procedure will repeat itself as long as a signal is applied, with the result that the A.C. voltage has been converted into a D.C. pulsating current, the meter in the anode circuit indicating a mean value. In Fig. 3 an attempt has been made to show this conversion graphically. An

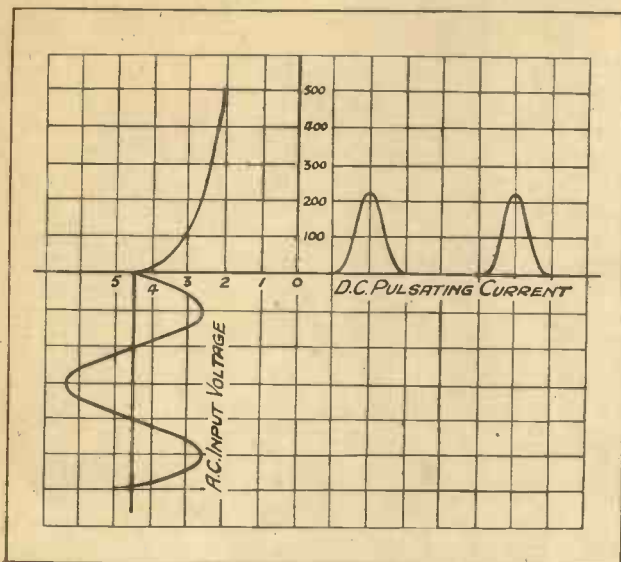

Fig. 3.—Converting an alternating input voltage into a pulsating output current.

A.C. voltage of sine wave form is applied to the grid of a valve biased to -4.5 volts, the peak value of the A.C. voltage being 2 volts, the valve characteristic being similar to that of Fig. 2. It will be noticed that the wave form has also been changed. In practice it is generally advantageous to adjust either the grid bias or high-tension to such a value that even when no signal is applied a small plate current is flowing. The reason for this can be seen clearly by referring again to Fig. 2.

Modifications

If an A.C. voltage of 0.5 volt peak is applied, the steady bias being -4.5 volts, then at the peak value the anode current will rise only to 10 microamperes. Had the bias, however, been -4 volts, the same A.C. voltage would have made it rise to nearly 50, a difference of 40, which would require a much less sensitive meter in the plate circuit for a given voltage to be measured. The circuit in Fig. 1, while having the advantage of applying very little capacitive load, and therefore being particularly useful for radio frequencies, has the disadvantage that it cannot be used to measure voltage across a condenser, or, what is of frequent occurrence, any circuit which has a D.C. component, which would immediately alter the steady bias voltage.

To make the instrument more universal, a grid condenser and leak is added together with a resistance, as in Fig. 4. If the resistance R is short-circuited the operation of the circuit is similar to that of Fig. 1, except that the grid of the valve is insulated from any

D.C. voltage. Now, if R is of not too high a value say 5,000 ohms, and the connection ZX is made, the drop, even with 500 microamperes flowing, is only 2.5 volts across the resistance, which, on H.T. voltages of over a hundred, produces a negligible difference in the anode current to all practical purposes.

Automatic Bias

If, however, Z is connected to Y , the point Y will be 2.5 volts more negative, also the grid, in respect to the filament, when 500 microamperes is flowing than when no H.T. current is present in the anode circuit. Therefore, although the bias is fixed at some definite value, the signal applied to the grid by means of this resistance is made automatically to increase the grid bias, the more intense the signal to be measured the greater the negative bias.

The great advantage of this type of circuit is that larger voltages can be measured with a given calibration, while the sensitivity at low inputs is hardly affected.

The calibration curves of a practical instrument are given in Fig. 5. In curve A R.M.S. volts have been plotted against the anode current indicated on a meter giving a maximum deflection at 500 microamperes. To obtain this curve the connection ZX was made (see Fig. 4), while for curve B the lead was changed to the position ZY . The H.T. and grid bias were so arranged that a steady current of 20 microamperes was flowing at zero input voltage.

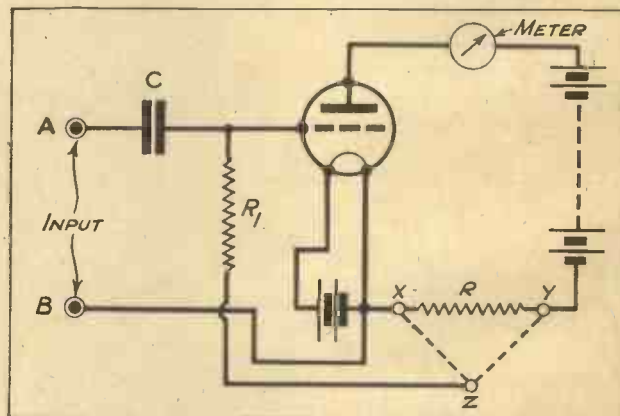

Fig. 4.—A more practical way for joining up a valve voltmeter. Automatic grid bias is secured.

The circuit given in Fig. 4 has the disadvantage of taking more power to operate it, this power varying over different frequencies. At high frequencies the grid leak and condenser wiring, plus the valve capacities, may seriously shunt R_1 unless C is of a much smaller order than these combined capacities. At low frequencies the valve and wire capacities will have a negligible effect, while the reactance of C may be of considerable order, so in practice the values of the grid condenser and leak must be chosen with the frequency error in mind.

Many Uses

The uses of the valve voltmeter are many. Voltages across different aerial tuning coils can be ascertained

when situated in close proximity to the local transmitter. In an ordinary radio receiver the A.C. volts across each grid can be checked, and, after noting the voltage, followed by a careful perusal of the valve's characteristics, it will often be found that the first stage valve of the low-frequency amplifier is being overloaded, a fact sometimes missed, even when a milliammeter in the general H.T. supply is apparently steady. This arises from the output valve current being so heavy compared with that of the rest of the valves that it swamps out the unsteadiness of the current feeding the overloaded valve.

Again, comparison of the voltage across the grid of one valve with the voltage across the grid of the next in an amplifier will indicate what magnification

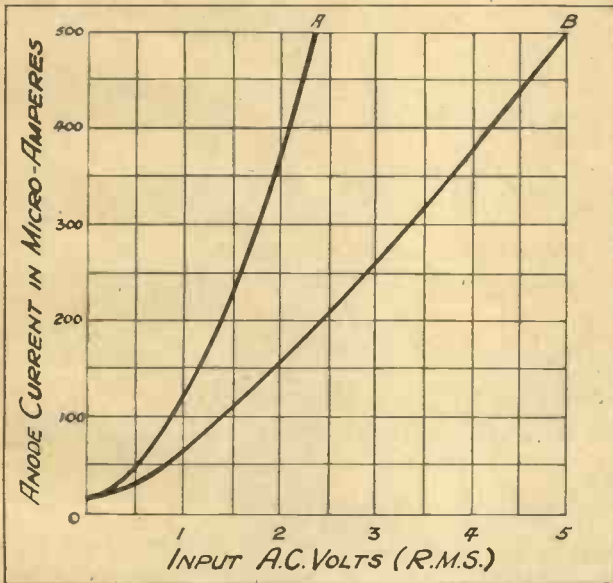

Fig. 5.—Calibration curves for an actual instrument (see text for details).

has taken place. For the satisfactory reception of television as broadcast by the London Regional Station the low-frequency amplifier requires to have a moderately even response over a range of frequencies from 25 to 10,000 cycles per second. In the final testing of this amplifier the valve voltmeter and some form of audio oscillator is of such great assistance that it must be used to be fully appreciated.

The signal from the local oscillator is set to a definite frequency, and applied to the amplifier input. The voltage is noted first across the input, and then the output, from which the amplification factor is derived. Keeping input volts constant change the oscillator's frequency and again check up the amplification factor. If this is done for the range of frequencies the amplifier has to pass, and a curve of frequencies against amplification is plotted, invaluable information of the apparatus under test is secured—and often some nasty disillusion about our pet designs!

This short description of the valve voltmeter will be followed by an article dealing with the practical construction of a handy and compact instrument.

IRISH Radio News

ΝΑΥΔΑΚΤ ΓΡΑΦΙΔΑΝ 1 η-Εμνην
With which is Incorporated "The Irish Radio Review"

Edited by JAMES KITCHEN, A.M.I.R.E.

IRELAND'S NATIONAL RADIO JOURNAL

IS
Published EVERY FRIDAY

PRICE
ONE PENNY

Regular Contents include :

- OFFICIAL IRISH AND B.B.C. PROGRAMMES FOR THE WEEK.
- "BROAD TUNING." By A. Z. (Gossip).
- HINTS FOR CONSTRUCTORS.
- GRAMOPHONE NOTES.
- NORTHERN IRELAND NEWS.
- Special Articles, News, Photos, Etc.

Why Not Become a Subscriber?

- One Year, Post Free - - 7s. 6d.
- Six Months, Post Free - 3s. 9d.

WRITE FOR A SPECIMEN COPY.

Irish Radio News

Editorial and Publishing Offices :

179, PEARSE STREET, DUBLIN.

'Phone : DUBLIN 43236.

LONDON OFFICE :

RICHMOND HOUSE, NORTHBROOK ROAD,
S. E. 13.

'Phone : Lee Green 1059.

The Capacimeter

A Tester for Measuring Capacities and Resistances

Designed and Described

By *William J. Richardson*

THE skilled mechanic who takes a pride in his handiwork works to within very fine gauge limits, and this is an example which could be followed with advantage by all wireless and television experimenters. Not only should care be taken in building up and wiring the apparatus, but, in addition, a knowledge of the resistance and capacity values of certain components will ensure that the fullest benefit is derived from the material used.

While it is realised that the wireless manufacturer of repute spares no pains in ensuring that his products are within a small margin of their rated values, it happens frequently that some are faulty or have become damaged through misuse by the purchaser. In low-frequency amplifiers the values of the resistances and condensers have an important bearing on the ultimate performance, while in the tuning circuits it is very advantageous to know the maximum and minimum capacity values, and even intermediate readings, of the variable condenser employed. Alternatively one may possess a condenser whose capacity is not stated, and

unless means are available for measurement the component is useless.

Using a Neon Lamp

Of course, elaborate instruments will be necessary if a minute degree of accuracy is desired, but it is surprising how even simple material will enable these values to be determined to within 2 per cent. to 3 per cent. or even less. For most purposes this is sufficient for the work in hand, and with this in mind I am sure readers will derive great benefit by the use of the simple testing unit which I am going to describe.

Now we are all familiar with the neon lamp; its

special purpose in television reception has been emphasised and dealt with many times in these columns. Its wonderful properties do not end here, however, and although it is not my purpose to dwell on the many fascinating experiments which can be carried out with this device, there is one feature to which attention must be drawn, for the Capacimeter functions as a result of the phenomenon.

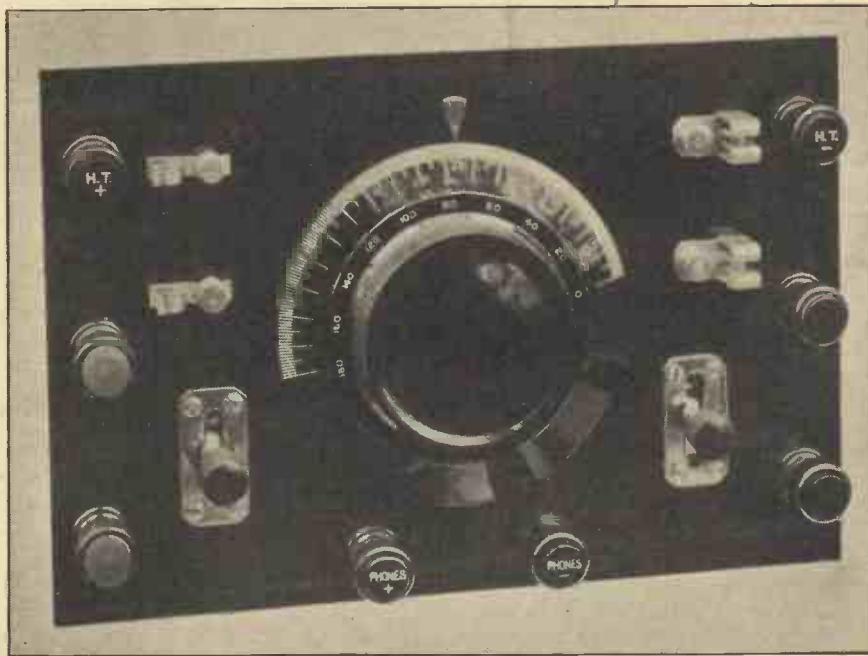

Particularly neat in layout, the meter described by William J. Richardson will make a wide appeal to readers.

Current Pulsations

If you take an ordinary beehive neon, such as illustrated in an accompanying photograph, and connect it in series with a D.C. voltage through a resistance, it will glow with the familiar orange colour. Now join a condenser of any capacity in parallel with the neon, and a transformation takes place in the circuit. The previous direct current supply is converted into a regular pulsating current. Provided the condenser is of high enough capacity, then the pulsations will evidence themselves as light flashes which can be counted. On the other hand, if the constants of the circuit are of other dimensions the neon lamp fluctuations can be heard as a note when a pair of headphones are included in the circuit.

The unique property does not stop here, however, for experiment has shown that the period of the neon flashes or current pulsations bears a definite relationship to the resistance and capacity included in the circuit. Turning to Fig. 1, and imagining the switches



Before wiring up, the back of panel has this appearance. Note the grid leaks, condensers, and neon lamp in the foreground.

are closed, so that the resistance R and the condenser C are in circuit, then we have this relationship, that the period of the current pulses P is proportional to the product of C and R , that is

$$P = KCR$$

where K is some constant.

With either C or R constant, and R or C varied, a linear law exists between the frequency of the "note" and the variable quantity, and this holds good over very wide limits. It is this simple factor that enables us to make the prescribed measurements with the Capacimeter.

Explaining the Circuit

Now let us see how this established phenomenon is used. Referring once more to Fig. 1, the diagram portrays in a simple manner the circuit which I embodied in the instrument. R_1 is a resistance of

known value, while R is a resistance whose value in ohms can be determined by the tests to be described. A rapid change over, so that either one or the other resistance is in circuit, is brought about by means of the single pole double throw changeover switch.

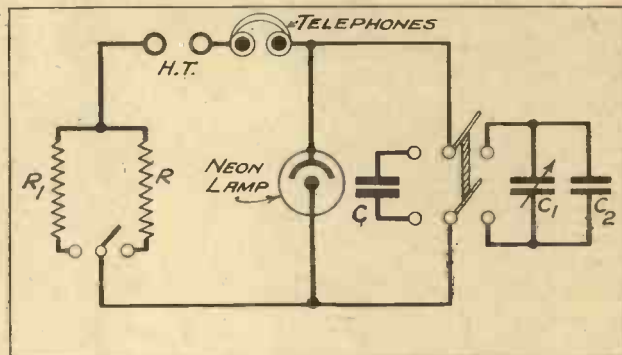

Fig. 1.—The schematic diagram of the unit which should be studied in conjunction with the text.

On the right of the diagram is shown a condenser C whose capacity is to be determined, while C_1 is an accurately calibrated variable condenser of .001 mfd. maximum capacity. To increase the utilitarian value of the Capacimeter fixed condensers C_2 of known capacity can be placed in parallel with C_1 , and in this way the range of one's tests extends beyond the maximum capacity of C_1 . The double pole double throw changeover switch enables either C or the combination of C_1 and C_2 to be introduced at will. These condensers are in parallel with the neon lamp, and to complete the circuit we have a source of H.T. supply and a pair of headphones.

Duplicating the Components

Having explained the theoretical circuit, we are now in a position to turn our attention to construction.

* *

A Philips beehive type neon lamp of the low-voltage class, which is used in the Capacimeter.

* *



In accordance with usual practice, and for the benefit of those readers who wish to duplicate the Capacimeter in every respect, I am including a list of the components employed. Since compactness and panel space is a

or naturally this will crack and render the lamp useless. When warm, the cap can be pulled away gently if held with pliers.

Then remove the resistance element and refix the brass cap in position with some suitable cement such as seccotine, plaster of paris, &c., after first of all resoldering the leads to the cap contact points.

A Note of Warning

Let me issue a small note of warning here to the effect that once the ballast resistance has been removed care must be taken to ensure that the neon lamp is not used in the ordinary house lighting mains socket. If this does happen the lamp will not subsequently function satisfactorily in the unit.

Returning once more to the assembly of the components on the panel you will notice that the operation of the Cyldon variable condenser is effected through the medium of a well-finished 4 inch dial supplied by the condenser makers. The advantage of this plain dial will be made apparent when you undertake measurements with this unit as I shall describe later. Furthermore there is a 180 degree scale, and these finer divisions, when compared with those of a 100 degree scale, will enable you to note the condenser reading with greater accuracy. This is very important in measurement work.

Facilitating Logging

Accurately centred at the top of the dial is a nickel plated indicator which tapers to a fine point, and in this way facilitates the "logging" of the scale degrees when testing. If preferred, this indicator can be dispensed with and a line about half an inch long marked on the panel. This should be on the centre line, and made with a sharp-pointed scribe. The narrow incision in the panel can then be filled carefully with white enamel paint so as to stand out boldly against the finished shiny black surface of the panel.

Note that the two red indicating terminals situated below that marked H.T.+ on the left of the panel are for joining to the resistance whose ohmic value is to be determined. Similarly the two black indicating terminals below H.T.— are for connecting to the condenser whose capacity is unknown.

All in Readiness

In mounting all the Belling-Lee terminals see that the proper size hole is drilled, and do not forget to "nick" the bottom of the panel hole so that it engages with the triangular projection on the terminal moulding. This effectively prevents the terminal rotating when making a firm grip on any wire connections.

The neon lamp is mounted inside the lid of the box housing the unit and in consequence is not shown on the panel layout.

All is now in readiness for the wiring which will be found quite straightforward.

(To be continued.)

Memorial to Sir J. W. Swan

We understand there is a movement on foot to recognise in some tangible form the work of Sir J. W. Swan. This will take the form of a bronze tablet which will be erected in Sunderland Central Public Library, Museum and Art Gallery, while in addition there is to be founded a National Swan Memorial Scholarship in Electrical Engineering Science.

Amongst British inventors few, if any, have shown greater versatility and a wider range in the flight of their inventive ideas and actual achievements than Joseph Wilson Swan (1828-1914). During his long and laborious life Sir Joseph Swan made many discoveries and inventions, but in two fields of scientific and industrial developments his inventive genius may justly claim special recognition and his name stands out pre-eminent. Firstly, in the development of practical photography and processes of photographic printing; and, secondly, in the invention and introduction of a practical lamp for incandescent electric lighting.

He was more than an inventor, he was an outstanding example of the true philosopher and lover of knowledge. At all times of the most modest and unassuming manner, his nature was one of considerate gentleness, graced by chivalrous courtesy. To everyone who came in contact with him he never failed to give of his best. He was the embodiment of generosity.

A CORRECTION.

In the list of components given for the Output Controller described by William J. Richardson in the February issue, the specification of one Colverstat, 5,000 resistance (Colvern, Ltd.), was inadvertently omitted. Will readers please make this correction on their list so as to avoid confusion?

In addition the last three diagrams were transposed. The diagram Fig. 5 should appear over caption of Fig. 4, the diagram Fig. 6 over caption Fig. 5, and the diagram Fig. 4 over caption Fig. 6.

BELLING-LEE TERMINALS

Specified for the
"CAPACIMETER."

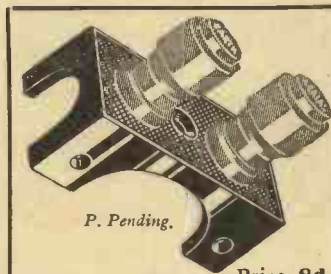

P. Pending.

Price 8d.

NEW BELLING-LEE TERMINAL MOUNT

Takes two terminals of any type and mounts them anywhere, anyhow—vertically or horizontally. The free Belling-Lee Handbook "Radio Connections" describes some of its many uses.

Mr. W. J. Richardson uses Belling-Lee Terminals, type "B," for the "Capacimeter" described in this issue. Belling-Lee Terminals are available in 36 letterings and three types, and fill the needs of every radio constructor.

Type "B" . . . 6d.
" "M" . . . 4½d.
" "R" . . . 3d.

WRITE FOR THE FREE
BELLING-LEE HANDBOOK
"RADIO CONNECTIONS."
(2nd EDITION.)

BELLING-LEE
FOR EVERY RADIO CONNECTION

Belling & Lee, Ltd., Queensway Wks,
Ponders End, Middx.

Television in France

Details of a very important development which has just taken place on the Continent.

TELEVISION, and more particularly Baird television, made a great step forward when negotiations were completed recently for the formation in France of a company under the name of "Télévision-Baird-Natan," to develop and exploit the inventions and patents of Baird Television Limited, in France, Belgium, Luxembourg, and in the French and Belgian Colonies.



A small section of the equipment employed in the Baird laboratories, where concentrated work is taking place in television development.

The formation of this company was the outcome of the negotiations between Baird Television Limited, their licensees, Mm. Robert Lyon and A. T. Stoyanowsky, and the famous Pathé-Natan group, which includes the Pathé Cinema Company of France (formerly Pathé Frères).

As an indication of the speed with which this new combination is working it is interesting to note that the broadcasting of television is already about to

commence for two hours daily from the Radio-Vitus station, and this broadcasting time is to be extended to three or four hours daily in the near future.

Constitution of the Board

The Board of the new Television Baird-Natan Company is constituted as follows:

President	Monsieur Natan
Vice-President	M. Emile Natan
Managing Director	M. Lemoigne
Directors and Managers	M. Robert Lyon and M. A. T. Stoyanowsky

Among the personnel is Monsieur Thomas, who has for several years occupied an important position on the engineering staff of the Pathé Cinema Company, and has now been appointed Engineer-in-Chief to the new Company.

The Radio-Vitus Broadcasting Station was recently purchased by the Pathé-Natan group, and further rapid developments may therefore be expected. This station was formerly situated in Paris itself, but has now been moved to a new and enlarged site in a suburb called Romainville.

Experiments will be made to ascertain the most suitable wavelength for television transmissions. At the outset the transmissions will be on 313 metres, and all available wavelengths will be tried in turn, and it is possible that eventually a wavelength in the neighbourhood of 220 metres will be decided upon.

Another Television Programme

The Pathé Company is too well known to need any introduction to our readers, and this powerful combination will undoubtedly do much to forward the advance of television in Europe. The new French Company will work in close co-operation with the Baird Company in England, and its associated company, Fernseh A.G., in Germany, and reciprocal visits between the principal engineers are being arranged to take place at frequent intervals.

The commencement of broadcasting through Radio-Vitus will add another television programme to the ether, and the transmissions will be from a standard Baird transmitter, so that the programmes will be receivable without modification on an ordinary commercial Baird "Televisor," equipped with a suitable wireless receiver.

"Television's" Third Birthday

ACTIONS speak louder than words"—the time-honoured platitude has an invigorating sound, suggestive of progress. And upon this occasion, the third birthday of the TELEVISION magazine, it has a special application. We are daily subjected to such disparaging criticisms in the press as "television is still in the laboratory stage," or prophecies to the effect that "it will be another ten years before television is a commercial proposition." These are the "words," the grudging opinion of a few sceptics, but what of the "action"? What of the many amateurs who, by their untiring efforts, are making television history, who are coming in at the beginning with all their inventive powers and assisting the laboratory experts by records of their personal experiences?

Gallant Experimenters

It is for these gallant experimenters that the TELEVISION magazine is most specially designed with its constructional articles, correspondence columns, and fine "Enthusiast" series. And what a good magazine it is, how excellently it sticks to the point and refuses to court popularity by irrelevant features. Television is a technical journal and, as such, gives undivided attention to the subject which affords it a title. It is, also, an all-British journal and, in consequence, a natural prominence is awarded to the true inventor of the new science, John Logie Baird. One-sided some people may term this, but too often the claims of extraneous systems are given preference and cause the public to forget the real genius behind a thing.

TELEVISION—during its lifetime, and it promises to be a long one—will always sing the praises of British achievement, which Britishers,—alas!—too often appear to forget.

TELEVISION is perhaps not a well-known paper with the general public. People are too prone to shrug it off with the excuse that its technicalities will puzzle them. This is only in a measure true, for in every issue articles of a simple character are included, and others of general interest. Development, development, development has been the cry of the last months, and it behoves everyone who considers himself an educated person to know what has been occurring in the television world.

A Rare Opportunity

New books, new plays and new films by well-known authors and artists arouse the curiosity and receive the support of the public, then why not the new achievements in the science of television, which promises to play a large part in the future of entertainment. Are we to believe that people are so sunk in stupor, so unprogressive, and conservative that they will not make use of an opportunity to learn

something fresh?—and what an opportunity the TELEVISION magazine offers them, at the negligible price of sixpence a month.

So often one hears the dispiriting words, "I simply can't understand how they televise people, it's beyond me." A strange confession to make and really one of failure. A truer statement would be, "I can't be bothered to inquire into the matter." This attitude prevents many from explanations, from guiding the victims of it, as one might intelligent and eager people, to the best source of information, the magazine, and yet from all accounts its sales continue to rise and its reading public stretches over the entire world. This makes one realise that there are still pioneers in the old world and that they didn't die a natural death with those who sailed to America in the *Mayflower*.

Readers of TELEVISION, who have proved themselves satisfied with its pages, are given a rare chance. Become missionaries of the gospel of the new science, and spread it amongst your friends. Don't take refusals, inspire others with your own fire and enthusiasm, and in this way help both them and yourselves to a fresh and absorbing interest in life.

R. M.

EXPERIMENTERS'

SCANNING DISCS

STANDARD - 20½-INCH
ALUMINIUM - 30-HOLE
BRASS-BUSHED

12/6

When ordering please remit sufficient to cover postage; also please state size of motor spindle.

30-TEETH MILD STEEL PHONIC WHEELS, 9/-
FIELD COIL MAGNETS:—
WOUND 36 S.W.G. 6/- EACH. WOUND 40 S.W.G. 7/6 EACH.

TRADE ENQUIRIES WELCOMED

S. LEE BAPTY
60, CRAVEN PARK ROAD, N.W.10
WILLESDEN 7084.

Consult us regarding—

AUTOMATIC MOVEMENTS
EXPERIMENTAL WORK
STAMPINGS
PRESSINGS
CASTINGS

ELECTRICAL MACHINES
EXPERIMENTAL WORK

Attention to the High Tension

PART III.

By *H. J. Barton Chapple,*

Wh. Sch., B.Sc. (Hons.), A.C.G.I., D.I.C., A.M.I.E.E.

HAVING dealt with "dry and wet" H.T. sources we are faced with finding the best solutions for those situations where some form of electrical power is available, either as D.C. or A.C., of any voltage within the usual limits.

Taking D.C. first, undoubtedly one of the best methods of securing a reliable H.T. supply of sufficient output voltage and current is to use "rotary transformers." With D.C. we cannot step-up the voltage by ordinary transformers which prove so convenient with A.C., and in consequence the recourse to machinery is inevitable. Machines are available which will run from an L.T. accumulator or D.C. mains, and will produce an anode supply at any desired voltage. Again assuming D.C. mains are available, a rotary transformer can be obtained which will run from these mains and give a low-tension output for valve filaments.

Anode Converters

For example, the M-L anode converter provides a perfectly smooth anode current, and will successfully replace existing dry or wet batteries if so desired. As will be pointed out later in dealing with wireless receivers of a very sensitive type, one or two precautions are necessary when installing a rotary transformer, but generally it can be used in conjunction with the set in exactly the same manner as a battery.

In conducting a very large number of television

experiments I have been impressed with the efficiency of these rotary converters, and a few notes concerning their construction and use will, therefore, be very appropriate in a series of this nature. Taking one range of the M-L machines previously referred to, we find that they consist of a small permanent magnet rotary transformer and smoothing apparatus, mounted in an aluminium case. The field comprises two bar magnets with laminated pole shoes. There are two windings on a laminated iron core for the armature,

these windings being brought out to separate commutators at each end.

Voltage Step-up

The L.T. or input side of the machine takes current from the available source of supply—L.T. accumulator, private house D.C. plant or D.C. mains. In this way the machine rotates as a D.C. motor, and induces an E.M.F. in

the H.T. or secondary winding which is proportional to the number of turns of the secondary winding and the speed. Now, since the speed of the machine is proportional to the primary turns and input volts, it is seen that the step-up in voltage will be approximately in the ratio of the turns. Some models are enclosed in an aluminium case to deaden mechanical noise and ensure perfect screening. A complete smoothing circuit is also included to suppress any ripple across the H.T. terminals of the machine, and to prevent high-frequency radiation from the machine which could be picked up and cause disturbances in the loud-speaker or spoil the television images.



A section of the workshop located in the Baird Laboratories in Long Acre.

An Expedient

On occasions it may be found expedient to use the same accumulator for running the anode converter

television purposes. If your receiver is highly sensitive, however, then it may be found necessary to include further condensers over and above the normal smoothing apparatus which is supplied with the

* * *

The Stanfield Universal Converter which was tested by Mr. Barton Chapple and gave good results.

* * *

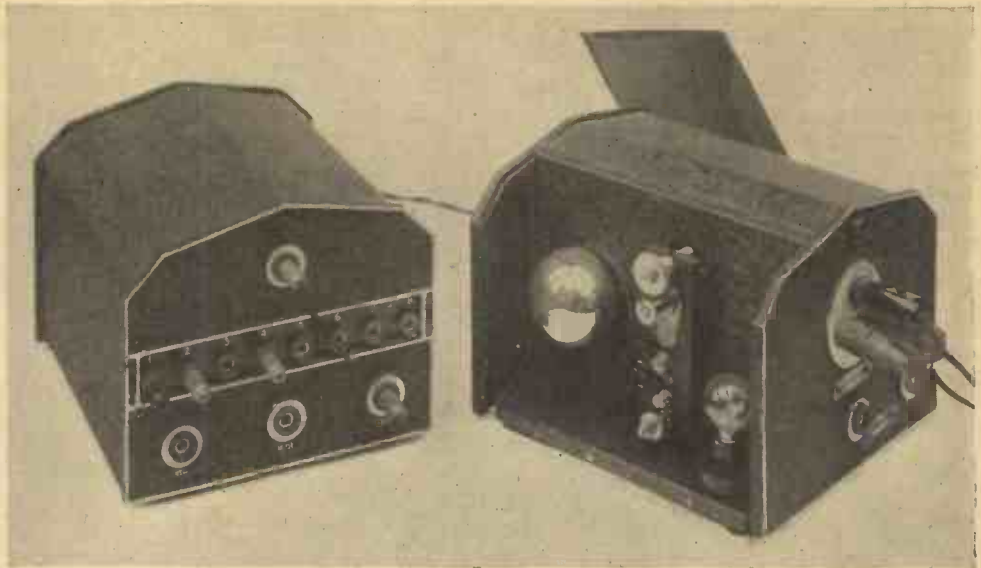

and supplying the valve filaments of the wireless set. Under these circumstances there is the possibility of a small ripple being impressed on the filaments due to the ripple transferred to the battery voltage by the input side of the machine. This defect can be eliminated by fitting low-frequency chokes in the input

machines. For example, if a "frying" noise is heard in the case of loud-speaker working, a silent background is obtained by connecting 1 mfd. fixed condensers between the input positive terminal and the output positive terminal, and also between the input negative terminal and the output negative terminal. A reference to Fig. 1 shows a very complete smoothing scheme which should overcome any trouble.

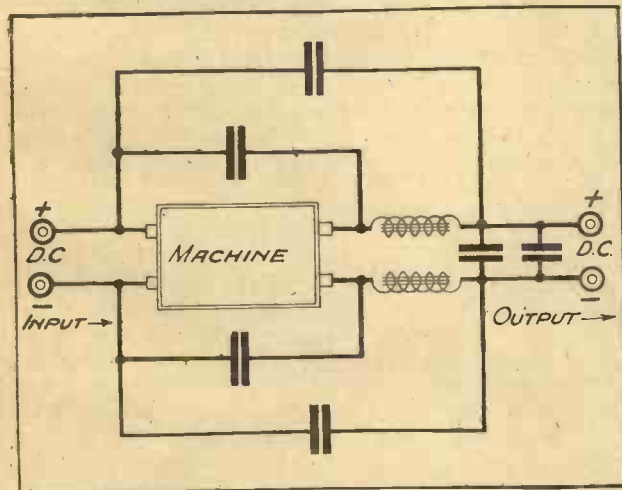

Fig. 1—A very complete smoothing scheme which will cure any difficulties which may arise.

leads. In some situations for television working it is also found advisable to employ lead-covered conductors for the connecting leads, and this covering should be earthed.

Adequate Smoothing

One of the accompanying illustrations shows an M-L model which has proved very satisfactory for

Future Developments

There are several first-class firms who specialise in these rotary transformers, and, in addition to the one previously mentioned, I can call to mind the equipment supplied by William Bayliss, Ltd. They make a very comprehensive range of machines, and are always willing to build apparatus according to individual requirements. Frequently this is of great advantage to the experimenter who is anxious to lay down plant with an eye to future developments, and yet finds it impossible to meet his demands from stock products.

A Stanfield Converter

I can call to mind other forms of H.T. supply which are of use for D.C. inputs, but at the moment I shall confine my remarks to a rather ingenious scheme which intrigued me considerably when I recently examined and tested the apparatus embodying the principle. I refer to the Stanfield Universal Converter. So far I have only been able to test the arrangement for voltages and outputs which are not sufficient for working in conjunction with vision apparatus, but, in view of possible future developments, to bring the apparatus within this category it is not out of place to dwell on the principles involved.

The Action Described

An accompanying photograph shows you the appearance of the two units which together go to make up the complete Universal Converter. The electrical action which is taking place may be briefly described in this way.

A vibrator, or specially-designed contact breaker, operates in the leakage field of a transformer for the purpose of breaking up or causing the current in the primary windings of the transformer to become intermittent. This results in the secondary windings passing a high voltage unidirectional current which is supplied to a rectifying valve. The top of this valve is seen in the illustration previously referred to. Then the output from the valve is passed to the smoothing box (the left hand unit) after which it is suitable for serving as a source of high tension for the wireless receiver.

Main Features

Anent the specially designed contact breaker fitted to the Converter, its main features are:—

- (1) That it must not be able to stop on contact.
- (2) That the periodicity of the blade shall be as far as possible constant, irrespective of the current that is being passed over the points.



Due attention to the high-tension (and low-tension) supply is paid by the Baird Co., judging by this photograph of a section of their battery room.

The first feature is brought about by mounting one contact on a light spring blade, biased lightly against a small rubber buffer. This said spring is mounted on the main vibrator and normally follows its movement. In the event of the contact points showing any tendency to stick, the main reed or armature will continue its movement towards the transformer, bringing into operation a small stud which acts as

trigger. This causes the points to be broken and the lost motion is picked up.

Constant Periodicity

Coming to the second feature, namely, maintaining a constant periodicity of the vibrator, reed, or armature, this is affected by turning a large brass-milled knob (located at the top of the contact breaker)



One form of M-L anode converter which has proved such a reliable source of H.T. for television purposes.

to left or to right. On examination, the whole contact breaker will be found to move bodily backwards or forwards. This action causes more or less current to pass over the contact points, the reason being that the farther away the armature is from the transformer the greater the magnetism required to break the points, thus resulting in more current being passed through the transformer windings or vice versa.

For D.C. or A.C.

In actual practice the Stansfield Converter may be operated from a 4 or 6-volt accumulator supply and also from 220/240 A.C. 50 to 100 cycle lighting mains. Furthermore, the smoothing box can be employed as a D.C. unit from 200/240 D.C. mains. When used with an accumulator both units are in service, and by following the issued instructions I was able to obtain a smoothed output voltage of about 120 volts when a current of 15 milliamperes was passing.

Special sockets are provided when the unit is used direct on A.C. mains, and, of course, both A.C. mains and accumulator must not be connected at the same time. From my work on the Stansfield Converter I am led to the conclusion that the ingenious ideas included in the apparatus are very promising, and it is for this reason that I have included a description at this section of the series. Next month we shall devote our attention to A.C. mains and find how conveniently they can be pressed into service as a source of high tension for television purposes.

A Sunderland Enthusiast's Experiments

(Reprinted from the *Sunderland Echo*.)

NOT so very long ago I read an article by Capt. P. P. Eckersley, the former B.B.C. engineering chief, in which he stated the considered opinion that the transmissions by the Baird system of television had been very little improved.

I took his word for it, and cast aside all thoughts of returning to experiments for years to come. I imagined that the ghostly images I had seen on the screen some two years ago, dancing shadows which gave one a weird feeling while sitting watching in the dark, was as far as they had got.

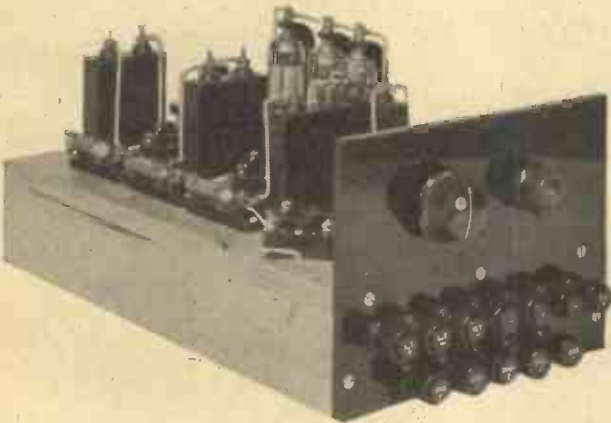

Two views of a special resistance capacity coupled amplifier described in our magazine a year ago (March, 1930). It is capable of producing first-class television images.

But I have proved my imaginations to be entirely wrong. In Valebrooke Avenue, Sunderland, there lives a young Durham School student who is steeped in the experimental ideas of television. He is Mr. F. G. R. Palmer, the son of the head of the well-known firm in the Arcade and St. Thomas Street, wireless and musical instrument factors—in fact, universal providers.

Young Mr. Palmer, I am told, developed his interest in television during last summer and directly as a result of the Baird demonstration brought to Sunderland for the first time by *The Sunderland Echo*. Now he has a technical knowledge which makes some of us older wireless enthusiasts pale.

At Mr. Palmer's invitation I visited his home in Valebrooke Avenue to renew acquaintance with television. He is working his Baird "Televisor" set in conjunction with a Philips de Luxe A.C. mains receiver—two screened grid, detector, and L.F. power

output. I envy him that set. Its reproduction upon a Philips loud-speaker is particularly fine, but to get the best results with the "Televisor" one is supposed to use two or three stages of R.C. amplification.

Nevertheless the results during the half-hour I watched and listened to the Brookman's Park transmission proved to me that Capt. P. P. Eckersley is wrong—television transmission has improved beyond measure. It is as far from being perfect as we were ten years ago when we were using the old S.T. 100 to receive signals, but the day may come when we can sit in our homes and watch an English Cup final.

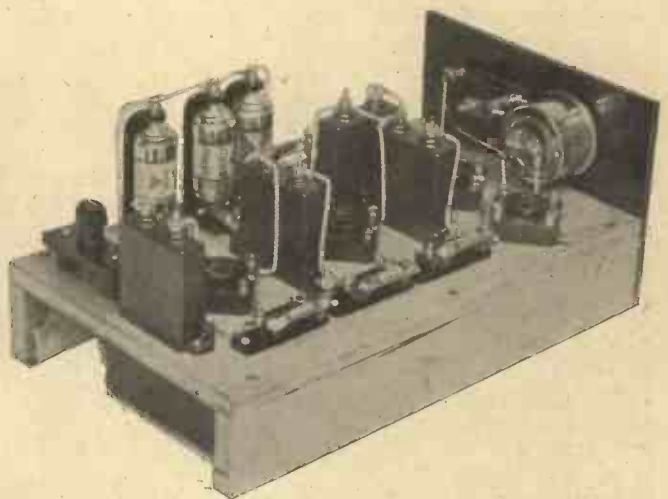

On the Brookman's Park television wavelength there was a lot of "jamming" through Morse signals, but synchronisation was fairly good for a daylight transmission, and Mr. Palmer was able to hold the picture of the announcer or singer for long periods. It was difficult to get the ghostly shadows from under the eyes of the speaker or the singers, but both speech and photography amazed me. When the following day's programme was sent over every word could be read.

Mr. Palmer is not only to be congratulated upon his enthusiasm, but also upon his results. He worked both the vision and the speech set from the same aerial, the current for the neon tube being supplied from a B.T.H. power unit. The monthly periodical, TELEVISION, is a favourite paper with him, and he considers that by supporting it the technical experimenters have an incentive to get "something done"—not hurriedly, but slowly and surely.

J. A.

Studio Topics

THERE is no doubt about the popularity of television broadcasting amongst those members of the theatrical profession who come to the Baird Studio. Of course it is something new to them, and no doubt the novelty of it has a very definite appeal. After all, their existence depends almost entirely upon change of environment. They are, in most cases, in and out of engagements year after year, and are of the type that could not live happily on a more or less humdrum routine.

Artistes like Television Broadcasting

Variety is the spice of life to them, and as each successive engagement draws to a close they often become despondent, but are buoyed up with the hope of something new, perhaps the chance to play a leading part in a new play, which, ultimately, might lead to that elusive top rung of the ladder. That is the star they are always following, for otherwise they could not overcome those too frequent moments of depression that inevitably occur when employment is scarce.

In these days of the talkie boom there is no glut of engagements, and this has left its mark in the ranks of the profession, already much overcrowded. So this new wonder called television opens up a fresh road to them, offering such chances as there are to



No matter where Baird Television is shown to the public, an enormous amount of interest is displayed.

those who care to take them. It is an outlet of great significance, and, as time goes on, will assuredly increase in magnitude.

The appeal of this new work to the artiste may be,

and quite likely is, its mysterious aspect. It is ever a source of wonderment to them that their images and movements can be seen by an audience many miles away. Their imaginations are stirred by such a "miracle" (to quote their own word), and they display a keenness and zest to become efficient, and a determination to learn the technique of this new branch of entertainment.



The queues of old and young alike bear testimony to the wonder expressed at the achievements in this new science.

In an endeavour to give full value to the television image or, in other words, to broadcast a picture that will at once hold the attention, it is essential for artistes to follow certain hints, which have been compiled, not only for their benefit, but also with a view to promoting a high standard of picture interest. These hints, when properly adhered to, achieve results which are satisfactory in every way. Individual performances are considerably enhanced, and the picture gains at least 100 per cent. in point of entertainment value.

Characterisation

For the sake of comparison we will say, for example, that a succession of faces appear on the "Televisor," each one without make-up or other adornment. Now, however charming they may be to look at, or however well they may sing, there would not be that appeal to enthusiasts of television which make-up and characterisation in the artiste's performance would otherwise have given to it.

Recent transmissions from the Baird Studio have proved the desirability of this aspect of television broadcasting, for many interesting pictures have been seen. Quite a number of singers are now appearing with head-dresses, wigs and make-up as a setting for their songs. They are becoming accustomed to specialisation for television, particularly those whose professional engagements rarely take them beyond those concert platforms where make-up, character costumes and so forth are not often used.

In addition to these performers, many amusing and entertaining novelties, such as sketches, silhouette portraiture, mirth-provoking inventions, and a potted pantomime ("Robinson Crusoe"), etc., have been televised.

HAROLD BRADLY.

Recent Developments in Photo-Electricity

PART II.

By *H. Wolfson*, B.Sc., F. Telev.S.

WE will now proceed to the investigation of the glow discharge lamp photo-electric cell. In this connection readers would be well advised to study two previous articles* in conjunction with the present one, as it will help them to understand the facts better.

The circuits which are given provide a means whereby a light-sensitive device or devices may be obtained which can function as photo-cells, relays, oscillators or amplifiers. This in itself, when further developed, is a noteworthy achievement. We shall find that the devices can be coupled together in the same way as we couple radio valves to act as amplifiers, and there is no knowing where such developments may lead us.

The devices operating in any of these ways may be applied to all arrangements in which the electric currents are controlled or regulated by light rays. The discovery is based on the silent discharge which takes place in gas-filled glow discharge tubes, such as the neon lamp, which are sensitive to light under certain conditions.

We are fully conversant with gas-filled photo-cells used in conjunction with a thermionic current limiter for the detection of light, but with these it is only possible to work in the unstable portion of the characteristic, and, moreover, any variation in the current produces a variation in the frequency. Difficulties also arise due to the internal capacity of the cell and current limiter, which causes a sparking at acoustic frequencies, whilst the use of a thermionic valve results in the practical disadvantages associated with the one-way conduction common to all thermionic devices.

Using Glow Discharge Tubes

In this new device no thermionic current limiter is employed, and all the phenomena are perfectly stable and reversible. The working is the same as that of all devices oscillating regularly, and the frequency may be varied at will without changing the working value of the current.

To use a neon or like rare gas discharge tube as a light-sensitive cell it must be suitably connected with a resistance and capacity, and be supplied with an

electric current, whereby an intermittent discharge is produced in the tube. The influence of light on the discharge tube is then found to be very regular and stable.

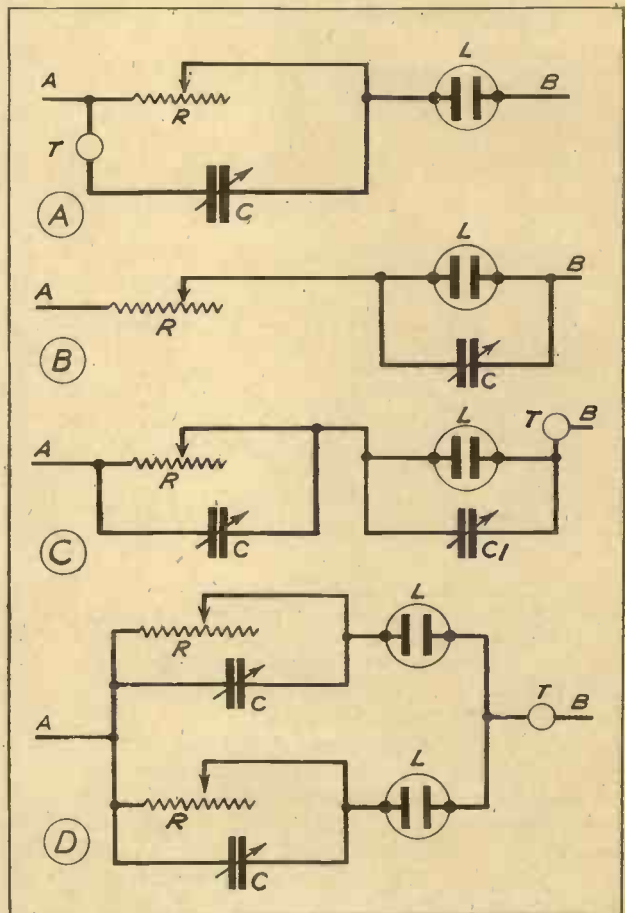

Fig. 1.—Refer to the text for details of these neon tube photo-cell currents.

The tube may have a condenser in parallel or may be connected in series with a high resistance shunted by a condenser, or may be at the same time connected with a condenser in parallel and a variable resistance shunted by a variable condenser connected in series.

* TELEVISION, No. 10, Vol. I., December, 1928.

TELEVISION, No. 15, Vol. II., May, 1929.

All of the above arrangements are characterised by a regular increase of oscillation current as a function of the illumination, and on the other hand by a decrease of current under certain conditions of illumination and adjustment, which may go so far as to cause the complete extinction of the illumination or oscillatory discharge. The region of working, as already mentioned, is perfectly stable (though oscillatory), and perfectly reversible as regards measurements.

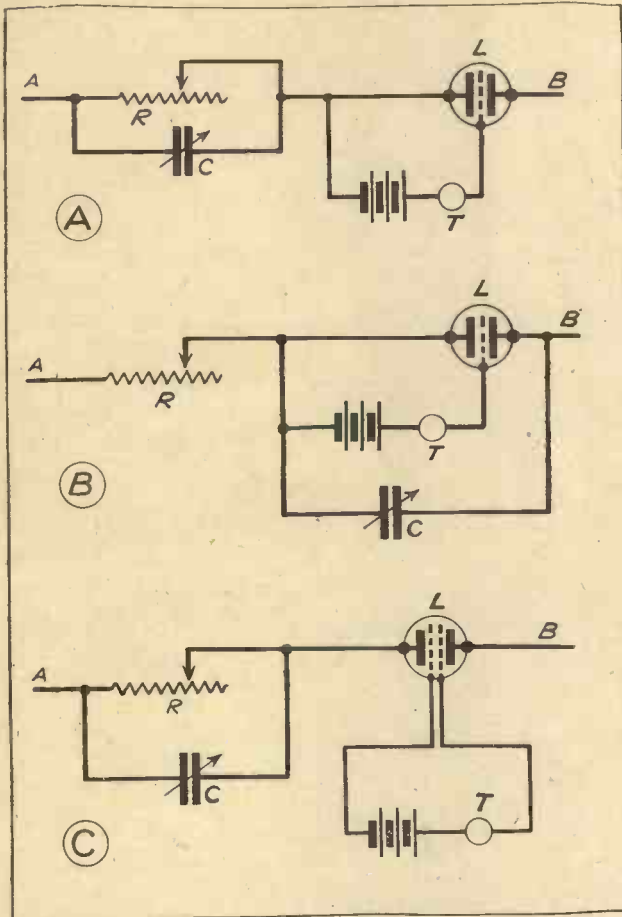

Fig. 2.—Where three or four electrode tubes are in use the above diagram shows how they can be connected.

Several Circuits

A number of circuits are given for two-electrode tubes in Fig. 1, while in Fig. 1 (d) two or more tubes are used to produce two or more independent oscillations acting on the telephone T. The tube L is connected in series with a D.C. source, R being a variable high resistance and C a variable condenser. AB is traversed by an alternating current which will have a constant frequency for a certain adjustment.

If the tube is illuminated progressively by a suitable source of light, the sound from the telephone varies in a continuous manner, and for a certain value

ceases entirely. The variations of intensity and frequency of the sound depend on the constants of the circuit AB. In almost all cases the progressive illumination of the discharge tube results in a considerable increase in the current flowing in the circuit, and the very feeble "dark current" increases in the ratio of 1:50 and more. This is much greater than with potassium vacuum cells and the like. For certain values of resistance and capacity it is possible to obtain a reverse effect, and illumination of the tube results in a diminution or total extinction of the discharge. As a result of the stability and reversibility of the device a certain value of illumination will always produce a definite intensity with a certain adjustment of R and C. This makes the device excellent for use in photometry. By using alternating current and unsymmetrical electrodes, whereby rectification to direct current results, it is possible to modulate the fundamental frequency of the resulting pulsating current at a frequency higher or lower than that of the feeding circuit.

Three- and Four-Electrode Tubes

In Fig. 2 (a) and 2 (b) we see the circuit for three-electrode tubes, while in Fig. 2 (c) we have a four-electrode tube. The 'phone may be replaced by a thermionic amplifier or relay if desired, or a plurality of these circuits may be interconnected, the output of one tube being connected to the terminals AB of another to produce circuit couplings similar to those used with thermionic low-frequency amplifiers. Where additional electrodes are used the feeding circuit is independent of the output circuit.

The colour sensitivity of the device depends wholly on the gas-filling, and the effect in turn depends on the pressure of the filling. When filled entirely with neon the cell is sensitive to the red region of the spectrum, and filled with argon it becomes sensitive to the blue end of the spectrum. Thus any desired sensitivity from blue to red may be obtained by suitably mixing these two gases. This device can replace the photo-electric cells at present employed in most of its applications, and has been used, experimentally, for transmission purposes, reproduction and recording of sound by visible and invisible rays, in photo-telegraphy, television, wireless telephony, and for the reproduction of talking films at a distance.

A New Physical Principle

It must not be thought that these cells are in any way "freak" cells, but there is much to be done yet in the way of research, more especially with the cuprous oxide cells and the neon lamp cells. There is nothing to hinder the keen amateur from carrying out experiments, and one is almost certain to find out new principles and applications.

It is interesting to note a new physical principle to which no previous reference has been made so far as the author is aware.

ADVERTISE YOUR NEEDS IN A TELEVISION "SMALL AD."

This is the connection between rectification of alternating currents and the photo-electric effect. It must be realised that in every case aforementioned the devices can function also as rectifiers. Cuprous oxide on copper is a well-known rectifier of alternating current used in battery eliminators, etc., while galena has been known for many years as a rectifier of wireless waves. There are a number of lesser known light-sensitive substances which also function as detectors

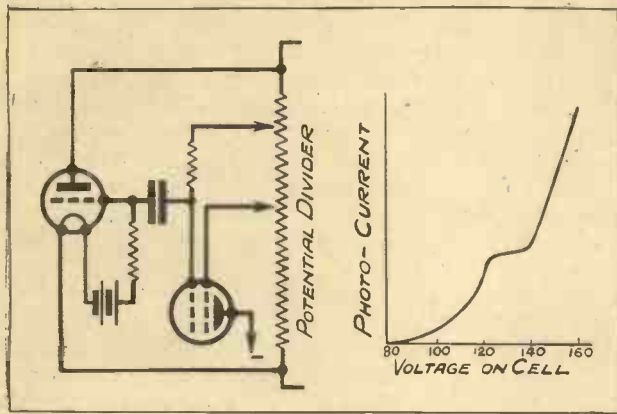

Fig. 3.—A screened grid photo-cell circuit together with a characteristic curve using 130 volts on the screen,

or rectifiers of wireless waves. Glow discharge lamps are also used as A.C. rectifiers, as in the Raytheon eliminator tube.

We realise, of course, the close connection between light waves and wireless waves, and it would seem that we can explain rectification and photo-electric effect in terms of one another, and by probing deeply we shall possibly be able to elucidate many of the mysteries which are wrapped up with both rectification and photo-electric effect.

Screened Grid Cells

Before concluding the article, it is advisable to draw attention to some very recent developments in connection with ordinary gas-filled potassium and other alkali metal cells. I refer to the so-called "screened grid" photo-cells, a development due to Richter and Geffcken. It is well known that in gas-filled cells, where the primary current is magnified by utilising the ionisation by collision effect of the gas-filling, that there is not absolute proportionality between photo-current and illumination. One needs to know the dynamic curve of the cell, not the static one, to find this out, just as in the case of thermionic valves. Thus to use ordinary gas-filled cells for television or talking pictures results in a lowering of the higher frequency response.

Working along the well-known lines of the design of the screened grid valve, these two workers placed an auxiliary grid between the normal anode and cathode, and maintained it at a definite potential. The results, though highly satisfactory, were different from what had been anticipated. A remarkable condition is noticed when the potential of the control

grid is increased from 100 to a value approaching the glow potential. At 100 there is no screening effect, but between 130-140 volts there is a portion of the curve which is practically horizontal, and the length of this horizontal portion is sufficient to enable full control of the three-electrode thermionic valve. The value of the auxiliary anode (screening grid) potential is fairly sharply defined, and for the cells already constructed a reduction of as little as 5 volts causes the horizontal portion to tilt about 20°. An increase of 5 volts from the optimum potential causes a similar tilt to the horizontal, but in the opposite direction. Fig. 3 shows the circuit for the screened grid cell, together with a voltage/current curve.

With the Television Lamp Screen in Stockholm

(Concluded from page 14.)

who finds it difficult to realise that it is just as difficult to transmit television over a distance of 100 yards as it is over, say, 10,000 yards. On the other hand, if the studio is in the same building, those of the spectators who care to do so are able to view the studio and control room, an experience which is often much appreciated.

With typical Swedish thoroughness, the theatre management made an exceptionally good job of the studio. This was a building about 6 metres long, 4 metres wide, and 3 metres high. It had a partition inside dividing off the control room from the studio proper, and all down one side was a row of observation windows, allowing spectators to see all that was going on. Both the studio and control room were lined inside and out with green pleated sponge cloth which, apart from being acoustically excellent, greatly enhanced the appearance of the structure.

Within a week of the studio being taken over by the Baird engineers a demonstration was given to the Stockholm Press, and the voluminous reports were extremely favourable.

The demonstrations were given twice daily for a fortnight, and many famous artistes and celebrities made their appearance before the "Televisor."

W. H. OATES

COMPLETE TELEVISION SERVICE

Our Depot affords unique facilities to those interested in Television. Our own transmitting apparatus enables us to give callers demonstrations upon request.

DEMONSTRATIONS

BETWEEN 9 A.M. AND 6 P.M.

THE BAIRD "TELEVISOR," ALSO HOME CONSTRUCTOR'S "TELEVISOR" KITS, SUPPLIED FROM STOCK.

Only genuine Baird components are supplied by us. We have a full range available of parts and accessories.

195, HAMMERSMITH ROAD, LONDON, W.6. RIV. 3342.

The Television Society

THE fifth meeting of the session was held at University College on February 11th, at 7 p.m., when a lecture entitled "The Stenode Radiostat and its Application to Television" was delivered by Mr. E. L. Gardiner, B.Sc., Fellow. A summary of the lecture is given below:

A stenode radiostat radio receiver suitable for broadcasting or television differs from conventionally designed sets in two fundamental respects only.

Firstly, the radio frequency circuits are made very much more selective than can be done in an ordinary receiver without producing a serious loss of the higher frequencies contained in the modulation; and secondly, the low-frequency amplifier is designed to have a rising frequency characteristic which compensates for the attenuation of these higher modulation frequencies, giving a final output which is a faithful reproduction of the original transmission.

It is important to realise, however, that the effect of this arrangement is in no way identical with that of an ideal band-pass filter circuit capable of accepting the same frequency band.

It is extremely difficult, in practice, to design circuits of low enough damping to make full use of the stenode principle, if at the same time these circuits have to be variably tuned over a wide band of frequencies such as the broadcast wave-lengths. Also it is not easy to stabilise such circuits on the short wave-lengths used in broadcasting and television. These considerations at once suggest the use of the superheterodyne principle, and this is in fact adopted in all the present designs of stenode receivers. It is then possible to incorporate the low decrement circuits in the intermediate frequency amplifier of the superheterodyne, where they can operate at a relatively low fixed frequency, and can readily be stabilised without the need of special precautions.

Reverting to the quartz crystal method of obtaining an extremely sharp resonance curve, the lecturer pointed out that means had to be taken to balance out by the use of a bridge circuit the shunting effect of the crystal holder and stray wiring capacity, as, in the event of this being neglected, the crystal is effectively by-passed by these capacities and its resonance curve is in effect greatly broadened.

Turning now to the direct application of the stenode to television, the lecturer indicated that simple models of the receiver now in use are capable of separating two radio transmissions of similar field strength when these differ in frequency by only five kilocycles instead of the nine or ten kilocycles which used to be considered essential, and this is done whilst maintaining all modulation frequencies up to five kilocycles or even higher.

Extending this process it would be possible to transmit a band of ten thousand cycles on an existing broadcasting channel only intended to accommodate

five thousand cycles, without interfering with the next adjacent channel. This process can be extended indefinitely as far as the stenode is concerned, since the doubling of the frequency band just mentioned is only a stage in the development of the invention, and is achieved without resorting to the use of quartz. Unfortunately, the use of higher modulation frequencies than those mentioned would result in serious interference to those still using old-fashioned receivers, and could not be tolerated at the present time.

Dr. Robinson is evolving a system of transmission which it is believed will be capable of reception only on stenode receivers, and which will be totally inaudible on ordinary receivers of relatively high decrement, thus producing no interference with existing services.

A complete report of the lecture will be issued in the Proceedings of the Society. The annual exhibition will be held in April at University College, London. Arrears of subscriptions should be forwarded to the Hon. Treasurer in time for the annual report to be read at the Annual General Meeting, to be held next month.

J. J. DENTON, A.M.I.E.E.,
Hon. Secretary (Members),
4, Duke Street, Adelphi, W.C. 2.

Lectures for March

Forthcoming lectures on television by Mr. J. J. DENTON, A.M.I.E.E. :—

MARCH 3RD, at 8 p.m.—Croydon Natural History and Scientific Society, Croydon.

MARCH 5TH, at 8 p.m.—Borough Polytechnic, Borough, S.E. Continuation of Course.

MARCH 9TH, at 3.45 p.m.—Mercers' School, Holborn.

MARCH 10TH, at 8 p.m.—St. Mark's Literary and Debating Society, Battersea Rise.

MARCH 12TH, at 8 p.m.—Borough Polytechnic, Borough, S.E. Continuation of Course.

MARCH 13TH, at 7 p.m.—Edmonton County School, Church Street, N.9.

MARCH 16TH, at 7.15 p.m.—Kingswood School, Bath.

MARCH 17TH, at 5.45 p.m.—Siemens' Engineering Society, Woolwich.

MARCH 19TH.—County School, East Sheen, S.W.4.

MARCH 24TH, at 3.30 p.m.—City of London School, Embankment.

MARCH 25TH, at 8 p.m.—Norwich Science Gossip Club, Norwich.

MARCH 31ST, at 7.30 p.m.—Northampton Radio Society, Northampton.

Cards of Admission can be had from Mr. J. J. DENTON, A.M.I.E.E., *Hon. Secretary* (Members), 4, Duke Street, Adelphi, W.C.2.

Reducing the Striking Voltage of Neon Lamps

By *Douglas Walters*

WHILE searching recently among various scientific publications for special information concerning neon lamps, some rather unusual applications of this form of glow lamp were found, of which the following may be of interest to the television experimenter who is directly concerned with this type of illumination.

Oschwald and Farrow describe a series of experiments carried out with an Osglim lamp, the striking voltage of which was found to be 164. Measurements of its frequency response showed that there was practically no lower limit, in fact they observed one discharge in 300 seconds. In the upper frequency register, however, by including inductance to increase the response, they obtained 95,000 flashes per second. This is interesting, inasmuch as the frequencies involved in present systems of television reception seldom exceed 30 or 40 kilocycles per second.

But what is probably of far more interest to the television amateur is the lowering of the critical striking voltage of a neon lamp by external means. Oschwald and Tarrant found that although 180 volts was the normal striking potential of the particular lamp used, it was possible by the application of X-rays to reduce this figure to 143. They also found that if the lamp had been idle for a considerable time, its striking voltage was even higher than 180, but once the discharge was started by some external means, it would continue at a lower voltage.

Another remarkable observation was that although 180 volts were required to start the discharge in the dark, exposure to light reduced the critical voltage to 164. Moreover, they asserted that the intensity of the light was immaterial provided it exceeded a certain minimum value.

Dr. Hopwood and Major Philipps* found that this lowering of the critical voltage provided an extremely sensitive test for detecting radioactive substances. Using a lamp which normally required 180 volts to start, they observed that 1 milligram of radium bromide, placed 6 feet from the lamp, reduced the striking voltage of the latter by 18, and at a distance of 27 feet, with 2 mm. of lead between, a discharge was started at 165.5 volts. Probably the most remarkable result was the detection by this method of radiations emanating from an X-ray tube situated 90 feet away. The lowest possible striking voltage obtained was 140.

* Proceedings of the Physical Society, 1924.

A reduction of only 40 volts of the striking-potential of the familiar flat cathode neon lamp would be of immense value to the average television enthusiast, who usually has only a limited H.T. voltage available.

In a series of experiments to verify these observations the writer has not yet met with any great success,

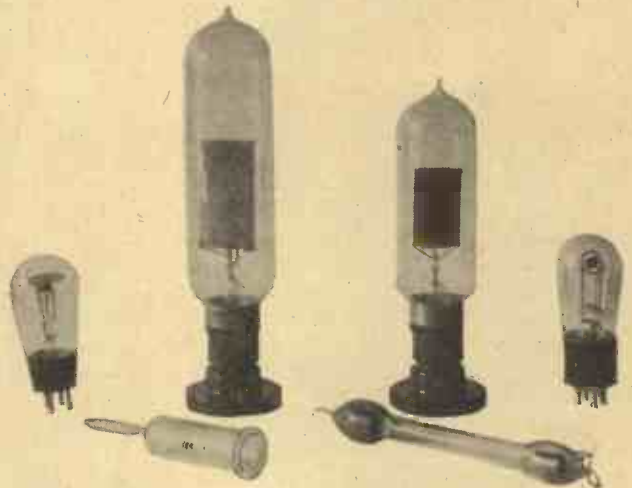

Various types of neon lamps which have played an important part in television researches.

but this is probably due to the radioactive substance used, of which very little is known at the present day.

In the "Physical Review" (1924), Vol. 15, some interesting data is recorded concerning the normal cathode fall or potential difference between the cathode and cathode glow, due to electrodes made of different metals and alloys.

L. LEAMAN
97, NORTHFIELD AVENUE
WEST EALING, LONDON, W.13
For Radio and Television
DEMONSTRATIONS
DURING TELEVISION TRANSMISSIONS
Baird Components Supplied
PHONE: EALING 5394 (MEMBER, TELEVISION SOCIETY)



TRADE NOTES OF THE MONTH

REPORTS ON APPARATUS TESTED

Bulgin Rheoswitch

MESSRS. A. F. BULGIN & CO., LTD., of Cursitor Street, E.C.4, have sent us a heavy-duty rheoswitch, Type A. for test and report. This component is designed specially for use in low-frequency amplifiers employing large H.T. voltages. Very often one is apt to overlook what happens in a wireless receiver or amplifier working with high voltages. When the apparatus is switched on suddenly, large surges of voltage are likely to occur, and this may not only damage the valves themselves but is quite likely to bring about breakdowns in choke or transformer windings and also in fixed condensers.

Strictly speaking, the correct procedure in cases of this character is to gradually and not suddenly render the valve filaments operative. When these filaments have, say, about a third of their normal current

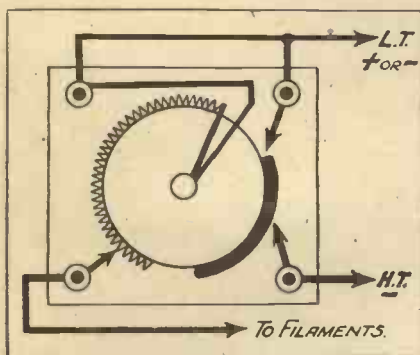

passing through them, the H.T. voltage can then be introduced suddenly without damage to the amplifier apparatus. After this the filaments may be brought up to their normal working current, the H.T., of

course, remaining on. Naturally when switching off the reverse process must take place.

In order to fulfil these conditions, Messrs. Bulgin have introduced their special rheoswitch. Four terminals are arranged, two being for the filament supply and two for the H.T. supply, and in the accompanying diagram is shown one method for

* * * *

*The Bulgin Rheoswitch
which performs an
important function when
switching on a high voltage
amplifier.*

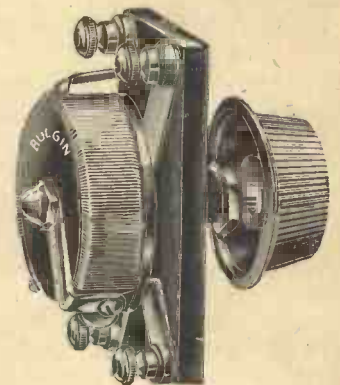

* * * *

*One way of
connecting the
Rheoswitch into
circuit so that
it operates in
the prescribed
manner.*

* * *

connecting the rheoswitch into circuit. In the product tested the insulation was of the highest order, and one-hole fixing was provided. Essentially it consisted of a rheostat winding for inserting in series with the valve filaments, a half turn of the switch knob cutting out the resistance. After about one-third of the knob's full movement, the H.T. circuit is made through the medium of a pair of contacts bridged by a metal strip located on the movable bobbin.

The component was found in every way to fulfil the maker's claims, and it should form an essential part of the experimenter's kit when he is employing voltages in excess of that normally required for ordinary receiver working.

Mullard P.M.1HL Valve

Following the recent introduction of the 2-volt power valve, type P.M.2A, which we reviewed last month, the Mullard Wireless Service Company has made a further addition to its 2-volt range, in Type P.M.1HL. The rated characteristics are given below:

Maximum Filament Voltage ..	2.0 volts.
Filament Current ..	0.1 amp.
Maximum Anode Voltage ..	150 volts.
*Anode Impedance ..	18,500 ohms.
*Amplification Factor ..	28.
*Mutual Conductance ..	1.5 mA/volt.
Retail Price ..	8s. 6d.

* At anode volts 100; grid volts zero.

It will be observed that the very high amplification factor of 28, and the low impedance of 18,500 ohms, gives a mutual conductance of 1.5 mA/volt, an unusually good figure for a valve of this class, and on test

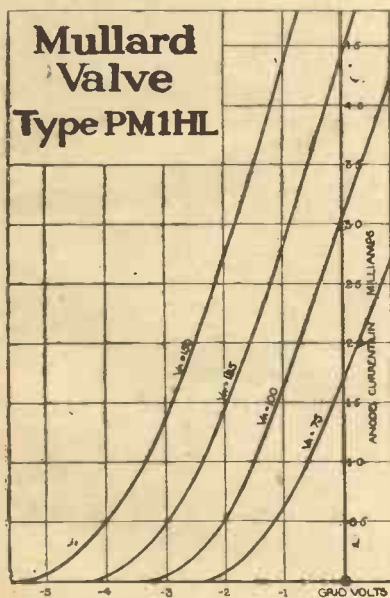

Interesting characteristic curves for the Mullard P.M.1HL valve reviewed in these columns.

the sample we tried gave figures very close to the rated values.

The advent of this new valve will be welcomed especially by owners of portable receivers comprising one or more aperiodic choke-coupled high-frequency stages, for which Type P.M.1HL is particularly suitable. The valve gives excellent results as a neutralised H.F. amplifier, in conjunction with carefully designed tuned anode circuits, and it is in this aspect that we perhaps find its best application in sets for receiving the television transmissions. It is also a most satisfactory detector for use before a high impedance, low current, low frequency transformer. As a low-frequency amplifier, Type P.M.1HL is at its best when followed by a resistance-capacity coupling employing an anode resistance of about 100,000 ohms.

Oldham H.T. Accumulators

We have had an opportunity of examining thoroughly some specimens of Oldham H.T. accumulators. It has been pointed out in these columns

that H.T. accumulators form a very satisfactory source of supply for television working. These accumulators are supplied in 10-volt units, the unit itself being made up from five separate 2-volt cells.

Oldham H.T. accumulators can be built up into neat and compact units as illustrated.



One noteworthy feature of these units is that they are air-spaced—that is to say air, one of the best insulators known, is permitted to circulate freely around the five glass cells composing the unit, and in this way electrical leakage is eliminated or reduced to the barest minimum.

The battery can be tapped every two volts, and a wandering terminal is supplied having a screwed knurled nut enabling a sound electrical contact to be made at each tapping. The units can be built up in 10-volt steps until the desired voltage is obtained, and, when required, oak trays, lids and bases are available to hold them neatly and compactly in position. Two types are listed, one with a rated capacity of 5,500 milliampere hours, and the other with the rated capacity of 2,750 milliampere hours. It is thus seen that these H.T. accumulators are in every way satisfactory for television purposes.

Sunlight at Home—New Invention to bring Health and Strength

A new invention has been placed on the market by Philips Lamps, Limited, which will enable jaded workers to turn on sunlight at will. They have introduced a lamp called the "Ultracol," which has been specially designed for home use, operating off the ordinary lighting mains, and consuming only 140 watts.

BE ON THE SAFE SIDE

BUY

**BAIRD
BRANDED
COMPONENTS**

BAIRD TELEVISION LTD.

133, LONG ACRE, LONDON, W.C.2

TEMPLE BAR 5401

We understand that the rays emitted by the "Ultrason" represent the nearest approach to natural sunlight, consisting of health-giving ultra-violet rays. An exposure of only a few minutes daily will give one a healthy tan and at the same time tone up the entire system. The "Ultrason" is quite safe in use, and can be used in nurseries without the risk of ill-effects.

A Multi-Purpose Terminal Mount

The Belling-Lee terminal mount is a very neat bakelite moulding designed to take two terminals of any make and particularly to accommodate the special non-rotating features of those manufactured by Belling & Lee, Ltd. In the samples we tested the moulding was of the highest order, and there are a multitude of purposes to which this mount can be placed by the experimenter. For example, it may be mounted either on its back with the terminals vertical or on its side with the terminals horizontal. In this way it is suitable for use at the back of the receiver cabinet for sub-panel or normal baseboard work and, of course, it can be mounted on the baseboard so that the terminals are actually inside the cabinet back and not protruding through it.

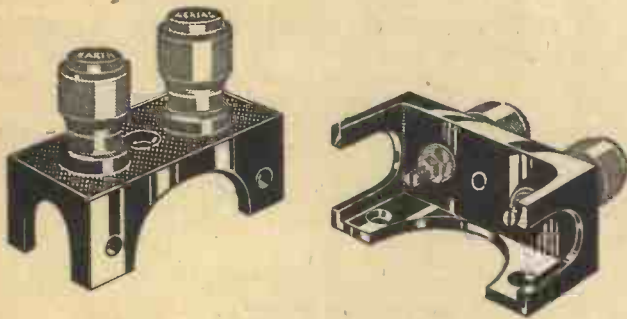

It is quite apparent that the Belling-Lee Terminal Mount has been designed for maximum utility.

Other examples which occur to us are for extension wiring so that a pair of terminals can conveniently be mounted under the mantelpiece, on the skirting board, picture rail, etc. Being of such a handy nature, the experimenter will find these of special benefit when he is undertaking "hook-up" tests, for by pressing the component into service he is able to make quick but efficient connections thoroughly insulated.

Gecophone Portable Set Price Reduction

The General Electric Co., Ltd., announce that the "Gecophone" portable screen grid four-receiver has been reduced in price from twenty-one guineas to fifteen guineas.

This announcement is sure to be received by the public with more than usual interest on account of the fact that this receiver is a modern portable set design, and should give a further stimulus to the sales of one of the most popular products which have yet been put on the market under the "Gecophone" name.

Cossor Detector Valve

In our January issue we drew readers' attention to the fact that Messrs. A. C. Cossor, Ltd., had introduced a special 2-volt detector valve which they claimed was completely non-microphonic. They claimed that they had overcome this trouble by evolving a method of gripping the valve filament in seven places by means of a spiral spring and minute porcelain covered hooks. The rated characteristics of the valve are as follows:—

Filament Volts	2 volts.
Filament Current	·1 ampere.
Max. Anode Volts	150 volts.
A.C. Resistance	13,000 ohms.
Amplification Factor	15
Mutual Conductance	1·15 mA/V.
Retail Price	8s. 6d.

In the samples we have now tested we found that the results were very consistent and gave figures closely approximating to the rated values. When used in the position normally designed for, namely, as a detector valve, it functioned well either with grid leak or anode bend working. The outstanding feature, however, was the way in which it reduced and very often eliminated those microphonic troubles frequently found in receivers, especially those of the portable class. It is for this reason that we can confidently recommend the valve to the attention of readers.

A New Home Recorder

We have had an opportunity of testing a new type of home recorder, the "Kingstophone."

We hope to give a complete account of the apparatus in our next issue, but for the present we would say that the "Kingstophone" shows in many ways a distinct improvement over other types of home recorders. One of the best features is that one of the models enables listeners to make records of any broadcast item. The significance of this feature need not be pointed out to television enthusiasts, who will at once appreciate the facilities opened up for vision recording.

Prices are attractive and within the reach of everyone, and we advise readers to see a demonstration if possible; these are given at 245, Tottenham Court Road, London, W.1. Full information can be supplied by post to readers who write to the Kingstophone Co., Ltd., 91, Tottenham Court Road, W.1.

*Have you seen our new
feature of*

"TELEVISION SMALLS"

Turn to page 39 and then supply us
with your ad.

LETTERS TO THE EDITOR

The Editor does not hold himself responsible for the opinions of his correspondents. Correspondence should be addressed to the Editor, TELEVISION, 505, Cecil Chambers, Strand, W.C.2, and must be accompanied by the writer's name and address.

FLAME MODULATION.

To the Editor of TELEVISION.

DEAR SIR,—There was in the correspondence columns of the December issue of TELEVISION an interesting description of a method of modulation of a gas-light flame by the passage of gas through a chamber having an oscillating diaphragm as one wall. It was stated in an editorial note that the flame failed to respond as required, and apparently the method has been abandoned. But, if workable, it has such obvious advantages that it is worth further consideration.

No details of the size of the diaphragm are given. If it were greater than a few inches, the diaphragm would fail to vibrate as a whole, and very little modulation or change of gas pressure would result at high frequencies. It is well known that a large cone or flat disc of some 6 to 10 in. diameter "breaks up" and vibrates in sections at high frequencies, as shown in Fig. 1. The nett change of volume in a chamber attached to such a diaphragm would be very small or zero. For the change of volume and the change of gas pressure to be proportional to the amplitude of impulses applied to the diaphragm, it (the diaphragm) should be small enough to vibrate as a whole even at high frequencies. A possible arrangement taking the above factors into account is given in Fig. 2.

A further comment suggests itself. A change of gas pressure changes the size of a bare flame rather than changes its intensity, and due allowance must be made in the optical parts of the vision apparatus to allow for this. Possibly a slit system could be devised to convert variations of height of flame into variations of intensity. Alternatively, a gas mantle might be used, in which variations of gas pressure produce directly the requisite change of intensity.

Yours faithfully,
E. G. BOWEN.

Physics Dept., University College of Wales,
Singleton Park, Swansea.

January 19th, 1931.

OVERLAPPING BANDS.

To the Editor of TELEVISION.

DEAR SIR,—With reference to Mr. Cato's letter on overlapping bands, it is interesting to point out that this system is covered in the Baird patent on three-

colour television, the three colours each overlapping one-third. In the patent it mentions that "this system may also be used with monochromatic television." The patent referred to is No. 328389, of 5th June, 1928.

Yours faithfully,
H. J. BARTON CHAPPLE.

London.

January 30th, 1931.

ATOMIC THEORY.

To the Editor of TELEVISION.

DEAR SIR,—Your contributor, Mr. James Scott, is, no doubt, an expert in the science of crystallography, but his article, in the January issue of your excellent paper, entitled "The Crystallisation of Selenium," leaves one with very grave fears as to his knowledge of the most rudimentary facts of atomic theory. In fact, some of his remarks are so completely misconceived as to be meaningless.

What, for instance, does he mean by "positive electrons"? This is a contradiction in terms. The electron is the unit of electricity and always carries a negative charge, while the corresponding positive unit is the proton. Further, what sense is there in the statement that "negative electrons are straight while positive electrons are wavy." It is almost impossible to make head or tail of this, but possibly

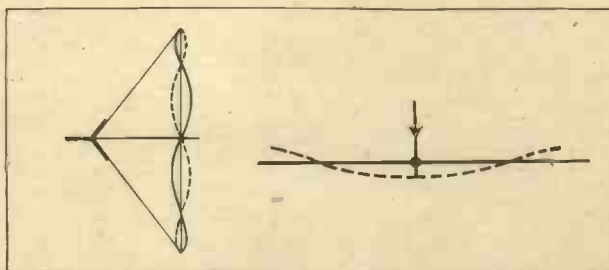

Fig. 1.—Mr. Bowen indicates how the cone or disc vibrates in sections at high frequencies.

what he refers to is C. T. R. Wilson's cloud-expansion method of making the paths of electrons and protons visible in an ionised gas. What this has to do with the crystallisation of selenium beats me. Modern X-ray analysis of crystal structure has indicated that the lattice may, in certain cases, consist of orderly arrangements of positive and negative ions, e.g., atoms which have lost or gained electrons respectively,

and presumably this is what underlies Mr. Scott's remarks; but who could have suspected that positive ions could be distorted into "positive electrons"?

The technical articles in your paper are of a high standard, as a rule, and as a reader from the first number I feel it my duty to point out such a set of confusing and careless misstatements which deviate from this standard.

Yours faithfully,
J. BALFOUR STUART.

149, Dalkeith Road, Edinburgh.

January 21st, 1931.

A READER BEGS TO DIFFER.

To the Editor of TELEVISION.

DEAR SIR,—In your issue of January, 1931, Mr. Barton Chapple makes rather a hopeless attempt to discount the results obtained from calculations of the sideband width essential for the transmission of television images. These results are not, as he states,

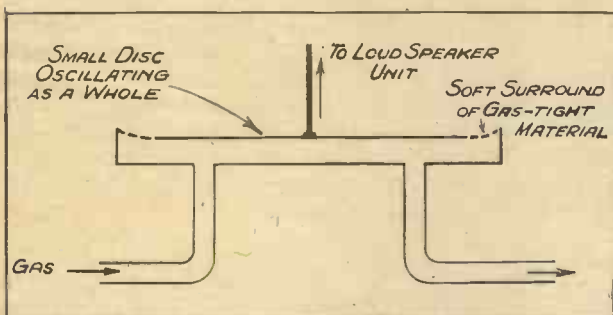

Fig. 2.—A suggestion to achieve proportionality between impulse amplitude and pressure and volume changes.

dependent upon the assumption that the image is actually divided into elementary areas, but are simply obtained by consideration of the dimensions and velocity of travel of the scanning spot, the smallest recognisable detail which can be reproduced being such that a cyclical variation in object brightness occurs in a distance equal to twice the length of the spot in the direction of its motion.

In still-picture transmission, which is similar in its essential principles to television, we can achieve any desired degree of definition by decreasing the size of the scanning spot, its velocity relative to the surface of the picture being correspondingly reduced to keep the frequency band within the limits imposed by the characteristics of the communication channel between transmitter and receiver. The time required for the transmission of a picture is thus fixed by the degree of definition required, having regard to the maximum frequency range with which the system can deal. But in television the controlling factor is that a certain number of complete images must be transmitted in a certain time (generally a minimum of $12\frac{1}{2}$ per second), and hence definition and frequency range become the only variables.

Just as in the early days of broadcasting, radio reproduction was inevitably compared with the gramophone, so the standard of television reproduction as judged by the public will be the talking picture. To attempt to attain such a standard by the methods at present employed, within a sideband width sufficient to accommodate only ten broadcasting stations, is optimistic in the extreme. The weakness of Mr. Barton Chapple's arguments is apparent from his concluding statement that in television "we are introduced, therefore, to a case where practice disproves theory. . . ." The whole art of electrical communication is based upon rigid mathematics, and the mathematical theory of television as developed chiefly by the engineers of the Bell Telephone Laboratories, and supported by careful experiment, indicates the magnitude of the problems which remain to be solved. Nothing but harm can accrue from attempts to minimise their difficulties: at present we cannot truthfully say that the solution is in sight.

KENNETH S. DAVIES.

68, Audley Road, Hendon, N.W.9.

January 15th, 1931.

[See "From My Notebook," on page 8, for Mr. Barton Chapple's reply.—ED.]

AN INVITATION TO READERS.

To the Editor of TELEVISION.

DEAR SIR,—I notice in the January issue of TELEVISION the many suggestions put forward by readers regarding proposed new features. I have always found your journal most interesting, and have no doubt that new features will be added from time to time as the occasion warrants. But it has occurred to me that half a column or so devoted to "Questions Answered" or "Queries and Answers" would be helpful in many cases of doubt and difficulty to those desirous of short succinct answers to questions of interest to television "fans" such as appear in the daily press on questions of general interest. I enclose one from a local newspaper and would call your attention to the question, *Inventor of Radio*, as an example of what I mean.

This would leave "Letters to the Editor" solely for discussion and expressions of opinion, and should you consider the suggestion I would myself initiate the column by asking the following questions suggested by the items marked on the enclosed cuttings:

1. What was the world première broadcast of a synchronized sight-sound dramatic production?
2. Who was the inventor of the thermionic valve which made radio possible?

Yours faithfully,
WILFRID E. JONES.

Toronto, Canada.

January 10th, 1931.

[The opinions of readers on the suggestion made by Mr. W. E. Jones will be welcomed, as we are always anxious to meet the needs of the majority in the columns of our magazine.—ED.]

A READER SINCE No. 1.

To the Editor of TELEVISION.

DEAR SIR,—I heartily agree with your correspondent, Mr. E. Wotton, in wishing that you would print the hours of transmission for all television stations. I have had each of your numbers since the first number, and have experimented with television since I built the simple "Televisor" described in your first number. One Saturday last year I sat up until midnight to get the Brookman's Park television transmissions, only to find that they were not transmitting that night. Mr. Wotton may like to know that I am also a Thanet experimenter, living in Ramsgate.

Yours faithfully,
J. CURLE.

Marlborough College, Wilts.

GOOD TELEVISION RECEPTION IN GERMANY.

To the Editor of TELEVISION.

DEAR SIR,—I was very pleased to note that you had reproduced my photographs and particulars in



Marburg/Lahn, where Mr. Richard Theile is successful in receiving such good television images.

the January number, under the title "The Enthusiast Sees It Through." I should be very pleased if you could send me further copies of the January, 1931, number, as I intend to show these to my friends to increase their interest in television.

Yours faithfully,
RICHARD THEILE.

P.S.—At the top of my letter you will see the wonderful situation of Marburg/Lahn, the place where television reception is so good. My dwelling is opposite to the famous castle.

Marburg/Lahn, Untenberg 8.

February 6th, 1931.

MUSIC FROM A FLASH-LAMP BULB.

To the Editor of TELEVISION.

DEAR SIR,—I do not know whether my experiences, using an ordinary flash-lamp bulb as a modulated light source, will be of any interest to either you

PREPAID
"SMALL ADS."

ALWAYS AT YOUR SERVICE

1/3 per line (1 insertion)

1/- „ „ (3 insertions)

SCANNING DISCS. PHONIC WHEELS. Special parts made to drawings.—JOHN SALTER, Featherstone Buildings, High Holborn, W.C.1.

FOR SALE.—"BAIRD TELEVISOR KIT," latest model. Offers invited for the complete outfit or any individual part. State requirements and offer.—Full particulars from ALEX. V. SIMPSON, M.I.R.E., F.T.S., 28, Westgate, Burnley, Lancs.

FOR SALE.—Lotus Remote Controls. Brand new. One "All-mains" type, 17s. 6d. (cost 47s. 6d.); one Eliminator type, for use with H.T. Eliminator and L.T. Battery, 16s. (cost 45s.).—WR, Box No. 310, TELEVISION.

A DOSSETT, Commercial Artist and Draughtsman for all technical diagrams, illustrations and layouts.—HAZLITT HOUSE, Southampton Buildings, Chancery Lane, London. Holborn 8638.

WANTED TO PURCHASE.—H.T. accumulator, 100 v., 3-5 amp. hr. Must be in first-class condition. Also 0-5 A.C. ammeter. State if can be seen.—BRIDGE, c/o Box 48, TELEVISION.

FOR SALE.—One W.B. (Lodestone) Moving Coil Loud Speaker, with Baffle Board. Cost £4 10s. As new. Offers.—Reply, BC, c/o Box 101, TELEVISION.

"TELEVISUALISTS" in West and South-West London can be sure of competent personal attention at our service station.—ECONOMIC LIGHTING STORES, 24, Fulham Palace Road, W.6.

EVERY TELEVISION ENTHUSIAST should be a member of the Television Society. Full particulars of membership may be obtained from the Hon. Secretary (Members), J. DENTON, A.M.I.E.E., 4, Duke Street, Adelphi, W.C.2.

FOR SALE.—Quantity Surplus Experimental Apparatus, for quick disposal (Coils, Condensers, etc.). State requirements.—Write, JW, Box No. 286.

"TELEVISION FOR ALL."—By Charles G. Philp. This popular book gives a clear explanation of the basic principles of television, and describes the various systems in use. Chapters on Noctovision, Television in Colour, and Stereoscopic Television are included. Price 1s., post free 1s. 2d.—PERCIVAL MARSHALL & Co., LTD., 66, Farringdon Street, London, E.C.4.

PLEASE MENTION "TELEVISION" WHEN REPLYING TO ADVERTISERS.

or Mr. E. Wotton, but I thought you might like to know about them.

As my television experiments have been held up temporarily by lack of a suitable motor (the only available one just turning a 12 inch disc at 800 r.p.m.), and also (like others of your younger readers) by lack of holidays and money, I decided to see if it was possible to transmit speech and music over a light beam with quite simple apparatus, already to hand.

In a well-known wireless paper the Philips' lamp works were said to have found that an ordinary flash-lamp bulb would respond up to frequencies of about 7,000 cycles per second. However, with an amplifier output of 1 to 1½ watts stepped down to a 2 volt spotlight bulb and with the beam focused on to a selenium cell, about 25 yards away, music (from a gramophone record) could be heard with quite good quality, and the higher notes were well reproduced.

The solution of the motor difficulty now appears to be in sight, and a relief from trying to place and punch holes 0.015 inches in size in a 12 inch disc accurately will be very pleasant.

I hope to be able to write to you soon and to tell of much better results than those which have been obtained so far.

Yours faithfully,

G. D. DAWSON, JUNIOR.

P.S.—The lamp had a constant biasing current flowing through it as in the diagram.

Penlee, Knutsford Road, Wilmslow, Cheshire.

February 5th, 1931.

FLICKER EFFECTS AND HOLE SHAPE.

To the Editor of TELEVISION.

DEAR SIR,—I should like to point out that the flicker effect referred to in my letter was not that due to the signals, but the kind caused by a disc or projector run too slowly. The object of the diamond-shaped holes arranged thus is to reduce, if possible, this flicker.

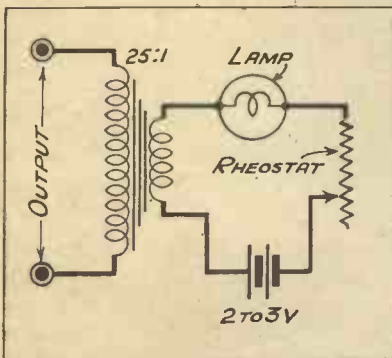

* * *

The diagram to illustrate Mr. Dawson's experiments with a flash-lamp bulb.

* * *

Suppose, for the moment, a single-spiral 30-hole disc, with diamond-shaped holes overlapping, gives as much true detail as an ordinary disc under similar conditions, though perhaps the latter's artificial sharpening of horizontal detail is more suitable for

small "Televisors." In the double-spiral disc, a 15-hole spiral taken alone would give a continuous image with *no finite* gaps, but appearing as though through a graduated screen excluding no part of the image completely. The other spiral, if used as well, might complement the first result, if the speed chosen is sufficient. Thus if the sending and receiving discs run at 375 r.p.m., 12½ pictures per second would be sent, though the 30 holes are given twice as long to scan the scene.

* * *

A possible sacrifice of detail might occur with a disc hole of this shape.

* * *

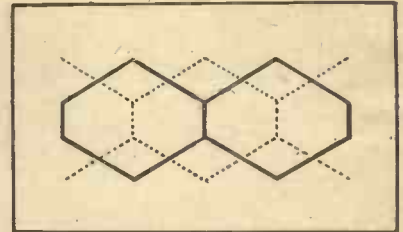

If this speed were possible, twice the detail could be contained in a given frequency band. The screening would oscillate sideways at 6½ per sec., but only to the extent of a strip's width. The detail difference between alternate images would be slight. If 375 r.p.m. is too slow, some speed below 750 r.p.m. might be suitable. A double spiral disc of 60 holes would probably increase the frequency band; but in colour television the speed does not have to be tripled.

Alternatively, some detail might be sacrificed by modifying the shape of the holes as in the sketch. I cannot, of course, truly predict the behaviour of the disc, as it would have to be eye-tested with a transmitted image.

Yours faithfully,

P. F. CARMICHAEL.

Claddoch, Gartocharn, Dumbartonshire.

February 9th, 1931.

The Farnsworth Claim

The Cathode Ray has repeatedly been proposed for television every since Boris Rosing, a Russian scientist, took out his patent in 1908, but no one so far has indicated how the Cathode Ray is expected to give sufficient brilliancy. This is one of the fundamental stumbling blocks in reproducing television on a large screen or with great detail.

Recently a Mr. Farnsworth claimed that he had overcome this as well as the other difficulties involved in the use of the Cathode Ray. He also claims to have found a means of overcoming waveband restrictions. The newspapers have given his claims the widest publicity, but what we want are not claims but demonstrations. There have been many claims about the Cathode Ray, often of the wildest description, emanating usually from America or from some remote spot in Europe where the truth cannot be verified. Until Mr. Farnsworth gives a demonstration his claims cannot be taken seriously.

|||
**TELEVISION
TO-DAY AND
TO-MORROW**

THE
BOOK
YOU
NEED

"THE
FINEST
WORK
ON THE
SUBJECT"

ORDER
NOW, FROM
**TELEVISION
PRESS, LTD.**
505,
CECIL CHAMBERS,
STRAND,
LONDON, W.C.2



SYDNEY A. MOSELEY

AND

H. J. BARTON CHAPPLE

B.Sc. (Hons.), A.M.I.E.E.

7/6^{D.}
POSTAGE
6D. EXTRA

|||

BAIRD

"TELEVISOR"

BAIRD



BAIRD SAFETY-FIRST KITS FOR YOU!

BAIRD
TELEVISION LTD.
133, LONG ACRE
LONDON, W.C.2. TEMPLE BAR 5401

BAIRD

"TELEVISOR"

BAIRD