

SEPTEMBER 1963

# TAPE

RECORDING MAGAZINE

1/6



## IN THIS ISSUE

- Results of the 1963 British Amateur Tape Recording Contest
- Test Bench reports on equipment
- Club news
- Producing a feature tape
- New Products
- Reviews of the latest record releases
- Recording sound effects for a play
- Travel with a tape recorder



## HEAR **ALL** MAKES

See all makes. Dozens of different models, by all well-known makers. They are *all* at the Tape Recorder Centre—the country's leading specialists in tape recording. At the Tape Recorder Centre you can see all makes, hear all makes, compare all makes, on the spot. Experts are on hand with informed advice, based on the wealth of Tape Recorder Centre experience, to make sure you choose the model that is best suited for you (and for your pocket). You will find everything you need for tape recording, office dictation and hi-fi at the Tape Recorder Centre, plus excellent HP terms. Hear all makes, see all makes, at

**THE**  
**T C R** **TAPE**  
**RECORDER**  
**CENTRE**

**Philips**  
**Elizabethan**  
**Grundig**  
**Ferrograph**  
**Stella**  
**Vortexion**  
**Brenell**  
**Ampex**  
**Tandberg**  
**etc**

82 High Holborn, London WC1. Tel: CHA 7401 ● 75 Grand Parade, Harringay, London N4. Tel: FIT 2316

no other portable  
tape recorder  
so versatile . . .



## UHER 4000 REPORT-S

Two tracks to international standard ■ reel size :  
up to 5" ■ four tape speeds :  $7\frac{1}{2}$  ips,  $3\frac{3}{4}$  ips,  
 $1\frac{7}{8}$  ips,  $\frac{15}{16}$  ips ■ frequency response ( $\pm 3$  db) :  
40-20,000 cps at  $7\frac{1}{2}$  ips, 40-17,000 cps at  
 $3\frac{3}{4}$  ips, 40-10,000 cps at  $1\frac{7}{8}$  ips, 40-4,500  
cps at  $\frac{15}{16}$  ips ■ contrast ratio : 55db ■ wow  
and flutter :  $\pm 0.15\%$  at  $7\frac{1}{2}$  ips (audible  
frequencies only) ■ output power : 1 watt  
(push-pull power stage) ■ power supply :  
five flashlight cells (1.5 volts each) or  
"dryfit" storage battery model Z 211 or  
model UHER Z 111 mains-operated power  
unit and battery charger or an automobile  
battery via automobile adaptor cable  
■ inputs : Micro 0.1 mV. at approx.  $2k\Omega$  ;  
Radio 1 mV at  $47k\Omega$  ; Phono 25 mV at  
1 megohm ■ outputs : 2 volts at 4 ohms ;  
1 volt at  $15k\Omega$  ■ operating time : intermittent  
operation of approx. 12 hrs : continuous  
operation and intermittent operation  
respectively from the "dryfit" storage battery  
—approx. 10 hrs. ■ dimensions approximately :  
11" x 8" x 3" ■ weight without batteries  
approximately 6lbs.

PRICE  
**93**  
GUINEAS  
Inc. microphone  
and L.P. Tape



Ask your dealer to demonstrate  
the UHER 4000 REPORT-S. If you do not see this amazing  
Portable tape recorder displayed in your area, write for illus-  
trated leaflet and further information to :

**BOSCH LIMITED** Domestic Appliance Division  
205 Gt. Portland Street, London W.1 Tel : LAngham 1809



MARK 5 Series 2

## Spotlight on quality...

### *Specification:*

*4 speeds 1 $\frac{7}{8}$ , 3 $\frac{3}{4}$ , 7 $\frac{1}{2}$  and 15 ips • frequency correction at all 4 speeds • 3 independent motors • exceptionally low wow and flutter content • double-gapped ferrite erase head to minimise erase noise • narrow-gapped record/playback head to give extended frequency response • pause control • superimpose control • recording level indicator (meter extra) • takes 8 $\frac{1}{2}$  in. dia. reels • fast rewind (1200 ft. in 45 seconds) • digital rev. counter.*

The Mark 5 Series 2 tape recorder is a high quality machine capable of making outstanding recordings.

It is tastefully finished in medium grey with chromed fittings, and designed not only for use as a complete portable recorder but for incorporation into a Hi-Fi installation.

(Deck, amplifier and power unit are available as separate items). A low-level compensated output socket is provided for driving an external Hi-Fi amplifier.

***Brenell***

**BRENELL ENGINEERING CO., LTD**  
1a DOUGHTY STREET, LONDON W.C.1.  
Telephone: HOLborn 7356/8



GO  
FOR ANY  
SOUND  
KEEP IT  
SAFE  
ON



# PHILIPS TAPE

Capture a sound on Philips Tape and it's yours for ever—yours to play back and enjoy whenever you like. Available in all current reel sizes of standard, longplay, doubleplay and tripleplay, Philips Tape gives you all these advantages: great sensitivity, wide frequency range, low noise level, high resistance to stretching or breakage, powerful adhesion of the magnetic coating. And of course, they're colour-packed for easy identification. Whatever tape recorder you own, get the best out of it—with Philips Tape.

GREEN  
for standard  
RED  
for longplay  
BLUE  
for doubleplay  
GREY  
for tripleplay



**FINE PRODUCTS FROM PHILIPS—THE FRIEND OF THE FAMILY**

PHILIPS ELECTRICAL LTD., ELECTRO-ACOUSTICS DIVISION, CENTURY HOUSE, SHAFTESBURY AVENUE, LONDON WC2

**METRO SOUND** TAPE RECORDER ACCESSORIES



## tape accessories

IN A PRESENTATION GIFT SET

Tape Accessory sets carded as shown and containing Klentatape, Metro-Splicer Metro-Brush 27/6 each

**KLENTATAPE** Price per Kit 12/6. Refill fluids 3/11 per bottle.

**METRO-SPLICER** Splicer Kit complete with Film Emulsion Scraper and Spare Cutting Unit—12/6. Spare Scrapers 1/10 each. Spare Cutting Units 2/6 each.

**METRO-TABS** 3/11 per set complete with Index.

**METRO-BRUSH** 2/6 each.

**METRO-STOP** 17/6 per set.



**METRO-SOUND MFG. CO. LTD.**  
19a Buckingham Road, London, N.1  
Tel: CL1ssold 8506

## BRITAIN'S FINEST TAPE DECK

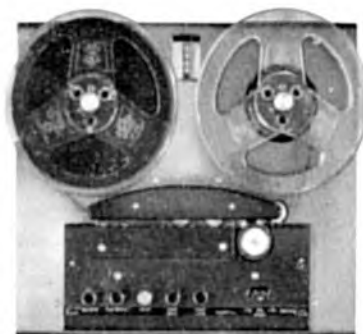

This is not merely our claim—it is the considered judgment of many leading experts. And now, under our 1963 production programme, there will be more PLANET tape decks available. Prices range from £39 10s. 0d.

- ★ The U1 deck has been designed to give a long trouble-free life and exceptional performance. That is why it is used by many professional studios and why it is the ideal deck for the serious amateur.
- ★ Now we introduce the U1/15, which is identical to the U1 except that it operates at 3½, 7½ and 15 ips. Improved production facilities at our new factory enable us now to accept orders for early delivery.

Write for illustrated brochure and independent test reports to:

**PLANET PROJECTS LTD.**  
Goodman Works, Belvue Road, Northolt, Mddx



## ONLY A PILLAR-BOX AWAY...

Wherever you live, you are only the nearest pillar-box from the biggest Tape Recorder dealers in the British Isles—

**HOWARD OF BROMLEY**

Thinking of buying a Tape Recorder, Hi-Fi Equipment or a Camera? Willing to risk 3d. to see if we really do offer you better terms than anyone else? Then contact us for full details of all our offers (which includes INTEREST FREE H.P. on most makes) and free brochures, etc.

If we do not convince you, you will only have lost 3d. and you can still go elsewhere. (But we bet you won't!)

WRITE, PHONE, CALL IN OR SEND CARRIER PIGEON:

**218 HIGH ST  
BROMLEY  
KENT**

**RAVensbourne  
4000 & 4477**

# HOWARD TAPE RECORDERS



# LOOKS SOUNDS BETTER!

It's the ever-popular Philips Family Tape Recorder in a handsome new PVC-covered wooden cabinet that enhances appearance, improves sound quality, gives you a de luxe tape recorder at middleweight cost. See and hear it at your Philips dealer's today!

WONDERFUL VALUE AT  
**42 GNS.**  
Complete with microphone, reel of tape and empty take-up spool



**PHILIPS**  
FAMILY  
DE LUXE  
TAPE RECORDER  
MODEL EL3541/H

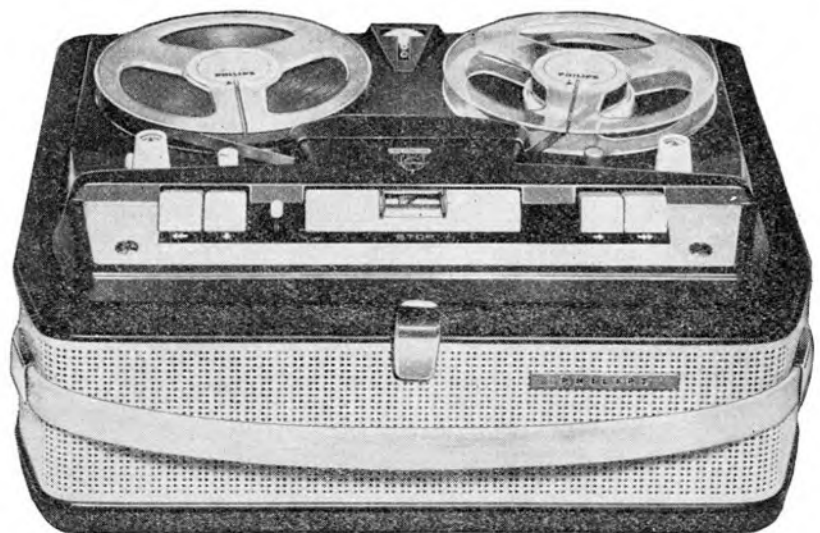

Another great tape recorder from PHILIPS – the friend of the family

PHILIPS ELECTRICAL LIMITED, ELECTRO-ACOUSTICS DIVISION, CENTURY HOUSE, SHAFTESBURY AVENUE, LONDON W.C.2.

## GRUNDIG TK60



S  
T  
E  
R  
E  
O

### SPECIAL OFFER!!

We have a number of the fabulous TK60 STEREO TAPE RECORDERS available at the fantastic price of 89 gns. This recorder is listed at £134 and at the price offered shows a saving of over £40! Absolutely complete in the last detail with two superb detachable acoustically designed speakers, 9 watts output, Frequency response 50-16,000 c/s Bass and Treble controls, automatic tape stops, etc. Superb value and an absolutely unrepeatable offer, BRAND NEW in sealed cartons with full makers' guarantee. Hire Purchase terms available. We specialize in mail order. Write to our HEAD OFFICE at Stratford—address below.

- ★ HIGHEST PART-EXCHANGE ALLOWANCES
- ★ OVER 250 NEW & S/H RECORDERS ON DISPLAY
- ★ H.P. TERMS OVER 9-24 MONTHS
- ★ FREE HOME DEMONSTRATIONS
- ★ TAPE RECORDER REPAIR SPECIALISTS
- ★ FREE DELIVERY, FREE TECHNICAL ADVICE

NOTE—OUR CITY SHOP CLOSED SAT. OPEN MON.-FRI. 9-6 p.m. SUN. 9-2 p.m.

**CITY & ESSEX**  
**T A P E**  
**RECORDER CENTRES**

228 BISHOPSGATE, E.C.2 (opp. Liverpool St. Station) BIS 2609  
2 MARYLAND STATION, STRATFORD, E.15 (adj. station) MAR 5879  
205 HIGH STREET NORTH, E.6 (opp. East Ham Station) GRA 6543



for the connoisseur

# IRISH

You prefer Brittany to Brighton. Höck to highball. Van Gogh to Velasquez. You're choosy as well as selective. Irish is your tape. Irish professional tape has connoisseur advantages precision-engineered into its mirror-smooth surface. The unique Ferrosheen process, by which this microscopically fine surface is obtained, provides exceptional high frequency response due to intimacy of contact between tape and heads . . . head wear is at minimum . . . makes for freedom from head contamination by oxide build-up, considerable reduction in background noise, minimum drop-out. Only Irish tapes have free 'signature binding' kit for authentic library-style filing—simulated Moroccan leather with 23-carat gold foil for simple 'tooling' of title. People like Tandberg recommend Irish. And every Irish tape carries a 100% unconditional guarantee. Your Irish Tape stockist, and other details including technical data, from: A. C. Farnell Ltd., Hereford House, Vicar Lane, Leeds 2. Tel: Leeds 35111.

'IRISH', 'FERROSHEEN' and 'Signature Binding' are registered trade marks of Orradio Industries Inc., Opelika, Alabama.



# PRE-TESTED FOR DURABILITY A PRECISION, COMPACT TAPE RECORDER

## MODEL UT-50

### 5-TRANSISTOR *with Speed Control*

- Recording Time: 40 minutes (Double Track)
- Freq: 200—7000 CPS
- Dimensions: 218mm x 218mm x 68mm
- Weight: 2.97 lbs. (1.3 kg)
- Accessoriés: Remote Control Microphone with Telephone Pic up, Earphone, Batteries (UM-2 x 2 & BL-006P x 1), 200 ft. tape with 3" Standard Reel.

Recipient of the Tokyo Metropolitan Government  
Award for quality in export products.

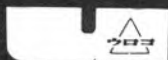

### UROKO SANGYO KAISHA, LTD.

New Tokyo Bldg., No. 2, 3-chome, Marunouchi, Chiyoda-ku,  
Tokyo, Japan. Cable Address: "UROKOTRADE TOKYO"



# UROKO

Engineering specialists in portable tape recording systems.



## How to make home movies with Emitape

A home movie is much more complete when it is backed by a sound-track on Emitape. Get a new reel now. Then team up your recorder and cine-camera, and put the silent screen behind you for good.

You can show what a sequence *sounds* like, and animate your screen personalities by giving them back their voices. It will be fun editing the tape, synchronising it with the film, adding music, and superimposing a

commentary. Don't be surprised if there are shouts of 'Producer' at the end of the première!

**NOT SURE HOW TO BEGIN?** Then write in for leaflet No. 5 in the new Emitape series: *Emitape for Home Movies*. It's free! John Borwick has written it specially for Emitape.

If you want other leaflets in this series, or would like to be placed on our mailing list, please fill in the coupon on the right.

Please send me free leaflets:

Emitape for Home Movies . . . . .  Storing Emitape . . . . .   
 Tape indexing with Emitape . . . . .  Emitape Outdoors . . . . .

Adding Sound to Slides with Emitape . . . . .

2 & 4 Track Recording with Emitape . . . . .

Please send me further leaflets in this series, when they are published . . . . .

NAME.....  
(BLOCK LETTERS PLEASE)

ADDRESS.....

.....

TRM 3

### Get another reel of **Emitape**

E.M.I. TAPE LIMITED, HAYES, MIDDLESEX

# IS HALF YOUR TAPE RECORDER

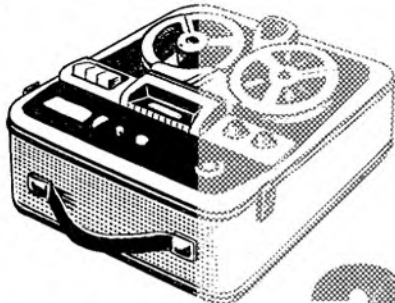

## WASTED?

The performance of a portable tape recorder is severely limited by the space available for its internal loudspeaker.

The connection of a high quality external speaker will reveal hidden detail in your recordings, and the Wharfedale PST/8 is an ideal choice.

This unique, patented enclosure design gives optimum results with Wharfedale 8" unit. Impedances are easily matched by fitting the WMT.1 transformer, costing only 13s. 6d.

*Descriptive literature sent FREE on request including Cabinet Construction Sheet*

## WHARFEDALE PST/8

PRICES — CABINET ONLY  
£10 10s. 0d., finished in  
walnut, oak or mahogany  
veneers.  
£7 10s. 0d. in whitewood

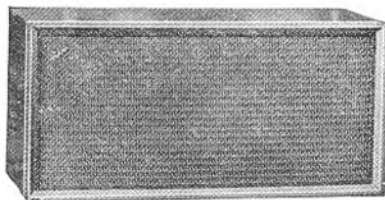

**Recommended units**  
8" Bronze/FS/AL  
75s. 10d. inc.  
10s. 10d. P.T.  
Super 8/RS/DD  
134s. 2d. inc.  
19s. 2d. P.T.

Tel: Idle 1235/6

Grams:  
'Wharfedel' Idle  
Bradford

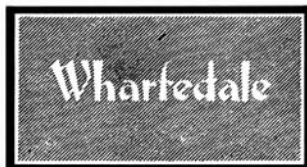

**WHARFEDALE WIRELESS WORKS**  
IDLE, BRADFORD, YORKS

# TAPE

RECORDING  
MAGAZINE

Vol. 7

No. 9 September 1963

### IN THIS ISSUE

Tape trends and tape talk	12
Documentary tape production	14
Nigel Rees	
British Amateur Tape Recording Contest	17
Winners and Prizes	
Sound-effects for Macbeth	18
Alan Sutcliffe	
Tape Talk	19
Alan Edward Beeby	
A tape recording console	20
Do-it-yourself article	
Travelling with a tape recorder	22
A pictorial feature	
Tape records reviewed	23
Edward Greenfield	
Tape recording simplified	25
Robert Hirst	
Test Bench	26
Tandberg 74 and Grundig stereo mixer	
Popular music on tape	29
Don Wedge	
New products	30
News from the clubs	33
Tape Exchanges	35

**COVER PHOTOGRAPH:** Bill Fleming (left) a lone prospector reminisces about his adventures panning for diamonds since 1930, to Alwyn Newton of Hull, a member of a team of prospectors seeking diamonds using the modern techniques. The Fi-Cord 202 belongs to R. W. Cundy, a journalist who met these adventurers on the Venezuelan border, 200 miles inland from Georgetown, British Guiana.

"TAPE Recording Magazine" is published on the third Wednesday in the month, by Print and Press Services Ltd., from 7, Tudor Street, London, E.C.4.

"TAPE Recording Magazine" is available by a postal subscription of 20s. per annum (U.S.A. \$3.50) including postage, or it can be obtained at newsagents, bookstalls and radio and music dealers. In the event of difficulty, write to the Publishers at 7, Tudor Street, London, E.C.4.

Back numbers, if still in print, are available at 2s. 6d. per copy for issues up to November 1959, and 2s. per copy for later numbers.

Address all communications

7 TUDOR STREET, LONDON, E.C.4 FLE 1455

### EDITORIAL

Editor,  
R. DOUGLAS BROWN

Assistant Editor, FRED CHANDLER

### ADVERTISING

Advertisement Manager,  
MISS PAMELA DURHAM

# Tape trends and tape talk

By the Editor

THE CONTEST JUDGING went off well; there were some very good tapes; the "Tape of the Year" was a deserving piece of recording and of fantasy. I shall write at length in our next issue about the judges' reactions to the best of the tapes entered. Meanwhile, I report one or two general thoughts.

We were struck by the extent to which recordings were imitative or repetitive. By that, I mean that there were very few pioneers trying out new ideas or techniques. And there were a surprising number of competitors whose names were familiar from other Contests—and not only their names, for their tapes were made in exactly the same idiom as their previous entries. Only the words were different! So, a little more boldness and experimentation, please.

Talking of experimentation, there were very few entries indeed in the technical experiment class; we are trailing a long way behind our continental friends in this form of activity.

The judges also felt that too many competitors do not appreciate the limitations they should set upon themselves. The "Tape of the Year," as it turned out, was an ambitious dramatic piece; but, as a general rule, it is unwise for amateurs to tackle this sort of exercise. It calls for too many facilities, including a good cast.

Competitors should also aim to keep their tapes shorter. Because there is a time limit of, say four

minutes in a class, that does not mean a tape lasting seventy seconds will be at a disadvantage. If that is long enough to "put over" the material, any effort to prolong the tape will merely lose marks.

One of the judges recommended competitors to study the three-minute items that are included in the BBC's "Today" programme.

And a number of them felt that it is rather too complicated to enter the Contest, because of the various classes and lengths of tape. Why not, they asked, organise a monthly or quarterly Contest, without classes, so that at the end of the year all the best tapes could be entered and automatically allocated to the classes to which they were best suited. What do readers think?

Incidentally, this year there will be a feature tape available containing the prize-winning entries and some of the judges comments. During the judges' session, Roger Aslin recorded material and the Federation of British Tape Recording Clubs will issue the tape later.

Prizewinners in the Contest will receive their awards at a special ceremony in London on September 21. This will be fully reported in our November issue.

## More to read in "TAPE"

THE ECONOMICS OF publishing become progressively more complex and difficult—which is why one hears so frequently of papers closing down. We are well into our seventh year now and, fortunately, well established and able to withstand the strains of the present situation, which are only evident in some other publications.

We are, however, anxious to give our readers the greatest possible value that can be contrived. With our selling price deliberately held down to 1s. 6d., it is impossible to add more pages.

What we can do, though—and what we are doing as from this issue—is to increase the number of words on each page.

Observant readers will have noted recent typographical changes in *TAPE Recording Magazine*. Apart from an improvement in appearance, these brought a slight increase in text matter by reducing the proportion of space given to headlines.

Now we are reducing margins and setting the type to a slightly wider measure. This is in line with contemporary typography and it will enable us to increase our editorial articles by 8 per cent. In this issue, that is equivalent to an extra page and a half of reading matter.

## LAUGH WITH JEEVES



"I rather fancy it's a leaky condenser"

# Learn while you sleep

By DAVID CURTIS

**S**TUDENTS have always pored over their books far into the night, hard-working and conscientious in their pursuit of learning.

Today it is possible to be equally conscientious without working nearly so hard. It is, in fact, possible to sleep on the subject—quite literally—and learn it faster and more thoroughly than the most determined application allowed in the past.

This new aid to education is called sleep-learning.

Sleep-learning, a very young science, is based on the receptivity of the subconscious to suggestion and instruction during the sleeping period.

Its principles were known to the ancients. In Egypt, priests taught the scriptures to sleeping novitiates in specially built slumber temples. In Egypt and Greece, people brought their problems to such temples. There, priests whispered helpful suggestions in their ears while they slept. The nocturnal advice dealt with matters of health, general living and the encouragement of confidence.

In informal ways we have been applying the principle of sleep-learning all along. We often decide to "sleep on" a problem we have been unable to solve and awake with the answer.

While we are asleep, some watchful part of us prevents us from rolling out of bed. Mothers who sleep through traffic noises, thunderstorms and the husbands' snoring awake at the slightest sound from their babies. Science has proven that the subconscious functions while we sleep and can be directed into channels of our choice.

In 1932, Aldous Huxley envisioned a

new world in which hypnopædia (sleep-teaching) would be used for purposes of conditioning future citizens along lines considered useful for the state, rather than for intellectual improvement.

The methods Huxley described are almost identical with those now in use. He speaks of a continuous, repetitious whisper under the pillow. The degree of his prophetic talent is evident in sleep-learning in which a pillow-speaker is attached to a clock-controlled record player or tape-recorder. The speaker's volume is just loud enough to reach only the ear of the sleep-learner and the material is repeated several times during the night.

More than a quarter of a century later, in *Brave New World Revisited*, Huxley still expressed concern about the possibility of misuse but, at the same time, recognised that factual material was being taught successfully to sleepers; that mankind was now putting to use the one-third of its life spent sleeping.

Responsible proponents of sleep-learning point out that the same risk exists in many scientific fields, but that this should not keep us from making use of the beneficial aspects of this new technique. Recent research whose findings have led to world-wide experimentation are the work at North Carolina University, the University of California, William and Mary, U.C.L.A., Georgetown University and the Institute of Logopedics in Kansas.

Psychiatrists have evinced particular interest in its potential value in therapy. In May, 1960, a paper presented to the Scientific Session of the American Psychiatric Association in Atlantic City by Dr. M. Ralph Kaufman, of the Mount Sinai Hospital, stated:—

*The situation at present is such that psycho-analysis that began as hypno-*

*therapy . . . has now given us the kind of understanding of hypnotic suggestion which again makes it available as a therapeutic measure for psychotherapy.*

At least 8,000 US college students supplement their daytime work with sleep-study. Language instructors report uniquely quick memorisation. Young children, whose studies involve a considerable amount of rote-learning, also benefit greatly.

Television actor Larry Blyden has learned complete roles quickly with the aid of sleep-learning equipment. Chilean opera star Ramon Vinay not only quickly memorised a leading operatic role but also learned to sing it in perfect, accentless Italian.

Equally successful results have been reported by people of various language backgrounds in learning English, again free from foreign accent. For instance, a young man learned conversational French while asleep, under controlled test conditions. After only one week of sleep-learning, Dr. Adrian Miller, Professor of Romance Languages at U.C.L.A., reported that the young man had absorbed the equivalent of half a year's classroom study.

Numerous famous personalities have also attested to the benefits of sleep-study. Alexander de Seversky eliminated his Russian accent, Rudy Vallee, Bing Crosby and Gloria Swanson have learned lines and lyrics in this way, and during World War II members of the US armed forces were taught the Morse code and foreign languages in a necessarily brief period with the aid of sleep-learning.

The Office of Strategic Services (O.S.S.) taught its agents not only languages but also accents, slang and custom of the countries to be infiltrated, and in Arabia, an oil company employs sleep-learning for teaching English to its native employees and Arabic to its American staff.

Business has been quick to recognise how sleep-learning can help build up sales. The *Wall Street Journal* of March 14, 1958, reported on a group of corporations using sleep-learning self-confidence-development sales courses to bolster the effectiveness of their salesmen.

Psychotherapists submit favourable reports on the use of sleep-teaching techniques for implanting therapeutic suggestions in the subconscious mind to supplement treatment during waking hours.

"There appears to be enough evidence to indicate that treatment during sleep is not only possible in theory but also effective in practice," writes Dr. Ernst Schmidhofer, chief of the Neuropsychiatric Service of the Memphis Veteran's Administration Hospital.

Psychologists have also reported success in breaking bad habits ranging from over-eating to speech defects. Mothers, following their suggestions, have been able to train their children out of thumb-sucking, bed-wetting and nail-biting.

Since certain diseases and mental disorders are the psychosomatic symptoms of a subconscious block, it is felt that the inner conflict must be recognised and faced consciously by the patient in order to overcome the problem. Since suggestion is the tool of psychotherapy, pre-recorded therapeutic messages (sleep tapes) can take their rightful place beside drugs and hypnosis as an effective device for reaching the subconscious.

If we are to utilise the educational and therapeutic potential of sleep-learning we should better understand how and why it works.

# Twelve hours in the life of a school

By NIGEL REES

THREE or four years ago, I was walking down a corridor at school during lesson time and as I went past each classroom I heard snatches of different subjects being taught: the chanting of Latin verbs, a conversation in French, a play-reading, and so on. The different sounds cross-faded just as in a film one scene dissolves into another.

The idea of producing a tape about the school had been at the back of my mind since I first became interested in

recording but this chance experience influenced my approach to what looked like being a difficult undertaking.

A school offers plenty of scope for varied and interesting recordings but also many problems in the selection of material and its presentation in sound terms. First, I compiled a list of all the school activities. There were enough to fill half a dozen programmes! However, as my time was limited to the month after my GCE Advanced Level examinations and before the end of the summer term, I could not possibly cover the whole school year (1962). My list was thus considerably reduced.

I was aiming at a general listener who knew nothing about the school but I did not wish the presentation to be of the pedestrian "this is a lesson . . . this is cricket" kind. I decided to experiment with the technique of dispensing with the commentator, employed with success by Richard Cawston in his television films: "This is the BBC," "The Teachers" (though this had not been shown at the time of making my recording) and, most recently, "The Pilots." Having a commentator is very much easier because words can be used to bind two widely differing ideas or sounds together and a few words can explain anything the listener needs to know.

The main difficulty, however, when sounds are made to speak for themselves is deciding what the framework of the programme is to be. Perhaps I chose rather an obvious path when I decided to relate the twelve hours in the school's life from nine in the morning till nine at night. The whole project was in fact a conscious adaptation of methods already explored by the cinema. James Fitzpatrick has spoken of the

"classic documentary theme of dawn to dusk" and indeed this framework is old; but it is in combining it with the no-commentator technique that the novelty occurs.

Fitzpatrick's piece on the assembling of American rockets, set to basic jazz rhythms, which did attempt the combination was accused of being obscure and hard to follow. As for trying it in sound no examples readily come to mind. Perhaps this is because, without visual images to aid comprehension, the idea has been dismissed as too difficult for the listener to follow. There are many programmes, of course, where people talk about their jobs in a way which is not strictly narration but is not natural, everyday conversation and speech either, which was what I was after.

Besides, the school-day was more likely to be revealing of the school's character than the comparatively rare events which happen once or twice a year or term (prize-givings, carol services, and the like). In the end I selected Wednesday as the more precise framework as it would enable a fair balance to be maintained between the various activities in and out of the classroom because that day is set aside as a half-holiday when games and other extra-curricular activities take place. This decided, my list was reduced again considerably.

A Grampian DP 4 microphone was used in conjunction with my Philips recorder for the basic recordings which were then begun. For outside work I used a Philips EL 3585 battery portable and I was most impressed with its performance, often under adverse conditions. For example, I had left the recording of a sequence about the rowing club till the last. All through July there had

## SLEEP LEARNING EQUIPMENT

### TAPE RECORDER

de Luxe model, with built-in time control unit, specially designed for Sleep Study and Therapy, but also suitable for high quality reproduction of music tapes. Speeds: 3 $\frac{3}{4}$ , 1 $\frac{3}{4}$  and  $\frac{1}{8}$  i.p.s. ... .. 69 gns.

### PILLOW SPEAKER

moving coil, set in sorbo rubber ... .. 3 gns.

### MICROPHONE

high-quality dynamic... .. 4 gns.

### TIME CONTROL UNIT

as used in above Tape Recorder. Has facilities for three or more "ons" and "offs" per 24 hours. Instant resetting, simplicity itself ... .. £5 : 19 : 6

### ENDLESS TAPE CASSETTES

Telefunken (36 minutes at 1 $\frac{7}{8}$  i.p.s.)... .. £2 : 10 : 0

Audio Vendor (48 minutes at 1 $\frac{3}{8}$  i.p.s.) ... .. £5 : 0 : 0

### INSTRUCTIONAL TAPE

pre-recorded, one hour, packed with latest information and advice on obtaining optimum results from sleep study. 5 $\frac{3}{4}$  ins. Std. or 5 ins. L.P. (State preference)... .. £2 : 10 : 0

### PSYCHOTHERAPY TAPE

the most potent tape yet devised for giving the mental tone a big lift and preparing the mind for the absorption of data. Pre-recorded matter occupies the first part of each track. You put your own material on remainder and change as often as required. 5 $\frac{3}{4}$  ins. L.P. or 5 ins. D.P. tape ... .. 3 gns.

Send for further details to:

### The INSTITUTE OF SLEEP LEARNING

(Props. Psychology Tapes Ltd.)

16, King's College Road, London, N.W.3.

Telephone: PRLmrose 3314



be an angel

write to us for a free specimen copy of RECORDS AND RECORDING or MUSIC AND MUSICIANS—the illustrated monthly magazines which are absolutely devoted to records and music

HANSOM BOOKS LTD

16 BUCKINGHAM PALACE ROAD · LONDON SW1

been strong winds which even the most efficient wind-shield would have failed to minimise. Came the last outing of the school eight and still the wind persisted. I packed the portable in my brief-case, set the recording level as low as possible, held the microphone in one hand, and pursued the rowing coach at high speed on my bicycle along a very bumpy towpath. Amazingly, out of twenty minutes' windswept recording I was able to extract what I wanted and even more amazingly the recorder still worked excellently!

Fortunately, other sequences were not as difficult as this but each posed its individual problems. Although nothing was scripted it soon became apparent that a number of items needed some sort of faking, "arranging," call it what you will. In order to get satisfactory balance and quality and thoughts of letting the recorder "eavesdrop" without any rehearsal or at the least planning had to be abandoned. The school had agreed to my making the recording so long as I refrained from recording anyone without his or her knowledge. This was never any serious recordist's intention of course, but the point is that such recordings are invariably of a low technical standard because the microphone has to be hidden and the speaker's words are not addressed to it.

However, I was always very careful not to give people too much warning of my intentions, otherwise "spontaneous" lessons and conversations would have sounded false. On one occasion, indeed, I arrived to find jokes and errors almost in script form on the blackboard! The best way was just to have a little preliminary positioning of people and microphones and then just to record a longish piece of the lesson with the minimum of interference on the part of the recordist. The geography lesson was most spontaneous in the conversational exchange of ideas uninhibited by the microphone.



Next came the problem of balance. I decided that from a sound, if not an educational point of view, the master's voice should dominate—chiefly because boys' voices tend to sound somewhat similar and also because the master was nearly always the "anchor man" as far as subject matter was concerned. The difficulty in conversational lessons is the need to have the microphone two feet from the master's mouth one moment and the other side of the room the next. The answer was both to limit the area in which questions were asked and for a brief pause to be left between speakers to enable the microphone to be turned in the appropriate direction. Sometimes it was a case of the master having to face the same way as his pupils. Although people were having to do some pretty unnatural things in order to obtain a natural sounding tape, it was far from just eavesdropping.

There were exceptions to this: to have had the infrequent sound of leather on willow to represent cricket would have been clearly inadequate. Fortunately, the scorer in making his notes almost gave a running commentary on the game, but this was perfectly natural and not prompted by recording considerations. Similarly, I did not want to provide a distraction when I introduced the recorder to a rehearsal of "Julius Cæsar" by a crowd of junior boys. They would have been difficult to "plan," and so I attempted to merge in with the crowd, only moving over to the producer when he spoke. I had difficulty keeping a check on the recording level when at the other end of a long microphone cable. By judicious positioning of the microphone in

### The author with his Philips EL3585 during the production of "Twelve Hours"

relation to the voices and the volume from them, this was overcome to a certain extent, though some parts had to be cut out. This sequence, as were many others, was a compilation of many brief snatches.

As the no-commentator technique was being used each sequence had to speak for itself. Wonders can be done through editing but if the basic remarks are not there the sequence will never be self-explanatory. In order that it should be obvious that this was a rehearsal, I made sure words like "stage," "exit" and "speech" were included, and that Cassius's and Brutus's names would indicate exactly what play it was. Within a few seconds the geography master mentions "equatorial forests," the chemistry master talks about "sodium and potassium," so there can be no doubt as to what is happening. At other times it was a case of inserting a significant sound. I found that if one was unaware what the Latin "grace" was about the chatter over dinner was just like any other. The dropping of a fork, quite naturally, as the boys sat down immediately enabled the scene to be located. In a few cases these "signposts" were perfectly straightforward; a telephone rings; "Hello, School Secretary speaking." Hardest of all to explain was a part of the broadcasting of meteorological readings over the inter-schools CCF network. As it was in code it would have been meaningless without a "planted" reference to it in conversation.

I particularly wanted to include this last item because it was interesting purely as *sound*. This was an important yardstick for selecting material to be recorded. Subjects like Art and Physical Education—requiring visuals to explain them—had to be passed over. It was natural, of course, to give a subject like Music prominence when it could act as a contrast to the voices of which there were almost too many. While trying to be fair and give a balanced view of the school I had to think of the listener as well and give him some unusual sounds: Greek and Russian being spoken, a circular saw in the Woodwork Room, and so on. Inevitably, however, there were cries of: "Why weren't we included?"

Each sequence was built up on the lines of a "story": in cricket it was the attainment of the hundredth run; in Maths, the setting and answering of a problem separated by another sequence, in order to save time. One criticism of this constant overlapping of fades is that the items tend to sound rather "bitty," but this is, to a certain extent, inevitable when you are trying to include as many "snapshots" as possible. The editing of the programme as a whole did require a good deal of care and ingenuity.



The main order of events was indicated by the actual day under consideration but individual items created their own problems. It would seem, for instance, that there is no right way of joining sequences, but after trying an excerpt in many different places the moment comes when you realise that the piece has, indeed, found the right place in the jigsaw puzzle. Inevitably, there are certain things which just refuse to be "manipulated"—the request that a boy is to see the Headmaster during the break must come sufficiently before the interview to explain what is to follow and yet must not seem too pointed—but more and more I found that there was a seemingly correct place if only it could be found.



About this time I was reading a book on the art of film editing compiled by Karel Reisz for the British Film Academy. Again I was consciously turning to this other medium for inspiration and I found the book stimulating and instructive. It reminded me that I had neglected to establish a tempo for the production and had ignored matters of pace and flow. In putting Maths (slow because it required writing on the black-board) next to English (fast because it was reading straight from a book) mood and atmosphere were being broken up by jerky progressions. In the afternoon I tried to weave a music rehearsal in and out of the various games sequences and one full orchestral piece had to be dispensed with because it was more in tempo with a rugby game than with a cricket match.



These then are some of the problems involved in producing a recording about a school, using the no-commentator technique. But an undertaking of this type which includes the participation of a large number of busy people at the busiest part of a term is not only a matter of technical considerations. I am indebted to the school for allowing me to make the recording and to all those whose enthusiasm and willingness to spend time over the preparation of the recording made my job much easier. Their voices and actions were the basic material which I could manipulate only to a certain extent in the editing stage.

When the tape was completed a group of masters and boys heard it first and decided that it gave a fair impression of the school within the limits of a half-hour programme. The criticism most often laid against the tape was that it did not express an opinion.

I had not intended the tape to be a personal impression, but neither could it be completely impartial; the selection of material and people must inevitably reflect something of the producer. I could have tried to show the school as seen through the eyes of a boy new to it or through those of some hypercritical sixth-former. But this was not what I wanted. I wished to compile a tape which would evoke a response according to the listener, which would not have set opinions, but which I could refer to in years to come, now that I have left school, to remind me of my place of education.

# WHATEVER YOUR ASSIGNMENT—GET THE FI-CORD 202

PORTABLE BATTERY/MAINS RECORDER—  
*so much in so little space*

Another assignment for Fi-Cord Fred, safely stowed under his belt, thanks to the compact versatility of the Fi-Cord 202. The Fi-Cord 202 caters for the most exacting professional and for the enthusiastic amateur. Whether you are in a sound-proof studio or perched on a rocky ledge, the Fi-Cord 202 gives you high-fidelity recording at your fingertips. And with this wonderful, lightweight machine you have all the practical advantages of a full-size recorder.

**The Fi-Cord 202 offers all these features:**  
2 speeds— $7\frac{1}{2}$  and  $3\frac{3}{4}$  · Standard 4" spools  
Vu-meter · Fast forward wind · Fast rewind  
Resettable counter · Manual volume control

Built-in loudspeaker · Sockets for microphone, extension speaker and remote control · Safety record switch · Easy-load battery cassettes · Battery warning lamp · Mains input optional.

**ACCESSORIES INCLUDE:** Carrying case, choice of microphones, power packs for mains and car.

There is a full range of Beyer microphones, from general purpose to ultra-studio quality, to cover every use of the Fi-Cord 202.

Price: 66 guineas, including long life mercury batteries and tape.

Write for fully illustrated brochure and address of nearest stockist to:



**FI-CORD INTERNATIONAL** 40A, DOVER STREET, LONDON, W.1. HYDe Park 3448





# BRITISH AMATEUR TAPE RECORDING CONTEST 1963

## Motor-cycle club

has second

“Tape of the Year”

success

## THE TAPE OF THE YEAR

“Breakdown,” a ten-minute “re-action for radio” describing the situation when the transport system of the U.K. decides to take control from the humans. Entered by Michael Avel of 57, Munster Road, Fulham, London, S.W.6, on behalf of the Tape Section of the ‘Triumph Owners’ Motor-cycle Club.

### AWARDS

The Emitape Challenge Cup presented by E.M.I. Tape Limited  
Amphlett Shield presented by the Federation of British  
Tape Recording Clubs  
TAPE Recording Magazine Ten-guinea cheque  
Certificate

*Equipment used: Ferrograph and home-made portable recorder and mixer unit; Reslo ribbon microphone; Bib tape splicer; and Emitape.*

## COMPOSITIONS

“Ode to an Inca God,” by T. Kurkowski, aged 37, of 30, Fair-hazel Gardens, London, N.W.6.

### AWARDS

Acos Challenge Cup presented by Cosmocord Limited  
TAPE Recording Magazine Ten-guinea cheque  
Certificate

*Equipment used: Repts R10 and Grundig TK24 recorders; Ronette crystal microphone, Bib tape splicer; Scotch tape and Emitape.*

**Runner-up:** “The Strikers,” an elaborate pun concerning the inside of a clock, by Terry Devereux (29) of Southall, Middlesex.

*Equipment used: Ferrograph 4A/N and Brenell recorders; Reslo ribbon and Aiwa microphones; Editall tape splicer; and Emitape.*

\* \* \*

## DOCUMENTARIES AND REPORTAGE

“Worcester Jail,” a report on some of the felons imprisoned at the turn of the century. Entered by Peter L. Bastin (41) of 2, Canynge Street, Barbourne, Worcester, Worcestershire.

### AWARDS

Irish Trophy presented by A. C. Farnell Limited  
TAPE Recording Magazine Ten-guinea cheque  
Certificate

*Equipment used: Simon SP4, Stella 459, Philips EL3585, and Cossor 1603 recorders; Gramplan DP4H microphone; Brenell mixer unit; and Philips tape.*

**Runner-up:** “Sole and Heel,” a report on the boot repair industry, by A. F. Stanway (40) of Mickleover, Derby.

*Equipment used: Telefunken 76KB and Cossor 1603 recorders; Telefunken D11B microphone; Leak Point One pre-amplifier; and Agfa PE31 tape.*

\* \* \*

## MUSIC OR SPEECH

“Somervell’s Magnificate in F” a stereophonic recording, by Philip P. Towell (32) of 107, Spilsby Road, Boston, Lincolnshire.

### AWARDS

TAPE Recording Magazine Ten-guinea cheque  
Certificate

*Equipment used: Sony 521 recorder; Reslo ribbon microphones; AKG stereo headphones.*

\* \* \*

## ACTUALITY

“Down those Steps,” an extract from a humorous conversation with a Council employee, by John Bradley (50) of 8, Canning Road, Croydon, Surrey.

### AWARDS

TAPE Recording Magazine Ten-guinea cheque  
Certificate

*Equipment used: Philips AG8109 and EL3585 recorders; Calrad microphone; Lee Electronics mixer unit; Editall tape splicer; and C.B.S. tape.*

**Runner-up:** “The Gossiping Frogs” by Arthur Acland (62) of Tonbridge, Kent.

*Equipment used: Stuzzi Magnette and microphone supplied; and Emitape.*

\* \* \*

## TECHNICAL EXPERIMENT

“The Double Reverse,” experiments with reversed speech, by Denis B. Affleck (57), of 248, Park Road, Peterborough, Northamptonshire.

### AWARDS

Wyndson Gold Medal presented by Wyndson Recording  
Co. Limited  
TAPE Recording Magazine Ten-guinea cheque  
Certificate

*Equipment used: Truvox R2 and Sound Studio recorders; Reslo ribbon microphones; Bib tape splicer; and Emitape.*

**Runner-up:** “Eldritch,” an electronic fantasy, by R. O. Broome (34) of Doncaster, Yorkshire.

*Equipment used: Two home-built recorders with Collaro decks, home-built oscillator and tremulo units; and B.A.S.F. tape.*

\* \* \*

## CLUBS

“Breakdown,” by the Triumph Owners’ Motor-cycle Club (see “The Tape of the Year”).

**Runner-up:** “Ceremony of the Freedom of the Borough,” a stereophonic documentary feature by the Boston Soundhunters.

*Equipment used: Sony 521 and Tandberg 64 recorders; AKG D19B and Reslo RBM microphones; Telefunken mixer unit; Quiksplicer; and Philips tape.*

\* \* \*

## SCHOOLS

“A Meditation on the Crucifixion,” a playlet on the anguish of Judas, performed by the nine-year-old children of Stimpson Avenue C.P. School, Northampton (Master-in-charge: H. J. Walding).

### AWARDS

Grundig Challenge Cup and Shield presented by Grundig  
(Great Britain) Limited  
TAPE Recording Magazine Ten-guinea cheque  
Certificate

*Equipment used: Brenell Mk. 5 and Tandberg 6 and 7 recorders; Gramplan DP4 microphones; Grundig mixer unit; and Emitape.*

**Runner-up:** “Against the Customs,” an historical playlet by R. B. Cruse and Class 4a of Pennington J.M. School, Lynton, Hampshire.

*Equipment used: Repts R40 and Gramdeck recorders; Film Industries ribbon microphones; Editall tape splicer; and Electronic World and C.B.S. tape.*

# Music and sound- effects for Macbeth

## Part One

By ALAN  
SUTCLIFFE

OF all Shakespeare's plays, Macbeth is probably the most interesting to provide music and effects for. The effects range from battle sounds, drums and flourishes, to an owl, knocking and the cry of women. Strange music is clearly appropriate in the witches scenes, and could well be used to add atmosphere in a number of other places—the sleep-walking scene and the appearance of Banquo's ghost, for example—but it would be easy to be carried away, as with any incidental music, and spoil the production with an excess of it.

So it certainly came as a challenge when Barbara Dalley asked me to provide music and effects for her production of the play by the Leeds Arts Centre, with ten performances to be given in the Civic Theatre. She had already decided what effects were needed and where music was to be used—it was merely my job to provide them.

In this first article I shall describe the effects I produced, and as I had no previous experience of making specific effects, readers may learn almost as much as I did from my failures and successes. In a second article I shall describe the concrete music devised for the show.

My first idea was to make a unified whole of music and effects so that weird music for the witches would not sound out of place next to a realistic flourish of trumpets for the entrance of King Duncan. But something quite different happened in practice, for although none of the effects was naturalistic, they were largely determined by the means I had available, and so showed no particular unity among themselves or with the music.

\* \* \*

*Make all our trumpets speak, give them all breath,  
These clamorous harbingers of blood and death.*

The stage directions call for flourishes, sennets and alarums. Taking the first two together, we divided these simply into peaceful and warlike trumpet calls. It was necessary to make one of each for Macbeth, and one of each for his adversaries. I had no trumpet, but I did have a french horn mouthpiece and some rubber tubing: I had heard Dennis Brain use just this combination most effectively to show that tone colour was largely independent of the machinery of the horn.

As I played it, the sound had a dead quality that added a suitably antique flavour to the flourishes I improvised. To amplify the sound and give it some presence, I held the end of the tube in a jar and stood the microphone beside it. I found that with about two feet of tubing I could get four notes, corresponding to C, D, E and G in key of C.

Other notes could have been added by cutting holes in the tube near the end, small enough to be covered with a finger, but it would not then have been possible to amplify the sound with a jar, and in fact I found the four notes quite sufficient to make four distinct calls.

On playing back I found that the sound was too low in pitch and too slow, both of which faults were easily overcome by increasing the speed of the recorder. Although the result was then quite acceptable when played at home, the result in the theatre was thin and weak. This could have been overcome by using a more full-blooded instrument, or by combining two or more together, but like most amateurs, we were cursed by lack of time, and were unable to try these alternatives. Only in the flourish for the final curtain did I superimpose on one of the calls the slower version of itself an octave lower: with a drum also added behind it the result was a much fuller and more convincing sound.

Another fault that came to light only after several performances was that one of the flourishes bore a striking resemblance to Happy Birthday to You.

\* \* \*

*Hark, peace; it was the owl that shriek'd,  
The fatal hellman, which gives the sterns't good-night.*

I was far more successful with another instrument I used—a treble recorder. There are two places in the play where a banquet is prepared, and while the stage directions call for oboes, the sound we had seemed

more appropriate for Scotland, and would usually be mistaken for a flute.

I improvised two short sections of melody: if one picks the right rhythm and keeps to the pentatonic scale (equivalent to the black notes on the piano) it is quite easy to produce any amount of Scottish-sounding melody. In performance we had to allow this to run on and cut it at the end of a phrase when the banquet setting was complete, for the time taken on different evenings varied quite considerably.

I also used the recorder to simulate the cry of an owl. This I did by stopping all the holes except the next but one from the bottom, and then gradually lowering the finger over this hole, at the same time blowing with a quivering breath. On two nights, returning home after the play I was lucky enough to hear a real owl, and this convinced me that my effort was just as good, though it had taken an exhausting number of attempts to get to that standard. Most important was the preliminary hoot before the long falling note, which I had put in almost without realising it.

\* \* \*

*A drum, a drum:  
Macbeth doth come.*

For the drums during the battle, I used the drum part of a small banjo. A simple repeated note played at a quarter of the recording speed served for Macbeth, while a little rhythmic figure played at half speed characterised his enemies. Thus quite a tiny instrument provided two distinctive and impressive drums. Macbeth's drum is heard earlier in the play when he visits the witches.

Since music for the witches had been running for several minutes before the drum was called for, it was not possible to synchronise this drum on the same tape, so that two machines were necessary at this point, as they were in one or two other similar situations.

Due to lack of time and want of any better idea, I used a commercial recording of crowds to fill out the sound for the battle scenes. We did spend some time trying to make our own recording with members of the cast, but the result sounded more like a party than a battle. Another effect we did not record was the cry of women, which signifies the death of Lady Macbeth, and this was provided live, offstage, at each performance.

\* \* \*

*Ring the alarum-bell; murder and treason.*

There are two bells called for in the play, a small one with which Lady Macbeth, offstage, signals to Macbeth, and a large bell which sounds the alarm when the murder of Duncan is known. As I had neither sort available I had to produce bell-like sounds as best I could. For the small bell I found two tumblers with very nearly the same pitch, and rattling a pencil between them gave a satisfactory result, though not perfect, for some people thought it sounded more like a large electric bell, than the hand-bell we intended.

You will know that by lightly touching a string, a piano string for example, in the correct place, one of its harmonics can be produced. These harmonics are too pure for a realistic bell, but I found that by touching a piano string in an intermediate position, a complex tone of the fundamental and some of the harmonics was produced.

I recorded a large number of such notes, using the lowest strings of the piano, and



# DO-IT-YOURSELF

By L. REID

## A recording console for the semi-professional

**S**ERIOUS recording enthusiasts often need to "boil down" a series of recordings, or mix in sound effects, to produce the finished tape, and usually the only satisfactory way of getting anything approaching professional results is to use several recorders, turntables, etc., connected through a mixer.

Such a set-up can become quite complicated (not to say untidy!) if the equipment has to be distributed on chairs and tables, with a web of cables all over the place. Valuable time is wasted in connecting up and dismantling, and besides, recorders are usually rather too heavy to be carried about unnecessarily. How much easier it would be if everything was ready to hand when a dubbing session was about to begin; but few of us could afford to build a complete recording studio.

One solution would be to have everything built-in to form a console, but even

this presents certain problems. However much we may covet a BBC-type console the average semi-detached residence lacks the space for anything on this scale (unless you live alone with your recorders!). A built-in job would also mean considerable outlay to purchase extra decks and their associated amplifiers, and as these could only be used in the console, which might be idle for long periods, the expenditure would hardly be justified.

Fortunately something much less ambitious will serve most of us just as well as a full-scale job, and we can make use of our present equipment in a dual capacity to provide the advantages of a con-

sole without having to sacrifice portability. Since none of the equipment is permanently fixed it can be removed in a moment when required elsewhere; in fact it will be more accessible than formerly.

After some thought I evolved a design which takes up a minimum of floor space yet gives the necessary facilities in the form of a miniature console-desk, with moveable stands to hold the recorders; the latter may either take the form of trolleys or cupboards, either of which will provide storage for accessories and cables. Being mounted on castors they are easily moved with the heaviest recorder on top.

By means of this "unit-construction" system advantage can be taken of those spare corners and alcoves when the outfit is not in use. A further saving in space is obtained by making use of the "stacking-chair" principle, so that two of the units occupy the same floor area.

Fig. 1 shows the three component units, and gives a general impression of the layout when connected together. Everything passes through the control panel of the console-desk in the centre, and this will be described in detail later. All connecting cables are made long enough to allow of free movement of the recorders on their stands.

The measurements shown are only a rough guide and will need to be varied to suit individual requirements, as recorders differ so much in size and shape. (It might even be possible to accommodate two small recorders on one stand.)

I found it convenient to have the decks of both recorders at the same level, and slightly below that of the console desk, but height from the ground depends on whether you mean to sit or stand when using the console!

Although all dimensions can be varied it is important to see that the desk and sides of the console are so spaced that one of the recorders, complete with its stand, can be "stacked" underneath. My dimensions allow a Ferrograph recorder to fit under the desk, and the recorder can, if required, be operated in this position.

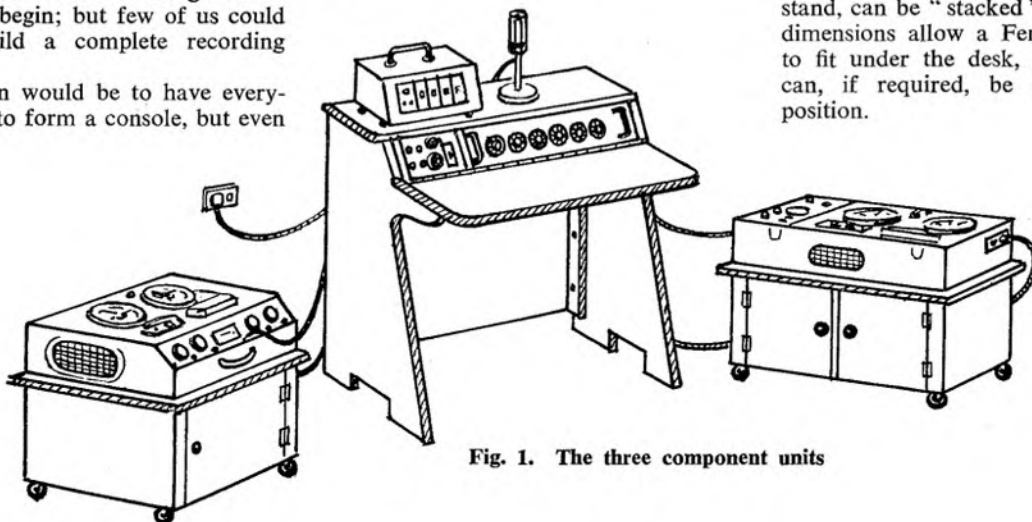

Fig. 1. The three component units

Each unit can be assembled by orthodox carpentry methods if you have the necessary skill and patience, but I devised something less laborious which could be put together in a few hours. The method used avoids all the usual woodworking joints, and has proved perfectly satisfactory in use. It relies for strength on the stiffness of thick plywood, and the recorder stands will bear my weight (11 st.) without protest, so the heaviest recorder will be in no danger!

As the dimensions of the console-desk depend on the size of recorder to be "stacked" underneath, it is best to make the recorder stands first. The material used was  $\frac{1}{2}$ -inch plywood screwed to hardwood battens, and construction was the same for each stand; the dimensions chosen were to suit a Vortexion/Ferrograph team, and bring the decks to the same level and at a convenient height for operation when seated. **Figs. 2 and 3.** (Not to scale.)

No trouble should be encountered as the drawings are self-explanatory. When the wood has been cut to size (you could get this done in the timber yard, if desired) it may be put together either by glue and oval nails punched below the surface, or by screws. If screws are used they look rather better if, instead of countersinking, dished washers are fitted under the heads.

The four legs of the stand, made from  $1\frac{1}{2}$  by  $1\frac{1}{2}$  inch hardwood, bear the weight and these are kept in position by the plywood panels.

Begin by screwing the legs to the side panels as shown, setting-in the rear pair by the thickness of the plywood. The

object of this is to give increased strength by making the back panel recessed.

Next, at the top and bottom edges of each side,  $1\frac{1}{2}$  x  $\frac{7}{8}$ -inch battens are screwed between the legs. Similar battens are attached to the top and bottom edges of the back, allowing  $1\frac{1}{2}$ -inch clearance at each side for the legs; the bottom panel also needs  $1\frac{1}{2}$  x  $1\frac{1}{2}$ -inch clearance squares cut from each corner before fitting.

After attaching the bottom and back panels to the sides, by means of screws into the battens, complete the front with plywood strips to conceal the front legs and front edge of each side. Clean up where necessary, and fit the top, which should project about one inch all round. This looks better and affords a grip;

### The complete installation in the author's home

here it is best to use countersunk screws to keep the surface flat. A rubber mat stuck on top gives a good finish and helps to reduce any motor noise from the recorder.

If desired a door, or doors, may be fitted by attaching suitable plywood panels by means of hinges; these are kept shut by spring or ball catches, *not* the magnetic types!

The construction is completed by fitting castors to the legs, and it is well worth while to pay a little more for the ball-bearing type which run easily over carpets.

Clean up with sandpaper and finish as desired. If veneered plywood has been used, French polish will give a rich appearance; or an ebonised effect on plain wood can be obtained by using black French polish. Another idea would be to use an adhesive plastic film, and these can be obtained in imitation wood grains.

The recorder stands by themselves will prove a great convenience when using two recorders, but the full benefit will not be obtained until the console desk is added, and this will be described in a further article.

TO BE CONTINUED NEXT MONTH

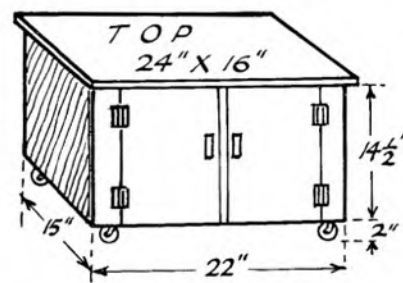
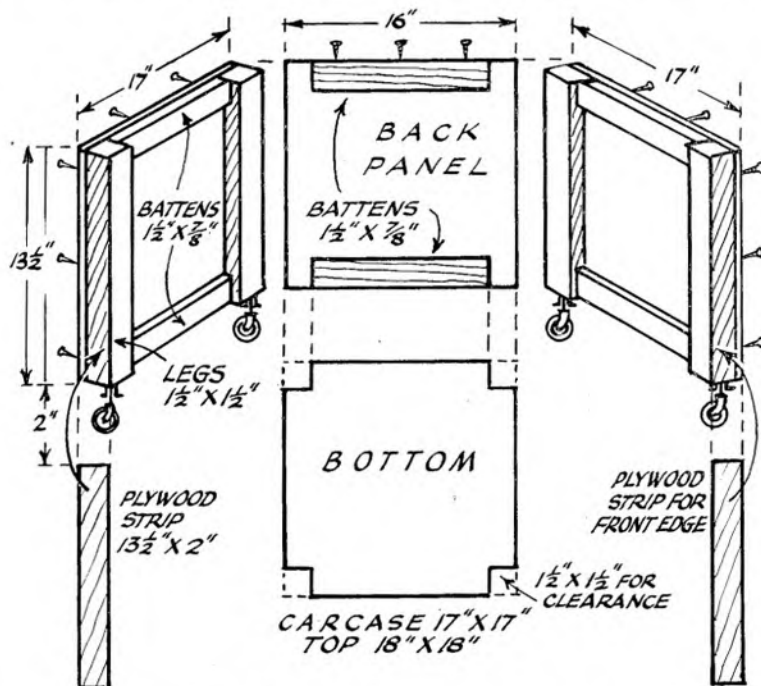

# TRAVELLING WITH A TAPE RECORDER

By LEN BLACK



Travelling with a tape recorder can double the pleasure of a holiday as Len Black found during his trip to Norway. The photographs show just some of the many items he was able to capture on tape. Top right: Norwegian children on the Gudvangen Ferry record some of their songs. Top left: An "on-the-spot" recording of the wild Norwegian countryside on the way to Lom. Centre right: Gard Fosse, a poly-lingual singer entertains the guests at the Grand Hotel Bellevue at Andalsnes. Above: Participants in the Norwegian motor-cycle rally enjoy a little music from the Grundig TK1 as they eat an open-air meal. Right: the TK1 records a description of the busy scene in Bergen's picturesque harbour.

# Tape records reviewed

Great care **CLASSICS**  
taken  
with  
these  
solo items  
By Edward Greenfield



**BACH.** Brandenburg Concertos Nos. 1 to 6. The New York Sinfonietta conducted by Max Goberman. Concertos 1 to 4, WRC (TT 241). Concertos 5 and 6, WRC (TT 242), 3½ ips, mono. 29s.

Bach's Brandenburg Concertos contain not only some of the most immediately attractive music he ever wrote, but they lift the eighteenth century idea of a concerto to heights never achieved before or since. Yet as with most of Bach's works these pieces were written to an ordinary commission from the Margrave of Brandenburg and there is little evidence that anyone at the time regarded them as anything out of the ordinary.

Even in comparatively recent times there has been a danger of their slipping out of the repertory because of the unusual forces required and the difficulty of performing them with a full band of strings. On record at least chamber performances have become the rule, and this one is particularly brisk and lively if hardly as well disciplined as it should be. What is specially interesting about it is that great care has been taken to have the original solo instruments specified by Bach. In the first concerto for example you have a violino piccolo (an antique violin much smaller than normal), and in the body of the orchestra a bass viol. The noises are certainly unusual and not necessarily attractive to our modern ears.

As usual sleeve notes are omitted from these tape issues but WRC has gone to the length of putting a special note on the odd sounds of the unusual instruments, mentioning the "characteristically wheezy tone" of the bass viol.

Such sounds are admittedly fascinating, but they tend to distract one rather than help with the music. In seeking authenticity a slightly less extreme approach strikes me as rather better, and that is exactly what you get from the Hamburg Chamber Orchestra on the rival tape issue of the Brandenburgs from Saga. Those two tapes are admittedly a little more expensive than these (STG8013 and 8014, 32s. 6d.; and STE3084 and 3085 (stereo), 63s.) and the recording is not quite so rounded, but the performances are almost always a shade better. Harry Newstone generally chooses more sensible speeds and there is almost always more spring in the rhythm, a very important point in these works. In the slow movements both versions are most recommendable as both Newstone and

Goberman strike a very happy balance between expressiveness of phrasing and classical purity. But after Goberman has gone to such lengths to secure the original antique instruments it is rather curious that he has adopted some very odd and not authentic-sounding readings of the ornaments, so difficult to interpret in Bach. The absence of some of the trills in the lovely slow movement of the Sixth Concerto has an oddly bald effect.

But whichever version you choose you can be guaranteed some of the most wonderful music Bach ever wrote in lively and intelligent readings.

**GYPSY FIRE.** Recruiting Song, Prelude and Csardas, the Fallen Pear Tree, Fantasy in A minor, I Shall Be a Tree, Only One Girl, I Court a Beautiful Woman, Csardas Potpourri. Karolyi Szenassi (violin) and his Gypsy Ensemble. Saga (STG 8105), 3½ ips, mono. 32s. 6d.

The great trouble with gypsy music is that any bit tends to sound very like every other bit. The opening Recruiting Song (Verbunkos in Hungarian) was so long-drawn-out and mournful I thought the tracks must have been reversed and this was the Fantasy in A minor. But no, apparently recruiting in Hungary is a mournful business and the words *Fly my swallow* here suggest that the sentiments are not necessarily those of the Recruiting Sergeant towards his recruit.

But periodically, of course, there are those wonderful csardas movements that inspired so many composers last century, and those I personally find more attractive than the mooning about elsewhere. But anyone wanting to be nostalgic about Hungary or Hungarian restaurants could hardly do better than this.

Szenassi has the authentic soupy style of gypsy violin playing and there is an authentic Hungarian cymbalom which twangs and rumbles throughout to make the loudspeaker rattle if you are not careful. Otherwise the recording is very acceptable.

**KHACHATURIAN.** Gayaneh — Ballet Suite. London Symphony Orchestra conducted by Anatole Fistoulari. WRC (TCM 41), 3½ ips, mono. 29s.

This is the most complete account of Khachaturian's ballet with its famous Sabre Dance that is available in any form, but you would not know that from the box. No information whatever is given about detailed items, and I myself would have been completely in the dark had not a disc version, much better documented, arrived at the same time. At least there is no difficulty in recognising the Sabre Dance at the start, but the other ten movements included are: Lyrical Duet, Dance of the Rose Maidens, Hopak, Lullaby, Lezhinka, Russian Dance, Gayaneh's Adagio, Dance of the Young Kurds, Dance of the Old Man and Fire.

The Sabre Dance may be the most striking of these pieces, but it is far from being the best. Most of this music is

simple, unpretentious and tuneful in the best Soviet tradition. It was written early in the war and like other music Khachaturian wrote at that time it has a highly patriotic theme with the folk music of his native Georgia used liberally. The recording from Everest is magnificent, and the playing of the London Symphony Orchestra under Fistoulari is most polished.

The legend **POPULAR**  
of  
Tommy  
Dorsey  
By Don Wedge



**THE DORSEY LEGEND.** Tommy Dorsey and his Orchestra. WRC (TT 245), 3½ ips, mono. 29s.

Legend is certainly a permissible word to use about Tommy Dorsey. For more than two decades he was in the forefront of the best dance music. This record was made in 1944 when his fame was at its height.

Members of the band at that time included drummer Gene Krupa and clarinettist Buddy de Franco. In the trombone section was a man later to gain much more fame as an arranger, Nelson Riddle.

The record was probably made by Dorsey privately and was issued for the first time quite recently. Though the *Sentimental gentleman of swing* is heard at the beginning introducing the record, I suspect that the tracks were recorded at different times.

On the first, *Boogie Woogie* had Alvin Stoller on drums, whereas on the reverse play the percussionist for *Opus No. 1* is Sy Oliver. The style of playing changes, too—from a loose "coloured" big band sound at first to the tighter swinging style more usually associated with Tommy Dorsey.

The leader's wonderful, smooth trombone playing is frequently heard though it is not as prominent as on the band's hit singles of the period. It is probably best on the ever memorable *Marie* which also packages a nostalgic band vocal, so typical of the period, lifting the solo vocalist, Stuart Foster.

This first-class record, very varied and entertaining nearly twenty years later, is highlighted by de Franco's *Clarinet Cascades*, a swinging *I never knew* from the Sentimentalists' vocal team and an exciting trumpet feature by Charlie Shavers, *Buddy's Chick* which also has him singing as a bandsman rather than a vocalist!

Featured singer is Foster, one of the successors to Frank Sinatra with Dorsey, who is best heard with *Like a leaf in the wind*, a song I wish I heard more of.

**AN EVENING WITH BIG BILL BROONZY.** Saga (STG 8069), 3½ ips, mono. 32s. 6d.

Big Bill Broonzy, who died in 1958, was one of the greatest of America's

(Continued on page 28)

The tape records reviewed this month are issued by the following companies:  
"Graphic Sound," Graphic Sound Ltd., 37, Jesmond Road, Newcastle-upon-Tyne, Northumberland.  
"Recotape," Eastern Productions Ltd., 22, Coastal Chambers, Buckingham Palace Road, London, S.W.1.  
"Saga," Saga Records Ltd., 127, Kensal Road, London, W.10.  
"W.R.C.," World Record Club, Box 11, Parkbridge House, The Little Green, Richmond, Surrey.

# TAPE RECORDER COVERS



Smart, waterproof cover to give complete protection to your tape recorder. Made from rubberised canvas in navy, wine, tan, grey and bottle green with white contrasting pipings, reinforced base, handy zip microphone pocket and name panel.

Grundig TK.5 ...	55/-	Cossor 1602 ...	57/6
" TK.8 ...	63/-	" 1601 ...	63/-
" TK.20 ...	52/6	Stella ST455 ...	63/-
" TK.24 ...	55/-	" ST454 ...	57/6
" TK.25 ...	55/-	Saja MK.5 ...	57/6
" TK.30 ...	60/-	Stuzzi Tricorder ...	58/-
" TK.35 ...	63/-	Saba ...	63/-
" TK.50 ...	60/-	Wyndor Viscount ...	55/-*
" TK.55 ...	63/-	" Victor ...	60/-*
" TK.60 ...	75/-*	Elizabethan Princess ...	60/-
" TK.830/3D ...	63/-	" Avon ...	60/-
" Cub ...	35/-	" Escort ...	57/6*
Telefunken 85 ...	60/-*	" Major ...	63/-
" 85 ...	65/-	" FT.1 ...	66/-
" 75/15 ...	55/-	" FT.3 ...	75/-*
" 76K ...	55/-	Fi-Cord ...	52/6
" 77K ...	75/-*	Korting (4 track stereo) ...	63/-
Philips 8108 ...	57/6	Harting Stereo ...	66/-
" 8109 ...	63/-	Fidelity Argyle ...	55/-*
" EL3538 ...	63/-	Walter 101 ...	55/-
" EL3542 ...	63/-	Simon SP4 ...	63/-*
" EL3536 ...	70/-*	Clarion (complete with strap) ...	52/6
" EL3515 ...	57/6	Brenell Mk.5 ...	77/-
" EL3541/15 ...	57/6	" 3 star ...	69/-
		Minivox ...	75/-*

**A. BROWN & SONS LTD.**

24-28, GEORGE STREET, HULL Tel: 25413, 25412

# AUTOMATED SLEEP-SUGGESTION

- WHAT IS SLEEP-SUGGESTION?
- HOW DOES IT WORK?
- HOW CAN IT BENEFIT YOU?

SEND NOW for FREE BROCHURE for up-to-the-minute information on this vital subject

**EDUCATIONAL RECORDINGS LTD.**

Dept. B, 21 Bishop's Close,  
Church Lane, London, E.17

## The Berean Forward Movement

(NON-SECTARIAN  
NON-DENOMINATIONAL)

Loan of over 700 reliable expositions of the Bible available on tape (3½ ips) for cost of postage only (free to the blind and infirm). Invaluable to all Christians, from teachers to tyros; for Bible Study groups or private meditation. Supporting literature also available. Send for free, complete list of tapes and literature to B.F.M. "Eastgrove," Marsham Way, Gerrards Cross, Bucks.

# FRANCIS OF STREATHAM

Akai M6 Stereo ...	30 gns.	*Telefunken 8SKL de luxe ...	82 gns.
Akai M69 ...	79 gns.	*Telefunken 95 ...	59 gns.
*Brenell Mk. V. Model M	88 gns.	*Telefunken 96 4 Tr.	49 gns.
*Brenell Mk. V ...	64 gns.	*Telefunken 97 Stereo ...	95 gns.
Cossor 4 Tr. 1602 ...	38 gns.	*Telefunken 98 Stereo ...	95 gns.
Cossor 4 Tr. 1608 ...	62 gns.	Truvox Series 60, 1/2 & 1 Tr.	39 gns.
Cossor 4 Tr. 1603 ...	28 gns.	Truvox Series 80/2 Tr.	55 gns.
Elizabethan Popular ...	24 gns.	Truvox Series 80/4 Tr.	59 gns.
Elizabethan L.Z. 30 ...	32 gns.	Uher Universal ...	82 gns.
Ferguson 3200 ...	26 gns.	*Vortaxion WVA ...	£93.13.0
Ferguson 3202 2Sp 4Tr ...	33 gns.	*Vortaxion WVB ...	£110.3.0
*Ferroglyph Series V ...	85 gns.	*Vortaxion C Stereo ...	£148.10.0
*Ferroglyph 422 or 424 ...	110 gns.	*Vortaxion CBL ...	£160
Fidelity Argyl Minor ...	22 gns.	*Wyndor International ...	69 gns.
Grundig TK14 ...	35 gns.		
Grundig TK23 ...	45 gns.		
Grundig TK40 ...	75 gns.		
Grundig TK41 ...	75 gns.		
Grundig TK46 Stereo ...	99 gns.		
Loewe Opta 403 2Sp ...	45 gns.		
Loewe Opta 404 ...	53 gns.		
Philips 4 Tr. 3514 ...	27 gns.		
Philips 4 Tr. 3541 ...	36 gns.		
Philips 4 Tr. 3549 ...	62 gns.		
Philips new 4 Tr. Stereo	92 gns.		
*Reflectograph 'A' 1/2 Tr.	105 gns.		
Robuk ...	36 gns.		
*Simon SP5 ...	93 gns.		
Sony Stereo 464 ...	75 gns.		
Sony 1/2 and 1/4 Track 521 ...	124 gns.		
Stellaphon 4 Tr. 454 ...	28 gns.		
Stellaphon 4 Tr. 454 ...	38 gns.		
Stellaphon 4 Tr. 459 ...	62 gns.		
Stuzzi 4 Tr. Junior ...	26 gns.		
*Tandberg Series VI Stereo 1/2 or 1/4 Tr.	110 gns.		
*Tandberg Series 7 ...	93 gns.		

*Telefunken 8SKL de luxe ...	82 gns.
*Telefunken 95 ...	59 gns.
*Telefunken 96 4 Tr.	49 gns.
*Telefunken 97 Stereo ...	95 gns.
*Telefunken 98 Stereo ...	95 gns.
Truvox Series 60, 1/2 & 1 Tr.	39 gns.
Truvox Series 80/2 Tr.	55 gns.
Truvox Series 80/4 Tr.	59 gns.
Uher Universal ...	82 gns.
*Vortaxion WVA ...	£93.13.0
*Vortaxion WVB ...	£110.3.0
*Vortaxion C Stereo ...	£148.10.0
*Vortaxion CBL ...	£160
*Wyndor International ...	69 gns.

### BATTERY PORTABLES

Philips Portable ...	24 gns.
*Butoba ...	66 gns.
Grundig TK1 ...	29 gns.
Clarion Phonotrix ...	39 gns.
Fi-Cord 202 ...	66 gns.
Stella ...	25 gns.
Stuzzi Memo-Cord ...	25 gns.
Optacord 412 Batt/Mains	47 gns.
Uher 4000 ...	93 gns.
Cossor ...	25 gns.

\*Microphone extra

Mains Power Pack for Philips or Stella ... £5.0.0

TRUVOX Decks with Pre-Amps  
PD 82—Standard Twin Tr. £42.0.0  
PD 85—Professional 4 Tr. £52.10.0  
PD 84—Professional 4 Tr. Stereo ... £43.0.0  
Decks also Brenell and Wearite

## LEADING STOCKISTS OF EQUIPMENT FOR TAPE and HI-FI

... and NO EXTRA FOR CREDIT TERMS

- ★ Minimum Deposit
- ★ No Interest or Service Charges on H.P. up to 18 months
- ★ Free Service during Guarantee Period

Prices subject to alteration as announced by manufacturers

- Gramplan Reflector... £5.15.0
- MICROPHONES & MIXERS  
Gramplan Ribbon GR102 £10.15.0  
Gramplan DP/4 Dynamic £8.0.0  
Lustraphone VR/70 Miniature Ribbon ... 10 gns.  
Lustraphone Ribbon ... £7.17.6  
Lustraphone LPV/59 Dynamic ... £8.18.6  
Simon 'Cadenza' Ribbon £10.10.0  
Reslo Ribbon or Dynamic £12.2.6  
Reslo Cardioid ... £9.12.6  
Reslo Pencil Ribbon ... £8.0.0  
A.K.G. Stereo D.88 ... £19.19.0  
A.K.G. K.50 Headphones £7.10.0  
Grundig Mixer ... £16.16.0  
Microphones by ACOS, and TELEFUNKEN All Walgain Products. Brenell and Philips mixers.

● TAPES & ACCESSORIES  
Standard, Double Play, Long Play and Triple Play in all sizes by all leading makers.

● Pre-recorded Tapes by Columbia, H.M.V., Saga, Music on Tape, etc. Bib, Bond and Romagna splicers. Matching transformers. Plugs, sockets, etc.

● Deflexers by Walgain, Wearite.

### HI-FI DEPT.

- STEREO AND MONO AMPLIFIERS by  
Quad Scott Chapman  
Tripletone Walgain Leak  
Rogers Armstrong B. & O.
- TUNERS by  
Quad Rogers Chapman  
Leak Armstrong Pye
- LOUDSPEAKERS by  
Quad Philips  
W.B. Wharfedale  
Goodmans Tannoy  
Leak Lowther  
Kef
- MOTORS, PICKUPS, by  
Garrard Tannoy  
Goldring-Lenco Connoisseur  
Shure Decca 'Deram'  
Stereo Ronette  
Philips SME  
B & O Thorens  
Ortofon

All types of Diamond and Sapphire styli, stereo and mono. Microlifts, Garrard SPG3, Acos Dust Bag.

● CABINETS Record Housing Design Furniture

Please note our only address as below

**169-173 STREATHAM HIGH ROAD, LONDON, S.W.16**

Between St. Leonard's Church and Streatham Station

STReatham 0446/0192



# Designing to a Specification

By R. HIRST

THE function of an equaliser is to correct any input differences of volume at different frequencies, so that the audible output from an amplifier is equal at all frequencies.

These differences in volume have two main origins. They can be brought about by the human element; or they can be caused by natural elements. We shall discuss the "Man-made" problems first.

When a gramophone record is being made a spiral groove is cut in a disc. The groove starts at the outer edge rotating in a clockwise direction towards the centre of the disc. The pitch of this groove being measured in so many grooves per inch—the more grooves to the inch the longer the playing time. However as the bass notes cause the recording stylus to cut wider grooves, these tending to break into the grooves either side, a compromise between the playing time and bass recording has to be made. It was decided to restrict the bass notes during recording, line CXD (Fig. 1) so that a reasonable playing time could be accommodated on a certain sized disc. This restriction of bass notes has to be corrected in the replay amplifier, line EXLF.

It can be seen in Fig. 1 that we require 20 db less volume at one kilocycle (point X), than we need at 31.2 cycles (point E), (20 db being ten times), therefore we have to reduce the volume ten times at 1,000 cps by means of a 10:1 divider network, R1-R2-C1, Fig. 2, R1 being the 10 section and R2 plus C1 the 1 section. If we neglect C1, R1 would have to be ten times greater than R2 so that at point A (Fig. 2) we will have ten times less output than point B. Unfortunately the resistor R2 reduces all the frequencies equally so we have to incorporate a device that will alter the reduction in output as the frequencies change. The device we shall use is called a condenser.

One of the peculiarities of a condenser is that as the frequency of the note is halved the "resistance" of the condenser is doubled. If R2 were to be omitted from the circuit in Fig. 2 the resultant output at point A would tend to be as line A-B (Fig. 3).

It will be seen in Fig. 3 line A-B 1,000 cps has been reduced by 32 times (30 db) and 8,000 cps reduced by a further eight times (18 db), this reduction taking the shape of the straight line A-B. As we require a curved line with a smaller amount of reduction (Fig. 1) line EXLF we shall insert the resistor (R2) in series with the condenser (C1) (Fig. 2), the total resistance of these

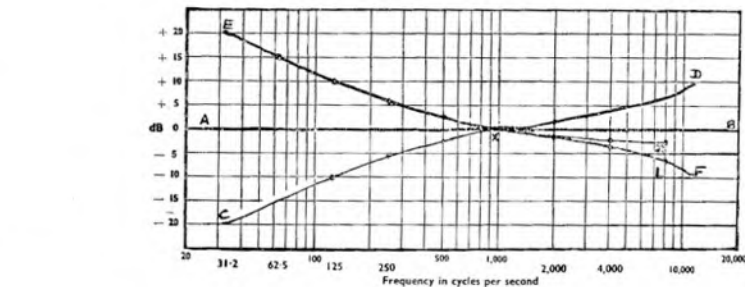

Fig. 1

TABLE ONE

Frequency	C1 Value Ohms	R2 Value Ohms	Total Value Ohms	Total transfer to figure 1 (Line E x Z)
31.2 c/s	9,600	700	10,300	+20
62.5 c/s	4,800	700	5,500	+15
125 c/s	2,400	700	3,100	+10
250 c/s	1,200	700	1,900	+6
500 c/s	600	700	1,300	+2.5
1 kc/s	300	700	1,000	0
2 kc/s	150	700	850	-1.5
4 kc/s	75	700	775	-2.0
8 kc/s	37	700	737	-2.5

two components to equal one-tenth of R1 at 1,000 cycles, so that there is a reduction of ten times at this frequency.

It will be seen in Table One that, if suitable values of C1 and R2 are chosen and their values added up at different frequencies these values then being transferred to Fig. 1, they will form the curve EXZ. The value of R1 being 10,000 ohms, R2, 700 ohms and C1 0.5 uf (approx. 300 ohms at 1,000 cps).

So far so good. We have however still to correct for 4 db too much output at 8,000 cps, points Z and L, Fig. 1. This we will regulate by placing another condenser (C2) across the output, point A, the resistance of this condenser should have very little effect at 1,000 cps yet will reduce the output by 4 db at 8,000 cps. The value of this condenser is 0.02 uf, the resultant details are shown in Table Two and transferred to Fig. 1 to give the line XLF. The overall

Therefore the resultant output should be line A-B (Fig. 1).

We have dealt with the reason and rectification of a "man-made" frequency irregularity. The "Natural" irregularity

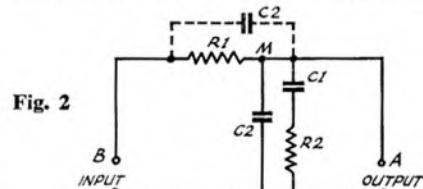

Fig. 2

can be much more of a problem as very little or no control at all may be exercised over the pattern this chooses to take, this sometimes making the equalisation curves take impossible shapes.

The easiest example however is the replay head of a tape recorder. If a signal of equal volume at all frequencies is recorded on a tape, the tape then passed in front of a replay head, the output from the head will look very similar to line SWGD (Fig. 3). As you will see the part of the line SW is exactly opposite to the line AW (this being the condenser reaction to change of frequency). Here once again we are able to

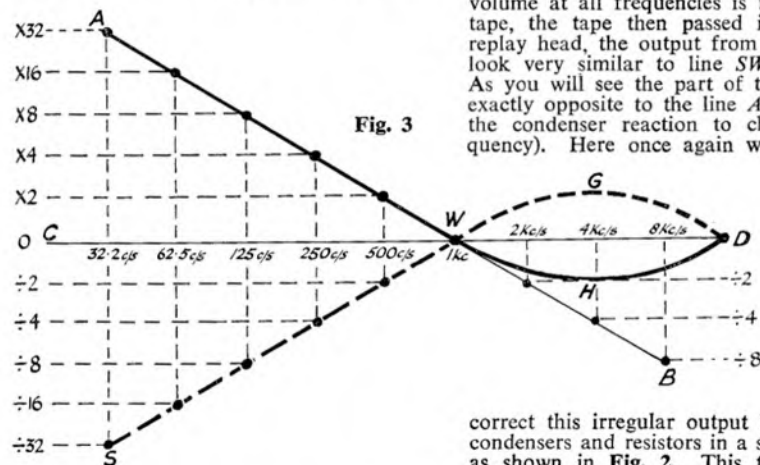

Fig. 3

results of R1-C1-R2-C2 being the required curve EXLF, Fig. 1. This curve is exactly opposite to the recorded curve CXD (Fig. 1).

TABLE TWO

Frequency	(C2) Value in Ohms	(C1+R1) Value in Ohms	Total Value in Ohms	Total transferred to diagram 1 (Line x L F)
1 kc/s	7,960	1,000	888	-1.0db
2 kc/s	3,980	850	700	-1.5 db
4 kc/s	1,990	775	557	-2.5 db
8 kc/s	995	737	423	-4.5 db

"Total value in Ohms" arrived at by the formula:  $\frac{1}{C2} + \frac{1}{C1 + R1} = \frac{1}{\text{Total value in ohms}}$

e.g.  $\frac{1}{7,960} + \frac{1}{1,000} = 888$  ohms at 1,000 cps.  $1,000 - 888 = 112 =$  a difference of 1db.

NOTE.—C1 and C2 values at set frequencies in ohms.

correct this irregular output by the use of condensers and resistors in a similar fashion as shown in Fig. 2. This time the ratio required of R1 to C1 + R2 is 32 to 1 at 1,000 cps. R2 in series with C1 again causes the line W-B (Fig. 3) to take the shape of line W-H-D. The condensers C2 however is removed from its original position (the value now being .002 uf) and placed across R1 in order to give some high frequency lift (point D) Fig. 3 rather than high frequency fall as in Fig. 1 line L-F.

The final curve A-W-H-D (Fig. 3) being exactly opposite to curve S-W-G-D gives a flat output C-W-D.

Equalisation may seem to be a simple though tedious problem. In certain instances this may be so but before we can arrive at

(continued on page 34)

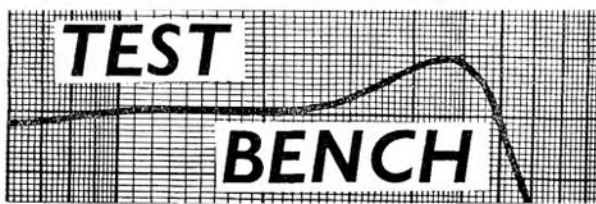
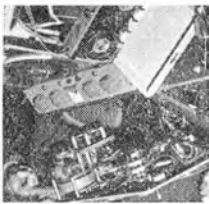

# TANDBERG 74

By John Aldred

**A**LTHOUGH the Norwegian firm of Tandberg Radiofabrikk A/S has been manufacturing tape recorders for some considerable time, they have not gained the same popularity in this country as some of their contemporaries. This is a pity because a Tandberg tape recorder is a first class instrument, even if its cabinet appears somewhat austere by normal standards.

The makers have concentrated all their skill on producing a first class tape mechanism and electronic system for their model 74, installed in a simple un-polished wood case with a hardboard bottom. There is no top cover, although a luggage type carrying case is sold as an accessory.

### FACILITIES

Model 74 is a four-track, three-speed stereophonic recorder which has two volume indicators and two internal loudspeakers. A twin track version model 72 is also available. Both recorders operate at 1½, 3½, and 7½ ips, permit low level monitoring on stereo, high level monitoring on mono (using the second channel as an amplifier), re-record one track into another if required, or playback a mono track through both channels—thereby doubling the output power of three watts per channel.

All these facilities are packed into a case measuring only 15½ × 11½ × 6 inches and weighing 27½ lb. No tone controls are fitted for adjusting the replay characteristic, except an optional bass lift circuit for use when listening on the internal loudspeakers.

### TAPE DECK

The tape deck is powered by a single split phase induction motor which maintains a speed tolerance of ±1 per cent. The speed change is accomplished by a stepped boss on the motor shaft, which engages with a rubber tyred pulley and drives the rim of a 4½ inch diameter flywheel. This is some flywheel when one considers that the capstan diameter is only 3/16ths inches, and the size is largely responsible for the complete absence of wow and flutter. The actual figures are considerably less than 0.1 per cent, except at certain frequencies in the lowest speed range.

All tape movements are controlled by a Tape Motion Lever. This has five positions, Off, Run, Rewind, Fast forwards, and Free. In the latter position, the lever releases the brake and felt clutch from each spool hub for loading purposes. The mechanism will not run unless the tape is correctly threaded, due

to a spring actuated micro-switch at one end of the tape slot. This feature serves as an automatic stop, and does not rely on the usual strip of leader foil.

Adjacent to the tape motion lever is a four-digit numerical counter, belt driven from the take-up spool hub. The fourth digit enables more accurate readings to be taken, especially with long play tapes

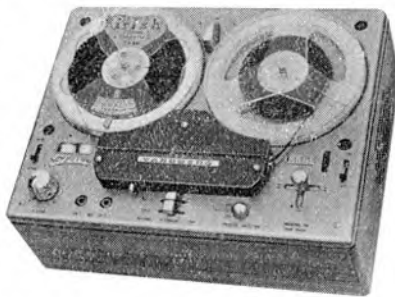

at the slower speeds. A built-in pilot light illuminates the counter. A brief stop is also fitted which can be locked in the pause position. The complete tape path is easily accessible for cleaning or tape editing, the front and rear covers being held in position by thumbscrews.

### AMPLIFIERS

The electronics of the Tandberg leave nothing to be desired, and both channels appeared to be completely hum free with normal usage, and without an earth! The reason for this becomes apparent when the recorder is lifted from its case (an operation necessary for valve replacement). The single mains transformer is completely enclosed in a mu-metal case, and located at the furthest point from the tape heads.

Printed circuit construction is employed, both channels being assembled on one long board. The two output stages are wired together on a separate board, together with their transformers. The speed change switch on the tape deck automatically adjusts the amplifier equalisation, both when recording and playing back. Treble lift is applied to the recording head at each tape speed to obtain an extended response, and the necessary bass rise for playback is in-

corporated in a feedback circuit in the first valve stage. A low noise transistor is used between the replay head and the first valve, thus eliminating some of the noise and hum problems associated with tape replay circuits.

The volume indicators are Telefunken magic eyes, type EAM 86, visible beneath a perspex cover on the left of the tape deck. They are fed with a signal containing treble emphasis to simulate the signal being recorded, thus assisting to prevent overload at high frequencies. Their twin beams are accurately adjusted to read 100 per cent modulation at the point of overloading.

### CONTROLS

There are only two controls for each channel; volume and a function selector switch. Both volume controls are mounted concentrically, and the two selector switches are located in front of the tape slot. These switches actuate multi-contact slide switches mounted on the printed circuit board, and contain positions for Record, Replay, and Amplifier. The latter position enables the recorder to be used as a stereophonic amplifier.

When either switch is in the Record position, both channel inputs are paralleled through one volume control. Any balancing of two sound sources must therefore be carried out externally. When playing back on either channel, the other track may be heard by simply switching the channel in use to Amplifier. By switching the channel not in use to Amplifier, both channels will replay the same track as previously mentioned.

A refinement is a five-position loudspeaker switch for connecting internal or external loudspeakers or both, also both loudspeakers to either channel 1 or 2. This latter position enables either channel to be sampled separately during a stereo recording.

### CONNECTION PANEL

A small panel at the rear contains two input and two output sockets, accepting miniature screened plugs. There is a high impedance (½ megohm) input for each channel with a variable sensitivity control, and a low impedance (4 ohm) output socket for an extension loudspeaker. Two high impedance microphone jack sockets are fitted on top of the tape deck. Inserting a plug here removes the other input from circuit. The mains lead is captive, and stows away in a small recess at the rear.

### MONITORING

Headphone or loudspeaker monitoring is possible at all times during recording, either stereo or mono, prior to the signal

**Overall record/replay frequency response of Tandberg Model 74. Curves at tape speeds of (A) 1½ ips, (B) 3½ ips, and (C) 7½ ips. The dotted curve shows the bass lift circuit for improving reproduction from the internal loudspeakers**

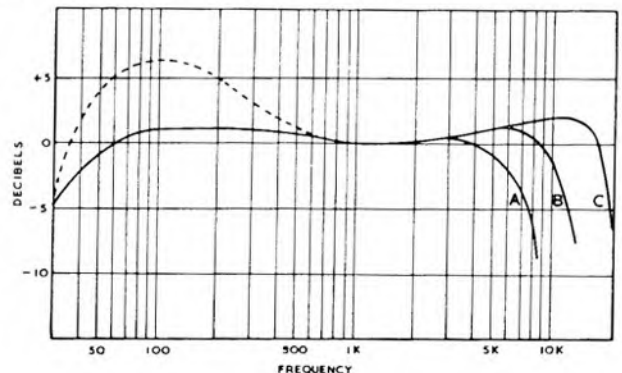

being recorded. There is no separate replay head and amplifier and therefore no tape monitor.

#### PERFORMANCE

The manufacturer's specification for an overall frequency response of 40-16,000 cycles  $\pm 2$  dB at  $7\frac{1}{2}$  ips is easily obtainable with a good grade tape. The bias oscillator waveform, which must be clean and free of harmonics for a quiet recording, was found to be exceptionally good for a domestic recorder.

Signal-to-noise ratio is often rather poor on a four-track recorder, due to the narrow track width and the extra amplification required. But the Tandberg model 74 is exceptionally quiet electronically, the signal-to-noise ratio being in the order of 50 to 55 dB. This is a figure normally associated with professional equipment, and is seldom found in recorders of this type. The cross talk between channels is also negligible for all practical purposes.

The facility for re-recording from one track to another, often referred to as "Multiplay," is only partially successful with the model 74. This is because each half of a single stacked head is used for playback and recording simultaneously, resulting in a certain amount of magnetic coupling between windings. The result is instability and oscillation when attempting to re-record at too high a volume setting. Re-recording can only be 100 per cent satisfactory when there are separate playback and record heads, such as on the more expensive Tandberg model 62 and 64.

The tape deck treats all kinds of tape with respect, regardless of spool sizes. Braking is efficient, and the tape lifted clear of the heads for rewind or fast wind on. The fact that the excellent Papst motor does not run continuously may be considered a disadvantage by some, since the deck takes two or three seconds to reach the correct recording speed. This wait can be eliminated by using the pause control, however.

It is essential to use a good quality tape on the Tandberg model 74 to minimise the possibility of "drop-outs"—there is no pressure pad on the record/replay head. Damaged or slightly buckled tapes should therefore be avoided.

#### COMMENT

The Tandberg model 74 is obviously a "no compromise" recorder, and I can thoroughly recommend it to anybody requiring professional results from a recorder costing under £100. The replay characteristics are suitable for C.C.I.R. recorded tapes, although the highest tape speed of  $7\frac{1}{2}$  ips is adjusted to give equally good results from N.A.R.T.B. tapes. The recording characteristics at this speed closely resembles the N.A.R.T.B. curve.

Enthusiasts who fight shy of a four-track machine will be easily satisfied with the twin track version, model 72, which retails at exactly the same price.

#### Manufacturer's Specifications

Operating Voltage: 110 to 245 v AC.  
Power required: 85 watts.  
Maximum spool size: 7 inch.  
Amplifier frequency response: 40-20,000 cycles  $\pm 2$  dB.  
Recorded frequency response: 40-16,000 cycles at  $7\frac{1}{2}$  ips  $\pm 2$  dB; 40-10,000 cycles at  $3\frac{1}{2}$  ips  $\pm 2$  dB; 40-5,500 cycles at  $1\frac{1}{2}$  ips  $\pm 2$  dB.

Signal-to-noise ratio: 55 dB below 100 per cent modulation.

Amplifier inputs: Micro  $2 \times 1.5$  mV at 3 megohms; Gram  $2 \times 100$  mV at 500 K ohm.

Amplifier outputs:  $2 \times 3$  watts at 4 ohms.

Tone control: 6 dB lift at 100 cycles on replay.

Valve line-up: ECC83, (2), ECL86 (2), ECC82.

Transistors: AC 107 (2).

Volume indicators: EAM86 (2).

Loudspeakers:  $7 \times 4$  in. elliptical (2).

Dimensions:  $15\frac{1}{4} \times 11\frac{1}{4} \times 6$  in.

Weight:  $28\frac{1}{2}$  lb.

Price: 93 guineas.

Carrying case: £7 1s. 8d.

Agents: Elstone Electronics Ltd., Edward Street, Leeds 2.

## GRUNDIG 608 STEREO MIXER

By John Aldred

**T**HE new Grundig Stereo Mixer unit, Model 608, has been designed mainly for use with Grundig tape recorders, especially the TK46. It contains three separate channels with slider type volume controls, and is fitted in a streamlined plastic case together with batteries and transistor pre-amplifiers.

Compatible for either stereo or mono use, it enables a stereo pick-up to be mixed with a stereo microphone, (or a pair of ordinary microphones). The third slider permits another microphone, tape recorder, or radio (diode socket), to be mixed into the left-hand channel. Alternatively, the output from the third slider

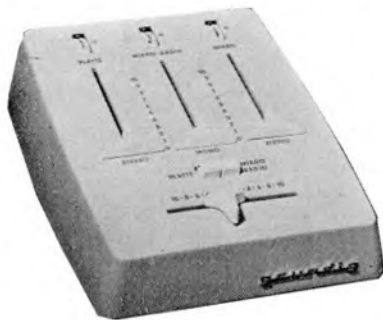

can be passed through a direction control (called a "Pan-Pot" by professionals) for "placing" the sound at any desired position in the stereo image.

The linear volume controls are of a new type, and do not rely on the mechanical operation of a rotary potentiometer. They are wound to the usual logarithmic rating and give a very smooth fade. In addition there are coarse controls fitted to the gram and micro/radio inputs, so that all sounds may be balanced to the volume level appearing from the stereo microphone.

(Continued on page 28)

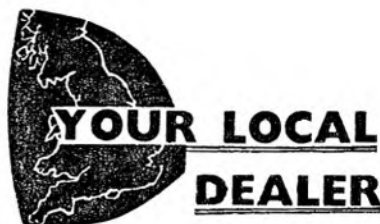

In this feature you can check your nearest dealer who is a hi-fi specialist giving expert attention to tape equipment.

## LONDON

### BARNET : HERTS

St. Albans Road, Barnet

PHILIPS · FERROGRAPH · GRUNDIG  
TELEFUNKEN · BRENNEL · SONY  
ROBUK, etc.

TAPE SPECIALIST CENTRE

Wyndsor Television

BARNET 1769

### HI-FI CENTRE

Branch of KINGS ELECTRONICS

178, HIGH STREET, E.17

Walthamstow's Leading  
Stockist of all makes of

TAPE RECORDERS

AMPLIFIERS, TUNERS, etc.

Free Demonstration in the  
comfort of your own home

'PHONE AMH 6242 or COP 4488

## Lee Electronics

THE TAPE RECORDER &  
HI-FI AUDIO SPECIALISTS

400, EDGWARE ROAD, LONDON, W.2

London's leading Stockists of High-Fidelity and Audio Equipment.

Many Bargains in new and  
reconditioned Equipment

SEND FOR FREE LISTS OF RECORDING  
TAPES, RECORDERS, AMPLIFIERS, ETC

All Machines demonstrated for performance on  
Record and Playback. All leading makes of HI-FI  
equipment from stock

PADDINGTON 5521

## Tape Records reviewed

(Continued from page 23)

folk-jazz singers. This record, made before a small enthusiastic, but not obtrusive, audience is double value.

The songs are in the main, well known folk-jazz and blues numbers like *The Bluetail Fly*, *Guitar Blues* and *Goodnight Irene*, although there is an interesting venture into the pop world for *A Shanty in Old Shanty Town*.

This is a wide sampling of material. The bonus comes from Broonzy talking to the audience. An old man, obviously, he has a whimsical, defeatist sense of humour. Perhaps best here is Broonzy's mock apology for altering the lyrics of *This Train*.

He gives *Bill Bailey* a softness not normally associated with it. *Shanty* gets a swinging treatment you don't normally associate with the song so often performed by barbershop groups. Broonzy's guitar playing, not regarded as the greatest in the world, certainly swings on this.

**COWBOY.** Jack Fallon and the Tennessee Three. Saga (STG 8103), 3½ ips, mono. 32s. 6d.

British folk singer Roy Guest, combined with Jack Fallon, an expert in the music of the wild west, has produced an excellent record, drawing upon the music associated with the legendary figures of the last century.

Many of the ballads, lonely and sad, convey the feeling of the remote plains and are well captured on this record, one

of the first to be made at Saga's new London studio.

In a sense, this is a specialised record. But it has so much charm and sometimes rough humour that it deserves a much wider listening.

**CONTINENTAL HOLIDAY.** Pepe de Santa Cruz and his players. Recotape (RML 235), 3½ ips, mono. 27s. 6d.

An accurately named record which is really a feature for pianist Tobias Valido, just as much as singer de Santa Cruz.

The accent is on songs from Spain, Italy and Portugal, most of them well known like *Adios Muchachos*, *Non Dimenticar*, *Perfidia* and *Malagueña*.

If you caught the continental music habit, you will probably enjoy this collection. Valido's piano is accompanied only by percussion instruments and de Santa Cruz's singing is, as you might expect, over-dramatic judged by English standards.

There is even a brief passage in English when de Santa Cruz introduces the Italian *Cella la*.

**GIGI.** Patricia Lancaster, Peter Cavanagh, Denis Quilley, Helen Clare. Saga (STE 3008), 7½ ips, stereo. 63s.

Though this is the only stereo version I know to be available in this country of the famous Alan Jay Lerner—Frederick Loewe film musical "Gigi," it duplicates two other versions, both mono—World Record Club's and the original film sound track on MGM.

Made some years ago, the stereo wealth gives an added life to Loewe's bubbling champagne type music, but in performance it must, of course, come second to that of the original stars' in the film.

The presence of the impressionist,

Peter Cavanagh, on record is unusual. He, of course, is excellent at French flavour, though he does not attempt a direct mimicry of Maurice Chevalier.

## A collection of Tyneside folk songs

**TYNESIDE SONGS OLD AND NEW.** Sung by Gordon Faith. Graphic Sound CB0001, 3½ ips, mono. 29s. 6d.

Geordies will be delighted with this celebration of the folk songs of their country. But everyone will be delighted with the vigour of the performance by Gordon Faith and by the fidelity of the recording. It is a fine tape.

It is an indication, too, to amateurs of the sort of recordings they should not miss a chance of getting. Folk-songs and dialect speech are dying, but there is still a wealth of material to be gathered.

Gordon Faith, of course, is a professional performer, well known on Tyneside and gives the traditional songs a freshness and universal appeal. Several of these songs, indeed, are world-famous, and it is good to have them on tape.

The first track contains *Blaydon Races*, *Newcastle is me native toon*, *Blow the wind southerly* and *Cushie Butterfield*. The other track carries *Me little wife at hyam*, *Caa Hawkie*, *Oh, I wish that the strike was done* and *The waters of the Tyne*.

R.D.B.

## TEST BENCH

(Continued from page 27)

This enables all sliders to be operated at approximately the same position to give similar output levels from the mixer.

Two push-buttons associated with the "pan-pot" occupy a central position, and select either the micro/radio output or a mono pick-up output for directional control. When both push-buttons are released, the output from the third sliding control is taken to the left-hand channel.

All input and output connections are brought out to the rear of the unit, and consist of multi-pin sockets which accept the standard type of continental screened plug. There are three microphone pre-amplifiers, fitted with low noise transistors, which have an input sensitivity of 0.1 to 20 mV at 2.5 and 4 K ohms. The gram input is of high impedance, and therefore suitable for most types of pick-up cartridge. But there is no amplifier following the gram controls, so the output from the mixer is considerably less than the input due to losses in the resistive combining network. No provision has been made for monitoring the combined output.

The mixer requires two PP3 batteries and consumes 3 mA., which gives a life of approximately 100 hours. An on/off

switch is provided above the right hand slider control.

### COMMENT

This is a very nicely designed mixing unit which works extremely well with other Grundig equipment. The output has been arranged so that it can feed directly into the radio socket on the TK series of recorders, and requires an impedance of 50 K ohms.

So far as inputs are concerned the mixer is not particularly flexible, and cannot conveniently combine sound sources other than those mentioned. There is no polarising voltage, of course, for the Grundig Condenser microphone. There is only one gram input and control. In order to use a Crystal microphone, one has to insert a series resistor in the microphone lead. If one wishes to feed a tape recorder into the radio socket, a low level transcription output is necessary with an impedance of 5 to 50 K ohms.

An interesting feature showing thoughtfulness in design is an internal strap across the output and radio sockets. This permits tapes (stereo or mono) to be replayed from the recorder through the mixer and into a radio set (or Hi-Fi) without further connecting leads.

The 608 mixer is a joy to use, and is completely free of hum and noise. The frequency response is flat throughout the audible spectrum, which is about as flat as anything can be.

A tri-lingual instruction book is supplied with each mixer, also a circuit diagram. The latter is, if anything, much more useful than the former; it shows at a glance the internal working of the unit, and the pin connections required on all sockets. It must be remembered that the transistors are only used as pre-amplifiers, and that the output from the mixer is very little above normal microphone level.

I can recommend this mixing unit as being capable of producing very smooth composite recordings, and with the minimum of fuss and bother.

### Manufacturer's Specifications

Operating Voltage: Two 9 volt batteries (PP3).

Current consumption: 3 mA.

Transistors: Three TF65 (low noise).

Frequency response: 30 to 20,000 cps.

Inputs: Two microphone (0.1 to 20 mV at 2.5 K ohms); micro/radio (0.1 to 20 mV at 4 K ohms); and two gram (0.15 to 15 mV at 500 K ohms).

Output: 2 mV at 39 K ohms.

Dimensions: 3 x 8 x 9½ inches.

Weight: 3½ lb.

Price: 18 guineas.

Manufacturers: Grundig (Great Britain) Ltd., Newlands Park, Sydenham, London, S.E.26.

## LOCATION RECORDING

# We took our tape recorder to the races

By F. J. G. HODGE

**H**AVE you ever tried to capture on tape that peculiar "crunching" noise colliding stock cars make as they meet head-on? We hadn't, until we went along to Belle Vue, Manchester, with a recorder, to add to our collection of new and unusual noises.

The Bristol Trophy meeting event was in progress, with the pick of stock car racing drivers competing. Drivers with names like Andy Capp, "Yogi" Larkin, Roy Rogers and other leading lights in the stock car world had come from all over the British Isles and were busily tuning up their specially "souped up" engines of their custom built cars ready for the off.

As we took our places in the stand, near the start/finish line, the loudspeakers were relaying canned music. This was soon followed by the announcer welcoming us all to the meeting, and warning the spectators on the popular side that the paint on the fencing was still wet!

Throughout the meeting a commentator, with a lively sense of humour, kept us informed of what was going on—explaining the finer points—telling us who to watch—who would provide the thrills and spills—what was under the bonnets of the various cars—and giving the placings of the drivers during the heats and even, when a car overturned and a small fire started, warning the spectators to stand well back as there was a danger of the car exploding. All this patter, coming loud and clear from the loudspeakers, made an excellent background to the actual car recordings.

Our problem was to find the correct recording level. Even on a very low setting there was a danger of occasionally over-recording when the cars came through in a bunch (as they frequently did in the earlier laps). We finally solved this problem by lowering the level as the cars came out of the pit bend and into the finishing straight.

Background noise from the crowd also created a problem, although the finished tape we produced makes good use of the oohs, aahs, cheers, jeers and general "atmosphere" sounds of the crowd. They serve as warnings when a particularly interesting item is coming up. This recording session proved once again that the human ear only hears what it wants to hear—there are numerous sounds on the tapes which never regis-

tered with us when we were making the recording.

Before the Trophy race itself there were a number of eliminating heats—each of 16 laps and lasting about 6½ minutes—the first six cars in each heat going forward to the final.

During each heat the commentator kept up a lively commentary of who was bumping who and, when the crashes occurred, who was no longer taking an active interest in the proceedings.

In one of the heats car 203 was leading with half a lap to go when his engine packed in. The commentator's comments included: "Look at poor Ron Carr, feeling like a pickled prawn sitting there in clouds of steam with a serious case of engine overheating—with an engine that never overheats!"

When the cars were lining up before the off for another heat there was a bit of bumping and on the tape you can hear the chain reaction as Dennis McGuinness bumped Tom Finigan who in turn bumped Alec Bleavers who finished up having to do a lap before the race started.

The technical details, provided over the loudspeaker system about what was under the bonnet, engines and h.p. and similar gen, came in as a handy guide to sorting out the various car sounds we had on tape. Linking up the description of the cars before the race with the actual commentary of their performance during the event as they hurtled round the track helped us to "place" each cars sound.

The final for the Trophy was very exciting and yet again the leading car developed engine trouble and had to retire. The eventual winner was Trevor Frost (all the way from Suffolk) who was presented with the trophy by pretty Miss Bristol ably assisted by TV stars Wendy Williams and Hugh Davies. At the start of the lap of honour Trevor's car needed a push to start it and Wendy Williams got a laugh and a cheer from the crowd as she joined the others in giving a shove.

We had found plenty to record at our visit to Belle Vue Stock Car Racing. The shouts of the crowds as the cars spun out and off the track—cars back-firing—cars colliding—and the humorous sallies of the commentator plus plenty of car sounds all combined to make an interesting addition to our collection.

As we walked away from the stadium the announcer invited us to go along next week and watch the Aces speedway team in action—come to think of it, maybe we will at that.

## YOUR LOCAL DEALER

### LONDON

- ★ TAPE RECORDER HIRE
- ★ TAPE TO DISC 78 & LP
- ★ RECORDING STUDIO
- ★ TAPE RECORDER REPAIRS
- ★ SALES—EXCHANGES

### MAGNEGRAPH

1, Hanway Place, London, W.1.  
Tel.: LAngham 2156

### Masseys Centre of Sound

West London's Hi-Fi Tape Recorder Specialist—Demonstration Room with Comparator

APPOINTED FERROGRAPH DEALER

### AT CHISWICK, W.4

Accessories, All Kinds—Servicing—Pre-Recorded Tapes Mono/Stereo  
121-123 High Road—10 a.m.—7 p.m.

◀ TEL: CHI 2082 ▶

(not closed for lunch)

Leonard G. Francis presents—

### SHEEN

### TAPE RECORDER CENTRE LTD.

Specialists in Tape Recorders and Accessories etc.

—THE CENTRE FOR—

FRIENDLY HELP — SALES — SERVICE  
HOME DEMONSTRATIONS ANYTIME  
— MODELS FROM 19 GNS. —  
PRE-RECORDED TAPE: LANGUAGES  
DANCE CLASSICS JAZZ

CALL—WRITE—PHONE

8 Station Parade, Sheen Lane, Sheen,  
London, S.W.14 (next to Mortlake Station, S.R.)  
Showrooms: PROSPECT 0985 10 a.m.—7 p.m.

### THE SOUTH

### HAMILTON

### ELECTRONICS

HIGH FIDELITY  
TAPE RECORDERS

35 LONDON ROAD  
SOUTHAMPTON

TELEPHONE 28622



**YOUR LOCAL  
DEALER**

*In this feature you  
can check your nearest  
dealer who is a hi-fi  
specialist giving expert  
attention to tape equip-  
ment.*

## SOUTH

### PORTSMOUTH and SOUTHAMPTON

#### Tape Recorder Specialists

APPROVED AGENTS FOR:—  
PHILIPS - GRUNDIG - FERROGRAPH  
VORTEXION, ETC.

- ALL MAKES OF TAPE RECORDERS SUPPLIED
- ACCESSORIES AND HI-FI EQUIPMENT
- PART EXCHANGES AND SECOND-HAND MACHINES
- PROMPT AND SKILLED SERVICING

#### RECORDING MACHINES LTD.

299 Commercial Road, Portsmouth  
Telephone: 23097  
4 New Road, Southampton  
Telephone: 27092

### TAPE RECORDERS

(Bournemouth) (Exeter)

LTD  
Southern England's  
Biggest Centres for  
PHILIPS · FERROGRAPH  
GRUNDIG · TELEFUNKEN  
BRENELL · AND ALL LEADING MAKES

Accessories by return Call, write or phone

#### THE TAPE RECORDER PEOPLE

874 Christchurch Rd., BOURNEMOUTH Tel. 45096  
3 Seamoor Road, WESTBOURNE Tel. 64292  
1 Sidwell Street, EXETER Tel. 75779

## SCOTLAND

### GLASGOW

#### Tape Recorder Specialists

APPROVED AGENTS FOR:—  
PHILIPS - GRUNDIG - FERROGRAPH  
VORTEXION, ETC.

- ALL MAKES OF TAPE RECORDERS SUPPLIED
- ACCESSORIES AND HI-FI EQUIPMENT
- PART EXCHANGES AND SECOND-HAND MACHINES
- PROMPT AND SKILLED SERVICING

#### RECORDING MACHINES LTD.

60 ST. VINCENT STREET, GLASGOW, C.2  
Telephone: City 3847/8

## NEW PRODUCTS

### NEW RANGE OF TAPE BY KODAK

KODAK LTD. have announced a new range of magnetic recording tape. The new tape will be available in four thicknesses: standard, long, double, and triple-play.

Each reel is enclosed in a polythene bag and attractively packaged in a box or carton according to size. Each type of tape has a different coloured label for rapid identification.

**Standard-play (T.100)** is available on a five-inch reel (600 ft.) for 18s. 0d., and on a seven-inch reel (1,200 ft.) for 30s. 0d.

**Long-play (V.150)** is available on 3½-inch reel (300 ft.), 11s. 0d.; five-inch reel (900 ft.), 28s. 0d.; and seven-inch (1,800 ft.), 50s. 0d.

**Double-play (P.200):** 3½-inch reel (400 ft.), 17s. 0d.; five-inch reel (1,200 ft.), 45s. 0d.; and seven-inch reel (2,400 ft.), 80s. 0d.

**Triple-play (P.300):** three-inch reel (450 ft.), 21s. 6d.; 3½-inch reel (600 ft.), 27s. 6d.; five-inch reel (1,800 ft.), 65s. 6d.; and seven-inch reel (3,600 ft.), 115s. 0d.

Kodak Limited, Kingsway, London, W.C.2.

### BOSCH ANNOUNCE THEIR LATEST RECORDER

BOSCH LIMITED announce the addition of a three-speed half-track tape recorder to their range.

The new model, the Universal 5000, illustrated below, is a fully transistorised machine with accommodation for up to 5½-inch reels. The tape speeds are 3½, 1½, 15/16 ips, providing a playing time of just over 45 minutes for each of its two tracks using standard-play tape at the top speed.

The quoted frequency responses are 40-16,000 cps at 3½ ips; 40-8,000 at 1½ ips; and 40-4,000 at 15/16 ips. Wow and flutter figures are given as within 0.2 per cent, and signal-to-noise ratio is rated at 50 dB.

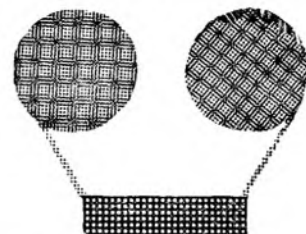

Among the many features of the 5000, the well-known Universal "S" with a new look, are an automatic level control, and a remote control switch on the microphone supplied with the machine. This enables the selection of record stop, playback, and rewind, and it can be used as a speaker/microphone. Recordings can be made up to thirty feet away from the recorder and instantly played back. Other features include meter recording level indicator, digital rev. counter, back-spacing, and foot or hand control facilities.

A 4½-inch loudspeaker unit is incorporated, and the power output is rated at four watts. Inputs are supplied for microphone (0.1 mV at 200 ohms); radio (1 mV at 22 K ohms); and pick-up (100 mV at 2 M ohms).

The 5000 measures 12½ (L) x 11½ (D) x 5½ (H) inches, and weighs 18 lb. The price is 89 guineas.

Bosch Limited, 205, Great Portland Street, London, W.1.

### TWO MORE MODELS INTRODUCED FROM JAPAN

A NEWCOMER to the market has recently announced the latest Japanese-produced tape recorder. This is the Ajax Mayfair, introduced by Acme Electrical Co. (Finsbury) Ltd.

The new recorder, illustrated below, is available in two versions. The photograph shows, left, the Super de Luxe which will accommodate five-inch reels with the lid closed, selling at 19 guineas; and the Super, three-inch reels with lid closed, selling at 18 guineas.

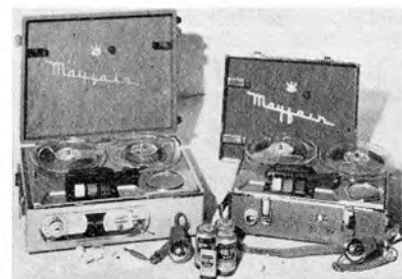

The quoted frequency response at 7½ ips is 200-7,000 cps; signal-to-noise ratio is given as better than 40 dB at 1,000 cps. A second speed, 3½ ips, provides a playing time of 32 minutes for each of the two tracks using standard-play tape on a five-inch reel which both models can accommodate. Fast rewind is achieved within two minutes.

The transistorised Mayfair weighs only 7 lb., and measures 11 x 8 x 3½ inches.

A 2½-inch round speaker is incorporated, and the power output is rated at 400 mW. Power source, 4½ volt, is

obtained from three 1½ volt U2 batteries for the motor, and one nine-volt battery (006P), supplied with the recorder.

Also included in the price is a microphone, earphone, five-inch reel and spare reel.

Acme Electrical Company (Finsbury) Limited, 63, Great Eastern Street, London, E.C.2.

## PHILIPS ANNOUNCE NEW PRE-AMPLIFIER

PHILIPS ELECTRICAL LTD. announce that their pre-amplifier, model EL3787, is now generally available at a retail price of £6 10s. 0d. Suitable for use with the Philips EL3549, Cossor CR1404 and CR1605, and Stella ST458, and ST459, the pre-amp considerably extends the facilities of these recorders.

Among these facilities are the playback of stereophonic tape records via a stereo radio, radiogram, or amplifier; playback of stereo tape records using the tape recorder for one channel and a mono radio or amplifier for the other channel; and playback of two separate mono recordings through separate sound channels.

It also enables the user to make a recording on one track whilst listening to a previous recording on another track (Duoplay) thereby obtaining perfect



synchronisation of the two recordings. The two tracks can be played back simultaneously by using the "parallel track" facility on the recorder. A recording on one track can be copied on to another track at the same time adding a new recording (Multiplay), thus building a composite programme up on one track.

The all-transistor device, illustrated above, uses a printed circuit and is powered from the tape recorder. It measures only 6½ x 4½ x 2 inches, and weighs 12½ ounces.

Philips Electrical Limited, Century House, Shaftesbury Avenue, London, W.C.2.

## LOUDSPEAKER UNITS BY RICHARD ALLAN

RICHARD ALLAN RADIO LTD. have recently introduced a new range of high fidelity loudspeakers using the latest ceramic magnet techniques.

Identified as the C.B. and C.G. range the overall depth of the twelve-inch speaker is only 4½ inches, making the unit particularly suitable for slimline enclosures.

The first unit of the new range is the twelve-inch speaker (shown above, right) available as a single cone bass unit, or as a twin cone wide range unit. Using a shallow curvilinear cone with a special

plastic doped linear surround has achieved a low fundamental resonance of 30 cps making it eminently suitable for use as the "woofer" in a slim, low-volume cabinet.

British power ratings for the speakers are 8 watts (CB12) and ten watts (CG12) with the respective American ratings being 16 and 20 watts.

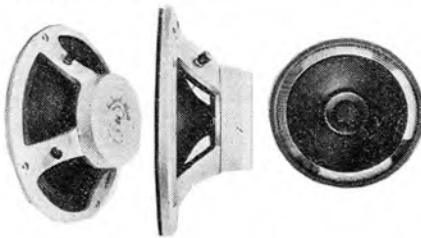

The speakers allow a response from 25 to 5,000 cps, or when fitted with a "tweeter" inner (see on right of illustration) from 25 to 15,000 cps. Also in the new range are 8-inch and ten-inch units available as for the 12-inch.

A range of slim enclosures, acoustically compatible and contemporarily designed are being developed to house these units.

Delivery within the U.K. is 21 to 28 days. Prices are available on application.

Richard Allan Radio Limited, P.O. Box No. 3, Batley, Yorkshire.

## GKD CABINET FOR TAPE EQUIPMENT

FOR the hi-fi enthusiast who wishes to accommodate tape equipment in the same cabinet as a Quad amplifier, tuner, and transcription motor, GKD have introduced their Anglian cabinet (illustrated below).

Designed specially for the Quad units, the removable facia of the Anglia is cut to receive the Quad control units for FM tuner and power amplifiers. If required an additional tuner for AM can be fitted below the turntable motor board.

The design follows the pattern of other GKD products, a single hinged front panel which lowers

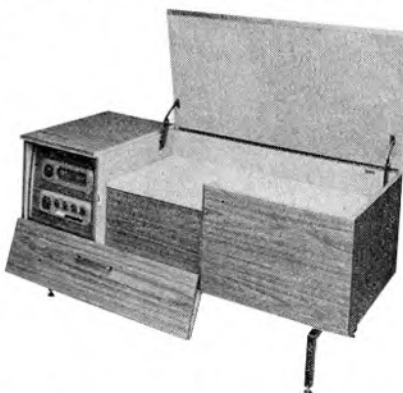

smoothly in a specially designed track providing access to the control panels. Two other hinged lids provide access to the other units.

A choice of finishes is available—sapele mahogany, dark Australian walnut or teak. Metal finishings are in satin anodised aluminium. Overall dimensions are 55½(W) x 21(D) x 25(H) inches. Retail prices are 37 guineas for sapele and walnut finishes, or 38 guineas in teak.

GKD Limited, King Street, Houghton Regis, Bedfordshire.

## Audix B.B. Limited

AUDIX B.B. LIMITED, manufacturers of audio and sound reproducing equipment, have asked us to announce that they are the sole U.K. distributors of microphones, accessories and products manufactured by A. B. Pearl of Sweden.

Audix B.B. Limited, Bentfield End, Stansted, Essex.

## YOUR LOCAL DEALER

### MIDLANDS

#### Audio Electronics (Midlands) Ltd.

Specialists in Dictation Mcs., Tape Recorders, Inter-Com., Tapes and Accessories

Full After Sales Service on all Equipment

PHILIPS, GRUNDIG, TRUVOX,  
ELIZABETHAN, ETC.

203 STAFFORD STREET,  
WALSALL. Tel.: 21086

### SOUND BUSINESS

Specialists in  
Sound Reproducing Equipment  
Stockists of Butoba, Grundig,  
Sony, Tandberg, Vortexion, etc.

Backed by a  
First-Class Service Department

### TYSONIC

W. M. Tyson, M.Brit.I.R.E.

41 Russell St., Leamington Spa  
phone 24935

### THE NORTH

#### CUSSINS & LIGHT LTD.

YORK'S LEADING RADIO  
TV & ELECTRICAL STORE

Visit our First Floor  
TAPE RECORDER  
CENTRE

LARGEST RANGE  
OF RECORDERS  
& ACCESSORIES  
IN THE NORTH

KING'S SQ.  
YORK



#### TAPE RECORDER CENTRE (Halifax)

stock all the best tape  
recorders and hi-fi equipment.

Agents for Revox, Tandberg,  
Ferrograph, etc. Demon-  
strations by expert staff.

Two years' free service on  
recorders over £35.

30 King Cross St., Halifax. Phone 66832

# Trade Mark **Scotch**

## Magnetic Tape

### **REDUCES THE COST OF TOP QUALITY RECORDING**

Down comes the cost of top-quality tape recordings. The makers of "SCOTCH" Magnetic Tape are pleased to announce price reductions throughout their range. For example, 5" No. 200, double play was 45/- — now down to 41/-. 5½" No. 150 long play was 35/- now down to 32/6. 7" No. 150 long play was 50/- now down to 44/6.

#### **MORE GOOD NEWS**

—A new standard play tape, polyester-backed No. 175 brings down the price of top quality polyester recording. **And** there's an exciting new pack, colour coded for easy identification. Now more than ever before, insist on "SCOTCH" Magnetic Tape. Get full details of the new prices and alterations in the range from your nearest "SCOTCH" stockist.

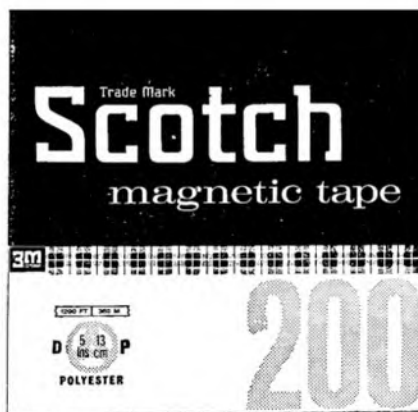

**3M** MINNESOTA MINING AND MANUFACTURING CO., LTD. 3M HOUSE, WIGMORE STREET, LONDON, W.1.





# News from the Clubs

## BUSHEY

The first-ever sound only programme organised by the Bushey camera and sound recording club was staged during April. A number of recorders, including a Grundig TK20, Brenell Mk V, H.M.V., and a Stella ST455, were used together with a Leak Point One Plus pre-amplifier, and TL12 power amplifier, plus three loudspeaker enclosures built by members. The programme included a short history of the development of disc and tape recording presented by Brian Thomas, an item on tape correspondence by G. Loraine, with contributions from some of his contacts in West Germany, Denmark, Berlin, New Zealand and America, and a fantasy called *The Clock* produced by George Lansdale using sound effects, music and his own voice. This last item took place in total darkness and produced a number of delightful shrieks from the ladies present.

A feature of the show, organised by the Urban District Council, was the set display of publications, including "TAPE," plus leaflets, catalogues and lists obtained from the disc, tape record, and equipment manufacturers.

Secretary: G. Loraine, Council Offices, Rudolph Road, Bushey, Hertfordshire.

## DUNDEE

The Dundee club will start its new season on September 2. The A.G.M. will be held on September 16, and future meetings will be held in the Salvation Army Hostel, Ward Road, Dundee, on alternate Mondays thereafter.

Secretary: Robert Taylor, 9, Baifin Street, Dundee, Angus.

## EPSOM

News of a new club about to be formed in Epsom is received from Geoffrey H. Bilton, of 8, Manor House Court, West Street, Epsom, Surrey. Interested persons are invited to contact him direct.

## HALESOWEN

Patients at Hayley Green Hospital, Halesowen, look forward to Tuesday nights when they get a programme of specially compiled music. Behind the effort is the Halesowen tape club which began the service shortly after its formation just over a year ago.

A three-man team edits, records and plays back the programme which consists of classical, pop, and religious music. For two hours every week, Brian Such and Gordon Waterhouse shut themselves in a room to put the up-to-45-minute programme together. At the regular Monday club meeting, the tape is played back, checked, and dubbed, between eight and ten records being included on each programme.

Record requests are few, and members try to meet them all. One of the first proved to be quite a headache. The search for the old record was far and wide—and unsuccessful. An offer by one of the club members to sing the required tune was tactfully turned down by his colleagues.

Secretary: Roy Finch, 37, High Street, Halesowen, Worcestershire.

## KIDDERMINSTER

One of the recent meetings of the Kidderminster club was spent making comparisons of recordings made of a cinema organ. The three-manual organ, built in the thirties, is seldom played because of the difficulty of obtaining competent cinema organists and retaining them.

The Kidderminster members were invited by the Cinema Organ Society to record live organ music, and the programme was opened by Mr. Stanley Harrison, manager of the Majestic Cinema, Cradley, playing a selection of music from the early twenties. He was followed by Mr. Vic Hammett who gave a recital of typical cinema organ music. From the two-hour programme a wealth of material was obtained for inclusion in the club's tape library.

Secretary: R. F. Drew, 87, Brindley Street, Stourport-on-Severn, Worcestershire.

## LEEDS

Due to changes in the committee and a removal to new premises, we have not heard from the Leeds society for some time. However, secretary C. M. Eagle writes to say they are still going strong.

Among some of their activities this year have been the organisation of a stand at a Garden Party held in a local hospital's grounds; a film show by B.A.S.F. Chemicals Ltd.; a practical demonstration by a member on how to get the best from a tape recorder; and an instructional demonstration of

several types of loudspeaker units presented by Richard Allan Ltd.

They are currently engaged on the formation of a hospital request programme.

Secretary: C. M. Eagle, c/o 9, Shaftesbury Road, Leeds 8, Yorkshire.

## LONDON

A change of secretary is announced for the London club where Douglas Morris has replaced the soon to emigrate Fred Fowle. Mr. Morris, welcomed back to the club after a two years' absence started his new membership with a well staged demonstration of the Uher 4000 Report battery/mains portable recorder. He operated the machine with great effect through all of its four speeds, the most fascinating of which was the ultra-slow 15/16th ips. This session at the May meeting was followed by a practical editing demonstration by Ken Blake.

Between this and the next meeting, the members visited a nearby church to attempt recordings at an organ recital.

The June meeting saw members welcoming Mr. Richard Keen, producer of the BBC Network Three "Sound." Mr. Keen spoke on the assembly of programmes from tape in the Talks and Features Departments. He described how producers are able to record interviews and edit them into a more concentrated form than is otherwise obtainable in a studio discussion, editing being a very long and tedious job, but allowing greater flexibility in the choice of material.

He also described how questions put to speakers during an interview are cut from the programme, studio narration or special sound effects being used to link the various comments. Much food for thought and experimentation was gathered by the members.

Mr. Keen followed his fascinating talk by arranging a similar lecture by one of his BBC colleagues, Mr. Rex Haworth. The London members visited the BBC for his talk on microphones and their uses. Such was the interest aroused by his lecture on acoustics that few members realised Mr. Haworth spoke for nearly two hours. Simple language and point by point demonstrations, including some humorous anecdotes, kept members enthralled throughout.

Their August meeting was to have included a visit by Mr. Len Freeman of the Sheen Tape Recording Centre for a questions and answers session, together with members' tape time.

Secretary: Douglas J. Morris, 80, Tangier Road, Richmond, Surrey.

## M.A.T.R.C.

The first meeting of the Midland Association of Tape Recording clubs took place in Birmingham recently. Among the clubs attending the meeting were Birmingham, Coventry, Kidderminster, Leicester, Northampton, Nottingham, Rugby, South Birmingham, Walsall, and Warwick and Leamington. Six further clubs professed interest, and are expected to join in the near future.

The main item for discussion at the meeting was the constitution. This took three out of the four hours available. Officials elected were: President, Mr. C. W. Horrell (Kidderminster); secretary, Mr. J. T. Gilbert (S. Birmingham); and treasurer, Mr. P. Lane (Walsall); Messrs. K. Fricker (Nottingham), L. Day (Coventry), and R. F. Drew (Kidderminster) were elected to the sub-committee for the organisation of events.

Secretary: J. T. Gilbert, "Woodcote," Box Trees Road, Durridge, Solihull, Birmingham, Warwickshire.

## MIDDLESBROUGH

A recent ambitious venture for the Middlesbrough society was "Audiorama," a special open exhibition of recording equipment staged in the town's Settlement Community Centre, where members hold regular meetings.

On show was equipment valued at over £1,500 offering a wide range for comparison with the owners in attendance eager to demonstrate the capabilities of their respective machines.

Among features of interest to the public were

tape competitions, details of the club's message service, tape-splicing demonstrations, and a tape record request service from the recordings made of various local groups, by the society's mobile unit. An added attraction was a lively tape/slide show programme entitled *Excursion in colour* run at hourly intervals by producer Mr. D. Trubshaw.

Opportunities for live recording were offered in the battery portable section where visitors could interview club members.

Periodic voice-recording tests were carried out in the club's studios which had been newly sound-proofed by covering the walls with egg-packing cases. The unusual decor enables recordings to be made which reach an almost professional standard.

The third of such shows to be held by this first-ever formed tape recording society, it proved a valuable shop-window being well attended by visitors, and receiving extensive press coverage.

Secretary: J. R. Allan, 16, Aire Street, Middlesbrough, Yorkshire.

## NORTH LONDON

The playback of an interview recorded with the chairman of the Enfield Over-21 club by Sinclair Scott began the most recent meeting of the North London club. Afterwards a shortened and humorous version of the same tape was played.

During the evening, Mr. Sinclair, retiring from his post as chairman, was presented with a travelling clock before leaving to move to Northampton. He has since sent a taped reply after joining the northern club.

The second edition of the club's magazine has been circulated to members as well as libraries and tape recorder dealers. It contains an editorial, short story, news about club activities, and features by and about members.

Member Joe Collinson has been spending much of his recent spare time listening to bells of the London churches and cathedrals. He is recording these on the direction of one of his Canadian tape contacts who requested recordings of bells with a peal of ten or more. The tapes thus achieved are also being kept for inclusion in the club's library.

Other members, meanwhile have been helping in the sound effects department at a local production of the comedy *A River Breeze*. In a recent club sound hunt, effects required included hiss and hum—the hiss of a gas street lamp, and hum from a shop neon sign.

Among recent activities at their regular weekly meetings have been discussions on tape speeds, lengths, and tracks; an interview hunt, a competition on the subject of water; and a practical editing and splicing session.

Secretary: Richard Collinson, 30, Ridler Road, Forty Hill, Enfield, Middlesex.

## OXFORD

A new teenage club is in formation in the Cowley Headington area. Any person interested is invited to contact the secretary Mr. D. A. Rose, 90, Divinity Road, Oxford, Oxfordshire.

## THORNTON HEATH

Since their last report much of the Thornton Heath club's members spare time has been taken up by assisting with music and public address for Summer Carnivals and Fêtes. So far this summer various charities have benefited to the tune of about £450 from these functions and the club's programme is so full it has had to refuse help in some cases.

Their second hospital record request programme for Croydon General Hospital had its opening on August 5; the long-established Mayday Hospital programme still goes out fortnightly.

Following the visit of Mr. Parrington of B.A.S.F. Chemicals Ltd. with the films *The Magic Tape* and *The Rainbow Makers*, the B.A.S.F. Tape Manual was made available and will be read on to tape for the benefit of blind members.

One of these, Mr. D. Miles, recently gave a talk on tape exchanges. His programme included an original recording by explorer and BBC adventure series' cameraman Eric Sipton.

Other activities have included the recording of an organ recital (this seems to be currently popular with clubs), and the recording of century-old bells at Croydon Parish church. The club's monthly competition encouraged some humorous entries when the subject was "The Beeching Plan." It was won by secretary John Bradley, who also, see page 17, had success in the Actuality section of the B.A.T.R.C.

Secretary: John H. Bradley, 8, Canning Road, Addiscombe, Surrey.

## WINDSOR

The fortnightly meetings of the Windsor tape club are to be held at various members' homes until further notice. Details of the dates and venues are obtainable from the secretary.

Secretary: Peter Streamer, 33, Frances Road, Windsor, Berkshire.

## Yearbook list of Club addresses

THE 1964 Yearbook is currently in preparation. Secretaries are requested to provide the name and official address of their clubs for insertion in the special list for this section of the Yearbook.

# CLASSIFIED ADVERTISEMENTS

Rate—Sixpence per word (minimum 5s.); Trade, ninepence per word (minimum 10s.); box numbers, one shilling extra. Payment with copy. Copy should be sent to Advertising Department, "Tape Recording Magazine," 7, Tudor Street, London, E.C.4.

## NEW EQUIPMENT

Ferrograph 5 A/N, 422 and 424, Revox E36, etc., always in stock. City and Essex Tape Recorder Centres. (See page 8).

Erase tape in seconds with the Global Speed-Erase. 45s. Global, 13, Stanley Street, Rothwell, Northamptonshire.

**TAPE RECORDERS.** SAVE FROM 30 per cent to 60 per cent on the original price. Large stocks of second-hand, new, shop soiled machines. All guaranteed. Obtainable on our **NO INTEREST TERMS**. Best part exchange allowances on your existing equipment. CALL, WRITE, PHONE today for free list. Quotation and details. Our Mail Order covers the whole Country.—R. E. W. Earlsfield Ltd., 266, Upper Tooting Road, London, S.W.17. Baham 7710.

£10,000 worth of Hi-Fi equipment and Tape Recorder accessories. Due to purchase of wholesaler's entire stock we can offer hundreds of bargains in pick-ups, cartridges, diamond styli, microphones, tape accessories at greatly reduced prices. Send 3d. stamp for comprehensive lists. Lee Electronics, 400, Edgware Road, London, W.2. PADDINGTON 5521.

## ORDER TO NEWSAGENT FOR "TAPE RECORDING MAGAZINE"

Published on the third Wednesday  
in every month. Price 1s. 6d.

To .....  
(Newsagent's name and address)

Please deliver me one copy of  
"TAPE Recording Magazine"  
each month until further notice.

(Signed) .....

Address .....

TAPE Recording Magazine is published by  
Print & Press Services Ltd., 7, Tudor Street,  
London, E.C.4, and distributed by Trans-World  
Circulation Co., Park Royal Road, N.W.10.

## ORDER FOR ANNUAL SUBSCRIPTION TO "TAPE RECORDING MAGAZINE"

Please post me one copy of  
"TAPE Recording Magazine"  
monthly for one year. I enclose  
£1 (\$3.50) in payment to commence.....issue.

(Signed) .....

Address .....

## MISCELLANEOUS

A BINDER is the ideal way of keeping your copies of *Tape Recording Magazine* clean and ready for easy reference. Prevents torn covers and dog-eared edges. Each copy is inserted as received to form a completely bound volume. Price 14s. 6d. (post free) from *Tape Recording Magazine*, 7, Tudor Street, London, E.C.4.

8 mm. Home Movies. Send 1s. for fully illustrated catalogue. (Dept. 31), Mountain Films Ltd., 1, New Burlington Street, London, W.1.

Good cash prices for tape recorders—Tel: Maryland 5879. (See page 8).

HIGHEST CASH PRICES offered for good quality Tape Recorders and Hi-Fi. See our advert page 39 this issue. R.E.W., 266-8, Upper Tooting Road, London, S.W.17.

Recorder need repairing? Then let City and Essex Tape Recorder Centres do it for you expertly and economically. (See page 8).

Underpillow Speakers. Listen without disturbing others. 3 in. x 5 in., 15 ohms, £2 11s. 6d. Timer Unit, designed especially for whisper teaching. Famous make. Three on/off periods in 24 hours. 13 amp, 200/240 v., comp., plugs, etc., £6 13s. 3d. S.P. Ltd., York House, Huddersfield.

## MAGNETIC TAPE

A UNIQUE BUY! Recording tape top brand, 5 1/2 in., 1,200 ft., 19s. 6d.; 7 in., 2,400 ft., D.P., 28s. 6d. P. & P., 1s. 6d. per spool. Bargains in all sizes. S.A.E. for list. E. C. Kingsley & Co., 132, Tottenham Court Road, London, W.1. EUSTON 6500.

TAPES POST FREE. High quality, low price. Long play PVC 4 in. 450 ft., 8s. 6d.; 5 in. 900 ft., 12s. 6d.; 5 1/2 in. 1,200 ft., 16s.; 7 in. 1,800 ft., 22s. 6d.; Double play polyester 3 in. 400 ft., 9s.; 4 in. 600 ft., 12s.; 5 in. 1,200 ft., 20s.; 5 1/2 in. 1,800 ft., 28s.; 7 in. 2,400 ft., 36s.; Discount on four or more. Refund guarantee. M.S. Recording Tapes (Dept. T.M.) 21, Hoyle Street, Radcliffe, Manchester. Also at Tottington, Lancs.

## TAPE RECORDS

American Pre-Recorded Stereophonic 4-Track Tapes supplied. Send 4s. 6d. for current catalogue, all makes. American Tapes, 11, South Leinster Street, Dublin 2, Ireland.

FOREIGN LANGUAGES ON TAPE from 38s. 6d. French, Italian, Spanish, German, Russian. Full money-back guarantee.—Details from Visaphone Co. Ltd., 28, Brookland Hill, London, N.W.11.

PRE-RECORDED TAPES. Unique complete catalogue listing all makes. Mono, Stereo, 7 1/2 and 3 1/2 ips, including World Record Club tapes. Call for FREE copy or send 1s. mailing fee.—Dept. T.R.I., Teletape Ltd., 33, Edgware Road, W.2. PAD 1942.

"SLEEP LEARNING"—the book essential for all go-ahead people. Send 6s. 6d. to York House, Dept. B, Huddersfield.

TAPE RECORDINGS. World-famous Hypnotist and Harley Street Psychoanalyst, W. J. Ousby (Instructional Recordings). For Increasing Confidence and Overcoming Inferiorities, Lessening Nervous Tension, also instruction courses on Self-Hypnosis and Auto-Suggestion. Send name and address for list of Mr. Ousby's tape recordings. Details sent in plain envelope without obligation. W. J. Ousby, Home Farm Estate, Northchurch, Berkhemstead, Hertfordshire.

## TAPE TO DISC

J. & B. RECORDINGS. Tape/disc. Mobile unit. Quality recordings. 14, Willows Avenue, Morden, Surrey. Mitcham 9952.

JOHN HASSELL RECORDINGS. Tape to Disc. Studio and mobile services.—21, Nassau Road, London, S.W.13. Riverside 7150.

TAPE TO DISC RECORDING  
Reduced prices. Finest professional quality. 10-inch LP—35s. (32 mins.), 12-inch LP—40s. (45 mins.), 7-inch EP—17s. 6d.

48-HOUR POSTAL SERVICE  
S.a.e. for leaflet to Deroy Sound Service, 52, Hest Bank Lane, Hest Bank, Lancaster. Tel.: H.B. 2444.

TAPE-TO-DISC RECORDING SERVICE. All speeds. 50-minute LPs. Photographic sleeves with all recordings.—E.R.S., 162, Shirland Road, London, W.9.

## TAPE EXCHANGES

ARMCHAIR TRAVEL for the price of the postage! Join friendly WORLDWIDE TAPETALK, 35, The Gardens, Harrow, Middlesex. S.A.E. for particulars.

FRIENDLY FOLK ASSOCIATION, Torquay (Est. 1943). Social introductions, Pen-friends, Book-lovers, Stamps, Photography. Tapesponding. Members 100 Countries.

Make interesting new friends UK and overseas, all ages. Join Victory Club, 34, Honeywell Road, London, S.W.11. Details free. Established 20 years.

## WANTED

WANTED FOR CASH. Good quality tape recorders and audio equipment—Part exchanges—Sales—Recording Services. Magnegraph, 1, Hanway Place, Oxford Street, London, W.1. Tel.: LANGHAM 2156.

## FOR SALE

Ferrograph 4 A/N, Bib Splicer, Reslo Ribbon microphone with 30 ft. lead, matching transformer, nosound monitor, reflex corner speaker. Mint condition. £82. 50, Selhurst Road, South Woodingdean, Brighton 7, (Rottingdean 4545.)

## Tape-to-Disc Services

### RAPID Recording Service

78s and L.P.s. from your own tapes. (48 hour service). Master Discs and pressings. Recording Studio. Mobile Recording Van.

Associated Company—

### EDUCATIONAL RECORDINGS LTD.

Specialists in Sleep-learning and Audio Learning. Tapes on Mind Management; Positive Personality; Memory Training; How to Pass Examinations. Manufacturers of the "Sleepomatic Unit" to be used with our Sleep-learning tape. Foreign language courses available for sleep-learning.

Brochures on request from:—

RAPID RECORDING SERVICE (Dept., TRG)  
21 Bishops Close, Walthamstow E.17 COP 3889

## Designing to a specification

(Continued from page 25)

any values of components an extensive number of outside factors have to be taken into consideration. Even the length of a piece of wire can upset calculations by as much as fifty per cent at the high frequencies especially when dealing with replay heads.

Having decided upon the component values, wired them into the prototype and finally tested to our satisfaction the main problem is on hand, can we reproduce this on a production line? Or as the designer said to the production manager, "Here we go again."

## Index to Advertisers

A. Brown & Sons Ltd.	24
A. C. Farnell Ltd.	8
Audio Electronics (Midlands) Ltd	31
B.A.S.F. Chemicals Ltd	Back cover
Berean Forward Movement	24
Bosch Ltd.	3
Brenell Engineering Co. Ltd.	4
City & Essex Tape Recorder Centres	8
Cussins & Light Ltd.	31
Daystrom Ltd	38
Educational Recordings Ltd.	24
Elstone Electronics Ltd.	37
E.M.I. Tape Ltd.	10
Fi-Cord International	16
Francis of Streatham	24
Gramlan Reproducers Ltd.	37
Hamilton Electronics	29
C. E. Hammond & Co. Ltd.	38
Hansom Books Ltd.	14
Hi-Fi Centre Ltd.	27
Howard Tape Recorders	6
Lee Electronics	27
Magnegraph	29
Massey Centre of Sound	29
Metro Sound Manufacturing Co. Ltd	6
Minnesota Mining & Manufacturing Co. Ltd.	32
Philips Electrical Ltd.	5 and 7
Planet Projects Ltd.	6
Psychology Tapes Ltd.	14
Rapid Recording Service	34
Recording Machines Ltd.	30
R. E. W. Earlsfield Ltd.	39
Sheen Tape Recorder Ltd.	29
Stereolectrics Ltd.	39
Tape Recorders (Bournemouth) Ltd.	30
Tape Recorder Centre	2
Tape Recorder Centre (Halifax)	31
Tysonic	31
Uroko Sangyo Kaisha Ltd.	9
Valradio Ltd.	37
Wharfedale Wireless Works Ltd.	11
Wyndors Television	27

# Tape Exchanges

**T**APE recorder owners who wish to contact others with similar interests to exchange news and views by tape are invited to send their name, age, address, special hobby or interest for this section.

The details, given below, also include speeds and spool size to be used, name of recorder, and special areas to be contacted.

(See form page 36)

**Applegarth, W.** (24). 2, Stanley Terrace, Preston, Lancs. Greek language, chess, music. 7½, 3½, 8½-inch spool. Grundig TK24, Ferrograph 5/AN.

**Baker, Cyril B.** (49). P.O. Box 69, Lusaker, Northern Rhodesia. 8 mm cine, 35 mm photography, travel, classical pianoforte. 7½, 3½ ips. 3-inch spool. Radionette recorder. Canada, Australia, New Zealand.

**Baker, Philip** (35). 21, Chatsworth Road, Croydon, Surrey. Gardening, travel, films, traditional folk music. 3½ ips. 5-inch spool. Civic A-23 recorder. South Africa, New Zealand.

**Barker, J.** (37). 8, Wellington Terrace, Littleborough, Lancs. 35 mm photography. 3½ ips. 3-inch spool. Sound. UK.

**Broadway, Robert** (20). 53, Stroud Green Way, Croydon, Surrey. All music. 7½, 3½ ips. 7-inch spool. Collaro four-track.

**Chaplin, Christopher J.** (22). "Wembury," Wayside, Chipperfield, Kings Langley, Herts. 8 mm cine and 35 mm still photography, travel, most music. 7½, 3½, 1½ ips. 7-inch spool. Truvox PD86, four track mono and stereo.

**Cobbin, Brian** (30). 9, Bence Road, Frenchwood, Preston, Lancs. Cine and 35 mm photography, Hi-fi, jazz (1930). 7½, 3½, 1½ ips. 7-inch spool. Norfolk.

**Dallas, Alfred** (44). 32, Lowman Road, London, N.7. Photography, philately, languages, religion, music. 3½, 1½ ips. 7-inch spool. Philips EL3542, four-track. Germany, France, Belgium.

**Davy, Peter** (32). 21, Woodville Road, Golders Green, London, N.W.11. Films, chess, stamps, classical and some pop music. 7½, 3½ ips. 7-inch spool. Sony 521. London. Female contacts preferred.

**Donnelley, Thomas** (44). 121, Queens Road, Liverpool 6, Lancs. Glen Miller and Eddy Arnold recordings. 3½ ips. 7-inch spool. Stella 454, four-track. USA.

**Foster, P.** (24). 81, Norfolk Road, Cliftonville, Kent. Outdoor life. 7½, 3½, 1½ ips. 10-inch spool. Revox stereo, Philips portable.

**Gould, Keith Haydn** (20). "Woodcroft," Highenden Valley, High Wycombe, Kent. Travel, cars, church bellringing, all music. 3½, 1½ ips. Elizabethan FT3.

**Harrison, John Wilfrid** (25). 48, St. Wilfrid's Road, Standish, Wigan, Lancs. 35 mm photography, most music. 15, 7½, 3½ ips. 7-inch spool. Sound A.20. Collaro deck. Overseas only.

**Hill Michael** (21). 134, Conway Road, Newport, Monmouthshire. Railways, cinema pop music. 3½ ips. 3-inch spool. Philips Starmaker.

**Jamieson, William A.** (33). 486, Leeds Road, Thackley, Bradford, Yorks. Opera and singing. 7½, 3½ ips. 7-inch spool. Argentina, USA, Italy, Austria.

**Jeffries, Anthony** (20). 108, Lakedale Road, Plumstead, S.E.18. Politics, satire, bridge, most sport. 3½ ips. 5½-inch spool. Elizabethan Popular 200. UK, USA, all Commonwealth countries.

**King, Roger** (22). 27, Willow Street, St. Matthews Estate, Leicester. Films, dancing, C & W, pop music. 7½, 3½, 1½ ips. 7-inch spool. Carousel recorder.

**Molloy, Jim** (36). 156, Aberporth Road, Gabalfa, Cardiff. Scootering, light and classical music. 3½ ips. 7-inch spool. Stella 450 and Philips, four-track.

**Mooney, Michael J.** (25). 144-57, 38th Avenue, Flushing 54, Long Island, New York, USA. 7½, 3½, 1½ ips. 7-inch spool. Norelco 100 and 400 recorders. Australia, West Germany, Ireland.

**O'Beirne, John P.** (33). 90, Bankhouse Road, Bury, Lancs. Photography, football, most music. 3½ ips. 5½-spool. Grundig TK14.

**Orpin, William J.** (52). 3, Wandle Road, London, S.W.17. Nursing, most music. 7½, 3½, 1½ ips. 7-inch spool. Studio and Kolster Brande.

**Owen, Cpl. Terry** 1923655, (27). 63, Carisbrook Grove, S.G. Estate, Singapore, 19. All music, except jazz, people. 3½ ips. 7-inch spool. Philips EL3514.

**Panting, Robert W.** (34). 33, Rupert Street, Reading, Berks. 8 mm and 35 mm photography, outdoor recording, people, most music. 7½, 3½ ips. 7-inch spool. Spectone 161, Grundig TK1, Fidelity Argyll.

**Riley, Tom** (30). 10, Vale Street, Haslingden, Rossendale, Lancs. Church, Boys' Brigade, pops, jazz and band music. 7½, 3½ ips. 7-inch spool. Simon SP5.

**Rolfe, Alan** (21). 10, Parsonage Street, Halstead, Essex. Building equipment, etc. 15, 7½, 3½ ips. 8½-inch spool. Brenell Mk 5.

(Continued on page 36)

# ADVERTISEMENT INQUIRIES SERVICE

*This is a special service for readers of TAPE Recording Magazine. It enables you—without cost—to get fuller information about those products in which you are particularly interested. Fill in one coupon below for each inquiry, writing in your name and address in each case. Then cut out the whole of this section, following the dotted line, fold as indicated overleaf and post to us.*

<p>I should like further information about the .....</p> <p>.....</p> <p>(product) mentioned on page.....of the ..... issue of TAPE Recording Magazine.</p> <p>NAME .....</p> <p>ADDRESS .....</p> <p>.....</p> <p>.....</p> <p style="text-align: right;">September 1963</p>	<p>I should like further information about the .....</p> <p>.....</p> <p>(product) mentioned on page.....of the ..... issue of TAPE Recording Magazine.</p> <p>NAME .....</p> <p>ADDRESS .....</p> <p>.....</p> <p>.....</p> <p style="text-align: right;">September 1963</p>
---	---

<p>I should like further information about the .....</p> <p>.....</p> <p>(product) mentioned on page.....of the ..... issue of TAPE Recording Magazine.</p> <p>NAME .....</p> <p>ADDRESS .....</p> <p>.....</p> <p>.....</p> <p style="text-align: right;">September 1963</p>	<p>I should like further information about the .....</p> <p>.....</p> <p>(product) mentioned on page.....of the ..... issue of TAPE Recording Magazine.</p> <p>NAME .....</p> <p>ADDRESS .....</p> <p>.....</p> <p>.....</p> <p style="text-align: right;">September 1963</p>
---	---

<p>I should like further information about the .....</p> <p>.....</p> <p>(product) mentioned on page.....of the ..... issue of TAPE Recording Magazine.</p> <p>NAME .....</p> <p>ADDRESS .....</p> <p>.....</p> <p>.....</p> <p style="text-align: right;">September 1963</p>	<p>I should like further information about the .....</p> <p>.....</p> <p>(product) mentioned on page.....of the ..... issue of TAPE Recording Magazine.</p> <p>NAME .....</p> <p>ADDRESS .....</p> <p>.....</p> <p>.....</p> <p style="text-align: right;">September 1963</p>
---	---

# Tape Exchanges

(Continued from page 35)

**Salt, Leon** (35). 15, Park Avenue, Lydiate, Maghull, Lancs. Sound effects, travel, pop and jazz music. 7½, 3½ ips. 7-inch spool. Ferrograph 808. **USA, Japan, Australia, Mexico and Pacific area.** Letters not required, female contacts preferred.

**Thomas, Peter** (38). 4, East View, Mangotsfield, Bristol, Gloucestershire. 35 mm photography. 7½, 3½, 1½ ips. 7-inch spool. Reqs R10, and Phonotrix 88. Letters not needed.

**Westwood, John** (20). 43, Normandy Road, Cleethorpes, Lincs. Cricket, pop music. 3½ ips. 5½-inch spool. Grundig TK20. **USA, Canada, New Zealand, Australia.**

**Williams, Harry** (30). 25, Tram Street, Openshaw, Manchester 11. Salvation Army music. 3½ ips. 4-inch spool. Brenell Mk 5M.

**Woods, David** (24). 39, Ickburgh Road, Clapton, London, E.5. Sports, classical music, trad jazz. 15, 7½, 3½ ips. 7-inch spool. Clarke & Smith CTR/1. **USA, Australia.**

## FAMILY EXCHANGES

**Bennett, R. D. Mr & Mrs** (29). 18, Station Road, Braintree, Essex. All sport, cinema, all music especially modern jazz. 3½ ips. 7-inch spool. Cossor CR1602 four-track. **Denmark, Sweden.**

**Jeffries, Mr & Mrs** (40). 35, Dewlands, Godstone, Surrey. 7½, 3½ ips. 7-inch spool. Akai four-track stereo and mono.

## TEENAGE

**Bell, Brian G.** (19). 79, Barrack Hill, Armagh, N. Ireland. Films, reading, pop music. 1½ ips. 4-inch spool. Philips EL3585. **UK, France, USA.** Letters not required.

**Bensilum, Walter** (19). Chess, camping, pop music. 3½ ips. 5½-inch spool. Fidelity Argyll. **UK, Israel, Europe.** Letters first please.

**Carling, B.** (12). 70, Glebe Road, Cambridge, Cambs. Hi-Fi, dancing, pop music. 3½ ips. 5½-inch spool. Fidelity Argyll.

**Gennell, C. J.** (18). 80, Fairholt Road, Stoke Newington, London, N.16. Science fiction, all music. 7½, 3½ ips. 7-inch spool. Truvox R.64 four-track. **USA, Canada.** Female contacts preferred.

**Meckhonik, M. S.** (17). 12, Barforth Road, London, S.E.15. Carpentry, cycling, pop music. 3½ ips. 7-inch spool. Wyndsor Trident. **UK, Israel, Germany.**

**Neusten, Bengt** (15). c/o, Jankov, Gotgatan 21, Malmo, S.V., Sweden. 35 mm photography, 8 mm cine, traditional jazz (dixieland), pop music. 3½ ips. 7-inch spool, Philips EL 3571 four-track. **England, USA, Germany, France.**

**Page, John A.** (16). 45, Elgin Avenue, Belmont, Harrow, Middlesex. Cycling, swimming, model railways. 7½, 3½ ips. 7-inch spool. Regentone. Letters first please.

**Potter, Terry** (15). 7, Somerset Road, Linford, Stanford-le-Hope, Essex. Photography, motor-cycles, jazz, pop music. 3½ ips. Reqs R.10 Grundig. Letters not required.

**Preen, Barry D.** (16). 160, Bellingdon Road, Chesham, Bucks. Still and cine photography, shipping and the sea, pop music. Telefunken Magnetaphon 95. 7½, 3½, 1½ ips. 7-inch spool.

**Prole, Antony John** (16). 11, Percy Place, Grosvenor, Bath, Somerset. Photography, radio engineering. 3½ ips. 5½-inch spool. Grundig. **UK only.**

**Robbins, Phillip T.** (16). 11, Kingston Avenue, Accrington, Lancs. Photography, humour, all music. 3½ ips. 5½-inch spool. Alba two-track. **UK, Australia, New Zealand, USA, Canada.** Contacts same age preferred.

**Smalley, John** (19). 3, Lilac Terrace, Shotton Coll. Co. Durham. Photography. 3½ ips. 5½-inch spool. Grundig TK24. **UK, Germany.**

Tape recorder owners wishing to make contact with others of similar interests are invited to complete and return this form. (BLOCK LETTERS PLEASE).

Name .....

Address .....

Age .....

Special interests .....

Speeds to be used..... Spool size.....

Recorder owned .....

Special areas to be contacted .....

(Unless otherwise stated, I am prepared to accept tapes from any part of the world).

FLAP B

SECOND FOLD HERE

POSTAGE  
WILL BE  
PAID BY  
PRINT AND  
PRESS  
SERVICES  
LIMITED

NO POSTAGE  
STAMP  
NECESSARY  
IF POSTED  
IN GREAT  
BRITAIN OR  
NORTHERN  
IRELAND

BUSINESS REPLY FOLDER  
Licence No. ND 922

## TAPE RECORDING MAGAZINE

7, TUDOR STREET,  
LONDON, E.C.4.

THIRD FOLD HERE

FLAP A

FIRST FOLD ALONG THIS LINE

Fold along lines as indicated and then tuck Flap A into Flap B.

CUT ALONG DOTTED LINES

# USE YOUR TAPE RECORDER FROM ANY D.C. SUPPLY

You can operate your recorder from a car, caravan or boat battery, or from any D.C. mains supply with a VALRADIO D.C. CONVERTER. These D.C. converters enable you to operate TAPE RECORDERS, etc., for play-back music, telephone conversations and reports whilst on long journeys, in addition to making outside recordings.

Electronic types of converters are also available for 200/250 D.C. with outputs up to 200 watts 50 c/s. from ships' supply or D.C. mains.

Available for practically all makes of recorders, record players, radiograms, amplifiers, etc. with prices ranging from £7 3s. 0d., VALRADIO D.C. CONVERTERS add versatility to your equipment.

Valradio and Stereosonoscope are the registered trade marks of Valradio Ltd.



For further details just post coupon below to:

**Valradio**

LIMITED  
Browells Lane,  
Feltham, Middlesex.  
Tel.: Feltham 4242-4837.



Please send me fully descriptive leaflet, ref: TRM on D.C. CONVERTERS for tape recorders and other equipment

Name .....

Address .....

Make and type of equipment: .....

D.C. volts in: ..... A.C. watts out: .....



## Alive to every sound

Like the ears of a wary fox, the Gramplan DP4 microphone is sensitive to an extremely wide range of sounds. With its uniform frequency response from 50 to 15,000 c/s, the reliable, medium-priced DP4 will greatly improve the standard of your recordings.

**Gramplan**

—also for broadcasting, public address and call systems

Low Impedance microphone complete with connector and 18 ft. screened lead **£8.0.0**

Medium and high impedance models **£9.0.0**

A complete range of stands, swivel holders and other accessories is available.

**GRAMPIAN—sounds like the real thing!**

Writes or phone for illustrated leaflet.



**GRAMPIAN REPRODUCERS LTD**  
Hanworth Trading Estate, Feltham, Middlesex. Feltham 2657

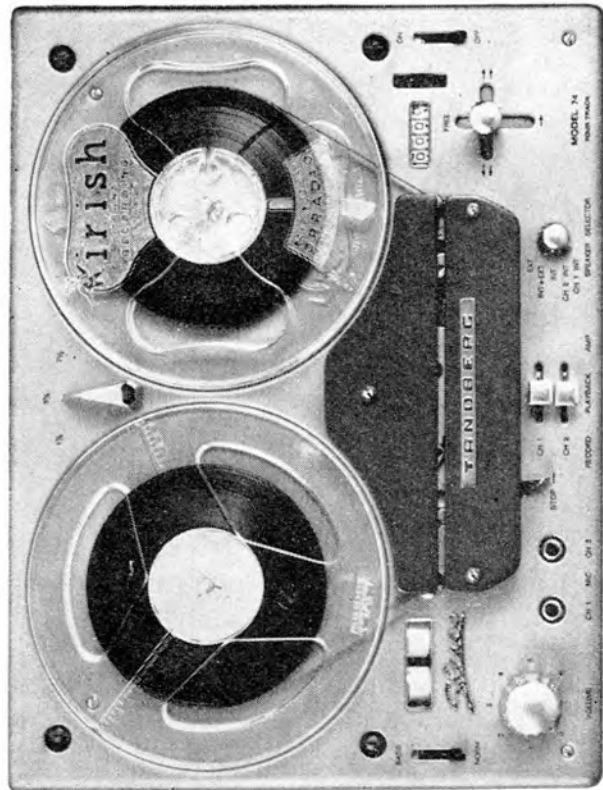

Turn to precise technical excellence that cannot be bettered. Turn to truly professional performance that you can be proud of. Turn to Tandberg for a new way of life in stereo recording. The Tandberg Series 7 stereo tape recorder has three speeds, two heads and two power amplifiers. Two indicators, two monitor speakers, two outputs for additional speakers or hi-fi. Four-track or two-track models. The finest portable tape recorder of its size in the world. Illustrated leaflet and Booklet of Technical Reviews on request.

**TANDBERG SERIES 7 STEREO TAPE RECORDER 93 gms**  
Model 74 (4 track)—Model 72 (2 track) (Illustrated: plan view of top plate—15½" x 11½")

**ELSTONE ELECTRONICS LIMITED**

EDWARD STREET  
TEMPLAR STREET  
LEEDS 2  
Tel: Leeds 35111 (7 lines)

# TURN TO Tandberg

## REVOX STAND THE GREATEST TEST—TIME



For two years now the Revox Language Laboratory at Hjørring in Denmark has operated during day and evening classes virtually without a stop. The total servicing requirements of the entire system have amounted to no more than half a dozen calls by the local engineer.

Revox Language Laboratories are now in use in many centres in Europe. They are chosen in the face of less expensive alternatives, simply because they are easy to operate and outstandingly reliable. They provide every facility and are adaptable to any teaching system. If you are interested in further particulars, please do not hesitate to contact us.

## REVOX—SOUND SUPREME

Write for further details to:

**C. E. HAMMOND & CO. LTD.**, 296 Kensington High Street, London, W.14—WESTERN 4343

FOR ALL MUSIC LOVERS AND HI-FI ENTHUSIASTS

We offer a wide range of different models including Radios, Speakers, Amplifiers and Test Instruments



Hear our Hi-Fi demonstrations at the D.I.Y. EXHIBITION, OLYMPIA, Aug. 30-Sept. 14

### Save Money Building Your own Equipment!



TA-IS

**TAPE AMPLIFIER UNITS:** Models TA-IM and TA-IS. The mono version, TA-IM, can be modified to the stereo version, TA-IS, by the modification kit TA-IC. Special features include bias level control, recording level indicators, print circuit boards.

TA-IC £6.15.0. TA-IM £19.2.6. TA-IS £24.10.0.

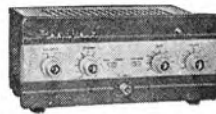

S-33

**HI-FI STEREO 6 W AMPLIFIER Model S-33**  
Only 0.3% distortion at 2½ w/chl. £13.7.6.

**DE-LUXE STEREO AMPLIFIER Model S-33H**

De-luxe version of the S-33 with two tone grey perspex panel. With higher sensitivity necessary to accept the Decca Deram pick up. £15.17.6.

**HI-FI FM TUNER Model FM-4U**  
Available in two units. Tuning unit (FMT-4U) £2.15.0 incl. P.T.). I.F.-amplifier (FMA-4U) £12.6.0. Printed circuit for I.F. Amplifier and Ratio detector own built-in power supply, 7 valves. Tuning range, 88-108 Mc/s. Total price £15.1.0.

**HI-FI AM/FM TUNER. Model AFM-1.**  
Also available in two units as above: Tuning heart (AFM-T1) £4.13.6 inc. P.T.) and I.F. amplifier (AFM-A1) £20.13.0.). Total £25.6.6.

**HI-FI STEREO 18W AMPLIFIER Model S-99**  
Within its power rating, this handsome looking amplifier is the finest available. U/L push-pull output. Printed circuit board construction. £27.19.6.



AM/FM TUNER

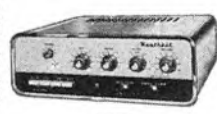

S-99

We guarantee that without any previous experience—you can build any of our models.

All orders delivered free U.K. ● ALL MODELS AVAILABLE ASSEMBLED—PRICES ON REQUEST ● Deferred terms available U.K. over £10

#### EQUIPMENT CABINETS

A range of equipment cabinets is available including kits, ready assembled cabinets or assembled and fully finished cabinets. Why not send for full details free of any obligation?

Prices from £6.19.6. to £29.8.0.

#### TRUVOX TAPE DECKS.

Models D83-2 D83-4

High quality stereo Tape

Decks.

D83-2 2 track for higher fidelity

£31.10.0.

D83-4 (identical presentation) 4

track. £29.8.0.



TRUVOX D83



MALVERN



COTSWOLD



STUDIO

#### COTSWOLD & MFS SPEAKER SYSTEMS

The "Cotswold" is an acoustically designed enclosure 26" x 23" x 14½" with 3 speakers covering the full frequency range 30-20,000 c/s.

The "Cotswold" MFS. A minimum floor space

model size 36" high x 16½" x 14" deep.

Price either model £23.4.0.

£17.10.0.

1½, 3½, 7½ i.p.s.

£17.10.0.

£17.10.0.

£17.10.0.

Without obligation please send me

#### FREE BRITISH HEATHKIT CATALOGUE

Full details of Model(s) .....

Name .....

Address .....

(Block capitals please) .....



T.9

AMERICAN HEATHKIT CATALOGUE SHOWING RANGE of over 250 models and full details of direct mail order scheme for only 1/- post paid, write to:

**DAYSTROM LTD.** Dept. T9  
Gloucester, England.

**NEW, BIGGER SHOWROOMS  
MEAN AN EVEN WIDER CHOICE**

from the Mail Order Service run by  
**TAPE SPECIALISTS  
FOR TAPE ENTHUSIASTS**

**R·E·W**

**'PLUS FIVE' SERVICE!**

A friendly welcome awaits you at our bright new showroom extension. Here you will find a lavish array of equipment at every price level . . . make your choice for immediate delivery, or if you cannot visit us, the fast and friendly R.E.W. Mail Order Service makes it easy for you to enjoy the professional results only possible with an advanced Tape Recorder. Get in touch with us now. We have thousands of satisfied customers and a reputation for generous part exchange, reliability and specialist service.

- Generous Part Exchange Allowances
- No Interest Terms—Lowest Deposits
- Off-the-shelf delivery from the biggest range under one roof
- Optional Personal Insurance
- FREE Servicing—FREE Delivery

**MACHINE OF THE MONTH**

**BRENELL Mk. 5 Series 2** 69 gns.

A magnificent new machine with a re-designed amplifier giving improved frequency response at all speeds on both record and playback.

4 Speeds: 1½, 3½, 7½ and 15 i.p.s.  
3 Independent motors Output 4 watts.

No Interest Terms £7 9s. deposit.  
12 monthly payments of £5 8s. 4d.  
Also available on H.P. Terms, 18-24 months to pay.

**CASH FOR YOUR TAPE RECORDER or HI-FI.** Highest cash offers for good equipment . . . get in touch today!

REMEMBER . . . you're guaranteed a better, faster deal

**AT R·E·W EARLSFIELD LTD.** Personal callers always welcome

Write or 'phone Mail Order Dept. "TRM" 266-8 UPPER TOOTING RD., LONDON, S.W.17.  
Telephone: BALham 7710

Just a few of the machines in stock waiting your inspection—NOW!

FERROGRAPH SAN...	... 85 gns.
GRUNDIG TK46	... 99 gns.
BRENELL Mk. V "M"	... 88 gns.
REVOX Stereo	... 110 gns.
REFLECTOGRAPH Type "A"	... 105 gns.
REPS. R.10 2-Track	... 59 gns.
SIMON S.P. 5	... 93 gns.
TANDBERG Stereo 6	... 110 gns.
TANDBERG Stereo 7	... 93 gns.
AKAI Stereo	... 130 gns.
VORTEXION WVA	... £93.13.0
FERROGRAPH 522-524	... 110 gns.
SONY Stereo 521	... 124 gns.
AMPEX Stereo 1273	... 290 gns.

**BINDERS**

Special binders for *TAPE Recording Magazine* designed to hold a year's supply are now available.

No more torn covers and dog-eared edges ★ No more hunting for those mislaid copies ★ Each copy is inserted as received to form a completely bound volume for permanent reference ★ All pages open flat and effect secure binding with steel bars from first to last copy ★ Strong board binders covered with rexine with the title printed in gold on spine.

**PRICE 14s. 6d. (post free)**

From: 7, Tudor Street, London, E.C.4

**Invitation to Sound Reality**

*High Fidelity Equipment should bring to you the closest possible approach to the original sound . . . but in choosing we have to bear in mind your own individual requirements.*

Let us assist you with a well chosen selection of equipment which can give you quick and accurate comparisons under the right conditions.

*Specialist in High Fidelity Sound.*

**H. D. KIRK**

*Stereolectrics*  
**LIMITED**

Phone: 23093

150 HIGHER BRIDGE STREET

**BOLTON**

**"Advice on buying a tape recorder"**

*Reprint edition now available—2s. 6d.*

**TAPE RECORDING YEARBOOK 1962-63**

**T**HE latest edition of the **TAPE RECORDING YEARBOOK** is now on the bookstalls. This fifth edition contains the popular "at-a-glance" comparison charts of every currently available tape recorder, microphone, tape deck, and mixer unit together with illustrations, and a valuable miscellaneous accessory guide and magnetic tape price list.

Other contents include a full review of tape developments during the past year; advice on choosing—and using—a tape recorder; tape and cine; copyright; tape records; and a full directory of manufacturers, agents, and tape club addresses.

**POST NOW to :** TAPE Recording "Magazine,"  
7, Tudor Street, London, E.C.4.

Please send me.....copy(ies) of Tape Recording Yearbook 1962-63 at 7s. 6d. a copy (including postage) (\$1.25), I enclose remittance herewith.

Name .....

Address .....

**TAPE RECORDING  
HANDBOOKS**

(Others in our series)

**INTRODUCTION TO THE  
TAPE RECORDER**

Charles Langton  
3/6 (post free) (U.S.A. \$0.75)

**HI-FI FOR THE MUSIC LOVER**

Edward Greenfield  
3/- (post free) (U.S.A. \$0.70)

**TAPE AND CINE**

John Aldred  
3/- (post free) (U.S.A. \$0.70)

**HOW TO RECORD WEDDINGS**

Paul Addinsell  
3/- (post free) (U.S.A. \$0.70)

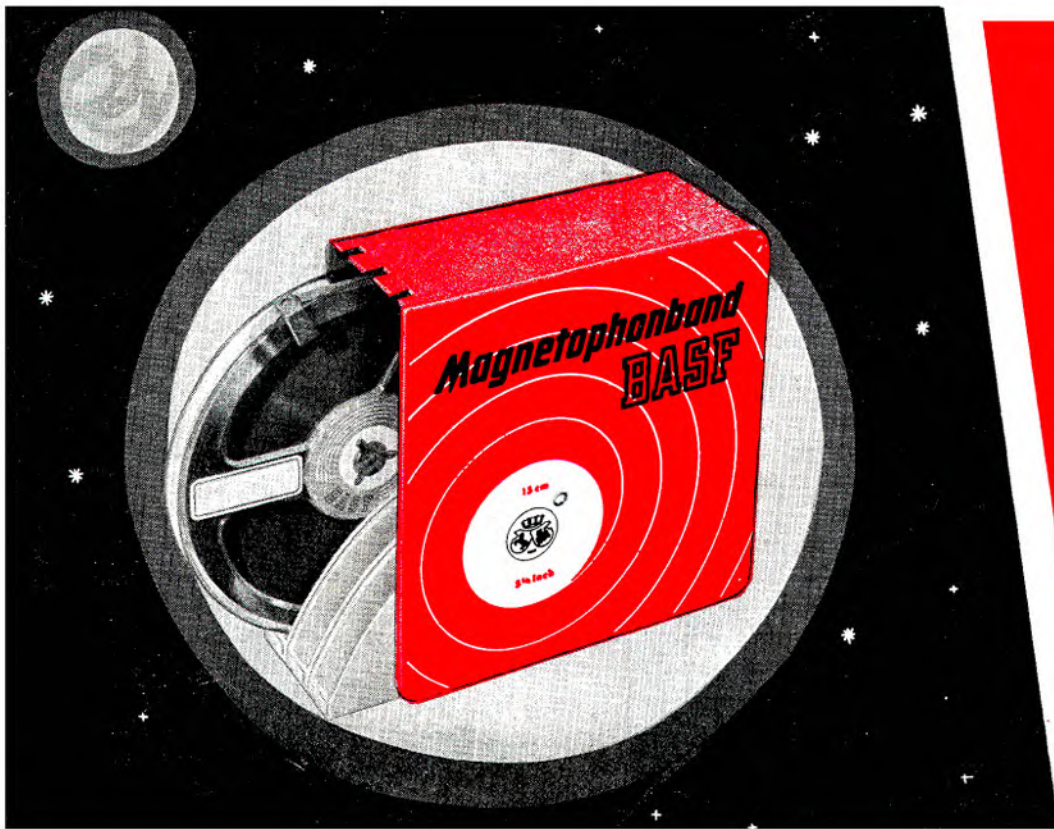

## WORLD WIDE DEMAND FOR BASF LIBRARY BOXES BRINGS PRICES DOWN!

NOW, BASF are able to offer price reductions on single tape Library Boxes with precision magnetic recording tape, and to introduce six new Double Play Tape Library Boxes at attractive prices.

### TAPES FREE FROM DUST AND DAMAGE!

You're sure to want to keep most of your unique recordings, so buy your tapes in BASF LIBRARY BOXES to ensure their safety from dust and damage. The boxes are made from hardwearing Polystyrol and hold the tapes in swivel-open cassettes for ready reference.

Store, tabulate and protect your recordings in these most practical LIBRARY BOXES made by BASF. And, to help with your collection, ask your dealer for the *BASF Library Index*, FREE.

**BASF Single Tape Library Boxes for long play tapes NOW cost:**  
 5" 31/- (4/- reduction) 5½" 38/6 (5/3 reduction) 7" 55/- (7/6 reduction)

**and introducing NEW DOUBLE PLAY TAPE LIBRARY BOXES:**  
 Single Tape 5" 45/- 5½" 58/6 7" 82/6      Three Tapes 5" 126/- 5½" 165/- 7" 232/6



—SYMBOL OF  
AUTHENTIC SOUND

BASF CHEMICALS LIMITED, 5a GILLESPIE ROAD, LONDON, N.5. Tel: CANonbury 2011