

**COMBINING
TAPE AND
CINE** pages
17-23

TAPE

RECORDING AND HI-FI MAGAZINE

Authentic Sound brings home the bacon

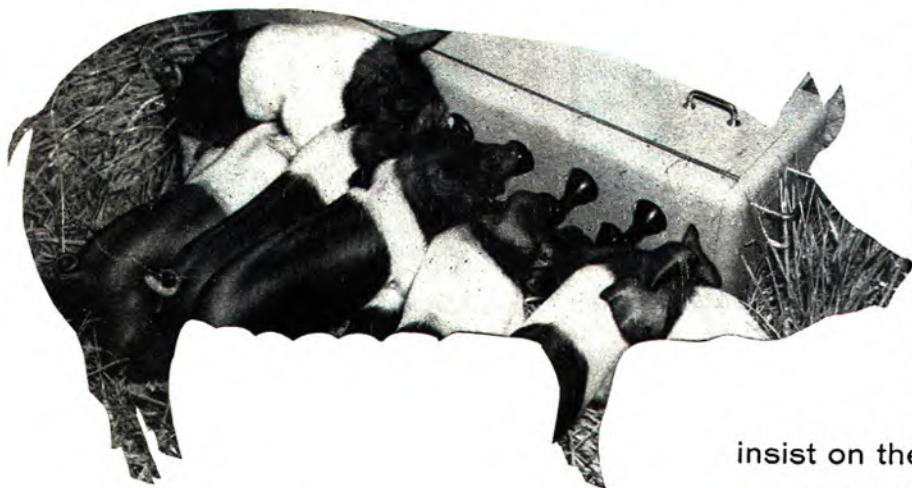

It's certainly a *Brave New World* existence these days for piglets. Caught in the drive for more meat more quickly, they are removed from the sow soon after birth, given special growth-aiding foods and kept emotionally warm by tape recordings of their mother's grunts. To convince even the youngest 'orphan' piglet the sow must sound authentic... the Authentic Sound you always get from recordings on BASF, the outstanding tape with the Luvitherm base. BASF Magnetic Recording Tape just cannot be equalled for a permanent true-to-life record of human voices, solo instruments, orchestras, party scenes as well as animal noises. It reproduces Authentic Sound whatever and wherever you record... however often the tape is used.

insist on the tape with the [®]Luvitherm base

• **Luvitherm**—your key to Authentic Sound

Luvitherm is a special plastic developed by BASF—the originators of magnetic recording tape. The ideal base for the specially processed magnetic oxide particles, it holds this highly sensitive recording surface in the tightest bond. This means you can't fail to register your recorder's complete range of frequencies and reproduce them with unmatched fidelity.

Look for the distinctive red box before you buy

BASF

Magnetic Recording Tape

Standard • Long Play
Double Play • Editing Sound

F. A. HUGHES & CO LTD 4 STANHOPE GATE LONDON W1

FIRST AND FOREMOST IN THIS FIELD

FORTNIGHTLY 1/6

13th June 1960

EVERYONE'S GOING ELIZABETHAN

Going for Britain's most popular tape recorders

Suddenly everyone is seeing the sense of buying a British tape recorder. Finding that British electronics, British engineering have no equals in this world. Finding that nowhere else do electronics and precision engineering combine so effectively as in the Elizabethan range.



GOING FOR THE MAJOR!

Without exaggeration, this superlative new machine offers a standard of performance and a range of facilities only found previously in highest grade professional equipment. Specially fitted 3 micron gap recording head gives phenomenal frequency response and the 6 watts push-pull output ensures sound reproduction of a uniquely high order.

Supplied with 7" reel of 2,400' double-play tape

65 gns

Microphone optional extra

- Phenomenal frequency response
 - 50-20,000 c/s at 7½ ips ± 3 dB
 - 50-14,000 c/s at 3½ ips ± 3 dB
 - 50-7,000 c/s at 1½ ips ± 3 dB
- Six watts push-pull output
- Professional type meter level indicator
- Large 10" x 6" high flux speaker with 4" tweeter
- Built-in superimposition and mixing
- Separate bass and treble controls

GOING FOR THE PRINCESS!

Terrific performance and value. Three speeds, four hours' playing time.

39 gns complete

GOING FOR THE AVON!

To-day's most astonishing tape recorder value. Excellent recording quality and reproduction, simple controls, splendid styling.

27 gns complete

ELIZABETHAN TAPE RECORDERS

ELIZABETHAN (Tape Recorders) LTD
Romford, Essex Tel: Romford 62366/7

SEND FOR DETAILS NOW!

To Elizabethan (Tape Recorders) Ltd., Edge Cluse, Romford, Essex
I'd like to know more about the Elizabethan range. Please send me
your free illustrated leaflets by return of post

NAME _____

ADDRESS _____



SOUND SENSE . . .

Obviously the quality of reproduction obtainable from your recording equipment depends basically on the input received from the microphone. Hence the wisdom of using a microphone of the highest sensitivity and response. The fact that STC microphones are used by the B.B.C. is sufficient recommendation. There is an STC microphone suitable for every purpose.

Type	Response in cycles	Suitability	Price*
4021 Moving Coil	30-15,000	Speech or Music	£21
4035 Moving Coil	40-10,000	General purpose and out-of-doors	£18.10.0
4037 Moving Coil	30-15,000	Speech or Music	£20
4038 Ribbon	30-15,000	Music	£38.10.0
4105 Cardioid (Moving Coil)	60-10,000	General purpose	£20

All microphones have an impedance of 30 ohms. Full range of stands, accessories and cables available.

STC MICROPHONES contribute to high-quality reproduction

* Subject to alteration without notice.



60/3C/PA

Standard Telephones and Cables Limited

PUBLIC ADDRESS DEPT:
CONNAUGHT HOUSE · ALDWYCH · LONDON · W.C.2



Get it TAPED — to perfection

— naturally



SIZES	STANDARD			LONG PLAY		
	FEET	TOTAL RUNNING TIME (I.P.S.)	PRICE £ S D	FEET	TOTAL RUNNING TIME (I.P.S.)	PRICE £ S D
3"	150	8MINS	5 6	225	12MINS	8 6
4"	300	16 "	10 0	450	25 "	14 6
5"	600	32 "	1 0 0	850	45½"	1 8 0
5½"	850	45½"	1 7 6	1200	1HR 4MINS	1 15 0
7"	1200	1HR 4MINS	1 15 0	1800	1.36 "	2 10 0
8½"	1750	1.33 "	2 10 0	2400	2.8 "	3 10 0
	DOUBLE PLAY			SUPERGRADE		
3"	300	16MINS	10 6			
5"	1200	1HR 4 "	2 5 0			
5½"	1800	1.36 "	3 10 0			
7"	2400	2.8 "	4 0 0	1200	1HR 4MINS	2 18 6

on

MEMBER OF THE B.I.C.C. GROUP

mss Mastertape

MSS RECORDING COMPANY LIMITED COLNBROOK, BUCKS TEL. COLNBROOK 2431
MSS SHOWROOM AND STUDIO: 21 BLOOMSBURY STREET, LONDON W1

FREE H.P.!

YOU PAY THE CASH PRICE ONLY—OVER 24 MONTHS!

We sell and stock more Tape Recorders than any other dealer in Gt. Britain. Why do thousands of people buy from us? Because we give the best terms—terms which include No-Interest Charges at all over 24 months—yes! 2 years * Deposits from only 10% any make * Free Servicing * Free Delivery anywhere in U.K. * No Purchase Tax * Free Tape offers * Commission on Sales * Part Exchanges * and lots more besides.



400 machines in stock—80 different new and second-hand models on permanent demonstration in our showrooms * Main Agents for ALL the best makes * Our Mail Order Dept. covers the whole of England, Wales, Scotland and N. Ireland—order from us wherever you live.

If you want to know why it will pay you to buy from us, write, phone or call in NOW for full details of all our terms, and free brochures on all our best makes:

HOWARD

PHOTOGRAPHIC

218 HIGH ST · BROMLEY · KENT · RAY 4477

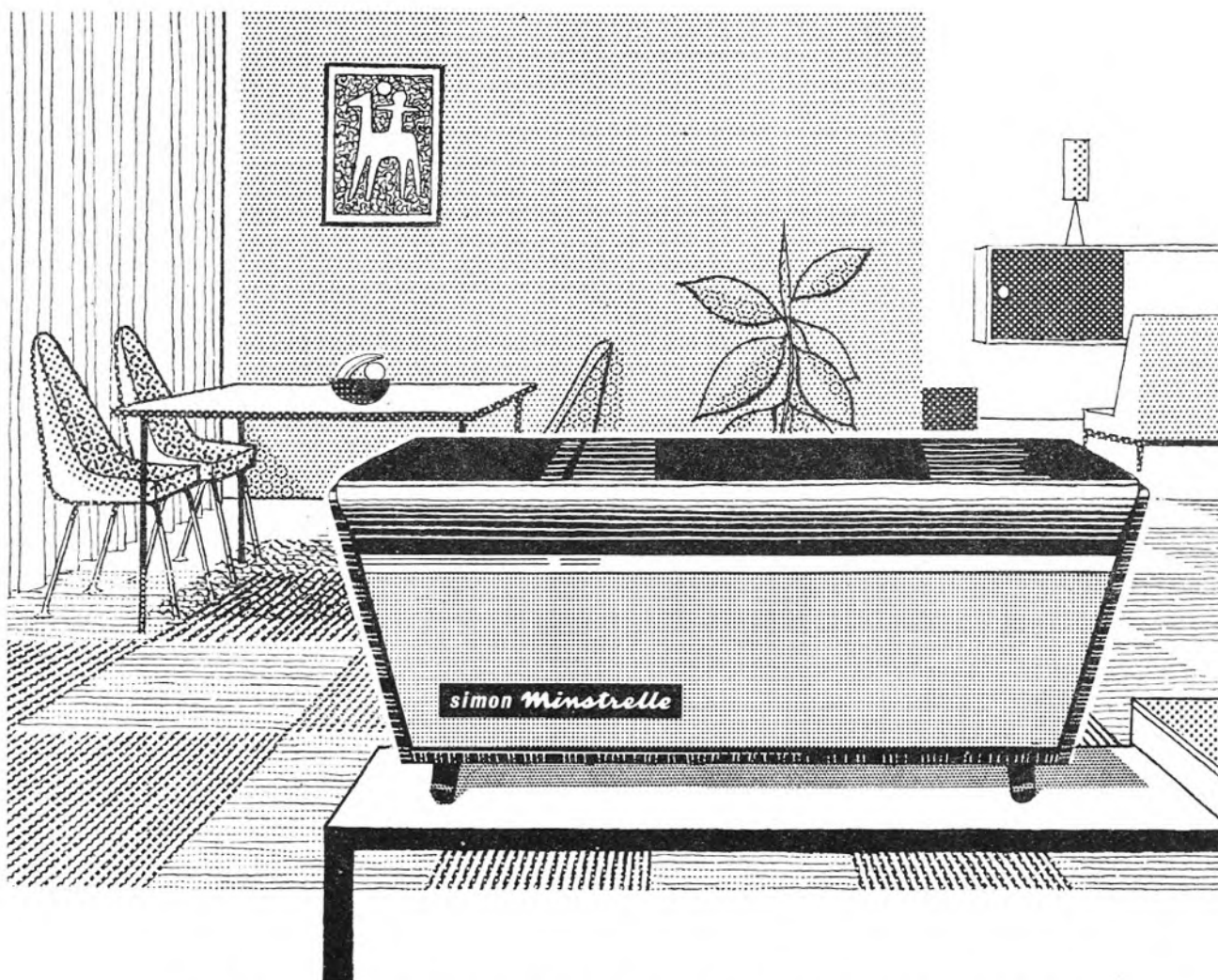

The perfect complement to your home



A high performance tape recorder with nothing stinted—that's the Simon Minstrelle. At last here's a tape recorder that is designed without compromise both as a piece of furniture to grace your home, and a fine instrument to do justice to your music.

So easy to use New features like the drop-on magazine loading (no tape threading or fuss) make its operation simple enough for the youngest member of the family. Recording is simple too, no trailing wires, no 'microphone shyness'—the microphone is built-in.

So attractive too In a handsome cabinet of polished sapele mahogany, the Minstrelle is a piece of fine furniture, and its superb tone matches this elegant appearance.

the simon **MINSTRELLE** tape recorder

- * Magazine Loading * Built-in speech microphone * Straight-through amplification
- * Full tone Control * Triode push-pull Amplifier * Superimposition * Mixing

Table cabinet or Portable optional

39 gns

inc. built-in microphone

At your local dealer or write to **SIMON EQUIPMENT LTD.** 46/50 George Street Portman Square London W1 WELbeck 2371



the **FINEST** TAPE RECORDERS on **INTEREST FREE** TERMS

Write, Phone or Call today. You can buy by post with perfect confidence
Deposits from 20 per cent, 12 months to pay

I know how difficult it is to choose the Tape Recorder. That is why more and more people come to the Royal Opera Arcade, because my advice, personal attention, and help are freely given. Full demonstrations at any time and you can always examine and hear the latest and most interesting machines. Remember—I am here to help you.

LAURENCE DICKINSON

Leaflets gladly sent if you are unable to call



NEW! 4-Track Monaural Recorders

PHILIPS 59 gns. TELEFUNKEN 64 gns.
4-Track Stereo/Monaural Recorders
PHILIPS 92 gns. HARTING 86 gns.
KORTING 68 gns. ELEKTRON 77 gns.

ACCESSORIES. We carry a wide range of microphones, earphones, leads, telephone adaptors, etc., etc.

SERVICING. We undertake rapid and efficient servicing of all Tape Recorders.

TAPES. Audio, Agfa, B.A.S.F., E.M.I., Geloso, Scotch Boy, Telefunken, etc. Send for lists.

CAMERAS. By Zeiss, Agfa, Eumig, Voigtlander, etc. Send for lists.

READ the all-in-one Tape Recorder Book. 12s. 6d. Packed with information.

TELEFUNKEN DA CAPO RADIO, 39 gns. Call and hear this fine instrument.

TELEFUNKEN TAPE DECK, 63 gns. Use it with your amplifier or with the Telefunken Radio.

Model	Gns.
Philips 3515	32
Sagatone	38
Elizabethan Princess	39
Simon Minstrelle	39
Perth Saja	45
Wyndor Victor	45
Elektron	47½
Magnafon	49
Spectone Ex Tape	49
H.M.V.	£50
Grundig TK20	52
Telefunken 75 with mic.	56
Perth Saja De Luxe	56
Brenell 3-Star	58
Veritone	58
Mobile	58
Ficord	59
Grundig TK25*	62
Telefunken Deck*	63
Korting Stereo*	68
Telefunken 4-track with mic.	68
Stuzzi-Magnette	69
Brenell MKV with mic.	69
Grundig TK30*	72
Brenell MV with meter, mic.	74
Elektron Stereo*	77
Telefunken 85KL*	79
Sabafon Automatic*	79
Harting Stereo*	86
Timbra*	89
Simon SP4*	95

* Excluding Microphone.

Dickinsons of Pall Mall Ltd. 11 Royal Opera Arcade, Pall Mall, S.W.1 TRA 2881

The Royal Opera Arcade lies behind Her Majesty's Theatre in the Haymarket (one minute from Piccadilly Circus or Trafalgar Square)

HIGH QUALITY TAPE RECORDER SPECIALISTS!

BEST PART EXCHANGE

OFFICIALLY APPOINTED AGENTS FOR:

- | | |
|--------------|-----------------|
| ★ FERROGRAPH | ★ REFLECTOGRAPH |
| ★ SIMON | ★ GRUNDIG |
| ★ REPS | ★ BRENELL |
| ★ VORTEXION | ★ WYNSOR |

ALLOWANCE ON YOUR [PRESENT TAPE RECORDER — HI-FI EQUIPMENT

MONO RECORDERS	Verdik	45 gns.	*Ferrograph 808	105 gns.	Grundig Etc.
Geloso	Specto 161	49 gns.	Ferrograph Stereo Add.	30 gns.	
Stuzzi-Mambo	Specto 171	39 gns.	TRANSISTOR—BATTERY		TAPES
Kurland Hi-Fi	Veritone Venus... .. .	58 gns.	Grundig Cub	26 gns.	B.A.S.F.
Brenell 3-Star	Philips	38 gns.	Clarion	25 gns.	Audiotape
*Brenell Mk. 5	Philips EL 3542	59 gns.	Fi-Cord	59 gns.	Irish Tape
Wyndor Victor	Simon Minstrelle	39 gns.	*Butoba	69 gns.	E.M.I.
Walter 101	Simon SP4	95 gns.	Minivox	37 gns.	Ferrograph
Walter De-Luxe	Saba Hi-Fi	79 gns.	Stuzzi-Magnette	69 gns.	Grundig
Walter 505	*Vortexion WVA	89 gns.	Steelman	55 gns.	PRE-RECORDED TAPES
Perth Saja	*Ferrograph 4 AN	81 gns.	MICROPHONES		ACCESSORIES
Perth Saja De-Luxe	*Ferrograph 4 SN	88 gns.	Reslo		TUNERS
*Telefunken 75 KL-15			Lustraphone		AMPLIFIERS
*Telefunken 85 KL	STEREO		Cadenza		SPEAKERS
Grundig TK 20	*Korting	68 gns.	T.S.L.		PICK-UPS
*Grundig TK 25	*Harting HM8	86 gns.	A.K.G.		MOTORS
*Grundig TK 30	*Brenell Mk.V	92 gns.			

* MICROPHONE EXTRA

THE BEST TERMS **NO INTEREST** 20% deposit, up to 2 years to pay.
ON THE BALANCE.

FREE SERVICING — FREE DELIVERY — FREE TAPE OFFERS — 150 MACHINES ON DISPLAY — OUR MAIL ORDER DEPARTMENT WILL DEAL WITH YOUR ENQUIRY BY RETURN. WRITE — PHONE — CALL FOR A QUOTATION ON YOUR MACHINE. A LARGE SELECTION OF USED TAPE RECORDERS.

REW EARLSFIELD LTD. 545 GARRATT LANE, S.W. 18 Tel.: WIM 0709
10 minutes from Tooting Broadway underground station. 100 yards from Earlsfield Station

There are two kinds of people who'll want this new



TK-24 4 TRACK MODEL

... Two quite different kinds of people will want the new TK 24 — the inexperienced and the experienced. The inexperienced because they don't know any better and the experienced because they don't know any better either: because there isn't any better than this brilliant new four track Grundig model. The new TK 24 makes no compromises. It doesn't ask you to choose whether you want high fidelity or long play — it gives you both! All the time! Six hours record/playback.

It doesn't ask you to scrap all your existing conventional twin track $3\frac{1}{2}$ i.p.s. tapes — it lets you play them back as well (and how good they sound!).

It doesn't expect you to have to make complicated arrangements to produce special trick effects — it allows two tracks to be recorded separately and then played back together. (Normally, of course, you would play them back separately to get the doubled playing time that four track gives you).

In fact it's the most accommodating tape recorder ever made — even by Grundig!

No matter how much you know — or don't know — about Tape Recorders, go to your nearest Grundig Approved Dealer and have him demonstrate the TK 24.

See and hear Grundig quality for yourself; the simplicity, the compactness, the styling, the really first rate performance of a new model that will stay 'new' for years.

PRICE **62** guineas (Including Microphone)

GET THE MOST OUT OF LIFE

GET THE **GRUNDIG** **TK24**

GRUNDIG (Great Britain) LTD.

Advertising & Showrooms : 39/41 New Oxford Street, London, W.C.1.
Trade enquiries to : Newlands Park, Sydenham, London, S.E.26.
(Electronics Division, Gas Purification & Chemical Company Limited)

Please send me the free fully illustrated leaflet of the wonderful new TK 24 four track model tape recorder.

Name

Address

Nearest Town

GS.TG.235



ALL YOUR RECORDINGS CAN BE FOUND QUICKLY AND EASILY BY USING —

METRO-TABS

3/11 per set

A new and scientific device designed to clean the Record and Erase heads of your tape recorder, and to reduce faults caused by oxide deposits. Price 12/6



Write for illustrated leaflets to:

METRO-SOUND MFG. CO., LTD.

19a BUCKINGHAM ROAD
LONDON - N.1
Telephone: CLIssold 8506/7

NEW FORMULA

Sound machine + Psycho-tapes or Discs = SUCCESS

SEND NOW for interesting 16 page FREE BOOKLET which will show you how to:-

- ★ DEVELOP PERSONALITY
- ★ GAIN SELF-CONFIDENCE
- ★ TRAIN YOUR MEMORY
- ★ LEARN SELF-HYPNOSIS
- ★ SPEAK IN PUBLIC, etc.

To EDUCATIONAL RECORDINGS, Dept. TN,
27 York Road, Ilford, Essex.

Please send 16 page free booklet in plain package

Name

Address

BUY YOUR RECORDER FROM THE SPECIALISTS!

the easiest of terms ☆ no interest charges over twelve months ☆ free delivery in U.K. ☆ come and see our selection ☆ plenty of room to park your car ☆ part exchanges welcome ☆ good guaranteed second hand models in stock

TAPE RECORDER SERVICE Co. Tel: RAVensbourne 6119
95 BECKENHAM LANE, SHORTLANDS, BROMLEY, KENT

Sensational success of audiotape

TRADE MARK

Tape Recording experts and enthusiasts all over the country are changing to AUDIOTAPE for its flawless perfection of sound reproduction over the entire audio range and its *consistent, uniform quality* from reel to reel.

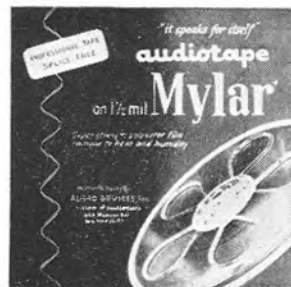

Available on all standard reel sizes, there are eight different types to meet every recording requirement. AUDIOTAPE, manufactured in the U.S.A., by Audio Devices Inc., gives you the truest sound your recording equipment can produce—try AUDIOTAPE . . . it speaks for itself.



Sensational C-SLOT REEL!

All 5" and 7" reels of AUDIOTAPE are supplied on the exclusive C-Slot Reel—the fastest-threading tape reel ever developed. The tape end, dropped into a slot in the hub, anchors itself automatically at the first turn of the reel.



ELPICO A NAME FOR BETTER PERFORMANCE

Concessionaires to the United Kingdom and Eire

LEE PRODUCTS (Gt. Britain) LIMITED

ELPICO HOUSE, LONGFORD STREET, LONDON, N.W.1

Telephone: EUSton 5754 (all lines) Telegrams: Leprod, London.



TWO YEAR GUARANTEE NOT MASS PRODUCED — BUT VIRTUALLY HAND-MADE FOR RELIABILITY AND CONSISTENTLY HIGH STANDARD OF PERFORMANCE

- ★ $1\frac{7}{8}$ ips can be fitted for an extra 3 gns. ★ Superimposing fitted as standard
- ★ Provision for 2-or 4-track stereo. ★ Mixing facilities

MODELS:

R20 62 GNS. with magic eye recorder indicator.
R30 66 GNS. with meter record level indicator.
R40 70 GNS. as R30 but with push/pull sound.

TECHNICAL SPECIFICATION

The R40. $1\frac{7}{8}$ ips 70—4,500± 3dBs. $3\frac{3}{4}$ ips 60—9,000± 3dBs. $7\frac{1}{2}$ ips 50—15,000± 3dBs. 15 ips 40—20,000± 3dBs. (signal noise ratio at $7\frac{1}{2}$ ips—47dBs.). Separate record amplifier. Push-pull bias erase oscillator for low tape hiss. Separate bass and treble controls± 15dBs at 14 kc/s—15dBs at 40 c/s. Supplied complete with Acos 39/1 microphone. Radio Record lead and 1,200' PVC Tape.

FURTHER FACTS:

It is not generally known that the Tape Deck mechanism is virtually re-built in the REPS machines. It is standard procedure to remove all rubber wheels—i.e., re-wind, idle and pinch—and re-grind them to a closer tolerance. Also the Capstan is skimmed to less than ± 0.0001". This has resulted in a very low "wow" factor, especially at $3\frac{3}{4}$ ips which has led to the logical introduction of $1\frac{7}{8}$ ips in place of the 15 ips. The principal cause of "flutter" is due to the eccentricity of the three-step pulleys which control the tape speed. This eccentricity occurs when the pulley is locked to the motor shaft and is due to the off-setting action of the fixing screws. This difficulty has been overcome by manufacturing pulleys over-size and machining to the correct diameter when fitted to the motor shaft. By this method a total variation of less than 0.0001" has been achieved at $1\frac{7}{8}$ ips. Initial measurement indicate total "flutter" content at $1\frac{7}{8}$ ips to be of a lower order than previously associated with $3\frac{3}{4}$ ips.

D. W. Aldous of 'GRAMOPHONE RECORD REVIEW' writes in March issue:—

"The overall performance of this Reps R30 recorder, coupled with its reliability and simplicity of operation, not to mention an attractive styling, must give it a wide appeal to tape recordists seeking an all-British machine of unusual quality."

Please send me without obligation full details of your range of Tape Recorders. I am particularly interested in

Model R.....

Mr.

REPS (TAPE RECORDERS) LTD.,
 Dept. T.R.H. . . . 118 PARK ROAD NORTH
 SOUTH ACTON, W.3. . . Telephone: Acorn 4141

Brown Band 195 (Acetate base)

600'	5" spool	17/-
850'	5½" spool	23/-
1,200'	7" spool	27/6

Green Band 211 * (Acetate base)

600'	5" spool	21/-
850'	5½" spool	28.-
1,200'	7" spool	35/-

Long Play 601 * (Mylar base)

225'	3" spool	9/-
900'	5" spool	28.-
1,150'	5½" spool	35.-
1,800'	7" spool	50.-

Double Play 724 * (Tensitized Mylar base)

300'	3" spool	13,9
600'	4" spool	25/-
1,200'	5" spool	45/-
1,650'	5½" spool	52/6
2,400'	7" spool	80/-

* Ferro-sheen process

irish

AMERICA'S FAVOURITE TAPE

Optimum fidelity is ensured by the exclusive Ferro-Sheen process—an integral part of the tape manufacture—which offers the following distinct advantages:



Exceptional high frequency response, due to intimacy of contact between tape and heads.



Minimum head wear.



Freedom from head contamination by oxide build-up.



Considerable reduction in background noise.



Minimum drop-outs (temporary loss of signal).

IRISH Brand Tapes are produced by Orr Industries Inc.—a division of the AMPEX CORPORATION—thus a combination of the Masters of Tape Manufacture and the Masters of Sound Equipment cannot fail to produce a tape of the highest quality.

IRISH BRAND SP-3 TAPE SPLICER. The only Tape Splicer available incorporating twin cutting devices. Produces professional-style splices in a few seconds, without scissors or razor blades. Price 67/6.

Sole Distributors:

WILMEX LTD · ST. STEVEN'S HOUSE · WESTMINSTER · LONDON S.W.1

TAPE

RECORDING
AND HI-FI MAGAZINE

Vol. 4 No. 14 13th July, 1960

Tape Recording and Hi-Fi Magazine is published fortnightly, on alternate Wednesdays, by Print and Press Services Ltd., from 7 Tudor Street, London, E.C.4

EDITOR: **R. D. BROWN**

TECHNICAL ADVISORY EDITOR: **CHARLES LANGTON**,
A.M.Brit.I.R.E., A.M.Inst.E.

MUSIC: **EDWARD GREENFIELD**
The Guardian recorded music critic

DON WEDGE
News Editor, New Musical Express

MOVIE-MAKING: **JOHN ALDRED**

NEWS AND CLUB ACTIVITIES: **FRED CHANDLER**

OVERSEAS CORRESPONDENTS:

FRANCE: **GEORGE GINIAUX**
Revue du Son, 40, rue de Seine, Paris-6e

U.S.A.: **PETER M. BARDACH**
210-16, Grand Central Parkway, Queens Village 27, New York

The Editor is always glad to receive articles, news items, illustrations, etc., intended for publication and payment is made on the first of the month following publication. When not accepted, material will be returned if a stamped addressed envelope is enclosed, but the Editor cannot accept responsibility for the safety of such material.

"Tape Recording and Hi-Fi Magazine" is available by a postal subscription at 45s. per annum, post free, or it can be obtained at newsagents, bookstalls and radio and music dealers. In the event of difficulty, write to the distributors, Rolls House Publishing Co., Breems Buildings, London, E.C.4.

Back numbers, if still in print, are available at 2s. 6d. per copy for issues up to November, 1959, and 2s. per copy for later numbers.

EDITORIAL

Address all communications

7 TUDOR STREET, LONDON, E.C.4
FLE 1455-6

ADVERTISING

All advertising communications to

**1 CRANE COURT,
FLEET STREET, LONDON, E.C.4**

FLE 0197

IN THIS ISSUE

We take the view . . . 12

The World of Tape 13
A News Digest

All the fun of the Fair 14
Denys G. Killick

MICROPHONE SUPPLEMENT 17
General introduction

Various types and their special uses 18

Contact microphones 19

Special Review Section 20

Sound Effects 26
Alan Edward Beeby

New York Fair 27
Peter M. Bardach

Letters to the Editor 28

New Products 29

Stereo Notes 30
Douglas Gardner

News from the Clubs 31

We take the view . . .

A DIGEST OF NEWS, COMMENT AND EDITORIAL OPINION

DURING the last few weeks—just as one of the popular daily newspapers was discovering, and reporting in giant headlines, that “home-made noise is booming”—quite a lot of people in the tape recording world have been meeting me with mournful faces.

They tell me that things are not what they were. The phenomenal demand for recorders and associated equipment that began at the end of last year and continued over into this has now slackened a little.

Surely this is not surprising? There is likely always to be a seasonal cycle in tape recorder sales; that it is not yet a firmly established pattern is due to the rapid expansion of these formative years in the trade. The government's credit restrictions have also had some effect.

Let us not be pessimistic about it, however. The market is still expanding. Established firms with reputable products can take an optimistic forward view. There may be keener competition ahead. Quality will count more, because the buying public is becoming better-informed and more discriminating. More aggressive sales policies may be called for.

But the tape revolution has barely begun. The prospects are rosy. Any temporary lull in business now should be behind us before the autumn. Those whose interests are involved should be planning now the biggest drive in the history of tape recording. Some of them, we know, are doing just that.

It is now a reasonable supposition that over a million people are using recorders in their homes. If we try, we can increase that number by at least a third within the next year.

Aid for an art form

AN admission that British enthusiasts are ahead of the Americans in the creative use of tape recorders is made by our U.S. contemporary, *Tape Recording*, in its latest issue. An envious eye is cast upon the healthy state of the club movement here and upon the contests to encourage good recording.

But the magazine makes a good point when it says that no art form can flourish unless it has, not only devotees but a wider audience as well. “Paintings may be seen on the walls of art museums,

photographs in photographic salons and at camera clubs, drama in the theatre, but the tape recorder has a potential audience far beyond any of these if some way can be found to reach it,” it declares.

In America, the magazine suggests, the answer is to be found in the network of local radio stations. That has proved to be a very effective answer in some other countries, notably Switzerland.

We should apply the same reasoning to the situation here in Britain; we are in no position to be smug. What are we doing to bring this new art form to the attention of the public?

We think the clubs are doing a very good job. We think the British Amateur Tape Recording Contest serves a useful educational function. But could we not do more?

In the absence of large numbers of local radio stations, what alternatives are available?

One of the most promising ideas is the magazine-on-tape. It is, of course, not

new. Many clubs have tried to produce such a feature tape regularly and some excellent results have been achieved; but it is a tremendous task to circulate such a production at sufficiently frequent intervals to maintain continuity of interest.

We believe the most promising idea is for a national tape magazine of some kind. It might be a private enterprise job depending largely on paid advertising spots, as does commercial TV; Mr. M. E. Renshaw, of Cambridge, has made a brave start in this field with his “Tapeorama,” which I have heard with interest.

Or it might be a product of, for example, the Federation of British Tape Recording Clubs—or, at any rate, issued under their imprimature.

In this issue we report a move to institute a national tape magazine for the blind. It is a move in the right direction. There are other exciting possibilities ahead.

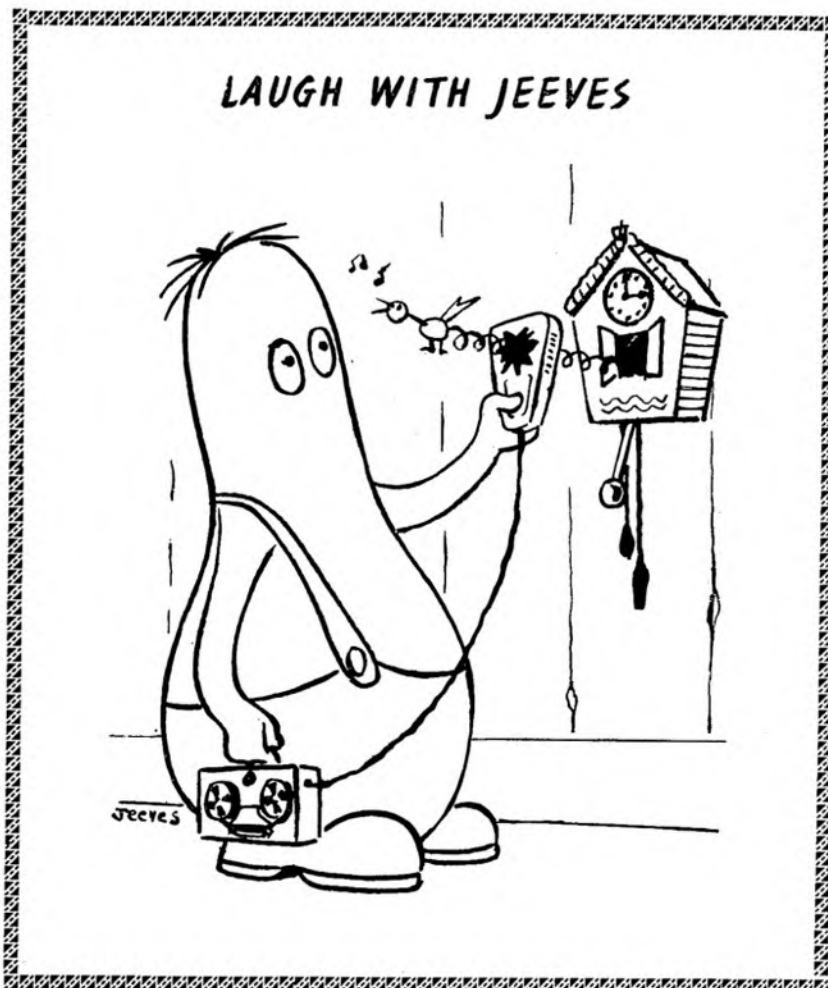



THE WAY TO THE STARS

IF you want to find glamour, take to tape recording. You'll find show business stars and beautiful girls behind almost every microphone!

Or so it seems as the publicity photographs flood in from enterprising and obviously artistically-minded manufacturers.

We present three of the latest offerings.

Blonde teenager Romaine Shipton (top photo) turned up at the Teenage Fair at Park Lane House with her Clarion Twinset and collected from disc-jockey David Jacobs the first "tape autograph" he'd ever been asked for.

It's obvious enough what a girl like 18-year-old London Palladium dancer Rosanne Jennings (centre) can do for tape. But what can tape do for her? Answer—it keeps her in touch with her boy friend, who is in Germany. She records show business gossip on her Elizabethan Avon in her dressing-room—and the other girls give a hand. When it's personal, she whispers into the mic. in private. Lucky microphone!

Grundig don't rest content with one star—their latest window display in New Oxford Street (bottom photo) looks like a theatre announcement of a "super-colossal" West End theatre hit. Giant enlargements of stars using Grundig recorders hammer home the sales slogan "Top Stars use the top tape recorder."

P.S. The tape recorders are pretty good, too!



STEREO FOR "VICTORY"

A TRIPLE amplifier and loudspeaker system receiving a sound input from a three-track stereophonic tape was installed recently aboard H.M.S. "Victory" in Portsmouth Dockyard by Standard Telephones and Cables Limited.

The installation was carried out in collaboration with Allen E. Stagg, of the International Broadcasting Corporation, who is responsible for the tape recording for the *Son et Lumiere* display now in progress nightly aboard Nelson's famous battleship.

Each of the three amplifiers in the system is capable of delivering 150 watts into the loudspeakers which are carefully designed to harmonise with the ship. The loudspeaker system is made up of a pair of the recently developed curved front column loudspeakers to handle the middle and low frequencies, and a small high frequency horn to give additional treble response.

The first performance of the story in light and sound of H.M.S. "Victory" was held on July 1, and performances will be given each evening throughout the summer until October 1. The cast includes Sir Laurence Olivier and Robert Morley. Presented by the Portsmouth Evening News, the profits for the show are to go to Naval Charities.

New tape service for the blind

BLIND BULLETIN, a tape recording lasting an hour and available every month on subscription to blind groups and individuals throughout the country, is the scheme Walter Gillings of 115, Wanstead Park Road, Ilford, wants to see come to life.

For nine weeks now, Mr. Gillings has been producing *What Goes on Here*, a thirty-minute tape recording as a voluntary service to the Ilford Blind Welfare Association. This tape, which gives a commentary of local news and actuality reports of various events, has been so well appreciated and was attracting so much attention in blind welfare circles that he plans to extend the idea.

He hopes to enlist the aid of recording enthusiasts in different parts of the country to collect material for the tape which will present news of activities by blind people over a much wider field and include actuality recordings from many sources.





THE possibilities for recording at a fair are as exciting as they are numerous: the side-shows, the roundabouts, the old hurdy-gurdy organ churning out its nostalgic, mechanical melody.

The opportunities for the enthusiast are endless. A feature tape for the recording society? An entry for the tape contest, perhaps. With such thoughts I grabbed the Fi-Cord, rammed a couple of spare tapes in my pocket and set off at a great pace in the direction of the fair.

My heart missed a beat at the sight of the cluster of lights in the distance, but I was returned to earth with a shock by a large painted notice at the entrance: "Men Wanted for Dismantling Tomorrow." So this was the last night. I had not bothered to check the dates quoted in the advertisement.

It had been raining heavily during the day and the path from the gate was ploughed into a rutted bog. The puddles in the shadow of the caravans squelched underfoot as a wheezy generator coughed and spluttered in the darkness. I began to wonder if this was such a good idea.

The biggest crowd stood sombre and silent in an orderly queue outside a booth selling hot fish and chips. The stench was appalling. The only music to be heard was canned and very, very badly reproduced. The traditional barkers stood dejectedly on.

A great blob of candy floss leered at me from the centre of an otherwise empty counter and from the far side of the ground came the sound of a girl's shrill, forced laugh. As the rain began to fall, I was already wading through the mud to the gate, leaving behind the saddest fair in all the world. To dismantle it would be the kindest thing to do.

Attention to detail

I was annoyed with myself for being so stupid. The first essential in any live recording is to consider carefully all the circumstances and conditions under which one will have to work. Sit down and imagine every event that will take place, and decide exactly how you intend to deal with each situation as it arises. The unexpected always happens, but at least one is more able to cope with it if the routine has been carefully thought out beforehand.

The visit to the fair ground was so depressing that I felt the only cure would be to make another attempt, but this time the project would be dealt with thoughtfully and sensibly.

The best of fairs can become depressing to an isolated individual wandering around on his own and, if for no other reason, a team of two is desirable; but it is worth remembering that an assistant can usually be of great help when taking any outside recording. A pair of workers suggests that one will look after the machine while the other handles the microphone, and so the length of cable required must be sufficient to permit a reasonable degree of separation between the two, but not so much that it would

be liable to trail in muddy ground or get itself tangled in any moving mechanism. At a fair this last point is most important. The compromise decided upon here was a cable length of just seven feet, running to a dynamic microphone.

Wind is the arch enemy of the outdoor recording engineer and, if at all possible, a wind shield should be included in the equipment as a matter of course.

The choice of location was the next consideration and, in an attempt to ensure that the "atmosphere" would be right, it was decided to take the recording at Battersea Pleasure Gardens during the Whitsun holiday weekend. If the final recording is to give a care-free air of people enjoying themselves, then the task is much simplified by working with plenty of people around dispensing a spirit of "We're all having such a good time."

Luckily the night chosen was warm and dry, without a breath of wind to move the leaves: just the weather to pray for when planning such an expedition. I decided to use the Grampian moving coil microphone. A wind shield is not yet available for this fine little instrument, but a useful tip offered by the manufacturers is that if the small eyelet port in the rear of the stem is covered, either by the hand or with a rubber band, wind noises will be considerably reduced. They do warn that this effect may be accompanied by a very slight cut in the lower frequencies, but for this purpose this would not be important.

When my assistant and I arrived at the Pleasure Gardens we found, to my great delight, a roundabout with a real hurdy-gurdy organ blaring out. Its sounds immediately brought back memories of the fairs of my childhood and we started recording in the certain knowledge that this was what we wanted.

ALL THE FUN OF THE FAIR

YOU MUST PLAN IN ADVANCE IF YOU WANT GOOD RESULTS

One of the unfortunate disadvantages of transistors is that they are inherently noisy; therefore, when using a transistorised machine of any make the recording should be taken modulated down to the lowest level capable of adequately loading the tape. By adopting this technique it will be found that one has a very acceptable signal-to-noise ratio on playback. The Fi-Cord has a numbered scale from one to eight on the panel at the base of the level control, and I was surprised to see that we were recording well at level number two. It was also surprising to discover how much wind was set up by the motion of the roundabout. Although the night was still and calm, I found I had to screen the microphone from quite a strong breeze as the horses swished by.

Elated by our success so far, we strolled over to one of the "rides" as a new set of passengers were being loaded aboard. It was somewhat similar to a roundabout, but had wooden scooters instead of horses. As it looked so harmless we recorded the voice of the barker and then took up positions on adjacent scooters. My assistant with the recorder and I with the microphone.

Difficult conditions

Sitting bolt upright and feeling not a little self-conscious, I started my commentary as we moved off, but was rather disturbed to find that this contraption travelled over a series of undulations as it went round, with a revolving switch-back motion. It was not unpleasant, and as I spoke up bravely I could see my assistant carefully watching the level indicator on the machine. The dull roar in the background began slowly to increase, a loudspeaker somewhere above our heads erupted into rock-and-roll and, in a moment, we were lurching round at a terrifying speed.

Every undulation tried to pitch one out of one's saddle, as centrifugal force clutched and dragged in the direction of the guard rails. The din was terrific. Thrown over on to my side at the first lurch, I was hanging for dear life on to the scooter next to me. Shouting into the microphone, I could scarcely hear the sound of my own voice. I caught a fleeting glimpse of my assistant; a brawny attendant was trying to hold her in place as, with hair streaming and frantic expression, she clung to her scooter and my Fi-Cord.

From my own near-horizontal position

says

**DENYS G.
KILLICK**



I continued to yell the first things that came into my head. Wind noises and recording levels were completely forgotten.

When it finally stopped we staggered to the ground. On playback, we found we had one of the most dramatic actuality recordings we have ever taken. There was much less over-modulation than I would have believed possible; but, if anything, a little distortion in such a context helps to heighten the colour.

It was interesting to hear how my voice, in spite of the devastating ambient noise level, came out well in the foreground. I had never shouted like that into a microphone before. I had made myself quite hoarse, in fact, but the secret of our success was in keeping the modulation control well down. Before my partner had lost interest in such things she had fortunately set the machine at its lowest possible level, and as I had contrived to hold the microphone fairly close to my mouth we had accidentally achieved a remarkably good balance, with the spoken words dominating the other sounds.

This particular recording is so good because it is so obviously sincere. When I, as the commentator, speak of this ride as being one of the most terrifying experiences I have ever had, the inflections in the voice indicate that this really and truly is what is happening. There is no technical formula for achieving a result like that. I could only convey that impression of excitement for the simple reason that I was scared to death!

Having recovered our composure with a cup of tea in the refreshment pavilion, we continued our recording. We took the Fi-Cord on the Big Dipper and recorded our impressions as we were rushing through the air high above the crowded booths and stalls. Space ships, ghost train, distorting mirrors: we went from attraction to attraction. The last thing we did was to take a ride on that dear old hurdy-gurdy roundabout, yet even here the unexpected happened.

With my colleague on one horse and I on another next to her, I started commenting as soon as we began to go round. By that time I was feeling rather tired and, after a very short while, I "dried up." Most people who have to speak extemporaneously have experienced it at some time or another.

The attendant, seeing we were recording, decided to co-operate by giving us an extra long ride, so there I was, going sedately up and down on my gilded horse, gliding comfortably along with the machine under perfect control next to me, the organ with its drums and cymbals delivering really authentic background noises, and all I could do was to speak in platitudes.

I wished it would stop, so we could get off. I even said so on the tape. The resulting recording, taken under ideal conditions, is absolutely useless. When giving a commentary, if there is nothing sensible you can add to the sounds already being recorded, the golden rule is "Shut Up!" There may be the opportunity to dub in some spoken words in the studio later, but if your remarks become banal they only spoil what might otherwise have been an excellent recording.

The production of a feature tape such as this one involves not only the exciting or frustrating business of outdoor recording. The tapes obtained from the site are nothing more than a series of disjointed episodes and impressions, some good, some bad and some indifferent.

The real work begins with editing, splicing, perhaps mixing or superimposing, adding introductions or studio commentaries until the picture that is to be conveyed takes shape, having a logical sequence to hold its parts together in a coherent whole. On this process depends the success or failure of the whole venture.

An imposing array of expensive equipment can be of great service to the skilled tape editor, but his two most important tools are a good imagination coupled with an inexhaustible store of patience.



Trade Marks		
"MASTER"	"RIBBONETTE"	"STEREOMIC"
"VELODYNE"	"VELODYNAMIC"	"LUSTRETTE"
"TRANSAMP"	"TRANSISTAMP"	"TRANSPHONE"
"LUSTRAND"	"TRANSISPHONE"	"FULL VISION"

the foremost name in Microphones and Microphone Accessories
famous and used by the famous

For many years the name of LUSTRAPHONE has been intimately associated with the design and manufacture of microphones of widely varied types. Progressive development has resulted in a range of instruments incorporating the best features in modern microphone techniques. Each has been produced to satisfy particular requirements in the ever-widening field of sound reproduction

"Make the most of your Tape Recorder with a Lustraphone Microphone."

"Add quality to your Recorder with a Lustraphone Microphone."

were among the headings used in many previous LUSTRAPHONE advertisements and such advice was accepted by countless Recorder users for Studios, specialised and domestic application.

British in design, materials and manufacture, consistent in quality and reliability, backed with a British factory guarantee, LUSTRAPHONE provides the fullest range for all requirements. Buy British always for you keep your fellow Britishers at work and then they buy the products of your manufacture.

Here is an abbreviated list of models and accessories:—

Model No.	Type	Price £ s. d.	Model No.	Type	Price £ s. d.
VR/53	Studio ribbon velocity.....	9 19 6	PPA/570	Portable P/A system	63 0 0
VR/64	Pencil ribbon velocity.....	7 17 6	TS/50	Mumetal Screened Matching Transformer	2 12 6
VR/65	Ribbon stereo velocity.....	31 10 0	TS/100	Mumetal Screened Matching Transformer	2 12 6
LFV/59	Dynamic full vision.....	8 18 6	SI/A	Plunger Floor Stand.....	6 16 6
LFV/H59	Dynamic pencil hand.....	8 8 0	SI/B	Hand adjustable Floor Stand.....	5 5 0
LV/59	Dynamic Lavalier	8 18 6	S5	Folding Floor Stand	5 5 0
LD/61	Dynamic Lustrette	3 7 6	S2XB	Single stem Table Stand.....	1 15 0
LD/66	Dynamic Lustrand	4 2 6	S2	Extensible Table Stand	2 12 6
LD/66Z	Dynamic Lustrand	4 12 6	S2B	Heavy Table Base	1 1 0
LX/55	Crystal	2 10 0	S2/M	Lightweight Table Base	0 12 6
MU/577	Transistor 4-channel mixer unit...	22 0 0			
TPA/556	Transistor 10 watt Amplifier.....	30 0 0			

THERE IS A LUSTRAPHONE MICROPHONE FOR EVERY REQUIREMENT

Enquiries invited for the latest Lustraphone Catalogue which details the complete range of microphone and ancillary equipment

LUSTRAPHONE LIMITED — ST. GEORGE'S WORKS — REGENTS PARK ROAD — LONDON, N.W.1



The Acos 40 with folding stand

Good tape recording is impossible without a good microphone. There are many types—designed for different purposes. You will find useful advice and guidance in this special supplement on

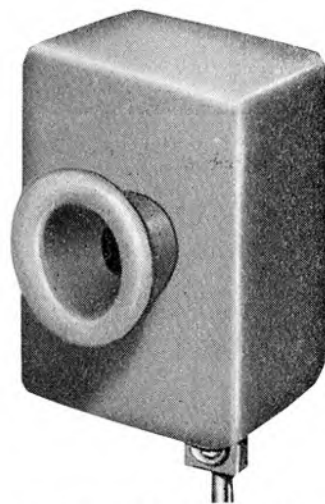

Lustraphone Lapel model LP/62

MICROPHONES

The general purpose Grampian DP 4



This introduction to microphones is published by courtesy of Standard Telephones and Cables Limited, whose products are described elsewhere in this issue.

ALTHOUGH it is possible to engineer one part of an audio system to compensate to some extent for the failings of another, it is obviously better to begin with the best input possible and to make all subsequent reproducing elements such that they pass on a faithful version of what is received. In short, the output of a system cannot be better than the input and to obtain the best results a high quality microphone is essential.

The desirable qualities of a microphone are: small size, robustness, high sensitivity to desired signals with rejection of unwanted sounds (such as background noise, hum, pick-up, etc.), uniform response to all frequencies and suitable directional properties. No single instrument can meet all these requirements and the best results depend on the choice of microphone to suit a particular application.

Certain classifications will occur to the user at once; for example, indoor and outdoor microphones, directional and omnidirectional microphones, and microphones for close or distant talking. Detailed consideration of these categories will help to make clear the

functional and constructional differences between various types of high quality microphones.

The distinction between high quality and low quality microphones must be considered. Where cost must be taken into account, it should be remembered that a good microphone does not usually add much to the overall cost of an installation; a cheap one is a false economy.

(Continued on page 18)



Standard Telephones 4032 with windshield



The Simon Cadenza ribbon

MICROPHONE

supplement

For many purposes a microphone needs to be sensitive to sound sources irrespective of the angle of sound incidence, as, for example, when the instrument is located centrally with respect to a group of performers. Such a microphone has been called non-directional since it has no favoured direction of acceptance, but "omnidirectional" is a better and more positive description to indicate that the microphone accepts sounds equally from all directions.

It is well known that in air, as in water, the static pressure is the same in all directions, i.e., air pressure is naturally omnidirectional. In general, therefore, omnidirectional microphones are pressure operated, since they respond to changes in air pressure produced by sound waves.

Most early microphones were of the pressure-operated type, but later microphones were made which responded to changes in pressure gradient rather than changes in pressure. In simple terms, if pressure is likened to the height of a hill, pressure gradient corresponds to the steepness of the sides of the hill and is thus a vector (i.e., directed) quantity. As air pressure varies with signal rhythm, so does pressure gradient, so that an electrical device sensitive to gradient changes can act as a microphone. Such a microphone is directional since, in its basic form, it is most sensitive to sounds arriving from the front and back and least sensitive to sounds from the sides, top and bottom.

Figure of Eight

The "figure-of-eight" directional pattern just described has certain advantages, as it is sometimes possible to arrange for unwanted sound sources to be on the insensitive axis of the microphone. Furthermore, in a reverberant room this type of microphone is less sensitive by a factor of 3:1 to the reverberant sound (which arrives from all directions) than to the wanted signal coming from the front. This helps considerably with feedback problems in public address work and permits natural reproduction in buildings which have not had adequate acoustic treatment. Also, it allows an artist to stand further from the microphone for a given degree of reverberation, which may be important for the artist's method of presentation, and in television production it assists in keeping the microphone out of sight.

Conversely, an omnidirectional microphone sometimes helps in a room which is acoustically overtreated. Such a room would sound "dead" if a directional microphone were used.

An even more useful sensitivity pattern is the cardioid (heart-shaped). Cardioid microphones have the same 3:1 discrimination between direct and random indirect sound as the bi-directional (figure-of-eight) types, but they have the additional advantage of being insensitive to sound arriving from the back. This property is particularly advantageous for use on a stage, since the cardioid microphone helps to suppress unwanted noises coming from the orchestra pit or the



Standard Telephone's 4104 lip microphone

audience and reduces echo effects from the back of the auditorium.

The growing popularity of stereo reproduction enhances the importance of directional qualities, since most systems depend on the use of matched and accurately orientated directional microphones.

In a studio, particularly when music is being reproduced, the sound source is some distance from the microphone, whereas in public address systems, often used in a noisy environment, the talker is much nearer to the instrument. Some vocalists sing within a few inches of the microphone and obtain special effects by so doing. Finally, the commentator who has to provide a commentary during a live programme must put his lips close to the instrument. These different requirements lead to the need for microphones with special characteristics.

Response Legend

Microphones are sometimes said to respond to talkers from a great distance. This is often legend or exaggeration, but it has a basis in fact and usually implies a microphone with very pronounced directional quality. Such an instrument will reject signals from other directions and so permit the amplifier gain to be increased until the distant talker is audible without a corresponding increase in other noise or in over-reverberant sound.

This fact emphasises one of the important uses of a microphone with directional properties, that of noise exclusion. Microphones, or more usually, an array of microphones, in which this effect is pronounced can to some degree be "focused" on the talker. The single cardioid or bi-directional microphone often gives a useful degree of exclusion of unwanted sound without the disadvantages of considerable size or complication.

VARIOUS TYPES AND THEIR SPECIAL USES

(Continued from page 17)

Microphones which operate on the pressure gradient principle have a special property not found with pressure-operated types. With the former, the response to low frequency sounds rises more rapidly as one approaches the instrument than do the middle or high frequency sounds. Ribbon microphones, which generally work on the gradient principle, are therefore well suited to studio use, but would give frequency distortion if used by a commentator. This property can, however, be put to good use by introducing elements into the construction of the instrument which attenuate the lower frequencies so as to give an overall flat response when used for close talking at a prescribed distance.

Mouth Guard

Microphones with these characteristics can be designed so as to be eminently suitable for a commentator's use. Room noises, or the programme through which the commentator has to talk, besides being relatively distant are robbed of most of their low frequency content. The result is an effective suppression of everything but the commentator's voice. A microphone of this type is fitted with a mouth guard so that the distance from the speaker's mouth is accurately fixed.

Microphones operate on the alternating components of air pressure which comprise the sound waves; thus puffs of air from mouth or nose, and bursts of pressure which accompany certain labial consonants (such as p or b), can produce disastrous results when amplified from a microphone. One of the difficult problems of close-talking microphone design is to neutralise this "blasting" without causing deterioration of the response.

It is more difficult to secure high quality in the open air than in the calm atmosphere of the studio. From the known properties of air streams it is obvious that a high wind, which can produce edge tones and various other forms of audible turbulence, can make speech unintelligible. Furthermore, protection against rain is essential.

A solution to these problems must be in the nature of a compromise, since, to be 100 per cent effective, a windshield would have to be too large to be practical. Nevertheless, great improvements can be effected by fairly simple means, particularly if, in the most severe cases, the lower frequencies are attenuated electrically. Simple windshields are available which have little effect on response but which give an appreciable protection against wind and rain.

One can only choose a microphone, or judge its performance, in close relation to the job it is required to do. If this is not clearly realised it is misleading to speak of one microphone as "better" than another of a different type.

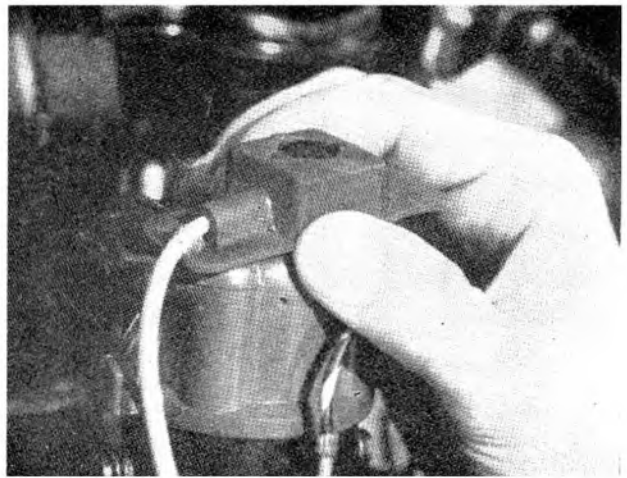
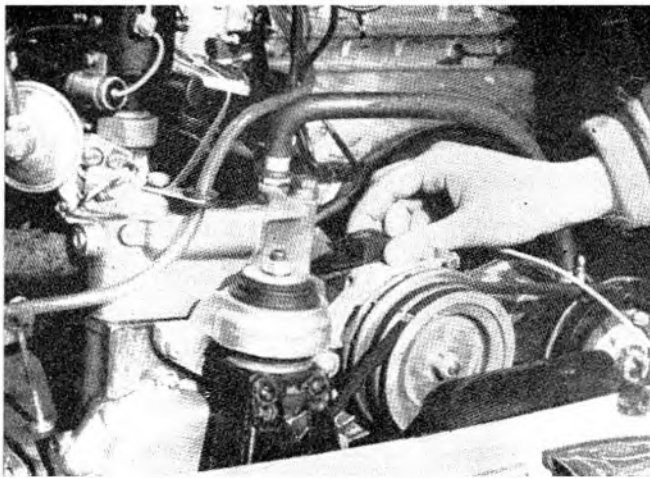

One of the uses the contact microphone can be put to is in checking engine parts on a sports car. On the left it is being held against the generator and on the right the distributor is checked

Contact microphones

THOSE readers who have, for the moment, exhausted the possibilities of conventional recording might like the following suggestion, which opens up a whole new range of sounds within the capabilities of the home recordist.

Does the term "vibration pick-up" convey anything to you? Or perhaps "contact microphone"? Both are terms for a special type of microphone, designed not to pick up vibrations from the air—as are conventional microphones—but to receive vibrations in solid materials. As such, they do not really look like microphones at all, but usually have a flat sensitive surface, which in use is fixed as closely as possible in contact with the structure the vibration of which is to be investigated.

One of the more common uses of the vibration pick-up is in acoustic measurement, when it is required to investigate the transmission of sounds through walls, floors and ceilings; for example, in the design of a broadcasting or recording studio.

It is obviously necessary to reduce the transmission of sounds outside the studio via the walls to as low a value as possible, or the studio will have an undesirable background of noise. Most home recordists will have had unfortunate experiences of unwanted background sounds intruding on an important recording, due to interference from such sources. We all know of the bugbear of the next-door radio.

These investigations are not really

Most people are familiar with the more normal applications of the microphone. This article deals with an unusual type of microphone and the intriguing experiments in which it can be used.

within the capabilities of the amateur recordist, but they are possible with the use of a vibration pick-up. Of course, it would be difficult for the average person to be able to act on the information he gained, so as to improve the sound insulation of a given room. That is a job for an expert, and usually rather expensive, but such an investigation can show where the worst parts of the room are from the point of view of transmitting interference, and these places can be avoided when making recordings.

The method of operation is simple. The floor, walls and ceiling are divided up into areas and each is investigated in turn, the pick-up being fixed to the surface in question by means of adhesive transparent tape.

Each recording must be made with the same setting of record gain control on the tape machine, or the comparisons will not be valid.

Investigating rooms, however, is not the only use of the contact devices. There are many others.

Are you a motor enthusiast? Do you really know what goes on inside the engine of your car when it is running? The vibration pick-up can

give you a great deal of information here, too. By holding the pick-up in close contact with various parts of the engine—say cylinder head, dynamo, distributor—such things as sticking valves can be heard.

It is a good idea to make these recordings at as fast a speed as you can, and then play them back at the slowest speed available. In this way the various sounds can be more easily identified. It is worth remembering that playing back at slow speed will reduce the available sound volume, so be sure that the maximum possible level is recorded.

The contact microphone can be used to produce unusual sounds from musical instruments. Most interesting results can be obtained by fixing the device to, say, a piano soundboard, or near the bridge of a stringed instrument. Sellotape is quite suitable for this.

Try the microphone against the outside of your throat—quite interesting speech sounds can be picked up this way, as can all sorts of unbelievable noises if the microphone is held in contact with various other parts of the body.

Unfortunately, these devices are not readily available to amateurs in this country. They can be obtained, however, from at least two firms—Cosmocord and Lustraphone—to special order.

An ex-government "throat microphone", a type of contact microphone, can sometimes be obtained from surplus stores.

MICROPHONE supplement

Angus McKenzie contributes the first in a special series of test reviews of microphones prepared for this supplement

LUSTRAPHONE

—increased sensitivity

FOR many years Lustraphone have been well-known for producing microphones and public address equipment of very high quality, and it is a pleasure to be given an opportunity of reviewing again some of their excellent products.

The types of microphone considered here are the type VR semi-professional ribbon, the VR 64 ribbon, the LD 66, and the VR 65 stereo ribbon.

I consider the most important change, that will interest all users of semi-professional microphones, is the increase in sensitivity in general of all the Lustraphone microphones. There are a number of ribbon microphones manufactured to-day which have very low sensitivities, although all are of good quality.

It is very difficult with a low sensitivity microphone to record speech satisfactorily because of the high amplification necessary to obtain a satisfactory output level fully to load the tape. Because of this, such a microphone will make a speech recording with a high degree of background hiss, due to the extra amplification.

There are also microphones available with a high output whose polar diagram is not that of a perfect figure of eight pattern. Comparing Lustraphone microphones produced about three or four years ago with those in current production an increase in sensitivity of approximately 6 dB has actually been measured.

It was noted that the Lustraphone

VR 53 gave an output not lower than any proprietary brand of semi-professional microphone known to the reviewer and, in fact, many dB higher than a number of such microphones being sold today.

This greater output is due to the employment of improved magnetic materials and small changes in the design of silk screens in the front of the ribbon. Another important factor in the excellent performance of this microphone is the very good figure of eight polar diagram. It was found that when speaking about 18 inches away from the microphone in a dead room, the output of 90 degrees from the front of the microphone was considerably less than one-twentieth of the output speaking into the front of the ribbon, and in fact seemed to be very nearly completely dead. As far as I can tell the only output of the microphone was from the reflections from the tiled walls and ceiling of the relatively dead room used for testing the microphone.

The microphone is available in three impedances, 30 ohms, standard, 600 ohms, or high impedance, and can be mounted directly on to a table or floor microphone stand. It is suggested that it is preferable to have the standard 30 ohm microphone and to use an external step up transformer as near the tape recorder or mixer as possible so that there will not be a loss of top on a long high impedance cable. Care should, of course, be taken to ensure that the microphone input transformer is not placed near a mains transformer of the equipment because a



The Lustraphone LD 66 reviewed on this page

hum can be induced into the microphone input transformer. The price of the Lustraphone VR 53 complete with 20 feet of cable is £9 19s. 6d. This price does not include a microphone stand.

THE VR 64 is a junior version of the VR 53. It is in fact half of the stereo microphone type VR 65. The quality is little inferior to that of its senior brother and the output is only very slightly less. It is extremely compact and, for a ribbon microphone, surprisingly robust. The top response, although extremely good, is not quite as good as the VR 53, which is to be expected, but the base response seems to be more or less the same. It is supplied with a small base for use on a table which allow it to be tilted back from the vertical if required. As usual with the Lustraphone microphones, VR 64 is supplied with a 20 foot lead of microphone cable, and can be supplied in three impedances for the same price; 25 ohms, 600 ohms, 50k ohms (Hi-Z). The price, including the stand and cable, is £7 17s. 6d. I consider this is very reasonably priced indeed and should be within the budget of most owners of good tape recorders.

THE LD 66 is definitely a cut above the average for its price, and is especially useful for high quality recording in the home when a more expensive model cannot be afforded. It should in no way be regarded as inferior as I have personally used it for high class recordings on battery portable recorders "in the field." It is especially useful for recording out of doors when there is a certain amount of wind blowing, and has a very clean response throughout its range. The base response is a little limited, but this is certainly not a bad thing if it is to be used for outdoor recording and the average recording in the home. It is available with a metal U-shaped attachment to allow it to be kept in position on a table, and this can incidentally be turned so that it wraps round the end of the microphone closely and is effectively out of use. For an extra charge, a special attachment enables the LD 66 to be used as a microphone stand. The cost is £4 2s. 6d. for the standard low impedance version and £4 12s. 6d. for

(Continued on opposite page)

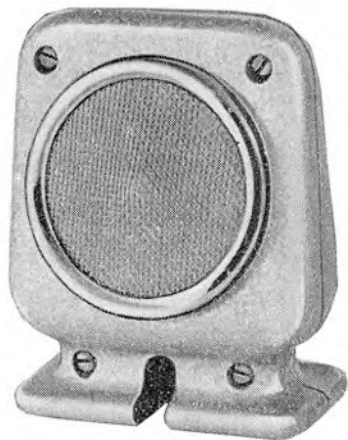

The Lustraphone LX 55

FAVOURITES IN THE ACOS RANGE

TWO POPULAR MODELS PRODUCED BY THE COSMOCORD FACTORY AND REVIEWED HERE BY A. BEAUTEMENT

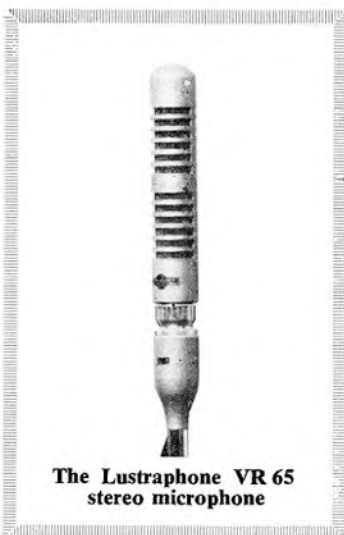

The Lustraphone VR 65 stereo microphone

the 600 ohms or high impedance version. The high impedance model has an extremely high output for recorders having a low sensitivity and has an impedance of approximately 140 k ohms. The 600 ohms version is especially useful for matching to transistor battery portable recorders for a normal input impedance of approximately 1,000 ohms.

THE VR.65 stereo microphone consists of two identical ribbon elements situated on top of each other—each in a similar housing to the VR.64 ribbon mic.

The two ribbon elements are so arranged that the top element can be rotated through an angle of approximately 100 degrees from the inline position, when both the elements are pointing in the same direction, thus enabling the microphone to be used in any possible combination of angles and phasing.

The VR.65 has many facilities, in that it is not only a stereophonic microphone but can become a ribbon velocity microphone of very high sensitivity for monaural use. As there is also a phase reversal switch at the rear of the switch unit, not only can one of the stereo channels be altered in phase, but when the two elements are put in series for monaural, the microphone can become a noise cancelling one.

The impedance of each unit is 20 ohms, giving an impedance of 40 ohms when the two elements are connected in series.

The accuracy of directionality of the Lustraphone microphone is astounding, and a beautifully clean stereo effect is produced. This applied not only to the music itself, but to the reverberation presence which makes recordings made with this microphone sound so realistic.

The VR.65 was found adequately sensitive for all recordings of music, but as with any ribbon microphone, because of the far higher gain required, a certain amount of hiss was heard when it was used for speech recording. The microphone was, in fact, tested with balanced input microphone amplifiers and no hum at all was present in the output from the microphone, confirming the obvious use by the makers of good ribbon transformers.

The makers' claim that the frequency response extends to 13,000 cps is, if anything, too modest. It also needs to be said that the bass response is excellent.

IT is pleasant to realise that the days have passed when it was necessary to pay a large sum of money to obtain a microphone of good, even if not quite-studio, performance, and this realisation is amply confirmed by the specifications of the Acos "stick" type 39-1 (£3 3s.) and hand/desk type 40 (£1 15s.) microphones. Together they offer a choice from which a wide range of requirements can be satisfied.

Both of them are light and comfortable in use, and older readers, who will remember the "hi-fi" mikes, in marble cases, or containing magnets heavy enough to break a wrist, will agree that "we've never had it so good" from the weight standpoint.

These two microphones require as small a space for storage as the portable equipment user could wish, but performance has been in no way sacrificed to achieve their convenient physical design.

The Mic 39-1 is cylindrical in shape, 4½ inches long and 1½ inches in diameter at the operative end; the bottom end, from which the cable emerges co-axially, is ¾ inches in diameter, and the whole forms a tapering shell which is easy to grip.

The outer case is in off-white plastic material which contains a one-piece die-cast liner, giving complete screening and freedom from hum pick-up under all normal conditions. An attractive finish is provided by a gilded grille over the insert and a gilded boss at the base. The weight, with lead, is 4½ ounces.

The hand or desk model, type Mic 40, is roughly rectangular in shape, being 2½ inches high, 2¼ inches wide at the base, 1½ inches wide at the top, and 1 inch deep. The case is of plastic material, obtainable in various colours, with a grille consisting of vertical slots in the moulding, and there is a narrow frame of identical or contrasting coloured plastic round the front of the case. This is pivoted at the bottom so that it can be pulled outwards at the top and rotated through 270 degrees,



The Acos Mic 45

where it locks into position to form a desk stand. The weight of the unit plus lead is 3½ ounces.

A word of warning is in order here. The unit by itself is so light by comparison with the lead that if it is placed on a polished surface, with part of the lead and, presumably, a metal jack plug, or something similar, hanging over the edge, their combined weight will pull the microphone down. So, to prevent any crystal breakage, it would be advisable to fix the cable firmly with something weighty, and avoid trouble.

Each unit is supplied with an 8-foot length of single-core screened lead, the

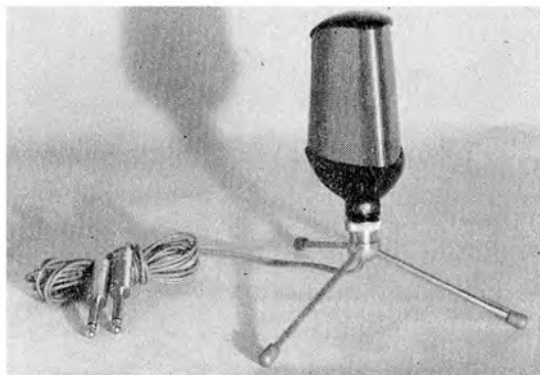

Tripod mounted, the Acos stereo Mic 44, a new model shortly to be released

MICROPHONE supplement

ACOS MODELS

(Continued from previous page)

screening braid being of strong, closely-woven copper which will keep hum pick-up to a minimum and give good mechanical strength, a "must" for a lead which is being continuously flexed. The plastic insulation round the core is tougher than most, and, to the writer, seems to be more heat-resistant than is usual for plastic coverings.

So much for the mechanical side; now on to the electrical, beginning with:—

Frequency Response

Here the "stick" mic shows its superiority. The response is virtually flat from 50 to 6,000 cps, the output then rising smoothly to a higher level (+5dB), at about 8,500 cps, and falling gradually back to level at over 10,000 cps, cutting off fairly sharply beyond this point. This response gives absolutely lifelike voice reproduction and reasonably good musical fidelity, but still lacks the treble response necessary for real hi-fi.

The rising characteristic above 6,000 cps is not a bad thing. Some amplifiers and recorders have a response which tends to fall off in this region, and so for them, automatic compensation is achieved, resulting in an almost level output. Users with wide-range tone controls on "higher-fi" equipment can easily compensate for the treble rise.

The last paragraph applies also to the Mic. 40, this response being from below level (-5dB), at 30 cps level from about 100 cps to 1,500 cps, rising above normal (+8dB), at 4,000 cps, and falling again to below normal level (-5dB), at 8,000 cps. All these variations are gradual and there are no sudden peaks, so that an average tone control network could easily provide any necessary compensation to about 5,000 cps, making this model quite suitable for voice reproduction.

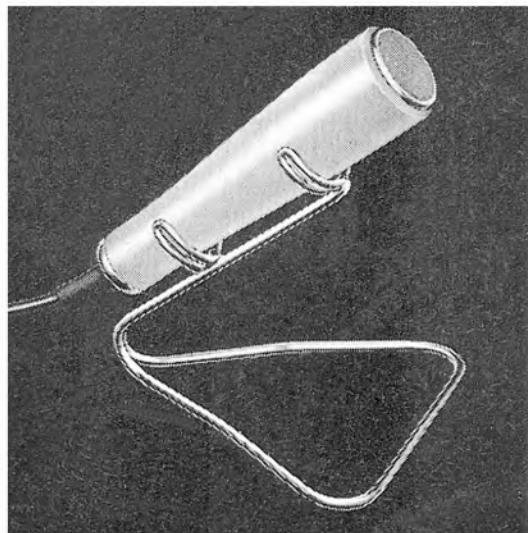

The Acos Mic 39-1

Incidentally, increasing the length of mic lead by any substantial amount will result in a loss of treble, and output, with any crystal device—the longer the lead, the greater the effect.

Output Level

The mean output voltage of the "stick" mic. is -62dB on a reference level of 1 volt/dyne/cm², which, to the non-technical, means that enough sensitivity will be available to drive better-class amplifiers, recorders, etc., but users of less expensive equipment might have to turn up their volume controls to the point where hum problems could arise. A pre-amp. would then be required to do the unit justice.

Extra care would have to be taken to see that the mic input plug and socket were as fully screened as possible.

The Mic 40 has a mean output voltage of -50dB on the same reference level as the "stick," which means that its output is four times as great, making it an obvious choice for use with simpler and less expensive equipment, such as public address and portable transmitters (for those with G.P.O. licences!) and other portable varieties. Note that the higher output is invariably accompanied by the lower quality. Regrettable but unavoidable.

Directivity

As one would expect, the pick-up of the "stick" mic. is omni-directional when held vertically, but some directional effect is noticed when it is tilted towards the sound source. Don't forget, by the way, that, although it may look unusual, a mic of this type hung downwards over a group of people is just as effective as when it is held upright amongst them—probably a little more so.

The Mic 40, when standing upright, has maximum pick-up on the front, but, due no doubt to the lightness of the case, its pick-up is almost as great at the rear and sides. It can, of course, be laid on its back for true omnidirectional pick-up with a slight loss in sensitivity.

Matching

All crystal devices have a high impedance output, which means that a matching transformer, between them and the amplifier input, becomes unnecessary, freeing the user from the hum pick-up troubles which often accompany, for example, ribbon and moving-coil pick-ups and microphones.

The recommended load impedance (virtually, the resistance between earth and grid of the first stage in the amplifier) for both of these units is 4.7 megohms, minimum, and any reduction in this value will cause a corresponding loss in bass response, which falls more sharply as the resistance value decreases. The correct performance of these microphones can only be obtained, therefore, when the proper load resistance is used.

MICROPHONE CHARACTERISTICS

FOR many years the professional recording or broadcasting engineer has had the choice of a number of types of microphone, each having excellent frequency response but having different types of polar characteristics. These characteristics are mainly of three kinds: figure of eight, cardioid, and omnidirectional (spherical). Some very elaborate and expensive microphones have a switch enabling these three and several other intermediate polar responses to be selected at will.

The operation of these microphones may be of interest. In the case of the omnidirectional microphone Fig. 1, this is operated by the pressure of the sound wave upon the front of the diaphragm, no sound being allowed to reach the rear.

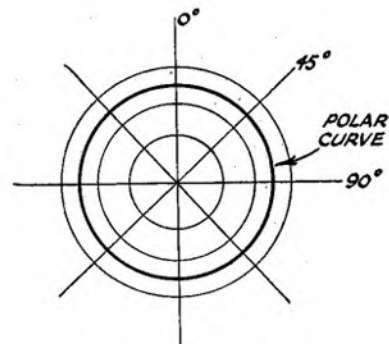

Fig. 1. Omnidirectional microphone characteristics

If the diaphragm itself is of sufficiently small dimensions, the spherical response can be extended to quite high frequencies, but the older types of pressure operated moving-coil microphones with large diaphragms tended to become more one-sided as the frequency increased.

Pressure operation is by no means confined to microphones of the moving coil type; most of the available crystal microphones operate in this manner, while the highest-quality pressure microphones work on the electrostatic principle.

Microphones having figure-of-eight polar responses, Fig. 2, operate somewhat differently, in that the sound is allowed free passage to both sides of the diaphragm, and the diaphragm movement

H. Burrell-Hadden discusses MICROPHONE CHARACTERISTICS and tests some domestic models

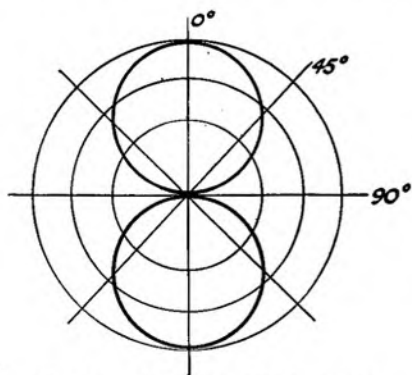

Fig. 2. A figure-of-eight response

is caused by the pressure gradient existing between the two sides. Such microphones are frequently of the ribbon type. Cardioid microphones, Fig. 3, the third

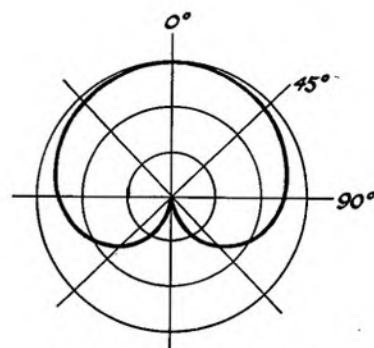

Fig. 3. A cardioid response

main group, operate with a combination of pressure and pressure gradient action. It is possible to produce a cardioid polar diagram by adding the outputs from an omnidirectional and a figure-of-eight microphone, and indeed the professional Standard Telephones and Cables microphone type 4033 operates on this principle.

One must add that the difficulty of doing this with any two microphones at random is that the two frequency responses must be identical and the individual polar responses must be maintained over the whole frequency range of each microphone, otherwise the cardioid pattern of the combined pair will not hold over the whole frequency spectrum.

This is not the only way, however, of

achieving a cardioid response. By ingenious design, it is possible to make a moving coil or electrostatic (condenser) microphone capsule which will behave as though it is partly pressure-operated and partly pressure gradient. This is achieved by carefully controlling the sound admitted to the rear of the diaphragm.

Until recently the microphones available at prices the domestic user could afford fell either into the omnidirectional (pressure) category or the figure-of-eight (pressure gradient). Quite recently, however, the AKG. Company, of Vienna, and the Philips Company have produced moving coil-cardioid types at prices within the reach of the domestic user. Some of these microphones are reviewed elsewhere in this issue.

The A.K.G. Type D.9

THE D 9 microphone is manufactured by Akustische-u Kino-geräte, the world-famous Viennese firm which supplies microphones used by many broadcasting and recording institutions. It is to be expected that even a domestic microphone from this stable will be well worth having.

This particular microphone has an omnidirectional moving coil capsule, and the frequency response (Fig. 4) is arranged to rise slightly at high frequencies, in order to compensate to some degree for the high frequency loss in domestic recorders working at $3\frac{1}{2}$ ips.

The microphone is attractively styled in ivory and brown plastic, with a hinged support enabling the microphone to be stood upright. If preferred, the support can be folded away and the microphone is of a convenient size to hold in the palm of the hand. A threaded hole is provided for floor stand mounting.

Some very good recordings were made with this microphone and I can recommend it to tape recording enthusiasts. It is available as a dual impedance version. The maker's specification is reproduced below. The price is £4 14s. 6d.

SPECIFICATION

Frequency range, 80-10,000 cycles.
Frequency response, ± 4 dB with reference to standard curve.
Internal resistance, 200 ohms/50 Kohm.
Dimensions, $3\frac{1}{4} \times 2\frac{1}{4} \times 1\frac{1}{4}$ in.



Fig. 4. The frequency response of the AKG D 9

The Philips Type EL.3750

THE Philips moving coil microphone type EL 3750 is supplied with their tape recorder type EL 3542 and can also be obtained separately. It is attractively styled in ivory plastic, with a gold-coloured grille and a stand attached to the microphone in such manner that it can be used either to support the microphone on the table or to hang it. The stand folds neatly, for the microphone to be used in the hand.

This microphone is of the cardioid type of polar diagram discussed above, and this cardioid response is exceptionally well maintained over the whole of the musical spectrum. There is some widening of the pattern at low frequen-

cies, but even at 150 cycles an excellent front to back ratio is achieved (Fig. 6).

The frequency response was found to fall off rather more at the high frequency end above 7,000 cycles than was expected from the maker's published frequency response curve (Fig. 5), but recordings made with this microphone had a clear quality and the lack of top was not very noticeable.

A switch on the back of the microphone labelled speech/music introduces a cut at low frequencies if required.

I can thoroughly recommend this microphone as good value for money at £5 5s.

Fig. 5. The frequency response of the Philips EL 3750

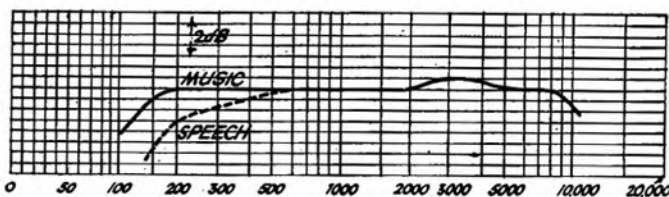

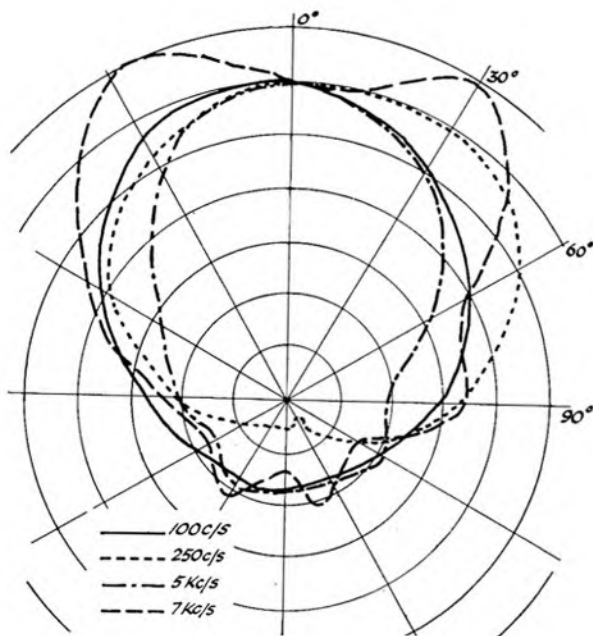

Fig. 6.—The Philips EL 3750 polar response

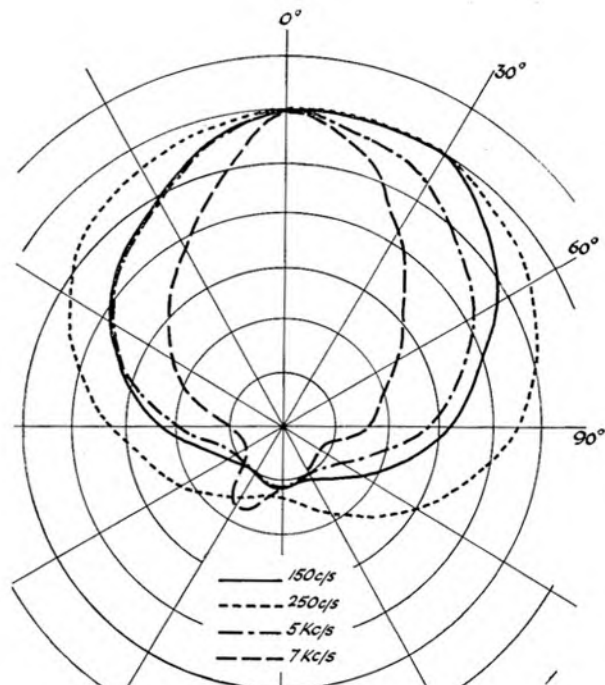

Fig. 7.—The AKG D.19B polar response

A.K.G. moving-coil Type D.19

THE A.K.G. D 19 B high-grade moving coil cardioid microphone, is rather more expensive than most used by amateur recordists, but for those people requiring a well maintained cardioid response over the whole frequency range, combined with an excellent frequency response, it is well worth having.

This microphone comes packed in an attractive velvet lined case and is unlike most domestic microphones in that its cable is not permanently attached. The microphone itself is finished in hammered bronze and gold and is of the "stick" variety, the vent for the rear side of the microphone being provided by a grille down the length of the stick. It is extremely important, if the microphone is held in the hand, that this grille should not be covered, or considerable deterioration of the cardioid response will result.

A switch is provided on the microphone for reducing the bass response if required. This switch is operated by turning a knurled ring either to the position "S" (speech), the bass cut position, or to the position "M" (music)—the normal position.

The frequency response of the microphone is excellent, although a speech test showed a slight tendency to emphasise sibilants. This, however, was not serious and the slightly rising top which it would indicate could be an advantage with many domestic tape recorders.

The polar response was measured at various frequencies and is reproduced in Fig. 7. As can be seen, a good front to back ratio is maintained over the whole spectrum. At high frequencies the microphone becomes rather more direc-

tional than at low and medium frequencies, but this is not too serious.

I can confidently recommend this as a microphone for those requiring a good cardioid characteristic.

Since the microphone is not provided with its own stand, some form of mounting for table or floor stand use is necessary. Two such were provided for review by the manufacturers. There were the A.K.G. ST 19 stand, with the stand adaptor "Sa 1" which together form a complete stand, and the "Sa 2" metal clamp stand adaptor, which will fit on

any microphone stand having the international standard thread.

The first of these stands is made of cast metal, and is of a most elegant design. The stand adaptor associated with it has a clever clamp made of soft plastic material, incorporating a steel spring; the microphone is just pushed into this and is held in a firm but shock-proof mounting. The Sa 2 metal clamp adaptor has a swivel joint and a rigid locking clamp to take the microphone.

The price of the **D.19B** which is available with either 60 or 200 output impedance, is 19 10s., and the prices of stand ST 19, adaptors Sa 1 and Sa 2 are £1 12s. 3d. and £2 10s. respectively.

T.S.L. Stereo microphone

UNTIL quite recently, the only twin microphones specially designed for stereo use available in this country were the professional models manufactured on the Continent, and these were only available in limited quantities to special order. In any case, they cost in the region of £300 each and so are probably out of the reach of most amateur tape recordists.

In the past few months, stereo microphones of rather more modest specification, and consequently more modest price, have been appearing in this country, and the T.S.L. S.2 is one of these. It sells at 19 guineas which, when one considers that it contains two separate microphone capsules with their axes mounted at 90° to each other in one case, is a reasonable figure.

The microphone is, in fact, produced to a T.S.L. specification by a famous firm of microphone manufacturers in Vienna.

It is intended to be used for the "coincident microphone" type of stereophony

and in this case the polar diagrams of the two capsules are cardioid in nature. Hence the expected combined polar response of the unit should be as shown in the diagram (Fig. 8). As can be seen this gives wide pick-up angle, rather more than is obtained with a crossed figure-of-eight pattern, whose acceptance angle is limited to 90°. This is because of the wider acceptance angle of the single cardioid, as compared to the pressure gradient (figure of eight) type.

The method of operation is briefly as follows. If a sound originates at a point S within the acceptance angle of the microphone, an output is produced from each capsule. Depending on the position of the sound the two outputs will vary in amplitude, and when these are amplified and fed to two loudspeakers, provided both systems are in phase, the speakers will reproduce sounds of similar relative amplitude to the outputs of the microphones.

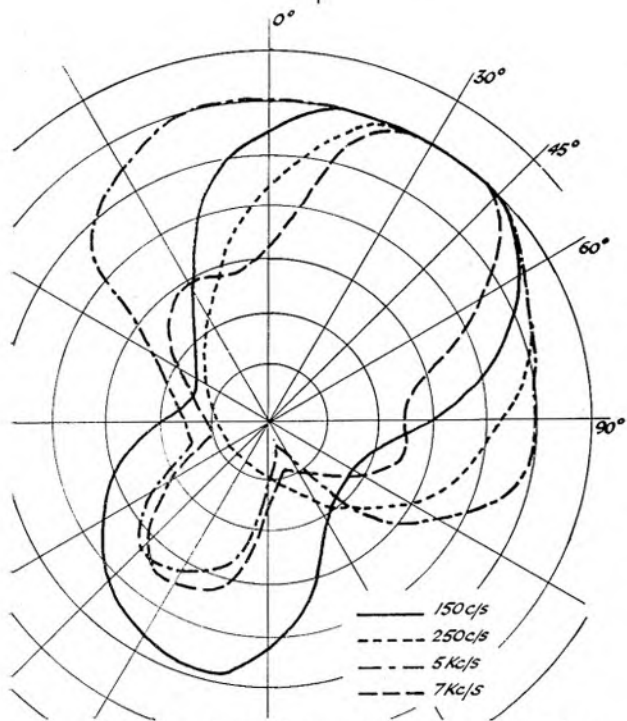
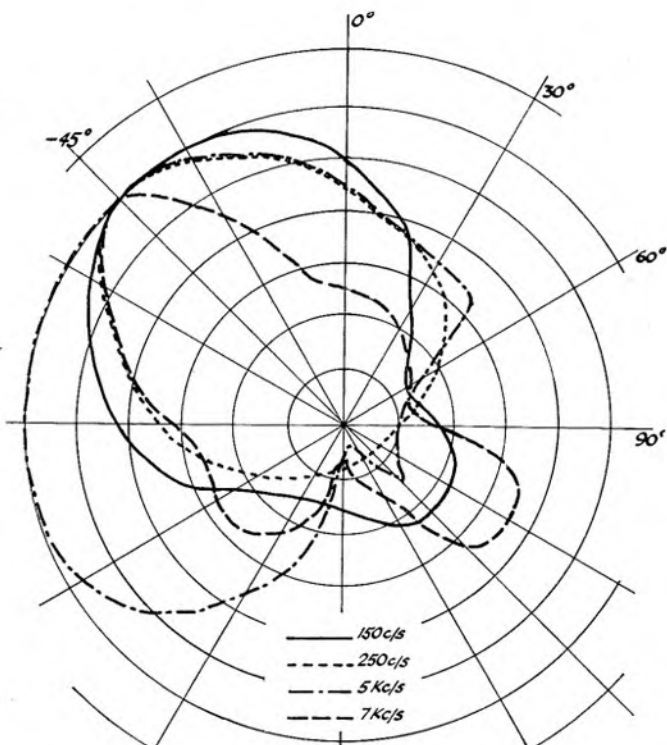
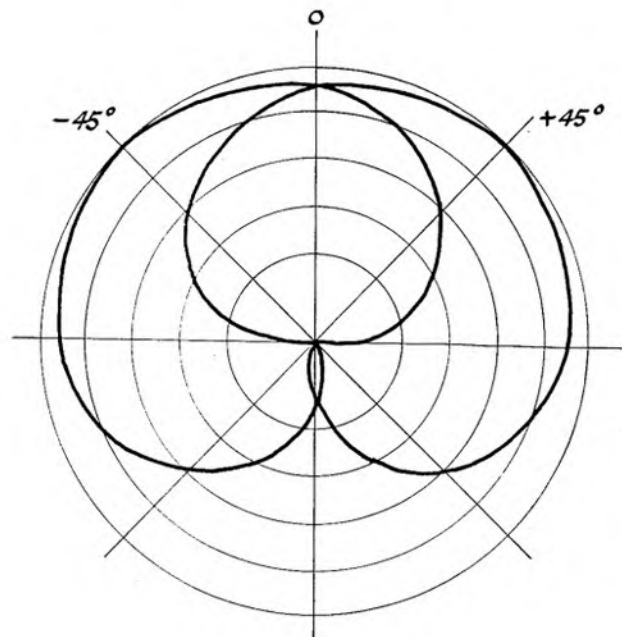

Fig. 8 (top left) shows the theoretical polar response of a twin cardioid stereo microphone. Fig. 9 (top right) is the polar response of one channel of the TSL S.2 stereo. Fig. 10 is the polar response of the second channel of the same microphone



OTHER MODELS FOR THE TAPE ENTHUSIAST

It is not possible, in the space available, to deal in detail with all available microphones. We are, therefore, only able to make brief mention now of a number of other excellent products that have proved popular with tape recordists.

The two Grundig microphones are specially manufactured for their own machines. Costing £6 6s. the condenser version, the G.C.M. 3, is omnidirectional and is claimed to be particularly suitable for musical recordings. A sensitivity of 2.5mV/dyne/cm² at 1,000 cps is quoted and the G.C.M. 3 has a circular frontal section mounted on a base.

Possessing a cardioid characteristic the high impedance moving coil G.D.M. 111 costs £8 8s. Also base mounted and possessing a rectangular frontal section, this model is said to have a sensitivity of 1.75 mV/dyne/cm² at 1,000 cps.

Both microphones are supplied with leads and plugs.

The two microphones of Simon Sound Service Ltd., are the Cadenza Ribbon and the Cadenza Crystal which cost £10 10s. and £3 13s. 6d. respectively.

The output on the former is claimed as flat within close limits between 50 and 12,000 cps, and the acoustic shell is said to give freedom from resonant peaks and troughs. Provision is made for both high (80 K ohms) and low (30 ohms) impedance output. The transformer is mounted in a metal shield and the microphone is fitted with an anti-

(Continued on page 34)

It can be shown that a listener sitting on the centre line of the speakers will receive similar relative phase and amplitude signals at his ears as he would have heard, listening to the original sound.

It is obviously necessary that two polar responses should be as alike as possible in order that accurate translation of the position of the source to its corresponding position in the reproduced image should be possible. In the case of the T.S.L. microphone, the two capsules were well matched in the forward position, and some very good stereo recordings were made. The front to back response, however, was better in the case of one capsule than in the other, especially in the region of 150 cycles. The practical effect of this would be to provide somewhat

more low frequency reverberation from one capsule than from the other.

In general, the cardioid responses of the two microphones were good at middle frequencies, but there was a noticeable rear lobe above 5,000 cycles, and some tendency, as might be expected, towards omni-directional operation at low frequencies (Figs. 9 and 10).

The frequency response of the two capsules was very good and should give excellent results.

The only criticism I have of this microphone is its external appearance. I feel that an instrument costing nearly £20 deserves a rather better outer casing than the present one made of ivory plastic and gold anodised aluminium mesh.

Sound Effects

ALAN EDWARD BEEBY, who has had long experience in devising and recording sound effects, continues his regular column of advice.

If there is an effect you want, and which is causing difficulty, write to him for guidance.

ONE of the most popular items in recorded drama is the ghost story, and it is something which really puts "sound effects" to the test. The successful employment of effects in this field is balanced on a precarious tight-rope of technical sleight-of-hand, coupled with imaginative use of everyday sounds.

They must not be overplayed nor underplayed, but must be just right. Like the story itself, they must be absolutely incredible . . . yet completely acceptable.

Let us look at a selection of general "ghost" effects.

SCREAMS. Did you know that for every 500 women, *only one* possesses the ability to scream *properly*? Most women either screech or yell their heads off, which isn't the same thing at all. A good dramatic scream should consist of a rich, high-pitched, bubbling crescendo of ear-shattering sound. It is an art in itself. So much so that one film studio in Hollywood pays a young girl named Shirley Jacobson 50 dollars a month to stand by to record any screams they might require for a horror production.

Notice I'm speaking of *women*. I've never yet heard a *man* who was able to scream realistically; and that includes professional actors.

GHOSTLY VOICES must, of course, sound *unnatural* yet, at the same time, the speech has to remain intelligible. Here's one way of doing it: record the speech at, say, 7½ ips, switch the machine to play it back at 3½ ips and try to imitate *exactly* the sound of the slowed-up speech. When perfect, record the imitation at 3½ ips and change to 7½ ips for final replay.

The speech will be quite understandable, but the voice itself will sound somehow odd and disjointed, in a rather subtle way. This effect is best tackled by someone having a fairly deep voice. A medium or high-pitched voice will tend to produce a "gabble" on playback, which will not only give the game away but also spoil the effect.

FALLING OBJECTS are usually associated with "poltergeist" stories where things apparently move about by themselves. Take the case of a large china bowl crashing to the floor. It is *not* enough just to record a solitary "Smash!" from an old piece of crockery; this will simply leave the listener wondering what the sound was supposed to represent. Instead, the working-script for such an incident might run as follows:—

CHARACTER: I won't stay in this dreadful house a minute longer! (Slithering sound is heard). What was that! (The sound comes again). Look, that . . . that bowl! (A fast, loud slithering noise, then . . . CRASH!).

In this way, the tension is built up from the prelude of uncertainty to a positive finish by running parallel, as it were, with the dialogue.

WEIRD SOUNDS bring us practically within the field of *musique concrete*, since these effects depend, largely, upon natural sounds being taken out of context and applied in various ways. Here are some suggestions:—

Record a single screech from a budgerigar (getting in with the mike as close as possible) and switch to half-speed for playback. Now add an echo to this by re-recording (see article in June 1 issue). I can assure you that this particular item takes quite a bit of beating for sheer unearthliness!

The sound of a wet cork drawn across a sheet of glass or the shrill whine of air escaping from the stretched neck of a balloon both good results if "treated" afterwards in this way.

'We want the sort of sound that Count Dracula (the bat-man) might make before attacking a victim' was a request that reached me recently (never a dull moment in this game!). After some head-scratching, I decided upon a very fast, tearing "Snap!" with a hint of reverberation.

This I achieved by ripping apart a length of rough emery cloth, *doubling* the speed for playback and adding a slight echo. It sounded quite effective. At any rate, that's one sound effect where the accuracy of my interpretation can't be called into question!

GHOSTLY FOOTSTEPS are best imitated by a shuffling sound, rather than the normal "walking" effect. Footsteps which are supposed to be coming from a room above should be well muffled; more like a thud. Banging the fist on to a rough towel folded into four does the job quite well.

THE TAP ON THE WINDOW depends for its effectiveness to a large degree upon good timing. Just before the incident occurs, the dialogue should be speeded up slightly, stopping abruptly at the sound, followed by a marked pause. Don't make the sound too loud. It must be insinuating, rather than penetrating. The fact that it has served to halt the dialogue itself will help to convey the importance of it as a break-in.

SILENCE. (Whatever next!) It is possible to reproduce silence, and most effectively, too! *Not*, I might add, by "recording" half-a-dozen yards of blank tape! Remember that there is no such thing as complete silence, even in an empty house there is always something to be heard: the creak of warped woodwork, the soft moan of the wind in the chimney or the subdued background noise of life outside the house, be it in town or country.

The real point of including a "silent" passage in a mystery play is to prime the listener's imagination to the degree of expectancy where he *knows* that something must follow; not to set him wondering if you've forgotten to change the spools over!

Now, one or two brief tips:—

Firstly, don't overdo the "echo" factor in your ghost effects. Unless this acoustic peculiarity is relevant to the location of the story it can sound very corny.

Secondly, to indicate the passing of time for that middle-of-the-night scene, fade in the ticking of a clock, mix to the heavy breathing of the sleeping person, then mix again to the clock. Where no person is supposed to be present, the faint hooting of an owl may be substituted in place of the breathing.

Finally, bear in mind that in this type of production it is vitally important that the dialogue should both support and give added weight to the sound effects used; not the other way round as in straight drama.

Having concluded, I shall now exorcize me flippin' self till next time!

NUSOUND RECORDING CO.

Ferrograph

(Appointed Dealer)

Tape Recorder & Hi-Fi Specialists

Showrooms: First Floor
3-8 BRIGSTOCK PARADE,
LONDON ROAD,
THORNTON HEATH, SURREY.
(Opposite Thornton Heath L.T. Bus Depot)
TELEPHONE: THO 7609

London Showroom:
35 CRAVEN STREET,
TRAFALGAR SQUARE,
LONDON, W.C.2
TEL: TRA 2080

British hi-fi scores at New York exhibition

AN EXCLUSIVE REPORT BY
OUR AMERICAN CORRESPONDENT

PETER M. BARDACH

WHO ALSO TOOK THE PHOTOGRAPHS

HI-FI was featured in the British Exhibition held here last month, coincident with the start of New York's "Summer Festival". The Exhibition, with its accompanying Military Tournament and Tattoo, opened on June 10 at the New York Coliseum and ran for two-and-a-half weeks. Co-patrons of the Exhibition were the Queen and President Eisenhower.

Although the high fidelity section occupied only a small portion of one of four floors, it was nevertheless well attended by the Exhibition visitors.

For those hi-fi addicts who had complained about the confusion and sameness of recent equipment shows in New York, the dignity and spaciousness of the British exhibits was a welcome change. As if by pre-arrangement (and no doubt that was the case), only one exhibitor played his apparatus at any given moment. As a result,



Mr. P. Glaser of Brenell with his 3 star stereo recorder at the BREMA stand

it was possible to listen with ease and to judge the tonal qualities without distraction.

The most ambitious exhibit was actually "a display within a display" and was staged by the British Industries Corporation, which serves as American importer and distributor for Garrard record-changers, Super K headphones, Wharfedale speakers and Leak amplifiers. BIC was, in fact, the only American exhibitor at the Coliseum. In addition to an impressive display of components, frequent stereo demonstrations were presented. A specially-designed stereo living room was on view, decorated by Lord and Taylor, New York's leading speciality store.

Another group exhibit was that of the Audio Manufacturers Group of BREMA, featuring a full line of tape, audio and television equipment on behalf of Beam-Echo, Brenell, Bush, Clarke and Smith, Ferguson, Gramophone Co., Lowther and Truvox.

High fidelity was only one of many items presented in a special exhibit of equipment manufactured by Pye.

Many of the tape recorders and accessories seen are not yet on sale in America, while others were shown here for



Entrance to the New York Coliseum

the first time, prior to completion of distribution agreements.

Those visitors' comments overheard were generally quite favourable, it being frequently mentioned that the British equipment seemed more "functional", with an absence of superfluous knobs and adjustment controls that tend to characterise many recent American models. On the other hand, cabinet stylings, for the most part, remain rather "old fashioned" by current U.S. standards.

AEI Sound Equipment Ltd announced that long before the successful exhibition closed its doors, "Sold" notices had to be placed on the BTH Type 451 16mm. Magnetic/Optical Sound Projectors, and much of the wide range of domestic stereo and hi-fi equipment displayed on their stand found enthusiastic purchasers.

Enquiries for both 16mm. and hi-fi exceeded all expectations. Trade and private individuals have shown great interest in high-quality British-made equipment and the company has high hopes of making a useful contribution to the country's dollar reserves.



Tuners and amplifiers on the BREMA stand

Letters to the Editor

Have you an idea, a complaint, or a bouquet to hand out? Write to us about it. Letters not for publication should be clearly marked.

"Proof of the pudding"

I DEPRECATE the comment in Mr. Douglas Gardner's article to the effect that technicians should be excluded from his survey of changing taste in loudspeakers. Generalisations of this nature can be very misleading and unfair to say the least. Let us recall that it was the technician, or more correctly, the engineer, who has made audio what it is today. That they have been maligned, can only be due to the inability of laymen to differentiate between the true engineer and the inexperienced amateur "trying out his wings."

My experience to date indicates that the majority of non-technical people who are discriminating enough to purchase a quality speaker, fall down when it comes to obtaining the best results. A typical example of this is where the loudspeaker is mounted in a vented cabinet without acoustic damping or adjustment to the vent area or volume. Figures from the manufacturers might show that the individual public demand for separate loudspeakers is far greater than it is for the speaker and tuned cabinet as a unit.

For years the standard method of appraising loudspeakers has been by checking for listener fatigue. The design of good quality audio reproducing equipment requires the application of science, but an artistic taste is also very necessary particularly in the approach to loudspeaker problems. Competent audio engineers by and large can sit and listen to a musical programme and enjoy it without constantly adjusting tone and volume controls. It is the layman who, given a surfeit of controls, never knows quite when or where to use compensation.

To a large extent the public tend to buy equipment by frequency response curves alone without considering (from the connoisseur's point of view) more important factors.

At the Audio Fair this year were displayed two very good examples of a reasoned and experienced attitude to good reproduction. The first was shown in the BBC studio monitoring gear, and the second in the flat but limited frequency response of the E.M.I. TR.52 recorder—the playback quality left many of the "up to 20 Kc/s and nothing less" fans wondering! This outstanding effect of realism can no doubt be attributed to the low distortion and flat response qualities—the result of advanced design studies, which you will agree stems from the combined design development and engineering processes, in other words, the work of the "technicians."

Mr. Gardner may not feel disposed to accept a qualified reply to his inquiry about "statistics of changing tastes," but in any case the figures weigh heavily in the affirmative.

Many enthusiasts with whom I come into contact have, during their early attempts at high fidelity, barked up the

wrong tree entirely. Some time has elapsed before the poor results have played on their nerves and they have seen fit to seek qualified advice.

A most noticeable point among our better judges, namely, the professional musician, is the rapid appraisal given by them to the playback quality such as that mentioned above, which to this end heartily endorses the engineer's approach.

It would prove no small task to bear out on paper the remarks of a professional design engineer, but as with the proverbial "proof of the pudding," my avid interest in putting over the value of good quality reproduction leads me to offer to interested bodies and tape recording clubs, demonstrations in the uses of tape recording gear, amplifiers, mixers, microphones, loudspeakers, etc., and professionally recorded tapes rank among the most interesting subjects for discussion.

Should further information be required, I can usually be contacted through the Crawley & Sussex Tape Recording Club.

DANIEL ARCHER.
Crawley, Sussex.

A word

First let me thank you for an all-round magazine. I have tried the others, but *Tape Recording Fortnightly* still holds its own and leads the field. . . .

F. HEEDS
Doncaster.

. . . . or two

. . . I found your issue featuring battery recorders extremely interesting, particularly the article by S. M. Wheatley, which I thought was packed with very useful practical information. His tips on microphone and interviewing techniques are most valuable.

EILEEN R. M. JONES (MISS)
Leamington Spa.

. of thanks

. . . I am happy to see you have a magazine strictly for tape, as good as and, in some cases, better than our own here in the States. . . .

G. TOTH
New Jersey, U.S.A.

TAPE SPEEDS — MORE COMMENT

IN reply to a letter in your June 15 issue, I really must correct what appears to be a glaring error in the assumptions of one of your correspondents about transferring tapes at double and-half speeds.

If a recording is made at a specific speed to a given recording characteristic for that speed and is then played back at an alternative speed with a different playback characteristic and re-recorded at another completely different speed with a still more different playback characteristic and then an attempt is made to yet again change the speed of the recording for playback purposes the ultimate copy of the original tape is bound to be very, very far out from the original in respect of frequency response and distortion levels, etc.

It should also be noted that optimum level settings at different speeds vary enormously. I feel this is a very important consideration in dubbing of the type mentioned in your correspondent's letter.

ANGUS A. MCKENZIE
London, W.1.

* * *

Donald Jeater, in the June 15 issue of *Tape Recording Fortnightly*, put over a very much simplified version of the method of trick recording at speeds not on one's own recorder. I thought he was unnecessarily scathing about the more detailed articles by Pat Copinger and Stanley Jepson, and think he might remember that learner-recordists like my-

self need much more detailed information than he would vouchsafe.

But I DO agree with him that 15 ips is OUT. It has long been a mystery to me why manufacturers provide this speed. Nobody uses it, not even the B.B.C. or the producers of commercial pre-recorded tapes, (I use it only for slowing down or speeding up a recording to produce weird effects.)

Although it is fun to try out this trick method of recording, I can see only three practical uses for it:—

(a) To test whether or not the heads on all one's recorders (I have three) are properly aligned (I find mine are).

(b) To prepare a recording to be sent to a tape correspondent whose machine has a speed not catered for on one's own machine.

(c) In some cases, as a tape saver (e.g., 3½ to 1½ ips).

One final point. What is the point of wasting time going to extreme lengths to CHECK speeds? Can one do anything about it if they don't match up to the reputed speeds? I KNOW that one of my recorders runs slightly slower than one of the others—simply by hearing the drop in pitch—but there's nothing I can do about it except by changing the machine for one which DOES match up with one of the others. Makers can't and don't guarantee that speeds are EXACT. Or am I quite wrong about this?

KEN RICHMAN
Shrewsbury.



Japanese Recorder for 23gns.

PRELIMINARY details of a new tape recorder are provided by Nortons of Manchester, who are distribution agents in this country for a twin-track recorder manufactured in Japan.

The machine is named the Fujiya, has a single speed of $3\frac{1}{2}$ ips, and a quoted frequency response of 200-6,000 cps. It is designed to operate on AC mains at 200-250v, 50 cycles. It will take spools of up to 5-inch diameter within the compactly-styled case which measures only $10\frac{1}{4} \times 5\frac{1}{2} \times 4\frac{1}{2}$ inches, and weighs 8 lb.

The circuit incorporates two valves and a three-inch speaker gives 1-2 watts output.

A pause control is provided, and the instrument is supplied complete with monitoring lead and headphone, microphone, tape and spools for 23 guineas.

A two-speed model ($1\frac{1}{2}$ and $3\frac{1}{2}$ ips) is available at 24 guineas.

Nortons, 14, Shudehill, Manchester 4.

AMPEX REDUCE THEIR PRICES

RANK Cintel Limited announce that the Ampex 351 range of professional tape recorders are now being manufactured by Ampex in this country, resulting in a decrease in price.

The new machines, built to the same specifications as the American models, are designed to operate from 240v AC, 50 cycles without the need of an auto-transformer. C.C.I.R. equalisation is supplied as standard, but N.A.B. equalisation is available if required.

Rank Cintel Ltd., Worsley Bridge Road, London, S.E.26.

New Products

NEW PORTOGRAM MODEL *Four-and-a-half hours play*

A SECOND version of their Portotape recorder has been recently introduced by Portogram. Incorporating the Collaro Studio deck, the Mk II Portotape is a twin-track recorder operating at $1\frac{1}{2}$, $3\frac{1}{2}$ and $7\frac{1}{2}$ ips.

Frequency response is given as 50-12,000 cps at the higher speed, and the output as 4 watts through the 8- x 5-inch elliptical loudspeaker.

Facilities are provided for superimposition and monitoring, and a host of other features include pause control, safety erase lock, magic eye level indicator and digital rev. counter. Inputs for microphone, radio/gram, and outputs for extension loudspeaker (3 ohm impedance) or a separate amplifier are also supplied.

The Portotape is designed for AC mains of 200-250 volts at 50 cycles. Valves used are: 8D8, 12AX7, two 6L84, EZ80, EM84.

It weighs 36 lb. and measures approximately $17\frac{1}{2} \times 16 \times 10$ inches. It will accommodate 7-inch reels, thus allowing $4\frac{1}{2}$ hours play on standard tape at the slowest speed.

The price of the recorder, which is housed in a two-tone rexine-covered case,



complete with Acos Mic 40 crystal microphone, 850 ft. of tape and empty spool, is 39 guineas.

Portogram Radio & Electrical Industries Ltd., Audio Works, Paxton Road, Tottenham, London, N.17.

Sonocolor introduce new tape

TAPE RECORDERS (ELECTRONICS) LTD. announce the availability of new specially-developed Sonocolor tape for use in four-track and stereo recorders. They claim that because of its great suppleness, no deviation from the tracks during recording is possible.

The initial release of the tape com-

prises three different types. A 5-inch spool holding 900 ft. of tape will retail at 32s. 6d., $5\frac{1}{2}$ -inch spools with 1,200 ft. at 42s., and a 7-inch with 1,800 ft. at 57s. 6d.

Tape Recorders (Electronics) Ltd., 784-788, High Road, Tottenham, London, N.17.

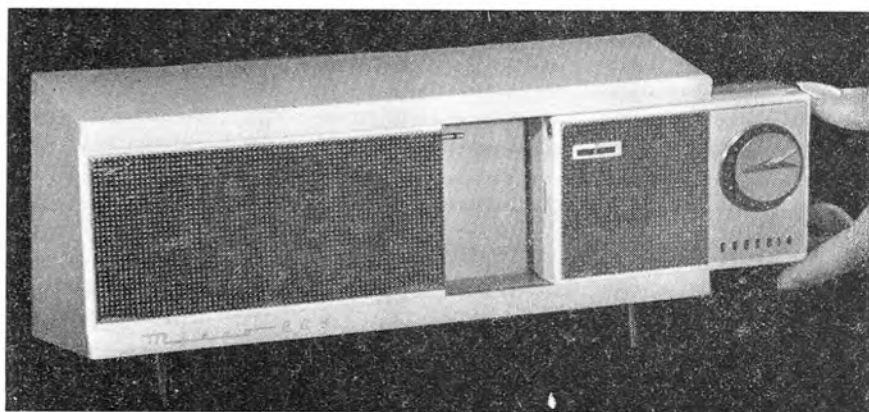

The new Grundig Transistor Boy radio receiver, $4\frac{1}{2} \times 3 \times 1\frac{1}{2}$ inches, weighs only $11\frac{1}{2}$ ounces, has full medium wave coverage, a battery life of about 80 hours, and is controlled by two thumb wheels—on/off switch and volume control and a station tuning control. Our photo shows the receiver being slid into a larger high quality speaker to form a compact table or bedside radio. The price of the two units complete is 25 guineas

THE WORLD OF TAPE

Grundig expand

PLANS have now been completed for the opening this year of a brand new factory to manufacture Grundig tape recorders in the United Kingdom. Production is expected to commence in September.

The company is being formed in Belfast and registered in Northern Ireland and will be known as Grundig Works Limited.

The Chairman is Herr Max Grundig, and other directors are Herr W. Zaune, Herr E. Hegerl, Herr C. Bussman and Mr. G. S. Taylor, who is the Chairman and Managing Director of Grundig (Great Britain) Limited.

At first production will be concentrated on one tape recorder model, but as the enterprise grows there is room at the side of the present building to build an extension of the same size as the parent factory. Eventually an increasingly large range of tape recorders will be made at Dunmurry, and future interests will also include the manufacture of all types of electronic apparatus.

Plant and materials will wherever possible be of British origin, and the factory will be staffed almost entirely by a locally recruited labour force. At the

start a certain number of production experts from the Grundig main factory at Nuremberg will be temporarily engaged and a reasonable proportion of skilled staff will already be available in Northern Ireland. For full-scale production new operatives will be enrolled and given thorough and extensive training.

THE state-controlled Rumanian Record Industry has placed an order worth over £30,000 with the Recording and Relay Equipment Division of The Gramophone Company, Hayes. The equipment will comprise the complete set-up for two stereo recording systems, including tape recorders, mixers, large monitoring speakers and provision for tape and disc play-back.

Northern Audio Fair

The Autumn Audio Fair, 1960, will be held at the Palace Hotel, Southport, on Friday, Saturday and Sunday, October 7, 8 and 9.

This choice was made after the consideration that the excellent road and rail communications make Southport a particularly suitable venue for the large populations of Liverpool, Manchester and Lancashire generally.

The organisers are Audio Fairs Limited, 22, Orchard Street, London, W.1. Tel.: WELbeck 9111.

Hi-Fi
HARRY
by rich



"I can't think why you're doing the housework in those silly earmuffs"

A move revives an old problem

MOVING into new accommodation has given me a fresh look at the old problem of integrating a stereo system into the home. With a good deal of thought and experiment one arrives at a solution, but I am sure that the whole thing would be easier if architects and builders would, from now on, take into account the fact that tape recorders and sound reproduction generally are a part of everyday life—not to mention television.

Some help from a room is a great thing—even if it is no more than a single recess that is deep enough to house an equipment cabinet.

It may be productive to give full rein to the imagination for a while on this subject, and then check back to see if any of the ideas that emerge have practical possibilities in the present or the not too distant future.

We might start by assuming that the largest room in a house would probably be the one used for music and viewing. In this room—which should be long rather than square—a certain amount of sound absorbing material should be incorporated, especially in the ceiling.

To aid the installation of speakers, turntables, tape recorders, television receivers and other equipment this room should be so constructed that uniform rectangular sections could be removed or

Stereo Notes

By D. W. GARDNER

replaced from the wall without difficulty (and without endangering the structure) up to, say, a height of 4 ft. 6 in. from the floor.

This would enable one to create recesses at convenient places and thereby avoid the major problem of having a number of large objects standing against the walls and projecting so far into the living space that the place is crowded before anything else goes in.

In a 9 in. wall, recesses of 8 in. deep could be provided without disturbing the adjoining room, and this would mean that a large tape recorder, television turntable, amplifier and so on could be comfortably housed in bookshelves projecting no more than the customary 9 in. from the true face of the wall.

Loudspeakers could be similarly accommodated, large cabinets with plenty of bass fitting in as neatly as any "book-case" speaker could do.

I do not believe that there could be any difficult with modern resources, in replacing sections and providing a perfect surface again.

Another thing I would ask architects and builders to do in order to cater for the modern world of sound and vision, would be to fit a form of skirting board

which would take a lot of wiring easily. What with mains leads, aerial leads and flex to two loudspeakers one soon despairs of making a neat job of the connections.

Perhaps the skirtings could be made detachable so that wiring could be run behind them. Special provision should also be made for running wires round fireplaces and doors.

Have you any ideas for architects? If so, I shall be glad to hear about them.

Did you take part in one of the tests conducted by Record Housing at the Audio Fair? Listeners were asked to distinguish between different pairs of speakers, with their back to the sound.

The results were very varied, showing that, even after a run through, a large percentage of people could not tell a very high quality speaker from a much cheaper one—at least when short excerpts were being played.

Tests of this kind can do an inestimable amount of good, because they teach people how to listen critically, noting omissions from the frequency range, smoothness of response and so forth—instead of merely giving equal approval to any "pleasant" sound.

Critical appreciation is essential if standards are to be maintained. Pavlova used to complain about the fact that audiences applauded with equal enthusiasm no matter how her performances varied. When this happens, artists and technicians find it very hard to do their job properly.

News from the Clubs

Edited by

FRED CHANDLER

THE West Middlesex club has been honoured by having its Chairman, Freddie Westcott, elected Chairman of the Federation of British Tape Recording Clubs.

I would like to endorse the club's congratulations to Mr. Westcott, and with them hope that he will be instrumental in furthering the interests of tape recording in this country, thereby carrying on the good work so ably initiated by Charles Gardner, Alan Stableford, Roy Penfold and other stalwarts who have played such a large part in putting the Federation on the map.

The West Middlesex Club was represented at the Congress and Federation A.G.M. by vice-president Fred Gazeley, who was re-elected to the committee, Ron Topham, elected to the special sub-committee to revise the constitution, and Sandy Saunders. Among the representatives of many other clubs at the Congress, their other vice-president, Pat Copinger and his wife Phyl, removed to Kilmarnock in 1958, were also present representing the Glasgow club.

At the meeting on June 9 members were given a highly entertaining demonstration of the new Walter mains/battery portable and the 404 by Mr. F. Parrington of Walter Instruments. The mains/battery machine gave a very good account of itself playing pre-recorded tapes and also when taken into the street to record traffic noises, or surreptitiously switched on during subsequent discussions.

Their June 23 meeting saw a return visit by Mr. Wilson of F. A. Hughes Ltd., who showed members *The Magic Tape*, the film which has won many awards at film festivals as an outstanding industrial film explaining the uses to which tape can be put, and based on the theme *Tape is a tool, and tools mean progress*.

A number of suggestions received by the Programme Committee as a result of a circular sent to members have resulted in plans for "practical meetings" in soldering technique, accessory construction, editing, splicing, etc. Demonstrations from the trade, more outside visits and collaboration with local organisations are also envisaged.

The latter is now well in hand following news that an offer to make available the club's machines to help patients in

the Hillingdon Hospital has been put to the Hospital Management Committee.

Four members attended a final rehearsal of *The Tinkling Bell* on July 12, to record the play being produced by the Old Hamptonians Dramatic Society. Other members attended as an audience and Tom Pasmore made plans to record the show in stereo.

Stereo predominated at the May 6 meeting of the Coventry club. Two stereo recorders—the Grundig TK 60 and the Philips EL 2536—were demonstrated by Mr. Hopkins and Mr. Spink.

Both machines were used first with pre-recorded musical tapes and then with tapes recorded by the owners. It was hoped to attempt some stereo recording during the evening, but time did not allow.

After the demonstration Tom Bagley played a recording made earlier that evening of the club barmaid opening bottles of beer! He used a Fi-Cord and the microphone supplied with his Philips AG 8108G for the effect. This was the first tape to be heard in the competition for recording household noises. Others heard included a hilarious recording of the progress made in cistern designs made you-know-where, and an enterprising tape by secretary Roy Reynolds of adulterated television commercials. Roy also presented another of his quiz tapes—the winner being Tom Bagley.

The June 9 meeting commenced with a recording Roy had received from a Canadian contact. This was the famous Orson Welles 1938 broadcast *War of the Worlds*. Unfortunately the tape did not reproduce too well on Henry Hopfinger's Telefunken and after ten minutes the project was abandoned. Peter Warden and Graham West were the instigators of the next item—a demonstration of the Steelman Transitate. They had been on location with this battery portable on a railway line, a farmyard, in heavy traffic, in Peter's home, and at his works.

After a lengthy interval for refreshments, a raffle and the customary sales, Henry Hopfinger played a number of his most recently produced tapes. A recording in Coventry's new cathedral had set him a number of problems with regard to microphone positioning, but he produced his usual first-class tape with the church atmosphere realistically obtained. Recording conditions in St. Mary's Hall for the recent Mayor-making ceremony were, if anything, even worse and Henry found himself compelled to record from the public address system. With speeches being made in all parts of the hall, it would have been impossible to record everyone without a battery of microphones and a mixer. The quality of recording naturally suffered, but this was partly overlooked in view of the fact that history was made in this first-ever recording of the ceremony.

Jack Hill gained most points in the "old and new" contest arranged by members of the West Herts society. His

tape heard at the May 18 meeting compared old and new domestic equipment. Highly commended for the competition was Dennis Millard's contribution which included an old-fashioned alarm clock and an electric clock.

The sound hunt at Watford on June 1 followed the usual pattern with two teams "out" and one "at home." On this occasion Vera Jackson, Sid Attwood and Dennis Millard the "home" crew, produced the winning tape.

The June 15 meeting at Hemel Hempstead was devoted to the playback of tapes. To begin with members had a final hearing of their National Contest entry before its dispatch, followed by recordings of the Watford Whit Monday Carnival, and of country dancing at Chipperfield made by John Grainger and Dennis Millard.

An endless loop tape produced from a two-minute recording of church bells provided an experimental interlude before the secretary Peter Holloway reported on the recent Federation Congress.

Two members have been active in the special tape services provided by the society. A descriptive commentary of a flower show, and recordings of the finals in a ballroom dancing contest and of locally recorded wild birds were included in a tape presented to the local blind club by John Grainger, while in conjunction with the Rotary Club, Sid Attwood presented a musical request programme for the patients at St. Paul's hospital.

Experience in the art of editing, superimposing and dubbing has been gained by members of the Bournemouth club who, for the six weeks prior to the closing date, were extremely busy producing their tape for this year's National Contest.

Although quite a large amount of time had been spent on this activity the members have not ignored the regular round of events. Among the highlights have been a visit to the B.B.C. studios at Southampton where they saw how the experts compile a programme. Mr. Peter Maggs, the studio manager, invited members to make a recording on the E.M.I. L2/TA transistorised recorder. The results, played back on the studio equipment, set the members green with envy. As an added experience members were also given an opportunity to see themselves on the closed circuit monitor sets.

Demonstrations of the Philips four-track recorder, and of the new transistorised portable recorder the Casian Trav-ler by Tape Recorders of Westbourne, completed a fairly hectic June.

Arrangements to visit the Southampton ITV studios to see a programme in preparation, are being made.

Three of the seven members present at the June 20 meeting of the Ware club presented recordings for the "five minute tape" competition.

First to be heard was by Mr. Barks who had recorded a model railway engine complete with whistle, commentary and an interview with the driver. The tape concluded with an excellent recording of a real train leaving a station.

Trains had also been chosen as the subject by Mrs. J. Wakely. The recordings were made from the front window

(Continued on page 34)

SPECIAL OFFER — Half-a-crown to find a ready buyer or a willing seller

IF YOU HAVE SURPLUS EQUIPMENT YOU WISH TO SELL, OR IF YOU WANT TO BUY ITEMS SECOND-HAND, YOU WILL GET RESULTS BY USING OUR CLASSIFIED COLUMNS, TO PROVE THE POINT, WE ARE OFFERING READERS A SPECIAL RATE UNTIL SEPTEMBER 1st NEXT—2s. 6d. FOR UP TO TWENTY WORDS IF YOU USE THE FORM BELOW

Classified advertisements

Trade, ninepence per word (minimum 10s.); box numbers, one shilling extra. Payment with copy. Copy should be sent to Advertisement Department, "Tape Recording Magazine," 1, Crane Court, Fleet Street, London, E.C.4.

FOR SALE. E.M.I. Professional tape recorder type TR90. £475. Complete MSS recording channel—Tape recorder—disc cutter—amplifier £150. Ferrograph Model 3A/N £52 10s. Vortexion Model 3A £55. The Magnagraph Recording Co. Ltd. 1, Hanway Place, London, W.1.

For Sale. Two Lustraphone LFV 59 pencil microphones, 25-30 ohms. £6 each. Holmes Tolley, 14, Hathaway Hamlet, Shottery, Stratford-upon-Avon. Tel.: 4144.

Widow wishes dispose Ferrograph 44AH, 15 ips, 7½ ips. Superb condition. Inspection most evenings. Kingston 0160. Also three unit speaker enclosure separate. Mrs. Williams, 26, Crescent Road, Kingston-on-Thames.

1959 Philips AG 8108 G Hi-Fi tape recorder. Complete mike, leads, new condition. Best offer over £45. Taylor, 24, Queensberry Place, S.W.7. Tel.: Ken. 2146.

Tape—Tape—Tape. BASF—Irish—Scotch. All types in stock. Send for price lists. C.W.O. Post free. Tape Recorder Centre (Halifax), 17, Rawson St., Halifax.

Clarion, mains unit, radio recording, playback, extension leads, telephone adaptor, two extra tapes, cost £36 16s. 9d. December, 1959, accept £28 o.n.o. Murrill, 48, Balmes Road, London, N.1.

Garrard R.C. 75A with symphony 5-watt amplifier. Both £8. S. Entin, 12, Geldeston Road, Clapton, London, E.5. Amh. 5817.

Acos G.P.54 p.u. arm for sale (adaptable for stereo). Perfect condition in maker's carton. List 39s. 6d. Offers? T. Gomes, 1, Abbey Street, Edinburgh 7.

Grundig TK 24. Latest 4-track direct from Germany. Cost £70. New and unused, £55. F. Riddle, 113, Church Road, Northolt, Middx. Viking 4734.

Tape Recorder repairs, all makes; also trade servicing—Telefunken service agents. Tape Recorder Centre (Halifax), 17, Rawson Street, Halifax. 66832.

Want to hire Fi-Cord recorder complete with Grampian mic. for first two weeks in August. Reasonable rates. J. Chinchin, 4, Meadow Road, Hailsham, Sussex.

WANTED. Telefunken 85, good condition. Up to £60 for 85 K or £65 for 85 KL. Would consider 85 T plus amp., etc. Box 374.

TAPE TO DISC—ALL SPEEDS; s.a.e. for leaflet. OMEGA RECORDING COMPANY, 112, Sunnybank Road, Potters Bar, Middx. Tel.: 6428 evenings.

Tape to Disc—All Speeds. Rendezvous Records. 19, Blackfriars Street, Manchester 3. Leaflet on request.

Ferrograph 4 A/N's, 808's, Vortexion WVA, WVVB, Simon SP4, Reflectograph "B," always in stock and ready for immediate delivery; as well as over 200 latest 1960 Recorders at London's Largest Tape Recorder Specialists. The best, lowest H.P. terms and the finest selection of new and S/H Recorders, from £18. Generous P/E allowances. Essex Tape Recorder Centres, 2, Maryland Point Station, Stratford, E.15, and 205, High Street North, East Ham, E.6.

W.A.L. Booster pre-amplifiers, the transistorised WAL GAIN, for tape heads (Gramdeck, Fi-Cord, Ferrograph, etc.), Mics (Reslo, etc.), p.u.s. (Garrard, Ortofon, etc., Decca ffs, etc.). Many applications including Mixing. Mono Wal Gain £5, Stereo £7 10s. The new WALTRAK, pocket audio oscillator with 1,000 cps signal, transistorised. Ideal for circuit checking £6 10s. The WAL BULK TAPE ERASER "cleans" reels of tape in 30 secs. £7 18s. 6d. Ask your dealer or send to us for full Technical literature. Wellington Acoustic Laboratories Ltd., TRCDG Dept, Farnham, Surrey.

JOHN HASSELL RECORDINGS. Tape/Discs. All Speeds. CCIR Studio, 21, Nassau Road, London, S.W.13. Riverside 7150.

FRIENDLY FOLK ASSOCIATION. 87, Terrace, Torquay. Leading International Correspondence Hobby Club since 1943. Now included, facilities for Tapesponding. Details free.

Premier "Petite" Portable Radio, red and grey case, perfect condition. £5. Cheap, worn out, battery operated tape recorder wanted. J. Penfold, 2, Harrowden Road, Luton, Beds.

New Clarion Tape Recorder. £19 10s. Used once, owner gone photographic. 157, Lyndhurst Drive, Hornchurch, Essex.

FOR SALE.—Philips EL 3515. 3½ ips. 7-inch spools. Four months old. Complete with microphone. £25. F. Westcott, 40, Fontwell Park, Ashford, Middlesex. Ashford 4277.

CLASSIFIED ADVERT — SPECIAL OFFER

I enclose postal order for 2s. 6d. Please insert as follows

Name..... **Address**

(Classified adverts must be received 14 days prior to date of the issue for which they are intended.)

Trade announcements not included. Box number extra

**COMPLETE
PROTECTION
IS OFFERED
BY
the
Tape Recording Magazine
BINDERS
Price 14s. 6d.
Available post free from
7 Tudor Street, London, E.C.4**

LOCAL DEALERS

LONDON

Lee Electronics

TAPE RECORDER & HI-FI AUDIO SPECIALISTS
400, EDGWARE ROAD, LONDON, W.2

London's leading Stockists of High-Fidelity and Audio Equipment. Many Bargains in new and reconditioned Equipment.

SEND FOR FREE LISTS

All Machines demonstrated for performance on Record and Playback. All leading makes of Hi-Fi equipment from stock

PADDINGTON 5521

THE SOUTH

There is always something extra when you buy a TAPE RECORDER from

THE HIGH-FIDELITY CENTRE
TAPE RECORDERS — HI-FI SPECIALISTS
— RECORDS

LARGEST STOCKISTS

Recorder Hire Service

SEND FOR OUR BARGAIN LISTS OF NEW AND SECONDHAND EQUIPMENT.

EQUIPMENT BUILT TO ORDER. Dorking 4229
61 WEST STREET, DORKING, SURREY

ALL TAPE RECORDERS

From the Specialists

TAPE RECORDERS

(Bournemouth) LTD.

Main Area Dealers for

FI-CORD : PHILIPS : GRUNDIG

Authorised Service Agents for

TELEFUNKEN & WALTER

(Southern England)

Tapes and Accessories by Return. Terms available on New or Reconditioned sets.

WRITE OR PHONE FOR FREE BROCHURE

Seamoor Road, Westbourne,
BOURNEMOUTH, Hants.
Telephone : Westbourne 64292

NORTH-WEST

YOUR NORTH-WEST DEALER ENTHUSIASTS

SIMON

THE SUPREME RECORDER FOR THE CONNOISSEUR. SEND FOR FULL ILLUSTRATED SPECIFICATION AND TERMS TO

SHINNS Ltd.

(20 years Recording and Service experience
TOWN CENTRE, LEIGH, LANCs.

Branches:- "Melody House," Hallgate, Wigan.
"Melody House," High St. Bangor, N. Wales.
"Melody House," Culcheth, Warrington.

Free demonstrations within 60 miles but
NO MAIL ORDER

Price Reduced

TAPE TIME CALCULATOR

The Tape Recording and Hi-Fi Magazine accessory, giving playing times for any size reel or length of tape is now available again—and at a reduced price.

Repeated requests for this simple, read-at-a-glance device for any speed from $\frac{1}{8}$ ths to 15ips, have led us to reprint and orders can now be accepted at the address given below.

Price 2/6d

(3/- including postage)

Order from:

Tape Recording Magazine,
7, Tudor St., London, E.C.4

Index to Advertisers

	page
Audio Devices Ltd.	9
British Ferrograph Recorder Co. Ltd.	36
Deroy Sound Service	33
Dickinsons of Pall Mall Ltd.	6
Grundig (Great Britain) Ltd.	3
Howard Photographic	4
Lee Electronics	33
Lustraphone Ltd.	7
Magnegraph	33
Metro-Sound Manufacturing Co. Ltd.	8
M.S.S. Recording Co. Ltd.	7
Psycho-Tape Institute	8
Rapid Recording Service	33
R.B. Tapes Co. Ltd	34
Reps (Tape Recorders) Ltd.	10
R. E. W. Earlsfield Ltd.	6
Shinns Ltd.	33
Simon Equipment Ltd.	5
Standard Telephones & Cables Ltd.	2
Sunderland Sound Services	33
Tape Recorders (Bournemouth) Ltd.	33
Tape Recorder Centre Ltd.	35
Tape Recorder Service Co.	8
Wilmex Ltd.	10

TAPE TO DISC SERVICES

SSS Private gramophone record made from your own tape

Microgroove LPs from 20/6
Standard 78s from 10/6

Mobile Unit available for Weddings, Receptions, Choirs, Meetings, etc. S.A.E. for full details:—
John Leviss, Sunderland Sound Services,
28, Viewforth Terrace, Sunderland S7032
• If you can hear it — We can record it! •

RAPID

Recording Service

78's and L.P.'s from your own tapes.

Master Discs and Pressings.

Recording Studio equipped with Bechstein Grand.

Practising studios with or without accompanist.

Mobile Recording Van.

"Off the Air" Service.

21, Bishops Close, Walthamstow, E.17. COP 3889

When writing to manufacturers for information about new products, please mention that you saw it in "Tape Recording and Hi-Fi Magazine."

TAPE RECORDER HIRE

TAPE TO DISC 78-LP
RECORDING STUDIO
SALES—EXCHANGES

MAGNEGRAPH

1, Hanway Place, London, W.1.

s.a.e. for leaflet or

telephone: LAN 2156

TAPE TO DISC RECORDING

Microgroove LP from 27/6d.

78 rpm from 11/-

Also 45 rpm

48 HOUR SERVICE

S.A.E. for comprehensive leaflet to:—
Marsh, "Deroy" Sound Service, Little Place, Moss Delph Lane, Aughton, Ormskirk, Lancashire. Tel.: AUG 3102

News from the Clubs

(Continued from page 31)

of her house and included steam, diesel and electric trains.

The third tape showed the differences between the extreme noise of a Saturday evening and the silence of a Sunday morning—broken only by singing birds, and was recorded from the bedroom window of Mrs. A. Campbell.

Comparisons between Telefunken and Grundig condenser microphones followed and the evening was rounded off with discussions of general recording technique and some technical hints, with technical types Messrs. Barks and Saul coming to the fore.

The next meeting will be on July 18 at 3, Chadwell, Ware and as usual newcomers are most welcome. Members are keen to exchange visits and tapes with other clubs. Secretaries are invited to contact Mrs. J. Wakely at the above address.

The Reading tape and cine club members propose to hold an annual competition on the same lines and with a trophy similar to the cine section who compete for a silver cup. They are beginning to compile a library of tape literature.

Recent demonstrations have included a Grundig recorder and a Minivox portable machine, and the new Dominus, a combined 8 mm. sound and projection model.

Demonstrations of the Garrard transcription motors and pick-ups, Clarion portable recorder, Ferrograph recorder and Grundig stereo model, have been enjoyed by members of the newly-formed

Rotherham club recently. They have also held practical sessions on dubbing and editing, and microphone technique.

Meetings are held fortnightly and the club has fifteen members. To encourage membership, the club issues each member with a card for general distribution inviting persons interested to contact Mr. G. J. Grover, 66, Broom Road, Rotherham.

An attempt is being made to form a club in West Suffolk. A number of enthusiasts have made a preliminary survey of the prospect and anyone interested is invited to contact the secretary, Mr. P. J. Blades, 68, St. John's Street, Bury St. Edmunds, Suffolk.

News of a new society recently formed in Johannesburg. The secretary is Mr. A. E. Peach, P.O. Box 11326, Johannesburg, South Africa.

The Brixton club is now under way, and secretary L. J. Walker, 124, Brankesome Road, Brixton, London, S.W.2., would like to hear from persons interested in becoming members.

The Brighton club members have advised me that they are no longer connected with the Tape Message Service operated by the now retired chairman and treasurer. The club points out that it does not wish to commercialise its social activities.

An opportunity to hear the BASF film *The Magic Tape* is made available by the invitation extended by members of the Leicester club. On July 22, the club welcomes Mr. B. Wilson, of F. A. Hughes and Co. to the Reference Library in Bishop Street, Leicester, and during his lecture on the BASF products, the film will be presented.

Other models for the tape enthusiast

(Continued from page 25)

vibration mounting contained in a double wind shield. Open circuit sensitivity is given as 58 dB (high impedance) and 93dB (low impedance; both with reference to 1 volt/dyne/cm²).

The Cadenza Crystal has a frequency range of 30-8,000 cps, and is similar in construction to the Ribbon model, being fitted with a hinged base. Open circuit sensitivity is quoted as 47 dB referring to 1 volt/dyne/cm².

One of the products of Grampian Reproducers is a hand microphone, the DP 4, which can be adapted to other uses. Quoted as having a frequency response between 50 and 15,000 cps the DP 4 weighs a little under ½ lb. and is available in low, medium and high impedance models. It can be supplied with a swivel holder for fitting to adjustable floor or table stands, a small circular base for desk or table use, an on/off switch assembly and a combined heavy desk stand and on/off switch.

The Standard Telephones and Cables Ltd. selection is applicable really only to the out-and-out fanatic who also has the money to buy absolutely top-rate equipment. The 4032-G at £18 is the cheapest but there are others round the £20 mark. This company also manufactures the 4104-B and C lip microphone which cost £75.

2 FREE BOOKLETS!

"How To Make BETTER Tape Recordings" (Irish Tape) and
Our SENSATIONAL CATALOGUE with Details of 140 DIFFERENT MODELS!

! R.B. TAPES DO IT AGAIN!

Brand-new FAMOUS FOREIGN TAPE RECORDERS offered at the Fantastic Price of **35 GNS** Dep. £7.5.0 including TAPE, MIC, AUTO- MATIC TAPE STOP, FULL MIXING, FREQU. 50—16,000 cps. 2½ watts undisturbed output!

LOOK! EASIEST TERMS EVER!

GRUNDIG Cub	£27. 6.0.	dep. £ 5.16.0
FIDELITY Argyll	£30. 9.0.	dep. £ 6. 9.0
SIMON Minstrelle	£40.19.0.	dep. £ 8. 9.0
WYNSOR Victor	£47. 5.0.	dep. £ 9.15.0
TELEFUNKEN 85KL	£82.19.0.	dep. £16.19.0

FREE AFTER-SALES SERVICE WITH
12-24 MONTHS GUARANTEE

R.B. TAPES

T H E S I G H T A N D S O U N D C E N T R E

179 STOKE NEWINGTON HIGH ST
LONDON N16 CLISSOLD 9477
also at 89-91 Gt. Ancoats St. Manchester 4



OPEN ALL
SATURDAY

Agents for:
GRUNDIG
TELEFUNKEN
WYNSOR
SIMON
VERITONE
SABA
ELIZABETHAN
SOUND
SPECTONE
and many others

Write NOW For ALL Your FREE Books!

NAME

ADDRESS

..... TRM

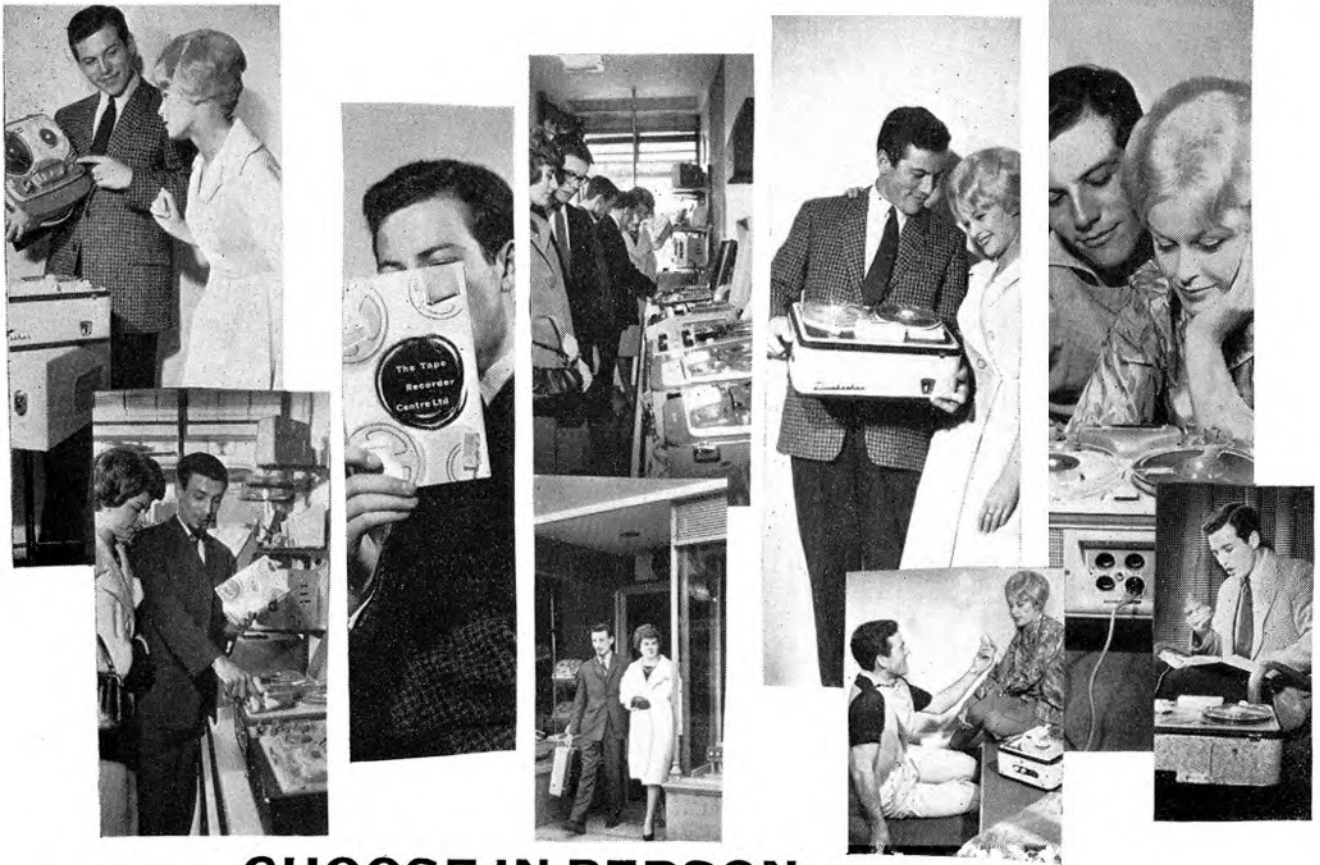

**CHOOSE IN PERSON—
CHOOSE BY POST—
NO INTEREST CHARGES**

All makes of Tape Recorders and Hi-Fi Equipment. Make sure you get exactly what you want and what you need. Make sure you get it at the best H.P. terms offered anywhere today. No interest charges on orders over £30. Make sure you choose from the Tape Recorder Centre. Choose in person — compare different makes on the spot in the Tape Recorder Centre Showroom; or choose by post — get a Free copy of the unique 72-page illustrated Tape Recorder Centre catalogue, listing hundreds of models and types.

In person or by post, the best choice in the country —

THE TAPE RECORDER CENTRE

For free Catalogue, send this coupon to
The Tape Recorder Centre Ltd., Dept. T,
75 Grand Parade, Green Lanes, Harringay,
London, N.4.
Telephone STAmford Hill 1146

Name

Address

BLOCK LETTERS PLEASE

Showroom open: Monday—Saturday 9-6, Wednesday 9-1

Who reads Ferrograph Advertising?



Some have bought their Tape Recorders because they liked the look of them. Others because their price was attractively low. Still more because they didn't know much about Tape Recorders anyway and sought the advice of their friends. All these are good and valid reasons and, we hasten to add, most will probably be quite satisfied with their purchases. But the purchase of a Ferrograph falls into rather a different category. Being almost always in short supply—inevitable with a high precision instrument requiring so much individual supervision during manufacture—only a relatively small number of Dealers can be permitted to distribute it. Our advertising, therefore, seeks to overcome this handicap by appealing to those thoughtful and discerning people who are more influenced by reputation and performance than by any other consideration. That is why there are no sensational claims or grandiose statements in Ferrograph advertising. It is sober, restrained and free from exaggeration. We believe that the purchase of a Ferrograph is a serious business—that almost invariably it is bought by those who, like the B.B.C. and other broadcasting organisations and leading personalities in the world of music and drama, are capable of assessing its great qualities at their true worth.

Stereo 808

Two speeds $3\frac{3}{4}$ and $7\frac{1}{2}$ i.p.s. For use with external Hi Fi amplifiers and Loud Speakers. The all-purpose machine for Monaural and Stereo Recording/Playback.
105 Gns.

Series 4A

4A/N Two speeds $3\frac{3}{4}$ and $7\frac{1}{2}$ i.p.s. Monaural Recording/Playback.
81 Gns.

*Three Independent Motors • Synchronous Capstan Motor • Recording Level Meter • Brief Stop • Interchangeable Plug-in-Heads
Switched Speed Change with Compensated Correction Network • Separate Tone Controls • High Fidelity $2\frac{1}{2}$ Watts Output Stage
Uses $8\frac{1}{2}$ " Tape Spools • Gear-Driven Turns Counter • Automatic Switch Cuts Motors at End of Spool • Endless Loop Cassette (Optional Extra)*

The Incomparable **Ferrograph**

BRITISH FERROGRAPH RECORDER CO. LTD.

(A subsidiary of the Ferrograph Company Ltd.)

131 SLOANE STREET, LONDON, S.W.1 • Tel: SLOane 1510, 2214 and 2215

**INDIA'S
FOREST
SOUNDS** pages 14-15

TAPE

RECORDING AND HI-FI MAGAZINE

HOLIDAY RECORDINGS?

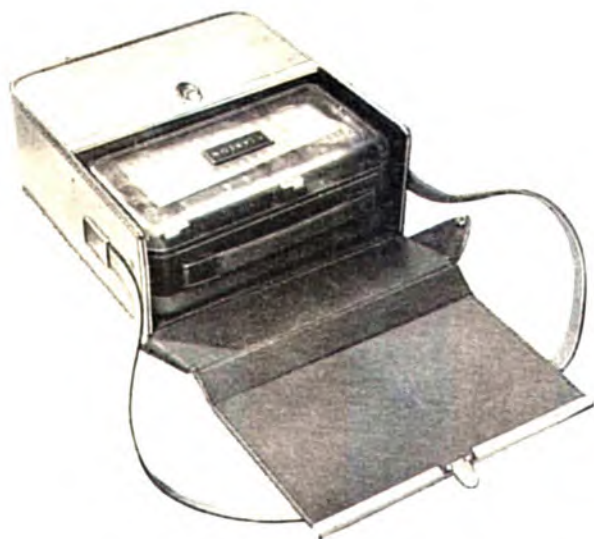

**YOU'RE
ALL SET
WITH
THE TWINSET**



Go outdoor sound-hunting this summer! The Clarion Twinset offers you the best of both worlds: all the convenience of the transistorised mini-portable Clarion *plus* the extra room-filling tone and volume of the Twinset on playback. Carry the Clarion alone for recording (and, of course for playback through its own amp/speaker). Then, for big volume reproduction play it back inside the Twinset. Both are transistorised—both are mains-free. A must for audio enthusiasts on holiday.

CLARION TWINSET

CLARION Mk. I: 50 hours play with 4 x U.2 batteries. Governed speed of $3\frac{1}{2}$ ips. 44 mins. recording time, yet it weighs only 5 lbs!

Only 25 gns

including mike and 360' of tape

CLARION TWINSET Mk. II: Transistorised throughout. 7in. x 4in. hi-fi speaker. Over $\frac{1}{2}$ watt push-pull output. Handsome simulated pigskin case.

Only 33 gns

complete with Clarion, mike and 360' of tape

TWINSET only, Mk. III: Amplifier, speaker and case to accommodate your existing Clarion. Sand tan simulated pigskin, brass trim.

Only 8 gns

Send now for illustrated brochure showing the full Clarion range and accessories. available at your dealer.

G.B.C. ELECTRONIC INDUSTRIES LIMITED, 121/123 Edgware Road, London, W.2. Telephone: AMBassador 2872

FIRST AND FOREMOST IN THIS FIELD

FORTNIGHTLY 1/6
27th, July 1960

FREE H.P!

YOU PAY THE CASH PRICE ONLY—OVER 24 MONTHS!

We sell and stock more Tape Recorders than any other dealer in Gt. Britain. Why do thousands of people buy from us? Because we give the best terms—terms which include No-Interest Charges at all over 24 months—yes! 2 years * Deposits from only 10% any make * Free Servicing * Free Delivery anywhere in U.K. * No Purchase Tax * Free Tape offers * Commission on Sales * Part Exchanges * and lots more besides.



400 machines in stock—80 different new and second-hand models on permanent demonstration in our showrooms * Main Agents for ALL the best makes * Our Mail Order Dept. covers the whole of England, Wales, Scotland and N. Ireland—order from us wherever you live.

If you want to know why it will pay you to buy from us, write, phone or call in NOW for full details of all our terms, and free brochures on all our best makes:

HOWARD

PHOTOGRAPHIC

218 HIGH ST. BROMLEY. KENT. RAU 4477

FRANCIS OF STREATHAM

- ★ COMPLETE T.R. SPECIALISTS
- ★ LARGEST SELECTION OF LATEST MODELS
- ★ SEPARATE HI-FI DEPT.

● The Centre for Prompt Personal Attention and respect for your Pocket

NO EXTRA FOR CREDIT

Minimum deposits and no interest or charges on H.P. up to 18 months. FREE SERVICE WHILST UNDER GUARANTEE

HIRE SERVICE

Tape Recorders available on hire from 45/- per week

MICROPHONES AND MIXERS

	£	s.	d.
Lustraphone LD/66 New Dynamic	4	2	6
Lustraphone "Lustrette" M/C	3	7	6
Lustraphone VR/64 Ribbon	7	17	6
Lustraphone LFV/59 Dynamic	8	18	6
AKG Dynamic Stereo D.88, High Z	19	19	0
Simon "Cadenza" Dynamic	10	10	0
Simon "Cadenza" Crystal	3	13	6
Reslo Ribbon	8	15	0
TSL MX3 Crystal	2	5	0
TSL 3-Channel Mixer	2	2	0
Grundig Mixer	16	16	0

Also by Ronette, Acos, etc. We will gladly advise on the type best suited to your requirements

HI-FI AND ASSOCIATED EQUIPMENT (AT 181 STREATHAM HIGH ROAD)

	£	s.	d.		£	s.	d.
Rogers Junior FM Tuner	24	13	5	Quad II Control Unit	25	0	0
Armstrong ST.3	26	gns.		Collaro 4T200	18	13	0
Dulci AM/FM	23	15	8	Lenco GL/58, less cartridge	19	17	6
Jason FM	22	15	8	Jason J2-10/MKIII	37	10	0
Jason JTV/2	25	7	3	Leak Stereo 20	30	9	0
Jason "Monitor"	19	16	3	Tannoy Cartridges			
Decca fss Stereo P.U.	20	19	5	Loudspeakers by—			
Garrard 301, strob.	23	18	4	Expert, C.Q., W.B., Pye, Goddards, Wharfedale, etc.			
Garrard 4HF...	18	9	9				
Quad Amplifier	22	10	0				

TAPE TO DISC AND TAPE COPY SERVICE

*Brenell Mk. V...	64	gns.	*Saba ...	79	gns.
Brenell 3 Star ...	58	gns.	Saga ...	39	gns.
*Brenell 3 Star Stereo...	89	gns.	*Simon SP4 ...	95	gns.
Cossor 4 Track...	37	gns.	Simon Minstrelle ...	39	gns.
Cossor 4 Tr. Stereo PB	59	gns.	Spectone 161 ...	49	gns.
Elizabethan Avon ...	27	gns.	Spectone 171 ...	39	gns.
Elizabethan "Princess"	39	gns.	*Telefunken 76 4 Track	64	gns.
Elizabethan Major ...	65	gns.	*Telefunken KL85 ...	75	gns.
Elpico TR.400 ...	26	gns.	*Telefunken 85K ...	79	gns.
*Ferroglyph 4AN ...	81	gns.	*Telefunken 75/15 ...	54	gns.
*Ferroglyph 4AN/H ...	86	gns.	Uher Universal ...	79	gns.
*Ferroglyph 4AN/S ...	88	gns.	*Uher 4 Track Stereo...	102	gns.
*Ferroglyph 808 ...	105	gns.	*Vortexion WVA ...	£93 13 0	
Fidelity Argyll ...	29	gns.	*Vortexion WVB ...	£110 3 0	
*Grundig TK60 Stereo	128	gns.	Walter 505 ...	57	gns.
Grundig TK20 ...	52	gns.	Wyndor Victor ...	45	gns.
*Grundig TK25 ...	62	gns.			
*Grundig TK30 ...	72	gns.			
*Grundig TK35 ...	83	gns.			
*Harting 4 Track Stereo	86	gns.			
H.M.V. ...	£50 0 0				
*Korting 4 Track Stereo	68	gns.			
Magnafon ...	49	gns.			
Philips 4 Track...	37	gns.			
Philips 4 Track...	59	gns.			
Philips 4 Track Stereo...	92	gns.			
*Reflectograph A-1 Track	95	gns.			
*Reflectograph B-1 Track	105	gns.			

*Microphone extra

TRANSISTOR MODELS

Butoba ...	76	gns.
Grundig "Cub" ...	26	gns.
Clarion ...	25	gns.
Minivox ...	37	gns.
Fi-Cord ...	59	gns.
Suzzi de luxe ...	75	gns.
Suzzi "Magnette" ...	69	gns.
Suzzi de luxe ...	75	gns.
Steeleman ...	55	gns.

ALSO Pre-Recorded Tapes by Saga and "Music on Tape," etc. Tapes of every size and type by leading makers ready for prompt dispatch.

169-171 STREATHAM HIGH ROAD, LONDON, S.W.16

Hi-Fi Dept. 181 STREATHAM HIGH ROAD, S.W.16

Between St. Leonard's Church and Streatham Station

STReatham 0466/0192

YOU GET *Vivid* REALISM...

...with the
wonderful



HMV TAPE RECORDER

Speech, music, sound effects . . . you get VIVID REALISM every time with this fine tape recorder. This isn't surprising when you consider its many 'professional' features. What is surprising is that such a quality machine should be so modestly priced. Hear it at your dealer's and you'll realize that "His Master's Voice" offers TODAY'S FINEST TAPE RECORDER VALUE!

- * Two speeds: $7\frac{1}{2}$ i/s and $3\frac{3}{4}$ i/s
- * Frequency response: 50-10,000 c/s at $7\frac{1}{2}$ i/s \pm 3dB
- * Takes 7" spools
- * Half-track operation
- * Three-motor drive
- * Separate record and playback amplifiers
- * Three head system for instantaneous playback
- * Pause control for instantaneous stop/start



ONLY £50

Complete with 1,200' Emitape, spare spool and crystal microphone.



THE GRAMOPHONE COMPANY LIMITED · HAYES · MIDDLESEX



RECORDING TAPE SPLICER

FOR EASIER AND ECONOMICAL TAPE EDITING

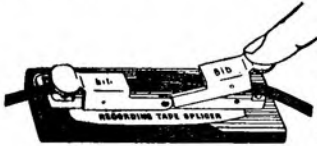

The easy-to-lift clamps on the new Mark II Bib Recording Tape Splicer are both hinged on the same side of the splicer, making the jointed tapes easy to remove. Precise, rapid tape jointing is ensured, and because you can use all the odd lengths of tape, you soon save the cost of the splicer.

Everyone who uses a tape recorder will need this little tool. It is indispensable. P. Wilson. "The Gramophone."

Send a stamped addressed envelope for a helpful leaflet on tape editing.

18/6 each (subject)

If you have difficulty obtaining a Bib splicer, let us know the name and address of your dealer.

Multicore Solders Ltd., Multicore Works, Hemel Hempstead, Herts. Tel: Boxmoor 3636

NUSOUND RECORDING CO.

Ferroglyph

(Appointed Dealer)

Tape Recorder & Hi-Fi Specialists

Showrooms: First Floor
3-8 BRIGSTOCK PARADE,
LONDON ROAD,
THORNTON HEATH, SURREY.
(Opposite Thornton Heath L.T. Bus Depot)
TELEPHONE: THO 7609

London Showroom:
35 CRAVEN STREET,
TRAFALGAR SQUARE,
LONDON, W.C.2
TEL: TRA 2080

NEW FORMULA

Sound machine + Psycho-tapes or Discs = SUCCESS

SEND NOW for interesting 16 page FREE BOOKLET which will show you how to:-

- ★ DEVELOP PERSONALITY
- ★ GAIN SELF-CONFIDENCE
- ★ TRAIN YOUR MEMORY
- ★ LEARN SELF-HYPNOSIS
- ★ SPEAK IN PUBLIC, etc.

To EDUCATIONAL RECORDINGS, Dept. TN,
27 York Road, Ilford, Essex.

Please send 16 page free booklet in plain package

Name

Address

DIXONS

OF MANCHESTER

offer you

TAPE RECORDERS ONLY

In addition to supplying all good makes and stocking almost every accessory, we are the main service and sales agents for the famous Telefunken.

Our service department cannot be equalled in the North and is up to Telefunken and Grundig standard so that we are able to implement maker's guarantee on most makes without returning to manufacturers.



Tapes, microphones and all spares by return of post and reasonable H.P. terms available.

DIXON'S TAPE RECORDERS

227, Oxford Road, Manchester

ARDwick 4269

NOTICE

YOU WILL NEVER KNOW HOW GOOD YOUR RECORDER CAN BE UNTIL YOU CHANGE OVER TO A



BRITISH-MADE MICROPHONE

There's a model for every requirement

Recommended and used for stage, screen, TV, record and radio. LUSTRAPHONE MICROPHONES are consistently specified by leading recorder manufacturers too. You can buy a LUSTRAPHONE MICROPHONE and improve your recordings from as little as 67/6. Literature on request

LUSTRAPHONE LTD.

ST. GEORGE'S WORKS
REGENTS PARK ROAD
LONDON, N.W.1

Telephone: PRImrose 8844

Are you getting the most out of your recorder?

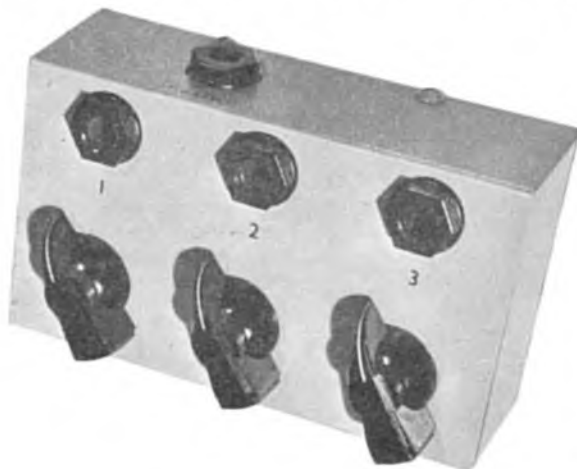

A TAPE RECORDER IS A VERY FLEXIBLE MACHINE; ITS FACILITIES CAN BE GREATLY EXTENDED, AND ITS USES INCREASED, WITH PROPER ACCESSORIES. DEKTRON SPECIALISE IN THE PRODUCTION OF INEXPENSIVE ITEMS WHICH WILL *DOUBLE* YOUR TAPE RECORDING INTEREST AND ABILITY.

2 THE MIXER-FADER

With this mixer-fader you can blend together three separate input sources to produce a single recording. Items can be faded in or out in professional style. Skilful use of this instrument can save you hours of tedious editing work, too. This is the smallest mixer-fader on the market (it will slip into your pocket)—and the cheapest and most efficient. The price is 39s. 6d.

3 THE MONITOR

It is of great assistance to know exactly what you are recording on a tape. This transistorised unit gives you full monitoring facilities. Used in conjunction with the mixer-fader, it acts as a pre-amplifier and gives you the essential basis of a home recording studio. The price is five guineas.

1 THE TELECON PICK-UP

This is a very simple, but highly efficient, instrument that enables you to record both ends of a telephone conversation and—if you wish—to amplify and broadcast it simultaneously to listeners in the room. It is of great value for family and business purposes. The pick-up is simply laid on a desk or table beside the 'phone and plugged into the recorder. The price is only 27s. 6d.



DEKTRON, 2 Westbourne Road, Weymouth, Dorset

Telephone : Weymouth 1987

FOR THE RECORD

CHOOSING a tape recorder calls for sound judgment (if you'll excuse the pun). We can't all have a fund of electronic and mechanical knowledge to draw on. But if we're wise we shop around with our eyes and ears wide open. We listen to every make within our reach and pocket. What's more we note which models are being demonstrated through their own speakers and which through some non-included-in-the-price external equipment.

That's only one of the many important ways in which the WyndSOR "Victor" scores. The WyndSOR Recording Company is one of the most experienced manufacturers having been specialising in nothing but quality tape recorders now *for ten years*. They know that a good-sized quality speaker is essential for reproduction of music faithfully and the WyndSOR "Victor" has this very feature.

Of course, if the amplifier isn't up to much it wouldn't matter, but WyndSOR have designed a special amplifier which has pre- and post-emphasis networks. They also guarantee that every tape recorder which leaves the WyndSOR factory is not only tested and measured to ensure it achieves the published specification, but is also equalised to C.C.I.R. International Standards. Play a professionally pre-recorded tape on any WyndSOR tape recorder and you'll hear what that means.

It also means that with the WyndSOR "Victor" you can make your own professionally-sounding recordings and you can mix and fade music and speech, all with finger-tip control of the most simple-to-operate group of controls on any tape recorder.

Write for a leaflet and the name of your nearest stockist to the modestly proud makers of the best sounding tape recorders in the middle-price bracket. There is nothing more annoying than hearing a WyndSOR just after buying an ordinary tape recorder.

* frequency responses:—

7½ i.p.s.—50 to 15,000 c.p.s. better than ±3 dB.

3¾ i.p.s.—50 to 9,000 c.p.s. better than ±3 dB.

1⅞ i.p.s.—50 to 5,000 c.p.s.

* full frequency equalisation *at all speeds*.

* 10" × 6" elliptical speaker in detachable lid.

* up to 8 hours playing time on one D.P. tape.

* monitoring through its own speaker with independent control.

* finger-tip controls closely grouped.

* mixing facilities for mic and gram/radio inputs.

* additional output with automatic speaker cut-out.

* facility for use as an amplifier.

* three independent 4-pole motors.

* unique styling in two-tone grey with gilt fittings.

* twin tracks * pause control * tone control.

* guarantee: 12 months (valves 90 days) and the name of WyndSOR.



the WyndSOR "VICTOR" complete with crystal microphone, 1,200 feet of tape, and spare jackplug, is only 45 guineas.

WYNSOR RECORDING CO. LTD.

(Contractors to H.M. Government)

WyndSOR Works,
2 Bellevue Road,
Friern Barnet, London, N.11

Telephone: ENTerprise 2226/7
Telegrams: Wyndreco, London

TAPE

RECORDING
AND HI-FI MAGAZINE

Vol. 4 No. 15 27th July, 1960

Tape Recording and Hi-Fi Magazine is published fortnightly, on alternate Wednesdays, by Print and Press Services Ltd., from 7 Tudor Street, London, E.C.4

EDITOR: **R. D. BROWN**

TECHNICAL ADVISORY EDITOR: **CHARLES LANGTON**,
A.M.Brit.I.R.E., A.M.Inst.E.

MUSIC: **EDWARD GREENFIELD**
The Guardian recorded music critic

DON WEDGE
News Editor, New Musical Express

MOVIE-MAKING: **JOHN ALDRED**

NEWS AND CLUB ACTIVITIES: **FRED CHANDLER**

OVERSEAS CORRESPONDENTS:

FRANCE: **GEORGE GINIAUX**
Revue du Son, 40, rue de Seine, Paris-6e

U.S.A.: **PETER M. BARDACH**
210-16, Grand Central Parkway, Queens Village 27, New York

The Editor is always glad to receive articles, news items, illustrations, etc., intended for publication and payment is made on the first of the month following publication. When not accepted, material will be returned if a stamped addressed envelope is enclosed, but the Editor cannot accept responsibility for the safety of such material.

"Tape Recording and Hi-Fi Magazine" is available by a postal subscription at 45s. per annum, post free, or it can be obtained at newsagents, bookstalls and radio and music dealers. In the event of difficulty, write to the distributors, Rolls House Publishing Co. Breems Buildings, London, E.C.4.

Back numbers, if still in print, are available at 2s. 6d. per copy for issues up to November, 1959, and 2s. per copy for later numbers.

EDITORIAL

Address all communications
7 TUDOR STREET, LONDON, E.C.4
FLE 1455-6

ADVERTISING

All advertising communications to
1 CRANE COURT,
FLEET STREET, LONDON, E.C.4
FLE 0197

IN THIS ISSUE

We take the view . . .	8
The World of Tape	9
<i>A News Digest</i>	
Teaching Mathematics by tape	10
<i>W. J. Carney</i>	
Bank Holiday Adventure	11
<i>A photo-feature</i>	
Recording in Australia	12
<i>Another overseas report</i>	
A tape album of your holidays	13
<i>Richard A. Margoschis</i>	
Sound hunting in India's forests	14
<i>Stanley Jepson</i>	
Have tape recorder—will travel	16
<i>David Dove</i>	
Sound Effects	17
<i>Alan Edward Beeby</i>	
Letters to the Editor	18
Stereo Notes	21
<i>Douglas Gardner</i>	
New Products	22
News from the Clubs	23

We take the view . . .

A DIGEST OF NEWS, COMMENT AND EDITORIAL OPINION

WE are at the high peak of summer and so we have made this a special summer issue of the magazine. One fact is certain: there will be far, far more battery tape recorders in use out-of-doors during the Bank Holiday week-end than on any previous occasion in our history.

But, in the tape recording world, summer passes swiftly and imperceptibly into the new season of indoor activity, due to the seasonal cycle created by the Radio Show.

This year's Show opens at Earls Court, London, on August 24. Already we have knowledge of some interesting new tape recorders due to be introduced there. We look forward to meeting many of our old friends on our own stand in the Audio Hall.

Our next issue will contain a special preview article on the Show. The following issue will be the Radio Show number, with the fullest catalogue of exhibits that you are likely to find anywhere.

Sound register

ARRIVING at a function in a London hotel recently, I was surprised—and pleased—to be asked to announce my name before a microphone, instead of writing it in the visitors' book.

Appropriately, the function was the preview of a new office dictating machine, the Fi-Cord 101. Details of this small, very efficient machine are printed elsewhere in this issue.

Voice from the dead

THERE has to be a first time for everything—and a week or two ago it was the first time an inquest coroner heard evidence from the man whose death he was investigating.

A young Hungarian who took his own life made a tape recording, addressed to a friend, as he lay in a room which was slowly filling with gas.

The police found the recorder switched on.

Said the Coroner: "I think this is

LAUGH WITH JEEVES



probably the first time in history and certainly in my experience of coroners' courts that we have had the voice of the dead man actually speaking to the court and announcing his intention of taking his own life."

Successful contest

BY the time this issue appears, the judging in the 1960 British Amateur Tape Recording Contest will have been completed. Winners will be notified during the early part of August, though the results will not be announced publicly until the official presentation of prizes on August 27.

It is already possible to say that the Contest attracted considerably more entries than in any previous year and

that the standard achieved in many of them is exceptionally high.

I have only had time so far to listen to a small proportion of the tapes myself; a few of them have been a sheer delight.

It is particularly encouraging to find that, after a rather hesitant start, the comparatively new classes for schools and for clubs have this year become well established.

Royal recordings

SOME time ago I reported in this column that tape amateurs had been warned not to try to record speeches by members of the Royal Family made at public functions. I suggested that this policy, if officially approved, was a mistaken one.

I am happy now to be able to put on the record a very different account of the facts.

Following the earlier publicity, one of our readers wrote to Buckingham Palace.

It can now be authoritatively stated that there is no rule governing the use of tape recorders during speeches made by members of the Royal Family.

At the same time, some discouragement might naturally be anticipated if on any particular occasion so many recorders were in use as to prove a distraction to the speaker.

This is a commonsense view of the problem with which everyone will have sympathy.

Rome bans tape

AUTOMATIC tape recorders telling the history of the church in the language of the listener's choice may no longer be installed in churches visited by tourists in Rome.

These coin-in-the-slot talking guides had begun to make their appearance in some of Rome's historic churches, and in a recent issue of the Vatican's own paper, it was reported that a request to install such a device, had been referred to the Sacred Congregation of Rites, and turned down.



Instead of a guest book, Croydon restaurateur Jack Glazer uses a Clarion portable recorder to collect the autographs of cabaret stars appearing in his night club.

Here he is with Shani Wallis, and judging by the looks on their faces, Shani seemed very happy to "sign the guest book."

WYNSOR "VICTOR" COMING TO YOUR SCREEN

RANK Screen Services Limited recently produced a fifteen seconds filmlet specially designed for dealers in tape recorders to use for advertising in their local cinema. The Wyndsor Recording Company were asked to co-operate in the making of the film.

At the time, the Wyndsor "Victor" recorder was in final development in their laboratory. The Rank organisation explained that the film would not be available to dealers for some time and so a prototype was built which, at camera distance, would pass off for the real thing. This was completed within 24 hours so that a new model would appear in the finished film.

Presentation is in model animation form, and shows three British-made tape recorders in beautiful colours.

Local dealers may have a print of this film carrying their own name and address and with a suitable sound commentary.



Tape unit opened

ONE of the principal features of a new store recently opened by W. H. Smith and Son, in Bradford, is this specially adapted "carousel" unit. Here, stocks of discs and pre-recorded tapes are kept, and the customer, having selected the record from the surrounding displays, handles a record only when actually purchased.

The unit is the centre piece of the record section which, as well as stocking a comprehensive selection of records from companies all over the world, will also introduce a wide range of tape recorders and accessories. A specialist staff will be available to give advice on all equipment.

To celebrate the opening of the shop, the twelfth and largest of its kind to be opened in just over two years, the Lord Mayor of Bradford, Alderman Edgar Robinson, unveiled a plaque in the shop on June 24.

Allan shows initiative

ALLAN WHISTON of Baguley, near Manchester, is an enterprising youngster with an eye for the main chance. He is also concerned with the plight of world refugees.

Recently Allan organised a children's garden fete in his back garden to raise funds for Refugee Year. Amongst the side-shows and attractions he devised was

a "Record Your Voice" stall. Using his tape recorder, given him by his father when he passed his eleven-plus examination earlier this year, Allan charged his young customers 2d. a time to talk or sing into the microphone and then hear their voice being played back.

Thanks to his efforts the funds are better off to the extent of £3 15s. Well done. Allan!



The Tallylyn Railway, a 2 ft. 3 in. track running through 6½ miles of North Merionethshire and first opened in 1866, is to be immortalised on a long-playing record. Three men, they are seen above preparing for a preliminary reconnaissance, will travel the length of the railway with a Fi-Cord portable capturing the sounds of Welsh voices, birds, sheep and even a Welsh Harp. The record will be made available as a souvenir from Bill Hartley Productions Ltd., 1266 Warwick Road, Knowle, Warks., price 37s. 6d.



TEACHING MATHEMATICS BY TAPE

By W. J. Corney

THE field of application of the tape recorder in schools is perhaps wider than many people appreciate. Have you thought, for example, that mathematics can be taught with tape? There is no reason why recording should not be brought with advantage into the arithmetic lesson.

There is a fruitful opportunity for experiment. I have done a little, although not nearly as much as I should have liked. I hope to continue, as and when I can, along lines which I outline in this article.

Let us consider, first, the general background.

We are living in a rapidly expanding scientific and mathematical age—the age of sputniks and space travel.

We are beginning to talk a new language. Scientific terms and expressions are creeping into everyday conversation. It is essential that we understand them, and children, too, must be taught to think and speak in this language.

If we accept, as I think we must, that mathematics is the language of science, then we must take every opportunity of extending the child's vocabulary.

The modern theory of teaching mathematics is that the child must understand what it is doing. This understanding has to be developed; it seldom comes naturally, except to the genius. It must be developed in stages from the earliest years, through experiment and experience. Concurrently with this acquiring of understanding must come the ability to express it.

It should be remembered, too, that mathematics cannot be divorced from other subjects. It is one facet of a well-ordered education.

It is in this setting that the value of the tape recorder in mathematics teaching should be assessed.

The use of tape can be directed along two broad channels.

Firstly, there is the novelty impact of the instrument. Children, especially the younger ones, are invariably impressed by "stunts," and the use of a recorder could help to fix more firmly in their minds the fact or rule being taught.

With the youngest children, Nursery Number Rhymes—such as "Ten Little Nigger Boys" and "One, two, buckle my shoe"—take on a fresh appeal when recited into a microphone and afterwards played back. The delight with which a child listens to itself will assist in driving home what otherwise might be unpalatable, though essential, "primary facts," the basic combinations upon which all mathematics teaching is based.

At later stages, multiplication and other tables may be taught in the same way. I have tried this with mentally retarded children, and it worked most successfully.

Tape helps to relieve the boredom of repetitive work, of which there must inevitably be a lot.

A variety of games with tape can be devised to establish firmly the fundamentals of the subject. Choral and solo speaking, question and answer, team and individual competitions are some which readily come to mind, all designed to capture the child's interest, and that, as all teachers know, is half the battle.

Secondly, the tape recorder may be used for diagnostic purposes. It enables the teacher, and the child itself, to discover any faulty reasoning or weakness in technique.

A child might explain orally how, for example, it works a compound multiplication sum. By listening to the playback, it can follow its own reasoning and note mistakes.

The teacher is helped by a similar routine to ascertain why some children are competent at mechanical arithmetic but fall down over problems, especially problems set out in a text-book. Reading the problem aloud, followed by playback, helps the child to organise its reasoning.

Other practical suggestions are listed below. The enthusiastic teacher will no doubt think out many more.

1. Commentary on mathematical experiments, graded according to age and ability:

(a) Comparing weights by balancing in hands. "The brick is heavier than the book."

(b) Weighing with scales.

(c) Dialogue in the school shop—pricing goods, adding bills, paying cash, checking change.

2. Oral recording of results of practical exercises, thus avoiding the complications arising when a child has the added operation of writing down results.

3. Group discussions on mathematical projects, e.g., a survey of the school building, working out a scale, unit of measurement, etc.

4. Imaginary conversations in a bus between conductor and passenger over fares, change, etc.

5. Correlation with other subjects. In English lessons, lecturettes, debates or playlets on scientific and mathematical topics, or mock interviews with famous scientists and mathematicians.

There may be possibilities, too, in the synchronisation of tape with film, but upon this I am not competent to comment.

I end on a warning note. Let no teacher think that the tape recorder is going to solve his teaching problems, or that the mathematics lesson is going to be a period of pleasure instead of what it so often is now, sheer drudgery. You can't teach anything successfully by pressing buttons. The recorder is but an aid, not a complete teaching device.

Care must be taken, therefore, not to overdo its use, but to employ it as an occasional stimulus.

Over the Channel



BANK HOLIDAY ADVENTURE

A QUICK hop over to France—and a little battery portable doubles the pleasure, and captures so much of the occasion that you will be able to spread the excitement of it over the years.

These photographs show a lucky young couple just before leaving England (left), in the air (below), and on the Continent (right).

They've taken their Grundig "Cub" and obviously they know how to use it effectively.



PRICES HINDER RECORDING PROGRESS IN AUSTRALIA

JOHN F. WALLEN, Secretary of the Australian Tape Recordists' Association reports on the enthusiasts' efforts Down Under to spread the use of tape, in face of the disadvantages met at every step.

AFTER a period of semi-stagnation, hobbyist tape recording in Australia is again increasing in popularity, in spite of the almost prohibitive prices of practically everything connected with it.

Magnetic recording was introduced into Australia from the United States of America, which exported, through a firm in Sydney, N.S.W., a recorder known as the Magnecorder. This was to be the forerunner of many brand makes through the ensuing years.

In 1948, a Melbourne manufacturer produced the Pyrox Magictape Recorder, with a single speed of $7\frac{1}{2}$ ips, under licence from an American corporation. Other manufacturers began to jump in, and within twelve months, in 1949, other brand-names began to appear on the market: Velco, Chieftain, Nicholls-Soundcraft, Novatape, Ferry, Technicorda, Byer.

While all this was going on, Tape Clubs began to form in the United States of America, spreading later to Australia. In 1953, our own Australian Tape Recordists' Association was formed in Melbourne. Membership was enjoyed by enthusiasts all over Australia, in the cities, the suburbs and the far outback.

While Australian members had to put up with inferior quality recording tape and, at that time, machines, their counterparts in other countries were enjoying the fruits of fast developments, not only in the quality of tape, but in workmanship and engineering skill which attained the same reproductive quality at lower speeds.

TV HITS TAPES

The hobby of Tapespondence appeared in Australia but was somewhat retarded by the introduction of television. Attendance at meetings in capital cities and country centres waned, until the strongest group of tape hobbyists was located in South Australia. In the eastern states of Australia a few years ago, several small clubs were formed, with members residing in various parts of the country, but as the all-powerful wave of TV entertainment swept in from the east, the novelty of tape recorders was all but drowned. Most TV dealers displayed a good range of "trade-in" tape recorders of various types.

In South Australia, however, the tape recording enthusiasts really came into their own, and still they are the most active and numerous.

Reduced hire purchase deposits, together with the lengthening of repayment periods, has made it easier to own a



recorder. Increased use is being made by the Cine and Camera Clubs throughout the country to aid synchronised sound.

With the easing of import restrictions, many imported tape recorders, previously viewed with envy in the overseas magazines, are becoming available from all parts of the world, and the increased production of mainly Australian-content units is having a profound effect upon sales counters throughout the country.

Fully imported makes available include Ferrograph, Vortexion, Grundig, Reflectograph, Simon, Walter, assorted Japanese makes, together with the Clarion, Fi-cord and Grundig transistorised portable models.

As examples of the out-of-all-proportion cost of recorders in Australia, consider the following prices: Ferrograph, £310; Grundig, £138 12s.; Triple-speed, £210; Stereophonic, £300 (approx.); Philips, 3-speed, £153 9s.; single-speed, £104; Elizabethan, £93 9s.; Clarion transistor, £55 13s.; Fi-Cord transistor, £145.

Australian recorder prices are as follows: Rola-Byer 66, £291; A.W.A. Magictape and Pyrox Magictape, both £135; Elcon, £141 15s. (new model being released shortly priced at £100); Ferry, made to specific customer requirement, from £70 to £500; Technicorda, £134 19s.

At present the only brand of recording tape manufactured in Australia is known as Rolatape, although a similar type of tape was produced in Sydney under the brand name of Aurovox some years ago. This concern was acquired by the Rola Company (Aust.) who have so far improved upon the quality of this tape that it is now comparable with any overseas-manufactured tape. It is available in standard and long play grades. Other products of the same company have been well-renowned for their quality for many years.

This organisation produces professional recorders equal in quality of reproduc-

tion and fidelity to any other recorder in the same class overseas, and these were formerly produced by a Company known as Byer Industries, under licence to Magnecord, U.S.A.

The use of tape recorders in schools, colleges, and blind institutes has shown a remarkable increase, particularly over the past two years. In line with this is the greater use being made of the office-type tape recorder in the business field.

By far the greatest users of recorders, however, are the hobbyists and enthusiasts; these account for approximately 70 per cent of all sales. Bearing this in mind, it is rather surprising that there is only one main Tape Recording Club in existence in Australia, plus a few small groups of the "meet-in-each-other's-home" category.

The Australian Tape Recordists' Association, with its Headquarters at Box 970 H, G.P.O., Adelaide, South Australia, is the original and major club of its type, and at present numbers over 200 members, with an average monthly intake of around 18.

TAPES CENSORED

A distant equivalent is a local group of one of the international clubs. Tapesponding, being a universally accepted pastime, is practised to the full in this country, but the postal authorities, with their unfair imposition of "Letter Rate" for taped messages, make the use of air mail postage a very expensive luxury.

Coupled with this, the Postal Customs Department's censoring of a percentage of incoming tapes does nothing to encourage friendly exchanges between recordists of different countries. From the number of censorship labels being sent in to ATRA Headquarters by its members, it would appear that personal tapes from the 3-in. to 7-in. sizes are receiving an ever-increasing amount of attention.

The official explanation for this "spot-checking" is that it serves a dual purpose of apprehending pornography and levying customs duty in the case of pre-recorded music tapes. This is partially understandable, no doubt; as in every country, the vast majority must suffer indignity because of abuse by the thoughtless few.

Australia has always been called "a land of opportunity," and this is even more true now; but, unfortunately, tape recorder manufacturers in general do not realise the full possibilities. It would appear that they have been content to rely on the immunity that import restrictions have hitherto afforded them. The quality and price of most Australian-manufactured recorders is in no way competitive now with equivalent overseas products.

RICHARD A. MARGOSCHIS

tells you how to create a family "tape album"

.....

WITHIN recent months we have been reading a lot about battery-operated tape recorders and the recent survey carried out by *Tape Recording Fortnightly* indicated that one in five of amateur tape recordists already possess such a machine. I imagine that during the next few weeks many of these will be in use to record a sound picture of the annual holiday, probably on the lines of recent articles. I want to suggest to those who own only a mains-operated machine that they, too, can make a record of their holiday which, in years to come, will be of great interest and value.

The idea is to produce something which will preserve just sufficient detail of incidents to jog one's memory when the tape is replayed after many years. To do this an "on the spot" recording is not essential, in fact, in many instances it is impossible, for the particular item to be recalled may have produced no sound whatsoever. In such a case the only way to record it in sound is by means of a word picture and unless you are reasonably experienced in making "off the cuff" commentaries such a word picture will be better if produced after giving some thought to its wording.

MAKE NOTES

The first essential to enable you to do this successfully is a pencil and note book. Each evening, while on holiday, spend a few minutes before going to bed in noting down what you have done and seen on that day and, if possible, persuade your wife and anybody else who is on holiday with you, to help you to make these notes; they may remember some point you might well have missed.

If, during the day, you can make a habit of jotting down in the back of your note book any incident which occurs so much the better, it can then be included in your evening summary and duly ticked off from the back of the book. I have often found that one word quickly noted can save a lot of wondering—"what did we do then?" or, "what did that chap say?" However, your notes should certainly be kept sufficiently brief to prevent them from becoming a nightly chore which could very easily ruin the holiday.

When the holiday is over and you are back home there is still some preparation to be done before setting up the

A holiday tape—with a mains model

recorder. First consider the following three ways in which the word picture of your holiday might be presented:—

(a) In the form of a narration presented by one person.

(b) In the form of a dialogue presented by two or more persons from a prepared script.

(c) In the form of a free conversation between two or more persons from notes only.

FREE AND EASY

The success or otherwise of this idea depends to a great extent on its being presented in a free and easy manner. After all its interest is going to be limited mainly to those who partook of the holiday, as a personal record, and I think that this would be difficult to achieve by using the first method mentioned. The second method is also liable to sound stiff unless the readers are experienced in presenting dialogue.

I suggest, therefore, that you should try the third method. I know from experience that it can work with two persons and see no reason why it should not work with three, or even four persons, but I feel that there is a limit to the number who can successfully take part.

The next step is to go through your note book, day by day, and sort out the items to be omitted, the ones to be retained and the important ones which might be enlarged upon. As you proceed prepare the notes from which you will make your recording, you will require a complete copy of these for each person taking part. The notes should be just sufficient to bring to mind the various incidents, detail can then be added as the recording is made.

When trying this for the first time it may be worth while having a rehearsal, but as experience is gained you will find this unnecessary. You will, however, have to decide who is going to be first speaker, after that it is for anybody to come in with their remarks.

There are two dangers, the one is that when moving from one item to another nobody speaks and there is a deathly

silence, and the other is that two people will speak at once. This can be overcome by treating the proceedings as a meeting with one person acting as chairman. If two people start to talk as once he can point to, or look at, the one who is to continue, and if nobody speaks it is up to him to start them off again on the next item.

In certain instances, where any particular item is to be dealt with in greater detail, it may be a help if the notes are rather more explicit and one person detailed to present them, then as the item is approached the chairman will see that the conversation is moved to give that person the necessary opening.

My wife and I have been using this method for over a year, and although we started it in connection with our holidays we have expanded it to produce a "Tape Album." This is done on similar lines to that described above. We jot down notes of any unusual or important happenings and then each month we sit in our fire-side chairs, with the microphone suitably placed between us, and talk to each other about the happenings of the month, with our notes to remind us of course.

ADDING PERSPECTIVE

The conversation normally revolves around ourselves, our relatives and close friends, but recently we have made a habit of including the odd items of national or world-wide interest and we think that when we listen to the tapes in future this will give added perspective to them. Very occasionally we have mixed in a brief extract of other recordings having a special bearing on our lives; a wedding for instance.

If you still have a holiday to look forward to this year, and have no portable machine to take with you, then think about taking a pencil and note-book, or if the holiday is over and still fresh enough in your mind make a start right away. I am sure it will lead you on to produce something the value of which will increase as the years go by and will make the possession of a recorder even more worth while.

SOUND HUNTING IN INDIA'S PRIMEVAL FORESTS



The author recalls his sound memories of 27 years spent in India—seven in the Indian Army and 20 as Editor of *The Illustrated Weekly of India*. He spent many of his holidays in the big forests and is the author of "Big Game Encounters."

WHAT sound-hunter with his modern portable tape machine has not felt that "call of the wild" which has featured in the pages of this magazine in the form of exciting travellers' tales? To many it may be just a vicarious joy, an armchair savouring of forest tape achievements.

I have felt this joy in the woods of Jersey, but my efforts with bird noises have been but a faint reflection of what I have experienced in the dense primeval forests of India . . . but,

alas, this was before the days of portable recorders, and mostly before the days of tape.

Perhaps the day is not far distant now when the tape enthusiast may avoid all those laborious days of trekking, with porters and headloads, or slow bullock carts. He may be able to go quickly to remote parts of dense forests by helicopter and return the next day with a wonderful assortment of forest noises on his tapes.

Our not-so-dumb forest friends are

worth hearing. For some years we owned a forest-surrounded week-end bungalow in the Ghats, above Bombay. Hundreds of monkeys were all around us at times, and they would descend to steal anything, from food in the kitchen to fruit on the table, vegetables and the choicest flower blooms.

As they were held sacred (see the exploits of Hanuman the monkey-god, in any reference book!) there was nothing we could do about it, though we did try bits of sticky flypaper on the vegetables and by poultry runs! The little fellows didn't like this on their hands. Their voices ranged from excited chatter to real heavy swearing, when angry. Try a zoo monkey tape!

Often when sitting up for panther or tiger, I have heard the monkey tribe moving in the trees overhead, giving warning of their sworn enemy's movements. However stealthily the tiger and panther move—and they can be noiseless, even over dry leaves—their efforts are quite cancelled out by the monkeys. For does not "Spots" devour the baby monkeys in heartless fashion, roaring suddenly from the ground so that the baby releases her hold of mother in sudden fright and tumbles down below?

HOW CARNIVORA USE SOUND

This sudden roaring, which needs no parabolic reflector to actuate a microphone, is not just a display of frightfulness. It is an intrinsic part of the hunt by creatures which must kill to live. I recall a Forest Ranger in the Central Provinces telling me he watched through glasses from a Rest House in the forest as a young tiger killed one of a pair of bullocks on a distant hillside. Then he turned to the second bullock and killed that, with just as neat a dislocation of the vertebra, using his 500 lbs.-odd of muscle and bone along the bovine's back, levering one way while his great paw turned the head and neck the other way.

Traits of a tape type

By F. J. G. HODGE

Born with a silver SPOOL in his mouth.

At school he was a MONITOR.

He is a good MIXER.

Has a WINKING EYE.

When he sees a pretty girl he goes WOW and his heart

Gives a FLUTTER. Liable to lose his HEAD.

Eventually he gets SPLICED.

Thereafter, his conversation is likely to be EDITED.

He receives presents marked HISS and hers.

Sometimes things will HUM and the NOISE will rise

Above the acceptable LEVEL.

Refers to his mother-in-law as the LOUDSPEAKER.

Has two pets. A dog, WOOFER, and a canary, TWEETER.

His favourite drink is BASS, and he goes on the TREBLE chance.

Not BIASed, but OSCILLATES between the merits of MONO and STEREO.

TWIN-TRACK mind—Hi-Fi and Hier-Fi.

After ERASURE, becomes a RECORDING Angel, and lives happily ever after.

SOUND HUNTING IN INDIA'S PRIMEVAL FORESTS

Narrative and photographs by Stanley Jepson

"How extraordinary," I replied. "Why ever didn't the second bullock run away?"

The Ranger replied that the second animal was petrified and had lost the use of his muscles for the time being through the tiger's terrifying roar.

Which reminds me that I have experienced this kind of paralysis, when walking by a reservoir north of Bombay one monsoon. My seven-year-old daughter had got in front along the forest path, and suddenly an evil-looking cobra raised his head three feet high, blew out his hood, and hissed evilly. Though I had a gun in my hand (I was looking for duck), I remained motionless, *unable* to move.

Fortunately my daughter did the same. At once the cobra turned, and glided away in the undergrowth. Had I attempted to raise the gun, or had she suddenly moved, the snake would undoubtedly have struck, in a split second, downwards at her feet or legs.

That cobra was making a most curious sound, blowing air into and out of his hood. I then remembered I had heard this sound once before, in the dark, a few feet from my face. It was in a godown (warehouse) where I had been foolishly striking matches, looking for a camp bed late at night. The sound was so eerie it frightened me off . . . otherwise I should probably have been dead in a few minutes.

NIGHT NOISES

Yet at times the big forests have a silence which can be felt, broken occasionally by leaves falling to the earth, or the quiet noise of insects. "Listen, Daddy, to the silence," said my young daughter once, holding up her finger. There was nothing to hear.

But at night, how different. It would be fascinating to go to India to spend a few nights up trees over hot weather pools or salt licks, where animals congregate. Those quiet footfalls or leaf rustling movements of the large animals coming closer and closer until they show in the moonlight below!

An old Shikari once told me to stop trying to stalk stealthily in the forest because it was impossible to be *quite* noiseless.

"Slither the feet in the leaves like this," he said, imitating the animals.

There was a man named Thompson in the Forest Service who lost a leg to a wounded tiger. When later he got his wooden leg, he claimed he could approach animals more easily—probably because the noise of the wood and one



The author and his wife, seen with a tiger and a sloth bear shot in one evening

foot did not resemble any human movements known to animals.

The leopard makes such a variety of noises that it would be well worth making a leopard tape. For two years my wife kept a young leopard, Miss Bimbo, who had been forsaken by her mother—probably because she knew she could not rear more than two of the litter.

When Bimbo got as large as an Airedale dog we had to give it away to the Bombay Zoo, where we often visited her, my wife astonishing folk by calmly stroking her through the bars, tickling her under the ears, which she loved. Bimbo had a rich vocabulary of sounds, from the loud purring, like a great cat, when pleased, to angry snarls, sharp coughs, and even a fairly good imitation of a saw.

NOT THE KING OF BEASTS

Listening to the lion in the zoo at feeding time, one might be pardoned for thinking of Leo as the "king of beasts." He cannot be, for at one time lions roamed the Middle East and the forests of India. Then came the tiger, from Siberia of all places (which is why he dislikes day-time hunting, owing to the heat), and, through the centuries, the tiger fought it out with the lion and practically liquidated him in India.

Now lions are just a few hundreds in the forests of Gir, carefully preserved as curiosities. Lions have also been hunted by worthies with bows and arrows

in East Africa, and the Masai would-be bridegrooms still hunt them with spears. No such liberties can be taken with the tigers of India, which still roam the forest nalas in their thousands. The Forest Department takes a yearly census. There are many more leopards, of course.

But, for sheer terrifying sound, the charging elephant takes the palm. A close second is probably the angry sloth bear . . . yes, the old gent with the white V on his chest, used by circus performers.

Once I heard a charging bear, and it sounded like a threshing machine gone wild. A wonderful cacophony of shrieks, grunts and squeals. The jungle villager is more afraid of the bear than of the tiger, for the former may charge on sight, while the latter gives man a wide berth if unhunted or without cubs.

If you can make a zoo camel talk, that is worth recording, a most curious belching gurgle, like a bagpipe gone wrong.

I can recall so many bird noises in the forests of India, from the whistling schoolboy, the coppersmith bird exactly like a copper worker tapping, the "brain fever bird" like a monotonous garden roller, chattering parrots, the hornbill, the "seven sisters" all chattering delightfully. You might get some of them at the zoo.

But I really can't go on . . . It's too nostalgic, when I think of the local woods!

HAVE TAPE RECORDER WILL TRAVEL

by David Dove

HI-FI enthusiasts and travelling men have at least one thing in common — dissatisfaction with the status quo. The true seeker after high fidelity looks for a building with perfect acoustics, or for an assortment of wires, valves, speakers, tuners and tape decks that will at once create any sound with ultimate clarity.

The travelling man seeks also something that no one else has yet discovered, the Silent Sago tribe of New Guinea (trouble here was that they were so silent that their discoverer, Hugo West, was unable to convince anyone else that they existed).

So it is that one can swiftly draw the conclusion that travellers should be equipped with tape recorders, and that hi-fi men should travel, especially if they live next door, and insist on experimenting with stereo in the late hours of the night. I knew a young sailor once, a fellow who carried a portable radio booming down the street whenever he came home on leave. Most of the locals thought that he was slightly barmy (not, I hasten to add, because he had signed on for a long period) until we realised that the strident blasts emitted from the three-inch speaker effectively kept away over-inquisitive neighbours who would have otherwise bombarded the future admiral with their questions. On the other hand, the poor lad might have felt lost without music.

Have you ever noticed how many regiments travel about to musical accompaniment from the glittering and polished military band? A good transistorised tape recorder could do away with all that spit and polish, you know. Although I don't suppose that it would be good public relations for any fine bunch o' soldiers to march down the Mall, with the bandmaster holding a tape machine.

Civilian folks like me, who travel only to the sound of cars, trains and the wild, wild wind, do not always realise that the main idea of a military band is to keep a swing in the step of the marchers. This does not always work out.

I remember a parade in which special electric lights had been placed in the trees surrounding the barrack square. The sergeant-major, a man of penetrating voice sufficient to ruin any mere tape recorder accidentally left on within a radius of 100 yards, explained that no commands would be given on the



barrack square, and that the men would move about according to the times that the lights in the trees flashed on and off. The local military band was in attendance, and played a suitable selection. However, things didn't work out well; something went wrong with the lighting system, some excitable participants "saw" the lights flashing at the wrong time, and the whole event seemed to dissolve into something resembling complete disorder. Since I was, alas, one of those unfortunates who saw lights flashing—must have been a migraine attack—when they were quite inactive, I soon found myself travelling once more, much to the relief of that gentle man, the sergeant-major. He had attempted some wedding of electronics to tradition, but had been severely disappointed by the result.

Still, there is no reason why he should not make a good, clear tape of the standard drill commands and get the brainy lance-corporal to play them on the recorder as required. Thus, as the R.S.M. sleeps peacefully until noon, his voice can still echo over the barrack square. Such is the wonderful world created by the tape machine.

All travelling men should have a transistorised tape recorder; this is the opinion of the writer of this article, who has sat, squirmed, shuffled and signed through a large number of hours in British Railways compartments during the last twelve months.

For one thing, the inherent conservatism of the British traveller may only be disturbed by a sudden burst of Stravinsky from the box of such innocent appearance on the seat. The owner of the recorder has to be careful that a nervous passenger does not at once throw the recorder out of the window, or pull the communication cord, or call the guard, or faint. Otherwise, this dramatic gesture can open a very useful conversation—"I do like Stravinsky's music, don't you?" If the passengers look worried, switch to Billy Cotton on track two.

Again, the mobile recorder is very useful at making a souvenir of the conversation in the compartment once it is in progress. The stout man in the check suit sitting in the corner, and his comments on the kind of people that travel on British Railways these days, are worth remembering. And that lady who attempted to persuade her Pekinese to bite you—well, that is also good material for your tape. If you have some unpublished—and fairly lengthy poetry, read a few dozen verses of this into the microphone. The other passengers can hardly fail to hear you, and, in this way, audience reaction may be achieved. Such as the mass exit of the rest of the voyagers in the compartment.

Sometimes, I think of all those tape recordings I could have made whilst waiting for the connections that I so frequently miss. I have surely composed some worthy prose sitting on those peeling, brown-painted wooden seats, but, owing to the non-possession of a transistorised recorder, these promising works have always been forgotten by the time I have turned the key in my back door. Until I can get a battery machine, I am going to practice thinking like a tape recorder, make my mind a kind of blotting paper.

Sometimes, I travel some distance to address a group of people. On these occasions, I have often discovered that I have left my notes in the refreshment room of some distant railway station, or brought the wrong lecture. I keep promising myself that I will record the appropriate address, and despatch it to the chairman by registered post. "Dear Sir," I will write, "There is now no need for my attendance to speak to you, but, since you may have difficulty in obtaining a machine on which to hear this splendid lecture, I will bring my comparatively unportable mains machine to your meeting."

And I was sitting in a train one day, my tape recorder sitting proudly on the rack above me, when an uncouth lad remarked of it, "That's a funny-looking suitcase, mister."

Sound Effects

ALAN EDWARD BEEBY, who has had long experience in devising and recording sound effects, continues his regular column of advice.

IN the course of these articles I have tried to give as clear and as wide an illustration as possible of the correct use of sound effects in tape recording. A sound effect, however realistic it may be, is of no value at all unless it is *applied* in the correct way.

Writing in *Tape Recording Magazine* last February, Charles Aitken, Secretary of the Dundee Club had this to say on the subject: "Sound effects in themselves are of little use *unless they add something to your story.*" I couldn't agree more. I've listened to many otherwise first-rate and original tape recordings which have been spoiled simply through the misuse or over-use of sound effects to the point where, as Mr. Aitken states: "... they become little more than gimmicks."

The root of the trouble, I think, lies in the tendency to regard a sound effect as an end-product in itself which is a bad mistake. The true end-product, of course, only materialises when the effect is accommodated correctly in the subject recording.

The two main fields in which sound effects are employed in tape recording are those of the dramatic and documentary production. Let's take drama first.

Here, the old rule: "When in doubt, leave out!" sums up the case perfectly. It is, for example, completely unnecessary to accompany a scene where guests are supposed to be arriving at a party with a succession of "car-arriving-and-stopping" noises. A subdued burst of conversation in the background just before each new character appears is quite sufficient.

"Sound effects should pass unnoticed but appreciated" was a useful piece of advice I was given in my early days. This simply means that an effect should occur *naturally* in the action of a play without giving the impression that it was introduced either with the idea of impressing the audience or of lending authenticity to a scene.

It is, I assure you, all too easy to give the first impression. I once listened to a taped version of the thriller-play "The Cat and the Canary" where this happened. The

effects were very good, the acting faultless and the production excellent *except* for the fact that the listener was treated every two minutes during the play's entire run to an ear-splitting, 10-watt clap of thunder! Do you see what I mean?

A sound effects-man working on a drama production should receive a copy of the script well in advance. Having noted all the effects listed in the existing stage directions he should then, in consultation with the producer (NEVER off his own bat) decide whether any further effects are needed. This is more likely to be the case where a stage production is being adapted for the recording medium when an extra, suitably-placed sound effect can prove itself useful as an "illustration" in the absence of the vision factor.

Again, I would like to stress the importance of good timing. The effects-man must "accompany" the action and dialogue of a play in much the same way as a pianist accompanies a singer.

The effects should be separated individually by splicing in short lengths of leader tape. Use more than one colour if possible, say, green, red and yellow. This makes the job of following the cue sheet a good deal easier if the effects are marked off in corresponding colours.

Finally, if you are using your sound effects to accompany a stage performance, do remember to check carefully before the actual night on the combined effects that amplification and hall-acoustics might have on playback quality. This is very important.

Now to the Documentary Production. First, you must decide whether your production is to be merely a "coverage" (like a news-item) or a "presentation" in which case, your effects will need to be more elaborate. The majority of sound effects used in documentary work are obtained on location, and it is this, I think, that causes quite a number of enthusiasts to lose sight of the main objective and to become *over-enthusiastic* in their efforts.

Faced with a bewildering medley of sounds, the problem is to select those

which will illustrate the scene and the accompanying commentary to the best advantage. To this end, I recommend what is known as the "three-stage plan." In explanation it is apt to sound rather restrictive but all it does, in fact, is to impose certain practical limits on the number of effects to be included, collectively, in any one scene and to decide the degree of prominence that each shall enjoy.

The "three-stage plan" divides the whole sound-scene (called a "scenic") into three main parts. These are: the "Immediate," the "Support," and the "Background." The chief thing to bear in mind is that the "Immediate," effect is to be *listened* to, while the "Support" and the "Background" effects are merely to be *heard*. Another important point to remember is that in the case of a running commentary the commentator's voice must be regarded as the "Immediate" effect. Where a person is being interviewed, both voices fill this position.

The "Support" effect refers to sounds taking place in the immediate vicinity which have a direct bearing on the subject in hand, leaving the "Background" effect to its normal job of setting the general scene.

Take, for example, the recording of a commentary at a fun-fair. The "Immediate" effect would be the commentator's voice. Directly behind this would come the "Support" effect of whichever item of fairground amusement he happened to be referring to and backed, to a slightly lesser degree, by the "Background" effect of music and crowd noises.

The chief difference between sound effects in dramatic and documentary recordings is that in drama the effects simply need to be *operated*; in documentary work, you have to *control* effects which are already there whether you want them or not! Remember that a microphone cannot think for itself. It's up to you to select the sounds you want, to decide which are the most important, and to deliver them to the microphone in the appropriate order. The "three-stage plan" is absurdly simple, I agree. But it does help you to retain a sense of proportion. And that's more important than anything!

Letters to the Editor

“STOLEN” RECORDINGS CRITICISED

LIKE Mr. Reginald Williams, I am a tape recording enthusiast but cannot agree with several of his statements in your issue of June 29.

It is certainly true that the professional artist is the servant of the conductor and society during the rehearsal and performance of a work; but I have never seen an artist's contract which includes an amateur tape recording as part of his or her contractual liability.

Broadcasting corporations throughout the world pay proportionate fees for repeat broadcasts of an artist's recorded performances; and I can see little difference in principle between what Mr. Williams wishes to gain for nothing and that for which other organisations are prepared to pay.

I am sure that many professional artists will agree to a recording exclusively for study purposes by the choir provided that the tapes be erased immediately after such *bona fide* study is completed.

But I cannot blame any artist who does not wish his or her performance to be played to all and sundry for an unspecified period of time.

Despite Mr. Williams's assurances regarding obtaining the approval of conductors and societies, the fact remains that many such recordings made by amateurs are of appalling quality and that many of these are, in fact, “stolen”

without the artists' knowledge at the time.

We both condemn this roundly, and is it not understandable that mistrust should be bred in an artist's mind as a result of faulty techniques in recording and dishonest behaviour?

Surely, Mr. Williams' remarks about first-class amateur performers is very naive. Were these admirable people to reach anything like first-class professional standards, amateur choral societies throughout the country would be only too eager to save themselves the expense of importing professionals.

A glance at any musical journal will show that this is far from being the case.

Despite the ten years of its existence, amateur recording is still very much of a “New toy”. Let it be used with tact and discrimination and not as a weapon to engender ill-feeling between professional broadcasts and amateur tape enthusiasts.

DR. DEREK GOLDFOOT
Hampstead, London.



IN his recent letter Mr. Reginald Williams omits any reference to Equity and gramophone record contracts, both of which figure in his original letter, and

are reasons enough in themselves for the professional artist to prohibit unauthorised recordings—and there the matter could end, but perhaps I may be allowed to take up one or two other points in Mr. Williams' letter.

He blithely casts aside any suggestion of the shady character and gazes benignly at the world through rose-coloured spectacles. Whether he likes it or not, both “charlatans” and “unscrupulous editing” do exist in this day and age, and a professional artist has every right to leave little to chance in protecting his reputation.

Mr. Williams has met artists who will allow themselves to be recorded—I'm sure he has! There are, no doubt, many artists who are willing to “play ball.” *But they should be regarded as the exception rather than the rule*, and Mr. Williams should not reach for pen and paper in outraged indignation when he meets with a refusal.

Finally, I don't think I suggested that a professional artist is indispensable for the first-class performance of a musical work. I am sure there are amateurs whose talents are equal to and, in some cases, even superior to some professionals. If, however, a society is willing to pay “30-100 guineas” for the services of a professional, then surely the assumption is that it is unable to fill the role from within its own ranks.

NORMAN PAUL
Muswell Hill, N.10.

Voice echo experiments

FOLLOWING your article in *Tape* about voice echoes, I carried out your recommendations with a Simon SP/4 and a Philips EL3538.

I was more than delighted to discover, after one or two trial runs, that I could get a very effective reverberation by your method. I feel it is absolutely necessary to mix in a direct channel from the second recorder, otherwise the microphone pick-up is far too boomy and heavy in bass frequencies.

The choice of microphones is important, too. I used a cardioid moving coil to feed the master copy to the Philips, and a ceramic ball-type, held about six feet away from, and slightly to the side of the Simon speaker. Experiments with crystal-type mikes were unsatisfactory in that they produced a highly metallic signal. As yet, I have not tried my ribbon mike, being a little concerned about its tendency to emphasise bass frequencies.

My experiments have been directed at the 3½ and 7½ ips range due to the fact that one machine has three speeds and the other two. I tried the 1½ and 7½ ips system, but it meant changing reels and using a jack-plug with a flattened end which allowed the internal speaker of the Simon to remain active whilst still feeding the Philips. However, I am not too keen on “splitting” a signal which may not be meant to be split in this way.

I have also experimented by taking a speaker into the bathroom from an amplifier and feeding the result, mixed with a direct channel, into my recorder. This is a bit messy and I am now thinking of trying out a suspended steel sheet—based on the B.B.C. method.

Many thanks for your interesting article.

P. L. BASTIN

Pershore, Worcs.

Calling the “Boffins”

A PROPOS A. Sulman's remarks (June 29) regarding use of two recorders for raising pitch of sound, I have heard the “Sound” B.B.C. Programme's demonstration and it would appear that background noise takes over after the recorded signal is considered inaudible.

I am unable to state with any experience whether it would be any more of a success or not, but if a signal, say the B.B.C.'s tuning signal were to be recorded (at least ten seconds in the first instance), then dubbed through the speeds to say 64 times original speed, it might be, with minimum background hiss, that a signal could be said to be in range of instruments for measuring supersonic sound.

A longer signal might have more or less effect but perhaps some of our “boffins” with facilities might care to experiment and report?

A. INGLIS.
Stonehouse, Lancashire.

Have you an idea, a complaint, or a bouquet to hand out? Write to us about it. Letters not for publication should be clearly marked.

Tape quality; USA views

I AM in the deepest sympathy towards H. J. Cubitt's dilemma (May 18). In America, and I believe everywhere, the trend towards bringing tape of quality in sound on the market is one of economy and efficiency. Of course this is well and good as far as the company is concerned. Or is it?

At times the conditions stated above can have a drastic effect on the market, and thus unmistakably lead manufacturers to believe there is no market for their product.

I find myself purchasing tapes of extreme calibre in music, rather than purchasing all tapes that I would like to have, mainly because recorded tapes are not of high quality to warrant such purchase, materially.

We can purchase tape in America made of "Mylar" or "Polyester" which are the best available, and in Mr. Cubitt's case, these tapes are not subjected to damage under tropic conditions.

However, from experience I find that the pre-recorded tapes that are stored for long periods do tend to curl and become in a ravellid condition. This can be overcome by rewinding your tapes occasionally even though you do not play them.

I hope in England, as it is getting to be in the States, economy will come after quality, both in recording and in material, and I believe only then will the tape field have an absolute edge over any other form of reproducing medium.

GEORGE TOTH

New Jersey, U.S.A.

Aid sought

MAY I, through your correspondence column, be permitted to contact other owners of the Simon SP2 tape recorder?

This machine incorporates an excellent 10-watt amplifier, but lacks a filter and record-equalizing circuit for the reproduction of records, etc. I am wondering how others have managed to overcome this, and what make of pick-up they have found most satisfactory.

Long may your magazine continue its present high standard. The articles are always extremely interesting.

GEORGE W. EWEN

London, S.W.2.

Hi-Fi HARRY by rich



"What do you think of this model with the red tape? I bought it from a civil servant."

MAGAZINE DIGEST

Amateur Tape Recording (July): *Echo Devices*. Another in the handyman series.

The Tape Recorder (July): *A delayed action time-switch*. Do it yourself instruction.

Tape Recording (American) (June): *Make creative sound your hobby*. Mark Mooney outlines ideas for recording.

Hi-Fi Stereo Review (American) (June): *Musical Monstrosities*. Humorous article by Frank and Rilla Remington.

Amateur Film Maker (June-July): *How to edit sound on a magnetic tape*.

V.I.Ps PEOPLE IN THE NEWS

E.M.I. Sales and Service Ltd. sales staff gather in the Shillingford Bridge Hotel garden prior to their first Sales Convention held at Wallingford, Berks., at the beginning of July.

The group includes Mr. H. A. Lewis, Managing Director, third from right, and Mr. P. H. Wetherill, Sales Manager (third from left).



THE WORLD OF TAPE

Los Angeles

THE biggest drawback to the use of tape for television recording—editing—looks as though it has been overcome.

Station KTLA, owned by Paramount TV Productions here, has developed the "TVola", which, it is claimed, makes video-tape as easy to edit as film.

The heart of the device is a portable 200-transistor console coupled to four Hughes memory tubes. This has been designed to freeze a frame image for as long as 20 minutes.

Previously it has been near impossible to locate accurately a splicing position. The process normally takes 45 minutes—it will be done in as many seconds with the TVola.

It will be ready for marketing before the end of the year by Paramount's subsidiary, Autometric.

Enthusiasts aid experts

TAPE recorders fitted to amateur radio enthusiasts' equipment in Britain are helping to record the "bleeps" of American and Russian space satellites. Not only this, but the amateur recordings often pick up signals missed by the official British tracking team at the Radio Research Station at Slough.

The amateur's work is well valued and in exchange for their recordings they get detailed predictions of where the satellites will be each day. The signals on tape are then changed into a permanent visual form and the experts can then discover the result of experiments being made inside the satellite while it is in space.

Teenage tapes

TEENAGERS in the West of Scotland have become voice conscious. Maybe it's the influence all these pop singers have on them? Anyway, tape recorders are being used in clubs and sessions of voice recordings with all the resultant criticisms from members often adds up to a hilarious evening. Maybe we're in for a new era of pop singers?

Equipment Under Test

THE PHILIPS EL 3542

By

H. Burrell-Hadden



THE EL 3542 recorder is the latest in the series of domestic tape recorders manufactured by the great Philips company. Philips have been manufacturing recording machines for more than 30 years, starting with sound on film photographic equipment, later with the Philips-Miller recorders used by many recording organisations during the war, and, of course, more recently with high quality professional magnetic tape equipment.

The EL 3542 is a four-track monophonic machine, that is it will record four separate tracks on standard quarter-inch wide tape. Three tape speeds are available, $7\frac{1}{2}$, $3\frac{1}{4}$, $1\frac{3}{8}$ ips. This means that using double play tape on a seven-inch reel, reasonable quality recording lasting 16 hours can be made or an exceptionally high quality recording lasting four hours. This machine is therefore, very economical on tape.

Fast wind and rewind are available and automatic stopping is provided both in these and in record and playback positions. This last is achieved by a metal foil on the tape. Suitable foil can be purchased from tape suppliers.

Inputs are provided for microphone (0.1 megohm), and radio/gram (1 megohm). Separate volume controls are provided for both these inputs so that mixing of, say speech and gramophone music can be carried out.

On playback a tone control is provided and the whole amplifier can be switched as a straight-through ampli-

fier for recorder, player or microphone. Facility is provided for monitoring on headphones while recording, and a magic eye indicator shows recording level. A pause control to halt the tape for short periods without stopping the motors is provided as well as a superimposition control enabling speech to be added over an existing recording. The timing indicator is of the digital type.

On playback the 2.5 watts output is fed to a five-inch diameter loudspeaker, and additional loudspeaker sockets are provided. A further socket provides an output to feed a high quality amplifier, whilst yet another socket is connected to the second head, so that with an additional amplifier and loudspeaker, stereo recordings can be played.

The recorder is attractively styled in a two-tone grey leatherette case and a microphone type EL 3750 is provided.

Frequency response measurements on the recorder gave very good results, although perhaps not quite so good as might be expected from the maker's specification. This states frequency ranges only, without stating tolerance limits.

At all speeds these ranges were undoubtedly met but at the extreme high frequency end of the range, levels were lower than the normal limits. Both replay tests using the *Tape*

Recording Magazine test tape, and overall "in/out" tests showed excellent correlation, and even the $1\frac{3}{8}$ ips speed gave quite good results on music. Wow and flutter were negligible at $7\frac{1}{2}$ and $3\frac{1}{4}$ ips and tolerable at $1\frac{3}{8}$ ips. In all other respects the makers specification was met.

One criticism: the compartment for carrying the mains lead is situated underneath the recorder and is closed by a removable plastic grid. This may be much stronger than it looks, but I felt that in appearance at least, it was rather flimsy and might soon be broken.

A word of praise for the excellent 15-page manual of operating instructions. In addition to a very comprehensive guide to the actual working of the machine there is a mine of information about microphone technique and suggestions for using the equipment. Editing and tape splicing are not forgotten. The book includes a list of useful accessories which can be obtained from Philips dealers.

The recorder sells at 59 gns. and I can thoroughly recommend this as a first-class piece of equipment.

Manufacturers Specifications

Mains supply: AC only, 110-245 volts, 50 cycles.

Frequency responses, 50-7,000 cps ($1\frac{3}{8}$ ips);

50-15,000 cps ($3\frac{1}{4}$ ips)

50-20,000 cps ($7\frac{1}{2}$ ips).

Signal-to-noise ratio, better than -40 dB.

Wow and flutter, less than 0.2 per cent at $7\frac{1}{2}$ ips.

Valves: EF 86, ECC 83, ECL 82, EM 81, EZ 80.

Power consumption, 60 watt.

Dimensions, $15\frac{1}{2}$ x 13 x $6\frac{1}{4}$ in.

Weight, 30 lbs.

Tropicalised.

Playback outputs, additional loudspeaker (3-7 ohms, 2.5 watts, 2 pole plug); radio/amplifier (0.05 megohm, 1.5 volts 2 pole plug) headphones, (1,000 ohms, 100 millivolts, 2 pole plug); stereo (1 megohm, 1 millivolt (166 cps), 2 pole plug; 4.5 millivolts (8,000 cps) for 100 per cent modulated (3 pole plug).

Our next issue will feature

STUDIO ACOUSTICS

the first article in a new series

by ALEC NISBETT

plus

A preview of tape recording and hi-fi equipment at the 1960 Radio Show

Out—August 10

Price—1s. 6d.

No Stereo in the Drawing Room

ANY tape recording club, or similar organisation interested in high quality home reproduction, might well consider organising a discussion evening at which wives are invited to give their views on the problem of fitting equipment into the home. There is a good deal of misunderstanding on this subject one way and another, especially of the kind that results in a stand being taken because of a mistaken belief that various features objected to are unavoidable. Most people agree, of course, that wives have a pretty strong claim on the score of furnishing and decoration since they usually spend much more of their time in the home than anyone else.

I heard of a case the other day of a wife who would not agree to stereo coming into the home at any price because of "all the clutter." It was many months be-

Stereo Notes

By D. W. GARDNER

fore it was discovered that she had been quite certain that two large corner speakers were needed for stereo. Her attitude changed for the better when her misconception came to light through a chance discussion and she discovered that two moderately-sized bookcase units would do the job.

Another case that came to my notice has given me plenty of food for thought. It began with a very firm "No stereo in the drawing room," but there was a casual post-script "unless you can keep it out of sight behind the settee when it isn't being used."

Odd afterthoughts of this kind can sometimes transform the picture—and may provide vital

clues in our collective search for the satisfactory integration of stereo into the domestic scene.

The settee in question normally stands about twelve inches from the wall, and it is interesting to speculate on the scope this might provide, accepting the disadvantage of the fact that anyone sitting on the settee probably would not enjoy a stereo effect.

One might think in terms of a large speaker substantially housed in the centre, and directed upwards, for the low frequencies together with small high-frequency units at each end—which would be visible and correctly positioned when stereo is being played.

Alternatively, two speakers of reasonable size might be arranged in such a way that they could be rolled out when needed—or raised above the height of the settee by some simple mechanical device.

"Hiding" the equipment is another problem, but I think that few wives would object to a visible tape recorder or gramophone unit providing the speakers are "looked after."

TRANSISTOR TUNER

FURTHER DETAILS

THE coil specified for our article on the T.R.F. transistor tuner was inadvertently quoted as a "range 1 green" Denco Maxi-Q coil. This should have read "Range 2 Green."

NOTE.—There are two types of Denco Maxi-Q coil. One has standard pins and plugs into an octal base and this is the one specified for our T.R.F. tuner. The other miniturised version plugs into a B7G base and is unsuitable for the tuner.

Readers have asked for identification of the transistor connections. These are as per the diagram below.

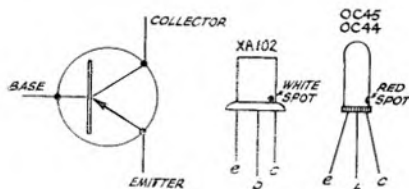

TAPE RECORDING CROSSWORD

ACROSS

- 2 and 13. How will I know where the tape really begins? It's child's play (6, 3, 6)
7. Heard in the Collaro arrival room (4)
8. An outspoken nuisance shows what tape recorder owners should never feel (5)
10. Jo Corbet—angry young man, perhaps? (8)
12. I have to leave the long speech for commerce (5)
13. See 2 across
14. Formerly impertinent, yet skillful? (6)
15. The French in the automobile? Why not? I can see through it! (5)
16. With 50 and 1,000 on his boat, Noah would have sought this (8)
19. Comes after the motor for transport (5)
21. The place for the ties (4)
22. Shunt soda for large numbers? (9)

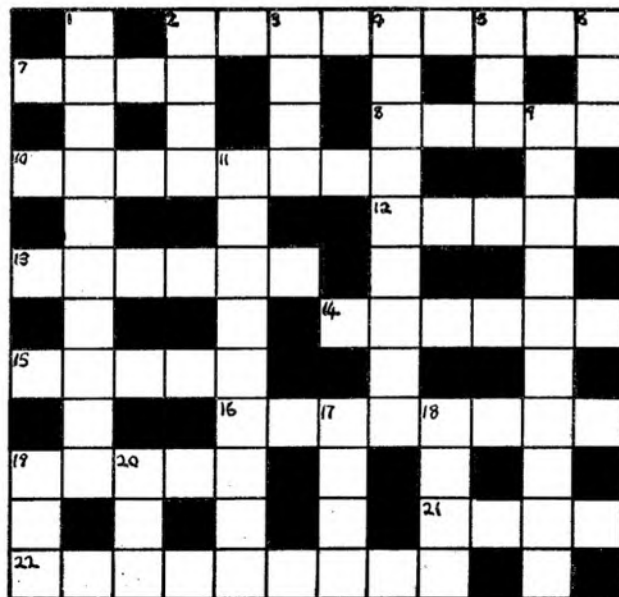

DOWN

1. Does it mean you have to put this tape on twice? (6, 4)
3. Tool up for booty (4)
4. Could be said of well-used recorder, but not of its purchaser (9)
5. Number reversed in cabinet (3)
6. Tape from the portable Minivox (3)
9. What the correspondents at Lloyd's do, is apparently insufficient (10)
11. Is this what you do when your team has a bad time of it? (9)
17. Palindrome time (4)
18. She won't make the Hit Parade (4)
19. Different act for household pet (3)
20. Goes with Bill? (3)



STORIES ON TAPE

FISHER ELECTRONICS LTD. are entering the pre-recorded tape field with stories for children.

The tapes, entitled "Anthology of the World's Tales," are to be released on five-inch spools, recorded at 3½ ips. Each of the four tapes in the initial issue will contain four stories, two per track on the standard two-track tapes.

The stories are aimed at the age group between seven and ten, and have been selected to provide interest for children of both sexes. The narration is by Melanie Scott, a newcomer to these shores, but no stranger to the broadcasting concerns in South Africa and other parts of the Commonwealth.

Fisher Electronics Ltd., 60-66, Wardour Street, W.1.



Telephone adaptor

ANOTHER Cosmocord product first shown at the Audio Fair and now in full series production is the Acos Telephone Adaptor. This small adaptor is fixed to any telephone or intercom by a rubber suction pad, as shown above, and permits the recording and amplification of two-way conversations.

The price is £1 1s.

Cosmocord Limited, Eleanor Cross Road, Waltham Cross, Hertfordshire

New Products

VERITONE MARKET NEW RECORDER AND MIXER UNIT

VERITONE LIMITED have recently introduced their first low-priced recorder. Utilising the Collaro Studio deck with three speeds, 1½, 3½, 7½ ips, the new recorder—the Vantage Portable—will retail at 42 guineas.

It has a quoted frequency response of 60-12,000 cps, and an output of 3½ watts through the 7 x 4 inches loudspeaker.

Facilities provided include superimposition, monitoring, separate bass and treble controls, safety erase lock, and digital rev. counter. Seven-inch spools are accommodated, providing a maximum playing time of eight-and-a-half hours on double-play tape.

The dimensions are 17½ x 15½ x 7½ inches, with a total weight of 30 lb.

Included in the price is an Acos Mic 40, spool of tape, spare spool, and radio lead.

Veritone have also introduced a self-powered transistorised mixer unit providing three inputs for microphone, radio and gram signals, each having separate volume controls. Ever-Ready batteries give 6-9 months use, and the price is 7 guineas.



Veritone Limited, 5, Avenue Parade, Ridge Avenue, London, N.21.

TELETAPE OPEN LONDON "TAPE BAR"

CLAIMED to be the first of its kind in this country, a "tape bar" has been opened at 33, Edgware Road, Marble Arch, London, by the Teletape concern. Two listening booths are installed in which it is hoped in the future to allow customers to hear any of the pre-recorded tapes available in this country. At present the numbers of tapes are limited,

but when the American United Stereo Tape division of the Ampex Corporation releases some of their tapes for Great Britain there will be a wider selection.

Apart from the "tape bar," the shop also provides facilities for hearing a majority of recorders immediately, and, if desired, through a variety of loudspeakers.

NEW FI-CORD

FI-CORD LTD., have introduced their latest recorder, a transistorised dictating machine—the 101. With a single speed of 1½ ips providing thirty minutes playing time, it measures 6½ x 3½ x 1½ inches and weighs only 27 ounces. The price is £55 13s.

The complete set of accessories supplied for the 101 are illustrated right, and include carrying case (£4 19s. 10d., including lapel microphone, telephone adaptor unit, 3 spare tapes, two spare batteries and forty index cards); stethophones with built-in volume control (£4 19s. 6d.); tape despatch carton and tape (12s. 9d.); desk stand and multiple listening loudspeaker (£21); and transcriber, left centre, with foot control (15 15s.).

Fi-Cord (Distribution) Ltd., 40a, Dover St., London, W.1.



News from the Clubs

Edited by

FRED CHANDLER

HAVE you noticed the influx of the ladies to tape recording?

Only a year ago, I can recall, a number of clubs regularly included a paragraph in their newsletters informing me that "refreshments were provided by the ladies." Since that time a transformation has taken place. With ever-increasing frequency I hear that the fair sex are being enrolled into *active* membership.

No longer are they content to sit back and listen to their husbands and boy friends exchange technicalities at the meetings—waiting for the nod signifying that refreshments should be served at the end of the next tape. They want to be in there with them. And they are certainly doing just that.

During the last twelve months a number of articles have appeared through these pages, written by or about the female tape enthusiast. Nearer home, to this page, we have heard of the successful **Ware** club, founded and encouraged by Mrs. Campbell and Mrs. Wakely. And if you cast your eyes down this page, you will see a photograph of another club which although small at present has a membership almost fifty per cent female.

This is the **Eastbourne** club, formed by Mrs. Dee Harris, with twelve members who meet on alternate Saturday evenings at the Y.M.C.A., Hartington Hall.

In general with other clubs, some of the really keen members meet midweek to compile musique concrete and for general practical work.

Members have been making the most of the local carnival activities. Mrs. Harris recently recorded a commentary of a carnival procession, while others were out interviewing holiday makers. A publicity scheme is in progress and our photo shows members of the club—who's looking for tape contacts—with a Grundig, and one of our publicity posters.

Walthamstow members decorated a van loaned to them by a local radio dealer and, to the rousing strains of Souza marches, journeyed around five miles of Walthamstow streets in the carnival procession held last month. Members Don Cooper, Bernard Wells, Sam Koster and Cyril Woods all co-operated to make the entry an attractive if at times noisy success (see photo bottom left).

During a busy festive day, members operated battery and mains recorders to record material for a tape which was played back in a hospital a few days later.

Other members were at the Connaught Hospital on the day of the carnival providing another in the regular series of fortnightly request programmes.

The sometimes hilarious day was summed up by secretary Ken Parks who said "although at times we didn't know whether we were coming or going, everything went off perfectly."

Members of the **Nottingham** club heard local secretary Norman Littlewood and Terry Sylvester describe the production of a documentary tape at the June 9 meeting.

The tape under discussion was "Saturday Roundabout visits the London Planetarium" the tape produced by students at the recent Rose Bruford Tape Course. Norman and Terry both attended the College and in general

praise of the organisation, stressed the tremendous co-operation received from everyone concerned during their stay.

A fortnight later, on June 23, members started production of their own tape which they are calling "Nottingham Roundabout." Their July 7 meeting was a Social Night. For the next two meetings, July 21 and August 4, they intend to hold a practical demonstration of magnetic strip recording on 16 mm. film, and a practical recording evening around the city with portable recorders.

Trevor Gilbert, vice-chairman of the **Warwick and Leamington** Society told members at the June meeting that his home-constructed stereophonic tape recorder had been awarded a prize in the British Sound Recording Association's National competition held in London recently.

Another pleasing item of news concerned their hospital service. Following the club's offer to play tapes to the aged and infirm in conjunction with the British Red Cross, they will be starting a programme at Castle Fromer in Leamington Spa on October 5. If any organisation or individual would like to take advantage of this service they are requested to contact the publicity officer, Miss E. Jones, 26, Hampton Street, Leamington Spa.

Earlier in the evening Chris Barnacle had presented another of his tape/slide shows, this time transporting members to the beauty of the Welsh mountains. During the programme recordings of Chris's sleeping hours among the mountains were heard—serving as a warning to others not to teach parents how to operate a recorder.

Members of the **Rugby** club will have had some grist added to their tape discussions mill during the earlier part of this month. The reason being the seven-inch reel of tape brought back from the National Congress by Mr. G. Dawson.

Recorded on the tape were extracts of the speeches made at the Congress, and parts of the debate which followed. Some interesting comments are liable to arise from the tape playback among the democratic minded and point raising members.

Although they spend a good deal of time in discussion, members also pay a lot of attention to what goes on around them. It has been estimated that over

(Continued on page 26)



Left to right: Don Cooper, Bernard Wells, Sam Koster and Cyril Longley of the Walthamstow club prepared for battle in the Walthamstow Carnival. Right: Eastbourne club members with (back row, left to right) Secretary Brian Whattingham, Treasurer Patricia Edwards, Chairman Dee Harris, Teresa Holroyd, Dennis Goldstraw. Front row: Margaret Lord and Peter Kefford

SPECIAL OFFER — *Half-a-crown to* *find a ready buyer or a willing seller*

IF YOU HAVE SURPLUS EQUIPMENT YOU WISH TO SELL, OR IF YOU WANT TO BUY ITEMS SECOND-HAND, YOU WILL GET RESULTS BY USING OUR CLASSIFIED COLUMNS. TO PROVE THE POINT, WE ARE OFFERING READERS A SPECIAL RATE UNTIL SEPTEMBER 1st NEXT—2s. 6d. FOR UP TO TWENTY WORDS IF YOU USE THE FORM BELOW

Classified advertisements

Trade, ninepence per word (minimum 10s.); box numbers, one shilling extra. Payment with copy. Copy should be sent to Advertisement Department, "Tape Recording Magazine," 1, Crane Court, Fleet Street, London, E.C.4.

Tape—Tape—Tape. BASF—Irish—Scotch. All types in stock. Send for price lists. C.W.O. Post free. Tape Recorder Centre (Halifax), 17, Rawson St., Halifax.

W.A.L. Booster pre-amplifiers, the transistorised WAL GAIN, for tape heads (Gramdeck, Fi-Cord, Ferrograph, etc.), Mics (Reslo, etc.), p.u.s. (Garrard, Ortofon, etc., Decca ffs, etc.). Many applications including Mixing. Mono Wal Gain £5, Stereo £7 10s. The new WALTRAK, pocket audio oscillator with 1,000 cps signal, transistorised. Ideal for circuit checking £6 10s. The WAL BULK TAPE ERASER "cleans" reels of tape in 30 secs. £7 18s. 6d. Ask your dealer or send to us for full Technical literature. Wellington Acoustic Laboratories Ltd., TRCDG Dept, Farnham, Surrey.

JOHN HASSELL RECORDINGS. Tape/Discs. All Speeds. CCIR Studio, 21, Nassau Road, London, S.W.13. Riverside 7150.

Tape to Disc—All Speeds. Rendezvous Records. 19, Blackfriars Street, Manchester 3. Leaflet on request.

FRIENDLY FOLK ASSOCIATION, 87, Terrace, Torquay. Leading International Correspondence Hobby Club since 1943. Now included, facilities for Tapesponding. Details free.

TAPE TO DISC—ALL SPEEDS; s.a.e. for leaflet. OMEGA RECORDING COMPANY, 112, Sunnybank Road, Potters Bar, Middx. Tel.: 6428 evenings.

EASYSPLICE TAPE SPLICER SPECIAL OFFER 3s. 9d. plus 6d. p. & p. guaranteed for easy accurate tape splicing. Easysplice Co., 30 Lawrence Road, Ealing.

Truvox two speed recorder Mark III deck, perfect, complete mike, tape. Bargain £24 o.n.o. Box 377.

Grundig TK830-30 complete. Mike and mike-extension lead, in perfect condition. Three speakers, two speed, £65. R. Onions, Norton Lindsey, Warwick.

Collaro Studio deck unused, cost £16 accept £12. Acos mic 40 £1. 27 Great North Way, Hendon, N.W.4. SUN: 1946

Try our bargain offers. Send us details of the machine you want and let us make you one of our bargain offers. Send s.a.e. You will be pleased. The High Fidelity Centre, 61, West Street, Dorking.

SIMON SP4, latest model, as new, perfect, guaranteed, sacrifice, 72 gns. Box No. 375.

FERROGRAPH 808, latest stereo model, unused, perfect, guaranteed, must sell, £90. Box No. 376.

Clarion Transitape, under guarantee, two extra leads £17. Cadenza high imp. ribbon mic in presentation case £8. G. Elliott, 87, Tanworth Lane, Shirley, Nr. Birmingham.

FOR SALE—Stuzzi battery portable. Only three months old. Mint condition. Original tapes and batteries. Carrying case. Cost £75 new. Any reasonable offer considered. Tel.: Woldingham 2218 evs. Temple Bar 9081 day.

Körting Stereo tape recorder only six months old. Cost 68 gns, will accept 50 gns. Genuine reason for sale. D. Blends, 22, Woodlands Ave., Woodley, Cheshire.

Grundig ribbon microphone, cost 13 gns, perfect working order, 5 gns post paid. Thompson, "Freya", Haverigg Millom, Cumberland.

Harting H.M.8 stereo record/replay, four months old, under guarantee, cost new £90, accept £65. Salmon, 31, Lady Margaret Road, Ifield, Crawley, Sussex.

Recording enthusiast wanted for amateur war fiction film, duration two years, willing to pay own expenses, knowledge of outdoor recording. Derek Milburn, Pegasus Film Unit, 1, Micawber Court, London, N.1.

Dig this, pen pals all ages, interests, cheapest service in the country, details s.a.e c/o P.S.A., 1a, Foulden Terrace, N.16.

Tape recorder enthusiasts required by tape recorder specialists for Saturday sales staff. Sales ability, good appearance essential. Interesting well-paid day's work. Maryland 5879.

CLASSIFIED ADVERT — SPECIAL OFFER

I enclose postal order for 2s. 6d. Please insert as follows

Name Address

(Classified adverts must be received 14 days prior to date of the issue for which they are intended.)

Trade announcements not included. Box number extra

B I N D E R S

The special binders for *Tape Recording and Hi-Fi Magazine* are now available

No more torn covers and dog-eared edges ★ No more hunting for mislaid copies ★ Each copy is inserted as received to form a completely bound volume for permanent reference ★ All pages open flat and effect secure binding with steel bars from first to last copy ★ Strong board binders covered with rexine with the title printed in gold on spine

PRICE 14s. 6d.
(post free)

Order from :
7, Tudor St., London, E.C.4

LOCAL DEALERS
THE SOUTH

There is always something extra when you buy a TAPE RECORDER from

THE HIGH-FIDELITY CENTRE
TAPE RECORDERS — HI-FI SPECIALISTS
— RECORDS

LARGEST STOCKISTS

Recorder Hire Service

SEND FOR OUR BARGAIN LISTS OF NEW AND SECONDHAND EQUIPMENT.

EQUIPMENT BUILT TO ORDER. Dorking 4229
61 WEST STREET, DORKING, SURREY

MIDLANDS

TAPE RECORDERS

on "NO-INTEREST" Terms!

NO EXTRA CHARGES FOR EXTENDED CREDIT. You pay the Retail Price only. Grundig, British Ferrograph, Philips, Vortexion, Telefunken, etc. Comparative demonstrations daily of all leading makes of Stereo Hi-Fi Equipment & Tape Recorders.

JEWKES & CO. LTD.

The Midlands Hi-Fi and Tape Recorder Specialists

285, Broad Street, Birmingham
Tel: MID 4829/20

R-E-S of COVENTRY

SPECIALISTS IN HIGH FIDELITY and all makes of Tape Recorders

- * Stocks of Stereophonic and Pre-Recorded Tapes
- * Demonstrations always available by fully qualified staff
- * The Best Selection—Terms or After Sales Service in the MIDLANDS

R-E-S (COVENTRY) LTD.

128 FAR GOSFORD STREET
Coventry 28781/2

NORTH-WEST

LIVERPOOL'S
TAPE SPECIALISTS.

Offer unique sales and service facilities throughout the North-west

Stockists of FERROGRAPH, REFLECTOGRAPH, GRUNDIG, etc., etc.
FREE H.P. up to 12 MONTHS.

COGHLAN & ROBINSON
LTD. 18 HACKINS HEY, (off Dale St.),
LIVERPOOL 2. CEN: 5245.

Price Reduced

TAPE TIME CALCULATOR

The *Tape Recording and Hi-Fi Magazine* accessory, giving playing times for any size reel or length of tape is now available again—and at a reduced price.

Repeated requests for this simple, read-at-a-glance device for any speed from $\frac{1}{8}$ ths to 15ips, have led us to reprint and orders can now be accepted at the address given below.

Price 2/6d

(3/- including postage)

Order from:

Tape Recording Magazine,
7, Tudor St., London, E.C.4

TAPE TO DISC SERVICES

SSS Private gramophone record made from your own tape
Microgroove LPs from 20/6
Standard 78s from 10/6
Mobile Unit available for Weddings, Receptions, Choirs, Meetings, etc. S.A.E. for full details:—
John Leviss, Sunderland Sound Services,
28, Viewforth Terrace, Sunderland S7032
* If you can hear it—We can record it! *

RAPID

Recording Service

78's and L.P.'s from your own tapes.
Master Discs and Pressings.
Recording Studio equipped with Bechstein Grand.
Practising studios with or without accompanist.
Mobile Recording Van.
"Off the Air" Service.

21, Bishops Close, Walthamstow, E.17. COP 3889

When writing to manufacturers for information about new products, please mention that you saw it in "Tape Recording and Hi-Fi Magazine."

Index to Advertisers

	page
Coghlan and Robinson Ltd.	25
Dektron	5
Deroy Sound Service	25
Dixon's Tape Recorders	4
Francis of Streatham	2
G.B.C. Electronics Ltd.	Front cover
Grampian Reproducers Ltd.	27
Howard Photographic	2
Jewkes & Co. Ltd.	25
Lustraphone Ltd.	4
Magnegraph	25
Multicore Solders Ltd.	4
Nusound Recording	4
Psycho-Tape Institute	4
Radiostructor	27
Rapid Recording Service	25
Reps (Tape Recorders) Ltd.....	27
R-E-S (Coventry) Ltd.	25
R. E. W. Earlsfield.....	26
The High Fidelity Centre.....	25
The Tape Recorder Centre Ltd.	28
The Gramophone Co. Ltd.	3
WyndSOR Recording Co. Ltd.	6

TAPE RECORDER HIRE

**TAPE TO DISC 78-LP
RECORDING STUDIO
SALES—EXCHANGES**

MAGNEGRAPH

1, Hanway Place, London, W.1.
s.a.e. for leaflet or
telephone: LAN 2156

**TAPE TO DISC
RECORDING**

Microgroove LP from 27/6d.
78 rpm from 11/-

Also 45 rpm

48 HOUR SERVICE

S.A.E. for comprehensive leaflet to:—
Marsh, "Deroy" Sound Service, Little
Place, Moss Delph Lane, Aughton, Orms-
kirk, Lancashire. Tel.: AUG 3102

News from the Clubs

(Continued from page 23)

130 hours was spent rehearsing and dubbing effects for the Girl Guides Pageant held on July 2. Over 800 persons attended the show, and Rugby gained some valuable publicity.

Demonstrations of personal recorders occupied the June 30 meeting, and among machines shown were the Brenell Mk. V by Mr. Pick, the Butoba MT4 by Mr. Williams, and the Stellaphone by Mr. Key.

The technique of interviewing was the main subject for the June 16 meeting of the Rugby club. Leslie Skingley of the Coventry club had been invited along for the evening and, repeating his success at the club's February meeting, started the ball rolling with a talk on the correct method of setting about this exacting occupation.

Station Officer Mann of the Rugby Fire Service had been invited to the meeting to give an account of the work done by members of the Fire Service. Mr. Dawson, putting into effect the lessons taught by Mr. Skingley, recorded an interview with Mr. Mann and the tape was played back, providing the Station Officer with the initial hearing of his own voice.

A light-hearted meeting of the South-west London club took place on June 15, when members recorded the first two scenes of a pantomime specially written for them by members Richard King and Denys Killick.

At a later meeting, on June 29, members welcomed Mr. P. E. G. Allen of

Grundig, who demonstrated the TK60 stereo model. A demonstration using the machine's own speakers was heard and compared with the result using two speakers loaned for the occasion by Bemar Teleradios Ltd., a local dealer.

The evening ended with a stereo recording being made of the questions put to Mr. Allen.

Accompanying recent greetings from Down Under, was a report from the New Zealand tape club. This announced a reshuffle in the organisation to provide greater coverage for tape enthusiasts within the Dominion. Previously, the "active" side of the club has been predominant in Auckland. It is now intended to extend the activities of the club, and branches are being formed throughout the country.

Murray Spiers, the former Secretary, now lives in Canada, and his post has been filled by Ken Tuxford, P.O. Box 7060, Ponsonby, Auckland, New Zealand. Dan Harkins is now the National President.

An interesting extract from the Australian Tape Recordists Association concerns member Ray Condor. A tape exchange enthusiast, he has successfully contacted a man with similar interests in Moscow. Following the receipt of his first tape from the Soviet Union, he sent a 3in. tape and requested a copy of the Russian National Anthem.

In the ATRA Newsletter he wrote: "Happily my Soviet friend speaks perfect English and is very co-operative."

For enthusiasts keen to take part in a Round Robin tape exchange, I pass on details of a club being formed by Mr.

R. M. Stimpson of 769, Oxford Road, Reading, Berkshire.

Together with Mr. A. Jefferson, 60, Langford Road, Burley-in-Wharfedale, near Ilkley, Yorkshire, he intends to circulate amongst an unlimited number of enthusiasts, a 7 in. tape every six months, and a 5 in. reel every three or four.

An initial charge for membership is seven shillings, to cover the cost of tape and communication expenses.

Each member will be allowed a ten-minute section of the tape and may keep the spool for a week before passing it on.

Lee Lacy, Editor of *The Voicespondence* club's tape magazine *Voices in the Post*, has asked me to point out that the magazine is "resting" for the summer and will re-appear in September. Inquiries about the magazine and the Voicespondence club will be attended to by Lee at 15, Fentons Avenue, Plaistow, London, E.13. Please enclose S.A.E.

Hans Baljet, a 47 year-old Dutch schoolteacher, has written asking for a tape contact. His interests include anything to do with the way of life and conditions in England; the English language; and the establishment of a regular exchange of tape between his 14-19 year-old pupils, and English boys and girls of the same age.

His recorder has three speeds, 1 7/8, 3 1/2 and 7 1/2 ips, and his address is Noordersingel 20, Hoogezand, Holland.

The Bristol Club has had a change of Secretary and meeting place. The new secretary is Mr. M. E. Hollier, 27, Dean Lane, Southville, Bristol 3, and meetings are to be held on alternate Wednesdays at the Ship Inn, Recliff Hill. The next on August 3.

HIGH QUALITY TAPE RECORDER SPECIALISTS!

BEST PART EXCHANGE

OFFICIALLY APPOINTED AGENTS FOR:

- | | |
|--------------|-----------------|
| ★ FERROGRAPH | ★ REFLECTOGRAPH |
| ★ SIMON | ★ GRUNDIG |
| ★ REPS | ★ BRENELL |
| ★ VORTEXION | ★ WYNSOR |

ALLOWANCE ON YOUR PRESENT TAPE RECORDER — HI-FI EQUIPMENT

MONO RECORDERS	Verdik 45 gns.	*Ferrograph 808 ... 105 gns.	Grundig
Geloso 26 gns.	Specto 161 49 gns.	Ferrograph Stereo Add. 30 gns.	Etc.
Stuzzi-Mambo 39 gns.	Specto 171 39 gns.	TRANSISTOR—BATTERY	TAPES
Kurland Hi-Fi 56 gns.	Veritone Venus... .. 58 gns.	Grundig Cub 26 gns.	B.A.S.F.
Brenell 3-Star 58 gns.	Philips 38 gns.	Clarion 25 gns.	Audiotape
*Brenell Mk. 5 64 gns.	Philips EL 3542 59 gns.	Fi-Cord 59 gns.	Irish Tape
Wynsors Victor 45 gns.	Simon Minstrelle 39 gns.	*Butoba 69 gns.	E.M.I.
Walter 101 29 gns.	Simon SP4 95 gns.	Minivox 37 gns.	Ferrograph
Walter De-Luxe 42 gns.	Saba Hi-Fi 79 gns.	Stuzzi-Magnette 69 gns.	Grundig
Walter 505 57 gns.	*Vortexion WVA 89 gns.	Steelman 55 gns.	PRE-RECORDED TAPES
Perth Saja 45 gns.	*Ferrograph 4 AN 81 gns.	MICROPHONES	ACCESSORIES
Perth Saja De-Luxe 56 gns.	*Ferrograph 4 SN 88 gns.	Reslo	TUNERS
*Telefunken 75 KL-15 52 gns.	STEREO	Lustraphone	AMPLIFIERS
*Telefunken 85 KL 79 gns.	*Korting 68 gns.	Cadenza	SPEAKERS
Grundig TK 20 52 gns.	*Harting HM8 86 gns.	T.S.L.	PICK-UPS
*Grundig TK 25 62 gns.	*Brenell Mk.V 92 gns.	A.K.G.	MOTORS
*Grundig TK 30... .. 72 gns.			

* MICROPHONE EXTRA

THE BEST TERMS NO INTEREST 20% deposit, up to 2 years to pay. ON THE BALANCE.

FREE SERVICING — FREE DELIVERY — FREE TAPE OFFERS — 150 MACHINES ON DISPLAY — OUR MAIL ORDER DEPARTMENT WILL DEAL WITH YOUR ENQUIRY BY RETURN. WRITE — PHONE — CALL FOR A QUOTATION ON YOUR MACHINE. A LARGE SELECTION OF USED TAPE RECORDERS.

REW EARLSFIELD LTD. 545 GARRATT LANE, S.W. 18 Tel.: WIM 0709

10 minutes from Tooting Broadway underground station. 100 yards from Earlsfield Station

NEW! DO-IT-YOURSELF TRAINING TECHNIQUE in RADIO & ELECTRONICS

You LEARN while you BUILD...

SIMPLE...PRACTICAL...FASCINATING...

ANNOUNCING—after years of successful operation in other countries—the latest system in home training in electronics introduced by a new British training organisation. AT LAST—a simple way of learning—by practical means—the 'how and why' of electronics with the minimum of theory and no mathematics! YOU LEARN WHILST BUILDING actual equipment with the components and parts which we send you—and you really have fun whilst learning! And afterwards—you have a first-rate piece of home equipment plus the knowledge of how it works and how it can be serviced. THIS NEW SYSTEM brings an exciting new opportunity and is very moderate in cost. Post the coupon now without any obligation for full details.



BUILD YOUR OWN:—

- RADIO EQUIPMENT
 - HI-FI INSTALLATION
 - TEST EQUIPMENT
- AND LEARN AS YOU DO IT

LOTS OF INSTRUCTIVE EXPERIMENTS AT HOME!

No Mathematics!

FREE-
POST TODAY

To: RADIOSTRUCTOR (Dept. G35)
46 Market Place, Reading, Berks.
Please send Brochure without obligation to

Name: _____ BLOCK
Address: _____ CAPS
(812) _____ PLEASE
11-59

RADIOSTRUCTOR
BRITAIN'S LEADING ELECTRONIC TRAINING ORGANISATION

Grampian DP4



brings out the best in any recorder

Even the most expensive recorder will only give its best performance if a good quality, reliable microphone is used.

In the DP4, with a uniform wide frequency response from 50 c/s to 15,000 c/s, Grampian have developed an outstanding, moderately priced instrument which will please the most exacting recordist.

The DP4 is equally suitable for Public Address, Broadcasting, Call Systems, etc.

OUTPUT LEVELS

DP4/L low impedance: 25 ohms 86 dB below 1 volt/dyne/2CM.
DP4/M, medium impedance: 600 ohms 70 dB below 1 volt/dyne/2CM.
DP4/H high impedance: 50,000 ohms 52 dB below 1 volt/dyne/2CM.

Retail Price: DP4/L complete with connector and 18ft. screened lead, £7 11s.
(Medium or High Impedance models, £1 extra).

A complete range of stands, swivel holders, etc., is available also.

A matching Unit (Type G7) can be supplied for adapting the microphone for a Recorder having a different input impedance, or when a long lead is required. Retail Price, £3 5s.

Write or telephone for illustrated literature

GRAMPIAN REPRODUCERS LIMITED
21 Hanworth Trading Estate, Feltham, Middlesex, FELtham 2657



TWO YEAR GUARANTEE NOT MASS PRODUCED— BUT VIRTUALLY HAND-MADE FOR RELIABILITY AND CONSISTENTLY HIGH STANDARD OF PERFORMANCE

- ★ 1 7/8 ips can be fitted for an extra 3 gns. ★ Superimposing fitted as standard
- ★ Provision for 2-or 4-track stereo. ★ Mixing facilities

MODELS:

- R20 62 GNS.** with magic eye recorder indicator.
- R30 66 GNS.** with meter record level indicator.
- R40 70 GNS.** as R30 but with push/pull sound.

TECHNICAL SPECIFICATION

The R40. 1 7/8 ips 70—4,500 ± 3dB. 3 3/4 ips 60—9,000 ± 3dB. 7 1/2 ips 50—15,000 ± 3dB. 15 ips 40—20,000 ± 3dB. (signal noise ratio at 7 1/2 ips—47dB.). Separate record amplifier. Push-pull bias erase oscillator for low tape hiss. Separate bass and treble controls ± 15dB at 14 kc/s—15dB at 40 c/s. Supplied complete with Acos 39/1 microphone. Radio Record lead and 1,200' PVC Tape.

FURTHER FACTS:

It is not generally known that the Tape Deck mechanism is virtually re-built in the REPS machines. It is standard procedure to remove all rubber wheels—i.e., re-wind, idle and pinch—and re-grind them to a closer tolerance. Also the Capstan is skimmed to less than ± 0.0001". This has resulted in a very low "wow" factor, especially at 3 3/4 ips which has lead to the logical introduction of 1 7/8 ips in place of the 15 ips. The principal cause of "flutter" is due to the eccentricity of the three-step pulleys which control the tape speed. This eccentricity occurs when the pulley is locked to the motor shaft and is due to the off-setting action of the fixing screws. This difficulty has been overcome by manufacturing pulleys over-size and machining to the correct diameter when fitted to the motor shaft. By this method a total variation of less than 0.0001" has been achieved at 1 7/8 ips. Initial measurement indicate total "flutter" content at 1 7/8 ips to be of a lower order than previously associated with 3 3/4 ips.

D. W. Aldous of 'GRAMOPHONE RECORD REVIEW' writes in March issue:—

"The overall performance of this Repls R30 recorder, coupled with its reliability and simplicity of operation, not to mention an attractive styling, must give it a wide appeal to tape recordists seeking an all-British machine of unusual quality."

Please send me without obligation full details of your range of Tape Recorders. I am particularly interested in

Model R.....

Mr.

REPS (TAPE RECORDERS) LTD.,
Dept. T.R.H. . . . 118 PARK ROAD NORTH
SOUTH ACTON, W.3. . . Telephone: Acorn 4141



**CHOOSE IN PERSON—
CHOOSE BY POST—
NO INTEREST CHARGES**

All makes of Tape Recorders and Hi-Fi Equipment. Make sure you get exactly what you want and what you need. Make sure you get it at the best H.P. terms offered anywhere today. No interest charges on orders over £30. Make sure you choose from the Tape Recorder Centre. Choose in person — compare different makes on the spot in the Tape Recorder Centre Showroom; or choose by post — get a Free copy of the unique 72-page illustrated Tape Recorder Centre catalogue, listing hundreds of models and types.

In person or by post, the best choice in the country —

THE TAPE RECORDER CENTRE

For free Catalogue, send this coupon to
 The Tape Recorder Centre Ltd., Dept. T,
 75 Grand Parade, Green Lanes, Harringay,
 London, N.4.
 Telephone STAmford Hill 1146

T C R

Name

Address

.....
 BLOCK LETTERS PLEASE

Showroom open: Monday—Saturday 9-6, Wednesday 9-1