

TAPE

RECORDING AND HI-FI MAGAZINE

The
sound engineer
has the world
to choose from—

—but he selects **SCOTCH** magnetic tape

for highest quality reproduction, the B.B.C. and recording companies use 'scotch' brand.

WHY? Because 'scotch' brand magnetic tape gives the quality of reproduction the expert sound engineer needs and demands. The exclusive silicone 'dry lubrication' minimises wear on magnetic heads, and the tape keeps its high quality for years and years.

200 DOUBLE-PLAY

'scotch' brand 200 Double-Play tape is the latest addition to the wide range of magnetic tapes produced by 3M for the perfectionist. It has a tensilized polyester base the thinness of which allows double the length on a standard spool. Pre-stretched tensilized polyester is extra strong.



WHENEVER YOU
BUY TAPE
BE SURE THAT
YOU GET
'SCOTCH' BRAND

MINNESOTA MINING & MANUFACTURING CO. LTD. • 3M HOUSE • WIGMORE ST. • LONDON W1 AND AT BIRMINGHAM • MANCHESTER • GLASGOW

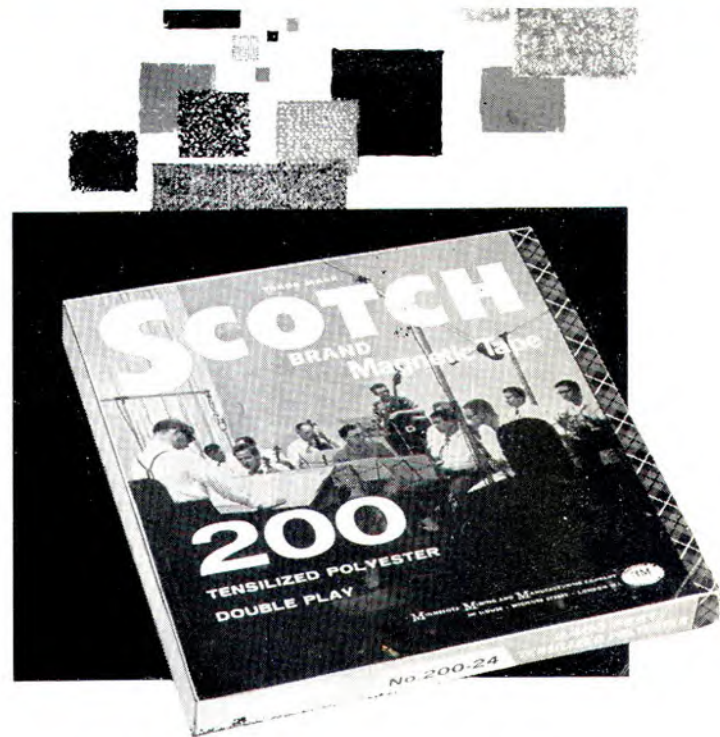

Ask for **SCOTCH** magnetic tape



BRITAIN'S LEADING PUBLICATION IN THIS FIELD



ORDEAL FOR TAPE RECORDERS

VISCOUNTS BREAK SOUND BARRIER

WYNDSORs are modestly proud of the way they make tape-recorders. And particularly of the trouble they take to ensure that every one bearing the WyndSOR motif tops the specification printed on the back of the leaflet.

The experienced WyndSOR design team don't consider it sufficient to develop a prototype, measure frequency response, signal-to-noise ratio and so on, and publish the answer as a production standard. To expect every one off the line to make the grade, however well made, is naive stuff.

So that although WyndSOR recorders are meticulously made and exclusively from close-tolerance components, they all have to run a gauntlet of quality tests. Standing guard between the production line and the packing department are four test bays, each housing a qualified test engineer and the latest test equipment. The gauntlet has two more sentinels: Final Inspector and Final Examiner, who make further tests to every machine. Only those that achieve WyndSOR standards throughout come out into the great wide world.

The gauntlet has undoubtedly a lot to do with the phenomenal (it's the only word for it) success of the WyndSOR "Viscount" portable which keeps the WyndSOR factory at capacity production on one model. Certainly at 49 guineas complete it is the best value on the market today. So should you have difficulty in getting a demonstration write direct to the makers for the name of your nearest dealer. There's nothing more maddening than seeing and hearing a WyndSOR "Viscount" just after you have bought something more expensive.

Drop a request for a leaflet (or a dozen, if you have that many friends who might be interested) to:—

WyndSOR Recording Co. Ltd.,
WyndSOR Works,
2 Bellevue Road,
Friern Barnet, London, N. 11

Telephone: ENTerprise 2226/7

Telegrams: Wyndreco, London

(Contractors to H.M. Government)



NOW a stereo version of the **BTH HI-FI amplifier**



20 WATTS OUTPUT
TWO TEN-WATT CHANNELS

With this compact new stereo unit, the brilliant reproduction is equal to that of the famous BTH single-channel amplifier, but with the added thrill of three-dimensional sound.

- Progressive balance control on stereo
- Stereo or mono pick-ups selected by switching
- Switched rumble filter
- Pre-amplifier suitable for high or low output pick-up, or can be fed direct from tape-head or tape pre-amplifier.

Further details will gladly be supplied and stereo demonstrations arranged on request.

LOUDSPEAKERS

Reproduction is only as good as the weakest link and high quality loudspeakers in correctly designed enclosures are essential for the finest results.

A suitable range of dual-channel or direct-radiator speakers, 18 inch and 12 inch, are available — please write for details.

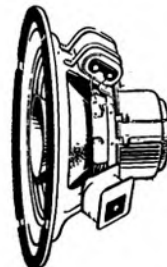

**DUAL-CONCENTRIC
LOUDSPEAKER
TYPE D.C. 12**

BTH SOUND EQUIPMENT LTD

CROWN HOUSE, ALDWYCH, LONDON, W.C.2.

A 5398



See us on
STAND 326
 Radio Show
 Audio Hall

incorporating the new Simon

simon



THE CADENZA. Ribbon microphone. Dual impedance head for flexibility in use; output sensibly flat between 50-12000 c.p.s. In handsome presentation case: head only 8½ gns. With tripod desk stand 10 gns.

and you can replay stereo, too, with the SIMON STEREO ADAPTOR

You can convert the S.P.4 for stereo at any time—and enjoy the brilliant realism in reproduction which only S.P.4 performance plus stereo can give. The Simon Stereo Adaptor replays pre-recorded tapes to C.C.L.E. specification and has full tone control as in S.P.4. Complete with amplifier and bass and treble speakers matching those in the S.P.4, price **49 gns.**

'A new standard of quality by which other machines will be judged'

Angus McKenzie in TAPE RECORDING AND HI-FI MAGAZINE

This is the enthusiastic opinion of an expert, an independent reviewer, after thoroughly testing the Simon S.P.4. Throughout the Hi-Fi world, this superb new tape recorder, with its combination of high performance and range of exclusive features, is sparking off similar praise from those who have seen and heard it. Look at this list of star features—then come and see it for yourself at your nearest dealer—try it, hear it and you too will join the crowds of Simon enthusiasts.

SIMON AUTOMATIC DECK fully 'push-button controlled'

AUTOMATIC TAPE REVERSAL without touching controls
3-WAY MIXING FACILITIES on both record and playback

BASS AND TREBLE LIFT AND CUT with independent controls

REMOTE CONTROL FACILITIES on both record and playback

HIGH QUALITY MONITORING paired bass and treble loudspeaker units

10 WATTS OUTPUT from ultra-linear push-pull amplifier

PUSH-PULL OSCILLATOR for noise and hum suppression

ACCIDENTAL ERASURE PREVENTION by special record 'safety button'

ACCURATE TAPE POSITION INDICATOR based on linear tape scale

'PIN-POINT' MODULATION with cathode ray magic eye

fully automatic deck

SP. 4

* Automatic, in the Simon sense, is meant to be taken literally: it means continuous replay—the machine stops, reverses and changes to the other track with only a two-second pause, and with no necessity to touch any control. Similarly, up to three hours continuous recording can be made without attention, the machine automatically stopping at the end of the second track.



Your Simon Dealer would be pleased to arrange H.P. terms

95 gns.

Choose Simon for Sound

Write for leaflet (E9) to: SIMON SOUND SERVICE LTD. 46-50 George Street, Portman Square, London W.1

A REVOLUTIONARY NEW BRITISH INVENTION!

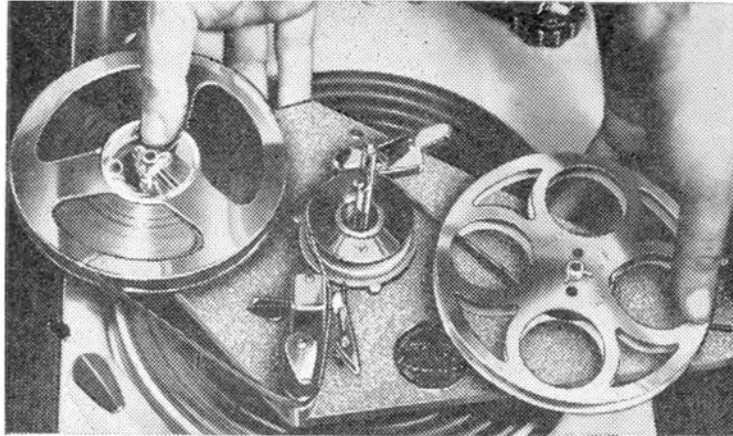

Gramdeck

GRAMOPHONE TAPE RECORDER

- Instantly turns your gramophone into a first-class Tape-Recorder.
- As easy as putting on a record. Slip it on—it's a tape-recorder! Lift it off—it's a record-player!
- Records direct from radio or microphone.
- Plays back at the flick of a switch through gramophone or radio.

**COMPLETE—READY TO RECORD
OR PLAY BACK!**
£13.12^s EASY TERMS
CASH AVAILABLE

**ALL THE ADVANTAGES OF A TAPE RECORDER
FROM YOUR RECORD-PLAYER OR RADIOGRAM
—AT LITTLE EXTRA COST**

*"Lifelike
realism"*



SAYS

**TED
HEATH**

*"Far better than anything
I have heard for a long time"*

- ★ Plays at 7½" per sec. Other speeds if desired.
- ★ Uses standard single or double-track tape.
- ★ Erase head. Fast motor rewind or hand rewind.
- ★ Instantly plays back through gramophone or radio.
- ★ Enables you to record out-doors too!
- ★ Tone as good as you get from your radio or gramophone.

"Ingenious—simple . . . why on earth did no one think of it before!"—*The Tape Recorder.*

"Ingenious and robust."—*British Sound Recording Association Journal.*

"Quality of reproduction excellent . . . real hi-fi results . . . potential is tremendous . . . both designer and manufacturer should be congratulated."—*British Radio & T/V Retailer's Review.*

"Better than many so-called hi-fi recorders! . . . robust . . . carefully designed . . . excellent value."—*Amateur Cine World.*

MADE BY THE FIRM THAT MAKES
MICROWAVE WAVE-GUIDES FOR
VISCOUNTS & BRITANNIAS

Gramdeck
GRAMOPHONE TAPE RECORDER

Gramdeck is completely new . . . a revolutionary and ingenious invention that instantly turns your gramophone into a tape-recorder and back into a gramophone at will! Slip the Gramdeck on to your turntable and you have the finest tape-recorder you've ever heard. Lift it off . . . your gramophone is ready to play records again. There are no motors or valves to go wrong—and you get a quality of reproduction that has to be heard to be believed! Everyone is praising the Gramdeck. "The quality is at least equal to that obtained from a good micro-groove disc," says a leading professional journal.

**WORKS FROM ANY RECORD-PLAYER
OR RADIOGRAM**

Hear music, speech . . . your favourite radio programme . . . the voices of your family—Gramdeck can record and reproduce them all with a wonderful depth and breadth of tone.

And, because Gramdeck uses the equipment you already possess in your own gramophone, it costs a mere fraction of the high-quality tape-recorder normally required to obtain such excellent results. Full details, technical specifications, photographs, Easy Terms . . . everything you want to know about the amazing Gramdeck, are given in the fully-illustrated Gramdeck Book. Find out how you, too, can so easily have full tape-recording facilities! Send for the Gramdeck Book today. It's FREE!

Free!



FREE BOOK—POST NOW!

I would like to know how to turn my gramophone into a first-class tape-recorder . . . please send me the Gramdeck Book—FREE and without obligation. (Write if you prefer not to cut coupon).

NAME

ADDRESS

GRAMDECK (Dept. TP/802) 29 WRIGHT'S
LANE, KENSINGTON, LONDON, W8.

GRAMDECK TURNS A TURNTABLE INTO A TAPE-RECORDER

STEREO without STYLUS

THE *New*
GRUNDIG
TK 55

MONO/STEREO
TAPE RECORDER

92 GUINEAS
(excluding microphone)

Stereo on tape—with the new TK 55—is stereo without tears. Superb stereo on tape that's indestructible and long play. How much more sensible to build your stereo collection on tape to start with. And what better way of hearing it than with the new Grundig TK 55. Examine this superb model, hear it at first hand; remember, you get *all* the features of a first-class Grundig Tape Recorder—3 speeds, six hours play, superimposition, cross-fade—*plus* stereo play back.

Make a point of asking your Grundig dealer for a demonstration.

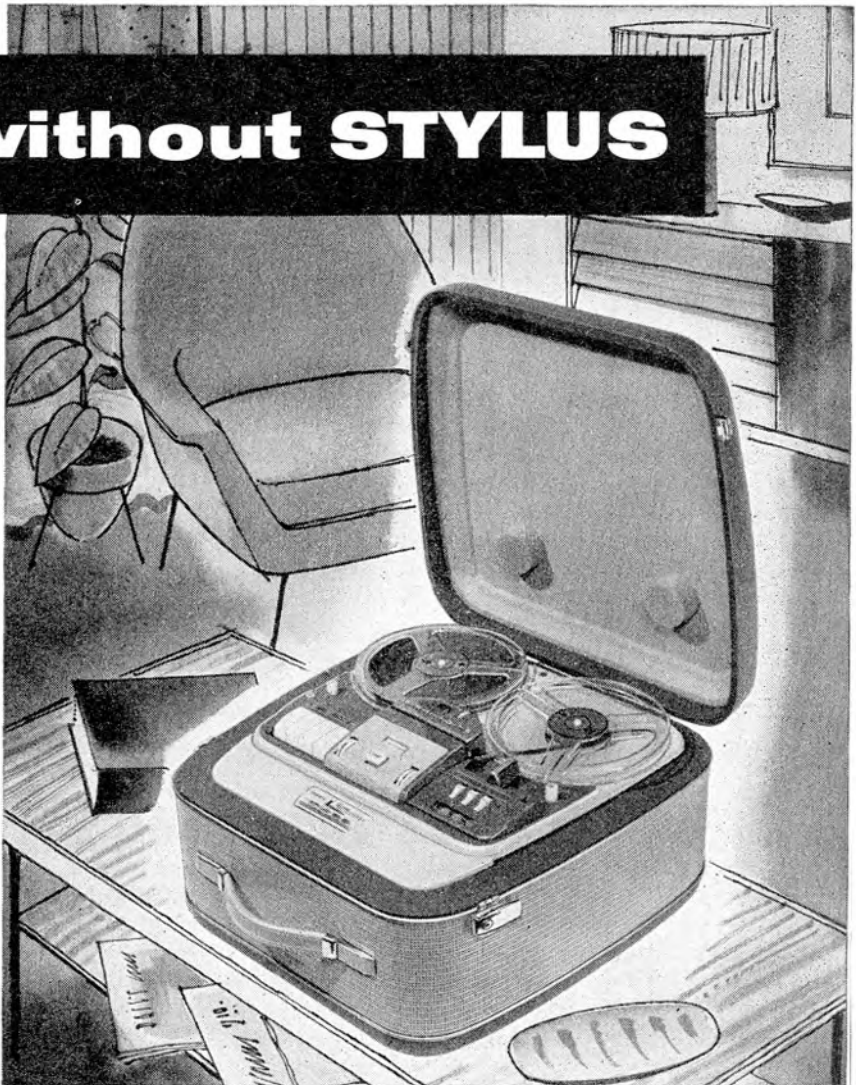

This switch gives you the choice of monaural or stereophonic reproduction—with superb fidelity.

Turn this speed change control, press the button marked '1 1/2' and you get six hours playing time per tape.

These are the input selectors that enable you to make the most of any type of recording.

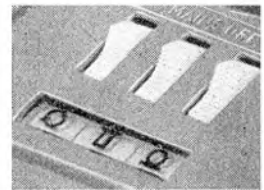
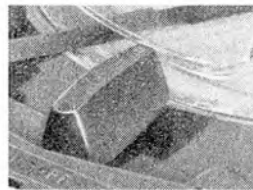
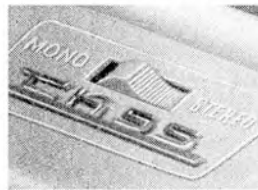

GET THE MOST OUT OF STEREO

GET A **GRUNDIG TK 55 TAPE RECORDER**

GRUNDIG (Great Britain) LTD.

Advertising & Showrooms: 39/41, NEW OXFORD STREET, LONDON, W.C.1
Trade enquiries to: NEWLANDS PARK, SYDENHAM, LONDON, S.E.26
(Electronics Division, Gas Purification & Chemical Co. Limited)

GS176

WE STOCK!

Model	Microphone	Price			Deposit		
		£	s.	d.	£	s.	d.
Clarion (Battery)	Included	26	5	0	2	12	6
Elizabethan Avon	"	26	5	0	2	12	6
T.R. 400	"	27	6	0	2	15	0
Elizabethan Bandbox	"	30	9	0	3	1	0
Sound Belle	"	30	9	0	3	1	0
R.G.D. Fidelity	"	30	9	0	3	1	0
Minivox (Battery)	"	35	14	0	3	14	0
Truvox Melody	"	36	0	0	3	12	0
Elizabethan Princess	"	40	19	0	4	2	0
Truvox Harmony	"	44	0	0	4	8	0
Sound 444	"	47	5	0	4	14	6
Verdik	"	47	5	0	4	14	6
Bromley 59	"	48	6	0	4	18	0
Wyndor Viscount	"	51	9	0	5	3	0
Spectone 161	"	51	9	0	5	3	0
Magnafon Courier	"	51	9	0	5	3	0
Regentone R/T51	"	51	9	0	5	3	0
Telefunken KL75/15	Extra	54	12	0	5	10	0
Bromley De-Luxe	Included	59	17	0	6	0	0
Brenell Three Star	"	60	18	0	6	2	0
Fi-Cord (Battery)	"	61	19	0	6	4	0
Reps R20	"	64	2	0	6	12	0
Stella ST450	"	66	3	0	6	14	0
Brenell Mk5	Extra	67	4	0	6	16	0
Telefunken 76	"	67	4	0	6	16	0
Sound 555	Included	68	5	0	6	18	0
Veritone Venus (console model)	Extra	69	6	0	7	0	0
Reps R30	Included	69	6	0	7	0	0
Stuzzi Magnette (Battery)	"	72	9	0	7	6	0
Reps R40	"	73	10	0	7	8	0
Elizabethan Mayfair	Extra	75	12	0	7	12	0
Telefunken K85	"	78	15	0	7	18	0
Telefunken KL85 (push pull output)	"	82	19	0	8	6	0
Harting HM5	"	86	2	0	8	14	0
Reflectograph 500	"	98	14	0	9	17	6
Telefunken M23 (studio model)	"	157	10	0	15	15	0

Also Microphones, Leads, Tuner Units, Floor Stands, Editing Kits, Mixers, B.A.S.F., Emi, Scotch Boy and Telefunken Tapes and all other accessories.

All the above Recorders are available on our no interest terms up to a period of 18 months OR our accessories offer, which enables you to put your Recorder to the fullest use immediately it is received. Please do send for our brochures, etc., which we shall be very pleased to despatch by return of post. Remember, delivery is free to any part of the Country! If you have any technical inquiries please let us know and we shall be very pleased to do our utmost to assist you.

TAPE RECORDER SERVICE CO.

43 Napier Road, Bromley, Kent.

Tel: RAVensbourne 4498/6119

STEREO

— FOR PEOPLE WHO MUST HAVE THE BEST

DYNATRON have nearly 30 years experience in building the best possible equipment for reproducing sound. Their leadership is based on three things. Advanced design. Scrupulous attention to detail. *And the narrowest tolerances in the industry.* This last point is especially important to Stereo enthusiasts. For it ensures that matching units really do match. Without this, stereo fidelity is impossible. Dynatron is never cheapest : it is always best !

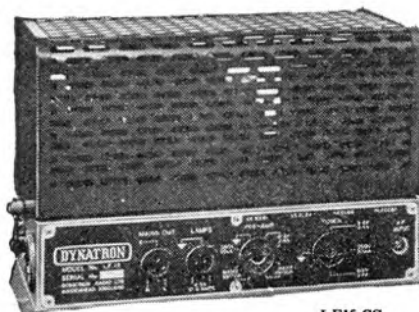

LF15.CS.

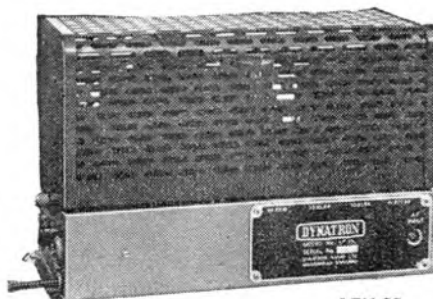

LF16.CS.

LF15.CS. POWER AMPLIFIER £20.5.0. 4-valve push-pull LF Amplifier, with auxiliary power supply for tuners, etc. 10 watts undistorted output. F.R. 15-30,000 c/s flat within 0.5 db. Neg. Feedback 20db. Hum & Noise 80db. below 10 watts. 1 volt R.M.S. input for full output.

LF16.CS. POWER AMPLIFIER £17.10.0. Specially designed as second channel amplifier in stereophonic systems. Specification identical to LF15 but auxiliary power outputs omitted. Mains output socket for gramophone or tape deck motors.

TC16.CS. PRE-AMPLIFIER £27. This very high performance unit comprises identical twin pre-amplifiers with a comprehensive control system. Duplicated inputs for magnetic or ceramic pick-ups, Radio and tape deck. Two output sockets for recording purposes. Pick-up equalisation by selective negative feedback. Frequency response 60-15000 c/s within ± 1.0 db.

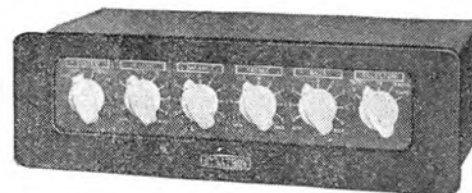

TC16.CS.

STEREOPHONIC
OR MONOPHONIC

DYNATRON

BUILD
TO
LABORATORY
STANDARDS

COUPON

Will you please send me a copy of the
**DYNATRON 'High Fidelity Audio
Equipment' brochure.**

NAME

ADDRESS

DYNATRON RADIO LIMITED, Dept. 3, St. Peter's Road,
Furze Platt, Maidenhead, Berks. Tel: Maidenhead 5151/2

A date with the

AVON



Make a date—with the new Elizabethan AVON. It's the most sensational tape recorder of the day : life-like reproduction ; versatile facilities including mixing and super-imposing of two programmes ; simple in use, and only two handy deck controls. It's the most attractive recorder you've ever seen, with the latest look and in a choice of the latest two-tone colour schemes. And the price is quite remarkable. *Make a date with the Avon—at your local dealer's, Now.*

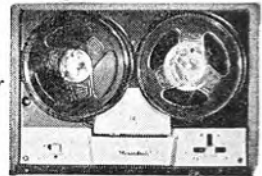

25 GNS

ready to use complete with microphone, tape, etc.

EAP For full details post this coupon to-day
 E.A.P. (TAPE RECORDERS) LTD.
 BRIDGE CLOSE, OLDCHURCH ROAD, ROMFORD, ESSEX

Name _____

Address _____

TRG _____ BLOCK LETTERS PLEASE

Elizabethan

TAPE RECORDS

S U P P L E M E N T

THE CLASSICS



by **Edward Greenfield**

(recorded music critic of *The Guardian*)

ONE of the more incomprehensible habits of the recording companies in this country is that British artists are often shamefully neglected. I can think of few violinists worthier of recording than Alan Loveday, yet it has been left to Saga, a comparative newcomer in the recording field to give us recordings of him and to allow us in the cold test of playing records side by side to estimate in the most calculating way of all just how he measures up to some of the world's great virtuosi.

Last year among the first Saga tapes I praised highly Alan Loveday's interpretation of the Beethoven Violin Concerto, which I felt had a breadth and spontaneity rare in any recorded performance. Now in his second Saga issue comes an interpretation of the last of Bach's six sonatas for solo violin which I am sure will prove riveting even for those who do not normally like chamber music or even like Bach. These solo sonatas are perhaps the most demanding violin music ever written. Without the support of another instrument the tone of a violin can easily pall, and though Bach's musical arguments are as weighty as any he ever conceived it takes a master violinist to hold each work together with the full concentration needed. The technical difficulties with double, triple and even quadruple stopping are formidable and a lesser player can easily get bogged down in them so that the whole work seems a collection of isolated parts.

There is an absurd confusion of nomenclature in these works. Bach wrote six of them, but for some incomprehensible reason the old tradition was to call the first, third and fifth "sonatas" and the second, fourth and sixth "partitas." I prefer to number them all together and call this last sonata in E major No. 6, but equally often you will find it called Partita No. 3.

There is virtually no distinction musically here between a sonata and a partita, but the point does underline the fact that to Bach a sonata was on the face of it a freer form than it became several decades later with Mozart and Haydn. This last one in E major has six movements beginning with a Prelude and continuing with a series of dance movements just as Bach's suites do (in fact when Bach wrote a set of precisely similar works for solo cello he did call them suites and not sonatas or partitas—such is the confusion of musical terminology). After the prelude there is first a Loure, a slow stately dance, then a Gavotte—the most popular movement in the work—a Minuet, a

(Continued on page 13)

Don't let *hiss-s-s-s* spoil your recordings

The recording head of any Tape Recorder tends to become magnetised in use. Small at first but gradually building up, this residual magnetism can seriously affect the quality of your recordings by progressively increasing the hiss level. It can also impart a noisy background—which can never be removed—to any pre-recorded Tape at the first time of playing.

Fortunately residual magnetism can be instantly removed with the Ferrograph De-fluxer. Get one to-day and, if you use it from time to time, you'll always enjoy tape recordings with a background as silent as the night.



Get a Ferrograph DE-FLUXER

50/-

Sold by all Hi-Fi Dealers and made by
BRITISH FERROGRAPH RECORDER CO. LTD.,
131 SLOANE STREET, LONDON, S.W.1 · Tel: SLOane 2214/5 & 1510

Accessories for enthusiasts by **DEKTRON**

The Monitor

A transistorised unit bringing monitoring facilities for all, it can also serve as an efficient pre-amplifier.

PRICE £5-5-0

The Mixer/Fader

A 3 channel mixer which fits into the pocket. Ideal for "on the spot" recording or for use with existing systems.

PRICE 39/6

The Telecon Pick-Up

Place it behind the telephone, & be certain of having the message correct.

PRICE 27/6

Write for further details to:—

**DEKTRON, 2 Westbourne Road,
Weymouth, Dorset**
Telephone: Weymouth 1987



The STUZZI MAGNETTE

"Completes the picture"

Really portable: 8lb. Transistorised, Battery Operated.

Really reliable: B.O.A.C. use it operationally on the Comet.

Really good quality: And all the facilities of a mains recorder.

Price: 69gns.

Where Portability Counts!

THE STUZZI TRICORDER

When only the Best will do!

- | | |
|-----------------------------|-------------------------------|
| 1. 3 speeds. | 7. DC heating. |
| 2. 40-16,000 cycles. | 8. Auto Stop. |
| 3. 12 hours on one reel. | 9. Built-in Mixer. |
| 4. Remote control. | 10. Monitor on Record |
| 5. Slide Projector control. | 11. Variable superimposition. |
| 6. Twin Loudspeakers. | 12. Tone Control. |

Price 75gns. Choice of Mics. extra

Recording Devices Limited
95 Villiers Road, London, N.W.2



The Mannequin

Only years of experience in tape recording and large scale production have made this possible!

Small size, good frequency range, plenty of volume and a host of features:

- | | |
|----------------------|--------------------------------------|
| ★ 90-9000 cycles. | ★ Tone control. |
| ★ Built-in mixer. | ★ Magic Eye. |
| ★ Superimposition. | ★ 2½ watts output. |
| ★ Monitor on Record. | ★ 26gns. inclusive of Mic. and Tape. |

Where Price and Value count!



Willsdn.
6678

(Continued from page 11)

Bourrée and finally—as in most Bach suites—a Gigue (after the English Jig) in 6/8 time.

Loveday plays with a command both technical and interpretative that few violinists today convey on records. Two who have on records displayed a similar sense of command in this work are Heifetz and the Hungarian violinist, Johanna Martzy. After being thrilled by Loveday's playing at the first hearing I made a point of comparing the three interpretations side by side. This, as I have said, is the most searching test that any performance can undergo. An interpretation can often pass the test of cohesion as an individual expression, but be seen to be markedly inferior to another when the parts are put side by side. After my initial hearing it did not surprise me, however, when Loveday's performance matched and even surpassed the other two.

Heifetz, of course, is by far the most dazzling technician of the three. His speeds, except for the final Gigue, are consistently faster than those chosen by the other two, yet his double stopping is crisper, firmer as though it were put together after two "takes." Technically the whole performance is breathtaking and there is an overall strength which grips one. Yet I have to admit there is a lack of warmth which these sonatas, intellectual as they are, certainly demand. Martzy provides such warmth. She has a fairly wide vibrato, yet the effect is warm rather than simply soupy and over-romantic. In this country at least she was comparatively little known when she made the recording, and she spent considerably more trouble over the recording sessions than many a more eminent violinist might have done. In many ways then an even more satisfying performance than Heifetz's.

★

But it is Loveday's that I would choose in the last resort in preference to either. He has just as rich a tone as Martzy, yet one does not even notice the vibrato at all—a sure sign of complete control. In other words there is purity as well as richness—the rarest combination. In the Loure Loveday chooses a fastish speed like Heifetz, remembering that though slow and stately this is also a dance. In the other movements he is not afraid to choose a basic speed slower than either of his rivals and in the Gavotte and the Gigue for example, this allows more natural spring in the music and greater delicacy of shading too. This never deteriorates into mere pulling about in the way that I for one find distracting in the performances of, say, Menuhin.

I could go on further but space forbids. The recording is outstanding with the catch of the bow on the strings clearly caught. The recording of the Bach E major concerto on the reverse is also outstanding.

The orchestra as in the Beethoven concerto is the Royal Danish under George Hurst and the recording engineer was again Allen Stagg of I.B.C. Unfortunately the orchestra was not on its finest form. So in the slow movement while Loveday plays the lovely cantilena with exquisite feeling the cellos—so important here—are very variable in their intonation. Even so this is not enough to make any difference at all to a firm recommendation for

(Continued on page 15)

Now! it's easy to edit tapes—economically



USE A PROFESSIONAL TYPE RECORDING TAPE SPLICER FOR EDITING AND MENDING RECORDING TAPE

On the new Mark II Bib Recording Tape Splicer both clamps are now of the easy lift type and are fitted on the same side to facilitate rapid removal of the jointed tapes. These improvements ensure even easier and quicker precise jointing of tapes. Because you can use all odd lengths of tape, you soon save the cost of the Splicer. If desired the Splicer can be attached directly to a tape recorder deck.

The technical experts say . . . "Everyone who uses a tape recorder will need this little tool. It is indispensable." P. WILSON, Gramophone.

"As a test I asked a non-technical person to splice some tapes and, after a couple of practice joints, perfect splices were made. A really useful gadget." D. W. ALDOUS, M.INST.E., M.B.K.S., Gramophone Record Review.

"The Bib Tape Splicer . . . produces a perfect joint with the minimum of effort." WIRELESS WORLD.

18/6
each (subject)



RECORDING TAPE SPLICER

Get one from your local stockist today. In case of difficulty write to us giving his name and address. Send stamped addressed envelope for helpful leaflet on tape editing.

Multicore Solders Ltd., Dept. T.R.3, Multicore Works, Hemel Hempstead, Herts.

If you want the best

In equipment, Service, Terms, Repairs or Complete Overhauls, The Recorder Company—Specialists in Tape Recorders—are at your service. Your complete satisfaction is our personal consideration. We can advise on the merits of different machines, offer side-by-side demonstrations of all models, find a solution to your problems, provide a speedy first-class Repair Service . . . indeed offer the background service of technical knowledge to which you can always turn to help you secure maximum enjoyment from your recordings.

- ★ We are mail-order specialists —free catalogues and full information on request.
- ★ INTEREST FREE H.P. TERMS
- ★ Open all day: Saturday, Friday until 6-30 p.m.
- ★ FREE INSURANCE POLICY covering your payments in the event of sickness, accident or unemployment, etc.

THE RECORDER CO.

(Dept. T) 188 West End Lane,
WEST HAMPSTEAD, LONDON, N.W.6.

'Phone: SW1 4977

Look at the **NEW MOTEK** **K10** ☆ ☆ ☆ ☆ ☆ **TAPE DECK**

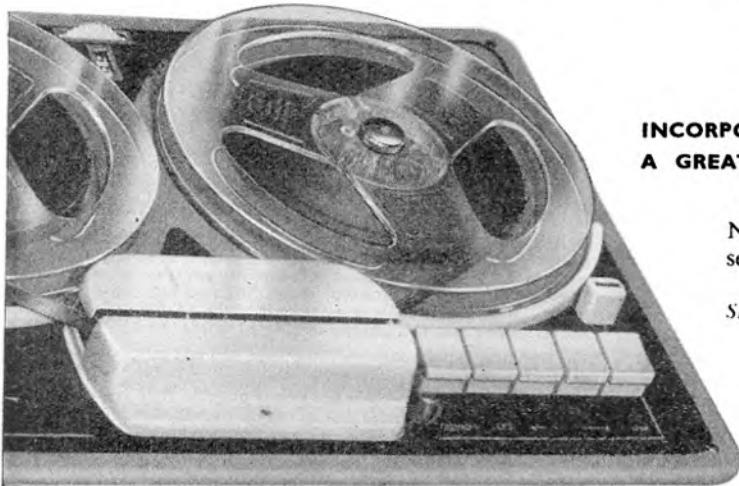

INCORPORATING MANY NEW FEATURES AND A GREATER FREQUENCY RESPONSE.

Now restyled in two tones of grey—you must see the new, attractive Motek K.10.

SEVERAL NEW FEATURES INCLUDE:

- ★ Enlarged drive wheel on the rev. counter ensures accurate tape positioning
- ★ Non-slip push buttons
- ★ Frequency response better than 40 c/s —12,000 c/s at 7.5" per sec. with extremely low hum pick-up

More and more manufacturers are installing Motek Tape Decks in their recorders

Patents pending

MODERN TECHNIQUES
 Wedmore Street, London, N.19. Tel ARChway 3114

PLEASE SEND FOR BROCHURE OF K.10



Armstrong

STEREO 44 VHF/MW RADIOGRAM CHASSIS

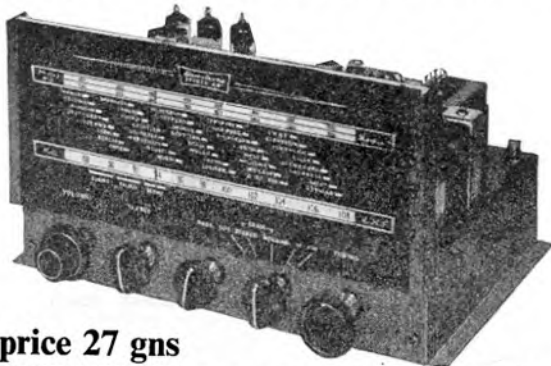

price 27 gns

Post this coupon or write for descriptive literature and details of Home Trial facilities, Hire Purchase Terms and Guarantee or call at our Holloway Showroom for full unhurried demonstration and professional advice on your installation. Open 9-6 weekdays and 9-5 Saturdays.

NAME.....TO4

ADDRESS

ARMSTRONG WIRELESS & TELEVISION CO.

▶ **DESIGNED FOR TAPE**

Connections provided for tape recording and playback, both stereo and single channel. You may listen at any level whilst recording or record quite silently.

▶ **STEREO and CONVENTIONAL**

Whether you want stereo right away or prefer to continue with ordinary single channel listening and turn to stereo later.

▶ **COMPACT**

Two independent amplifiers giving 8 watts high fidelity output, VHF and medium wave tuners on a chassis only 12in. x 8in. x 7in. high.

▶ **EASY TO FIT**

Easy to fit into a cabinet or mount simply on a shelf. A ready-cut panel and satin-brass dial surround are available.

▶ **NO ELECTRICAL KNOWLEDGE**

The fullest instructions are provided with every chassis and these assume that the user has no electrical knowledge whatsoever.

▶ **BEST VALUE EVER**

By which we mean, quite literally, higher quality, better design and more facilities at less cost.

Other models in our range of radiogram chassis

STEREO-TWELVE

36 GNS.

12 watts high fidelity output; VHF; medium and long wavebands; separate ganged tone controls; balance control; tape recording and play-back facilities.

JUBILEE

28 GNS.

A high grade monaural chassis; 6 watts high fidelity output; VHF, medium and long bands; separate tone controls; tape recording and playback facilities.

LTD. WALTERS ROAD, LONDON, N.7.

NORth 3213

(Continued from page 13)

this tape. I have spent the whole of this month's article on it because it is an outstanding issue, and one which I think many tape enthusiasts not normally interested in recorded tape will find attractive. Saga has managed to squeeze both works on to one of its 600 foot tapes at 35s. (STA 7014.)

BEAT AND OFF-BEAT



by Don Wedge

(of "New Musical Express")

JACK PAYNE is a name known to everyone, young or old. A pioneer of radio, he has adapted himself to the modern needs of television. He has also produced one of the finest albums yet to come from British studios—Jack Payne Presents "Say It With Music" (HMV HTD 821).

The title is significantly worded. Payne, always a forthright man, has not been happy with the way so many recording, radio and television studio leaders are billed "So-and-so and his Orchestra."

Too frequently the personnel of one orchestra is virtually the same as the others. A small, very affluent coterie of highly-skilled musicians, known as "session men," have cornered the market and just move from one studio to another to play under different conductors.

It is these conductors, of course, who decide what music will be played. They are also responsible for the orchestration, either writing it themselves or calling in an arranger to do it for them.

When Jack Payne was asked to return to the recording studios to conduct again after an absence of more than a decade, one of the conditions Payne made was that it would not appear as though the orchestra belonged to him.

The session men chosen for the record included several known as soloists or leaders themselves—Alec Firman, Anthony Pini, Jock Bain, Bert Weedon, Charles Katz, Bernard Monshin and Louis Voss among them.

Payne's arrangers were Dick Barrell, Brian Fahey and one of the outstanding recording leaders of today, Tony Osborne.

The tunes were picked with outstanding care, most of them with associations for Payne. "Say It With Music" is his signature tune; "Love Is the Sweetest Thing" was written by Ray Noble for him to sing in a film; he was part composer of "Blue Pacific Moonlight."

The other numbers were also played by Payne's pre-war and war-time bands—"Just One More Chance," "I'm In

(Continued on page 17)

Add **QUALITY** to your recorder
with a **LUSTRAPHONE**
microphone

MODEL VR/53 RIBBON VELOCITY MICROPHONE

Bi-directional microphone, having a high level of sensitivity and extended frequency response. Blast screening and anti-vibration mounting are fitted. The VR/53 will provide the highest standard of sound for single channel or stereophonic reproduction and is particularly recommended for use with good tape recorders as well as for broadcasting and other professional requirements. With stirrup positioning attachment. In high, line or low impedances.
£9.19.6

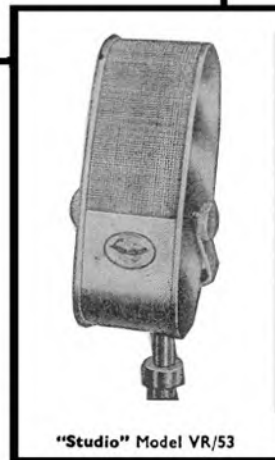

"Studio" Model VR/53

British in Design,
Materials and Manufacture



Details of this and other LUSTRAPHONE microphones and 4-Channel Mixer Unit sent on request.

LUSTRAPHONE LTD.

ST. GEORGE'S WORKS,
REGENTS PARK ROAD

Telephone: PRImrose 8844 LONDON, N.W.1

YOURS FOR 10% DEPOSIT

Detailed below is a selection
of equipment available on
easy repayment terms

Whatever your requirements—we stock it

	Cash	Deposit	12 Monthly Payments of	18 Monthly Payments of
AMPLIFIERS & CONTROL UNITS				
Acoustical Quad M. II ...	£42 0 0	£4 4 0	£3 12 6	£2 10 6
Leak TL12+ and Point One C/U ...	£31 10 0	£3 3 0	£2 14 4	£1 17 10
Rogers Junior Mk. II ...	£28 0 0	£2 16 0	£2 8 4	£1 13 7
LOUDSPEAKER ENCLOSURES COMPLETE & SPEAKER UNITS				
Wharfedale S.F.B.3 ...	£39 10 0	£4 0 0	£3 8 1	£2 7 4
Goodmans Sherwood I ...	£32 11 0	£3 6 0	£2 16 1	£1 19 0
Acoustical Electrostatic ...	£52 0 0	£5 4 0	£4 7 5	£2 19 10
Wharfedale Super 12 FS/AL ...	£17 10 0	£1 15 3	£1 10 2	£1 1 0
Goodmans Stereophonic Bowl Unit ...				
Goodmans Axiom 300 ...	£8 8 0	£1 4 0	19 4	13 6
TAPE RECORDERS				
Grundig TK35 ...	£86 2 0	£8 13 6	£7 8 5	£5 3 3
Ferroglyph 3AN ...	£82 19 0	£8 9 0	£6 19 8	£4 15 3
Veritone Venus ...	£69 6 0	£6 19 0	£5 15 5	£3 19 7
*Sound 555 ...	£68 5 0	£6 17 3	£5 17 3	£4 1 10
*Brenell 3 Star ...	£60 18 0	£6 8 0	£5 1 9	£3 7 5
*Grundig TK20 ...	£54 12 0	£5 12 0	£4 11 6	£3 2 8
Telefunken KL75K ...	£52 10 0	£5 5 0	£4 8 3	£3 0 5
*Sound 444 ...	£47 5 0	£4 14 6	£4 1 6	£2 16 9
*Verdik ...	£47 5 0	£4 14 6	£4 1 6	£2 16 9
*Sound Belle ...	£27 6 0	£2 16 0	£2 5 9	£1 11 4
*Complete with Microphone				
TURNTABLE UNITS & PICKUPS				
Garrard 301 Stroboscopic Connoisseur Type B ...	£23 18 4	£2 8 4	£2 1 3	£1 8 8
Lenco GL 58/RD (with Stereo Pickup) ...	£27 16 0	£2 16 0	£2 6 8	£1 12 0
Decca Stereo Pickup ...	£27 16 6	£2 16 6	£2 6 8	£1 12 0
Decca Stereo Pickup ...	£21 0 0	£2 0 0	£1 16 5	£1 5 4

THE RADIO CENTRE E & G THE RADIO CENTRE LTD.
33 Tottenham Court Road, London, W.1
Tel.: MUSeum 6667

LONDON'S TAPE RECORDER CENTRE

THE NEW SPECTONE

1 6 1

THE TAPE RECORDER THAT HAS REALLY GOT SOMETHING!

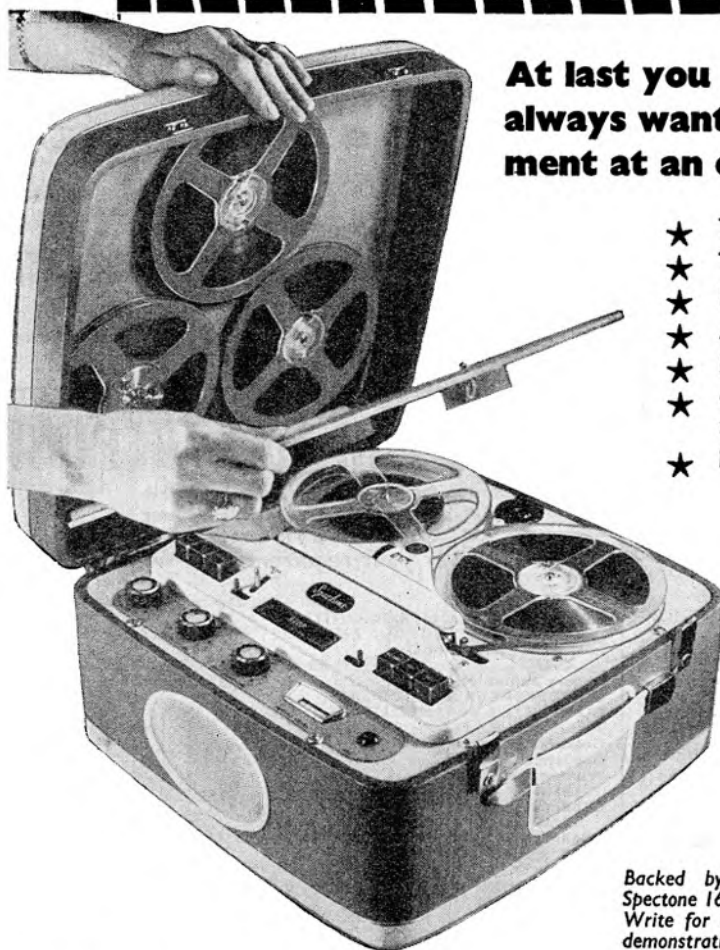

At last you can have what you've always wanted—a luxury instrument at an economy price.

- ★ Three speeds
- ★ Twin track operation
- ★ Full mixing facilities
- ★ Automatic tape position indicator
- ★ Pause control
- ★ Can be used as amplifier for radio, gram and microphone
- ★ Facility for extension speakers
 - ★ Unique tape storage facilities
 - ★ Accidental erasure prevention device
 - ★ Handsome two-tone case and a host of other essential features

Price 49 GNS.

Backed by an unsurpassed after-sales service, the Spectone 161 is the finest recorder on the market today. Write for illustrated folder or ask your dealer for a demonstration.

Specto
LIMITED

VALE ROAD . WINDSOR . BERKS

Tel: Windsor 1241

(Continued from page 15)

the Mood For Love," "Love In Bloom" and "I Surrender, Dear" among them.

For this record, Payne was looking for outstanding songs that had not been over-recorded, yet were still well known. He succeeded.

Inevitably with such an intention the numbers have a nostalgic air. But the treatment is completely modern and far from dated.

* * *

Another master of album music is George Melachrino. He has won such a following in the United States that he now records for an American company, RCA-Victor, although his sessions still take place in London.

Previously he was under contract to HMV and some of his work for them is available on tape. **Soft Lights and Sweet Music** (HTD 803) being one of them.

George records with two combinations, the Melachrino Strings and an orchestra featuring woodwind and brass, too. It is the strings that are featured on this tape, and there are two featured piano solos by Semprini.

The album has an apt title. It comprises sweet music played as softly and, usually as slowly as is decent. Really dreamy stuff, ideal for relaxation.

Most of the numbers are standards—the title tune, "The Touch of Your Lips," "Love Walked In" are three—but Semprini's two features are from film scores. One of them, the theme from "The Story of Three Loves," has a long lineage. The piece is really one of Rachmaninoff's variations on a theme by Paganini!

However, both this and Semprini's other feature, the theme from "The Last Rhapsody," merge into the mood created by Melachrino.

* * *

Ray Martin is another musician who exported his records to America and now has a contract direct with a United States firm. Not only that, he saw such a bright future there that he emigrated.

Martin gave up his position as artist and repertoire manager of Columbia, a job he shared with Norrie Paramor, who continues alone. In addition to his managerial responsibilities, Martin also recorded for his label as an orchestra leader.

Both he and Norrie Paramor combined for one album, available on tape, **Latin Nights** (CDT 860). It is rather heavier stuff than Melachrino's. Though still restrained, the use of fairly unusual rhythms creates a more fluctuating mood.

A wider range of instrumentation emphasises this effect. Use of accordion and organ is particularly noticeable. There is a nice balance of new and old tunes which also adds to the listening pleasure.

"Jealousy" and the traditional "Two Guitars" seem to complement "Mambo In the Moonlight" and "I Speak to the Stars," hit parade items of not very long ago.

The two conductors alternate on the various tracks. I can't help wondering if they were using the same orchestra. Certainly the general sound is the same. It raises the question whether any record album should set out to sustain a mood or be one of variety.

Both types seem to enjoy success as far as discs are concerned, but those who issue pop music on tape have to take into account that a lot of it is bought for commercial use. This particularly applies to orchestral records, which generally tend to sustain a chosen mood.

TREMENDOUS BARGAINS!

Secondhand Recorders in excellent condition
All with microphone

GRUNDIG TK25 as new	50 gns.	ELIZABETHAN "Escort" as new	35 gns.
GRUNDIG TK5 excellent	39 gns.	STELLAPHONE 1959 model	£32
PHILIPS AG8106 2 speeds was 62 gns.	39 gns.	FI-CORD (Transistor) with changer, 2 months old	49 gns.
PHILIPS AG8107 was 39 gns.	25 gns.	PHONOTRIX Transistor Battery operated,	only 15 gns.
PHILIPS AG8108G todays model	£55	E.M.I. REPRODUCER Converted into quality recorder, 7½" per sec. (NO MIKE) would cost £70-£80, our price 39 gns.	
PHILIPS AG8109 1958 model was 39 gns.	29 gns.		
SAJA 2 speeds, list 56 gns. unused	45 gns.		

We stock all makes of New Recorders of proved value and reliability, also all HI-FI equipment, Records, etc.

SPECIALISED REPAIRS

Our modern workshop is fully equipped for repairs to Recorders, Hi-Fi Equipment etc.

Our TAPE bargains are rarely beaten, yet all the tapes are A1 and fully guaranteed. For example:—

7" L.P. Generally 50/-, only 32/6
5" L.P. Generally 28/-, only 19/6.
7" 1,200 P.V.C. Generally 35/-, only 20/-.
3" L.P. 7/-.
4" Standard 8/- P. & P. 1/6 up to 3 reels.

Send for complete list of all our bargains!

E. C. KINGSLEY & CO.

132, TOTTENHAM COURT ROAD (corner of Warren St.) LONDON
Telephone: EUSton 6500 W.1

WAL GAIN TRANSISTOR PRE-AMP

"After trying this little device with my moving coil pick-ups I would never again dream of using a pick-up input transformer... the WAL Gain improved the crispness to a notable degree... So far I have only tried it out with Ortofon, Expert, and Garrard moving coil pick-ups... Price £5. Size 3½" plus Phono Plugs by 2½" sq.

Moreover there is no hum pick-up, magnetic or otherwise and the background noise is negligible... I can imagine, too that it will prove useful for the input to the playback amplifier of some tape recorders."

Percy Wilson, M.A.,
The Gramophone,
June 1958 issue.

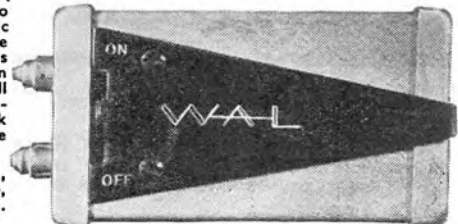

"A WAL professional tape eraser which wipes both tracks perfectly clean in a space of half-a-minute... it is a real godsend."

Percy Wilson, M.A.
The Gramophone,
August 1958 issue.

An ideal instrument for professional recording engineers for cleaning message reels, office tapes, tapes used as background music for cine films, etc.
Price: £7 18s. 6d.
Size: 6½" x 4½" x 3½"



Ask your dealer for a WAL

Wellington Acoustic Laboratories Ltd., Farnham, Surrey, England
Phones 6461 and 4961

This is THE RAVEL—



Write today for full details, to Dept. TR 910

If you can indicate your nearest main shopping centre we shall be pleased to advise you of your local stockists.

a new multi-purpose hi-fi cabinet making a total of seven hi-fi cabinets all matching in style and finish.

Under the lid can be housed every kind of turntable, auto-change or transcription. The other half of the lid is fixed. Behind the left-hand door are mounted the pre-amp. controls and radio tuner, all concealed until required. On the right is the record storage compartment, ingeniously divided to take either 200 seven-inch records, or 100 twelve inch L.Ps.

DIMENSIONS:

37" wide; 19" deep; 17" high, plus 12" legs.

PRICE 19 GUINEAS

RECORD HOUSING BROOK ROAD, LONDON N.22 BOW es Park 7487/8

FRANCIS OF STREATHAM

- ★ COMPLETE TAPE RECORDER SPECIALISTS
- ★ LARGEST SELECTION OF LATEST MODELS

The Centre for Personal Attention and respect for your Pocket

NO EXTRA FOR CREDIT
NO INTEREST OR CHARGES ON H.P. UP TO 18 MONTHS
FREE SERVICE WHILST UNDER GUARANTEE

HIRE SERVICE

Tape Recorders available on hire from 45/- per week

MICROPHONES AND MIXERS

	£	s.	d.
Lustraphone "Lustrette" M/C	3	7	6
Lustraphone VR/64 Ribbon	7	17	6
Lustraphone LFV/59 Dynamic	8	18	6
Simon "Cadenza" complete	10	10	0
Grundig GCM 3	6	6	0
Reslo Ribbon	8	15	0
TSL 3-Channel Mixer	2	2	0
Grundig Mixer	16	16	0

Also by Ronette, Acos, etc. We will gladly advise on the type best suited to your requirements

HI-FI & ASSOCIATED EQUIPMENT

	£	s.	d.		£	s.	d.
Rogers "Junior" FM Tuner	24	13	5	Collaro 4TR200	14	11	0
Stirling FM Tuner	13	13	0	Lenco GL/58 less cartridge	19	17	6
Dulci AM/FM	24	19	0	Garrard 301	26	8	3
Jason FM	22	17	1	Pamphonic 3000	31	10	0
Jason JTV	25	8	10	Leak Stereo 20	30	9	0
Pye FM	23	2	0	Loudspeakers by—			
Pye AM/FM	30	9	0	Expert, C.Q., W.B., Pye, Goodman, etc.			
Garrard 4HF and P.U. cartridge to choice							

TAPE TO DISC SERVICE
P.T. Reductions passed on where applicable

Amplion	29gns.	*Saba	89gns.
Balmoral	43gns.	*Simon SP4	95gns.
*Brenell Mk. V	64gns.	Sound A20	55gns.
Brenell 3 Star	58gns.	Sound 555	65gns.
Elizabethan Avon	25gns.	Spectone 161	49gns.
*Elizabethan Princess	39gns.	*Telefunken KL85	75gns.
Elizabethan Profsnl.	59gns.	*Telefunken 85K	79gns.
EMI TR 51	100gns.	*Telefunken 75/15	50gns.
*Ferroglyph 4AN	81gns.	Trix	29gns.
*Ferroglyph 4ANH	86gns.	Verdik	45gns.
*Ferroglyph 4AN/S	88gns.	*Vortexion WVA	£93 13 0
Ferroglyph Stereo-Ad. ...	30gns.	*Vortexion WV.B.	£110 3 0
Fidelity Argyll	29gns.	Walter 101	29gns.
Grundig TK20	52gns.	Walter 303 De Luxe	42gns.
*Grundig TK25	62gns.	Walter 505	57gns.
*Grundig TK30	72gns.	Wyndor Viscount	49gns.
*Grundig TK35	82gns.		
*Harting	82gns.		
Perth-Saja Standard	45gns.		
Perth-Saja De Luxe	59gns.		
Philips EL 3527	39gns.		
Philips 8108G	62gns.		
*Reflectograph 500	94gns.		
Reflectograph 570 Stereo	149gns.		

PRE-RECORDED TAPES AND TAPE SERVICE

ALWAYS AVAILABLE Pre-Recorded Tapes by Saga and "Music on Tape," etc. ALSO Tapes of every size and type by leading makers ready for prompt dispatch.

169-171, STREATHAM HIGH RD., LONDON, S.W.16

Between St. Leonard's Church and Streatham Station

STReatham 0466 & 0192

Catch it! (and keep it)

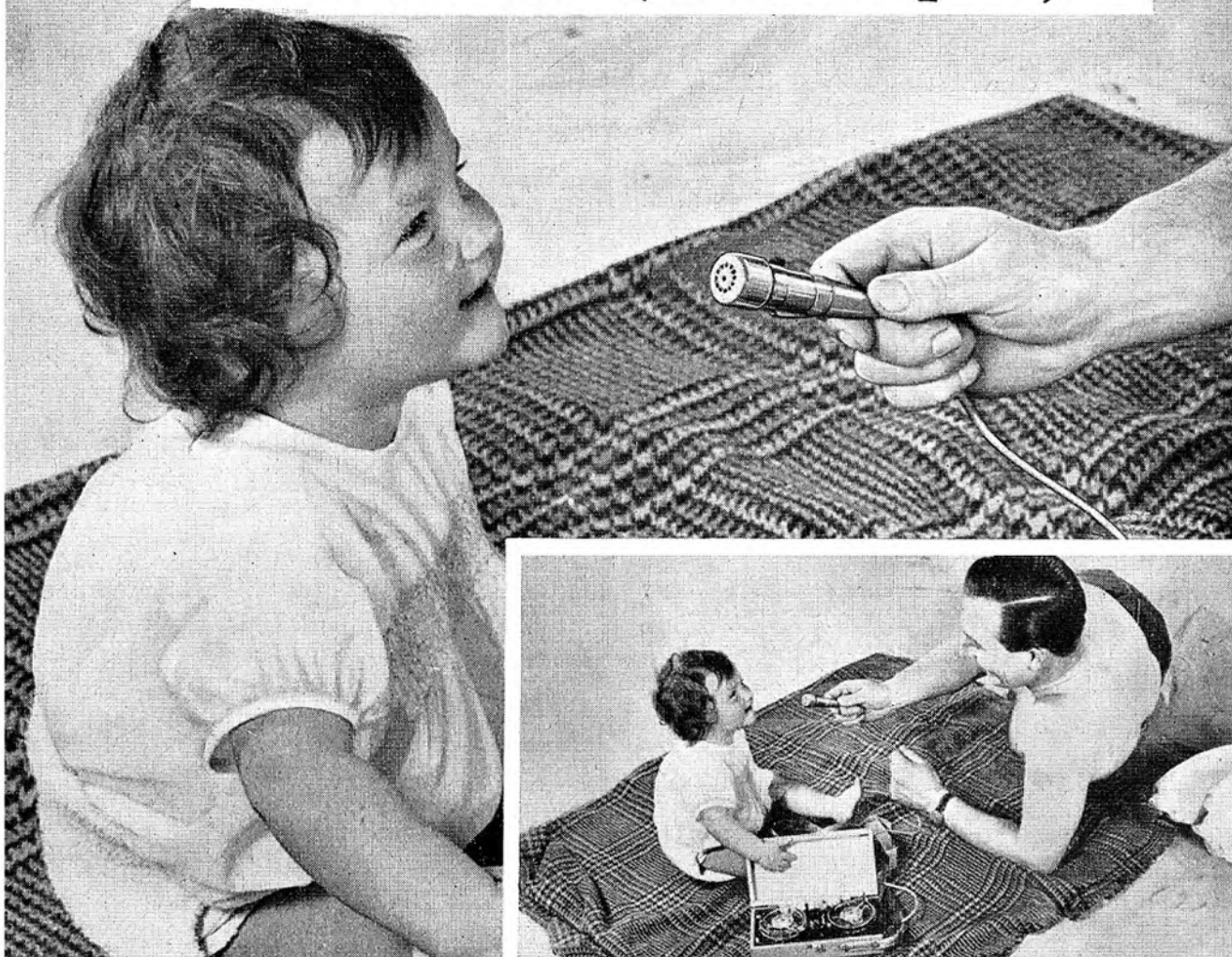

with **FI-CORD** hi-fi PORTABLE TAPE RECORDER

The FI-CORD is a jewel amongst recorders. And like all jewels it packs a lot of value into the smallest space: $9\frac{1}{2}'' \times 5'' \times 2\frac{3}{4}''$. The fidelity of the FI-CORD is amazing—from 50 to 12,000 cycles \pm 3db. It's fully transistorized, uses re-chargeable batteries and provides full playback volume. Yet its price is only **59gns.** including microphone, tape, batteries and charger.

Send for details to—



FI-CORD LTD. 40A Dover Street • London • W.1.
Tel: HYDe Park 3448

HAND MADE . . .

This is no idle statement, it virtually sums up the REPS recorders, for high quality products such as these cannot possibly be mass produced. Our production capacity is therefore strictly limited, and for this we make no apology; rather we pride ourselves that all models manufactured comply with this published technical specification.

The whole mechanism is mounted on rubber which together with careful selection of motors reduces mechanical noise to a minimum.

Provision is made for the addition of a stereo head with both channels available either to an external stereo amplifier, or one channel through the internal amplifier and the other externally.

TECHNICAL SPECIFICATION

Amplifier 30 — 25,000 cps \pm 2 dbs
(R20/30)
15 — 50,000 cps \pm 1 dbs
(R40)
3½ ips at 60 — 5,000 cps \pm 3 dbs
7½ ips at 50 — 10,000 cps \pm 3 dbs
15 ips at 40 — 16,000 cps \pm 3 dbs
(Signal/Noise ratio at 7½ ips—47 dbs)

The frequency range in the treble region has been limited to obtain the maximum signal/noise ratio compatible to a low distortion factor. Distortion introduced in the recording process is so small that the magnetic tape becomes the limiting factor. 600 ohm cathode follower line output socket, for feeding external amplifier.

* Separate bass and treble controls. * Range of treble control at 10 kcs \pm or — 12 dbs. * Range of bass control at 60 cps—15 dbs. * Push/pull bias erase oscillator, for low background noise, minimum interference with radio reception. * Loudspeaker 9" x 5" hi-flux magnet with extended treble response. * Amplifier output 6 watts peak on models R20, R30—10 watts peak R40. * Mains on/off indicator lamp. * Supplied complete with Acos 39/1 microphone, stand and 1,200 feet of P.V.C. tape.



MODEL R30/40

MODELS

R20 62 GNS. with magic eye record indicator.
R30 66 GNS. with meter record level indicator
R40 70 GNS. as R30 but with push/pull sound output

* All recorders can be adapted for replaying Stereo tapes.

A selection of HI-FI Dealers in the London Area who will be pleased to arrange a demonstration.

QUALITY MART

8 Dartmouth Park Avenue, N.W.5 GUL 1131

TELETAPE

230 Hertford Road, Enfield Highway, Middx,
HOW 1799

59a Edgware Road, W.2 PAD 1942

H. C. HARRIDGE

8 Moor Street, Cambridge Circus, W.1
GER 7108

HOLLEY'S

315 Camberwell Road, S.E.5 ROD 4988

CLASSIC ELECTRICAL Co. Ltd.

352-364 Lower Addiscombe Road, Croydon
ADD 6061

SYPHA SOUND SALES

75 Grand Parade, Haringay, N.4 STA 1146

TELEONICS

181 Earl's Court Road, S.W.5 FRO 2468

WADDON AND HILL, Ltd.

44 High Street, Hounslow HOU 1736

MUSICRAFT

20-22 High Street, Southall SOU 3828

13 King Street, Richmond RIC 6798

80-82 Uxbridge Road, Ealing, W.13

RECORDER Co.

186-188 West End Lane, West Hampstead,
N.W.6 SWI 4977

Please send me without obligation full details of your range of Tape Recorders. I am particularly interested in Model R.....

Mr.

For demonstrations write or phone 9 a.m.—6 p.m. Monday—Friday.
By appointment Saturday

REPS (TAPE RECORDERS) LTD

118 Park Road, North Acton, London, W.3
Phone: ACOrn 4141

TAPE RECORDING AND HI-FI MAGAZINE

Vol. 3 No. 10 OCTOBER 1959

Tape Recording and Hi-Fi Magazine is published on the 20th of each month by Print and Press Services Ltd., from 7 Tudor Street, London, E.C.4.

EDITOR: **R. D. BROWN**

TECHNICAL ADVISORY EDITOR: **CHARLES LANGTON**,
A.M.Brit.I.R.E., A.M.Inst.E.

TECHNICAL ADVISORS: **ANGUS MCKENZIE**
F. C. JUDD, A.M.Inst.E.

STEREO: **DOUGLAS GARDNER**
Editor of Stereo Sound and Music Magazine

MUSIC: **EDWARD GREENFIELD**
The Guardian recorded music critic

DON WEDGE
News Editor, New Musical Express

MOVIE-MAKING: **JOHN ALDRED**

NEWS AND CLUB ACTIVITIES: **FRED CHANDLER**

The Editor is always glad to receive articles, news items, illustrations, etc., intended for publication and payment is made on publication. When not accepted, material will be returned if a stamped, addressed envelope is enclosed, but the Editor cannot accept responsibility for the safety of such material.

"Tape Recording and Hi-Fi Magazine" is available by a postal subscription at 28s. per annum, post free, or can be obtained at newsagents, bookstalls and radio and music dealers. In the event of difficulty, write to the distributors, Rolls House Publishing Co., Breems Buildings, London, E.C.4.

Back numbers are available at 2s. 6d. per copy, if still in print.

EDITORIAL

Address all communications
7 TUDOR STREET, LONDON, E.C.4
FLE 1455-6

ADVERTISING

All advertising communications to
1 CRANE COURT
FLEET STREET, LONDON, E.C.4
FLE 0197

IN THIS ISSUE

We take the view . . . 23

Editorial comment and information

Tape Records reviewed 11
Edward Greenfield and Don Wedge

**British Amateur Tape Recording
Contest 24**
Results and Report

Performance specifications 28
F. C. Judd, A.M. Inst.E.

Copyright—the Federation view 32
An important statement for clubs

Exchanging Tapes 35
W. Patrick Copinger

Capacitors 38
Charles Langton

**RADIO SHOW SUPPLEMENT
and New products review 43**

Tested in the Lab. 52
New machines described

News from the clubs 54



AN AUSTRALIAN

An idea born in
Brighton twelve years ago
has come to fruition
on the other side of
the world—in Brisbane

AMATEUR TAPE DRAMA SCHOOL

THE story of Phoenix Productions—an amateur tape group which has been operating in Australia for several years—really starts in England. In 1947 Mr. C. L. Appleby, its Director and a founder member of the British Sound Recording Association, formed a small organisation calling itself the "Microphone Players" in Brighton, Sussex, with the object of writing, performing and recording radio drama by keen amateurs.

At this time, before the popularity of tape recorders, all work had to be done direct on to disc, with its obvious limitations of high expense and short playing time. Finance limited the work done and, having no positive outlet for productions, enthusiasm waned and the idea was temporarily shelved.

In 1952, Mr. Appleby emigrated to Australia and it wasn't long before the idea of an Australian version of the "Microphone Players" began to take shape.

Wider Scope

The Australian Broadcasting Commission's two stations, and four other independent commercial stations in Brisbane, seemed to offer wider scope for an outlet for their efforts than was ever possible in England.

A few other English migrants and a small band of enthusiastic Australians got together to form Phoenix Productions. Two small rooms were acquired for the studio—one room for the technical equipment and the other for the studio itself. A hole was knocked in the dividing wall and a plate glass panel inserted.

A second-hand tape recorder was bought and re-built. Two old "78" turntables and pick-ups were next obtained and a mixer for two mikes and two turntables designed. A modernistic desk was made from scraps of timber. Curtains and floor-covering were turned out of junk rooms and, finally, a fairly presentable replica of a broadcasting studio came into being.

The available talent in script-writers, artists and technicians encouraged the tackling of many phases of radio entertainment—drama, short stories, interviewing, burlesques, panel games, etc., but a disappointing setback was encountered.

Australian radio does not take kindly



to amateurs trespassing on their sacred soil unless used as a "gimmick" in commercial exploitation. But still the work went on.

Closed Circuit

Amateur writers could hear their work performed on a "closed circuit" and were enabled to pick out their faults in writing for the ear rather than the eye. Actors and actresses were able to develop their mike technique and characterisations. Producers learnt the art of using the musical bridge, and what "effects" to leave out.

Some of the writers now found that their work was beginning to be accepted with encouraging frequency by professional radio. Several actors and actresses passed auditions for A.B.C. drama roles on the strength of experience gained in the Phoenix Studio.

Unfortunately, one or two of the successful ones deserted to become full-time

radio personalities. Those who remain still seek an outlet for much hard work and thought. The possibility of an exchange of tapes with similar groups or individuals in the old country, and of entering the British and International tape recording contests, has given a new thrill to Phoenix activities and a very definite incentive to perfect, rather than just to experiment.

Links Wanted

An attempt was made to contact similar clubs throughout the Commonwealth of Australia by means of editorial Press mentions, but without success. The Press were not really interested and the lack of response made it obvious that Phoenix was the only club of its kind in Australia.

So if any British Club is interested in communicating with a Club from "down under" they should contact C. L. Appleby, 149 Sirius Street, Coorparoo, Brisbane, Queensland.

We take the view .

A DIGEST OF NEWS, COMMENT AND EDITORIAL OPINION

MMARGUERITE CUT-FORTH, producer of the B.B.C. "Sound" programme for recording and hi-fi enthusiasts, tells me that it is to be heard in future on Sunday afternoons. Obviously, this is going to be a better listening time than previously, and the programme should gain a lot of new admirers.

"Sound" returns to the air on Sunday, September 27; incidentally, I shall not be surprised if you hear in the first programme something about our third British Amateur Tape Recording Contest. At the time of writing, the winning tapes are being studied at Broadcasting House.

During its trial run earlier in the year, "Sound" was transmitted in the Network Three programme on Monday evenings. It will still be heard at that time, too. There will be a new programme every fortnight, first heard at 3 p.m. on a Sunday afternoon, then repeated at 6.40 p.m. on the Monday eight days later.

The improvement is made possible by a bold piece of B.B.C. re-thinking on Network Three and its admittedly minority audience. In future we are to get afternoon programmes at weekends, in addition to the evening transmissions.

Every Saturday afternoon from October 3 there will be two hours of uninterrupted "music of the masters"—a symphony concert, with a recital fitted into the interval.

Continental Visitors

SSOME of the men who have presided over the tape recording revolution on the Continent will be in London at the end of next month for the annual congress of the International Federation of "Chasseurs de Son." Already, I have heard from friends in France, Holland and Switzerland who will be here. Others are expected from Belgium, Germany, Italy and Scandinavia.

We are planning a reception in London at which the visitors will be able to meet their British opposite numbers, including representatives of the clubs, the B.B.C., and the industry.

The judges in the recent British Contest hope to be present and one of them, Douglas Cleverdon, will know by then how he has fared in the most exacting contest of them all—that for the International Italia Prize, which professional radio producers regard as a badge of outstanding skill.

Mr. Cleverdon's productions have ten times been selected as B.B.C. entries for the Prize; three of them have received awards.

This time his production of Bill Naughton's "June Evening"—heard

on the Third on July 29 last year—has been submitted.

No Joke

JJO DOUGLAS was seen going around the Radio Show appealing to her friends to supply her with a joke about tape recording for use in her speech at the recent Emitape lunch at the Savoy.

It was a delightful speech when she made it—but she failed to find a tape joke.

Perhaps our readers can oblige. A five-inch reel of tape will be sent to whoever sends the best joke about tape recording, in time for publication in our next issue.

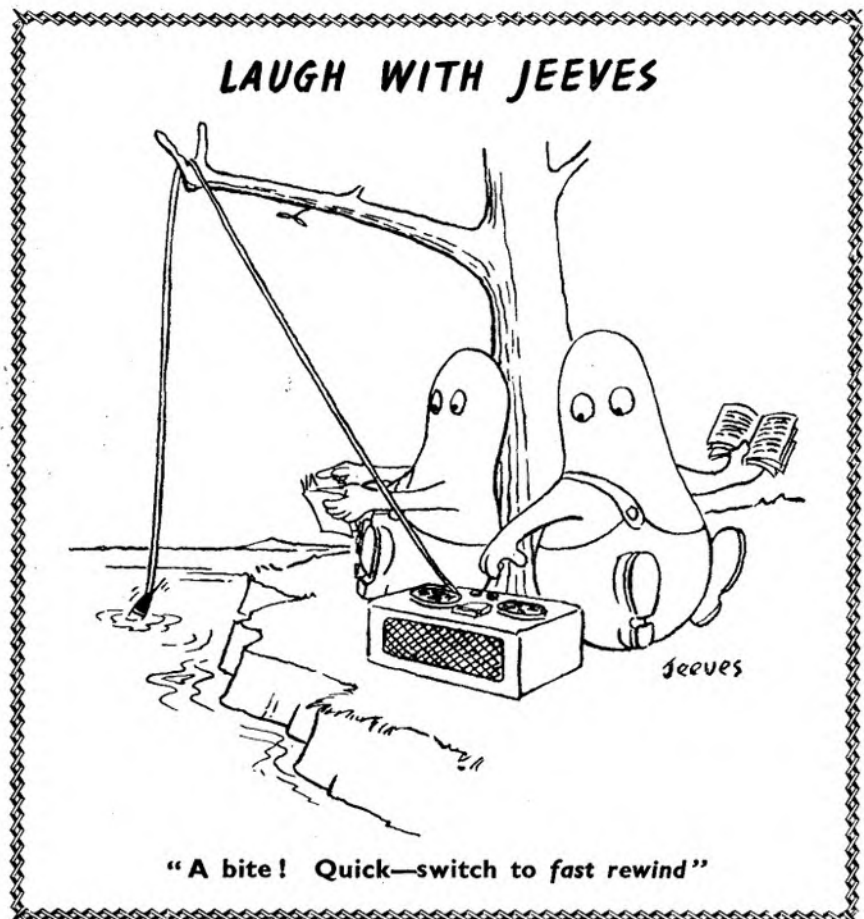

British Amateur Tape Recording Contest 1959

Nightingale's midnight song makes Tape of the Year

MR. A. ACLAND, winner of the Emitape Challenge Cup, the Wyndsor Gold Medal and a ten-guinea cheque for his recording of Kentish nightingales, had every right to look pleased (see right) when he came to London to be hailed as the producer of The Tape of the Year.

Mr. Acland, who is 58, has been recording for only seven months. His four-minute tape, made on a Stuzzi Magnette battery portable, was recorded at midnight as he knelt deep in a wood beside the converted Nissen hut in which he lives.

It was only his second attempt at recording the nightingales. It came off brilliantly. A few feet of tape was shed from the end, but otherwise no editing was called for.

And the judges commented: "A first-rate recording. . . . Not a very ambitious subject, perhaps, but the programme carries out perfectly what it attempts to do."

* * *

It may not have been quite as simple as it seems at first. Mr. Acland's father had a life-time of experience with song-birds, and he has inherited the interest.

Two other winners came to London for the Emitape Luncheon at the Savoy



Hotel and to visit the Radio Show afterwards.

Mr. D. E. Harrison, 32-year-old librarian from Leeds, entered a humorous composition that tickled the judges' fancy—a satire on travelogues.

Mr. Richard Margoschis, of Ather-

stone, a 38-year-old Health Inspector, recorded an old country traditional ceremony.

Another winner was unable to be present—Mr. Harry L. Ayers, a 44-year-old Dundee industrial chemist, who, unfortunately, was indisposed.

The Dundee Club, however, won the Club Section of the Contest and Mr. Leonard Douglas, who flew down to represent it, was able to represent Mr. Ayers as well.

* * *

Apart from the actual winners, there were many exceptionally good tapes submitted. Though the total number was not much up on the previous year, the judges unanimously agreed that their quality showed a marked improvement. Many were of near-professional standard.

In the Documentary Section, Mr. Kenneth Blake, of London, submitted a feature on radio-taxis, which was considered so good that the judges split the ten-guineas prize in this class, awarded six guineas to Mr. Margoschis and four guineas to Mr. Blake. In this same section, Mr. B. W. Harley, of Birmingham, winner of the Tape of the Year title in the two previous contests, produced a highly-commended effort called "Chainmakers of the Black Country."

Another of last year's prize-winners who scored a "near miss" this time was Nigel Rees, whose ingenious and imagina-



WINNERS AT THE SAVOY: Left to right, Mr. Leonard Douglas, representing the Dundee Tape Recording Club and Mr. Harry Ayers; Mr. D. E. Harrison, of Leeds; Mrs. H. A. Lewis; Mr. A. Acland, of Walderslade, Kent; Mr. Douglas W. Gardner and Miss Jo Douglas, two of the Judges; Mr. H. A. Lewis, Managing Director of E.M.I. Sales and Services Ltd.; and Mr. R. A. Margoschis, of Atherstone



EMITAPE LUNCHEON: Some of the winners, judges, E.M.I. representatives and guests seen at the Emitape luncheon at the Savoy

tive entry called "All about tripe on tape" was highly commended. So was Mr. R. K. Trotter's "Found in the morning."

In the Music Section, Mr. Richard Williams was highly commended for "Bach—Gloria," an ambitious attempt to record chorus and orchestra.

Other commendations went to Mr. Norman Paul, for "Dover Beach," a recording of Tennyson's poem against a background of waves on a shore, and to Mr. R. L. Armstrong, for "L'eau concrete," an attempt at music concrete based on water sounds.

* * *

Those who may have hesitated to enter for fear that they lacked sufficient experience will be interested to know that two of the four sectional winners had had only six or seven months' experience—Mr. Acland and Mr. Harrison.

* * *

Some competitors used ambitious equipment. Mr. Margoschis, for example, used Bradmatic and Brenell decks, C.J.R. and home-built amplifiers, a home-built mixer, a Bib splicer and a Reslo microphone.

Mr. Acland, on the other hand, went out with his Stuzzi, with the microphone and the tape that came with it, and made The Tape of the Year.

There was contrast, too, in the amount of work put in after the actual recording.

JO JOKES: Miss Jo Douglas, speaking for the guests, was in lively and witty form. Beside her, Mr. J. Wooller, of the E.M.I. Recording Materials Division, laughs at one of her jokes

THE WINNERS

The Tape of the Year

"Just a Song at Midnight," a recording of nightingales in a Kentish wood, by A. Acland, Esq., of "Berkeley," Boxley Road, Walderslade, near Chatham, Kent.

Section 1—Compositions

"In Search of Bunjistan," a satire on travelogues, by D. E. Harrison, Esq., of 3, Garth Road, Leeds, 17.

Section 2—Documentary

"Lane Setting," reporting a country tradition, by Richard A. Margoschis, Esq., of 14, Victoria Road, Mancetter, Atherstone, Warwicks.

Section 3—Music or Speech

"Second Fiddle," a recording of organ and violin, by Harry L. Ayers, Esq., of 88, Clement Park Road, Dundee, Scotland.

Section 4—Actuality

"Just a Song at Midnight," by A. Acland, Esq. (see above).

THE CLUB SECTION was won by a documentary tape on the jute industry entered by the Dundee Tape Recording Club.



Mr. Nigel Rees reported that he had made 145 splices in editing his tape.

Obviously, there are no set rules. Any one with the interest to make a real effort stands a genuine chance of being among the winners.

For those who came to London for the presentation of prizes there were plenty of excitements. First the Emitape Luncheon at the Savoy, which Messrs. E.M.I. Sales and Service Ltd. have now established as a red letter day in the tape recording year.

* * *

This year, for the first time, the event was honoured by the attendance of Mr. H. A. Lewis, the managing director of the firm, and his wife charmingly presented the Challenge Cup to Mr. Acland.

Afterwards, the party moved on to the Radio Show at Earls Court. On the

(Continued on page 27)

simon choose **BASF** exclusively

—match excellence

with excellence



- * Because of its specially developed, extremely flexible LUVITHERM base, BASF tape ensures intimate contact with the recording head, enabling it to register and reproduce the full recording range of frequencies with unmatched fidelity.
- * Because of its super-smooth magnetic coating, BASF tape reduces recording head wear to a minimum.
- * Because of its strength, stability and freedom from curl, BASF tape will keep indefinitely . . . continue to give you authentic sound reproduction no matter how often it is used.



**STANDARD
LONG PLAY
DOUBLE PLAY
EDITING SOUND**

For the Simon SP4 . . . and every other make of recorder

F. A. HUGHES & CO LTD

4 Stanhope Gate London W1 Hyde Park 6080



**Magnetic
Recording
Tape**



THE PRESENTATIONS: On the left, Jo Douglas with Mr. H. M. Creek, Managing Director of Wyndor Recording Co., is seen presenting the Wyndor Gold Medal to Mr. Acland on "Tape Recording Magazine" stand at the Radio Show

(Continued from page 25)

Tape Recording and Hi-Fi Magazine stand in the Audio Hall Jo Douglas presented the remaining prizes. Mr. H. M. Creek, Managing Director of Wyndor Recording Co., was there for the presentation of the Wyndor Gold Medal, which his firm has presented.

Mr. Acland went off to the TV studios. First, the independent Tyne-Tees concern interviewed him on closed-circuit television, while the thousands of visitors watching sets on the various manufacturers' stands looked in.

Later, Jo Douglas interviewed Mr. Acland for the B.B.C., and this was transmitted "live" the following day.

The tapes submitted by Messrs. Acland, Harrison, Margoschis, Ayers and Kenneth Blake will now automatically be entered as the British entries in the International Tape Recording Contest this autumn.



Left: Mr. Acland is seen receiving the Emitape Cup from Mrs. H. A. Lewis

SCHOOLS WINNERS VISIT ZOO

A SCORE of pupils from the Meeching Junior School, Newhaven, Sussex, were entertained by Messrs. Grundig (Great Britain) Ltd. this month to celebrate their triumph in the Schools Section of the British Amateur Tape Recording Contest.

Meeching were winners of this section for the second consecutive year.

This time their entry, under the general title "As we see other countries," was an imaginative account of a trip to a mythical country. In fact, it was recorded in the Ouse Valley in Sussex and in Somerset.

Mr. John Weston, the same schoolmaster who was in charge of last year's successful production, was in charge of the Meeching effort.

The children who participated were collected by Grundig from Newhaven and taken by coach to Maidstone Zoo

Magician D'Arcy presents the Challenge Shield and a box of tapes to Mr. John Weston, of Meeching Junior School, Newhaven

AS GRUNDIG GUESTS

for the afternoon. They had tea there and enjoyed a conjuring entertainment by D'Arcy.

The Grundig Challenge Shield and half-a-dozen tapes for future use were

presented to Mr. Weston by D'Arcy. The official presentation of the Grundig Challenge Cup to the Meeching School will take place later in the year.



THE PERFORMANCE YOU ARE ENTITLED TO EXPECT . . .

and how to check whether you are getting it

MY first article dealt with the general requirements associated with tape transport mechanism, azimuth alignment and tape heads. The following paragraphs deal with some of these items in greater detail, and introduce the performance standards required of the type of amplifier(s) normally used with high fidelity recorders (not to be confused with professional equipment used by recording studios and broadcasting concerns).

TAPE GUIDES

In order that the tape lies correctly on the heads and winds on to the spool symmetrically between the spool flanges, the guides must be accurately placed. An incorrectly positioned guide can also cause vibration and oscillation of the tape, and when the tape is passing over the heads and guides there must be no tendency for the tape to ride up or down.

Vibration due to poorly designed guides and pressure pads will cause fluctuation in response from the tape, especially at the higher frequencies; when a test tape or recorded tone is played through, the effect is obvious by a rapid change in intensity of the tone. Such an effect may not be noticeable from recorded speech or music. If the potential buyer of a recorder is in doubt, ask the demonstrator to play through a frequency test tape.

Flutter effect, if any, is particularly noticeable between 2,000 and 6,000 cps, as the pen recording of Fig. 1 shows only too clearly.

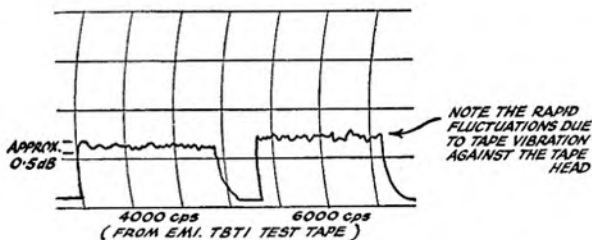

Fig. 1. Fluctuation from tape head output due to poor pressure pad adjustment

A bad example of tape vibration due to poorly designed tape guides and pressure pad mechanism is shown by another pen recording (Fig. 2) which was taken over the frequency range 40 cps to 14,000 cps from a domestic class

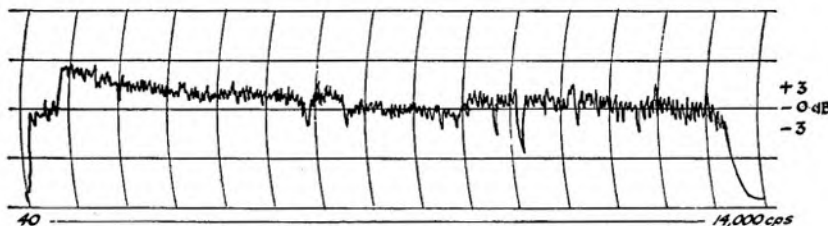

Fig. 2. Pen recording showing fluctuation in tape head output due to poorly designed tape guides and pressure pads

recorder. The overall response from a frequency point of view, is excellent, but note the continuous variation throughout the entire frequency range by more than plus or minus 1 dB at some frequencies, particularly above 2,000 cps. From recorded music these variations were just noticeable, but an untrained ear might not have been aware of them.

WOW AND FLUTTER

Out of a dozen technical specifications for well-known makes of tape recorders, only five or six quoted any specification for wow and flutter. Those given below are an average representation of the figures to be looked for or inquired about when buying a recorder, although such percentages are not always maintained in mass produced equipment—a point which is sometimes painfully obvious with recorders submitted for review.

- Maker A: Less than 0.2 per cent (rms) at $7\frac{1}{2}$ ips tape speed.
- Maker B: Less than 0.2 per cent (rms) at $7\frac{1}{2}$ ips.
Less than 0.25 per cent (rms) at $3\frac{1}{2}$ ips.
- Maker C: Less than 0.2 per cent (rms) at $7\frac{1}{2}$ ips.
- Maker D: Less than 0.25 per cent (rms) at $3\frac{1}{2}$ ips.
Less than 0.4 per cent (rms) at $1\frac{1}{2}$ ips.

BEAT NOTES

Another phenomenon not normally detectable by ear is the formation of beat notes, whether from recorded tones on a test tape, or musical instruments. In a small domestic recorder, 50 cps hum due to poor smoothing may not be noticed by the average listener, owing to the comparatively poor bass response of the small cabinet and internal speaker usually associated with transportable recorders.

While a low level of 50 cps hum may have no annoying effect, "beat notes" produced by signals passing through the amplifier can produce unpleasant sounds which would be noticeable with intent listening, but might not be heard by the casual listener.

The pen recording of Fig. 3 shows the large fluctuation caused by beat note effects where a fundamental tone of 200 cps is nearly zero beat with the fourth harmonic from 50 cps ripple voltage present in the output stage. The beat notes are of very low frequency in this case, but beat notes produced at other frequencies within hearing range can also be generated in the same way, or by a badly designed amplifier.

Beat notes at random frequencies are difficult to detect when listening to recorded music and again a suitable test tape is a useful aid to detection. To test for beat notes due to the presence of 50 cps ripple voltage, listen carefully with one ear close to the loudspeaker and the gain control turned fairly well up (tape stationary); hum or ripple at 50 cps should be obvious if it is present to any extent. Run the test tape through at frequencies of 100 or 200 cps, at the same time turning the gain control slowly up and down. Beat notes will be quite noticeable when the amplitude of both the test tone and any 50 cps ripple are about the same.

F. C. JUDD

A.M.Inst.E.

offers further advice to those buying new equipment or wishing to check their existing set-up

Beat notes can occur at all frequencies and are determined by the relationship of fundamental tones and their harmonics. For example, a tone of 100 cps mixed with a tone of 105 cps will produce a beat frequency of 105 minus 100, which equals 5 cps. A tone of 105 cps mixed with 50 cps may produce a beat tone of 105 minus 50, which equals 55 cps, as well as a beat note of 5 cps due to the second harmonic of 50 cps, namely 100 cps. (105-(50×2) equals 5 cps.)

The pen recording of Fig. 3 may serve to show this more clearly. It will be seen that the beats can reach an amplitude several dB above the steady output from the test tones and will vary in frequency as the frequency of one of the tones is changed.

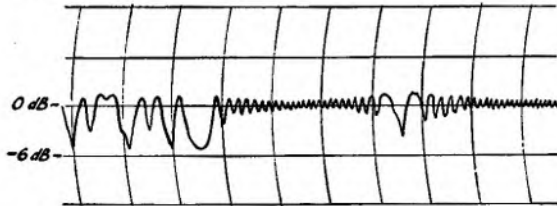

Fig. 3. Beat notes produced from steady recorded tone by presence of 50 cps ripple voltage at output stage

OTHER TAPE DECK FACILITIES

Most manufacturers provide additional controls such as a pause button, trick recording button, record safety button, tape length indicator, etc., all of which are useful but cannot be classified with performance specification.

Such items as a separate monitoring head, automatic tape stop devices, or a remote control system are often included in more expensive recorders, but are not essential to good electrical performance.

If any of these items are provided, however, they should function properly and the purchaser should ask for a demonstration. The tape length indicator, for example, should be accurate enough to return the tape to within a few inches of a desired position.

Mechanical noise from the drive motors or other continuously moving parts should be considered and, although ideally there should be no noise at all, it should at least be inaudible above quiet passages of music or speech.

AMPLIFIER AND FREQUENCY RESPONSE

The frequency characteristics for correct reproduction is that preferred by the Comité Consultatif des Radio-Communication (C.C.I.R.)* for programme interchange at a tape speed of 7½ ips. This requires a bass rise equivalent to that of a series combination of resistance and capacitance with a time constant of 100 micro-seconds, together with high frequency lift to compensate for replay head losses.

This means that certain frequency response correction must be applied, first in the recording process and secondly in the playback process, to compensate for frequency response losses due to both the tape head and the tape magnetising process. (Fig. 4).

The usual procedure is to emphasise the higher frequencies

REPLAY HEAD OUTPUT & C.C.I.R. CHAIN REPLAY RESPONSE

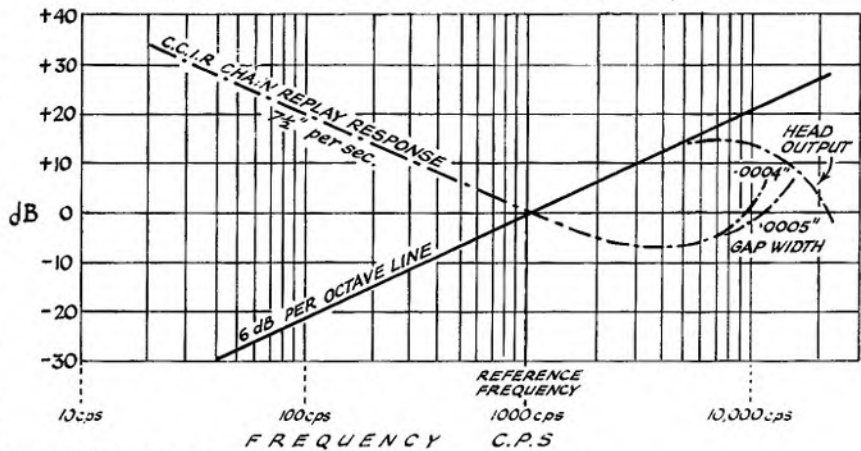

Fig. 4

during recording and the lower frequencies during playback and, therefore, amplifiers with special frequency characteristics are required.

The specifications for high fidelity amplifiers call for certain figures with regard to hum and noise, harmonic and inter-modulation distortion, etc., and a well-designed tape recorder amplifier should call for similar requirements. All too often harmonic and inter-modulation distortion is forgotten, and hum and noise are left to the imagination.

It is no good expecting high fidelity reproduction from a first-class external amplifier and speaker, if the tape recorder internal amplifier is incapable of reproducing to the same standard.

For example, if the tape recorder internal amplifier(s) have a hum and noise level of -30 dB no improvement will be made by using an external power amplifier with a hum and noise level of -60 dB. Most noise and hum generation occurs in the first stage of an amplifier which, in the case of the tape recorder, will be the valve immediately following the tape head. The signal for an external amplifier is generally taken from either the first valve, but more usually from the second, and any hum and/or noise generated in these stages will therefore be reproduced by any following amplifier. The same applies to harmonic, inter-modulation distortion and noise or distortion produced by over emphasis during the record or playback (early stages) process.

If you have a tape recorder with reproduction which seems quite satisfactory from its own amplifier and speaker, do not be disappointed if results with an external Hi-Fi amplifier and speaker are not what you expected.

The following figures are quoted from specifications supplied by different makers and are representative of good design standards:—

Manufacturer	Hum and Noise Level	Harmonic Distortion
A. (Domestic class)	-45 dB below signal at full output	None quoted
B. (Semi-professional)	-45 dB at full output	None quoted
C. (Professional recorder)	-55 dB at full output	2 per cent at peak recording level
D. (Domestic class)	-45 dB at full output	None quoted
E. (Domestic class)	-50 dB at full output	None quoted

It will be noticed that only one manufacturer quotes a distortion level, which for the average domestic class tape recorder should be no more than 3 or 4 per cent. The distortion content of tape is generally lower than the output of a gramophone pick-up and, of course, there is no deterioration in quality towards the end of a recording, such as that due to imperfect tracking of a pick-up. If a tape recording is occasionally allowed to overload, the subjective effect is not as bad as that produced by excessive level sometimes found on modern disc records.

If really full justice is to be done to a good tape recording, the amplifier chain should have an ideal signal to noise ratio of 60 dB because of the wide dynamic range that can be obtained with tape.

* British Standards Specification No. BS.1568. 1953—P.D. 1908 "Magnetic Tape Sound Recording for Programme Interchange."

The 'Masters' of your are made favourite LP records on

Emitape

Amid the wealth of skill that goes into modern LP recordings is one vital factor—Emitape! For to-day the great majority of original 'master' recordings are made on Emitape magnetic recording tape . . .

Emitape is used because it offers the highest possible standards in recording quality, consistency and durability.

Emitape is chosen by world-famous recording companies—like H.M.V., Capitol, Columbia, Parlophone—for recording the greatest artistes of our time . . . It is also the choice of the B.B.C. and I.T.V. for recording every kind of programme every day and of the research workers for countless applications in industry and science. And, of course, Emitape is made by E.M.I.—leaders in sound recording for over 60 years . . .

Here then is good reason for *you* to choose Emitape for your own tape recordings. With Emitape you can always be sure of the finest possible recording quality—remember, the Emitape you buy is the same .0015" PVC base Emitape used by professionals the world over.



E.M.I. SALES & SERVICE LTD
(RECORDING MATERIALS DIVISION)
HAYES · MIDDLESEX

The 'Masters' of your are made favourite LP records on **Emitape**

*—that's why leading tape recorder makers
recommend it . . .*



FERGUSON

Model 441 T.R. portable tape recorder

This portable model with an output of 2½w. is provided with twin tracks, giving a total playing time of 3 hours by using 'double play tape'. Will make recordings from microphone, radio or gramophone records, and an electronic recording level indicator is included. There is automatic erasure when recording, and an extremely simple operation with interlock to prevent accidental erasure. The single tape speed is 3½ips. and reel diameter 5½". Included with this model is one reel of tape and take-up spool and a crystal microphone. The cabinet is attractively covered in plastic leathercloth over moulded wood fibre, and weighs only 15½ lb.

SPECIFICATIONS

- ★ Single speed: 3½ ips.
- ★ Twin tracks—total playing time 3 hours (using double play tape)
- ★ Automatic erasure when recording
- ★ Fitted with tone control
- ★ New type cathode ray recording level indicator
- ★ Extremely simple operation with interlock to prevent accidental erasure.

PRICE 28 gns.

SPECTO LTD · VALE ROAD · WINDSOR

E.M.I. SALES & SERVICE LTD

(RECORDING MATERIALS DIVISION)

HAYES · MIDDLESEX

COPYRIGHT — THE FEDERATION VIEW

THE Committee of the Federation of British Tape Recording Clubs has now completed the consideration of the Copyright problem which was decided upon at the recent Federation annual general meeting.

It has issued the following as an official statement of its policy:—

RECORDING OF LIVE PERFORMANCES OF COPYRIGHT MUSIC

Amateur recordists generally are familiar with the legal position regarding the recording of *public* performances of copyright music. The Committee has found no evidence to suggest that individuals or clubs have been guilty of any infringement of the law relating to such recording.

No question of a system of licences arises in this case, since the question of copyright is not the only one which has to be considered in recording of this nature. The organisations concerned with protecting the interests of the performer are also involved. The Federation recognises that tape recording clubs stand in the same relationship to the law on this subject, as any other organisation.

The recording of "live" performances of copyright works *in private*, and the subsequent play-back of such recordings *in private*, is what the proposals by Mechanical-Copyright Ltd. are designed to bring under control. The proposals also refer to this type of recording, when undertaken as a *club activity*.

The Committee of the Federation of British Tape Recording Clubs is firmly of the opinion that there can be no justification whatsoever for any agreement involving the purchase of a licence purporting to give the "right" to record in the privacy of the recordist's home.

Everyone has the right to himself *perform* copyright music *in private*. The recording of such performances for the immediate or subsequent enjoyment of the recordist, *in private*, is such a minor extension of the existing right, that the Committee sees no reason why this should involve payment of a fee.

Finally, it must be pointed out that the Federation has no control over the private recording activities of individuals belonging to Member Clubs. Nor would it wish to have such control. Unless Mechanical-Copyright Protection Society Ltd. enjoys powers considerably in excess of what might reasonably be supposed, any system of licensing would be difficult to administer and impossible to enforce.

The other "right" to which Mechanical-Copyright's proposal refers, is the right of a tape recording club to record *as a club activity*, for subsequent play-back *as a club activity*, works which are the subject of copyright.

Now, the common interest which leads individuals to form tape recording clubs, is the common interest in the *art and science of tape recording*. It may well

"No grounds for payment"

A number of readers' letters dealing with copyright have been held out to make room for this important statement. We shall devote more space to the subject in our next issue.

be, that on occasion, members of such a club will record a performance in a private meeting of the whole or of part of a copyright work. However, the object of making such a recording is *never* to play it for the enjoyment, by members of the club, of the work involved.

The interest lies, not in the work itself, nor yet in the manner of its performance; the interest lies in the recording as an example of recording technique, or as an indication of the quality of a particular piece of recording equipment. The content of the recording is of negligible importance. Club recordings such as these are *never* given public performance and, indeed, are rarely preserved after having served their purpose.

In view of these facts, the Committee considers that any agreement, involving payment for the "right" to use copyright works for these purely technical purposes, would be totally unjustified and contrary to the spirit, if not to the letter, of the Copyright Act, 1956.

RECORDING OF RADIO AND TELEVISION BROADCASTS

Recording of this sort forms no part of the activities of a tape recording club. Exceptionally, a manufacturer's representative might make such a recording at a club meeting, in order to demonstrate the facilities provided by a particular machine.

As a *private* activity of tape recorder owners, the recording of broadcast material, insofar as it is not covered by the dispensation published by the British Broadcasting Corporation, is beyond the control of the Federation. The Committee suspects that it is also beyond the control of Mechanical-Copyright Protection Society Ltd.

COPYING OF GRAMOPHONE RECORDS AND PRE-RECORDED TAPES

Tape recording clubs are not concerned with the copying of commercial recordings. As a *private* activity, this is doubtless illegal. The assumption by the Federation of the duties of a law-enforcement agency would prove to be unpopular, unrewarding and unconstitutional.

The Federation recognises that the advent of the domestic tape recorder, capable of producing, cheaply very high

quality copies of gramophone records, might well cause concern to those whose financial interests are involved. However, it is clearly no part of the duties of the Federation to provide a solution to the problem.

PUBLIC PERFORMANCE OF COPYRIGHT WORKS

The Federation is always willing to advise individual recordists and tape recording clubs of the correct procedure to be adopted in order to comply with the law relating to the *public performance* of copyright music. The existing arrangements seem to be perfectly adequate, the tape recorder, in this case, serving merely as an alternative to the gramophone.

SUMMARY

It will be seen that the anxiety felt by the copyright protection organisations concerning the activities of tape recording clubs is based on a misunderstanding of the objects of these clubs.

Members of tape recording clubs are involved in two basic types of activity. They listen to talks and take part in discussions on technical matters relating to the whole subject of sound recording and reproduction. Insofar as this involves the use of copyright material, this is invariably incidental to the main purpose of technical exposition.

It is the creative activities of tape recording clubs—the production of original recorded features and programmes—which are fundamental to their existence. The primary object of a tape recording club is to produce tapes, in much the same way as the production of photographs is the primary object of members of Photographic Clubs. We have not heard it suggested that these clubs should pay a licence-fee, on the grounds that the equipment which they use is capable of producing copies of copyright pictures.

It is the opinion of the Committee of the Federation of British Tape Recording Clubs that there are no grounds for entering into any agreement which involves payment by Member Clubs for "rights" which they do not desire or which they already possess.

Members are advised to familiarise themselves with the Copyright Act, 1956; and to ensure that, as a club, they strictly observe the provisions of the Act relating to public performance of copyright material.

On no account should tape recording clubs, whether members of the Federation or not, take unilateral action of a sort which might tend to prejudice the case as stated. It is unlikely that this statement will prove to be the last word on the problem of copyright. The support of *all* tape recording clubs for the Federation's stand, would do much to ensure that the Tape Recording Movement continues to flourish, unhindered by financial penalties imposed by the guardians of commercial recording interests.

Rose Bruford students in the field. Left, recording skiffle in Chislehurst Caves. Right, interviewing a whelk stall-holder are Miss J. Hutson, Romford teacher, and Mr. T. Sylvester, a Nottingham research worker



THEY TAPED JAZZ IN CAVES, CADETS ON PARADE – AND A WHELK STALL

OVER forty enthusiasts from all parts of England and Wales gathered at the Rose Bruford Training College for the second six-day tape recording course organised by Geoffrey Hodgson. Men and women from all walks of life, including a psychiatrist and a G.P.O. engineer, were present. The teaching profession was well represented.

A varied programme was arranged, with Jack Singleton, of the B.B.C., as senior programme producer, assisted by Desmond Briscoe and a team of experts in the recording field. Graham Jones, technical operations manager, had equipment worth £2,000 in his care. Full use was made of the mobile transmitters provided and operated by Fred Judd, one of the technical advisers of this magazine.

Practical experience in interviewing and editing, a popular feature of the course, was obtained when teams were sent out to collect material for a programme entitled "Saturday Roundabout." Chislehurst Caves provided the setting for a jazz recording session, while a whelk stall at New Cross Gate enabled the students to obtain not only an interview with the proprietor, but refreshments as well.

Visits were also made to the motor-car racing at Brands Hatch and to the parade ground at Woolwich Barracks, where Air Training Cadets were recorded in action.

One of the students at the course was the producer of the "Tape of the Year" — Mr. Arthur Acland.

The next course will be held during April next year; final details will be published shortly.

Tape report of Show for Clubs

THE Federation of British Tape Recording Clubs made an interesting innovation at this year's Radio Show. Secretary Alan Stableford secured official permission to tour the stands and to record interviews with representatives of the various firms, discussing new products of interest to tape enthusiasts.

These interviews, which capture much of the atmosphere of the Show, will be edited into a tape containing a general survey.

This tape will be circulated to all clubs affiliated to the Federation.

It will also be made available, without charge, to any other tape recording club which is interested.

Details can be obtained from Mr. Stableford, at 9, Normandy Terrace, London. E.16.

STAR RECORDIST

ANOTHER top-line star is identifying herself with tape recording. It is still a fact that the majority of tape recorder owners are lovers of serious music, and they will appreciate the enthusiasm of Joan Sutherland, the operatic singer, for the medium.

She has agreed to endorse Grundig products and will soon be featured in their publicity campaign.

Like many other musicians, she uses her recorder for rehearsals and broadcasts.

Lord's Prayer

MR. H. J. WALDING, of Northampton, is trying to get together a collection of the Lord's Prayer spoken in as many different languages as possible, preferably by a native of the country concerned.

He has many examples already, but if anyone would care to get in touch with him direct, at 48, Freehold Street Northampton, he will let them know whether their particular language has already been recorded.

MAGIC WITH A RECORDER

A NEW use for the tape recorder has been found—appropriately enough —by a magician. D'Arcy, who is a Gold Star member of the Inner Magic Circle, hit on the idea when seeking a new method of cabaret entertainment.

The act took nearly a year to perfect. It involves split-second timing, so much so that some who have seen it are convinced that D'Arcy is a master ventriloquist. The tape recorder, in fact, tells him what to do and supplies the answer to many of the tricks.

D'Arcy displayed his skill to the children from the Meeching Junior School, Newhaven, who were entertained by Messrs. Grundig (Great Britain) recently. He uses a Grundig machine in the act.



NEW! DO-IT-YOURSELF TRAINING TECHNIQUE in RADIO & ELECTRONICS

You LEARN while you BUILD...

SIMPLE...PRACTICAL...FASCINATING...

ANNOUNCING—after years of successful operation in other countries—the latest system in home training in electronics introduced by a new British training organisation. AT LAST—a simple way of learning—by practical means—the 'how and why' of electronics with the minimum of theory and no mathematics! YOU LEARN WHILST BUILDING actual equipment with the components and parts which we send you—and you really have fun whilst learning! And afterwards—you have a first-rate piece of home equipment plus the knowledge of how it works and how it can be serviced. THIS NEW SYSTEM brings an exciting new opportunity and is very moderate in cost. Post the coupon now without any obligation for full details.



BUILD YOUR OWN:—

- RADIO EQUIPMENT
 - HI-FI INSTALLATION
 - TEST EQUIPMENT
- AND LEARN AS YOU DO IT

LOTS OF INSTRUCTIVE EXPERIMENTS AT HOME!

No Mathematics!

FREE-
POST TODAY

To: RADIOSTRUCTOR (Dept. G35)
46 Market Place, Reading, Berks.
Please send Brochure without obligation to

Name: _____
Address: _____
(812) _____

BLOCK
CAPS
PLEASE
10-59

RADIOSTRUCTOR

BRITAIN'S LEADING ELECTRONIC TRAINING ORGANISATION

DIXONS OF MANCHESTER offer you

TAPE RECORDERS ONLY

In addition to supplying all good makes and stocking almost every accessory, we are the main service and sales agents for the famous Telefunken.

Our service department cannot be equalled in the North and is up to Telefunken and Grundig standard so that we are able to implement maker's guarantee on most makes without returning to manufacturers.



Tapes, microphones and all spares by return of post and reasonable H.P. terms available.

DIXON'S TAPE RECORDERS

227, Oxford Road, Manchester

ARDwick 4269

FIRST OF A SERIES OF THREE ARTICLES FOR THOSE WHO WISH TO START A FASCINATING NEW HOBBY

CLUBS or societies now exist in most countries to help the owners of tape recorders to converse with one another all round the world by exchanging recorded messages. But there may still be many readers who have not used their recorders in this way and this series of articles is intended to help and encourage them to take the first steps in a most enjoyable hobby.

JOINING A CLUB

I have been a member of the Voicespondence Club for over two years, so my remarks will apply mainly to that club, but the same general principles apply to all similar clubs.

The Voicespondence Club issues a quarterly magazine, giving news about members and activities of the club, with a supplement listing new members. In addition, an annual Directory of Members is issued, which lists their interests, hobbies, professions, and type of tape recorder, giving speeds and other relevant details.

To join a club, first write to the secretary asking for particulars and a membership application form. If you intend to join a club overseas, enclose with your letter one International Postal Reply Coupon obtainable for 9d. from General Post Offices. This is polite and really necessary, as these clubs are non-profit-making and, in most cases, the staff are part-time honorary workers without remuneration.

On receipt of the application form, complete it in the usual manner, including your Christian name and those of your wife and family, if they intend to join in. All these clubs are very friendly and members are always known by their Christian names.

You will find on the application form a section where you should list your interests and hobbies. It is very important not to list too many interests. Write in those about which you are prepared to do the talking, and can talk knowledgeably.

You may have other hobbies and interests which you would like to know more about. Don't include these, as you will find some person listed with whom you can soon start talking. Also on the form you may find a section asking how you were introduced to the club; perhaps you would mention this magazine.

The annual subscription may vary from club to club, but in the case of the Voicespondence Club it is three dollars for U.S. and Canadian members, while members in other countries send eight 9d. International Postal Reply Coupons to cover cost of mailing.

Making friends by tape exchanges

When you receive your Directory of Members you will find it difficult to choose a contact. When I joined the Voicespondence Club, my wife and I spent days going through the list. You could start as I did, by looking for a member with the same job as yourself in the States. But when I tried this, there wasn't one!

I should think most jobs, professions and occupations — such as Craneman, Light Buoy Tender, Concession Stand Operator, Railway Shunter—are listed, but there was no Air Traffic Control Officer.

Eventually we sent off two air letters to members in the States, asking if they would "Voicespond" with us.

You might prefer to study the interests of various members to find those which coincide with yours. There may be quite a number. This makes it more difficult, so what about choosing different parts of the world, or places you may have visited? We selected people from U.S.A., living on the Eastern and Western Seaboard and in Central and Southern States, and we found it most intriguing to compare the different accents from these parts of the States.

In your first letter you should list your interests and hobbies; your contact won't have your listing in the Directory, as you will be a new member. It is essential, and one of the few rules agreed internationally, that you always write first before making a tape contact—unless the particular member has stated in the Directory that a letter is not necessary.

The Voicespondence Club has a special list of experienced members who are prepared to start you on your way with the first tape, if you don't feel confident enough to start on your own.

YOUR FIRST TAPE

As soon as you receive a letter in reply, asking you to go ahead, start work on your first tape. Your contact may start the ball rolling by replying to your letter with a tape. This, of course, makes it easier for you.

It will be up to you to decide the size of reel to start with, but a total of 30 minutes (15 each track) should suffice. If you feel that is too long for your first tape, try a 15-minute one. When you get established and know your friends well, you can easily introduce a longer tape if required.

Always begin by giving your name, your friend's name and the date, and with your first reel it is a good plan to enclose your name and address on a piece of paper. You might start your tape something like this:—

"Hallo, George Smith. This is Bill Brown, coming to you from London, England, on this sunny August morning of Saturday, September 29, 1959. The music you just heard was . . . etc., etc."

If possible, it helps to make a better and more interesting tape if you can start with some suitable music, preferably of the type which he likes; but keep it short, as he is waiting to hear you speak. Some people have a regular

By W.
**PATRICK
COPINGER**



signature tune with which they begin and end their tapes. You will always associate such a tune with your friend who uses it, giving an additional link.

WHAT TO SAY

Make a few brief notes on what you intend to talk about, in order to keep your thoughts together and compose a reasonably coherent programme. Never write out what you are going to say. This would defeat the whole object of the hobby.

You must try to maintain a completely unrehearsed conversational naturalness, which is not difficult if you mentally change the microphone into the person to whom you are talking.

On your first tape you should be able to keep going quite easily, particularly if you have selected someone from foreign parts, which I consider is far more interesting than a contact in this country.

Your brief notes might read:—

"Self — age — wife — children — names — ages. House — garden — town — village — street live in — job — how far to work — travel by bus, car, train, etc."

You then give details about these brief headings, talking naturally. Don't bother about phraseology or wording. Don't get pedantic in your speech. If you normally drop your aitches don't try to put them back in! Go on to talk about your interests and ask your correspondent questions about his.

NEXT MONTH—Receiving your first reply.



Enthusiasts!...

**HERE'S
SOMETHING
TO GET
ENTHUSIASTIC
ABOUT!**



Walter 303 De Luxe

This is the 'popular' Walter. Ideally suited for family use, it has a very good dynamic range and incorporates all the features you have been waiting for . . .

* Walter Mark II tape deck * Exclusive Walter joy-stick control * 2 speeds— $3\frac{1}{2}$ in. and $7\frac{1}{2}$ in. per sec. * 2 inputs—microphone and radio/gram. * 2 outputs—extension speaker and external amplifier * Record safety button * Instant stop/start control * Magic-eye recording level indicator * Revolution counter * Drive for Walter Cine Synch. attachment * Tone control * 3 watts undistorted output—enough volume to fill a small hall.

42 gns.

Walter 505

This is a set for the connoisseur—a set which gives top performance at anything but 'top' price. Rich low notes, brilliant high frequencies and excellent dynamic range—giving an uncanny 'three dimensional' quality of sound.

* 2 speeds — $3\frac{3}{4}$ " and $7\frac{1}{2}$ " per sec. * modern pencil type microphone * 4 watts undistorted output through 2 speakers — enough volume to fill a medium-sized hall * sockets for recording from microphone, radio set, gramophone pick-up or Walter telephone attachment * separate input recording level controls for recording simultaneously from two channels * superimposing button * straight through amplifier to reproduce from microphone, radio input or gramophone pick - up either through the built-in speakers or an extension speaker * instant stop/start control for interrupting any recording temporarily * sockets for extension speaker or external hi-fi amplifier * monitoring through internal speaker while recording.

57 gns.

Walter Service Centres

have been established throughout the country, staffed with Walter trained engineers, able and eager to give advice and help with any problems you

may have, deal with any repairs or renewals, and give full replacement service under guarantees, irrespective of where your instrument is bought.

WALTER INSTRUMENTS LIMITED

Morden, Surrey Telephone: DERwent 4421/5

To: **Walter** Instruments Ltd.,
Morden, Surrey.

Please send me full details of the following:—

Walter 505

Walter 303 De Luxe

Walter 101

Also, name and address of my nearest Walter dealer

NAME

ADDRESS

Walter 101 A set for the younger set!
Remarkable performance at a reasonable price.

* Exclusive Walter joy-stick control * Recording level indicator * 2 inputs—microphone and radio/gram. * High quality crystal microphone * Socket for external loudspeaker * 5 in. loudspeaker * 2 watts undistorted output—enough volume to fill the largest room * 5 in. tape spools—holding enough for 2 hours with double play tape.

29 gns.

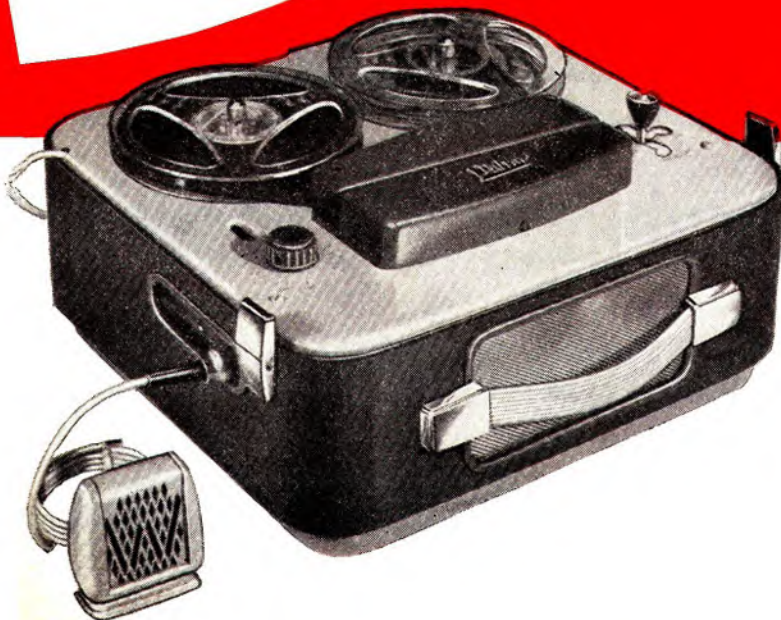

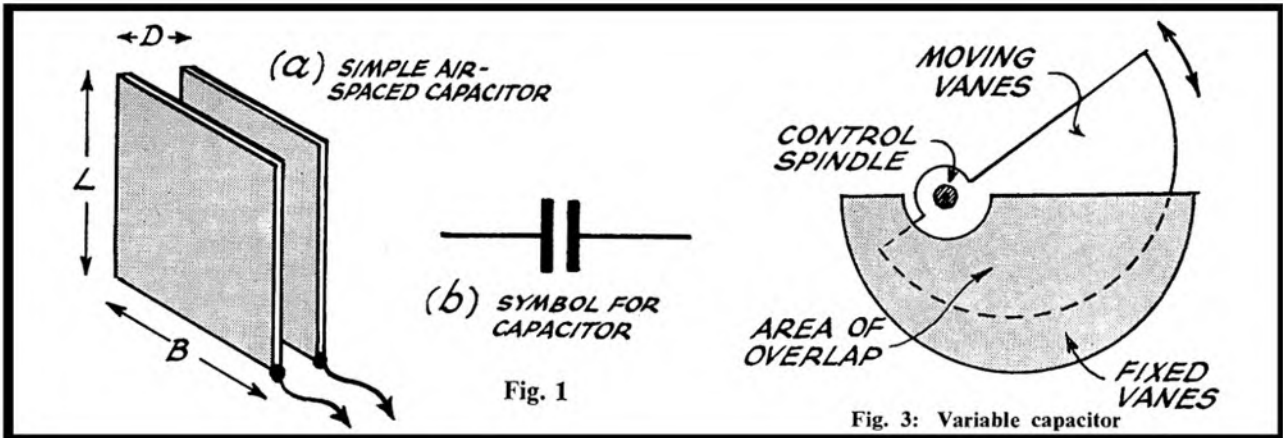

CAPACITORS

MANY capacitors are used in tape recorders and, although the study of capacitors is a subject in itself, this article may help towards a clearer understanding of their purpose.

The old, but still widely used, name for a capacitor is *condenser*. Capacitors are classed according to their construction and, although various types differ widely in this respect, the principle of operation is the same for all.

Capacitors are used for storing electricity and can be charged up rather like a car battery, but with certain very important differences. Whereas a car battery can supply current for many hours after being fully charged, a capacitor is only capable of holding a minute quantity of electricity in practice, and can be discharged in a fraction of a second. In most cases they do not need to hold their charge for more than a few milliseconds (or even microseconds) so this is no disadvantage.

The amount of electricity which the capacitor will hold depends upon its *capacitance*, or value. The unit in which this is measured is called the *farad*, although this is too large for practical purposes when it becomes rather like a housewife weighing her cooking ingredients in tons. Therefore, for practical purposes a much smaller unit is used, the *microfarad* (mf or pf). This is one millionth of a farad, and the largest capacitors used in tape recorders have a capacitance of about 50 mf.

Even the microfarad is too large for many purposes, and the still smaller *pico-farad* (pf), or one millionth of a microfarad is used. Thus 0.001 mf may be expressed as one thousand picofarad. This is more convenient than dealing with decimals, and becomes even more so for capacitors

as low as, say, 5 pf, or 0.000005 mf. The simplest capacitor consists of two metal plates having their faces parallel, placed close together but not touching, Fig. 1. This is a two-plate, air-spaced capacitor, and its capacitance depends upon the area of the plates (assuming they completely overlap) and the distance D between the plates.

There is, of course, a limit to the extent to which the area of the plates may be increased and, if a larger capacitance is required, more plates may be used, as shown in Fig. 2. Fig. 2a shows a three-plate capacitor and a moment's thought will reveal that the capacitance is now twice as great as a two-plate capacitor having identical dimensions. Actually, the capacitance of a multi-plate capacitor is proportional to the number of *spaces*, so that the five-plate capacitor of Fig. 2b will have four spaces and is, therefore, four times as great as the equivalent two-plate component.

In practice, air-spaced capacitors are only available up to about 500 picofarads, and find their use mainly as tuning capacitors in radio receivers. These have to be variable, and so one set of plates is fixed to the main framework, while the other set may be moved into or out of mesh with the fixed plates. Thus the area of overlap may be adjusted to produce the desired capacitance, Fig. 3. In a typical case, the capacitance may be varied from 50 pf to 500 pf.

As the majority of capacitors in a tape recorder are larger than 500 pf, a second

method is adopted to increase the capacitance without actually increasing the physical dimensions of a capacitor. If we take any air spaced capacitor, and completely fill the spaces between plates with any liquid or solid insulating material, such as oil, or sheets of mica, paper, etc., then the capacitance immediately increases to double, treble, or many times the original value.

For example, immersing in oil may multiply the capacitance three or four times. Mica insulation may increase up to seven times. Other materials, such as ceramic, produce an increase of 500 or more times.

The physical size of a capacitor can thus be reduced considerably by the use of such insulation. The insulation between the plates is known as the *dielectric*, and the number of times the capacitance is increased by the use of such insulation is known as the *dielectric constant* of the material. Thus, if the dielectric constant of air (or vacuum) is taken to be unity, then that of oil is three or four, mica up to seven, and ceramic 500. These are only representative figures, and different grades of a particular material will usually display various values of dielectric constant.

A further advantage of using a solid dielectric is that it may be made very thin, so that in effect the plates can be spaced closer together without touching each other than could be the case in an air spaced capacitor. This, once again, results in an increase in capacitance.

All capacitors have one basic function: Although they will not allow the passage of DC, they do offer an easy path to AC. Fig. 4 illustrates this. The capacitors in a tape recorder make use of this principle, and Fig. 5 shows some of them at work in an amplifier. Generally, capacitors are used for *coupling* an AC signal from one point to another, or for *decoupling* an unwanted AC signal to earth.

(Continued on page 39)

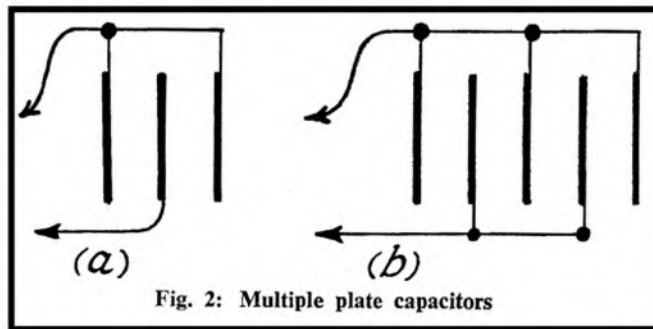

Fig. 2: Multiple plate capacitors

THE SCIENTIFIC BASIS OF TAPE RECORDING by CHARLES LANGTON, A.M.Brit.I.R.E., A.M.Inst.E.

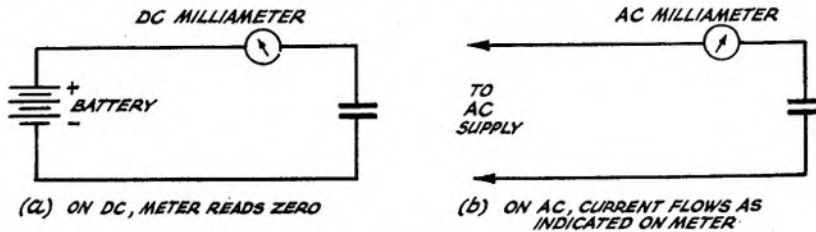

Fig. 4

For example, C³ is necessary in order to transfer the amplified audio signal from the anode of V¹ to the grid of V² for further amplification. A wire could not be connected directly between these points, because the HT voltage on the anode of V¹ would then be applied to the grid of V². This would damage V². Fortunately, however, the HT is DC and the audio signal is AC; therefore the coupling capacitor C³ may be joined between the two points, so as to block the HT from the grid while allowing a free passage for the audio signal. C⁵ acts in a similar manner in the following stage.

V¹ is a pentode valve, and the screen grid has to be connected to HT, usually at a lower voltage than the anode. Thus, a resistor R¹ is used to drop the voltage to a suitable value. An audio voltage would be present on the screen grid, however, if it were not for the decoupling capacitor C¹, and this would reduce the gain and possibly lead to instability. C¹,

therefore, allows an easy path to earth for the unwanted audio voltage. Decoupling capacitors are sometimes known as *bypass* or *filter* capacitors.

C² and C⁴ are the cathode decoupling

capacitors. Once again, they short out to earth any audio voltage appearing at the cathode of the appropriate valves, while their presence does not interfere with the direct bias voltage which is developed across the resistors.

A further example is C⁶, connected between HT positive and HT negative. As the HT will normally be obtained from the mains operated power pack, there would very likely be a certain amount of AC superimposed on the HT. This would cause hum, as it is essential that the HT should be pure DC. Therefore C⁶ is a decoupling capacitor of large value which shorts out the AC ripple to earth, leaving the HT line clear. C⁶ is called a *smoothing* capacitor.

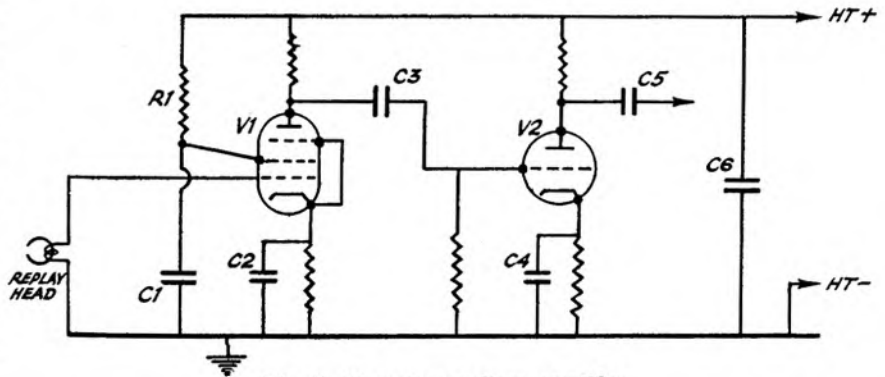

Fig. 5—Two-stage voltage amplifier

EST. 1889 **THE SERVICE Co. (LONDON) LTD.** HOL. 1792-2193

14, HIGH HOLBORN, W.C. 1

(25 YARDS FROM CHANCERY LANE TUBE STATION)

CENTRAL LONDON'S TAPE RECORDER & PHOTOGRAPHIC DEALERS

A Tape-Recorder offers a complete new interest to the movie camera enthusiast—sound with your films is a possible exciting addition to your hobby-music commentary-dialogue! All yours on the "SERVICE" plan. Or if you have a Recorder think what a difference colour home movies will make to your life. Write or call for full details.

Remember that Cameras—Projectors—Enlargers—in fact all your photographic equipment is available on the famous "SERVICE" terms.

It will be to your advantage to come to us!

NO INTEREST CHARGES — DEMONSTRATIONS — SMALL DEPOSIT

All postal enquiries answered by return of post

	Cash Price	Deposit	12 Monthly Payments
	£ s. d.	£ s. d.	£ s. d.
Grundig TK20	54 12 0	4 4 0	4 4 0
Philips EL3527	40 19 0	3 3 0	3 3 0
Brenell Three Star.....	60 18 0	4 13 0	4 13 8
Brenell Mk. 5.....	67 4 0	5 4 0	5 3 4
Wyndor Viscount	51 9 0	4 1 0	3 19 0
Walter 303	44 2 0	3 8 0	3 7 10
Elizabethan Essex	68 5 0	5 5 0	5 5 0
Elizabethan Mayfair ...	75 12 0	5 17 0	5 16 3
Elizabethan Escort.....	47 5 0	3 15 0	3 12 6
Philips AG 8108.....	65 2 0	5 2 0	5 0 0
*Telefunken KL75K	52 10 0	4 1 0	4 0 9
*Telefunken KL85K	78 15 0	6 3 0	6 1 0
*Grundig TK30	75 12 0	5 17 0	5 16 3
*Grundig TK25	65 2 0	5 2 0	5 0 0
Elizabethan F.M. Tuner	17 0 0	1 7 0	1 6 7

*Microphone Extra

ALL MAKES OF TAPES & ACCESSORIES SUPPLIED

HEAR THE **SPECTONE**

LOOK AT ITS SPECIFICATION!

The Most Astounding Value **£51. 9. 0.**

Deposit **£4 1s.** and 12 Monthly Payments of **£3 19s.**

Two pairs of recording, playback and erase heads for continuous operation.

Pause control for momentarily interrupting recording or playback. Conforms to C.C.I.R. specifications. Provision for full size 7-in. spools. Built-in facilities for mixing all inputs.

Built-in superimposition facilities. Three knobs for simple operation of:—

- (1) mains on/off/tone control;
 - (2) microphone or playback volume;
 - (3) radio/gram volume.
- Complete with Acos mic.

NEW *free catalogue* NOW 72 PAGES

To make sure you choose the right Tape Recorder or Hi-Fi Equipment, YOU MUST SEE the new Comprehensive Review from the Tape Recorder Centre. The most complete Catalogue ever published: 72 illustrated pages. Free of charge. Full details of hundreds of Tape Recorders, Accessories and Hi-Fi Equipment from all leading manufacturers.

All Orders Over £30 on No-Interest Terms.

TAPE RECORDERS

Grundig
Elizabethan
Ferrograph
Vortexion
Walter
Brenell
Reflectograph
Simon
Tandberg
Harting
Telefunken
Philips
Spectone
Verdik
Veritone
Stuzzi-Magnette
Ficord
Truvox
Baird
Magnafon
Kurland
Reps
Revox
Wyndson
Regentone
Perth-Saja
Elektron
Minivox

HI-FI EQUIPMENT MICROPHONES, SPEAKERS, ETC.

Leak
Quad
Rogers
Armstrong
Dulci
Jason
Pamphonic
Avantic
W. B. Stentorian
Pilot
Collaro
Elpico
Decca
Pye
Philips
Wright & Weaire
G.E.C.
Dynatron
Goodmans
C.Q.
Wharfedale
Elac
B.J.
Garrard
Connoisseur
Goldring

T.S.L.
Stirling Tuners
Acos
Lustraphone
Elpico-Geloso
Simon-Cadenza
Reslo
Record Housing
Linear
Tannoy
Ortofon
R.C.A.
Lowther
Film Industries
Audiomaster

TAPE

Emitape
Scotch Boy
BASF
Grundig
Telefunken
Agfa
Elpico
Soundrite
Gevaert
Philips

All Accessories, Tape, etc., by return of post. All makes in stock.

Choose with confidence from the leading Specialists in the country



THE TAPE RECORDER CENTRE

For free catalogue send this coupon to: Sypha Sound Sales Ltd., Dept. T,
75, Grand Parade, Harringay, London, N.4. (Tel.: STA 1146.)

Name.....
Address.....

Radio Show should have convinced remaining doubters

STEREO

PAGE



**Edited by
D. W. GARDNER**

SPARING use of spectacular sound effects and a larger number of well-organised programmes of stereo music played their part in assuring visitors to this year's Radio Show that stereophonic sound is not something to marvel at and leave alone, but something worth spending money on in anticipation of hours of musical enjoyment in the home.

Helping to settle the doubts of people who have been confused through hearing cheap "only just" stereo, were such demonstrations as those by E.M.I., using an array of expensive professional tape equipment at 15 ips. Listeners were thereby left in no doubt about the desirability of stereo in principle and, with the highest standards to guide them, they were in a good position to reach sound, critical assessments of the equipment in the lower-price groups.

Among features of special interest to stereo-tape enthusiasts were the new Cosmocord stereo microphone, the Simon stereo replay adaptor, the Collaro "Studio" deck (with space for a third head for stereo playing) and the stereo version of the Brenell 3-star recorder.

The latter, a prototype, was performing very nicely, and has a number of useful facilities for people making their own stereo and monophonic tapes. With 4 watts per channel, three playing speeds (7½, 3¼ and 1½ ips), and a price of 89 guineas, without microphone. This model seems to have a bright future before it.

In the stereo amplifier field there were interesting innovations by B.T.H., Pyc, Associated Electronic Engineers and the combined forces of E.M.I. and S.T.D. The Emisonic-Orthotone high-fidelity equipment emerging from the latter association captured a considerable amount of attention. The stereoscope, an amplifier designed with the American market in mind, is a fascinating piece of equipment with an array of controls and switches that should stagger even the U.S. hi-fi fan.

In addition to scratch and rumble filters and a loudness control switch, there is an oscilloscope-type indicator to provide visual balance. The amplifier costs nearly £70, but it has a great deal to show for it.



JUST before the opening of the Radio Show, G.E.C. staged a laudable and daring demonstration of stereo on tape in closely integrated comparison with live sound. It arose from Hugh Brittain's determination to achieve "natural standards of reference," and utilised a piece of music, specially composed for the purpose and played by members of the G.E.C. staff, entitled "Sonata for Jazz Group and Beer Tankards."

The piece was first recorded on tape, with carefully arranged gaps for the various instruments involved: for the demonstration the performance began "live" and first one and then another instrumentalist ceased playing—in favour of beer tankards—allowing the stereo tape to take over.

This enabled the listeners to compare the recorded performance of each instrument with its live counterpart. The new G.E.C. slender "periphonic" speakers were used, together with two G.E.C. 12-watt amplifiers, and very few people were able to detect any difference between the live and the recorded sounds.

Naturally, to achieve quality that will stand immediate comparison with reality demands the highest standards of recording technique, as well as of the equipment, but the principle is one that might well be tried out by clubs and individuals as a method of checking the capacity of various items of equipment.

After all, our objective should be, not so much to decide whether one piece of equipment seems to perform better than another, but to discover how close each comes to the ideal of reproducing the original sound perfectly.

STEREO QUIZ

- Q. Can you get stereo from a monophonic recording by using two channels ?
- A. *Never. Only the complete stereo chain can give you the true original location of the instruments or other sounds. The separation sometimes achieved by juggling with frequencies represents a serious distortion of the positional content of the performance, by allocating high notes to one side and low notes to the other.*
- Q. How do you find out about all these things ?
- A. *By studying Stereo Sound and Music Magazine regularly.*
- Q. How do you make sure of getting a copy every month ?
- A. *By placing a regular order with your newsagent.*



the **FINEST** TAPE RECORDERS on **INTEREST FREE** TERMS...

Write, Phone or Call today. You can buy by post with perfect confidence

I know how difficult it is to choose the Tape Recorder. That is why more and more people come to the Royal Opera Arcade, because my advice, personal attention and help are freely given. Full demonstrations at any time, and you can always examine and hear the latest and most interesting machines. Remember—I am here to help you.

LAURENCE DICKINSON.

Leaflets gladly sent if you are unable to call.

All machines are complete with tape and microphone except those marked*.

Model	Cash Price Gns.	Deposit £ s. d.	12 Monthly Payments £ s. d.
Philips EL3527.....	39	4 19 0	3 0 0
Elizabethan Escort	45	6 5 0	3 8 4
Saja Standard	45	6 5 0	3 8 4
Verdik S1	45	6 5 0	3 8 4
Elektron	47½	6 17 6	3 12 2
Wyndor Viscount	49	6 19 0	3 14 2
Spectone 161 (Ex Tape)	49	6 19 0	3 14 2
Grundig TK20	52	7 0 0	3 19 4
Dulci-Harting Deck* (with pre-amp)	55	7 5 0	4 3 4
Elpico	55	7 5 0	4 3 4
Telefunken 75KB (with microphone)	56	7 6 0	4 5 10
Brenell 3 Star	58	7 10 0	4 9 0
Veritone Portable	58	7 10 0	4 9 0
Saja Export	59	7 19 0	4 10 0
Truvox R2	59	7 19 0	4 10 0
Grundig TK25	62	8 2 0	4 15 0
Telefunken Deck*	63	8 3 0	4 16 8
Philips 8108	63	8 3 0	4 16 8
Elizabethan Essex*	65	8 5 0	5 0 0
Veritone Venus*	66	8 9 0	5 2 6
Brenell Mk. V (with microphone)	69	8 11 0	5 5 6
Stuzzi Magnet	69	8 11 0	5 5 6
Grundig TK30*	72	9 12 0	5 10 0
Telefunken 85*	75	9 15 0	5 15 0
Harting HMS*	82	10 12 0	6 5 8
Grundig TK35*	82	10 12 0	6 5 8
Sabafon Automatic*	89	13 9 0	6 13 4
Simon*	95	14 15 0	7 1 8
Tandberg Stereo* (4-track)	124	20 4 0	9 3 4

CHOOSING OR USING A TAPE RECORDER, WE HIGHLY RECOMMEND—

“THE ALL-in-ONE TAPE RECORDER” BOOK
Price 12s. 6d. Post Free



NEW EQUIPMENT We now have

- Jason Tuners and Amplifiers
- Eumig Cine Projectors with tape link
- Telefunken Deck
- Dulci-Harting Deck
- Veritone Portable Recorder
- C.Q. Speakers
- Tandberg 4-track Recorder

and the new battery recorders:

Fi-Cord 59gns. Minivox 37gns. Clarion 25gns.

Dickinsons of Pall Mall Ltd

11 Royal Opera Arcade, Pall Mall, S.W.1. TRA. 2881

The Royal Opera Arcade lies behind Her Majesty's Theatre in the Haymarket (one minute from Piccadilly Circus or Trafalgar Square).

FIDELITY RADIO PRESENTS THE

ARGYLL

TAPE RECORDER

NEW!

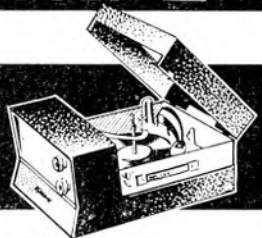

MODEL HF16

Brilliant new Automatic Record Player with 4 spd. Auto-changer with Turnover Crystal Head and permanent Sapphire. Loads 10 records with Automatic size selection. AC only 200/250 Volts

18 gns. Inc. P.T.

Fidelity Radio Presents the New Argyll Tape Recorder.

The Argyll is of the very finest quality and, for a machine so cheap, has outstanding specifications. Post the coupon for full details.

29 GNS



MODEL HF12

An attractive 4 speed Amplified Record Player in the lowest price range. Takes all sized records; Turnover Crystal cartridge; finishes: blue/cream or maroon/grey candy stripe. AC only 200/250 Volts.

9½ gns. Inc. P.T.



Please send me full details of: The ARGYLL HF16 HF12

NAME

ADDRESS

To FIDELITY RADIO LTD.
11/13, Blechynden Street, W.11.



1959 RADIO SHOW

The Radio Show of 1959 will be remembered as a milestone in the history of tape recording. It was there that the industry gave notice that it was ready to go out for the mass market. The big radio firms took the field; a whole batch of new tape decks were introduced; prices of recorders began to tumble; stereo became a commonplace on every stand.

The one big overwhelming feature was the appearance of a whole range of recorders costing less than thirty guineas—machines aimed at a market which is as yet scarcely touched.

One came away with the impression that the tape industry may easily double its capacity before we see another Radio Show.

The Garrard "Bichette" deck—the first with tape loading in magazines—naturally attracted much attention. Other manufacturers are busy experimenting on similar lines; the merits of magazines, as against the present-type spools, was a staple of Show conversation.

★

The news that H.M.V. will be in the market soon with a £50 domestic tape recorder caused a stir in the trade, but the public must wait for a few more weeks for news. Meanwhile, Ferguson are in the field with a recorder, as are several other big radio manufacturers.

Two firms have brought the price of complete stereo tape equipment below the £100 mark.

THE NEW DECKS

THE significant growth of activity revealed by the Radio Show was a direct result of the development of several new decks. In particular, the new B.S.R. "Monardeck," which is going to manufacturers at a price well below anything previously available, has made possible the sudden appearance of numerous recorders at under thirty guineas.

It is used, for example, on the Elizabethan "Avon" (illustrated in our last issue) and on the new Sound "Prince."

It has tempted a number of manufacturers who have hitherto not appeared to be fully committed to large-scale output of tape recording to take the plunge—Portogram, E.A.R., R.G.D., all have modestly-priced machines incorporating the Monardeck.

New firms have entered the field as manufacturers, using this deck—Alba, Saga, Amplion and Avatone to mention a few.

Naturally, the other big firms who have been in the gramophone field are looking to their guns in the face of this B.S.R. incursion. One of the most interesting things at the Show was the demonstration of the new Garrard "Bichette" deck, the first made in this country to operate with tape loaded in magazines.

It is a neat design, with controls so simple that a five-year-old could operate them without going wrong. Two 4-in. spools are entirely enclosed in a transparent plastic case, the whole of which drops into position on the tape deck as easily as a disc on a turntable. There is no tape threading, no anchoring of tape, no tape spilling.

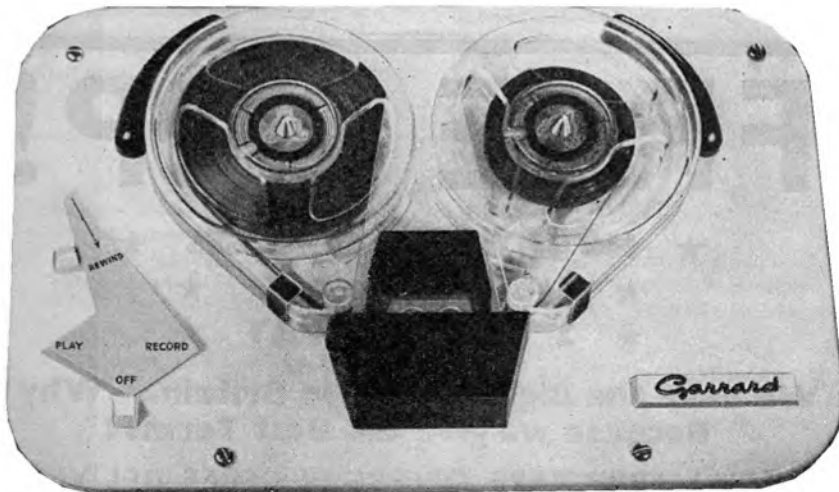

The Garrard "Bichette" deck—the first British design incorporating magazine loading of the tape

The tape can be stopped at any point and the magazine removed from the machine. Later it can be replaced and the playback continued from the same point.

Double-play tape is used, so that a magazine gives a total of 70 minutes on the two tracks—the speed being 3½ ips.

The deck will play conventional spools of tape, too, but in that case there may be difficulty with braking. The only other limitation that needs to be mentioned is that the deck provides for "fast forward" but not "fast rewind." It is

so simple, however, to turn the cassette over to achieve the desired result that this is not considered a drawback.

The spools in the magazine are held by a spring-loaded brake, which is only released when the deck is switched on. The tape is thus kept taut and there is no danger of spillage when the magazines are handled away from the recorder. When playing, the magazine is locked on the deck.

Frequency response is given as 30 to 7,000 cps, or up to 10,000 cps with a

(Continued on page 45)

MATERNITY WARD

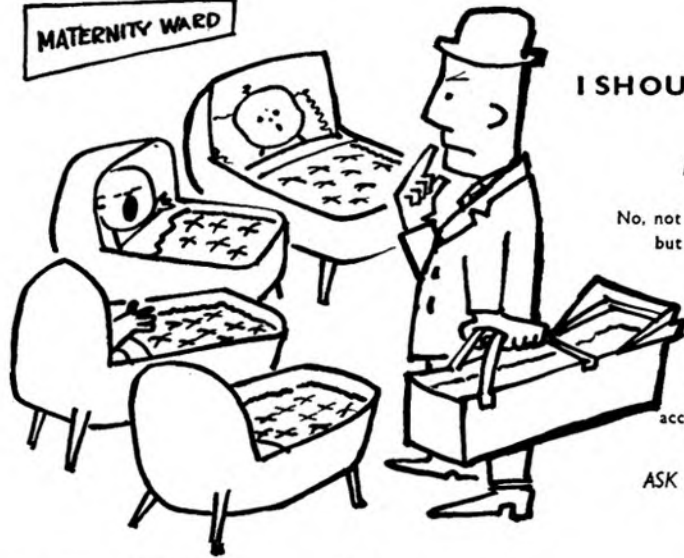

I SHOULD HAVE USED METRO-TABS!

FOR INSTANT RECOGNITION

No, not of babies, bottles or bathing beauties,
but of tape recordings.

All your mixed up tape recordings can be found
so easily and quickly when you use
the new Metro-tabs index system.

Quick and colourful, Metro-tabs are fully visible
on a wound spool.

Just one of the range of tape recorder
accessories made by

ASK YOUR DEALER TODAY!

Price 3/11



Metro-tabs

METRO-SOUND MANUFACTURING CO. LTD., 19A, BUCKINGHAM ROAD, LONDON, N.1. CLISSOLD 8506/7

FREE H.P.!

- ★ NO INTEREST CHARGES ★
- ★ 1/- IN £ DEPOSIT ★
- ★ 2 YEARS TO PAY ★



**We have the Biggest Sales in Britain. Why?
Because we give the Best Terms!**

SPECIAL FREE TAPE OFFERS ★ FREE DELIVERY ANYWHERE IN U.K. ★
 FREE SERVICING FOR 12 MONTHS ★ NO PURCHASE TAX ★ PART-
 EXCHANGES & SECOND-HAND MACHINES ★ 200 machines, 35 models in
 stock ★ Mail Order Department covers the whole country ★ Open all day
 Saturday ★ Main Agents for all the best makes ★

HOWARD

PHOTOGRAPHIC

218 HIGH ST · BROMLEY · KENT · RAV 4477



PORTABLE STEREO—Attractive Ann Peel, of Egham, Surrey, proves that the new Veritone Venus stereo model is really portable. Both cases—one houses the recorder and the other the two speakers—weigh 50 lbs. together. And the cost is less than £100

suitable amplifier design. There are only two controls—the rewind switch and a three-positional function switch for Play-Off-Record.

First firm to announce a machine incorporating this deck is E.A.R. A prototype was shown at the Radio Show and production is about to start, but full details are not yet available. It is obvious that other manufacturers will not be far behind.

Garrard think that the deck may be available for retail early in the New Year.

The third big firm to come forward with a new deck was Collaro, whose "Studio" deck (described and illustrated last month) was seen at Earls Court to be a most handsome and efficient design. With its 1½, 3½ and 7½ ips speeds and the provision for easy fitting of a third head, to provide monitoring or stereo facilities, this deck has a flexibility that ensures wide popularity.

One cannot help wondering whether Collaro themselves have done so much to popularise the idea of separate controls for the two tracks that users will be loath to go back to lifting off and reversing reels; but a big difference in cost of production is involved, and the "Studio" deck has so attractive a specification that it is likely to be as widely used in future recorders as previous



1959 RADIO SHOW REVIEW

(Continued from page 43)

Collaro decks have been in the past.

Here again, it is likely to be a few months before the decks are sold separately through retailers.

Apart from new machines introduced at the Show, there were a number on private view to dealers, which will be introduced shortly. None was more interesting than the £50 model with which H.M.V. are about to enter the domestic tape recorder market. This is a two-speed machine (3½ and 7½ ips) with a quoted frequency response of 40 to 12,000 cps ± 5dB at the top speed. It takes 7 in. spools and rewind time is only 50 seconds.

There are three heads and separate record and playback amplifiers. Fuller details are likely to be available for our next issue.

Walter Instruments also had interesting news for the future—a stereo reproducer that will go into production early next year. This firm is working on miniaturised and transistorised recorders.

E.A.P. was showing a prototype of a machine to be known as the "Major", using a Collaro Studio deck and a push-pull amplifier delivering six watts to the internal four-speaker system. Production begins this month and the provisional price is 59 guineas.

(Continued on page 47)

ECONOMY MACHINES—Three of the new recorders introduced at the Radio Show which set new price levels. Left is the Sound "Prince," using the B.S.R. deck, including such facilities as mixing of two inputs, superposition and monitoring. It costs only 32 guineas.

Below, new machines by two big radio manufacturers who have now entered the tape field. On the left is the Alba "Duchess" costing 26 guineas; on the right, the Ferguson 441 TR, priced at 28 guineas.





A fully transistorised battery operated recorder with all the features expected from a mains operated recorder of advanced design.

NEW WATERPROOF COVERS to protect your valuable recorders. Choice of colours: bottle green, navy blue, tan, and wine with white piping. Full range in preparation.

COVER PRICES

TK5 with microphone pocket	36s.
TK20 with microphone pocket	35s.
TK8 with microphone pocket	39s.
TK25 cover with microphone pocket	39s. 6d.
TK30 with microphone pocket	40s.
TK35 with microphone pocket	45s.
TK55 with microphone pocket	45s.
TK820/3D (no pocket)	40s. 6d.
TK830/3D (no pocket)	40s. 6d.
Telefunken 65KS and 65KX (no pocket)	31s. 6d.
Telefunken KL85 (no pocket)	45s.
Telefunken 75	38s.
Telefunken 85	45s.
Elizabethan Escort (no pocket)	37s. 6d.
Philips AG8108 (with pocket)	41s. 6d.
Philips AG8109 (no pocket)	38s.
Regentone	38s.
Sound 444	46s.
Stella ST450	42s.
Wyndor Viscount	41s. 6d.
Saba with microphone pocket	45s.
Electron with microphone pocket ...	39s.
Perth-Saga MK5 with mic. pocket ...	45s.
Saga M40 with microphone pocket ...	37s. 6d.
Grundig Cub with microphone pocket	30s.

TRADE ENQUIRIES INVITED LEAFLETS NOW AVAILABLE

THE STUZZI 'MAGNETTE' IT'S SPECTACULAR!

- * Size 11" x 4 1/2" x 8" Weight 8lbs.
- * Twin Speed 1 1/2 and 3 1/2. * Twin Track.
- * Frequency 80-9000 cycles.
- * Up to two hours per reel playtime.
- * Magic Eye. * Position Indicator.
- * Amplifier Facilities.
- * 1d. an hour to run—approx.

69gns. complete with microphone and radio connecting leads.



also the

minifon

One of the world's smallest wire recorders

TAPE RECORDERS BY

Grundig, Geloso, Telefunken, Truvox, Elizabethan, Wyndor, Simon, Ferrograph, Electron, Fidelity, Clarion, Tutor, Ficord, Reflectograph, Perth-Saja, Tandberg, Harting, etc.

MONAURAL AND STEREOHONIC PRE-RECORDED TAPES.

MICROPHONES AND STANDS. Grundig, Cadenza, Geloso, Cosmocord, Lustraphone, Reslo, etc.

CRYSTAL PEN STAND MICROPHONE complete with ball point pen—suit Geloso TR 175. Price £5 10s. 0d.

TAPES. Grundig, B.A.S.F., Emitape, Scotch Boy and Telefunken Double Play.

JOINING AND EDITING ACCESSORIES. Mixers, Tuners, Amplifiers, Converters, Speakers, Record Transcription Units, Spares.

★ No Interest Terms ★ Free Delivery

A. BROWN & SONS LTD.

TAPE RECORDING DEPT. 24-28 George Street, Hull, E. YORKS. Telephone: 15412, 15413

THE NEW SPECTONE 161

The Tape Recorder that has really got something



PRICE Deposit £5 9 0
49 Gns. 12 payments of £3 16 8

REW EARLSFIELD LTD., 545, GARRATT LANE, S.W. 18.

5 MINUTES TOOTING BROADWAY UNDERGROUND STATION

NEW AND USED TAPE RECORDER SPECIALISTS

BEST PART EXCHANGE ON YOUR TAPE RECORDER NO INTEREST TERMS

- ★ A luxury tape recorder at an economy price
- ★ Three speeds
- ★ Twin-track Operation
- ★ Automatic Tape Position Indicator
- ★ Pause Control
- ★ Can be used as Amplifier for Radio, Gram and Microphone
- ★ Facility for Extension Speaker
- ★ Unique Tape Storage Facilities
- ★ Accidental Erasure Prevention Device
- ★ Handsome Two-Tone Case and a host of other Essential Features

FREE INSURANCE

in the event of

- Unemployment
- Sickness
- Accident
- Death

the payments cancelled not postponed

150 MACHINES ON DISPLAY

Main sales and service agents for best makes. Special Cash Terms Free Delivery

TEL: WIM 0709

BUS STOP OUTSIDE, 100 YARDS FROM EARLSFIELD STATION

MORE NEW MODELS AT THE 1959 RADIO SHOW

(Continued from page 45)

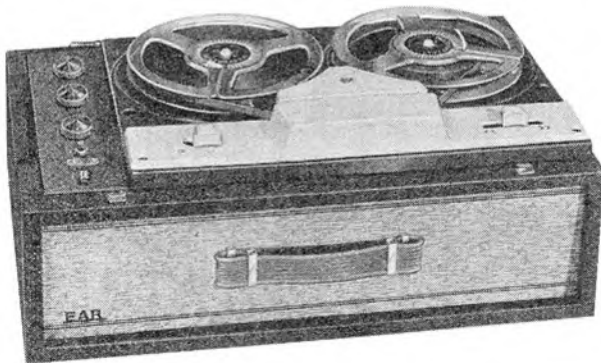

The new E.A.R. "Bantam"



Truvox showed this new R. 7 recorder

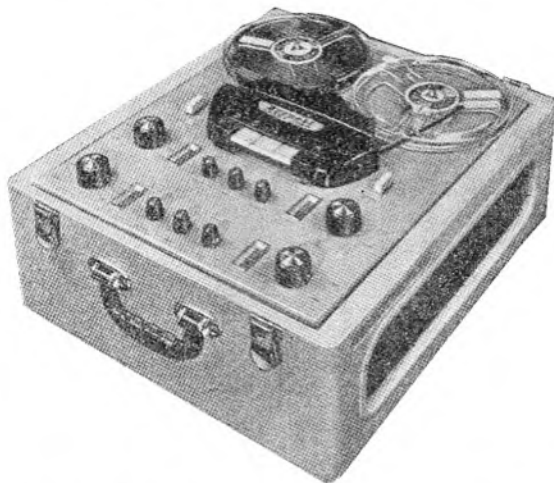

The new stereo version of the Brenell 3-star machine
(Continued on page 48)



In this feature every month you can check

YOUR LOCAL DEALER

who gives special attention to tape

LONDON

Lee Electronics

TAPE RECORDER & HI-FI AUDIO SPECIALISTS

400, EDGWARE ROAD, LONDON W.2

London's Leading Stockists of High-Fidelity and Audio Equipment. Many Bargains in new and reconditioned Equipment.

SEND FOR FREE LISTS

All Machines demonstrated for performance on Record and Playback

All leading makes of Hi-Fi equipment from stock

PADDINGTON 5521

Hi-Fi Consultants and Dealers

STUDIO RECORDING & DUBBING FACILITIES

Studio A, 40 ft. x 40 ft.

TAPE to DISC

professional standards

OLYMPIC SOUND STUDIOS

Carton Hall, Carton Street, London, W.1

Tel.: HUN. 1635

Agents for SAGA Records and Tapes

Dealers in CQ Audio Equipment

Cabinets, enclosures and equipment by Stamford

EQUIPMENT CABINET
3ft. wide, 35in. x 14in.
Motor Board, 35in. x 13in.
Control Panel or portion for tape storage.



Price £16.16s. or Deposit 51s. and nine monthly Payments of 34s. Choice of finishes.

	Cash Price		Hire Purchase	
	£	s. d.	£	s. d.
TUNERS				
Dulci H4T2 AM/FM	24	19 0	75	0 27 2
Chapman FM85	28	17 6	87	0 31 4
Quad FM	28	17 6	87	0 31 4
AMPLIFIERS				
Rogers HG88	37	10 0	112	6 40 9
Leak TL12 and Vari-slope 111	34	13 0	103	9 37 8
MOTORS				
Garrard 4HF	18	9 9	55	6 20 1
Collaro 4T/200	18	12 0	55	6 20 2
SPEAKERS				
Axette	6	12 2	19	0 7 2
WB HF1012	4	15 0	14	3 5 2
Golden 10in. FSB	8	7 3	25	0 9 1
Axiom 300	11	5 9	33	6 12 4

A. L. STAMFORD, LTD. (Dept. J.3)
84/86/98, Weymouth Terrace, Hackney Rd., London, E.2



In this feature every month you can check

YOUR LOCAL DEALER

who gives special attention to tape

LONDON

Been to the Radio Show?

Now come and see us—perhaps we can solve your problem

WADDEN & HILL Ltd.
HOUNSLOW, ISLEWORTH, FELTHAM & BOSTON MANOR

THE SOUTH

ALL TAPE RECORDERS
From the Specialists

TAPE RECORDERS
(Bournemouth) LTD.

Main Area Dealers for
FI-CORD : PHILIPS : GRUNDIG

Authorised Service Agents for
TELEFUNKEN and WALTER (Southern England)

Tapes and Accessories by Return. Terms available on New or Reconditioned sets.

WRITE OR PHONE FOR FREE BROCHURE
Seamoor Road, Westbourne, BOURNEMOUTH, Hants.
Telephone: Westbourne 64292

HAMPSHIRE—HIGHCLIFFE-ON-SEA

J. H. WOOD

TAPE RECORDER STUDIO

Elizabethan, Ferrograph, Brenell, Reflectograph, Spectone, Truvox, Clarion, etc.

STEREOPHONIC & MONOPHONIC HIGH FIDELITY SOUND EQUIPMENT

Demonstrations of synchronised sound with home cine.

117, Ringwood Road, Highcliffe-on-Sea Telephone: 2040

THE RADIO SHOW

(Continued from page 47)

On the stereo front, Veritone introduced at the Show the stereo version of their Venus machine. This is a very handsome and compact equipment, housed in two matching cases—machine in one, speakers in the other—which weigh 50 lb. between them. The price is 95 guineas.

Brenell also showed a new model—a version of their well-known 3-Star—which provides full stereo recording and reproducing facilities in a very convenient form. All controls and all input and output sockets are easily accessible at the front of the machine; there are two modulation indicators—one for each track—close together on the deck so that both can be watched together; and there are two built-in speakers so that recordings may be checked without external aids.

Frequency compensation is provided at the three speeds—7½, 3½ and 1½ ips. The two amplifiers can be used independently of the tape mechanism and so are suitable for reproducing stereo discs.

The price is 89 guineas, or 95 guineas with two microphones.

It is not possible here to do more than mention a few of the other exhibits at the Show. Fuller information about specific machines will appear in future issues of *Tape Recording and Hi-Fi Magazine*.

Saga—well-known for their tape records—have entered the field with three machines, including a 19-guinea "Tapelet" which is designed to couple with the amplifier in a radio.

Truvox showed their entirely new design R.7 recorder, which tracks in both directions, takes 7 in. reels and has an output exceeding 4 watts. Speeds of 7½ and 3½ ips are provided. The same firm showed its Mark IV deck in mono and stereo versions, at 25 guineas and 37 guineas respectively.

Reps have introduced a new R.10 recorder, using the Collaro "Studio" deck and incorporating some ingenious dual-purpose controls. For example, the "record commence" button becomes a super-imposing button during recording, and the main volume control adjusts the monitoring level when recording. The price is 56 guineas.

Lee Products showed their extremely neat TR400, with the B.S.R. deck, at 26 guineas.

At the more expensive end of the scale, the Simon and Reflectograph machines attracted great interest.

In our next issue we shall introduce a new feature called "THE NEW MODELS," which will illustrate and describe the latest machines in full detail.



The 3S.38—one of the recorders in the new Sagatone range

PRODUCTS REVIEW

A NEW GELOSO



A NEW MODEL ELPICO Geloso recorder, known as the G.256, is a beautifully compact example of modern Italian styling. "It looks like a jewel and works like a gem," say the manufacturers, who announce it as the smallest mains-operated recorder in the world.

It measures 10 x 5½ x 4 in. and weighs 6½ lbs.

It operates at 1½ ips, at which a frequency response of 80 to 6,000 cps is claimed. Using standard tape on 3½-inch reels, and using both tracks, this gives an hour's recording time.

Tracks are changed by reversing the spools. There are simple, straight-forward push-button controls. Power output is approximately two watts and signal to noise ratio is quoted at better than 40 db.

With a crystal mic. and a 430-ft. spool of tape and spare reel, the machine costs 26½ guineas.

Accessories available include headset and foot or desk finger-tip controls, for use as an office dictating machine; and a converter with which to operate the recorder from a 12v. D.C. battery.

Lee Products (Gt. Britain) Ltd., Elpico House, Longford St., London, N.W.1.

Philips Market Tape Cassette



A CASSETTE to provide continuous playback of messages of up to twenty minutes' duration has been introduced by Philips Electrical Ltd. Catalogued as type EL3963/00, it is designed for use with the Philips AG8108G recorder, but it can also be used with certain other models with a left-to-right tape sense and facilities for locking the tape turntable in a stationary position during recording and playback.

The cassette contains low friction magnetic tape coated on both sides and has a diameter of 3½ in. The playing time may be doubled by the formation of a "mobius loop."

Price is £5.

Philips Electrical Ltd., Century House, Shaftesbury Avenue, London, W.C.2.



In this feature every month you can check

YOUR LOCAL DEALER

who gives special attention to tape

THE MIDLANDS

R-E-S OF COVENTRY

SPECIALISTS IN HIGH FIDELITY and all makes of Tape Recorders

- ★ Stocks of Stereophonic and Pre-Recorded Tapes
- ★ Demonstrations always available by fully qualified staff
- ★ The Best Selection—Terms or After Sales Service in the MIDLANDS

R-E-S (COVENTRY) LTD.
128 FAR GOSFORD ST. Coventry 60913

TAPE RECORDERS

on "NO-INTEREST" Terms!

Buy your new Tape Recorder without touching CAPITAL! NO EXTRA CHARGES FOR EXTENDED CREDIT. You pay the Retail Price only. All leading makes stocked—Grundig, British Ferrograph, Philips, Vortexion, Telefunken, Baird, Walters, etc.

JEWKES & CO. LTD.

The Midlands Hi-Fi and Tape Recorder Specialists
285, BROAD STREET, BIRMINGHAM 1. MID 4829/20

THE NORTH-WEST

Yorkshire's Leading Tape Recorder Specialists

Comparative Demonstrations Daily
Call and see our extensive range
Official Telefunken Service Agents

TREVOR FAWTHROP LIMITED

17, RAWSON STREET

Phone: Halifax 66832



In this feature every month you can check

YOUR LOCAL DEALER

who gives special attention to tape

THE NORTH-WEST

MANCHESTER

HIGH FIDELITY DEVELOPMENTS LIMITED
THE SOUND REPRODUCTION SPECIALISTS
FOR TAPE RECORDERS

FERROGRAPH : TELEFUNKEN : PHILIPS
HARTING : GRUNDIG : REFLECTOGRAPH
BRENNELL WYNDSOR : TANDBERG etc.

RADIO TUNERS · LOUDSPEAKER SYSTEMS

The HOME MUSIC Shop
8 DEANS GATE
MANCHESTER

(Near Grosvenor Hotel)



JOHN SHINN & SONS LTD. Electronic Engineers

TOWN CENTRE, LEIGH, LANCS.
Also at MELODY HOUSE, 109 HIGH STREET,
BANGOR, N. WALES.

and MELODY HOUSE, 43 HALLGATE,
TOWN CENTRE, WIGAN, LANCS.

Pioneers in Tape Recorders since 1946

ALL MAKES STOCKED - TERMS AVAILABLE
All customers are made honorary members of the John Shinn Recording Club, with its attendant benefits

SCOTLAND

for SOUND
value SEE US

Hear and test the latest Philips, Simon, Vortexion, Elizabethan, Grundig, etc. You're safer with the specialists (fully equipped service department). Terms arranged.

M^cCORMACK'S

7 COWCADDENS ST.
(Opp. Buchanan St. Railway Stn.)

GLASGOW C.2 Phone: DOUGlas 2846



THE MANNEQUIN

RECORDING DEVICES LTD. have introduced the "Mannequin"—a new machine made entirely in England, using the B.S.R. deck, and priced at 26 guineas, including microphone.

It is a small, compact machine, but has built-in mixing and superimposition facilities. It can be used as a straight-through amplifier.

Recording Devices Ltd., 95, Villiers Road, London, N.W.2.

FOUR-TRACK TELEFUNKEN

A NEW FOUR-TRACK Telefunken recorder is announced by Welmecc. Model 76TR, the Magnetophon, takes 5½-in. spools and operates at 3½ and 1½ ips. It is thus capable of 12 hours 40 minutes recording or playing time.

The machine is basically similar in appearance to earlier Telefunken models, but additional small push-buttons situated between the spools enable the desired track to be selected. Recordings on two tracks can be played back together.

There is a new transistor pre-amplifier stage and frequency response claimed is 30 to 9,000 cps at 1½ ips and 30 to 16,000 cps at 3½ ips.

The Magnetophon sells at 64 guineas, excluding mic.

Welmecc Corporation Ltd., 147 Strand, London, W.C.2.

IN BRIEF

WYNDSOR RECORDING CO. LTD. announce that Mr. R. Russell, General Manager, has been appointed a director, joining the present directors, Mr. H. M. Creek (chairman and managing director) and Mrs. E. A. Creek (secretary).

THE FIRM OF DULCI has been taken over by Lee Products (Great Britain) Ltd. Present Dulci models are being continued and the range is to be extended and improved.

ELECTRIC AUDIO REPRODUCERS LTD. announce that the issued shares of the company have been purchased from Gas Purification and Chemical Company Ltd., by Mr. Leonard Stone and the other former directors of the company, Mr. E. Kaye and Mr. J. R. Sharp. The company's range of products has been extended to include tape recorders.

OWING TO EXCEPTIONAL PRESSURE ON SPACE, DESCRIPTIONS OF A NUMBER OF NEW PRODUCTS HAVE HAD TO BE HELD OVER UNTIL OUR NEXT ISSUE.

F. C. JUDD offers a preliminary laboratory report on

THE TAPE RECORDING MAGAZINE TEST TAPE

THE first combined monaural and stereo frequency test/demonstration tape to become available in this country has been specially made by Olympic Sound Studios, of London, for exclusive issue by *Tape Recording* and *Stereo Sound* magazines. The standard of recording is high and complies with specifications generally adopted in Britain. It is a tape which should be in great demand by tape recorder owners, dealers and manufacturers.

Frequency Test Bands for the three tape speeds of 3½, 7½ and 15 ips are provided for stereo and monaural testing, and the tape contains selected demonstration recordings in stereo.

An announcement at the beginning of the tape warns users about the importance of demagnetising the playback heads before running the tape through on the frequency test bands. Partial magnetisation of the head can damage the tape and render it useless for accurate test purposes.

The first frequency band is at 7½ ips and commences at 10 Kc/s (10 dB below peak recording level) for azimuth alignment.

Then follow sections containing the following frequencies:—

7½ ips :	1 Kc at peak level			
	3 Kc/s Wow Test			
	1 Kc	20 dB below	peak level	
	15 Kc/s	"	"	" "
	12 Kc/s	"	"	" "
	10 Kc/s	"	"	" "
	8 Kc/s	"	"	" "
	6 Kc/s	"	"	" "
	2 Kc/s	"	"	" "
	1 Kc	"	"	" "
	500 cps	"	"	" "
	250 cps	"	"	" "
	126 cps	"	"	" "
	60 cps	"	"	" "
	40 cps	"	"	" "

3½ ips :	160 cps at peak level			
	160 cps	20 dB below	peak level	
	8 Kc/s	"	"	" "
	6 Kc/s	"	"	" "
	4 Kc/s	"	"	" "
	160 cps	"	"	" "
	60 cps	"	"	" "
	40 cps	"	"	" "

15 ips :	1 Kc peak level			
	1 Kc	20 dB below	peak level	
	15 Kc/s	"	"	" "
	12 Kc/s	"	"	" "
	10 Kc/s	"	"	" "
	6 Kc/s	"	"	" "
	120 cps	"	"	" "
	60 cps	"	"	" "
	40 cps	"	"	" "

The final section of the tape is intended for owners of stereophonic recorders and playback machines. The test section contains an 80 cps band, in phase, followed by a band at 80 cps, out of phase.

Special tests for determining the correct connection of the two channels are included, together with further recordings for checking the phasing of the loudspeakers and balance of the amplifiers. Speech and a metronome are used for these tests, which are extremely valuable for setting up and balancing new equipment.

The section ends with first-class stereophonic recordings of a jazz group, a woodwind ensemble, road drills and trains.

Angus McKenzie is to be congratulated on the excellent recording and the accuracy of the frequency test bands.

Further details of how the tape may be used to best advantage will be given later, with a technical report on the accuracy of the frequency band levels, and details of a simple output meter which, together with the test tape, will enable one fully to test the response of any machine.

READY NOW

We apologise for the delay that has occurred in production of the special Test Tape. Supplies are now available and those who have made inquiries may now send remittances with firm orders, and tapes will be despatched immediately.

This tape has been designed to test the efficiency of tape recorders and to check the balancing of stereo.

PRICE • TWO GUINEAS

for orders received before October 30th.

Order from:—

TAPE RECORDING & HI-FI MAGAZINE
7 Tudor Street, London, E.C.4



TESTED IN THE LAB

THE SPECTONE 161

THE Spectone 161 portable tape recorder is a moderately priced machine, operating at 15, $7\frac{1}{2}$ and $3\frac{1}{2}$ ips, using the well-known Collaro Tape Transcriber, and capable of very good results from microphone, radio, or other inputs. Its performance as a player for pre-recorded tapes is excellent.

The machine has various facilities which are becoming more and more necessary as the art of home recording progresses. For example, two simultaneous inputs of low and high level are provided, which can be mixed on their own controls; and provision is made for superimposing one recording on another, with means of fading down, or even out, the previous recording, as required. An output to feed a quality amplifier is provided, as is also an extension speaker socket, this last muting the internal speaker.

The finish of the recorder is excellent and there is ample carrying room for four reels of tape, three in a compartment in the lid and one on the machine.

One adverse criticism: the compartment at the back of the machine, designed to contain microphone, spare plugs and leads, and mains lead, is far too small. There is only really enough room for the mains lead with a 2-Amp plug. The flap which covers this compartment could well have been provided with a slot for the mains lead so that it could be closed when the machine was in use.

FUNCTIONAL TEST

The recorder received for review was tested for frequency response, wow and flutter, signal noise ratio, etc., and found, with some slight exceptions to be within the maker's specification.

Frequency response at $7\frac{1}{2}$ ips was tested with a CCIR test tape and, after suitable adjustment of the tone control, was found to be within ± 3 dB between 40 and 12,000 cps, and 7 dB down at 15,000 cps, measured on the extension speaker terminals with 15 ohm load, showing the machine to be an excellent reproducer of pre-recorded tapes.

The overall response, from record input to play output, on Emitape at $7\frac{1}{2}$ ips was found to be slightly worse at the high frequency end, and on investigation it appeared that there may be some loss of high frequencies in the recording amplifier, if the level indicator—an easily read magic eye—is to be believed at all frequencies. This loss was noticeable on the other speeds as well, but at all speeds use of the tone control—a top lift one, by the way—could put things right again. This, however, with some increase in hiss.

At $3\frac{1}{2}$ ips the response was ± 3 dB from 60 to 8,000 cps, being 10 dB down at 10,000 cps. At 15 ips the response was

somewhat up in the bass, being +5 dB at 50 cps, +3 dB at 200 cps. From then on it was ± 3 dB to 15,000 cps, -3.5 dB at 16,000, and -20 dB at 20,000 cps. Frequency response on both heads (this is a reversing machine) was very similar.

Noise level was better than -40 dB below full tape modulation, and mostly consisted of rumble from the motors, possibly due to a microphonic valve.

Slight wow and flutter were detectable by ear at $3\frac{1}{2}$ ips, but the machine was still within specification, and at $7\frac{1}{2}$ ips measured better than 0.2 per cent.

The Collaro deck is so well known that there is little need to comment on it here, and the one on this recorder performed well, as would be expected.

Sensitivities for peak tape modulation, as shown by the level indicator, were: microphone 0.6 mv, and radio/gram. 10 mv.

The maker's specification, which the recorder performs well, is given for those who are technically minded.

Supply: 210-250 A.C. 50 cps.

Maximum power consumption: 85 watts.

Tape deck: Latest Collaro Mark IV tape transcriber.

Speeds: 15 ips, $7\frac{1}{2}$ ips, $3\frac{1}{2}$ ips.

Rewind time: 3 minutes (approx.).

Frequency response: 15 ips ± 3 dB 50-16,000 cps; $7\frac{1}{2}$ ips ± 3 dB 50-12,000 cps; $3\frac{1}{2}$ ips ± 3 dB 50-8,000 cps.

Hum and noise: Better than 45 dB below peak output.

Wow and flutter: Better than 0.15 per cent.

Bias and erase frequency: Approx. 60,000 cps.

Erase socket: Used when superimposing one recording on top of another.

Inputs: Microphone (High Impedance); Radio/gram. (250,000 ohms); Extension amplifier (Minimum matching impedance 50,000 ohms); Extension speaker (15 ohms $2\frac{1}{2}$ watts).

Sensitivities: For 2 watts output: Radio/gram.—120 m/v; Microphone—3 m/v. For Peak Recording: Radio/gram.—30 m/v; Microphone—0.75 m/v.

Valves: E.C.C.83, E.C.L.82, E.L.84, E.M.84.

Speakers: 7 x 4 Elliptical 15 ohms P.M.

Controls (other than Tape Deck): Tone/mains on-off.

Microphone/playback volume and radio/gram. volume, with full mixing facilities on recording.

Weight: 36 lbs. (complete), approx.

Dimensions: $15\frac{1}{2}$ x $15\frac{1}{2}$ x $8\frac{1}{2}$ ins.

The microphone supplied with the recorder is the Acos 39/1 and is capable of some very good results. The record amplifier has ample gain for low level ribbon or moving coil microphones and the serious recordist would be well advised to buy one of these. The recorder's potentialities are greater than those of the microphone supplied with it.

One final point: the amplifier can be used as a "straight-through" reproducer for radio or gramophone or for microphone on its extension loudspeaker.

At 49 guineas the Spectone 161 is a good, reasonably priced recorder, capable of giving a great deal of pleasure to all those who invest in it.

B.H.

THE ARMSTRONG PCU.27 STEREO PRE-AMP

DESIGNED to provide every possible facility for all sources of sound reproduction both now and in the future, the PCU.27 stereo pre-amplifier is an engineered product of sound design and construction. It has an elegant appearance that will do justice to any hi-fi furniture with its neat white 14½ in. × 4½ in. control panel, artistic lettering and decoration. It is recommended as a high fidelity instrument and will operate with the Armstrong A.10 or any other power amplifier of comparable quality.

The controls are nicely spaced for convenient manipulation, each having its own direct indication of position which is visible through a small window in the control panel. The unit cover and chassis are constructed from high grade rust-proof steel and stove enamelled with a hammered bronze finish.

The chassis layout and component distribution is excellent, all components being of high quality and securely fitted in their respective positions.

The functions of the PCU.27 are mainly to receive and select a signal from any sound source and to match the source so that the quality of reproduction is not impaired. Accepted standards of correction can be applied to adjust the signal where necessary to suit individual programme

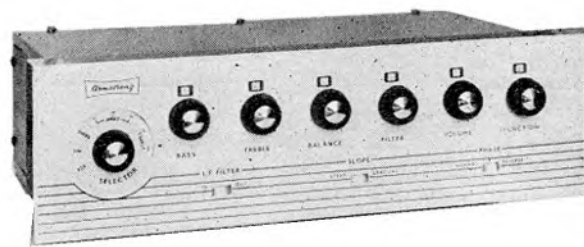

The controls are nicely spaced for convenient manipulation

material and finally pass the signal via a correctly matched output terminal to the power amplifiers.

The controls and switches of both channels are ganged to provide simultaneous operation; closely matched potentiometers and other components being used to ensure no disparity of adjustment between the two channels.

Input selector switch

The input selector switch is an eight-position control for switching the various inputs, all of which are available for stereo or monophonic sound sources.

I was invited to witness the Armstrong laboratory tests for frequency range, square wave response, as well as satisfactory operation of all controls to the maker's specification. In addition, a wide range of tests were applied in my own laboratory, where the PCU.27 was subjected to pen recording tests for frequency response, actual operation into power amplifiers, operation from stereo on tape, frequency tests from tape, listening from an AM/FM tuner, etc.

The results, which were published in detail in the July issue of *Stereo Sound Magazine*, were extremely good, following closely the Armstrong specification and in some respects surpassing it.

The unit may be used as a recording amplifier and provides a signal level of 350 mV at 270 K.ohms impedance for stereo or monaural recording.

The power required to drive the PCU.27 is as follows:—
HT+300 volts at 8 mA. LT. AC 6.3 volts at 2 amps.

The input circuits are designed so that the input voltage can be approximately 30 dB above the quoted sensitivity in each case before overloading occurs.

Listening tests were conducted with the aid of two A.10 amplifiers, each feeding loudspeakers suitably placed for stereo reproduction. Although each speaker was of different make and consequently had a different frequency response and sensitivity, the controls on the PCU.27 provided more than sufficient range to cater for differences such as these. The unit was also tested, using an A.10 amplifier on one channel and a Mullard 510 home constructed amplifier on the other channel. Again the PCU.27 controls proved capable of equalisation for two dissimilar amplifiers as well as the loudspeakers.

Reproduction from stereo on tape was excellent and monaural operation using a single channel input, from a radio tuner for example, but using both channels of the amplifier chain was most effective.

Armstrong are to be congratulated on producing this new unit which made its debut at the recent London Audio Fair and should cater for the most ardent hi-fi enthusiasts with its versatile range of control and selection of inputs.

Anyone contemplating setting up for stereo would do well to consider this unit as the nucleus of a complete system, for it is reasonably priced at £26 10s. **F. C. J.**

THE SONOCOLOR KIT



The Sonocolor splicing and editing kit, which is now available in this country at £3 12s. 6d., is a splendidly comprehensive kit, with a very efficient splicer, adhesive tape and splicing glue, three reels of differently coloured leader tape, and a box of useful clips for securing tape ends. I have had it in regular use for two months and, with it, I have the confident feeling that I can do anything a professional studio editor can do! Tape Recorders (Electronics) Ltd., 784, High Road, London, N.17, will provide on request a full catalogue of this and other tape accessories.—R.D.B.

NEWS FROM THE CLUBS

CONGRATULATIONS to **Dundee Tape Recording Club**, who collected two prizes in the B.A.T.R.C. The number of entries in the club section of the Contest was, frankly disappointing. Most of the clubs who specially requested us to add a club section did not, in the end, submit tapes. Perhaps this was due to the short time left between the announcement and the Contest closing date.

Edited by

FRED CHANDLER

I have received varied comments from club secretaries on the new presentation of this column—brickbats and bouquets are about evenly distributed. Suggestions are always carefully considered, but we must try to give an overall description of club activities, and with more clubs forming weekly it is difficult to promise anyone regular space in every issue. It is for new ideas, as well as tried and tested methods, that we look, ideas that can be passed on to the younger clubs.



One of the greatest deficiencies has been our inability to print the dates of future meetings. We believe we have found a way to overcome this problem. More details next month. Meanwhile, will club secretaries include in reports the date, time and venue of future meetings?

One of the embarrassments of actuality recording, particu-

larly interviews with "the man-in-the-street," one that I have suffered many times, is the need to explain to the "victim" exactly what you are up to. The **National Federation** have a plan to dispose of, at least, the introduction problem. Secretary Alan Stableford has designed an official card that gives the name, address and photograph of the holder. Further details will be available shortly.

Outside recordings have taken the place of many club meetings recently. The **London** club substituted a trip to the Sussex coast for their August meeting. Fourteen members and five recorders invaded the quiet of Eastbourne to collect recordings of a speedboat trip; a ride on a miniature railway; an open-air church service and interviews with holiday-makers.



Two members of the **Coventry** club have also been out and about. Roy Reynolds operated the Boosey-Hawkes portable recorder and Ted Bright interviewed, when they sought the opinions of "Mr. and Mrs. Coventry," on the re-development of the city. Terry Nurse and Mr. Minton of **Birmingham** club have had the same idea, using a Stuzzi. Their tape included interviews with a newsagent and the owner of an amusement arcade.

The recently formed club in **Ipswich** has had a busy time lately. Their outside recording dates included two fetes; a visit to the local Saturday morning children's film club; interviews at the Spa Pavilion, Felixstowe; a local girls' choir and

(Continued on opposite page)

Convert to **STEREO REALISM**

for only **£4:19:6**

Plus cost of second loudspeaker

(Please specify 2-4 ohms or 10-15 ohms model when ordering)

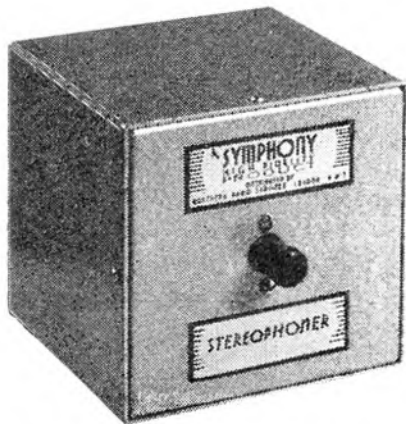

Illustrated leaflet available on mentioning this magazine

We are extremely pleased to announce our introduction to the British Market under licence from the inventor

Professor Dr. Hermann Scherchen
the world famous Swiss orchestral conductor

of the sensational patent device called

THE STEREOPHONER

which gives stereophonic sound from any monaural source:

Tape Recorder :: Radiogram :: Radio Set
Amplified Record Player or Monaural Hi-Fi Amplifier

Simply plug into the output of your Tape Recorder or other instrument and two loudspeakers (a built-in speaker can be used for one side if required) in order to obtain full sound spaciousness with each instrument clearly defined and localised in space. We can supply any make of matching loudspeaker required.

The Stereophoner creates an arena of space between the speakers and places the orchestra in it!

Price only £4:19:6 Plus postage 2/6

Overseas £5:10:0 (or \$15 post paid)

We can supply direct by post to all parts of the world

NORTHERN RADIO SERVICES

11 Kings College Road, Swiss Cottage, N.W.3

Telephone: PR1mrose 3314

Send for your Stereophoner now (delivery from stock) or call for demonstration 9 a.m. to 6 p.m. Monday to Saturday inclusive. Satisfaction guaranteed. Trade inquiries invited.

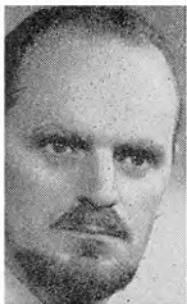

Club Personalities No. 3

ALAN STABLEFORD

Federation of British Tape
Recording Clubs

ALAN STABLEFORD has been interested in tape recording for about four years. A member of the London Tape Recording Club since its inception, he recently became its chairman. In 1958 he attended the inaugural meeting of the Federation of British Tape Recording Clubs in Coventry, and was elected to the Committee. He became Secretary of the Federation at the A.G.M. last June. He also founded the West Essex Tape Recording Society in February 1959 and was its first secretary.

He has broadcast in the B.B.C. "Sound" programme and recently collaborated with Ken Sykora in a Children's Hour broadcast, during which a number of his own recordings were used.

He uses a Vortexion WVB recorder, a Grundig TK35 and a Fi-Cord, and is particularly interested in actuality recording and unscripted interviews. Normally a tolerant person, Alan tends to become enraged on hearing the word "Tapespond," and is unenthusiastic about the pleasure to be derived from an exchange of small-talk with a taxi-driver from Boise, Idaho, or even a druggist from Dallas, Texas.

Aged 35, married, with two children, he hopes one day to be able to devote more time to tape recording, and less to tape recording club "politics."

He is Managing Director of a firm of retail chemists.

a visiting Dutch girls' choir. Planned for the future are interviews of the show companies at the Spa Pavilion.

An introductory commentary, a description of the bride's arrival and comment on her dress were included in a recording of a local wedding made by Nevin Anderson, Chairman of the Sheffield society, using a Stuzzi portable.

Warwick and Leamington members supported a fete organised by local teen-agers to raise funds for a Youth Centre last month. Demonstrations of tape recorders and a "record your voice" stand were among the interests provided. Visitors could also hear tapes outlining the Society's hospital tape service, the various world tape organisations, and local recordings made last year. Seventy persons visited their tent and the entrance money collected was presented to the "Riverside Cavalcade" organiser.

The visits by Mr. Parrington, of Walter Instruments Ltd., demonstrating the Walter 101, 303 De luxe and the 505, are proving very popular among clubs. His most recent visits were to the clubs in Edinburgh and Kettering. The West Middlesex members have entertained Mr. Barrington-Coupe, of Saga Records Ltd. He presented a programme of Saga classical pre-recorded tapes and introduced Sergio Fiorentino and Joyce Hatto, two of the pianists who are featured on Saga tapes. One of the tapes heard was a master tape, being played virtually for the first time. The soloist, Sergio Fiorentino, had not even heard it.

Mr. Tucket, of Fi-Cord, paid members of the Walthamstow club a visit to demonstrate the battery portable. Recordings made on the instrument were played back on the Chairman's Baird recorder, with impressive results. Members of this club were recently treated to a demonstration of a home-made microphone built from a telephone ear-piece.

Clubs are not sitting back and waiting for demonstrations to come to them. A number are visiting factories and show-rooms individually and in groups. Two companies, Grundig and Walter Instruments, have already held tours of this kind. West Middlesex, luckier than most in this respect, are able to

make regular visits to Olympic Sound Studios for the various lectures and demonstrations held on the first Saturday in each month.

Members of another London club, in Catford, were invited to visit the M.S.S. Recording Studios in August. After inspecting the equipment used in the studios, they were able to see disc cutting in operation. The Wakefield club members travelled to Batley, where they were introduced to the range of cabinets and speakers produced by Richard Allen Ltd. Although strictly a disc demonstration, the information obtained, especially regarding stereo, was gratefully received.

Further north, in Aberdeen, an informative evening was enjoyed by the members who were conducted around the B.B.C. Studios by Mr. Lyons, Acting General Programme Producer. After explaining the different operations involved in broadcasting, Mr. Lyons played back material which had just arrived for editing.

The first edition of the British Tape Recording Society's inter-club news magazine has been circulating among clubs. Included in the tape is a 15-minute interview with Tony Schwartz—a professional sound recordist in America. The second issue of The Recordist, house journal of B.T.R.S. is also available. Both these new issues are distributed from the society's new headquarters at 52a, 64, Hough Green, Chester.

A change of venue has also taken place in Leeds. Meetings will in future be held at The Adelphi, adjacent to Leeds Bridge. Their A.G.M. will take place there on October 8.

While the established clubs are expanding, new clubs are springing up throughout the country. The latest has appeared in Aberystwyth, where the West Wales Tape Recording Club held its inaugural meeting in July. The Secretary is Gareth Jenkins, 5, Glyndwyr Road, Aberystwyth, Cardiganshire. Meetings are to be held monthly.

Two other clubs are proposed in Birkenhead and Manchester. John Booth, 11, Rose Gardens, Neston, Wirral, Cheshire, is keen to start a club in the Birkenhead and Wirral district. In Manchester, Joseph Kerrs is forming a club. His address is 20, Naylor Street, Hulme, Manchester 15.

Dennis Osborne, founder of the Birmingham club, has relinquished his position as secretary. His resignation has prompted the idea of starting a Family Tape Circle. He would like to hear from any family who is interested in exchanging tapes with his family. They have three children, George (13), Maria (12) and Veronica (5). Write to him at 75, Millmead Road, California, Birmingham 32.

The Secretaries of the clubs mentioned this month are: Charles Aitken, 59, Strathmartine Road, Dundee, Angus. Nat. Federation: Alan Stableford, 9, Normandy Terrace, London, E.16. London: Roger Aslin, "Fairlea," Boars Head, Crowborough, Sussex. Roy Reynolds, 1, Thurlstone Road, Radford, Coventry. Terry Nurse, 161, Stuart Road, Yardley, Birmingham 33. Malcolm Wilding, 31, Darwin Road, Ipswich, Suffolk. B. T. Jeeves, 58, Sharrard Grove, Sheffield 12. Warwick: Brian Race, 30, Ashford Road, Whitnash, Royal Leamington Spa, Warwick. John Penman, 22, Lauriston Place, Edinburgh 3. A. M. Webb, 93, Regent Street, Kettering, Northants. West Middlesex: H. E. Saunders, 20, Nightingale Road, Hampton, Middlesex. Walthamstow: J. A. Wells, 178, Selwyn Avenue, Highams Park, London, E.4. Derek Harker, 62, Barmeston Road, Catford, London, S.E.6. Michael Storey, 331, Horbury Road, Wakefield, Yorkshire. William Hobben, 22, Ruthrie Terrace, Aberdeen. B.T.R.S.: Ted Yates, 210, Stamford Road, Blacon, Chester. Terence Quigley, 32, Derby Road, Rawdon, Leeds, Yorkshire.

ONE-TENTH DEPOSIT

THREE YEARS TO PAY!

All makes stocked

Let us quote you

SIMMON OF HALIFAX

Paul Simmon, 35 Northgate, Halifax

Classified advertisements

Rate—Sixpence per word (minimum 5s.); Trade, ninepence per word (minimum 10s.); box numbers, one shilling extra. Payment with copy. Copy should be sent to Advertisement Department, "Tape Recording Magazine," 1 Crane Court, Fleet Street, London, E.C.4.

J. & B. Recordings, tape/disc, all speeds. 14, Willows Avenue, Morden, Surrey. Mit 8155.

Our Stratford Branch stocks almost every make of tape recorder manufactured. All recorders available on our unique No-Interest Terms. Highest part-exchange allowances obtainable anywhere. Examples: Grundig TK9/12 £25-£35. TK5/20 £23-32. TK8/3D £33-£43. Telefunken KL75 £28-33. Philips AG8108 £32-£43. AG8109 £19-£23. Write for lists. Essex Tape Recorder & Hi-Fi Centres, 2, Maryland Station, Stratford, E.15. Maryland 5879.

FRIENDLY FOLK ASSOCIATION, 87, Terrace, Torquay. Leading International Correspondence Hobby Club since 1943. Now included, facilities for Tapesponding. Details free.

JOHN HASSELL RECORDINGS. Tape/Disc. All Speeds. C.C.I.R. Studio, 21, Nassau Road, London, S.W.13. Riverside 7150.

TAPE RECORDERS. players, radios, etc. (modern), wanted for cash or exchange. Callers or particulars: Cooks, 159 and 187, Praed Street, W.2 (opp. Paddington Station). PAD 6464.

TAPE RECORDERS. Large selection of used models, most as new. Three months guarantee. Part exchanges with other machines, cameras, binoculars, etc. Ferrograph Tape, 7 in. spool, 1,200 ft. 25s. Cooks Miscellaneous Store, 159 and 187, Praed Street, W.2 (opp. Paddington Station). PAD 6464 or 5931.

Pre-recorded tapes of new piano medleys. Played in modern style by Al Marsden. Full tape 5 in. dia, price 50s. Recording Dept., 51, Garden Street, Nelson, Lancs.

Sonomag Adaptatape. March '58. Extras, good condition. Offers. 29, Leechcroft Road, Wallington.

LINEAR LT45 tape amplifier for sale. Suit Collaro, Truvox, etc. In new condition, unused. Cost 12 gns. £6. Box 309.

TAPE/DISC/TAPE transfer, editing, copying. If quality and durability matter (especially with LPs from your precious tapes) consult in your own interest Britain's oldest (not cheapest!) transfer service. **SOUND NEWS**, 10, Clifford Street, London W.1. REG 2745. P.S.: few Gevaert 1,700 ft. tape, 31s. 6d., E.M.I. 1,200 ft. on Ferrosponds 25s., post free.

SPECTONE 151.B., 1957. Microphone, Tape. Straight from manufacturers check-up. Cost £77. £40. Allen, 27, Alexanders Terrace, Corsham, Wilts.

EXPERT tape recording amplifier. Also Expert "Master" amplifier and pre-amplifier. London. Offers. Box 310.

QUALITY PRINTING at reasonable prices. The Asphodel Press, 45, Picton Street, Bristol 6.

LOOKING FOR BARGAINS ??? Don't miss our biggest ever **HALF-PRICE** clearance sale. Tape Recorders (from £17), Decks, Hi-Fi Equipment, Radios, leading makes, all **BARGAINS**, many stereo-adaptable. If you cannot call, send stamp for Catalogue. September 26th-October 3rd only. ARC Showrooms, 23, Arcadian Gardens, Wood Green, London.

Grundig TK 830/3D with microphone. Condition as new. Original cost £111. Quick sale offered at £65. Phone: ELMbridge 7935 (London).

DUPLICATING. High class work. Tape Club News Letters, Circulars, etc., Electronic stencil illustrations. Write samples, **ROTECH**, 152, Maybank Road, London, E.18. BUCKhurst 9315.

Sprung pivoted clamps of EASYSPLICE make tape splicing simple and accurate

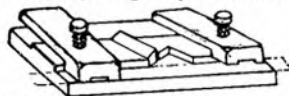

PAT. No. 815333 PRICE 6/9 P. & P. 6d.
**EASYSPLICE CO. 30, LAWRENCE RD.
EALING, LONDON**

**TAPE RECORDING AND HI-FI
MAGAZINE ADVICE BUREAU**

OCTOBER, 1959

Next Month

Features in our next issue will include:

THE NEW DECKS

Charles Langton introduces a new series of articles describing recently introduced tape decks, with an illustrated review of the B.S.R. "Marardeck"



RECORDING AN EISTEDDFOD

G. Holmes Tolley relates his experiences when he went to Wales to record "The Singing Valley"



HOW TO USE A TEST TAPE

F. C. Judd gives a detailed explanation of the way to test your equipment with the new *Tape Recording Magazine* test tape



And all the usual features
Out on October 20th. Price **2s.**

Here at last, pre-recorded tapes of new piano medleys, played in modern style by Al Marsden, full tape size 5 in., price 55s., including postage. Recording Studios, 51, Garden Street, Nelson, Lancs.

DULCI-HARTING DECK. Cadenza Mike. Virtually unused, under guarantee. £50. Strong, 67, Woodstock Road, N.4.

COLLARO TRANSCRIPTOR OWNERS. Double your playing time. Modified Pulley to substitute 1½ in. for 15 i.p.s., available at 10s. each. Howard Freer, 5, Romford Road, Coventry.

DUPLICATING. High class work. Tape Club News Letters, Circulars, etc. Electric Stencil illustrations. Write samples, **ROTECH**, 152, Maybank Road, London, E.18.

GRUNDIG TK8, as new, £50; cost over £80. 40, Church Street, Sheffield 1.

TAPE TO DISC SERVICES

TAPE TO DISC SERVICE
78's or L.P.
QUEENSWAY RECORDING STUDIOS
123, Queensway, London, W.2
Tel.: BAYswater 4992
Inquiries must be addressed direct to us

RAPID RECORDING SERVICE
21, Bishops Close, Walthamstow, E.17. LAR 3889
Recording Studio equipment with new Steinway
Grand. Mobile Recording Van. 78s. and L.P.s
from your own tapes. Commentaries and music
on Synchronised L.P.s for cine enthusiasts.
Master Discs and Pressings

45 EPs



★ 25/- D.S.
... from your tapes!
MOBILE SOUND LTD.
54 CHARLMONT ROAD, LONDON S.W.17

RENDEZVOUS RECORDS
(T. H. ADKINS)
TAPE TO DISC SERVICE
33 — 45 — 78 R.P.M.
S.A.E. to:
19 Blackfriars Street, Manchester 3
Phone: Rusholme 6868

TAPE TO DISC RECORDING
Microgroove LP from 27/6d.
78 rpm from 11/-
Also 45 rpm
48 HOUR SERVICE
S.A.E. for comprehensive leaflet to:—
Marsh, "Deroy" Sound Service, Little
Place, Moss Delph Lane, Aughton, Orms-
kirk, Lancashire. Tel.: AUG 3102

TAPE RECORDER HIRE
TAPE TO DISC 78-LP RECORDING STUDIO SALES—EXCHANGES
MAGNEGRAPH
1 Hanway Place, London, W.1.
s.a.e. for leaflet or
telephone LAN 2156

If you write to manufacturers direct for information, please mention that you saw it in **Tape Recording and Hi-Fi Magazine.**

.....CUT ALONG DOTTED LINE.....

ADVERTISEMENT ENQUIRIES SERVICE

This is a special service for readers of TAPE RECORDING AND HI-FI MAGAZINE. It enables you—without cost—to get fuller information about those products in which you are particularly interested. Fill in one coupon below for each inquiry, writing in your name and address in each case. Then cut out the whole of this half-page, following the dotted line, fold as indicated, and post to us.

<p>I should like further information about the (product) mentioned on page.....of the issue of <i>Tape Recording and Hi-Fi Magazine.</i></p> <p>NAME..... ADDRESS</p> <p style="text-align: right;">October, 1959</p>	<p>I should like further information about the (product) mentioned on page.....of the issue of <i>Tape Recording and Hi-Fi Magazine.</i></p> <p>NAME..... ADDRESS</p> <p style="text-align: right;">October, 1959</p>	<p>I should like further information about the (product) mentioned on page.....of the issue of <i>Tape Recording and Hi-Fi Magazine.</i></p> <p>NAME..... ADDRESS</p> <p style="text-align: right;">October, 1959</p>
---	---	---

INDEX TO ADVERTISERS

	page		page
A.P.R. Electronics	59	Multicore Solders Ltd.	13
Armstrong Wireless & Television Co. Ltd.	14	Northern Radio	54
Brenell Engineering Co. Ltd.	60	Norwich Union	59
British Ferrograph Recorder Co. Ltd.	11	Olympic Sound Studios	47
Brown, A., & Sons Ltd.	46	Perth Radios Ltd.	59
B.T.H. Sound Equipment Ltd.	3	Queensway Recording Studios	57
Dektron	11	Radiostructor	34
Deroy Sound Service	57	Rapid Recording Service	57
Dickinsons of Pall Mall	42	Record Housing	18
Dixon's Electronics	34	Recording Devices	12
Dynatron	9	Rendezvous Records	57
E.A.P. (Tape Recorders) Ltd.	10	Reps (Tape Recorders) Ltd.	20
Easysplice	56	R.E.S. (Coventry) Ltd.	49
E.M.I. Sales and Service Ltd.	30 & 31	R.E.W. Earlsfield Ltd.	46
Fi-Cord Ltd.	19	Shinn, John, & Sons Ltd.	50
Fidelity Radio	42	Simmon, Paul	55
Francis of Streatham	18	Simon Sound Service Ltd.	4 & 5
Gramdeck	6	Specto Ltd.	16
Grundig (Great Britain) Ltd.	7	Stamford, A. L.	47
Hi-Fi Developments Ltd.	50	Sypha Sound Sales Ltd.	40
Howard Photographic Ltd.	44	Tape Recorders (Bournemouth) Ltd.	48
Hughes, F. A., & Co. Ltd.	26	Tape Recorder Service Co.	8
Jewkes & Co. Ltd.	49	Teleonic	17
Lee Electronics	47	The Radio Centre	15
Lustraphone Ltd.	15	The Recorder Co.	13
Magnagraph	57	The Service Co.	39
McCormack's	50	Trevor Fawthrop Ltd.	49
Metro-Sound Manufacturing Co. Ltd.	44	Wadden & Hill Ltd.	48
Minnesota Mining & Manufacturing Co. Ltd.	Front cover	Walter Instruments Ltd.	36 & 37
Mobile Sound Ltd.	57	Watts Radio (Mail Order) Ltd.	59
Modern Techniques	14	Wellington Acoustic Laboratories Ltd.	17
		Wood, J. H.	48
		Wyndors Recording Co. Ltd.	2

TAPE LECTURES

(A series of monthly lectures organised by "Tape Recording and Hi-Fi Magazine" in association with Olympic Sound Studios.)

October 3, at 3 p.m.

Mr. G. E. SPARK

of the

Garrard Eng. & Mfg. Co. Ltd.

will demonstrate the new

BICHETTE

recorder with
tape cassettes

Olympic Sound Studios

**Carton Street,
London, W.1**

Admission free

CUT ALONG DOTTED LINE

POSTAGE
WILL BE
PAID BY
PRINT AND
PRESS
SERVICES
LIMITED

THIRD FOLD HERE

**TAPE RECORDING & HI-FI MAGAZINE,
ADVERTISEMENT ENQUIRIES,
7, TUDOR STREET,
LONDON, E.C.4.**

BUSINESS REPLY FOLDER
Licence No. ND 922

SECOND FOLD HERE

FLAP A

NO POSTAGE
NECESSARY
IF POSTED
IN GREAT
BRITAIN OR
NORTHERN
IRELAND

FLAP B

FIRST FOLD ALONG THIS LINE

**TO OBTAIN DETAILS
OF ADVERTISERS**



Make sure your name and address etc., is clearly shown on the form overleaf.

Cut along the dotted lines.

Fold along lines as indicated and then tuck Flap A into Flap B.

October, 1959

RECORDING TAPE

DOUBLE PLAY

B.A.S.F. 300ft. (3") 14s. 600ft. (4") 25s. 1,200ft. (5") 42s. 1,600ft. (5½") 52s.6d. 2,400ft. (7") 77s.6d.
 SCOTCH BOY 200.—400ft. (3½") 17s. 1,200ft. (5") 45s. 2,400ft. (7") 80s.
 TELEFUNKEN.—1,200ft. (5") plastic container 35s. 2,400ft. (7") 72s.6d.

LONG PLAY

B.A.S.F. 210ft. (3") 9s. 850ft. (5") 28s. 1,200ft. (5½") 35s. 1,800ft. (7") 50s.
 EMITAPE 99.—250ft. (3½") 9s.6d. 850ft. (5") 28s. in Emicase 30s.6d.
 1,200ft. (5½") 35s. in Emicase 37s.6d. 1,800ft. (7") 50s. in Emicase 52s.6d.
 2,400ft. (8½") 72s.6d.
 GELOSO.—430ft. (3½") 16s.
 GRUNDIG.—1,200ft. (5½") 35s. 1,800ft. (7") 50s.
 MSS.—225ft. (3") 8s.6d. 450ft. (4") 14s.6d. 850ft. (5") 28s. 1,200ft. (5½") 35s. 1,800ft. (7") 50s. 2,400ft. (8½") 70s.
 PHILIPS.—850ft. (5") 28s. 1,800ft. (7") 50s.
 SCOTCH BOY 150.—300ft. (3½") 9s.6d. 900ft. (5") 28s. 1,275ft. (5½") 35s. 1,800ft. (7") 50s.

All post free. Standard Tapes and Accessories also stocked.
 Full list available free.

WATTS RADIO 54, Church Street, Weybridge, Surrey
 (Mail Order) Ltd. Telephone: Weybridge 4556
 NOTE.—Post orders only to this address please

E.T.D.

The Super High Fidelity Magnetic Tape

QUALITY TAPE—
 PROFESSIONAL RESULTS

1800' L.P. PLASTIC BASE
 7" NON-WARP PLASTIC SPOOL **35/-** POST FREE

A.P.R. ELEC. 11, Old Bond Street, W.1



or similar apparatus you will, if you are wise, insure it with the Norwich Union. This policy covers accidental loss or damage, fire and burglary.

(Electrical or mechanical breakdown excluded)

YEARLY PREMIUM FROM 7/6

Post the coupon NOW for full details to

Norwich Union

INSURANCE SOCIETIES

16-26 Surrey Street, NORWICH, Norfolk.

You may send me (M)
 without obligation,
 details of Norwich Address
 Union Policy for
 tape recorders etc. T.R.9

more features in PERTH-SAJA

Made in Germany to exacting specifications

Stop-start lever and automatic locking device to prevent accidental crasing during play back

Tape speed control. Speeds: —two hours' recording at 3½" per second on 1,200 feet. Wow and flutter below 0.5%.

Trick effect button for superimposing speech on to recorded music.

Automatic tape stop switches off when tape stops playing.

Magic eye for accurate recording level.

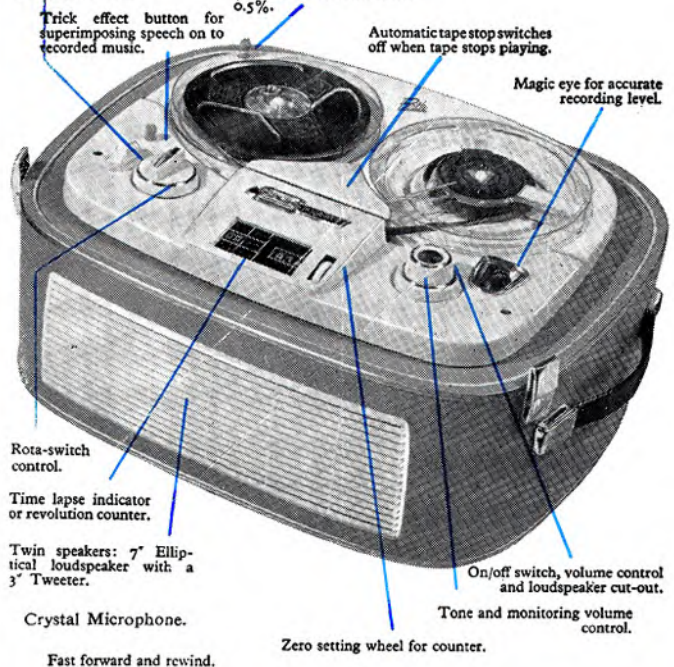

Rota-switch control.

Time lapse indicator or revolution counter.

Twin speakers: 7" Elliptical loudspeaker with a 3" Tweeter.

Crystal Microphone.

Fast forward and rewind.

Zero setting wheel for counter.

On/off switch, volume control and loudspeaker cut-out.

Tone and monitoring volume control.

Lovelier styling plus extra features make the Perth-Saja Tape Recorder the finest value money can buy. Send coupon for illustrated literature and name of nearest stockist



Beautifully styled two-tone carrying case. Easy to carry.

TWIN DE LUXE MODEL 59½ GNS

Complete with Microphone and Tape.

STANDARD MODEL - 45 GNS

Complete with Microphone and Tape.

**EASY TERMS
 AT YOUR DEALERS**

To **PERTH RADIOS LTD., Marten House, 39-47 East Road, London, N.1**

Please send me literature on the Perth-Saja Tape Recorder

Name.....

Address

Hi-light of hi-fi

The Brenell 3 STAR

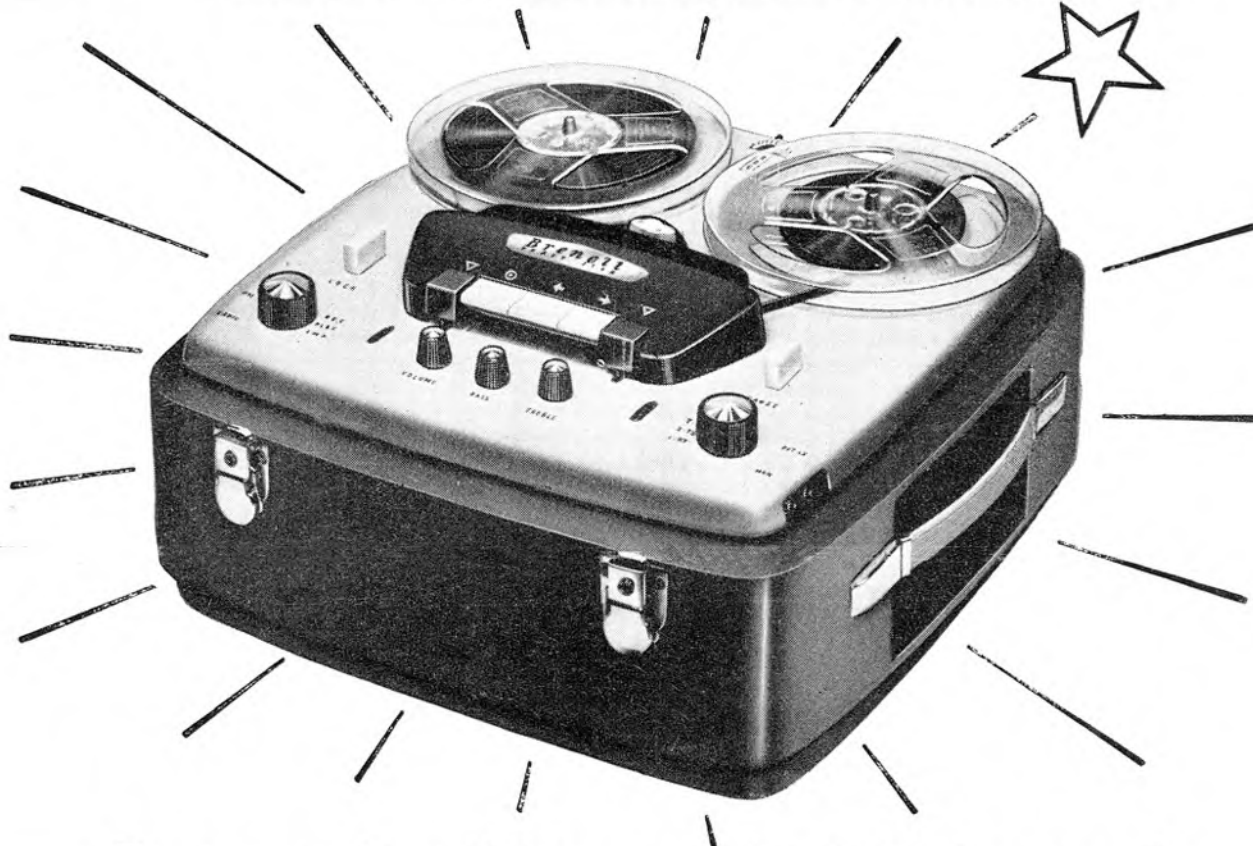

To own a Brenell tape recorder is to be assured of quality performance, a sound engineering job and a British made product of outstanding design



3 STAR PORTABLE.—Before you finally decide on the type of recorder you want, make a special point of seeing and hearing the Brenell 3 Star. Examine its well-thought out design which has been based on almost 10 years' exhaustive manufacturing experience—consider its many fine features which include three recording speeds with frequency compensation at all speeds; push button control (interlocked for safety); printed circuit amplifier; separate bass and treble controls; high quality loud-speaker (8in. x 5in.); takes spools up to 7in.; pause control; digital revolution counter; contemporary style wooden cabinet for improved acoustic performance—judge its hi-fi reproduction. Once you have seen the 3 Star in action you'll find it very difficult indeed to find anything to equal this truly remarkable machine in value for money.

PRICE

58

GNS

including 1,200ft. of tape, spool and microphone

Also available THE MK.5 TAPE DECK, MK.5 RECORD/PLAYBACK AMPLIFIER. MK.5 PORTABLE TAPE RECORDER AND STEREOPHONIC EQUIPMENT. Leaflets on request.

Sole manufacturers:—
**BRENELL
ENGINEERING CO. LTD.**

Brenell PERFORMANCE
IS TRUE-TO-LIFE
PERFORMANCE

1a, DOUGHTY STREET,
LONDON, W.1.
Telephone: HOL. 7358 and CHA. 5809