

Vol. 2. No. 6. December, 1926.

Price 1/-



CRYSTAL CONTROL
NUMBER.

QUARTZ

Having supplied quartz crystals to the leading experimenters and commercial stations in all parts of the world, I am now in a position to supply quartz oscillators to fulfil amateur or broadcasting requirements as a matter of routine.

My factory organisation is on these lines :

The rough quartz is optically examined and the axes are determined. Slices are cut to certain stock thicknesses, one side being optically polished before going into store.

In the next shop they are ground as required, about 5 or 10 metres too high, and in another shop with still finer abrasive to $\frac{1}{2}$ or 1 metre too high. If still greater accuracy is desired, I now take them in hand, and adjust to about 0.1 metre or better.

Before issue, each specimen is carefully tested by me for wavelength and oscillating properties.

Each stage of workmanship calls for more time and greater care and accuracy. The work can be done by any amateur with the necessary patience. A small reduction in wavelength will not spoil the crystal; in fact, an improvement may be expected as a result of better polish and running it for several hours as an oscillator.

PRICES :

Nominal Wavelength.	500	380	200	100	70	50	40	25 metres
Air-gap ...	40/-	—	—	—	—	—	—	—
No reaction	30/-	32/6	35/-	—	—	—	—	—
With reaction	20/-	22/6	25/-	30/-	40/-	60/-	80/-	—

Extra for adjustment of wavelength to yield the one finally required : $\left\{ \begin{array}{l} 5 \text{ to } 10 \text{ metres above, plus } 10 \text{ per cent.} \\ \frac{1}{2} \text{ to } 1 \text{ metre above, plus } 25 \text{ per cent.} \\ 0.1 \text{ to } 0.2 \text{ metre above, plus } 50 \text{ per cent.} \end{array} \right.$

The items priced above are normally carried in stock. Prices and particulars of quartz to meet any specification gladly furnished on request.

Crystal Mountings, Mounted Crystals, and all Auxiliary Apparatus may be obtained from the Southend Radio Co., Ltd., Wickford, Essex.



We are Exhibiting at the **BRITISH INDUSTRIES FAIR 1927**

A. HINDERLICH
1, Lechmere Road,
LONDON, N.W.2

Enquiries in foreign languages specially welcomed.

M'crivez en francais.

SHORT WAVE Transmitting and Receiving Apparatus

CRYSTAL CONTROL:

CRYSTAL HOLDERS, to take oscillating crystals 1 in. square, top and bottom plates ground dead true, adjustable pressure and contact. As supplied to 2NM, 2SZ, and other famous amateurs. Price each .. **10/6**
 Fitted with detachable plug in base .. **15/-**
 Ebonite dust covers extra **3/6**

COUPLED COILS for intermediate stages of crystal control, as used on the Goyder system.
 Per stage **37/6**
 Any number of stages can be coupled together.

TRANSMITTER INDUCTANCES, loose coupled for 23-46 metres for low power up to 100 watts **37/6**
 For powers up to one k.w., wound with copper tube **55/-**

GRID LEAKS 5,000 to 15,000 ohms, wire wound **12/6**

GRID LEAKS, carbon rod type, 10,000 ohms only, cannot burn out **7/6**

MILLIAMMETERS, 0-100 circular type **30/-**
 0-300 do. .. **32/6**

Any range, Edgewise type **35/-**

FILAMENT AMMETERS AND VOLTMETERS.
 From **6/-**

DUBLIER GRID CONDENSERS, tested to 1,000 volts, capacities from .0001 to .01 **7/6**

SMOOTHING CONDENSERS, Mansbridge type, tested to 2,000 volts: 5 m.f., **62/6**; 2 m.f., **32/6**; 1 m.f., **20/-**; ½ m.f., **15/-**; ¼ m.f., **11/-**.

T.C.C. MANSBRIDGE CONDENSERS, 2,500 volts, 2 m.f. **50/-**

H.F. CHOKES, wound on glass tube .. **10/6**
 Do. on ebonite **8/6**

SIX-VOLT ACCUMULATORS

Surplus stock at reduced prices.

Made by Exide's.

10 amp. **9/9**. 30 amp. **21/-**. 40 amp. **25/-**.
 50 amp. **29/6**. 60 amp. **33/9**. 4 volts, 60 amp.
 only **24/-**

All brand new. Offers subject to being unsold.
 Carriage forward.

Capacities quoted are all ACTUAL.

Export Orders specially attended to.

All apparatus manufactured under
 Marconi Licence.

TRANSMITTER PANELS & PARTS.

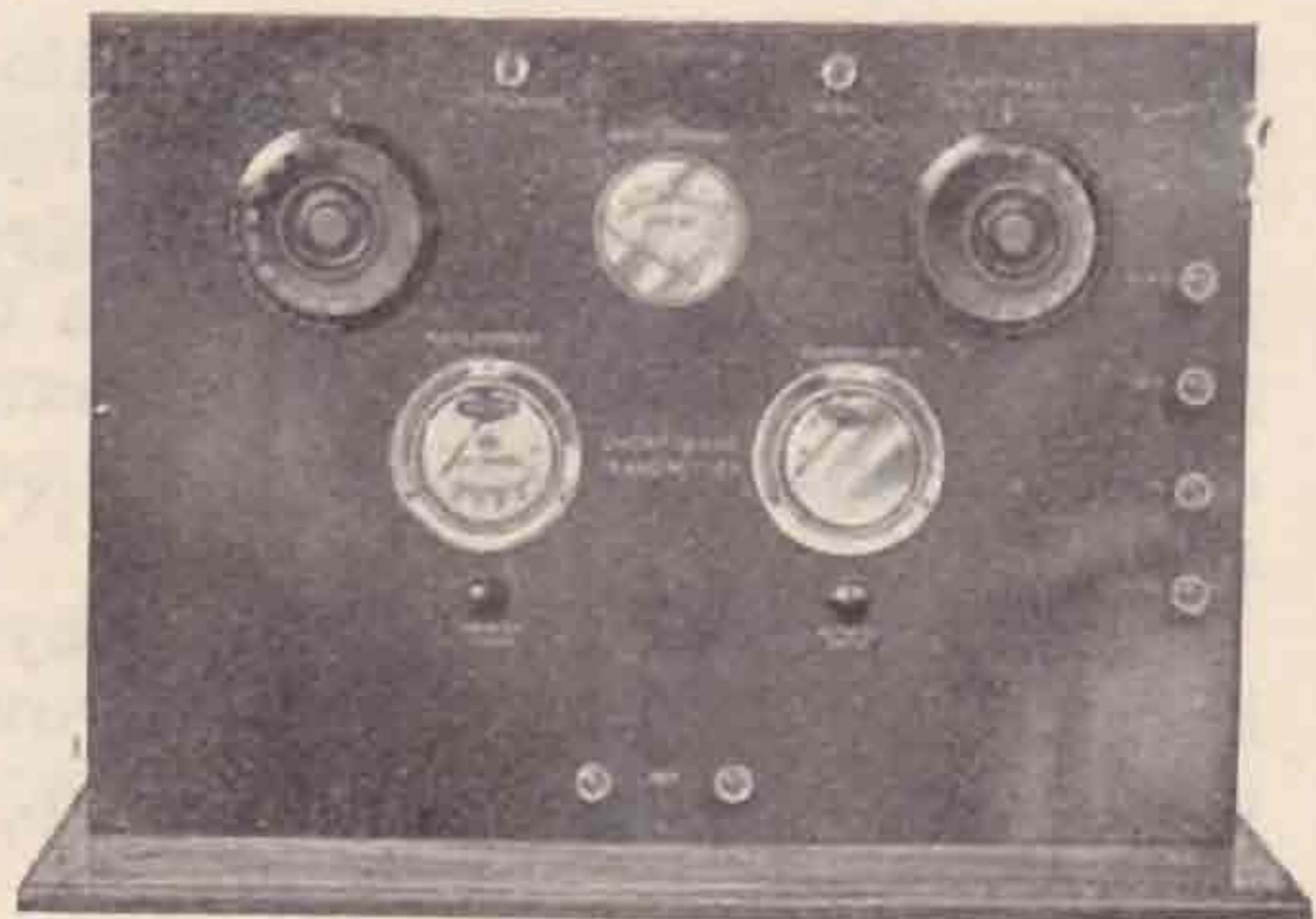

Any type of Panel built up to client's specification.
 Drilled, Matted and Engraved. Size 12" x 17" .. **22/6**
 Mahogany base board and frame **17/6**
SPEECH CHOKES and smoothing Chokes for low powers **12/6**
 Do. for passing up to 300 milli-amps. .. **50/-**
 Modulation Transformers **25/-**
ANODE RESISTANCES for sub-modulators and for resistance-coupled modulators, wire wound **17/6**
HAND MICROPHONES **22/6**
 Insets for ditto **2/6**

OSCILLATING CRYSTALS.

In conjunction with Messrs Hinderlich, we are able to supply tested crystals for any wave-length. Prices on application, which vary according to thickness and accuracy required.

NEON TUBE WAVEMETERS.

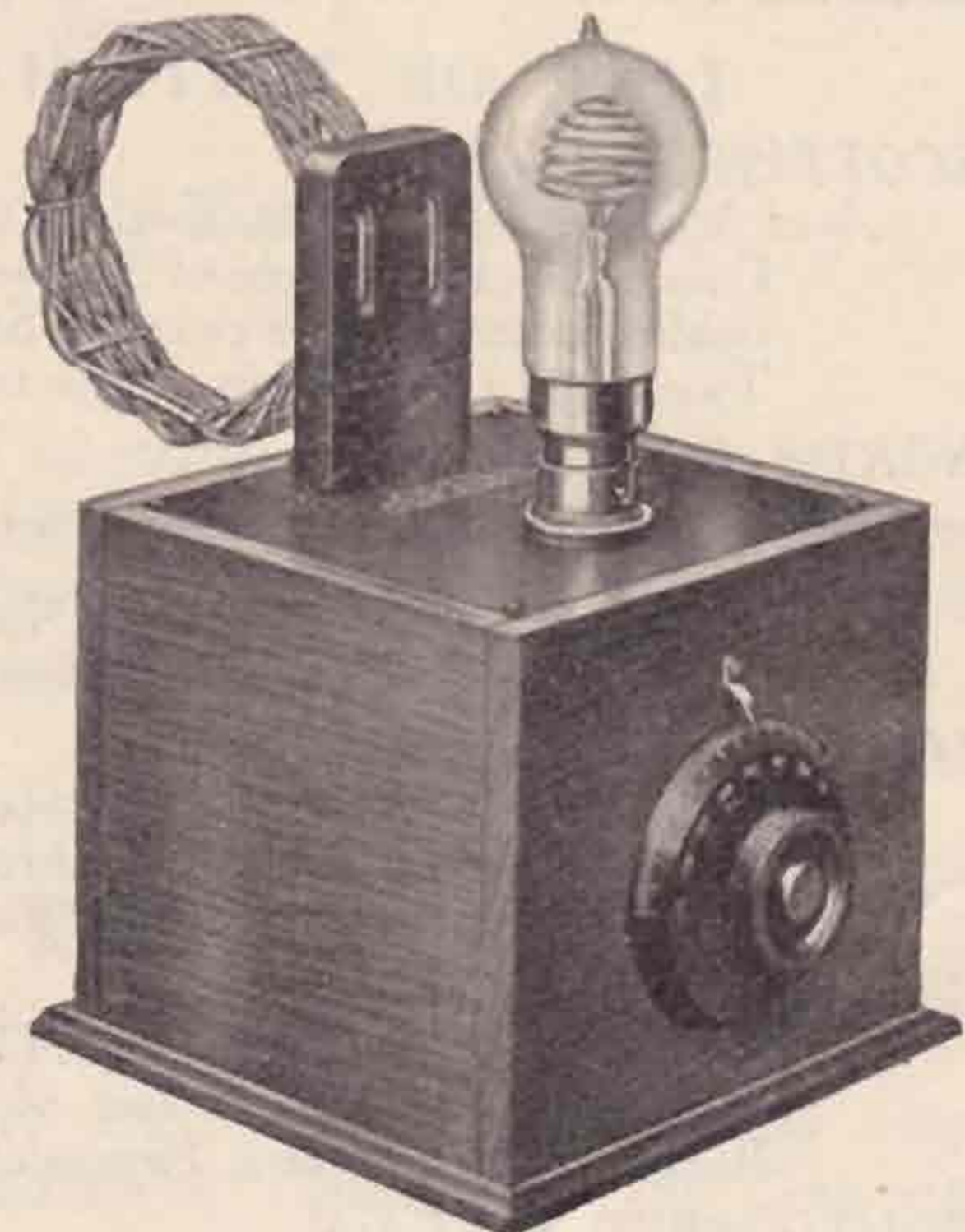

Range 15-200 metres. Can be used on transmitter and receiver.
 Price **50/-**

THE SOUTHEND RADIO CO., LTD., WICKFORD, : : ESSEX.

And at 5, Central Arcade, Southend-on-Sea.

Phone: Wickford 5.

THE T. & R. SECTION, Radio Society of Great Britain

THIS SECTION of the Radio Society of Great Britain is a virile and progressive body of amateur radio experimenters bonded together for promotion of knowledge and brotherhood of those interested in the Radio Art. It exists also with the object of the advancement of the Art, the representation of the amateur in legislative matters, and for the disciplined use of the ether in so far as amateur experimenters are concerned.

The Section is governed by a Committee which is elected annually in accordance with rules approved by a Convention held at the Institute of Electrical Engineers, London, in September, 1926, and the Constitution is democratic in character.

The policy of the Section is to accept to its Membership any person or persons who are able to satisfy the Committee that they are interested in Radio Art, or who in their opinion are persons whose Membership is desirable in the interests of the Amateur Experimenter.

The "Bulletin" is published by amateurs for amateurs. The Section is the body recognised by the British Postmaster-General as being representative of the aims and objects of the experimenter. Through its agency great concessions have been obtained in the matter of licences in the past. We have members in every corner of the earth, and we welcome inquiries from prospective Members at all times. A bona fide interest in experimental Radio work is the only essential qualification.

LIST OF BRITISH AREAS AND AREA OFFICERS.

SCOTTISH AREA.

Area Manager : J. WYLLIE, Esq. (5YG), 105, Mossgiel Road, Newlands, Glasgow.

Consisting of the whole of Scotland, including the Hebrides, Orkney Islands, Skye, and the other smaller islands on the coast of Scotland, the boundary on the South being formed by the River Tweed and the Cheviots. The town of Berwick is included in the Scottish Area.

NORTH BRITAIN AREA.

Area Manager : S. R. WRIGHT, Esq., A.M.I.R.E. (2DR), 14, Bankfield Drive, Nab Wood, Shipley, Yorks.

Consisting of the Counties of Northumberland, Cumberland, Westmorland, Durham, Yorkshire, Lancashire, Lincoln, Nottingham, Derby, Cheshire, and the Isle of Man.

MID-BRITAIN AREA.

Area Manager : CAPTAIN H. J. B. HAMPSON (6JV), 477, Earlham Rise, Norwich.

Consisting of the Counties of Shropshire, Leicester, Rutland, Cambridge, Huntingdon, Northampton, Warwick, Worcester, Hereford, Stafford.

SOUTH-EAST BRITAIN.

Area Manager : F. A. MAYER, Esq. (2LZ), "Stilemans," Wickford, Essex.

Consisting of the Counties of Essex, Suffolk, Bedford, Oxford, Hants, Sussex, Hertford, Buckingham, Berkshire, Hampshire, Surrey, Kent, Middlesex, and the Isle of Wight.

SOUTH-WEST BRITAIN.

Area Manager : Seat on Committee and Appointment vacant. Volunteers wanted.

Consisting of the Counties of Cornwall, Devon, Somerset, Dorset, Wilts, Gloucester, and the Scilly Isles.

NORTHERN IRELAND.

Area Manager : F. R. NEILL, Esq. (5NJ), "Chesterfield," Whitehead, near Belfast, Co. Antrim.

SOUTHERN IRELAND.

Area Manager : Seat on Committee and Appointment vacant. Volunteers wanted.

Reports to F. R. Neill (5NJ).

T. & R. Bulletin

Devoted to the Interests of the Transmitting Amateur

— The Official Organ of —
THE TRANSMITTER AND RELAY SECTION
of

THE RADIO SOCIETY OF GREAT BRITAIN,
53, Victoria Street, S.W.1



HON. ORGANISER:

J. A. J. Cooper, GRAD.I.E.E., A.M.I.R.E., F.R.S.A. (G5TR)

EDITORIAL COMMITTEE:

H. Bevan Swift, A.M.I.E.E. (G2TI), *Chairman*. Gerald Marcuse (G2NM), *Secretary*.

R. L. Royle (G2WJ)

ADVERTISING MANAGER:

A. Hambling, A.M.I.R.E., (G2MK).

QRA & QSL SECTION:

C. A. Jamblin, Esq. (6BT).

BANKERS:

Messrs. Lloyds Bank, Ltd., 6, Pall Mall, S.W.1



The EDITOR will be glad to receive articles and illustrations within the scope of the BULLETIN. The illustrations should preferably be double size and should be original. Contributions should be addressed to 53, Victoria Street, S.W.1., and marked EDITORIAL, ADVERTISEMENTS, Etc.



SUBSCRIPTION RATES

The T. & R. BULLETIN IS SENT POST FREE TO ALL T. & R. MEMBERS.

The price to non-members is 1/1 post free per single copy. Non-members may obtain the Bulletin by ordering each copy singly in advance. The Editorial Committee reserves the right to refuse copies to non-members if so disposed.

ADVERTISEMENT RATES

Rates for display advertisements will be sent post free on application. Small advertisements are charged for at the rate of 1d. per word or a minimum charge of 2/6.

CRYSTAL CONTROL

The object is to secure constant frequency.

The received signal from a transmitter controlled by a bad crystal is no steadier than another controlled by a self excited valve. In most cases it is inferior.

The signal from a c.w. station employing a crystal scientifically prepared from the purest quartz is immediately distinguished by the receiving operator from those others whose painful signal is caused by using impure quartz, badly prepared and inadequately mounted.

ARE YOU QUITE SURE YOURS IS WORTH WHILE ?

There is a big difference in cost between the one variety and the other, but then a thing that is cheap is generally nasty, that's why it's cheap.



QRP



BULLETIN.

The only British Wireless Journal Written and Published by Amateurs

DECEMBER, 1926.

Vol. 2. No. 6.

EDITORIAL

It is with great pleasure that we present to members this special Crystal Control Number, to which various prominent members of the Section have contributed, and we believe that the articles will be very much appreciated by all readers, whether they be owners of High or Low Power Stations. All those amateurs who have experimented with short-wave transmitters realise the advantages to be gained by the ability to produce a perfectly steady carrier wave without fading, distortion, wave changing and the like, and we are sure that it will come as a pleasant surprise to many that "crystal control" is available at the cost of a comparatively small sum of money.

Our advertisers have also combined with us in making this special and unique number the success which we feel sure it will be and it is hardly necessary for us to ask that they be not forgotten when you are ordering the parts for your amplifier and control unit.

Owing to the special nature of this number we have printed an extra quantity of the issue and it would be helpful if members would take an early opportunity of bringing the BULLETIN to the notice of transmitters who are not already members by suggesting that they might purchase a copy at the price named on the cover. It is proposed to run a short series of these "special" numbers as an experiment and the next one will appear in February next, the main subject matter being "Station Design and Layout." Articles on this subject are invited and authors need not necessarily confine their attention to building special transmitters or stations, but a description of their existing station with diagrams and photographs will suffice.

The articles selected for publication in that issue will be those which are considered to embody the most useful and novel features or possess other desirable features such as neatness, efficiency,

successful mastery of power problems and the like. The author should at the end of the article relate a brief history of his achievements with the gear under discussion. IN THE MEANTIME WE ARE STILL LOOKING FOR TECHNICAL ARTICLES OF EVERY DESCRIPTION.

Greetings.

This being also our Christmas and New Year number we take this opportunity of wishing every member the compliments of the season. At this time of year everybody is more or less inclined to be retrospective and we at Headquarters look upon our past year's work with great satisfaction. The continued growth of our membership, the enthusiasm for the cause of amateur radio, as shown by the excellent attendance at the Convention and the excellent financial position of the BULLETIN are factors which all combine to make us particularly optimistic as to the future. If all members will remember that the future of the amateur movement depends upon the efforts of every individual and not merely upon a handful of officers at Victoria Street, the success of the movement in Great Britain is assured. There have been and still are many difficulties to surmount, things are by no means such easy and straight sailing as many appear to think, but the combined pull of all of us *in the same direction* will help us to gain the conditions which we desire. A good DX year to all.

Further QRP Tests.

Arrangements are being made for a further series of QRP tests to be held in February, the wavelength being 23 metres and power 25 watts. Further details will be circulated to members in due course as soon as the necessary arrangements have been completed.

Obituary.

We learn with deep regret that 6YJ, F. Metcalfe, who was a comparatively new Member of the Section, was killed in a motor bicycle accident on October 11. We extend our heartfelt sympathy to his relatives and friends.

Crystal Control for the Medium Power Station.

By C. W. GOYDER (2SZ-2HM).

UP to the present very few stations in Great Britain have changed over to crystal control. This may be due to the fact that crystal-controlled sets, when described in articles, always seem formidable and expensive. This is partly true for high-powered sets using the ordinary method of high-frequency amplification.

The set described here is designed for powers up to 75 watts and uses a method of coupling the crystal to the transmitter which has been found simpler, more efficient and reliable than pure high-frequency amplification. Those who want a detailed account of the method and suitable circuits for powers of up to 1 k.w. are referred to *Experimental Wireless and Wireless Engineer* of this month. The following description deals with the practical construction and adjustment of a low-powered set of this type. In the event of higher power being required at some future time this set may be used as the first amplifier without any changes.

The photo shows the lay-out of the components of the set which is going to be described.

The H.T. is obtained from the transformer at the left of the photo. This is rectified by the "S" tube, giving half-wave rectification. For smoothing, a choke and two microfarads will be ample. To get the maximum allowable input to the valve with this set on an H.T. voltage of 800-1,000 will be necessary. As every amateur will have his own method of obtaining this voltage, further description of the method used here is unnecessary.

Inductances.

As five inductances will be required a detailed description is given for those who may wish to make them up in a similar manner. Inductances of the type shown are very simply made. The large type consists of three ebonite rings 3in. diameter and $\frac{1}{2}$ in. wide. Six ebonite strips $\frac{1}{2}$ in. wide and $\frac{1}{4}$ in. thick are spaced symmetrically about the rings. They are screwed on at each end. The third ring is placed in the centre of the coil to prevent

the ebonite strip sagging. It is not necessary to fix this, due to the pressure of the wire and strips. For these inductances a piece of ebonite tube is required from which the rings are cut—6in. will be sufficient. All the strips may be cut from a piece 6in. by 9in. by $\frac{1}{4}$ in. It is worth while to make a template for boring the six holes in the ebonite rings. Wrap a strip of paper round the rings to find the length, then divide this accurately into six parts. The paper may then be stuck on to

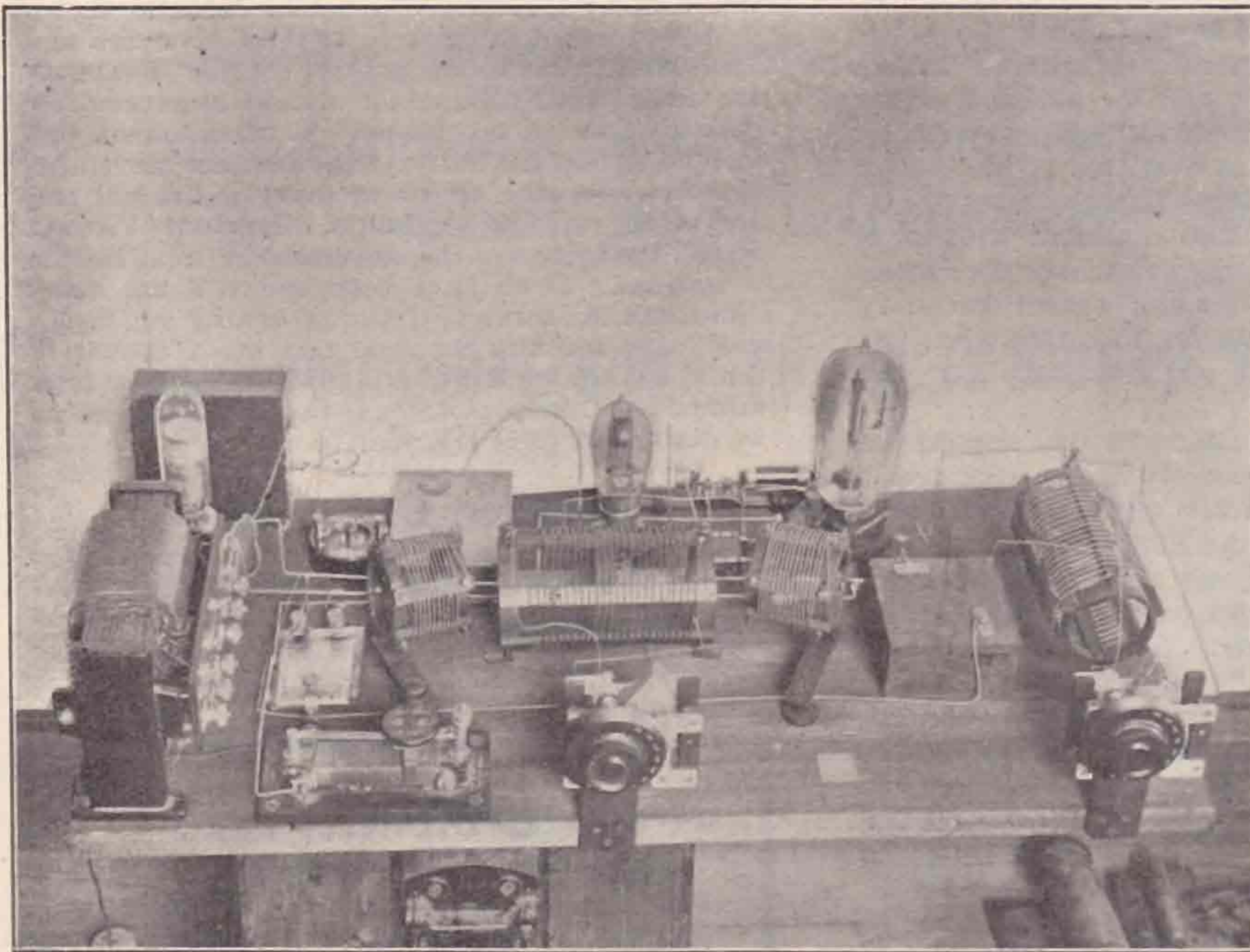

MR. GOYDER'S CRYSTAL-CONTROLLED TRANSMITTER.

Photograph reproduced by kind permission of the proprietors of *Experimental Wireless and Wireless Engineer*.

the rings when boring. For anyone accustomed to using a saw it is convenient to bore all the holes in the ebonite tube first and then cut out the rings. Cutting rings from ebonite tube is not so easy as it seems! The small inductances are made in exactly the same manner, but the ring in the centre is not necessary.

The two large inductances are 6in. long and are wound with 25 turns of No. 20 tinned copper wire spaced $\frac{1}{8}$ in. The other three inductances are 3in., 2in., and 2in. long, wound with 15, six and six turns, respectively, of the same wire. The strips must be notched so that the wire does not slip. This may be done by fixing all the strips in a vice with the $\frac{1}{4}$ in. side facing up. A notch is then filed in the $\frac{1}{4}$ in. side of the strip. This will be found sufficient to hold the wire, as when it bends over in the inductance it fits nicely into the notch formed by the filing. Feet for the fixed inductances may be made by boring a hole in the two projections of a Z-shaped piece of metal. The top projection is held between one strip and the ebonite ring—the screw going through the hole. The bottom projection is screwed to the board. The other movable coils are made in this case by attaching a strip of ebonite 3in. long to the coil. The other end of the strip is fixed to the board by a long wood screw which passes through an ebonite bushing. This raises the coil to the required level. This method is quite satisfactory as the coupling is only varied very occasionally. The photo will help to make the construction clear. The position of these inductances in the circuit may be seen from Fig. 1. L_1 , L_2 , and L_3 have 15, 25, and six turns. The coupling between these coils is variable. They are shown in the centre of the photo. L_4 and L_5 have 25 and six turns, and are also arranged so that the coupling may be varied. They are shown on the right of the photo. The high-frequency chokes (L_6 in Fig. 1) may be made by winding 75 to 100 turns D.C.C. wire on a 3-in. cardboard tube. Slight spacing between successive turns is an advantage.

The grid leak of the crystal oscillator in this case is a wire wound anode resistance of 80,000 ohms resistance. This is rather high, but works quite satisfactorily. The grid leak of the output stage should have a resistance of 10,000 to 20,000 ohms.

The condensers C_1 and C_2 should be of the low loss type with the movable plate connected to the frame. The new Ormond low loss receiving type are used in this set and are quite satisfactory and inexpensive. For C_3 a receiving condenser may be used, but the spacing of the plates will need to be fairly great. Igranic receiving condensers have fairly large spacing. If the full 75 watts is used it will probably be necessary to make up a

condenser with double spacing between the plates. The capacities of C_1 and C_2 are .00025 mfd., the smallest size made of the type of condenser mentioned. C_3 may be .0001 or even less.

The Crystal Oscillator.

The maximum voltage which will be required in this circuit will be 400. This can be obtained from the 800-1,000-volt supply to the output stage by inserting a series resistance of 10,000 to 15,000 ohms, depending on the type of valve used. Instead of a pure resistance a high-resistance choke may be employed in the smoothing equipment of the crystal oscillator. The choke then performs the double purpose of smoothing and cutting down the voltage. Such a choke may often be picked up from ex-Government stores. Before putting the crystal in circuit it is well to check up the voltage on the valve, if no high-resistance voltmeter is available, by measuring the anode current with about 10 volts negative grid bias from dry cells, then by referring to the characteristic curve of the valve the approximate anode volts

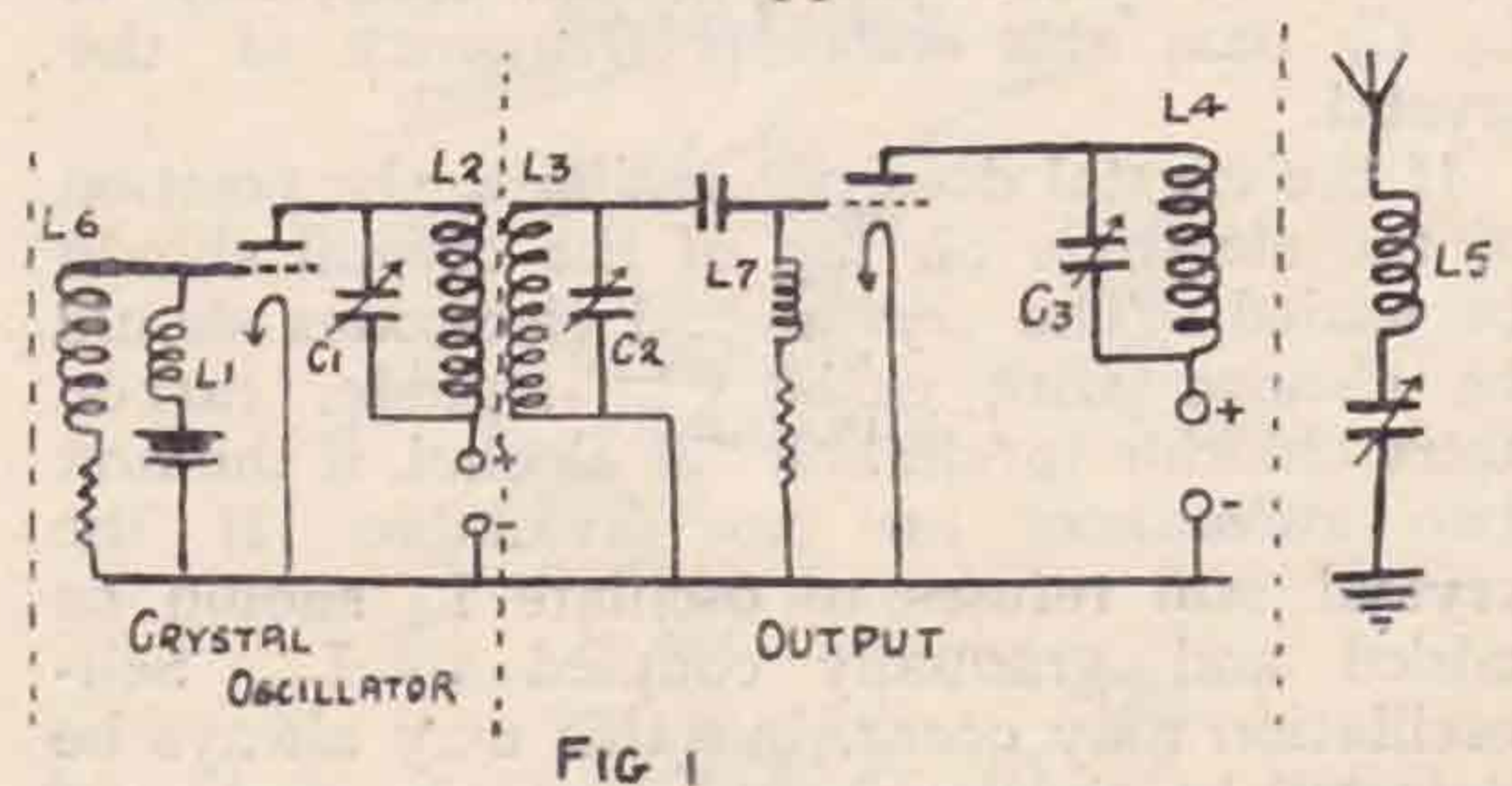

for these conditions may be obtained. It must be remembered that the voltage across the valve increases as the current passing through it decreases due to grid voltage variations. This is caused by the large series resistance. The voltage on the valve determined by the previous experiment is only true for the particular anode current obtained. If the anode current drops below this value (when the crystal is oscillating) the voltage will be higher. The plate current of the crystal oscillator is roughly 20 ma. under normal conditions.

A receiving type power valve of medium internal resistance and fairly high mutual conductance works well as a crystal oscillator (e.g., a DFAS, DE5, B4 or DFA6).

The crystal holder in this case is made from a large copper-plated steel plate for one electrode, and a penny, ground flat on one side, for the other. This construction is employed so that several crystals may be placed together on the plate for testing. Other suitable holders have been described in "QST."

Quartz crystals suitable for this work can be obtained from A. Hinderlich, 1, Lechmere

Road, Willesden Green, N.W.2. There are two types. The first are the more expensive type, which are guaranteed to oscillate without any assistance.

The second type require assistance. This is obtained by the coupling between L_1 and L_2 in Fig. 1. By this means, crystals which are not true or pure, or crystals which have a slight flaw, may be made to oscillate. Without the coil L_1 the feed-back through the capacity of the valve is relied upon to make the crystals oscillate. With L_1 magnetic coupling is added, in addition to the existing electrostatic coupling, in order to increase the feed-back. This method was described by Hinderlich in the "Wireless World," July 21, 1926. For this method to work the crystal must, of course, have reasonable piezo-electric properties. It will not make any crystal oscillate.

Adjustment of Crystal Oscillator.

For the first test, the inductance L_1 should not be in circuit. Use about 200 volts on the valve and vary the condenser C_1 over a range which will make the resonant frequency of $L_2 C_1$ pass the resonant frequency of the crystal.

If the crystal does not oscillate, the position of the electrode on top of the crystal should be varied. The crystal and electrodes should be cleaned with carbon bi-sulphide, carbon tetra-chloride (preferable) or alcohol, if the first two substances are not available. If the crystal still refuses to oscillate L_1 should be added and gradually coupled to L_2 . Self-oscillation may occur, but this may always be detected by the rough and unsteady quality of the beat note obtained in an oscillating receiver. Whether or not the crystal is oscillating may be determined as follows:—

When the crystal is not oscillating the plate current will be steady. As the capacity of the condenser C_1 is gradually increased a point will come where the current drops. The crystal is now oscillating. If the capacity is further increased the plate current will drop to a minimum and then jump up to its original steady value. The crystal has now stopped oscillating. If the set does not behave in this way, but the plate current does drop, look for self-oscillation.

When the crystal is oscillating satisfactorily the plate voltage may be increased to 400.

(By coupling L_2 to an aerial the crystal oscillator may be used as a low power transmitter.)

The Amplifying Stage.

The output stage of Fig. 1 is the well-known tuned-plate, tune-grid circuit. The adjustment of this circuit has been described often elsewhere (see particularly "Tuning Transmitters," T. & R. BULLETIN, September, 1926).

For the amateur who has already a set of this type it is only necessary to make the crystal oscillator. Using this method of crystal control the crystal control becomes purely additive in nature. When the crystal oscillator is switched off the set functions as a simple self-excited circuit.

To control 70-80 watts with the few watts in the crystal stage it is necessary to employ the fundamental of the crystal. This is quite satisfactory down to 45 metres, although care must be taken when handling a crystal for this wavelength. The 32 and 23-metre bands are not generally used so they will not be considered. Using the harmonic of the crystal on these wavelengths the crystal oscillator will control about 40 watts satisfactorily. The successful operation of the set in this case is largely dependent upon the care which has been exercised in obtaining a strong harmonic.

Theory of Operation.

When two separate and strong oscillations of the same frequency are coupled together there is present an inherent synchronising effect which tends to keep these oscillations oscillating together, despite small changes in inductance or capacity of either circuit.

The reason for this is given by E. V. Appleton in the "Proceedings of the Cambridge Philosophical Society, Vol. 21, page 231. Considering the grid circuit $L_3 C_2$ of Fig. 1, the range over which the oscillations will remain in synchronism is proportional to the voltage induced from L_2 to L_3 and inversely proportional to the amplitude of the oscillations which already exist in the circuit $L_3 C_2$ due to the self-oscillation. The oscillation of the self-excited circuit should therefore be made as weak as possible consistent with normal efficiency.

The frequency of the crystal oscillator is fixed. If the self-excited circuit is tuned to this frequency its frequency will be held in synchronism with that of the crystal oscillator over a certain range. This range is made sufficient to cover all the usual undesired frequency variations in a transmitter due to keying, H.T. variations and aerial swinging.

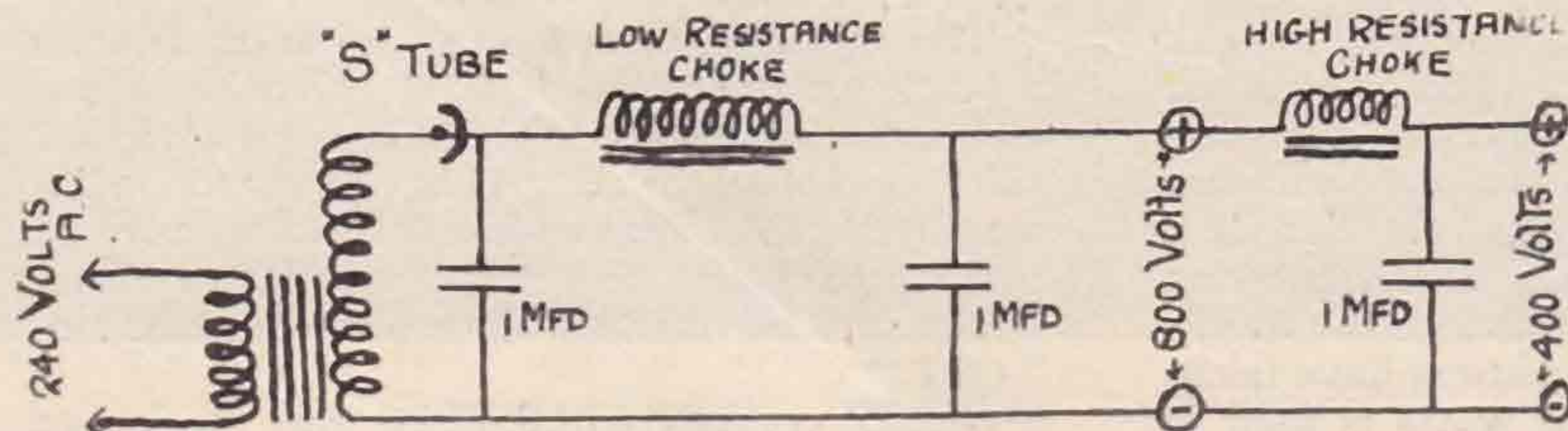

FIG 2

As long as the crystal oscillator and output stage are in synchronism the note will have all the properties of a crystal-controlled set.

To adjust the set, then, the crystal oscillator is switched on, a beat note is obtained with it in a receiver; C_2 of the self-excited circuit is varied so that the frequency of the self-excited equals that of the crystal oscillator. This is determined by the increase in strength of the beat note of the crystal oscillator. The mid-point of the range over which the two oscillations are kept in phase is shown by a minimum reading of the plate current of the crystal oscillator. This is the point to which the set should be tuned. In the case of dull emitter valves it is well to make sure the emission has not fallen off. Insufficient emission in the output stage prevents the crystal oscillator from controlling satisfactorily.

The advantages of crystal control are too well known to need repeating. The amateur using a crystal-controlled set may always feel he has a note to be proud of and that he is causing the least possible interference to other stations. This set is not difficult to make. The amateur contemplating a transmitter can start by building the crystal oscillator and using it as a low-power transmitter until the amplifier is available. Those who have a low-power transmitter will not find it difficult to add the crystal oscillator.

This set just described is used at 2SZ as the amplifier for the 250-watt set which has been working on this principle for some time. For low-power work it is used alone under the call sign 2HM.

Some experiments carried out since this article was first written show that, for some as yet obscure reason, a single layer spaced inductance is not the most suitable for the crystal reaction coil L_1 . It has been found that a concentrated inductance such as a basket coil or a flat pancake coil gives better results. The coil need not be of the low-loss type. A high self-capacity seems to be one of the essential features. When once the crystal is oscillating it is advisable to cut down the turns in L_1 to a minimum. The coil L_1 should, of course, only be used if it is not possible to get any oscillation at all with the usual crystal oscillator connection.

One disadvantage of the tuned-plate tuned-grid circuit shown is that there is no provision for controlling the strength of the oscillations. The set oscillates by virtue of the self-capacity of the valve which may vary with different sets. To get the maximum control available it is desirable to control the reaction to some extent by using a variable grid condenser of low capacity or a neutralising condenser. In this manner the strength of the self-oscillation may be reduced

Some Notes on Weather Conditions and Reception

By A. HINE, D.Sc. (BRS34).

(Concluded from page 6, Vol II, No. 5.)

As regards certain definite localities, it was found that during June and July Scandinavian signals were not subject to very much serious variation. Conditions in that direction were normally quite steady, and on occasions isobars were parallel between here and there, giving very good signals.

Disturbances of ordinary magnitude passing over Scandinavia did not appear to affect signals very much, probably owing to the distance being sufficiently great, but on one occasion, towards the end of July, a large cyclone moved from Iceland towards the

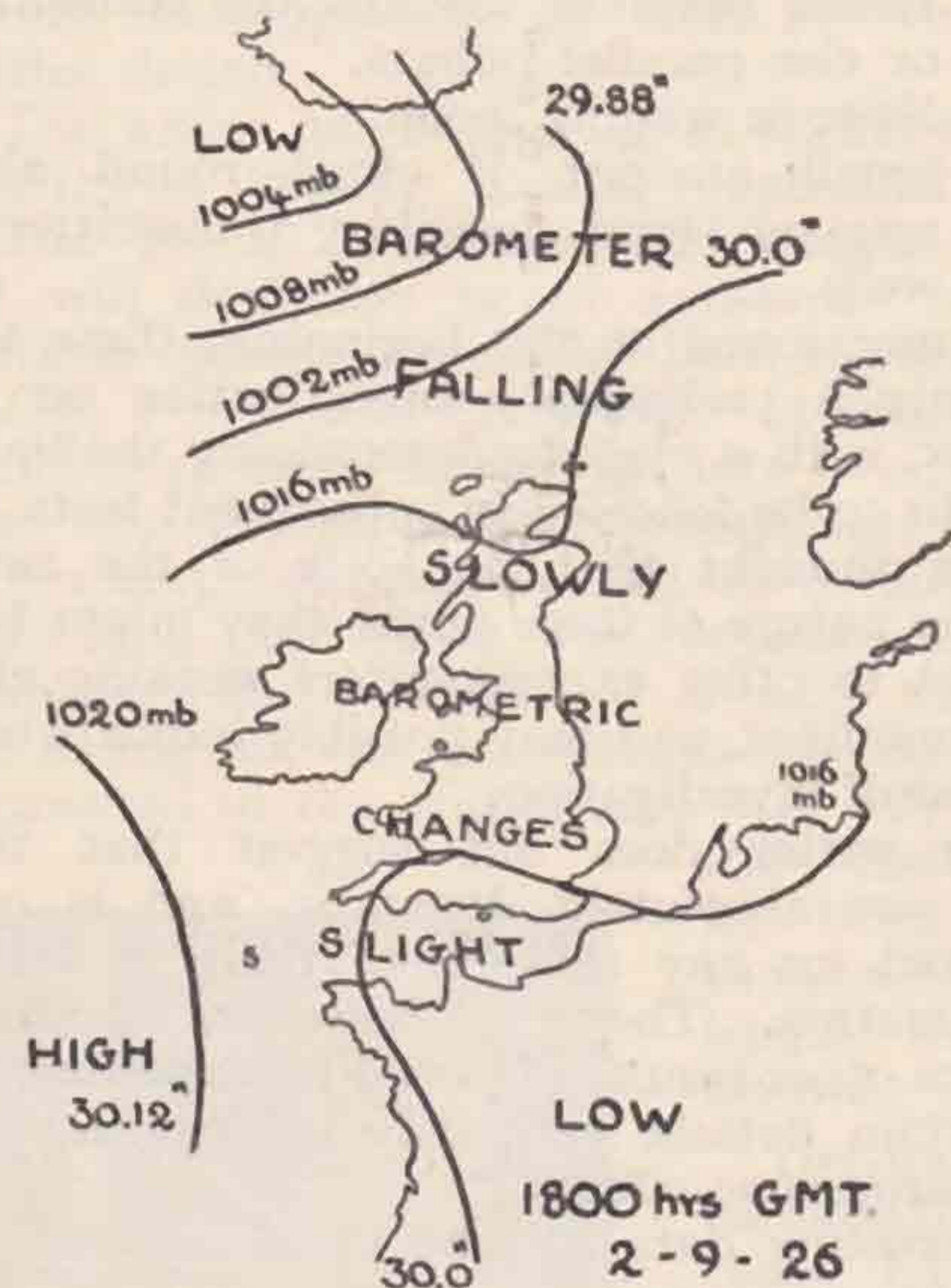

Baltic. When this was passing over Finland, and appeared to be just beyond that country, signals fell off, and on one occasion disappeared. Fading became very noticeable, whereas usually it is hardly apparent.

American signals were very subject to the pressure state west of Ireland; a depression in that region caused adverse results and vice versa in the case of a large anticyclone.

Brazilian signals were usually fairly steady and constant most of the time; there was usually a practically continuous state of high pressure over the south-west of Britain. Bad signals were observed to be coincident with intense secondaries passing south of the receiver, and especially when bad thunderstorms occurred in the south of England. The normal pressure gradient in that direction was either rising or else isobars were approximately parallel.

One feature of the DX graph is that it appears to group itself into a number of similar periods. This may be a cyclic effect produced by the lunar phases, or it may be a separate natural phenomenon almost in phase with the moon. In any case it seems to be capable of modification to a certain extent by meteorological conditions and if certain conditions are prevailing at any time which are opposed to other factors controlling DX reception, some unexpected variations are likely to occur in the shape of the graph, and the suggested cyclic variation may be distorted to a great extent.

It would appear, then, from the results that the best conditions for DX are:—

- (1) Steady and settled meteorological conditions in general.
- (2) Steady temperature (and humidity).
- (3) Steady barometer (preferably high).
- (4) Rising pressure towards the transmitter or else parallel isobars.
- (5) New, or waning moon.
- (6) Small amount of cloud round about receiver (and possibly transmitter as well).

As mentioned at the beginning, these tests are only a preliminary investigation on this subject, with a view to determining the line of thought to be followed in subsequent tests, but it was thought that, in spite of the rather sketchy nature of these notes, they might be of interest to other experimenters working along the same lines, and may possibly indicate some method of investigation.

The writer does not suggest that these views are absolutely dogmatic, and is quite prepared for any revision of them in further investigation. They do, however, appear to confirm other results obtained by experimenters in certain details, especially as regards lunar and barometric effects.

Interesting data can be obtained from the weather maps printed in the "Daily Telegraph" or "Times." In the example shown the DX conditions were as follows: U.S.A., quite good and heard early in the evening, especially 3rd District; Brazil, almost silent, with BZ1AW only R4; France, rather weak; Belgium and Holland, very strong; Scandinavia, not heard.

The other figure, showing pressure distribution systems in isobars and pressure gradients, shows pictorially the results observed from the use of weather maps.

Quartz Snags.

PENDING the arrival of a real specification that will ensure maximum output from a crystal-controlled valve, most amateurs rig up a circuit from the components that happen to be available. This is all right in its way, but sometimes the thing simply refuses to

start, and the difficulty is then to know what to alter. The following hints will not produce a powerful set, but they will enable the beginner to start, and by substitution of other components arrive at a really satisfactory set.

For top and bottom electrodes use metal no larger or heavier than pennies, not polished too flat. Slightly spherical ones often work best. Use 36 SWG. or finer to connect the top electrode—thicker wire is apt to cant it.

Use a receiving valve of moderately high impedance, with no grid bias or choke, and don't substitute the power bottle till everything else has been improved.

For some weird reason, spaced coils aren't so good. A spiral, basket or Lorenz seems to do the trick when others fail.

Try shifting the plates about. Some quartz specimens appear to have well-defined sensitive spots. A little pressure may help.

If no oscillations are observed when the plate condenser is increased VERY SLOWLY (else you may easily miss the sharp dip of the needle, besides which some crystals take as much as a second to build up) you are perfectly safe in using reaction.

The reaction coil is preferably a few turns coupled VERY TIGHTLY.

Make sure that the first kick of the needle isn't due to ordinary self-oscillation (when you'll get similar results after substituting paper or mica for the quartz).

Always use the smaller reaction coils first, but never mind if you have to use one so large that self-oscillation sets in. Measure the W/L. As long as it is more than 10 per cent. below that expected of the crystal, you'll be able to spot the latter chipping in by the needle dropping back twice as the plate condenser is varied.

Once the crystal has started to oscillate, slacken the reaction coupling till oscillation almost ceases, and re-tune. Then any alteration in mounting or components that causes stronger oscillations is an improvement. Which sounds obvious, but you'll appreciate the point when you come to try things out.

When you get oscillations for the same setting of plate condenser, but using different sizes of reaction coil, they are indubitably due to the quartz. Always use the SMALLEST REACTION COIL that you can, and keep on trying smaller ones or none at all. Lots of crystals require to be driven for a couple of hours before they will start off without assistance.

The fundamental oscillation may easily be missed on your receiver owing to complete wipe-out. Try a harmonic. To identify your note, "key" in the H.T. of the quartz-controlled valve.

2QY.

The Application of Quartz Crystal Control to Transmitters.

By E. J. SIMMONDS (G2OD), M.I.R.E., F.R.S.A.

MOST experimenters are agreed that the future short wave transmitter will incorporate some form of quartz crystal control, so that the frequency may be stabilised. This is, of course, particularly necessary in telephony transmissions, when any frequency distortion of the carrier is detrimental to the quality at a distant receiver.

Many workers, however, seem to be under the impression that the application of quartz control to existing transmitters, especially when using powers in excess of 100 watts, is both a difficult and costly proposition, and it is the aim of this article to dissipate this idea, and to direct attention to the simplicity and economy of this form of control.

In the opinion of the writer it is preferable to use crystals of comparatively long wavelength, and employ some method of multiplying the original crystal frequency in successive stages of an amplifier.

It is, of course, feasible to grind crystals with fundamentals down to 20 metres, but the percentage of useless crystals, and crystals with poor oscillating qualities increases very

greatly as the thickness is reduced, and it must also be borne in mind that in the near future it will be desirable to apply this form of frequency control to transmitters operating on wavelengths of 5 metres and below, and it will hardly be possible to produce crystals to oscillate fundamentally at these wavelengths.

Therefore the use of crystals of comparatively long wavelength, and some simple method of frequency multiplication seems necessary and desirable to meet the trend of future developments of short wave transmitter design.

The writer has been using at G2OD for some months a quartz crystal controlled transmitter on 32.25 metres, and details of this set will doubtless be of assistance to other workers engaged on similar lines of research.

Fig. 1 indicates the scheme of connections, which may really be divided into two portions, viz., the crystal oscillator-amplifier and the power amplifier stage feeding the aerial system.

Dealing first with the crystal oscillator-amplifier, this consists of a LS5 valve V^1 oscillating at the wavelength of the crystal connected in the grid circuit, viz., 129 metres,

the inductance L_1 being tuned to the same wavelength as the crystal.

The number of turns on the inductance L_1 should be varied until a sharp drop in the plate current reading of V^1 indicates that this valve is oscillating vigorously.

It will be convenient to include 0.50 milliammeter in the H.T. + feed to this valve, and it will be observed that as the filament is gradually brought up to full emission by variation of the rheostat, the plate current also

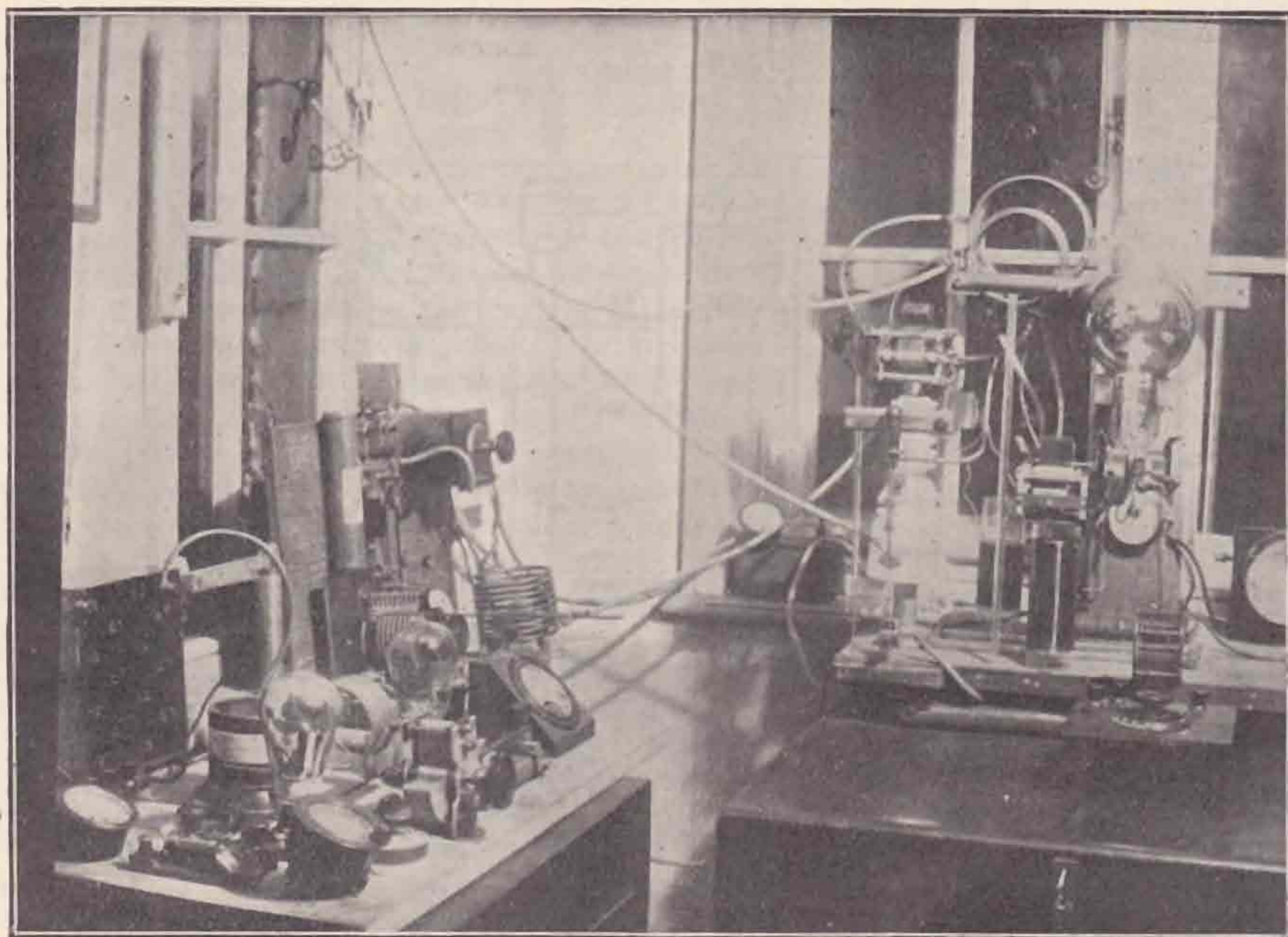

THE CRYSTAL-CONTROLLED TRANSMITTER AT G2OD.

increases up to a high value until the oscillation point is reached, which is indicated by a sharp drop in the plate current. The number of turns in L1 should be carefully adjusted to make this drop as large as possible. The physical dimensions of the radio frequency choke in the grid circuits in series with the one megohm resistance, should be as small as possible in order to avoid any possibility of magnetic linkage with L1. The number of turns in this R.F.C. are of no importance so long as its resonance point is of a longer wavelength than the crystal in use, and it may conveniently be "scramble wound," which will reduce the magnetic leakage and decrease the risk of harmonic oscillation, which is very liable to occur with R.F. chokes carefully space wound in solenoid form on "low loss" formers.

This point should be borne in mind when designing R.F. chokes for use in the power amplifier portion of the set, where, owing to the higher powers, the danger of harmonic oscillation of the R.F.C. is much increased.

The one megohm grid leak calls for no special comment as it is the standard type as used for receivers. The inductance L2 is tuned by condenser C1 to the first harmonic of the crystal, viz., 64.5 metres, and here again, careful observation of the plate milliammeter will accurately determine this position.

As the tuning of the L2 C1 circuit is varied around 64 metres, a point will be found where the plate meter to the first valve shows a sharply defined dip, indicating that the L2

C1 circuit is accurately tuned to the first harmonic of the crystal.

It is necessary to point out that only by careful adjustment and measurement stage by stage as the amplifier is built up, can any measure of success be attained; haphazard methods will certainly only yield poor results, and entail the loss of unnecessary power in the amplifier.

The grid of V² is capacity [coupled to the L2 C1 circuit, and is therefore excited at the first harmonic of the crystal. By the use of a high impedance valve and suitable adjustment of negative grid bias, it is possible to so distort the output from this valve V² that the original frequency impressed on the grid is practically suppressed, and a resultant of double the frequency (in this case 32.25 metres) is obtained in the inductance L3. It is most important in this stage that the negative grid bias and operating constants should be carefully adjusted if maximum control of the power amplifier stage is desired, for it must be borne in mind that if the original frequency impressed on the grid of V² is unduly pronounced in the anode coil L3, there will be a great tendency to excite the grid of the power amplifier at this frequency, as well as the desired frequency, resulting in the radiation of energy on an unwanted wavelength and consequent loss of efficiency.

The method adopted by the writer in the adjustments of this stage will therefore be detailed, as by this means the necessary

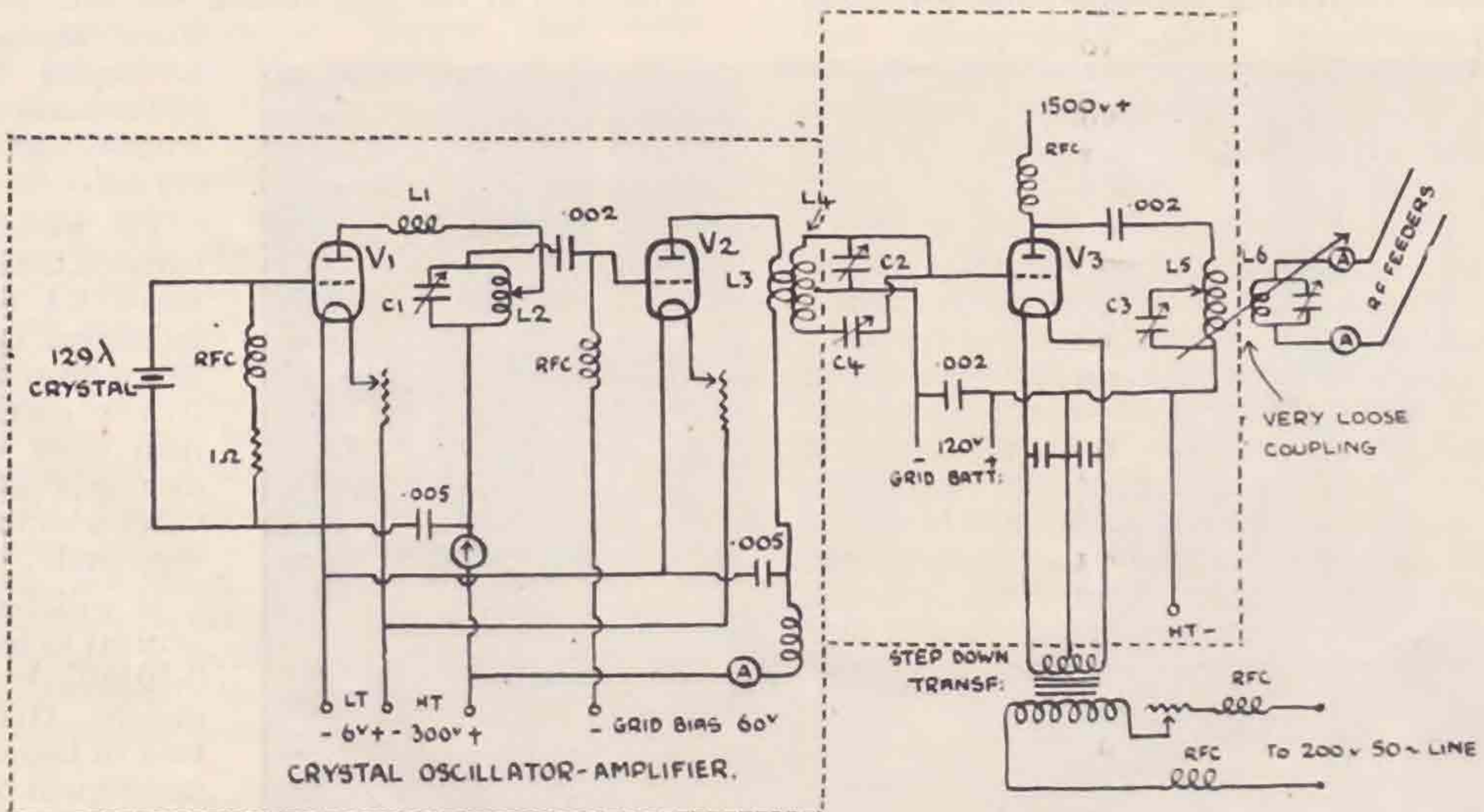

- L1 tuned to 129 metres.
- L2 tuned to 64.5 metres.
- C1, C2 and C3 = .00025 mfd.
- C4 Neutralising Condenser as used in receivers.
- V1 = L.S. 5 valve. V2 T15.
- V3 = 250 watt Osram valve.

- L3 = Tuned to 32.25 metres.
- L4 = " " "
- L5 = " " "
- L6 = " " "

precise adjustments may be made by observation before the crystal oscillator-amplifier is coupled to the final power amplifier stage.

An absorption circuit, consisting of an inductance and variable condenser with a Weston thermo couple galvanometer as a current indicator, was loosely coupled to the inductance L3, and readings taken of the radio frequency currents in inductance L3, both at the original frequency (64.5 metres) impressed on the grid of V^2 , and the resultant frequency (32.25 metres) obtained by distortion of the output of V^2 . It was then comparatively simple to so arrange values of grid bias plate voltage and filament emission of V^2 that the original frequency impressed on grid of V^2 was practically suppressed. In this particular instance the galvo, which has an equally divided scale of 100 degrees, gave a full scale deflection when the absorption circuit was tuned to 32.25 metres, and a deflection of only eight degrees when the absorption circuit was tuned to 64.5 metres, in both cases the distance between the "pick up" coil and L3 remained unchanged.

The following combinations of valves have been used in the crystal oscillator-amplifier for the control of input powers to up 100 watts to the power amplifier V^3 :—

V^1 equals DE5. Anode volts equals 200. Input 2.5 watts.

V^2 equals DE5D. Anode volts equals 200. 45V negative grid potential. Input 3 watts.

Total input equals 5.5 watts.

For power amplifier inputs up to 200 watts.

V^1 equals LS5. Anode volts equals 300. Input, 3.5 watts.

V^2 equals T15. Anode volts equals 300. 60V negative grid bias. Input equals 5 watts.

Total input equals 8.5 watts.

Thus, a total expenditure of 5.5 watts in the crystal stages with two *receiving* valves will *efficiently* control 100 watts in the power amplifier stage. It is, of course, obvious that the voltage impressed on the grid of the power amplifier V^3 by the crystal oscillator-amplifier is insufficient to fully swing the grid of V^3 , and what really happens is that a large percentage of the power for efficient excitation of V^3 is supplied by "feed back" in the valve itself, as it is *properly* under neutralised, and the energy supplied from the crystal stages acts as a "trigger" to control and stabilise V^3 and its associated circuits.

After the crystal stages have been set up and adjusted step by step to function correctly, the final power amplifier stage may be added.

The layout and circuit arrangements used are quite standard and consist of the usual tuned grid and anode circuits, with the exception that the grid coil is tapped in the centre for the filament tap, and the two outer ends of the coil are connected respectively to the grid of V^3 and the neutralising condenser C4.

It should also be noted that a grid battery is used in preference to the more usual grid-leak. This arrangement has the advantage that should the crystal stop oscillating for any reason V^3 will be protected from excessive feed current, and the plate milliamperes will drop to a small value. The value of negative grid bias on V^3 will depend entirely on the characteristics of this valve, the plate voltages used and the outputs required, but care should be taken to avoid the use of excessive negative grid potentials, as not only will the output be unduly restricted, but there is also a tendency to accentuate the harmonics. The diagram shows V^3 lit from AC supplied by the stepdown transformer with the usual centre tap. There will be no difficulty in obtaining a good note even though AC is used on the power amplifier filament, as the crystal control will obviate the modulation of the carrier by the 50c. supply. Care must, however, be taken to fix the centre tap to the electrical centre of the filament transformer.

There are many simple methods of keying, of which three will be mentioned, viz. :—

(1) *Keying in the primary of the H.T. transformer.*

This is a simple arrangement and works well, but has a tendency to give "tails" to the dots and dashes if large smoothing condensers are used. With crystal control large smoothing condensers are quite unnecessary, and 0.5 mfd. on the output side of the smoothing unit is ample. This will also ensure that the Morse characters are clean cut.

(2) *Keying in the centre tap to transformer.*

This gives very sharp and well-defined Morse, but has the great advantage of causing bad local "key clicks," and also with H.T. transformers of high leakage the H.T. voltage may rise to a very high value during the period when no H.T. current is being drawn, which is therefore likely to puncture smoothing condensers and unduly strain other parts of the apparatus.

(3) *Keying in the H.T. lead to the frequency doubling valve V^2 .*

This is a very good method if the power amplifier is correctly adjusted and neutralised. It gives clean-cut Morse signals, and at the same time, as the feed current of the power amplifier does not fall to zero, but only to a value determined by the grid bias, the whole of the high frequency and low frequency circuits of the power stage and its associated power supply are saved undue strain and shock.

At the time that this article is being prepared the aerial system in at G2OD consists of a horizontal half wave antenna, fed by two parallel R.F. transmission lines as indicated in the diagram, an arrangement which is much preferred to the more usual single wire feeder system in operation at many stations. One

(Concluded on page 19)

Crystal Control for QRP Stations.

By G5HS.

It appears that the reasons for crystal control not being commonly used for *low-power* work are:—(1) The method is expensive (2) considered troublesome (3) its merits are not appreciated. The method can certainly be expensive if one starts off by buying a guaranteed crystal complete in holder and several low impedance valves, and it can be troublesome unless a start is made along the right lines. It is proposed first to indicate the methods of persuasion to be employed by the beginner who possesses a slice of quartz one inch square, ground down so that its fundamental oscillation will fall within the 44-46 metre band.

THE CRYSTAL HOLDER.

The first thing is to construct a holder for the crystal. This may be made up from old crystal detector parts (Fig. 1).

The top plate is a sixpenny piece ground quite smooth on one side and soldered to a piece of brass spring, while, in order to avoid faulty contacts, a flexible wire is run from the top plate to the bolt holding the stand to the panel. A holder of this type has been found quite satisfactory, as the top plate can be applied to various parts of the crystal, the pressure can be varied, and the setting is unaffected by small shocks.

The bottom plate is a copy of one used by 2QY. It is a square piece of brass strip the same size as the crystal, ground perfectly smooth, and secured to the panel with a small and well countersunk bolt. Every crystal will have its individual peculiarities and should be tried in various positions and with various pressures in order to find the most stable and efficient point.

FORCING OSCILLATION.

With unguaranteed specimens free oscillation without feed-back is the exception rather than the rule. I will now describe in some detail the method first shown me by 2QY of forcing the crystal to oscillate. An oscillator should be built up employing the circuit shown in Fig. 2 (neglecting for a moment the part to the right of the dotted line). First of all one should make sure that the oscillatory circuit $L_2 C_2$ will oscillate on the 44-46 metre band. (Note: C_2 could be shunted directly across L_2 , but always use the method shown.) This is done by short circuiting the crystal, when we have the simple reversed feed-back circuit which we can make oscillate by using a suitable valve of inductance for L_1 . L_1 and C_2 , should be varied until the valve is oscillating with minimum anode current, on the right wavelength. The crystal should then be put

into circuit, the inductance L_1 having previously reduced to 3 or 4 turns. The coupling between L_1 and L_2 should be very close and the connections in the sense shown, or, of course, with both sets of connections reversed. The condenser C_2 should then be slowly varied, the milliammeter in the anode circuit being watched for the sudden drop indicating crystal oscillation. Various points on the crystal should be tried with the top plate, and the valve, which *must* be of low impedance, should be at *saturation point*. It is as well to start off with a low anode voltage of about 60 volts. If there is no oscillation, gradually increase the inductance L_1 , turn by turn, varying C_2 and the crystal adjustment at the same time. There is still hope even if one reaches the value of L_1 , used in the trial R.F.B. circuit, and by this time the valve should be oscillating on some wavelength owing to the coupled circuits L_1 (with capacity of crystal and plates in series) and $L_2 C_2$. In fact, in my case this self-oscillation seemed to help the crystal to start off on its own! It was found that the valve was oscillating on a wavelength considerably below the 44-46 metre band, this oscillation being indicated by a gradual drop in anode current, and it was proved that it was not due to the crystal as lifting the top plate just off the surface of the crystal did not affect it when the capacity, being only slightly changed, the self-oscillation

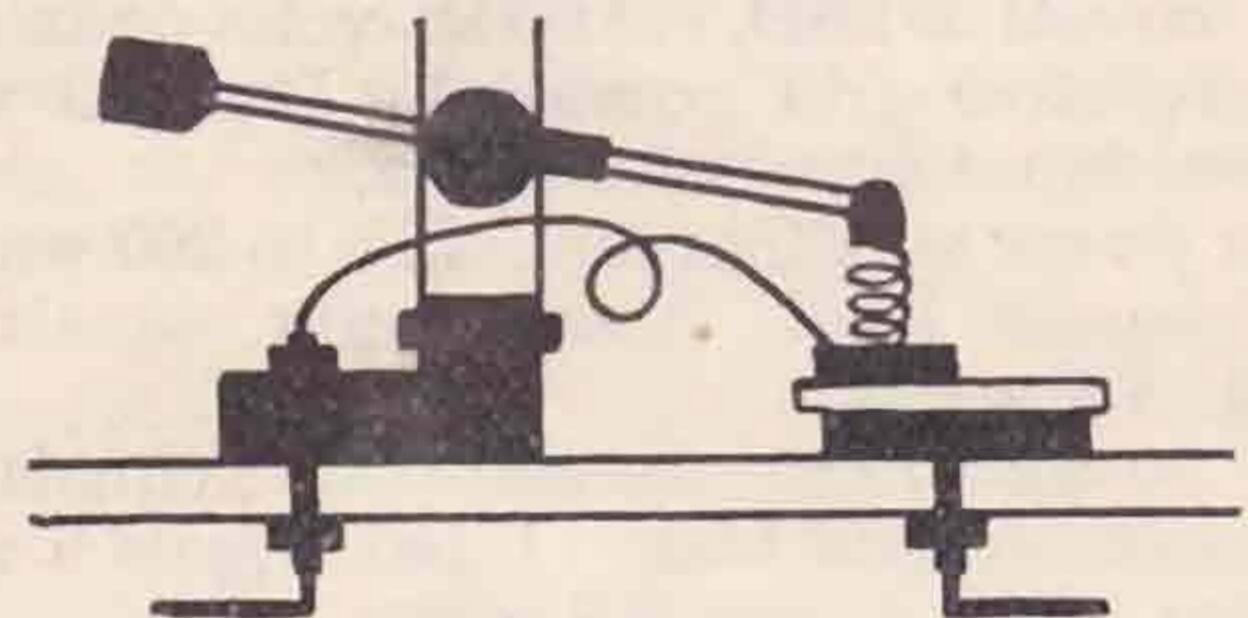

Fig. 1.

continued. C_2 was then increased, and at last a point was found where a sudden drop in anode current should be about 50 per cent. and the top plate should be moved about to find the most efficient point. The next step is to reduce the size of the feed-back coil L_1 , and this can sometimes be reduced to one or two turns. The anode voltage can now be increased with safety until the valve is handling about 5 watts. The crystal could probably handle more power, but the danger of cracking would be increased, for the crystal becomes quite warm even with 5 watts. Altering the H.T. will probably necessitate slight re-tuning, and possibly the crystal will require greater or less pressure as the case may be.

THE AMPLIFIER.

I will now describe the transmitter in use during the recent QRP tests (Fig. 4). The crystal oscillator is the one used before, while the amplifier employs the same circuit and

(Continued on page 14)

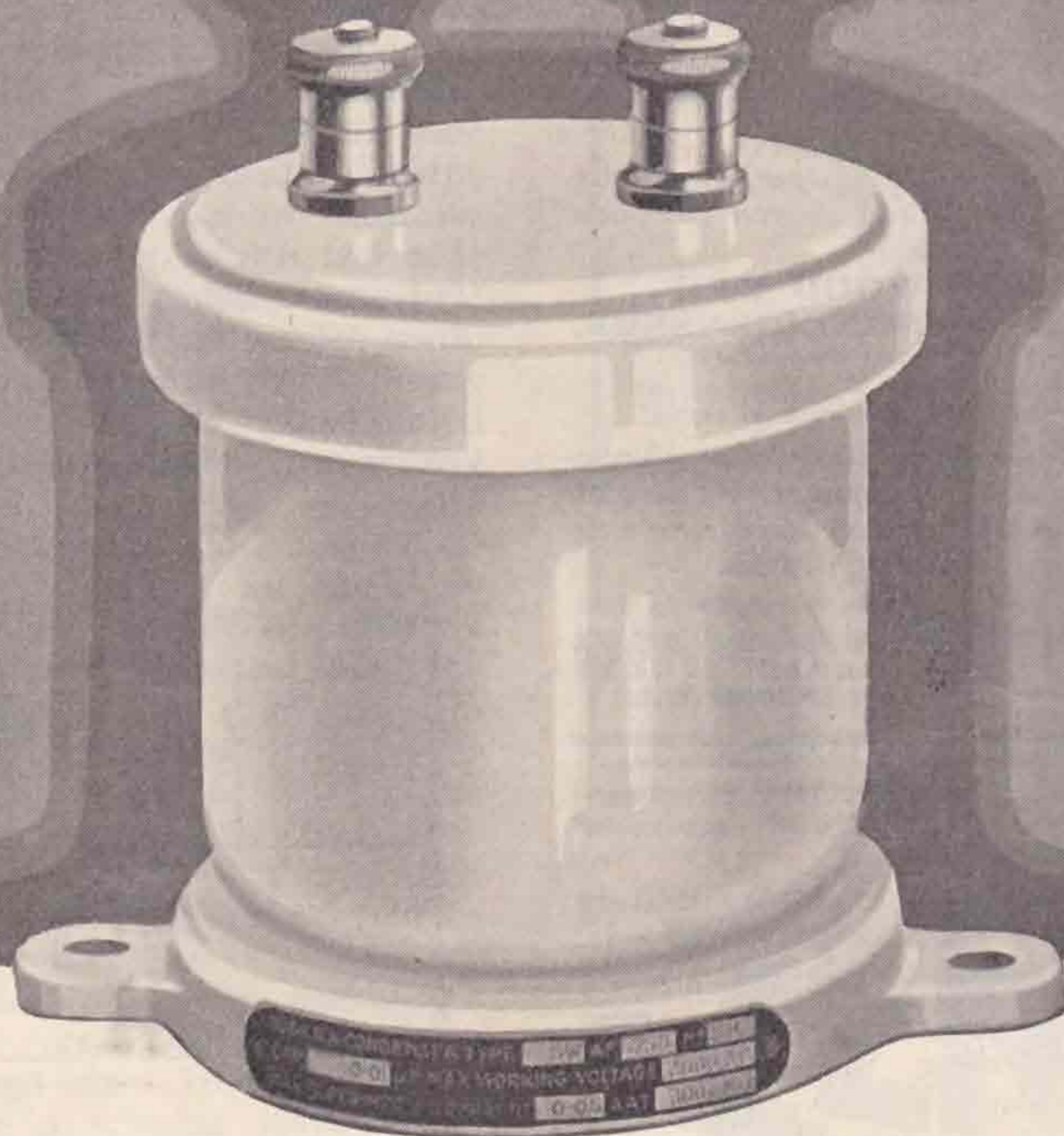

Condensers for Transmission

Our range of Condensers for Medium and Low Power Transmitters covers all normal requirements, and we shall be pleased at all times to advise those engaged in research as to the Types best suited to their needs.

The AF range, designed primarily for Anode Feed purposes, and the SWAF range, designed to operate in circuits where the wavelength is below 100 metres, have capacities between 0.00005 MF and 0.05 MF for working voltages up to 6,000 D.C.

As will be seen from the illustration (which shows a Type SWAF 750) these condensers are enclosed in porcelain containers. Adequate insulation is thus provided for the high potentials above earth at which the condensers will generally be required to operate.

These condensers may be employed as high frequency by-pass condensers or as grid condensers for transmitters.

The Type SWAF are also suitable for use as Aerial Series Condensers, Oscillation Circuit Condensers, etc.

The prices for these condensers vary from 35/- to 70/- according to the type required, and we shall also be pleased to quote for any condensers constructed to meet special requirements.



ADVERTISEMENT OF THE DUBILIER CONDENSER CO. (1925) LTD.
 DUCON WORKS, VICTORIA ROAD., N. ACTON, W.3

Losses and Gains

Losses are disastrous in S.L.F. Condenser design.

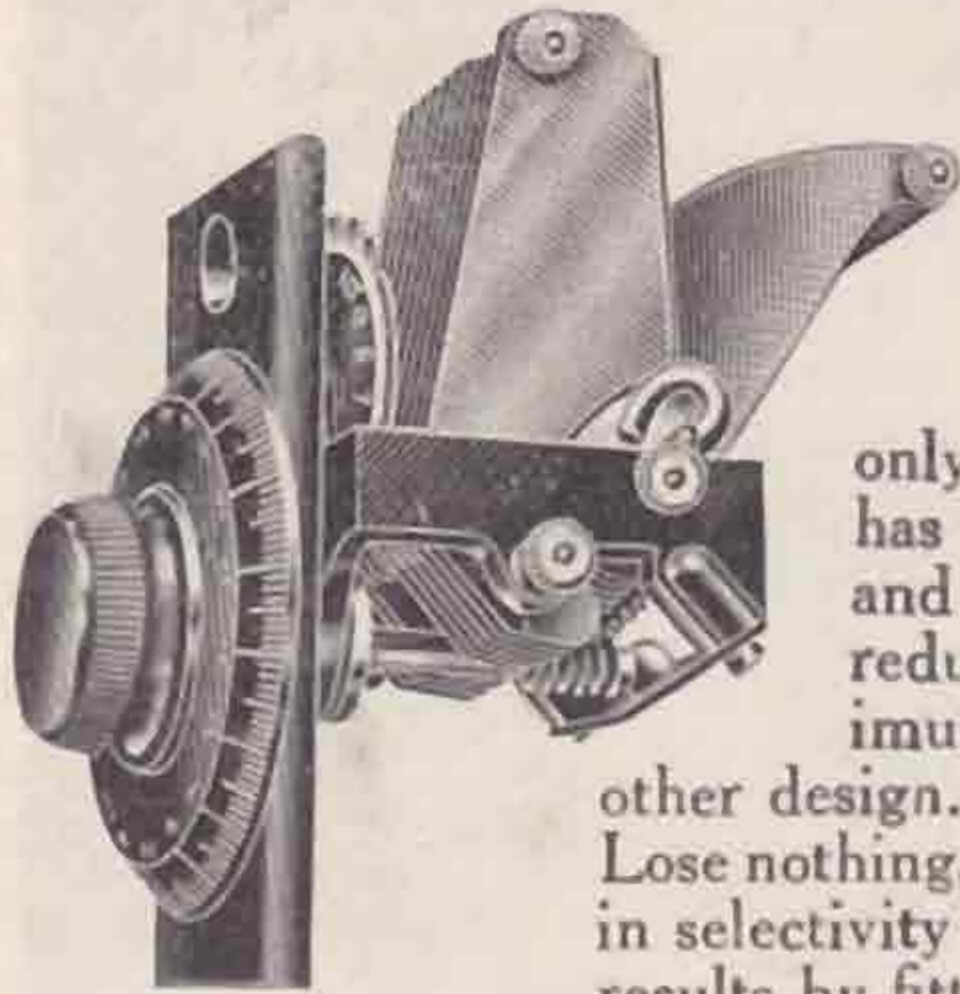

The more supports there are between the fixed and moving vanes, the greater is the leakage.

The Bretwood is the only condenser made that has only TWO supports, and losses are therefore reduced to a greater minimum than that of any other design.

Lose nothing, but rather gain greatly in selectivity and general reception results by fitting

BRETWOOD S.L.F. LOW-LOSS CONDENSERS.

Free illustrated folders of all Bretwood Components on request.

Grid Leak de Luxe—Auto-Audio Frequency Amplifier—Filament Rheostats—Valve Holders—Coil Plugs—Switches.

Send p.c. for copies by return of post.

BRETWOOD LTD.

**LONDON MEWS
MAPLE STREET
LONDON, W.1.**

Patrs Ad.

Crystal Control for QRP Stations—continued from page 12,

method of aerial coupling. One is immediately faced with the problem of how to avoid self-oscillation of the amplifier, but this tendency is reduced if the amplifier grid is loose-coupled as shown instead of being tapped straight on to the tuned inductance L_2 . Neutrodyning has been attempted, but without success so far; but when the amplifier is required to handle only low power it can be avoided by a rather curious method of keying. Suppose both K_1 and K_2 are closed and that the control valve is oscillating efficiently, then on tuning the circuit $L_3 C_3$ to the same wavelength, the amplifier valve should start oscillating as indicated by a drop in its anode current. The aerial can then be coupled on and put into oscillation. Now, to test if the crystal is controlling, lift the top plate just off the surface, when the amplifier should either cease to oscillate or else self-oscillate violently. If it was already self-oscillating there will be no change. The tendency for self-oscillation may be reduced by increasing the resistance of the amplifier grid circuit; one way of gaining the desired effect is to use a small bye-pass condenser C_4 , but, of course, the efficiency is slightly lowered. The method of keying employed for the QRP tests makes use of the fact that the crystal will absorb energy when in

resonance. By critical tuning of C_2 and C_3 a position was found such that when K_1 was closed, the amplifier was in oscillation, while when K_1 was open the oscillation either ceased or fell to a very low value, indicated by increased amplifier anode current and no visible aerial current. The fact that this method worked best with moderate pressure on the crystal shows that the explanation must be that when K_1 is closed the oscillating control valve supplies sufficient energy to the amplifier grid circuit to put it into oscillation, while when K_1 is open the crystal, being closely coupled to the amplifier grid circuit, will absorb sufficient energy from it to prevent self-oscillation of any magnitude. This method was quite satisfactory and seven Transatlantic stations were worked with moderate ease on the last day of the QRP tests. (I had never got across before with less than 80 watts and then none too well!) The disadvantages of this system are the very critical tuning required, the fact that by keying the control valve any defects will be amplified, and that

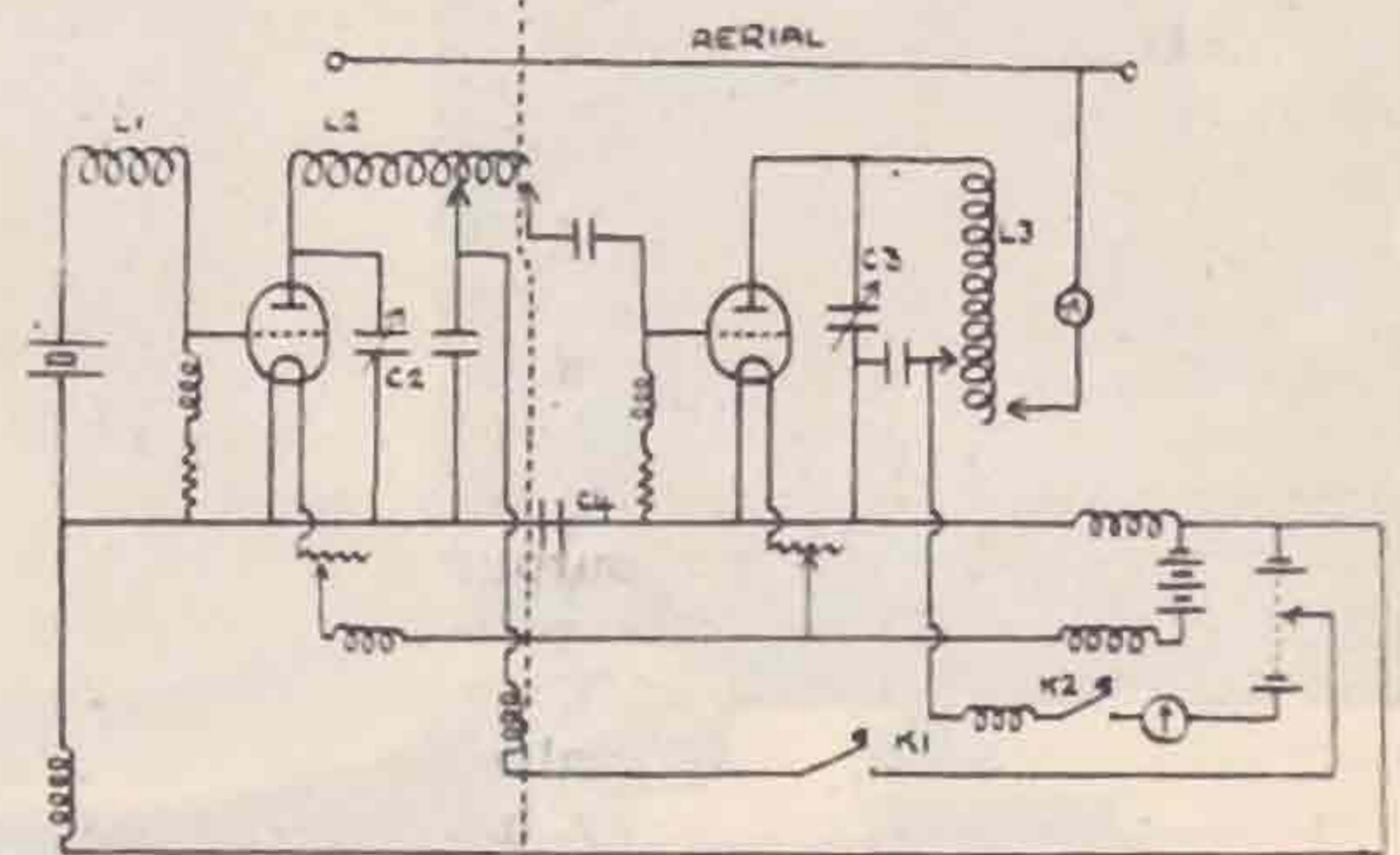

Fig 2

the amplifier valve will have to carry rather a heavy current when its oscillation is stopped; but one can be sure that the output is entirely crystal-controlled. So I tried keying in the anode circuit of the amplifier valve with K_2 keeping K_1 down and the control valve oscillating all the time. This system works well, but only provided that the adjustment just described has been made, or one cannot be certain that the crystal is controlling. A curious effect was noticed at this point. Suppose as at first K_1 is closed and we are keying with K_1 . A touch on the condenser C_3 will give a position where with K_1 down the output is the same as, or slightly greater than, before while with K_1 up the output instead of falling very low, will be about 80 per cent. of its former value. I found by lifting the crystal on and off, and by listening on the receiver to a weak harmonic (the crystal note can be distinguished at once by its dead steadiness and absence of chirp) that this oscillation was not plain self-oscillation, but was weakly

crystal controlled. By closing K_1 the crystal note became much louder and the crystal took full control. What must happen in this case is that when the power is cut off from the control valve, the inertia of the crystal will make it continue to oscillate and take control of the amplifier valve, which will then maintain the oscillation. This view is confirmed by the fact that the crystal cannot be made to control the amplifier directly by closing K_2 unless K_1 has previously been depressed and the crystal put into oscillation. Now, in this position keying cannot be done with K_1 , since there would be spacing and marking waves on exactly on the same wavelength, but by closing K_1 and keying with K_2 we can be sure that the output is crystal controlled, while the adjustment is far less critical than with my earlier method. This seems to be the best method of keying, and I am going to try it soon on the U.S.A. under QRP conditions to compare results. There is one *very* important point to notice with both keying systems, and that is that the power input to the control valve should be as small as possible, otherwise the actual power input to the amplifier will be considerably greater than that indicated by its anode current. I find that if the control valve is itself handling 5 watts, then the output to the aerial *via* the grid to plate capacity of the amplifier valve (with its power cut off) can be as great as 50 per cent. of the output when the power is switched on to the amplifier, and this last output is larger than that obtained when lower power is applied to the amplifier grid; hence, energy is passing through the amplifier valve increasing its input by a quantity very hard to measure. Another point is that when keying with K_2 we shall again have a spacing wave interfering with the marking wave on the same wavelength. To allow for this extra power *via* the high resistance path, in the QRP tests, I used 4.8 watts input to the amplifier, and one-tenth of this to the control valve.

CONCLUSION.

Now that I have dealt with a few of the peculiarities I have experienced, I should like to say a word about expense. The best valve I have found for both control and low power amplification is a Dutch power valve of the .25 amp. filament class with an impedance of about 6,000 ohms. This "ratraco radio tube" is retailed at Camden Town Station at 9s. 6d. (or 18s. the two!). My only extravagance was in buying a good slow motion .00025 mf. S.L.F. condenser for C_2 —and a crystal! The superiority of this transmitter over my old 5-watter is far greater than I was expecting, and shows how greatly the efficiency of c.w. transmission can be lowered by a slight ripple and a slight chirp. Besides, the lovely QSB reports I get, my signals seem more QSA

ONE METER.

SUPRECION Model 303. Sensitivity 2ma, 100mv, for use with Multipliers. Guaranteed equal or better than any similar meter at double the price.

Our Price 25/-

SUPRECION Model 103. World Famous Test Set Ranges 6v, 120v, 300mv, 3ma, 12ma, 120ma, 6amps. Also measures Megohms, Ohms, and Microamps.

Price 52/6 complete



Call and see our immense stock of instruments of all descriptions. A post-card brings illustrated lists free.

F. C. HEAYBERD & CO.

8 & 9, Talbot Court, Eastcheap, E.C.3.

ZENITH

HIGH AND LOW TENSION TRANSFORMERS

SMOOTHING CHOKES AND REGULATING INDUCTANCES

"ZENITE" (TRADE MARK) WIRE-WOUND EMBEDDED RESISTANCE UNITS

REGULATING RESISTANCES

RECTIFIERS FOR H.T. ACCUMULATOR CHARGING

THE ZENITH ELECTRIC CO. LTD.

(Formerly the Zenith Manufacturing Co.)
Sole makers of the "Zenith" Electrical Products.
Contractors to H.M. Admiralty, War Office,
Air Ministry, Post Office, L.C.C., Etc.

ZENITH WORKS, VILLIERS ROAD,
WILLESDEN GREEN, LONDON N.W.2

Telephone: Willesden 4087-8

YOU WOULD HAVE A BIGGER "BULLETIN."

everywhere, and crystal control will in future always be used for QRP work—it says so on my new cards!!!

In conclusion, I should like to thank 2QY for putting me on the right track, and also those T. & R. members who have helped me with these tests.

Research Sub-Section.

As reported in the November BULLETIN, the Committee decided that such a sub-section should be formed, and in consequence of this decision, a small sub-committee was appointed consisting of Messrs. Gregory, Morrow, Robinson and Simmonds.

Mr. Simmonds acted as chairman of this sub-committee, which met on November 2 to consider the original proposals drawn up by Mr. Morrow for the management and constitution of the Research Sub-section. As a result of this meeting, rules covering the activities of the sub-section were agreed to, and these were put in suitable form for presentation to the General Committee, who have been recommended to endorse same with a view to commencing the work of the Research Sub-section at an early date.

This recommendation of the sub-committee will come before the General Committee at its next meeting on November 25, and it is hoped that the necessary organisation may be completed to enable the sub-section to commence its activities at the New Year.

The management and operation of the Research Sub-section will be in the hands of a Research Sub-committee, consisting of a maximum of six members, who will handle various problems in an executive capacity, and, where necessary, outline the method to be adopted in working on any particular investigation.

This sub-committee has not, as yet, been appointed, since the responsibility of filling the necessary seats will rest with the General Committee, who will consider the matter very carefully in order that the management of the sub-section will be vested in those who are most suited for the position.

Membership of the Research Sub-section will, of course, be open to all members of the T. & R. Section, and will not entail any additional subscription.

We would, therefore, take this opportunity of asking all those who are desirous of becoming members of the Research Sub-section to make written application to the Research Sub-committee at No. 53, Victoria Street. It is essential that such applications should state:—

- (a) The particular line or lines of investigation in which the member concerned is interested in.
- (b) Any special qualification which the applicant considers will be of importance.
- (c) A brief outline of the equipment available at the applicant's station.
- (d) The approximate amount of time per month which the applicant feels able to devote to the work of the sub-section.

We would especially request all those who wish to join the sub-section to send in their applications at the earliest possible opportunity in order that

the organisation may be proceeded with as soon as possible.

It is felt that a number of applicants will, no doubt, be interested in identical or similar lines of research, and this being the case, it is proposed to form such members into groups for the purpose of co-ordinated work on any one line of investigation.

It cannot be too highly stressed that the work of the sub-section will be carried out for the benefit of ALL members of the T. & R. Section, and, therefore, everyone, irrespective of whether they wish to become members of the sub-section, are asked to send in an indication of the particular problems or lines of investigation which appeals to them in order that the sub-committee may organise the work of the research members in such a way that useful information may, in due course, be available to all members.

It is also proposed from time to time that the work carried out by the Research Sub-section shall form the basis for papers, etc., to be read at the ordinary meetings of the section.

The attention of all members is specially called to the announcement which appears in this issue with respect to the investigation of the height of the Aurora Borealis, in which we have been asked to co-operate with the Royal Society through Professor Chapman, of the Imperial College of Science.

G. L. M.

Determining the Height of the Aurora Borealis.

The T. & R. Section has been approached by Mr. Pollock (5KU), on behalf of Professor Chapman, of the Imperial College of Science, with a view to enlisting the help of our members in investigations which are taking place into the height of the Aurora Borealis.

For such investigations to have the value it is desired, it is important that the observing stations should be located in a high latitude, and therefore should prove of especial interest to those of our members living in Scotland.

This work has been passed to the newly-formed Research Sub-section, and the arrangements will be in the hands of that body.

It need hardly be pointed out that work of this nature is of the utmost importance, not only to the Art of Radio Communication in general, but to all those associated with short-wave operation in particular, and all those who are interested are asked to communicate with the Research Sub-Committee at No. 53, Victoria Street, as soon as possible.

It should be pointed out that the investigations in question will take the form of photographic measurements of the Aurora, and should, therefore, appeal strongly to those who are interested in photography, as well as radio. In this work, radio will probably be of the utmost service in maintaining communication between the observing stations on occasions when synchronised observations are essential.

Whether we are able to co-operate with the Royal Society in this matter will, of course, depend on obtaining sufficient volunteers, and it is to be hoped that the subject will appeal to sufficient members to enable us to proceed.

G. L. M.

An Amateur Radio Station at Sea.

By ERIC MEGAW (6MU).

GX6MU was an experimental short wave station installed during the past summer on board the steamers "Lord Antrim" and "Carrigan Head" in order to investigate Trans-Atlantic radio conditions generally and to find to what extent low power short wave radio was capable of keeping ships at sea in reliable communication with land. The apparatus was installed and operated by GI6MU, and consisted of a Hartley transmitter designed for a power of about 50 watts, and an ordinary two-valve receiver. The circuits are shown in Figs. 1 and 2.

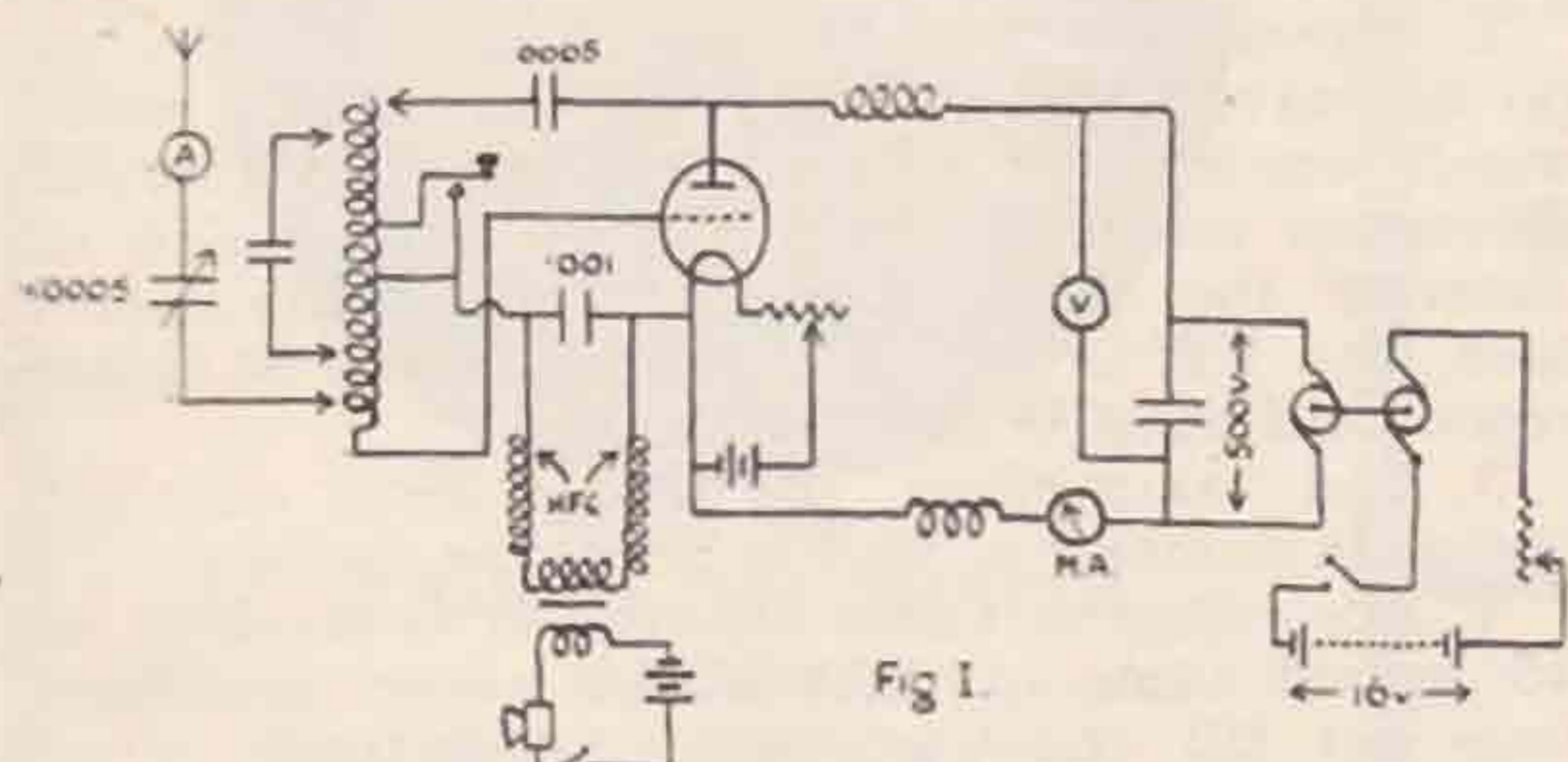

Fig. 1.

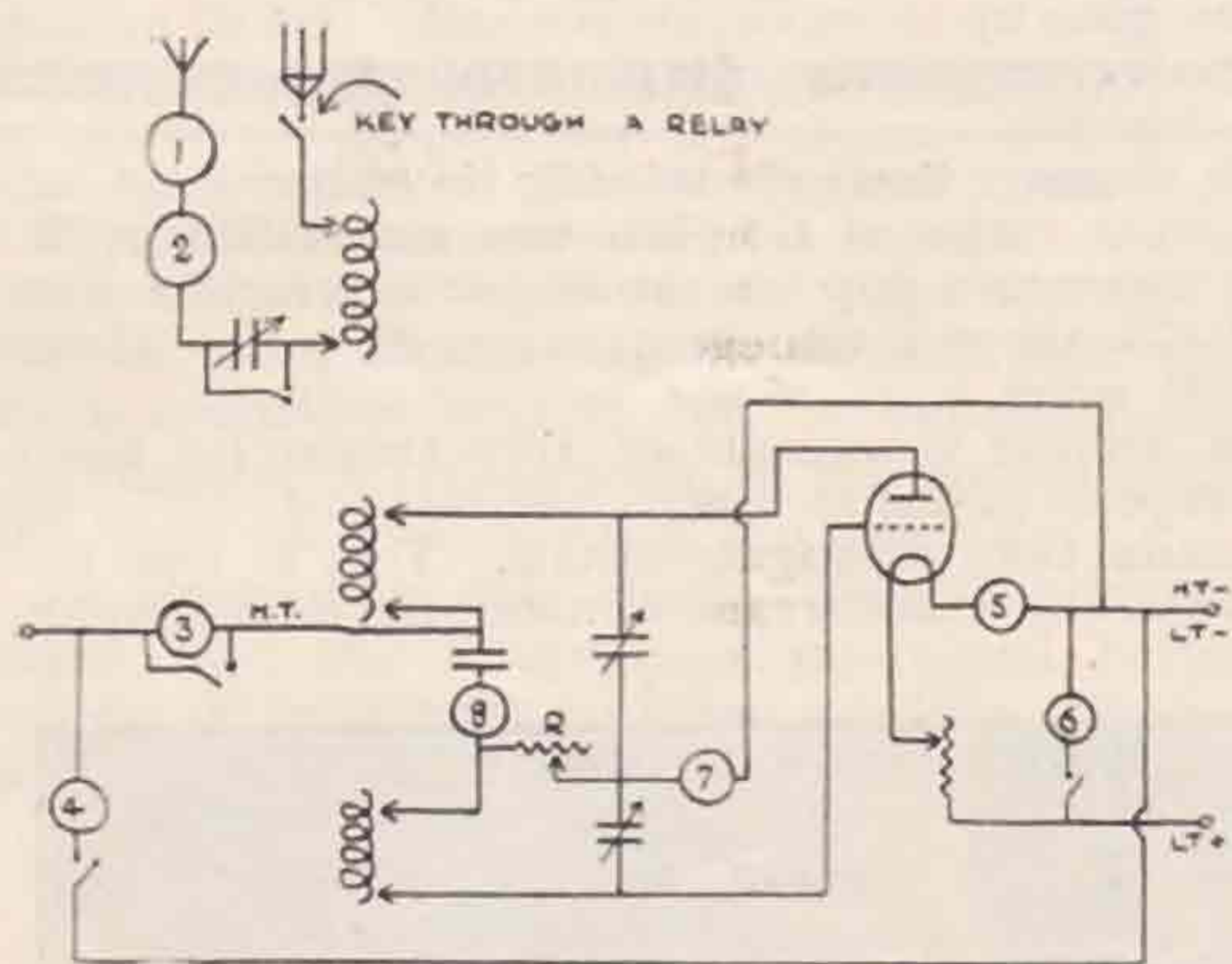

Fig. 2.

The transmitter was a slight modification of the ordinary Hartley. No variable condensers were used (except the aerial series), and tuning was accomplished by varying the tapplings to the coil: a fixed three-plate condenser was tapped across part of the Hartley coil to bring the wavelength up to the required figure. The valve used was a "Fotos" 45-watter, which gave excellent service under very trying conditions. H.T. was obtained from a battery-driven rotary transformer at about 500 volts. For speech work plain grid control was used.

The receiver was copied (with a few alterations) from one designed by U9EK (Burgess Battery Co.), and possesses no unusual features. Mullard P.M. 3 valves were used for both detector and amplifier.

The ship's main aerials were used on both steamers, as preliminary experiments indicated that a separate small aerial would not be satisfactory owing to screening troubles and difficulties in erection in the available space. The aerial on

the "Lord Antrim" was an ordinary twin T about 180 feet long and about 60 feet above the deck; on the "Carrigan Head" the dimensions were roughly the same, but the aerial was of the "slat" type, which might be described as a two-wire cage. Owing to various unforeseen circumstances the set had to be erected in a very short time, and further difficulties were introduced by the "Lord Antrim" sailing from Dublin instead of from Belfast as had been expected. The transport from Belfast to Dublin was effected by sea, on the s.s. "Lord Downshire," which arrived at the latter port on July 1. The next day "GX6MU" was installed in the wireless cabin of the "Lord Antrim" after a perilous journey down the quay on a coal-cart—during which the only spare transmitting valve went west! While in Dublin I visited GW18B and met several other GW's. My best thanks are due to 18B and also to GI5GH and GI5NJ for their assistance in getting GX6MU "on the air" at exceedingly short notice. On the night of July 3 the "Lord Antrim" sailed for Sydney, N.S., and Montreal; that night some preliminary tests were carried out with 18B, and the next day the wiring-up of the set was finished and the tests proper commenced.

Considerable difficulty was experienced with the receiver at first, owing to noises from the ship's dynamo and mechanical vibration: the latter was remedied to some extent, but the "dynamo QRN" made reception difficult throughout the trip. When everything was in order schedules were commenced with 5NJ, 6YW, 18B, CIAM, and later with CIED. The schedules with 5NJ and 6YW were kept up without a single miss the whole way across the Atlantic. 18B was lost about half-way across, but was worked later from near the Canadian coast. CIAM was worked almost every night throughout the trip, though some trouble was caused for a few days by very bad conditions which set in on about July 8. Signals from the U.S.A. were very strong all the time, though no American station was worked till July 10, when contact was established with U2WC. After this several European and American stations were worked each night.

When we reached Sydney, Nova Scotia, both 5NJ and 6YW had to close down, and the schedule was terminated by a very successful two-way phone working between 5NJ and GX6MU at Sydney Harbour. At Sydney a very interesting day was spent with CIED, of Sydney Mines, and in the evening I had the pleasure of working G2GO from CIED's "shack." As the "Lord Antrim" only touched at Sydney to bunker, we sailed for Montreal the same night. Shortly after leaving Nova Scotia we got into a thunderstorm which rendered radio work not only impossible but dangerous for some time.

After this (July 19) GX6MU was off the air until shortly before leaving Montreal. While in Montreal I met a number of C2's, among them the star stations 2BE and 2CG: during my stay I had the pleasure of "pounding the brass" at both these stations. In Toronto, where I spent a few days, I met several more Canadian transmitters, and the kindness and hospitality of all these people was in the true amateur radio spirit. Perhaps a few words about my impressions of radio in Canada would not be out of place here. First, with regard

to the broadcast service. The stations are, of course, owned by different firms who do not receive any percentage of the licence fee (\$1). The quality of the transmissions is excellent in most cases, and the programmes are similar to those of the B.B.C., but perhaps contain fewer talks and more jazz. I was, however, considerably struck by the superiority of the organisation of the B.B.C. over that of most of the stations on the North American continent. The jamming is no worse in Montreal than it is at home. Unfortunately, this does not apply to the amateur wavelengths: the QRM from the American amateurs at a distance of a few hundred miles has to be heard to be believed! Compared with the U.S.A., there seem to be comparatively few transmitters in Canada, and I was surprised to hear that in Montreal the numbers have fallen off considerably since the old days of spark. The Canadians, in the inland districts at all events, do not seem to be favoured with particularly good radio conditions: it is generally quite a feat for any of the 2's, 3's or 4's to work each other, and

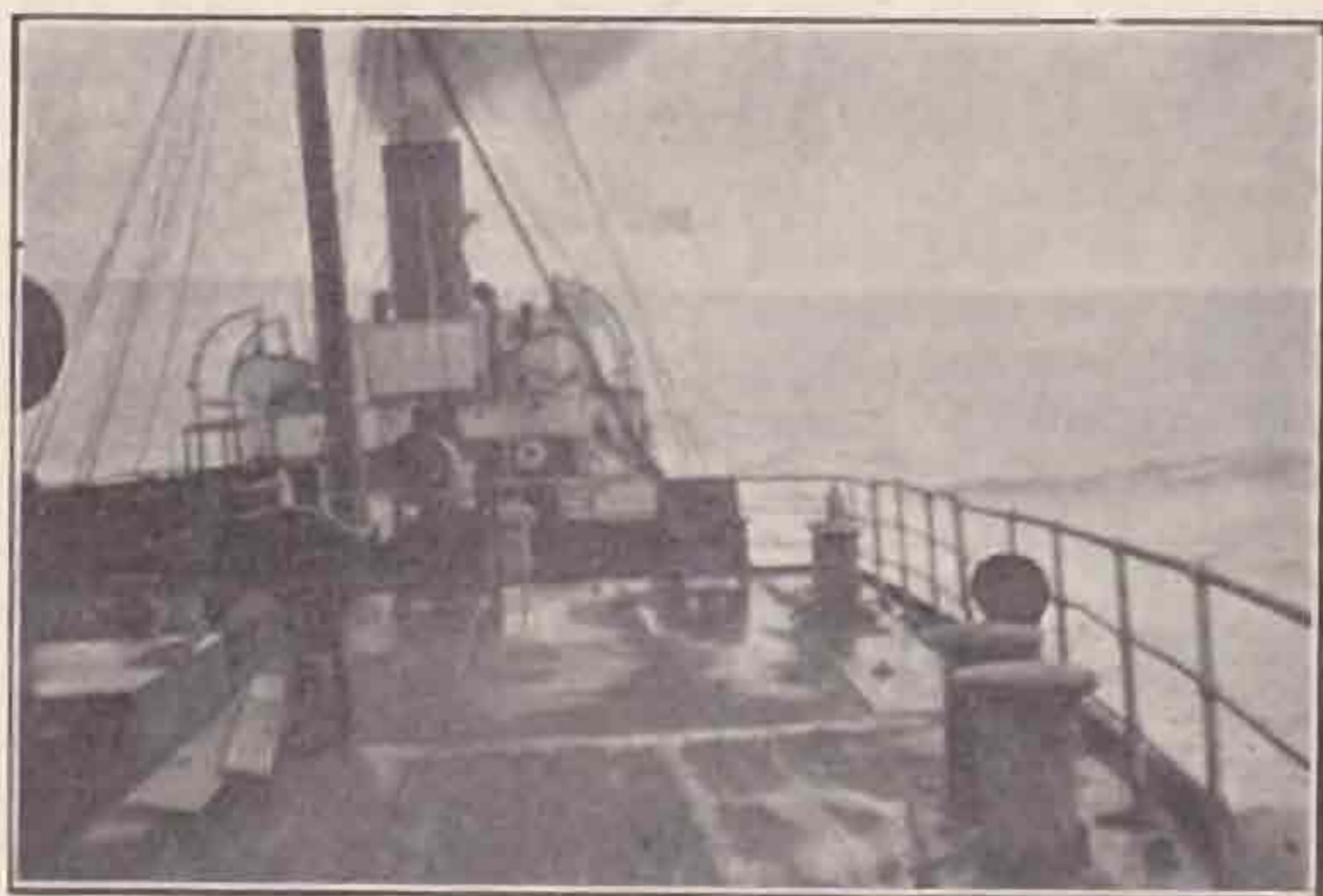

as a rule the DX certainly seems to come in better on this side of the Atlantic. Also, while it is quite easy to work Europe every night from the East Coast, it is quite a different matter from Montreal.

And now to return to GX6MU. On Saturday, August 21, the apparatus was installed on s.s. "Carrigan Head"—the "Lord Antrim" having returned to Belfast in the meantime. No "juice" was available at first for the transmitter, but a number of European stations were heard in Montreal Harbour—in spite of bad screening by one of the world's biggest grain elevators! On the following Tuesday (August 24) we left Montreal, and the schedules with 6YW and 5NJ were taken up again before we were out of the St. Lawrence Gulf. G2NH was the first European worked on the return journey, but several stations have since reported hearing GX6MU before we left Montreal, though the input then was only about 20 watts. During most of the homeward trip it was about 30 watts: on the "Lord Antrim" it was rather less, about 20 to 25. The small powers used were due to trouble with the H.T. system, which was fixed up at the last moment because a 110-volt motor could not be procured. The batteries for the generator were kindly lent by Messrs. J. B. Ferguson, of Belfast.

The GI schedules again proved entirely successful, and communication was maintained every night with Canada and U.S.A.

Conditions seemed exceptionally good when we were in the ice region round Belle Isle, several Europeans reporting R8 at this time. On Sunday, September 25, the Irish coast was sighted and many G stations were worked on phone. The same night the "Carrigan Head" anchored in Belfast Lough, and GX6MU, after working several Americans, closed down for the last time.

As I have been very QRW since my return I have had little or no time for working out results from the data obtained during the trip, but a few of the outstanding observations are:—

1. That short wave radio is capable of keeping a ship in any part of the North Atlantic in reliable communication with both sides of the ocean even under bad conditions, excepting only in a local thunderstorm, which would render all radio apparatus practically useless.

2. Signals on the 30-50 metre band (and possibly on all waves) travel better eastwards than westwards across the Atlantic: even the powerful European amateurs do not seem to come in in America the way American stations are heard here, and FW is certainly weaker in the St. Lawrence Gulf than WIZ is in Belfast.

3. The "skip effect" on near stations at night occurs in summer as well as winter in Canada.

4. According to C2CG (Montreal) G stations on 45 metres come in there about sunset and then fade out till about midnight (local time), when they come up to maximum strength. On 80 metres signals come in soon after dark and remain constant in strength.

5. During the outward trip in early July the daylight range of GX6MU was about 500 miles. On the return trip late in August a schedule with UICZ showed the daylight range to be about 1,000 miles.

6. During the period of July-August (at least) European 32-metre signals are received better in Canada than 45-metre signals. This is also the case on the Atlantic west of about the 30° meridian.

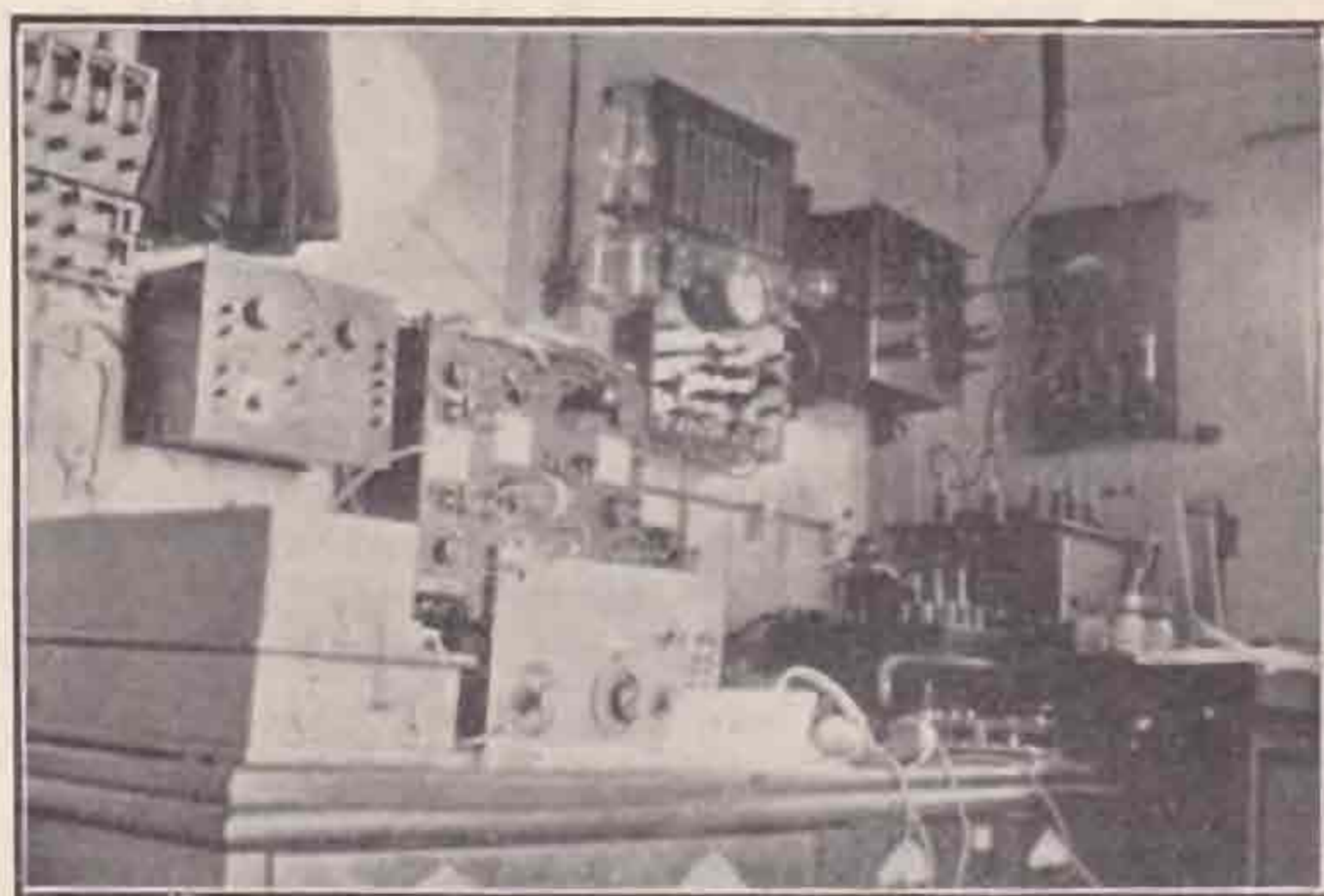

I should welcome any suggestions or comments with regard to these observations, also any reports from those who heard GX6MU at *any* time during the trip—and it is information rather than wallpaper that is wanted!

In conclusion, I should like to express my gratitude to all those who contributed to the success of the trip, and especially to the directors and officers of the Ulster Steamship Co., Ltd., through whose kindness the experiments were made possible.

GET THAT "BULLETIN FEELING"

WESTON Filament Voltmeter

for Receiving Sets

MODEL 301.

Simplifies tuning by eliminating guesswork as to valve adjustments.

Filament voltage control increases the life of the valve from two to three times.

The Western Filament Voltmeter is accurate and can be relied upon for duplication of results.

ALL THIS MEANS BETTER RECEPTION!

Weston Electrical Instrument Co., Ltd.
15, Great Saffron Hill, E.C.1

Telephone:
Holborn 2029.

Telegrams:
"Pivoted, Smith, London."

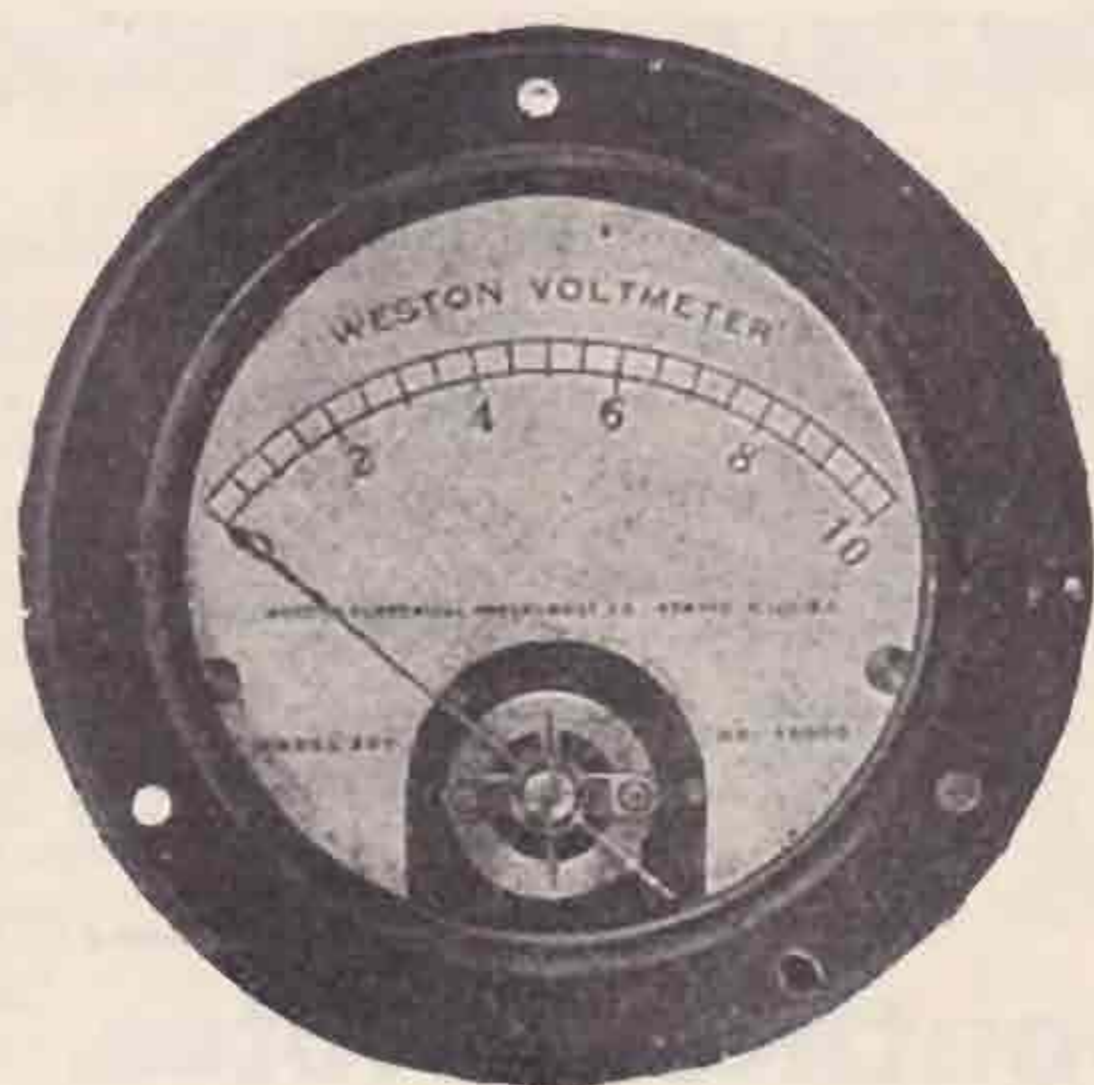

Model 301
FILAMENT VOLTMETER

LIST PRICE

£2 : 9 : 0

The Application of Quartz Crystal Control to Transmitters—continued from page 11.

great advantage of the twin wire system is that by using R.F. ammeters in each feed wire the transmission system may be balanced, and the amount of radiation from the transmission line then becomes a negligible quantity.

In concluding this short article the writer hopes that the information contained herein will be of assistance to other workers engaged in this fascinating branch of radio research.

THE LAMENT OF BRS19.

I've built a two-tube short-wave set,
(I can't afford a superhet)
But the only station I can get,
IS WIZ.

There are OMS famous, short and tall,
Some work from Winter to the Fall,
Who's most consistent of them all?
'TIS WIZ!

What station's this across the sea,
Who works from four o'clock till three?
Who's always calling ABC?
'TIS WIZ!

OMS you've heard them East and West,
But what's the station I detest?
Oh, pray each night 'twill have a rest,
THIS WIZ.

Convention Photographs.

Many enquiries have been received as to the availability of these. They may be obtained from Messrs. Barratts Photo Press, Ltd., 89, Fleet Street, E.C.4, price 4s. 6d. mounted, size about 14" x 4". Photo A (Daylight) is recommended.

Radio Riffs.

The eloquent salesman with a pan full of optimistic exuberance who attempted to sell to a well-known London ham a piece of —ite crystal with the assurance of it being just as good as quartz is still sick, very sick.

"Over to you, old man." The recent prosecution resulting in a fine of £10, £5 costs, and confiscation of gear should be a salutary warning to those illicit transmitters in London district, Essex and other parts.

SEVERAL WATTS ? ? ? ? ?

Was it four ex that said two quarts make one crystal?

Do U.S. ever listen for QRP G sigs. on 45 metres?

Has 5SO any QSL cards?

Will 2WE join up?

Is 5WV a singer?

Where are all the A's and Zedders? Several BO's recently have resulted in nix.

Have you heard 2QN's hungry sea lions or the real jumbo speech from 5TZ on 44.6?

What we all know. Good DX like invention is 99 per cent. hard work and 1 per cent. luck.

On two occasions recently the five minutes' time signal from PKX Malabang P.I. has been picked up around 39 metres. He signs off 2239 GMT.

2TO since working darkest Africa has fired his transformer and thinks of trying a new iodyne circuit. What's the matter with aspirin?

ETHERCOMBER.

Traffic Notes.

London Area.

Rule 4 (b) of our Constitution provides:—
At each Annual General Meeting existing members of the Committee, other than Area Representatives or co-opted members, shall be eligible for re-election without nomination.

Rule 4 (a) provides that invitations for nominations of members to serve upon the Committee shall be sent out by the Honorary Secretary, 14 days prior to the meeting.

See that you nominate your candidate while you have the opportunity.

Danish Notes.

By E. POULSEN (D7MT).

We have done very little DX work here during the last month, as a number of our Hams have to QRT for the winter, but we hope it will be a good season with world-wide DX for us all.

7BJ now works with 20 watts DC, but will soon be on the air with 100 watts crystal controlled, and 10 watts ditto. F.B. First CC here!

7BX QST the World de D-7BX! He regrets he has had to close down for the winter. He is QRW with examinations. He hopes to open up next fall with a new transmitter. He hopes, meanwhile, to occasionally work from the other D stations. He thanks all G hams for their kind co-operation in the past.

7BZ is now on the air again after a long holiday.

7CH, although married this summer, still finds time to work with a 15 watts DC transmitter. He will work later on with 100 watts AC and 120 watts DC. The call of this station was 7AH.

7EW is QRT through the same reason as 7BX. He will work occasionally from 7MT.

7FP.—A new transmitter just started.

7JO (Faroe Islands) has not reported. I see from the "BULL." that G5TZ has worked him.

7JS (our QSL member) occasionally works hams with fine high-speed morse. Ask G6QB about it!

7ZG is QSO all Europe, and now has increased his power to 100 watts. He is reported as RAC, but here in Copenhagen it is a good ICW! Hi!

7LO.—A new transmitter, who has worked several Europeans on low power.

7MT has done no DX work since QSO with BZ11B on five watts. He works without a grid condenser and leak, and would be glad to hear, via the "BULL.," if any other readers do this. He is rebuilding to use 20-30 watts. DC, and hopes, then, to cover the world. Hi!

7NI.—Another new transmitter in touch with all Europe.

7XF.—QSO all Europe, and assists 7FP.

7XU has returned from his summer QRA, where he was QSO U.S.A. with 80 watts A.C.

7ZM has now a special licence for 250 watts and all wave-lengths. He is QRV for QSO's on Sundays.

DNSC is a new Danish Commercial Station situated on the coast in Copenhagen. Power: 1 kilowatt.

We all enjoy the BULLETIN here in Denmark!

Will all D's please report to me by the first of each month.

D7MT.

Southern Notes.

Prepared by G-2LZ.

5WV reports working four American stations on 5 watts during the QRP tests. He has now worked the 1st, 2nd, 3rd and 8th U.S.A. districts, using a Newton alternator driven by a treadle.

5KU, worked a 1st and 2nd district U.S.A. station during the tests on 5 watts. He reports good results on 23 metres, and gets R9 at 1,000 to 1,500 miles distance. On 8 metres a schedule has been kept with 6CP, but so far has resulted in failure. 5KU would like to get in touch with anyone experimenting on 8 metres.

6CL has added a further 79 QSO's to his log, bringing the total up to 290 in five months. Power, 5 watts. Good reports are obtained from all over Europe. Also two reports of reception have been received from Russia. 6CL offers to assist in collecting reports from the North London area. Will stations in this area please note.

2CB (Putney) is now operating on 5 watts input and hopes to work many stations he has been in touch with when using the call 2BJK.

5UP using a power of 4.8 watts was QSO with four U.S.A. stations during the tests. All Europe was worked on a power of 4 watts.

6PU is experimenting with crystal control on 90 metres. His best DX has been with 3rd district U.S.A. for the first time.

6HZ has now managed to get a pure D.C. note and has been QSO with Portugal, Poland, Latvia and Italy. These are all new countries for him.

2ZC says nothing to report as he is building a new transmitter.

5OK reports working 2MN of Liverpool on 150 metres when using power of 5 watts.

Irish Notes.

By 5NJ.

As there are only about three transmitters—2IT, 5NJ and 6MU—in the whole of Ireland who may be considered as "high power" men, it was only to be expected that the gang here

would take a lively interest in the recent QRP tests, and from the results already to hand, Irish amateurs appear to have easily retained their position in the forefront of low power transmitters. With the exception of a report from GW19B, I have heard nothing about the results obtained by the Free State men, so that this month I shall only be able to deal with the GI stations.

6YW, using 5 watts, worked four Yanks, including the 2nd and 3rd districts, the lowest QRP being R4, in one night, and also C2AX. U3LW told him that he was the best G station heard that night. He also worked Morocco and a host of Europeans, and was heard and called by PR4SA, being very unlucky not to receive this call. Outside QRP test hours, he added Czecho-Slovakia to his list of countries worked on under 10 watts, thus bringing the number of countries worked up to 25. This is excellent work, as 6YW was suffering from an attack of "flu" right through the tests, besides having his aerial carried away twice.

6MU worked, on under 5 watts, no less than five Yanks, including the 1st, 3rd and 8th districts. Outside QRP hours, but using 4.3 watts, he also worked Czecho-Slovakia, Finland, and LA1A, as well as sundry other Europeans, and was reported R6 in East Prussia when his input was 1.3 watts. This is surely fine work also, and shows that 6MU is as familiar with 5 watts as with 40.

5WD, a comparatively new station "on the air," using 4 watts, was QSO practically the whole of Europe in the QRP tests, and was also successful in working U.S.A. He intends putting up a new aerial shortly, and hopes to work more U's in due course.

5MO, another new transmitter, using 4.8 watts, worked UIAYL, who reported him R7. His present power is derived from dry batteries, but he hopes to install a hand generator very shortly. He was also, during QRP week, QSO sundry Europeans.

6SQ was unfortunately laid up for the greater part of the QRP week, but outside of this he had had some good results. D7ZG was worked in daylight on half a watt, also many English and Scotch stations, amongst whom were 6KO, 6YR, 6UV, and 6WS.

5NJ had not time to enter for the QRP tests, and can only get on the air now on Sundays. Very consistent results are, however, being obtained. On 75 watts, four continents were worked recently in two hours. QSO has been had with Johannesburg (A5X), two Australians (A4RB and A2YI), PIIBD on several occasions, and BXY in China and SK2 (Borneo). The latter two are first two-way QSO's from Ireland. All this took place between 18.00 and 20.00 on Sundays.

The following stations did not report:—2IT, 6TB, 6YM, 6QD, 6HI, 2WK, 5GH, and 6WG. Even if you have no DX, a card by the 10th will be much appreciated.

In the Free State, the only report to hand is from 19B, who states that the QRP tests were a "wash out" with him on account of the power supply being cut off at midnight. But his results included QSO's on 3.8 watts with KCZ1, D7ZG, U2CVJ, and G6WS. 2CVJ was worked quite easily for 25 minutes, when the power was cut off. There seems little doubt that 19B would have had a splendid list of DX worked if he had been able to work after midnight.

Mid-Britain Notes.

Prepared by 6JV.

JUDGING from reports to hand (and from personal experience) it would seem that October has been a somewhat disappointing month. Conditions have been generally poor, and this seemed almost to have culminated during QRP week. Anyway, better luck next time, and meanwhile this is what the sub-areas have to report:

Shropshire (via 5SI).

6TD reports a few QSO's with the States. He says that in justice to the 0/150 (see last month's BULLETIN) it had lived through two hard years. He is now using 75 watts on a 250-watter, which is clearly not overloading!

5SI has nothing except two QSO's with Australia to report. Considering that in neither case did the input exceed 12 watts this seems nearly good enough, however.

Cambridge (via 2XV).

2DB started the month by dropping his 0/20 Mullard and had to revert to a B4, on which he has done good work under poor conditions. He has worked Italy, Spain, Austria and Faroe Islands on less than 2 watts, also two 1st District U.S.A. stations on 10 watts, being reported R7 in each case.

5YK is weary of the bad conditions existing, and is making a few special tests meanwhile.

2XV has nothing startling to report, but adds that this is due not to lack of enthusiasm but rather to poor conditions once more. He has worked three U.S.A. stations, also H.M.S. "Fylgia" (SBM), on 32 metres.

Northampton.

In accordance with last month's notes, I am pleased to give the name and QRA of a new sub-area organiser for this county. Please report in future to:—

P. H. B. Trasler (BRS30),
37, York Road,
Northampton.

Warwick (via 2BPI).

BRS29 (Birmingham) reports logging an increasing number of BZ stations and also Q8KP. He sends the following news:—

A7HL is temporarily in Sydney and working with the call A2HL. He will welcome reports. His QRA is 3, Kahibah Road, Mosman, Sydney.

U4LI has made many attempts to attract the attention of G2OD, but so far without any luck.

U7WU is working every Sunday at 04.30 GMT, and will appreciate reports and QSO's from G's.

U9CTG (Mohawk) wishes to inform G2KF and G6TD that their sigs are FB.

BRS3 reports satisfactory receiving conditions and forwards a good log. He reports hearing Fi 1B on 24 metres.

6JL (Coventry) also reports favourable receiving. 2BMW is working at remote control experiments. 6YU and 2BLM only report QRW (no, not from YL's).

2BPI thinks conditions are now improving.

Worcester.

Bravo! At last we have a sub-area office here. Please report to:—

F. Aughtil (G6AT),
28, Terry Street,
Dudley.

6AT reports that he has not done very much

DX lately owing to QRW, but hopes to be active again shortly. He works mostly on 45 metres and 150 metres for local fone.

Stafford (via 5UW).

Reports are not as numerous as they ought to be, but all to hand agree that conditions are very inconsistent.

6UZ has been experimenting with a crystal and reports that "it doesn't seem to work right yet." He has worked 1st, 2nd and 3rd Districts U.S.A. and 1st District Canada, also Africa, but could not connect with BZ.

6OH reports little doing but worked TPAW during QRP tests, using two watts only.

Wolverhampton.

2WN reports that he is still punching nails instead of the key. The new hut is not quite complete, but he hopes to be on the air again in about a fortnight.

2OQ has been very QRW. He worked U.S.A. first test of the new shack, but reports thoroughly bad conditions generally.

6HT has a crystal that does oscillate sometimes. He has been QSO Europe.

5PR is helping 6HT and hopes to be on the air shortly at a new QRA.

5UW has been experimenting with his Hertz. He has QSO'd the States and has been reported R4 in Australia. 5DA from Berwick has paid a visit to 5UW and 2OQ.

6PB is still working on 150 metres.

Reports from all Staffs. men by 7th of month, please.

Norfolk.

6ZJ has blown his rectifying valve and is reduced to 2 watts.

5UF is on the air on 160 metres with 8 watts. He would like to arrange tests.

6JV has done nothing startling. He has worked 3rd District U.S.A. on 20 watts during one of the few favourable nights. He is building rectifiers for H.T. and L.T. accumulators charging on the premises, since the weight of the batteries for the new 150 watter makes this course preferable to transporting them for charging. He hopes to be on the air with 100 watts on 32 metres by the end of November, when he purposes to continue his tests with Antenna systems.

Errata in November BULLETIN:—

Warwick—For 2BUN read 2BUL.

„ 6JN „ 6JL.

Scottish Area Notes.

THIS month I am going to commence with a "grouse." I hate to complain, but when only nine transmitting stations report out of a possible 30, I think you will admit that some comment on the matter is called for.

October was not a bad month from a DX point of view, and I heard quite a considerable number of "G.C." stations working on long range during the month. Of course I know you are all very QRW, but surely five minutes once per month is not too much to ask from you. I would remind you that these notes are not purely a chronicle of DX, and if you have no DX to report, possibly you have a story of some gadget tried out, new circuit tested, or in fact anything which may be of interest to your fellow "hams," and give indication of the fact that your enthusiasm has not flagged. The

"gift o' the gab" is mine I know, but it is simply beyond my powers to manufacture reports for thirty stations out of "sri OM hve nothing to report this month," or worse still, SILENCE.

For the first time since its formation, No. 4 District has failed to yield a single report.

I do not wish to write any more on this subject, OMS, so please take my remarks to heart, and make the Scottish Area a thing of life and vim.

I have to welcome a new transmitter to No. 1 District in the person of Mr. Alan Wilson, 2WL, 206, Newlands Road, Cathcart, Glasgow. Mr. Wilson, though a new licensee, has been acting for many months as assistant Op. at 5YG, and I expect great things from him once he gets going properly. He has joined the T. & R. Section, and will shortly take over No. 1 District in the capacity of Area Sub-Editor, but of this more anon.

I have pleasure in recording a flying visit received from 5JK, and hope that he will be able to spend more time with me on the occasion of his next visit to Glasgow.

6IZ has now assumed the duties of Area Sub-Editor of No. 2 District, vice 5JD, and has been in touch with his district during the month.

No. 4 District stands without a leader owing to the departure of 5DA. Any volunteer?

Considerable trouble was experienced in Scotland during the few nights in October when the Northern Lights (Aurora) were strongly in evidence. On one night at least the effect produced was the complete damping out of all signals, including our "friend the enemy"—WIZ. Another night the product of the Aurora was violent QRN. Observations were made by 2WL on this particular night, and it was found that each "flicker" corresponded with a violent "crash" in the receiver.

5YG.

No. 1 District (by 5YG).

2FV has not been on the air at all during the month, but has been carrying out a great deal of experimental work with relation to short-wave receiving gear. He hopes to be more active from a transmitting point of view in November.

2WL, although commencing to transmit only during the last few days of the month, had quite remarkable success in spite of the fact that he started off with the "hookiest" of "hook-ups." He has been using 180 volts dry batts. to the plate of a DE5, and by using a master oscillator, succeeded in getting a beautifully steady sig. Considering the fact that he is only using 2 watts maximum, his transmitter must be really efficient, as he has received uniform R6 reports from practically all over Britain and the near Continent, this up to 23.00 GMT, which is remarkable in itself. He has obtained an E. & V. generator and hopes shortly to apply it to the anode of a T.50, still retaining his tuned plate and grid xmitter with master oscillator drive.

5YG in the matter of DX has not very much to shout about. Being thoroughly fed up with rectified 25 cycle A.C., the A.C. gear was scrapped at the end of the month, and a little work done with power from dry batts. The only QSO's worth mentioning were first with an "F" station, and with SFV. The first was carried out with an input of 1 watt and the sigs reported R3. The second took place while SFV was off Southampton outward bound to RIO, the input on this occasion being 2 watts. Sigs were reported R7. Both of these QSO's were carried out about mid-day. The

station will be QRT during November for rebuilding. A generator and T50 have been purchased and will be used in conjunction with a master oscillator drive.

6NX has again been very active. He has been QSO for the second time with C8RG, and on this occasion carried out the QSO without QSS. He has also "bagged" his first Yank—1ADM. In both cases sigs were reported R3-4 and the input approximated 8 watts. The station was QRT during the last week of the month owing to rebuilding. The pure D.C. QSB is threatened with temporary extinction, as the D.C. supply presently in use is shortly to be converted to 25 cycle A.C. (You have my sympathy OM—5YG.)

The following stations did not report:—

2MG, 2TT, 5YQ, and 6OW.

No. 2 District (by 6IZ).

2JZ still reports heavy business QRM, but hopes that circumstances will permit him to resume transmitting at an early date.

2VX.—The new QRA of this station is 35, Anderson Avenue, Woodside, Aberdeen (6BT please note). The station has been QRT owing to business QRM, and circumstances attendant on the change of QRA, but Mr. Clark hopes to make a start very shortly.

5JK is off to sea again for an indefinite period.

6IZ continues to work the usual Continental stations and was recently QSO with B4AA whom he visited while on holiday. 4AA informed him that he (4AA) had been QSO U.S.A. at 20.00 GMT. Mr. Ingram's best DX for the month was a QSO with TJCRG. (Arabia). The Arabian station reported sigs R4-5, and stated that he was working through a terrific electric storm. This is the first recorded "GC" QSO with "TJ." The power used at 6IZ during this QSO was exactly 10 watts. Experiments are being made with a "break-in," but a certain amount of trouble is arising from the hum of the mains and the transmitter. The station is now licensed for 50 watts, and a motor generator is sought for preference 1,000 volts 60 M/A, and 6IZ will be glad to hear from anyone who desires to dispose of such a machine. The input would be 220 volts D.C.

6VO has added Portugal to his list of countries worked, having been QSO with PIAE. He has also received a report on his sigs from Algiers. Power is derived from Ever-Ready H.T. accumulators, and the valve in use is the ubiquitous DE5. A master oscillator is frequently in use, also the orthodox R.F.B., but Mr. Simpson finds that the MO gives a steadier wave, no matter how low the input.

The following station did not report:—6GQ.

Concluded on page 24.

Northern Notes.

Prepared by 2DR.

SO far as I can make out, several of the Northerners have found the QRP Tests too much for them, for I have had no reports from Lancashire this month. Perhaps my "Call to Arms" paragraph last month did not meet their eye? So far as I can gather, the palm is held by Ireland, particularly the Northern Section, who seem to have found working U.S.A. on five watts quite an easy matter given a reasonable night on

which to do it. I think we shall have to have a handicapper next year for these "go getters." Certainly their geographical position is very favourable, but that does not altogether detract from the very fine show they put up.

Personally I found conditions extremely bad until November 6, and up to that date only logged three U's, but on November 6 and 7 I brought the total up to 52 with quite a short time spent at the receiver. These conditions seem to have been pretty general, and many hams got fearfully disgusted by about half-way through the week.

There is no doubt the Tests were a success, although I have had one or two grumbles, notably from Cheshire, that hams there had no official notification or official logs sent to them. There has been some hectic correspondence on this subject as to where reports had to be sent. While there seem to be good grounds for complaint, I think, next year, the organisers will have got more used to the job, and I hope the same thing will not happen a second time.

Another "grouse" I have had made to me is the fact that it takes about three weeks to get a reply to a letter sent to Headquarters. This is a matter for the Committee hams, and I will have it placed on the agenda for the next meeting.

Now for the reports, although they are terribly scarce again this month.

Yorkshire.

(Send Reports to 2DR.)

5KZ has been using a quarter-wave Hertz after having a practical demonstration of its powers at 2DR, and has found it fairly satisfactory for QRP work. During the Tests he worked Europeans only, but since using the Hertz he has had an average of R5 reports from 25 QSO's. He had rather rough luck in the Tests, but has done good work on 4.8 watts. He reports dud conditions on most nights until November 6.

6YR, who is our star performer on QRP, also failed to get across the "pond," and confined his actual contacts to Europe, although he is awaiting a confirmation from U-IAAO, who was reported to have been calling 6YR after a test call. I hope this report is confirmed OM. 6YR had the bad luck to fall ill, and was laid up for several nights during the tests. 6TY has worked 28 new stations this month, using 5 watts. Here the Hertz has been tried, but has gone out of favour in place of a twin inverted L. (6TY suffers from lack of span, hence the twin.) He reports good results with this aerial operated at the third harmonic. During the Tests Europe was worked on several occasions, but business QRM has rather spoiled 6TY's chances. Hard luck, OM. 6HF was prevented from partaking in the Tests owing to lack of the necessary D.C. supply, as his power plant is a one-man generator. Both voltage and current-fed Hertz aeriels have been in use here, but the current-fed gave the best results, getting R7 to R8 reports at ranges of well over 1,000 miles, the input being a very modest 8 watts. Using this power 6HF also worked U-IASU and got R3. Keep it up, OM.

5SZ is now settled down at his new QRA, and expects to have his shack up this next week, while two 40-ft. masts are already in position. I am expecting to have a report from him next month. He is so disgusted at being accused by the powers-that-be of working off his wave, when all the spring

and summer his station has been entirely closed, that he has requested the P.M.G. to cancel his 440-metre licence altogether. There is no doubt that there is far too little care displayed by some hams on 440 metres, not only working off their wave, but there is also too much "Over to you, OM," at the end of a transmission, instead of a correct sign-off. I can foresee a heap of trouble coming on this waveband very shortly.

2DR is still suffering from lack of sleep after the QRP Tests. His chief trouble was how to keep warm with the shack thermometer at zero, or below. Rumour has it there is a fine collection of electric radiators here!! Good work was done out of QRP hours with Europe, but during the Tests Spain represented the furthest European station worked. After much brass pounding on the night of November 6-7, U-1CVJ was induced to reply to a test call, and reported sigs. R5. The input was of course 5 watts. This was the only bright spot in the Tests, but it was worth sitting up to hear U's calling G's, and yet not be able to hear the G's replying!! Such is 45 metres!! The following have not reported: 2XY, 6IG.

Durham, Northumberland, Cumberland, and Westmorland.

WANTED.—A REAL HOT WIRE to get in reports from this area. Will hams holding the necessary qualifications please apply to me? Now, no rushing, you fellows!!

Lancashire.

(Reports to 5XY.)

5JW is the sole representative of Lancashire this month. I think 5XY must have gone west. I hope the Mortley has not burned him up, because they really can give one a hefty kick when they feel annoyed with one.

5JW has been busy removing of late, but hopes to get going this month. Please note his new QRA:—Mr. P. Cox, "Sonoma," Sandhurst Avenue, Withington, Manchester. Just before he closed down for the change he had a fine QSO with Argentine on 4 watts. Hope to hear more of you next month, OM.

Cheshire.

(Reports to 6TW.)

6TW has built a new transmitter using tuned grid and plate coils, but without magnetic coupling between these two circuits. He does not say how this perks, but perhaps we shall hear anon. This gentleman seems to have some roaring good gales around his abode, for two masts, one wood and one steel, have been demolished at this station within a month. A 52-footer has now been put up (steel), but wider guying used. Say, OM, I have had a 50-ft. up here for many weeks, and we get some wind, too, and it has been absolutely steady. It is made by Spring Washers, Ltd., Alexandra Street, Wolverhampton. The guying space required for this one is 15 ft. radius only, and it is ridiculously easy to put up on account of its telescopic features. I am telling you this in case your last goes before I hear from you again!!!

2SO has been busy with the QRP tests, and has done some very good European work, including Italy and Spain. At the time of writing, he has not been heard over the "pond," but judging from his work, I should think he is likely to have got over. It is certainly not for lack of trying, I am sure.

Lincolnshire, Derbyshire and Nottinghamshire.

WANTED.—ANOTHER REAL HOT WIRE!! Please see above, OM's.

Isle of Man.

(Reports to 5XY.)

No reports this month. Hi! OM's.

Scottish Area Notes, No. 3 District—concluded from page 23.

5NW has received his 1KW licence, and is looking about for a 1KW generator. Meanwhile, business permitting, he is transmitting at irregular periods with an input power 100 to 200 watts derived from two generators running in parallel. He has been experimenting with aerial systems and finds, as far as his station is concerned, that a large 6-wire cage worked on one of its harmonics is responsible for much better sigs. than a short, almost vertical wire worked near the fundamental. All reports received so far indicate R8-9 and much is expected when the Station QRO's to 1KW.

6KO was laid up during the latter part of the month. (nw QSA I hope om—5YG.) Great work has been done with what he calls "an aggravated hertz." From the circuit diagram this would appear to be an orthodox "Hertz" with a 70 ft. counterpoise "tacked on" to the end of the pick-up coil remote from the "feeder." The "feeder" joins the aerial about 5 ft. from the lamp, and the lamp is found to glow with a 5-watt input, but no current is evident in either "feeder" or "counterpoise" until the input reaches 12 watts. Tests have shown this arrangement to be far superior to the inverted "L," at least as far as work up to 1,000 miles is concerned. A report, however, has been received from Victoria, Australia, giving "R3-4 and steady." The input on the occasion inspiring the report was 10 watts and the aerial an inverted "L" worked on its 2nd harmonic, which would appear to show that this type of aerial is quite a sound proposition as far as real DX is concerned.

The following stations did not report:—
2BB, 2SR, 5WT, 6GY.

No. 4 District.

(No Reports.)

The R.O.T.A.B. Challenge Cup.

This cup will be presented to Mr. C. W. Goyder (2SZ) at the Annual General Meeting on December 17 (Institute of Electrical Engineers, at 5.30 p.m.). His pioneer work on crystal control well merits his holding the cup which has been through the hands of many distinguished British amateurs.

December Meetings.

December 17th, Annual General Meeting.

Friday, December 17, at the Institute of Electrical Engineers, Savoy Place, Thames Embankment, S.W.1. Annual General Meeting at six o'clock. *All members are warned to be present on this occasion as matters which concern the whole future of the movement will be discussed and certain decisions will be arrived at.*

Friday, December 31. A meeting preceded by tea at 6 p.m.

QRA and QSL Section.

WE wish to draw members' attention to the list of "QSL's Waiting" hereunder.

Although this is gradually diminishing, it is still much too large!

Will you not help us to reduce it? If you see calls of transmitters you know, will you not drop them a card about it?

We are pleased to be able to announce that our old friend, Major Borrett (CIDD), whose name is so familiar to all T. & R. members, has kindly consented to forward cards to Canadian Hams.

He specially requests that all cards are sent to him, should the postal QRA not be known, as CARDS, and not under cover of envelopes, as the forwarding of envelopes entails further postage.

Please, therefore, add the following to the list of forwarding agents already published:—

CANADA—c/o CIDD,
Major W. C. Borrett,
14, Sinclair Street,
Dartmouth, Nova Scotia.

We have a card here from HIK, with no call sign! Who claims it?

At the time of writing this report, quite a number of QRP report cards are still unclaimed. Have you stamped addressed envelopes at this Section?

SS2SE (R. E. Earle, member T. & R.).—All cards for this station should be forwarded to the QRA and QSL Section, Box 1.

QSL's WAITING.

The following have not less than three cards each waiting to be claimed.

Will they please forward stamped addressed envelopes to this Section for them:—

2AFD	2KF	5DS	6KK
2BDY	2LF	5GF	6PA
2BK	2OG	5HA	6QH
2BMO	2OJ	5HG	6RM
2BNR	2PP	5IR	6TD
2BOW	2RL	5LI	6TM
2BZ	2UD	5LS	6TV
2CA	2VG	5LX	6US
2CH	2VL	5MF	6WS
2DA	2VQ	5MU	6YQ
2DF	2VS	5OK	6YV
2DX	2WW	5RU	6YX
2DY	2WY	5RZ	6ZC
2FM	2ZA	5SO	BRS6
2FO	2ZF	5UQ	BRS9
2GV	5BV	6CI	GW15B
2HQ	5CZ	6DO	GW18B
2IT	5DH	6FA	GW14C
2JX	5DK	6JU	

Mr. Abbott, of Balham.
Mr. Baskerville, of Altrincham.
Mr. Bennett, of Croydon.
Mr. Haddock, of Forest Gate.
Mr. Harwood, of Hale.
Mr. Hooke, of Balham.
Mr. James, of Walthamstow.
Mr. Lewis, of Pucklechurch.
Mr. Lyon, of Aberystwyth.
Mr. Page, of Manchester.
Mr. Phillips, of Landore.
Mr. Picken, of Battersea.
Mr. Pither, of Thornton Heath.
Mr. Pritchard, of Cefn.

Mr. Scarr, of Rotherham.
Mr. Scott, of Rathgar.
Mr. Smith, of Hackbridge.
Mr. Smith, of Northampton.
Mr. Spafford, of Warsop Vale.
Mr. Spalding, of Chelmsford.

QRA's FOUND.

CS2UN.—Mr. Moravic, c/o Radiowelt, Wien III, Rudengasse II, Austria.

HIK.—F. Chapman, c/o The Barahona Co., Barahona, Dominican Republic, W.I.

LAB.—Military Radio Laboratory, Utrecht, Holland (Inf. G6CL).

SPM.—Major B. Petrelius (S2NBC), Puolustusministeriön Radiolaboratorio, Albertink 40, Helsinki, Suomi, Finland.

QRA's.

2AUX.—C. S. Bradley, 10, Montenotte Road, London, N.8.

GC2WL.—A. T. Wilson, 206, Newlands Road, Cathcart, Glasgow.

GI5MO.—C. Morton, "Simla," Glastonbury Avenue, Belfast.

GI5WD.—W. S. Davison, "Dunmore," Taunton Avenue, Belfast.

6ON.—W. H. Felton, "Wiltonest," Arundel Road, Durrington, Worthing.

G6XL.—F. W. Garnett, The Park, Eccleshill, Bradford. All licensed wavelengths, 10 watts, Trans-Oceanic Permit.

CHANGE OF ADDRESS.

2AO.—Now "Gavinwood," Willingden Road, Eastbourne.

2BHC.—Now Bermuda Cottage, Warren Road, Guildford, Surrey.

2BZC.—Now 38, Purley Avenue, Cricklewood, London, N.W.2.

5JW.—"Somona, Sandhurst Avenue, Withington, Manchester.

6FZ.—Now "Warkworth," Onslow Crescent, Woking.

6NP.—Now 6, Bank Terrace, Heckmondwike.

CHANGE OF CALL SIGN.

2AYP now 5OK.

5SQ now 2BZH.

6JS now 2AOZ.

B4QQ now BQ2.

QRA's WANTED.

BXY JM2PZ G5ALT

All new QRA's by G6BT!

G6TD has sent the Section a complete list of Uruguayan Ham QRA's, and the "Wireless World" has very kindly supplied us with a complete list of the new German call signs.

We are, therefore, able to supply members with any QRA in these countries on receipt of a stamped and addressed P.C.

G6BT,

QRA and QSL Section,
T. & R. RSGB,
Bury, Suffolk

STRAY.

SS-2SE,

R. E. Earle,

Singapore

(a new T. & R. Member)

would like to fix schedules with "G's" who are asked to look out for him on Tuesdays from 21.30-23.30 GMT, and Saturdays from 19.00 to 23.30 GMT. QRH 33.2 metres.

Calls Heard.

A—2yi. C—2he, 2al. G—5tz (fone). R—aal, la1. TJ—crj. U—lahv, lera, 2sw, 2fj, 4iz, 4ft, 4mi, 8bf, 8adg, 8vx, 8buy, 9cet. Y—dcr. Z—4av. Chinese—hva. Russian—1nn. Miscellaneous—kjce, ketv, wiz, way, souu, cedj, csun, skrtj, kss28, fa8jo, fn8mc, gc8ko. All c. 35-60 metres on O-V-2 Reinartz during October 1 to October 31 inclusive. Glad to QSL with details of QRK, QSB, QSS, QRH es WX, psc QSL.—A. S. CLACY, 10, Melrose Avenue, Reading, Berks.

U—laay, laep, lajx, laza, labz, laib, lajc, lajh, lajp, lapv, lomp, lrd, lxaa, lxx, 2af, 2anx, 2arm, 2agi, 2bsl, 2cvj, 2cyq, 2czr, 2mu, 2nf, 2tp, 2afq, 2ccv, 2ceb, 2co, 2zo, 4cu, 4fm, 4iz, 8bte, 8bf, 8bre, 8bth. C—2ax. FR—4ja. G—8kp. BZ—lan, law. lbi, 2af, 2aq, 6qb. Miscellaneous—gkup, ptr, rxy, sq4, wudo. Who wants a card?—G2BZC, 38, Purley Avenue, Cricklewood, London, N.W.2.

U.S.A.—U—laxa, lapv, laay, lamd, laox, lahr, lam, lce, lctp, lcmf, lcn, lciz, lcib, lcox, lckp, lcrx, lcaw, lcrp, lcjh, lbtj, lbez, lkk, lrd, lic, lzs, lsw, 2ud, 2ls, 2aib, 2nu, 2cvu, 2acg, 2nf, 2tp, 2crb, 2cjp, 2lw, 2zd, 4sa, 4ft, 4ak, 5wj. Poland—T—px, pav, pach. Finland—S—ldj, 2ns, 2nd, 2co. Denmark—E—7as, 7ux, 7xu, 7hg, 7mt, 7zg, 7js. Sweden—smxb, smrr, smui, smxv, saw, sad, sgl, sgt. Germany—K—4abf, 4mkw, 4asp, 4xs, 4mfl, 4rw, 4ya, 4ra, v8, k0, 2do. Miscellaneous—Vcz1, kc24, l-lag, oww, l-orl, ys7xx, lz-lj2, hyj, rrp, 6w3, caox, vviv, gw19z, ea-4sn. Received on O-V-0 on 47-35 metres by G5UF, "Langside," Cromer.

U.S.A.—4dd, 4ft, 4iz, 4jk, 4li, 4pk, 4qy, 4amt, 5fr, 6dnk, 7vh, 7wu, 8alk, 8atv, 8aul, 8avd, 8avl, 8bay, 8bnj, 8bra, 8bth, 8buy, 8daq, 8drj, 8pk, 8tby, 8ze, 9act, 9tdo, 9bl, 9pb, 9cd, 9ctg, 9czw, 9ek, 9ln, 9to. Canada—C—lem, lar, 2zc, 3kp. Mexico—M—ln, 9a. Cuba—C—8kp. Porto Rico—FR—4ja, 4sa. Brazil—lac, lad, laf, lai, laj, lak, lam, lao, lap, lae, lar, lau, lav, law, lax, lay, lhd, lhg, lhb, lbi, lbl, lib, lqa, 2ab, 2af, 2ag, 2aj, 2ak, 2ar, 5ab, 5ad, 6qa, 6qb, sym, sq1x, sq4. Uruguay—Y—lhp, ltu, lcd, leg, 2ak, 2ap. Argentine—R—af1, ct8, db2, dx8, dz9, ha2, na2. Chile—CH—2ld. Latvia—KC—z4. (Lithuania?)—LIT—lb. Trans-Jordan—TJ—crj. Japan—J—3xp. Philippine Islands—Pi—lau. Algeria—FA—8jo. Tripoli—DA—lcw. Sudan—krc. Belgian Congo—CP—f2. South Africa—C—z3b, a6n. Australia—A—2bk, 2ij, 2tm, 2yi, 7cw, 7hl. New Zealand—Z—2ac, 2ae, 2xa, 3ai, 3ak, 3ar, 3xb, 4aa, 4ac, 4am. Various—nidk, ntt, nulx, wnp (fone), yoq, ss-2se, bxy, and, anf, xan, lor. Receiver, O-V-1. Below 50 metres. QSL's appreciated.—LAWRENCE L. PARRY (BRS29), 106, Church Road, Moseley, Birmingham.

DX Recv. Date October 24, 1926. Time 8.45 p.m. to 9.25 p.m. G.M.T. Some QRN:—

Calling.	Call Sign.	R.	qsb.
CQ	BZ-1AM	6	CW pure
3ANY	U-1AMD	6	RAC
CQ	C-1DM	4	RAC
CQ	U-4FT	5	RAC
CQ, BZg	BXY	6	1CW
FSMSV	FM-SRA	6	RAC
CQ	U-1AAO	6	RAC
F8KF	U-2UF	5	RAC

Receiver: Lo Los Reinartz es 1 step A.F.—6JL, P. N. Gouston, Coventry.

U—labz, laay, ladl, ladm, lab, lag, laic, lajx, laup, lamd, lavh, laxa, lazz, lawe, lbb, lbez, lbg, lxx, lbbm, lbj, lbqt, lcaw, lch, lcmp, lcmf, lda, ley, lia, liv, lkk, lmv, lnx, lrd, lsw, luw, lxx, lzd, lzs, 2ago, 2ajx, 2ail, 2ait, 2amj, 2apd, 2apv, 2aqk, 2awf, 2awo, 2baa, 2bad, 2btx, 2ber, 2bgl, 2brb, 2byg, 2cmx, 2crb, 2cw, 2cty, 2cvj, 2fc, 2fj, 2fu, 2hp, 2md, 2sa, 2tvr, 2uk, 2vo, 2uf, 2sy, 2tp, 2rz, 2xg, 2xs, 2xt, 3cev, 3ay, 3cdv, 3cs, 2gp, 2ru, 3ld, 3py, 3im, 3zs, 4am, 4axt, 4by, 4cv, 4ft, 4mw, 4nb, 4rr, 4ux, 5ql, 5jd, 8adg, 8abc, 8akk, 8aly, 8aul, 8bte, 8ber, 8bpo, 8bth, 8bzc, 8cdv, 8ctl, 8cuk, 8cyv, 8dc, 8dp, 8puj, 8drs, 8dsy, 8kj, 8sf, 8zu, 8dg, 8adk, 8ara, 8axh, 8baz, 8bje, 8bem, 8cc, 8dcu, 8ecc, 8ejh, 8rk. FR—4sa. C—lar, 2fo, 2ax, 2ai, 2aq. R—la1, ct8, dz9, fc6. CH—2aw, 2ah. Y—lhp, ltu, lcd, leg, 2ak. C—8kp. C—al, a4z, a6n. Pi—lhd, lhr, nro. India—dcr. Indo-China—filb. A—2sh, 4rb, 5kn. Z—lau, 2ac, 3ai, 4so. BZ—lac, lad, la, lai, laj, lah, lak, lam, lan, lao, la1, lap, lac, lar, lav, law, laz, lhd, lbi, lbl, lia, lca, 2ab, 2ad, 2ae, 2ag, 2ak, 2am, 6qa, 6qb, sc4, ptf, ptg, pti, ptp, pts. Miscellaneous—uabi, wiy, ktc, and, gejn, x815, rxy, lxy, gup, xyz.—B. and F. SMITH (BRS8).

A—2cs. A1—(1cw). B—(el), (o8), (zl), h(5), (k44), (4qq), 4zz, v33, 3aa, b52, s6, 2ssk, bl, m8, e4, n8, v8, 9j, n33, ch2. BZ—lad, lai, lam, lao, laq, lqa, 2ab, 2ad, 2af, 2am, 5ad. C—2ax, 2be, 2fo, 3ax. CB—f2. CH—2ab, 2ld. CS—okl. D—7bj, (7mt), (7xf), (7zg). EAR—4, (6), 9, (19), 23, (26), 28. F—Too numerous. FA—8ip, 8xuv, 8mco. FC—8flo. FM—8ma, 8mb. Ocrb. G—Too numerous. GI—(2it), (5nj), 5mo, 6ky. GW—12b, (18b), 11c, (14c). GX—(6mu). I—(1au), lak, lax, lay, (1ba), (1bb), lce, lch, ldc, ldo, lgw, lrm, lss. K—k7, 4s, j2, 4yae, 4mfl, (p6), 4ha, (2do), (4ya), (w7), 4bk, j2, 4cu, 4abi, 4yab, 4abi, kpl. LA—la, le, lx. N—Oag, Oam, Oga, Okh, (Oly), Opm, Opz, Ori, Orb2, Oss, (Oth), Ous, Ovn, Owf, (Owc), Oaz, (2pz), 12bb, pb2, pb3, pck4, pck5. OE—(hu), (ke), (w3), gp. P—(lae). PI—1bd. PR—4ja. Russia—1llq, 1nn. Argentine—de2. S—2co, (2bs), (2nd). SS—2sc. SM—(tn), (to), (ua), (uk), ui, uv, zt, rt. TE—xx. TL—(lit-lb). TP—ai, (ach), (av), xx. U—1aib, lav, laay, laxa, lafl, lafw, laae, lads, lba, lbez, lbhm, lbq, (lcmx), lkk, lij, lrd, lrn, lro, lsw, 2avr, 2apv, 2aqk, 2ahk, 2bbx, 2bj, 2czr, 2fj, 2mu, 2tp, 2wc, 2za, 3cc, (3bu), 3 jo, 7cw, (8amb), 8alf, 8bct, 8bf, 8ccq, 8ded, 8don, (8kf), 9bpb, 9cpq, (9ek), 9sj, Z—2ae. Parenthesis () means crds red. Tnx JOM's. Psc QSL to BRS41.—Calls heard by J. B. and R. D. SCOTT (BRS41), 9, Upper Garville Avenue, Rathgar, Dublin, Ireland.†

A—4rb. B—4aa, 5er, bl, ch2, e4, h5, j9, m2, u3. BZ—lac, law, lak, lam, laq, lar, lhc, lbd, lbi, lqa, sq4, 2ab, 2ar, 2ak, 2ag, 2ad. D—7jo. F—fl*, berri, 872, 888*, 8arm, 8cac, 8cn, 8fmr, 8hu, 8jf, 8kk, 8lz, 8mul, 8mco, 8oqp, 8rl, 8rot, 8rsp, 8sr, 8ssq, 8ut, 8wn, 8woz, 8ww, 8xu, 8ynb. Fa—8ip. Fm—ocrb. G—2db, 2cs, 2gm*, 2go, 2jj, 2nm*, 2od, 2ra, 2vg*, 2vr, 2vs, 2xy, 5ad*, 5bu, 5by*, 5go, 5bx, 5hy*, 5io, 5is, 5pm, 5qv, 5sk, 5td, 5tz*, 5us*, 5wc, 5wg, 5wv, 5xy, 5za, 6tr, 6ci, 6cj, 6cl, 6gi*, 6ia*, 6ig, 6lj, 6no, 6og, 6ot*, 6ra, 6ru, 6co*, 6oh*, 6rd, 6rm, 6ry, 6tx*, 6ty, 6ug, 6vp, 6wv, 6yd, xan, gfa, glq. Gc—6nx, 6ko, 6vo. Gi—5nj, 6mu. Gw—3xo, 11b, 14c. I—1au, lco*, ler, lgw, lma, ldo. K—ayy, c8, 4wb. N—Oam, Obp, Cgg, Okh, Cuc, Ovn, pck4, pell, pcr, pccu. O—a6n. Pi—1hd. R—af1. Russia—1nn. S—2bs, 2co, 2nd, 2nm. Sm—smua, smuk, smto, smwr, smxv. U—1aao, lapu, lasu, lbqt, lcaw, lch, lcki, lckp, lcmf, lcmp, lcmx, lcw, lmv, lmy, lxx, lsw, 2bbx, 2blm, 2ctn, 2czr, 2uo, 3auv, 3cdv, 4ft, 8adg, 8ctl, 8kf, abl. Y—led, lcg, 2ah, 2ak. Z—4aa. * indicates telephony.—Calls heard by P. H. BRIGSTOCK TRASLER (BRS30), 37, York Road, Northampton.

Calls heard, extracted from Latvian "Radio":—By 2A—g2ab, 2bz, 2jb, 5kz, 6ia. By 2C—2gb, 2vj, 5gw, 6hc, 6ut. By 2K—2nm, 5tz, 6og, 6lj. By 2N—2nh, 5da, 5is, 5pm, 6lj.—Extracted by G6BT.

Stations worked 33 metres:—U.S.A.—6 bhr, 6bxo, 6daq, 6kd, 6mu, 6rw, 6zat, 7ii, 7vh, 7rl. Aust.—2sh, 6am, 6sa. Pi—1at, 1au, 1hr. Fic—1b. China—1ers. NZ—2ac, 4aa. Africa—oa3e. France—8jn, 8tuv. England—2nm. India—ydc, y2jy. Stations worked 23 metres:—filb, z2ac.

England—2lz, 2xy, 5tz. Belgium—4ax. Sweden—smtn. U.S.A.—6adp, 6ahw, 6ann, 6awe, 6bgv, 6bjx, 6bxi, 6bo, 6bnz, 6bzm, 6btm, 6cto, 6che, 6dcu, 6daj, 6ddo, 6ih, 6kb, 6nd, 6nx, 6oi, 6rw, 6tkx, 7tm. Aust.—2bk, 2cg, 2ky, 2so, 2ij, 2re, 2yi, 3cm, 4rb, 5ab, 5bg, 5bw, 5mw, 5oa, 5kn, 6kg, 7gb, 7cw. NZ—1ax, 2bx, 2xa, 2ae. Pi—1hd, lin, lxx, law. Africa—ade, a4z, ale, a5o, a5z. Japan—1sh, 1sk, 1sm, 1ts, 1mu, 1zb, 1fx, 3ab, 3az, 3kk. Brazil—1ao. I am now restricted to 23 metres.—R. E. EARLE (SS2SE), Singapore, S.S.

[APPEALS.

We want a number of linguists to place their services at our disposal for the translation of letters written in the following: Russian, French, German, Italian and Spanish. Any offers?

A member is wanted to prepare for us a list of "ham" abbreviations and intermediates for publication in the BULLETIN. Any offers?

Election Result.

(Northern Area).

Mr. S. R. Wright (2DR) was elected as Area Manager of this Area for the ensuing year.

Majority: 18 votes.

Correspondence.

FREQUENCY MEASUREMENTS.

To the Editor of T. & R. BULLETIN.

DEAR SIR,—May I use your columns to notify a change of address to Abbey Court Hotel, Torquay?

I hope any member visiting that town will look me up when, by way of a change from radio, I will offer him an opportunity of making some measurements as to the amplitude and frequency of the fish underlying the wave band of Tor Bay.

Yours faithfully,

J. H. REEVES.

2, Penywern Road, Earl's Court, London, S.W.5.

Q.R.P. SOCIETY.

To the Editor of T. & R. BULLETIN.

DEAR SIR,—With reference to the newly-formed Q.R.P. Transmitters' Society, there appears to be some misunderstanding as to what the Society really is. May I take this opportunity of stating that every member of Q.R.P. is a staunch T. & R. man.

Q.R.P. is a small gathering of personal friends all residing close together, who have been in the habit of gathering together in a disjointed way and discussing ham radio.

It was thought that the organised and systematic exchange of data and ideas brought about by the formation of the Society would benefit amateur radio generally.

In conclusion, may I add that I have had several applications from outsiders to join the Society and in each case, the membership being limited, the T. & R. has been suggested, with the result that we have been the means of securing at least one new T. & R. member.

Wishing the BULLETIN every success.

I remain,

Yours hamfully,

L. J. FULLER,

Hon. Secretary.

Glenburn, 13, Seagry Road, Wanstead, Essex.

APPRECIATION.

To the Editor of T. & R. BULLETIN.

DEAR SIR,—Will you forward the enclosed cards to BRS25 and 5MQ? Thanks.

The R.S.G.B. is sure doing good work in handling reports, etc., and is much appreciated by the amateurs here.

Yours truly,

WM. TREDWELL (CICX).

Glace Bay, Nova Scotia, Canada, Box 38.

F8PY.

To the Editor of T. & R. BULLETIN.

DEAR SIR,—I should be very pleased if you would be kind enough to insert the following note in the T. & R. BULLETIN, and, in this hope, I remain,

Very hamfully yours,

HENRY PIRANY.

"Radio-Amateurs" (*Revue Pratique et Technique de la T.S.F.*), 45, Rue Saint-Sébastien, 45, Paris (XIe).

My station (F8PY) is closing down for a certain time, owing to heavy YL-itis. I should be pleased to know if any G ham I have QSO has not yet received my QSL; if not, "just drop a line." By the way, I should be glad to be QSL'd by Messrs. 6ZA, 6PU, 2DQ, 5MY, 2BQ, 5QZ, but may they be quiet. I'm not as ferocious as 6CJ! So, cuagn next winter, and 73's to all.—Sig., F8PY.

To NOWB.—In the October issue of the BULLETIN, you ask for QSL's not sent by you; I never rec'd urs, OM. Did u get mine?

UNLICENSED AMATEUR.

To the Editor of T. & R. BULLETIN.

DEAR SIR,—There is a (to me) new amateur transmitting station recently started in this district and, judging by the strength, I should imagine he is about 15 or 20 miles from my station. He starts on Sunday mornings on a wave of about 420 metres, at 11.30 a.m., sending gramophone records. He sends continuously for an hour without a break, only now and then announcing the name of the record, but never any call sign. He kept on to-day till 12.30, and then announced "We are now closing down till 1.15." Promptly at 1.15 he started records again, without any preliminary words at all, and no call sign. He never listens in as is obvious from his continuity. I think he must be a "Pirate," and there must be someone near him who knows who he is. He is a perfect nuisance, and I hope this letter may enable him to be traced and stopped.

The transmission of gramophone records by any station should, in my opinion, be taboo by all decent transmitters.

Yours faithfully,

W. ISON (G2FB).

To the Editor of T. & R. BULLETIN.

DEAR SIR,—Please note that my call sign has now been changed from 2AYP to 5OK. Maximum power, 10 watts; wave, 150-200 metres.

I should be glad of any reports from members giving details with regard to fading effects, if any, at distances of 50 miles or more. All cards will be answered, and perhaps you can find space to put this in the BULLETIN, for which I shall be greatly obliged.

Thanking you in anticipation.

Yours faithfully,

W. J. COYLE.

134, London Road, Southend-on-Sea.

PROCEDURE.

To the Editor of T. & R. BULLETIN.

DEAR OM,—As the result of several months' work on the 45 band, I am driven to the conclusion that a large number of foreign amateurs give misleading and exaggerated R strengths.

I have proved this fairly well by inserting in my procedure the question, "What is the weather with you?" This finds them out very quickly and invariably you receive "sri, om, qss qrm." Try it, OMS?

In point of fact the question itself if properly answered gives even more information than QSB. I would like, then, to suggest that all G stations adopt some selected code group such as "WX" when seeking this information. During the tests, I put this question to about 15 continentals, and received satisfactory replies to eight only, although most of the other stations had given me a good R strength.

Finally, I consider that all G's should, when giving QRK, state the number of valves being used for receiving; at the moment many stations are neglecting this very important piece of information.

Trusting you can find a corner for these few suggestions.

Yours sincerely,

J. CLARRICOATS (G6CL).

107, Friern Barnet Road, London, N.11.

To the Editor of T. & R. BULLETIN.

DEAR SIR,—I see in the October issue of the BULLETIN, under the QRA and QSL section, a sentence to the effect that where QRA's are known cards should be sent direct so as to lighten the load of the amateurs who are handling these.

Would it be possible for the T. & R. Section to make further use of the QRA and QSL section and publish and keep up to date the QRA's of amateurs throughout the world? This would be very useful and also would be the means of lightening the work of a number of people who no doubt would be glad of more time for experimental work. I should like this country to be the first to issue a directory of radio amateurs of the world, and hope it may be recognised as the official list.

I should be glad to help in any way to further this scheme if other members think anything of it.

With kind regards.

Yours truly,

ARTHUR E. WATTS.

58, Woodside Avenue, Highgate, N.6.

[ED. NOTE.—We already have such a scheme under consideration.]

To the Editor of T. & R. BULLETIN.

DEAR SIR,—I wish to thank two new transmitters for their great kindness and unselfish endeavours to keep 6YW "on the air" during the tests. Twice my aerial carried away and twice they (5MO and 5WD) came to the rescue. Once I was able to help, but once I was on late duty while they lowered a heavy wooden 40-foot mast in the darkness, mud and rain, and toiled at it for three hours when they should have been resting for the night watches of the QRP tests.

I cannot thank them enough for their great help, but I should like to make this small appreciation of their services in the columns of the BULLETIN, and to say that, of the many examples of "the true amateur spirit" I have come across, this example is *le dernier cri*.

With best wishes.

Yours sincerely,

T. P. ALLEN (G16YW).

19, Ardreenan Drive, Strandtown, Belfast.

November 10, 1926.

WEATHER CONDITIONS AND RADIO.

To the Editor of T. & R. BULLETIN.

DEAR SIR,—It may be considered premature to make any comments on Mr. A. Hine's article on Weather Conditions in the November BULLETIN before the concluding instalment is published, and therefore I offer these remarks with apologies.

Mr. Hine's article is particularly interesting to me as the experiments described are similar in some respects to my own experiments during the past two or three years. The chief difference is, I think, that Mr. Hine has investigated mainly European conditions, whereas I have investigated transatlantic conditions. The graph I obtained for transatlantic conditions during 1924 was published in *Experimental Wireless*, December,

1925: this graph appears to be repeated every year, and it is very interesting to note that some similarity can be detected between Mr. Hine's graph for April-July, 1926, and my graph for the corresponding period in 1924. This is surprising as the graphs apply to reception in *opposite* directions.

Since the end of 1925 I have been investigating the pressure gradients across the Atlantic in relation to the transatlantic receiving conditions, but I have found that the connection, if any, is more complex than might at first be imagined, and, on the whole, my results do not check up with Mr. Hine's illustration on page 7. Then, of course, there is the difference that Mr. Hine's set of observations were taken mainly across land, and mine were taken across water. As I have just mentioned, the graph I obtained appears to be repeated every year, and if the reception conditions depend upon the pressure gradient along the direction of the signals, then the pressure gradient in that direction should be the same (disregarding the effects of other variable factors) on corresponding days in successive years. I will mention here that with the help of weather charts of the Northern Hemisphere back to January, 1924, I have found some evidence to show that this is the case. A detailed account of the work will be published shortly.

I cannot agree with Mr. Hine that reception is poor when *local* temperature and pressure are fluctuating. From observations over a period of more than two years I have found that reception may be very good or very bad when local conditions are fluctuating all over the place, and it is only the conditions between the transmitter and the receiver which affect the reception. That the conditions in the intervening space should be steady for good reception is in accordance with my observations.

Again, I cannot agree that the intervening distance should be entirely in either the light or the dark. This condition appears to vary with the slope of pressure along the direction of the signals.

Apparently Mr. Hine strongly suspects the moon: I have tried without success to connect the phases of the moon with the variations of reception conditions, but it has been my opinion for some time that the moon will affect reception by the tidal movements of the atmosphere and the consequent variations in the atmospheric ionization.

The question may be asked whether such experiments as those described by Mr. Hine can be conclusive. Four months is a comparatively short period for observations of this sort, and 1,000 miles or so is a comparatively short distance in terms of depressions and anti-cyclones. That is one reason why I have made observations on North and South America and continued the experiments for nearly three years.

We are always up against the difficulty of having so many variable factors at work—the pressure, temperature, clouds, sun, moon, aurora, magnetic storms, and so on—and if things don't turn out as we hope, we can generally blame one or more of the other factors. So little is known about the mechanism of the variations in reception, that great care should always be exercised when attempting to draw conclusions.

Yours faithfully,
S. K. LEWER (G6LJ).

32, Gasceny Avenue, West Hampstead, London, N.W.6.
November 13, 1926.

SCIENTIFIC WORK AND THE AMATEUR.

To the Editor of T. & R. BULLETIN.

SIR,—In noting that Mr. H. A. Clark has taken me to task for the expression of certain opinions relative to my heading, I am impelled to the conclusion that there is actually no divergence of opinion, but only of understanding between us.

If Mr. Clark will read my letter again he will see that I urge the necessity of teaching us amateurs the mysteries of radio mathematics—but with consideration rather than in overdoses. This is precisely the same attitude as expressed in another way by Mr. Clark when he says that the man wanted by the Research Section is he who says, "I don't know much theory, but I wish I did, and will dig into it as well as I can."

The point which I wish to convey is that excessive use of higher mathematical terms—however well understood they may be by those who have been trained in their use—are actually "jargon" to the uninitiated.

A case in point is that of a certain periodical whose early numbers were of the greatest value to amateurs but whose value has in my opinion definitely declined, *from the amateur point of view*, in proportion to its increased value to the mathematician.

Without in any way disparaging "maths," I think that in most cases it is the experimenter who sets the pace and makes the progress, while the mathematician contributes to the realms of pure knowledge by following with his slide-rule and explaining quantitatively just what has been achieved and why.

In this way the experimenter and the mathematician are mutually complementary, and the truly wise man is he who is master of both arts.

Yours faithfully,
HUGH J. B. HAMPSON (G6JV).

To the Editor of T. & R. BULLETIN.

DEAR SIR,—Your contributor, 6UV, on the subject of the counterpoise seems to treat the whole matter as though the counter-

poise acted as a more effective substitute to the earth, and he rightly suggests that the name "earth-screen" is more suited. Surely most amateurs use a "counterpoise" in the true sense of the word—*i.e.*, the counterpoise is not employed to obtain a virtual reflection of the antenna, but rather as a continuation of a Hertzian radiating system. A counterpoise is really not a necessary part of a radiating system, and "Sec" replaces it by a "tank-circuit." It would be very interesting to have transmitting amateurs' experiences on the effect of position of the counterpoise with respect to the aerial. I should not be at all surprised to hear that for DX the counterpoise should point in the opposite direction to the antenna, and that for local work a counterpoise under the antenna was most effective. When treating it as a true counterpoise there should be no need to have any more wires than one is accustomed to use in one's antenna.

Re 5YM's receiver, he states that for maximum QSA that one should use maximum inductance and minimum condenser. I should very much like to know what proof he has for this. I used to be under this misconception until I actually tried the experiment. Also several of the members of the Experimenters' Section ARRL are working on this subject, and although no results have appeared yet the tendency is to disbelieve the old theory. I also presume that 5YM is aware of the principle of amplification, that the output impedance should be equal to the valve impedance in the last stage of L.F. amplification, so could he inform me of a pair of 'phones having an impedance equal to that of a high mag. valve? I have found that a small power valve is most suitable for a pair of ordinary 'phones.

I have found for maximum QSA that a low-loss receiver is advisable. I personally choke the filament of the det. (a DEV) and do not earth the set, and can keep the R.F. within its proper bounds, and as a result I can, by removing the grid coil and replacing it by the minimum of wire necessary to short the sockets, make the set oscillate at a QRH of under two metres. (This is measured by the "dead-spot" method, and the length of wire corresponding to minimum QRH was 75 cms.)

Can 5YM, and any others who employ aerial and counterpoise systems "tuned" to 3rd harmonic, tell us how they know they are tuned to 3rd and not 2nd harmonic? I have a QSL from a B.Sc. who uses an aerial of length 65ft. and a counterpoise of not more than 55ft. which he "tunes" to 3rd harmonic with a series condenser. It strikes me he is operating on the 2nd harmonic.

Also, why is a perfectly good wave band around 23 metres being wasted by the T. & R.? Surely people would like to get away from the Sunday QRM, so why not put your TX's on 23 and work a few Yanks? The French are not nearly so sleepy, and 8JN has now got a route opened to Z2AC, filB, and the U's on 20, and I am sure he would be only too willing to QSP anyone across. By the way, beware, and only call U's who sign 2T as about 50 per cent. of the "Yanks" heard on 20 metres turn out to be harmonics of their 40 metre TX's.

Please excuse me taking up all this space.

I am,
N. C. SMITH (G2AYB).

"Crotholme," 117, Chesterton Road, Cambridge.

EXCHANGE & MART.

FOR SALE.—Morse Inker with P.O. and Weston Relays and Spare Tape, £5; Weston 0—5 Milliammeter in portable base, 35s.; Sterling Collapsible Frame, adapted s/ws, £1; D.E.Q., 10s.; Zenith 30,000-ohm Grid Leak, 15s.; Buzzer Wave-meter, 20-50 metres, 25s.; all perfect condition. Also lots of Junk. Exchanges and offers considered. Wanted, Evershed Hand Generator or Belt Drive, and suitable A.C. Motor for 230-volt 50-cycle mains.—6BR, Overdale, Ilkley, Yorkshire.

2,000 VOLT NEWTON (DERBY) D.C. GENERATOR, $\frac{1}{2}$ amp., 2,500 revs., direct coupled to Newton D.C. 220-volt motor, fine condition, £40. Airship 500-cycle Alternator, self excited, ball bearing; and Oil Insulated Transformer, unused, tested to 3 K.V.A., £10.—D. LAVIN, Old House, Sonning, Reading, Berks.

A.C. GENERATOR, Newton 200 watt, and Transformer by Foster (500-1000 volts output) £3. Voltmeter and Ammeter for same (10 volts 20 amps., six in. scale), Westinghouse & Everett-Edgcombe, £3.—Box 1, T. & R. BULLETIN.



MICRO-AMPS TO
20 AMPS
MILLIVOLTS TO
2,000 VOLTS
50 OHMS TO
50 MEGOHMS
WITH
**ONE
METER**

The Dixon **ULTRA ONE-METER**

Readers of the "T. & R. Bulletin" are capable of appreciating the full value of these press reports.

The *Wireless World* says:—"A new measuring instrument which is particularly suitable for carrying out practically all the tests associated with wireless apparatus is obtainable from novel constructional which throws the meter pressing the key. The instrument a number of typical measurements met complete, and the determinations are worked

**Have you bought
YOUR
one - metre
yet ?**

The *Electrical Review* says:—"The ONEMETER microamperes, volts, millivolts, ohms and megohms to the one instrument."

Amateur Wireless says:—"We have carried out tests vouch for its remarkable accuracy, and it is a very useful moving

The *Wireless Trader* says:—"All the refinements of a high-class included. Comparing the ONEMETER with our standards we found that it accurate. Its universal application is an outstanding point of the ONEMETER, low consumption as a voltmeter, and neatness of the outfit are good points. We have yet to see its equal in value."

THE SPECIAL FEATURES OF THE ULTRA ONE-METER ARE:--

- | | | |
|------------------------------------|---|---|
| (1) Is absolutely Dead Beat. | (7) Internal Resistance, 500 ohms per volt. | (10) Accuracy to British Engineering Standards for first-grade instruments. |
| (2) Has Safety Contact Key. | (8) Sensitivity, 100 Millivolts. | (11) Western quality at Eastern price. |
| (3) Multiple Overload Capacity. | (9) Knife-edge Needle and Double Scale. | |
| (4) High Grade Sapphire Bearings | | |
| (5) Front Zero Adjuster. | | |
| (6) Full Scale Current only 2 m.a. | | |

PRICES FOR MULTIPLIERS :

Current, all ranges, Milliampers to 20 amps.	each	6/6	
Voltage, all ranges	To 100 ..	6/6	To 150 ..	7/6	To 200 ..	9/-
	To 250 ..	10/6	To 300 ..	11/-	To 500 ..	16/6
	To 750 ..	27/-	To 1,000 ..	38/-	To 1,500 ..	57/-
			To 2,000 ..	74/-		

Extra Cases, with slotted base, to take 4 multipliers, 4/-

PRICES :

ULTRA "ONE-METER," in case, reading 0-2 milliamps, 40 microamps. per div., 0-100 millivolts, 50/-

LESLIE DIXON & CO., 218, Upper Thames Street, London, E.C.4.

Parrs Ad.

SELECTED BOOKS FOR "T. & R." MEMBERS.

- ALTERNATING CURRENT WORK : by A. SHORE, A.M.I.E.E. 163 pages, 86 diagrams, 7 illustrations. Price 3/6 net, post free 3/9.
- ELEMENTARY MATHEMATICS AND THEIR APPLICATION TO WIRELESS TELEGRAPHY : by S. J. WILLIS. 182 pages, 120 illustrations. Price 5/- net, post free, 5/6.
- ELEMENTARY PHYSICS, SELECTED STUDIES IN : A Handbook for the Wireless Student and Amateur : by E. BLAKE, A.M.I.E.E. 176 pages, 43 diagrams and illustrations. Price 5/- net, post free 5/3.
- MAGNETISM AND ELECTRICITY FOR HOME STUDY. 50 graded lessons. 515 pages, 224 diagrams. Price 6/- net, post free 6/6.
- OSCILLATION VALVE : The Elementary Principles of its Application to Wireless Telegraphy ; by R. D. BANGAY. Price 6/- net, post free 6/3.
- WIRELESS TRANSMISSION OF PHOTOGRAPHS (the only Book published on the subject). Price 5/- net, post free 5/6.
- CALCULATION AND MEASUREMENT OF INDUCTANCE AND CAPACITY : by W. H. NOTTAGE, B.Sc. Price 7/6 net, post free, 8/-.
- RADIO EXPERIMENTER'S HANDBOOK : by P. R. COURSEY, B.Sc. (Eng.), F.Inst.Phys., A.M.I.E.E. Price 3/6 each net, post free 3/10 each.
- WIRELESS TELEGRAPHER'S POCKET-BOOK OF NOTES, FORMULÆ, AND CALCULATIONS : by J. A. FLEMING, M.A., D.Sc., F.R.S., M.I.E.E. 352 pages, 7½ x 5½ ins, 39 diagrams and illustrations. Price 9/- net, post free 9/6.
- WIRELESS TELEGRAPHY AND TELEPHONY : by H. M. DOWSETT, A.M.I.E.E. 331 pages, 305 diagrams and illustrations. Price 9/-, post free 9/5.
- WIRELESS VALVE TRANSMITTERS : The Design and Operation of Small Power Apparatus : by W. JAMES. 270 pages and over 210 figures and plates. Price 9/- net, post free 9/6.
- THE RADIO AMATEUR'S HANDBOOK : A Manual of Amateur Short Wave Radiotelegraphic Communication : by F. E. HANDY, A.R.R.L. Price 4/-, post free

Order your Books from the Sales Department "T. & R. Bulletin."

We can supply all British and Foreign Books to order. The above is merely a list of books which we have selected as being thoroughly sound and suited to the needs of the amateur.

Help us to help you. Buy your Books and Stationery through this service which has been inaugurated for your benefit.

TERMS: CASH WITH ORDER. No Trade Terms allowed.

Complete list of recommended books sent upon receipt of stamped addressed envelope.

Address your inquiries to—

SALES DEPARTMENT, "T. & R. BULLETIN," Radio Society of Great Britain
53, Victoria Street, S.W.1



Enamelled Emblems

(Black & Gilt)

Price $2/6$ Each



First-Class Paper
Headed with the
Title of the
Section ready for
Overprinting
with Your Own
Address.

PRICE

$3/-$

Per 100 Sheets.

ORDERS TAKEN
for TECHNICAL
BOOKS,

ENGLISH
& FOREIGN,

at CURRENT
LIST PRICES.

Rubber Stamps
PRICE $3/-$ EACH

Small Stereo Blocks

FOR USE ON YOUR
OWN NOTEPAPER.

Price $2/6$ Each



USE T. & R. STATIONERY & ASSIST THE SECTION

ADDRESS YOUR ORDERS TO:

“Sales Dept.” T.&R. Section, Radio Society of Great Britain
53, VICTORIA STREET, WESTMINSTER, S.W.1

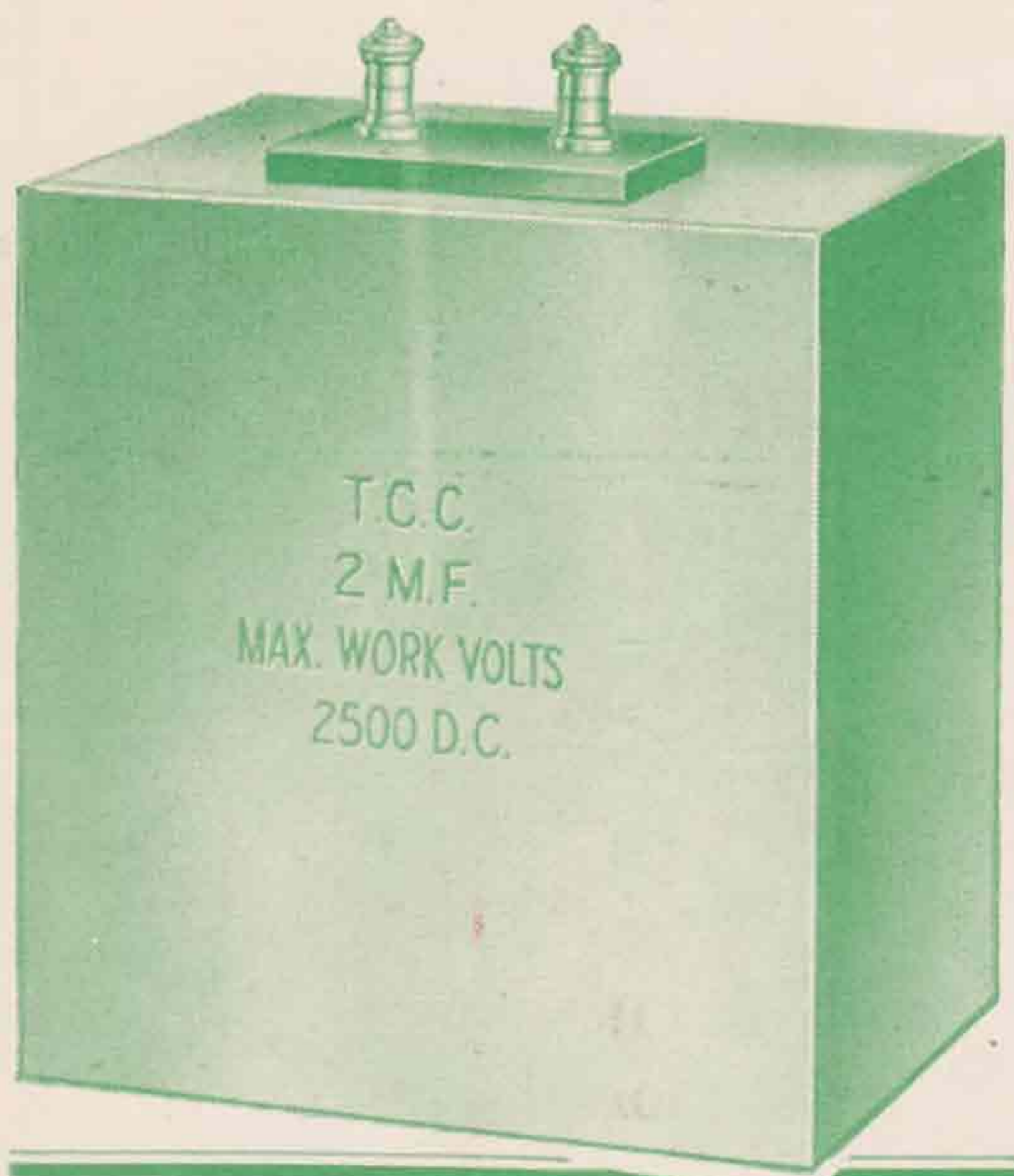

**Choose your
"smoother" with
care**

FOR over twenty years the Telegraph Condenser Co., Ltd., have been solely engaged in the manufacture of Condensers. Millions bearing the mark T.C.C. are now in use—from big power Condensers weighing over 3 tons to the familiar little green Wireless Condensers,

In choosing this T.C.C. Smoothing Condenser you can be confident that it contains all the essential features which have been responsible for the name which T.C.C. have built up—that of absolute accuracy and unusual dependability.

Condensers for maximum working voltage of 1500 peak value.

4 mfd.	6" x 6" x 2"
2 mfd.	6" x 6" x 1"
1 mfd.	5" x 3" x 1"
.5 mfd.	5" x 3" x 1"

Condensers for maximum working voltage of 2500 peak value.

4 mfd.	6½" x 6" x 8½"
2 mfd.	6½" x 6" x 4½"
1 mfd.	6" x 6" x 2"

The type illustrated is the 2mfd.—Max. Work. Volts 2500 D.C. Price £2 10s.

T.C.C.

Condensers for Transmitters

Telegraph Condenser Co., Ltd., Wales Farm Rd., N. Acton, W. 3.
G.A. 6347

**IF YOU
MANUFACTURE**

**TRANSMITTING
OR RECEIVING
GEAR**

OR

**HAVE
APPARATUS
TO SELL**

**LET US SELL
IT FOR YOU**

*We reach all
:: Live ::
Experimenters*

Terms for Display or Small Advertisements may be had on application to

**THE ADVERTISING MANAGER,
T. & R. Bulletin,
53, Victoria Street,
Westminster, S.W.1**

Your H.T. Requirements from A.C. Mains

For charging H.T. Accumulators or working an H.T. Supply Unit, provided with a smoothing circuit, use the Mullard DU/5 low temperature filament rectifying valve.

This valve has been specially designed to be used in conjunction with the house lighting supply, the filament being run from a transformer that gives a current of 0.77 amps at 2.7 volts.

A very important feature of the DU/5 valve is the marked conservative rating of the filament voltage. Constructors will be pleased to know that the filament can be safely run up to 4 volts with increased emission and without fear of damage.

All receivers that embody an H.T. Battery eliminator should employ the DU/5, because the wide range of filament voltages (2.7 to 4) will provide unfailing H.T. supply to as many valves as may be required. This will secure not only a standard rectifying valve, but one that will not fail under the hardest working conditions, making the complete equipment a no-trouble eliminator or H.T. accumulator charger.

Write for technical leaflets, free on request.

Mullard

THE MASTER VALVE

TYPE DU/2

Full wave
rectifying
valve
Filament
Volts
4.0. Filament
amps
l.l. Price

30/-



THE DU/5
Price

15/-

Low and Medium Power Transmitting

Valves.

TYPE.	FIL. VOLTS.	FIL. AMPS.	ANODE VOLTS.	IMPEDANCE OHMS.	PRICE. £ s. d.
*DFA6	4.5	.85	100/400	4,500	2 0 0
*DFA7	4.5	.85	100/400	2,850	2 0 0
*DFA8	4.5	.85	100/400	15,000	2 0 0
O/30A	5.4	1.8	1000/1200	30,000	2 15 0
*DO/40	6	2	500/1000	4,200	5 5 0
VO/50	9	4.4	800/1200	13,000	5 12 6
VO/150	11	6	1500/2500	24,000	6 10 0
VO/250	11	10	2000/3500	11,000	9 0 0
*DO/250	6	6	2000/3000	11,000	15 0 0

* Long-Life Dull Emitter Valves.

The Mullard Wireless Service Co., Ltd., Mullard House, Denmark St., W.C.2