

FOR THE
RADIO LISTENER

shortwave magazine

DECODE SPECIAL

Data Modes- Getting Started

Exclusive
JPS ANC-4 Antenna Noise Reducer
Reviewed
Professional Data Analyser
From Wavecom

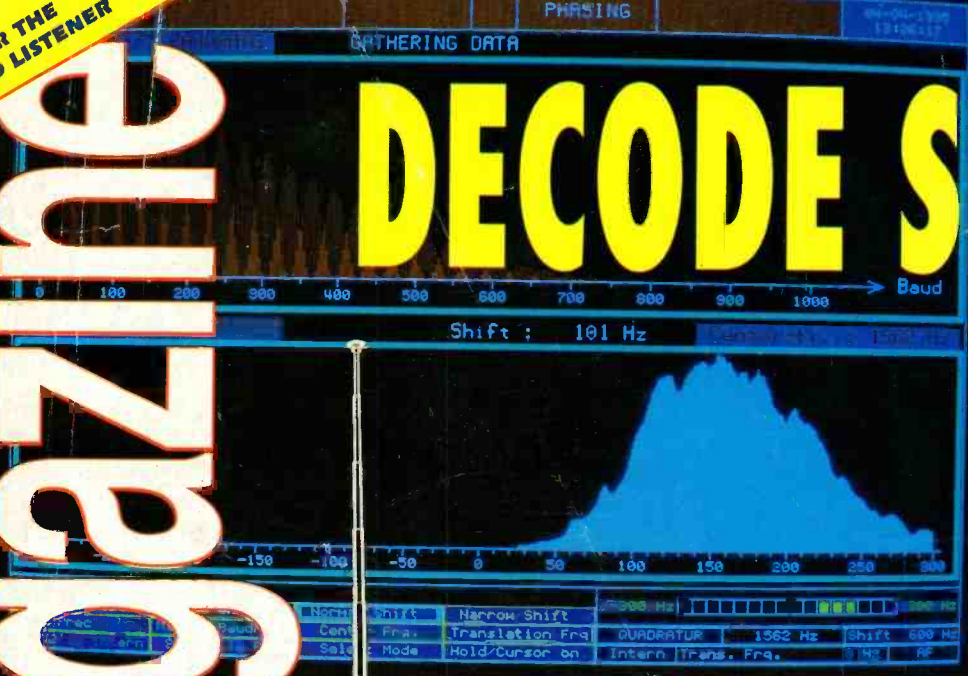

May 1995 £2.25 ISSN 0037 426



Win a PRO-2035

Plus Regular Features Covering

Airband, Scanning, Junior Listeners, SSB Utility Listening, Propagation, Amateur Bands, Long, Medium & Short Waves, Satellite TV Reports, Weather Satellites and more.



The radio spectrum at your fingertips

The **AR3000A** has established itself as a high performance base mobile receiver offering an extremely wide frequency coverage of 100 kHz - 2036 MHz and all mode receive. The introduction of the **AR3000A PLUS** provides even greater performance and capabilities. What is the plus? Plus five custom modifications applied as standard: Switchable narrow AM filter for improved shortwave listening, switchable WFM filter for WEFAX reception, 10.7 MHz I.F. output and switch for compatibility with the SDU5000, tape relay with independent contacts and switched audio, discriminator output. Further custom modifications are available and may be applied to existing units. Simply request the descriptive leaflet and price menu for full details.

AR3000A PLUS
£995



The **SDU5000** is a spectrum display unit designed with the AR3000A in mind. Locating brief transmissions has never been so easy, by using the MAX facility any transmission within ± 5 MHz may be identified and signal strength measured in dBm. A small modification is required to the standard AR3000A to provide compatibility but the **AR3000A PLUS** is ready to go. (The SDU5000 will also operate in conjunction with the AR3000 but facilities are reduced - a small modification to the AR3000 is still required). **SDU5000 £799**

The **AR3030** is The New Classic of short wave receivers. Coverage is from 30 kHz - 30 MHz and all mode receive. The legendary 6 kHz mechanical AM filter is fitted as standard along with a 2.4 kHz Murata filter for SSB and an additional filter for NFM. Stability is excellent due to the standard fitting of a TCXO. Many options are available including VHF converters, Collins SSB, CW & AM filters, Concerto PC software etc. **AR3030 £699**



The **AR8000 UK** receiver is without doubt the most full featured wide band hand-held receiver on the market today. Frequency coverage is from 500kHz to 1900MHz without gaps with all mode reception... twin frequency display, alphanumeric text comments. **PC MANAGER** is an optional new DOS utility for memory and search bank management. The software (which works in conjunction with the optional CU8232 interface) permits upload, download, editing, renumbering, saving of data plus a built-in terminal driver.

AR8000 UK £449.00
PC MANAGER £49 + £3 P&P

Fast mail order available for direct orders. Most items are available from dealers throughout the UK and Eire.



The **NEW AR2700 UK** receiver is the very latest high-tech hand held receiver from AOR. Frequency coverage is 500 kHz - 1300 MHz with receive modes of NFM, WFM & AM.

A large LCD with three way rear illumination provides all operational details. An optional **VOICE RECORD** chip RU2700 permits an **instant 20s digital recording off air** which may be replayed over and over again. Computer control is also possible by using the optional IF-ADP and CU8232 adaptor and interface unit.

AR2700 UK £289

short wave magazine

Vol. 53 ISSUE 5 MAY 1995

ON SALE April 27

Next issue on sale May 25

EDITOR: Dick Ganderton, C. Eng., MIEE, G8V FH
 ASSISTANT EDITOR: Kevin Nice, BRS95787, G7TZC
 EDITORIAL ASSISTANT: Zoë Shortland
 ART EDITOR: Steve Hunt
 LAYOUTS: Richard Gale

EDITORIAL

Arrowsmith Court, Station Approach, Broadstone,
 Dorset BH18 8PW

Telephone: (01202) 659910

Facsimile: (01202) 659950

If you wish to send E-mail to anyone at SWM
 then our Internet domain name is:
pwpub.demon.co.uk
 Simply add the forename of the person you wish
 to contact. For example:
dick@pwpub.demon.co.uk

BOOK SERVICE, SUBSCRIPTIONS, BACK ISSUES ETC.:

CREDIT CARD ORDERS: (01202) 659930

(Out-of-hours service by answering machine)

ADVERTISEMENT DEPARTMENT

ADVERTISEMENT MANAGER

Roger Hall G4TNT

Telephone: 0171-731 6222

Facsimile: 0171-384 1031

Mobile: (0585) 851385

ADVERTISEMENT DEPARTMENT (Broadstone)

Lynn Smith (Advertisement Sales)

Ailsa Turbett G7TJC (Advertisement Production)

Telephone: (01202) 659920

Facsimile: (01202) 659950

© PW PUBLISHING LTD. 1995.

Copyright in all drawings, photographs and articles published in *Short Wave Magazine* is fully protected and reproduction or imitation in whole or in part is expressly forbidden. All reasonable precautions are taken by *Short Wave Magazine* to ensure that the advice and data given to our readers is reliable. We cannot however guarantee it and we cannot accept legal responsibility for it. Prices are those current as we go to press. *Short Wave Magazine* is published monthly for £22(UK) or \$45 (USA) per year by PW Publishing Ltd., Arrowsmith Court, Station Approach, Broadstone, Dorset BH18 8PW. Second class postage paid at Middlesex, NJ. Postmaster. Send USA address changes to *Short Wave Magazine*, c/o Permit to post at Hackensack pending. The USPS (United States Postal Service) number for *Short Wave Magazine* is: 006696.

Cover Subject

Pipe-dreams. We review the stunning Wavcom 4100 Data Analyser.

Cover Photo: Craig Dyball



DISCLAIMER. Short Wave Magazine wishes in no way to either condone or encourage, listeners to monitor frequencies and services which are prohibited by law. We respectfully refer you all to both the Wireless Telegraphy Act 1949, and the Interception of Communications Act 1985. Some of the products offered for sale in advertisements in this magazine may have been obtained from abroad or from unauthorised sources. *Short Wave Magazine* advises readers contemplating mail order to enquire whether the products are suitable for use in the UK and have full after-sales back-up available. The Publishers of *Short Wave Magazine* wish to point out that it is the responsibility of readers to ascertain the legality or otherwise of items offered for sale by advertisers in this magazine.



Features

14 **Decoding Interfaces - Getting Started**
 Mike Richards G4WNC

18 **Wavcom W4100 Review**
 Mike Richards G4WNC

24 **Beginners Guide to RTTY**
 Mike Richards G4WNC

29 **How to Choose a Receiver for Data Reception**
 Mike Richards G4WNC

31 **Books and CD Roms for the Decode Listener**
 Mike Richards G4WNC

32 **Discoveries in 'Mundo Maya'**
 Richard Diamond G4CVI

37 **A Super-Regenerative VHF Receiver**
 Brian Adkinson

39 **JPS ANC-4 Antenna Noise Reducer - Preview**
 Mike Richards G4WNC

44 **Sets in Conflict - VE Day Commemoration**
 Ron Ham

48 **Lowe Factory Visit**
 Dick Ganderton G8V FH

Regular Columns

Airband	62
Amateur Bands Round-up	56
Book Store	79
Bandscan USA	51
Decode	68
Editorial	4
Grassroots	6
Grandad	11
Info in Orbit	65
Junior Listener	7
Letters	4
LM&S	70
Watching Brief	74
News	10
New Products	46
Propagation Forecast	49

Win a PRO-2035 base station scanner

Second part of our competition on page 54.

Rallies	6
Reflections	53
Satellite TV News	57
Scanning	60
SSB Utility Listening	59
Subs Club	46
Trading Post	77
Special Offers	
Subs Club	46

Good Listening

SWM SERVICES

Subscriptions

Subscriptions are available at £25 per annum to UK addresses, £28 in Europe and £30 overseas. Subscription copies are despatched by accelerated Surface Post outside Europe. Airmail rates for overseas subscriptions can be quoted on request. Joint subscriptions to both *Short Wave Magazine* and *Practical Wireless* are available at £42(UK) £47 (Europe) and £51 (rest of world).

Components for SWM Projects

In general all components used in constructing SWM projects are available from a variety of component suppliers. Where special, or difficult to obtain, components are specified, a supplier will be quoted in the article.

The printed circuit boards for SWM projects are available from the SWM PCB Service, Badger Boards, 80 Clarence Road, Erdington, Birmingham B23 6AR. Tel: 0121 - 384 2473.

Photocopies and Back Issues

We have a selection of back issues, covering the past three years of SWM. If you are looking for an article or review, or whatever that you missed first time around, we can help. If we don't have the whole issue we can always supply a photocopy of the article. Back issues are £2.30 each, photocopies are also £2.30 per article, plus £0.50 for subsequent parts of serial articles.

Binders, each taking one volume are available for £5.50 plus £1 P&P for one binder, £2 P&P for two or more, UK or overseas. Please state the year and volume number for which the binder is required. Prices include VAT where appropriate.

Orders for back numbers, binders and items from our Book Service should be sent to: PW Publishing Ltd., FREEPOST, Post Sales Department, Arrowsmith Court, Station Approach, Broadstone Dorset BH18 8PW, with details of your credit card or a cheque or postal order payable to PW Publishing Ltd. Cheques with overseas orders must be drawn on a London Clearing Bank and in Sterling.

Credit card orders (Access, Mastercard, Eurocard or Visa) are also welcome by telephone to Broadstone (01202) 659930. An answering machine will accept your order out of office hours and during busy periods in the office. You can also FAX an order, giving full details to Poole (01202) 659950.

Technical Help

We regret that due to Editorial time scales, replies to technical queries cannot be given over the telephone. If you require help with problems relating to topics covered by SWM, please write to the Editorial Offices, we will do our best to help and reply by mail.

editorial

When is a Camel not a Camel?

Following the publication last year of the very interesting feature on the radio communications used during the '94 Camel Trophy in South America, I received a letter from the BMA pointing out that SWM was helping to promote smoking!

Whilst not wanting to get into an argument about the rights and wrongs of smoking - but anyone who knows me personally will be aware that I am very seriously affected by cigarette smoke - I find myself in somewhat of a dilemma. The **only** name by which this intriguing 'off-road' event is known is the Camel Trophy and it is sponsored by a multi-million dollar leisure activities company marketing such items as watches, boots and leisure wear. Yes, I realise that they are part of a group with tobacco connections, but they use a totally different logo with not a committee designed horse in sight!

So - in this issue you will find another very interesting article on the communications set-up for this year's event. Just remember the health warnings - smoking can seriously damage your health!

Pipe-dreams

I firmly believe that everyone needs to have the odd pipe-dream. So, I make no apologies for presenting, in this issue only, the ultimate decoder's dream machine - the Wavecomm 4100. However, if past reviews of exotic gear are anything to go by, I fully expect that there will be some of you out there who will be adding this fantastic piece of equipment to your station!



Dick Ganderton

Dick Ganderton G8VHF

letters

The Editor reserves the right to shorten any letters for publication but will try not to alter their sense. Letters must be original and not have been submitted to any other magazines. The views expressed in letters published in this magazine are not necessarily those of *Short Wave Magazine*.

Dear Sir

It was very good of your to reply to my letter of February 9 regarding the Realistic DX390 world band portable radio. I would like to know more about it and if you could publish a request in your *Letters* pages for comments from other

users, I would be very grateful. Very many thanks again.

Joe Maitland
Hanslope
Milton Keynes

We can, we have, let's hope that someone out there has some info.

Dear Sir

I feel I must write and inform you of the most helpful and patient attitude of one of your advertisers, Satellite and Sound 2000 Ltd. I telephoned them as a result of their advert in *Short Wave Magazine* and, after some discussion, agreed to buy an almost new scanner.

After many hours delving in the instructions, I did manage to program some memories, although this did involve some 'phone calls to S&S 2000 Ltd., whose advice was most useful. I guess advancing years don't help with fiddling with hand-held scanner controls!!

The squelch control on a Maruhama RT618 is almost beyond reach of a mildly arthritic digit!! Having 'phoned S&S Ltd. to explain my problem, they (Martin) agreed straight away to change the unit for a PRO43 which has easier controls and is similar to the PRO44, which my better half has 'taken over'!

What super folks they are at St. Neots - only fair to give praise where due. I enjoy SWM greatly, having discovered the new airband listening hobby.

I learnt to fly in a Chipmunk in the 1950s and the electronics were partly hand signals from one aircraft to another! It's all very sharp and correct now - super fast speech and only a few off the cuff remarks.

My very best wishes to you.

E. Ralphs
Blythe Bridge
Stoke on Trent

IF YOU HAVE ANY
POINTS OF VIEW
THAT YOU WANT TO
AIR PLEASE WRITE TO
THE EDITOR. IF YOUR
LETTER US
PUBLISHED YOU WILL
RECEIVE A £5
VOUCHER TO SPEND
ON ANY SWM
SERVICE

Dear Sir

In the April edition of SWM (which I received yesterday) there is a letter about insurance from M. Gardiner, Hedge End, Southampton. I would like to say that only last week I consulted my insurance agent as regards to my radio equipment, including aerials and he assured me that **all** my equipment was fully covered through my contents insurance, (I pay the first £50 of each claim).

This is a new for old policy and if M. Gardiner is interested, the insurance firm is the Co-Op insurance - I suppose that there will be an office in Southampton.

N. Carrington
Sutton in Ashfield
Notts

Different companies seem to have differing clauses regarding radio equipment, it's best to check with your broker.

letters

Dear Sir

I have just picked up the April issue of *SWM* (my third 'cos I'm new to the game) and as I recently purchased an MVT7100 as my introduction to radio listening I have been interested in the letters on short wave use of this set. I have to agree with your comment at the end of Mr. Miller's letter. There's absolutely nothing wrong with a bit of DIY!

My wife won't let me get away with spending too much on this hobby so I have to be careful with the pennies! Therefore I decided on a 'cheap' version of the W&S kit. I must start out by saying that I haven't yet had time to put my 'bits' into operation, but I think they fulfil the W&S conditions for short wave listening and I look forward to trying them soon.

Firstly, £20 for a bit of wire - come off it. I reckon for receiving you don't need this. We aren't desperate for absolute impedance match (the balun and tuner take care of that). I will be using some single strand connecting wire (about £6 for 100m from Cirkit - at that price I don't mind if it is damaged by the wind!).

The balun you have to buy (£20). The a.t.u. is home made from a design in a book called *Practical Wire Aerials* (I think) which I borrowed from the local library. This set up is for receiving so doesn't need wide spaced capacitors.

I expected to have to buy the capacitors for about £20 from Maplin but picked up a pair at Picketts Lock for £7. Switches and knobs and coil formers from the scrap box. Plastics case from Cirkit (about £6) - Total cost about £40.

It would have been nice not to have to have spent this money but I feel a lot better knowing that I've saved £100 - now what can I buy with that?

By the way, I have just made a couple of flexible whip aerials (for 430MHz and 1200MHz) as well. These are made by soldering 0.75mm stainless steel wire into a BNC plug, insulating the inner with a bit of plastics tube (or coaxial inner insulation) and then crimping silicone rubber tube overall (to stop me poking my eye out!).

The end is sealed with epoxy resin filled with talcum powder (any perfume will do!). How much has this saved me?

Thanks for an interesting magazine.

David Guest
Harlow
Essex

Of course not everyone feels brave enough to indulge in a bit of home construction. Antennas, however, are probably the best way to get started.

Dear Sir

Many radio listeners rightly complain about the poor standard of medium wave and long wave reception available on modern domestic receivers. The popular stereo radio cassette units are, more often than not, particularly bad offenders in this regard.

I myself own one such unit (from a well known manufacturer) which gives a most unsatisfactory reception on medium wave, sensitivity is very poor, especially at the high end of the band. Furthermore, a serious problem of 'breakthrough' from strong short wave broadcasts occurs on the medium wave band (due to poor front end filtering allowing such signals to mix with local oscillator harmonics).

This can result in whistles and other 'phantom' interference, even when tuned to fairly strong medium wave stations. Amateur operators, transmitting on h.f. bands and blameless of any problem, could very easily, cause such image interference on these sets, and be held responsible.

Dear Sir

Inmarsat Monitoring.

Inmarsat is the medium which international trans-oceanic aircraft are moving to from h.f. voice communication. The satellite-equipped aircraft (steadily building in numbers) are transmitting a combination of ACARS data, cabin telephony and flight deck telephony. Some of the messages, including a propagation of the ACARS, are generally automatically.

If an aircraft is satellite equipped and within range of a v.h.f. ground station, the ACARS will route through either 131.55, 130.25, 129.025 or (in Europe) 131.725MHz. If out of range of a land based v.h.f. station, the equipment will redirect any messages via the satellite.

Following the recent radio communications monitoring convention last October in Atlanta, USA, such transmission via satellite have been available to the airband enthusiast for the first time.

The basic requirements are: a satellite dish of at least 1.8m, a wave guide feedhorn, a microwave r.f. amplifier, an i.f. (intermediate frequency) line amplifier, r.f. connectors, coaxial cable, insulated wire, a weatherproof cover and a receiver capable of f.m. reception from 1530.000 to 1545.000MHz.

Aircraft transmit on 1645.500 - 1646.500MHz, up-converted to Inmarsat from 3619.000 - 3620.00MHz. Receive is 1544.000 - 1545.000MHz, down-converted on Inmarsat from 6439.000 - 6440.000MHz.

Inmarsat reception is possible! The system is about to become a reality to many with a keen interest in aircraft monitoring. The estimated cost should be under £200, plus the dish. The cost of a suitable computer should also be considered.

I am following developments both in the USA and Australia and hope to report in the near future of further information as it comes to hand.

M. J. Wynn
Oxford

Dear Sir

First, I would like to give you my thanks for publishing such an interesting and easy to read magazine. I think that many non-native speakers, like me, enjoy it world-wide, without a chronicle use of a dictionary!

Then, I would like to ask

you for a favour. I'm French and living in Tokyo and a keen s.w.l. Nevertheless, there are only a very few non-Japanese s.w.l. in Japan. I would be very pleased if you could help me to find other English, French or German speaking s.w.l.s in Japan by publishing this letter.

Dear Sir

It appears that I have stirred up a hornet's nest with my recent criticism of rally venues! I read with a smile the very eloquent, yet irrelevant letter from T. B. Ellard, March issue.

Being a very interested, yet choosy member of the great, broad-based, hobby like ours surely does not mean that I must accept poor rally/exhibition conditions!

As a hobby, we have seen amazing technical advances, from the early 'crystal tickling' to the highly complex devices now available to us. What a pity, then, that we must be stuck in poorly sited venues to enjoy these 'goodies'.

Unfortunately, my wife and I are limited by circumstances to restricted distance and geography when attending shows/rallies, but our vote goes to the excellent Lincoln show-ground where one can enjoy our hobby in it's country aspect and abundant 'fresh air'.

Is it a sin to expect, and get, better facilities we wonder?!

E. Billiald
Nottingham

Perhaps voting with your pocket is the best solution to this problem.

Dear Sir

I am trying to obtain, for a severely handicapped friend, a replacement Van der Molen cassette unit, series 1000. This unit, consisting of cassette deck, associated printed circuit boards, twin VU meters and DIN socket was fitted, with other audio items, into a period furniture cabinet. It was marketed under the 'Havering' name by Mconomy (now Comet) in the 1970s.

Van der Molen of Romford still exist but now make printed circuit boards and have not carried spares for 14 years. Information leading to a perfect complete unit or a working cassette deck with no wear in any of the rotating parts would be greatly appreciated.

H. Tyson G3IXO
Somerset

In advance, thank you very much.

P.S. I can also be contacted by Fax: +81-3-3927-3709.

F. Collin
Japan

Good luck with finding some like-minded listeners.

grassroots

rallies

May 6: The Dartmoor Radio Rally is being held at Yelverton Memorial Village Hall, Meavy Lane, Yelverton, Devon. Doors open at 10.30am. There is enough parking for 600 cars with access for disabled visitors. There is also a playground for children, trade stands, a Bring & Buy and refreshments, etc. Talk-in on S22. For further details contact **Ron on (01822) 852586**.

May 14: The Dunstable Downs Radio Club are holding their 12th Annual National Amateur Radio Car Boot Sale at Stockwood Country Park, Luton, Nr. Jn. 10 M1. Doors open 10am until 5pm. Talk-in on 144MHz. Attractions include open day, environmental exhibits, side stalls, and free entry to the Mossman Collection of horse-drawn vehicles, craft museum, train and carriage rides, plus much, much more. **Ken Brewer on (01582) 451057**.

May 14: The Drayton Manor Radio and Computer Rally is to be held at Drayton Manor Park Zoo, Pazyby, Tamworth, Staffs on the A4091. The main traders will be in four marquees. There will be an outside flea market, large Bring & Buy stall, local clubs and special interest stands. Doors open at 10.30am. Make it a day out for all the family. **Norman G8BHE 0121-422 9787 or Peter G6DRN 0121-443 1189** evenings please.

May 20: The Ipswich Computer Show is being held at Willis Corroon Sports & Social Club, The Street, Rushmere St Andrew, Ipswich. Entry fee for adults is £1.50 on the day. Children under 14, DAPs, UB40 and wheelchair users only 50p. Doors open 10am to 4pm. Free parking. **Sharward Promotions on (01473) 272002 or FAX: (01473) 272008**.

May 21: The 11th Yeovil QRP & Construction Convention is being held at the Preston School/Centre, Monks Dale, Yeovil, Somerset. Doors open at 9am. Admission is £1.75. There is a free car park and refreshments all day. The convention will be preceded by a Morse Fun-run on each evening from Tuesday 9 to Friday 12 May. Further details can be obtained from **G3CQR, QTHR. (01935) 813054**.

May 28: The 19th Annual East Suffolk Wireless Revival will be held at The Maidenhall Sports Centre, Stoke Park High School, Ipswich, Suffolk. Doors open at 10am to 4pm. There will be a Bring & Buy, car boot sale, vintage radio display, Novice stall, rig clinic, antenna test, RAIBC, BYLARA and RAYNET stands plus lots more. Talk-in on S22 GB4SWR. Admission is £1.50 which includes car parking. Further details from **Bob Baal G7HZV on (01394) 271257**.

***May 28:** The Great Northern Rally, G-MEX, City Centre, Manchester. All the usual attractions, admission is £1.50. Doors open at 10.30am and close at 5pm. **0161-748 9804**. **Yes! This is the correct date! This year, the rally has changed from its usual February slot.**

May 28: The Maidstone YMCA Radio Rally. Route - M2 junc. 3 or M20 juncs. 4, 5, 6 or 7 then A229 to Loose Village, two miles south of Maidstone. QX5 GX8TRF (S22) and GX3YSC (10FM and SU22). Exhibition h.f. station GX3TRY. Doors open at 10.30am (free 10am admission for severely disabled). Entry fee £1.50 per adult. All day videos, free sweets and sickly drinks for juniors. Snack bar also available. Do your own Bring & Buy, outdoor tables for hire. **(01622) 743317**.

June 11: The annual Royal Navy Amateur Radio Society Rally will take place between 10am and 5pm on the Sports Field, HMS Collingwood, Fareham, Hants. **Clive G3YTD on (01329) 234143**.

June 17/18: The Bletchley Park Amateur Radio & Computer Rally is being held at Bletchley Park, Bletchley, Milton Keynes, Bucks. Doors open at 10am to 5pm, both days. This is a new rally in the grounds of the former Second World War top-secret code-breaking, cipher and intelligence centre. There will be special interest groups, Morse tests, numerous interesting displays, talk-in and a Bring & Buy. One price admission to rally and museum. For further details you can ring **(01923) 893929**.

***June 23-25:** Ham Radio '95 Friedrichshafen, Germany. The largest amateur radio show in Europe, and well worth a visit. The Flea Market alone is worth the journey and Friedrichshafen, situated on the Bodensee - Lake Constance to the English - and within easy reach of Austria and Switzerland, is a fantastic area for a holiday.

***June 25:** The 38th Longleaf Amateur Radio Rally. Further details from **Gordon Lindsay GOKGL on 0117-940 2950**.

July 2: The 6th York Radio Rally will be held in the Tattersall Building, York Racecourse, York. Doors open at 10.30am. Admission is £1.50. Children accompanied with adult FREE. Ample free parking. Amateur radio, electronics and computers, Morse tests and Repeater Groups. Refreshments and licensed bar. Talk in on S22. **Dave Moreland G7FGA (01904) 790079**.

If you're travelling a long distance to a rally, it could be worth phoning the contact number to check all is well, before setting off. The Editorial staff of **SWM** cannot be held responsible for information on Rallies, as this is supplied by the organisers and is published in good faith as a service to readers. If you have any queries about a particular event, please contact the organisers direct.

Editor

AVON

Bristol International RC: Tuesdays, 8pm. The Fighting Cocks Public House, Hengrove. All visitors are welcome. The club has been formed so that all radio enthusiasts, whether they be Licensed Amateurs, s.w.l.s or CBers can get together and have a good natter and do things that you do in radio clubs. PO Box 28, Bristol BS99 1GL.

South Bristol ARC: Wednesdays, 7.30pm. Whitchurch Folkhouse Assoc., Bridge Farm House, East Dundry Rd, Whitchurch. May 3 - 20m activity evening/committee meeting, 10th - Building computers - tech. upgrade, 17th - Aircraft video night, 24th - Club annual fox hunt. For more information ring (01275) 834282 on a Wednesday evening.

BUCKINGHAMSHIRE

Aylesbury Vale RS: Wednesday evenings, 8pm. Hardwick Village Hall, (Hardwick is situated off the A413 between Aylesbury and Buckingham). May 3 - Discussion evening, 17th - Cellular radio technology by M. Knight. Ivan Eamus G3KLT. (01296) 437720.

DERBYSHIRE

Derby & DARS: Wednesdays, 7.30pm. 119 Green Lane, Derby. May 3 - Junk sale, 10th - Weather instruments by Kevin Jones G4FFY, 17th - 'The islands on the air award' by Ken Frankcom G3OCA, 24th - Aerials - the weak link? Mrs Hayley Winfield, 2 Hilts Cottages, Crich, Matlock, Derbyshire DE4 5DD. (01773) 856904.

DEVON

Plymouth RC: Tuesdays, 7.30pm. The Royal Fleet Club, Devonport, Plymouth. May 16 - Selection of rally jobs, 23rd - Selection of Field Day team and helpers. F. P. Russell on (01752) 563222.

Torbay ARS: Fridays, 7.30pm. ECC Social Club, Highweek, Newton Abbot. May 19 - Junk and 90/10 sale. Peter G4UTO. (01803) 864528.

EDINBURGH

Lothians RC: 2nd & 4th Wednesdays, 7.30pm. Orwell Lodge Hotel, Polworth Terrace, Edinburgh. May 10 - DF hunt tune-up/club project workshop, 24th - 'Top Band' DF hunt - open to all (Braid Hills Hotel). GM4DIJ, QTHR on 0131-337 7311.

ESSEX

Vange ARS: Thursdays 8pm, Barnstable Community Centre, Long Riding, Basildon, Essex. April 27 - Wartime radio equipment. Doris. (01268) 552606.

GRAMPIAN REGION

Aberdeen ARS: Fridays, 8pm. RC Hall, 70 Cairngorm Crescent, Kinloch. April 28 - Earnest debate: 'This house believes that f.m. should be banned', May 5 - Junk sale, 12th - 2m P.A. project by Steve Gould GM0ULK, 19th - VHF/UHF field day planning. Martin GM0JCN. (01569) 731177.

GREATER LONDON

Crystal Palace & DRC: 3rd Saturdays, 7.30pm. All Saints Church Parish Rooms, Beulah Hill, London SE19. May 20 - Baldco and the Radio Interference Service by Colin Richards G3YCR. Wilf G3DSC on 0161-699 5732 or Bob on (01737) 552170.

Edgeware & DRS: Thursdays, 8pm. Watling Community Centre, 145 Orange Hill Road, Burnt Oak. April 27 - Morse training evening plus topical discussion, May 11 - EMC discussion, 19th - Straight key evening, 25th - NFD briefing plus Constructors Cup. Rod Bishop. 0181-204 1868.

Southgate ARC: 2nd & 3rd Thursdays, 7.30pm. The Pavilion, Winchmore Hill Cricket Club, Firs Lane, Winchmore Hill,

Club Secretaries:

Send all details of your club's up-and-coming events to: Lorna Mower, *Short Wave Magazine*, Arrowsmith Court, Station Approach, Broadstone, Dorset BH18 8PW. Please tell us your County and keep the details as brief as possible.

London N21 3ER. April 27 - Club radio on the air, May 11 - Talk 'Meanwhile what were the Germans doing?' by Mr Stan Wood, the Marconi historian, 25th - Club radio on the air. M. E. Viney GOANN. (01707) 850146.

Wimbledon & DARS: 2nd & last Fridays, 7.30pm. St Andrews Church Hall, Herbert Road SW19. April 28 - Come fly with me by GOAWQ, May 12 - Book Bring & Buy. (01737) 351313.

HAMPSHIRE

Hordean & DARC: 1st & 4th Tuesdays, 7.30pm. Lovedean Village Hall, Lovedean Lane, Lovedean, Hants. May 2 - Club night, 23rd - EMC by Nigel Gerdes G7CAW. S. Swain (01705) 472846.

Winchester ARC: 3rd Fridays, Red Cross Centre, Durngate House, North Walls, Winchester. 7.30pm. May 19: HF receiver design by Chris Cory G3MEV. P. Simpkins G3MCL. (01962) 865814.

HEREFORD & WORCESTER

Bromsgrove ARS: 2nd & 4th Tuesdays. Lickey End Social Club, Alcester Road, Burcot, Bromsgrove. May 9 - AGM. Barry Taylor. (01527) 542266.

HERTFORDSHIRE

Hoddesdon RC: Alternate Thursdays, 8pm. Conservative Club, Rye Road, Hoddesdon. May 3 - Inter-club darts match at Cheshunt Club, 11th - Planning permission talk by G3TZZ, 25th - Visit to Hertfordshire display co. with John Watkins G4VMR. Dave G1CAY on (01992) 460841.

KENT

Bromley & DARS: 3rd Tuesdays, 7.30pm. The Victory Social Club, Kechill Gardens, Hayes. May 16 - SSTV by A. Messenger G0TLK. A. Messenger G0TLK. 0181-777 0420

Maidstone YMCA ARS: Fridays, 8pm. YMCA Sports Centre, Melrose Close, Maidstone, Kent, ME15 6BD. April 28 - Rally meeting, May 5 - RAE, Morse tuition and club night, 6th - RSGB Morse test, 12th - Club night, Morse tuition, especially for beginners, 19th - RAE, Morse tuition and club night. (01622) 743317.

Medway AR & TS: Fridays, 7.30pm. Tunbury Hall, Catkin Close, Tunbury Avenue, Walderdale, Chatham, Kent. May 8 - VE Day Special Station, 19th - Getting Started in Contests by Dave G4BUO. G3VUN, 40 Linwood Avenue, Strood, Rochester, Kent ME2 3TR. (01634) 710023.

LANCASHIRE

Bury RS: Tuesdays, 8pm. The Mosses Centre, Cecil Street, Bury. May 2 - Committee, 9th - Life on the ocean waves by G0PNL, 16th - RSGB video, 23rd - Technical forum and beginners c.w. class. Laurence G4KLT. 0161-762 9308.

LINCOLNSHIRE

Lincoln SW Club: Wednesdays, 8pm. City Engineer's Club, Waterside South, Lincoln. May 10 - AGM, 17th - Visit to RAF Waddington. (01427) 788356.

MERSEYSIDE

Wirral ARS: 1st & 3rd Wednesdays at Ivy Farm, Arrowe Park, Birkenhead, Wirral. Informal natter nights on each Tuesday. May 3 - 'Audio' Part 2 by Cedric Cawthorne, 17th - Visit to A.R.C. Newton le Willows. A. Seed G3FOO on 0151-644 6094.

NORFOLK

Norfolk ARC: Wednesdays, 7.30pm. Formal and informal meetings at The Norman Centre, Bignold Road, Off Drayton Road between 'Asda' and Three Mile Cross Roundabout, Norwich. May 3 - GB3NB repeater group AGM, 10th -

Night on the air/construction QRP/Morse practice, 17th - Radio navigation by Dr. Philip Lawrence G8MRQ, 24th - Night on the air/construction QRP/Morse practice. Mike G4EOL. (01603) 789792.

NOTTINGHAMSHIRE

Mansfield ARS: 2nd Mondays, 7.30pm. The Polish Catholic Club, off Windmill Lane, Woodhouse Road, Mansfield. May 1 - AGM. Mick G0UYQ, QTHR. (01623) 792243 or Howard G1JGY, QTHR. (01623) 423697.

South Notts ARC: Fridays, 7pm. Highbank Community Centre or Fairham Community College, Farnborough Road, Clifton Estate, Nottingham. April 28 - Construction plus on air h.f. and v.h.f. Julie Brown G0SOU. (01509) 672734.

OXFORD

Oxford & DARS: 2nd and 4th Thursdays, 7.30pm. The Grove House Club, Grove Street, off Banbury Road, Summertown, Oxford. D.A. Walker G3BLS on (01865) 247311.

Vale of White Horse: 1st Tuesday of each month, 8pm at The Fox, Steventon. Ian White. (01235) 531559.

SHROPSHIRE

Salop ARS: Thursdays, 8pm. Oak Hotel, Shrewsbury. April 27 - RAE tuition and workshop evening, May 4 - Junk sale, 11th - Telford rally group night, 18th - 2nd foxhunt. Ian Davies G7SBD, QTHR. (01743) 463711.

SOMERSET

Yeovil ARC: Thursdays, 7.30pm. The Red Cross Centre, 72 Grove Avenue, Yeovil. April 27 - 1st meeting of the new committee and club station on the air. Cedric White, QTHR. (01258) 473845.

WARWICKSHIRE

Stratford-upon-Avon & DRS: 2nd & 4th Mondays, 7.30pm. Home Guard Club, Main Street, Tiddington, Stratford-upon-Avon. May 8 - Digital broadcasting, 22nd - 2m foxhunt. Martin Rhodes G3XZO. (01789) 740073.

WEST MIDLANDS

Sandwell ARC: The Broadway, Warley. RAE class on Monday nights, Morse class on Wednesday nights and RAE Novice class on Thursday nights. Three operating shacks, h.f./v.h.f./u.h.f., Phone, c.w., RTTY, AMTOR, Packet, all bands. Talks, outings, contest and demonstrations. For further information please ring 0121-552 4619/0121-552 4902. (01634) 710023.

WEST YORKSHIRE

Denby Dale ARS: Wednesdays, 8.30pm. Pie Hall, Wakefield Road, Denby Dale, West Yorkshire. May 3 - Simple ATV 10GHz by John G6GSV, 14th - Drayton Manor Rally coach trip, 17th - Sky Update by Phil G4FSQ, 24th - Fox hunt. Denby Dale ARS also provides RAE, Morse and Novice RAE classes and is a registered City & Guilds examinations centre for both the RAE and Novice RAE exams. Further details from the examinations secretary Brenda G4OTE on (01484) 424776 or secretary Kevin G1FYS on (01484) 547553 for club activities.

Keighley ARS: The Ingrow Cricket Club, Ingrow, Keighley. Thursdays, 8pm. April 27 - Junk sale, May 4 - Natter night, 11th - Fox hunt, 18th - Natter night, 25th - Amateur TV demo by G3TQA. Kathy GORLO. (01274) 496222.

WILTSHIRE

Trowbridge & DARC: 1st & 3rd Wednesdays, 8pm. The Southwick Village Hall, Southwick, Trowbridge. May 3 - Visit by G4YNM of Ben Spencer Consultants, who will be displaying and demonstrating his range of kits and modules for the radio amateur. Ian G0GRI. (01225) 864688.

Elaine Richards
PO Box 1863,
Ringwood,
Hants BH24 3XD.

junior listener

DXTV

Katy Martin (15) has written from Margate asking about starting in DXTV. So, if you think you could get interested in searching for both foreign TV signals and ones many miles away, where do you start?

Well, DXing television systems isn't something I've ever been really interested in, but (to use a well-worn phrase) 'I know a man who can' help. I would encourage anyone thinking about this area of the hobby to get yourself the latest catalogues from both Aerial Techniques, 11 Kent Road, Parkstone, Poole, Dorset BH12 2EH. Tel: (01202) 738232 and HS Publications, 7 Epping Close, Derby DE3 4HR. The people involved with these companies are real enthusiasts when it comes to TV DXing and are, therefore, a great source of information.

Unfortunately, even to receive signals from other TV regions in this country you do need specialised equipment. Things like a steerable (often called rotatable) high-gain antenna (and the equipment to turn it through 360° hunting for signals) and probably a pre-amp to boost the signal too.

As for watching foreign channels, then you will probably need a special kind of television receiver too - I don't expect many of you have them in the lounge. Different countries use different formats - what I mean by that is that their TV signals are produced by different methods to ours. Have you ever tried to play a video you bought on a foreign holiday on your own video when you got home? If you did, it probably didn't work unless you have a special kind of video player - we have one, for example, that plays the American NTSC system video tapes as well as our own PAL ones. Books telling you what channels to watch and who the various test-cards you may come across belong to will be an asset - a bit like you use frequency guides on the broadcast bands to help locate stations.

Companies like Aerial Techniques can supply all the equipment you need and HS Publications produce booklets to help you on your way. It doesn't have to be expensive (but like most areas of this hobby it can be!). Don't expect to be able to sit down, tune around the TV channels and

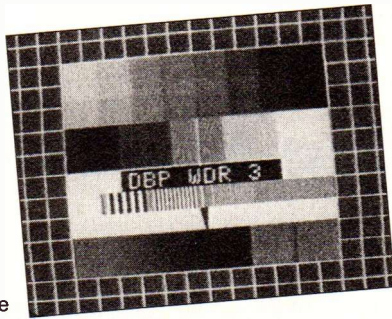

watch beautiful pictures from all over the world. It doesn't work like that. You need even more patience for TVDXing than you do for broadcast listening. Pictures fade in and out, the sound is usually transmitted separately and so you need a receiver for that, and sometimes you won't be able to lock onto a picture for days at a time.

The summer months can often be a good time to start looking for TV signals as there are atmospheric anomalies (commonly known as lifts) to help. If the weatherman gives out a warning of unusual atmospheric and apologies for the state of your TV signal, that's a good time to try TV DXing.

If you have some back issues of *Short Wave Magazine*, look for a column called 'DXTV Round-up', Ron Ham gave lots of examples of the kind of picture you can expect to receive.

New Book

Many of the national and international listening groups produce very good literature that is suitable for beginners and the experienced alike. The British DX Club have published the 13th edition of their *Radio Stations in the United Kingdom*. It's a 43-page, A5 booklet that lists all the British medium wave and f.m. radio stations, both BBC and independent ones in frequency order. You also get the information on their location and transmitter power too. There is also an alphabetical listing giving the station name, address and telephone/fax number.

One thing that is always pleasing is when you see a very reasonable price tag alongside so much useful information. At just £2.50, including postage, you get a lot of information for each penny spent!

If you're interested, send your money to:
British DX Club, 126
Bargery Road, Catford, London
SE6 2LR.

Silence is Golden!

Listening, whether you are into broadcast station, amateur station or scanners, is a very individual hobby. But, unless you use headphones, you tend to share what you are hearing with all those around you. Not always something to make you popular, especially if you are DXing late at night when everyone else is trying to sleep!

If you are experimenting with some of the 'greyer' areas of listening, then using headphones is a must. Unfortunately, not all radios come with headphones, especially if you are buying second-hand, or you may only get an ear piece provided. The cause of all this - a press release from Maplin Electronics for their new earphones. These are the kind that fit into the outer part of your ear and are very light and

comfortable. The new type are stereo earphones with samarium cobalt speakers and cost £6.99. They come with a case to store them in and a 3.5mm gold-plated jack plug. The impedance is 22 to 32Ω and that's for a frequency range of 15Hz to 20kHz.

I've used these types of earphones when using my Philips portable on holiday. I found them to be great to use - small to pack - and they enabled me to listen in peace.

If you've got a Maplin catalogue you'll find them under the code RZ93B.

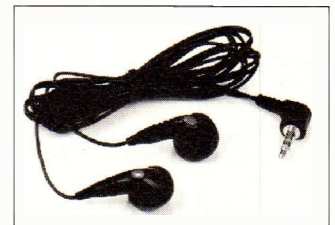

Competition

Maplin Electronics have just introduced some new personal earphones featuring cobalt magnet speakers. They are mentioned some where else on this page.

Maplin have very kindly offered six sets as prizes. You can win a pair for listening to short wave, airband or even the hi-fi. All you have to do is answer the three questions below. All the correct answers will be entered in to a draw. Next month I'll pull out six correct answers and announce the winners

Questions:

1. What's the symbol for the chemical element cobalt?
2. What does dB stand for?
3. What's the frequency range and impedance of the Maplin phones?

Don't hang about - get your answers off to me at the address at the top of then page. All entries must reach me by the 26 May. Good luck.

Change of Address

Many 'junior listeners', when they are first involved in the hobby of listening, try to obtain some of the many awards around. It's a nice way of showing other people that you've achieved something. If you are working towards one of the International Short

Wave League Awards, then you should note that their Awards Manager has changed. You should now address everything to:

Herbert Yeldham
G-20006/G6XOU, ISWL Awards
& Contest Manager, Belle
Fleurs, Wade Reach, Walton on
the Naze, Essex CO14 8RG.

Oops!

Both Geoff Chance and Chris Carrington have pointed out that some of the dates mentioned in the list of rallies the ISWL are attending were muddled. I'm sorry and hope that no-one made any fruitless journeys. Here's the correct list.

May 28
June 11
June 25
July 8
August 19/20
September 3

Plymouth Amateur Radio Rally
Elvaston Castle Mobile Radio Rally
Longleat Amateur Radio Rally
Cornish Amateur Radio Rally
Staffordshire Hamfest
TARRG, Telford

LISTENING TO

Successful Listening Starts Here . . .

New from Kiwa Electronics - the Medium Wave Loop

The loop antenna no serious MW DXer will want to be without
Table top installation
Signal regeneration
Coarse/fine tuning control
Built-in compass
Tilt control



Just £349.00

plus £10.00 P+P



New from JPS Communications ANC4

Antenna noise canceller
Effectively reduces power line noise,
computer noise, TV timebase noise
and many other interference signals.

See the review in this issue!

Just £189.00

plus £5.00 P+P

INTERNET ADDRESS:

orders@lowe.demon.co.uk
info@lowe.demon.co.uk
New check out Lowes new
pages on the World Wide Web
<http://www.demon.co.uk/lowe/index.html>

BERKSHIRE

3 Weavers Walk
Northbrook Street
Newbury
Tel: (01635) 522122

NORTH EAST

Mitford House
Newcastle Int. Airport
Newcastle Upon Tyne
Tel: (01661) 860418

WALES & WEST

79/81 Gloucester Rd
Patchway
Bristol
Tel: 0117-931 5263

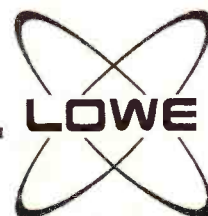

Low

Chesterfield Road

THE WORLD



Lowe Electronics jump start the frog!

"What a difference! There is no comparison! ...The Kiwa filters have turned the Yaesu into a real DX rig." Elton Byington - DX Ontario

Tests on the FRG100 have show that the -6dB bandwidths of the AM filters are typically wider than the published specifications. A test sample showed 9.1kHz and 7.5kHz where the specifications read 6 and 4kHz respectively. For many people this has put them off considering the FRG100 as a replacement for older equipment, quite a shame as the basic receiver and the operating facilities represent very good value.



The FRG100 is probably one of these products where a little bit of money spent will make quite a difference to those who do need the extra performance and for those people, we are pleased to announce the FRG100DX. The FRG100DX will already have the new filters fitted by Lowe Electronics and each will be provided with its own test certificate during the course of our modifications and alignment.

Kiwa Electronics in the USA have specialised in filter upgrades for a number of years and as their newly appointed European distributor, we are pleased to be able to offer their highly acclaimed upgrades for the FRG100. Kiwa's IF filter upgrade dramatically improves both wide and narrow band performance of the FRG100 receiver by replacing both AM filters with superior modules offering a tremendous improvement in selectivity.

Each replacement filter uses Filter Module technology for precise filter requirements. Each module is constructed of three cascaded ceramic filters with input and output buffer amplifiers for maximum performance. Other features include zero insertion loss and a guaranteed shape factor (-60dB/6- 6dB BW ratio) of less than 1.8, typically less than 1.65. For the 6kHz filter we've chosen a 6kHz model from Kiwa Electronics.

This gives a performance almost equal to Yaesu's 4kHz (!) This will make quite a difference to selectivity and you'll notice an immediate improvement in performance. This is ideal for general listening right across the short-wave bands and in particular on medium wave.

For the DX chaser, we've chosen to replace Yaesu's 4kHz with Kiwa's 3.5kHz filter offering once again a huge leap in performance. We feel this is a great choice for the avid broadcast band DXer as it offers the best compromise between fidelity and digging the signal out of strong interference.

SOUTH EAST

Communications Hse.
Chatham Road
Sandling, Maidstone
Tel: (01622) 692773

YORKSHIRE

34 New Briggate
Leeds
North Yorkshire
Tel: 0113-245 2657

SOUTH WEST

117 Beaumont Road
St. Judes
Plymouth
Tel: (01752) 257224

EAST ANGLIA

152 High Street
Chesterton
Cambridge
Tel: (01223) 311230

Lowe Electronics

, Matlock, Derbyshire DE4 5LE Tel: (01629) 580800 Fax: (01629) 580020

The CONET Project

We have been informed of a plan to produce a CD of spy station recordings. The record label - 'Irdial Discs', will release the collection of the infamous numbers stations, which are heard with clockwork regularity on the h.f. bands 24 hours a day, around the globe. Signals to be included are MOSSAD stations, the 'British Man', 'Bulgarian Betty', the '3 Note Oddity', the 'German Child's Voice' and many others.

The CD will include signal types from the some 30 year history of these stations, which are used by the world's intelligence organisations to communicate with agents in the field.

It is planned that the signals will be presented both as received and in a noise removed form. The 'Sonic Solutions' profiling system will be used to remove the background noise.

The Sonic Solutions system is claimed to be so powerful, it can take a recording from an answering machine, and resolve the background noise so that it is completely inaudible! When applied to the Numbers stations recordings, Irdial say the results will be spectacular.

Irdial are still looking for sources of recordings, particularly those of stations that are no longer transmitting. All contributions will be fully credited. Submissions can be made on any recording format, and all media will be returned to their owners. Recordings with logs are preferred, since the project will form a historical documentation of the numbers phenomenon. The CD is apparently to be catalogued by the British Library.

Contributions should be sent to
**Irdial Discs,
Attention Numbers,
PO Box 424,
London SW3 5DY.
Fax: 0171-351 4858,
Internet:
irdial@irdialsys.win-uk.net.**

Sunday Open Day for W&S

Waters & Stanton will once again be holding their annual Open Day at their Hockley premises. The Open Day, which is free to all, will be held on 21 May between 1000 and 1700.

As on previous Open Days there will be a 'vast quantity' of special offer items.

Visitors are advised not to be late, as in previous years there have been queues of bargain hungry customers at dawn. Jeff Stanton tells us that every department is making a special effort to clear stocks.

Refreshments will be provided free of charge to help those weary bargain hunters. For further information contact **Waters & Stanton Electronics, Spa House, 22 Main Road, Hockley, Essex SS5 4QS. Tel: (01702) 206835, Fax: (01702) 204965.**

Lowe Caught on the Web

Lowe Electronics now have a home page on the World Wide Web at address <http://www.demon.co.uk/lowe/index.html>

The page has currently just completed the 'genesis' stage and is growing daily. Lowe intend to eventually have their entire catalogue of receivers, scanners, amateur radio equipment and accessories available on line.

They will also upload onto it technical reviews, articles on antennas, decoding, etc. plus in depth third party reviews of their own receiver range.

Comments from users are welcomed as to the type of information that they would like to see on the page as the database slowly builds up.

Non E-mail users can contact **Low Electronics** at their Headquarters, **Chesterfield Road, Matlock, Derbyshire DE4 5LE. Tel: (01629) 580800.**

National Transmitter News

New BBC FM Transmitters

March 7 Keswick Forest, Cumbria. This new station brings good f.m. radio reception, including stereo, to approximately 6700 people in Keswick, Bassenthwaite and surrounding areas. The station is located some 4km north west of Keswick, it entered service following a period of test transmissions which began on Thursday January 19 1995.

The frequencies used by the station are, Radio 1 99.2MHz, Radio 2 89.6MHz, Radio 3 91.8MHz and Radio 4 94.0MHz. The polarisation for external and loft mounted antennas is **horizontal.**

Further information on f.m. reception in the Cumbria area including advice on fitting an external f.m. antenna, is available from:

Engineering Information
BBC Broadcasting Centre
Barrack Road
Newcastle-upon-Tyne
NE99 2NE
Tel: 0191-232 1313

or

BBC Engineering Information
Villiers House
The Broadway
Ealing
London W5 2PA
Tel: (0345) 0101 313
(local call rate)

NVCF'95

The forth National Vintage Communications Fair will be held on May 14 at the Pavilions Hall of the NEC. Featured will be thousands of rare and collectable vintage technology items with a special emphasis on early radios, television receivers, gramophones, telephones and classic 1950s Hi-Fi. In attendance there will be over 300 specialist dealers from the UK, Europe and the USA. This is reputed to be the event of the year for the seasoned collector.

For the newcomer pondering as to whether to take up collecting, there will be helpful advice and guidance on hand from many leading collectors' clubs, societies and specialist magazines.

The fair is presented annually by the *Sound and Vision Yearbook*, which is a comprehensive reference guidebook in this field. For early arrivals at this year's fair the admission fee of £5 includes - while stocks last - a complimentary copy of the latest edition of the *Yearbook*, which is normally £3.50.

The fair starts at 1030 and the doors close at 1700. Enquiries to the organiser, **Johnathan Hill, NVCF'95, 2-4 Brook Street, Bampton, Devon EX16 9LY. Tel: (01398) 331532.**



The best of classic British audio - model TL/10 10W monoblock amplifier with Point One control unit, made by H.J. Leak & Company of Acton, London W3 in 1954.



The Maxfield offer to buy the programme and transmission arm of the ailing Gibraltar Broadcasting Corporation is still on the table, including the programme maker 'Strait Vision Productions', according to the Gibraltar Chronicle. In a new twist the GBC are wanting, it is rumoured, to off load the Strait Vision contract though recent press suggests that GBC are still offering programme commissions to Strait. With GBC now relaying the 'BBC Prime' satellite service during the day (with opt outs for GBC own offerings), locals are none too happy with the BBC service of repeats, preferring the earlier BBC World Service.

Ajman is a small state in the United Arab Emirates and a forth government owned TV station will open in 1996. Two programme channels will be on offer, one in Arabic and the other offering foreign language programmes.

It's thought that initially nearly 30 DAB transmitters will be established in the UK with five around the capital city. The London service will radiate from Crystal and Alexandra Palace, Guildford, Bluebell Hill and Reigate. Other DAB outlets will be constructed in the main population areas, Bristol, Cardiff, the North East, North West and Belfast.

Better pictures in the Sudan with the National Television Service buying eight new transmitters to relay the first programme in Duwaym, Buram, Kassala, Dongola, Fulah, Kadugli, Juba and Malakal.

The close down of the Norwegian Band 1 transmitters will 'take quite a long time' and a time span of two to three years is suggested, the replacement u.h.f. transmitter operating in parallel alongside the terminating Band 1 partner. Gamlesveten already has the parallel u.h.f. transmitter installed and this year will see parallel units sited at Hemnes, Bagn and Melhus. The Norwegian Telecoms Authority state the reason for Band 1 closure is the interference levels experienced during the Sporadic E season and the need to utilise Band 1 frequencies 'for other use'! The first Band 1 closures should therefore not happen until 1997/8.

A letter from Robert Copeman (Australia) stresses that their u.h.f. channels differ slightly from the European channel allocations, for example their ch.31 is 548.25MHz vision where-as ch.E31 Europe is 551.25MHz, a full tabulation appears in the *World Radio TV Handbook*. Channel 31 is used extensively in Australia for community TV such as CTS 31 - Sydney, NSW; MCT 31 - Melbourne; BRIZ 31 - Brisbane, Qld and ACE 31 - Adelaide. Alice Springs is shortly having a commercial station (TEN Network affiliate) and operating on ch. 31 - though not as a community station. In mid-January '95 Robert received via Sporadic E, several 1W tourist information f.m. stations from North Queensland, the Gold Coast, Qld and Northern NSW, hopefully a pointer of better things for our Sporadic E season in May onwards.

ISWL Awards Change

We have been informed by Chris Carrington that, as of April, the address for the ISWL Awards Manager will become:

Mr Herbert Yeldham (G-20006/G6XOU)
ISWL Awards and Contests Manager
Belle Fluers
Wade Reach
Walton on the Naze
Essex
CO14 8RG



Anyone wishing to obtain details or apply for any of the ISWL awards should contact Herbert.

Malta VE Day Station

The AREC club in Malta have organised an event station for the Victory in Europe Day commemorations. The call-sign for the event is 9H50VE, the station will be on air for 24 hours on the May 6, 7, and 8 1995. Proposed frequencies to be used are 3.775, 7.044, 14.225, 21.20 and 28.55MHz s.s.b.

Direct QSLs only will be accepted with two dollars accompanying the report. QSL requests should be sent to **9H50VE, PO Box 114, Valletta CMR01, Malta.**

Summer DX Guide

The annual Summer edition of *Transmissions in English 1995* is now available from the World DX Club. Compiled by Alan Roe, this is a 24 page A5 size, listing of English language programmes broadcast on short wave stations world-wide. The listing is organised in time sequence. Details of time, station, country, target and frequencies used, are given. Where relays are used the transmitter locations are also supplied.

The guide is ideal for packing together with a portable radio when travelling abroad.

Transmissions in English 1995 is available from the **World DX Club, 17 Motspur Drive, Northampton NN2 6LY**. Price £1.00, \$2.00 or three IRCs.

Listen With Grandad by Leon Balen & David Leverett

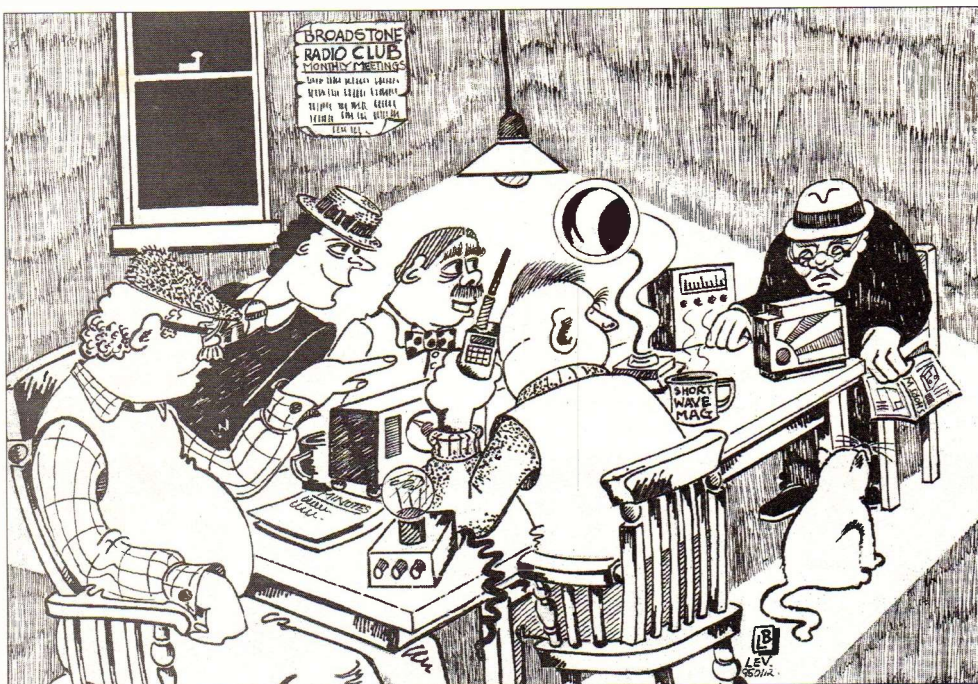

The only thing poor old Fred gets on his receiver these days is dust.

Wrong Price

Last month we inadvertently misprinted the price for the Barton Communications Magnetic Balun. The correct price is £21.45. The complete antenna kit costs £27.95. Barton Communications can be contacted on **Tel: (01325) 377086** for further information.

Your news and product details can reach thousands of listeners, drop a line to Kevin. Post, Fax or E-mail accepted.

YOU DECIDE - WE PROVE

OPTOELECTRONICS PRICES SLASHED



OPT-3300

The latest mini freq. finder from Optoelectronics (smaller than a packet of cigarettes.) Inc. NiCads/Charger/Ant. (1MHz-2.8GHz) £169.95

£139.95

P&P £6



OPTO-SCOUT

New - top of the range mini counter 400 memory system. Filters Pc Compat. 10MHz-2.8GHz. £399.95

£349.95

Includes: NiCads/Charger/Antenna

SCANNING ACCESSORIES

BSS-1300

Double nest of dipoles. The ultimate base antenna! Receives 10-1300MHz. Supplied with 10m coaxial lead and BNC plug fitted. 34" high, loft or outdoor mounting use a flat wall or pole mount. **£69.95** NB. Antenna mounts vertically Delivery £7



YUPITERU'S TOP UK DEALER

MVT-7000

Do you really want SSB. If not, then this is the one for you. Still the UK's best selling mid priced h/held scanner on the market. It will pick up everything from 8MHz to 1300MHz without any gaps. Complete with Nicad's and Charger. £289



PLUS

OUR PRICE **£269**

We are giving away a FREE PA-600 power amplifier worth £30 with every MVT-7000 sold this month.

ALSO STOCKED

MVT-7100	£389	£CENSORED
MVT-8000	£369	£CENSORED
MVT-225	Civil/Military Aircraft	£225
MVT-125	Civil Aircraft	£169

AOR - THE ULTIMATE RANGE

AR-8000

The only h/held scanner with full computer compatibility. Covers 500kHz - 1.9GHz. Why not part-ex your old scanner and move into the 21st century. We guarantee best part exchange deals around. £449



OUR PRICE **£389**

ALSO STOCKED

AR-2700 0.5 - 1300MHz	£289	£259
OPTIONAL VOICE RECORDER		£39.95

NETSET PRO-44

Listen to Aircraft, Ham, Marine and much more with this superb scanner. Covers 66-88/108-174/380-512MHz



£149.95

OUR PRICE **£114.95**

ALSO STOCKED

Realistic PRO-43

Handheld scanner covers 66-88/118-174/220-512/806-999MHz ~~£249~~ OUR PRICE

£199.95

NiCads/Charger/PSU for the above only £15.99

NEW

MA-339

Mobile holder suitable for all handhelds. Superb - no marks - "It just grips your handy" - fits anywhere - quick "push button release". To top it all there's an optional airfreshner facility!



INTRO OFFER

£9.99

P & P £2

AR-3000A

Full coverage from 100kHz straight through to 2036MHz. Includes RS232 interface for computer control. £949



OUR PRICE

£845

ALSO STOCKED

AR-3000A PLUS Now with even greater performance. ~~£999~~ OUR PRICE **£899**

AOR SDU-5000

A must for any serious VHF/UHF monitoring station. Spectrum display unit enables you to monitor up to 10MHz of a selected band on a LCD colour display. £799



OUR PRICE **£699**

ICOM ICR-7100 DC

The ultimate VHF/UHF receiver covers everything from 25MHz - 2GHz with performance that can't be matched. (2 year guarantee). £1449



OUR PRICE **£1249**

PLUS ICR-9000 (100kHz - 2GHz) You won't miss any radio transmissions with this receiver. ~~£5499~~ OUR PRICE **£4399**

DSS-1300

Low profile desk top nest of dipoles receives 10-1300MHz. Supplied with coaxial cable and BNC plug fitted.



£44.95

Delivery £3

NEW UK SCANNING

DIRECTORY 4th Edition

Packed with frequencies. From 25 to 1300MHz.



£17.50

INCLUDING FREE P&P

THE ONLY SERIOUS GUIDE.

SCAN BUSTERS

How to tune into more frequencies and beat new technology.



ONLY

£4.95

+ £1.00 P&P

SCANNING ACCESSORIES

P&P £1 on any of the following:

OP-51	Case (7100)	£17.95
OP-50	Case (7000)	£17.95
CA-8000	Case (8000)	£17.95
CA-7200	Case for PRO 43/44	£14.99
QS-200	Air vent mount H/helds.	£9.99
QS-300	Desk mount H/helds.	£19.99
NE-1023	Scanner ant (rubber)	£8.99
NE-1012	Scanner ant (black telescopic)	£9.99
TSC-2602	Scanner ant (rubber)	£22.95
ABF-125	AOR airband filter.	£24.50
S.W.F.M.	S.W. guide lists everything from 0-30MHz	£12.95
L.W.K.	Long wire kit N.B. p&p £3	£24.95
SP-55	Scanner Pre-Amp	£74.95
PA-600	Power Amp + speaker	£29.95
HS-5	Kenwood deluxe H/phones	£49.95
HS-6	Kenwood lightweight H/phones	£32.95
MA-339	Adjustable Mob holder	£9.99
Introduction to Scanners (Book)		£4.95

NB: P&P on SP-55 is £5

HAYDON COMMUNICATIONS

WARNING!! Not all advertisers in this magazine are authorised stockists for the products they sell. Manufacturers advise customers to purchase from authorised dealers to ensure full company guarantee back up. HAYDON COMMUNICATIONS sell only brand new factory sealed stock direct from the manufacturers & are authorised for all its brands.

IDE. CALL 0181-951 5781/2

★ STOP PRESS ★ STOP PRESS ★ STOP PRESS ★ STOP PRESS ★

NEW SWA-30 At last we've solved the problem! No more upsets with the neighbours or the other half! No more strange things sprouting from the chimney or stretching down the garden. Yes, it's a self contained passive (non-powered) desk or wall mount shortwave antenna. (0-30MHz) and don't forget - you will not have to go out and spend £45 on a magnetic balun - it's got one fitted.

All this for **£44.95** - how did we do it - with great difficulty. p&p £4.00



Sangean ATS-803A

Our best selling low priced portable short wave receiver. All modes including s.s.b. ~~£129~~

£119.95

£5 delivery

PORTABLE SHORTWAVE NEW SONY SW-7600G

With synch AM. 0.15-30MHz all mode.

~~£179.95~~ OUR PRICE **£159.95**

ALSO STOCKED

SONY SW-100	£199	£179.99
SONY PRO-80	£249	£299.99
SONY SW-77	£399	£349.99
RC-818 S/W + cassette	£219	£199.00
RC-817 S/W portable	£189	£169.00
ATS-818 NEW portable s/w		£159.95
HF-150 port/desk top	£389	£349

MBR-8

This low priced short wave receiver is a must for the beginner. So full of facilities that we don't have space to list them all here. Will also receive airband/marine & PSB's.

£64.95

DELIVERY £6



KENWOOD R-5000

This classic from Kenwood is still the best selling top range communication receiver. Covers 100kHz - 30MHz.

~~£999.95~~

OUR PRICE **£PHONE**



DRAKE R-8E

★ 100kHz - 30MHz communication receiver

★ Passband tuning ★ Built-in pre-amp & selectable AGC ★ Twin VFO's timer functions ★ Dual noise blanker ★ RS-232 interface for complete control ~~£1195~~

OUR PRICE **£1095**



YAESU FRG-100

UK's best selling short wave receiver. In case you missed our Yaesu challenge, we're always glad to take your old receiver in a part-ex. We guarantee the best part-ex deals in town. ~~£559~~

OUR PRICE **£499**

SWA-30 ANTENNA WORTH £45 FREE WITH THE FRG-100



NEW AT-100

Active antenna + preselector. Superb indoor antenna/tuner. (300kHz-30MHz) Batt's supplied.

Optional **£79.95** FREE P&P (AC PSU £7.95)

ANTENNA TUNING UNITS

HOWE CTU-8

Ready built! Ready to go! 0.5-30MHz. Improve your SW receiver with this little beauty.

£49.95 + free del

ALSO STOCKED

GLOBAL AT-2000... Our price..... £95
CTU-8..... Kit..... £29.95



DIGITAL AUDIO FILTERS TIMEWAVE DSP-9 PLUS

The ultimate digital noise filter. Previously reviewed with top rating.

**** OUR PRICE **£229.95**

ALSO STOCKED

DATONG FL-3 ~~£149.95~~ £139.95
MFJ-784 ~~£249~~ £239.95

UK's LARGEST STOCKIST OF SECONDHAND EQUIPMENT

LOWE HF-150



Communication receiver.

As new... **£329**

Drake R-8E	Ex demo	£949
R-72	Ex demo	£649
R-70	VGC	£449
R-5000	Ex demo	£839
R-71	As new	£649
R-7000	As new	£749
ATS-803A	VGC	£89
SW-7600	VGC	£99

YUPITERU MVT-8000



As new (8-1300MHz)

£299

AR-2002	(8-512)	£299
AR-2500	(0.5-1300)	£329
AR-950	(60-950)	£149
MS-1000	(0.5-1300MHz)	£219
AIR-7	As new	£169
Sony SW-1ES	(complete kit)	£149
SW-1E	Minature S/W	£99
SW-22	Minature S/W	£49

YUPITERU MVT-7100



Complete as new

£299

PRO-43	(66-1800MHz)	£169
PRO-39	(66-960MHz)	£149
HP-2000	(0.5-1300)	£199
MVT-7000	(1-1300)	£229
AR-2000	(0.5-1300)	£219
BC-200XLT		£169
PRO-44	As new	£99
Alinco DJ-X1D	As new	£249

NOTE: ALL ABOVE FULLY GUARANTEED: EX DEMO - 12 MONTHS/SECONDHAND - 3 MONTHS

NB: ALL PRICES INCLUDE VAT

★ Outside office hours 01850 586313 ★ Mail Order: Same Day Despatch ★

Sales/service:- (Phone/Fax) - **0181-951 5781/2**

132 High Street, Edgware, Middlesex HA8 7EL

Close to Edgware underground station (Northern Line). Close to M1, M25, A406.

★ FREE PARKING ★

★ OPEN:-
MON-SAT 10-6PM

DELIVERY (UK MAINLAND) 24HR £10 / 48hr £7.50

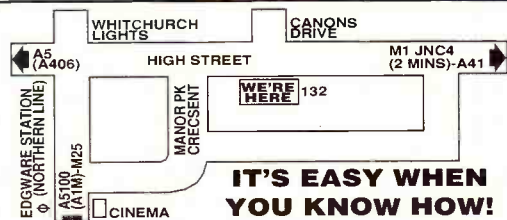

IT'S EASY WHEN
YOU KNOW HOW!

interface, but need some help, you could try one of the kits that are currently available on the market. An example of this is the HAMFAX interface produced by G0LOV/G4LUE Amateur Software. The kit is supplied with all components and copies of the HAMCOMM and JVFX software. The kit supplied for review did not include a case, but there are a wide range of suitable boxes available from your local component shop. The build instructions were very comprehensive taking you right from component identification through to final testing. There was also some advice for installing and configuring the software.

The JVFXR kit from Badger Boards is also a simple, receive only, interface. Again, no case is supplied, just the p.c.b., components, instructions and JVFX software.

Ready-Built

If you'd rather go straight for a ready-assembled interface there are a number to choose from. If you're only interested in reception, the interface produced by Pervisell Ltd is very popular. The electronics are housed in the 25-way D connector and the standard of construction is very high due to the use of surface mount technology. The connection to the receiver is by a flying lead that's ready terminated with a 3.5mm jack plug. Ideal for the new listener.

A second alternative is the complete transceiver package that's available from Venus Electronics. As well as providing a very neat interface, their Datapack includes the JVFX and HAMCOMM software plus some sample images. An extra advantage of this system is the use of a standard DIN plug and

socket arrangement that aligns with the standard used for Packet radio TNCs. This is very convenient for those that already have a Packet TNC incorporated in their station.

The latest interface to arrive on the market is the RSD 116 low noise unit from CommSLab Ltd. This new unit uses surface mount technology to fit all the electronics inside the 25-way D connector. The RSD 116 also includes full transmit facilities with separate leads for the transmit switching and audio signals. All three leads are without connectors so you can select the right plugs for your system.

One particularly attractive feature of this system is the inclusion of a detailed question and answer paper that covers many aspects of the software installation and configuration. Particularly attractive to the new users is the provision of a phone-in help-line where your questions will be answered.

Complex Interface

If you are particularly interested in receiving FAX images from satellites using JVFX, you will need a more sophisticated interface. This is required to process the amplitude modulated signals that are used by the weather satellites. Although you can build your own interface using the circuits supplied with JVFX, you really need to be a very competent home constructor for this particular project. For most people, the best option is to choose a ready built unit such as the JVF1 from Martelec Communications. This

unit was reviewed back in the December '94 *Short Wave Magazine* and I'm sure the Editorial Office will supply a copy (£2.30 per copy) if you want to check out the full details. Once the initial configuration adjustments have been completed, the unit is very easy to use. The JVFX1 features automatic triggering to the satellite signal with just the external gain needing to be set by the operator.

Support Shareware

Now for a plea on behalf of the authors of JVFX and HAMCOMM! These excellent programs provide a first rate starting point for many listeners new to the data modes, but often users fail to register their programs or make a contribution to the author. If these programs (and others) are to continue to be developed, you really need to register your software. Not only does this help to guarantee the future of the programs, but it also eases your conscience! Full details of the registration requirements are included with each program.

Suppliers

Badger Boards,
80 Clarence Road,
Erdington,
Birmingham B23 6AR.
Tel: 0121 - 384 2473.

CommSLab Ltd,
PO Box 19, Erith,
Kent DA8 1LH.
Tel: (01322) 330830.

G0LOV/G4LUE Amateur Radio Software,
8 Hild Avenue,
Cudworth, Barnsley,
South Yorkshire S72 8RN.
Tel: (01836) 748958.

Pervisell Ltd,
8 Temple End, High
Wycombe, Bucks 5DR.
Tel: (01494) 443033.

Venus Electronics,
26 Pevensey Way,
Frimley Green,
Camberley,
Surrey GU16 5YJ.
Tel: (01252) 837860.

Martelec Communications Systems,
The Acorns,
Wyck Lane,
East Worldham,
Alton, Hants GU34 3AW.
Tel: (01420) 82752.



Martelec JVF1

NEVADA

YUPITERU

As Yupiteru's authorised distributor in the UK, we stock their full range including accessories and spares. All Yupiteru is in stock now and ready for immediate despatch. Call us now - we guarantee you won't be disappointed!

MVT-7100

This is still the Number 1 Handheld Scanning Receiver, with wide frequency coverage and SSB mode you have to go a long way to beat it!



Price..... **£CALL**

MVT-7000 Standard Model..... **£Call**

MVT-8000 Mobile/Base + Free PSU .. **£Special**

VT-225 Civil/Military Airband H/Held **£249**

VT-125 Civil Airband..... **£189**

WE WILL, WITHOUT HESITATION, MATCH ANY GENUINE ADVERTISED PRICE OR OFFER. FURTHERMORE I PERSONALLY GUARANTEE YOU CANNOT BUY YUPITERU CHEAPER - ANYWHERE!

John Gordon - Retail Manager

AOR SCANNERS

We carry the "largest" Stocks of AOR Scanners & Receivers and as such are able to offer you very competitive prices!

AR2700 - NEW

Why not Part Exchange your old handheld or pay by 3 post dated cheques for this new handheld that has optional

- ★ Voice Recording
- ★ Computer Control
- ★ Data Clone



Price..... **£289**

AR2700 - VC

AR2700 fitted with Voice Rec. Chip. Price..... **£299**

AR8000 - NEW HANDHELD

1000 memories with Wideband all mode Coverage (500 KHz - 1900 MHz)..... **£399**

Computer Interface for AR8000..... **£79.95**

AR1500EX

Handheld. 1000 channel memory, 500 KHz - 1300MHz with SSB..... **£349**

AR3000A

Base scanner covers 100 KHz - 2036 MHz receives AM/FM/SSB plus many more features including computer control

Price..... (Special) **£899**

AR3000A (PLUS)

Customised AR3000A with switchable narrow AM and SAT filters, tape relay, SDU ready and discrimination output..... **£995**

AR3000/3000A - Computer Control

SCS software gives computer control and logging. (Demo disk £1.50)..... **£59.95**

SEARCHLIGHT for windows on IBM PC gives full computer control plus more. **£99.95**

NEVADA MS1000

Our own superb base scanner with many features.

- ★ 500 KHz - 1300 MHz (with gaps)

- ★ 1000 Memories

- ★ Auto Tape Switch

- ★ Audio Squelch..... **£299**



BEARCAT

BEARCAT 220XLT

★ A new handheld scanner covering right up into the high 900MHz bands.

★ Ideal - Airband, PMR, Amateur and Marine Bands

★ Includes Mains charger

SPECIAL OFFER **£199**



BEARCAT 65XLT

A very simply to use budget handheld. 10 memory channels. An ideal beginners model!

★ Freq. range 66-88, 137-174, 406 - 512 MHz..... **£99.95**



BEARCAT 2500XLT

New redesigned case. 400 programmable memories, wideband coverage (25-1.36GHz)

- ★ Auto Store

- ★ VFO Control

- ★ Inc. Nicads & charge..... **£299**



TRIDENT SCANNERS

NEW LOW PRICES!

TR980 -A compact full featured H/Held with continuous coverage. Ideal for Civil & Military Airband plus all other services!

- ★ 5 to 1300 MHz

- ★ 125 Memories

- ★ AM/FM/Wide FM

- ★ Delay/Hold

- ★ Triple Conversion RX

Special Price

(Less Nicads/Charger)..... **£199.95**

(Takes 4 AA Batteries)

Special Price

(Inc Nicads/Charger)..... **£209.95**

TR2400 -Top of the range with Ultra Wide Coverage and all mode reception including SSB.

- ★ 100 KHz -2060 MHz

- ★ 1000 memories

- ★ AM/FM/WFM/SSB

- ★ Fast Scan

- ★ Includes Nicad & Charger

Special Price..... **£349**



NEW - REALISTIC PRO 2039

A new base scanner from realistic with hyperscan.

- ★ 68 - 960 MHz (with gaps)

- ★ 200 memories

- ★ Fast Scan/Search

Special Price..... **£189.95**



NICAD BATTERIES

UNIDEN

BP205 Slide on Bat. Pack 100/200XLT..... **£29.95**

BP220 Bat. only 220XLT..... **£19.95**

BP200 Bat. only 100/200XLT..... **£19.95**

BP2500 Slide on Bat. Pack 2500XLT..... **£29.95**

SINGLE NICADS

AA 1.2V 500 mAh Nicad Cells..... **£1.25**

AA 1.2V 620 mAh Nicad Cells..... **£1.45**

SKY SCAN DESK TOP

A wide band antenna for use at home. Covers 25 - 1300 MHz c/w base, coax & BNC connector. Height 36". Can be used on your car when static. **£49.00**



SCANMASTER® - HIGH QUALITY ACCESSORIES

SCANMASTER BASE ANT.

New high quality wide band receiving antenna uses fibre glass/stainless steel, with 4 small radials. 'N' type connector.

Length 1.1 mtr..... **£39.95**



SCANMASTER DISCONE

A Quality wideband stainless steel discone. Range 25-1300 MHz with 'N' type connector. Transmits on 2m, 70cms..... **£49.95**

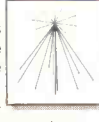

SCANMASTER DOUBLE DISCONE

A high performance wideband antenna offering gain over a conventional discone. Stainless steel construction with mounting kit and short pole.

- ★ 25-1300MHz

- ★ Wide TX range..... **£59.95**



SCANMASTER MOBILE

A Complete, ready-to-go magnetic mount wideband antenna.

- ★ 100-1000MHz

- ★ Fitted cable & BNC

Connector..... **£29.95**



SCANMASTER ON GLASS

Discreet but effective wide band mobile antenna 25-1300 MHz supplied with cable/BNC connector.

Price..... **£29.95** p&p £2.75



SCANMASTER MOBILE MOUNT

Mounts on air vent grills on the car dashboard. Allows easy and safe operation of most handhelds..... **£9.95**



NOMAD PORTABLE RECEIVING ANTENNA

The NOMAD is a fully portable flexible wire scanning receiving antenna. Covering both VHF & UHF it's compatible with all scanning receivers. Simply suspend it with the cord supplied.

- ★ Optimised for airband

- ★ 4M Coaxial Cable

- ★ Fitted BNC..... **£19.95**



AMPLIFIED SPEAKERS

Boost the output of your scanner with this pair of amplified speakers. Will run off batteries or 6V adaptor (not supplied). Each speaker gives 2.5W audio output..... **£29.50 Pair**



SCANMASTER SP-55

A low noise pre-amplifier with even better performance, improved circuit design & selectable band pass filters to optimise the receiving range of your choice. 25-1500, variable gain & attenuation. Powered from batteries or 12V DC..... **£69.95**



SCANMASTER GW-2

Low noise GaAs FET pre-amp covering 1-1400MHz with variable gain of -3 to +20dB (requires PP3 battery)..... **£59.95**



SCANMASTER BASE STAND

A fully adjustable desktop stand for use with all handhelds fitted BNC and Coaxial fly lead..... **£19.95**



SCANMASTER NOTCH FILTER

A variable 30dB notch covers 85 to 170 MHz to eliminate music, tones, and voices that break through onto the frequency you are listening to. With low insertion loss the filter can be left in line and helps reduce interference from shortwave broadcasts below 1.7MHz..... **£29.90** P&P £2.75



AIRBAND FLEXI WHIP

Will give optimum performance on Civil Airband. Length: 2ft with BNC..... **£13.95**

NEW SCANMASTER AIRBAND BASE ANTENNA MODEL SBA 100

The first in our professional series, this antenna was primarily designed for commercial use where quality of construction, reliability and performance are of utmost importance - however it has been well received by enthusiasts who want the very best airband performance.

- ★ Designed to commercial standards
- ★ Suitable for reception & transmission
- ★ Covers 108 to 136 MHz
- ★ Transmit up to 1KW
- ★ 1.05mtrs long
- ★ SO239 type VHF connector

Introductory Price..... **£59.95** P&P £4.75



TWO NEW HOT SELLERS!

SCANNER BUSTERS

Overcome new technology and listen in to what you packed with info on how to get more from your Scanner. Includes first class frequency lists showing where to tune and explains many of the new technologies now in use..... **£4.95**



EAVESDROPPING ON THE BRITISH MILITARY

A fascinating book that tells you how to tune into British Military Communications with ease. With this book and Short Wave or Scanning receiver a secret world will open up providing hours of enjoyment. Price..... **£17.50**



USE YOUR CREDIT CARDS FOR SAME DAY DESPATCH

ORDER HOTLINES:

TEL: (01705) 662145
FAX: (01705) 690626

HUGE STOCKS - FAST DELIVERY - FULL SERVICE BACKUP
... Now in our 25th Year ... Buy With Confidence From NEVADA!

THE VERY BEST RECEIVERS FROM DRAKE USA



- DRAKE R8E**
- ★ 100KHz - 30MHz wide coverage
 - ★ Passband tuning
 - ★ Built-in Pre-Amp & Selectable AGC
 - ★ Twin VFO's & Timer Functions
 - ★ Dual Noise Blanker
 - ★ RS232 Interface for Complete Control

The R8E's performance is truly staggering, it has a full compliment of filters, synchronous AM detector, multiple scan facilities, 100 memory channels, plus all mode coverage. Why not part exchange your old receiver for this latest model from the USA, we offer excellent PX deals call our hotline now! **£1195**

DRAKE SW8

- ★ Short Wave Coverage 500KHz-30MHz
- ★ VHF Airband (116-136MHz)
- ★ VHF FM (87-108MHz)
- ★ AM/FM/SSB
- 240 V AC adaptor included



A top class portable Short Wave Receiver with VHF airband and FM coverage. Drake have incorporated a quality large front-mounted speaker, direct frequency access keypad, four antenna inputs and complete portability with fitted telescopic whip antenna an optical NiCads. 70 programmable memories, clock, synchronous AM detector. **£649**



NEW MAGNETIC LOOP ANTENNAS

- ★ (3 - 30) MHz Coverage
- ★ 200W PEP Power
- ★ Remotely Tuned
- ★ Flexible for Loft Mounting & Portable Operation
- ★ Low Visual Profile

Our new Drae magnetic loops use high quality semi rigid 13mm Japanese Ultra Low Loss cable for the radiating element, making loft mounting & portable operation possible. Packs easily away into the Car Boot. Each loop is supplied c/w remote tune control for full frequency coverage from the Shack. Fibreglass construction ensures full weatherproofing. Comparisons of the Drae loops with 32mm Aluminium loops have shown no significant differences.



MODEL ML80

Freq: [7 - 30] MHz continuous
 Diameter: 80cms
 Control Unit: Supplied - req. 6V DC
 Price: **£179.95** (P&P £5.75)

MODEL ML170

Freq: [3 - 10.3] MHz continuous
 Diameter: 1.7 mtrs
 Control Unit: Supplied - req. 6V DC
 Price: **£199.95** (P&P £6.75)

SHORTWAVE BALUNS & ANTENNAS

LONGWIRE BALUN (DLB)

Matches end fed long wires to 50 ohm coaxial cable, helps on receive reduce noise and interference and allows transmit up to 100Watts. Fully moulded for full weather protection. **£39.95**



END FED WIRE (EFW)

The EFW is a complete 20mtr long short wave receive AND TRANSMIT end fed wire antenna. Balun fed, Uses high quality "Flex Weave" copper wire. 100 Watts RF (with ATU). Covers 1 - 30 MHz. **£59.95**

VECTRONICS AT100

Active Antenna & Pre-Selector

If you are an apartment or flat dweller you no longer need to suffer poor reception due to antenna restrictions. This new portable active will receive 300 kHz - 30 MHz indoors with the supplied whip/Ext. Antenna
 Price: **£79.95**



GLOBAL AT2000

New SWL ATU with Q Selector to prevent interference. (100KHz - 30MHz) **£96.95**



GLOBAL CX201

Two Way Antenna Switches Switch your receiver between 2 ant. with this high quality switch. CX201 PL259 Sockets **£18.95**
 CX201 'N' Type Sockets **£26.95**



NEW COMMTEL SCANNERS

Manufactured by Uniden two new Scanners we thoroughly recommend.

COMMTEL 213

A new handheld with "jetscan" giving an incredible 100 ch/second sampling.

- ★ 100 Memories
- ★ 66 - 956 MHz (with Gaps)
- ★ Data Skip control
- ★ AM/FM Modes (self selects AM on Airband)
- ★ Supplied with Nicads



Price: **£165**

COMMTEL 215

A superb desktop scanner with Turboscan facility and auto station programming.

- ★ 200 Memories
- ★ 66 - 956 MHz (with Gaps)
- ★ 5 year memory back-up
- ★ 12 Volt
- ★ AM/FM



Price: **£235**

RECEIVERS

- YAESU FRG-100** Entry Model £499
KENWOOD R5000 Competition Class £945
LOWE
HF-225 Receiver £479.00
D-225 Synchronous DET £43.95
HF-150 Receiver £389.00
HF-150M Marine Version £429.00
IF-150 RS232 I/face HF-150 £39.95
PR150 Pre Selector £199.95
SP150 Spkr c/w filter + meter £189.00
Key Pad For Direct Freq. Entry £39.95
ROBERTS
RC817 Multi band radio £169.99
RC818 Multi band w/cass £199.99
SONY
 As a Sony Shortwave Centre we carry the full range of Portable Radios -
SW 7600G Save £20 £159.99
SW100E Save £20 £179.00
SW55 Save £30 £249.00
SW77 Save £50 £349.00
AN1 Act. Ant.(150 - 30 MHz) £59.95
AN3 Gen. Purp Ant £59.95
SANGEAN
ATS803 Portable with SSB £129.95
ATS818 Portable with Stereo FM,SSB £169.95

TRADING POST

SCANNING RECEIVERS

- AOR AR900 £175
 AOR AR1000 £185
 AOR AR2800 £195
 BEARCAT 50XL £65
 BEARCAT 580XLT £120
 BEARCAT 890XLT £230
 BLACK JAGUAR BJ200 £130
 COMMTEL COM 204 £175
 FAIRMATE HP1000 £195
 REALISTIC PRO-32 £110
 REALISTIC PRO-50 £95
 REALISTIC PRO-2005 £185
 TRIDENT TR-2400 £299
 WIN 108 £105
 YUPITERU MVT-3100 £185
 YUPITERU MVT-6000 £195
 YUPITERU MVT-7100 £265
 YUPITERU VT-125 £125
 YUPITERU VF-225 £175
 JIM M-75 £49
 JIM M-100 £55

SHORTWAVE RECEIVERS

- ICOM R70E RX £395
 ICOM R71E RX £599
 KENWOOD R2000 RX £375
 KENWOOD R2000 + VHF £495
 SONY SW15 £130
 STEPLETONE MBR7 £45
 YAESU FRA7700 £45
 YAESU FRG7700 £425
 YAESU FRG7700 + CONV £450
 YAESU FRG8800 + VHF £495

NEW FROM OPTO

OPTO 3300

A new miniature H/Held counter - thats very sensitive.



- ★ 1 MHz - 2.8 GHz
- ★ 10 Digit LCD Display
- ★ Hold Switch Locks Display
- ★ Sensitive
- ★ Supplied c/w Ant, NiCads & Chargers

Special Offer ~~£169.95~~ **£139.95**

OPTO SCOUT

This New mini counters got the lot!



- ★ 10 MHz - 2.8 GHz
- ★ 400 Memories
- ★ Reaction Tune of Receiver (with C1-V Port)
- ★ Digital Filter & Auto Capture
- ★ 16 Segment Bargraph for Signal Level
- ★ Software Supplied For PC Upload
- ★ Supplied c/w Ant, NiCads & Charger

Special Offer ~~£399.95~~ **£369.00**

OPTO INTERCEPTORS

These clever units instantly lock on to any close strong signal, allowing instant monitoring. Ideal for use at airports, sporting events, on cruise ships or anywhere two way communicators are in use!

R10

- ★ Receives FM from 30-2000 MHz in less than 1 second!
- ★ Deviation Check facility
- ★ Fully Automatic
- ★ Earphone supplied
- ★ Signal strength bargraph display
- ★ C/w antenna, NiCads+Charger



Price ~~£399.95~~ **£389.95**

R20

- ★ Interceptor/Bug detector
- ★ 500 KHz - 3000 MHz
- ★ AM monitoring w/earphone
- ★ FM detection
- ★ Field strength indicator
- ★ 9V battery operation



Price **£139.95**

OPTIONAL BAND PASS FILTERS

- HP400 (400 - 1500) MHz **£69.95**
- HP800 (800 - 2000) MHz **£69.95**

FOURTH EDITION UK SCANNING DIRECTORY

Now with spiral binder and even more frequencies! - order yours now.
Price: £17.50 POST FREE

ERA MICROREADER

New Version 4.2



Decodes CW,AMTOR, RTTY, SITOR.
 Special Offer - Microreader w/leads, instructions plus free post & packing and also Save £10 ~~£199~~ **£189**

PSU101 MK IV

A combined desk stand and pwr supply/charger for handheld scanners. Suitable for most popular models. Special versions avail. Call for details. **£29.50**



PSU101TA 9V Version **£29.50**

PAY BY THREE POST-DATED CHEQUES

ON ANY ITEM OVER £100 IN VALUE

Simply divide the price into 3 equal payments. Write 3 cheques dated in consecutive months starting with today's date. Write your **TELEPHONE NO., CHEQUE CARD NO. & EXPIRY DATE** on the back of each cheque. Post them to us, enclosing your name and address & we will (subject to status), send your goods immediately.

SHOWROOMS:- 1A MUNSTER ROAD, PORTSMOUTH PO2 9BS

MAIL ORDER:- 189 LONDON ROAD, PORTSMOUTH PO2 9AE

MIKE RICHARDS G4WNC PRESENTS SWM'S DECODE SPECIAL

Wavecom 4100

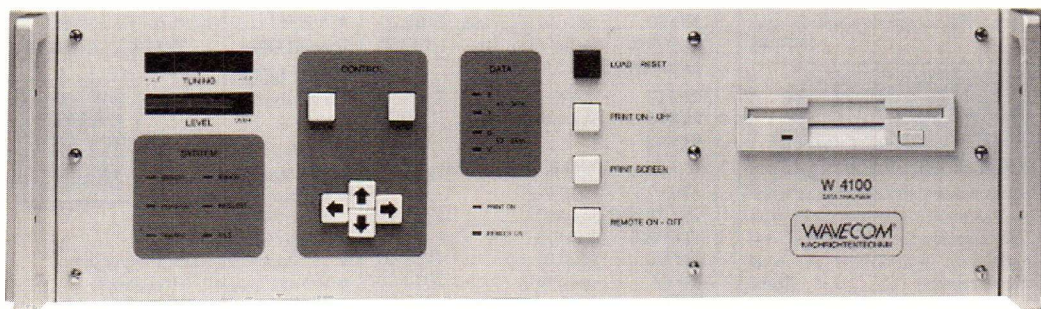

If you need help spending your Lottery winnings, the Wavecom 4100 reviewed here by Mike Richards could help!

Whilst few of us can afford to buy a top flight decoding system, we all need dreams and the Wavecom 4100 certainly falls into the right category! Having said that, when you consider what people pay for other hobbies, such as boating or maybe golfing, the Wavecom's substantial price tag starts to seem much more affordable. Perhaps the more important point is whether or not it represents good value for money. In this review I'll guide you through the 4100 in detail so you can form your own view on this.

Overview

Before I get into the detail of the 4100's performance, an overview of how it operates and interfaces to the outside world may be helpful. The 4100 is essentially a stand-alone decoding system. This means that it accepts an audio signal from the receiver, decodes it, and then displays the result on a video monitor. The range of signal types covered by this type of decoder tends to run hand-in-hand with the cost, and the Wavecom 4100 features over 54 modes. These spread from simple c.w. through to complex multi-tone systems like Piccolo.

One of the main advantages of this type of decoder over a computer based system is simpler operation with far fewer set-up problems. For example, the 4100 includes a fully automatic analysis mode, so you can just tune-in the signal and let the decoder do the rest. Another spin-off

comes in the form of a much reduced level of r.f. interference, simply because the decoder has been designed to operate in an r.f. sensitive environment.

Setting-up

The first point to note about the 4100 is that it's designed primarily for the professional market. As a result, the whole build standard is aimed at extended operational periods (like 24hr) whilst located in high density equipment racks. Hence the 19in rack mount constructional style with a built-in fan to keep the internal temperature under control. The 4100 is also very heavy, weighing in at some 8.5kg. Although the review model was supplied without an outer sleeve, these are readily available from many outlets.

Moving on to the connections, the 4100 has a comprehensive range of standard interfaces assembled on the rear panel. Let's tackle the essential connections first. There are two audio input connections both of which unusually employ BNC connectors. It's not until you realise that the 4100 can accept direct r.f. inputs that you appreciate the reasons for the use of such high quality connectors. If you're using a conventional audio output from your receiver, the AF socket is the one to use. This input has an automatic gain control feature, so as long as the input level is somewhere between 500mV and 2V, the 4100 will automatically adjust the input circuitry for optimum performance.

If you've really won the Lottery and you have a professional class

receiver that uses standard digital signal processing (d.s.p.) techniques, the 4100 can accept a direct digital output. The only condition is that the d.s.p. signal must align with the Racal industry standard and you need to use the optional Wavecom d.s.p. demodulator. For displaying the decoded signals, the 4100 uses a standard VGA computer monitor (not supplied) and the rear panel connector is fully compatible with the video system used by IBM PCs and clones. This means you can take advantage of the good prices that come from high volume sales of PC monitors. The printer connection also follows IBM standards, providing a good match to a wide range of printer systems. One point to note here is that the internal software is optimised for use with Hewlett Packard DeskJet 560 colour printers. Although there are drivers included for standard 9 and 24-pin dot matrix printers, by using the recommended Hewlett Packard printer you can produce full colour screen prints.

You will note from the photographs that the front panel features four arrow keys. These are used to select the appropriate operating mode. A more convenient alternative is to use a Trackman Mouse system as supplied with the review model. This connects via a standard 9-pin D connector on the rear panel and give a much friendlier feel to the overall operation. To enable easy updating of the main decoding software, the 4100 includes a built-in 3.5in floppy disk drive. At switch-on this drive is always used to load the decoding software. As this disk was formatted to normal

MODE DECODE

IBM standards you could make safety back-ups on any IBM PC with a 1.44Mb drive.

Advanced Inputs

In addition to the basic inputs covered so far, the 4100 includes some advanced options. When attempting to receive v.h.f. and u.h.f. digital modes such as POCSAG, GOLAY and INFOCALL, it's necessary to access the receiver's i.f. signal to ensure minimal errors in the decoding process. To facilitate this, the 4100 has three separate i.f. inputs for 455kHz, 10.7 and 21.4MHz signals. This should cover the requirements of most high quality receivers. If you're very seriously into decoding software, there's also a PC/AT Host interface connection. When used with a dedicated Wavecom card in your PC, you can directly download software from a PC to the 4100. This interface is provided essentially for development work. This feature is supplemented with an external demodulator socket for use with specialist transmission systems.

The two serial ports, also mounted on the rear panel, are used to provide yet more interesting features. The first port is used to carry decoded data from the 4100. This could be connected to a PC for storage or further processing of the received data. The second serial port is also designed for use with a computer but, in this case, gives access to the remote control of the 4100's main features. Although mainly of interest to professional users the ability to both control the 4100 and monitor the decoded output on a PC opens-up lots of opportunities for processing the more difficult and complex signals.

Documentation

To make good use of a sophisticated unit like the 4100 a good user manual is essential. The review 4100 was supplied with two manuals, one covering all the operational details whilst the other was a comprehensive technical manual

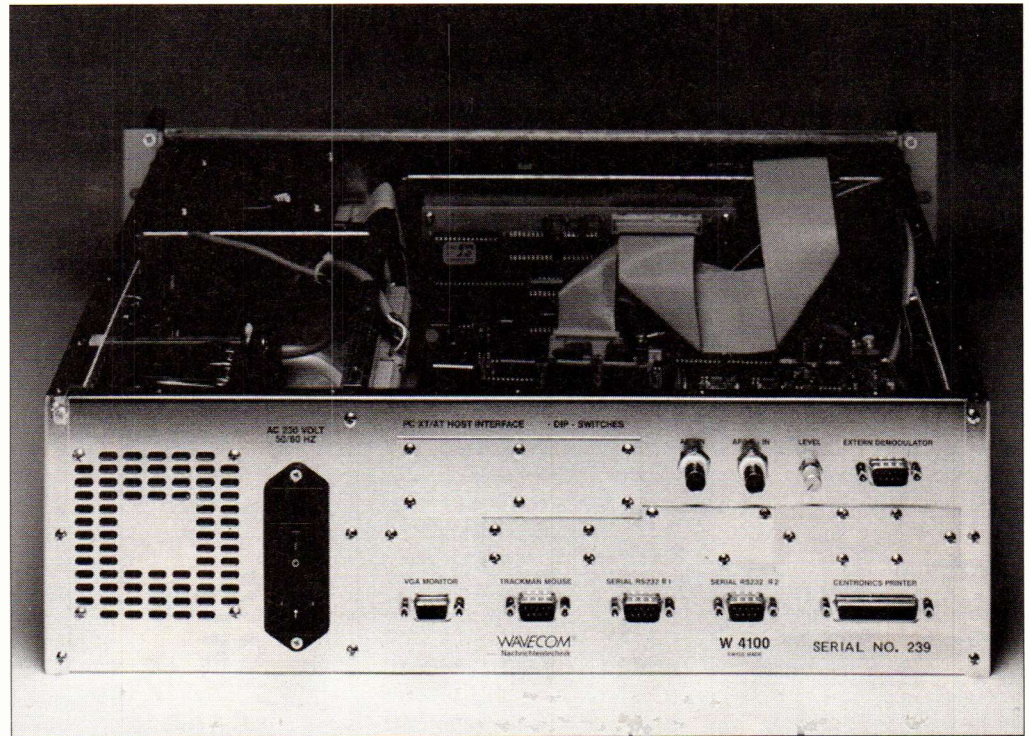

with all the circuit diagrams. I understand that the technical manual is not normally supplied, but is available as an extra.

The main user manual was very well presented in a substantial ring binder with plastics section dividers. The installation section was very thorough and described all the interconnections in great detail. The next section was very well set-out and guided the operator through the use of the main interface to the 4100's facilities. Once you've mastered the basic operation, the MODES section provided descriptions of each operating mode and all the associated decoding features. Although the manual covered the 4100's operation in plenty of detail, some sections suffered a loss of intelligibility through the translation process

Navigation

With the 4100 set-up and ready to go, the next step is to understand the operation of the various controls. To keep the user interface as simple as possible, Wavecom have adopted a well structured menu system. The standard menus are displayed at the bottom of the main receive screen.

Although movement of the highlighted cursor can be controlled by the arrow keys on the front panel, the mouse option is to be preferred. This uses a Trackman mouse system

to navigate your way around the system. If you've not used one of these systems before, you will find it does take some getting used to but, once mastered, it's very fast and convenient. Having selected the required option, you just press the enter key on the mouse to activate it. That sounds simple enough, but there are some other tricks to make life easy. Once you've entered an option, pressing the escape key on the mouse or keypad takes you back one menu. Just using these two keys you can quickly whip through several layers of menus and pop back out again. The third button on the mouse is used to activate the full-screen menu. This menu provides very quick access to all the 4100's features and, in some cases, can be quicker than burrowing through the multi-layer menu system.

Now there are times during operation of the 4100 when you need to enter a numeric value. A typical example being when you want to set the 4100 to a specific baud rate. Wavecom have this very neatly buttoned-up. When an option is selected that requires this type of input, the default value appears with one of the digits highlighted. The value of the highlighted digit can then be changed by moving the mouse forward to increase the value or backwards to reduce it. If you move the mouse to the side you can move the highlight from one digit to

01702
206835

Waters & Stanton

"SCANNING SECRETS" **£16.95**

Exciting New Book!

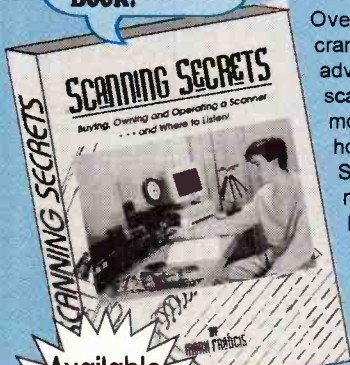

Available MAPLIN Stores

At Last The Truth!

Over 280 pages and 30 chapters crammed with information. Gives you advice on buying and operating your scanner. Explains all the mysteries of monitoring. What's the best aerial, how do you improve your reception? Secrets and hints on all those topics not covered by other publications. New frequency modes, encryption, methods of finding obscure frequencies. You get all the information you need to unlock the power of your scanner. Hunt those elusive signals down. Nothing's secret any more! We expose all the myths and folk lore. This book gives you the truth. If you own a scanner you can't afford to miss this valuable reference book. It's UNIQUE Add £2 post to total order

Order today



01702 206835

Short Wave International Frequency Handbook **£12.95**

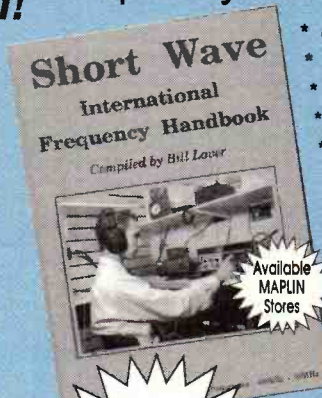

- * Completely Revised
- * 10,000 entries 500kHz - 30MHz
- * Marine, Aviation, Military, Press etc
- * Every entry monitored and checked
- * All old information removed
- * 192 A4 size pages beautifully bound.
- * Frequency, callsign and mode
- * Location and times etc.

Both Books £25!
UK Scanning Directory

£17.50

Purchase a copy of the UK Scanning Directory (£17.50) together with a copy of Short Wave International Frequency Handbook and pay only £25 plus £2 post.

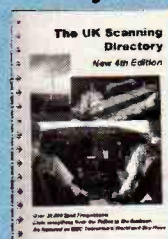

Save **£5.45**

This Month's Special Offers

DATONG FL3 Audio Filter

£139

Post £5.00

Simply plugs into headphone socket. Drives speaker or headphones. 12V powered

CW & SSB - A Great filter



Save **£10**

New SONY ICF-7600G

AM - SSB - FM £159

Sony's latest short wave receiver covering 150kHz - 30MHz plus FM stereo 76-108MHz. You'll enjoy superb SSB and AM reception on the complete short wave spectrum. 1kHz readout and programmable memories add to the many features of this receiver. Post £5.00



Save **£20**

"Opto" 3300 Counter Mk II

£139

1MHz - 2.8GHz Ni-cads & Charger

This is the latest model with greater sensitivity and improved internal design. It will sniff out and lock onto frequencies over several hundred feet. As recommended in Scanning Secrets. The small size slips into the pocket and the clear LCD provides precise readout. The internal ni-cads provide extended operational life. Make sure you get the latest model and not old stock. We even match our competitor's prices on old stock! Now that has to be a bargain! Post £2.00



Save **£30**

Police Style Lapel Speaker

Save **£2**

£9.95

Ideal for scanner owners. Clips on lapel or seat belt. Gives clear crisp speech. Similar to that used by Police. Fitted with curly cord and standard 3.5mm plug. Matches all scanning receivers. Postage £1.50

Mobile Bracket

Free Post

£9.95

SPECIAL PURCHASE

Was £79.95

£49.95

MBR-8 7 Band HF - VHF Receiver

- * Lw/Mw + 2.2 - 22MHz
- * 88 - 174MHz VHF
- * 7 Bands
- * AC Mains or Battery
- * Directional Ant.
- * Slow motion dial
- * Analogue S-meter
- * 12 Month Warranty

Save **£30**



Wideband Scanning Aerials
All cover 25 - 1300MHz

- SS-Mobile - Magnetic £24.95
Height 60cm £19.95
- SS- Desktop - £49.95
Height 90cm £39.95
- SS - Base Discone £49.95
Height 120cm £39.95

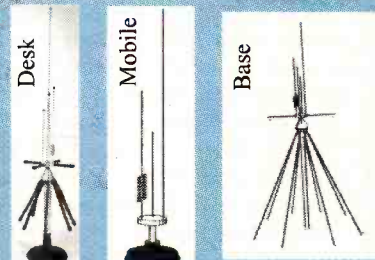

WATSON

Long Wire Balun transforms your scanner's short wave performance

Package Deal Balun & ATU

£67.50 Post free



Post £1.50

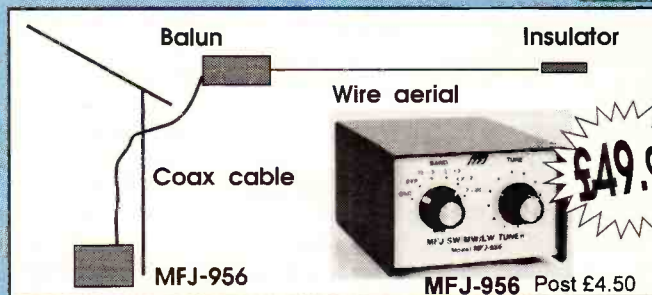

Save **£49.95**

MFJ-956 Post £4.50

The most amazing improvement in short wave scanner reception (1.5 - 30MHz). Just add the long wire balun to the end of a wire, add the MFJ-956 passive preselector and hear signals literally jump out of the noise! Makes reception as clear as many base station receivers. Lets you realise the full potential of your scanner. Full 10 day money back guarantee - now that's confidence for you!

Everything For The Listener

The products below are also available from all **32 MAPLIN STORES**

WATSON

25 - 1900MHz

A new range of scanning aerials designed to give you what others promise.

Tele-Gainer: 41cm telescopic with knuckle joint BNC . £14.95
 Regular-Gainer: 21cm flexible whip BNC £12.95
 Super-Gainer 40cm flexible whip BNC £19.95

**Hear the difference
 Pocket the difference!**

These antennas are specially made by Watson to enhance your scanner's performance. They are of extremely high quality and the first true dedicated 25 - 1900MHz scanning aerials to be offered in Europe. Don't be fooled by the low prices - these really are great performers.

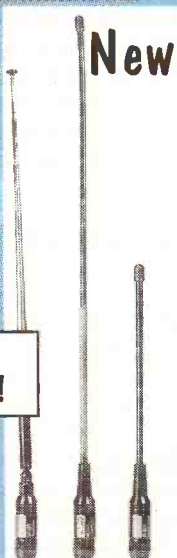

New

Price Match

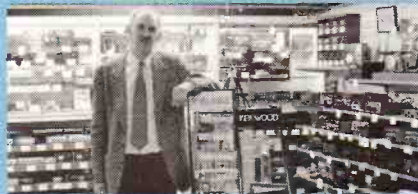

As the largest distributor in the business we have the ability to offer you some great deals. The Yen is about to destroy prices as we know them today. So there's not much time left. Give us a call now and do that Deal. Don't say we didn't warn you! Simply look through the pages of this magazine at all the adverts and then give us a call and we'll quote you our super deal price. What's more, you'll have the strength of a company that has been in the business for 22 Years. *Peter Waters G3OJV/G0PEP*

Open Day

Hockley Sunday 21st May
 Many items at trade prices!
 Free food & drink - 145.550MHz
 Be There!

MFJ-722 Signal Optimizer



A superb dual module bandpass and notch filter for SSB and CW. Provides extremely flexible adjustment. Can be used with headphones or speaker.

MFJ-722 Audio Filter

Simply plug between receiver and headphones to remove the interference!
 Great performer.



Second Hand

- Mobile/Base Scanners**
 PRO-2022 68-88/108-174/380-512/806-960MHz £199
 R-535 Airband VHF/UHF the business! £239
 ACR-2002 25-550/800-1300MHz £269
 PRO-2005 25-520/760-1300MHz £199
 BC-700 Bearcat 29-54/108-174/408-512/900 £149
- Handheld Scanners**
 IC-R1 100kHz-1300MHz £299
 AR-1500 500kHz - 1300MHz SSB £249
 AR-1500EX 0.1-1300MHz inc SSB £269
 AR-1000 8-600/805-1300MHz £219
 Black Jaguar 26-30/60-88/115-260/410-512MHz £119
 Bearcat 50XL Bands - 10 channels £79
 PRO-34 68-88/108-174/380-512/806-960MHz £139
 PRO-37 68-88/108-174/300-512/806-960MHz £139
 Pro-43 66-88/118-174/220-512/806-960 £139
 Air-8 Sony - SSB SW + VHF £139
 WIN-108 VHF Airband digital display £119
 Sony PRO-80 150kHz - 30MHz (SSB) + VHF £139
- Short Wave**
 DX-390 Realistic short wave with SSB £99
 ICF-760L Portable short wave £89
 ICF-SW77 Sony super SSB portable £289
 ICF-SW-100E Sony micro short wave portable £149
 ICF-SW1E Sony portable short wave in ant/psu £150
 ICF-7600 Sony SSB portable - great performer £119
 RFB-45 Panasonic SSB portabl £99
 ICF-7601 Sony portabl short wave £89
 MR-4099 Matsui portable short wave £89
 ICF-7600DS Sony short wave portable £99
 HF-150 Lowe short wave - great performer £299
- Accessories**
 MFJ-1278 Data controller £199
 PK-232 Data unit (see SWM review) £199

Yaesu
 FRG-100
 Short Wave



Phone for Price

Phone for Price

LOWE
 HF-150
 Short Wave

Kenwood R-5000



Phone for Price

ICOM R-71 Normally £1075



£799

New AT-2000 Rx ATU

Hear the difference!
 Unique "Q" Selector

The Best Receiver
 ATU - Amazing!
 100kHz - 30MHz
 £99.95



ALINCO
 DJ-X1D
 Scanner

Make sure you get the NEW version. Check for the UK warranty inside!

AM - NFM - WFM
 200kHz - 1300MHz

- * No gaps
 - * 100 Memories
 - * Battery Saver
 - * Ni-cads & Charger
 - * Fully programmable
 - * Helical whip
 - * LCD readout
 - * Rotary tuning knob
 - * Tough case
 - * Very sensitive
- Maplin Code CM84

Offer Price
 £299

In All
 Maplin
 Stores

YUPITERU

MVT-7100UK

100kHz - 1300MHz
 Scanner Receiver
 WFM-NFM-AM-SSB
 Maplin Ref RU00
 Only when you buy Yupiteru from ourselves or any Maplin store do you get the following:

- * Genuine factory chargers
- * Yupiteru UK Warranty
- * Free Warranty Extension
- * WSE Service backup

MVT-7000UK

100kHz - 1300MHz
 Scanner Receiver
 WFM-NFM-AM
 Maplin Ref CM00

REALISTIC

PRO-44
 68-88/108-174
 380-512MHz
 FM/AM
 50 Memories
 Maplin Ref AG98

£149.95

PRO-46
 66-88/108-174
 406-512/806-960MHz
 FM/AM
 100 Memories
 Maplin Ref AG97

£199.95

PRO-46

PRO-44

Shop and Mail Order; 22, Main Rd., Hockley, Essex. SS5 4QS Tel: (01702) 206835 Fax: 205843

VISA Branch Shop: 12, North Street, Hornchurch, Essex. RM11 1QX Tel: 01708 444765 ACCESS

MAIL ORDER To Hockley - 24 Hour Answerphone and Fax. Open 6 Days 9am - 5.30pm

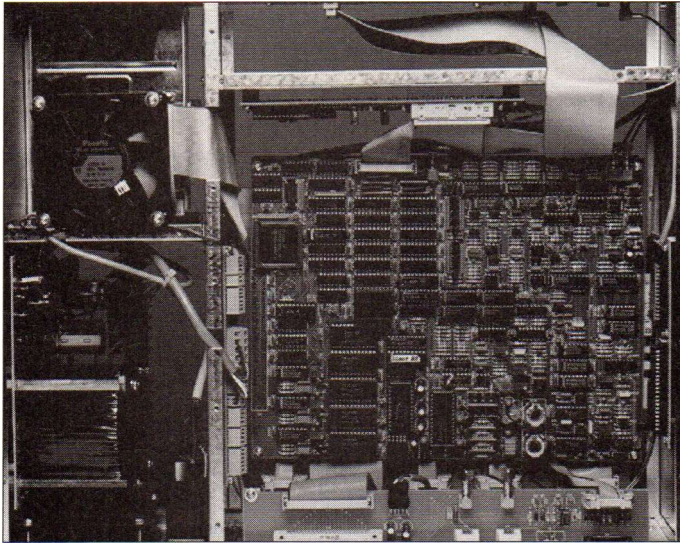

The 4100 is just packed with powerful electronics. The main board assembly is in fact two boards deep. The p.c.b. that is hidden from view is just as densely populated as the one above.

the next. This is a wonderfully simple and quick way of including numeric input without having to add a keypad.

The mouse comes into its own when using the analysis modes as it can be set-up to scroll the data blocks. This is essential to explore the effects of the different decoding options. One of the great benefits of the very well thought-out use of the mouse is that you can access all the 4100's features just using this compact mouse. Because of its relatively small footprint you can leave it conveniently placed by the side of the receiver ready for instant action.

Front-End

The secret of any good decoding system is the initial processing of the incoming signal. Whilst the simplest systems just limit the signal and then apply it to a computer. Successful decoding of difficult or noisy signals requires a more subtle approach. The input stages of the Wavecom are extremely comprehensive and give the operator the choice of several types of demodulator.

To give you an idea of the complexity, the demodulator circuit diagrams alone take up fourteen A4 pages in the technical manual! As this is the heart of any decoder, I think it's worth taking some time to cover the facilities in some detail (sorry if it's a bit technical). The input signal is passed to the 3.6kHz bandwidth limiting filter via a balanced modulator. This stage is

required when handling signals direct from the receiver's i.f. stages. The carrier frequency supplied to this modulator is crystal controlled and fully adjustable to align precisely with your receiver's i.f. In addition to adjustment of this translation frequency, you can also adjust the effective centre frequency of the bandpass input filter. This first bandpass filter is an essential component as it minimises the risk of out-of-band signals degrading the demodulator performance.

Next come the demodulator stages. These have the job of converting the filtered audio signal into a digital format for final decoding. In order to provide maximum flexibility the 4100 includes three main demodulator systems. The direct demodulator processes the signal by accurately measuring its period. Whilst this is similar to the system used by the simpler computer based systems, it suffers from poor performance with noisy signals. Although this mode is unlikely to be used for mainstream decoding its prime function in the Wavecom is to support the automatic frequency control system.

Probably the most versatile demodulator is the quadrature system. This is able to handle all signal types except the a.m. satellite based weather services. The main advantages of the quadrature system are excellent performance with the higher speed signals and very good performance with noisy signals.

For basic RTTY and the slower speed ARQ signals, the Mark-Space demodulator is by far the best. This

operates by processing each of the two RTTY tones through separate 8th order filters. This produces excellent resistance to noise and minimises errors. The final, a.m. demodulator is automatically selected for the reception of images from weather satellites. Like all the other demodulators, the a.m. demodulator was configurable to suit the input signal. With the a.m. system you could set the frequency to $\pm 500\text{Hz}$ and set the gain in 50 discrete steps.

Operating Modes

To cater for such a wide range of operating modes the Wavecom uses a series of sub-menus to make access simpler. These are divided-up as follows: Standard, Duplex, Simplex, FEC, MFSK, v.h.f./u.h.f. and FAX-SSTV. Each of these modes also features access to the signal analysis mode. This provides a comprehensive analysis of the speed and shift of the signals under investigation. In addition to the signal analysis, each of these sub-menus includes demodulator selection, speed settings and any other specific parameters required for that mode.

However, one of the big plus points is the provision of a full auto mode. This gives completely automatic analysis and configuration to suit the incoming signal. This was an excellent option that worked well under most operating conditions. One of the advantages of the very fast decoding processors is the 4100's ability to adjust parameters such as shift without losing sync. with the received signal. The decoded output from the decoder is normally displayed on the screen but a single button press also activates the printer output.

Comprehensive Analysis

One of the key differences between amateur and professional decoding systems is the quality and scope of the analysis tools. In addition to the Signal Analysis described earlier, the 4100 includes three types of bit analysis, auto-correlation and code analysis. Of these, the code analysis is likely to be the most used. This comprehensive mode attempts to automate the complete analysis process. When activated, the 4100 first establishes the shift and baud rate. This information is then used

along with the incoming data to evaluate the precise transmission mode. Whilst processing the signal, the 4100 displays the options being considered in the status display. If a successful conclusion is reached, it automatically switches to the appropriate receive mode and starts decoding.

The code analysis worked extremely well providing it was fed with a good quality signal. I tested it with a wide range of both simple and complex signals and all were identified and decoded very quickly. If you're seriously into data signals, you'll find the other analysis modes to be very comprehensive. Virtually any type of data signal could be completely taken apart. Not only could you freeze samples of the signal, but you could also control a pair of cursors to obtain a precise measurement of the signal's timing parameters. With all the analysis systems it's important to note that you do need a degree of technical knowledge to use them effectively.

Summary

As you can see from my review, the Wavecom 4100 is a very comprehensive decoding systems with an extremely wide range of options. Wavecom have achieved a masterful design in making such high technology equipment so easy to use. I believe the operation is so straightforward that comparative newcomers would be able to make good use of the Wavecom's main decoding modes. However, to really make the Wavecom fly, you need a good technical comprehension of data transmission systems. I thought the way in which the Trackman mouse was set-up to control the Wavecom's features was very well thought out. However, I did feel that the responsiveness of the mouse could benefit from some additional

Specification

(abbreviated - the full spec. runs to 12 pages!)

Graphics Processor:	TMS34010 32-bit Graphic system processor with host interface, 50MHz clock, 4Mb RAM and 500Kb video RAM
Demodulator Processor:	TMS34010 32-bit demodulator processor, 50MHz clock, 512Kb DRAM, 12-bit A/D converter, two quadrature demodulators, mark space demodulator plus GAL logic for period and bit length measurement
Video:	VGA output with 640 x 480 resolution
AF Input:	400mV to 2.5V
AF/HF Input:	200mV to 5V
Demodulators	
Quadrature 1:	10-210Hz bandwidth
Quadrature 2:	220-3500Hz bandwidth
Mark-Space:	Shift Range 50-3600Hz
AM Demodulator:	Double rectifier
Period length logic:	2-3600Hz bandwidth
Demodulation modes:	Teletype, F1B Twinplex, F7B Morse, A1A Morse, F1A Facsimile, A3C Facsimile, F3C MFSK, Piccolo, Coquelet
Receive Modes:	ALIS, ARQ-E, ARQ-E3, ARQ-N, ARQ-M2-242, ARQ-M2-342, ARQ-M4-242, ARQ-M4-342, ARQ6-90, ARQ9-98, ASCII, ATIS, AUTOSPEC, BAUDOT, CIS-11, COQUELET-8, COQUELET-13, CW-Morse, DUP-ARQ, DUP-ARQ-2, FEC-A, FMS-BOS, GOLAY, HC-ARQ, HNG-FEC, INFOCALL, METEOSAT, NOAA-GEOSAT, PACTOR, PACKET RADIO, PICCOLO-MK6, PICCOLO-MK12, POCSAG, POL-ARQ, PRESS-FAX, RUM-FEC, SI-ARQ, SI-FEC, SITOR-AUTO, SITOR-ARQ, SITOR-FEC, SPREAD-11, SPREAD-21, SPREAD-51, SSTV, SWED-ARQ, TWINPLEX, WEATHER-FAX
Review Software:	W4100 ver 3.0.08
Frequency Ranges	
1st i.f.:	3800Hz bandwidth
2nd i.f.:	20-1000Hz and 3800Hz
AF Input:	400-4000Hz or 400Hz-10kHz with translation
AF/HF Input:	400Hz-4kHz or 400Hz-1.5MHz with translation
Frequency shift:	F1A and F1B 20Hz to 3.5kHz
Frequency Shift:	F7B 20Hz to 2kHz
Dimensions:	133 x 483 x 370mm
Weight:	8.5kg

smoothing.

The off-air decoding performance of the 4100 was extremely good and could be optimised by choosing the appropriate demodulator system. Likewise the analysis modes were extremely powerful in the right hands. So what of my original question regarding value for money? I believe the answer to this is a resounding yes. In considering this you have to remember that the 4100

is a very specialist piece of kit, which means low volume sales.

When you combine this with the high development costs, the **DM 11250** ex works price tag becomes quite reasonable. For more details contact **Wavecom Elektronik AG, Badenerstrasse 122, CH-5466 Kaiserstuhl, Switzerland. Tel: 0041 1 858 02 00, Fax: 0041 1 858 02 11.** My thanks to Wavecom for the loan of the review model ■

MIKE RICHARDS G4WNC PRESENTS SWM'S DECODE SPECIAL

RTTY - A Gentle Introduction

For many people the data modes are considered to be a form of black art, only understood by those with a thorough technical background. Thankfully this is not actually true, as the basic principles are really quite easy to grasp. In this short feature I will take you through the operation of a basic RTTY signal as used by many press stations on the h.f. bands.

So what's a Radio Teletype (RTTY) link used for? It is simply a way of sending text messages over a radio link, so the range of material transmitted is almost limitless. The most common examples to be found on the h.f. bands are press reports, weather information and amateur radio messages. In each case, the RTTY link starts with a text message that needs to be sent to a distant point. For the sake of simplicity, I will assume that both the sending and receiving stations use computers to generate and decode the RTTY signal.

The Conversion

Once the message to be sent has been typed into the computer, we are ready to follow the transmission right through to the displayed output at the far end. At the very start of the process we need to carry out some form of conversion to convert the individual letters that make up the message into a form that can be handled over a radio link. The first part of this process is to convert each letter into a number simply because computers can only deal in numbers! The method of converting letters to numbers is done using what's known as a look-up table. As the name implies, this really is just a table where each letter is cross referenced to a specific number. Rather than use

a decimal number that we all know so well, the RTTY system uses binary numbers. The important point about a binary number is that it is made up from just 1s and 0s. If you've not covered this in your school maths you might be starting to worry - don't, it's very simple. In **Table 1** I've shown that each column in a binary number has a weighting that shows how it can be converted back into a decimal number. As an example, you can see that the binary number 10000 is the same as decimal 16 and 10101 is 21. Try using the table to work-out the following binary numbers: 01101, 01011, 11010 and 10011. You can see that, with just a little practice, you can quickly convert between binary and decimal numbers.

Table 1

Decimal	16	8	4	2	1
16	1	0	0	0	0
21	1	0	1	0	1
29	1	1	1	0	1

International Alphabet

In order for the system to work effectively for radio communication across the globe, we clearly need some standardisation of the way letters are converted to numbers. This is all catered for by using the International Telegraph Alphabet No 2 (ITA2) which can be seen in **Table 2**, and defines the RTTY conversion rules. One of the important points about the ITA2 is that the binary numbers only contain five binary digits (bits). Now if you care to do your sums using **Table 1**, you will soon see that using just five bits provides only 32 combinations. Now this isn't enough to cover our alphabet plus numbers and punctuation. The solution is to use

what's known as a shift character. This gives each of the 32 combinations an extra meaning depending on whether a shift character has been sent or not. The best way to think of it is rather like a toggle switch - when it's switched one way the codes represent letters and the other way they represent figures and punctuation. Although an ingenious system, it has the drawback of increased errors. This is because the loss of a shift character turns all the following message into gibberish!

The next stage is to transform the binary number into an electrical signal that it can be applied to a radio transmitter. This is done by first breaking the binary number into its individual digits and then passing them, one at a time, to a device that can generate an electrical signal. This is rather like putting coins in a money box or parking meter! As the individual binary digits (bits) can only be a 1 or a 0, the circuit just needs to generate two output voltages. In a typical computer based system, these voltages would be approximately 5V for a 1 (called logic 1) or 0V for a binary 0 (logic 0). I've shown what this signal would look like in **Fig. 1**. What we've created here is known as serial data as the signal is broken into a series of discrete elements.

The Transmitter

The commercial transmission of RTTY signals is usually handled by a special transmitter set-up for what's known as frequency shift keying or f.s.k. This type of keying is very easy to understand and, in simple terms, means that the transmitter can send just one of two specific frequencies. These two frequencies are very closely spaced and typically are only 400Hz apart. So to create our RTTY

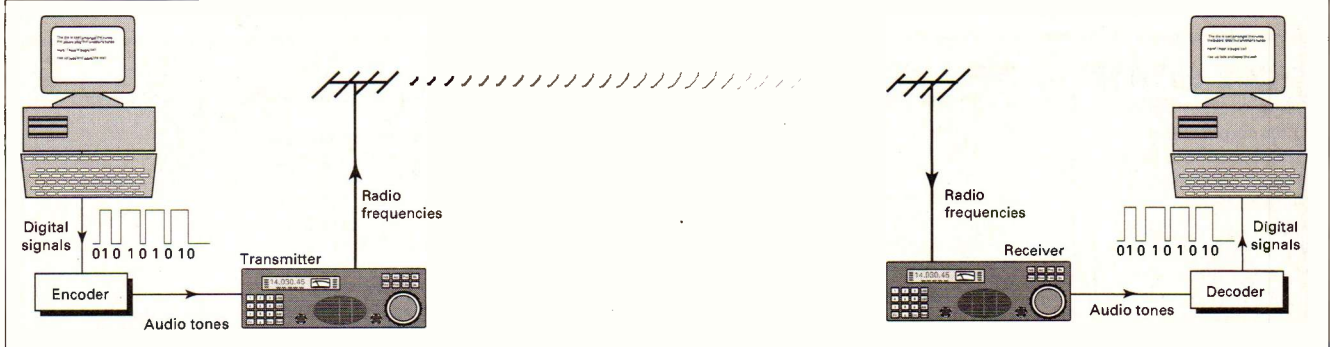

Fig. 1.

transmission, all we have to do is feed the serial electrical signal from the computer to the transmitter and we have a f.s.k. RTTY signal. Now's a very good time to take a listen to a typical RTTY signal, so set your short wave receiver to s.s.b. and tune to 4.489MHz. If you don't hear a fast warbling (diddle- diddle-diddle, etc.) sound try tuning around by ± 10 kHz. The station you're listening to is the meteorological data signal from Bracknell. This signal runs at 75 baud and uses a shift of 400Hz - don't worry about bauds yet - I'll cover those later.

Receiving

Now that you have a basic understanding of the RTTY transmission process we can look at how we can reverse the process at the receive end and display the message. If you managed to find the Bracknell Met signal you will realise that our RTTY transmission can be converted to two audio tones simply by listening to the signal using an s.s.b. receiver. These two tones also have the same spacing as the original transmission which in this case is 400Hz. So the first stage in RTTY reception is to convert the alternating tones into a d.c. signal that can be fed to our computer. In this case we want the higher of the two frequencies to produce a 5V signal and the lower to give 0V. There are lots of different ways of doing this, but the general name for a unit that performs this task is a terminal unit. Having recreated our serial data the computer can re-construct the binary number and use the ITA2 look-up table to recreate the original message and display it on the screen. That's really all there is to the receive process. However, few modern systems use a separate terminal unit and the two most common methods

are, a) decode the tones directly in the computer or b) include the terminal unit and decoder in a stand-alone unit.

Baud Rates

Having grasped the basic concept of RTTY, you're probably wondering where baud rates fit in. One of the problems with the transmission of serial data signals is the need for some synchronisation between the transmitting and receiving stations. This synchronisation is required to ensure that the receive decoder processes the serial data signal at the same rate as its being sent. A good analogy here is to think of an orchestra without a conductor - you can just imagine what would happen if everyone used a different tempo! The same principle applies to our RTTY signal and the receiving computer wouldn't know where to start reconstructing the message. The term baud is derived from one of the pioneers of teletype equipment, Emile Baudot. In technical terms the measure refers to the transmission rate in bits per second. So a 50 baud signal will be transmitting its data signal at a rate of 50 bits every second. When listening around the h.f. bands you will find that there are a number of standard baud rates in use. The most common are: 45.45 baud (amateur RTTY), 50, 75 and 100 baud (commercial press and met stations).

Summary

That about completes this basic introduction to RTTY, but the basic principles described here apply to most of the data modes used on the h.f. bands. If you'd like to try receiving

RTTY and you have access to an IBM PC or compatible, why not take-up my Decode offer (page 69) and get yourself a copy of HAMCOMM. ■

Table 2.

International Alphabet No 2

Letters	Figures	Binary Number
A	-	11000
B	?	10011
C	:	01110
D	\$	10010
E	3	10000
F	!	10110
G	&	01011
H	#	00101
I	8	01100
J	Bell	11010
K	(11110
L)	01001
M	.	00111
N	,	00110
O	9	00011
P	0	01101
Q	1	11101
R	4	01010
S	'	10100
T	5	00001
U	7	11100
V	=	01111
W	2	11001
X	/	10111
Y	6	10101
Z	+	10001
<	<	00010
*	*	01000
let. shift	let. shift	11111
fig. shift	fig. shift	11011
space	space	00100

S.R.P. TRADING

SKY SCAN

Magmount MKII

For improved performance, wide band reception, 25 to 1300MHz.

Comes complete with protective rubber base, 4m RG.58 coax cable and BNC connector. Built and designed for use with scanners.



£24.95

+ £3.00 p&p

SKY SCAN

DX V1300 Discone

Most discones only have horizontal elements and this is the reason that they are not ideal for use with a scanner. Most of the transmissions that you are likely to receive on your scanner are transmitted from vertically mounted antennas. The Sky Scan V1300 discone has both vertical and horizontal elements for maximum reception. The V1300 is constructed from best quality stainless steel and aluminium and comes complete with mounting pole. Designed and built for use with scanners.

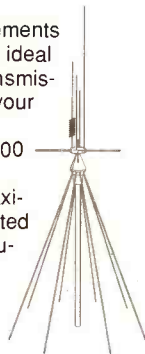

£49.95

+ £3.00 p&p

SKY SCAN

Desk Top Antenna Model Desk 1300

Built and designed for use with scanners. Coverage: 25 to 1300MHz. Total height - 36ins - 9ins at widest point. Comes complete with 4 metres of RG58 coax cable and BNC connector fitted. Ideal indoor - high performance antenna and can also be used as a car antenna when your car is static. REMEMBER YOUR SCANNER IS ONLY AS GOOD AS YOUR ANTENNA SYSTEM!

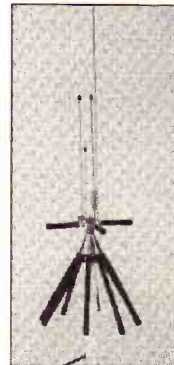

£49.00

+ £3.00 p&p

Grundig Yacht Boy 500



40 Memory channels with RDS
• 1.6 - 30MHz • full s.s.b • complete with P.S.U & carrying case

£189.95 + £5 p&p

MVT 7100

Specifications

- NFM / WFM / AM / LSB / USB
- 530kHz - 1650 MHz
- 1000 memory channels
- 500 search pass frequencies
- 10 search bands
- 30 channels per sec. scan speed
- 12v d.c. or 4 x AA power supply
- Back lit l.c.d. & buttons



Grundig Yacht Boy 400



40 Memory Channels • Signal meter
& carrying case • 1.6 - 30MHz • full s.s.b.

£129.95 + £5 p&p

FREE S.W. ANTENNA worth £14.99



AOR AR8000

The elusive one.
Ring for details.

New Carry Case for
PRO-44 COM 204
PRO-43 COM 203
PRO-39 COM 202

£14.99 + £1 p&p



Clip-on Mini Speaker

Ideal for portable scanners. Swivel clip attaches to your collar or lapel for easier listening while you carry your portable on its belt-clip. With 3.5mm plug.

£7.99 +

£1.00 p&p

PRO-44

50 Channel Scanner
66-88, 108-136.975(AM)
137-174,
380-512MHz

£129.95 + £5 p&p

inc NiCads and charger worth £20



Telescopic scanner antenna

Extends portable scanner range. Nine sections, centre loaded. For 1-1300MHz. BNC connector.

£8.99 + £1 p&p



PRO-43

200 Channel Scanner
10 Monitor Channels

£229.95 + £5 p&p

inc NiCads and charger worth £20



PRO-2039
£199.99



PRO-2036
£349.99



PRO-2006

Special part exchange deals on PRO-2006E
PRO-2035 RING FOR DETAILS

FREE UK SCANNING DIRECTORY WORTH £16.95 WITH THESE THREE WINNERS



Mail Order: SRP Trading, Unit 20, Nash Works, Forge Lane, Belbroughton, Nr. Stourbridge, Worcs. Tel: (01562) 730672. Fax: (01562) 731002

Shop: SRP Radio Centre, 1686 Bristol Road South, Rednall, Birmingham B45 9TZ. Tel: 0121-460 1581/0121-457 788



A REAL BASE STATION SCANNING RECEIVER

PRO-2035



1000 channel with hyperscan
£349.99 Free P&P

Very special
part exchange
deal available
on this radio

PLEASE RING FOR
DETAILS

FREQUENCY RANGE AND MODE:

Freq (MHz)	Step	Mode
25.000-29.995	5.0kHz	a.m.
30.000-87.495	5.0kHz	n.f.m.
87.500-107.995	50.0kHz	w.f.m.
08.00-136.995	12.5kHz	a.m.
37.000-224.995	5.0kHz	n.f.m.
225.000-400.000	12.5kHz	a.m.
400.005-520.000	12.5kHz	n.f.m.
760.000-1300.000	12.5kHz	n.f.m.

- **1000** memory channels
(100 channels x 10 banks)
- **10** limit search banks
- **100** monitor channels

■ Accessory:

Telescopic antenna and
owner's manual

■ Display:

Large l.c.d. with l.e.d. backlighting

- Large **rotary** or
keypad frequency control

■ Dimension:

Approx 232 (W) x 210 (D)
x 90 (H) mm

■ Receiving wave mode:

- Wide f.m. ▶ TV sound
- ▶ f.m. broadcast
- Narrow f.m. ▶ Business
- ▶ Communication
- ▶ Ham radio
- a.m. ▶ Aircraft
- ▶ CB radio

■ Scan and search speed

Approx 50 channels/sec.
and 50 steps/sec.

Available now from:

SRP TRADING

Mail Order

SRP Trading, Unit 20, Nash Works,
Forge Lane, Belbroughton,
Nr. Stourbridge, Worcs.

Tel: (01562) 730672
FAX: (01562) 731002

Shop

SRP Trading, SRP Radio Centre,
1686 Bristol Road South, Rednall,
Birmingham B45 9TZ.

Tel: 0121-460 1581/0121-457 7788
FAX: 0121-457 9009

S.M.C., A.R.E. & REG WARD

THE UK'S NO1 INDEPENDENT
RETAILER FOR ALL YOUR
RECEIVER REQUIREMENTS
Established 1958

We believe in offering our customers the best deal possible. By dealing direct with the manufacturer we are in effect "cutting out the middle man". Consequently, we are able to offer **LOWER PRICES** than previously possible.

THIS MONTHS SPECIALS - AOR SCANNERS

AR2000

Save
£30



Only
£269

AM, FM, WFM, 500kHz - 1300MHz.
Carr. B 1000 memory channels

AR1500EX

Save
£50



Only
£299

AM, FM, SSB, 500kHz - 1300MHz.
1000 memory channels Carr. B

★ ONLY WHILE STOCKS LAST ★

HF RECEIVERS



AOR AR3030 30kHz-30MHz. AM, SAM, USB, LSB, CW, FAX, FM. 100 memory channels
OUR PRICE **£659**^D

ICOM R-71E 100kHz-30MHz. AM, SSB, CW, RTTY, FM (option) 32 memory channels
OUR PRICE **£975**^D

ICOM R-72DC AM, SSB, CW, FM (option) 99 memory channels
OUR PRICE **£799**^D



ICOM R-100 100kHz - 1856MHz. AM, FM, FM wide, 100 memory channels
OUR PRICE **£599**^C

KFNWOOD R-5000 100kHz-30MHz. AM, FM, SSB, FSK. 100 memory channels
OUR PRICE **£899**^D

YAESU FRG-100 50kHz-30MHz. AM, SSB, CW, FM (option). 50 memory channels
OUR PRICE **£495**^D
+ FREE PAIIC mains adaptor



SCANNING RECEIVERS

NEW



AOR AR-2700
Handheld scanner
500kHz - 1300MHz.
AM, FM, WFM.
500 memory channels

OUR PRICE
ONLY
£259

YAESU FRG9600
60-905MHz. AM, FM, WFM, SSB, CW,
100 memory channels
OUR PRICE **£529**^C

ICOM ICR-7100DC
25MHz-2GHz. AM, FM, WFM, SSB,
900 memory channels
OUR PRICE **£1359**^B

ICOM ICR-1
100kHz - 1300MHz. AM, FM, FM wide.
100 memory channels
OUR PRICE **£389**^B

MVT-7100
500kHz - 1650MHz ... OUR PRICE **£349**^B
AM, FM, SSB, WFM, 100 memory channels



AOR AR3000A
100kHz-2036MHz. SSB, CW, AM, FM, FM wide. 400 memory channels
OUR PRICE **£899**^D

AOR AR8000
500kHz - 1900MHz. AM, FM, FM wide, SSB CW. 1000 memory channels
OUR PRICE **£419**^B

SONY RECEIVERS

ICFSW100E	OUR PRICE	£199	B
ICFSW1E	OUR PRICE	£159	B
ICFSW7600G	OUR PRICE	£169	B
ICFSW55	OUR PRICE	£269	C
ICFSW77	OUR PRICE	£359	C
PRO-80	OUR PRICE	£315	B
AIR-7	OUR PRICE	£269	B



Special Offers subject to availability Carriage B=£5.00 C=£7.50 D=£13.50 E=£16.50
Service Department Direct Line Monday - Friday 9am - 5pm (01703) 254247
Showroom Hotline Tel: (01703) 251549 HQ Main Office Tel: (01703) 255111



SOUTHAMPTON
South Midlands Comms Ltd.
S M House, School Close
Chandlers Ford Ind Estate
Eastleigh, Hants SO5 3BY
Tel: (01703) 251549/255111
Fax: (01703) 263507

LONDON
ARE Communications
6 Royal Parade
Hanger Lane, Ealing
London W5A 1ET
Tel. 0181-997 4476
Fax: 0181-991 2565

AXMINSTER
Reg Ward & Co
1 Western Parade
West Street
Axminster EX13 5NY
Tel. (01297) 34918
Fax: (01297) 34949

LEEDS
SMC (Northern)
Nowell Lane Ind. Est.
Nowell Lane
Leeds
Tel. 0113-235 0606
Fax: 0113-235 0155

CHESTERFIELD
SMC (Midlands)
102 High Street
New Whittington
Chesterfield
Tel. (01246) 453340T
Fax: (01246) 453340

BIRMINGHAM
SMC
504 Alum Rock Road
Alum Rock
Birmingham B8 3HX
Tel. 0121-327 1497
Fax: 0121-327 6313

MIKE RICHARDS G4WNC PRESENTS SWM'S DECODE SPECIAL

Choosing a Data Modes Receiver

In this feature I'll attempt to guide you through the various elements you need to consider when choosing a receiver for monitoring the data modes. A little time spent carefully considering your requirements before you buy can save disappointment for those new to the hobby.

Variety

When first considering moving to the data modes, you may be put off by the thought that, as well as a decoder, you'll have to splash out on an expensive receiver. You'll be glad to hear that is not the case in practice and there is a very wide range of receivers in regular use by decoding enthusiasts. These span from simple portable receivers that are available from the major high street chains, through to top flight professional receivers costing several thousands of pounds. Now somewhere within that range is a receiver that will suit both your budget and decoding requirements. Rather than try and list all the available receivers here, I will concentrate on the most important features of a data receiver so you can make your own decisions as to which is the most suitable for you. One of the main factors that will determine your receiver is the type of data signals you intend to monitor. Whilst a simple portable may well be fine for occasional RTTY use, if you're into the more complex modes, you may need a very stable receiver that can be set-up for unattended operation.

Frequency Selection

One of the most important aspects to consider with most modern receivers is the tuning frequency steps. Although the receiver may have a conventional tuning knob that gives the impression of continuous tuning,

virtually all modern receivers use digital frequency synthesis. With this system, the movement of the tuning control is converted into small frequency changes in line with the direction the knob is being turned. Now the size of these frequency steps varies from one receiver to the next, but is vitally important for the data monitor. If, for example, you were trying to receive a typical ship's Telex transmission and your receiver's tuning steps were set at 100Hz you would find it very difficult to decode the signal reliably unless you were very fortunate. This is because the ship's signal uses a shift of just 170Hz and you could find that your receiver is always straddling the signal and never able to tune spot-on. However, if the required signal was using a shift of, say, 800Hz, the effect would be far less noticeable. You can see from this that you will need a receiver with much smaller frequency steps if you regularly want to decode systems that transmit using a narrow shift such as many ARQ modes plus amateur RTTY and Packet. If you're stuck with a receiver that uses 100Hz frequency steps all is not lost as some data decoders have a trick up their sleeve that can help. These decoders feature an adjustable centre frequency that can be used to compensate for the tuning deficiencies in the receiver. Some decoders even include fully automatic tuning, which can be very convenient. The downside here is that the automatic systems don't work too well with noisy signals as they can't tell the difference between noise and signal! So what frequency steps do you really need? One of the most common in the better receivers is 10Hz steps though for most purposes you can get away with frequency steps up to about 25Hz. With steps greater than that you may find problems if you're interested in receiving signals with shifts of 200Hz or less.

Stability

The more critical nature of data signals means that the frequency stability of the receiver becomes more important. This is because of the fine tuning required to resolve narrow shift signals combined with the need to be able to stay tuned for long periods. As with the frequency steps described earlier, the need for good frequency stability increases as you explore the more complex transmission modes. If we take FAX reception as an example, to receive Offenbach Met on 132.4kHz we need to be able to tune the receiver within about 30Hz of this signal and it has to stay on that frequency for at least the time taken to receive one image, e.g. fifteen minutes. The serious FAX listener may also want to use fully automatic picture reception where the receiver may be required to stay on frequency for hours at a time. The good news is that the stability of most modern communications receivers is well up to this standard. If you're considering an older receiver or maybe a portable you may find the stability to be somewhat lacking. However, there are a few tricks you can use to minimise the effects. The first is to note that most frequency drifting is caused by temperature changes within the receiver. To minimise this you need to make sure the receiver is kept well away from any draughts. You can also help by switching the receiver on an hour or so before you begin your monitoring session. This will give the receiver time to stabilise at its normal working temperature. If your shack is left without heating you also need to make sure this has been on for a while before you start operating. Closely related to the stability of the receiver is its frequency accuracy. For most, this is not particularly critical, providing the receiver has a digital display to get you close to where you want to be. One of the few situations that demand particularly good frequency accuracy is the use of your

station for unattended operation under computer control.

Modes

This is the easy part as all you need is straight forward s.s.b. mode preferably with selection between upper and lower sideband. The only point to watch for is the use of a beat frequency oscillator (b.f.o.) on some of the cheaper and older receivers. Whilst these systems are fine for s.s.b. audio signals you can hit stability problems. The trick here is to try before you buy. You can do this by tuning into a broadcast signal, switching the b.f.o. on and tuning the b.f.o. knob to produce a strong beat note. Now just leave it like that for a while and listen for any change of pitch. If there is any fluttering or a steady change of note, you will have trouble with data reception. You will note that some of the more sophisticated receivers include a FAX mode. This is usually the same as s.s.b. except that the carrier insertion frequency is changed. In my experience, there is little, if any, difference between the reception quality using specialist FAX modes or s.s.b. The only way you can really see a benefit is if the FAX mode offers a slightly wider bandwidth than s.s.b. as this will help to preserve fine detail in the chart.

Filters

You will no doubt have noticed that many of the more expensive receivers often include a selection of filtering systems. This can range from switchable i.f. bandwidths through to quite complex audio filters. Although many of these are designed and optimised for dealing with speech signals, they can be very useful for the utility enthusiast. However, you need to be wary of over-using these filters as you can cause a degradation of the signal if you apply too much filtering. It's also important to remember that there are many external filters on the market that can also prove very useful for the data listener. The ones to watch out for here are the new digital signal processing (d.s.p.) filters. These provide extremely sophisticated, yet simple to use filtering systems that can transform many difficult signals.

Connections

Before you finally decide on your receiver you need to consider how you will make the connections to your antenna and decoding systems. If you're using a computer for your decoding and are considering a portable receiver you need to be very careful with the antenna connection. Whilst some have a proper external antenna socket that disconnects the telescopic whip, others do not. If you try using a portable receiver and computer with the telescopic antenna still active you will suffer severe interference problems. Another area to consider is the audio feed from your receiver to the decoder. The best choice is to feed the decoder from the line output of the receiver (if it has one). This provides a relatively constant output level that's independent of the volume control setting. If your receiver doesn't have a line-out then you will have to use the external speaker or headphone jack. The problem here is that by plugging into this jack you disconnect the internal speaker so can't hear what's going on! The answer is to make, or buy, what's known as a Y adapter. This is very similar to a telephone adapter and converts the single external speaker socket into two sockets, one for an external speaker the other for your decoder.

Summary

As you can see, there are many parameters that need to be considered when choosing your data mode receiver, but one of the most important is the modes you are intending to receive. To help you with that decision, here's a summary of the typical demands made by a selection of popular modes:

Morse

Least demanding of the utility modes is c.w., providing you're prepared to manually adjust the tuning. The frequency steps will depend very much on the decoder and whether or not the centre frequency can be adjusted. A narrow i.f. filter (500Hz) can be a very useful

accessory for pulling signals out of the noise.

RTTY

Press and other commercial RTTY signals are usually receivable with frequency steps of 50Hz or less. The stability demands are modest providing you are prepared to manually adjust the tuning during the monitoring period. If you're interested in amateur RTTY you will need 20Hz or better tuning steps as these signals operate with 170Hz shift.

SITOR (or AMTOR)

These signal use a 170Hz shift so demand tuning steps of 20Hz or better. Stability requirements are generally the same as RTTY and ARQ variants. These advanced modes require 20Hz or better tuning steps and good frequency stability to support the extended monitoring periods often required with these modes. Piccolo and Coquelet demand very precise tuning and frequency accuracy with 10Hz tuning steps being the minimum.

FAX

The tuning steps depend very much on the decoder as many systems have built-in automatic tuning to off-set shortcomings in the receiver. However, stability demands are high as the receiver must be able to remain within a few hertz for extended periods. Whilst you can manually adjust the tuning during picture reception, this inevitably produces stripes on the final image. ■



MIKE RICHARDS G4WNC PRESENTS SWM'S DECODE SPECIAL

Books for Data Listeners

With so many different types of data signal it's not surprising that there are a wide range of publications available. In this article I will cover the most popular data mode books and explain how they can help the listener get more from the hobby.

Frequency Guides

Probably one of the first books bought by the new listener is a frequency guide. Although they form an essential reference they are also the cause of disappointment for many. This is because inexperienced listeners mistakenly think they will be able to hear all of the many thousands of frequencies listed. The main point of these frequency guides is to act as a reference document rather than a simple list of stations to monitor. Most experienced listeners use these frequency guides to help with the identification of signals that have been found whilst tuning around the bands. You can, of course, use the guide to find stations - you must take into account propagation conditions and operating times.

1995 Guide to Utility Radio Stations 13th Edition by Joerg Klingenfuss

This is one of the best established of the frequency guides and is regularly updated every year. This makes it one of the more up-to-date publications available. In addition to listing some 15000 frequencies, the guide contains a host of valuable material. One of the most popular type of station is the foreign press RTTY transmissions. These emanate from most of the world's Third World countries and can make fascinating listening. The guide includes a very handy section that lists press transmissions by time. So all you have to do is look-up the required time of day and all the active transmissions will be listed. Another very useful feature is the FAX schedules. This list includes all the h.f. weather FAX stations by country transmission schedules and frequencies. All this is supplemented with a comprehensive listing of abbreviations, call signs and QSL addresses.

Ferrell's Confidential Frequency List 9th Edition compiled by Geoff Halligey

Another very popular frequency guide that has been running for many years. One of the great attractions of this book is the spiral binding. Not only does this make the book physically very strong, but it also makes it very easy to keep your place. You

can even fold the book back on itself to save desk space. The main frequency listing covers from 1.6MHz through to 30MHz. In addition to the frequency and station details many of the stations include mode, shift and speed details. This is all valuable information for the utility enthusiast. The last section of the guide provides a range of useful references. Included here are details of international callsign allocations and a very useful reverse reference. This provides details of utility stations indexed by callsign. Against each callsign is the operating mode plus all the active frequencies.

Pocket Guide to RTTY and FAX Stations by Bill Laver

This handy little reference book makes a good starting point for those new to the data modes. By simplifying the list to just RTTY and FAX station it becomes far less daunting than the more conventional frequency listings.

Mode Guides

Guide to FAX Radio Stations by Joerg Klingenfuss

This established favourite comprises 400 pages of specialist information for the FAX monitor. The frequency list of FAX stations is supplemented by full transmission schedules for every station. This book also contains a very large selection of sample FAX charts from all around the World. Not only do these charts cover original clean images but there are plenty of off-air examples. Essential in the identification of the various chart types. The charts also give a good idea of the quality of reception you can expect under different conditions. If you've often wondered what those odd codes included in FAX chart titles mean, this book has the answer. The schedules section includes a full breakdown of the chart i.d. system. There was also a section devoted to the various weather satellite systems.

Air and Meteo Code Manual by Joerg Klingenfuss

This specialist publication provides a host of vital information to support meteorological and air traffic utility transmissions. As well as providing a description of the services and their method of operation, there is extensive coding details. This provides a full breakdown of the meteorological code formats with examples of how to resolve them. For the air enthusiast there's details of the Air Traffic Services (ATS) message system and the NOTAM code.

Radioteletype Code Manual by Joerg Klingenfuss

Just about the only publication that gives in-depth technical information on the data utility modes. This is where you'll find details of all the international telegraph alphabets. The number of alphabets covered is very comprehensive ranging from the most basic systems through to Third-shift Amharic! Also covered is the operation of a wide range of utility modes. The descriptions are by necessity technical, but none the less very helpful. If you're seriously into decoding this book is a must.

CDs and CD-ROMs

The rapid spread of the CD-ROM for home computers has made the production of specialist CD-ROMs for utility listeners a practical reality. To my knowledge there are currently three of these specialist CDs on the market.

1995 Super Frequency List by Joerg Klingenfuss

This new CD-ROM has been designed for use with IBM PCs or clones running Windows 3.1. The CD-ROM comes complete with its own viewing software and includes 14000 frequencies that have been extracted from the Klingenfuss *Guide to Utility Stations*. This frequency listing is supplemented by 1000 abbreviations and 1200 formerly active frequencies. As this list was last updated in January '95 it's well up-to-date.

Intelligence Services

This is the very latest package to be released and is likely to be of particular interest to the more experienced listener. The disk contains over 1300 pages of information covering the activities of more than 200 intelligence agencies from all over the world. Like the *Super Frequency List* this also comes complete with its own viewing software.

Compact Disk Recording of Modulation Types

This double audio CD has been produced to help both the newcomer and experienced operator identify utility modes. Whilst the new listener will find the examples of systems like RTTY and FAX very useful, there's even more for the experienced operator. The 2.5 hours of audio includes samples from 71 different modes from the simplest through to advanced military systems. ■

Discoveries in

Driving Land Rover Discoveries along disused Central American jungle logging tracks, sometimes thick with mud, often under water, the competing teams in the Camel Trophy '95 rely on radio communications. Richard Diamond explains what goes into providing the communications infrastructure.

This year's Camel Trophy Event - 'The Last Great Adventure' - is to be held in Central America, starting and finishing in Belize. During the course of three weeks, the convoy of 20 international teams driving Land Rover Discoveries will transit Mexico, Guatemala, El Salvador and Honduras, an area known collectively as the 'Mundo Maya', World of the Maya, an ancient civilisation that has left numerous archaeological artefacts to be seen throughout the route.

Mayan Pyramids

The 'start' is located in Belize at Lamani, an idyllic spot on the 'new river lagoon' (Lamani Lake), where a number of Mayan temples were constructed shrouding the area with the mysticism of the ball courts (a game to settle tribal disputes), ritual sacrifice and overwhelming presence of the Mayan pyramids. The pyramids are very different in concept to the Egyptian equivalents, as numerous bodies are to be found buried inside along with their belongings. Each layer of the pyramid represents about fifty years of culture and some considerable engineering skills, which are so often only associated with the Egyptians. The peace and tranquillity of this site will be only momentarily disturbed by the arrival of the competing teams, who will be treated to an evening of cultural presentation including a Solair illumination of the Jaguar temple. Of course, none of this happens by itself and a

great deal of planning and effort goes into making the whole Camel Trophy event a success, supported by a management group, headed by Event Director Iain Chapman, and boasting a variety of skills including communications.

The Team

Gerry Brennan G4GOL, who surprisingly is not attached to the communications team, acts as Logistics Director, applying skills picked up during his 26 years service with the British Army. Gerry now runs his own logistic company, Logistic Support Services Ltd. (LSSL) and has the responsibility of getting all the equipment onto site including 2 x 100kW diesel generators and a 6m container full of communications equipment.

Richard Diamond G4CVI, a director of South Midlands Communications Ltd., heads up the communications team on his fourth Camel Trophy Event supported by Mike Devereux G3SED, Managing Director of Nevada Communications, Paul Simons G4CCZ of Westwood Communications, Richard Mumford G8SVC of SMC, Darren Bito and Adrian Collins, both service engineers at SMC.

On arrival in Belize City, the group will set about fitting out some 54 Land Rovers with Yaesu v.h.f. 169MHz transceivers, Trimble and Garmin GPS units (Global Positioning Systems), Codan 100W h.f. transceivers and a quantity of associated equipment. Fortyone of these vehicles were pre-fitted at Land Rover's Solihull factory during February. The pre-fit exercise carried out by the

communications team was undertaken during somewhat contrasting weather conditions to those found in Belize at this time of year (hot and wet). While Richard Mumford installed the GPS antennas on the vehicle roofs, a blizzard started with temperatures approaching 0°C. Perhaps it would have been better not to fit out the vehicles in the British winter, but to have waited for the warmth of Belize - a simple decision after the event!! Surprisingly, the vehicle fits are only a small percentage of the work carried out. The Event HQ located at the Ramada Hotel, Belize City, has to be fitted out with a total communications package including Satcom links, telephone lines, v.h.f. base stations, h.f. equipment and of course the amateur radio facility, callsign V31RD, not to mention numerous photocopiers, faxes, computers, etc.

Base and Repeaters

Mobile operations centres are set up at Lamani (start) and Xunantunich (finish) with both h.f. and v.h.f. communications, the latter being enhanced by placing two Icom repeaters fitted with 'phone patch and rural cellular 'phones on top of Pine Ridge, a mountainous region to the South West of Belize City. The repeaters being some 1000m a.s.l., will provide extensive coverage throughout the Northern region of Belize. Of course, it's not possible to find a convenient power point at the top of most mountains, consequently, everything has to be brought to the site. The repeaters are solar powered with a reserve battery

Dates:

April 29 onwards

- Event set-up commences.

May 5

- Amateur operations commence.

May 20

- Event starts.

June 6

- Amateur ops cease.

June 8

- Event finishes.

June 12

- Staff return to UK.

'Mundo Maya'

capacity of 500Ah. Unfortunately, as it is now the wet season, this may not give sufficient capacity, so to minimise current consumption, the rural cellular units are powered down until a control DTMF signal, requesting patch operation, is received at the repeater. This simple arrangement saves nearly 60Ah consumption per day! Even with these savings, it is unlikely that the reserve capacity will cope with the heavy airtime usage at the end of the event. For this reason a 70Ah charger and generator has also been placed on site. Various discussions took place regarding automating the start up, but in the end, it will be just as easy to send someone up to the site for a few hours to top up the batteries!

At the start and finish sites, an AV system has been specified as a requirement for the initial briefing and the final awards ceremony. The requirements, whilst apparently straightforward, slowly became more and more complicated with sequenced light switching synchronised to the musical build-up, complimenting the solar illumination of the Jaguar pyramid and the later introduction of the 16-screen video wall complete with multiple camera feeds, video feed and interactive CD. The only straightforward part of the presentation is the operation of the 2.5kW audio system!

High Radiation Angle

A 24-hour radio watch is maintained throughout the event primarily for safety cover followed by logistics

requirements and as a means to propagate journalists' reports. In order to provide this level of cover, frequencies in the region of 5.5 and 9MHz are used in conjunction with a variety of antennas, some of which are as low as 3m above ground level in order to produce very high angles of radiation, in fact as near vertical incidence as possible. This is done to fill in the short range communications out to about 160km, the higher antennas being used for the lower angle requirements.

Three FT-1000 transceivers from Yaesu are used as they have the facility of a second receiver. This gives the option of monitoring six channels simultaneously - an option that is necessary, particularly at dawn and dusk when propagation can change dramatically. Even though all usage of radio equipment is licensed by the local authorities, interference can be a significant problem, both man made and static.

Because of the nature of the region, telephone lines are not predominant. Consequently a great deal of communications is made by radio and there is no such thing as an exclusive channel on h.f. and v.h.f.! Static is another worry. Even though the FT-1000 'S' meter is not known for its great sensitivity - sometimes as much as 15dB down on a Kenwood one - it still manages to read S9-S9 + 10dB on back ground noise which means that the mobile stations have to put in a big signal or the operators have to have sharp ears - the latter prevails.

Event Communications

In addition to the team's

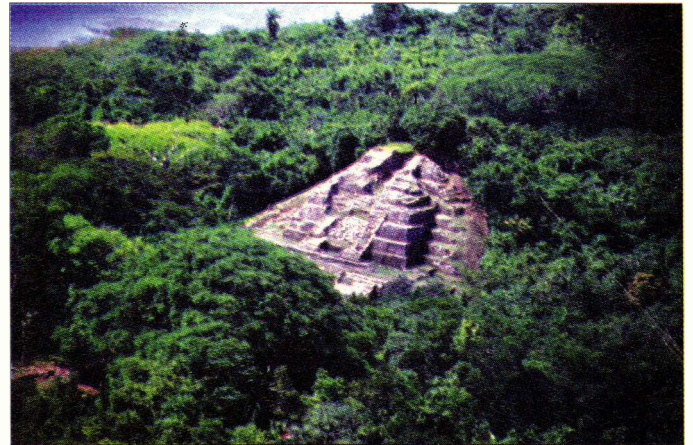

A view of the Jaguar Temple at Lamani where the Event starts.

The station during last year's recce trip. Over 1000 c.w. QSOs were made from this site.

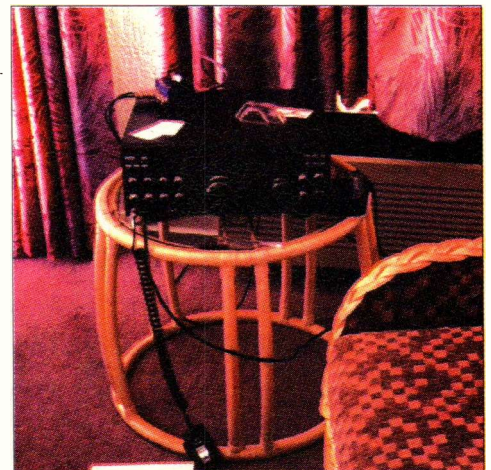

responsibilities to the Camel Trophy, they are also active on the amateur bands. This year the 160-2m bands are being catered for. The 2m result will be most interesting with e.m.e. operation on 144.022MHz from moonrise to moonrise +1hr, the team are using 'even' one minute periods for transmit and will listen 2-3kHz h.f. Being the 'E' season, direct contacts into the USA are expected and the entire operation is likely to create a great deal of interest.

Of course, amateurs calling V31RD must remember that the primary function of the team is 'event communications' and this

may cause the operator to instantly vacate the frequency to deal with such matters. However, it is normally possible to resume operations after only a short delay, so please wait on frequency.

All QSL cards should be via G4SMC at South Midlands Communications Ltd., School Close, Chandlers Ford Industrial Estate, Eastleigh, Hampshire SO53 4BY. QSLs will be issued for s.w.l. reports.

FIND OUT WHAT

Follow the

EASY PAYMENT OPTIONS

If you're between 18-70 years of age working, retired or disabled, subject to status, you may well qualify for our new "Easy Payment Options" For fast mail order service, phone Coastal today.

1. "Easy Payment Options" are available subject to status on any equipment over £280.00: Accessories (Scan Directory, Discones etc) may be added to radios under this value, to bring them up to £280.00 or above.
2. P/X welcome, and may be used as "Easy Payment Options" deposit.
3. Delivery is normally free and next working day, subject to stock availability.
4. All prices quoted are current RRP, and correct at time of print E&EA.
5. With "Easy Payment Options" you pay only the RRP, no finance interest, no hidden charges, and all prices are inclusive of VAT at the current rate.
6. Our "Easy Payment Options" is done by means of an unsecured loan, so there is no risk of losing your home etc.
7. Some examples are given below, but full written details are available upon request.

SKYCALL The professional amateur radio callbook program. Requires DOS 3.1 386 IBM PC1 Windows 3.1, 4mb of RAM, Hard disk 8.2 available space **£19.95 Free P+P**

HANDHELDS

▶ UNDER £250.00

- PRO44** RRP £149.95 66-512MHz (with gaps).
VT125 RRP £189.95 108-142MHz AM Airband.
VT150 RRP £189.95 142-170MHz FM Marine.
PRO43 RRP £229.95 66-999MHz (with gaps).
VT225 RRP £249.95 1000-142AM/149-160FM/220-391

▶ £250.00-£350.00

AOR AR2700 RRP £289.00
 DEPOSIT £49.00, 6 x £40.00 = **£289.00**
 500KHz - 1300MHz WFM/NFM/AM



YUPITERU MVT7000 RRP £289.95
 Deposit £49.95, 6 x £40.00 = **£289.95**
 200kHz-1300MHz WFM/NFM/AM



UBC 2500XLT RRP £299.00
 Deposit £59.00, 6 x £40.00 = **£299.00**
 68-1300MHz (with gaps).



MARUHAMA RT618 RRP £299.00
 Deposit £59.00, 6 x £40.00 = **£299.00**
 500KHz-1300MHz All mode



ALINCO DJ-X1D RRP £299.95
 Deposit £59.95, 6 x £40.00 = **£299.95**
 200KHz-1300MHz WFM/NFM/AM

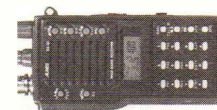

AOR AR1500EX RRP £349.00
 Deposit £49.00, 6 x £50.00 = **£349.00**
 500KHz-1300MHz All mode.



▶ £350.00-£450.00

ICOM IC-R1 RRP £395.00
 Deposit £39.95, 9 x £39.45 = **£395.00**
 2MHz-950MHz WFM/NFM/AM

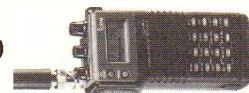

YUPITERU MVT7100 RRP £399.95
 Deposit £39.95, 9 x £40.00 = **£399.95**
 100kHz-1650MHz All mode.

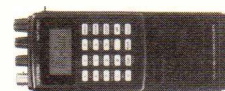

AOR AR8000UK RRP £426.00
 Deposit £48.00, 9 x £42.00 = **£426.00**
 500kHz-2036MHz All mode.



*As authorised main dealers for
 Kenwood, Yaesu, Icom & Hustler, we can offer a
 FAST NEXT DAY DELIVERY on most items.
 For polite, efficient & fast service call "Coastal".*

- the traditional retailer -

CHECK THE COMPETITION!



THE No1 ANTENNA SYSTEM IN THE STATES. THAT'S CATCHING ON VERY WELL OVER HERE. SEND AN A4 SAE FOR LATEST FULL INFO PACK INCLUDING HRT & PW REVIEWS. WHEN THE SIGNAL MATTERS USE HUSTLER.

T'S ON THE AIR, Red Arrows

CAUTION:

Although many scanners are capable of monitoring broadcasts from the Police, Ambulance, Fire Brigade, Cellular telephones, Cordless phones, Military, Government bodies etc.
It is illegal to use scanners for these purposes.

BASE STATIONS

 **£350.00-£450.00**

REALISTIC PRO2035 RRP £349.00
Deposit £34.00, 9 x £35.00 = **£349.00**
20-1300MHZ WFN/NFM/AM



YUPITERU MVT8000 RRP £369.95
Deposit £36.95, 9 x £37.00 = **£369.95**
200KHz-1300MHZ WFN/NFM/AM



LOWE HF-150 RRP £419.00
Deposit £41.00, 9 x £42.00 = **£419.00**
30KHz-30MHz SSB/CW/AM/DATA



 **£450.00-£600.00**

LOWE HF-225 RRP £499.00
Deposit £49.00, 9 x £50.00 = **£499.00**
30KHz-30MHz SSB/CW/AM/DATA



YAESU FRG100 RRP £559.00
Deposit £55.00, 9 x £56.00 = **£559.00**
500KHz-30MHz SSB/CW/AM



YAESU FRG9600 RRP £589.00
Deposit £58.00, 9 x £59.00 = **£589.00**
60MHz-905MHz SSB (up to 460MHz)
AM/FM



 **£600.00-£900.00**

ICOM IC-R100 RRP £629.00
Deposit £65.00, 12 x £47.00 = **£629.00**
50KHz-1800MHz WFM/NFM/AM



AOR3030 RRP £699.00
Deposit £99.00, 12 x £50.00 = **£699.00**
300KHz-30MHz SSB/CW/AM/DATA



LOWE HF-225 EUROPA RRP £699.00
Deposit £99.00, 12 x £50.00 = **£699.00**
30KHz-30MHz SSB/CW/AM



ICOM IC-R72E RRP £859.00
Deposit £139.00, 12 x £60.00 = **£859.00**
100KHz-30MHz SSB/CW/AM/FM



 **£900.00 PLUS**

AOR AR3000A RRP £949.00
Deposit £145.00, 12 x £67.00 = **£949.00**
100KHz-2036MHz SSB/CW/AM/FM/DATA



KENWOOD R5000 RRP £999.95
Deposit £99.95, 12 x £75.00 = **£999.95**
100KHz-30MHz SSB/CW/AM/FM



LOWE HF-235 RRP £1116.00
Deposit £156.00, 12 x £80.00 = **£1116.00**
30KHz-30MHz SSB/CW/AM



KENWOOD R5000+VC20 RRP £1199.90
Deposit £179.90, 12 x £85.00 = **£1199.90**
100KHz-30MHz SSB/CW/AM/FM



COASTAL COMMUNICATIONS

AMATEUR RADIO FOR THE RADIO AMATEUR

19 Cambridge Road, Clacton-on-Sea, Essex CO15 3QJ

VISA, ACCESS, AMEX, RSGB, DELTA, SWITCH, Licensed Credit Brokers

MON-SAT 9-5pm
WED 9-2pm

**01255
474292**

ASK ELECTRONICS LTD

248/250 TOTTENHAM COURT ROAD, LONDON, W1P 9AD • Tel: 0171-637 0353/0590 • Fax: 0171-637 2690



YOUR SONY SPECIALIST

All products covered by a total manufacturers guarantee

ICF-SW77 Similar specification to the ICF-2001D but with 160 memories & labelling facility

ICF-SW77	£349.95
ICF-SW55	£249.95
ICF-SW100	£175.00
ICF-SW100S	£249.95
ICF-SW1E	£149.95
ICF-SW7600G	£159.95
ICF-PRO80	£299.95
AIR-7	£249.95
ICF-SW30	£89.95
ICF-SW33	£109.95
ICF-SW22	£69.95
ICF-SW10	£44.95
AN-1 Active SW ant	£59.95

ROBERTS

RC-818	£184.95
R-817	£159.95
R-808	£94.95
R-617	£120.95
R-621	£59.95
R-101	£49.95

AS ADVERTISED IN SW MAGAZINE

GRUNDIG AT ASK

Sattalite-700	£349.00
Yachtboy-500	£159.95
Yachtboy-400	£120.00
Yachtboy-230	£65.95
Yachtboy-222	£52.95
Yachtboy-206	£37.95
Yachtboy-205	£30.00
Concertboy-230	£35.95

MAIL ORDERS WELCOME ON THE ABOVE PHONE NUMBERS. FAST-EFFICIENT-CONVENIENT TO YOUR DOOR STEP!!

We also have in stock a range of Frequency Scanning Guides

UK Scanning Directory 4th Edition	£17.50
The VHF/UHF Scanning Guide	£12.95
Monitoring the World Above 30MHz	£19.95
Shortwave International Frequency H/Book	£14.95

Panasonic

RF-B45L digital SW receiver	£139.00
RF-B65D digital SW receiver & ssb	£165.00



SW Receivers

HF-150	£355.00
KEY PAD	£34.95
PR-150	£190.00
IF-150 interface	£34.95

HANDHELD & BASE

SCANNERS

YUPITERU

MVT-125II air band	£169.95
MVT-150 FM marine	£169.95
VT-225 civil & military airband	£239.00
MVT-7000 100kHz-1300MHz (no gaps)	£259.00
MVT-7100 500kHz-1650MHz	£365.00
MVT-8000 home base 8MHz-1300MHz	£349.95



AR-1500EX 500kHz-1300MHz	£310.00
AR-2800 500kHz-800MHz, 800-1300MHz	£395.00
AR-2000 500kHz-1300MHz	£274.95
AR-8000 100kHz-1950MHz no gaps	£415.00
AR-3000A 100kHz-2038MHz home base	£840.00
AR-3030 30kHz-30MHz home base	£615.00

TAX FREE FOR EXPORT.
MAIL ORDER
IMMEDIATE DESPATCH.
GOVERNMENT
& LOCAL AUTHORITY
ORDERS WELCOME

YAESU

FRG-100 50Hz-30MHz	£509.95
FRG-9600 60MHz-905MHz	£525.00

DJ-X1D 200KHz-1300MHz	£295.00
-----------------------	---------



ICR-1 100KHz-1300MHz	£349.00
(The smallest hand held scanner)	
ICR-7100 homebase	£1220.00

All products are subject to a posting & packaging charge

PLEASE MAKE ALL CHEQUES PAYABLE TO ASK ELECTRONICS AT 248-250 TOTTENHAM COURT ROAD, LONDON W1P 9AD

For the best prices give us a call on: 0171-637 0353

A Super-regenerative VHF Receiver

In this first part of a receiver construction mini series, Brian Adkinson has come up with a hand-held design for v.h.f. listening. If this part of the spectrum has had you tempted, then why not have a go with this two part project. The first part covers the theory and parts required, next month Brian covers the construction and setting up of the receiver.

This hand-held receiver will cover the v.h.f. band from about 105 to 185MHz. It gives reasonable audio quality from either a.m. or f.m. transmissions making it suitable for reception of the air, 2 metre amateur and marine bands as well as various other services that use this portion of the radio spectrum.

Regeneration is automatic in this particular design so no adjustment is required once the receiver has been built. Also, the detector stage is largely un-affected by 'wilting' battery supplies and will maintain its sensitivity even when the battery is nearly exhausted.

The circuit is based upon the super-regenerative principle of detection which can give truly outstanding sensitivity. Like many simple and effective radio designs this one was conceived of not long after the birth of radio and, using so few components, is yet to be bettered.

High Sensitivity

Some of the advantages of the super-regen are, as mentioned, very high sensitivity, particularly at higher frequencies where its relative - the 'regenerative receiver' becomes 'trickier' to operate. Also, the regeneration can usually be set at one optimum position with little or no further adjustment being necessary. It does have some disadvantages however, mainly - relatively poor selectivity (not too important for this application), a constant background hiss in the absence of a signal plus a strong tendency to indiscriminately 'spray' interference from the oscillating detector over a wide range of frequencies. By comparison, a simple superhet politely 'blows' on one frequency only and the regenerative receiver keeps its 'business' completely to itself (unless mal-adjusted).

In view of the latter shortcoming, this design

incorporates an r.f. stage, the primary function of which is to help isolate the detector section from the aerial.

Without it you might find yourself the only one 'picking up' anything at the spectators area of your local airport, while all the sophisticated scanners are suffering from 'earache'. Fine until you get rumbled - then you'll know what it's like to have a flat battery - and a flat radio!

This little receiver could serve as an introduction to the v.h.f. spectrum before investment in a scanner. For existing scanner owners it could prove useful at new locations, such as when on holiday, where say the approach, departure and tower frequencies of an airport are not known. Here it can be used to locate local 'ball park' areas of activity before precise

location with a scanner. The same goes for any other v.h.f. services in the area.

Circuit Description

Before describing the circuit in more detail the principles of the super-regenerative detector will be explained. In the regenerative detector maximum sensitivity and selectivity is achieved by manually increasing the r.f. feedback to a point where the circuit just fails to break into oscillation. At this critical point the losses in the tuned circuit are largely offset and it is this that greatly enhances the sensitivity and selectivity of the detector. In contrast to this the super-regenerative detector is



Fig. 1.

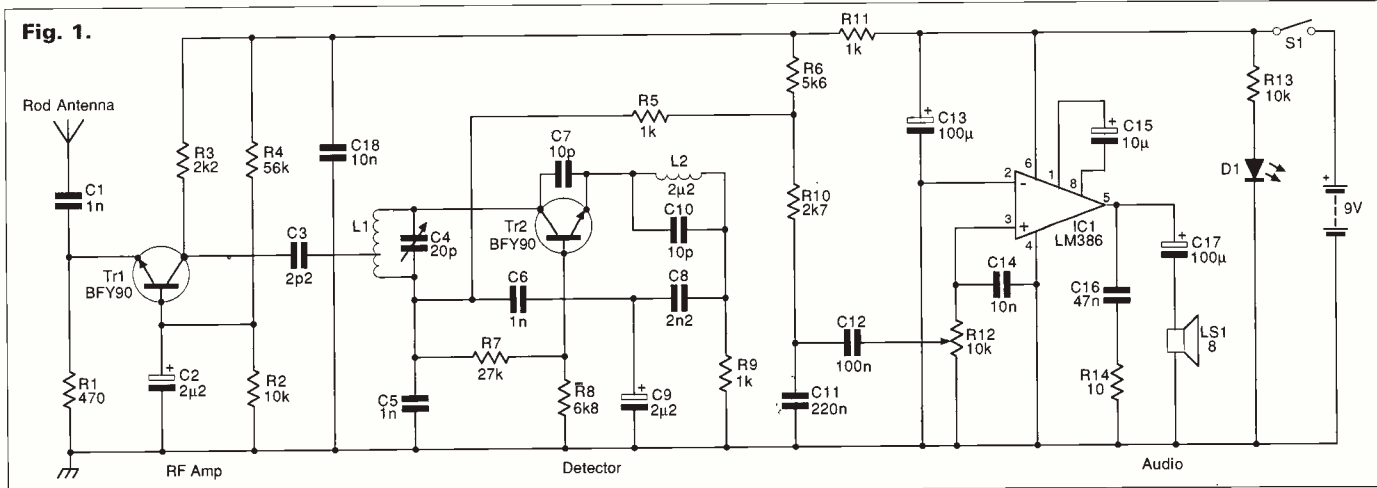

A Super-regenerative VHF Receiver

designed to oscillate continuously but is stopped or 'quenched' periodically by a second and much lower frequency oscillation. This quench frequency can conveniently be generated by the detector itself and this type of detector is thus called 'self-quenching'. The quench frequency is neither a sine or square wave but rather a type of ramp waveform.

It is possible to use a separate circuit to generate the quench frequency and then inject this into the detector to control it. The main advantage in using this, more complicated method, is that precise control can be made over the waveform shape and frequency and this can optimise the detectors sensitivity.

Because the 'super-regen' detector is continually being

swept through its most efficient point of operation its sensitivity is high and is automatically set at an optimum point, so no manual intervention is needed, as is the case with the regenerative detector.

Unfortunately, it is this sweeping through and past the optimum point which also causes the main disadvantage of this type of detector - poor selectivity. So it has some advantages over the 'regen' but poorer selectivity, which is why its use is usually confined to the higher frequencies or where channel spacing are large (such as its widespread use in cheap 'toy' radio controlled models).

In a carefully designed circuit with an optimised quench waveform, a sensitivity of better than 1µV can be achieved. Quite remarkable for a v.h.f. receiver using just one r.f. transistor!

In this particular receiver good selectivity would be a distinct disadvantage due to its wide frequency coverage. For the 'R/T' type communications it is intended to receive the operator would need lightning fast reflexes and nerves of steel to tune into and hold a transmission before it disappeared!

It should be appreciated that adjacent transmissions - particularly in the crowded airband - will all talk at once and strong signals will 'walk over' weaker ones! In general though this doesn't detract from the usefulness of the receiver.

In Depth

Now to the circuit in detail Tr1 is configured as a grounded base untuned r.f. amplifier and buffer stage. As previously stated its main purpose is to help prevent the detector stage from 'blowing' while it 'sucks' and causing a major communications blackout in the surrounding area. No, its not really anywhere near as bad as that but we don't want to add unnecessarily to pollution of the ether do we? This stage provides minimal gain.

Capacitor C3 couples the signal to the detector stage which is based around Tr2 and its associated components. C7 provides the feedback between the collector and emitter of Tr2 to initiate oscillation and C8 and R9 are the primary components that set the quench frequency which in this circuit is approximately 100kHz.

The audio output is taken from the collector of Tr2 via L1, R5, R10, C12 & R12 to the audio output stage IC1. The bottom end of coil L1 is grounded as far as radio frequencies are concerned but still contains the quench frequency at a high amplitude. Although inaudible, if this were allowed to enter the output stage it would cause IC1 to work very hard doing absolutely nothing at all useful! This hard work, apart from making IC1 hot and irritable, would rapidly drain the battery. Therefore, R10 and C10 form a simple low pass filter with C14 additionally added directly

across the input to IC1, to filter out the 100kHz signal. The values of these components have also been selected to produce a fairly 'smooth' hiss in the absence of a signal whilst still maintaining reasonable audio clarity. C15 increases the nominal gain of the LM386 from 20 to 200 obviating the need for an audio driver stage.

PCB layout & Constructional details next month.

You Will Need

Resistors

Carbonfilm, 5%, 0.25W

10Ω	1	R14
470Ω	1	R1
1kΩ	3	R5,R9,R11
2.2kΩ	1	R3
2.7kΩ	1	R10
5.6kΩ	1	R6
6.8kΩ	1	R8
10kΩ	2	R2,R13
27kΩ	1	R7
56kΩ	1	R4

Potentiometers

Carbon track (log)

10kΩ	1	R12 (JM77J)
------	---	-------------

Capacitors

Ceramic

2.2pF	1	C3 (WX36P)
10pF	2	C7,10 (WX44X)
2.2nF	1	C8 (WX72P)
1nF	3	C1,5,6 (WX68Y)
10nF	2	C18,14 (WX77J)

Mylar

47nF	1	C16 (WW20W)
100nF	1	C12 (WW21X)
220nF	1	C11 (WW83E)

Electrolytic 10V working

100µF	2	C13,17 (RK50E)
-------	---	----------------

Electrolytic 16V working

10µF	1	C15 (YY34M)
------	---	-------------

Electrolytic 63V working

2.2µF	2	C2,9 (YY32K)
-------	---	--------------

Variable

20pF	1	C4 a.m./f.m. Tuning Capacitor (AB11M)
------	---	---------------------------------------

Semiconductors

Transistors

BFY90	2	Tr1,2 (QQ64Q)
-------	---	---------------

Integrated circuits

LM386	1	IC1 (UJ37S)
-------	---	-------------

Diodes

	1	D1 (see text) (UF72P)
--	---	-----------------------

Inductors

	1	L1 (see text)
2.2µH	1	L2 r.f. choke (WH31J)

Miscellaneous

Speaker 8Ω (WB13P); S1 Switch (FH36P); Case (LF01B); Knobs x 2 (FE74R); Telescopic antenna (RK49D); Battery Connector (PP3) (HF28F); p.c.b.

Maplin Stock Codes shown in brackets.



JPS ANC-4 - Preview



Is your listening being disrupted by local interference? If so, the new ANC-4 noise cancellation unit from JPS could be the answer. Mike Richards delves deeper.

With so many electrical and electronic appliances appearing in the home it's no surprise to find that most listeners have interference problems to some degree. This can range from increased background noise on some bands through to a total wipe-out. Consequently, any device that purports to reduce or eliminate noise always attracts a lot of interest. Whilst most noise reduction accessories tackle the problem at the audio level, the ANC-4 attempts to correct the problem before it passes through the receiver. The main advantage from this approach is that the noise is prevented from affecting the receive parameters such as the automatic gain control. If you're suffering high noise levels you can find that the a.g.c. action will desensitise the receiver. Although you may be able to reduce the noise with audio filtering, you won't be able to recover the lost sensitivity. The basic operating principle used by the ANC-4 is certainly not new, but can be very effective and involves cancelling-out the noise before it enters the receiver.

Heavy-Weight

Like all the products I've seen from JPS, the ANC-4 features a very high build quality. Despite its compact size at 43 (h) x 152 (w) x 109mm (d) the case is constructed from 2mm steel - I'm sure you

could drive a car over it without any damage! Setting-up the ANC-4 was very simple and involved just a few connections. As the unit eliminates noise prior to the receiver, the main antenna feed has to pass via the ANC-4. This is done using two SO-239 (u.h.f.) sockets that were mounted on the rear panel. The power requirements were +11 to +16V d.c. at 150mA connected via a standard coaxial power socket, also on the rear panel. The review model didn't include a power supply, but the voltage range of the ANC-4 indicated that it could be fed from a plug-top power unit or even the car when used for mobile operation. The final connection on the rear panel was a phono jack for the connection of an external noise antenna. An alternative here is to use the supplied telescopic antenna that's mounted through a hole in the top panel. As the review model was hot from the factory it was accompanied by a draft manual. Providing the manual content flows through to the final product, it's likely to be a very good manual with comprehensive explanations of the operating principles. There was also lots of operating hints and suggestions to cover the requirements of most listeners.

Antenna Cancellation

To be able to use the ANC-4 with some proficiency, you

Specification

Operating Frequency Range:	500kHz to 80MHz (usable down to 100kHz)
Signal Loss, Main Antenna to Radio:	6dB
RF Input Level:	3V r.m.s. (main antenna)
Max Transmit Power:	150W p.e.p. or average
Time to Switch to bypass when r.f. is detected:	7ms typical
Time to Return to Receive Mode:	0.5s typically
Typical Local Noise Types:	Power line, Computer, TV Noise, etc.
Noise Cancellation:	Typically 40dB or greater
Input Power:	+11V to +16V d.c. at 150mA
Weight:	0.91kg
Temperature Range:	-20 to +55°C operating -40 to +55°C storage
Humidity:	Up to 95% at 55°C

first need to appreciate the principle used for the noise cancellation process. First of all, the ANC-4 is aimed specifically at reducing locally generated noise - it will do nothing to reduce atmospheric, heterodyne or other remotely generated noise. In order to eliminate the local interference, the ANC-4 uses two antennas - your main station antenna and a local noise antenna. The idea being that the local, noise antenna is located such that it will pick-up mainly noise, e.g. the opposite of what we normally want an antenna to do. These two signals, main antenna and noise antenna, are then mixed together within the ANC-4 to produce a cancellation of the local noise. This cancellation works by processing the signal from the noise antenna so that it has exactly the opposite polarity to the noise in the main antenna. If these two signals are carefully mixed together the noise elements will cancel each other out. In order for this process to work successfully, you have to

adjust the noise signal so that it is both exactly the opposite polarity and exactly the same level as the interference in the main antenna. In theory, when this balance is attained, complete cancellation of the noise occurs. In practice, complete cancellation is not possible, but the ANC-4 claims and delivers very worth while reductions of 40dB or more. The limitations are primarily due to the nature of the noise and the accuracy with which the front panel controls can be adjusted.

Operation

Once the operating principle is understood, the ANC-4 becomes very simple to use. A look at the photographs with the review shows a very simple layout with just four main front panel controls. The PHASE RANGE button and NOISE PHASE rotary control are used to adjust the polarity of the noise signal

Continued on page 41



Communications Centre (Photo Acoustics Ltd.)

TWO-WAY RADIO ● AMATEUR RADIO ● AUDIO VISUAL ● SALES & SERVICE

58 High Street, Newport Pagnell, Bucks MK16 8AQ. Tel: (01908) 610625 FAX: (01908) 216373



The **AR8000 UK** receiver is without doubt the most full featured wide band hand-held receiver on the market today. Frequency coverage is from 500kHz to 1900MHz without gaps and all mode reception. The display provides twin frequency read-out and alphanumeric comments for memory and search banks. The receiver may also be operated via computer using the optional CU8232 interface. The AR8000 UK is a remarkable receiver.

AR8000 UK £449.

Fast mail order available for direct orders



The new **AR2700 UK** receiver is the very latest high-tech hand-held receiver from AOR. Frequency coverage is 500kHz to 1300MHz with receive modes of n.f.m., w.f.m. and a.m.

A large i.c.d. with three way rear illumination provides all operational details. An optional **VOICE RECORD** chip RU2700 permits an instant 20s digital recording off air which may be replayed over and over again. Computer control is also possible by using the optional IF-ADP and CU8232 adaptor and interface unit.

AR2700 UK £279.



The **AR3000A** has established itself as a high performance base mobile receiver offering an extremely wide frequency coverage of 100kHz to 2036MHz and all mode receiver. The introduction of the **AR3000A PLUS** provides even greater performance and capabilities. What is the plus? Plus five custom modifications applied as standard, switchable narrow a.m. filter for improved short wave listening, switchable w.f.m. filter for WEFAX reception, 10.7MHz i.f. output and switch for compatibility with the SDU5000, tape relay with independent contacts and switched audio, discriminator output. Further custom modifications are available and may be applied to existing units. Simply request the descriptive leaflet and price menu for full details

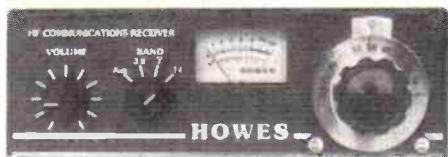

HOWES KITS - Great Projects to Build! MULTI-BAND SSB/CW RECEIVER

The HOWES DXR20 covers 20, 40 & 80M bands plus any other HF frequency with optional plug-in modules. The photo shows the receiver built with DXR20 and DCS20 ("S meter") kits and HA20R hardware pack (case etc.). Excellent performance and compatible with many of our transmitter and accessory kits.

Optional band module kits include 160M, 30M, 15M & 10M amateurs plus 5.45MHz HF airband at £7.90 each.

DXR20 electronics kit: £39.90

DCS2 "S meter" kit: £10.90, HA20R hardware pack: £28.90

AA4 ACTIVE ANTENNA FOR SCANNERS

Covers 25 to 1300MHz. Broad-band performance in a neat, compact package. Just over 16 inches long. Excellent performance in a small space!

AA4 Kit: £19.90 Assembled PCB Modules: £27.90

AB118 AIR-BAND ACTIVE ANTENNA

Optimised for long distance reception on 118 to 137 MHz air-band. Tuned antenna with pre-amp & band-pass filter. Hear ground stations you've never heard before!

AB118 Kit: £18.80 Assembled PCB modules: £25.90

Second-Hand Equipment

- AOR-2800E** base/mobile/portable scanning receiver, 500kHz to 1300MHz, a.m., f.m.n., f.m.w., l.s.b. (This unit is complete). £290.00
- SX-200N** base station scanning receiver, a.m./f.m. selectable. Radio is in excellent condition and complete. £135.00
- WIN-108** hand-held airband scanning receiver. Excellent condition. £135.00
- JRC-NRD525** 50kHz to 30MHz short wave receiver. One of the best receivers ever made. £650.00
- Yaesu FRG-100** short wave receiver. (This unit is a shop demo model and is complete and as new. Full 12 months warranty). £499.00
- Yaesu FRG-8800** short wave receiver, 100kHz to 30MHz, all mode receiver. This unit is in good condition and at a bargain price. Only £399.00
- Yaesu FRG-9600** h.f./v.h.f./u.h.f. all mode scanning receiver, covering 60 to 905MHz. £299.00
- AOR-1000** h.f./v.h.f./u.h.f. 25 to 1300MHz hand-held scanning receiver, f.m./a.m./w.f.m. with 1000 memory channels. This unit is in very good condition and complete. £195.00
- Yupiteru MVT-7000** h.f./v.h.f./u.h.f. hand-held scanning receiver, n.f.m./a.m./w.f.m. This unit is in very good condition and complete. £229.00
- Yaesu FRG-7700** short wave receiver covering 100kHz to 30MHz. This unit is all mode and comes complete with the matching a.t.u. and v.h.f. converter. £285.00
- Yaesu FRG-8800** short wave receiver, 100kHz to 30MHz, all modes, this unit is also fitted with the matching v.h.f. converter. £499.00
- Icom IC-R72** short wave receiver, 100kHz to 30MHz, a.m., u.s.b., l.s.b., c.w. (f.m. optional extra). This radio is as new condition and complete with box and manuals. (Internal NiCad pack also fitted). £599.00
- AOR-2001** h.f./v.h.f./u.h.f. base/mobile scanning receiver covering 25 to 550MHz, a.m./n.m./w.f.m. £149.00
- Drake SW8** short wave receiver covering 100kHz to 30MHz all modes. This unit also covers v.h.f. airband and f.m. broadcast band giving stereo output via headphones. This unit is in mint condition. £399.00
- Drake R8E** superb short wave receiver covering 100kHz to 30MHz, all modes. If you want a top of the range communications receiver, then this is the one to go for. £650.00
- Universal M7000** data decoder. This unit decodes Packet, c.w., AMTOR, FAX and RTTY. Ideal to use with one of the above receivers to expand your listening horizons. This unit is a stand alone unit and does not require any computer. £350.00
- Video monitor**, ideal to use with the M7000 decoder. £45.00
- Realistic PRO-43** v.h.f./u.h.f. hand-held scanning receiver. £149.00

All second-hand equipment comes with a three month return to base warranty.

AUTHORISED AGENTS FOR KENWOOD, ICOM, YAESU & ALINCO. FULL SERVICE FACILITIES AVAILABLE

SPEND UP TO £1,200 INSTANTLY WITH A PHOTO ACOUSTICS LTD. CREDIT CHARGE CARD

PART EXCHANGE WELCOME, ASK FOR KERRY G6IZF OR ANDY G4YOW

RETAIL SHOWROOM OPEN MONDAY - FRIDAY 9.30 - 5.30, Saturday 9.30 - 4.30

Goods normally despatched within 24 hours. Please allow 7 banking days for cheque clearance. Prices correct at time of going to press - E&OE



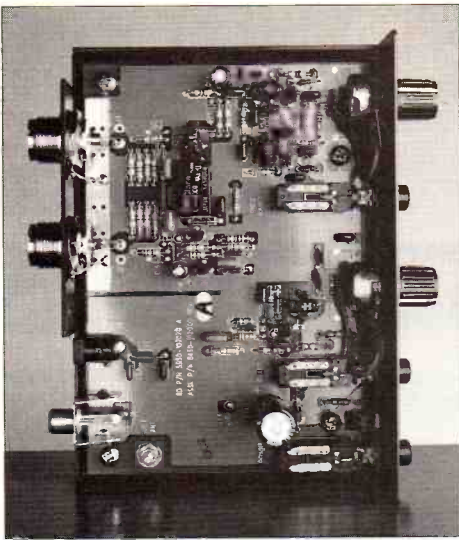

whilst the NOISE GAIN sets the level of the noise signal. The remaining FREQ RANGE button switches the unit between its low (100kHz-20MHz) range and the high (20-80MHz) range. Probably the most crucial aspect of using the ANC-4 is the choice of noise antenna. It is vital that this is placed to provide a good strong noise signal. Whilst the telescopic antenna may be great for dealing with computer noise, it's unlikely to be good enough for handling noise from the next door neighbour's workshop. So, before you start you must



think about the noise source you're trying to eliminate and position the antenna so that it picks up as much as possible. The key is that the noise antenna must have significantly more noise than signal when compared with the main antenna. With the antennas sorted out, optimising the noise reduction is very straight forward. You first find a spot on the selected frequency band where you can hear only noise. You then carefully adjust the NOISE GAIN until the noise level changes then the NOISE PHASE to minimise the noise. If this doesn't produce the required reduction you simply have to change the PHASE RANGE.

Performance

All the theory sounds wonderful, but what's it really like to use? Put simply it's very effective **but** only for reducing locally generated noise. I can't stress this enough as using the ANC-4 to tackle any other type of noise will result in disappointment. However, used for the type of local noise it's intended to tackle the ANC-4 is very effective and simple to use. It is also true to say that the simpler the noise signals are handled better that complex wideband noise sources. In my home set-up I was able to produce a worthwhile reduction in computer noise by mounting the ANC-4 next to the computer and using the telescopic noise antenna. The noise reduction held good

whilst tuning around within a given band, but some trimming was required following a large frequency change. An interesting secondary use for the ANC-4 is as an active antenna. In this guise the noise antenna becomes the main antenna and the NOISE GAIN control is used as the antenna gain setting. If you have an interest in amateur radio you'll be pleased to hear that the ANC-4 can be used in the antenna feed of transmitters with powers up to 150W thanks to built-in TX/RX switching.

Summary

The ANC-4 represents a different and very worthwhile approach to noise reduction that's ideally suited to anyone plagued by locally generated noise. The ANC-4 costs £189 and can be obtained from **Lowe Electronics, Chesterfield Road, Matlock, Derbyshire DE4 5LE. Tel: (01629) 580800, Fax: (01629) 580020.** My thanks to Lowe Electronics for the loan of the review model. ■

COMPUTING IN RADIO SPECIAL

REVIEWED: THE YAESU FT-51R DUAL-BAND FM TRANSCEIVER

FEATURES: BITS & BYTES SPECIAL CHOOSING & USING YOUR COMPUTER AMATEUR RADIO & THE INTERNET

BUILD: PART 3 of the PW MARTLET 70MHz TRANSCEIVER

REGULARS EACH MONTH - EVERYTHING FOR THE RADIO AMATEUR

- ☆ NOVICE MATTER
- ☆ CLUB SPOTLIGHT
- ☆ ANTENNA WORKSHOP
- ☆ BITS & BYTES - The Computer In Your Shack
- ☆ VALVE & VINTAGE
- ☆ REGULAR REPORTS ON ALL BANDS
- ☆ NEWS & FEATURES
- ☆ COMPETITIONS AND LOTS MORE

COMING NEXT MONTH

MORSE SPECIAL

REVIEWED: THE ALINCO DR-150E 144MHz MOBILE TRANSCEIVER

SUBSCRIBER'S OFFER: A SELECTION OF JONES' MORSE KEYS

PW QRP CONTEST RULES

FEATURES: MORSE CHOICE MANNION'S MORSE METHOD AM I SENDING FAST ENOUGH?

SUBSCRIBER'S OFFER: A SELECTION OF JONES' MORSE KEYS

BUILD: AN ELECTRONIC MORSE KEYS A 50/70MHz LOW PASS FILTER

Look out for the June issue - ON SALE 11th May

Plus all your regular favourites

DON'T MISS IT - ORDER YOUR COPY TODAY!

FREE FINANCE

No catch, no extended payment schemes - no interest! If you are in full time employment or retired/invalidity benefit then you can probably take advantage of our free finance option. Call or write today for details.

IF YOU DON'T WANT TO TAKE ADVANTAGE OF MY FREE FINANCE AND WOULD RATHER PAY CASH, CHEQUE, CREDIT CARD OR TRADE-IN, THEN CALL 0181 - 566 1120 TODAY FOR EXPERT ADVICE.

I promise you the best overall deal in the U.K. Get ringing, or you'll miss the bargains!

*Please NOTE prices & monthly payments are based on 17.5% VAT & no more price increases! E&OE

Martin Lynch is a licensed credit broker. Full written details are available on request.

MARTIN

G4

THE AMATEUR RADIO

Keypad for the YAESU FRG-100

When Yaesu launched their FRG-100 receiver at the Leicester show in 1993, there was one major feature missing - a keypad for frequency access. Available from MARTIN LYNCH, the new MyDEL KP-100 is an instant access keypad for the Yaesu FRG-100 receiver. In addition to frequency entry, the KP-100 also allows entry of memories, "up and down" frequency shift and turning the set on and off.

The KP-100 is available at **£44.95 incl VAT + £3.00 p&p.**



Sprite Software for the YAESU FRG-100

Introduced last year, the Sprite FRG-100 Control software has been an instant success for those who want a "user friendly" programme. Using your PC in conjunction with Microsoft Windows, SPRITE allows you to control your receiver from your P.C. Giving you endless memory banks, (depending on the size of your hard disk), including names to each channel, tune up and down, keypad frequency entry from your mouse and lots more.

Supplied with an RS232 interface, software disk and manual, **£79.95 p&p £3.00**

MARTIN LYNCH FOR SONY

SONY ICF SW100E - Small pocket all wave all mode (incl ssb) receiver. **£199.99**



SONY ICF SW7600G - All mode 22 presents, Synchronous detector receiver. **£179.99**



SONY ICF SW55 - All mode 125 presents, AC adapter incl. receiver. **£299.99**



SCANNERS

AOR AR-2700

To replace the AR-2700, AOR have introduced this fantastic LOW PRICED scanner into the market. Completely re-styled, larger display, NO GAPS, the new AR-2700 has a special feature that no



other scanner holds - a option, the user can press a button to instantly record a whole 20 seconds of audio, for playback at any time! Add to that a Data Port for computer control, (with the optional CU8232) and AOR, once again brings you a winner!

AR-2700 RRP £269. Voice module £39. SPECIAL OPENING OFFER, by both for only £279, including delivery!

AOR 3000A PLUS

Modified by the boys at AOR UK, the new 3000A plus provides even greater performance and capabilities. Five modifications including wider FM filter for WEFAX, 10.7MHz I.F. output for driving the SDU5000 plus more, the extra facilities are certainly worthwhile.

The AR3000A plus is available from stock. **RRP £995. See special purchase offer with the SDU5000!**

AOR SDU5000

Designed primarily with the AR3000A in mind, the SDU5000 enables the user to "view" up to 10 MHz of the selected band selected on a LCD colour display. Even small signals can be seen with ease, making it invaluable for the serious VHF/UHF monitoring station.

AOR SDU5000 RRP £799. BUY BOTH THE AOR3000 plus and the SDU5000 for only £1625, saving £169!! Super low finance plan also available!

AR8000 UK

Designed for the world market, the AR8000 covers just about everything that is transmitted in the entire usable radio spectrum. The ONLY scanner to cover 500kHz-1.9GHz in your hand, its been our best seller for some months now.

LOOK AT THE SPECIAL APRIL PRICE!! AR8000 RRP £449. ML PRICE £399, saving £50!



MVT7100

The "Ford Cortina" of all scanners, tens of thousands have been sold throughout the world.

RRP £389. Lynchy price = Guaranteed UNBEATABLE!!

Bearcat UBC220XLT

The easiest to use, no nonsense scanner from the worlds largest scanner manufacturer - BEARCAT! **RRP £199**



ICOM IC-R7100HF GT VHF



Up until now, the only way HF was possible on this excellent VHF/UHF receiver was to fit an internal "converter" using the set as a "tuneable I.F.". After a consid-erable amount of research and design,

Graham Tingey, our Chief Engineer, has developed a more positive solution. Without the use of any "after-fit" internal converters, Graham has re-

VT-225 & VT-125

These two twins are the very best for scanning the Air Band. The VT-225 covers both the Civil & Military frequencies and the smaller VT-125, Civil only.

VT-125 £179.95 VT-225 £229.95



Kenwood R-5000

Still the best selling receiver and still no price increase! Offered on FREE FINANCE, £99 Deposit, 12 x £75, Total £999, and we will throw in a FREE CW or SSB Filter!

Yaesu FRG-100

An easy to use shortwave receiver. Use our new KP-100 keypad and its even easier! **RRP £549, £69 Deposit, 12 x £69, plus FREE MyDEL KP-100 KEYPAD! (April only).**



AOR-3030

A Japanese receiver with an American appearance, the AR-3030 is a real alternative to the normal layout of receivers. It works well too! **RRP £699, £99 Deposit, 12 x £50, plus FREE antenna!**



Lowe HF Europa

An HF-225 with all the options, plus better AM selectivity. **RRP £699, or Deposit £99, and 12 payments of £50 per month FREE FINANCE.**

JRC NRD-535

If it came with all the options fitted at this price, we probably wouldn't sell anything else! The ultimate receiver. **RRP £1549, £499 Deposit, 12 x £87.50, plus FREE DATONG ACTIVE ANTENNA.**

ACCESSORIES - ALWAYS A MASSIVE SELECTION AVAILABLE

- MLB-1** Magnetic long wire balun, eliminates noise off feed line RRP **£44.95**
- DATONG AD270/370** Active antenna that really work! Indoors or outside RRP **£59.95/£79.95**
- EAVESDROPPER** The best made outdoor shortwave antenna. Built to last RRP **£89.95**
- MyDEL MINIMAG PROSCAN** The latest MyDEL design, a mini magnetic antenna 100 - 1000MHz. RRP **£29.95**
- MyDEL HELICONE** Specifically designed shortwave to 1300MHz outdoor antenna for handheld & base scanners, using helical resonator & radials. RRP **£59.95**
- DIGITAL FILTERS - STOP UNWANTED NOISE - TRY A DSP FILTER TODAY**
- TimeWave DSP9+ Favourite of the RadCom team. RRP **£239**
- TimeWave DSP9. Budget version of the 9+ RRP **£169**
- TimeWave DSP59. All mode DSP. RRP **£299**
- JPS NTR1. The easiest to use DSP RRP **£199**
- JPS NIR10. The ultimate all mode DSP RRP **£399**
- Datong FL3 RRP **£149**

24-HOUR B.B.S. LYNCHLINE IS NOW OPEN

5 YEAR UK WARRANTY FOR SW LISTENERS

Access the **Lynchline** B.B.S.

0181-566 0000

Purchase a new piece of gear from Martin Lynch and he'll offer you the chance of a whole FIVE YEARS WARRANTY, covering parts & labour. The warranty also includes COLLECTION & DELIVERY on the U.K. mainland.



THE MARTIN LYNCH 5 YEAR WARRANTY

Telephone Jennifer on **0181 566 1120** and ask about 'Take 5'

Yes I Would Rather Buy

LYNCH

HKS
O EXCHANGE CENTRE

Officially appointed "Master Dealer" by YAESU U.K.



0181-566 1120

140 - 142 NORTHFIELD AVENUE, EALING, LONDON W13 9SB

AFTER HOURS: 0973 339 339

FAX: 0181 - 566 1207

B.B.S.: 0181 - 566 0000



F/UHF RECEIVER ON ZERO APR

programmed the set to tune the entire range from 60kHz to 2GHz. As before, frequencies below its usual 25MHz are tuned by depressing the original dimmer switch, now re-labelled HF. Removing the converter board ensures greater stability, strong signal handling and sensitivity. The modifications are available to any customer already owning an ICR-7100 for only £199.95, including VAT & return delivery. (U.K. mainland). For customers wishing to purchase a new IC-R7100 with the HF "GT" conversion, the price is only £1549.00.

RRP £1549 Available on FREE Finance. Deposit £559, 12 x £82.50, ZERO APR.

Lowe HF-225

The big brother of the HF-150. Only £499, Deposit £99, 12 x £33.33

Drake R8E

The Drake is my own personal favourite. It doesn't look or feel like a normal receiver, but the PassBand tuning



and American designed filters win me over every time. If you can afford that little extra, then go for it!
RRP £1199. Deposit £179, 12 x £85.

Control software for ICR-7100

Supplied with computer interface, the new ICRC-7100 will allow full computer control of the Icom ICR-7100. Only £49.95



DECODERS AND DECODING SOFTWARE

ON DEMONSTRATION AT MARTIN LYNCH

Universal M-8000

The ultimate in all mode code converters. Mainly used by commercial organisations throughout the world, UNIVERSAL have managed to engineer the package at a price within reach of the true hobbyist. A true colour VGA output is given to enhance the incredible definition obtainable in all modes by this advanced piece of hardware. It's easier to use than you think - a few hours will soon bring decoded data to your own screen from around the world. Open your eyes to a new world just waiting for you to explore. Put your NRD535 or R5000 or Drake R8E to real use today!



Due to a large commercial order, during May we can offer the M-8000 at only £1150.00 incl. VAT, saving nearly £200!!

A 10" VGA HIGH RES COLOUR Monitor is available for only £199.95 incl. VAT

A Universal M-1200 PCB version for installing into a computer is available at £399.00

AEA PK-232MBX

All mode TX/RX TNC. Hooks up to your PC. Easy to use. RRP £329

AEA FAX II

Software driven decoder for WEFAX, RTTY & CW transmissions. RRP £139

Lowe Modemaster

Data decode & control software for HF-150. Hook up to your PC. RRP £139

Lowe Airmaster

Data decode & control software with PC interface. RRP £89.95

Lowe Synop

New! Decode complete weather maps. RRP £149

Lowe HF-150 & "Friends"

The British "Quad" of Radio Communications, Lowe Electronics are flying the U.K. flag, thanks to the excellent value for money, advanced circuit design and overall packaging of their receiver range.

This month, Martin Lynch is offering the "HF-150 Stack", not only on FREE FINANCE, but offering an EXTRA ONE YEAR WARRANTY for every system ordered during May '95.

HF-150	RRP £419
PR-150	RRP £235
SP-150	RRP £219
Rack	RRP £59.95

Total Value £932.95

Deposit £132.95,

plus 12 x £66.66.



WHY "RADIO READY?"



All items are available on Low Cost Finance, call for details. Please note: The QUAD speed CD-Rom, 16 BIT sound card & speakers shown in the photograph are optional extras costing £295.

Specifications

Motherboard	VLB
Cache	256K
RAM	See each machine
HDD	See each machine
Controller	VL Bus
VGA card	SPEA VEGA PLUS
VGA Mem	1MB, VLB
FDD	3.5" 1.44MB
Keyboard	Yes - Cherry
Mouse	Yes - Logitech
Software	DOS V6.2, WFW V3.11
Monitor	14" SVGA .28 pixels Non-interlaced, Low Radiation with Power Management

Now there's a question! Firstly, the PEACOCK range of PC's were chosen by Martin Lynch for their LACK of RFI in comparison to other makes evaluated. Secondly, the machines are configured for your own specific requirements. For example, if you wandered into your local PC store and asked for the system to be set up to run a new PK-900, operating your six metre rig and at the same time control a logging program for all the contacts you've made over the last fifteen years, he'll probably look at you with a rather blank expression. Get the picture? People buy computers from MARTIN LYNCH because we understand your requirements and make sure it operates with software and products related to the 'Ham Shack'.

Furthermore, buying a NON BRANDED MACHINE is rather like buying a "KIT" car; (would you feel confident buying a 'Chinese' copy of the latest HF rig, made up from whatever bits the supplier had at the time?). Buying a recognised name will ensure a better resale value, not to mention quality of assembly.

FOUR OF THE BEST

PEACOCK DX2/66 BASIC PC

4Mb RAM, 420Mb Hard Disk Price incl. VAT, £1099.00

PEACOCK DX2/66 'PREMIUM' MULTIMEDIA QUAD PC

4Mb RAM, 540Mb Hard Disk, 2Mb VGA Mem, Quad Speed CD-Rom, 16 Bit Sound Card, Speakers Price incl. VAT, £1599.00

PEACOCK PENTIUM 60 PC

8Mb RAM, 540 Mb Hard Disk Price incl. VAT, £1499.00

PEACOCK PENTIUM 60 'TAKE' MULTIMEDIA QUAD PC

8Mb RAM, 540Mb Hard Disk, Quad Speed CD-ROM, 16 Bit Sound Card, Speakers Price incl. VAT, £1789.00

Carriage extra at £20 per system, UK Mainland.

All machines are loaded with HAM software, including Log Program, Packet Controller, Word Processor, DOS V6.2, Windows for Work Groups V3.11, plus lots more.

*Pentium 90 and DX4/100 Machines are also available.

Buy From Martin Lynch!

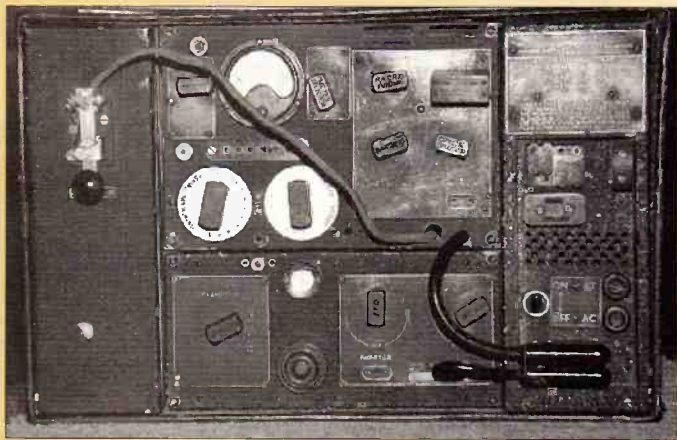

Fig. 1.



Fig. 2.

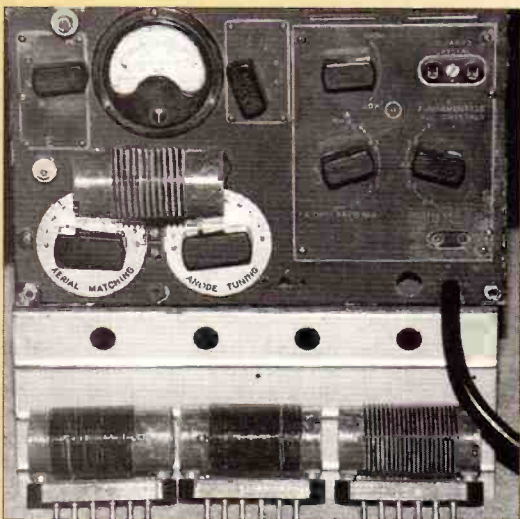

Fig. 3.



Fig. 4.

Ron Ham explores the radios used during the Second World War and in particular those concerned with the activities surrounding the campaign that culminated in VE Day.

Last June, I showed you some of the wireless sets used by the army during the D-Day landings in Normandy on June 6, 1944. This year we are commemorating the ending of the war in Europe, VE-Day, on May 8 1945. Technology has changed since then, we now have microchips instead of valves, tiny transceivers and mobile 'phones working from small dry batteries and world-wide communications via computers and satellites. fifty years ago there was none of this and wireless communications depended on the mechanically delicate and current hungry thermionic valve.

Vital Information

Communications between Allied agents working in enemy occupied Europe and the United Kingdom must have been a hairy business to say the least. The various resistance groups were frequently asked by London to obtain information about German military activity in their particular area. Having obtained this material it had to be coded ready for transmission to one of the monitoring stations in the UK. Can you imagine connecting up and tuning a transmitter at some secret location, sending the message and waiting for confirmation and all the time knowing that there would be terrible consequences if caught?

Wireless Equipment

In addition to it being a serious offence to own a short wave receiver or transmitter in occupied Europe, most of the good domestic sets had been confiscated by the occupying forces. This made it almost impossible for locals to hear the special programmes transmitted for their benefit by the European Service of the BBC. Among the sets used by Allied agents for clandestine work was the 'B2' transmitter and receiver, Fig. 1. and a miniature communications receiver, M.C.R.1., shown in a typical operator's layout in Fig. 2. The latter was packed into a 2lb biscuit tin and dropped by

parachute to the various resistance groups.

M.C.R.1

Whereas the 'B2' has four indirectly heated (6.3V heaters), octal-based valves, type 7Q7 and 7R7, in the receiver and two international octals, EL32 and 6L6, in the transmitter, the M.C.R.1 uses five, directly heated, miniature glass valves, from the 1T4, 1R5 range, with 1.4V filaments. Because of these low voltage valves the M.C.R.1 could work from a special 'all-dry' battery as well as its dedicated, variable voltage, mains power pack, seen under the receiver in Fig. 2. The tuning scale, scribed 0 to 180, is viewed through a tiny window above the large tuning knob on the right of the receiver unit. One of the four coil packs, centre right, Fig. 2, is plugged on the end of the set to change the frequency range. Pack 1, = 150kHz to 1.6MHz, 2, = 2.5 to 4.5MHz, 3, = 4 to 8MHz and 4, = 8 to 15MHz. Each pack has a scale on the top which relates the frequency to the dial reading.

The 'B2'

The Morse key for the 'B2', upper left Fig. 1, is screwed to the lid of the accessories box when in use and afterwards stored inside the box along with four transmitter tank-coils, headphones, antenna wire, quartz crystals and spare valves. A similar shaped box on the opposite side contains the adaptable power unit which supplies the transmitter, upper centre Fig. 1 and the receiver below it. All four units are neatly packed inside an attaché case which disguised the set when being moved between transmission sites. It weighed more than two-stone, so carrying it could not have been easy!

Frequencies

Instructions for tuning the receiver and transmitter are glued to the underside of the accessories box lid. For instance, like the M.C.R.1,

the receiver dial is calibrated 0 to 180 and seen through a magnified glass positioned at the top centre of the receiver panel, Fig. 1. On the set in Fig. 1, a dial reading of 100 represents 3.95MHz on Band 1 (3.1 to 5.4MHz), 6.60MHz on Band 2 (5.2 to 9MHz) and 11.30MHz on Band 3 (8.7 to 15.5MHz).

Each of the transmitter's six-pin tank-coils is designed to work on two frequency-ranges and fit into the socket under the meter in Fig. 1. For example, the base of one coil is marked L1A (3 to 4MHz) on one side and L1B (3.75 to 5.25MHz) on the other. By reversing the coil the tuning range of the transmitter's tank circuit is changed. The other three 'tanks' carried the overall range in similar steps to 16MHz. Fig. 3 shows the transmitter unit with its set of tank-coils. The transmitters frequency was determined by a 10XJ type quartz crystal plugged in at the top right of the transmitter panel, Figs. 1 and 3. Tuning such a transmitter to give its best performance on a given frequency required a good understanding of radio. The crystal's fundamental frequency is selected by the knob below it. The grid of the p.a. valve is tuned by the upper and lower knobs to the left of the crystal and the p.a. anode and antenna matching is adjusted by the two large knobs under the tank-coil.

Special Features

Even running the 'B2' from the mains was not straightforward for the operator. First the mains voltage at the location had to be known before the 'jumpers' on the mains adjustment panel, upper left of the p.s.u., Fig.1, could be set. Secondly, if the German detector vans heard a 'suspect' transmission they would have the supply cut off in the area to see if the signals stopped, if they did, then a thorough search was made of that area. However, the oblong plug under the mains 'jumper' block helped toward solving this problem because, the power unit also contains a six-volt vibrator pack, which enabled the 'B2' to run from a 'wet' vehicle battery if no mains supply was available. To select mains or battery this oblong plug is reversed. Now, if the operator had the battery connected, via the large plug on the right of the 'jumpers', while transmitting on the mains and the supply was cut off, the oblong plug was quickly reversed and transmissions continued. This gave

the enemy detectors the impression that they had cut off the supply in the wrong area.

Bravery

It's well documented that the clandestine wireless operators were very brave people who used their sets under really hostile conditions. You can find out much more about the 'B2' and the M.C.R.1 in action, the operators' codes and weapons, the enemy's efforts to trace them and the services who supported them, by reading the book, which I strongly recommend, called *Secret Warfare*, by Pierre Lorain, published by Orbis, ISBN. 0-85613-586-0

Monitors

Sophisticated monitoring stations in the UK used numbers of high quality communications receivers like the AR88. Fig. 4, the HRO, the Royal Navy's CR100 and the RAF's R1155, Fig. 5, to listen for the clandestine signals at prearranged times. Each of these sets are sensitive and selective and are fitted with very stable tuning mechanisms. Such features were essential because the agent's signal may have been weak because of their temporary antenna and shielded location.

In my view, the AR88, beautifully engineered by RCA, was the finest communications receiver built during the Second World War. Its two r.f. stages ensures good sensitivity and the gear box, between the tuning knob and the 4-gang variable capacitor, makes the tuning very smooth and positive. Mechanical and electrical stability are very important in such a receiver and essential when looking for tiny signals. The logging scale, top centre Fig. 4, is conveniently above the main tuning knob. This scale has the six-waveband main dial to its left and the 'S' meter on the right. Other controls are for antenna matching, b.f.o., audio-gain, noise limiter, selectivity and on/off switches for the a.g.c. and mains. The set in Fig. 4 has a contemporary field telephone on the top which was often used between wireless operators in a group.

Special Features

The American HRO and the British CR100 and R1155 receivers have purpose-designed, slow-motion,



Fig. 5.

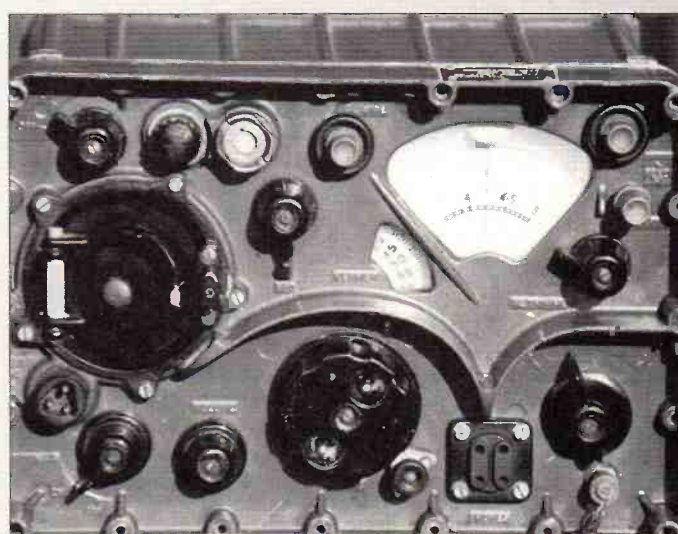

Fig. 6.

dial drives. Each one of these sets have different features. For instance, the HRO has plug-in coils to change the frequency and the numbers on the dial correspond to a frequency graph on the front of the coil pack. Two logging scales work in conjunction with the main dial on the six-waveband CR100 which also has a super five-position selectivity switch ranging from 100 to 6000Hz. The R1155 is a 'special' designed for the RAF and used as a partner to the T1154 transmitter, in aircraft, air-sea rescue launches and dedicated base stations. Sometimes an '1154/1155 combination was installed away from the main RAF station in order to keep in touch with any 'stragglers' who did not make it home with the main squadron. The R1155 has five-ranges, 75 to 200kHz, 200 to 500kHz, 600kHz to 1.5MHz, 3 to 7.5MHz and 7.5 to 18MHz. Each range on the 180 degree dial is coloured to match the tuning knobs on the '1154 transmitter.

The tuning on the '1155 has two extremes, a fast dial sweep by the outer knob and ultra slow-motion by the inner. The fast sweep enabled the airborne wireless operator to quickly locate the German night-fighters' R/T channel and then, if possible, jam it with the transmitter. Several controls on the '1155 are dedicated to its direct finding capabilities.

Post-War

Fortunately, many of the outstanding features of these sets, designed and built for conflict, were incorporated after the war in both civilian and military equipment. Nearly all the valve types used in the AR88, B2, CR100 and R1155 were used in mains operated domestic receivers and those from the M.C.R.1 appeared in many battery portables and the early post war army receivers like the R209, Fig. 6 and the R216, intended for use in vehicles. ■

New Products

This month's round-up of new products, books and catalogues

More Memory for the Scout

Optoelectronics have just updated their Scout. We took a look at the previous version in the March issue of *SWM* and improved the storage. The new version, the Scout 400 derives its name from the number of captured frequencies it can store. The memory is now non-volatile, whereas its predecessor was dependent on battery support.

The importers of the Scout, **Waters & Stanton Electronics** can be contacted at **Spa House, 22 Main Road, Hockley, Essex SS5 4QS. Tel: (01702) 206835, Fax: (01702) 204965.**

Selcall Directory

Seldec have just published a new *Directory of Aircraft Selcalls*. This directory lists approximately 8000 aircraft Selcalls, including civil airliners, military aircraft and business jets and makes the ideal partner to their Selcall

decoder reviewed recently in *SWM*.

The information is presented in some 250 pages. The A5 size volume is spiral bound, and is therefore able to lay flat on the desk.

This book contains four main sections presenting tabular formatted information. Section one gives Selcall, registration, aircraft type, operator and serial number. Section two and three provide the same information but indexed by registration number. Section three likewise, but indexed by operator. Finally section four gives airline three letter codes.

Seldec will also provide an update and amendment service, whereby, for the price of the return postage a monthly update is sent to the purchaser. Full details of this useful service are given in the directory. The Directory costs £10.85 plus £2.00 and is available from **Seldec, PO Box 3, Kidderminster, Worcestershire DY12 1YZ. Tel: (01299) 861372, Fax: (01299) 861530.**

Loop from Lowe

Lowe electronics have just announced that they are stocking the unique Kiwa MW Air-Core Loop Antenna. This marvellous piece of engineering is worthy of a place in an art gallery, as can be seen from the accompanying picture.

The antenna is tuneable over the range 530-1700kHz using the main and fine tuning controls. It features a separate control box to facilitate adjustments.

The antenna may be rotated for maximum signal pick-up. It may also be tilted via a 3:1 reduction gear for precise nulling of local signals and interference. Maximum tilt is $\pm 90^\circ$ from vertical. With the tilt angle is read directly in degrees.



To enable heading to be determined the antenna is fitted with an integral liquid-filled compass. The antenna features a regeneration control to provide a 'Q-multiplier' type of arrangement. The claims for this antenna are really excellent. The antenna costs **£349** plus £10 P&P. More details are available from, **Lowe Electronics, Chesterfield Road, Matlock, Derbyshire DE4 5LE. Tel: (01629) 580800, Fax: (01629) 580020.**

SWM SUBS CLUB

HAVE YOU JOINED THE SUBS CLUB YET? SEE PAGE 83 FOR DETAILS OF HOW TO SUBSCRIBE TO YOUR FAVOURITE MAGAZINE AND BENEFIT FROM THE SUBS CLUB SPECIAL OFFERS.

ADJUSTABLE MOBILE MOUNT FOR HAND-HELD RADIOS

Are you fed up with your scanner falling off the seat of your car? *SWM* has the answer - an adjustable mobile mount for hand-held radios.

Works with cellular phones and handy transceivers too.

This self-adhesive mount adjusts to fit your radio. Simply insert your rig between the adjustable sides and squeeze them together. The foam rubber sides grip and hold it secure. To remove, depress the quick release button.

OFFER PRICE £8.49
NORMALLY £10.99

SAVE
£2.50

Post and Packing
add £2.00



LOWE BOOKSHELF

Radios are great things, opening your mind to a welter of broadcasts and communications. A number of good books kept by your receiver will help you to get more out of your listening and expand your knowledge. Here's what's currently sitting by my receiver . . .

WORLD AERONAUTICAL COMMUNICATIONS FREQUENCY DIRECTORY

Quite the best guide to HF airband monitoring we've ever seen. Extensive explanations, including a chapter covering ACARS.

£19.95 plus £3.00 p&p

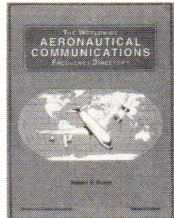

CALLSIGN '95

New from Photavia Press

A useful companion to AIRWAVES '94, this book gives you an alphabetical listing of civil and military aviation callsigns. For military traffic, this allows you to discover the aircraft type, the air arm it belongs to, its unit code, squadron and base. For civil callsigns, you can find out the three-letter air traffic prefix, company or operator and country of origin. A super book that will help you get more out of airband monitoring. 108 pages, A5.



£7.95 plus £1 p&p

AIRWAVES '94

from Photavia Press

The best frequency guide we've ever sold for the airband enthusiast. Covers H.F., civil and military frequencies. Comprehensive coverage of UK

stations, listed by airfield and cross-referenced by frequency. Major European frequencies are also covered. 88 pages, A5.

£7.95 plus £1 p&p



PASSPORT TO WORLDBAND RADIO '95

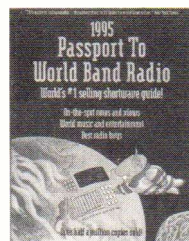

The definitive guide to English language short-wave programs. Also crammed with informative articles about world radio stations and the broadcasters themselves and a very

comprehensive guide to buying short-wave receivers.

£14.95 plus £2.00 p&p

UNDERSTANDING ACARS

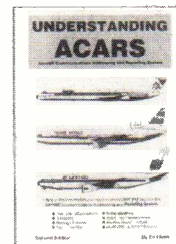

by Ed Flynn

All the necessary information including: Report Forms, Abbreviations, Airport identifiers, Airline

identifiers, and much much more. £9.95 plus £2.00 p&p

HOBBYIST'S GUIDE TO COMINT COLLECTION AND ANALYSIS

By Tom Roach

Communications intelligence (COMINT) is considered by most governments as the most sensitive and secret of all their intelligence activities. Now you can get in on the act! This book covers the equipment you need, how to put it all together and then how to analyse the material collected. An excellent little book that makes fascinating reading.

£19.95 plus £2.00 p&p

INTERPRETATION OF FACSIMILE WEATHER MAPS AND CHARTS

By Philip C Mitchell

Decoding weather information is one of the many things you can do with a short-wave receiver and a computer. What you do with the maps and charts received is then a problem! Recently updated, this manual provides over 70 pages of useful information that will help you interpret what you receive.

73 pages, A4 size.

£8.95 plus £2.00 p&p

WEATHER REPORTS FROM RADIO SOURCES

By Philip C Mitchell

A useful little publication covering many aspects of weather watching. Includes broadcast sources as well as VOLMET stations, there is even a guide to "decoding" VOLMET data. UK sources are covered as well as the major regions of the world. 35 pages A4 size.

£6.95 plus £2.00 p&p

You can pick these up from any Lowe branch or order by 'phone or FAX or E-mail via the Internet.

We've now expanded our communications systems to include the Internet. You can contact via E-mail for speedy processing of orders or information requests. We have two Internet addresses for your convenience, orders@lowe.demon.cc.uk to place your order or if you would just like the information on any of our products, use info@low.demon.co.uk. Please include your postal address and daytime telephone number.



Lowe Electronics

Chesterfield Road, Matlock, Derbyshire DE4 5LE Tel: (01629) 580800 Fax: (01629) 580020

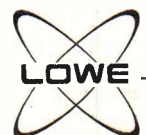

Lowe Electronics Receiver Production

The recent 'Win a Lowe HF-225 Europa' competition in *Short Wave Magazine* proved very popular with readers. The winner, Mike Wootton, along with Dick and Peggy Ganderton, were treated to a guided tour of the Lowe Electronics establishment at Matlock to see how Europas are produced.

Lowe Electronics have just finished moving production of their range of radios from Cromford to their Matlock headquarters. All components are sourced from Matlock and kits of the parts needed to produce the main receiver assembly are then made up and issued to one of the sub-contractors who perform the initial assembly. On delivery from the sub-contractor, all the chassis are powered up and undergo extended soak testing before checking, alignment and final assembly. Our picture story shows the various stages in receiver manufacture and testing at Matlock.



The Europa is a 'turbo-charged' HF-225. Here Steve is converting a basic HF-225 chassis to Europa spec.



Concentration is needed by Carl as he works on one of the smaller sub-assemblies.

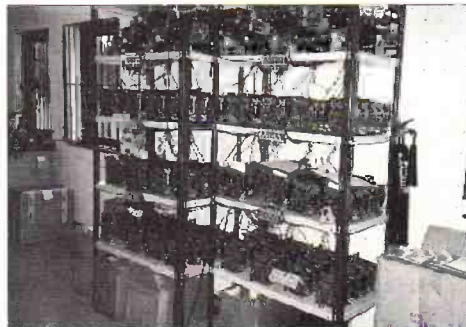

Shelves of the popular HF-150 chassis, all under power, await the final stages of assembly.



Initial testing of an HF-150 chassis is carried out on the bench by Mark.



Above: Competition winner, Mike Wootton, watches Jon 'clothing' an HF-225.



The Matlock showrooms of Lowe Electronics has a working display of their range of receivers.

Right: HF-225 chassis, in from the subcontractors, undergo a lengthy period of soak testing before being tested, aligned and finished off.



Below: Tom Crosby on the left and Kevin Whitehead, General Manager Production at Lowe Electronics discuss something about the production facility with Peggy Ganderton.

World Propagation Forecasts May

Circuits to London

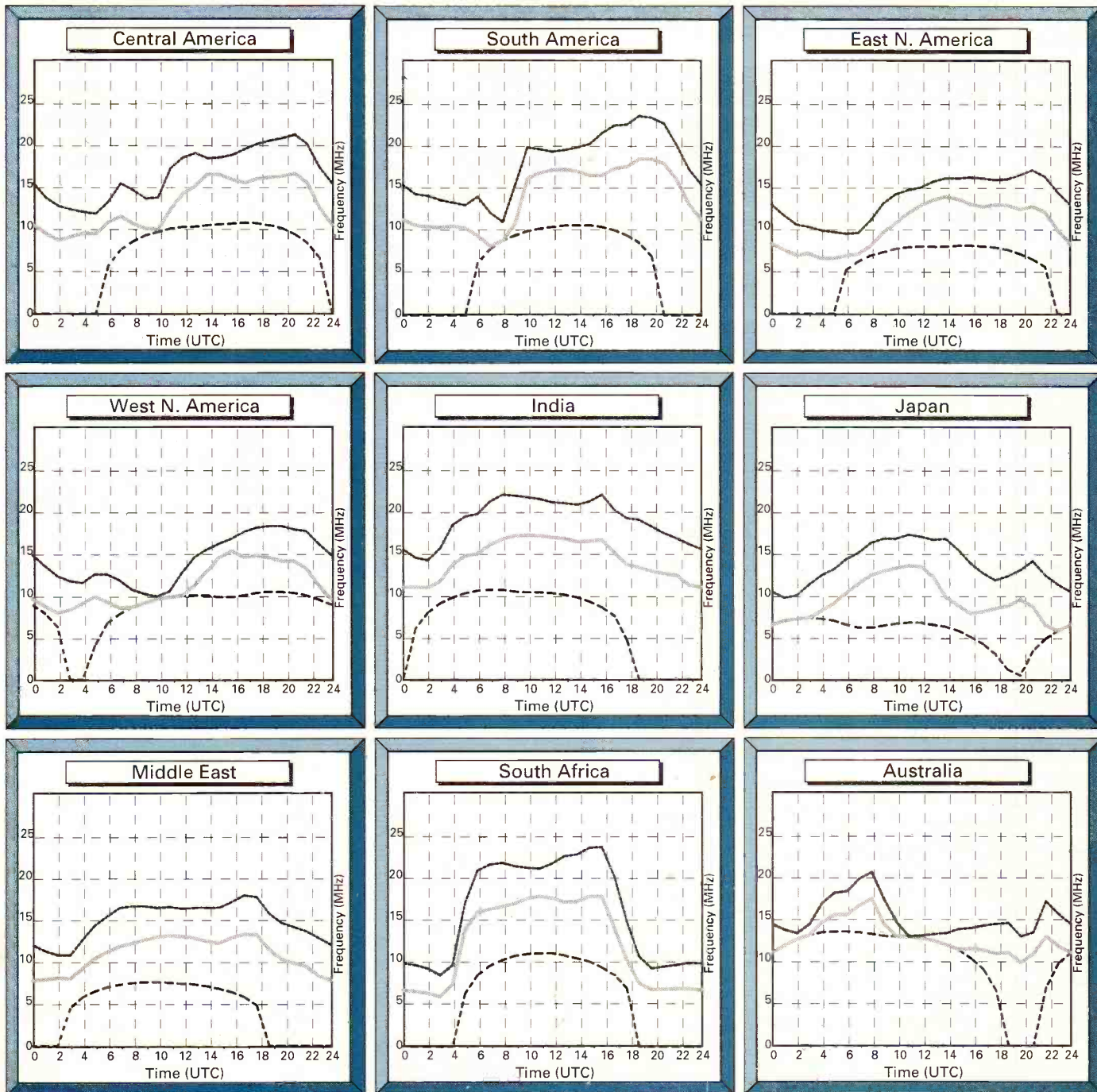

How to use the Propagation Charts.

The charts contain three plots. The lower dashed line represents the lowest usable frequency (LUF), or ALF (Absorption Limiting Frequency). The chances of

success below this frequency are very slim.

The middle line indicates the optimum working frequency (OWF) with a 90% probability of success for the particular path and time.

Lastly, the upper dashed line, represents the maximum usable frequency (MUF) a 50%

probability of success for the path and time.

To make use of the charts you must select the chart most closely located to the region containing the station that you wish to hear. By selecting the time chosen for listening on the horizontal axis, the best frequencies for listening can be

determined by the values of the intersections of the plots against frequency.

Good luck and happy listening.



SATELLITE & SOUND 2000

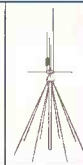

THE PRICES SHOWN BELOW ARE ONLY A GUIDE. WE CAN NORMALLY BEAT ANY GENUINE PRICE THAT YOU HAVE BEEN GIVEN

AOR

AOR 8000 **£385.00**

AOR 3030 **£629.00**

AOR 3000+ **£895.00**

AOR 3000A **£835.00**

AOR 2700 **£265.00**

BEARCAT

65XLT **£99.00**

220XLT **£199.00**

DRAKE

R8E **£1175.00**

SW8 **£639.00**

ICOM

ICR-1 **£350.00**

ICR-100 **£560.00**

ICR-7100 **£1225.00**

ICR-71 **£975.00**

ICR-72E **£750.00**

ICR-9000 **£PHONE**

RECEIVERS

KENWOOD

R5000 **£895.00**

LOWE

HF-150 **£385.00**

HF-225 **£475.00**

HF-225 Europa **£Phone**

JRC

NRD-535 **£1540.00**

REALISTIC

PRO 2039 **£199.00**

PRO 2036 **£325.00**

PRO 2035 **£310.00**

PRO 44 **£125.00**

PRO 43 **£225.00**

SONY

SW-77 **£359**

SW-55 **£279**

SW-100 **£179**

SW-7600 **£169**

YUPITERU

MVT-8000 **£335.00**

MVT-7100 **£335.00**

MVT-7000 **£265.00**

MVT-225 **£225.00**

YAESU

FRG-100 **£Phone**

AOR

AR-3030 G5RV aerial bows CT8 ATU VHF converter **£650.00**

AOR

AR-3000+ SDU5000 purchased together **£1499.00**

ICOM

ICR-72 G5RV dipole Howes CTU8 ATU 2yr. G'tee **£779.00**

ICOM

ICR-100 CTE discone. 4th Scan Directory **£575.00**

LOWE

HF-150 SWL antenna. Howes CTU8 ATU. SW listeners guide **£399.99**

LOWE

HF-225 G5RV dipole. Howes CTU8 A **£499.99**

REALISTIC

PRO-2036 discone ant. 4th Scan Directory. Airband amp **£369.00**

YUPITERU

MVT-7100 case. 4th Dir active antenna **£369.00**

YUPITERU

MVT-7000 case. 4th Dir active antenna **£295.00**

SCANNER SHORTWAVE KIT

Howes CTU8 ATU Watson bauln G5RV antenna **£65.00** or **£128.00**

Global 2000 ATU

ACCESSORIES

AOR

CU8232 **£80.00**

SDU5000 **£649.00**

8000 Case **£17.00**

SDU5000 **£649.00**

DRAKE

Speaker **£49.95**

VHF Converter **£225.00**

Software **£59.95**

HOWES

AA2 SW active ant **£8.90**

AA4 VHF active ant **£19.90**

ASL5 filter **£29.20**

CTU8 ATU **£49.00**

CTU30 ATU **£39.90**

DXR29 80/40/20 receiver metres. **£49.00**

SSB with HF airband

REVEX

HX800 **£19.95**

HX9000 **£29.95**

ICOM

SP3 **£69.00**

SP7 **£35.00**

Various **£25.00**

Software from

JPS

NTR-1 **£199.00**

NRF-7 **£279.00**

NR-10 **£399.00**

KENWOOD

VC20

HS-6

HS-5

LOWE

SP150 **£210.00**

PR150 **£235.00**

RK150 **£55.00**

IF150 **£39.00**

Keypad **£39.00**

GLOBAL

2000 ATU **£95.00**

1000'S OF BOOKS AVAILABLE

SCANMASTER

Mobile mount **£9.95**

Desk Stand **£19.95**

SP55 Pre-amp **£69.95**

GW2 Pre-amp **£59.95**

Notch filter **£29.90**

TIMEWAVE

DSP 9 VER2 **£189.00**

DSP 9 plus **£225.00**

DSP 59 plus **£289.00**

VECTRONICS

Active ATU Preselector **£75.00**

2 way antenna switch **£18.00**

CABLE

RG58 **£0.50**

5DF8 **£0.85**

8DFB **£1.95**

Per metre

AOR 3030 as new **£499.00**

AOR 2000 used **£175.00**

AOR 1500EX used **£199.00**

AOR 3000A as new **£599.00**

Icom ICR-1 as new **£279.00**

Icom ICR-100 as new **£375.00**

Icom ICR-7000 demo **£695.00**

Icom ICR-7100 as new **£875.00**

Icom ICR-72E demo **£625.00**

Yupiteru 7000 2 in stock **£189.00**

Yupiteru 7100 3 in stock **£199.00**

Sony SW55 used **£155.00**

AERIALS

Skyscan 1300 **£49.00**

Skyscan Desk **£49.00**

Skyscan Mobile **£24.00**

Scanmaster Base **£38.00**

Scanmaster Discone **£49.00**

Scanmaster SBA100 **£59.00**

Scanmaster Double Disc **£69.00**

BSS1300 Base station **£65.00**

DSS1300 Desk top **£41.00**

MSS1300 Mobile **£41.00**

SWA30 Shortwave with Bauln **£40.00**

1/2 size G5RV Dipole **£24.00**

Full size G5RV Dipole **£28.00**

(half-size 51' - full size 122'/50kHz - 30MHz)

Diamond D707 active VHF/UHF antenna 20dB amp **£129.00**

Watson Bauln **£18.00**

SECONDHAND

WE NEED YOUR USED EQUIPMENT BEST PRICES PAID BEST PX OFFERS, PHONE NOW

ERA Micro reader 2 ex demo **£125.00**

Realistic Pro 2022 good **£125.00**

Realistic Pro 2006 new **£185.00**

Realistic Pro 2035 ex demo **£250.00**

Yaesu FRG100 tatty **£250.00**

Yaesu FRSDX400 good **£255.00**

Lowe PR150 fair **£250.00**

Lowe PR225 good **£325.00**

JRC JST125+spk good **£899.00**

Yaesu FT290RII inc-linear good **£325.00**

Alinco dual bander with extended RX good **£325**

Showroom: Unit 1, 86 Cambridge Street St. Neots, Cambridgeshire PE19 1PJ



NEXT DAY COURIER SERVICE

Phone 01480 471001

Fax 01480 470771 E&OE

All prices subject to change

Bandscan

America

The North American short wave hobby community received quite a shock when two DX clubs discontinued operations, the announcements coming almost back to back. The Association of DX Reporters ceased activity because of what was termed insufficient member support. ADXR was an outgrowth of the old Newark News Radio Club, which was founded in the early days of commercial radio and ceased publishing in the early 1980s. ADXR continued NNRC's tradition of being an 'all wave' club for 13 years (and it was the only national club still trying to cover all the major bands - amateur, SWBC, medium wave, utilities and amateur).

Speedx discontinued operations after its January issue. Declining membership had left the club with no operating funds and thus unable to publish another bulletin. Speedx had operated for nearly a quarter century.

ANTARCTICA - Unfortunately, the news of AFAN-McMurdo's reactivation on short wave seems to have been wrong. It appears that the station's only activity is on the f.m. band.

BOLIVIA - Recently logged stations include Radio Movima on 4.472MHz around 1000, Radio Abaroa 4.713MHz after 1000, Radio Illimani 4.945MHz around 1015 (and also on 6.025MHz) and Radio Santa Cruz 6.135MHz about 2300.

Also Radio Perla del Acre 4.600MHz at 1000 and Radio El Mundo 6.015MHz also around 1000. Other activity includes Radio Eco on 4.409MHz, Radio San Joaquin on 4.509MHz and Radiodifusora Tropic on 4.552MHz, all received at around 2300.

BRAZIL - Recent loggings and other notes from this country include: Radio Nova Visao, Santa Maria on 11.705MHz at around 0000. This is the former Radio Transamerica. Radio Alvorada, Parintins is heard on 4.965MHz around 0945. Radio Nacional Amazonia 6.183MHz (normally 6.180MHz) at 1000. Radiodifusora Londrina is coming through on 4.815MHz around 0330 (in Portuguese).

Radio Cancao Noa 6.105MHz with religious programming around 0600. This station also uses 4.825 and 9.675MHz, all Portuguese.

Radio Gazeta is noted on 9.685, parallel 15.325MHz in Portuguese around 2230.

CHILE - The long silent government station Radio Nacional and La Voz de Chile, that had a 'for sale' sign posted on it for quite some time has a new owner. Reverend Jose Holowaty, former programme director

for the now closed KGEI in California, has purchased the facility and will put a new station on the air in the form of Radio America International. It may even be active as you read this. The facility includes eight 100kW transmitters, 22 acres and nine towers - which went for a reported \$350 000US. Initially the station plans to focus coverage on Latin America, more or less trying to pick up the audience KGEI had. Later the station may beam broadcasts to Russia and Europe.

Frequency and scheduling information has not yet been made available, but keep an ear to the old Radio Nacional frequency of 15.140MHz, just in case!

Radio Esperanza, variable 6.089MHz, has plans for a new 5kW transmitter and 24 hours per day operation.

COLOMBIA - Radio Nacional de Colombia has begun use of a 60m band frequency - 4.955MHz and is being heard well in North American evenings, i.e. 0200UTC. Reception reports are requested to Radiodifusora Nacional de Colombia, Radio Canal Internacional, PO Box 93994, Bogota.

Radio Super de Ibaque on 4.785MHz is the former Ecos del Combeima, a part of the Super network. Combeima left short wave and took over the facilities of medium wave stations La Voz del Navado.

DOMINICAN REPUBLIC - Check 4.780 until 0300 for Onda Musical, Santo Domingo, which is active again. The frequency varies ever so slightly. And be wary of another Central American, Radio Cultural Coatan, Guatemala. There's often just a fraction of a kilohertz difference between the two.

ECUADOR - A new outlet in this country is Radio Alianza on 5.454MHz, being heard in Spanish until sign off sometime after 0200. Another fairly new one is Estereo Carrizal in Calceta (Manabi), which runs until just after 0400.

And a station expected to be active soon is Good Shepherd Radio, located in Saraguro. Broadcasts will be aimed at the local Quechua Indians.

The government's 'Radio Nacional' service, mentioned last time as being carried on HCJB has been suspended. I've no idea why or for how long.

GUATEMALA - Union Radio - the AWR station is Guatemala is sometimes noted on 5.981MHz, running until 0100 close. The new Radio Cultural Coatan elbow each other and battles it out with Onda Musical.

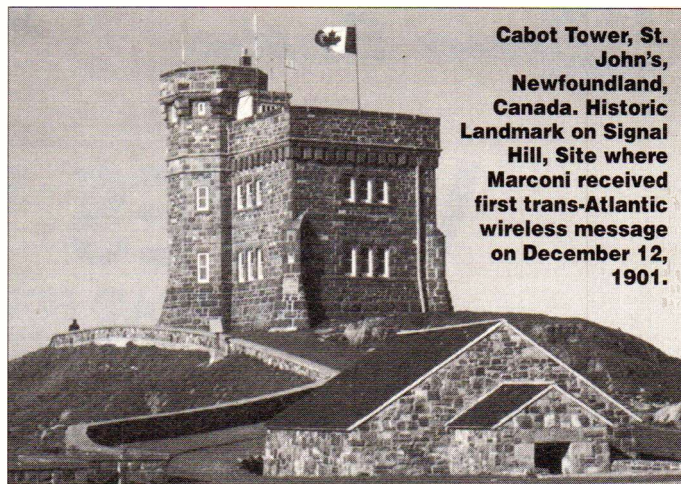

Cabot Tower, St. John's, Newfoundland, Canada. Historic Landmark on Signal Hill, Site where Marconi received first trans-Atlantic wireless message on December 12, 1901.

HONDURAS - Radio Copan International 15.675MHz is carrying some independent programming, some of it produced by current, former or would-be pirate broadcasters. Check Saturdays at 2000-2100 for Southern Music Radio, based in New Zealand, Radio Albatros from 2100-2200 on Sundays. Others include Radio Marabu, based in Germany, 2100-2200 Fridays, Radio Modern Rock, Tuesdays at 2200-2230, Wednesdays 0000-0030, Saturdays 2230-2300. Not that these times are the winter schedule, which has probably changed now, so add an hour to each time - 2200UTC instead of 2100. These kind of broadcasts stay on the schedule only as long as the money lasts and, as a result, some have short life spans.

A reactivated station is Radio Luz y Vida on 3.2495MHz from San Luis, in Santa Barbara department. The station operates daily until just before 0400 and includes some English language religious programming in its mainly Spanish language schedule.

KIRIBATI - Radio Kiribati is being heard with news from Radio Australia at 0600 on 9.825MHz, followed by local and regional news.

NICARAGUA - Radio Miskut can occasionally be picked up in upper sideband mode on 5.770MHz running until sign off at 2330 or slightly before.

PERU - New and sort of new ones from Peru, Radio Soledad on 4.6335MHz running to sign off a few minutes past 0400. Radio Sensacion 6.895MHz is heard to sign off a bit past 0100. Radio Vision dos Mil on 5.131MHz has been reactivated. Try around 2330.

More from Peru include Radio Marginal on 4.039MHz, Radio Paucartambo 4.510MHz, Radio Ondas del Sur Oriente 5.069MHz, Radio Miundo 5.082MHz and Radio Tacna 9.505MHz. Radio Jaen, off short wave for a decade, has returned to 5.005MHz. Its slogan is La Voz de la Frontera.

The Peruvian short wave broadcasting scene is - with Bolivia - the most changeable in all of Latin America, with stations coming and going all the time. Schedules and frequencies also tend to be variable.

UNITED STATES - Another opposition group is using a commercial US broadcaster to sell its

message. The Voice of Oromo Liberation was recently discovered on WHRI, Indiana on 13.760MHz. Check around 1600. This may not be a daily broadcast, exact schedule has not yet been confirmed. The broadcast is produced by the Ormo Liberation Front which opposes the present government of Ethiopia.

Now having paid all the money, Prophecy Countdown (WVHA) has taken complete control of the former WCSN (Christian Science) short wave facility in Maine. WVHA announces their location as Greenbush, WCSN announced it as Scott's Corner. There's been no physical move of the facility.

WRMI - Radio Miami International includes DX information as a part of its programme *Viva Miami*. The feature is *Wavescan* a media/DX programme produced by Adrian Peterson on behalf of Adventist World Radio. It airs on Sundays (UTC) at 0100. The English version of *Viva Miami* is scheduled at 0000-0030 Mondays (UTC) and at 0100 Tuesdays through Sundays. All WRMI transmissions are on 9.955MHz.

URUGUAY - Radio Monte Carlo (not the station in Monaco) is being noted from Uruguay occasionally around 0000 on 11.730MHz. You may also hear mentions of or IDs from Radio Oriental, the listed station on this frequency. It sometimes relays Radio Monte Carlo. Monte Carlo programming can also be heard on occasion around 0000 on 9.595MHz.

VANUATU - Radio Vanuatu's two new 10kW transmitters are registered for use on 2.485, 3.330, 3.945, 4.960, 6.100 and 7.260MHz. 3.945 and 7.260 are frequencies that have been used by the station all along. The old transmitters are to be retired. At this writing, the new transmitters do not appear to be on the air and, apparently, the old ones are operating only irregularly.

VENEZUELA - Watch 3.375MHz for the return of La Voz de la Fe in Maracaibo, which says it plans to return to short wave.

Radio Barquisimeto still plans a return to short wave, but its initial start-up date had to be delayed. When (or if) they do reactivate, the frequency reportedly will be 9.510MHz.

That covers things from the America's for this time. Will have more for you in three months. Until then - good listening.

VALVES WANTED

**TOP PRICES PAID FOR NEW BOXED VALVES
SEE LIST BELOW:-**

Px25 MARCONI OR OSRAM GLOBE SHAPE.....	£90 ea	DA30/DA60 G.E.C.....	£80 ea
Px4 MARCONI OR OSRAM.....	£50 ea	KT66 G.E.C.....	£35 ea
PP3-250 MAZDA OR OSRAM.....	£50 ea	KT88 G.E.C.....	£50 ea
805/845/211 U.S.A. ORIGINALS.....	£25 ea	EL34 MULLARD.....	£12 ea
STC 4212E UK.....	£100 ea	300B U.S.A. or S.T.C.....	£150 ea
DA100 G.E.C.....	£100 ea	EL37 MULLARD.....	£10 ea

**ALSO WANTED USED VALVES AND OLD
VALVE AMP EQUIPMENT**

LEAK, QUAD RADFORD, ETC.

SEND, PHONE, FAX, LIST, INSTANT DECISION

JAVIATION

CARLTON WORKS, CARLTON STREET, BRADFORD, WEST YORKSHIRE BD7 1DA

TELEPHONE: (01274) 732146

CAMNIS HSC-010

This is just the same as the
AR2000 & Trident TR-1200.
500kHz -1300MHz,
1000 channels, 10 search banks.
AM, NFM & WFM

£229

VHF/UHF Airband Guide

New edition out now, updated December 1994.

£7.50 inc p&p

Military Callsigns

Over 5,000 military aircraft callsigns listed with aircraft type & unit.

£6.50 inc p&p

£425

The New Concept AR8000

Including the Official AOR Carry Case **FREEEEE**

How about part exchanging your current receiver?

**LEATHER CARRY
CASES**

MVT-5000/MVT-7100,
AR1000/2000 & FAIRMATES,

If you would like further information please feel free to telephone, write or e-Mail, it would be nice to speak with you.
If you would like a catalogue would you please send a large SAE - Thanks.

CompuServe: 100117,535

Internet: info@javiaton.demon.co.uk (please note spelling of Javiation when sending E-Mail!)

If you have a WWW browser go "http://www.demon.co.uk/javiation" for an on-line catalogue

Reflections

My quick reply to a question, "how long has the transistor been with us?" was, "a good 30 years." However, I looked it up in the encyclopedia, *Encarta '95*, CD-ROM and found that this little device, which revolutionised the radio and electronics industry, was developed in 1948 by three American physicists at the Bell Telephone Laboratories in the USA. In 1956, they, Walter H. Brattain, John Bardeen and William B. Shockley shared the Nobel prize for Physics. It doesn't seem possible that my answer should have been nearly 50 years!

Valve

It's unlikely that the exploration of space, which began when Russian scientists launched *Sputnik 1* in October 1957, would have been possible without the transistor. I doubt that a delicate glass valve could have withstood the shock of the launch and would have required too much electrical power from a satellite's limited supply. Compared to the transistor, all valves are current hungry. For instance, the 1T4 valve, standing left **Fig. 1**, in a seven-pin holder, needs 1.4V at 50mA to light its filament and up to 90V on its anode. A screening can is fitted over the valve and retained by the metal part of the holder that remains above the set's chassis. Even that small valve assembly, measured from the base of the holder to the top of a screen, is approximately 65mm and has a 20mm diameter base.

At least four such valves make up a domestic receiver. Now compare that to the GEC radio on the right of **Fig. 1**, which measures approximately 95 x 60 x 25mm complete with a PP3 battery which

fits under a flap at the lower rear of the set.

Domestic Market

From the retailer's point of view, our radio battery stocks rapidly changed from the large 90 and 1.5V packs, for the valved sets, to the 'PP' range that included the six-volt PP1 and the nine-volt PP3, PP4, PP6, PP7 and PP9. Other battery makers used 'VT' and 'DT' in front of the number.

I believe that the transistor gave millions more people around the world a chance to have a radio. Compared to the valved receivers, the transistorised sets were relatively small, cheap to run and less costly to maintain.

Among the sets made prior to 1965, now sought after by collectors, is the 'palm-held' GEC, **Fig. 1**, the Ekco PT352, **Fig. 2**, with its preset tuned 'Light' programme (currently BBC Radio 4) on the long wave and the Regentone TR410, with a band-spread for Radio Luxembourg. In some areas the reception of this famous station was difficult and that special band helped to overcome the problem. Each had its place with the user, especially for listening to the news and sport when away from home. At that time sets like the GEC were popular for the handbag or pocket and the Ekco for the briefcase, desk-top and work-bench.

Red Shift

Last month I selected 'Main Program' from the opening options in *RedShift*, so this time we will look at the alternative 'Guided Tours'.

The *RedShift* instruction book suggests that the user begins by following one of the 20 guided tours.

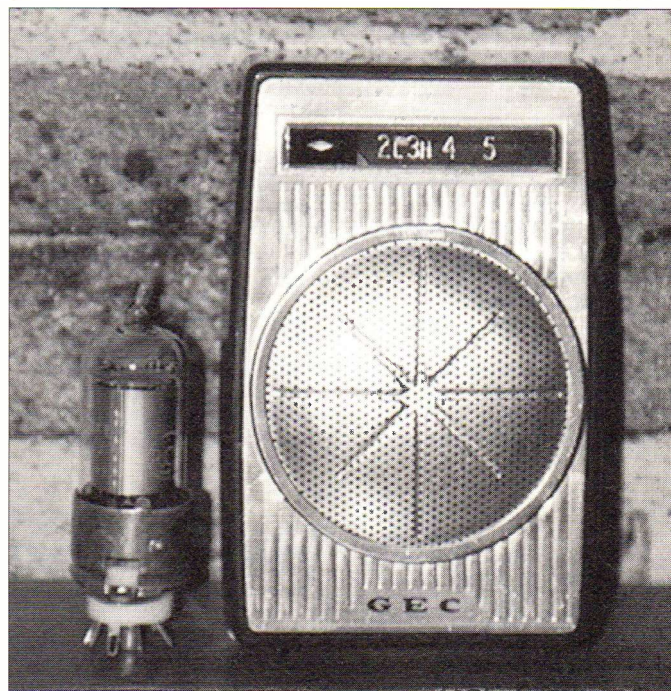

Fig. 1

This I did and was offered a number of titles covering movements of the earth, moon, planets, eclipses of the sun, as seen from the surface of the earth or moon and 'The Sky Viewed From Earth'. The latter produced the night sky above the horizon, as seen from London in real time. Also on screen came a 'box' of instructions and the controls and settings menus.

According to the chosen subject, the *RedShift* photo library can be accessed from the 'box'. Watching a solar eclipse from the earth or moon or seeing the movement of the planets and their moons is both fascinating and informative. The settings, control and zoom menus enable the user to better understand how the mechanics of these subjects work. In addition, the library has photos of comets, taken by NASA and the National Optical Astronomy Observatories and about nine sections, each with a number of titles, under the 'Galactic' and 'Extra Galactic' headings.

I tried 'Gaseous nebulae' from the galactic menu and looked with amazement at more than 30 pictures including some spectacular views of Orion's Horse-head nebula.

From the 'Information' menu I selected 'Movie Gallery' and was offered five moving pictures of the surface of Venus, two of the moons surface and four from the Apollo landings, including a 'ride' in the Lunar Rover.

The more *RedShift* is used, the more obvious it becomes that this is a big program with many features. If your geography is rusty, it has well featured maps of the earth, moon and mars which are complete with gazetteers to help you quickly find a named location.

As yet I have not tested this, but *RedShift* allows the user to set the time and date anywhere between 4712BC and 11000 AD.

Observations

Although close to sunspot minimum, "there is still a bit of activity about coming from the sun's corona," wrote **Ron Livesey** (Edinburgh) at the end of January. Ron uses a 2.5in refractor telescope with a 4.0in projection screen and his daily observations revealed one active area on the solar disc on days 22, 24, 25, 26 and 28 and two on the 18th, 19th, 20th and 23rd.

During his morning sunspot observations, **Patrick Moore** (Selsey), found a small group of spots on his projection screen on February 4, two single spots on the 7th and a spot, followed nearby by a group of four tiny spots, **Fig. 3**, on the 18th.

Aurora

Ron Livesey, the auroral co-ordinator for the British Astronomical Association received reports of aurora described as 'homogeneous arcs and bands' for the overnight periods on January 2/3, 5/6, 17/18 and 29/30, 'rayed arcs and bands' on 17/18 and 29/30, and 'active aurora' on 3/4, 17/18 and 29/30, from observers in Aberlady, Banff, Edinburgh, Kincardine, Kinloss, Portpatrick, Kirkwall and St. Andrews.

Magnetic

The magnetometers used by **John Fletcher** (Tuffley), **Tony Hopwood** (Upton on Severn), **Karl Lewis** (Saltash), **Ron Livesey**, **David Pettitt** (Carlisle), **Tom Rackham** (Goostrey) and **Tony Rickwood** (Gillingham), between them, recorded strong disturbances to the earth's magnetic field on

Fig. 2



January 16, 17, 18 and 29 and lesser events during the first week and the last three days of the month.

Weather

In February I recorded 6.35in of rain compared to 3.44in for the same period last year. Large amounts of 0.95in and 0.80in fell on the 14th and 19th respectively and lesser amounts, ranging from 0.10in to 0.68in, was spread among 15 other days. Hail and thunder accompanied the rain on the 15th and slight frosts occurred overnight on the 26th and 27th.

"February's weather systems

gave us all sorts of conditions," wrote **Arthur Grainger** (Carstairs Junction) and added that most days were wet with some gales and a few sunny days in between.

Although he did not notice any big tropospheric openings during the period he found that Radios Gloucestershire and Lancashire, on 104.7 and 104.5MHz respectively, gave good signals throughout the month.

The daily variations in atmospheric pressure from January 26 to February 25, **Fig. 4**, were taken at noon and midnight from Arthur Grainger's barometer in Scotland (dotted trace) and from my own barograph here in Sussex.

Fig. 4.

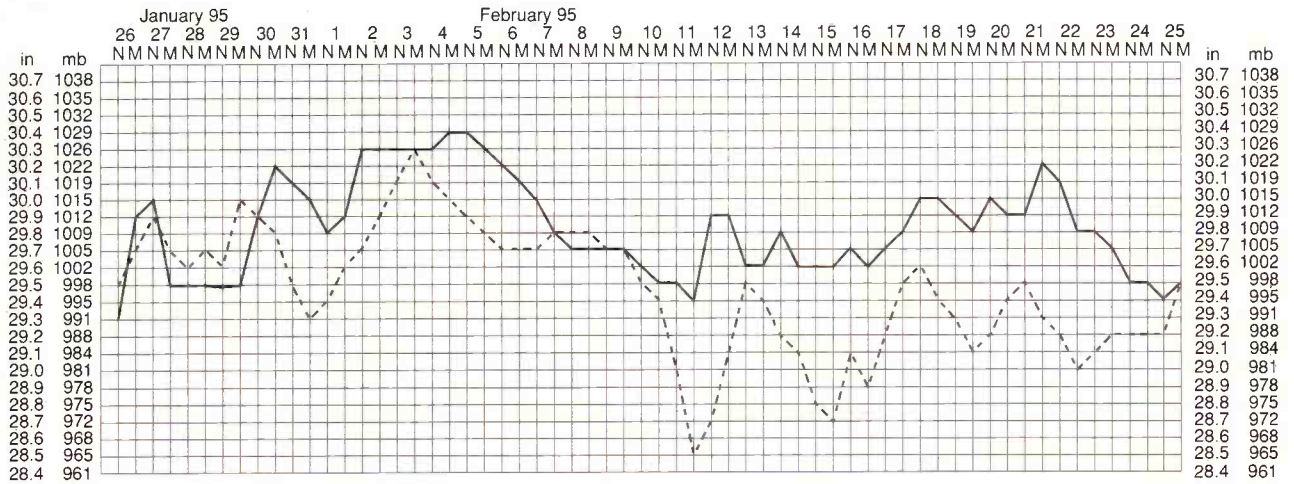

Fig. 3.

COMPETITION

WIN THIS PRO-2035 SCANNER



Worth £350

The Realistic PRO-2035 base station scanner was reviewed in our recent *What Scanner* magazine presented free with the March 95 issue of *SWM*. **SRP Trading** have generously given the review model as a prize in a three-part competition.

The second part should have appeared in last month's *SWM*, but fate conspired against us and the second part is presented here. The third and final part will now appear in the June 95 issue.

To enter, just write the answer to the question on the coupon on this page. Save the coupon, together with the coupon from page 3 of *What Scanner*, March 95 and the final coupon from next month. Full instructions on submitting your entry will appear with the third part. If you missed the first part of the competition, back issues of *SWM* March 95 - with *What Scanner* - can be obtained from the Broadstone Offices price £2.30 inc. postage.

QUESTION 2

What is the total number of channels the PRO-2035 can store in its memories?

ANSWER...

NEW PRODUCTS

MULTISYSTEM DIGITAL VIDEO CONVERTER

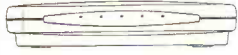

- Input Signal NTSC 3.58, NTSC 4.43, PAL, SECAM
 - Output signal NTSC 3.58, PAL (B, D, G, I)
 - Input Auto Detecting
 - Input Signal Indication (PAL, SECAM, NTSC) via LED's
 - Video input & output via RCA phone socket
 - Line conversion: 525 to 625 Lines 625 to 525 Lines
 - Field conversion 60 to 50 and 50 to 60 Fields
 - Power supply DC 15 volts @ 450mA
 - Accessories, set of leads & AC adaptor
- £399.00**

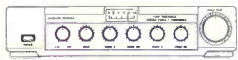

NEW! Fully manually controlled satellite receiver. Built-in bandwidth filter. C/Ku band switching, 14/18V LNB options, low threshold, eight front panel user controls, ideal for weak signal work. (SAE) for details

£199.00

(All prices are inclusive of Vat, Carriage & Insurance delivery £9.00 on large items).

Full range of satellite equipment supplied.

Our **CATALOGUE** at £1 samples some but not all that we can supply, send for your copy today. UK & overseas despatch normally ex stock within 24 hours, we'll accept the usual credit cards, cash, cheques, POs - as convenient. Ring daytime with you query or late on our 24 hr 'phone or send in your fax and we'll get back to you shortly.

KANSAI TVR51K 21"

Multisystem Colour TV
Aerial Techniques brings you more new products to complement our already extensive range.

- "Personal Preference" memory function - (Volume, Colour, Brightness, Contrast and Hue)
 - 5-System: PAL-B/G, PAL-D/K, PAL-I, SECAM B/G, SECAM D/K and NTSC 3.58/4.43
 - Infrared Remote Control
 - 90 Preset Channels
 - Automatic Tuning
 - On Screen Display - Volume, Colour, Brightness, Contrast, Hue and Channel
 - EURO-AV (SCART) Socket
 - Sound Muting Function
 - Presetable Off Timer (15-120 minutes)
 - Automatic Power Off Function - when no broadcasting signal is received within 10 minutes
 - Full VHF/UHF Coverage
 - Cable Tuner
 - Single or Dual Digital Control
- £269.00**

Aerial Techniques



11 Kent Road, Parkstone, Poole, Dorset BH12 2EH
Tel: 01202 738232 Fax: 01202 716951

Let Your Computer Control Your Radio! ... with SCANCAT

Once you use the SCANCAT computer program with your radio, you will never operate your radio again without it! SCANCAT Version 5.0 controls the following radios:

- * AOR 2500, 3000
- * DRAKE R-8
- * ICOM R-71, R-7000, R-9000, R-7100
- * NEW! PRO2006/OS456
- * NEW! AR-8000
- * KENWOOD R-5000, TS-140, TS-450, TS-711, TS-950
- * YAESU FT-757GX, FRG-9600 - FRG-100 New
- * JRC, NRD-525, NRD-535
- * HF1000 WATKINS JOHNSON

For other ICOM and Kenwood radios please write.

SCANCAT 5.0 UNIVERSAL FEATURES

- * Create Frequency Databases
- * Up to 400 Frequencies/File
- * Built-in TNC comm program
- * Scan between ANY Frequencies
- * Scan by ANY increment and delay
- * Share ANY radio's file
- * Import text files

EXTRA SCANCAT-PRO FEATURES

- * DBase support
- * Multiple Scanning banks (up to 15)
- * UNLIMITED file sizes
- * Dual simultaneous scanning of TWO Icom radios

FEATURES FOR:

- HF-150, HF-1000, AOR-3000, ICOM, NRD-535, FRG-9600, FRG-100, AR8000 & OS5456
- * Auto logging to disk files
- * Auto signal detection/scan stop
- Optional squelch detect cable - Specify Icom or Yaesu
- Scancat-Pro \$79.95 Upgrade \$24.95 Scancat 5.0 \$49.95
- * Spectrum analysis with spectacular graphics
- * Save/Load radio's memories to disk

Charge Cards welcome
Please call

@ DBA Computer Aided Technology

Please add \$7.50 P&P per order

P.O. Box 18292, Shreveport, LA 71138

Phone: 318-636 1234 (8-5 CST) or FAX 318-686 0449(24 hours)

Also Available in the UK from Javiation Tel: (01274) 732146



For all WEATHER SATELLITE enthusiasts THE INTERNATIONAL GROUP



RIG publishes a quarterly Journal containing: Many images from space, some in colour. Orbital elements and predictions. Articles about the interpretation of weather images, equipment construction and software. Helplines to advise beginners. All the news about weather satellites.

RIG supplies (to members only): receivers etc. at a discount, shareware of relevant programs, images on disk and CD-ROM.

Send for free Information Pack (UK readers SAE please) to:-
RIG-S3, PO Box 142, RICKMANSWORTH, Herts WD3 4RQ, UK

C.M.HOWES COMMUNICATIONS

Mail Order to: Eydon, Daventry,
Northants. NN11 3PT
☎ 01327 260178



RX Audio Filter £29.80



Morse Oscillator £19.90



Speech Processor £28.70

Digital Readout £74.80



There are lots
more kits in our
free catalogue!

Please send an SAE for your copy



Top Value SWL ATU

The HOWES CTU8 SWL ATU covers medium and shortwave bands (500kHz to 30MHz). Increases wanted signals by providing impedance matching, and at the same time reduces spurious signals and interference with "front end" selectivity for the receiver. Kit contains case and all parts. Reviewed in the December issue of SWM. Great performance, easy to build. The top value general coverage receiving Antenna Tuning Unit!

Factory Built: **£49.90**

Kit: **£29.90**

The famous HOWES Active Antennas

AA2 150kHz to 30MHz ACTIVE ANTENNA

The neat compact answer for those with limited space, holiday use, mobile operation etc. Two selectable gain settings, local or coax powering (12 to 14V). Good strong signal performance, IP3 +38dBm. Easy to build, and much liked by customers!

AA2 Kit: **£8.90** Assembled PCB Module: **£13.90**

AA4 ACTIVE ANTENNA FOR SCANNERS

Covers 25 to 1300MHz. Broad-band performance in a neat, compact package. Just over 16 inches long. Excellent performance in a small space!

AA4 Kit: **£19.90** Assembled PCB Modules: **£27.90**

AB118 AIR-BAND ACTIVE ANTENNA

Optimised for long distance reception on 118 to 137MHz air-band. Tuned antenna with pre-amp & band-pass filter. Hear ground stations you've never heard before!

AB118 Kit: **£18.80** Assembled PCB modules: **£25.90**

HOWES KITS - Great Projects to Build!



MULTI-BAND SSB/CW RECEIVER

The HOWES DXR20 covers 20, 40 & 80M bands plus any other HF frequency with optional plug-in modules. The photo shows the receiver built with DXR20 and DCS2 ("S meter") kits and HA20R hardware pack (case etc.). Excellent performance and compatible with many of our transmitter and accessory kits. Optional band module kits include 160M, 30M, 15M & 10M amateurs plus 5.45MHz HF airband at £7.90 each.

DXR20 electronics kit: **£39.90**,

DCS2 "S meter" kit: **£10.90**, HA20R hardware pack: **£28.90**

PLEASE ADD **£4.00 P&P**, or **£1.50 P&P** for electronics only kits.

HOWES KITS contain good quality printed circuit boards with screen printed parts locations, full, clear instructions and all board mounted components. Sales, constructional and technical advice are available by phone during office hours. Please send an SAE for our free catalogue and specific product data sheets. Delivery is normally within seven days.

73 from Dave G4KQH, Technical Manager.

Amateur Bands Round-up

Listening to the Amateurs

We kick off this time with a mention of the White Rose SWL Contest, that runs from 0900 to 2100UTC on June 25. Use 3.5, 7, 10, 14, 18 and 21MHz bands. Log up to five stations on each band in as many countries as possible, as defined by the *ARRL Countries List*.

Scoring is: one point for each station heard on each band, plus five bonus points for each new country. (Your first G on any given band then, one plus five, subsequent Gs on 5 point each). Final score, sum of the band scores. NO CQ, QRZ, or similar calls count; aeronautical or maritime mobiles not to be logged. Logs to show Date, Time in UTC, Station Heard, Station being worked, RS(T) at s.w.l. station. If both sides of the contact are heard they may be claimed and both calls logged. No station can be logged more than once on any given band. Separate log sheets for each band, plus a cover sheet listing the countries claimed on each band.

Entries to **D. A. Whitaker c/o White Rose ARS, 57 Green Lane, Harrogate HG2 9LP**, postmarked no later than July 24 1995.

A word from me on this: get a copy of the rules from the address above and study them. In the January effort, someone lost 17 000 points by misunderstanding!

Problems!

This one comes from **Bob Taylor** of Stourbridge, who wants to run more than one receiver from his one antenna. Personally, I would simply use a wafer switch between the antenna tuner and the receiver, which implies switching at low impedance. True 'diversity' reception calls for a separate antenna for each receiver, since it is meant to combat fading. To achieve what Bob says he wants would call for feeding the output of the tuner into an isolating stage, followed by two isolated outputs, one for each receiver. It could be made to work, but it would degrade the overall performance to an extent determined by the theoretical design.

A noise 'like hot fat spitting' plagues **F. Lennon** in Hyde, Cheshire; worst in the morning, but seems to go away as the day wears on. It is worst on the lower frequencies. It seems unlikely to be anything to do with propagation, and sounds man-made to me.

Something breaking down in the morning dews maybe? He mentions W1TRC, KP2BH (American Virgin Is), US0GA, AB4RU, 9K2MU and W8KTH all around 3.790-3.8MHz. On 14MHz he notes W0GKL in Nebraska, VU2MPS, W7ZQ in Wyoming, 5Z4SM, UA0AP, TJ1A, 4W1KZ, JA1PJ, A22MN, ZS6KRU, 9J2AE, ZL1AV and EP2MHB; 18MHz showed PJ8AD on two occasions and US0NZ. Finally 21MHz where K6OKW, K0TPF (S. Dakota), W7LTH and K7RST in SE Arizona were all entered in the log.

Skibbreen in South-West EI is where **Finbarr O'Driscoll** listens from. This time, Finbarr was tuning around the VOLMET frequency of 6.676MHz in the middle of last year when he came across a group using what appeared to be amateur operating techniques and fairly low power. They seem to call on 6.670MHz lower sideband and then shift away slightly for a natter. Finbarr has heard various countries in this group. In fact, this sort of thing has been going on for many years, and it is long overdue for the EC countries to bust them once and for all.

Now to Derby where **Ian Hatton** runs a Yaesu FRG-100 into a triband rotary dipole at around 9m, plus an extended double Zepp for 18MHz that can also be tuned over all the other bands. On 28MHz we see 9G1MR, CX2UO, EA8AMT, ZS6TB, ZS6MB, PU2MHB, 5R8EH, 5R8DS, ZS5AFJ, 5N0GC, all on sideband, plus 9J2FB on f.m. 24MHz came up with Z21CS, WP4ENA, 9K2ZZ, HZ1MM, A45ZZ, W5IZ, 4X4DK, KF7E, S0/KC0PA, OD5YT, KP4TB, TA2ZY, ZS6WB, A71AN, A71CW, 5N0CGC plus HZ1AB on the key. At 21MHz we see PT7BZ, TI2/NZ4K, ZS5RF, VP8CQG, BV4FH, BV4AS, TG9GI, YV5IVB, FS5PL, CO7JC, OD5NH, S0/KC0PA, ZS6PW, P49V, 9G7MW, 7Q7CT, 3XY0A, TU2JL, YC8DDU, VK5YN, DU7KGJ/DU4, TJ1AG, A22MN, 9J2GA, 5N0GC, ET3AA, V59T and J55UAB.

A look at 14MHz resulted in FG5KA, FM5CW, VE8GL, FY5GJ, 3B8GF, ZL3GS, KL7XD, SU3AM, V44KBP, FY5FJ, SU1SK, V29NR, VP8CPC, 8P9AF, ZS3JR, 5R8DS, VE6JFS, VE8RCS, KH6WU, A41JR, AH8A (US Samoa), ZL3RD, VP2MDY, D68QM, EP2MHB, ZP5MAL, LU3DFA, 9G1BJ, S0/KC0PA, D44AB, XT/TU5BA, YB5AQG, 9M2CW, 9M8YJ, VP8CQS (S Shetland), ZL4OD, KP4SB, VE6UML, ZD7WRG, 5Z4PL, TN2M, ZD7SM, 7Q7JL, Z22JE, TR8SX, 9Q5TT, 5H3JB, VK9CR (Cocos-

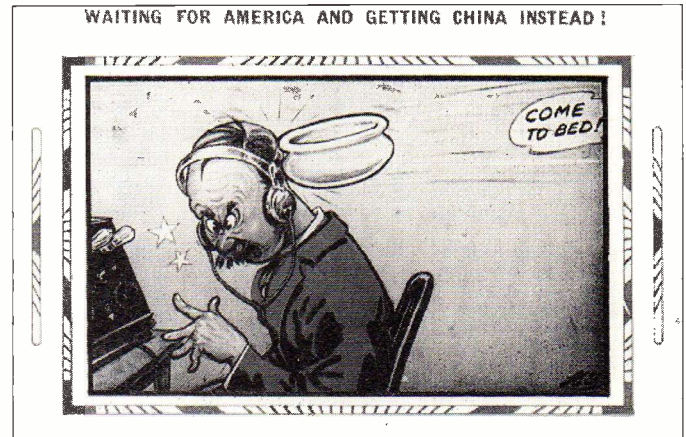

Keeling Is), J28RP, 7P8PG, J52AK, VE7MCK, a couple of BVs, 5N1DNA, 4S7RF, VU2RCN, NL7J, VP5/JR3RVO, 3XY0A, WL7HP, ZD9BV, TJ7DH, FJ/OZ7SM, EL2J, T26VV, HR7KAS, 9Q5TR and S83H.

18MHz produced JO1DZA, CN8FD, S0/KC0PA, JR6SVM on Okinawa, KP2J, TL8MS, PY2XB, 9K2HA, EX0M, PJ8AD, CU7AX and A71AN. 7MHz showed another fine crop, as did 3.5MHz, while Top Band was used by IC8JAH (Capri), RK9XWH, SV8CS, VE1ZZ, OY9JD, T93M, S57DX, LY1FW and EU6AF.

Having acquired a nice RA17 receiver, **Mark Borthwick** of Hawick is back in business. On 7MHz, Mark noted CU3/CT1FDD in the Azores, EA8TL in the Canaries, 4X4JU, OD5NJ, CN8ET, CN8SN, PT7NK and ET3HB. 14MHz stumped up a couple of EA6s in the Balearic Is, 5B4ES, 9K2ZZ, 5Z4PL, A41JR, A45ZZ, three 4S7s, 7Q7JL, ZA0B (Sazani Is), VP9AT, three ZS5s, three VKs, A71AN, ZB2AZ, CN8CV, IC8GVV (Capri), a brace of EA8s OD5NH, EA9AU, KH6WU, FS5PL, PYs and LUs, CU2AA (S. Miguel Is), CU3YY (Azores), three VO's, and an absolute raft of American and Canadian stations, including rarities such as W2N9Q/7 in Oregon, AA7MH in Arizona, a brace of Alaskans, WB8QFH in Colorado, and K00TPF and K0CX who were both in S. Dakota. Finally, a peek at 18MHz found CU1AX (Santa Maria Is), PJ8AD, A71BH, ZA1E, ZB2GR, T77CD, K1BGT, W2YD, N2PPB, W3FX, WT4K/MM, W8AH and ND0F.

Dangers

At the time of writing, I know of two groups proposing to activate Spratly, though both will be over by

the time you read this. One group of JAs propose to be on Layang Lagang Island, March 29-April 3 with cards via JA9AG; the second effort is a Philippine group to sign DU0K between April 10-16 with the cards going to DU0RG. I just hope no-one gets hurt!

Readers will be aware that there are several countries claiming the Spratly group as theirs, and older readers will recall the death of at least one DX operator by military fire in an attempt to activate the group.

Some QSL Addresses

AP2AMA goes via Box 1452 Islamabad

CN8HR via Said Noumani

CN8NS POB 6577 Rabat

EL2NB via PO Box 2751 Monrovia Liberia

OY2H via Cesare Casaroli

I0WDX, Piazza Conti 2, I-00010 Poli, Italy

TR8IG via PO Box 740, Libreville, Gabon

ZD8WRG via WA2JUN

Satellite TV News

The Latest from the Clarke Belt

There's a little confusion as to the happenings of the Gorizont craft at 11° and 14°W. Late February saw the 14°W bird carrying a caption indicating that as from the 28th the new Loutch co-ordinates would be Gorizont 12 @ 11°W Reuters TV Moscow have, however, been appearing on 14°W and a further confusion is that two downlinks have been monitored simultaneously (by **Maurice Hiller**, Lockerley) from this satellite suggesting that the bandwidth of the usual Loutch transponder centred at 11.526GHz is perhaps wider than thought - even suggesting up to 68MHz.

Certainly up to end March, the 14°W Gorizont was in use by Reuters Moscow bureau during mid mornings. The Gorizont 22 satellite at 40°E has also been seen running 2 downlinks though with data only (11.510, 11.545GHz).

Further speculation has offered thoughts that a new Express satellite, the up-market successor to the dated and unstable Gorizont, is now on station at the 11/14°W slot. I'm sure that the situation will become clearer over the future weeks and will be included in this column.

A little excitement for several readers who happened to come across a new channel on Intelsat 702 at 1°W, evening programming with a corner logo 'ID TV'. Unfortunately this excitement was short lived, 'ID TV' was a temporary programme feed from Oslo's Telenor Expo communications event over the March 14-18 period. The 10.970GHz horizontal frequency is one to check out periodically for other Scandinavian OB's events.

Whilst on a Nordic theme, the ex German TV SAT-2 is now operating from its new parking slot of 0.6°W and is downlinking in Ku-DBS. *Transponder* bulletin advises 11.747GHz LHC on test from March 10.

Donald Lynn (Melton Mowbray), our Microsoft software monitoring expert, advises that the times of Microsoft transmissions as previously mentioned on the 1st/3rd Tuesdays in each month may vary from previous data. In February the programme from Microsoft Television (MSTV) was at 1345UTC and not 1430UTC as monitored in January. Various transponders have been used, more recently the 11.472GHz horizontal trdr on Intelsat K at 21°W. Donald advises the audio appears on 6.60 and 7.38MHz subcarriers.

I wonder how many readers availed themselves of the opportunity to visit the Jason 6 Project centres throughout the UK in mid March. I know that **Andrew Sykes** (Kings

Lynn) visited Lakenheath air base where a large viewing auditoria was established. Full marks though to **John Locker** (Wirral) who manned the Liverpool Maritime Museum main UK centre for Jason 6 in a voluntary PR capacity for the project. He attended 25 shows and answered questions promote the hobby and interest of satellite viewing - there is a satellite world up there other than Sky TV on Astra!

Jason this year was based on the side of an active volcano in Hawaii, uplinking onto Galaxy 4 (99W) into the 'States for local distribution - again via Galaxy 4 using B MAC. PanAmSat then received the B MAC signal at their East Coast Homestead Teleport, digitally compressed the signal and uplinked via PAS 1 @ 45°W for the feed into Europe on the Atlantic path.

Being mid March, a slight solar outage was seen first on PAS-1 around 1530UTC (as the sun passes across the dish axis and behind the distant satellite) and then on the Galaxy 4 bird at 1900ish UTC. Son of Jason (7) continues and in 1996 will be featured underwater in Florida.

Roy Carman (Reigate) has sent in a very long satellite logging including that of an Hispasat OB link for Canal Plus, France using the 12.591GHz vertical trdr. The Spanish have been advertising surplus capacity on Hispasat and its likely that various outside broadcast/corporate events will be carried from the 30°W Hispasat slot.

The new Intelsat 704 at 66°E can now be received across much of the UK albeit rather low on the South Eastern horizon. **Ian Waller** (Lincoln Satellite) has received strong signals at 11.479, 11.518, 11.695GHz horizontal - though being digitally compressed no pictures can be seen! These downlink signals are ex Orbit International, Rome and comprise nearly 12 TV channels covering much of Europe and the Middle East. Ian previously was very active with C Band (4GHz) reception using a large dish, unfortunately this was spotted by a planning committee member, the result was a retrospective planning permission refusal and Ian fought this decision at appeal, he is awaiting the results of that case, we wish him well.

Transponder Bulletin

TRANSPONDER is an up-to-date satellite news bulletin published fortnightly giving an accurate rundown of the latest sightings in the Clarke Belt and of current news events in the world of satellite. Contributors generally are using small dishes and reports therefore reflect

what most readers can be expected to achieve given the one main ingredient of all hobbies - the time! A highly recommended and respected publication, it costs £48 annually in the UK from 'Transponder', PO Box 112, Crewe, Cheshire CW2 7DS, Tel: (01270) 580099 or Fax (01836) 635510. Send £2 for a sample.

Orbital News

Eutelsat aren't having a wonderful time this year with yet further delays to the launch of their Hot Bird 1 by Arienspace Flight 71 and at the time of writing a 3rd launch date was being discussed. At least the Eutelsat public relations department have the right idea, a pre-launch party for the 'trade' was held in Manchester mid March recently! Something that DID launch successfully was Intelsat 705 which is slotting at 50°W offering both C and Ku band downlinks (4 and 11GHz bands). This far West slot gives coverage over all the Americas with numerous customers booked from South America, if you're lucky enough to have a clear view towards the south-west then check out this craft for some perhaps exotic test patterns and news feeds.

The new Intelsat 704 bird has now opened service from 66°E with digital compressed programming for the Rome based 'Orbit Communications'. Offering 51dBW signal levels on 2 spot beams - one being across Europe and the UK - good quality reception is possible using a 900/1000mm dish provided there is a clear view to the south-east - and of course that there are conventional analogue TV signals present.

Compressed signals monitored by **Ian Waller** (Lincoln) are at 11.481, 11.495, 11.516, 11.675GHz horizontal though digital compression will not display pictures on a standard TV.

Things that go bang in the night typified the fated Apstar-2 satellite, it and the launch rocket exploded on take-off and witnessed by viewers to China's 1st programme network. Apstar-2 was fully booked with many C Band broadcast customers who are now scratching around for other downlinking capacity. Speaking of the explosion, PanAmSat vice president said "We don't call it a crash. We call it a launch anomaly". A rather loud bang for a 'launch anomaly'! Some media pundits herald the setback as a step forward for the arrival of digital compression, but India's Doordarshan are known to have offered capacity on Insat 1B and the Russians are also shuffling forward waving capacity to let on their new Express 6 bird.



Apstar-2 goes bang on Chinese network TV.



Intelsat K @ 21°W downlinks a video package for the next day's GMTV programme.



The Liverpool Maritime Museum, the end of the Jason Project, here Professor Robert Ballard intros a camera on the volcano slopes in Hawaii, the large screens are for public viewing in the main hall.



Telecom 1C @ 3°E (12.606GHz V) was used for numerous satellite feeds during the World Figure Skating Championships 1995 ex. NEC.



A self explanatory test card via the new Orion Atlantic bird at 37°W.

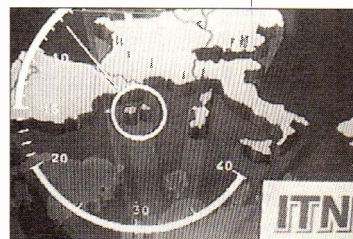

Both ITN and the BBC regularly use Orion, signal levels in the UK using a 900mm dish are high and easy to receive.

SUMMER 1995 CATALOGUE

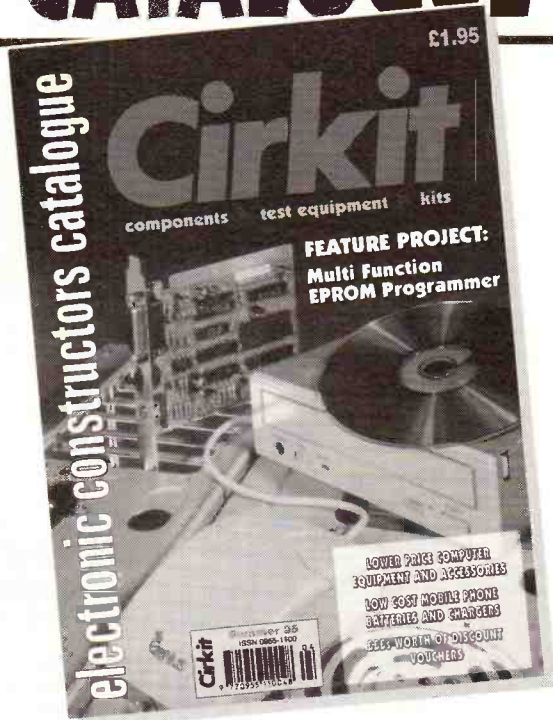

The Summer '95 edition has 280 pages packed with over 4000 products and now with news and features including a full construction project.

- ▶ The computer section is greatly increased with new ranges of equipment and accessories for PCs including:
 - Mother boards, CPUs and SIMMs
 - CD ROM drives and hard drives
 - Sound cards, I/O cards, disc drive cards and video cards
 - Mice, trackerballs and joysticks
 - Power supplies and cases
- ▶ Feature project for an EPROM programmer
- ▶ New 20MHz 'scope from Leader, training systems from Flight and an extended range of mobile phone batteries and accessories from Uniross
- ▶ Latest addition from Velleman kits including a video digitiser card
- ▶ 280 pages, 26 sections, over 4000 products from some of the worlds finest manufactures and suppliers
- ▶ Available at most large newsagents, from 13th April, or directly from Cirkit
- ▶ **Send for your copy today!**

£1.95
+ 30p p&p

Cirkit



Cirkit Distribution Ltd

Park Lane · Broxbourne · Hertfordshire · EN10 7NQ
Telephone: 01992 448899 · Fax: 01992 471314

MOMENTUM COMMUNICATIONS

FOR THE SERIOUS UTILITY LISTENER WITHOUT A COMPUTER

MCL 1100 DATA DECODER
From **£255.00**



Optional Monitor

STANDARD FEATURES:

- SMARTLOCK system for easy tuning.
- Full screen of readable text with on-screen tuning indication.
- Automatic decoding of RTTY, CW, FEC (NAVTEX) and ARQ.
- Auto or manual selection of transmission speeds.
- Extremely rapid lock onto signal.
- Connection for a parallel type printer.

"Overall the MCL-1100 Easyreader and Starter pack proved to be very compact and effective decoding system."

Mike Richards, SMW, May 1994.

★ **NEW UPGRADE AVAILABLE** ★
meteo modes-synop/temp/pilot/airep

ZCZC 905
ULUKO EGRR 05786 KINGDOM
TTCC 56053 383
76543 89654
15869 2654 FLIGHT No. 437
03256 909: 10 UTC
56987 000 FEET
01 000 TO 153 SYNOPTIC REPORT E
700 TIME 0830 UTC DUTCH STATION
TO COVER 1/8TH CUMULONIMBUS
PRESSURE 1008.1 MILLIBARS
AIR FRANCE FLIGHT No. 634143
POSITION 6IN 020W E 1
FLIGHT LEVEL 33000 634143
AIR TEMP -48°C 53257632
WIND 15 DEG 10 68907 0

PHONE HOT-LINE FOR DETAILS



01384 896879



6 & 7 Clarkson Place, Dudley Road,
Lye, West Midlands DY9 8EL

SSB Utility Listening

HF Sideband

Thank you for all your letters requesting copies of the new ITU Region 1 'Off-Route' frequencies. I was quite surprised to receive so many requests, it took a while to clear the backlog. Over 60 letters were received within a week, which is ten times my normal postbag!

Some were delayed as they had the wrong address, and some were addressed to a 'Mr. Turner'; since they contained s.a.e.s and a request for a frequency list, I guessed that they must have been for me! Unfortunately, very few of the letters contained copies of your logs, and only a few took the opportunity to ask questions. I have a few more ideas for listings that I may make available later in the year, but they will probably only be available to those who send me a copy of their own loggings, so you had better start recording those details now!

ICAO

I am surprised that nobody has written to ask what has happened to all the German ICAO airfield codes. These codes are used in flight-plans and all sorts of aviation documents, they are also used by pilots. When East and West Germany combined a few years ago, airfields kept their old ICAO designator; East German airfields were 'ETxx' and West German airfields were 'EDxx'. Now that they are one country, it made sense for them to be reorganised. From January 5 1995, all German military airfields are in the range 'ETxx' and all German civil airfields are in the range 'EDxx'. The third letter is used to indicate the user of the airfield; those 'EDDx' are international airports, those 'EDUx' are British military airfields, and so on.

These new codes have been in use for a few months now, they are being used on USAF GHFS frequencies by US aircraft flying to Germany, and by RAF aircraft operating to Germany on the RAF 'Architect' frequencies.

WUN

Many people these days have access to computers, and almost everybody must have heard about the 'Information Superhighway' (what an awful phrase).

A number of utility listeners recently formed a group on the Internet known as the 'World Utility Network' (or 'WUN'). This group was

as a result of the demise of the SPEEDX group, which used to produce a monthly newsletter for Utility listeners. The new group is also producing a newsletter, but it is designed for distribution across the Internet and other electronic methods. The first 'issue' appeared during February, and makes very interesting reading. One of the benefits of subscribing to this group is that you receive regular (i.e., almost daily!) updates and information from listeners all around the world.

So, how do you join the group? If you are already active on the Internet, just send a simple message to 'majordomo@phoque.info.uqam.ca' containing the text 'subscribe wun'. That's all it takes, and there are no subscription fees to pay. Within a few days you should start to receive regular messages from the group. The messages that I have seen so far vary from callsign lists for Russian ships, to questions about a 'time' station on 4.625MHz, to loggings from all around the world.

There are plans to make paper copies of the news-letter available, but the only address that I know of is in the USA. The group's newsletter also appears on FidoNet, so if you use any BBS, I would suggest that you send a message to the SYSOP asking if they will subscribe to FidoNet.

Your Letters

Barry S from the West Midlands wrote enclosing a tape-recording of San Francisco ATC, and included a written transcript of the tape. I have tried a few times to hear signals from that part of the world, but I have not had any luck. His letter explains that the recording is from 5.574MHz between 1500 and 1600UTC, which is around local sunrise on the west coast of the USA.

Although his recordings were from late December, I didn't receive the tape until early February; as soon as it arrived, I tried listening to 5.574MHz one afternoon, and there beneath the noise was the distinctive chimes of a Selcall, followed shortly by San Francisco ATC working a United Airlines flight going to Hawaii.

Kenneth P from Exeter writes asking for advice on which frequencies to hear VOLMET broadcasts from Paris. I have looked through quite a few books, but I cannot find any broadcasts actually coming from Paris, but Shannon

VOLMET covers the Paris airports in its broadcasts at 15 and 45 minutes past each hour. Does anyone have any further suggestions?

Stan Bethel wants to hear from somebody who is using one of the SELDEC Selcall decoders mentioned in the August 1994 issue. He is thinking of buying, but wants to get some further opinions on the unit. Is there anybody using one of these units who can pass-on their opinions - don't worry, I'll send your comments on to Stan, I won't print them in *SWM*.

D C Stewart writes to ask where he can get hold of a copy of either the *Canadian Forces Flight Supplement*, or the *USAF Flight Information Handbook*. I mentioned these in the February column, and he would like to get copies for himself. Unfortunately, I do not have an answer for this question; my copies arrive quite anonymously with a brief note saying 'I hope this is of use?', but I have never found out who my anonymous benefactor is! There used to be a company in

the USA who sold them, but I did hear that they went out of business. If anyone can offer any advice, it would be appreciated.

Now Hear This...

Once in a while, it is nice to be able to report some future event that will be of interest to utility listeners. You are all aware that many Space Shuttle missions now include some form of amateur radio experiments, and these missions can usually be followed on h.f. courtesy of several US stations who re-transmit the audio directly from NASA.

During June or July, a Shuttle mission is planned that will link-up with the Russian MIR orbiting space-station, so this is an ideal time to hear live commentary from space. Even better, for those readers in the UK, the orbit of the MIR space-station comes over the UK a few times each day, so you also have the opportunity to actually see it if the weather conditions allow it.

Traffic Log

(all frequencies are MHz u.s.b., unless stated; times are UTC)

- | | |
|--------|---------------------------------------------------------------------------------------------------------------------------------------------------------------------------------------------------------------------------------------------------------------------------------------------------------------------------------------|
| 2.182 | (6/3/95, 22.53) GK YQ/HMS <i>Fearless</i> calling Wick Radio requesting a frequency for some 'phone-patches. Wick said to QSY to 'Channel A' (2.006/2.751 ship/shore). |
| 5.670 | (4/3/95, 17.15) Indonesian 9912 working Madras ATC with a position report. Also heard were Singapore 322, Singapore 404 and Iran Air 841. Is this a new Madras ATC/SEA-1 frequency, I have not seen it listed anywhere; this frequency is also used by Portishead - I wonder if it causes problems? |
| 8.331 | (25/2/95, 21.45) Station 'OS' requesting station 'P6G' to intercept Track 5740, and to instruct the vessel to slow to 5 knots. Station '0VM' also working 'OS' reporting Track 5716 vessel 'Miava' had been handed over to the Italian Coast Guard. More Bosnia blockade traffic on a frequency that I have not seen reported before. |
| 8.933 | (28/2/95, 19.47) Springbok 2289 working Johannesburg (i.e., South African Airways Ops) reporting their position, and said that they will make their next call at 2045. |
| 8.989 | (26/2/95, 23.08) NATO 19 (a NATO E-3 aircraft) working Trenton Military. '19' said that they would need a 'phone-patch at 0000, but Trenton suggested waiting until 0015 due to their shift change-over. NATO 19 wanted to try a 6MHz frequency, but Trenton said that 11.265 was a better frequency for them. |
| 9.018 | (21/2/95) SAM 846 working Andrews VIP. '846' reported that they had some unspecified problems, and not be arriving until 1615, they also made arrangements for baggage and transportation on their arrival. Does anyone know any more about this SAM callsign, as this is a new one to me. |
| 9.352 | (22/2/95, 17.50) Station '08T' working 6HD and 7LT, wanting to know 'at what time do you want all stations to go XAI?', to which the reply was 'at 1920'. Almost certainly an air-defence exercise, but on a strange frequency. I have no idea what the 'XAI' code means. |
| 11.265 | (26/2/95, 23.10) NATO 19 working Trenton Military, up from 8.989MHz. Radio checks followed by a personal 'phone-patch to a number in Canada. NATO 19 said that they were 'circling over Bosnia'. |

Scanning

"I'll open this month with greetings to **Anssi Nieminen** of Jyväskylä in Finland who was in touch and sent me a 1994 copy of a Finnish magazine called *Skanneri* - no prizes for guessing the contents of that!

Anssi also writes and informs me that he lives on the Russian border and scans and searches accordingly. Magazine coverage is from 26.065 through to 2500.000MHz. I can't read Finnish, of course, but the magazine is well laid out and tabulated in a presentable way. It seems enthusiast directed, well produced and is - I'm sure - a 'must' for scannerists in Finland. Anssi does, I'm pleased to report, read *Short Wave Magazine!*

Now, help required! **Wyn Davies** of Wrexham requests assistance with the following problem he is encountering with his Bearcat BC 2500XL. His battery pack seems to discharge after 24 hours without the set being switched on! Obviously Wyn, you're using Ni-Cads and it may well be that they have been, at some stage, overcharged and are now 'useless'. That's the obvious answer. However, I'm sure some reader may be able to throw other light on the problem.

Wyn also asks if modifications exist to be able to alter the a.m./f.m. range of the set which is set on certain bands. Wyn does say he bought the set while on holiday in the US. Again, my guess is that the set is designed for the US domestic market and modifications may well help. If you have tried a.m./f.m. switching on this set then please share with Wyn via the column.

John W. Hepburn of Ashington writes in with a cutting from his local paper dated Feb 2 1995. The cutting concerns new equipment for South East Northumberland Police, where they piloted a new encryption system designed to stop eavesdropping by scanner users in an effort to step-up secure communications and present a more confident face to the public.

I did warn you a while back that secure comms systems were coming in. How long before we have it nation-wide? Not, I'll hazard a guess, too long. I can see more law enforcement agencies going over to secure communications - and with the downturn in defence expenditure and subsequent competing for contracts, there are plenty of defence communications experts out there who will be able to come up with some pretty heavy systems that will be beyond amateur expertise in deciphering!

John has a comprehensive set-up at his QTHR consisting of the

following: Realistic PRO-2005, PRO-30, Sony Air-7, Realistic DX-100L, Yaesu FR-50B, Selena Vega and a Maplin Ranger for 160m - which shows he covers both h.f. and v.h.f. plus.

Frequencies Now

A letter from **S. H. Hosegood** of Carshalton in Surrey on railway frequencies quotes the following heard in the South East.

453.55 Croydon Selhurst Depot.
453.900 Unknown.
454.940 Driver talking to Victoria Signal Box.
453.625 Selhurst.
205.800 / 205.950 / 206.100 Speaking Clock.
165.4125 London Underground Control.

456.865 was also heard - being used by the crew filming the popular TV drama *The Bill*.

I've checked through these frequencies myself and BR Engineering are allocated frequencies in Band III with LU active on the following:

165.4625 Central / Jubilee / Northern / Victoria.
165.4375 Hammersmith and City / Piccadilly Line / Metropolitan.
165.4125 Bakerloo / District and Circle.

Some of these frequencies do not appear in the publications available on the market - why defeats me! - so I am indebted to listener's who send in information for inclusion. If it wasn't for you, how would we get by? An insert also appears this month listing BR Trunked Radio Channels - railway buffs should be content with that one!

A letter from **K. L. Jones** of Oswestry asks me if I know frequencies for aircraft that pass over his QTHR. I'd suggest keeping an eye on Godfrey Manning's column - 'Airband' - which is up to date. I have, on occasion, got some of my data slightly out of date when it comes to airband listening and Godfrey's very definitely the man when it comes to up to the minute information! I'd also suggest getting one or two of the many airband publications available through the magazine such as those published by Photavia Press like *Callsign 95* and *Airwaves 94*. They can be contacted at: Photavia Press, 21 Downlands, Pulborough, West

Sussex RH20 2DQ.

Now, a request for help from **Tim Anderson GOGTF** who - as regular readers will recall - produces the excellent 'Amiscan' program for PCs. Tim is considering expanding and asks if readers are prepared to send in frequencies either to him, or via the column. Some criticism has been levelled at Tim for having more South East based frequencies in but, as he points out, the program is really a database program - the frequencies within are a bonus! He plans to separate the database, and produce a second disc - ASCII file type - of frequencies. Amiga and PC versions as before.

Tim suggests that if people from all over the country send in frequencies - of any sort above 25MHz - then he should get a good listing. What's more, frequencies from 25MHz would be welcome. Tim specialises in low band v.h.f. logging and promises to send in E catches through the summer - from as far afield as the US - so we should all see what's been going on during these next few months! If you'd like to assist, contact Tim at: 2 Burry Road, St. Leonards, E. Sussex TN37 6QX. Or, via packet radio on GOGTF@GB7HAS.#38.GBR.EU No 7 Plus files please!

I have used Tim's lists myself - and still do, down here in Oxford and when I/P around the West Bucks area - and find them useful. I agree with his comments that maybe they're not so useful up in Scotland as most of the listings are southern biased but then, many of the frequencies that appear in publications on the market are - in a word - useless! Horses for courses isn't it?

I have some interesting news from **Pat** of E. Yorks, who wrote me an interesting and very informative letter with gen I'm only too happy to pass on. In the December *Scanning* column I reported 141.8925 as being within the airband. Pat points out it isn't but is within the allocation for outside broadcasts. So it is, sorry!

Pat also goes on to say that this band is also used by the Joint Radio Committee fuel and power people - this being a 'new' allocation used by the Gas and Electricity supply authorities in England and Wales. It uses f.m., is trunked, and is spaced at 6.25kHz.

Balloons next. 122.475 (a.m.) is a recognised frequency complementing and not replacing 129.900. Two corrections gratefully received, thanks.

Inter-agency use of sets was brought up by Pat and he reports that Humber Coastguard at their

centre in Bridlington have a Fire Brigade set permanently connected and ready for use. Also that Humber Tugs have a 'duty' tug available for marine fire-fighting and also carrying a brigade radio.

I can verify that some tugs do, indeed, carry sets for brigade work. Some coastal area brigades will work alongside local tug owners for marine fire-fighting emergency work whilst others may be airlifted by the RAF, RN or HMCG helicopters, put aboard by RNLI lifeboat - the means of transport would be many! Communications would, obviously, play a great part and I suspect that hand-helds would be used a lot. I feel sure that I heard whispers that Gwynedd Fire Brigade have marine v.h.f. hand-helds available. With Holyhead being a major ferry port I suspect this is more than just a rumour!

Maxwell Ramirez of Islington asks a very basic question about radio waves. Like, what are they and where does each band start. I'll have to put my theory head on and simplify this! Radio waves are electromagnetic waves - two other examples being light and X-Rays. Travelling at the speed of light (299 792km per second or 186 280 miles per second) they are one million times faster than the speed of sound!

Radio frequencies are rapidly oscillating (varying) electric and magnetic fields - in their most simplest terms - and the rate at which they oscillate is measured in Hertz (Hz) also called frequency. 1Hz = one oscillation per second. 1kHz, therefore, is equal to 1000Hz.

With regard to measurement, the Long Wave (l.w.) comes between 30 - 300kHz, and having a rough range of about 1000km or 600 miles - but subject to atmospheric conditions. Then we have the Medium Wave (m.w.) or Medium Frequency (m.f.) between 300 - 3000kHz (or 3MHz) and with a rough range of about 100km - again, dependant on conditions and with a range increase usually at night.

These are followed by Short Wave (s.w.), at 3000 - 30 000kHz (3 to 30MHz) travelling great distances by bouncing off the ionosphere, which is an atmospheric layer. Of more interest to us is the Very High Frequency band (v.h.f.) that runs from 30 000 - 300 000kHz (30 to 300MHz) and usually travelling line of sight - but again subject to conditions like 'lifts' that can enhance the short range considerably - US stations heard on low v.h.f. in the UK and so on. This is followed by Ultra High Frequency (u.h.f.) at 300 000 -

3 000 000kHz (300MHz to 3GHz or Gigahertz) - signals like TV and so on.

Lastly, we have Super High Frequency (s.h.f.) which start at 3 000 000 kHz (3GHz) and used by satellites and re-broadcasts to earth, for example.

Like I said, very simply put but it should explain where each band starts. Low band v.h.f., by the way, starts around 25MHz or 25000kHz. It's this band that offers fantastic DX potential when conditions are right. I hope this goes some way to explaining what and where the bands are. There are many theory books abound on the market - Newnes and Babani being two good publishers, though lots of titles and descriptions can be had from the *Book Service* to the rear of the magazine.

Lastly

Regular readers of the magazine will have seen the statement from the Radiocommunications Agency on scanners and the law in the March *SWM*. I trust that each of you have written for a copy of their *RA 169 - Receive Only - Scanners, etc.* leaflet? If you haven't - do so now.

I maintain that scanning is an illegal hobby, but that, with care and consideration, we can continue to

monitor if we keep it low key. I'll also state - again - that I will NOT publish frequencies sensitive, controversial or to do with stuff that could be secret - like cellphones and so on, police frequencies and Customs, Immigration and the like. The answer as to why is clearly contained in the leaflet that you can get, free of charge, from: Licensing Section, Radiocommunications Agency, Waterloo Bridge House, Waterloo Road, London SE1 8UA.

To put it in a nutshell, ASPECTS OF SCANNING IS ILLEGAL - but, with care and attention and a little bit of common sense, we can enjoy what we have within limits prescribed by law. If this angers those people who think that I should go ahead and publish then I make no apology. It would be me who'd get prosecuted - and would those who want frequencies published pay my fine? I don't think so! We can maintain what we have if we are careful - and up to now we've done that. Let's keep it this way and not get stupid over something all of us want to see continue.

That about wraps it up again for another month. Keep sending in your news, views, criticisms, comments and frequencies to me for onpass. In the meantime, keep on logging and catch you all down the log next month.

British Rail Trunked Radio Channels

Channel Code	DTI Ch. No	TX	RX
1T	349	204.850	196.850
2T	353	204.900	196.900
3T	357	204.950	196.950
4T	361	205.000	197.000
5T	365	205.050	197.050
6T	369	205.100	197.100
7T	373	205.150	197.150
8EW	377	205.200	197.200
9EW	381	205.250	197.250
10EW	385	205.300	197.300
11T	389	205.350	197.350
12T	393	205.400	197.400
13T	409	205.600	197.600
14T	413	205.650	197.650
15E	415	205.675	197.675
16T	417	205.700	197.700
17C	419	205.725	197.725
18T	421	205.750	197.750
19T	425	205.800	197.800
20C	428	205.8375	197.8375
21T	429	205.850	197.850
22T	433	205.900	197.900
23T	437	205.950	197.950
24T	441	206.000	198.000
25C	443	206.100	198.100
26T	453	206.150	198.150
27C	461	206.250	198.250
28T	465	206.300	198.300

C = Control.
T = Traffic.
E = Emergency.
EW = Early Warning.

PHOTAVIA PRESS ANNOUNCE AIRWAVES 95

THE SECOND EDITION OF THE UK'S MOST COMPREHENSIVE AND UP TO DATE HF / VHF / UHF AVIATION FREQUENCY DIRECTORY

AIRWAVES 95



THE COMPLETE HF / VHF / UHF AVIATION FREQUENCY DIRECTORY
PHOTAVIA PRESS

WE HAVE ADDED A SERIES OF NEW MAPS SHOWING UK TRANSMITTER SITES, UK AREA RADAR SECTORS AND FREQUENCIES, MILITARY TACAN ROUTES, PLUS MAJOR AIRWAYS AND REPORTING POINTS. THE EXTENSIVE CHANGES TO THE LONDON CONTROL TMA / SECTOR FREQUENCIES HAVE BEEN FULLY INCORPORATED INTO THE MAIN TEXT AND MAPS

TO KEEP THE READER UP TO DATE, AIRWAVES 95 IS SUPPLIED WITH AN UPDATE SHEET OF THE LATEST TOPICAL FREQUENCY INFORMATION

AIRWAVES 95 - PUBLISHED 10th MAY 95
UK PRICE £ 7 - 95 - EEC & EIRE £ 8 - 95

ATIS - RADAR - TOWER - VOLMET - GROUND APPROACH - AIR TO AIR - AREA RADAR - AFIS AIR REFUELING - AIRLINE OPERATIONS - STUDS SSR SQUAWK CODES - AIR / GROUND - RANGES GROUND OPERATIONS - AEROBATIC TEAMS UK & EUROPEAN CIVIL / MILITARY AREA RADAR SPACE SHUTTLE - AIR DEFENCE RADAR

IN TOTAL, THERE HAVE BEEN OVER 700 FREQUENCY ADDITIONS & AMENDMENTS SINCE THE FIRST EDITION. ALL SECTIONS OF AIRWAVES 95 HAVE BEEN COMPLETELY REVISED AND UPDATED WITH THE ADDITION OF A VARIETY OF NEW INFORMATION. SOME SECTIONS HAVE BEEN REFORMATTED FOR EASE OF REFERENCE.

THE HF SECTION HAS BEEN COMPLETELY UPDATED INCLUDING THE ADDITION OF OVER 450 NEW FREQUENCIES. THIS INCLUDES, THE NEWLY REALIGNED US MILITARY HF GLOBAL NETWORK. PLUS CHANGES TO MOST SECTIONS, INCLUDING THE MAJOR WORLD AIR ROUTES, DOMESTIC, AND AIRLINE COMPANY FREQUENCIES.

CALLSIGN 95

THE MILITARY SECTION CONTAINS OVER 5300 CURRENT AND HISTORICAL TACTICAL CALLSIGNS. THE INFORMATION INCLUDES, CALLSIGN - AIRCRAFT TYPE - AIRARM - CODE UNIT or SQUADRON - HOME BASE - PLUS OTHER RELEVANT INFORMATION.

THE MILITARY SECTION NOT ONLY LISTS AIRCRAFT CALLSIGNS, BUT ALSO COMMAND POSTS, GROUND STATIONS AND OTHER MILITARY RELATED BASE STATIONS. THERE IS ALSO DETAILS OF RAF THREE LETTER TRI-GRAPH CALLSIGNS, AND FOR CERTAIN CALLSIGNS A NUMERIC ANALYSIS RELATING TO SPECIFIC TYPES, UNITS AND AIRCRAFT.

THE CIVIL SECTION LISTS ALPHABETICALLY, ALMOST 3000 CALLSIGNS IN CURRENT USE WITH AIRLINES, HANDLING AGENTS, GOVERNMENTS AND OTHER OPERATORS, FROM OVER 180 COUNTRIES. THE INFORMATION INCLUDES, CALLSIGN - 3 LETTER ATC PREFIX - AIRLINE OR OPERATOR AND COUNTRY OF ORIGIN.

CALLSIGN 95 / UK PRICE £ 7 - 95 / EIRE & EEC £ 8 - 95
TO KEEP THE READER UP TO DATE, CALLSIGN 95 IS SUPPLIED WITH AN UPDATE SHEET OF THE LATEST TOPICAL CALLSIGN INFORMATION

COMING SOON - AIRWAVES EUROPE

A DIRECTORY OF THE CIVIL AND MILITARY VHF / UHF AVIATION FREQUENCIES OF 19 EUROPEAN COUNTRIES. AUSTRIA, BELGIUM, BOSNIA, CYPRUS, DENMARK, FINLAND, FRANCE, GERMANY, GREECE, ITALY, LUXEMBOURG, NETHERLANDS, NORWAY, PORTUGAL, SPAIN, SWEDEN, SWITZERLAND, TURKEY AND YUGOSLAVIA. CURRENTLY SCHEDULED FOR PUBLICATION IN JUNE, PRICE TO BE ANNOUNCED.

CALLSIGN 95

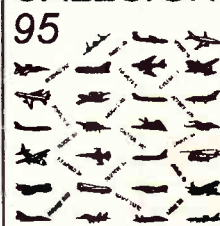

THE CIVIL AND MILITARY AVIATION CALLSIGN DIRECTORY
PHOTAVIA PRESS

ALL PRICES INCLUDE P & P / CHEQUES / EUROCHEQUES / IMO's / POSTAL ORDERS PAYABLE TO PHOTAVIA PRESS
PHOTAVIA PRESS (Dept SW) - 21 DOWNLANDS - PULBOROUGH - WEST SUSSEX - RH20 2DQ
TEL : 01798 - 872100 Email : airwaves@photav.demon.co.uk

Airband



The author in an Antonov AN-2 Christine Mlynek

A convention that baffles many newcomers is the omission of the least significant digit of v.h.f. airband communications frequencies. For example, **Jason Downing** (Redditch) investigated 126.92MHz that was tuned in by a receiver during a flight (see February 'Airband'). Jason is quite correct that this is Woodford's Tower, but I can't explain why a commercial flight over northern France would need it - and it would probably be out of range, anyway. Of course, the exact frequency is really 126.925MHz but, since the channel spacing is 25kHz, the final digit is usually assumed and not quoted when tuning airborne equipment. Ground-based receivers, on the other hand, may require the full frequency and it's up to you to tag the final 5kHz digit on if necessary.

Your Experiences

A friendly RAF contact from Oxford tells me that fewer Grob 109s will be based at Halton once 612 Volunteer Gliding School moves to Abingdon, leaving 613 School behind. The good news is that 612 School will expand to 5 aircraft, the bad news being that the similar operation at Kenley will close, but their instructors should be distributed among the remaining two schools.

Hardware

Certain upper airways frequencies are likely to be assigned 8.33kHz channel spacings (see December *Airband*). Both **George Tillett G3KXP** (Hornchurch) and **Roger Syrratt** (Buckingham) have more information. Possible implementation date is January 1 1998 and one of the causes is the growth in the number of nations!

Every time a bit of the old Eastern Bloc declares independence it also has to 're-invent the wheel' and set up its own flight information region. Replacing voice by data would be an alternative solution. Whichever way, it's going to cost money all round and the airlines need to trade off the price of new equipment versus the financial penalty of not being allowed along certain routes due to inability to communicate.

Follow-Ups

If this column can make a contribution to flight safety then its educational value will be enhanced further. A recent subject has been the

use of electronic equipment in flight by passengers: can interference be caused to navigational systems? Refer to *SWM 'Off The Record'* October 1994 page 74 and January 1995 page 63, as well as this column last month ('Information for Passengers'). My attention is drawn to NASA safety reports by an article in *The Log* (February/March 1995, 'Safety Reminders'). Out of 40 reports in which passengers' electronic devices affected aircraft systems, three are studied in detail.

Deviations from a v.o.r. track were traced to either a portable radio (with headset) or a cellular telephone (that was claimed to have been unused), although exactly which of the two was responsible was not determined. The equipment owners did not respond to cabin announcements to turn their apparatus off, so perhaps it did not register with them that they could cause interference. In another instance, the electronic flight instrumentation screens blanked when a portable radio was switched on.

Finally, the compass deviated during operation of a lap-top computer, the cause of which was verified by turning the computer off and back on a number of times. The main compasses on an airliner have electronic sensors (flux gates) in the wing-tips. The familiar magnetic compass is available to the pilots for emergency purposes and initial cross-checking only. I'm sure that readers of this magazine won't become an inadvertent menace themselves!

ACARS

Under 'Hardware' in last month's column I mentioned how much interest there now is in this system. The facility allows aircraft to communicate with their operating companies by v.h.f. data link; some of the messages (e.g. time of take-off) being sent automatically. Heard on a normal receiver, ACARS messages sound like quick bursts of noise but computer software is available to decode the noise into readable characters.

I complained that the Lowe Airmaster decoder seemed to stop short, as the characters still didn't read as plain text. Further decoding would be necessary. **Ray Whiting** (Harefield) has been trying to do this, referring to a decoding book whilst watching a sales demonstration of the system. One problem is that each company adopts a different format for some of



Control tower & fire station at Cranfield

Christine Mlynek

the messages; having encrypted them in the first place, they don't want their rival airlines to eavesdrop! It seems to me that there will be limited value in decoding ACARS and any potential purchasers should consider the cost-benefit equation before buying.

Ray says that Concorde will eventually be equipped with ACARS - once they prevent the antennas from breaking off! As it already has other reliable v.h.f. antennas I'll hazard a guess that this problem will only be short-lived.

Roger Preston (Rickmansworth), PPL holder, understands the marketing game and wonders if owners will be asked to upgrade (at a price!) when an enhanced ACARS decoder eventually comes out.

Scotty (Tonbridge) points out that 130.025 and 131.475MHz are available for ACARS mainly in North America. In addition to the usual 131.725 in the UK, I did read that British Airways were operating on 131.55MHz but I don't know if they continue to do so.

Information Sources

Roger Preston invites you to the London Society of Air-Britain where there will be a talk about Northolt's 32 Squadron (Royal Flights) on Wednesday June 14 starting 1900, at The Victory Club, 63-79 Seymour Street, London W2. Admission is £4.

The Aviation Hobby Centre (1st Floor, Main Terminal, Birmingham International Airport B26 3QJ, Tel: 0121-782 6560) publish *The Airband Jargon Book* that contains simple descriptions of aeronautical equipment and facilities. The cover price is £6.95 and it weighs just less than 120g (for postage purposes). I regret that, due to pressure of time, I won't be able to review any books in the near future but I hope to report on it eventually.

If, like **Pat Bracken** (Glasgow) you have access to French publications then try *Megahertz*

which (I translate) is the 'Monthly meeting place for the communications enthusiast'. Cover price is 27 Francs (*SWM* is better value!). There is some aeronautical coverage from which I learn that France is divided into five Flight Information Regions and Lower Airspace is defined as below FL195.

Those with a military bias (why is it always USAF?) you'll appreciate *Signet* and *Logbook* from the Black Cat Aviation Group (19 Crescent Road, Hunstanton, Norfolk PE36 5BU). *Logbook* costs £6 (with UK postage) for 12 issues.

Over to Ireland now and Aircorn Communications (Broomfield, Malahide, Co. Dublin, Tel: 00-353-1-846-3349) produce the *Irish Airband Listening Guide* at IR£6.50 including (inland?) post. Beware that advice on listening to cellular telephones is inappropriate in countries such as the UK and the current update doesn't show the extended band (up to 137MHz). The v.h.f. marine distress channel is 156.8MHz (misprinted on P.27). A useful summary for residents in/visitors to the Republic.

Airtime Publishing (13 The Hollows, Long Eaton, Nottingham NG10 2ES) produce their summer timetables again. UK costs £11.95, Heathrow & Gatwick £5.20 and Frankfurt & Dusseldorf £5.95; all post free (inland).

Close to St. Mawgan, **W. Vincent** asks about information sources. Start by sending a stamped, self-addressed envelope to the Broadstone editorial office to request the *Airband Factsheet*. Use this to contact the regular suppliers of official information. For starters, I recommend the *Aerad En Route Supplement Europe & Middle East* as well as the charts EUR 1/2 and H201/202. These show reporting points such as MERLY out in the Bristol Channel half-way between Land's End and Pembroke. Note that I can't supply the Factsheet myself and that all replies are in this column, never direct.

Up-to-date frequency changes



Jodel D.120

Christine Mlynec

are promulgated by *NOTAM*, an expensive facility that I can't afford but which might be on display at your local airfield or flying club. Do ask before inviting yourself in!

Frequency and Operational News

W. Vincent is close to one of Concorde's fixed routes and supplies some of the applicable frequencies: LATCC 126.075 and 132.8MHz. The company frequency of 131.9MHz remains unchanged as far as I know. The Atlantic crossing is controlled on the same h.f. channels as other aircraft. On our side, Shanwick consists of controllers at Prestwick linked to

radio operators at Shannon. My information is that the link is by land-line teleprinter so **Geoffrey Rees** (Neath) can forget about 'hacking' in to it! Besides, the information is exactly the same as sent/received by the Shannon operator.

Heathrow has had two ground movements frequencies available for some time, but now Ray Whiting notes that the northern parallel runway is controlled on 121.9 whilst the southern one is handled by 121.7MHz.

In the Cockpit

Continuing from last month, here's more about the Automatic Direction Finder (ADF) that picks up signals

Abbreviations

ACARS	Aircraft Communications Addressing & Reporting System
FL	flight level
g	grams
h.f.	high frequency
kHz	kilohertz
LATCC	London Area & Terminal Control Centre
MHz	megahertz
NOTAM	NOTice to AirMen (includes AirWomen)
PPL	Private Pilot's Licence
v.h.f.	very high frequency
v.o.r.	very high frequency omni-directional radio range

from Non-Directional Beacons (NDBs). Two antennas are needed. The first has precise directional properties, conventionally consisting of a loop like a big coil of wire. This can be rotated until the minimum received signal (the null) is obtained and, from the direction in which the loop is now pointing, a line can be plotted along which both the aircraft and NDB lie.

Where's the catch? The loop is incapable of determining which way along the line the beacon lies. Say the loop gives a null when pointing roughly left-to-right at right-angles to the aircraft's path. Where's the beacon? Is it left of the aircraft, or is it to the right? An error here would result in the pilot flying in exactly the opposite direction to that required! A simple sense antenna (usually a straight wire) resolves the ambiguity

when the phase of the signal on the two antennas is compared. That's how the pointer on the RMI instrument (see last month) can be driven in exactly the right direction.

These days, loops aren't mechanically rotated but two loops at right-angles are sensed electronically. They're often found above the fuselage, near the front, in quite discreet bumps. The sense wire is plainly visible on some aircraft types. Next time: how the ADF helps in flight.

The next three deadlines (for topical information) are May 12, June 16 and July 14. Replies always appear in this column and it is regretted that no direct correspondence is possible. Genuinely urgent information/enquiries: 0181-958 5113 (before 2130 local please).

INTELLIGENCE SERVICES NACHRICHTENDIENSTE

on CD-ROM • £ 55 or DM 120.-

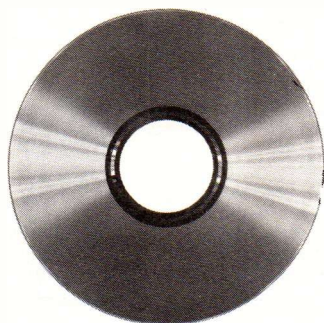

The only up-to-date and comprehensive survey available today - published **February 1995!** Excellent country portraits and analyses of more than 200 intelligence services worldwide, covering: *English texts*: global analysis; Armenia, Azerbaijan, Georgia, Hungary, Ireland, Kazakhstan, Kyrgyzstan, Poland, Romania, Tajikistan, Turkmenistan, United Kingdom, and Uzbekistan. *German texts*: global analysis; Albania, Austria, Belarus, Belgium, Bosnia and Herzegovina, Bulgaria, Canada, Croatia, Czech Republic, Denmark, Estonia, Finland, France, Germany, Greece, Italy, Japan, Latvia, Lithuania, Luxembourg, Macedonia, Moldavia, Netherlands, Norway, Portugal, Russian Federation, Serbia, Slovakia, Slovenia, Spain, Sweden, Switzerland, Turkey, Ukraine, United Kingdom, United States of America, Vatican, and supranational organizations. More than 1300 pages on one compact disk for PCs with DOS™ or Windows™, or Macintosh's™. For overseas airmail add £ 2 / DM 5. Please fax or mail your order to ©

Klingenfuss Publications

Hagenloher Str. 14 • D-72070 Tuebingen • Germany
Fax ++49 7071 600849 • Phone ++49 7071 62830

26 Clarendon Court • Winwick Quay
Warrington • WA2-8QP
Tel (01925) 573118



For years the Microreader has been one of the most successful and widely used decoders in Britain and has opened up the world of utility decoding for thousands of listeners and hams. With the Microreader you don't need computers, monitors or any special equipment simply plug into your speaker socket and turn on. What could be simpler? But don't be fooled by it's small size and low price, the Microreader is powerful and can match the performance of other big box units. The built in tutor has helped hundreds to learn to read and send CW perfectly. The latest version 4.2 firmware is the result of listening to what people want and expect from a decoder and combines ease of use with the highest ever level of performance. When you buy a Microreader not only do you get a full two years guarantee you get access to help assistance from a company committed to 100 percent customer satisfaction. The Microreader comes complete with leads, easy to read instructions, frequency list and you want to display the decoded messages on a computer screen. Please call or write for more information as space limits a full description.



**MkII (V4.2)
MICROREADER
£199.50**

SYNOPTIC DECODER

This is the easy way to translate the five figure code groups from the many meteo weather stations around the world into plain and readable English. No more books and tables, reports from aircraft, ships and land station are translated instantly and in full detail. How thick is the fog on the Tyne? What is the cloud type in New York? Transmissions from Bracknell are intended for the M.O.D. but you can decode them together with similar data from around the world. Works in conjunction with the Microreader or with any other decoder equipped with a serial RS232 output. Decoded messages can be displayed on home PC, dumb terminal or printed using a serial printer. Write or ring today for more information together with example print-outs.



£99.50

**MkII Microreader £199.50
Synoptic Decoder £99.50
Computer Terminal Program £10.00
Upgrade old MkII Microreader £20.00**

ALL PRODUCTS GUARANTEED FOR 2 YEARS & PRICE INCLUDES VAT & DELIVERY
UPGRADES £20.00 | TERMINAL PROG £10.00 |

GREAT RADIO BOOKS

Eavesdropping on the British Military

For the first time a book has been published showing how to monitor British Military communications. Listen into Royal Navy's UKMACCS, RAF Air Defence Systems or the British Army. Giant frequency list cover VLF, LF, MF, HF, VHF, UHF and Skynet, plus the largest British military callsign list ever published. There is no other book like it!

Price £17.50 + £1.25 UK post. Add £2 Europe & sea, or £5 airmail.

The UK Scanning Directory

4th Edition - Lists over 20,000 Spot Frequencies

Here is the book every scanner owner has been waiting for! Listing over 20,000 spot frequencies 25MHz - 1.8GHz, remains the biggest and best guide, and covers utilities, security, telephones, military and lots more we dare not mention!

Price £17.50 + £1 UK post. Add £2 Europe & sea, or £5 airmail.

Scanner Busters

How to Tune into More Frequencies and beat New Technology

Police scrambling new trunked radio systems and encryption are making it harder to eavesdrop on conversations. *Scanner Buster* shows how to deal with these systems. PMR, digital telephones and the Emergency Services.

Price £4.95 incl. UK post. Add £1 to Europe & sea, or £1.50 airmail.

Monitoring the Yugoslav Conflict - 3rd edition

Latest frequencies and information to help you tune into the war and peace keeping forces. Also includes telex circuits, UNHCR, Red Cross, aircraft enforcement, relief flights, British and French Forces, etc. keeping you in the thick of the action.

Price £4.95 incl. UK post. Add £1 to Europe & sea, or £1.50 airmail.

Grove Shortwave Directory - 8th edition

Every imaginable HF frequency listed worldwide, including maritime, aeronautical, governments, embassies, space, broadcast feeders... they are all here, authoritatively identified and currently verified. Plus the most comprehensive and up-to-date US forces listings.

Price £18.75 incl. UK post. Add £3 to Europe & sea, or £5 airmail.

Intercepting Number Stations.....	£9.95	Intercepting Numbers Stations.....	£9.95
International Callsign Handbook.....	£18.50	Monitoring Times.....	£3.75
Computerised Radio Monitoring.....	£19.50	Satellite Times.....	£3.75
Audio Guide to SW Sounds.....	£4.95	Prices incl. UK post. Overseas post extra	

Ask for FREE Catalogue of all books

Allow 14 days delivery

INTERPRODUCTS (S55)

8 Abbot Street, Perth PH2 0EB, Scotland

Tel. & Fax: 01738 441199



RadioSport-RSGB Events, 1995

Make a note of this in your diary!

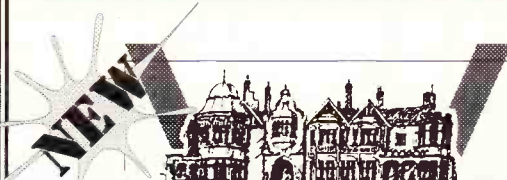

BLETCHLEY PARK AMATEUR RADIO & COMPUTER RALLY

- Large Trade Presence
- Special Interest Groups
- Radio & Computer Museum
- Working Y Station
- Priority admission for disabled
- On-demand Morse Tests
- Talk-in on 2m & 70cm
- Giant Bring & Buy sale
- Lectures
- Churchill Memorabilia
- Military Uniform Display
- Firearms Display
- Vintage Vehicle Display
- Crashed Aircraft Display
- ENIGMA Cypher Machine Display
- Cinema Projector Display
- Catering
- One-price Admission to Rally and Museum

Bletchley Park, Bletchley, Milton Keynes, Bucks
Saturday June 17th & Sunday June 18th



The County Showground,
Weston Road, Stafford

Saturday August 19th
& Sunday August 20th

For details contact RadioSport Ltd., 126 Mount Pleasant Lane,
Bricket Wood, Herts, AL2 3XD. Tel 01923-893929. Fax 01923-678770.

GAREX ELECTRONICS

WIDEBAND SCANNERS

All major brands available, with the all-important service back-up from a Company who pioneered the UK scanner market; we are completely independent so contact us for impartial advice.

WIDEBAND SCANNER AERIALS

"REVCON" premium quality British VHF/UHF Discone 16 element for all-round coverage. SO239 connector £38.95 or N-Type connector for improved UHF performance £39.95. "REVCON PLUS" with improved low frequency coverage £48.95. "REVCON EXTRA" ready to go package; discone, 10m co-ax fitted PL259, mast clamps, BNC plug £49.95.

"RADAC" NEST OF DIPOLES

Limited but not equalled. Receive 25-1300MHz, outperforms discones with guaranteed Tx performance on 2m and either 4m or 6m: £69.95. Special VHF/UHF Airband RADAC: 108-136MHz and 220-400MHz £69.95. Custom versions with Tx capability on 6 customer-specified bands in the range 27-470MHz £87.50. Top quality cable and connectors also available.

"NOMAD" PORTABLE SCANNER AERIAL

Lightweight design using ribbon cable elements: rolls into a small bundle for ease of transport, hang from any convenient point, ideal for travelling, with 4m co-ax and BNC plug. £16.95.

SCANNER AERIAL FILTER

Is your scanner useless due to breakthrough? Then this product could solve your problem: a specially designed tunable filter to be fitted in-line with the aerial feeder, reduces breakthrough from strong VHF signals, (e.g. Band II, pagers, police) also includes HPF to reduce SW & MW interference. BNC connectors £27.95.

VHF PREAMPLIFIERS

Miniature (only 34x9x15mm), any frequency in the range 40-300MHz, up to 25dB gain. Assembled, but unboxed pcb. Stock versions: 6m, 4m, 2m, 137MHz (W-Sat) £12.95. Airband (118-136MHz) (reduced gain due to frequency spread) £12.95. Other frequencies in the range 40-300MHz to order: £14.95.

VHF AIRBAND PREAMP 118-137MHz

16dB gain, boxed ready for use, powered by internal battery or external 9-15 volts DC, BNC connectors, £29.95.

VHF MARINE BAND PREAMP 156-162MHz

20dB gain (other details as Airband model) £29.95.

PYE AERIAL RELAYS

12v operation, handles 50 watts up to 200MHz £2.00 5+ £1.60 each.

FLEXIBLE 1/4 WAVE AERIALS

Discover a whole new world of signals: full-length 1/4 waves are several dB better than "rubber ducks". BNC plug. Available for VHF Airband, UHF Airband, 2m, 70cms also other VHF & UHF bands to order. VHF models: £11.95. UHF: £9.95.

Write, phone or fax for lists. Regular lines, components and bargains for callers.

Open 10am-5pm Mon-Fri (occasional Sats)

ALL PRICES INCLUDE UK CARRIAGE AND VAT AT 17.5%

GAREX ELECTRONICS

STATION YARD, SOUTH BRENT, SOUTH DEVON TQ10 9AL

Phone (01364) 72770 Fax: (01364) 72007



SSE HIGH QUALITY ACCESSORIES

THE CHARGER & SCANNER SPECIALISTS

FOR SCANNING MONITOR RECEIVERS

JIM PSU-101

1. JIM PSU-101 MkIV. A high quality UK manufactured fully regulated 220-240V AC power supply with RADIO BASE HOLDER combined. For use with nearly all pocket scanners in the UK (please state radio type) 2DC output sockets one for radio and the other for accessories. Separate DC leads included. A 9 volt version for Tandy, Comtel, Netsat etc available (PSU101TA). PRICE £29.95.

2. ★ NEW JIM PSU-101 MkIVC. Now includes fitted coaxial cable assembly approx 12" long with right angle BNC plug and BNC socket for base antenna connection etc. SPECIAL PRICE £34.95

3. JIM BH-A3. Universal base stand for handheld scanners-transceivers etc. convenient, safe support of radio. Adjustable front stop. Heavy duty chromed base. Bracket for BNC socket for base antenna connection. PRICE £10.95.

*4. JIM BH-A3C. Now fitted as standard with approx. 30cm (12in.) high quality low loss 50 ohm RG58A/CU cable with professional right angle BNC plug and BNC bulkhead socket. Ideal for RX and TX up to 4GHz (no SO239 socket). PRICE £13.95.

5. JIM CH-A4. Car mounting holder for handheld scanners- transceivers with BELT CLIP support. Safe and convenient use of scanner etc. in car, truck, boat etc. PRICE £7.95.

6. JIM BC-4H. Unique FAST Universal 4 hour + 14 hour Ni-cad charger. "auto-switch-off" timer (no more guessing). Ideal Fairmate, AOR, Yupiteru etc. Leads + 4 sizes of AA holders supplied. PRICE £19.50.

7. JIM SM-A1 High quality S meter for scanners CB. SPECIAL OFFER £20.

Payment by postal order or cheque, prices include postages.

Further information on SSE products, send A4 SAE to:

SOLID STATE ELECTRONICS (UK)

6 The Orchard, Bassett Green Village,
Southampton SO2 3NA

Tel: (01703) 769598



NEW PSU-101 MkIVC

Info In Orbit

Recent announcements concerning the future of METEOSAT and the polar orbiting WXSATs provide both interest (in the design of the new equipment scheduled for launch), and concern (regarding the desirability of continued amateur reception). My own view remains positive - I am sure we will learn to cope!

Current WXSATs

For the second time, the American WXSAT NOAA-10 remained transmitting a.p.t. on 137.50MHz during its v.h.f. clash with NOAA-12 in early March. It was belatedly switched off around March 10, but not before the strange effects of interfering transmissions were experienced for several days. NOAAs 9 and 14 continued routine a.p.t. transmissions on 137.62MHz and beacon telemetry on 137.77MHz. NOAA-9 is now effectively in a morning, descending orbit, providing us with well illuminated images around 1030UTC; NOAA-12 passes over around 0645UTC when solar illumination is relatively low. NOAA-14 is the official early afternoon ascending orbiter, providing well-illuminated images a little after midday.

METEOR 3-5 continued routine daylight-only transmissions on 137.85MHz during its north-bound passes. It is a long time since we have seen any METEOR infra-red transmissions!

The puzzle of the month came in a telephone call from **Brian Dudman** of Harrow, who told me that he had heard just two minutes of a.p.t. from a satellite on 137.30MHz - a frequency not heard for many a month. I missed that transmission, but reports elsewhere indicate that the old oceanographic satellite COSMOS 1766 may have briefly operated on February 6 at about 1000UTC.

OKEAN-4 appeared to remain dormant for some weeks after its initial burst of activity, following an autumn launch. I did not monitor any transmissions after early January, until a letter and picture arrived from **Les Hamilton** of Aberdeen. He witnessed a most unusual transmission sequence from OKEAN; on February 26 Les recorded a transmission at 0703UTC - see **Fig. 1** - showing the classic coastline features of Norway. The image shows the number sequence, that represents the operational state of equipment onboard the satellite, and the elapsed time since midnight in Moscow. The same image was re-transmitted on the following orbit, with greater clarity.

Les's Aberdeen home is favoured for OKEAN transmissions; living in the west country and having houses rising to the east, I can only receive OKEAN telemetry when the satellite rises above some 7-10° elevation.

The picture in **Fig. 2** is also from Les; an OKEAN image from March 5 showing microwave, radar and visible-light sections. Les points out that ice can be seen in the White Sea, and that major cities - such as Moscow - show up well in the radar image. Inland waterways can be followed, but unfortunately the visible section is almost completely clouded out. Les uses a crossed-dipole antenna, tilted about 20-30° to the horizontal, pointing virtually due north for OKEAN passes.

For those new to the WXSAT scene, I should explain that the crossed-dipole antenna, phased to receive right-circular polarisation, is one of the most suitable antenna designs for polar weather satellite reception, where picture decoding is planned. Such antennas have a characteristically wide angle of reception, but not quite omnidirectional, so are normally pointed vertically, in which position they can receive signals over a significant section of the local sky. In the absence of interference, horizon-to-horizon reception will be achieved. For those living in a location where there is a good eastern horizon, the antenna can be optimised for easterly passes by tilting it, as Les has done. Les also reports having received excellent NOAA-10 images as the satellite passed near the North Pole. Living in Aberdeen obviously has its advantages! My thanks to Les for these and other interesting WXSAT images - held for a future edition.

METEOSAT - The Future

The METEOSAT Operations Programme (MOP) officially ends on November 30. However, users should not notice anything unusual at one minute past midnight because the METEOSAT Transition Programme (MTP) follows immediately. This programme continues until the end of the year 2000, when METEOSAT Second Generation (MSG) operations commence. For beginners, it might be helpful for me to summarise the present situation.

METEOSAT-5 is a geostationary WXSAT (weather satellite) that transmits a considerable amount of varied data. If you buy or construct suitable equipment, you can receive WEFAX (weather facsimile) images. You need either a dish or Yagi for

**Fig. 1: OKEAN-4
February 26 from
Les Hamilton.**

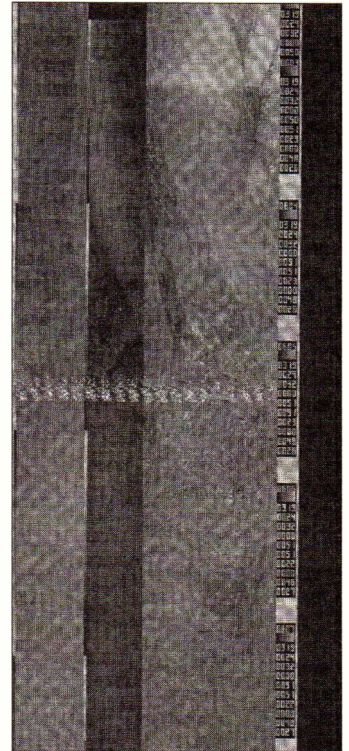

**Fig. 2: OKEAN-4
March 5 from Les
Hamilton.**

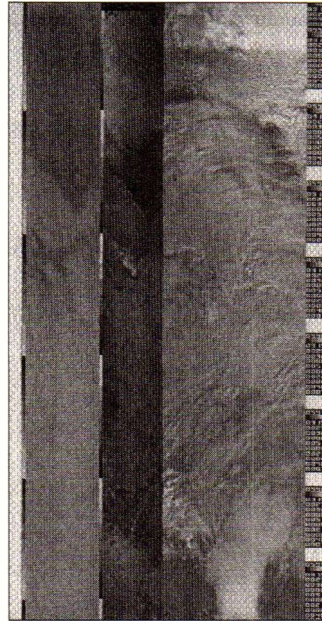

reception of the 1691MHz (or 1694.5MHz) signal, a good pre-amp, a down-converter (to change the 1691MHz signal down to 137.50MHz for feeding a conventional WXSAT receiver), or a direct METEOSAT receiver, and finally a decoder and software. Suitable complete systems are advertised around the £800 mark - assuming you already have a suitable computer.

At this point I am ignoring Primary Data Systems (PDUS), for simplicity. The equipment mentioned should be capable of receiving virtually noise-free WEFAX images, every four minutes, from METEOSAT-5, currently positioned at 0° longitude. METEOSAT's neighbours include METEOSAT-6 (also known as MOP-3), which has an image anomaly still being examined.

Each image transmitted, originates from a high resolution image taken every 30 minutes. This is split into several sections, some of which are then transmitted as one of the four minute formats - called WEFAX images. The main channel for WEFAX is A1 on 1691MHz, but some very interesting WEFAX images are also transmitted on channel A2 on 1694.5MHz. For those who would like a copy of the METEOSAT transmission schedule, just send me an s.a.e., enclosing one extra stamp towards copying costs.

The METEOSAT Transition Programme includes the construction and launch of METEOSAT-7, currently scheduled for launch by EUMETSAT at some stage after mid-1996.

METEOSAT Second Generation - 2000AD

The MOP satellites form the METEOSAT First Generation, and carry the standard 3-channel imaging radiometer, producing visible, infra-red and water vapour images. Each satellite carries enough fuel for five years of station keeping - the process in which thruster rockets are occasionally fired to keep each METEOSAT in its geostationary orbit - 35 800km above earth.

The MSG satellites are a generation ahead, compared to the MOP series. They are designed to carry a 12-channel enhanced radiometer, and enough fuel for 10 years of station keeping. The imaging specifications are enough to really whet the appetite! Eleven of the channels will produce images having an on-ground resolution of 3km (METEOSAT Primary Data currently provides down to 2.5km resolution in the visible-light image); the 12th channel will be dedicated to High Resolution Visible (HRV) imaging at 1km (better than NOAA). These images will be received every 15 minutes.

I will leave further detailed descriptions of the MSG satellites for a future column. This significant system upgrade for the new generation of METEOSATs will inevitably require a new generation of METEOSAT hardware and software for routine 'amateur' involvement. When you realise the enormous strides made by computer manufacturers during the last few

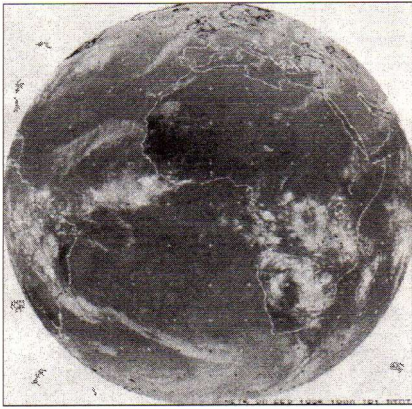

Fig. 3: DROT - METEOSAT image from Geoff Chance.

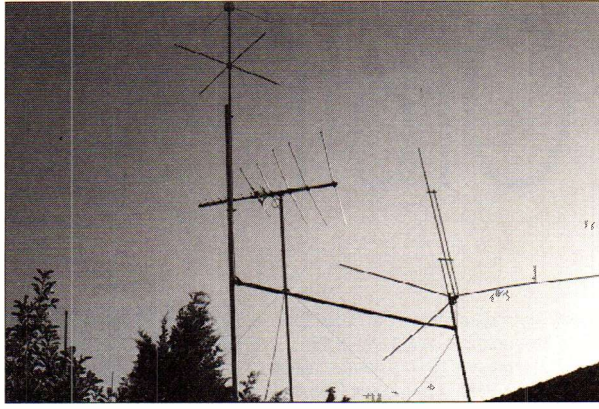

Fig. 4: WXSAT antenna from Gordon Griffin.

years, I take the view that 'amateur' priced hardware may well become available when it is wanted.

Meanwhile, during the next few years, newcomers to METEOSAT reception will increasingly need to appreciate what is just around the corner. This column will keep you informed. My grateful thanks to EUMETSAT for providing this information on the METEOSAT programme via their specialist publication Image.

Birddog - New Version

As mentioned in a previous month, some problems were discovered after updating the Birddog satellite predictions program, using recent (1995) Kepler elements. The problem was two-fold. Some satellites displayed negative orbit numbers, then, during January, some new elements produced wrong positions for some satellites - they were shown about 100° longitude off their true positions.

The day after I noticed this effect, a letter came from **Geoffrey Chance** of Redruth reporting the same problem. Not all elements produced the problem but once a 'bug' is discovered the reliability of other calculations can be suspect.

Geoffrey examined the problem and found that a 'fix' could be done by reverting to 94 and adding 365 days to the epoch. However, the bugs appear to have been completely removed with the latest release - version 3.0 - of Birddog. Les Hamilton received this revision, apparently originating from the Internet, and kindly forwarded a copy to me. I have been running it - together with other programs currently under test - and it has behaved well. Anyone wanting a copy can write to me, enclosing a 3.5in disk with pre-paid return package, and one extra stamp.

Letters

Correspondence for 'Info' comes from readers all over the world. **Gordon Griffin** now lives in Waitara, New South Wales, Australia, where he uses a 486 computer running PC GOES/WEFAX version 4 (I have yet to see that one). Gordon mentions using a scanner to tune into satellite beacons and a.p.t.

Today's TIP

I also use a general purpose scanner to monitor NOAA beacons, as well as using a purpose-designed WXSAT receiver for monitoring a.p.t. As often mentioned in the frequency list at the end of the column each month, NOAAs use either 136.77 or 137.77MHz for beacon telemetry. NOAAs 10 and 12 use 136.77MHz, NOAAs 9, 11 and 14 use 137.77MHz.

The beacon contains a variety of both housekeeping data (measurements of a routine nature, such as temperatures), and from each of the onboard scientific monitoring experiments - HIRS, SSU, MSU, SBUV/2, SEM, DCS, spacecraft pointing data, and more - much of which I summarised in the February column. All this information is produced by the Tيروس Information Processor - known as the TIP.

Technically, the signal baseband carries data at 8320 b.p.s. using split-phase, phase-shift keyed (PSK) modulation. Although it is possible to build hardware to decode this information, I have not heard of anyone who has done so; the most interesting data is normally the a.p.t. (picture) signal. For those (like me!) who are fascinated by the prospect of monitoring satellites which are 'off', try tuning into the beacons of NOAAs 9, 10 and 11 when they are not transmitting a.p.t. You should find that the NOAA 9 beacon remains detectable during the a.p.t. 'off' periods. As I wrote this, my scanner detected the NOAA-11 beacon (137.77MHz).

As Gordon mentions, it is possible to use a general purpose scanner in w.f.m. (wide-band f.m.) mode to hear WXSATs well enough to decode their a.p.t. The problem with this is that the antenna provided with such receivers is far from suitable - having poor characteristics for receiving right-circularly polarised radiation from a spinning satellite! In addition, the bandwidth in w.f.m. mode is far greater than needed for a.p.t. signals.

My Tandy PRO-2004 scanner has a quoted selectivity of $\pm 150\text{kHz}$ (-6dB) in this mode - typical of similar units - and is therefore relatively insensitive to a.p.t. Allowing for Doppler effects, a.p.t. needs a receiver designed to have an i.f. spectrum bandwidth maximum of 50kHz.

To further clarify this point, remember that the a.p.t. signal from the WXSAT contains a spectrum some 30kHz wide. If the satellite was stationary with respect to the ground, then a receiver with this bandwidth could cope. The (Doppler) effect of the relative movement of the satellite adds another 20kHz to the signal, resulting in a final spectrum containing up to about 50kHz bandwidth. This is the reason for the need to use purpose-designed receivers.

Judging by the details in Gordon's letter, he has constructed his own antenna. It incorporates four welding rods as the main radials, fitted into an electrician's junction box. He drilled holes, then used a brass collar for soldering. Wiring was done using 72Ω 428mm coaxial cable, and the radials were fixed using epoxy cement. Such is the detail kindly provided by Gordon that I wondered whether it could make a separate article. From the various pictures that he sent me, I selected a picture that shows his other antennas as well.

Those GMS Grids

Images from the geostationary WXSATs - METEOSAT, GMS and GOES - have grids showing major intersections of latitude and longitude, superimposed by the satellite image data processors. The use of software filters can sometimes minimise the obtrusiveness of these grids. A reader from Neath asked me whether I could use my 'influence' to persuade the authorities to remove the gridding from the images! Oh, that I had such power!

New Products

I have just taken delivery of a METEOSAT Yagi, data decoding system and down-converter. I am particularly pleased with this opportunity to review these products following several requests from readers, so look out for this in a future edition.

New Technology

A number of correspondents have written to me about their WXSAT

equipment, mentioning that they are not able to produce good quality printed pictures from a 9 or 24-pin printer. I am pleased to mention that I can now take images on standard PC disks, in any of the well-known formats e.g., GIF, PCX, JPG, TIF, for possible inclusion in the column. Pictures should be of good quality, and I would appreciate an s.a.e. for the return of the disk. If you prefer to send printed copy, that is fine - I suspect that most pictures will continue to be provided in this manner.

Computer Networks

Several years ago I worked on satellite projects at the Rutherford Appleton Laboratory (Oxfordshire), during which time various computer networks were being set up. One of these became known as Janet - the Joint Academic Network, allowing easy communications between universities and similar establishments. Other computer communications systems have been developed, particularly in America, and perhaps the most famous of these is the Internet.

Probably all of the official organisations involved in satellite planning and operations have involvement on the Internet, as it seems, do a variety of non-scientific establishments. I am collecting lists of Internet sites/addresses that provide current WXSAT images, rather than those that keep archived images. If any readers find newly established sites I will be pleased to receive details for future inclusion. Meanwhile - happy surfing!

Shuttle Info and Kepler Elements

- 1: For a print-out of the latest Shuttle schedule or WXSAT elements, send an s.a.e. and separate, extra stamp for each. All WXSATs plus MIR are included, together with transmission frequencies if operating. This data originates from NASA.
- 2: I now send monthly Kepler print-outs to many people. To join the list please send a 'subscription' of £1 (plus four self-addressed, stamped envelopes or international reply coupons) for four editions. Foreign requests can forgo the £1!
- 3: You can have a computer file containing recent elements for the WXSATs, and a large ASCII file holding elements for many satellites. A print-out is included, identifying NASA catalogue numbers (for the WXSATs, Amateur Radio satellites, and others of general interest), in date and object format. Please enclose £2 with your PC-formatted disk and s.a.e.

Frequencies

NOAAs 9, 14 a.p.t. on 137.62MHz;
NOAAs 10, 12 on 137.50MHz;
NOAA beacons (including N-11) on 136.77 and 137.77MHz;
METEOR 3-5 a.p.t. on 137.85MHz.
and OKEAN-4 may use 137.40MHz occasionally.

Timestep

PROsat II is used by most leading Weather Satellite enthusiasts. They have come to rely on the vastly superior features of **PROsat II**. Features such as 1,000 frame full screen full colour animate, 3D, direct temperature readout, latitude-longitude overlays and country outlines from NOAA, and Windows export make Timestep products preferred by most serious users. All satellites are catered for including the awkward Japanese GMS and the very infrequent Soviet Okean series. All current SVGA cards are supported. NOAA images contain full resolution visible and infrared data in a stunning 2.4Mb file!

If you really are serious about Weather Satellites, phone or write us now for a colour catalogue and find out why the world's experts including Arthur C. Clarke use and recommend our equipment.



Advanced Weather Satellite users will by now have read about our new **TRACK II** prediction software. Full screen colour graphics and 6 simultaneous satellites are just some of the amazing features. For the ultimate in detail we offer **HRPT** digital systems with five 1.1km ground sensors, towns and rivers are clearly visible. For everyday use we also have the **PDUS** digital Meteosat system that takes 2.5km data every 30 minutes. Timestep **PDUS** colour animate is used several times a day by Anglia Television because of its very high resolution combined with spectacular colour. Forecasters will appreciate temperature calibrated 30 minute interval images.

A full range of separate Antennas, Preamplifiers, Cables, Receivers and accessories are held in stock.

Timestep PO Box 2001 Newmarket CB8 8QA England
Tel: 01440 820040 Fax: 01440 820281

SKY-NEWS

SYNOP now available for most PC decoders

SkyComm have released a new version of the popular Skyview Systems SYNOP program aimed at users of third party decoders.

The 5 figure groups that many people decode from a RTTY signal can now be turned into impressive weather maps by using "Weather Chart", developed from their present SYNOP product.

So if you can decode RTTY and save it to disk using your PC, then you can now have ability to convert those 5 figure groups to intelligent data.

Skyview WeatherChart
Only £49.95

Icom Control Software with New Interface

Computer aided control of Icom receivers will now be a lot more affordable thanks to the latest version of ICRX from Skyview Systems.

The latest version is supplied complete with RS232 interface known as the IF-ICOM, which is contained within a 25 pin D-Type connector.

ICRX provides a host of features including signal meter, frequency control, large frequency display, squelch and a data base memory management system.

ICRX£44.95
IF-ICOM£24.95

Skyview Communications

Skyview House, Alresford, Essex CO7 8BZ
Tel: 01206 823185 Fax: 01206 825328

Unique Pocket Sized UK VHF/UHF Airband Frequency Guide - £4.45 Post Paid

Revised and reprinted every year but always up to date-as it is supplied with update sheets as necessary.

An All New Airband Listeners Jargon guide with a difference. Its a Unique Armchair Pilots guide as well. £7.45

THE AIRBAND JARGON GUIDE

Subjects covered include airband radios and reception, antennas. Plus if you ever wondered what it is like to fly a light aircraft or how their pilots operate them and find their way about then this book will enlighten you along with the basics of A/C Instruments and Air Traffic control. A serious subject covered in an easy going but factual manner. 72 pages A5 size.

New Video - ON THE FLIGHT DECK Vol One - £15.95 Post Paid.

5 varied flights giving nearly two hours of aviation video with full ATC chit-chat. Includes an overhead join and landing at WELSHPOOL in a C172, an approach and landing at PRAGUE in a CSA B737-500, LARNACA-PAPHOS-LARNACA from the right hand seat of a Grob 115a, LARNACA-BEIRUT-LARNACA, Great aerial footage of BEIRUT and its Airport in a Cherokee Archer 2. Back to PRAGUE this time in a CSA TU154m with a chatty crew.

We also stock airband Radios, Scanners, Accessories, Antennas and have over 700 Aviation Book titles in stock plus good advice always available. Now in our 9th Year.

If you can't visit then send for our latest Catalogue. For immediate dispatch order direct, we accept VISA, ACCESS, Am-EX, DINERS Cheques etc. or call in, we are open 7 till 7, 7 days a week.

THE AVIATION HOBBY CENTRE
1st floor MAIN TERMINAL
BIRMINGHAM INTERNATIONAL AIRPORT
Tel: 0121-782 2112 or Fax: 0121-782 6423

Decode

All the Data Modes

After reading my review of the PRO-2035 and my comment about a mono-wired headphone socket, **Geoff Halligey** of *Confidential Frequency List* fame has dropped me a note pointing to the range of adapter systems available from Maplin Electronics. According to Geoff, Maplin list a wide range of adapters for mono to stereo use, 3.5 to 6.3mm and many others. If you'd like to know more you can usually find the catalogues on sale in W.H. Smith.

Les Crossan of Wallsend has sent in this month's shack photo. The picture shows Les's station hard at work decoding a FAX chart from USN Norfolk in the early hours of the morning on 3.357MHz. You will note that his HF-150 receiver is nowhere to be seen! This is a deliberate ploy, to reduce interference - it's actually kept on the other side of the room.

In his latest letter, Les at last reports success in curing a particularly bad interference problem. Not only did the interference wipe out his h.f. listening but he was also suffering interference to his TV picture. After lots of investigating using his Sangean ATS-803A as a portable detector, the problem was traced to his neighbour's video recorder. The machine in question was a JVC all singing and dancing unit with Nicam stereo, etc. It was shipped off to the local dealer where he was told the problem was caused by the modulator and it was going to be expensive. Unconvinced, Les took on the problem himself and located it to a faulty internal shield in the chopper transformer (£10 to fix).

What Decoder

Regular readers will know that I'm currently canvassing the views of Decode readers to help me compile my *What Decoder FactPack*. This will attempt to cover all the current decoders plus a good selection of those that are to be found on the second-hand market. So far I've had a very good response, but if you would like to contribute it's not too late. Just send as much detail as you can on your equipment and in particular your views on decoders that you've owned. I'm particularly interested in your view as an operator.

FAX Definition

Once you've started receiving your first FAX images, most people start looking for ways to improve the

quality of the received image. There are several factors to consider, so this month I'll run through some of the details.

If you're looking for good quality images the very first thing you need is a good clean signal. It's not so much the strength that counts as the lack of any interfering signals. Both intermittent bursts and continuous interference sources will have an adverse effect of the FAX image. Any interfering tones or heterodynes will tend to show-up as horizontal stripes. However, static crashes and other impulsive noise usually shows as extra dots on the image.

Perhaps more serious in terms of image corruption is the part played by the prevailing propagation conditions. You will no doubt have already noticed that propagation conditions are highly variable and have a dramatic effect on the received signal. This is precisely why most major FAX stations operate on a range of different frequencies. These frequencies have been chosen to provide reliable coverage to the target area under all normal propagation conditions.

The trick, of course, is selecting the right frequency as it's not always the strongest that's the best. So how do you select the right channel? Probably the simplest way is to use the strongest signal that produces clean copy. You should always monitor the frequency for a few minutes to make sure the frequency really is clear and stable. Points to watch out for are interference from adjacent stations, noise, fading and multi-path distortion. I've covered this latter point before in this column, but the effect shows itself as smearing of the image, in some cases a ghost image appearing next to the original. If you have any multi-path distortion the only solution is to change frequency.

Having selected the best frequency, there are some receiver adjustments that can be crucial to the image quality. The first is the selection of the receiver's intermediate frequency bandwidth. The facility to adjust this bandwidth is only available in a few receivers so you may just have to accept the default setting. However, where you have the choice of bandwidth it's important that you select this wisely. Whilst it's very tempting to wind in the bandwidth to cut out noise and interference there are drawbacks. The important point is the bandwidth required by the fine detail in the chart. If you think about the FAX transmission process you will remember that the chart is wrapped



Les Crossan's Decoding Station.

around a drum and spun at 120 r.p.m. A scanner then moves slowly along the drum to convert the chart into an electrical signal.

Let's now consider the information that has to be sent for a single line of the chart. To understand the problem I'm going to calculate the speed at which the chart passes under the scanner. We can then use this information to see just how tiny the signal would be for a thin line on the chart.

For this example, let's use a typical meteorological chart with a width 470mm. Now with this chart wrapped around a 152mm diameter drum and spun at 120 r.p.m., we can calculate the speed in mm per second that the chart must be passing under the scanner. First convert the drum speed to revs per second by dividing 120 by 60 = 2 revs per second. Now we can work out the chart speed in mm per second which is the chart width of 470mm x 2 revs per second. This gives a final speed of 940mm per second.

If we now use this basic information to look at our FAX signal you can see that a 1mm thick line on the chart would cause the FAX signal to swing from white to black for 1/940th of a second or 1.06 milliseconds (ms). A return to some basic maths will show that a signal with a period of 1ms is equivalent to a 1kHz. This is well within the capabilities of our s.s.b. receiver so this should be reproduced without problem. Now a 1mm line is really quite thick and the fine detail on some charts may only be 0.2mm wide. In this case the FAX signal will move from white to black for just 0.2 milliseconds. This equates to a 5kHz tone and is likely to be well outside the passband of most communications receivers. I hope you can now see that a narrow bandwidth in your receiver will effectively filter-out the fine detail of a FAX chart.

This effect is not only present when using tight i.f. filters but also when using external audio filters. In practice, you usually have to make a compromise between the reduction of noise through filtering and the loss of fine detail in the chart.

One other point to watch, particularly with external filters, is

group delay and ringing. Group delay is where different frequencies pass through the filter at different speeds. The difference in speed is usually very slight but it can cause adverse effects on the FAX image. Ringing is exactly as the name implies and can cause an effect very similar to multipath propagation with smearing or ghosting of the image.

The best approach to take is to set your receiver and filter controls to give what appears to be the best image. Then try switching the filters in and out to check that the image really has been improved. As with most things in life you have to accept that FAX reception on the busy h.f. bands will always be a compromise.

APT Modes

Alastair McIntyre of Glasgow has recently written asking what are the best APT modes to use for receiving Bracknell, Hamburg and Northwood. I often receive questions on this topic so let's just run through the details. So what is APT? The term relates to Automatic Picture Transmission (APT). This is a system that was developed for commercial FAX stations to enable unattended operation. The practicalities of FAX transmission using paper charts first requires the operator to load the chart and then start the FAX machine using the optimum drum speed and Index Of Co-operation (IOC). At the receiving end, the machine also needs all this information to ensure that the received picture is properly synchronised and proportioned. The answer lies in the controls signals transmitted as part of the APT process. Let's just run through a typical transmission to see how it works.

Once the chart has been loaded and is ready for transmission the start sequence begins. This starts with a start tone which is used to communicate the IOC of the signal. The two standard tones for this are 300Hz for IOC 576 and 675Hz for IOC 288.

Next comes the drum speed synchronising sequence. This comprises a 30 second transmission

of alternate black and white signals that run at the precise drum speed. Common values are 1Hz for 60 r.p.m., 1.5Hz for 90 r.p.m. and 2Hz for 120 r.p.m. This start-up signal can either be equal durations on black/white or more commonly 5% white and 95% black. From this signal the receiving FAX machine not only knows the exact drum speed but also the location of the edge of the image. This latter point is vital for correct alignment of the chart.

Next comes the chart detail which can take up to 15 minutes to send. Once this is complete, a five second 450Hz stop tone is sent followed by ten seconds of continuous black.

As you can see, the APT process is really quite simple but remarkably effective. I frequently use APT for unattended reception of extended periods with great success. The only APT problems I've noticed tend to be caused by noise at the receive end. This is because some software based decoding systems are a little too keen to start and will falsely detect a start tone from noise!

Just to conclude, I've shown a sample chart that illustrates a range of propagation effects. Although the chart initially looks very poor, a close inspection will reveal that there are two vertical stripes where the quality is really very good. This variation in quality is caused by the changing propagation during the transition between day and night. The remainder of the chart shows the smearing caused by multipath propagation effects.

Internet Update

Activity continues to grow and there is now quite a healthy range of services available to support the short wave listener. The only problem is that the information is constantly changing so it's quite a challenge to keep up-to-date. However, there are a number of shortcuts you can take to help you find new information quickly. One of these is to make use of the Internet's search facilities. One of my favourites is YAHOO at Stanford University in the USA. The site is accessed using a World Wide Web browser and connecting to <http://akebono.stanford.edu/yahoo/>. Once connected you can run a search on any phrase or word you choose. The results are then displayed with short summaries of the findings. To find short wave information sources just type short wave in the search field.

The other way to keep up-to-date is to seek out Usenet groups that cover your interests.

If you enjoy surfing around the Net looking for new software a good document to get hold of is ham-ftp.zip. This file maintains a list of all Internet sites that carry amateur radio information. The home site for this list is ftp://netcom.com/pub/VE3SUN/ham_ftp.zip. According to **Ken Michaelson**, a Usenet group worth a look is aus.radio. If you have any information on hot sites please let me know.

Shifts

Robert Mason of Kilwinning in Ayrshire uses a Yaesu FT-747GX transceiver with a 15m wire antenna, Pervissell interface plus Hamcomm and JVFAX for decoding. All is working very well except he's not too sure about the use of shifts when receiving RTTY signals. Whilst HAMCOMM, like most other systems, is pre-set with 170, 425 and 850Hz, many signals seem to use 400Hz. He asks how important is setting the correct shift.

The reason HAMCOMM uses 170, 425 and 850Hz shifts is that this is the standard range of shifts used by amateurs (nowadays most use just 170Hz). Now, those of you with decoding systems that can calculate or measure the shift of live signals will know that most commercial stations use 170 or 400Hz shifts. The question is can you successfully receive 400Hz shift signals using a decoder that only has 425Hz available. You'll be pleased to hear that the answer is a firm yes. With most decoding systems, the filtering associated with setting the shift size shift settings have a comparatively wide bandwidth. This means that a 425Hz system is fine with 400Hz shifts and vice versa. You are only really likely to come unstuck if the shift settings are widely mismatched.

New Modes

Back in February I reported on what could well be a new transmission mode on h.f. The signals had been noted by **Mike** of Bath. Well, it appears that the 250 baud 850Hz signals is not DUP-ARQ after all but an ASCII (ITA5) alphabet based FEC system.

I've also heard from a listener in Switzerland who has logged several occurrences of the 288 baud ARQ-E signals as follows:

13.0734MHz, 328Hz shift, 1034-1142UTC
13.4189MHz, 170Hz shift, 1034-1142UTC
10.7494MHz, 334Hz shift, 1625 & 1801UTC
10.348MHz, 170Hz shift, 1735UTC
16.3124MHz, 346Hz shift, 1428UTC

If you have any further information on these transmissions please write and let me know.

Decode Special Offers

Here's a summary of the readers offers currently available.

IBM PC Software: JVFAX 7, HAMCOMM 3
Literature: *Day Watson Beginners List, Decode List, Complex Modes List, FactPack 1 - Interference, FactPack 2 - Decoding Accessories, FactPack 3 - Starting-Out, FactPack 4 - HAMCOMM/JVFAX Primer, FactPack 6 - Internet Starter.*

To receive any of these offers just send a self addressed sticky label plus 50p per item or £1.50 for 4,

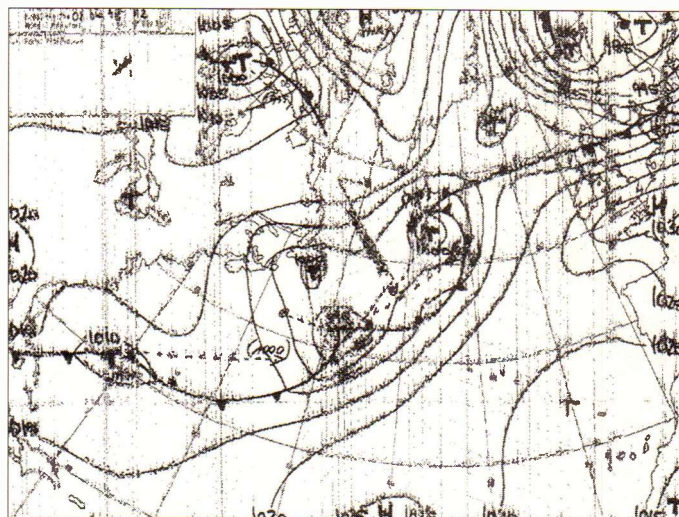

Distorted fax image referred to in text.

£2.50 for 6 or £3.00 for 8 items, £4.00 for 9 or 10 items. If you're ordering JVFAX or HAMCOMM you will also need to send a blank formatted 720kb disk for each program or just one 1.4Mb disk.

I've had a couple of un-named disks that have recently become separated from any letter. If you have been waiting more than three weeks, let me know. Finally, as we approach the summer months, please bear in

mind we may have escaped for our annual holiday, all orders will be sent out as soon as possible once we return.

Frequency List

This month's frequency list comes courtesy of **David Holman, Guy Denman, Les Crossan and Day Watson**. Frequencies in MHz.

Freq (MHz)	Mode	Speed	Shift	Call	Time	Notes
3.172	RTTY	50	850	IMB1	1808	Rome met
3.280	FAX	90	576	RBX 70	1914	ashkent Meteo
3.357	FAX	120	576	NAM	0834	USN Norfolk
3.360	FAX	90	576	RPN 71	1955	Kiev Meteo
3.810	FAX	90	576	RST 75	2000	Minsk Meteo
3.875	FAX	120	576	RCI 72	1720	Moscow Meteo
4.2125	FEC	100	170	WOO	0130	USA Ocean Gate
4.525	FAX	120	576	RPN 75	2002	Kiev Meteo
5.240	RTTY		425	40C 2	2124	Belgrade Press (TANJUG)
5.285	FAX	90	576	RBX 71	0040	Tashkent Meteo
5.755	FAX	120	576	AXI 32	2135	Darwin Meteo
5.850	FAX	120	576	OXT	0045	Copenhagen Meteo
6.4525	FAX	120	576	GYA	1148	Royal Navy
6.880	FAX	120	576	RAN 77	1006	Moscow Meteo
6.950	FAX	90	576	RJK 78	0838	Kiev Meteo
7.535	FAX	120	576	AXI 33	140	Darwin Meteo
7.640	FAX	90	576	RST 76	0844	Minsk Meteo
7.750	FAX	120	576	RAW 78	0845	Moscow Meteo
7.806	RTTY	50	425	YZD 7	2127	Belgrade Press (TANJUG)
7.880	FAX	120	576	DDK 3	1724	Hamburg Meteo
8.028	ROU-FEC	164.5	400	V5G	-	MFA Budapest
8.040	FAX	120	576	GFA 23	0846	Met Office Weather Fax
9.900	FAX	120	576	NPG	0847	USN San Francisco
11.132	RTTY	50	400	BZG41	1450	XINHUA Beijing
11.536	RTTY	50	400	HMF49	1820	KCNA Pyongyang
12.165	FAX	90	576	RKB 78	0902	Moscow Meteo
12.185	RTTY	50	400	-	1812	JANA Tripoli
13.366	RTTY	50	400	5YD	1736	Nairobi flight data
13.470	FAX	90	576	RKU 71	0951	Moscow Meteo
13.876	ARTRAC	125	170	HGX21	1502	MFA Budapest
13.947	FAX	90	576	ROM 5	1119	Tashkent Meteo
14.436	FAX	120	576	GFE 23	0954	Met Office Weather Fax
14.573	RTTY	50	400	-	1734	JANA Tripoli (Arabic)
14.982	FAX	90	576	RBV 76	0954	Tashkent Meteo
15.950	FAX	120	576	RBI 77	0955	Moscow Meteo
18.261	FAX	120	576	GFE 24	0956	Met Office Weather Fax

LM&S

Long, Medium and Short Waves

The information here is based on reception by UK listeners and other countries during February. In view of the deteriorating conditions in the higher frequency bands, some international broadcasters may alter their short wave schedules at the end of March. Such changes will be in the LM&S data in the June SWM.

Long Wave Reports

Note: l.w. & m.w. frequencies in kHz; s.w. in MHz; Time in UTC (=GMT). Unless stated, all logs compiled in the four weeks ending February 28.

During the evening of February 5 the sky waves from the Radiotelevisione Italiana (RAI) 10kW outlet at Caltanissetta, Italy on 189 reached the UK. In Woking, **John Eaton** logged them as SINPO 33343 at 2240UTC.

After dark, **John Stevens** (Largs) found that the signals from Poland via Raszyn on 225 often suffer from co-channel interference, so far he has been unable to identify it. It seems likely that he is hearing the sky waves from the 600kW transmitter at Van, Turkey that shares 225.

Listeners who search this band on a regular basis at night may have noticed that the broadcasts from Oslo, Norway on 216kHz have ceased. The 200kW transmitter was 40 years old and it was becoming both expensive and difficult to maintain, so NRK decided to stop using it from January 4.

Medium Wave Reports

The reception at night of m.w. broadcasts over transatlantic paths was reported by several listeners in the UK. **David Edwardson** (Wallsend) searched the band each night during the early part of February. Sometimes he picked up very weak signals from VOXM in St.John's on 590 before 2200! Usually they improved later. He logged CJYQ in St.John's on 930 as 24432 at 2318 and WQEW in New York on 1560 as 24542 at 2325. WTOP in Washington on 1500 and WSSH Boston on 1510 were audible around dawn.

Over in Co.Fermanagh, **Paul Logan** (Lisnakea) was able to receive the broadcasts from several stations in C/S.America during some nights in the first half of the month. Among the entries in his log were the Caribbean Beacon, Anguilla on 1610 at 0151; Harbour Lt, Grenada 1400 at 0210; R.Taino, Cuba 1180 at 0228;

R.Globo, Sao Paulo Brazil 1100 at 0231; R.Vibracion, Carupano Brazil 1470 at 0250; Caribbean Christian R and Grand Turk 1020 at 0300. On the 15th he logged CBG Gander on 1400 at 0315, but better reception from Canada and the USA was evident on the 20th, when he heard CHCM in Marystown on 740 at 0050; WINS New York 1010 at 0135 and WQEW New York at 0155.

Down in E.Worthing **Ron Damp** also found the conditions favourable on the 20th. He was able to receive CJYQ on 930, albeit faintly, while using his Sangean ATS-803A portable with internal ferrite rod! He then brought his large home-built spiral loop into play and logged their signal as 32222 at 0016.

Favourable conditions also occurred on the 21st. While using a Sangean ATS-803A portable, **Paul Bowery** (Burnham-on-Crouch) logged CFBC in St.John on 930 as 13211 at 0004; VOXM as 14432 0200; CJYQ as 13332 at 0217 and WBBR in New York on 1130 as 11321 at 0236. Up in Derby, **Roy Patrick** received a fairly good signal that night from WSSH at 0005.

On the 24th Roy listened to an all sports programme broadcast at 0015 by WLPZ in Portland on 1440. **Harry Richards** (Barton-on-Humber) found that CJYQ was clearly audible on 930 and by 0020 their signal was 23222. He then tuned to 1510 and heard a broadcast from WSSH in Boston. At first their signal was 24232, but by 0130 it was peaking 34332.

Following Paul Logan's reception in December of the sky waves from the Kenya BC 20kW outlet at Nakuru on 1386kHz, **Eddie McKeown** has kept a careful check on that frequency in Newry. He picked up their transmission at 0200 on one night in February, noting it as 25211. The sky waves from stations in the Middle East and N.Africa also reached the UK after dark, see chart.

Up in Lanarkshire **Arthur Grainger** (Carstairs Junction) compiled an extensive local radio DX log. He found reception unusually good in daylight and heard BBC R.Solent via Bournemouth on 1359 for the first time at 1328, when it peaked 22222.

Short Wave Reports

The **25MHz (11m)** band is no longer being used by international broadcasters.

Conditions in the **21MHz (13m)** band have varied from day to day. When favourable, R.Australia's

Long Wave Chart

Freq kHz	Station	Country (kW)	Power	Listener
153	Bechar	Algeria	1000	J*,N*
153	Donebach	Germany	500	B,C,E,FH*,I,J,K,L*,M*,O*
162	Allouis	Fance	2000	B,C,E,F,G*,H*,I,J,L*,M,N*,O*
171	Nador Medi-1	Morocco	2000	J*,L*
171	Kaliningrad	Russia	1000	B*,C,E*,G*,H*,I,J,K,L*,O*
177	Oranienburg	Germany	750	B,C,H*,I,J,K,L*,O*
183	Saarlouis	German	2000	A,B,C,G*,H*,I,J,K,L*,O*
189	Caltanissetta	Italy	10	D*
198	BBC R-4 via ?	UK	?	B*,C,E*,G*,H*,I,K,L*,M,N,O
207	Munich	Germany	500	B*,C,E*,H*,I,J,K,L*,O*
207	Azilal	Morocco	800	E*,J*
216	Roumoules RMC	S.France	1400	B,C,E,H*,I,J,K,L*,O*
225	Raszyn Resv	Poland	?	B*,C,E*,F,H*,I,J,K,L*,N*,O*
234	Beidweiler	Luxembourg	2000	B,C,E*,H*,I,J,K,L*,M,O*
234	St.Petersburg	Russia	1000	L*
243	Kalundborg	Denmark	300	B,C,E,FH*,I,J,K,L*,O*
252	Tipaza	Algeria	1500	B*,C*,E*,I*,O*
252	Atlantic 252	S.Ireland	500	A,B,C,E,H,I,J,K,L*,M,N,O*
261	Burg(R.Ropa)	Germany	200	E*,J*,L*,O*
261	Taldom Moscow	Russia	2000	E*,H*,J*,L*
270	Topolna	Czech Rep	1500	B*,C,E,H*,J*,L*,O*
279	Minsk	Belarus	500	B*,C,H*,J*,L*,O*

Note: Entries marked * were logged during darkness. All other entries were logged during daylight or at dawn/dusk.

Listeners:

A	Tim Allison, Middlesbrough.	I	George Millmore, Wootton, IoW.
B	Paul Bowery, Burnham-on-Crouch.	J	Fred Pallant, Storrington.
C	Martin Dale, Stockport.	K	Martin Price, Shrewsbury.
D	John Eaton, Woking.	L	Harry Richards, Barton-on-Humber.
E	Sheila Hughes, Morden.	M	Tom Smyth, Co.Fermanagh.
F	Rhoderick Illman, Oxted.	N	John Stevens, Largs.
G	Stephen Jones, Oswestry.	O	Andrew Stokes, Leicester.
H	Eddie McKeown, Newry.		

Darwin broadcast to Asia on 21.725 (Eng 0900-1100) could be heard here. It was 43323 at 0900 by **Norman Thompson** in Oadby and 33322 at 0950 by **Robert Connolly** in Kilkeel.

Sometimes, broadcasts from other areas could be heard here quite well. Among those noted in the morning were R.Japan via Moyabi 21.640 (Jap to Eu, M.East 0800-0900) 45444 at 0857 by **Tim Allison** in Middlesbrough; R.Pakistan Islamabad 21.475 (In to SE.Asia 0900-1000) 24322 at 0909 by **Rhoderick Illman** in Oxted; R.Netherlands via Flevo 21.505 (Eng to Far East, Pacific 0930-1025) 42432 at 0930 by **Gerry Haynes** in Bushey Heath; UAER, Dubai 21.605 (Eng to Eu 1030-1055) 55444 at 1040 by **Michael Griffin** in Ross-on-Wye; BBC via Ascension Is 21.660 (Eng to W/E.S.Africa 1100-1700) 43333 at 1200 by **Bernard Curtis** in Stalbridge.

In the afternoon HCJB Quito 21.455 (Eng, u.s.b. + p.c.) was SIO244 at 1245 with **Kenneth Buck** in Edinburgh; UAER, Dubai 21.605 (Eng to Eu 1330-1355) as 54444 at 1330 by **Sheila Hughes** in Morden; BBC via Limassol 21.470 (Eng to E.Africa 1400-1615) as SIO111 at 1402 by **Julian Wood** in Elgin; Monitor R.Int via WSHB 21.640 (Eng to E.Africa 1600-2000?) 44344 at 1617 in Woking; WYFR via Okeechobee 21.745 (Eng to Eu 1600-1645) 35433 at 1635 by **Darren Beasley** in Bridgwater; R.Japan via Moyabi 21.700 (Jap to Eu, M.East, Africa 1600-1700) 32132 at 1646 in Newry.

In the **17MHz (16m)** band, conditions also varied from day to day. Sometimes R.Australia's Carnarvon signal to Asia 17.715 (Eng 0100-0900) could be heard here. In Wallsend it peaked 25532 at 0801. More often noted were Africa No.1, Gabon 17.630 (Fr to W.Africa

0700-1600) SIO322 at 0800 by **Bill Clark** in Rotherham; R.Pakistan, Islamabad 17.900 (Eng to Eu 0800-0845) 45243 at 0800 in Newry & (Eng to Eu 1100-1120) 33333 at 1100 by **Thomas Williams** in Truro; R.Slovakia Int via Rimavska Sobota 17.485 (Eng to Aust 0830-0857) SIO444 at 0830 by **John Slater** in Scalloway; Voice of Greece, Athens 17.725 (Gr, Eng to Aust, Eu 0800-0950) 55555 at 0942 by **Chris Shorten** in Norwich; R.Norway, Oslo 17.840 (Norw to M.East 0900-1000) 33343 at 0945 in Oxted; Channel Africa via Meyerton 17.810 (Eng to Africa 1000-1100) 22442 at 1010 in Bridgwater.

After mid-day VOA via Ascension Is 17.875 (Sp to S.Am 1200-1300) was logged as SIO333 at 1235 by **Philip Rambaut** in Macclesfield; R.Finland via Pori 17.740 (Eng to N.Am 1330-1400) 54333 at 1335 in Bushey Heath; HCJB Quito 17.490 (Eng, u.s.b. + p.c.) 35333 at 1400 in Ross-on-Wye; BBC via Ascension Is 17.830 (Eng to W/C.Africa 0730-2030) 34343 at 1401 in Woking & via Antigua 17.840 (Eng to N/C.Am 1400-1615) 32222 at 1600 by **Howard Seddon** in Wigan; RCI via Sackville 17.820 (Eng [CBC progs] to USA, Caribbean 1300-1400 Mon-Fri, 1400-1700 Sun) SIO455 at 1415 in Edinburgh, (Eng, Fr to Eu, M.East, Africa 1430-1600, not Sun) SIO222 at 1430 in Elgin, (Eng to Eu, M.East 1745-1800) 54545 at 1745 by **George Tebbitts** in Penmaenmawr & (Fr, Eng to Eu, M.East, Africa 2000-2230) 33333 at 2015 in Kilkeel; WYFR Okeechobee 17.760 (Eng to Eu, Africa 1700-2000) 25332 at 1738 in Middlesbrough; WVHA via Scotts Corner 17.612 (Eng to Eu, Africa 1800-1900, Mon, Wed & Fri) 35333 at 1800 in Derby; R.Netherlands via Bonaire 17.605 (Eng to W.Africa 1830-2025) 45444 at 1835 in Burnham-on-Crouch.

Medium Wave Chart

Freq kHz	Station	Country	Power (kW)	Listener	Freq kHz	Station	Country	Power (kW)	Listener	Freq kHz	Station	Country	Power (kW)	Listener
520	Hof-Saale (BR)	Germany	0.2	E*	882	Washford (BBCWales)	UK	100	D,G,H,K,N,PR*	1341	Tarrasa (SER)	Spain	2	K*,N*
531	Ain Beida	Algeria	600	E*,K*,R*	891	Algiers	Algeria	600/300	D*,J*,K*,N*,R*	1350	Nancy/Nice	France	100	J*,K*,N*,R*
531	Leipzig	Germany	100	D*,J*,K*,R*	891	Huisberg	Netherlands	20	J*,K	1359	Arganda (RNE-FS)	Spain	600	J*,K*,N*,R*
531	RNE5 via ?	Spain	?	J*,K*,R*	900	COPE via ?	Spain	?	J*,R*	1368	Foxdale (Manx R)	I.O.M.	20	D,G*,K*,M,N,P
531	Beromunster	Switzerland	500	N	900	Milan	Italy	600	D*,J*,K*,N*,R*	1377	Lille	France	300	J*,K,N,R*
540	Wavre	Belgium	150/50	D*,J*,K,N,R*	900	Quarayat	Saudi Arabia	1000	K*,R*	1386	Nakuru (KBC)	Kenya	20	J*
540	Conamara	Ireland (S)	2	P	909	B'mans Pk (BBC5)	UK	140	K*,R*	1386	Bolshakovo	Russia	2500	R*
540	Sidi Bennour	Morocco	600	D*,J*,K*,R*	909	M'side Edge (BBC5)	UK	200	N	1386	R.Ned via B'shakovo	Russia	2500	C*,D*,G*,J*, K*,N,R*
540	Vitoria (EI)	Spain	10	K*	918	Plesivec (Sloven/IR)	Yugoslavia	600/100	D*,J*,K*,R*	1395	Lushnje (Tirana)	Albania	1000	C*,G*,J*,K*,N,R*
549	Les Trembles	Algeria	600	D*,E*,J*,K*,R*	918	Madrid (R.Int)	Spain	20	D*,K*,N	1395	Ufa	Russia	?	J*
549	Thurmain (DLF)	Germany	200	D,H,J*,K,N,R*	927	Wolvertem	Belgium	300	D*,J*,K,N,R*	1404	Brest	France	20	H*,J*,K,N,R*
558	Espoo	Finland	100	K*	936	Bremen	Germany	100	J*,K*,N*,R*	1404	Dnepropetrovsk	Ukraine	30	J*
558	Rostock (NDR)	Germany	20	J*	936	Venezia	Italy	20	K*	1413	RNE5 via ?	Spain	?	J*,K*,N*,R*
558	RNE5 via ?	Spain	?	D*,J*,K*,R*, N*,P*,R*	936	RNE5 via ?	Spain	?	J*,K*,P*	1413	Pristina	Yugoslavia	1000	P*
567	Berlin	Germany	100	J*,K*,R*	945	Toulouse	France	300	J*,K*,P*	1422	Alger	Algeria	50/25	K*
567	Tullamore (RTE1)	Ireland (S)	500	D,G,H,I*,K,N,PR*	954	Brno (Dobrochov)	Czech Rep.	200	J*	1422	Heusweiler (DLF)	Germany	1200/600	D,J*,K,N,R
567	RNE5 via ?	Spain	?	E*,J*,K*	954	Milan	Italy	20	D*,J*,K,N,P*,R*	1431	Nikolayev	Ukraine	400	J*,N*,R*
576	Muhlacker (SDR)	Germany	500	D*,J*,K,N,R*	963	Pori	Finland	600	A*,D*,H,J*,K*,N*,R*	1440	Kyzylorda	Kazakhstan	?	J*
576	Riga	Latvia	500	K*	963	Paris	France	8	J*,K	1440	Marnach (RTL)	Luxembourg	1200	D,H,J*,K,N,O,P*,R
576	Barcelona (RNE5)	Spain	50	J*,K*	963	Tir Chonail	Ireland (S)	10	K*,P*	1440	Damman	S. Arabia	1600	K*,N*,O*
585	Paris (FIP)	France	8	D*,J*,K	972	Hamburg (NDR)	Germany	300	D,H,J*,K*,N*,R*	1449	Squinzano	Italy	50	J*,K*,O*
585	Madrid (RNE1)	Spain	200	D*,J*,K*,N*,R*	972	RNE1 via ?	Spain	?	J*,K*	1458	Lushnje (Tirana)	Albania	500	R*
585	Dumfries (BBCScot)	UK	2	N	981	Alger	Algeria	600/300	J*,K*,N*,R*	1467	Monte Carlo (TWR)	Monaco	1000/400	D*,G*,J*,K*,N,R*
594	Frankfurt (HR)	Germany	1000/400	H*,J*,K,N*,R*	990	Berlin	Germany	300	J*	1476	Wien-Bisamberg	Austria	600	K*
594	Oujda-1	Morocco	100	K*	990	R.Bilbao (SER)	Spain	10	D*,J*,K*,R*	1476	Sanandaj	Iran	200	N*
594	Muge	Portugal	100	J*,K*	990	Redmoss (BBC)	UK	1	N	1481	Dubai	UAE	1500	L*
603	Lyon	France	300	J*	999	Schwerin (RIAS)	Germany	20	J*	1485	AFN via ?	Germany	1	R*
603	Sevilla (RNE5)	Spain	50	D*,J*,K*	999	Madrid (COPE)	Spain	50	N*,R*	1485	SER via ?	Spain	?	N*
603	Newcastle (BBC UK)	UK	2	O,P*,R*	1008	El Arish	Egypt	100	N*	1494	Clermont-Ferrand	France	20	K,R*
612	Athlone (RTE2)	Ireland (S)	100	D*,K,N,PR*	1008	Las Palmas (SER)	G. Canaria	?	J*,K*,R*	1494	St.Petersburg	Russia	1000	H*,J*,N
612	RNE1 via ?	Spain	10	J*,K*,R*	1008	Flevo (Hilly-5)	Holland	400	D*,J*,K,PR*	1503	RNE5 via ?	Spain	?	J*,R*
621	Wavre	Belgium	80	D*,J*,K,N,R*	1017	Rheinsender (SWF)	Germany	600	D,H,J*,K*,R*	1512	Wolvertem	Belgium	600	B*,D*,G*,J*,K, M*,N,R*
621	RNE1 via ?	Spain	10	R*	1026	SER via ?	Spain	?	J*,R*	1512	Jeddah	S. Arabia	1000	E*,L*
621	Barcelona (OCR)	Spain	50	J*,K*	1035	Tallinn	Estonia	500	K*	1521	Kosice (Cizatice)	Slovakia	600	J*,N*
630	Dannenberg (NDR)	Germany	100	D	1035	Lisbon (Prog3)	Portugal	120	D*,J*,R*	1521	Duba	S. Arabia	2000	K*,L*,R*
630	Vigra	Norway	100	D*,J*,K*,N*,P*,R*	1044	Dresden	Germany	250	J*,K*,P*,R*	1530	Vatican R	Italy	150/450	C*,G*,H*,J*, K*,N,R*
630	Tunis-Djedida	Tunisia	600	D*,J*,K*	1044	Sebaa-Aioun	Morocco	300	K*	1539	Mainfingen (DLF)	Germany	700	K*,N*
639	Praha (Libice)	Czech	1500	D*,J*,K	1044	S.Sebastian (SER)	Spain	10	J*,K*,N*,R*	1539	Valladolid (SER)	Spain	5	J*,K*,R*
639	RNE1 via ?	Spain	?	D*,J*,K,N,R*	1053	Iasi	Romania	1000	K	1557	Nice	France	300	N
648	RNE1 via ?	Spain	10	D*,J*	1053	Zaragoza (COPE)	Spain	10	D*,J*	1566	Nagpur	India	1000	L*
648	Orfordness (BBC)	UK	500	D*,K,N,R*	1053	Talk Radio UK via ?	UK	?	A,D,FG*,K,N,P,Q,R	1566	Sfax	Tunisia	1200	J*,N*
657	Neubrandenburg (NDR)	Germany	250	J*,K*	1062	Kalundborg	Denmark	250	J*,K*,N*,PR*	1575	Genova	Italy	50	J*,K*
657	Napoli	Italy	120	K*	1062	Diyabakir	Turkey	300	E*	1575	SER via ?	Spain	5	J*,K*,N*,R*
657	Madrid (RNE5)	Spain	20	J*,K*,P*,R*	1071	Brest	France	20	K	1584	SER via ?	Spain	2	K,N
657	Wrexham (BBC Wales)	UK	2	D,N,R	1071	France-Inter via ?	France	?	D*	1593	Holzkirchen (RFE)	Germany	150	J*,N*,P*
666	Messkirch/Rohrd (SWF)	Germany	300/180	J*,N*,R*	1071	Lille	France	40	J*,N*,R*	1602	SER via ?	Spain	?	R*
666	R.Vilnius	Lithuania	500	J*,P*	1071	Riga	Latvia	50	K*	1602	Vitoria(EI)	Spain	10	J*,K*,N,P*
666	Lisboa	Portugal	135	J*,K*	1071	Bilbao (EI)	Spain	5	K*,R*	1611	Vatican R	Italy	15	H*,J*,N,R*
675	Marseille	France	600	J*,K*,P*	1080	Talk R.UK (N'castle)	UK	1500	J*,K*,N*,R*					
675	Lopic (R10 Gold)	Holland	120	A*,D,H,J*,K,N,O,R*	1080	Katowice	Poland	?	J*,K,N					
684	Sevilla (RNE1)	Spain	500	D*,J*,K*,N*,R*	1089	SER via ?	Spain	?	P*,K,N					
684	Avala (Beograd-1)	Yugoslavia	2000	D*,J*,K*,R*	1089	Durres	Albania	150	P*					
684	Droitwich (BBC5)	UK	150	D*,K,N,PR*	1089	Krasnodar	Russia	300	J*					
702	Flensburg (NDR)	Germany	5	D*,J*,K*,R*	1089	Talk Radio UK via ?	UK	?	A,D,FG*,K,N,P,Q,R					
702	Zamora (RNE1)	Spain	10	D*,J*,K*,N	1098	Nitra (Jarok)	Slovakia	1500	D*,J*,K*					
711	Rennes 1	France	300	J*,K,N,R	1098	RNE5 via ?	Spain	?	J*,K*,N					
711	La Youne	Morocco	600	E*,J*,K*,R*	1107	AFN via ?	Germany	10	A*,G*,J*,R*					
711	Murcia (COPE)	Spain	5	K*,R*	1107	Sitkunai	Lithuania	150	K					
720	Langenberg	Germany	200	K*,R*	1107	RNE5 via ?	Spain	?	G*,J*,R*					
720	Lisnagarvey (BBC4)	Ireland (N)	10	K,N	1107	Talk R.UK via ?	UK	?	D,K,N					
720	Norte	Portugal	100	J*,K*,N*	1116	Ban	Italy	150	K*					
720	Stax	Tunisia	200	K*	1116	Pontevedra (SER)	Spain	5	J*					
720	Lots Rd, Ldn (BBC4)	UK	0.5	D,K,R	1125	La Louviere	Belgium	20	J*,K					
729	Cork (RTE1)	Ireland (S)	10	K,N,R	1125	Deanovec	Croatia	100	K*					
729	RNE1 via ?	Spain	?	D*,J*,K,N,R*	1125	RNE5 via ?	Spain	?	K*,N,R*					
738	Paris	France	4	K*,R*	1134	COPE via ?	Spain	2	D*,J*,K*,N*,P*,R*					
738	Poznan	Poland	300	K*	1134	Zadar (Croatian R)	Yugoslavia	600/1200	D*,J*,K*,R*					
738	Barcelona (RNE1)	Spain	500	D*,J*,K*,N*,P*,R	1143	Stuttgart (AFN)	Germany	10	J*,K*,R*					
747	Flevo (Hilv2)	Holland	400	A*,J*,K,N,R	1143	COPE via ?	Spain	2	J*,K*,N,R*					
756	Braunschweig (DLF)	Germany	800/200	D*,J*,K*,N,R	1152	RNE5 via ?	Spain	10	D*,J*,K*,R*					
756	Bilbao (EI)	Spain	5	K*	1161	Stara Zagora	Bulgaria	500	P*					
756	Redruth (BBC)	UK	2	K*,P*	1161	Strasbourg (Flint)	France	200	D*,G*,J*,K*,N					
765	Sottens	Switzerland	500	D*,J*,K,N,R*	1179	Solvesborg	Sweden	600	D*,G*,H*,J*, K,N,O*,R*					
774	Bonn (WOR2)	Germany	5	R*	1188	Kuurne	Belgium	5	H*,J*,K*,N,R*					
774	RNE1 via ?	Spain	?	D*,J*,K*,R*	1188	Reichenbach (MDR)	Germany	5	R*					
783	Burg	Germany	1000	D*,J*,K*,N*,R	1188	Szolnok	Hungary	135	J*					
783	Miramar (R.Porto)	Portugal	100	J*,K*	1197	Munich (VOA)	Germany	300	D*,J*,Q,R*					
792	Limoges	France	300	D,K,N	1197	Virgin via ?	UK	?	D,K,N,PR					
792	Sevilla (SER)	Spain	20	D*,J*,K*,R*	1206	Bordeaux	France	100	J*,N,R					
792	Londonderry (BBC)	UK	1	P	1215	COPE via ?	Spain	?	J*					
801	Munchen-Ismaning	Germany	300	D*,J*,N*,R	1215	Virgin via ?	UK	?	D,K,N,O,P,Q,R					
810	RNE1 via ?	Spain	?	D*,J*,K*	1224	Virgin via ?	UK	?	K*					
810	Madrid (SER)	Spain	20	J*,K*	1233	Liege	Belgium	5	J*,K*					
810	Westerglen (BBCScot)	UK	100	D,G,H,I*,K*,N,PR	1233	Virgin via ?	UK	?	D,K,N,R					
819	Toulouse	France	50	J*,R	1242	Marseille	France	150	J*,O*					
819	Warsaw	Poland	300	D*,J*,N*,R*	1242	Virgin via ?	UK	?	D,N,P,R					
819	S.Sebastian (EI)	Spain	5	R*	1251	Mercati	Hungary	500	J*					
828	Hannover (NDR)	Germany	100/5	D*,J*,N*,R*	1251	Huisberg	Netherlands	10	D*,J*,K*,R*					
828	Barcelona (SER)	Spain	50	D*,J*,K*,R*	1260	Duba	UAE	600	K*					
831	Alger	Algeria	300	K	1260	SER via ?	Spain	?	D*,J*,K*					
837	Nancy	France	200	D*,J*,K*,P*	1260	Guldford (V)	UK	?	K					
837	COPE via ?	Spain	?	D*,J*,K*,N*	1269	Nunmunder (DLF)	Germany	600	A*,D,J*,K,N,R*					
846	Rome	Italy	540	D*,H,J*,K*,N*,R*	1269	COPE via ?	Spain	?	K					
855	Berlin	Germany	100	D*,I*,K*	1278	Strasbourg	France	300	K					
855	RNE1 via ?	Spain	?	D*,I*,K*,P*,R*	1278	Dublin/Cork (RTE2)	Ireland (S)	10	D,H,K,N,PR*					
864	Samah	Egypt	500	D*,E*,K*,N*	1287	RFE via ?	Czech Rep.	400	J*,K*,R*					
864	Paris	France	300	D*,J*,K,N,PR*	1287	Verida (SER)	Spain	10	K*,N					
864	Socuellamos (RNE1)	Spain	2	E*,R	1296	Valencia (COPE)	Spain	10	J*,K*,N*,R					
873	Frankfurt (AFN)	Germany	150	A*,D*,G*,J*,K,O,R*	1305	Rzeszow	Poland	100	K					
873	Zaragoza (SER)	Spain	20	J*,K*,N	1305	RNE5 via ?	Spain	?	J*,K*,N*,R*					
873	Enniskillen (R.U)	UK	1	P,R	1314	Kvitsov	Norway	1200	A,D,G*,J*,K, M*,N,PR*					
882	COPE via ?	Spain	?	J*,K*,R*	1323	Wachenbrunn (RMWS)	Germany	1000/150	J*,N,R*					
					1332	Rome	Italy	300	J*,K*,N*					
					1341	Lisnagarvey (BBC)	Ireland (N)	100	D,G,H,K,N,PR*					

Note: Entries marked * were logged during darkness. All other entries were logged during daylight or at dawn/dusk.

Listeners:

- A Tim Allison, Middlesbrough.
- B G. Carroll, Bournemouth.
- C Bernard Curtis, Stalbridge.
- D Martin Dale, Stockport.
- E John Eaton, Woking.
- F Francis Hearne, N.Bristol.
- G Sheila Hughes, Morden.
- H Rhoderick Illman, Oxted.
- I Stephen Jones, Oswestry.
- J Eddie McKeown, Newry.
- K George Millmore, Wootton loW.
- L Roy Patrick, Derby.
- M Claire Field, while in Appleby.
- N Martin Price, Shrewsbury.
- O Harry Richards, Barton-on-Humber.
- P Tom Smyth, Co.Fermanagh
- Q John Stevens, Largs.
- R Andrew Stokes, Leicester.

Local Radio Chart

Freq kHz	Station	ILR BBC	e.m.r.p (kW)	Listener	Freq kHz	Station	ILR BBC	e.m.r.p (kW)	Listener
558	Spectrum R	I	7.50	B,J,K,L,P	1161	Tay AM	I	1.40	D,I*,K
585	R.Solway	B	2.00	D,I*,K,L	1161	Humberside (Gt.Yks)	I	0.35	B,K,L
603	Cheltenham (CD603)	I	0.10	B,J,K,N,O,P	1170	GMR Teeside	I	0.32	D,I*
603	Invicta SG (Coast)	I	0.10	J,L,P	1170	Hi Wycombe 1170AM	I	?	O,P
630	R.Bedfordshire (3CR)	B	0.20	B,E,J,K,L,N,O,P	1170	Portsmouth (SCR)	I	0.12	G,J,P
630	R.Cornwall	B	2.00	J	1170	Signal R (S.Gold)	I	0.20	B,K,N
657	R.Clywd	B	2.00	D,H*,J,K,L,O,P	1170	Swansea Sound	I	0.58	D*
657	R.Cornwall	B	0.50	G,J	1242	Invicta Snd (Coast)	I	0.32	P
666	Gemini AM	I	0.34	E,J,P	1242	Isle of Wight R	I	0.50	J
666	R.York	B	0.80	B,D,L,N,P	1251	Saxon R (SGR)	I	0.76	I*,K,L,P
729	BBC Essex	B	0.20	F,J,K,L,M,N,O,P	1260	Brunel R (Cl.Gold)	I	1.60	J,M*
738	Hereford/Worcester	B	0.037	J,K,N,O,P	1260	Marcher Snd (Gold)	I	0.64	B,D,J*,K,O*
756	R.Cumbria	B	1.00	A,D,I*	1260	Sunrise R, Midlands	I	0.29	I*,N,P
756	R.Maldwyn	I	0.63	B,H*,J,K,P	1260	R.York	B	0.50	L
765	BBC Essex	B	0.50	B,D,F,J*,J,L,N,P	1278	Bradford (Gt.Yks)	I	0.43	K,L
774	Gloucester (3CSG)	I	0.14	J,K,N,O,P	1305	Barnsley (Gt.Yks)	I	0.15	B,D,J*,K,L,N,O*
774	R.Kent	B	0.70	J,O,P	1305	Touch R	I	0.20	D,I*,J,P
774	R.Leeds	B	0.50	B,L	1323	R.Bristol (Som.Snd)	B	0.63	P
792	Chiltern (S.Gold)	I	0.27	G,J,K,L,N,O,P	1323	Brighton (SCR)	I	0.50	J,P
792	R.Foyle	B	1.00	D,I*,M	1332	Hereward R (WGMS)	I	0.60	D*,K,L,N,O,P
801	R.Devon & Dorset	B	2.00	G,I*,J,K,M*,N,P	1332	Wiltshire Sound	B	0.30	J,K,P
828	Chiltern (S.Gold)	I	0.20	N,P	1359	Essex R (Breeze-AM)	I	0.28	P
828	R.Aire (Magic828)	I	0.12	B,L	1359	Mercia Snd (Xtra-AM)	I	0.27	D,K,N,O*,P
828	2CR (Cl.Gold)	I	0.27	J	1359	Red Dragon (Touch R)	I	0.20	D
837	R.Cumbria/Furness	B	1.50	D,I*,K	1359	R.Solent	B	0.85	D
837	R.Leicester	B	0.45	B,F,G,J,K,L,N,O,P	1368	R.Lincolnshire	B	2.00	A,D*,L,N,O*,P
855	R.Devon & Dorset	B	1.00	J	1368	Southern Counties R	B	0.50	F,P
855	R.Lancashire	B	1.50	A,B,D,L	1368	Wiltshire Sound	B	0.10	D*
855	R.Norfolk	B	1.50	D,F,J,L,O,P	1431	Essex R (Breeze-AM)	I	0.35	J,P
855	Sunshine R	I	0.15	E,K,N,P	1431	R 210 (Cl.Gold)	I	0.14	J,L,P
873	R.Norfolk	B	0.30	F,J,K,L,N,P	1449	R.Peterboro/Cambs	B	0.15	I*,J,K,L,N,O*,P
936	Brunel R (Cl.Gold)	I	0.18	G,J,K,O,P	1458	Fortune	I	5.00	B,D,I*,K,M,O
945	R.Trent (Gem AM)	I	0.20	B,D,I,J,K,L,N,O,P	1458	R.Cumbria	B	0.50	D
954	Gemini AM	I	0.32	G,J,P	1458	R.Devon & Dorset	B	2.00	J
954	R.Wyvern (WYVN)	I	0.16	D,E,J,K,L,N,O,P	1458	R.Newcastle	B	2.00	D
990	WABC (Nice & Easy)	I	0.09	B,K,N,O	1458	Radio WM	B	5.00	D
990	R.Devon & Dorset	B	1.00	J	1458	Sunrise R	I	50.00	B,D,I*,J,L,N,P
990	Hallam R (Gt.Yks)	I	0.25	B,L,P	1476	Guildford (M.Xtra)	I	0.50	D,I*,J,K,P
999	R.Solent	B	1.00	C,F,J,P	1485	R.Humberside (Hull)	B	1.00	A,F,I*,L,O*
999	R.Trent (Gem AM)	I	0.25	K,L,N,P	1485	R.Merseyside	B	1.20	B,D,I*,K,M
999	Red Rose (Gold)	I	0.80	A,B,D,M	1485	Southern Counties R	B	1.00	F,J,N,P
1017	Beacon R (WABC)	I	0.70	B,D,J,K,L,N,P	1503	R.Stoke-on-Trent	B	1.00	B,D,F,I*,J*,K,L,N,P
1026	Downtown R	I	1.70	D,M	1521	Reigate (M.Xtra)	I	0.64	D,I*,J,K,P
1026	R.Cambridgeshire	B	0.50	B,F,L,N,O,P	1530	Huddersfield (Gt.Yks)	I	0.74	B,D,K,L
1026	R.Jersey	B	1.00	F,J,P	1530	R.Essex	B	0.15	F,J*,P
1035	Country 1035	I	?	B,D*,J,K*,M*,P	1530	R.Wyvern (WYVN)	I	0.52	D,I*,J,K,N
1035	NorthSound Two	I	0.78	D,I*,O	1548	Capital R (Cap G)	I	97.50	J,M,P
1035	R.Sheffield	B	1.00	B,L,N	1548	R.Bristol	B	5.00	J
1035	West Sound AM	I	0.32	D,I*,K*	1548	Liverpool (City G)	I	4.40	B,J*,K
1107	Moray Firth R	I	1.50	D,F,I*	1548	R.Forth (Max AM)	I	2.20	D,I*
1116	R.Derby	B	1.20	B,D,F,I*,K,L,N,O,P	1548	Sheffield (Gt.Yks)	I	0.74	L,N
1116	R.Guernsey	B	0.50	F,J,P	1557	Northants R (S.Gold)	I	0.76	A,D*,L,N,O*
1152	BRIMB (Xtra-AM)	I	3.00	E,K,N,O	1557	Southampton (SCR)	I	0.50	J,P
1152	LBC (London Newstalk)	I	23.50	G*,J,P	1557	R.Lancashire	B	0.25	I*,K
1152	Piccadilly R (Gold)	I	1.50	B,K	1557	Tendring (Mellow)	I	0.125	P
1152	R.Broadland	I	0.83	B,I*,P	1584	Kettering (KCBG)	I	0.04	F,N,O*,P
1152	R.Clyde (Clyde 2)	I	3.06	D	1584	R.Nottingham	B	1.00	B,D*,F,I*,L,M*,N,P
1161	Brunel R (Cl.Gold)	I	0.16	J,K,P	1584	R.Shropshire	B	0.50	F,K
1161	R.Bedfordshire (3CR)	B	0.10	N,O,P	1584	R.Tay	I	0.21	D,I*,K
1161	Southern Counties R	B	1.00	F,J,P	1602	R.Kent	B	0.25	D,I*,J,K,O*,P

Note: Entries marked * were logged during darkness. All other entries were logged during daylight or at dawn/dusk.

Listeners:

- A Tim Allison, Middlesbrough.
- B Martin Dale, Stockport.
- C John Eaton, Woking.
- D Arthur Grainger, Carstairs Junction.
- E Francis Hearne, N.Bristol.
- F Sheila Hughes, Morden.
- G Rhoderick Illman, Oxted.
- H Stephen Jones, Oswestry.
- I Eddie McKeown, Newry.
- J George Millmore, Wootton, IoW.
- K Martin Price, Shrewsbury.
- L Harry Richards, Barton-on-Humber.
- M Tom Smyth, Co.Fermanagh.
- N Andrew Stokes, Leicester.
- O Norman Thompson, Dabdy.
- P John Wells, East Grinstead.

1800) 33223 at 1510 in Rugby.
 Also heard in the day were Slovak R.Int, via Velke Kostolany 11.990 Eng to Aust 0830-0857) SIO544 at 0830 in Scalloway; FEBC Philippines 11.690 (Eng to China 0930-1100) 32332 at 0945 in Kilkeel & 11.995 (Eng to India, SE.Asia 1300-1600) 34553 at 1410 by **John Parry** in Larnaca, Cyprus; ERA Thessaloniki 11.595 (Gr to Eu 1000-2255) SIO455 at 1100 in Edinburgh; R.Georgia, Dusheti 11.815 (Eng to Eu 1100-1130) SIO322 at 1110 in Macclesfield; Polish R, Warsaw 11.815 (Eng to Eu 1300-1355) SIO433 at 1300 by **Tony King** in Swindon; RCI via Sines 11.915 (Eng to Eu, M.East, Africa 1430-1500) 54454 at 1440 in Burnham-on-Crouch & via Skelton 11.935 (Eng, Fr to Eu, M.East 1430-1600) 44444 at 1452 in Penmaenmawr.

Later, AIR via Bangalore 11.620 (Eng, Hi to Eu 1745-2230) 44444 at 1745 in Morden; R.Pakistan, Islamabad 11.570 (Ur, Eng to Eu 1700-1855) 43333 at 1830 in Stalbridge; R.Netherlands via Talata Volon 11.655 (Eng to C/W.Africa 1930-2025) 34332 at 2025 in Middlesbrough; R.Japan via Moyabi 11.925 (Eng to Eu 2100-2155) 32323 at 2100 in Bishops Stortford; RCI via Sackville 11.945 (Eng to Eu, M.East, Africa 2100-2230) 44444 at 2100 by **Garry Crawford** in Kennoway; R.Havana, Cuba 11.720 (Eng to Eu 2100-2200) 33333 at 2130 in Appleby; also 11.740 (Sp? to Eu 2100-2200) 43343 at 2130 in Wigan; R.Nac da Amazonia, Brazil 11.780 (Port 0900-0200) 35543 at 2150 in Wallsend.

Sometimes R.New Zealand's signals in the **9MHz (31m)** band have reached here. During favourable conditions their 100kW signal on 9.700 (Eng to Pacific areas 0759-1300) was SIO433 at 0934 in Rotherham and SIO344 at 1200 in Edinburgh. Some R.Australia's signals have also been heard here - 9.510 from Carnarvon (Eng, Chin to Asia 0900-1200) was 42332 at 0900 in Bushey Heath & 9.770 (Eng to Asia 1430-1630) 44344 at 1410 in Penmaenmawr; 9.860 from Shepparton (Eng to Pacific, Asia 0630-1200) SIO222 at 1112 in Macclesfield and 9.615 from Darwin (Eng to S.Asia 1100-1428) 23322 at 1258 in Burnham-on-Crouch.

Although beamed to other areas, broadcasts from the Voice of Greece, Athens 9.425 (Gr to M.East 1100-1150) rated 44444 at 1130 in Rugby;

1400-1455) SIO312 at 1235 in Macclesfield; AIR via Aligarh 15.120 (Eng to SE.Asia 1330-1500) 33222 at 1330 in Newry; Voice of Vietnam, Hanoi 15.010 (Fr, Eng to ? 1300-1400) 43344 at 1335 in Wigan; RCI via Sines 15.325 (Eng to Eu, M.East, Africa 1430-1500) SIO444 at 1430 by **Tom Smyth** in Co.Fermanagh; R.Japan via Moyabi 15.355 (Eng to S.Africa 1500-1600) 32323 at 1500 in Oadby; Channel Africa via Meyerton 15.240 (Eng to C/W Africa 1600-1700) 32442 at 1612 in Woking; WVHA via Scotts Corner 15.665 (Eng to Eu 1500-1655 Tues) 44544 at 1615 in Bridgwater.

In the evening RNB Brazil 15.265 (Port, Eng, Ger to Eu 1630-2020) was 21212 at 1800 by **John Sadler** in Bishops Stortford; WEWN Birmingham 15.695 (Eng to Eu 1900-2000) 43223 at 1930 in Stalbridge; R.Netherlands via Bonaire 15.315 (Eng to S/E/W.Africa 1830-2025) 32233 at 2000 by **Martin Dale** in Stockport; HCJB Quito 15.490 (Eng to Eu 1700-2000) 45323 at 1930 in Ross-on-Wye; RCI via Sackville 15.325 (Fr to Eu 2000-2100) 32322 at 2000 in Oadby; WRNO New Orleans 15.420 (Eng to E.U.S.A, Eu 1500-2300) 25222 at 2033 in Burnham-on-Crouch; KTBN

Salt Lake City 15.590 (Eng to N.Am 1600-0000) 32222 at 2045 in Kilkeel; R.New Zealand Int via Rangataiki 15.115 (Eng to Pacific areas 2051-0715) 34333 at 2121 in Bushey Heath; RAE Buenos Aires 15.345 (Sp, Eng, It, Fr, Ger to Eu, Africa 1800-2300) 25532 at 2158 in Wallsend.

Good reception was noted from some areas in the **13MHz (22m)** band. In the morning R.Netherlands via Irkutsk 13.700 (Eng to Pacific 0830-0925) was 35323 at 0830 in Newry; SRI via Sottens? 13.685 (It, Eng, Fr, Ger, Port to Aust, S.Pacific 0830-1100) heard at 0900 in Appleby; Monitor R.Int via KHBI 13.615 (Eng to Oceania 0800-1000) 34333 at 0909 in E.Worthing; BBC via Rampisham 13.745 (Russ to Eu 1030-1130) SIO444 at 1117 in Macclesfield; R.Tashkent, Uzbekistan 13.785 (Eng to S.Asia 1200-1228) 44333 at 1200 in Morden.

In the afternoon RFI via Fr.Guiana? 13.625 (Eng to C.Am 1200-1300) was 35222 at 1205 in Bridgwater; UAER, Dubai 13.675 (Eng to Eu 1330-1355) SIO444 at 1330 in Edinburgh & (Eng to Eur 1600-1640) 32323 at 1600 in Bishops Stortford; R.Tashkent,

Uzbekistan 13.785 (Eng to S.Asia 1330-1358) 35553 at 1350 in Wallsend; R.Netherlands via Flevo 13.700 (Eng to S.Asia, M.East 1330-1525) 34443 at 1514 in Woking; R.Austria Int via Moosbrunn 13.730 (Ger, Eng, Fr, Sp to Eu 0400-1800) 44444 at 1531 by **Peter Pollard** in Rugby.

Later, WHRI South Bend 13.760 (Eng to E.U.S.A, Eu 1500-2200) 45334 at 1912 in Burnham-on-Crouch; VOA via Selebi-Phikwe 13.710 (Eng to Africa 1630-2200) 34433 at 1943 in Lisnaskea; RCI via Sackville 13.650 (Eng to Eu, M.East, Africa 2100-2230) 24231 at 2118 in Oxted; WYFR via Okeechobee 13.695 (Eng to Eu, Africa 2000-2300) 43343 at 2140 in Bushey Heath; R.Austria Int via Moosbrunn 13.730 (Ger, Sp, Eng to S.Am 2200-0400) 11221 at 2330 in Stockport; KAIJ Denton 13.740 (Eng to N/C.Am 2300-0200) 32332 at 0035 in Kilkeel.

In the **11MHz (25m)** band R.Australia was noted on 11.800 from Shepparton (Eng to Asia 1200-1630) as 21321 at 1200 in Newry, 11.695 (Eng to Pacific 1430-1700) 22432 at 1522 in Woking, 11.880 (Eng to Asia 1630-2100) 22222 at 1630 in Norwich; 11.660 from via Carnarvon (Eng to S.Asia 1430-

Tropical Bands Chart

Freq MHz	Station	Country	UTC	DXer	Freq MHz	Station	Country	UTC	DXer
2.310	ABC Alice Springs	Australia	2044	F,G	4.925	R.Nacional, Bata	Eq.Guinea	1911	A,L,M
2.325	ABC Tennant Creek	Australia	1817	FG	4.927	RRI Jambi	Indonesia	2323	F
2.485	ABC Katherine	Australia	1916	G	4.931	RInternacional	Honduras	2358	P
2.850	KCBS Pyongyang	N. Korea	2037	F	4.935	KBC Gen Sce Nairobi	Kenya	2030	A
3.200	TWR Manzini	Swaziland	1923	G	4.940	AIR Guwahati	India	1507	G
3.220	R.HCJB Quito	Ecuador	0340	K	4.950	R.Nacional, Mulenvos	Angola	2151	G,L
3.223	AIR Simla	India	1730	B,G	4.955	R.Cultura, Campos	Brazil	0025	B
3.230	R.Sol de Los Andes	Peru	0015	B	4.965	R.Alvorada	Brazil	0040	B
3.240	TWR Shona	Swaziland	1838	G	4.970	PBS Xinjiang	China	1402	G,P
3.245	AIR Lucknow	India	0200	B,G,P	4.970	R.Rumbos, Caracas	Venezuela	0045	B
3.255	BBC via Maseru	Lesotho	1925	G,K	4.975	R.Uganda, Kampala	Uganda	2050	A,K,L,N,Q
3.270	SWABC 1, Namibia	S.W.Africa	1957	B,G,I,L	4.980	PBS Xinjiang, Urumqi	China	1424	B,G
3.277	AIR Srinagar	India	1732	G	4.980	Ecos del Torbes	Venezuela	2300	A,B,F,H,K,M,P
3.290	SWABC 2, Namibia	S.W.Africa	1807	B,G	4.985	R.Brazil Central	Brazil	0050	B,K
3.295	AIR Ranchi?	India	1457	G,P	4.990	AIR Ext. Service	India	0011	B,K
3.300	R.Cultural	Guatemala	0253	B,K	4.990	FRCN Lagos	Nigeria	1908	A,K,L,O
3.306	ZBC R-2?	Zimbabwe	2034	G,J,L,R	4.990	R.Ancash, Huaraz	Peru	0105	B
3.315	AIR Bhopal	India	1458	B,G,P	5.005	R.Libertad, La Paz	Bolivia	0349	K
3.316	SLBS Godesherch	Sierra Leone	0117	K	5.005	R.Nepal, Kathmandu	Nepal	1641	G,P
3.325	R.Liberal	Brazil	0230	B	5.010	R.Garoua	Cameroon	0027	K
3.325	FRCN Lagos	Nigeria	0445	F,K	5.010	Guangxi 2, Nanning	China	0055	P
3.355	AIR Kurseong	India	1459	G,K	5.010	AIR Thiru'puram	India	0105	B,P
3.356	R.Botswana	Gaborone	1958	L	5.020	Voz del Upano, Macas	Ecuador	0050	B
3.359	RTV Malagasy	Madagascar	1806	G	5.020	La V du Sahel, Niamey	Niger	1901	A,B,L
3.365	R.Rebelde, La Julia	Cuba	0220	B	5.025	R.Parakou	Benin	1901	A,L,P
3.365	GBC R-2	Ghana	2144	A,B,E,F,I,K,L,P	5.025	R.Rebelde, Habana	Cuba	0055	B,K,P
3.365	AIR Delhi	India	1500	G,P	5.025	R.Uganda, Kampala	Uganda	2018	K,Q
3.375	R.Nacional S.Gabriel	Brazil	1816	B,G	5.030	AWR Latin America	Costa Rica	0630	R
3.377	R.Nacional, Mulenvos	Angola	2240	D	5.030	R.Continente Caracas	Venezuela	0351	K
3.380	NBC Blantyre	Malawi	1734	G,L	5.035	R.Aparecida	Brazil	0110	B
3.385	RFO Cayenne	Guiana	0010	B	5.035	R.Bangui	C.Africa	2100	A,B,K,P
3.395	ZBC Gweru	Zimbabwe	0315	J	5.040	Voz del Upano, Macas	Ecuador	0025	B
3.915	BBC via Kranji	Singapore	1735	C,E,H,K,L,P	5.045	R.Cultura do Para	Brazil	0125	A,B,K
3.940	PBS Hubei Wuhan	China	2327	E	5.047	R.Togo, Lome	Togo	1903	A,B,F,K,L,P
3.945	AIR Gorakhpur	India	1501	G	5.050	Voz del Yopal, Yopal	Colombia	0030	A,P
3.950	Qinghai PBS, Xining	China	0015	B,E,P	5.050	R.Tanzania	Tanzania	1942	K,L
3.955	BBC via Skelton	England	2356	B,D,E,F,H,K,S	5.055	RFO Cayenne(Matoury)	Fr. Guiana	2020	B,K
3.955	R.Budapest	Hungary	2200	N,O	5.060	PBS Xinjiang, Urumqi	China	0055	B,G,P
3.960	RFE/RL Biblis	Germany	2154	E,K	5.060	Sist d'Em Progreso	Ecuador	0110	B
3.965	RFI Paris	France	2256	B,D,E,H,K	5.075	Caracol Bogota	Colombia	0015	A,B,F,K,M,P
3.970	RFE Biblis	Germany	2020	B	5.083	R.Mundo, Cusco	Peru	0030	B
3.975	R. Korea via Skelton	England	2045	K					
3.975	R.Budapest	Hungary	2020	H					
3.980	VOA via Munich	Germany	2244	B,H,K					
3.985	China R via SRI	Switzerland	2200	H,N,S					
3.985	SRI Beromunster	Switzerland	2105	B,H,I,K,N,Q					
3.990	Xinjiang BS, Urumqi	China	1434	G					
3.990	RFE via ?	Germany	2243	K					
3.995	DW via Julich	Germany	2046	B,K					
4.330	Xinjiang BS, Urumqi	China	1401	G					
4.500	Xinjiang BS, Urumqi	China	0013	F,K					
4.735	Xinjiang, Urumqi	China	0015	A,B,G,K					
4.755	R.Educ CP Grande	Brazil	0100	B,K					
4.760	AIR Port Blair	India	1728	G					
4.760	ELVA Monrovia	Liberia	2020	A,G,K					
4.765	R.Integracao	Brazil	0030	B,K					
4.775	FRCN Kaduna	Nigeria	1926	A,F,K,L,M,P					
4.775	AIR Guwahati	India	0050	B,G					
4.783	RTM Bamako	Mali	2030	A,K					
4.786	Ecos del Combeima	Colombia	0256	K					
4.790	AIR Shillong	India	1730	M					
4.790	Azad Kashmir R.	Pakistan	1802	B,G					
4.790	TWR Manzini	Swaziland	1706	L					
4.800	CPBS 2 Beijing	China	2302	E,F					
4.800	AIR Hyderabad	India	1706	E,G,H,L,M					
4.800	LNBS Lesotho	Maseru	1812	A,G,K					
4.805	R.Nac.Amazonas	Brazil	0010	B,E,K					
4.810	R.San Martin Tara	Peru	0050	B,E					
4.810	SABC Meyerton	S.Africa	2200	A,P					
4.815	R.Difusora, Londrina	Brazil	0025	B					
4.815	R.diff TV Burkina	Ouagadougou	2104	A					
4.820	La Voz Evangelica	Honduras	0022	B,K					
4.820	AIR Caicutta	India	1504	G					
4.828	ZBC R-4	Zimbabwe	1944	G,L					
4.830	R.Botswana, Gaborone	Botswana	2111	A,K					
4.830	R.Tachira	Venezuela	0005	A,B,F,K,P					
4.832	R.Reijo	Costa Rica	0815	FR					
4.835	ABC-Alice Springs	Australia	2142	L,P					
4.835	R. Tzetzulutan, Coban	Guatemala	0033	B,E,P					
4.835	RTM Bamako	Mali	1943	A,B,H,K,L,P					
4.840	R.Interoceanica	Ecuador	0040	B					
4.840	AIR Bombay	India	1505	B,G,H,M					
4.845	RTM Kuala Lumpur	Malaysia	1631	P					
4.845	ORTM Nouakchott	Mauritania	2000	A,B,K,L					
4.850	R.Yaounde	Cameroon	2252	A,B,K					
4.850	AIR Kohima	India	0050	B					
4.850	Ulan Bator 1	Mongolia	0115	P					
4.860	AIR Kingsway(Feeder)	India	1708	A,E,G,H,L,M					
4.865	PBS Lanzhou	China	2209	A,F,P					
4.865	L.V. del Cinaruco	Colombia	0020	B					
4.870	R.Otonou	Benin	1923	A,L					
4.875	R.Roraima, Boa Vista	Brazil	0012	P					
4.879	R.Bangladesh	Bangladesh	1445	G					
4.885	R.Clube do Para	Brazil	0035	B,K					
4.885	KBC East See Nairobi	Kenya	1912	A,K,L					
4.890	RFI Paris	via Gabon	0358	K					
4.890	R.Port Moresby	New Guinea	2007	F					
4.895	Voz del Rio Arauca	Colombia	0045	B,K					
4.895	Pakistan BC	Pakistan	1709	G,K,L,M					
4.900	V. of the Strait 2	China	0000	A					
4.900	SLBC Colombo	Sri Lanka	1524	G					
4.905	R.Nat. N'djamena	Chad	1940	A,F,K,L					
4.910	Tennant Creek	Australia	2134	L,P					
4.910	V. de la Mosquitia	Honduras	0008	P					
4.910	R.Zambia, Lusaka	Zambia	2130	A,G					
4.915	GBC-1, Accra	Ghana	2132	A,B,F,K,L,M,P					
4.920	R. Quito	Ecuador	0759	F					
4.920	AIR Madras	India	1709	G,K,L					

Broadcasters using the **7MHz (41m)** band to reach Europe include R.Japan via Skelton 7.230 (Jap, Eng 0500-0800) 54444 at 0700 in Appleby; Croatian R. via Deanovec 7.370 (News in Eng 0803 Sun) 45554 at 0805 in Wallsend; R.Korea, Seoul 7.550 (Eng 0800-0900) SIO433 at 0830 in Scalloway; R.Prague, Czech Rep 7.345 (Eng 1130-1157) SIO322 at 1130 in Co.Fermanagh; R.Netherlands via Nauen 7.130 (Eng 1130-1325) 43333 at 1145 in Stalbridge; Polish R, Warsaw 7.145 (Eng 1300-1355) SIO433 at 1300 in Swindon; AIR via Aligarh? 7.412 (Hi, Eng 1745-2230) 55333 at 1847 in Ross-on-Wye; R.Romania Int, Bucharest 7.195 (Eng 1900-1956) 32333 at 1940 in Newry; R.Budapest, Hungary 7.220 (Eng 2000-2030) 32132 at 2000 in Bishops Stortford; DW via Sines 7.285 (Eng 2000-2050) 43333 at 2030 in Morden; Israel R, Jerusalem 7.490 (Heb [Home Sce relay] 1800-0400, also to USA) heard at 2100 in Bournemouth; China R.Int via Russia 7.170 (Eng 2200-2257) 54444 at 2204 in Bushey Heath; WYFR via Okeechobee 7.355 (Sp 2200-2300) 43444 at 2205 in Rugby; R.Ukraine Int, Kiev 7.240 (Eng 2200-2300) 44344 at 2248 in Woking.

Some of the many broadcasts to other areas came from the Voice of Nigeria via Ikorodu 7.255 (Eng to W.Africa 0455-0700) 34333 at 0624 in Burnham-on-Crouch; WHRI South Bend 7.315 (Eng to E.USA 2300-1300) SIO444 at 0745 in Rotherham; R.Australia via Carnarvon 7.260 (Eng to S.Asia 1430-2100) SIO433 at 1430 in Edinburgh; VOA via Selebi-Phikwe 7.415 (Eng to Africa 1900-2200) 34223 at 1929 in Middlesbrough; R.Nacional de Angola 7.245 (Port 2200-2300) 22222 at 2248 in E.Worthing; WRNO New Orleans 7.355 (Eng to E.USA 2300-0300) 35333 at 2300 in Derby; R.Bulgaria via Plovdiv 7.205 (Eng to N.Am 0000-0100) 54444 at 0007 in Norwich; KTBN via Salt Lake City 7.510 (Eng to N.Am 0000-1600) 33333 at 0130 in Kilkeel.

In the **6MHz (49m)** band R.Japan via Skelton 5.975 (Jap, Eng to Eu 0500-0800) was SIO323 at 0130 in Co.Fermanagh; Polish R. Warsaw 6.135 (Eng to Eu 1300-1355) SIO222 at 1300 in Swindon; VOA via Philippines? 6.110 (Eng to S.Asia 1400-1800) 23552 at 1435 in Larnaca; R.Sultanate of Oman via Seeb 6.085 (Ar to M.East 1700-2200) was 'just audible' at 1920 in Oxted; R.Pyongyang, Korea 6.576 (Eng, Fr to Eu, M.East, Africa 2000-2150) 24122 at 2150 in Rugby; R.Vlaanderen Int, Belgium 5.910 (Eng to Eu 2200-2255) heard at 2210 in Bournemouth; VOFC Taiwan via WYFR? 5.810 (Eng to Eu 2200-2300) SIO222 at 2240 in Rotherham; RCI via Sackville 5.960 (Eng to USA 2200-0000) SIO222 at 2327 in Elgin & via Sines 6.150 (Eng to M.East 0400-0430) 44344 at 0405 in Norwich; R.Netherlands via Bonaire 6.165 (Eng to N.Am 2330-0125) 53433 at 0043 in Ross-on-Wye; BBC via Antigua 5.975 (Eng to C/S.Am 2100-0600) 44433 at 0046 in E.Worthing; DW via Antigua 6.040 (Eng to N.Am 0100-0150) SIO433 at 0115 in N.Bristol.

- ### Station Addresses
- BBC Southern Counties Radio**, Broadcasting Centre, Guildford, Surrey. GU2 5AP.
 - ILR Radio City (Gold)**, P.O.Box 967, Liverpool L69 1TQ.
 - Radiodiffusion Algerienne**, 21 Boulevard des Martyrs, Alger, Algeria.
 - Radio Dniester International**, ul. 25 Oktyabrya 45, 278000 Tiraspol, Moldova.
 - Radio Free Europe**, Oettingenstrasse 67, 80538 Munich, Germany.
 - Etablissement de la Radiodiffusion TV Tunisienne (ERTT)**, 71, Avenue de la Liberte, Tunis, Tunisia.

Note: Entries marked * were logged during darkness. All other entries were logged during daylight or at dawn/dusk.

- ### DXers:
- A Darren Beasley, Bridgwater.
 - B Robert Connolly, Kilkeel.
 - C Bernard Curtis, Stalbridge.
 - D Ron Damp, Worthing.
 - E John Eaton, Woking.
 - F David Edwardson, Wallsend.
 - G Gordon Smith, Kingston, Moray.
 - H Sheilla Hughes, Morden.
 - I Rhodence Illman, Oxted.
 - J Paul Logan, Lisnaskea.
 - K Eddie McKeown, Newry.
 - L Fred Pallant, Storrington.
 - M Roy Patrick, Derby.
 - N Clare Pinder, while in Appleby.
 - O Peter Pollard, Rugby.
 - P Richard Reynolds, Guildford.
 - Q Chris Shorten, Norwich.
 - R John Slater, Scalloway.
 - S Tom Smyth, Co.Fermanagh.

Monitor R.Int, via KHBI 9.355 (Eng to NE.Asia 1300-1600) 34553 at 1500 in Larnaca; R.Netherlands via Talata Volon 9.605 (Eng to S/E/W.Africa 1730-1930, C/W.Africa 1930-2025) 43433 at 1819 in Ross-on-Wye; DW via Kigali? 9.615 (Eng to W.Africa 2100-2150) SIO323 at 2100 in Swindon; UAER, Abu Dhabi 9.605 (Eng to W.USA 2200-0000) 43433 at 2256 in Stockport; RFI via Montsiner 9.800 (Sp to N.Am 2300-0000) 43433 at 2300 in Wigan; R.Bulgaria via Plovdiv 9.700 (Eng to N.Am 0000-0100) SIO444 at 0045 by Francis Hearne in N.Bristol; R.Nac del Paraguay 9.735 (Sp 0800-0400) 33553 at 0127 in Wallsend.

Some intended for European listeners came from R.Jordan via Al Karanah 9.560 (Ar, Eng 1500-1730) SIO322 at 1500 in Co.Fermanagh; VOA via Gloria 9.760 (Eng 1700-2100, also to N.Africa, M.East) 44444 at 2016 in Morden; R.Thailand, Bangkok 9.655 (Eng 2030-2045) heard at 2035 in Bournemouth; Voice of Turkey, Ankara 9.400 (Eng 2100-2150) 35242 at 2105 in Bridgwater; Monitor R.Int via WSHB 9.355 (Eng 2000-2200) 44444 at 2128 in Oxted; R.Cairo via Abis 9.900 (Eng 2115-2245) 44431 at 2227 in E.Worthing; R.Vilnius, Lithuania 9.710 (Eng 2230-2259) SIO444 at 2230 in Scalloway.

Watching Brief

Our Quarterly Look at Amateur Television

Technology is the subject of this quarter's article, clearing up a couple of FAQs or Frequently Asked Questions.

What's the difference between a sync stabiliser and a time-base corrector? Will one do the job of the other and where can I get them?

There seems to be a bit of confusion over these two devices, that perform very different functions, so let's look first at the problem and then how we can solve it. Technical experts who think these explanations are a bit simplified are correct - they are, deliberately.

To display a video signal reliably, you need both picture information and synchronising information. This applies equally to over-the-air signals (amateur and broadcast), cable TV, satellite TV and the video signal coming off tape, and if the sync signals are weak or distorted, you cannot expect to see a proper signal. In amateur television, the sync's are often weak or defective because the signal has come a long way (propagation loss) or because the signal was not transmitted in a linear fashion in the first place! Hands up all licensed amateurs who monitor their transmitted signal with an off-air probe - not as many as I'd like to see!

DX television reception can suffer in the same way, whilst some satellite and cable TV signals have the syncs suppressed intentionally, so that only authorised viewers can see them (with a special decoder that reconstructs the sync signals).

Finally, in the case of video recordings, people sometimes have difficulty making stable copies from existing tapes, either because the first tape is a multiple generation copy (copy of a copy of a copy) or because the master tape has been 'nobbled' with Macrovision or some similar technique to prevent copying.

In most of these situations a sync restorer will help. The sync restoration circuit takes the video signal, strips out the old syncs that are weak or distorted and inserts brand new syncs. It may perform other processing as well to ensure the video signal has the proper 70:30 sync-to-video ratio. A circuit for a sync restorer was published in the BATC magazine CQ-TV many issues ago, but it required a lot of patience in setting up to make it work well.

Commercial devices for the same purpose can be found among the small ads of satellite television and home video magazines. The first type costs about £100 and is a proper professional device (and at that price you'd expect it to be). The second

Remarkably good pictures can be received on amateur television, especially when conditions are good. Here ON5NY in Belgium, shows his 24cm receiver to PE1LRS in the Netherlands - going via the Lowestoft (UK) repeater. Photo Paul Godfrey G8JBO.



type go under the 'Bug Blaster' name (or something similar) and costs about £40 or £50. You can recognise them by the advertisements that rattle on about not using them to duplicate copyright films.

I haven't bought one of these, but another amateur who did said the product he bought was rubbish and not of merchantable quality; I suppose people are unlikely to complain that the pirate device they have just bought doesn't work!

Finally, I am told that the Panasonic video mixers have an effective sync regenerator circuit built-in (but you might not feel very keen about spending £700 or more just to get this facility).

What do time-base correctors do, then? Don't they also clean up video recordings with rolling pictures and wacky syncs? Well, yes and no. With all analogue video recordings a bit of instability is introduced by the recording process and a perfectly stable signal going in may not come out quite as good when replayed, particularly in a different machine. This is because the head drums are not always 100% round and in effect the tape speed is not absolutely constant.

The aberrations are trifling to begin with, but when a tape is copied, particularly on a machine with different characteristics, the errors are compounded. You can prove this to yourself by examining what's known as horizontal jitter. Look at vertical lines on a VHS recording (e.g. telegraph poles or lamp posts) and see how they look fuzzy. Now copy that tape several times and note how the vertical edges look far more indistinct. This is down to minute timing errors and the syncs are affected in the same way.

A time-base corrector minimises this by playing the signal off tape through a framestore buffer. The best way I can describe this is as a kind of mangle that smoothes out minor 'crinkles' in the picture. Several of the better

Panasonic video recorders have a time-base corrector (TBC) built-in nowadays and the improvement in picture quality is remarkable, particularly if you intend to re-record the programmed. You can get stand-alone time-base correctors but there are no consumer price models on the market. Professional models will be close to broadcast standard and way outside your budget, but if you check out the rally bargains and the second-hand lists of the pro video dealers, you can sometimes pick up a five-to-ten year old TBC for around £250. Don't expect any guarantee or paperwork with it at that price, though.

I use the little VHS-C cassettes in my camcorder. When I come to edit them to full-size VHS, will I get better results by playing them back in the camcorder or using an adapter in a normal VHS deck?

Good question: there's no easy answer. Camcorders are optimised for recording, not for playing back, so in theory you should get better results (with better picture processing) in a full-size deck, particularly if it uses a larger head drum size (for better speed regulation) and has an on-board TBC. That's the theory.

In practice, there's always the time-base error that I mentioned before between different machines, particularly when recorder and player use different size video head cylinders and tape wrap methods. Your best policy is to make a test and see which procedure gives better results.

Incidentally, the same applies with 8mm tapes, although more people use the camcorder to play back, simply because bench playback machines for 8mm are rather expensive and less common, relatively speaking.

If you have some pressing question about amateur television or video, do send it in. If it's of general interest, I'll answer it here in this column (but no personal replies unless accompanied by £50 notes - hi!).

Air Supply,
83b High Street,
Yeadon, Leeds LS19 7TA

Holdings Amateur Electronics,
45 Johnston Street,
Blackburn BB2 1EF

Amateur Radio Communications Ltd,
38 Bridge Street,
Newton-le-Willows,
Merseyside WA12 9BA

AMDAT,
4 Northville Road,
Northville,
Bristol BS7 0RG

BBC World Service Bookshop,
Bush House,
Strand,
London WC2 4PH

Bredhurst Electronics Ltd,
High Street,
Handcross,
Haywards Heath,
West Sussex RH17 6BW

Cirkit Distribution Ltd,
Park Lane,
Broxbourne,
Herts EN10 7NQ

Electronics Equipment Bank,
323 Mill Street NE,
Vienna,
VA 22180, USA

Flightdeck,
192 Wilmslow Road,
Heald Green,
Cheadle, Cheshire SK8 3BH

Haydon Communications,
132 High Street,
Edgware,
London HA8 7EL

Lowe Electronics Ltd,
Chesterfield Road,
Matlock,
Derbyshire DE4 5LE

Lowe Electronics,
Retail Branches:
79/81 Gloucester Road,
Patchway,
Bristol BS12 5JW

152 High Street,
Chesterton,
Cambridge CB4 1NL

34 New Briggate,
Leeds LS1 6NU

Communications House,
Chatham Road,
Sandling, Maidstone ME14 3AY

Mitford House,
Newcastle International Airport,
Woolsington,
Newcastle-upon-Tyne NE20 9DF

117 Beaumont Road,
St Judes, Plymouth PL4 9EF

3 Weavers Walk,
Northbrook Street,
Newbury,
Berkshire

Martin Lynch,
140-142 Northfield Avenue,
Ealing, London W13 9SB

OSL Communications,
Unit 6,
Worle Industrial Centre,
Corker Road,
Worle, Western Super-Mare BS22 0B

The Radio Place,
5675-A Power Inn Road,
Sacramento, CA95824, USA

Tucker Electronics,
1801 Reserve Street,
Gasland, TX 75042,
USA

Ward Electronics,
422 Bromford Lane,
Ward End,
Birmingham B8 2RX

Waters & Stanton,
22 Main Road,
Hockley,
Essex,
SS5 4QS

12 North Street,
Hornchurch,
Essex

BARTON COMMUNICATIONS

AMATEUR RADIO 01325 377086

WE WILL MATCH ANY ADVERTISED PRICE ON NEW YAESU EQUIPMENT

MAGNETIC BALUN FOR RECEIVING ANTENNAS

Matches usual high impedance of long wire to coaxial cable, supplied with mounting stud and insulator to attach to bracket to take standard 1/8" threaded vertical whip or usual long wire.

BALUN **£21.45** COMPLETE ANTENNA KIT **£27.95**
£1.50 p&p

 **NEW SHOWROOM OPEN** 

BARTON PARK, BARTON, RICHMOND, N YORKS DL10 6BN
1 MILE FROM SCOTCH CORNER

GROSVENOR SOFTWARE (G4BMK)

AMTOR - PACTOR - RTTY Are you missing out?

The amateur bands are busy with the sounds of Factor. Mailboxes • Bulletin Boards • DX Stations • Pictorial QSOs.

BMK-MULTY is excellent for monitoring both high and low speed Pactor, as well as CW, RTTY, Amtor, NAVTEX etc. You need a PC, BARTG modem (£62) and your chosen selection of BMK-Multy software. Use the modem with JVFXA tool

Complete 8-mode program with matching modem £182.

Pactor + RTTY + Amtor + CW (software only) £81.

Single modes from £15. Interface for the PK-232 £29 + software. Atari ST/STE - Amtor, CW and RTTY available.

Send SAE for full details.

GROSVENOR SOFTWARE (G4BMK)

2 Beacon Close, Seaford, East Sussex BN25 2JZ - Tel: (01323) 893378

RAMS IV

MULTIMODE Rx PROGRAM FOR YOUR SPECTRUM

RTTY 5 Baud rates
AMTOR (SITOR)
MORSE To 250 wpm or more
SSTV Large picture and multi speed

All this with generous
QSO Review and picture store **£25.00**

RMS III users upgrade for £12.50

Please add £1.50 post & packing

Send large SAE (33p stamp) for details of all our products.

J. & P. ELECTRONICS LTD.

Unit 45, Meadowmill Estate, Dixon Street,
Kidderminster DY10 1HH Tel: (01562) 753893 

FLIGHTDECK



MANCHESTER'S PREMIER AVIATION STORE

- | | |
|-----------------------------------------------------------|-------------------------------------------------------|
| <input checked="" type="checkbox"/> Airband Radios | <input checked="" type="checkbox"/> Books & Videos |
| <input checked="" type="checkbox"/> Scanning Receivers | <input checked="" type="checkbox"/> Accessories |
| <input checked="" type="checkbox"/> Helpful Advice | <input checked="" type="checkbox"/> Airliner T Shirts |
| <input checked="" type="checkbox"/> A/C Spotting Software | <input checked="" type="checkbox"/> Display Models |
| <input checked="" type="checkbox"/> Maps & Charts | <input checked="" type="checkbox"/> Shortwave Sets |

Catalogue £1 from Dept. SW, 192 Wilmslow Rd, Heald Green
Cheadle, Ches. SK8 3BH. Tel: 0161-499 9350 Fax: 0161-499 9349
Open: 9.30am - 5.30pm Mon to Sat. Closed Wednesdays

Many Radio Amateurs and SWLs are puzzled. Just what are all those strange signals you can hear but not identify on the Short Wave Bands? A few of them such as CW, RTTY, Packet and Amtor you'll know - but what about the many other signals?

HOKA ELECTRONICS HAVE THE ANSWER! There are some well-known CW/RTTY decoders with limited facilities and high prices, complete with expensive PROMS for upgrading etc., but then there is CODE3 from Hoka Electronics! It's up to you to make the choice - but it will be easy once you know more about Code3. Code3 works on any IBM-compatible computer with MS-DOS 2.0 or later and having at least 640K of RAM. The Code3 hardware includes a digital FSK Converter unit with built-in 230V AC power supply and RS232 cable, ready to use. You'll also get the best software ever made to decode all kinds of data transmissions. Code3 is the most sophisticated decoder available and the best news of all is that it only costs **£329!**

- Morse - Manual/Auto speed follow. On screen WPM Indicator
- RTTY /Baudot/Murray/ITA2/CCITT2 plus all bit Inversions
- Sitor - CCIR 625/476-4, ARQ, SBRS/CBRS FEC, NAVTEX etc
- AX25 packet with selective call sign monitoring, 300 Baud
- Facsimile, all RPM/IOC (up to 16 shades at 1024 x 768 pixels)
- Autospec - Mks I and II with all known interleaves
- DUP-ARQ Artrac - 125 Baud Simplex ARQ
- Twinplex - 100 Baud F78C Simplex ARQ
- ASCII - CCITT 5, variable character lengths/parity

- ARQ6-90/98 - 200 Baud Simplex ARQ
- SI-ARQ/ARQ-S - ARQ1000 simplex
- SWED-ARQ/ARQ-SWE - CCIR 518 variant
- ARQ-E/ARQ1000 Duplex
- ARQ-N - ARQ1000 Duplex variant
- ARQ-E3 - CCIR 519 variant
- PDL-ARQ - 100 baud Duplex ARQ
- TDM242/ARQ-M2/4-242 CCIR 242 with 1/2/4 channels
- TDM342/ARQ-M2/4 CCIR 342-2 with 1/2/4 channels

- FEC-A - FEC100A/FEC101
- FEC-S - FEC1000 Simplex
- Sports Info. 300 Baud ASCII F78C
- Hellscreiber - Synch./Asynch.
- Sitor RAW - (Normal Sitor but without synchronisation)
- ARQ6-70
- Baudot F78BBN
- Piccolo Mk6 12 tone/ASCII mode - coming soon!
- GMDSS 100 Baud system - coming soon!

All the above modes are pre-set with the most commonly seen baudrate setting and number of channels which can be easily changed at will whilst decoding. Multi-channel systems display ALL channels on screen **at the same time**. Split screen with one window continually displaying channel control signal status e.g. idle Alphas/Beta/RQs etc, along with all system parameter settings e.g. unshift on space, **Shift on Space**, multiple carriage returns inhibit, auto receiver drift compensation, printer on, system sub-mode. Any transmitted error correction information is used to minimise received errors. Baudot and Sitor both react correctly to third shift signals (e.g. Cryillic) to generate ungarbled text unlike some other decoders which get 'stuck' in figures mode!

Eight options are currently available extra to the above specification as follows: 1) Oscilloscope. Displays frequency against time. Split screen storage/real time. Great for tuning and analysis. £35. 2) Piccolo Mk 6. British multi-tone system that only we can decode with a PC! £65. 3) Ascii Storage - Save to disc any decoded ascii text for later processing. £35. 4) Coquelet - French multi-tone system, again only on offer from Hoka! £65. 5) 4 Special ARQ and FEC systems i.e. TORG-10/11, ROU-FEC/RUM-FEC, HC-ARQ (ICRC) and HNG-FEC. £75. 6) Auto-classification - Why not let the PC tell YOU what the keying system is?! £65. 7) SYNOP Decoder for AAXX & BBXX formats. FULL WMO station list. £35. 8) PACTOR (both Amateur and ICRC!). £25.

Please add **£7.50** to the above prices for carriage by fully insured First Class Postal delivery (default method).

Call or write for our comprehensive information leaflet - there is just not enough room here to tell you everything about Code3!

Professional users - please ask about our new CODE30 DSP unit available now! (Piccolo down to -12dB S/N!!) Prices start from £1775 (includes all options).

HOKA ELECTRONICS (UK)

Sales Office: Ntech Communications, 8 The Crescent, Willingdon
East Sussex BN20 9RN • Tel/Fax: (01323) 483966 • Mobile: (0850) 545871

THE VINTAGE WIRELESS BOOK LISTING

Published regularly. Containing 100s of out of print, old and collectable wireless and amateur radio books, magazines etc. Send six first class stamps for catalogue or £3.75 for next four issues.

ESSENTIAL NEW BOOKS

BARGAIN OFFERS. THE LAST 50 COPIES OF JANES. NOW REDUCED.

Janes Military Communications 1990-91

A vast volume of 886 pages. Large format wraps. Contains descriptions, photographs and basic details of the worlds military communications equipment, some of which has been in service for up to ten years previously. Brand new. Published at £80 Special price £35 p&p £5 (overseas postage extra).

Also reduced: The Teleprinter Handbook by A. G. Hobbs.

Covers in detail the theory and practice of teleprinter equipment, both European and American. Includes full descriptions and maintenance data for most machines and ancillary equipment. Over 300 pages with photos and circuits. Now £5.50 p+p £2.50.

Eddystone Communications Receiver Data 1950-1970

A facsimile reprint of the circuit diagrams, general description and some service notes for sets from 1955-1970. 50 pages. £9.50 incl post.

Communications Receiver Type CR100.

Complete handbook. 56 pages, full circuits layout and alignment notes. Large format. £7.95 including p+p.

Wanted for Cash

Valve communication receivers, working or not. Items of govt. Surplus wireless equipment. Pre 1975 wireless and TV books and magazines.

(Dept SW) CHEVET SUPPLIES LTD.

157 Dickson Road, BLACKPOOL FY1 2EU

Tel: (01253) 751858. Fax: (01253) 302979. Telephone orders accepted.



SATELLITE SECRETS REVEALED!

Learn the trade secrets about satellite television

HOW TO BUY
WHERE TO BUY
WHERE TO INSTALL
HOW TO MAINTAIN
HOW TO REPAIR

By Jack Armstrong
ARLON HOUSE PUBLISHING



256 PAGES FULL OF PRACTICAL AND VALUABLE INFORMATION

Available from:
ARLON HOUSE PUBLISHING

£19.95 inc p&p

Please make cheques payable to
Arlon House Publishing and forward to:

ARLON HOUSE PUBLISHING
Arlon House, Station Road,
Kings Langley, Herts WD4 8LF

TELEPHONE: (01923) 268328

JV FAX – HAMCOMM – PC HF FAX and PKTMON12

Read Mike Richards' review in SWM DECODE March '94

Demodulator for these popular programmes – connect to audio output, plug the 25 way connector into your PC and monitor Fax RTTY Morse and Packet at an AFFORDABLE price. UK/Eire price £16.99 inc VAT and P&P – Overseas £19.99. 25 way to 9 way Adaptor UK/Eire £3.00 inc. Overseas £5.00.

All products carry full money back guarantee.

NEW!! JVFAX V7.0 on 3.5" HD or send one HD 5.25" or two DD 3.5" or three DD 5.25" disks. ONLY £2.50 inc P&P.

Pervisell Ltd, 8 Temple End, High Wycombe,
Bucks HP13 5DR

Tel: (01494) 443033 Fax: (01494) 448236

SCANNER EXCHANGE FROM THE REALISTIC SPECIALISTS

- Trade in your old scanner for the latest model
- Realistic, Yupiteru, AOR, Bearcat
- Phone for best deal
- New and secondhand scanners always available
- 3 months warranty on secondhand scanners
- Retail, export and trade sales

G6YTI

Link Electronics

G0CVZ

216 Lincoln Road, Millfield, Peterborough PE1 2NE

Tel (01733) 345731 Fax (01733) 346770



THE SUPER FREQUENCY LIST

now on CD-ROM • £ 23 or DM 50



©Copyright 1995 - All rights reserved by

KLINGENFUSS PUBLICATIONS

14,000 special shortwave frequencies from our international best-seller 1995 GUIDE TO UTILITY RADIO STATIONS, updated January 1995. Plus 1,000 abbreviations and 12,000 formerly active frequencies - all on one compact disk for PCs with Windows™. Not only can you browse through all that data in milliseconds, but you can search for specific frequencies, stations, call signs and countries as well. It can't get faster than this! This unequalled product is based on 26 years of experience in the radio monitoring and publishing field. Airmail included. Dealer discount rates on request. Please fax or mail your order to ☺

Klingenfuss Publications
Hagenloher Str. 14
D-72070 Tuebingen
Germany

Phone 01049 7071 62830
Fax 01049 7071 600849

WEATHER MONITORING AT A GLANCE

- * WIND SPEED & DIRECTION
- * TEMPERATURE Min & Max.
- * MAHOGANY CABINET
- * HUMIDITY & DEW POINT
- * BAROMETER
- * RAINFALL
- * SUNSHINE HOURS
- * 12-24V or MAINS

Prices from only

£ 199 inc.vat
FULL REFUND GIVEN IF NOT DELIGHTED

Send for colour brochure now to -

R & D ELECTRONICS

Tel. (0843) 866662
Fax. (0843) 866663

Beaufort House, Percy Ave, Kingsgate Broadstairs, Kent. CT10 3LB



NEW! TU3 Antenna Tuner

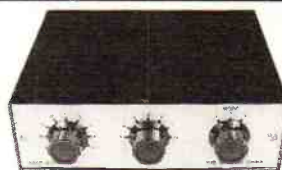

- * Ideal for receivers with a long wire Antenna on the H.F. bands, 1-30MHz.
- * Versatile! The touch of a switch gives any one of 3 different arrangements.
- * Quality case - black with printed aluminium front & back facias. Measuring only 170-140-50mm.

* Kit complete with ALL components and hardware including pre-punched case and panels.

Price **£44** Plus £4.00 P & P

Ready made **£54** Plus £4.00 P & P

Send SAE for details of our full range of kits or call **0115 938 2509**

LAKE ELECTRONICS

7 MIDDLETON CLOSE, NUTHALL, NOTTINGHAM NG16 1BX

(Callers by appointment only)



TRADING POST

Fill in the order form clearly in **BLOCK CAPITALS** - up to a maximum of 30 words plus 12 words for your address, and send it together with your payment of £3.00, to Zoë Shortland, Trading Post, Short Wave Magazine, Arrowsmith Court, Station Approach, Broadstone, Dorset BH18 8PW.

If an order form is not provided due to space constraints, a form from a previous issue can be used as long as the cornerflash or Subscriber Number is attached as proof of purchase of the magazine. Adverts appear on a first-come-first-served basis. If there is not enough space to feature a Trading Post ad in the issue you request it is automatically entered into the next one. All queries to Zoë Shortland on (01202) 659910.

We cannot accept advertisements from traders, or for equipment which is illegal to possess, use or which cannot be licensed in the UK.

For Sale

Air band receiver, as new condition, £120 o.n.o. Tel: Norfolk (01553) 770693 evenings.

Alinco DJX1D scanner, 200kHz to 1300MHz, comes with NiCad, charger, case and three aerials. All boxed, absolute mint condition, the very best you will find anywhere, used only twice, £250 o.n.o. Tel: Crawley (01293) 883356 evenings or anytime on Wednesdays.

AOR 8000 UK receiver, absolutely as new, NiCads and charger, unused leatherette case, £300 o.v.n.o., plus postage. Also Sky-Scan Magmount portable antenna, new, £15 plus postage. John, Warwickshire. Tel: (01926) 886411.

AOR AR1000 hand-held scanner, mains adapter, etc. JIM p.s.u., £145. As new Midland CB radio, buyer pays postage, £35. Tel: West Yorks (01535) 654418.

AOR AR2000 hand-held scanner, 500kHz to 1300MHz continuous, no gaps, a.m., n.b.f.m., w.b.f.m., 1000 memories, complete with v.h.f./u.h.f. whip, NiCads, charger, soft case and operating manual, perfect, £200. Graeme G3GG, Worcs. Tel: (01299) 403372.

AOR AR2002 scanning receiver, p.s.u., instruction booklet, excellent condition, £200. ERA Microreader, version 4.2, as new, £95. ERA display unit RS232, as new, £90. Tel: Liverpool 0151-259 2456 after 6pm.

AOR AR3000A multi-mode scanner, as new, inc. manual, £550. Datong FL3 a.f. filter inc. manual, £70. ERA Microreader MkII inc. manual, £80. Postage extra. Tel: Lincs (01754) 611472 anytime.

AOR2002 scanner, good condition, may be able to deliver, only, £250 o.n.o. Tel: Cardiff (01222) 712397 or (0585) 900124.

AOR3000 and **AOR900** hand-held, both boxed with instructions, no reasonable offer refused. Tel: Ipswich (01473) 241551.

Bausch and Lomb 8 x 40 legacy binoculars, unused with box and case, ideal aircraft spotting, cost £115, will accept £60. Also discone

aerial for scanners or base set, unused, boxed, £25. Tel: Wigan (01942) 728531.

Bearcat DX-100 h.f. receiver, 10kHz to 30MHz, a.m., s.s.b., f.m., microprocessor controlled, g.w.c., £200 o.n.o. Tony, Hants. Tel: (01962) 855076.

Datong FL3 multimode filter, hardly used, mint condition inc. power supply, £90. Tel: Essex (01268) 752000.

Drake R8E, mint condition with Datong 370 active antenna, offered for sale at excellent price for this outstanding radio, owner non-smoker. Please no time wasters. Paul, West Yorkshire. Tel: (01924) 267509 after 1800 hours and before 2100 hours.

Dressler ARA30 active short wave antenna, 50kHz to 40MHz, including cable, connectors, pole, clips. Good value for just, £35. Collect. Tel: N. London 0171-700 1540.

Early transistor radios, Hacker NORP37, RP37A, RR35, Roberts, Bush, Marconi, all excellent condition. Akai reel to reel, model 1721W, lots of tapes, Mozart box of valves, about 150. Exchange for communications receiver or sell. Tel: Bradford (01274) 573370.

Eddystone 880 MkII, £180. 940, £150. 680X, £140. 730, £100. 640, £80. EC10, £60. Marconi TF144H sig. gen., 72MHz, £45. 606B sig. gen. 50kHz to 65MHz, £45. R107, £65. Advance scope 35MHz, £90. Alan, Berks. Tel: (01344) 27869 ('phone or fax).

Fairmate HP200E scanner 500kHz - 1300MHz, 1000ck memory, a.m., f.m., w.f.m., boxed, as new, complete with all accessories inc. three antennas, charger, carrying case, etc., a fine example of this highly rated hand-held, £200. Tel: Harrogate (01423) 770860.

Flight disk, latest World Airways Guide on disk for Microsoft Windows 386 computer onwards. Requires Windows 3.1, 4Mb RAM world-wide data on airlines, flights, airports, etc., £45 inc P&P. Tel: Oxford. Tel: (01865) 749374.

Frequency calibrator, 50MHz to 11GHz, £100. Wayne Kerr waveform analyser, £60. Guided missile

monitor, £50. Radio compass (direction finding) receiver, £30. Buyer collects. R. Hayward, Kent. Tel: (01304) 853375.

Grundig Satellit 650, still in box, as new with 'joystick' aerial, £200. Tel: West London 0181-578 2774.

Grundig Satellit 700 world receiver, immaculate condition, purchased on 28.10.94, hardly used, still under guarantee, boxed with manual, £200. No offers and buyer collects. John, Glasgow. Tel: 0141-558 6345.

Icom IC-R100 base mobile scanner, 500kHz to 1.8GHz, excellent condition and performance, reason for selling? - need cash, £430. Buyer collects or free carriage. Tel: London 0171-700 1540 anytime, except weekends.

Icom IC-R71E RX plus IC-EX257 f.m., boxed, £575. Icom R7000 RX, s.s.b., f.m., n.a.m. with TV f.m. adapt., boxed, £600. Eddystone 1837/2 digital table top model, excellent performance, manual, £350. FRG8800 like new, £350. Sony PRO80 with v.h.f. converter, £140. Drake Spr4, all broadcast and all Ham bands, crystal loaded, very sensitive, mint condition, £175. Sony 2001D, boxed, £160. Tel: Middlesex 0181-813 9193.

Icom SP20 speaker with filters, as new, will utilise two radios at once, £80. Tel: Lincs (01754) 762359 anytime.

ICS FAX1 with p.s.u., £85. Microreader with manual, £40. Tel: Stafford (01785) 223249.

Internal 500Mb SCS1 5.25in tape back-up unit with PC-15A adapter card (1510) and connecting cables, mint condition, £300, price includes delivery. Stephen, London. Tel: (01956) 544202 evenings/weekends.

JRC NRD535, mint condition, £950 o.n.o. Computers 386 SX20 with printer, modem, sound card, £400. Toshiba T1000SE lap top, £200. Peter GM7JFR, Glasgow. Tel: 0141-942 2432.

Kenwood R2000, 0-30MHz plus VC10 converter, 118-174MHz with a.t.u. and manuals, all as new, £360. J. Green, Kent. Tel: (01303) 241452.

Kenwood R5000 with SP23 speaker, ERA MkI Microreader, Global a.t.u. AT1000, Datong AD370, Morse tutor, all v.g.c., £750 o.n.o. Tel: Totnes (01803) 864661.

Lowe HF225 Europa, six months old, as new, £500. Cash only and buyer to inspect and collect. Martin G3NGC, Cheltenham. Tel: (01242) 519281.

M8000 universal decoder with VGA video monitor and manual, all leads and original box, cost £1300, accept £600. B. M. Davies, Dyfed. Tel: (01267) 267649.

MFJ 1040B, £45. 934 beam, £12. Collinear, £15. 27MHz/40 hand-held, £45. 4ft m.w. loop, £12. Notch filter,

£7. Audio processor, £7. Uher CR240, £100. Xtrvision decoder, £15. Prices include P&P UK. Paul, Bucks. Tel: (01844) 237131 anytime.

Momentum MCL1100 data decoder in perfect working order, good condition, £135. Monitor also available. Richard, Eastbourne. Tel: (01323) 482529.

Momentum MCL1100 Easy Reader data decoder in perfect working order, £135. Monitor also available. Tel: E. Sussex (01323) 482529.

Pair of Yaesu 144MHz handie transceivers, model FT209RH, NiCad batteries plus chargers (110V a.c.), Autoformer available, absolutely complete, sensible offers please. J. Manfield, Surrey. Tel: (01428) 713326 (evenings) or FAX: (01428) 717167.

PK232MBX boxed with manual, latest type with Pactor, £220. Datong FL3 filter, £90. SEM multi-filter, £50. All items as new and post paid. G. Denman, Hants. Tel: (01705) 787693.

PRO2006 scanner, 400 channels, new, manual, boxed, £175 o.n.o. SEM QRM eliminator, new, £70. Global AT1000 a.t.u., new, £65. Tel: Warwicks (01926) 54556.

PRO41, £50. Datong PC1 converter, £30. Datong 144-28 ditto, £15. *W1FB's QRP Notebook*, £3. Klingenfuss twelfth edition Utility Stations, £5. All v.g.c., boxed, plus post. Harmer, 9 Park Square East, Jaywick, Essex CO15 2NL.

Psion 3a with world time (prog), alarms, calculator, database, agenda, word (procer), spr eadsheet, sound recorder, dialling (auto), printing, open files, disks (opl), programme graphics. A tool must for every short wave and scanner enthusiast, bargain price of, £190 only. Immaculate condition. First to ring will get it. Sunny, Berkshire. Tel: (01753) 730579 between 11.30 to 4.30pm or (01753) 816306 from 5pm to morning 9am Monday to Friday.

R2000 receiver, excellent condition, VC10 converter 118-174MHz, boxed with manual, £300. May part exchange for scanner or w.h.y.? John, Devon. Tel: (01647) 61245.

Realistic PRO-43 200 channel scanner, 68 to 999MHz with manual, little use, still boxed, £150. Tel: Glos (01242) 675990 after 6pm.

Realistic PRO2035 base scanner, 1000 channels, boxed, as new, only one month old, bargain at, £250. Will send c.o.d. if required. Peter, Port Talbot. Tel: (01639) 888610 anytime.

Realistic PRO32 v.h.f./u.h.f. hand-held receiver, 68-88MHz, 108-136MHz, 138-174MHz, 380-512MHz, 200 memories, search, scan, priority, usual features, fully working, very good, clean, with aerial, instructions, mail order, only, £60 inclusive. Peter, Essex. Tel: (01268) 287176 answermachine.

Redifon 500HF, in mint condition, with full operator and maintenance manuals, current model (cost £12500), £550 o.n.o. or swap for other professional kit. Tel: (01323) 483966.

Roberts RC818, long, medium and short wave bands, plus f.m. and cassette tape recorder, boxed, all accessories, very little used, mint condition, £130. Can deliver up to 80 miles radius. John, Somerset. Tel: (01934) 712553.

Sangean ATS 803A, new, £90. Howes CTU8 a.t.u., aerial switching and by-pass, £40. Maplin a.t.u., attenuator, aerial switching and by-pass, £40. Maplin a.t.u. attenuator, aerial switching and by-pass, £40. RF systems MLB, £25. SEM QRM eliminator, £65. Tel: Penzance (01736) 871464.

Shack clearout: Sony 2001 digital full coverage mains/battery, g.w.o., £65, plus P&P. Panasonic R3000 full coverage in six bands, no b.f.o., mains/battery, g.w.o., £45 plus P&P. Tel: Cheshire (01244) 310271 evenings only please.

Short Wave Magazine first nine issues, April to December 1987, £10. All others in dozens, January to December 88-94, £12 per year. Postage £1 per parcel, some old *Wireless World, Everyday Electronics*. D. Smith, Northants. Tel: (01327) 702095.

Siskin Multicat RS232, interface controls Icom, Yaesu and Kenwood transceivers/receivers fitted with Cat sockets, complete with all cables, hardware and software, suitable for Windows or Dos, £50 post paid. Ken G3RDG, London. Tel: 0181-455 8831 anytime.

Sony AIR7, as new, £130. Trio TR7500 144MHz mobile TX/RX, good condition, £100. Roy G4MVZ, Lincs. Tel: (01754) 5945.

Sony ICF-2001 receiver, the original one, working, £50 plus postage. Tel: London 0181-310 7162.

Sony ICF-SW77 world band radio, 150kHz to 30MHz plus f.m., boxed with manual and p.s.u., stereo headphones, mint condition, £225 plus postage. Tel: South Wales (01792) 830962 weekends only.

Sony ICF2001D, full kit with AN-1 antenna, boxed, instructions, £225. Global AT1000 a.t.u., £50. ERA BP34 noise filter, £60. All excellent condition, £325 for the lot, plus free gift! John, London. Tel: 0181-478 1803.

Sony ICF4600W receiver, 1.6-30MHz analogue/digital read-out, battery mains, £145. Also Trio valve set and speaker, all good working order, £50 o.v.n.o. Sorry no 'phone. Both with operator manuals. John Stevens, 5 Heol Daniel, Felinfoel, Llanelli, Dyfed, South Wales SA14 8AL.

Sony ICF5W7600 receiver, good condition, £80. Racal RA117 receiver, fair condition, £80. National NCX3 three band transceiver, 80/40/20m, needs attention, 110V, £100. Amstrad 1640 PC with colour monitor and 20m HD, £150 o.n.o. Brian Shaw, Swindon. Tel: (01793) 750130.

Sony PRO70 (same as PRO80), v.g.c., cased, £95 o.n.o. Steve Kitchener, Herts. Tel: (01442) 822875.

Sony SW55 short wave receiver, f.m., l.w., m.w., s.w., s.s.b., in hard carry case, power adapter, earphones, instruction books, internal and travel aerial, boxed, as new and unused, £210 o.v.n.o. Tel: Cardiff (01222) 251566 ask for David, after 6pm, leave message if unavailable.

Sony WMFX 403 Walkman, a.m., f.m. stereo digital radio - auto reverse cassette, 10 station pre-set, boxed, latest walkman, new and unused, cost £70 new, will accept, £35 inc. P&P. Tel: Oxford (01865) 749374.

Test gear: Marconi TF2370, 110MHz spectrum analyser, £650. Tektronix portable storage scope 434, £150. TF2700 LCR bridge, portable, £95. Marconi sig. goes to 480MHz, £50. Sedonal scopes from £75. Tel: Berks (01344) 27869.

TH78E 2/70 handie, all accessories plus spare battery, pouch and eartalkers, v.g.c., £400 o.n.o. John, Norfolk. Tel: (01379) 652043 evenings/weekends.

Trio R5000 h.f. receiver with VC20 v.h.f. converter, 108 to 174MHz in box with manual, also Datong FL3 notch filter, brand new, £100 for notch and £650 for Trio. Poss P/X. Stephen 2MIDTA, Fife. Tel: (01592) 266458.

Universal M8000 VGA monitor, c/w fully comprehensible manual, current price £1325, selling at £800. FAX, RTTY, Packet, SITOR A.B. NAVTEX, ARQ, FEC, SWED, Morse, ASCII, ACARS, Pactor SP, no computer required. Tom GOUPEV, Stoke on Trent (01782) 311386.

Yaesu 8800 with antenna tuning unit, FRT7700 fitted with FRV8800 v.h.f. converter, 118-174MHz, mint condition, £350. Tel: Surrey 0181-540 2654.

Yaesu FRG7000 short wave receiver, excellent condition, very little use, manual and boxed, £190. Tel: Essex (01702) 556080.

Yaesu FRG9600 w.f.m., n.f.m., a.m., s.s.b., 100 memories, 60-950MHz. Raycom extended coverage, p.s.u., manual, in mint condition, £300 inc. P&P. Tel: Oxford (01865) 749374.

£590. Lowe HF225, £400. Icom 7100, mint, £960 o.n.o. MS1000, £220. All with original boxes and manuals, etc. Tel: Essex (01860) 488464 anytime.

Yupiteru MVT7000, mint condition in original box with instructions, handbook and accessories, a very good performer, £200. Tel: Liverpool 0151-920 6226 anytime.

Yupiteru MVT7100, boxed, as new, excellent condition, plus UK *Scanning Directory* and leather case, £295 o.n.o. Tel: Middlesex 0181-841 9066.

Yupiteru VT-225 scanner, perfect condition, boxed with charger and extra aerial, £100. Buyer collects. H. White, Gwent. Tel: (01633) 264342 after 6pm.

Wanted

Any information on a printer, Memorex 2173. Require user handbook or manual, will photocopy and return or purchase and pay any costs. F. R. Day, 29 Borstal Street, Rochester, Kent or Tel: (01634) 400096.

Collector, will travel to buy 1920s crystal sets, early wireless sets, anything to do with Marconi, photos, books, adverts, also wanted pre-war TVs, Morse keys, printers, Spy radios. Reg Dykes, 312 Carterhatch Lane, Enfield, Middlesex. Tel: 0181-363 7494 evenings.

Early small pocket Japanese transistor radios, especially made by Sony. Need not to be working. Also anything made by Marconi before 1929. Distance no object and collection possible. Enrico Tedeschi, Brighton. Tel/FAX: (01273) 410749 or (0850) 104725 (mobile) anytime.

Eddystone EC10, EC10 MkII, 960, EB35/37, 870, diecast speaker, 'S' meter, wartime civilian set, Pye transistor with watch incorporated for cash. Collection possible. 'Phone anytime. Peter Lepino, Surrey. Tel: (01374) 128170.

Eddystone receivers, etc. EC10, EC10 MkII, 960, EB35, EB37, 888A, S870A, diecast speakers, 'S' meter, Edometer, any Clarke & Smith school radio, wartime civilian receiver. Cash waiting. Collection possible. Peter Lepino, Surrey. Tel: (01372) 454381 or FAX: (01372) 454381 or Tel: (01374) 128170.

International v.h.f. 8800 converter. Tel: (01553) 770693 evenings.

Marconi items wanted, books, photos, crystal sets, early wireless sets, first world war radio items, Morse keys, inkens, trench sets, spy transceivers. Best price paid for rare items, also TVs. Mr Dykes, Middlesex. Tel: 0181-363 7494.

Racal equipment and spares, anything considered, urgent, 3kHz filter, 455 i.f. Cash waiting. Tel: (01323) 483966.

Receivers bought and sold, must be in clean working order, best prices paid, cash waiting. Tel: Oxford (01865) 749374.

Redifon R55IN receiver, 0.30MHz, must be in good condition and working. Wanted good transceiver 10m band, your price. Valve set preferred, KW Vespa or similar. Tel: Staffs (01538) 385735.

Software for Kantronics Cam plus Host Master, etc., or anything that will run in Windows and make operation simpler. Dave, Cheshire. Tel: (01925) 574108 after 6pm.

TCS-6 transmitter in clean condition. David Fletcher, Cambridge. Tel: (01223) 843408.

Two sets: A Sony SW55, Sony SW77 or Roberts 817 or 818 or similar Grundig. And Kenwood R5000, NRD535 or Icom 71 or 72 range. Tel: Paignton (01803) 522109.

WWII R1155 receiver, any condition or any parts. Could collect. Reasonable price, as retired. Please search attics or cellars! M. D. Lawdham, London. Tel: 0171-352 4174.

Yaesu FR101 digital receiver, must be in good condition and good working order. Tel: Swindon (01793) 481877.

Yaesu FRG7, low cost, need not be in working order. Tel: Cheshire 0161-969 0325 weekends or evenings after 7pm.

Yupiteru MVT5000 scanner, must be in good condition. Tel: Dyfed (01970) 890297.

Zenith Transoceanic Royal D7000Y in good condition. Peter Pompe, 38 Valdu Prince, B-1950 Kraainem, Belgium. FAX: 322/731.62.84.

Exchange

Lowe HF225 with keypad for R2000 with v.h.f. converter. Tel: Warwick (01295) 670749.

My base 60 memories scanner, Realistic PR02024, cost £179.95, boxed, plus cash, for your Yaesu FRG7700 receiver. Tel: Tyne & Wear 0191-257 7875 anytime.

Short wave receiver wanted, anything considered in exchange for my Amstrad 1640 computer with hard drive and colour monitor. Richard, Yorks. Tel: (01595) 600667 after 6pm.

BOOK SERVICE



£50 PRIZE DRAW

For every book order received between May 1 1995 and May 31 1995, the name and address of the customer will be entered into our prize draw for this issue. On June 1 one name will be pulled from the sack. The lucky person will win a £50 note (the genuine article!). So why not order that book or books you've been thinking about, you could well be our lucky winner next time, don't forget it's much shorter odds than the National Lottery!

The books listed have been selected as being of special interest to our readers. They are supplied direct to your door. Many titles are overseas in origin.

TO ORDER:

PLEASE USE THE ORDER FORM ON PAGE 83 OR TELEPHONE THE CREDIT CARD HOTLINE ON (01202) 659930.

LISTENING GUIDES

CALLSIGN 95

The Civil & Military Aviation Callsign Directory

Intended for the aircraft and radio enthusiast to use as a stand alone reference, or as a partner to *Airwaves 94*. Over 5300 military and 3000 civil callsigns are covered in detail. 108 pages. £7.95

AIRWAVES 94

The Complete HF/VHF/UHF Aviation Frequency Directory

Much of the more obscure (especially military) information is made accessible in this volume. Not only are facilities/activities listed, giving their frequencies, but also there are reverse lists - when the frequency is known, the allocated user can be found. Airways sectors are listed so much more clearly than in the *Supplements*. The main transponder code groups are included. In fact, the book covers all the way from h.f. up to u.h.f. 88 pages. £7.95

The AIRBAND JARGON BOOK
Ron Swinburne

Designed to give the newcomer some guidance on what to expect from Airband and how to extract the most from listening to it. This guide is essential reading for those not involved in the aviation industry. It gives a valuable insight to many aspects of aviation. Explained are the principles of Airband reception, aircraft instrumentation, radio services, weather navigation, etc. and air traffic control, to list but a few. Read this book and you could well be hooked. 72 pages. £6.95

AIR BAND RADIO HANDBOOK
5th Edition

David J. Smith
Air band radio listening enables you to listen-in on the conversations between aircraft and those on the ground who control them, and is an increasingly popular and fascinating hobby. A new chapter on military air band has been added. The author, an air traffic controller, explains more about this listening hobby. 190 pages. £8.99

THE COMPLETE SHORT WAVE LISTENER'S HANDBOOK 4th Edition

Hank Bennett, Harry Helms & David Hardy
This book is a comprehensive guide to the basics of short wave listening. Everything you need to get started as an s.w.l. is explained in a clear and easily understood manner. Receivers, antennas, frequencies, propagation, Q-codes, etc. are all covered. 321 pages. £17.95

EAVESDROPPING ON THE BRITISH MILITARY

Michael Cannon
For the very first time a book has been

published showing how to monitor British Military communications. All you need is a short wave receiver, lots of time and patience, and this secret world will open up to you, providing many hours of enjoyment. Also included is the largest British military callsign list ever to be published. 166 pages. £17.50

FERRELL'S CONFIDENTIAL FREQUENCY LIST 9th Edition

Compiled by Geoff Halligey
Spirally bound, this easy-to-use reference book covers 1.6 - 28MHz in great depth, all modes and utility services, with new reverse frequency listing showing every known frequency against each callsign, who's using what frequency and mode, what's that callsign? 544 pages. £17.95

SCANNER BUSTERS
D.C. Poole

This guide to the methodology of beating the electronic ban on Scanning, deals with the subject of scrambling and encryption systems. The author explains in simple terms how p.m.r. works, the new digital cellular radio telephone systems, spread spectrum, frequency hopping and emergency services communication. How to get more from your scanner and a list of frequencies to listen to are also covered. It is a great reference for both new scanner owners and veterans alike. 64 pages. £4.95

SCANNING SECRETS
Mark Francis

The mysteries of monitoring explained. Advice on buying and operating your scanner. Where to listen and how to gather obscure frequencies. The myths and folk lore exposed. All the information need to unlock the potential of your scanner. 280 pages. £16.95

FLIGHT ROUTINGS 1994
Compiled by T.T. & S.J. Williams

This guide was produced with the sole aim of assisting airband listeners to quickly find details of a flight, once they have identified an aircraft's callsign. Identifies the flights of airlines, schedule, charter, cargo and mail, to and from the UK and Eire and overflights between Europe and America. 122 pages. 0/P

GUIDE TO FAX RADIO STATIONS
14th Edition

Joerg Klingenfuss
The new edition of this super reference book covers the world's facsimile stations, their frequencies and methods of working. There is a section covering the equipment needed to receive FAX over the radio. To give you an idea of what is available there are many pages of off-air received FAX pictures. 392 pages. £20.00

GUIDE TO UTILITY STATIONS
13th Edition

Joerg Klingenfuss
This book covers the complete short wave range from 3 to 30MHz together with the

adjacent frequency bands from 0 to 150kHz and from 1.6 to 3MHz. It includes details on all types of utility stations including FAX and RTTY. There are 19549 entries in the frequency list and 3590 in the alphabetical callsign list plus press services and meteorological stations. Included are RTTY & FAX press and meteo schedules. There are 11800 changes since the 10th edition. 534 pages. £30.00

INTERNATIONAL RADIO STATIONS GUIDE
BP355

Peter Shore
As in 'Broadcast Round-up', his column in *PW*, Peter Shore has laid this book out in world areas, providing the listener with a reference work designed to guide around the ever-more complex radio bands. There are sections covering English language transmissions, programmes for DXers and s.w.l.s. Along with sections on European medium wave and UK f.m. stations. 250 pages. £5.95

POCKET GUIDE TO RTTY AND FAX STATIONS

Bill Laver
A handy reference book listing RTTY and FAX stations, together with modes and other essential information. The listing is in ascending frequency order, from 1.6 to 28.8MHz. 57 pages. £3.95

RADIO LISTENERS GUIDE 1995
Clive Woodyear

This is the third edition of this radio listener's guide. Simple-to-use maps and charts show the frequencies for radio stations in the UK. Organised so that the various station types are listed separately, the maps are useful for the travelling listener. Articles included in the guide discuss v.h.f. aeriels, RDS, the Radio Authority and developments from Blaupunkt. 68 pages. £3.45

SHORT WAVE INTERNATIONAL FREQUENCY GUIDE

This book contains a comprehensive frequency listing covering 400kHz - 30MHz and is packed with everything from the basics of short wave listening to explaining FAX and RTTY. In this updated version there are many new broadcast and utility stations listed. 188 pages. £12.95

UK SCANNING DIRECTORY
4th Edition

This spiral bound book lists over 20000 UK spot frequencies from 25MHz to 1.6GHz. Articles on scanning in the UK. 335 pages. £17.50

WORLD RADIO TV HANDBOOK 1995

Country-by-country listing of l.w., m.w. & s.w. broadcast and TV stations. Receiver test reports, English language broadcasts. The s.w.l.'s 'bible'. £15.95

SATELLITES

NEWNES GUIDE TO SATELLITE TV

Derek Stephenson

This book, the 3rd edition, is a hard bound volume, printed on high quality paper. The author is a satellite repair and installation engineer and the book covers all information needed by the installation engineer, the hobbyist and the service engineer to understand the theoretical and practical aspects of satellite reception with dish installation and how to trouble-shoot when picture quality is not up to anticipated reception. Mathematics has been kept to a minimum. 371 pages. £18.95

SATELLITE BOOK - A Complete Guide to Satellite TV Theory and Practice

John Breeds

This book deals almost exclusively with television broadcast satellites and is a comprehensive collection of chapters on topics, each written by an expert in that field. It appears to be aimed at the professional satellite system installer, for whom it is invaluable, but it will be appreciated by a much wider audience - anyone interested in satellite technology. 280 pages. £32.00

SATELLITE EXPERIMENTER'S HANDBOOK
2nd Edition

Martin Davidoff K2UBC

The book is divided into four main sections - History, Getting Started, Technical Topics and Appendices. It provides information on spacecraft built by, and for, radio amateurs. In addition, it discusses weather, TV-broadcast and other satellites of interest to amateurs. 313 pages. £14.50

SATELLITE TELEVISION

A layman's guide

Peter Pearson

Pictures from space, that's what satellite television is all about. Orbiting satellites, 35000km high, receive TV signals from stations on the earth and re-transmit them back again. This book explains all you need to know to set up your own satellite TV terminal at home, dish and accessories, cable and tuner. 73 pages. £1.00

SATELLITE TELEVISION INSTALLATION GUIDE

5th Edition

John Breeds

A practical guide to satellite television. Detailed guide-lines on installing and aligning dishes based on practical experience. 76 pages. £15.00

WEATHER SATELLITE HANDBOOK

5th Edition

Dr Ralph E. Taggart WB8DQT

This book explains all about weather satellites, how they work and how you can receive and decode their signals to provide the fascinating pictures of the world's weather. Plenty of circuit diagrams and satellite predicting programs. 192 pages. £14.50

WRTH SATELLITE BROADCASTING GUIDE

1994 Edition. Bart Kuperus

This brand new publication, written by one of the experts from the respected *World Radio TV Handbook*, will be a great help to everyone interested in the world of satellite radio and television. Featuring over 300 pictures and graphics. All the information you need to know about installing your own satellite system. 366 pages. £15.95

AMATEUR RADIO

ALL ABOUT VHF AMATEUR RADIO

W. I. Orr W6SAI

Written in non-technical language, this book provides information covering important aspects of v.h.f. radio and tells you where you can find additional data. If you have a scanner, you'll find a lot of interesting signals in the huge span of frequencies covered, 100-300MHz & 50, 420, 902 & 1250MHz bands.
163 pages. £9.50

AMATEUR RADIO CALLBOOK & INFORMATION DIRECTORY (RSGB)

Latest Edition

The first 124 pages provide a useful information directory with details of specialised clubs, county lists, repeater details, band plans and reference material. Then follows the callbook itself with over 60 000 call signs including E1 and Novice stations. A new section has been added towards the back of the book giving lists of surnames and initials of listed radio amateurs followed by call signs and the same under post-code areas.
308 pages. 0/P

AMATEUR RADIO FOR BEGINNERS RSGB

Victor Brand G3JNB

An ideal book for the absolute beginner to the amateur radio hobby. Well illustrated and an interesting read.
65 Pages. £3.50

AMATEUR RADIO LOGBOOK

Published by RSGB

This standard spirally bound amateur radio log book has 100 pages and is marked out with the format required in the UK. There are columns for date, time (UTC), frequency, power (in dBW), station worked/called, reports, QSL information and remarks. £2.99

AMATEUR RADIO TECHNIQUES RSGB

Pat Hawker G3VA

Anyone who enjoys Pat Hawker's 'Technical Topics' in *Radio Communications* will enjoy this book. An amateur radio manual itself, this paperback book, the 7th edition, can only be bettered by a new edition. A truly excellent reference source with a practical bias.
368 pages. £9.50

ANTENNAS AND TECHNIQUES FOR LOW-BAND DXING (ARRL)

John Devoldere ON4UN

This unusual book will be of particular interest to 1.8, 3.5 and 7MHz operators as it's packed with information on antennas and operating tips for 'Top Band to Forty' fans. There are chapters on low band propagation, operating techniques, equipment and for the computer minded there's a chapter on newly-available low band software.
383 pages. £14.50

ARRL HANDBOOK FOR RADIO AMATEURS 1995

This is the 72nd edition of this handbook and contains the best information from previous issues. New for this edition is some information on feedback-loop design for power supplies, a new gel-cell charger project, updates on antenna systems and new coverage of baluns, propagation programs are compared and colour SSTV and telephone FAX machines are also covered. Finally there's a new section on 'for the workbench' with new projects for the reader to build.
1214 pages. £19.95

ARRL OPERATING MANUAL

Another very useful ARRL book. Although written for the American amateur, this book will also be of use and interest to the UK amateur. Topics covered range from short wave listening through operating awards to repeaters, operating and satellites.
684 pages. £12.95

ARRL SATELLITE ANTHOLOGY

The best from the Amateur Satellite News column and articles out of 31 issues of *QST* have been gathered together in this book. The latest information on OSCARs 9 through 13 as well as the RS satellites is included. Operation on Phase 3 satellites (OSCAR 10 and 13) is covered in detail.
97 pages. £5.95

ARRL UHF/MICROWAVE EXPERIMENTER'S MANUAL

Various Authors

A truly excellent manual for the keen microwave enthusiast and for the budding 'microwaver'. With contributions from over 20 specialist authors. Chapters covering techniques, theory, projects, methods and mathematics.
446 pages. £14.50

THE BRIGHT SPARKS OF WIRELESS RSGB

G. R. Jessop G6JP

This hardback book is well illustrated with some excellent photographs. It pays tribute to and takes a good look at the personalities behind the early days of amateur radio and the equipment they used. A good read.
90 pages. £12.50

COMPLETE DX'ER

Bob Locher

This book covers equipment and operating techniques for the DX chaser, from beginner to advanced. Every significant aspect of DXing is covered, from learning how to really listen, how to snatch the rare ones out of the pile-ups and how to secure that elusive QSL card. 204 pages. £7.95

HINTS AND KINKS FOR THE RADIO AMATEUR

Edited by Charles L. Hutchinson and David Newkirk

A collection of practical ideas gleaned from the pages of *QST* magazine. Plenty of projects to build, hints and tips on interference, c.w. and operating and snippets of information from amateurs who've tried and tested the idea.
129 pages. £4.95

HOW TO PASS THE RADIO AMATEURS' EXAMINATION (RSGB)

Clive Smith G4FZH and George Benbow G3HB

The background to multiple choice exams and how to study for them with sample RAE paper for practice plus maths revision and how to study for the exam. The majority of this book is given to sample examination papers so that candidates can familiarise themselves with the examination and assess their ability.
88 pages. £7.99

INTRODUCTION TO AMATEUR COMMUNICATIONS SATELLITES

BP290. A. Pickard

This book describes several currently available systems, their connection to an appropriate computer and how they can be operated with suitable software. The results of decoding signals containing such information as telemetry data and weather pictures are demonstrated. 102 pages. £3.95

INTRODUCTION TO AMATEUR RADIO BP257

I. D. Poole

This book gives the newcomer a comprehensive and easy to understand guide through amateur radio. Topics include operating procedures, jargon, propagation and setting up a station. 150 pages. £3.50

INTRODUCTION TO RADIO WAVE PROPAGATION

BP293

J.G. Lee

How does the sun and sunspots affect the propagation of the radio waves which are the basis of our hobby? They affect the ionosphere, but differing frequencies are treated differently. Find out how to use charts to predict frequencies that will be the most profitable. What effect will noise have on the signal? Find out with this book. 116 pages. £3.95

INTRODUCTION TO VHF/UHF FOR RADIO AMATEURS BP281

I.D. Poole

An excellent book to go with the new Novice or full call sign. Nine chapters and an appendix deal with all aspects and frequencies from 50 to 1300MHz. Topics include propagation, descriptions of the bands, antennas, receivers, transmitters and a special chapter on scanners. 102 pages. £3.50

LOW PROFILE AMATEUR RADIO - OPERATING A HAM STATION FROM ALMOST ANYWHERE

Jim Kearman KR1S

This book delves into to the techniques of being a 'hidden Ham'. There are chapters on specialised equipment, operating techniques and antennas to name but a few. If you have a fascination for spy type radio equipment or like the idea of having a complete h.f. or v.h.f. rig built in a suitcase, then this little American book is for you. 124 pages. £5.95

MICROWAVE HANDBOOK RSGB

Volumes 1, 2 and 3

Edited By M. W. Dixon G3PFR

Approximately 350 pages (each volume). Vol. 1 costs £9.99, Vol. 2 and 3 cost £14.99 each.

PACKET: SPEED, MORE SPEED and Applications

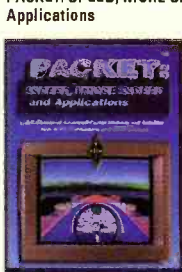

There is a lot to see, learn and do with packet. You don't need to be a 'guru' to join in the fun. This collection of articles and updates from ARRL *Computer Networking Conference Proceedings*, *TAPR's Packet Status Register*, *QEX*, *QST* and the *ARRL Handbook* promises an exciting ride for both packeteers and future packeteers. Hang onto your seat and start-up your modem!
144 pages. £12.95

PRACTICAL GUIDE TO PACKET OPERATION IN THE UK

Mike Mansfield G6AWD

Introduces the concept of packet radio to the beginner. Problem areas are discussed and suggestions made for solutions to minimise them.

Deals with the technical aspects of packet taking the reader through setting up and provides a comprehensive guide to essential reference material. 220 pages. £9.95

QRP CLASSICS

Edited by Bob Schetgen

Operating QRP is fun. The equipment is generally simple and easy to build, but often performs like more sophisticated commercial equipment. Some QRP Field Day stations operate a full 27 hours on a car battery - it's the perfect equipment for emergency communication when the power fails. Extracts from *QST* and the *ARRL Handbook*. 274 pages. £9.95

RADIO AMATEUR CALLBOOK INTERNATIONAL LISTINGS 1995

73rd Edition

The only publication listing licensed radio amateurs throughout the world. Also includes DXCC Countries list, standard time chart, beacon lists and much more. Over 1400 pages. £20.95

RADIO AMATEUR CALLBOOK NORTH AMERICAN LISTINGS 1995

73rd Edition

Listings of US amateurs (including Hawaii). Also contains standard time chart, census of amateur licences of the world, world-wide QSL bureau, etc. Over 1400 pages. £20.95

THE RADIO AMATEUR'S GUIDE TO EMC RSGB

Robin Page-Jones G3JWI

This paperback book provides essential information and reading for anyone who has an EMC (interference) problem. With the help of the well-illustrated text and techniques, much of the mystery from the troublesome world of electromagnetic compatibility is removed.
117 pages. £7.99

RADIO COMMUNICATION HANDBOOK (RSGB)

6th Edition

Dick Biddulph G8PDS

This long awaited new edition has been extensively up-dated and is full of diagrams and photographs. This book is a complete handbook/reference work and project book all rolled into one. The final innovation is that the necessary p.c.b. templates for the featured projects are provided at the end of the book making them much easier to work from when making your own p.c.b.s. 750 pages. £20.00.

RAE MANUAL RSGB

G.L. Benbow G3HB

The latest edition of the standard aid to studying for the Radio Amateurs' Examination. Updated to cover the latest revisions to the syllabus. Takes the candidate step-by-step through the course.
127 pages. £7.99

RAE REVISION NOTES

George Benbow G3HB

If you're studying for the Radio Amateur's Examination, this book could be useful. It's a summary of the salient points of the *Radio Amateurs' Examination Manual*, the standard textbook for the exam. It's A5 size and therefore can be carried with you wherever you go. Easy-to-read, it's divided into 13 chapters with topics like receivers, power supplies, measurements, operating procedures, licence conditions and a summary of the formulae all dealt with. 92 pages. £4.99

REVISION QUESTIONS FOR THE NOVICE RAE RSGB

Esde Tyler G0AEC

In effect Esde Tyler's book could be considered as being a training manual for the RAE. Answers are supplied and the book provides a useful reference source. 60 pages. £5.00

RECEIVING STATION LOG BOOK

Published by RSGB

£3.50

SPACE RADIO HANDBOOK RSGB

John Branegan G4I4HJ

236 pages. £12.50

THE NOVICE LICENCE STUDENT'S NOTEBOOK

John Case GW4HWR

This is the recommended course book for anyone taking the Novice Licence. Covering all aspects of amateur radio and electronics it would be useful to anyone starting out in amateur radio. Every left hand page is for your own notes of explanation. 124 pages. £5.99

TRAINING FOR THE NOVICE LICENCE RSGB

John Case GW4HWR

Aimed at the Novice licence instructor this manual provides the syllabus and an excellent framework textbook to help novice, instructor and beginner alike. An excellent basic reference work. 101 pages. £6.50

VHF/UHF OX BOOK

Edited Ian White G3SEK

An all round source of inspiration for the v.h.f./u.h.f. enthusiast. Written by acknowledged experts this book covers just about everything you need to know about the technicalities of v.h.f./u.h.f. operating. 270 pages. £18.00

VHF UHF MANUAL RSGB

G. R. Jessop G6JP

The 4th edition of this well-known book is in

paperback form. Packed with information for the world of radio above 30MHz. It covers everything from v.h.f./u.h.f. radio history and theory and propagation to projects and techniques. An excellent reference source.
Approximately 1000 pages. £10.50

W1FB's DESIGN NOTEBOOK

Doug DeMaw W1FB

This book is aimed at the non-technical amateur who wants to build simple projects and obtain a basic understanding of amateur electronics. Your workshop does not need to be equipped like an engineering lab to be successful as an experimenter. Don't let a lack of test equipment keep you from enjoying the thrills of experimentation. 195 pages. £8.50

W1FB's HELP FOR NEW HAMS

Doug DeMaw W1FB

This book covers everything from getting acquainted with new equipment to constructing antennas, station layout, interference and operating problems to on-the-air conduct and procedures. 155 pages. £8.95

W1FB's QRP NOTEBOOK

2nd Edition. Doug DeMaw W1FB

The new improved and updated 2nd edition of this book, covers the introduction to QRP, construction methods, receivers and transmitters for QRP. This workshop-notebook style publication, which is packed with new designs for the keen QRP operator, also covers techniques, accessories and has a small technical reference section.
175 pages. £7.95

WORLD AT THEIR FINGERTIPS RSGB

John Clarricotts G6CL

307 pages. £6.00

YOUR GATEWAY TO PACKET RADIO

Stan Horzepa WA1LOU

What is packet radio good for and what uses does it have for the 'average' amateur? What are protocols? where, why, when? Lots of the most asked questions are answered in this useful book. It included details of networking and space communications using packet. 278 pages. £8.95

YOUR PACKET COMPANION

Steve Ford WB8IMY

This American book goes to considerable lengths to explain in simple terms how the radio amateur can get going on packet, how it works and what the various systems are. There are chapters dealing with assembling a packet station, sending and receiving packet mail and exploring advanced networking systems. *Your Packet Companion* goes a long way to explain some of the mysteries of packet radio. 170 pages. £5.95

DATA REFERENCE

NEWNES AUDIO & HI-FI ENGINEER'S POCKET BOOK

Vivian Capel

190 pages. Hardback. £10.95

NEWNES COMPUTER ENGINEER'S POCKET BOOK

255 pages. Hardback. £12.95

POWER SELECTOR GUIDE BP235

J. C. J. Van de Ven

160 pages. £4.95

NEWNES ELECTRONICS ENGINEER'S POCKET BOOK

1st Edition

Keith Brindley

This fact-filled pocket book will prove useful for any electronics engineer. Its comprehensive coverage includes literally everything from electronic physics to abbreviations, information on integrated circuits, applications, component data, circuits and systems. In effect this book provides a very useful portable electronics reference source. 305 pages. £12.95

A REFERENCE GUIDE TO BASIC ELECTRONICS TERMS BP286

F. A. Wilson

Covering everything from Amplitude Modulation to Zener Diodes, this excellent guide is a manual, dictionary and revision book all rolled into one. With concise explanations, clear diagrams and easy to follow examples, this is an essential addition to the library of anyone contemplating taking the RAE. 474 pages. £5.95

A REFERENCE GUIDE TO PRACTICAL ELECTRONICS TERMS BP287

F. A. Wilson

This is a well written clearly illustrated reference guide which, when used on its own, is perhaps of more use to those interested in the constructional side of amateur radio. However, it is of particular benefit to those taking the RAE especially if used in conjunction with *A Reference Guide to Basic Electronics Terms*. 442 pages. £5.95

INTERNATIONAL TRANSISTOR EQUIVALENTS GUIDE BP85

Adrian Michaels

300 pages. £3.95

CONSTRUCTION

CIRCUIT SOURCE BOOK 2 BP322
R. A. Penfold 214 pages. £4.95

COIL DESIGN AND CONSTRUCTION MANUAL
BP160
B. B. Babani 106 pages. £2.50

G-QRP CLUB CIRCUIT HANDBOOK
Edited by Rev. G. Dobbs G3RJV
This paperback book has been compiled from circuits published in the G-QRP Club journal *Sprat* from the years 1974 to 1982. Essentially it's a collection of circuits and projects covering everything from receivers, transmitters, antennas and accessories together with sed QRP test equipment. This book is aimed at the keen constructor and provides all the information required to build the host of projects described.
96 pages. £8.50

HOW TO DESIGN AND MAKE YOUR OWN PCBs
BP121 R. A. Penfold
The purpose of this book is to familiarise the reader with both simple and more sophisticated methods of producing p.c.b.s. The emphasis of the book is very much on the practical aspects of p.c.b. design and construction. 66 pages. £2.50

MORE ADVANCED POWER SUPPLY PROJECTS
BP192 R. A. Penfold
The practical and theoretical aspects of the circuits are covered in some detail. Topics include switched mode power supplies, precision regulators, dual tracking regulators and computer controlled power supplies, etc. 92 pages. £2.95

PROJECTS FOR RADIO AMATEURS AND SWLS
BP304 R. A. Penfold
This small book covers the construction and use of radio frequency and intermediate frequency

projects, and audio frequency projects. Under the first heading ideas include a crystal calibrator, an antenna tuning unit, a wave trap, a b.f.o. and other useful projects. On the audio side projects include a bandpass filter, a by-pass switch, a c.w./RTTY decoder and many other practical ideas and suggestions for the home constructor.
92 pages. £3.95.

POWER SUPPLY PROJECTS BP76
R. A. Penfold
This book gives a number of power supply designs including simple unregulated types, fixed voltage regulated types and variable voltage stabilised designs.
89 pages. £2.50

SHORT WAVE SUPERHET RECEIVER CONSTRUCTION BP276
R. A. Penfold
A general purpose receiver to build, from antenna to audio, described in understandable English. 80 pages. £2.95

TEST EQUIPMENT CONSTRUCTION
BP248 R. A. Penfold
Describes, in detail, how to construct some simple and inexpensive, but extremely useful, pieces of test equipment. Stripboard layouts are provided for all designs, together with wiring diagrams where appropriate, plus notes on their construction and use. 104 pages. £2.95

50 (FET) FIELD EFFECT TRANSISTOR PROJECTS
BP299
F. G. Rayer
50 circuits for the s.w.l., radio amateur, experimenter or audio enthusiast using f.e.t.s. Projects include r.f. amplifiers and converters, test equipment and receiver aids, tuners, receivers, mixers and tone controls.
104 pages. £2.95

COMPUTING

INTERFACING PCs AND COMPATIBLES BP272
R. A. Penfold.
86 pages. £3.95

ELECTRONIC PROJECTS FOR YOUR PC BP320
R. A. Penfold.
102 pages. £3.95

INTRODUCTION TO COMPUTER COMMUNICATIONS (AN) BP177
R. A. Penfold
Details of various types of modem and their applications, plus how to interconnect computers, modems and the telephone system. Also networking systems and RTTY.
72 pages. £2.95

NEWNES AMATEUR RADIO COMPUTING HAND BOOK
Joe Pritchard G1UQU
Shows how radio amateurs and listeners can 'listen' to signals by reading text on a computer screen. This book also covers the application of computers to radio 'housekeeping' such as log-keeping, QSL cards, satellite predictions and antenna design as well as showing how to control a radio with a computer. 363 pages. 0/P

PCs MADE EASY. Second Edition
James L. Turley
A friendly, comprehensive introduction to every personal computer - including Macs! This book is packed with valuable tips on every aspect of computer technology available today and will help you to get comfortable with your computer - fast. 438 pages. £15.95

MORSE

INTRODUCING MORSE
Collected Articles from PW1982-1985
48 pages. £1.25

SECRET OF LEARNING MORSE CODE
Mark Francis
Updates for the Novice Licence. Designed to make you proficient in Morse code in the shortest possible time, this book points out many of the pitfalls that beset the student. 84 pages. £4.95

THEORY

CIRCUIT SOURCE BOOK 1 - BP321
R. A. Penfold
Written to help you create and experiment with your own electronic designs by combining and using the various standard 'building block' circuits provided. Deals with filters, amplifiers, voltage comparators, etc.
182 pages. £4.95

CIRCUIT SOURCE BOOK 2 - BP322
R. A. Penfold
Complimentary to *Circuit Source Book 1*, helps you create and experiment with your own electronic designs by combining and using the various standard 'building block' circuits provided. Covers signal generation, power supplies and digital electronics, etc.
214 pages. £4.95

ARRL ELECTRONICS DATA BOOK
Doug DeMaw W1FB
Back by popular demand, completely revised and expanded, this is a handy reference book for the r.f. designer, technician, amateur and experimenter. Topics include components and materials, inductors and transformers, networks & filters, digital basics and antennas and transmission lines. 260 pages. £8.95

AUDIO
Elements of Electronics - Book 6 BP111
F. A. Wilson
This book studies sound and hearing, and examines the operation of microphones, loudspeakers, amplifiers, oscillators, and both disk and magnetic recording. Intended to give the reader a good understanding of the subject without getting involved in the more complicated theory and mathematics.
308 pages. £3.95

BEGINNERS GUIDE TO MODERN ELECTRONIC COMPONENTS BP285. R. A. Penfold
This book covers a wide range of modern components. The basic functions of the components are described, but this is not a book on electronic theory and does not assume the reader has an in-depth knowledge of electronics. It is concerned with practicalities such as colour codes, deciphering code numbers and suitability.
166 pages. £3.95

EVERYDAY ELECTRONICS DATA BOOK
Mike Tooley BA. 250 pages. £8.95

FILTER HANDBOOK
A Practical Design Guide
Stefan Niewiadomski
A practical book, describing the design process as applied to filters of all types. Includes practical examples and BASIC programs. Topics include passive and active filters, worked examples of filter design, switched capacitor and switched resistor filters and includes a comprehensive catalogue of pre-calculated tables. 195 pages. £30.00

GUIDE TO CREATIVE CIRCUIT DESIGN
Robert Grossblatt
A book that takes you through all stages of design and building of (mainly) digital circuits, though many of the principles apply to all forms of design and building. One nugget from the book, 'if you can't replace it - don't use it'.
235 pages. £17.95

FURTHER PRACTICAL ELECTRONICS CALCULATIONS & FORMULAE BP144
F. A. Wilson. 450 pages. £4.95

AN INTRODUCTION TO THE ELECTROMAGNETIC WAVE BP315
F. A. Wilson
This little book deals effectively with a difficult abstract subject - the invisible electromagnetic wave. Aimed at the beginner, the book with its basic approach to electromagnetics, antennas, waves, propagation and constraints is a good starting point, complete very simple but clear

diagrams and the minimum of mathematics.
122 pages. £4.95.

NEWNES PRACTICAL RF HANDBOOK
Ian Hickman
This book provides an easy-to-read introduction to modern r.f. circuit design. It's aimed at those learning to design r.f. circuitry and users of r.f. equipment such as signal generators and sweepers, spectrum and network analysers.
320 pages. £16.95

THE ARRL SPREAD SPECTRUM SOURCEBOOK
Many readers thought an article about spread spectrum communications in the April 1993 *PW* spoof, but this book shows the reality of the technique. The ten chapters contain descriptions of the basic theory, the designs, and the techniques involved, and there are basic transceiver building blocks for your experimentation. 360+ pages. £14.50.

PRACTICAL ELECTRONICS CALCULATIONS AND FORMULAE
BP53. F. A. Wilson
Written as a workshop manual for the electronics enthusiast, there is a strong practical bias and higher mathematics have been avoided where possible.
249 pages. £3.95

REFLECTIONS
Transmission Lines & Antennas
M. Walter Maxwell W2DU
This will help dispel the half-truths and outright myths that many people believe are true about transmission lines, standing waves, antenna matching, reflected power and antenna tuners.
323 pages. £14.50

SOLID STATE DESIGN FOR THE RADIO AMATEUR
Les Hayward W7ZO1 & Doug DeMaw W1FB
Back in print by popular demand! A revised and corrected edition of this useful reference book covering all aspects of solid-state design. Topics include transmitter design, power amplifiers and matching networks, receiver design, test equipment and portable gear.
256 pages. £10.95

TRANSMISSION LINE TRANSFORMERS
Jerry Sevick W2FMI
This is the second edition of this book, which covers a most intriguing and confusing area of the hobby. It should enable anyone with a modicum of skill to make a balun, etc. Topics include analysis, characterisation, transformer parameters, baluns, multimatch transformers and simple test equipment.
270 pages. £13.50

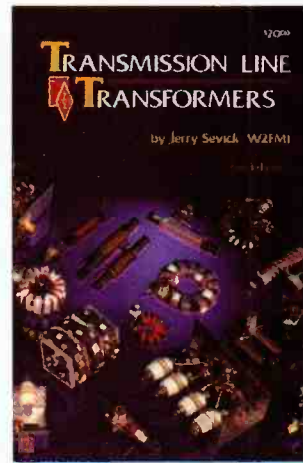

BEGINNERS

ELECTRONICS SIMPLIFIED - CRYSTAL SET CONSTRUCTION
BP92 F. A. Wilson
Especially written for those who wish to take part in basic radio building. All the sets in the book are old designs updated with modern components. It is designed for all ages upwards from the day when one can read intelligently and handle simple tools.
72 pages. £1.75

RADIO

THE WORLDWIDE AERONAUTICAL COMMUNICATIONS FREQUENCY DIRECTORY 2nd Edition
Robert E. Evans
This book covers aeronautical radio communications, voice and digital, within the range of h.f. and v.h.f./u.h.f. frequency bands. Commercial, military and para-military operations are included. Divided into logical sections, it provides useful information and frequencies on almost anything and everything airband.
260 pages. £19.95

UNDERSTANDING ACARS 2nd Edition
Aircraft Communications Addressing and Reporting System
Ed Flynn
Here is the information you need to understand and decode the Aircraft Communications Addressing and Reporting System, otherwise known as ACARS. Deals with the equipment needed as well as message format and type.
80 pages. £9.95

AIR & METEO CODE MANUAL 14th Edition.
Joerg Klingentuss
Detailed descriptions of the World Meteorological Organisation Global Telecommunication System operating FAX and RTTY meteo stations, and its message format with decoding examples. Also detailed description of the Aeronautical Fixed Telecommunication Network amongst others.
358 pages. £20.00

MARINE SSB OPERATION
J. Michael Gale
How do you stay in touch when you sail off over the horizon and into the blue? What you need is a single sideband radio, a marine s.s.b. This book explains how the system works, how to choose and install your set and how to get the best out of it. There is also a chapter on amateur radio with the emphasis on the increasingly important maritime mobile nets. 96 pages. £10.95

MARINE VHF OPERATION
J. Michael Gale
A v.h.f. radiotelephone is essential equipment for any sea-going boat, but what can you do with it? Who can you call, and how do you make contact? Which channel do you use, and why? What is the procedure for calling another boat, calling the family through the telephone system, or making a distress call? This book will tell you.
47 pages. £7.95

PASSPORT TO WORLD BAND RADIO 1995
This book gives you the information to explore and enjoy the world of broadcast band listening. It includes features on different international radio stations, receiver reviews and advice as well as the hours and language of broadcast stations by frequency. The 'blue pages' provide a channel-to-channel guide to world band schedules.
416 pages. £14.50

RADIOTELETYPE CODE MANUAL 13th Edition
Joerg Klingentuss
This book gives detailed descriptions of the characteristics of telegraph transmission on short waves, with all commercial modulation types including voice frequency telegraphy and comprehensive information on all RTTY systems and c.w. alphabets. 96 pages. £14.00

AN INTRODUCTION TO SCANNERS AND SCANNING BP311
I. D. Poole
This book is ideal for anyone wanting to know what scanning is, and how it works. There are also chapters on radio in general, covering antennas, radio waves and how they travel, types of transmissions, broadcasting and amateur radio. All in all a superb starter book. 152 pages. £4.95

SCANNERS 2
Peter Rouse GU1DKD
The companion to *Scanners*, this provides even more information on the use of the v.h.f. and u.h.f. communications band and gives constructional details for accessories to improve the performance of scanning equipment. 261 pages. £10.95

SCANNERS 3 PUTTING SCANNERS INTO PRACTICE. New Edition 4th Revision
Peter Rouse
The title *Scanners 3* has been chosen to avoid confusion, as the book has undergone a virtual rewrite since *Scanners 3rd Edition* was published. Although written by the late Peter Rouse, Chris Lorek G4HCL has edited and 'finished off' this, the latest in the *Scanners* series. Including frequency lists, and for the first time, a section on the h.f. bands. Also listed are full British bandplans from 25 to 2000MHz, as well as a section on scanner and accessory dealers. 271 pages. £9.95

SHORT WAVE COMMUNICATIONS
Peter Rouse GU1DKD
Covers a very wide area and so provides an ideal introduction to the hobby of radio comms. International frequency listings for aviation, marine, military, space launches, search and rescue, etc. Chapters on basic radio propagation, how to work your radio and what the controls do, antennas and band plans. 187 pages. £8.95

WORLDWIDE HF RADIO HANDBOOK
Martyn R. Cooke. 124 pages. £6.95

1934 OFFICIAL SHORT WAVE RADIO MANUAL
Edited by Hugo Gernsback
A fascinating reprint from a bygone age with a directory of all the 1934 s.w. receivers, servicing information, constructional projects, circuits and ideas on building vintage radio sets with modern parts. 260 pages. £11.60

ANTENNAS (AERIALS)

AERIAL PROJECTS BP105

Practical designs including active, loop and ferrite antennas plus accessory units. 96 pages. £7.50

ALL ABOUT VERTICAL ANTENNAS

W. I. Orr W6SAI & S. D. Cowan W2LX
Covers the theory, design and construction operation of vertical antennas. How to use your tower as a vertical antenna and compact vertical designs for restricted locations. All about loading coils and a.t.u.s. 192 pages. £7.50

ANTENNA EXPERIMENTER'S GUIDE

Peter Dodd G3LDO
Although written for radio amateurs, this book will be of interest to anyone who enjoys experimenting with antennas. You only need a very basic knowledge of radio & electronics to get the most from this book. Chapters include details on measuring resonance, impedance, field strength and performance, mats and materials and experimental antennas. 200 pages. £8.90

ANTENNA IMPEDANCE

Matching
Wilfred N. Caron
Proper impedance matching of an antenna to a transmission line is of concern to antenna engineers and to every radio amateur. A properly matched antenna as the termination for a line minimises feed-line losses. Power can be fed to such a line without the need for a matching network at the line input. There is no mystique involved in designing even the most complex multi-element networks for broadband coverage. 195 pages. £14.50

ANTENNAS FOR VHF AND UHF BP301

I. D. Poole
Antennas are a very important part of any receiver or transmitter and in this book the author gives a general background to antenna operation as well as describing antennas that are suitable for v.h.f. and u.h.f. operation. Chapters include Basic Concepts, Feeders, The Dipole, Aerial Measurements and Practical Aspects. There is something of use for everyone with an interest in antennas in this book. 104 pages. £4.95

ARRL ANTENNA BOOK

17th Edition
This volume now in its 17th edition contains essential information regarding propagation and constructional details of just about every type of antenna known to man. Included is a 3.5" diskette contain in PC programs for Yagi analysis, propagation forecasting, transmission line analysis and other. A definite must. 732 pages. £19.95

ARRL ANTENNA COMPENDIUM

Volume One
Fascinating and hitherto unpublished material. Among the topics discussed are quads and loops, log periodic arrays, beam and multi-band antennas, verticals and reduced size antennas. 175 pages. £9.50

ARRL ANTENNA COMPENDIUM

Volume Two
Because antennas are a topic of great interest among radio amateurs, ARRL HQ continues to receive many more papers on the subject than can possibly be published in QST. Those papers are collected in this volume. 208 pages. £9.50

ARRL ANTENNA COMPENDIUM

Volume Three
Edited by Jerry Hall K1TD
As the title suggests, this book is the third in the continuing series on practical antennas, theory and accessories produced by the ARRL. The book reflects the tremendous interest and activity in antenna work, and provides a further selection of antennas and related projects you can build. 236 pages. £9.50

ANTENNA COMPENDIUM

Volume 4
The fourth volume in the ever popular series contains 38 previously unpublished

articles, covering a wide range of antenna related topics - all the way from the maths intensive, heavyweight discussions to fun antennas for specific purposes, such as a balloon supported Field Day loop.

For the first time in the series there is a disk included with the book, which contains source data used to model many of the antennas. In short, there's something for virtually every antenna enthusiast. 204 pages. £14.50

BEAM ANTENNA HANDBOOK

W. I. Orr W6SAI & S. D. Cowan W2LX
Design, construction, adjustment and installation of h.f. beam antennas. The information this book contains has been compiled from the data obtained in experiments conducted by the authors, and from information provided by scientists and engineers working on commercial and military antenna ranges. 268 pages. £7.50

HF ANTENNA COLLECTION (RSGB)

Edited by Erwin David G4LQI
This book contains a collection of useful, and interesting h.f. antenna articles, first published in the RSGB's *Radio Communication* magazine, between 1968 and 1989, along with other useful information on ancillary topics such as feeders, tuners, baluns, testing and mechanics for the antenna builder. 233 pages. £10.99

HF ANTENNAS FOR ALL LOCATIONS RSGB

Les Moxon G6XN
This book provides a reference source for all h.f. antenna work, whether it be for fixed, mobile or using test equipment. In effect it is a manual on antenna work, with useful tips, projects and ideas. 322 pages. £13.99

INTRODUCTION TO ANTENNA THEORY

BP198
H. C. Wright
This book deals with the basic concepts relevant to receiving and transmitting antennas, with emphasis on the mechanics and minimal use of mathematics. Lots of diagrams help with the understanding of the subjects dealt with. Chapters include information on efficiency, impedance, parasitic elements and a variety of different antennas. 86 pages. £2.95

PRACTICAL ANTENNAS FOR NOVICES

John Heys G3BDD
In this guide, written especially for newly qualified holders of the UK novice Licence, John Heys describes in detail how to build simple but efficient antennas for each of the Novice bands up to 434MHz, as well as useful ancillary equipment to ensure that they are working correctly. A complete chapter is devoted to the safety and common-sense aspects of installing and using a transmitting antenna.

This book will be invaluable not only to Novices, but also to any beginning amateur looking for easy-to-build antenna systems that really work. 52 pages. £5.99

PRACTICAL ANTENNA HANDBOOK

2nd Edition
Joseph J. Carr
As the name suggests, this book offers a practical guide to everything to do with antennas, from h.f. to microwaves. It also has sections on propagation, transmission lines, antenna fundamentals and a helpful introduction to radio broadcasting and communication. The book neatly balances a practical approach with the minimum of mathematics, good diagrams and a lively text. 437 pages. £23.95

PRACTICAL WIRE ANTENNAS RSGB

John Heys G3BDD
Many radio enthusiasts have to be content with wire antennas. John Heys' practical approach to wire antennas provides plenty of ideas and projects to help get the best



out of a simple system. A helpful book, and good reference source. 100 pages. £8.50

G-QRP CLUB ANTENNA HANDBOOK

Compiled and edited by P. Linsley G3PDL & T. Nicholson KA9WRI/GWOLND
This book is a collection of antenna and related circuits taken from *Sprat*, the G-QRP Club's journal. Although most of the circuits are aimed at the low-power fraternity, many of the interesting projects are also useful for general use. Not intended as a text book, but offers practical and proven circuits. 155 pages. £5.00

RADIO AMATEUR ANTENNA HANDBOOK

W. I. Orr W6SAI & S. D. Cowan W2LX
Yagi, Quad, Quagi and LPY beam antennas as well as vertical, horizontal and sloper antennas are covered in this useful book. How to judge the best location, DX antenna height, ground loss and radials. 188 pages. £7.50

RECEIVING ANTENNA HANDBOOK

Joe Carr
Your receiver is only as good as your antenna. This book is a complete guide to high performance receiving antennas. It is a comprehensive examination of antennas intended specifically for receiving purposes. An essential addition to your technical library, the listeners antenna bible. 189 pages. £17.50

SIMPLE, LOW-COST WIRE ANTENNAS FOR RADIO AMATEURS

W. I. Orr W6SAI & S. D. Cowan W2LX
Efficient antennas for Top Band to 2m, including 'invisible' antennas for difficult station locations. Clear explanations of resonance, radiation resistance, impedance, s.w.r., balanced and unbalanced antennas are also included. 188 pages. £7.50

W1FB'S ANTENNA NOTEBOOK

Doug DeMaw W1FB
This book provides lots of designs, in simple and easy to read terms, for simple wire and tubing antennas. All drawings are large and clear making construction much easier. There is no high-level mathematics in this book, just simple equations only when necessary to calculate the length of an antenna element or its matching section. 123 pages. £6.95

YAGI ANTENNA DESIGN

Dr James. L. Lawson W2PV
This book is a polished and expanded version of a series of articles first published in *Ham Radio* following on from a series of lectures by the author, who was well-known as the expert on Yagi design. Chapters include simple Yagi antennas, loop antennas, effect of ground, stacking and practical antenna design. 210 pages. £10.95

25 SIMPLE AMATEUR BAND AERIALS

BP125
E. M. Noll
63 pages. £1.95

25 SIMPLE INDOOR AND WINDOW

AERIALS BP136E
E. M. Noll
50 pages. £1.75

25 SIMPLE SHORT WAVE BROADCAST

BAND AERIALS BP132
E. M. Noll
63 pages. £1.95

25 SIMPLE TROPICAL AND MW BAND

AERIALS BP145.
E. M. Noll
54 pages. £1.75

£50 PRIZE DRAW

If you are ordering a book don't forget you'll be entered into our prize draw. See the top of page 79 for full details.

FAULT FINDING

GETTING THE MOST FROM YOUR MULTIMETER

BP239
R.A. Penfold
This book is primarily aimed at beginners. It covers both analogue and digital multi-meters and their respective limitations. All kinds of testing is explained too. No previous knowledge is required or assumed. 102 pages. £2.95

HOW TO USE OSCILLOSCOPES & OTHER TEST EQUIPMENT BP267

R.A. Penfold
Hints and ideas on how to use the test equipment you have, to check out, or fault find on electronic circuits. Many diagrams of typical waveforms and circuits, including descriptions of what waveform to expect with particular faults, or distortion in audio amplifiers. 104 pages. £3.50

MORE ADVANCED TEST EQUIPMENT CONSTRUCTION BP249

R.A. Penfold
A follow on from *Test Equipment Construction (BP249)* this book looks at digital methods of measuring resistance, voltage, current, capacitance and frequency. Also covered is testing semi-conductors, along with test gear for general radio related topics. 102 pages. £3.50

TROUBLESHOOTING WITH YOUR TRIGGERED-SWEEP OSCILLOSCOPE

Robert L. Goodman
This book steers you through the various features - old and new - that scope technology provides and is an invaluable guide to getting the best out of your scope. An overview of available scopes will help you choose the one that best suits your needs. Areas covered include spectrum analysis, test applications, multiple-trace displays, waveform analysis, triggering, magnified sweep displays, analogue and digital scopes, etc. 309 pages. £17.50

MORE ADVANCED USES OF THE MULTIMETER

BP265
R.A. Penfold
This book is primarily intended as a follow-up to BP239, *Getting the most from your Multi-meter*. By using the techniques described in this book you can test and analyse the performance of a range of components with just a multi-meter (plus a very few inexpensive components in some cases). The simple add-ons described extend the capabilities of a multi-meter to make it even more useful. 96 pages. £2.95

OSCILLOSCOPES, HOW TO USE THEM, HOW THEY WORK. 3rd Edition

Ian Hickman
248 pages. £15.95

TELEVISION

ATV COMPENDIUM

Mike Wooding G6IOM
This book is for those interested in amateur television, particularly the home construction aspect. There isn't a 70cm section as the author felt this was covered in other books. Other fields such as 3cm TV, are covered in depth. A must for the practical ATV enthusiast. 104 pages. £3.00

INTERFERENCE

INTERFERENCE HANDBOOK (USA)

William R. Nelson WA6FG
How to locate & cure r.f.i. for radio amateurs, CBers, TV & stereo owners. Types of interference covered are spark discharge, electrostatic, power line many 'cures' are suggested. 250 pages. £9.50

MAPS

NORTH ATLANTIC ROUTE CHART
This is a five-colour chart designed for the ATC in monitoring transatlantic flights. Supplied folded. 740 x 520mm. £6.50

RADIO AMATEURS MAP OF THE WORLD
This a brightly coloured map clearly showing call sign prefixes for the world and is up-to-date with recent European boundary changes. Supplied folded in a clear plastic wallet. 980 x 680mm. £5.95

QTH LOCATOR MAP OF EUROPE

Traxel DK5PZ
Radio Map Service
This comprehensive map of the European call sign area has now been updated and enhanced. This well thought out, coloured map covers from N. Africa to Iceland and from Portugal in the west to Iran in the east. Folds to fit into the 145 x 240mm clear envelope. 1080 x 680mm. £5.95

SUBSCRIPTION RATES

SHORT WAVE MAGAZINE - 1 YEAR

- £25.00 (UK) £28.00 (Europe)
 £30.00 (Rest of World)

Please enquire for airmail rates

SPECIAL JOINT SUBSCRIPTION WITH PRACTICAL WIRELESS (1 YEAR)

- £42.00 (UK) £47.00 (Europe)
 £51.00 (Rest of World)

Please start my subscription with theissue.

SUBS CLUB Page 46

- Please send meMobile Mounts(s)
 @ £10.49 inc P&P (UK)£

BINDERS

- Please send me SWM Binder(s)
 @ £5.50 each. £
 Postal charges: £1 for one, £2 for two or more
 (UK & overseas surface)

BOOKS

- Please send me the following books

.....£
£
£
£
£
£
£
£
£

Postal charges.

UK: £1 for one, £2 for two or more. £

Overseas:

£1.75 for one, £3.50 for two or more. £

NEW FASTER NEXT DAY SERVICE (UK) £

(For orders received am) £3.75 £

GRAND TOTAL £

ORDER FORM

FOR ALL MAIL ORDER PURCHASES IN SHORT WAVE MAGAZINE

We have re-designed our Order Form to accommodate the new Cardcharge service for Subscribers. This enables Subscribers to save a lot of hassle by using their credit card to pay for their subscription on an automatic annual renewal basis. To take advantage of this service complete the special Cardcharge form at the foot of this page and we will take care of the rest.

CREDIT CARD ORDERS TAKEN ON (01202) 659930

between the hours of 8.30 a.m. - 4.30 p.m. Outside these hours your order will be recorded on an answerphone

FAX ORDERS TAKEN ON (01202) 659950

Or please fill in the details ticking the relevant boxes, a photocopy will be acceptable to save you cutting your beloved copy!

To: PW Publishing Ltd., FREEPOST, Arrowsmith Court, Station Approach, Broadstone, Dorset BH18 8PW.

PAYMENT DETAILS

Name

Address

.....Postcode

Telephone No.

I enclose cheque/PO (Payable to PW Publishing Ltd.) £
 \$

Or
 Charge to my Access/Visa Card the amount of £
 \$

Card No.

Valid fromto.....

SignatureTel:.....

Orders are normally despatched by return of post but please allow 28 days for delivery. Prices correct at time of going to press. **Please note:** all payments must be made in Sterling.

CREDIT CARD ORDERS TAKEN ON (01202) 659930

FAX ORDERS TAKEN ON (01202) 659950

Use this part of the Order form **only** if you want to use Cardcharge to pay for your subscription. If you want to take out a subscription, or order other items and want to pay by conventional methods, please use the main part of the Order Form.

CARDCHARGE AUTHORITY (for subscriptions only)

To

I authorise you, until further notice in writing, to charge my card unspecified amounts in respect of.....(yearly magazine subscription)

as and when they become due

Visa/MasterCard account number

Expiry date

Name (as on credit card).....

Full Address.....

.....

.....

.....Postcode.....

Merchant reference 6940936

Signature

Date

This authority may be cancelled by writing to PW Publishing Ltd. at any time.

SCANNER OWNERS
TURN YOUR 'SHACK' INTO A MONITORING STATION!
 Connect to any receiver with a squelch control and the **AUTO-VOX** will automatically switch your tape recorder on and off as signals are detected. A **must** for all scanner owners. 'Return to a neatly compressed tape of all the action'. Supplied as a kit with full instructions or ready built and tested.

Kit £15.00 AUTO-VOX Built £25.00

Send large SAE for details of all our scanner upgrades

Radio Research, P.O. Box 555, Stoke-on-Trent ST6 5BF

RAE 'THE VIDEO' – The definitive learning aid for the exam!

A full three hour VHS video based on the highly successful training course developed and presented by **Chris Budd GOLOJ**.

This unbeatable package comes complete with a detailed course study booklet, packed with key learning points, facts and diagrams for instant reference and easy revision. **Only £22.50** including postage and packaging or available to callers.

Send cheque or postal order to: Tricorn Marketing Ltd, 10 Park Row, Bristol BS1 5LJ Telephone 0117-921 5390.

PRIORY SOFTWARE *AMIGA Software for OS2 and above, PAL only*

Aerolog	Plane Callsign, Position, Selcall Log	£7.00
*Data Processor	Save, Load, Edit and Print RTTY Data	£7.00
*QSLD Base	QSL Database	£7.00
Radio Log	Radio Log Book	£7.00
Radio MemDB	500/1000 Channel memory databases	£6.00/£7.00
*Weather Decoder	Decode Ship & Synop Weather Reports	£9.00

**A RTTY decoder with ASCII output is required to use these programs. Prices include p&p. Payment by Cheque or P.O. SAE for program details.*

7 The Priory, 137 Priory Road, Hungersford, Berks RG17 0AP

ELECTRONICS VALVES & SEMICONDUCTORS

Phone for a most courteous quotation
0181-743 0899
Fax: 0181-749 3934

We are one of the largest stockists of valves etc, in the U.K.

COLOMOR (ELECTRONICS) LTD. 170 GOLDHAWK ROAD LONDON W12 8HJ

G2VF LOOP ANTENNAS WITH ATU FOR HF HAM BAND TRANSMISSION (SWR One to One 40, 15 and 10 One Point Five to One 80 and 20) **AND SWLS LONG AND MEDIUM WAVE FOR BCLs.** Loops 21 inches square or triangle. No special skills required. Circuits, Parts Lists sources of supply assembly data. HIGH FREQUENCY LOOP 80 to 10 Metres £5. LONG AND MEDIUM WAVE LOOP FOR BCLs £3. LONG MEDIUM SHORT WAVE LOOP 1500 to 10 METRES FOR BCL SWL £8. SHORT WAVE ATU LOOP OR LONG WIRE £4. PRE AMP LW MW S WAVE £2. MW LOOP WITH PRE AMP ATU £3. PRE AMP FOR G2VF HF LOOP OR ATU £4. SHORT WAVE ATU BUILT-IN PRE AMP FOR LOOP OR LONG WIRE £7. SAE details. DIY projects. Z Match ATU 80 to 10 metres £3 BFO £2. **F. G. Rylands, 39 Parkside Avenue, Millbrook, Southampton SO16 9AF. Tel: (01703) 775064.**

 **Seldec Aircraft Selcall Decoder**
 The Seldec Decoder enables instant decoding and display of universal aircraft selective calling tones.

A must for serious shortwave utility listeners.

- Instant Display of Aircraft Selcall
- Simple to connect & use
- Remote Reset available
- Attractive 2 colour case

For further information contact Seldec
P.O. Box 3, Kidderminster, Worcs. DY12 1YZ Tel: 01299 661372 Fax: 01299 661530

VALVES WANTED **KT88, PX4, PX25, £45, KT66, £30, KT77, £12**

Any audio valve considered. Top prices paid, prompt decision and payment. Visitors strictly by appointment only please.

Tel: (01403) 784961 Fax: (01403) 783519
Billington Export Ltd.
 Unit 1E Gillmans Industrial Estate, Billingshurst Sussex RH14 9EZ.

SCIENTIFIC SHAREWARE Discover the true wealth of PD & shareware for the PC. Since 1982 PDSL have supplied the best and latest programs covering all interests. *All Software can be provided on Floppy disc or CD ROM*

Business, Leisure, Engineering, CAD, DTP, Maths, Stats, Chemistry, Education, Electronics, Ham Radio, Esoteric, Medical, Raytracing, Programming & languages, Tools, Utilities, WP, Editors, Comms, Special applications, Esoteric, Novelty, Astronomy & hundreds more.

Whatever your interest we probably have it. Send today for our PC Shareware reference guide. It runs to more than 250,000 words and is probably the most comprehensive catalogue currently available. Send £2.50 (voucher provided refundable on first order) or phone/fax using Access/Visa/MC to:

PDSL, Winscombe House, Beacon Road, Crowborough, East Sussex, TN6 1UL Tel: 01892 663298 Fax 01892 667473

ADVERTISERS INDEX

Aerial Techniques	55	Howes, CM	55	Priory Software	84
AOR UK	2	Icom UK	cover iii	R & D Electronics	76
Arlon Publishing	76	Interproducts	64	Radio Research	84
ASK Electronics	36	J & J Enterprises	55	RadioSport	64
Aviation Hobby Centre	67	J & P Electronics	75	Remote Imaging Group	55
Barton Comms	75	Javation	52	Satellite & Sound 2000	50
Billington Export	84	Klingenfuss	63, 76	Seldec	84
Chevet Books	76	Lake Electronics	76	Skyview Systems	67
Circuit Distribution	58	Link Electronics	76	SMC	28
Coastal Comms	34/35	Lowe Electronics 8/9, 47, cover iv		Solid State Electronics	64
Colomor Electronics	84	Martin Lynch	42/43	SRP Trading	26/27
FG Rylands	84	Momentum Comms	58	Sussex Surplus	52
Flightdeck	75	Nevada Comms coverii/1, 16/17		Timestep Weather Systems	67
Garex Electronics	64	PDSL	84	Tricorn Marketing	84
Grosvenor Software	75	Pervisell	76	Waters & Stanton	20/21
Haydon Comms	12/13	PhotAvia Press	61		
Hoka Electronics	75	Photo Acoustics	40		

PUBLISHED on the fourth Thursday of each month by PW Publishing Ltd., Arrowsmith Court, Station Approach, Broadstone, Dorset BH18 8PW. Printed in England by Southernprint (Web Offset), Factory Road, Upton Industrial Estate, Poole, Dorset BH16 5SN. Tel: (01202) 622226. Distributed by Seymour, Windsor House, 1270 London Road, Norbury, London SW16 4DH. Tel: 081-679 1899, Fax: 0181-679 8907, Telex: 881245. Sole Agents for Australia and New Zealand – Gordon and Gotch (Asia) Ltd.; South Africa – Central News Agency Ltd. Subscriptions INLAND £22, EUROPE £25, OVERSEAS (by ASP) £27, payable to SHORT WAVE MAGAZINE, Subscription Department, PW Publishing Ltd., Arrowsmith Court, Station Approach, Broadstone, Dorset BH18 8PW. SHORT WAVE MAGAZINE is sold subject to the following conditions, namely that it shall not without the written consent of the publishers first having been given, be lent, re-sold, hired out or otherwise disposed of by way of trade at more than the recommended selling price shown on the cover and that it shall not be lent, re-sold, hired out or otherwise disposed of in a mutilated condition or in any unauthorised cover by way of Trade, or affixed to or as part of any publication or advertising, literary or pictorial matter whatsoever.

Two of the best



Shown above is ICOM's IC-R72 HF receiver, ideal for monitoring broadcasts, marine vessels, aircraft and emergency services on AM, SSB, CW plus optional FM between 100kHz and 30MHz. The IC-R72 has high sensitivity, an advanced DDS system, 100dB dynamic range and a very interesting range of options, as does the IC-R7100...

ICOM's wide-band IC-R7100 is the visual twin to the R72E, together they look good and work well in any shack.

The IC-R7100 gives continuous coverage in all modes from 25MHz to 2GHz. Working characteristics of both receivers are similar enabling easy operation if used simultaneously or by computer control..



ICOM also manufacture a full range of base-stations, mobiles and handheld transceivers to cover all popular Ham frequencies... and beyond. No matter what your requirements, ICOM have the radio for you. For details of your local authorised Icom dealer contact:
Icom (UK) Ltd. Sea Street Herne Bay Kent CT6 8LD.
Telephone: 0227 743001(24hr). Fax: 0227 741742

The ICOM logo, consisting of a red circle with a white dot inside, positioned above the word 'ICOM' in a bold, white, sans-serif font on a dark purple rectangular background.

famous the world over

The Lowe receiver range

- **HF-150**
Your first 'real' receiver
- **HF-150M**
Marine version of the HF150
- **SP-150**
Matching speaker/filter for the HF150
- **PR-150**
RF preselector for the HF150
- **RK-150**
Stack and rack system
- **HF-225**
Higher specification h.f. receiver
- **HF-225E**
Super high performance model



**Distributors
and dealers
in most
countries**

Contact Lowe
Electronics to find out
your nearest dealer

**Tel: (01629) 580800
Fax: (01629) 580020**



Manufactured by:
**Lowe Electronics,
Chesterfield Road,
Matlock, Derbyshire, DE4 5LE, UK**