

SHORT WAVE
MAGAZINE

shortwave magazine

December 1991 £1.75 ISSN 0037 - 4261

SPEEDBIRD CONCORDE ZERO ONE

Peter Rouse
flies to New
York at Mach 2

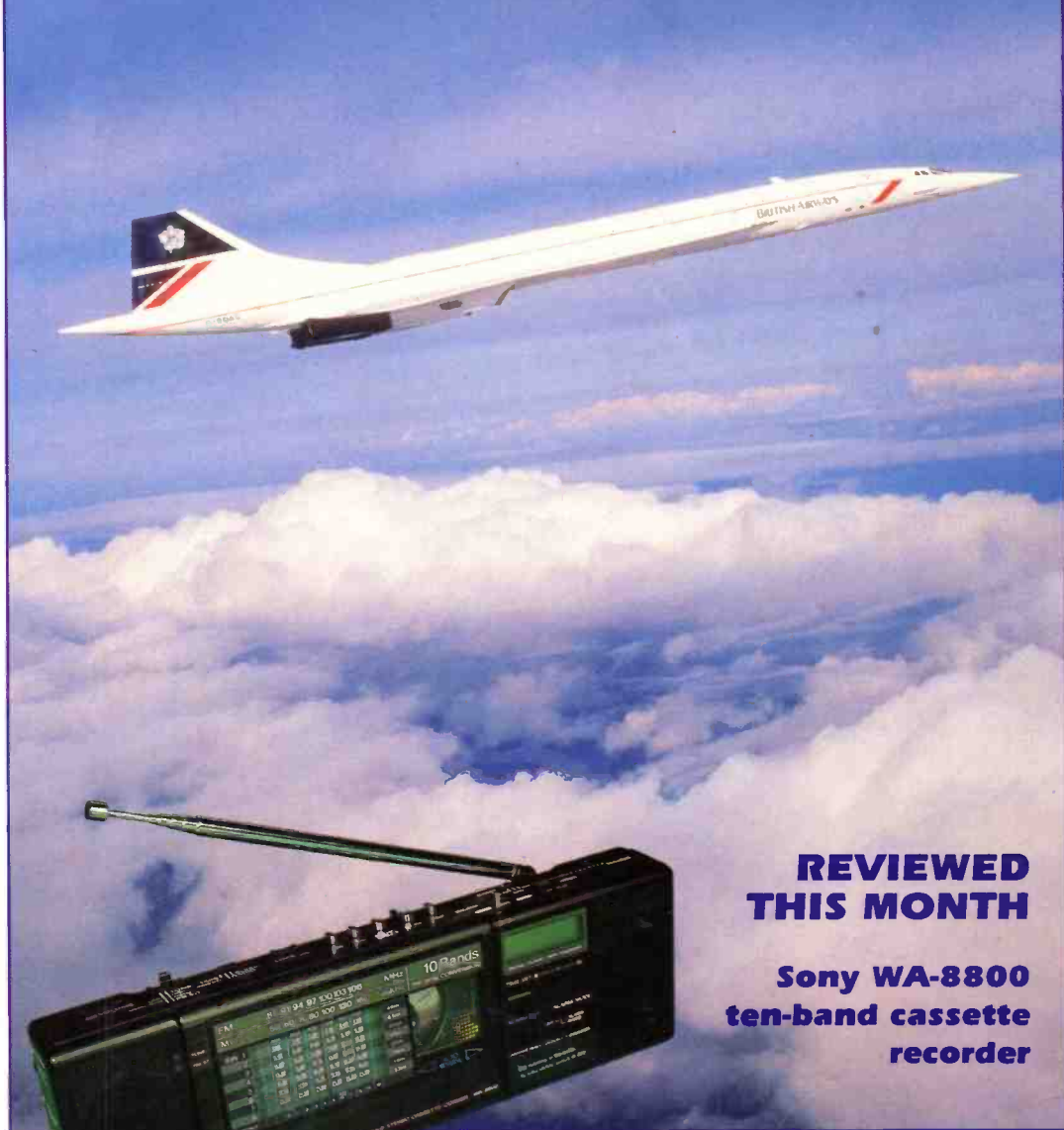

**REVIEWED
THIS MONTH**

**Sony WA-8800
ten-band cassette
recorder**



**YESTERDAY'S SPY SET
The 128 Set Revisited**

BUILD THE LONGWAVE LOOP ANTENNA

INDEX TO VOLUME 49



**Regular Features for Airband, Scanning,
Junior Listeners, SSB Utility Listening,
Propagation and Broadcast Enthusiasts**

NEVADA™

Extra Wideband Scanning Power New Models With Even More Facilities!

JUST RELEASED. NEW HP2000

Now with continuous coverage featuring a complete re-design and new p.c.b. layout

* Frequency coverage:- 500KHz - 1300MHz with no gaps

- * 1,000 channel memory
- * Receives AM - FM - Wideband FM
- * Search steps selectable from 5KHz to 995KHz
- * Keypad or rotary tune controls
- * Switchable 10dB attenuator

Each set is supplied with:-

- * Full set of high power NiCad rechargeable batteries
- * UK spec. charger
- * Three antennas - VHF, UHF, short wave telescopic
- * Carrying case, belt clip, shoulder strap
- * Dc cable for car cigar adaptor supply
- * Earpiece for private listening..... **£269**

New Nevada MS1000 Mobile/Base Scanner

An exciting new scanner with all the specifications of the HP200 above plus:-

- * Switchable audio squelch
- * Tape recorder output socket
- * Automatic tape recorder switching circuit switches tape recorder on when a signal is present
- * All metal case for improved EMC compatibility..... **£279**



Available From Authorised Dealers Throughout The UK.

Nevada Communications, 189 London Road, North End, Portsmouth. PO2 9AE

Send in £2 now for our LATEST CATALOGUE with full details of our complete product range (includes a £2 voucher).

**VOL. 49 ISSUE 12 DECEMBER 1991
ON SALE NOVEMBER 28**

(Next Issue on sale DECEMBER 20)

EDITOR: Dick Ganderton, C. Eng., MIEE, G8V FH
ART EDITOR: Steve Hunt
NEWS & FEATURES: Elaine Richards G4LFM
TECHNICAL ARTIST/PHOTOGRAPHER: Rob Mackie

EDITORIAL

**Enefco House, The Quay,
Poole, Dorset BH15 1PP**
TEL: (0202) 678558
FAX: (0202) 666244
CREDIT CARD ORDERS: (0202) 665524
(Out of hours service by answering machine)

ADVERTISEMENT DEPARTMENT

ADVERTISEMENT MANAGER

Roger Hall G4TNT

TEL: 071-731 6222

FAX: 071-384 1031

ADVERTISEMENT PRODUCTION (Poole)

Marcia Brogan

TEL: (0202) 676033

FAX: (0202) 666244

© PW PUBLISHING LTD. 1991.

Copyright in all drawings, photographs and articles published in *Short Wave Magazine* is fully protected and reproduction or imitation in whole or in part is expressly forbidden. All reasonable precautions are taken by *Short Wave Magazine* to ensure that the advice and data given to our readers is reliable. We cannot however guarantee it and we cannot accept legal responsibility for it. Prices are those current as we go to press. *Short Wave Magazine* is published monthly for \$40 per year by PW Publishing Ltd., Enefco House, The Quay, Poole Dorset BH15 1PP. Second class postage paid at Middlesex, NJ. Postmaster: send address changes to C & C Mailers International, 40 Foxhall, Middlesex, NJ 08846.

contents

- 10** Speedbird Concorde Zero One
Peter Rouse GU1DKD
- 12** A Basic RTTY Receive-only Terminal unit -
Part 2
Bernard J. Greatrix G4ICZ
- 21** Radio Times - Poem & Competition
David Leverett
- 22** Educational Software for Basic Electronics -
Part 10
J.T. Beaumont G3NGD
- 25** Brief Thoughts on the ATU
Paul Essery
- 27** Sony WA8800 Ten-band Radio Cassette
Recorder Review
Mike Richards
- 34** The LongWaver Loop Antenna
Richard Q Marris
- 38** Yesterday's Spy Set - The 128 Set
June Stirrat
- 40** A Short Wave Crystal Set & Competition
Roger Laphorn G3XBM
- 79** Index to Volume 49

REGULARS

Cover:
Concorde is
one of the most
beautiful
aircraft flying
today as well
as being a
technological
miracle. Peter
Rouse recalls
his trip to New
York at Mach 2.



- 53 Airband
- 48 Amateur Bands Round-up
- 44 Bandscan - Australia
- 74 Book Service
- 60 Decode
- 51 DXTV Round-up
- 2 Editorial
- 4 Grassroots
- 58 Info in Orbit
- 76 Index to Advertisers
- 5 Junior Listener
- 2 Letters
- 63 Long Medium & Short
- 29 New Book
- 6 News
- 42 Propagation
- 4 Rallies
- 45 Satellite TV News
- 54 Scanning
- 2 Services
- 43 SSB Utility Listening
- 30 SWM Subscribers' Club
- 69 Trading Post
- 65 Watching Brief

...GOOD LISTENING

Radio Programme
Coupon Dec.

Crystal Set
Coupon Dec.

Trading Post
Coupon Dec.

editorial

SWM SERVICES

Subscriptions

Subscriptions are available at £21 per annum to UK addresses £23 in Europe and £25 overseas. Subscription copies are despatched by Accelerated Surface Post outside Europe. Airmail rates for overseas subscriptions can be quoted on request. Joint subscriptions to both *Short Wave Magazine* and *Practical Wireless* are available at £34 (UK) £37 (Europe) and £39 (rest of world).

Components for SWM Projects

In general all components used in constructing SWM projects are available from a variety of component suppliers. Where special, or difficult to obtain, components are specified, a supplier will be quoted in the article.

The printed circuit boards for SWM projects are available from the SWM PCB Service.

Back Numbers and Binders

Limited stocks of most issues of SWM for the past five years are available at £1.80 each including P&P to addresses at home and overseas (by surface mail).

Binders, each taking one volume of the new style SWM, are available price £5.50 plus £1 P&P for one binder, £2 P&P for two or more, UK or overseas. Please state the year and volume number for which the binder is required. Prices include VAT where appropriate.

Orders for p.c.b.s, back numbers, binders and items from our Book Service should be sent to **PW Publishing Ltd., FREEPOST, Post Sales Department, Enefco House, The Quay, Poole, Dorset BH15 1PP**, with details of your credit card or a cheque or postal order payable to PW Publishing Ltd. Cheques with overseas orders must be drawn on a London Clearing Bank and in sterling.

Credit card orders (Access, Mastercard, Eurocard or Visa) are also welcome by telephone to Poole (0202) 665524. An answering machine will accept your order out of office hours.

Another year has almost ended and for me this has been a great one. We got off to a good start with the redesign of the front cover and a revamp of the inside of the magazine. The result of this effort, coupled with the enormous increase in interest in short wave listening, brought about by the Gulf War, meant that the circulation of SWM soared to new heights.

May saw Peg and myself leading a small party of readers on a visit to Quito, Ecuador and The Voice of the Andes - HCJB. We had a fantastic two weeks 9500 feet up as the guests of HCJB and, from what you have told me at rallies, you enjoyed the account of our adventures.

Our PC Special issue was

a success, as was *Weather Watching*, which we published earlier in the year. With the *International Radio* magazine in the October issue and *What Scanner* in November we had the two

largest issues ever - 100 pages, if you count the covers!

All that remains is for me to wish you all the best for 1992 on behalf of all the staff here at *Short Wave Magazine*.



letters

Dear Sir

Regarding the attitude taken towards listeners' reports by broadcasting stations, my own experience may interest your readers.

Recently returned to the hobby of short wave listening and readership of SWM after retirement from 43 years as a BBC engineer, my penultimate post was as Engineer-in-Charge of BBC Radio London, where for several years we ran a programme called *Sounds Good*.

Originally intended for hi-fi enthusiasts, we included a fifteen minute slot for radio hams. This attracted a large postbag, particularly as enthusiasts were taping the programmes and posting copies to friends all over the world. Reception reports and programme comments began to pour in. We received letters, photographs, maps and tapes by the sackful.

We were totally unprepared for this and had few suitable staff to deal with such specialist mail. I dealt with as much as I could in (rare) off-duty time, and answered some of it over the air. The worst offenders were those who

would send me a 120 minute cassette.

How could I give my full attention to two hours of uninvited information, often delivered in halting English and recorded at an odd speed with inaccurate tape azimuth setting?

Even more problematical were 3 or 5in reels of domestic standard 4-track tape recorded at one and seven eighths p.s. on all tracks, which our professional tape machines were quite unable to cope with. Eight or ten-page handwritten letters were not unusual either.

Reception reports and programme comments are always welcomed by staff, but don't get upset if you don't get a prompt reply. The chances are that your report and letter has been much appreciated and probably pinned up to the station notice board, but no-one sufficiently qualified has been available to write to you.

When writing to a broadcasting station, always remember that **you** are indulging in your favourite hobby, but **they** are doing their everyday work! You will

have more chance of success if you keep it **brief** and always enclose a stamp or IRC.

**John Longden
Uxbridge.**

Dear Sir

I have recently purchased a unit from J&P Electronics Ltd of Kidderminster. The unit was to give me packet receive and transit, plus multi-mode receiver for the Spectrum, all on EPROM. I had problems getting it to work properly, and after a few 'phone calls and a visit to their premises the problem was found to be my Spectrum, which was put right by them.

I found them most helpful and very patient sorting out my problem. It is nice to know that in this day and age you can still find a company who still care about their customers.

Many thanks J&P for your help and excellent product.

**Bob Taylor G6XNQ
Bristol**

letters

Dear Sir

One of the problems that many a broadcast listener experiences when receiving a programme schedule is that by the time it reaches them its 'shelf' life may be near to expiration.

May I therefore suggest that anyone writing to any broadcast station in future add a suggestion that since most international broadcasters are government funded, why not make their current schedule available to the listener via the nearest embassy or consul.

This would have the benefit of reducing costs to all concerned and providing a quicker (?) service to the listener. Even if return postage is needed, that surely must, in most cases be cheaper than the cost of 1 or 2 IRCs.

Since governments spend vast sums of getting their point across, anyone wishing to hear these broadcasts would be better served using these 'diplomatic channels'.

So come on you broadcast listeners, put in an appeal every time you write to a radio station. Sooner or later someone, somewhere will wake up to the benefits of providing schedules in this way.

Malcolm Goodman
Leeds

Dear Sir

Having just started interest in scanning, using a Realistic PRO-2024, also having only seen your May issue, you may like to know that, operating indoors completely with a commercial mag-mounted whip, I had some success, but considerably increased contacts using the coat-hanger dipole I finally made up, reducing the coaxial cable to 1m tuning the dipole to mid-band by cutting the dipole 'legs' to mid-band length according to the formula. With the home-made dipole stuck on to a vertical dressing-table mirror with adhesive tape in a built-up area in a tower block (2nd floor only) I obtained intelligible contacts on 90 frequencies (to-date), thus exceeding the 65-channel memory slots available. Except one, there were no ground contacts, as expected on v.h.f., but for aircraft the coat-hanger was a great success.

Eric Ratliffe
Stevenage

Dear Sir

At the RAE course held at Henley College, Coventry, I have a hand-out for candidates for guidance regarding distress messages. Part of which reads, "... It is very doubtful if an amateur or an s.w.l. would be the sole recipient of distress traffic under current conditions. However, if you do copy a message which you consider has not been generally received, then contact your local police headquarters by land line. Take all the details you can and request that the police telex the information to the International Rescue Centre at Plymouth or Air Traffic Control at West Drayton as appropriate. If you do take this action then the police and the Radio Communications Agency will certainly pay you a personal visit. So have your log and your gear in immaculate order!"

James Glanville, Coventry

Dear Sir

September *Short Wave Magazine* has been brought to my notice, and I read with great interest the article on the EF50. There are some comments I would like to make. The valve was developed in Holland before the war, see *Wireless World* for 16 February 1939, and incorporated in the Pye 45MHz straight television receiver. This was much used in airborne radar as an i.f. amplifier. Reference to the *Wireless World* article will show that the valve originally had no screening can and had locking pins.

Your photograph shows the production versions. Mullard denied that there ever was a different prototype, which was rather unfortunate since I have one, marked with a proviso that it is a prototype and production could not be guaranteed.

I also have a prototype EE50, of similar appearance. This valve is adequately described in *Wireless World* for 20 April 1939, but it never really caught on. The EF50 managed an adequate mutual conductance without recourse to secondary emission.

Incidentally, the ratio of mutual conductance to input capacity is generally regarded as the criterion of goodness for r.f. amplification, noise factor also being important and the RL7 (VR136) was the European leader at the time. However, the RL7 was not suitable for pulse circuits, and cost more, therefore it was used for head amplifiers only. The EF50 was the op-amp of that era, as I explained in an article on the Anode Follower in *SWM* some time in the late forties, when Austin Forsyth was the editor.

R. Brett-Knowles G3AAT
Havant

Dear Sir

John Wilson's letter in July's *SWM* is really very brave and full of knowledge. I have just bought an ICR-7000 (after the 7100 was announced) and although much slower than other scanners I would not change it. Its antenna is the lcom discone for it. Surprisingly, my Sony Air 7 connected to this antenna performs very well indeed without any kind of problem in the v.h.f. air and amateur band. On the other hand my reasonably good h.f. PRO 80 when used with its v.h.f. converter is not capable of handling many signals with its built-in antenna, whether you switch on the attenuator or shorten the whip antenna. I could go very much further in this matter, but I think it's not worth it. Added converters, for going up or going down, for many reasons are not advisable. And for ending the best thing is to go through the 'Trading Post' and you will find for sale brand new model receivers or scanners one month after another one. Some reason must be. My congratulations to Mr John Wilson for his very good letter.

Ernesto Hafner Caulfield
Tenerife, Canary Islands

Dear Sir

I am a scanning enthusiast and admit that I regularly listen to emergency service broadcasts, they are some of the easiest signals to receive and some of the most interesting. My interest in this facet of the hobby is now so great that I am hoping to change my career and join the police.

Recent media attention to 'joy riding' and 'ram raiding', however, has placed the spot light on scanning receiver, giving them a great deal of bad publicity. Until now, I believe, the government has turned a blind eye towards the use of scanner. This must surely be about to change. How can it be illegal to listen to such broadcasts, whilst it is perfectly legal to buy or sell a scanner? Surely the scanning receiver's days are numbered?

It does seem a great shame that such a small minority should spoil a fascinating pastime for thousands of enthusiasts, but then, that is true of many things these days.

Name & address withheld
£5 donated to the Police Benevolent Fund.

IF YOU HAVE ANY POINTS OF VIEW THAT YOU WANT TO AIR PLEASE WRITE TO THE EDITOR. IF YOUR LETTER IS USED YOU WILL RECEIVE A £5 VOUCHER TO SPEND ON ANY SWM SERVICE.

The Editor reserves the right to shorten any letters for publication but will try not to alter their sense. Letters must be original and not have been submitted to other magazines. The views expressed in letters published in this magazine are not necessarily those of *Short Wave Magazine*.

grassroots

rallies

* Short Wave Magazine & Practical Wireless in attendance *

December 1: The Bishop Auckland RAC are holding their rally at the Sunnydale Leisure Centre, Shildon, Co. Durham. Doors open 11am (disabled 10.30am). **GOFBK. Tel: (0388) 606819.**

***December 8:** The Verulam Christmas Rally will be held once again at the Hatfield Polytechnic, Hatfield. Doors open at 11am. This is a good chance to get your presents before it's too late.

***December 15:** The Centre of England Amateur Radio Rally will be held at the British Motorcycle Museum, Bickenhill, near the NEC Birmingham (junction 6 M42). Doors open 10.30am, admission £1, OAPs 50p, children free. Over 60 trade stands in three large exhibition halls, Bring & Buy, talk-in on S22, bar and restaurant available, ample free parking, concessionary rates to visit museum. **Frank Martin G4UMF. Tel: (0952) 598173.**

1992

January 26: The 2nd Lancastrian Rally will be held at the University of Lancaster. Doors open 10.30am for the disabled and 11am for everyone else. **Sue G10HH. Tel: (0524) 64239.**

February 16: The Kidderminster & DARS rally will be held at the Harry Cheshire School, Habberley Road, Kidderminster, Worcs. Doors open 10am. **G8JTL. Tel: (0384) 894019.**

February 23: The Northern Cross Radio Rally will be held at Rodilian School, Lofthouse, West Yorkshire. Doors open 11am (10.30am for the disabled). On site parking for 1000+ cars. Dealers, craft stands, Bring & Buy, Morse Tests, Bar and Refreshments. Entry 50p (programme draw prizes). **Dave Gray G0FLX. Tel: (0532) 827883.**

March 7: The TARS annual rally will be held as a new venue this year, the Temple Park Leisure Centre in South Shields. **Jack G0DZG. Tel: 091-265 1718.**

April 5: The Launceston 6th Amateur Radio Rally will be held at Launceston College. Doors open 10.30am. **Maggie. Tel: (040921) 219.**

April 19: The Centre of England Easter Sunday Radio & Electronics Rally will be held at the National Motorcycle Museum, Bickenhill. Doors open 10.30am (10am for the disabled) and admission £1. Over 60 traders in three large halls, ample free parking, Bring & Buy, talk-in on S22, bar and restaurant facilities. **Frank Martin G4UMF. Tel: (0952) 598173.**

April 26: Bury Radio Society will be holding Hamfeast '92 at the Castle Leisure Centre, Bolton Street, Bury. **L.H. Jones, Mosses Community Centre, Cecil Street, Bury.**

Acton, Brentford & Chiswick RC: 3rd Tuesdays, 7.30pm. Dec 18 - Problems in Setting Up an HF Station by G0JRY. Paul Truitt G4WQO. 071-938 2561.

Barnsley & DARC: Mondays, 7.15pm. Darton Hotel, Station Road, Darton, Barnsley. Dec 2 - Junk Sale, 9th - Jandek Kits, 16th - On the Air Night, 23rd - Construction Competition plus Xmas Raffle. Ernie G4LUE. (0226) 716339.

Bromley & DARS: 3rd Tuesdays, 7.30pm. The Victory Social Club, Kechill Gardens, Hayes. Dec 17 - Xmas Party. Geoffrey Milne. 081-462 2689.

Chelmsford ARS: 1st Tuesdays, 7.30pm. Marconi College, Arbour Lane, Chelmsford. Dec 3 - Radar by Stan Wood, 14th - Christmas Social. Roy Martyr. Chelmsford 353221 ext 3815.

Cheshunt & DARC: Wednesdays, 8pm. Church Room, Church Lane, Wormley, Nr Cheshunt. Dec 4 - Natter Night, 18th - Xmas Social, 25th - No Meeting! Roger Frisby. (0992) 464795.

Conwy Valley RC: 1st Thursdays, 7.15pm. The Studio, Penrhos Road, Colwyn Bay, Clwyd. Dec 5 - Satellite Communications by GW1VCN. Merfyn Jones GW4NLL, 72b Princes Drive, Colwyn Bay, Clwyd. (0492) 530725.

Coventry ARS: Fridays, 8pm. Baden Powell House, 121 St Nicholas St, Radford, Coventry. Nov 29 - Talk by Mr Allen. Neil Blair. (0203) 523629.

Derby & DARS: Wednesdays, 7.30pm. 119 Green Lane, Derby. Dec 4 - Junk Sale, 11th - Constructor's Contest, 12th, c.w. Enthusiasts Night, 18th - Xmas Party, 25th - No Meeting. Richard Buckby. Ambergate 852475.

Dorking & District RS: 2nd & 4th Tuesdays, 7.45pm. Friends Meeting House, South Street, Dorking. Dec 6 - Society Dinner, 10th - Informal at the Falkland Arms, 17th - Social. John Greenwell G3AEZ. (0306) 77236.

Edgware & DRS: Watling Community Centre, 145 Orange Hill Road, Burnt Oak. Nov 28 - The Novice Licence and Club Participation, Dec 12 - Junk Sale. Hank Kay G0FAB. (081-205 1023).

Fareham & DARC: Wednesdays, 7.30pm. Porchester Community Centre, Westlands Grove, Porchester, Fareham, Hants. Dec 4 - Reliability by G3XPH, 18th - Xmas Quiz. Rod Smith G0ERS. (0705) 373572.

Hastings E&RC: 3rd Wednesdays, 7.45pm. West Hill Community Centre, Croft Road, Hastings. Fridays, 8.30pm. Ashdown Farm Community, Downey Close, Hastings. Reg Kemp. 7 Forewood Rise, Crowhurst.

Horndean & DARC: 1st Thursdays, 7.30pm. Horndean Community School, Barton Cross, Horndean. Dec 5 - Liquid Crystals by Merck Ltd. S.W. Swain. (0705) 472846.

Keighley ARS: Thursdays, 8pm. The Cricket Club, Ingrow, Nr Keighley. Nov 28 - The Ionosphere by LM Dougherty,

Dec 5 & 12 - Natter Night, 19th - Xmas Buffet. Kathy Bradford. (0274) 496222.

Mansfield ARS: 1st Thursdays, 8pm. The Polish Catholic Club, off Windmill Lane, Woodhouse Road, Mansfield. Dec 5 - Christmas Social Evenings, families and friends welcome. Mary GONZA. (0623) 755288.

Midland ARS: 3rd Tuesdays, 7.30pm. Headquarters Unit 22, 60 Regent Place, Birmingham B1 3NJ. Dec 3 - Xmas Party. John Crane G0LAI. 021-742 8712 (evenings).

Mid-Warwickshire ARS: 2nd & 4th Tuesdays, 8pm. St John Ambulance HQ, 61 Emscote Road, Warwick. Dec 10 - Xmas Pies and Wine, 24th - Net on 145.350MHz at 8pm. Mike Newell. Kenilworth 513073.

Nelson & DARS: Wednesdays. Llancaich Junior School, Nelson, Mid Glam. Leighton Smart. (0443) 411736 evenings.

Norfolk ARC: Wednesdays, 7.30pm. The Norfolk Dumpling, The Livestock Market, Harford, Norfolk. Nov 27 - Informal, Dec 4 - Licence Conditions Q & A, 11th - Xmas Party, 18th - Night on the Air - very informal!, 25th - No Meeting. Jack Simpson G3NJQ. (0603) 747992.

North Ferraby United ARS: Sundays, 8pm. North Ferraby United Football Club Social Room, Church Road, North Ferraby. Nov 29 - RSGB Video with G3YCC, Dec 6 - The Way Ahead Meeting by G4VKK, 13th - LF Band DX by G4BYG, 20th - Xmas Quiz with G4XWA, 27th - Night on the Air. F.V. Lee. (0482) 650410.

Preston ARS: Alternate Thursdays. The Lonsdale Sports & Social Club, Fulwood Hall Lane, Fulwood. Nov 28 - A Kenya Adventure by Mr Ruthven, Dec 12 - The Xmas Buffet, 26th - Xmas Recs. Eric Eastwood G1WCO. (0772) 686708.

Saltash & DARC: 1st & 3rd Fridays, 7.30pm. TOCH Hall, Burraton, Saltash. A.T. Blackmore. 3 Parkesway, St Stephens-by-Saltash, Cornwall. Tel: Saltash 843472, 842537 or 847705.

Sevenoaks & DARS: Sevenoaks DC, Council Offices, Argyle Road, Sevenoaks. December 2 - AGM and Christmas Social.

Shefford & DARS: Thursdays, 8pm. The Church Hall, Amphill Road, Shefford, Beds. Nov 28 - A Guide to Things IBM Compatible by G1JKF, Dec 5 - VHF Contest Through the Ages by G4LOO, 12th - The Constructors' Contest, 13th - Return Quiz vs Cambridge Club held at Cambridge, 19th - Chairman's Mince Pie Night. Nigel G1JKF. (0908) 274473.

South Bristol ARC: Wednesdays. Whitchurch Folkhouse Assoc, Bridge Farm House, East Dundry Rd, Whitchurch. Dec 4 - Exhibition of Calligraphy with G0AWX, 11th - Xmas Party, 18th - HF Activity Evening, 25th - No Meeting. Len Baker. Whitchurch 832222.

Club Secretaries:
Send all details of your club's up-and-coming events to;
'Grassroots',
Lorna Mower
Short Wave Magazine,
Enefco House,
The Quay, Poole,
Dorset BH15 1PP

Southgate ARC: 2nd & 4th Thursdays. Winchmore Hill Cricket Club Pavilion, Firs Lane, Winchmore Hill, London N21. Nov 28 - Construction Demo, Dec 12 - AGM. Brian Shelton G0MEE. 081-360 2453.

Stevenage & District ARS: Tuesdays, 7.30pm. Ground Floor Rear Suite, Sitec Building, Ridgemoor Park, Stevenage. Dec 3 - Practical Feedline Testing, 10th - Construction Projects Evening, 17th - Dutch Party & Quiz. Peter Daly G0GTE. Tel: (0438) 724991.

Stourbridge & DARS: 1st & 3rd Mondays. Robin Wood's Community Centre, Scotts Road, Stourbridge. Dec 2 - On Air Night. Dennis Body G0HTJ. QTHR.

Stratford upon Avon & DARS: 7.30pm. The Home Guard Club, Main Road, Tiddington, Stratford-upon-Avon. Dec 9 - Chaired Discussion Evening, 25th - Xmas morning greetings at 11am on 145.275MHz.

Three Counties RC: Alternate Wednesdays, 7.30pm. The Railway Hotel, Liphook, Hants. Dec 4 - Quiz Night. Dave G4VKK.

Todmorden & DARS: 1st & 3rd Mondays, 8pm. The Queen Hotel, Todmorden. Dec 2 - Annual Xmas Lecture by G3RJV, 16th - Social and Natter Night. Mrs E Tyler. (0422) 882038.

Torbay ARS: Fridays, 7.30pm. ECC Social Club, Highweek, Newton Abbot. Dec 13 - Xmas Party. Walt G3HTX. (0803) 526762.

West Kent ARS: 3rd Fridays, 8pm. The School Annex, Albion Road, Tunbridge Wells, Kent. Dec 20 - Xmas Party. John Taylor G3OHV. (0892) 664960.

West of Scotland ARS: Fridays, 8pm. Scout Shop, 21 Elmbank Street, Glasgow. Dec 4 - Visit to BBC/IBA Blackhill, 6th - EME on a Shoestring, 13th - Kilmarnock Club, Bright Sparks Trophy, 20th - Equipment Specification Checking and Xmas Social. Jack Hood. (0698) 350926.

Wimbledon & DARS: 2nd & last Fridays, 7.30pm. St Andrews Church Hall, Herbert Road, SW19. Oct 25 - AGM, Nov 8 - Desert Island Radio Nov 29 - Meet the Committee Evening, Dec 13 - Xmas Social, 27th - No Meeting. Chris Frost. 081-397 0427.

Wirral ARS: 1st & 3rd Wednesdays, 7.45pm. Ivy Farm, Arrows Park Road, Birkenhead, Wirral. Dec 4 - SSB QRP Radio by G3RJV, 18th - Xmas Party.

York ARS: Fridays, 7.30pm. York City Social Club, Bootham Crescent, York. K.R. Cass G3WVO. 4 Heworth Village, York.

junior listener

British DX Club

This month, **David Kenny** of the British DX club has written with a host of information that should prove very useful for the junior listener. The club has been active since 1974 when it started as the Twickenham DX Club. Since then, it has grown steadily and it's monthly newsletter, *Communication*, recently reached its 200th edition. Having just received the October edition of this newsletter, I was very impressed with the contents. The newsletter comprises thirty-two A5 pages and is packed with useful information. The very comprehensive news sections featured items from all over the globe and were very informative. To supplement the news items were regular logs for medium wave, h.f. and the tropical bands. In addition to all this was a short review of the Yaesu FRG-7 and a number of specialist reports. As you have probably gathered I was impressed!

One of the services that they offer to members is the supply of ready-printed reception report forms. These contain the club logo and can be used to QSL with commercial radio stations around the world.

For those with an interest in UK broadcasting stations the club produces an excellent booklet entitled *Radio Stations in the United Kingdom*. This is a very comprehensive publication that covers all UK stations and includes address, phone number, power and transmitter locations. The main frequency list is also cross referenced to show the parallel transmissions. All this for just £1.50 to members or £2.00 for non-members!

Another interesting feature is the Tape Circle. This is an optional service for members and comprises a monthly ninety minute programme on a cassette tape. The tape contains recordings of DX catches as well as chat from members.

If I've wetted your appetite, the UK membership rates are £9.00 per year and enquiries should be addressed to:

The British DX Club, 54 Birkhall Road, Catford, London SE6 1TE. I would recommend membership as an ideal Christmas present for the young enthusiast!

HCJB Birthday Celebrations

How would you like an expenses paid trip to HCJB's station in Ecuador? If the answer is yes, all you have to do is send them a card with the words 'Happy 60th Birthday'. All the cards they receive will be entered in a prize draw that will take place on Christmas Day. The address to send your card is: HCJB, Box 691, Ecuador.

Still with HCJB, I have received news that they will be running a very special transmission from December 6 to 8. During this period HCJB's comprehensive antenna system will be used for amateur transmissions using the special callsign HC60JB. The frequencies in use will be 14.225, 21.3 and 28.5MHz \pm a few kHz.

The antennas to be used for the transmissions are actually located in Pifo which is 29km from the capital, Quito. Keith Clukey (KC6SMW/HC1) will be co-ordinating the event and plans to have two amateurs working simultaneously on two different bands. These amateurs will actually be operating from their homes and using their own antenna systems for reception. The transmit side being handled first by phone and then tapped into HCJB's microwave radio link. The reason for this is complicated set-up is that there would be too much interference from HCJB's other transmissions to allow reception on site. Although HCJB's Siemens s.s.b. transmitters are capable of operating at 30kW they will be detuned to the amateur limit of 1.5kW for the special event station. However, the tremendous gain of the antennas mean that the signal strength will be boosted by between 18 and 25dB!

Of the 31 antennas on site, the amateurs will have the choice of a large rhombic with 8-13dB gain or perhaps the thirty storey high curtain antenna with eight parallel fed dipoles. There is also a steerable antenna that is capable of handling 500kW! Perhaps one of the most impressive is their 24-element quad antenna with four parallel fed arrays, each 6-elements deep! The quad antenna was invented by a former HCJB engineer, Clarence Moore specifically to overcome problems with high power broadcasting in the rarefied air of Quito's 9300ft Andes location. I've included a photo of the HCJB station so you can see how impressive it is.

If you would like to play a part in this special event, you can receive a very special QSL card if you log one of the amateur transmissions between 2100 on December 4 and 0030UTC on December 8. The address for your QSL card is:

HCJB, Casilla 17-01-00691, Quito, Ecuador, S.America.

Time Update

Following on from my feature on 'time' in the October 'junior listener', **Chris Broughton** of Southsea has written with news of a free publication that may be of interest. The book refers specifically to the standard time transmissions that are broadcast by a number of stations in the US. These stations usually transmit a carrier that is interrupted every second to provide an accurate reference. However, there is much more to these stations as they convey all manner of useful data related to time. The problem has always been where to get the details of what is sent. This is where the publication located by Chris comes in as it gives all this data. As well as the basic transmission data the book includes addresses for obtaining more detailed information. The title of this book is *Special Publication 432 (revised)* and the address is: National Institute of Standards and Technology, M/S 847, 325 Broadway, Boulder, Colorado 80303, USA. My thanks to Chris for this useful information.



Jon Jones
PO Box 59
Fishponds
Bristol BS16 4LH

Radio Prague Monitor Club

This is a free club that anyone can join, so is bound to attract a healthy membership. To join all you have to do is provide regular reports of a range of programmes broadcast by Radio Prague. For those in the UK, a total of fifteen reports per year are required to secure membership. You will need to make sure the reports are marked 'For Monitor Club Membership' and numbered one to fifteen. You can either send your reports in together or just send them as you log the station. Once you have achieved membership status you will be sent a membership card and certificate. As a member you'll also be able to apply for their DX Diploma which is awarded for achievements in short wave listening. The frequencies to monitor for English transmission in Europe are: 5.93, 6.055, 7.345, 9.605, 11.685, 11.990, 17.84 and 21.705MHz.

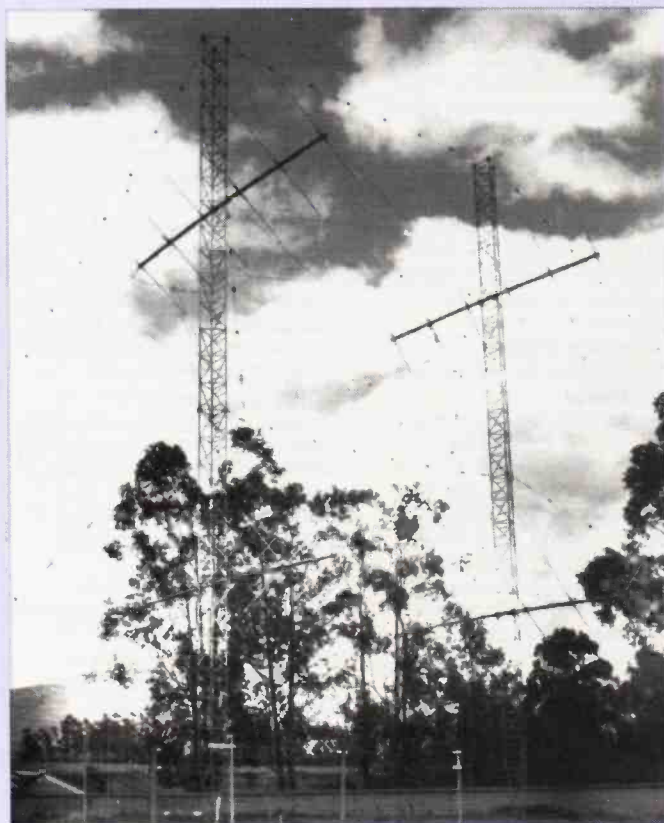

Radio Polonia

Whenever you want to hear about Poland, Radio Polonia maintain they are the best source. It is the external service of Polskie Radio Warsaw and offers seven English-language broadcasts daily providing comprehensive and unbiased coverage of news events and all aspects of life in Poland.

Regular spots and features include:

News from Poland - current affairs coverage (Mon-Fri), news and commentary (Sat-Sun)

Panorama - weekly coverage of the Polish scene with hosts Jacek Detko and Michal Kubicki

Focus - on the arts and entertainment in Poland with hosts Rafal Keipuszewski, Michal Kubicki and Mirosław Lubon

Postbag - review of listeners' comment and queries with Jacek Detko and Ann Flapan

Topic of the Week - political analysis

What we Said - digest of the week's best on the English service

Jazz, Folk, Rock & Pop from Poland - the music scene with Jacek Detko, Roman Waschko, alternately with

Top Twenty - pop charts with Rafal Keipuszewski

DX Club Show - telecommunications magazine with Marek Lasota and Slawek Szefs

Request Concert - music requests and dedications with Stella Zielinska

0630-0725 - 9.675 & 7.27MHz

1200-1225 - 11.815 & 9.525MHz

1430-1455 - 9.525, 7.285, 6.135 & 6.095MHz

1600-1630 - 9.54 & 6.135MHz

1830-1855 - 9.525, 7.285, 6.135, 5.995 & 1.503MHz

2000-2055 - 9.525, 7.27 & 6.135MHz

2200-2255 - 7.27, 6.135, 5.995 & 1.503MHz

Your opinions and comments on Radio Polonia broadcasts are appreciated. Reception reports are confirmed with QSL cards. DXers are invited to join their DX Club (membership rules available on request or see 'junior listener' on page 5). Music requests are welcomed.

Please address all letters, reception reports, inquiries and requests to:

Radio Polonia, English Service, PO Box 46, 00-950 Warsaw, Poland.



HCJB's 60th Anniversary

If you'd like to add a rare QSL card to your collection then listen out from Friday December 6 at 2100UTC to Sunday December 8 at 0300UTC for the call HC60JB. Listen out on 14.225, 21.3 and 28.5MHz for the operators celebrating HCJB's 60th Anniversary.

The operators will have access to some of the world's most powerful short wave antennas, located at Pifo - a quick look back through 'DXing in Ecuador' over the last few months will give you an idea of what they're like.

Short wave listeners need to log the callsign of the station worked, the frequency, date and time in UTC. To get you special QSL card, send your logs to:

**HCJB, Casilla
17-01-00691,
Quito, Ecuador.**

public radio service with up to 40 local and 4 regional radio stations together with a new TV service - good news for radio/TVDXers!

Finally, this autumn saw the commencement of a Western financed cable company - Comsat Video Enterprises - in the cities of Moscow, Riga and Tbilisi with an initial 3 channel carriage rising to 8 as the customer base expands, including general news and sports (in English). With expansion both a children's and movie channel will be included. The cable service will be scrambled though decoder hire charge is very low - by UK standards.

DXTV News

Good news in Ghana, with the Tamale region enjoying TV after nearly a decade. Due to lack of funds and spares, the TV transmitters in that state have been off the air. Thanks to the USA firm Harris Allied International, two 'dual 10kW transmitters' have been supplied and being installed that should provide nearly 75% coverage with full servicing over the next 5 years. Thereafter, the Volta, Akatsi and Amedzofe regions of Ghana will have proper TV restored.

The new Maltese Broadcasting Bill will provide a further 10 v.h.f. radio frequencies for commercial radio with 3 already being taken by the Catholic Church (RTK) and 2 political parties (the Nationalists = Radio 101 and the Labour Party Radio Super One). By December, decisions will have been made on another 5 radio channels. A new cable TV service will be authorised and at the Gharghur transmitter side a 'new transmitter system' is to be constructed, alongside that of Xandir Malta.

The Israeli TV are

considering another TV channel, but the main problem is the lack of available TV channels - if a high co-channel interference protection ratio is to be achieved. It's likely that any new service will be delayed until the AMOS Israeli constructed satellite is available from 1995 onwards.

The Sri Lanka government owned 'Independent Television Network' (ITN) is to be privatised with shares being offered on the open market, though 30% will go to the government and a further 10% to employees. A 3rd TV channel operated by the Maharaja Organisation and based in Darwin (Australia!) is also likely to provide a satellite linked service into Sri Lanka offering general entertainment, films and sports - scrambled and with commercials.

A new independent TV channel in New Zealand is to be opened - Canterbury Television (CTV) - over the most populated part of South Island in former NZBC facilities.

Radio Bangladesh has but purchased 6 truck mounted v.h.f. transmitting units for

each main region that will offer outside broadcast facilities and improve news gathering - with the extreme cyclonic weather in that area bordering the Bay of Bengal, the mobile units will also provide radio contact with the outside world when the normal radio communication masts and cables are destroyed.

A new broadcasting region - the Mitteldeutscher Rundfunk (MDR) - was inaugurated July 1 and will offer 3 radio programmes and an additional MDR-3 TV programme, taking the mainstream ARD evening programme and with a local opt-out programme 1800-2000. Leipzig is the centre of the MDR with studio feed-ins from Halle, Landesrundfunkhauser, Erfurt, Magdeburg and Dresden. Licences for private TV in the MDR should be offered in 1992. The 3 Lander of Saxonia, Saxonia-Anhalt and Thuringia comprise the new MDR region.

The monopoly that the CLT Luxembourg has enjoyed for many years had ended with the government allowing a

BBC World Service

The BBC has signed an agreement that will put BBC Russian Service programmes onto Russian airwaves. Radio Russia will broadcast two half-hour BBC Russian Service current affairs programmes each weekend, starting early next year. Radio Russia's network reaches more than two thirds of the former Soviet Union's population. It spans the Russians Federation all the way from St. Petersburg across 11 time zones to Vladivostok on the Sea of Japan. The BBC programmes will be beamed to Moscow by satellite and then rebroadcast simultaneously all over Russia. Radio Russia will also be scheduling a Russian Service feature programme once a week from a selection of tapes sent from London. In return for this rebroadcasting arrangement, the BBC has agreed that one of the Radio Russia's broadcasters will come and gain work experience in London for six months with the Russian Service at Bush House.

Also, the BBC World Service is to start broadcasting in Ukrainian early next year. It will be the first time the BBC has transmitted any Soviet language other than Russian and will bring the total number of languages broadcast by the World Service to 38. The BBC Ukrainian Service will add up to seven hours a week to BBC World Service's output which has now exceeded 800 hours, the highest weekly level since the end of WWII.

Switching Direction

Tremiver Ltd has recently revamped its switch product family. This is a continuation with their policy of only sourcing from the top European, North American and Far Eastern suppliers, most of whom have established brand names in their own right.

The new product family contains a range of switches available in differing specifications. The various configurations available are either fuse/unfused, illuminated, push button, toggle or rocker switches, panel or p.c.b. mount.

For more details, contact: **Tremiver Ltd., Unit 1, Summerlea Court, Alton Road, Herriard, Basingstoke, Hants RG25 2PN. Tel: (0256) 381514.**

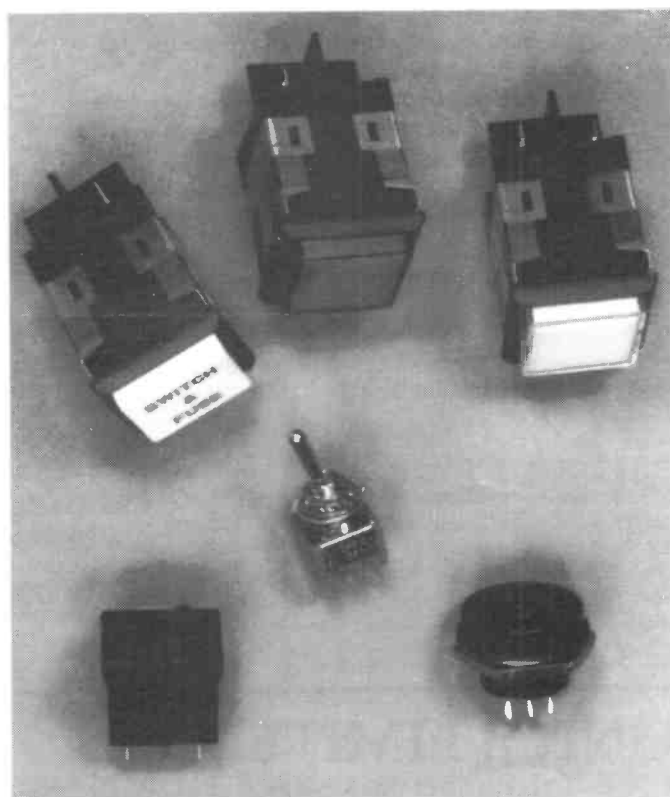

New Catalogues

The new Henry's 300 pus page, colour catalogue is now available by post or at their shop. Complete with a Retail/Mail Order price list and £90 purchase vouchers and £2 off first purchase. The cost of the catalogue is £2 for callers or a C4 s.a.e. with £2.65 stamps affixed for UK by post.

A quantity price list is also available free to Trade, Industry, Educations & Training establishments. **Henry's Audio Electronics, 404 Edgware Road, London W2 1ED. Tel: 071-258 1831.**

The 1992 Greenweld catalogue is now out. New to this year's edition are a range of quartz clock movements, dials and hands, a section devoted to craft materials - timber, wheels, pulleys, propellers, balsa packs and adhesives; a choice of 28 analogue and digital multimeters from £9.95; a big selection of opto devices from subminiature 1.8mm l.e.d.s to 2.24in displays; a wide range of low-cost kits for railway and other modellers; 9 different radio receivers; many different soldering tools; plus, of course, a complete range of resistors, capacitors and semiconductors as well as a wide selection of test equipment from panel meters to oscilloscopes.

The catalogue costs £2.00 post free. **Greenweld Electronic Components, 27 Park Road, Southampton SO1 3TB. Tel: (0703) 236363.**

RAIBC News

The Radio Amateur Invalid & Blind Club (NI Area) is a charity with a difference. They realise that there are so many other charitable organisations asking for cash and donations from the public, so they are asking for donations of Air Miles, trading stamps and petrol coupons of all kinds as these generally clutter up the dash board of many cars until they are either cleaned up or go out-of-date.

Their efforts in this have been well rewarded in the past. These tokens, when converted into cash, are then used to provide home study courses and radio equipment for blind and disabled people who are, in some cases, house bound.

So, they would like to renew their appeal for readers to have a look in their cars and send them and tokens, vouchers and stamps that they can. They are especially looking for BP Lifestyle coupons which go out of date on 31 December 1991.

Your coupons can be sent, free of charge, to: **RAIBC (NI), FREEPOST BE1769, Belfast BT12 5BR.**

New Call-in Programme

HCJB are starting a new telephone call-in programme on November 4. 'Open Line' will be broadcast each Monday evening at 8.30pm Eastern Standard Time. It will offer people from around the world to call in and express their opinion on a variety of topics.

Ken MacHarg will host 'Open Line' and this will be the first regular programme involving specific topics for discussion. Initial topics, tentatively scheduled, are 'What makes for a good marriage?', 'Christopher Columbus: hero or villain?'; 'The environment: what is the Christian experience?'

If you want to take part, then the telephone number to remember is: 011-593-2-241-560. The line will not be answered until just before the caller is put on the air to save on telephone charges.

When it comes to sheer know-how Look to Lowe

The NRD-535 with a subtle difference



The NRD-535 is a fine receiver, and fully confirms the JRC leadership in this particular field. However, even the best can be improved in specific areas; and after lengthy evaluation of the NRD-535 we decided that there were worthwhile improvements which we at Lowe, with our knowledge and specialist expertise could introduce to the more discerning listener - for it is the true "listener" who will appreciate what we have done.

First; we thought that the audio from the NRD-535 was not totally easy on the ear, and detailed investigation showed that the audio response had been "tailored" to suit the rather round shouldered response of the IF filtering. So, we went back to the IF filters and specified a higher performance SSB crystal filter with a 6dB bandwidth of 2.4kHz and a typical shape factor of 1.8:1; with less than 1dB passband ripple. For AM, we fit a more expensive filter with a 6dB passband of 5.7kHz and a shape factor of 1.5:1. The response of these new filters is very flat within the pass band, with steep symmetrical sides giving excellent adjacent channel rejection. The use of these more expensive filters allowed us to flatten the audio response of the receiver giving a much cleaner sound quality and a real improvement in intelligibility both on communications and broadcast stations.

We have noticed in the past that the audio output power from most modern receivers is barely adequate for driving a good loudspeaker, and since we now had top quality audio from the NRD-535, we designed and fitted a completely new audio power amplifier with enough power (3W at 5% distortion) to enable the user to sit back and enjoy that quality to the full.

The use of synchronous AM demodulation and/or ECSS is an established feature of many newer receivers, and fitting the optional CMF-78 ECSS board to the NRD-535 provides the user with the potential to recover good audio from signals which are subject to selective fading.

However we noticed a tendency for the ECSS to unlock during deep fades and then fail to re-lock after the fade. We now have a series of detailed modifications to the ECSS unit which removes this tendency and also improves the recovered audio.

The Lowe Electronics modification pack definitely makes a good receiver into an outstanding receiver. When we sent a sample of our modified NRD-535 to Jonathan Marks at Radio Nederland, he confirmed that the results were quite remarkable and said so in no uncertain terms. We think that you will agree.

Naturally, these modifications cost a little more, but to complete the whole package we also pre-age the master reference oscillator in the receiver, check out the alignment, and issue an individual test certificate with each one. And because we are proud of our work we add a discreet badge to the front panel to tell you that you own a receiver with a difference.

The "Lowe" NRD-535. We make a good receiver into an outstanding receiver.

- New high specification IF crystal filter for SSB
- New high specification IF filter for AM
- New calculated audio bandwidth "flattening".
- New higher power audio output system.
- New tighter specification ECSS system.
- Pre-ageing and "burn-in" of master oscillator.
- Individual test certificate for each receiver.

Cost of modification before shipment . . £100 + VAT

Retro-fitted modification is not available at the moment due to the pressure on our skilled engineers, but may be available in the future. Contact us for details.

FREE

Send four first class stamps to cover the postage and we will send you, by return, your FREE copy of 'THE LISTENERS GUIDE' (2nd edition); a commonsense look at radio listening on the LF, MF and HF bands. Its unique style will, I am sure, result in a 'good read'; but underneath the humour lies a wealth of experience and expertise. You will also receive detailed leaflets on our range of receivers and a copy of our current price list.



FOR DETAILS, TELEPHONE 0629 580800

LOWE ELECTRONICS LIMITED

Chesterfield Road, Matlock, Derbyshire DE4 5LE Telephone: 0629 580800 Fax: 0629 580020

When it comes to customer satisfaction Look to Lowe

5, MEADOW WALK, GREAT ABINGTON, CAMBRIDGE CB1 6AZ
Tel. (0223) 891997

Oct 29/91.

LOWE ELECTRONICS
CAMBRIDGE
OUT TOWN 94NBS.

Dear Tom, I felt I must write to you & your company to express the satisfaction I am receiving from the HF225 I had been receiving which I purchased from you about a month ago.

The performance is remarkable and in particular the selectivity & the S-meter letters provide a performance which is far superior than certain oriental receivers that I have had over the years.

The HF225 has significantly improved the enjoyment I receive from short wave radio & your company is to be congratulated on designing & producing this Super set. I am delighted to think that it is British made and great value for money.

I would appreciate it if you would pass my comments on those responsible in your company for this excellent product.

Yours sincerely,
J. Beardsall. C. Eng. M.I.E.E. J6174.

THE LISTENERS' BOOK OF THE YEAR GETS EVEN BETTER

The new 1992 issue of 'Passport to World Band Radio' is now with us and it's even better than before. The 200 pages have risen to almost 400 and every section carries the unmistakable authority of the world's best short wave companion.

Broadcasts are listed as before; not only in frequency order but also by language, country of origin AND the times of broadcasts. There are no less than 56 pages of receiver reviews, including the latest NRD-535 and Drake R-8, together with news, views and general information.

If you own a short wave radio, you simply MUST have the 'Passport' by its side. The price last year was £12.95; we have kept the price exactly the same this year at £12.95 (plus £1.55 for post and packing). Send off today.

*Bournemouth: 0202 577760 Bristol: 0272 771770 Cambridge: 0223 311230 Cumbernauld: 0236 721004
London (Heathrow): 0753 545255 London (Middlesex): 081-429 3256 Newcastle: Tel No TBA

*Closed all day Monday

Speedbird Concorde Zero One



One of the great technological achievements of our age. Concorde must be one of the most graceful aircraft flying. Photograph by Adrian Meridith, courtesy British Airways.

*Peter Rouse
GU1DKD
recently flew
to New York at
twice the
speed of
sound. In this
article he lets
us share his
experiences.*

"Speedbird Concorde Zero One is cleared to line-up and hold zero nine right." Twenty seconds later came the clearance to go and Captain Viv Gunton eased up the throttles to zero power surging through the four Rolls Royce - Snecma *Olympus 593* engines. On went the afterburners and at 10.58am London time G-BOAD roared down Heathrow's runway *Zero Nine* at the start of her flight to New York's John F Kennedy airport propelled by 38000 pounds of thrust. The acceleration was phenomenal and although I have travelled in a lot of aircraft I have never felt such thrust. G-BOAD swept down the runway through VI and V2 and then, just under three and half thousand metres along *09 Right*, came 'rotate' at 215 knots and we roared up from the ground like a rocket heading east towards the city of London. Seconds later came a fairly hard right turn towards the south and a throttling back of the engines as noise abatement procedures were implemented. Throughout the brief sequence I was amazed to see the air vaporising over the leading edge of the wing, such was our speed. It was as if a layer of fog was whipping over the wing's surface. Within four minutes we had broken through the layer of cloud at 5000 feet that was blanketing Southern England

as our course took us via Reading and on to the Bristol Channel where we would go supersonic. The turn continued as we came round through 180° to head towards the Woodley beacon (Whiskey Oscar Delta on 352kHz). From there Concorde has a special clearance direct towards the Bristol Channel and onwards to the magic position known as 'Accelpoint', 51.24 North, 03.50 West (go on, look it up on a map and you will find it roughly half-way between Cardiff and the coast of Cornwall. But let us step back for a moment because from lift off I was jotting down times and all the data that appeared on the big I.e.d. displays in the cabin. 11 minutes from lift off and we already at 23000 feet and climbing at 15000 feet per minute at a speed of 620 miles per hour. The Machmeter was showing 0.89 and the outside air temperature was minus 23 degrees Celsius.

Champagne

The steward and stewardess in our section were by now pouring out Champagne although I opted for a lager accompanied by derisory howls from the rest of the press party. The simple fact is that I just do not like Champagne although the Champagne houses of France are quite welcome to sponsor me on a trip on one of the Air

France Concordes to try and persuade me that I am grossly mistaken. Anyway, I digress. Still we kept climbing and within a few minutes we were holding a steady Mach 0.97. In other words Concorde was being flown with its speed kept a trickle below the magic Mach 1, the speed of sound. Then the overhead loudspeaker murmured into life and Captain Viv Gunton announced that we would feel a slight lurch as power was applied and we went supersonic. Sure enough, seconds later at 19 minutes into the flight and with the approval of ground controllers, the Machmeter hit 1 and kept going up.

The Name of the Game

By now you will probably gather that everything is done to make the entire flight, not just the supersonic bit, as fast as possible and that is the name of the game. People who pay to fly on this aircraft fork out something like two and a half thousand pounds one way and they expect to get to JFK in the shortest possible time. They also expect something a bit special in the way of on-board service and so, leaving the technical aspects aside for a moment, I decided to carry out a subjective (no test gear with me) review of the cuisine and wines. The sea food salad was excellent, the steak with a

Julienne of pepper strips was superb. The *Chateau La Forte de la Tour 1978* was served at exactly the right temperature and had obviously been allowed to breath for the right amount of time. If you are into this sort of thing then the Chef is Anton Mossiman (seen him on the Beeb) and the man who choses the wines is Hugh Johnson of wine book fame. All of this is served on real China, in real glasses and with proper cutlery. Richard Branson and cheap and cheerful Virgin 'it aint', but then you are paying a wee bit more. And before the writs fly, as well as the 'planes, I might add that Virgin are an excellent airline with whom I usually fly on my visits to the USA. There were then sweets, cheese and biscuits, vintage port and anything else your little heart desired whilst sitting back in well spaced seats, which are upholstered in genuine grey leather. The inside of Concorde is small compared with the wide-bodied Jumbos and seating is two-by-two. Even the windows are tiny measuring a mere 127 x 89mm. The view outside is quite odd. At 58000 feet altitude the earth's curvature is quite pronounced when viewed through the windows and the upper sky is a deeper blue than you would normally see from the ground.

SelCal BDAK

Back to the exciting bit - yawn! Thirty minutes into the flight and we are now travelling at

Mach 1.73 which is 1130 miles per hour at an altitude of 43500 feet. The outside air temperature is now a staggering minus 54 degrees Celsius and we are still accelerating. What is more we are now losing v.h.f. contact with Shannon and being transferred to Shanwick Oceanic on h.f. Track *Sierra Mike* will take us on the shortest route to run us across the Atlantic and down the east coast of the USA (the West-East track is slightly different and known as *Sierra November*). Communication with Shanwick is on 8.879MHz and 'Concorde Zero One' is assigned the SelCal BDAK. Although Viv Gunton talks to operators in Shannon, all the communications are routed to controllers at Prestwick in Scotland. The Shanwick organisation is slightly unusual in that the voices you hear on the oceanic frequencies are not those of controllers but professional radio operators. The idea is that the controllers at Prestwick get on with the job of controlling whilst the operators at Shannon do what they are best at; receiving and sending messages under conditions that are not always ideal.

I was interested to learn both on the Concorde flight and the return British Airways Jumbo trip that the crews do not like h.f. They sneeringly refer to it as a throwback to World War 2. But then they are hardly radio enthusiasts and they wonder why they cannot

have something clearer and simpler such as satellite communications. Pulling rank ("I work for Britain's leading communication magazine") I managed to get a quick chat with the crew in the cockpit. I learned that G-BOAD was one of seven Concorde operated by British Airways with Air France having the same number of aircraft. The crew consists of the captain, first officer and flight engineer. That's exactly the same as on a Jumbo which actually has less room in the cockpit. What the crew modestly did not mention was that they and the six cabin crew are the best of the best and are specially selected by the airline.

Mach 2

One and half hours into the flight our speed was up to Mach 2 (1320 m.p.h.) and our altitude had increased to 58000 feet. As the fuel is burned off and the aircraft becomes lighter it is simply allowed to rise and get faster. Half an hour later we started tracking down the eastern seaboard of Canada and the USA. Communication was now back to v.h.f. and first contact was with Gander on 125.900MHz. Contact with Gander was quite brief because at this stage, although G-BOAD was just off the coast, she was still supersonic. A few minutes later Concorde was passed to Moncton on 135.300MHz and contact was maintained until she reached the New York area. At 1.55pm

British time she finally returned to subsonic speed at an altitude of 32000 feet. Descent was then quite rapid and G-BOAD flashed across the New York State coastline just seven minutes after going subsonic. Ten minutes later the wheels touched the ground and massive retrothrust was applied to slow down the aircraft. British time was 2.12pm and our journey had taken just three hours and fourteen minutes. We may have just had lunch but it was now breakfast time in New York. We hardly seem to have been in the air before we were there and that's what I call travelling - no gritty eyeballs, no soggy clothes and no cramped joints. However, I hear the question asked: "Yes, but would you spend two and a half thousand pounds of your own money going by Concorde?". I will be honest with you and British Airways. No, I would never have dreamed of doing it. But having experienced it I know that I would have missed out on one of lifes great experiences. There is no doubt that flying on Concorde is a remarkable experience - during my time in New York I occasionally mentioned that I had travelled there on the aircraft and jaws dropped in amazement. Funny how we take the aircraft for granted, some British people even sneer at it as being a great folly, yet the Americans I spoke to saw it as one of the great technological achievements of our age and were clearly envious. ■



Concorde's hi-tech cockpit. Photograph courtesy British Airways.

The author would like to thank British Airways for arranging the trip and in particular Peter Crespell, who is their Station Manager in Jersey.

A Basic RTTY Receive-only Terminal Unit - Part 2

This month Bernard J. Greatrix G4ICZ describes the construction of the simple RTTY terminal unit and gives the software listings needed to run RTTY on the Commodore C64 computer.

The layout of the circuit is shown in Fig. 2.1. Veroboard is used and the layout has been designed for a CA084 op-amp with a dual polarity supply rail. The completed Veroboard is fitted in a plastics RS Components box (Electromail 508-598). Sticky Fixers could be used to secure it in place. By increasing the length of the Veroboard to 68 holes it can be simply dropped into the internal moulded slots. This leaves room for a transmit section to be added later if desired. The front panel carries two switches labelled FORWARD-REVERSE and 1445-2125Hz (or your preferred alternative frequencies). The back panel is furnished with input and output sockets.

For the sockets either phono or 3.5mm jack would be suitable as there are standard leads available for each of these.

For the output socket a 5-pin DIN allows provision for all the necessary connections to the computer. Fig 2.2 shows the connections to the board from the switches and sockets. Connections for the oscilloscope are again either two 3.5mm jacks, two phono

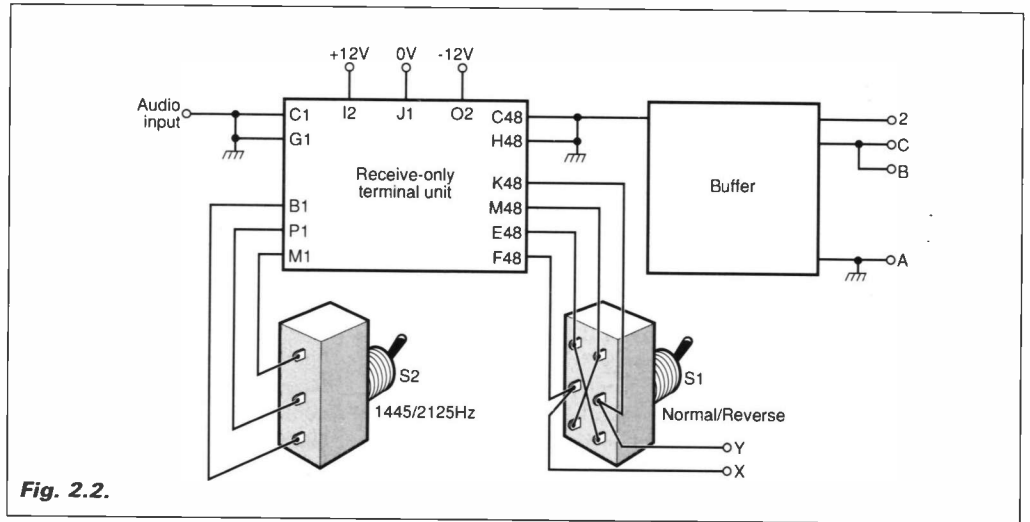

Fig. 2.2.

sockets or a single 3-pin DIN socket to suit the availability of cables.

Setting Up

Setting up the filters is a straight forward affair and merely consists of applying a "space" signal of 1275Hz to the input and adjusting R9 (approximately 178Ω) to give a maximum +ve signal on the cathode of D3 with the direction switch set to REVERSE.

A "mark" signal of 1445Hz is set by adjusting R8

(approximately 139Ω) to give a maximum +ve signal on the cathode of D3 with the direction switch set to NORMAL.

For those of you only wanting a single 170Hz shift unit, R21 may be omitted and replaced by a link between B2 and P1. If however a secondary tone is to be used a "mark" signal of 1700 or 2125Hz should be set by adjusting R21 (approximately 100 or 64Ω) in the above manner.

Obviously we need an audio signal generator to help

in this task, don't we? Well - not really. The Commodore 64 is furnished with a programmable sound chip and we can make this do the job for us. A DIN plug, a short length of screened cable, a couple of small crocodile clips and some more software is all that is required.

LISTING 2 gives the bare bones of a program to generate a square wave tone (perfectly adequate for this job) either from a stored value (1275, 1445, 1700, 2125Hz) or from a frequency value entered on the keyboard. With

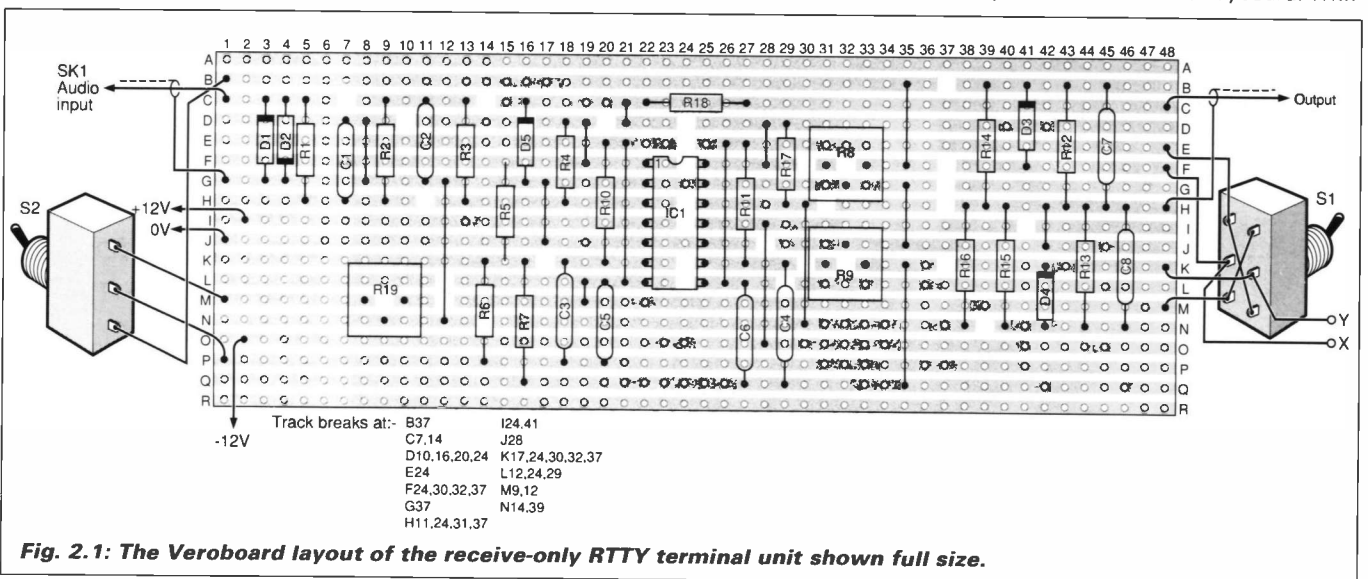

Fig. 2.1: The Veroboard layout of the receive-only RTTY terminal unit shown full size.

Listen to AOR

The **AR3000** now extends your listening horizons. Frequency coverage is from 100 kHz to 2036 MHz without any gaps in the range. All mode: USB, LSB, CW, AM, FM (narrow) FM (wide). 400 memory channels are arranged in 4 banks x 100 channels. 15 band pass filters before the GaAsFet RF amplifiers ensure high sensitivity throughout the entire range with outstanding dynamic range and freedom from intermodulation effects. An **RS232** port is provided to enable remote operation by plugging directly into most personal computers.

ACEPAC3 is an exclusively developed multi-function IBM-PC based program to further increase the versatility of the AR3000. A sweep facility provides a spectrum analysis graph. The very latest version displays frequencies in X axis and squelch opening percentage on each frequency in the programmed frequency search range. This indicates 'how active' the frequencies are in the programmed search range. In addition to the graphic display, ACEPAC3 can produce a detailed numerical list from the graphic information. One memory file has 400 channels divided into 4 banks of 100 channels. More than one memory file can be created to increase the memory storage capability. If you make just one extra memory file you can store 800 memory channels!

DA3000 Wide band 16 element discone aerial for external mounting. Frequency range 25 MHz to 2000 MHz (2 GHz). The aerial is supplied with approx 15m of coax terminated in a BNC connector ready to plug in and use with any AOR receiver. 'V' bolts and clamps are provided, however an additional supporting pole will be required for installation.



AR2000 *ultimate portable monitor receiver...*

AOR have followed on from the successful AR1000 and have made the specification of the AR2000 even better. (One major change is the replacement of the 154.825 MHz crystal with a highly-stable 12.8 MHz reference and multiplier chain). Whether out in a field running hand-portable, in the car or at home the AR2000 enables you to listen to both VHF and UHF airbands. Of course if you get tired of listening to airband, you can push a button or two and the world is yours! 'If it moves you can monitor it' - *well almost*. The choice of listening is endless, marine, Amateur band, airbands even BBC radio 2 on VHF FM. There are 1000 memory channels and 10 search banks, even a rotary tuning control is fitted to further enhance operation.

Search banks:

Bank 1	Shortwave	2 - 30 MHz	5 kHz step	AM
Bank 2	VHF FM	88 - 108 MHz	50 kHz step	WFM
Bank 3	VHF Air	108 - 138 MHz	25 kHz step	AM
Bank 4	UHF Air	225 - 400 MHz	50 kHz step	AM
Bank 5	VHF Amateur	144 - 146 MHz	12.5 kHz step	NFM
Bank 6	UHF Amateur	433 - 435 MHz	25 kHz step	NFM
Bank 7	VHF Marine	156 - 163 MHz	25 kHz step	NFM
Bank 8	VHF PMR	165 - 174 MHz	12.5 kHz step	NFM
Bank 9	C-Mobile	890 - 905 MHz	12.5 kHz step	NFM
Bank 0	C-Base	935 - 950 MHz	12.5 kHz step	NFM

UK Specific:

For ease of operation in the UK, the search banks have been pre-programmed at the factory. They may be easily re-programmed by the user. Each of the ten numeric keys is labelled with the corresponding search band, simply press one button and the receiver starts looking for interesting frequencies.

Frequency coverage:

The receiver has an exceptionally wide frequency coverage from 500 kHz to 1300 MHz (1.3 GHz) with no gaps. The modes available are AM, FM (narrow) and FM (wide). Any available mode may be selected at any frequency within

the receiver's coverage. There is no frustration in mode selection encountered here, you are *not forced* to listen to a specific mode at a specific frequency or band.

Accessories supplied:

- DA900 single wide band whip aerial for VHF and UHF
- AC charger
- 4 x AA High capacity rechargeable NiCad batteries
- 12V DC lead fitted with a cigar lighter plug for mobile operation
- Soft case with carry strap
- Belt hook
- Earphone

Everything you need is included to just switch on and start listening - today.



*Also available: AR2800, AR2500, etc.
For a complete set of leaflets and price list please send a S.S.A.E. (34p).*

AOR™ AOR (UK) Ltd.
Room 2, Adam Bede High Tech Centre,
Derby Road, Wirksworth, Derbys. DE4 4BG.
Tel: 0629 - 825926 Fax: 0629 - 825927

A subsidiary of AOR Ltd Japan.

E&OE

South Midlands Communications Ltd.

Southampton (0703) 255111 Leeds (0532) 350606 Chesterfield (0246) 453340
Birmingham 021-327 1497 Axminster (0297) 34918

RECEIVING O.K.?

IF NOT, WHY NOT CONTACT SMC FOR INFORMATION ON OUR COMPLETE RANGE OF RECEIVERS AND SCANNERS.



The **FRG9600**, a premium scanning receiver covering 60-905MHz, SSB, CW, AM & FM modes. 99 memories. 5, 10, 12.5, 25 & 100kHz scanning steps. Keyboard frequency entry. Optional converters to extend range from 0.15-30MHz and 800-1300MHz.



The **FRG8800** HF communications receiver. A better way to listen to the world. Continuous coverage from 0.15-30MHz optional module for VHF coverage from 118 to 174MHz. SSB, CW, AM & FM modes. Direct frequency entry keyboard.

Yaesu's serious about giving you better ways to tune in to the world around you. And whether it's for local action or world-wide DX, you'll find our HF/VHF/UHF receivers are the superior match for all your listening needs. When you want more from your receivers, just look to Yaesu. We take your listening seriously.

SMC are pleased to be able to offer the SONY range of Multiband Receivers. They feature all the latest technology allowing unequalled coverage of both broadcast and shortwave bands, yet remaining both compact and easy to use. All the models illustrated cover VHF broadcast, SW broadcast, and some models cover other bands as well.

The **ICFSW7600** is a sophisticated portable receiver that combines power and flexibility with one-touch convenience. Freq. range AM 150-29995kHz and FM 76-108MHz.

The **ICFSW1E** is possibly the world's smallest shortwave radio, fully featured with a multiple tuning system and PLL synthesised circuitry for digital precision. AM 0.15-30MHz & FM 76-108MHz.

The ultimate Multiband receiver, the **ICF2001D** combines sophisticated shortwave technology with the ease and versatility of both digital and analogue tuning. Freq. range AM 0.15-30MHz, FM 76-108MHz and AIR 116-136.6MHz.

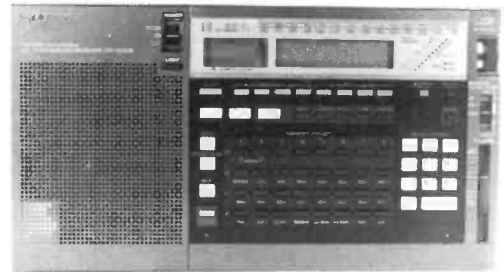

The **ICFPRO80** is a handheld professional receiver with air band capability and an 8-way tuning system. Frequency coverage 150kHz-108MHz and 115.15kHz to 223MHz with FRQ 80 frequency converter.

The **Air 7** is an all purpose handheld multiband receiver with continuous waveband coverage including air band and utilising a 6-way tuning system AM 150-2194kHz, FM 76-108MHz, Air 108-136MHz and PSB 144-174MHz.



The **Bearcat 200XLT** is the cream of the Bearcat handheld scanner range. With 200 memory channels and simple operation these are proving very popular. Freq. coverage 66-88, 118-174, 406-512 and 806-956MHz.

The compact **HX850E** is a basic scanner with a few memories. Ideally, suitable for a novice in the scanner market. AM/FM modes and a frequency coverage of 60-89, 118-136, 140-174 and 406-495MHz.



The **NRD525** is a high-class, general coverage receiver with expandability looking to the future. Combining traditional technology unique to JRC with the most advanced digital technology gives superb performance whilst remaining extremely easy to use. The NRD525 covers 90kHz-34MHz and with an optional VHF/UHF converter also covers 34-60, 114-174 and 423-456MHz. Modes of operation CW, SSB (USB/LSB), AM, FM and RTTY with optional demodulator.

The **HP200E MKII** is a 1000 channel, programmable, handheld scanner. AM, FM and FM wide for commercial channels covering 500kHz-600MHz and 805-1300MHz. Supplied complete with NiCad charger, Antennas, DC cable, shoulder strap, outclip, carry case and earpiece.



The **AIR HANDY** is a compact thumbwheel controlled handheld receiver. Light in weight and easy to use makes it an ideal introduction to receive. The AIR handy covers 118-136MHz and is AM.



Low receivers are available from Reg Ward & Co Ltd. Some Icom receivers available from most branches.



- Free Finance on selected items, subject to status. Details available on request.
- Up to £100 instant credit, a quotation in writing is available on request, subject to status.
- Yaesu Distributor Warranty, 12 months parts and labour.
- Carriage charged on all items as indicated or by quotation.
- Prices and availability subject to change without prior notice.
- Same day despatch wherever possible.

Southampton (0703) 255111
SMC HQ, School Close
Chandlers Ford Ind. Est.
Eastleigh,
Hants SO5 3BY
9am - 5pm. Mon-Fri
9am - 1pm Sat

Leeds (0532) 350606
SMC Northern,
Nowell Lane Ind. Est.
Nowell Lane,
Leeds LS9 6JE
9am - 5.30pm. Mon-Fri
9am - 1pm Sat

Chesterfield (0246) 453340
SMC Midlands,
102 High Street,
New Whittington
Chesterfield
9.30am - 5.30pm.
Tues-Sat

Birmingham 021-327 1497
SMC Birmingham,
504 Alum Rock Road,
Alum Rock,
Birmingham B8 3HX
9am - 5.00pm. Tues-Fri
9am - 4pm Sat

Axminster (0297) 34918
Reg Ward & Co. Ltd.
1 Western Parade,
West Street,
Axminster,
Devon EX13 5NY.
9.00am - 5.20pm. Tues-Sat

Project

the program running the signal from pin 3 of the 5-pin DIN (Audio/Video) socket on the back of the computer is fed to the input of the terminal unit [4 pages 396-397]. This signal is about 1V peak to peak, with the level set to the maximum value by the value 15 in LINE 40. There are many improvements that can be made - screen layout for one, adding filtering to the sound for another. My only comment is 'do it!'.

We could also make use of the joy-stick port with a suitable interface, and again some more software as the voltmeter also needed, but this is probably taking this project too far when a general purpose multimeter should be in every toolkit.

Software

Now to the conversion of the digital information into readable characters. Given in LISTING 3 is a simple RS232 receive program for use with the Commodore 64. Unfortunately, not having access to other micros, the author is not able to advise on conversion. However, it is believed that many of the popular machines (e.g. BBC and Spectrum) have access to the 'user ports' and can be programmed to accept a RS232 signal. With this in mind it is hoped that the following comments will both help in the understanding of how the C64 can be made to comply, and also how other machines may respond :

Line 10. Opens a communications channel to device No. 2 (Modem) and sets this channel as 5 bit (baudot), 1 start bit, 1 stop bit, half duplex. It also sets the baud rate to 50.

Fig. 2.3.

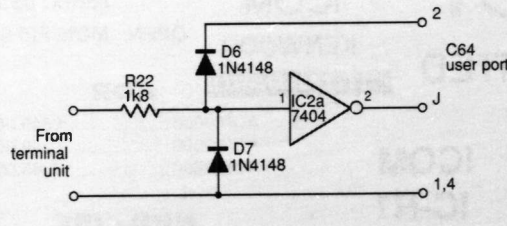

Line 11. Use as an alternative to line 10 if 45.45 baud is required.

Lines 12-15. Dimensions an array to 65 and reads into this array the alphabet and numerals etc., also sets an arbitrary 'flag' character to zero.

Lines 20-25. Gets a character from the input port and converts it into an ASCII value.

Lines 26-28. Picks up figure shift/letter shift and modifies the ASCII accordingly.

Line 30. If there is a character available prints its image in black (the black square is a Commodore 'special' character, see *User Manual*).

Line 40. Go back to line 20 and do it all again.

Obviously such a program is very limited and variations are given later for those who wish to experiment. Any noise in the receive chain will undoubtedly cause figures in the place of letters and vice versa with obvious confusion and the only way to deal with this 'hiccup' using such a simple program is to:

a: Wait for the sender to insert the correct 'shift'. He probably won't bother whilst he's sending something interesting. You'll have to wait ages.

b: Stop the program and restart hoping that the correct shift is in use - most unlikely. Don't forget Murphy.

c: Insert a line in the program to check the

keyboard so that the operator can modify the display accordingly.

For this last option and other 'useful' additions see LISTING 4. This extends the simple program to permit the user to vary the baud rate in 1 or 10 baud steps and also change the 'shift' from letters to figures and back again, during receive

I should point out that whilst the upgraded program is a little larger there are no major surprises that should cause problems in interpretation except for lines 200 to 350. These lines are specific to the Commodore 64 in that, having read the keyboard instructions to change the baud rate, values

are 'poked' into the RS232 registers within the C64 memory.

All that remains to do now, having built the unit is to connect it to the computer (via a TTL buffer, if you're as cautious as I am) as suggested by Fig. 2.3 and run the program.

I would suggest searching around 14.090MHz for suitable amateur signals or 145.300MHz if you have an active v.h.f. group in the area.

Finally it has not been the intention to steer any would be purchasers away from the ready made 'black boxes'. Rather, the aim has been to encourage the reader to experiment with simple circuits, and explore the realms of basic computer programs both of which do work reasonably well, and then hopefully, to enable them to decide from a position of experience what would suit them best.

Turn to page 17 for the program listings.

YOU WILL NEED

Resistors

Carbon Film 0.25W 5%

1.8kΩ	2	R1, 2
4.7kΩ	3	R5, 16, 18
22kΩ	3	R3, 14, 15
100kΩ	2	R12, 13
220kΩ	2	R6, 7
390kΩ	2	R10, 11
5.6MΩ	2	R4, 17

Potentiometers

Cermet preset

200Ω	4	R8, 19, 20, 21
------	---	----------------

Capacitors

Polyester

15nF	6	C1, 2, 3, 4, 5, 6
22nF	2	C7, 8

Semiconductors

Diodes

1N4148	4	D1, 2, 3, 4
4.7V 400mW	1	D5

Integrated circuits

CA084	1	IC1
-------	---	-----

Miscellaneous

Veroboard 50 holes x 18 tracks (see text); Plastics box (Electromail 508-598); Sockets (see text); Switches (see text).

Veroboard Connections

Signal input.	C1
Signal ground.	G1
+12V	I2
0V	J1
-12V	O2
Select 1445Hz.	B2
Select 1275Hz.	M1
Selected value.	P1
Output signal.	C48
Signal ground.	H48
Select Forward.	E48
Select Reverse.	M48
Return connections.	F48 & K48

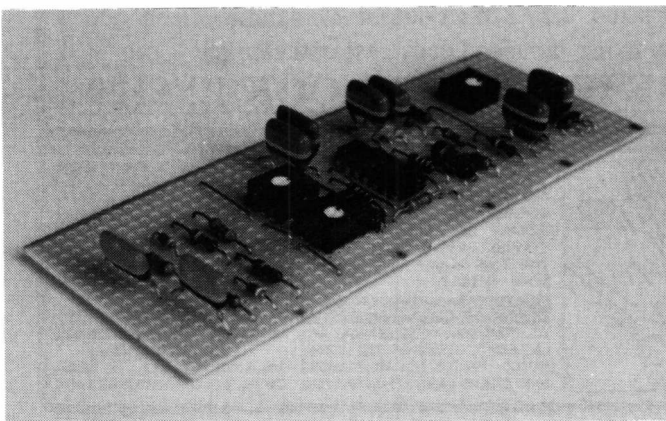

dressler

COMMUNICATIONS LIMITED

YAESU 191 Francis Road, Leyton, LONDON E10 6NQ
 Tel: 081-558 0854/556 1415 Fax: 081-558 1298
ICOM Telex: 8953609 24 Hr Hotline ansaphone
KENWOOD OPEN: MON-FRI 9AM-5.30PM OPEN: SAT-9.30AM-4.30PM

STANDARD

AOR

YAESU

DRESSLER ACTIVE ANTENNAS

ARA60

ACTIVE ANTENNA
 50kHz - 60MHz
 WITH LIMITED
 PERFORMANCE
 UP TO 100MHZ

Exciting new
 Shortwave Active
 Antenna
 940mm High
 64mm Diameter
 Complete with
 cable + PSU &
 Interface

£163.00

**ARA
 1500**

50MHz - 1500MHz

Frequency	Gain
50-1000	11.5dB
100-1500	11.0dB

£163.00
 'N' Connection

Now fully
 tuneable
 interface.
 Intercept
 point +
 21dBm
 Typical.

**ICOM
 IC-R1
 £325.00**



**PRICE BREAK
 THROUGH
 SHINWA SR001**

Remote control full
 feature receiver
 Down to: £299

AOR 3000 £649.00
 AOR 2000 £249.00
 AOR 2800 £385.00

NRD - JRC

535 + ARA 60 £1050.00
 535 only £949.00
 All accessories available.

STANDARD

AX 700 £545.00

FAIRMATE

HP200 £269.00

SONY

ICF SW 7600 £145.00
 ICF SW 77 £339.00

**ICOM
 IC-R72
 £550**

**SPECIAL STOCK
 CLEARANCE
 OFFER**



FRG 8800 HF Receiver £585.00

FRG 9600 50-950MHZ £500.00



R5000 HF Receiver only £895.00
 R2000 £585.00
 LOWE 225 £429.00

SPECIAL OFFERS

Icom R71 +
 ARA 60 £875.00
 Icom R7000 +
 ARA 1500 £1015.00
 Icom R7100 +
 ARA 1500 £1050.00
 Icom R9000 +
 ARA 60 & 1500 £4000.00
**YUPITERU MVT7000
 ONLY £269**

**FRG 8800 or
 Kenwood R2000: £585**

**COME AND VISIT OUR TOTALLY
 REFITTED LONDON SHOWROOM**

**PHONE FOR LATEST
 PRICES AND OFFERS**

Prices correct at time of going to press. Please
 phone for latest quote. Or contact your local
 agent any time on the following number: Terry
 (Biggleswade, Beds.) 0767 316 431.

RAYCOM

FOR ALL YOUR AMATEUR
 RADIO REQUIRMENTS.

021 552 0073

RAMSEY KITS

AR1K AIRCRAFT RECEIVER.....£24.95
 FR7K 2 METRE RECEIVER£29.95
 FR6K 6 METRE RECEIVER£29.95
 FR10K 10 METRE RECEIVER ..£29.95
 HR20K 20 METRE RECEIVER ..£27.95
 HR30K 30 METRE RECEIVER ..£27.95
 HR40K 40 METRE RECEIVER ..£27.95
 HR80K 80 METRE RECEIVER ..£27.95
 QRP20K 20 METRE CW TX£29.95
 QRP30K 30 METRE CW TX£29.95
 QRP40K 40 METRE CW TX£29.95
 QRP80K 80 METRE CW TX£29.95
 SR1K SHORTWAVE RX£27.95
 AA7K ACTIVE ANT£24.95
 FTR146 2M TX/RX 5W£129.95

ICOM IC7100

The latest base scanning receiver from
 ICOM is packed with features, 25 - 2000Mhz
 all mode AF, FM, FMW, SSB, 900, memory
 channels, 5 Scan modes, 10 search banks,
 AC or DC power, Large LCD display. Plus
 lots more inc free discone antenna !!!

ONLY £999.00

NOVICES

RAYCOM would like to congratulate all
 new novice licence holders on getting their
 new calls. We hope to meet them on the air
 soon.

**NEW for the novice RAMSEY FTR433K
 70CMS TRANSCIEVER KIT ONLY £129**
 Cheap 70cms h.heldsCALL !!!

JUST PASSED THE RAE !!!

RAYCOM now have the cheapest 2 metre handheld on the
 market fully synthesized, 2.5 / 1 Watt output .This radio comes
 complete and ready to use inc nicad pack case and charger.

IT MUST BE WORTH AT LOOK !!! £129

RAYCOM COMMUNICATIONS SYSTEMS LIMITED, INTERNATIONAL HOUSE, 963 WOLVERHAMPTON RD, OLDBURY, WEST MIDLANDS B69 4RJ. TEL 021-544-6767, Fax 021-544-7124, Telex 336483 IDENTI G.

RAYCOM
 COMMUNICATIONS SYSTEMS LIMITED



RAYCOM gives you more BUYING POWER

ALL MAJOR CREDIT CARDS AC-
 CEPTED. VISA, ACCESS, DINERS,
 INSTANT CREDIT (SUBJECT TO
 STATUS). FREE CREDIT ON CER-
 TAIN ITEMS AT MRP. CALL NOW FOR
 MORE DETAILS.

ORDERING INFORMATION

WE STOCK ICOM, YAESU, BEARCAT, MFJ,
 BUTTERNUT, CUSHCRAFT, AEA, TONNA,
 NAVICO, TEN-TEC AND WELZ AMONG
 MANY OTHERS SEND SAE FOR FULL LIST.

TEL: 021-552-0073

PHONE BEFORE 4PM FOR NEXT DAY
 DELIVERY BY COURIER (£15.00) -OR- 2PM
 FOR DELIVERY BY POST (£10.00 P&P).
 PLEASE ALLOW TIME FOR CHECKS TO
 CLEAR. MANY OTHER ITEMS IN STOCK.
 PLEASE CALL FOR MORE INFO AND FOR
 EXTRA SPECIAL DEALS!

INFOLINE 0836-771500 5-9pm (weekdays)

OPENING HOURS
 9.30 - 5.30 MON TO SAT . 73 DE RAY
 G4KZH, JOHN G8VIO AND FRED G4HXK.

Project

```
1 REM ::: LISTING 2
2 :
3 REM ::: PROGRAM TO EMULATE AN
4 REM ::: AUDIO SIGNAL GENERATOR
5 :
6 REM ::: G4ICZ JANUARY 1991
7 :
8 REM ::: SET UP SOUND PARAMETERS
9 REM ::: TO GENERATE SQUARE WAVES
10 :
20 S=54272:
30 FOR X=0 TO 24: POKE S+X,0: NEXT
40 POKE S+24,15: POKE S+5,0: POKE S+6,240
50 POKE S+3,8: POKE S+1,HI:POKE S,LO: POKE S+4,65 60 :
100 PRINT "1.. 1275HZ"
110 PRINT "2.. 1445HZ"
120 PRINT "3.. 1700HZ"
130 PRINT "4.. 2125HZ"
140 PRINT "5.. ANY OTHER FREQUENCY"
150 GET A$: IF A$="" THEN 150
160 A=VAL(A$): IF A<1 OR A>5 THEN 150
170 ON A GOSUB 500,510,520,530,550
180 F=F/.058717
190 HI=INT(F/256): LO=F-(HI*256)
200 GOTO 40
210:
500 F=1275:RETURN
510 F=1445:RETURN
520 F=1700:RETURN
530 F=2125:RETURN
550 INPUT "ENTER FREQUENCY";F
560 IF F<100 OR F>3000 THEN 550
570 RETURN
```

Note. 1. The value of 0.058717 in LINE 180 was the value needed to make **my** C64 produce correct frequencies. This is a variation on the 'correct' value, which I've put down to variations in clock crystal frequencies between the USA and the UK.

2. The frequency limit has been set to 100-3000Hz by LINE 560. Little or no other error checking has been added.

```
1 REM ::: LISTING NO 3
2 :
3 REM ::: SIMPLE RTTY
4 REM :::RECEIVE PROGRAM
5 :
6 REM ::: G4ICZ JANUARY 1991
7 :
8 :
10 OPEN 2,2,0,CHR$(96+1)+CHR$(16)
11 REM :OPEN 2,2,0,CHR$(96)+CHR$(16)+CHR$(243)+CHR$(41)
12 DIMD(65):P=0
15 FOR N=1 TO 64:READ D(N): NEXT
20 GET#2,A$
25 N=ASC(A$+CHR$(0))
26 IF N=31 THEN P=0
27 IF N=27 THEN P=32
28 N=N+P
30 IF A$<>"*" THEN PRINT "*"CHR$(D(N)):
40 GOTO 20
50 :
100 DATA 69,32,65,32,83,73,85,13,68,82,74,
78,70,67,75,84,90,76,87,72,89,80
110 DATA 81,79,66,71,32,77,88,86,32,32
120 DATA 51,32,45,32,39,56,55,13,32,52,32,
44,37,58,40,53,43,41,50,92,54,48
130 DATA 49,57,63,64,32,46,47,61,32,32
140 :
150 REM: CONNECT INCOMMING SIGNAL
```

```
151 REM: TO PINS B & C OF USER PORT
152 REM: PROGRAM AS LISTED RUNS
153 REM: 50 BAUD
154 REM: TO RECEIVE AT 45.45 BAUD
155 REM: DELETE LINE 10 AND THE
156 REM: "REM" IN LINE 11
157 :
158 REM: NOTE "*" IN LINE 30
159 REM: SHOULD BE CONTROL/1
160 REM: (IE PRINT IN BLACK)
```

```
1 REM ::: LISTING NO 4
2 :
3 REM ::: MODIFIED RTTY
4 REM :::RECEIVE PROGRAM
5 :
6 REM G4ICZ JANUARY 1991
7 :
8 :
10 OPEN 2,2,0,CHR$(96+1)+CHR$(16)
11 :
12 DIM D(65):P=0:B=50:PRINT B" BAUD"
15 FOR N=1 TO 64: READ D(N): NEXT
20 GET#2,A$
25 N=ASC(A$+CHR$(0))
26 IF N=31 THEN P=0
27 IF N=27 THEN P=32
28 N=N+P
30 IF A$<>"*" THEN PRINT "*"CHR$(D(N)):
40 GOSUB 200: GOTO 20
50 :
100 DATA 69,32,65,32,83,73,85,13,68,82,74,
78,70,67,75,84,90,76,87,72,89,80
110 DATA 81,79,66,71,32,77,88,86,32,32
120 DATA 51,32,45,32,39,56,55,13,32,52,32,
44,37,58,40,53,43,41,50,92,54,48
130 DATA 49,57,63,64,32,46,47,61,32,32
140 :
200 IF K$="+" THEN B=B+1
210 IF K$="-" THEN B=B-1
220 IF K$="I" THEN B=B+10
230 IF K$="D" THEN B=B-10
234 IF K$="L" THEN P=0
236 IF K$="F" THEN P=32
240 PRINT: PRINT B"BAUD": PRINT
250 GOSUB 300
260 RETURN
300 F=0.98525E6
310 HI=INT((F/B/2-100)/256): POKE662,HI
320 HA=INT((F/B/)/256): POKE 666, HA
330 LO=INT(F/B/2-100-(HI*256)+.5): POKE661,LO
340 LA=INT((F/B-(HA*256))): POKE665,LA
350 RETURN
360:
400 REM: CONNECT INCOMMING SIGNAL
401 REM: TO PINS B&C OF USER PORT
402 REM: PROGRAM AS LISTED RUNS
403 REM: 50 BAUD
404 REM: TO MODIFY USE _____
405 REM: '+' INCREASE BY 1 BAUD
406 REM: '-' DECREASE BY 1 BAUD
407 REM: 'I' INCREASE BY 10 BAUD
408 REM: 'D' DECREASE BY 10 BAUD
409 REM: 'L' CHANGE TO 'LETTERS'
410 REM: 'F' CHANGE TO 'FIGURES'
411 :
412 REM: NOTE "*" IN LINE 30 SHOULD BE
413 REM: CONTROL/1 (IE PRINT IN BLACK)
```

RECEIVERS ARE 'IN' AT WATERS & STANTON

DIAMOND ANTENNA

D505 ACTIVE AERIALS 1.5MHz - 1300MHz
£69



ONE AERIAL DOES IT ALL!
Just think one aerial for all your receivers. Both have built in matching circuits at the base of the antenna to provide high gain performance!

Mobile Aerial D505

This aerial covers everything from long-wave to VHF. It is no larger than a conventional mobile aerial measuring just 29.5" long, fits any standard mobile mount and comes complete with cigar lighter lead and matching box with RF gain control.

Base Station Aerial D707

Beautifully made from fibre glass, this rugged aerial will fulfil all your needs whether it be HF, VHF, or UHF. It comes complete with all the mounting hardware for mounting externally.

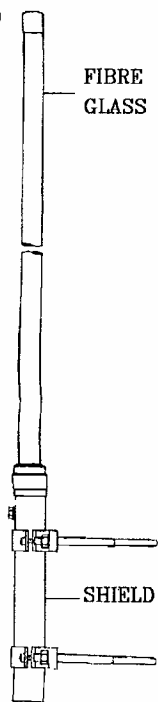

D707 £99
ADD £4.50 DELIVERY

OUR BEST SELLING BOOKS

SHORT WAVE LISTENERS CONFIDENTIAL FREQUENCY LIST Bill Laver. Covering the services and transmission modes that can be heard on the bands between 1.635 and 29.7MHz New 1991 Ed. **£8.95**

THE COMPLETE VHF/UHF FREQUENCY GUIDE 1991 Edition This book gives details of frequencies from 26-2250MHz with no gaps and who uses what. Recently updated, there are chapters on equipment requirements as well as antennas, etc. **£5.95**

THE SECRET OF LEARNING MORSE CODE Mark Francis Designed to make you proficient in Morse code in the shortest possible time, this book points out many of the pitfalls that beset the student. **£4.95**

MARINE UK RADIO FREQUENCY GUIDE Bill Laver A complete guide to the UK s.w. and v.h.f. marine radio networks. Useful information, frequency listings and the World Marine Coastal Phone Stations **£4.95**

HF OCEANIC AIRBAND COMMUNICATIONS 3rd Edition Bill Laver HF aircraft channels by frequency and band, main ground radio stations, European R/T networks and North Atlantic control frequencies. **£3.95**

THE POCKET GUIDE TO RTTY & FAX STATIONS Bill Laver Just updated. Invaluable to all data users, information includes Embassies News Media, Military Marine aircraft etc. **£3.95**

P&P £1 EACH BOOK.

MORE BEST SELLING RECEIVERS

MVT-6000 25-550MHz + 800-1300MHz Base unit 240V/12V	£249
AOR-2000 500kHz-1300MHz Hand-held NO GAPS	£269
HP-2000E 500kHz-1300MHz Hand-held NO GAPS	£269
R2000 Kenwood super short wave receiver	£549
R5000 Kenwood top range super sensitive receiver	£895
FRG8800 Yaesu short wave receiver	£649
ICR71E Icom super top performer	£875
ICR72E Icom's budget short wave receiver	£659
HF225 LOWE Budget price - superb performance	£425
ICF2001D SONY No other portable can touch it!	£289
SW7600D SONY The smallest truly portable SSB/AM	£149

FREE DELIVERY - ANY RECEIVER

REAL HANDHELD SCANNER AERIALS!

IMPROVE YOUR SCANNER
Dual Band Transceiving Aerials!
That are cut on 144,
300, 430, 800 & 900MHz.
Both BNC up to 5.5dB Gain

YOUR SCANNER DESERVES THE BEST

ORDER NOW!

49cms long RH900 - £29.95
18.5cms long RH700 - £16.95

RH900 RH700

Panasonic RFB65D

best portable SW receiver including SSB **£179**

Economic version also available RFB45 still with SSB £129

Brand new Alinco DJ-X1E
Handheld Scanner now in stock **£269**

NEW Sony SW77
Short Wave Portable in stock **£349**

Send stamp for our 'ALL NEW CATALOGUE' and price list.

YUPITERU SCANNERS

New Low Price
MVT-5000
£229

The MVT-5000 is still available and covers 26-550/800- 1300MHz.

If you don't mind missing the TV band, this model has to be one of the best ever scanners built. Its sensitivity is still unbeaten and its construction and reliability is legendary. **FREE CHARGER!**

The NEW MVT-7000
1MHz-1300MHz

- AM-NBFM-WBFM
- Multiplesteps
- Better than 0.5µV
- 200 Memories
- Rotary Dial
- S-meter
- Fast Scan Speed
- Lockout/Priority
- NiCads
- Charger/AC PSU
- 12V Lead

£289

The NEW VT-125 AIRBAND MK-II.

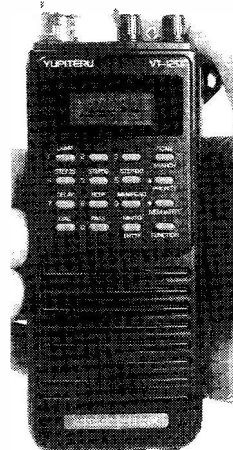

- 108-142MHz AM
- Better than 0.5µV
- Ultra compact
- 25kHz Steps
- 30 Memories
- Super audio
- NiCads
- Charger
- 12V DC

£169

Where does our equipment come from?

This is a question that you may be asking yourselves before you part with your hard earned cash. We are the official U.K. importers for ALINCO, MICROSET, TEN-TEC, DIAMOND, AZDEN, TONNA, ADONIS, REVEX, SAGANT, CREATE & GLOBAL. We are Authorised Distributors for KENWOOD, ICOM, YUPITERU, STANDARD, FAIRMATE, YAESU, NRD, SONY, PANASONIC, JAYBEAM, G-WHIP, DEE-COMM, SEM, SHINWA, AOR, AKD, ERA, BEARCAT, BLACK JAGUAR, SKY-SCAN, AEA, PAC-COMM, DAIWA, KENPRO, TOKYO & DEWSBURY. Nothing we sell is grey imported by us and we can therefore give you full confidence in our products and after sales service. See us at the Leicester exhibition and let us help you make the right choice at a competitive price!

Waters & Stanton BEST PRICES!

Retail and Mail Order: 22 Main Road, Hockley, Essex SS5 4QS. Tel: (0702) 206835/204965 Fax: (0702) 205843
Retail Only: 12 North Street, Hornchurch, Essex. Tel: (04024) 44765
VISA & ACCESS MAIL ORDER. 24 Hour Answerphone. Open 6 Days a Week 9am-5.30pm
Rail: Liverpool St./Hockley or District Line/Hornchurch

ALINCO's

"Professional Grade" Scanner DJ-X1. 500kHz-1.3GHz

"A Scanner of Unrivalled Performance"

Specification:

Modes: AM/Narrow FM/Wide FM
Steps: 5, 9, 10, 12.5, 20, 25, 30, 50, 100kHz
Antenna: 50Ω BNC
Supply: 6-15V DC (Internal 9V AA)
24mA (Battery save.)
Dimensions: 110 x 53 x 37mm
Weight: 370g
Configuration: AM/FM Triple conversion
Sensitivity: NBFM -8dB (12dB SINAD)
AM -2dB (10dB S/N)
Memories: 100 in banks.

STOP PRESS!!!
"Sensitivity far better than its
obvious rivals"
says Japanese magazine
review

Up until now most handheld scanners have been large and cumbersome with low grade plastic cases using technology that has been around for several years. The arrival of the ALINCO DJ-X1 has changed all that. This brand new receiver is ruggedly built, compact, and above all, ultra sensitive. ALINCO are the first major manufacturer of communications equipment to produce a new generation of scanning receiver. All of a sudden its competitors seem drab, old fashioned and lacking in sparkle and performance.

The new exciting DJ-X1 should be available now at your local dealer. Try it out for yourself, experience the superior design and performance. Compare it with "yesterday's" models and find out just how far advanced the new ALINCO scanner is! But just to wet your appetite, here's a few of its features:

★ 3 scanning speeds ★ 3 scanning modes ★ 100 memories in 3 banks ★ Auto memory loading ★ Priority channel ★ Dual rate battery saver ★ Large battery pack ★ Rotary frequency control ★ Illuminated key pad ★ Auto illumination mode ★ Dual antennas ★ 5 programmable bands ★ Widest range of frequency steps ★ Super front end sensitivity ★ Memory lockout ★ Mode scanning ★ Auto power off ★ Wide range of battery packs ★ Wide range of accessories ★ Intelligent mode programme ★ Rapid tuning rates of 1MHz-10MHz.

*Each unit now comes with the UK Gold Seal Warranty. Look for the sign on the box!

ALINCO STOCKISTS:

AVON: G4TJB (0934) 512757 : Uppington Tele-Radio Ltd (0272) 557732 : Amdat (0272) 699352
BUCKINGHAMSHIRE: Photo Acoustics Ltd (0908) 610625 CAMBRIDGESHIRE: Link Electronics (0733) 346770
CHESHIRE: CB37 Communications (0270) 588440 : Flightdeck Ltd 061-499 9350
CORNWALL: RV Heming Ltd (0637) 872191 : Marine Instruments (0326) 312414 COUNTRY
DURHAM: Border Communications 091-4109 6969 DORSET: Poole Logic (0202) 683093 EIRE:
Intronics 010-35321 1631007 ESSEX: Waters & Stanton (0702) 206835 : Selectronics (0268) 691481
HAMPSHIRE: Farnborough Communications (0252) 518009 : Siskin Electronics (0703) 207155 : Nevada
Communications (0705) 662145 ISLE OF MAN: Audio & Domestic Spares (0624) 815889
LANCASHIRE: Holdings Amateur Electronics (0254) 59595
: Stewarts Radio (0253) 21163 LONDON (CENTRAL): Pali-Fones 071-436 0022 : Lee Electronics 071- 723 5521 : Ask Electronics 071-637 0590 : Ramsons 071-724 2373
LONDON (EAST): Dressler Communications 081-558 0854 : Waters & Stanton (04024) 44765 LONDON (NORTH): Radio Shack 071-624 7174 LONDON (WEST): Martin
Lynch 081-566 1120 : ARE Communications Ltd 081-997 4476 MERSEYSIDE: Amateur Radio Comms (09252) 29881 NORFOLK: Eastern Communications (0692) 650077 :
DP Hobbs Ltd (0603) 615786 NORTH HUMBERSIDE: Heatherlite Communications (0964) 550921 NORTHERN IRELAND (LONDONDERRY): Omnicomm (0504) 48295
NORTHERN IRELAND: Tyrone Electronics (0662) 242043 NOTTINGHAMSHIRE: RAS Nottingham (0602) 280267 SCOTLAND: Jaycee Electronics Ltd (0592) 756962
YORKSHIRE: PA Electronic Supplies (0709) 527109 SURREY: Syon Trading (0372) 272587 SUSSEX: BREDHURST ELECTRONICS (0444) 400786 TYNE & WEAR:
Alyntronics 091-2761002 WALES: TMP Electronics (0244) 549563 : Electromart (0792) 842135 WEST MIDLANDS: Aviation Hobby Centre 021-782 6560 : Hewards Home
Stores Ltd 021 354 2083 : Raycom Communications Ltd 021 544 6767 : Dewsbury Electronics (0384) 390063 WEST YORKSHIRE: Fish Communications (0484) 420774
WORCESTERSHIRE: Johnson Sound Services (0905) 25740 : SRP Trading (0562) 730672 YORKSHIRE: Air Supply (0532) 50981.

UK Distributors: Waters & Stanton Electronics
22 Main Road, Hockley, Essex Tel: (0702) 206835



*And there were in the same country shepherds abiding in the field, keeping watch over their flock by night.
 And lo, the angel of the Lord came upon them, and the glory of the Lord shone round about them; and they were sore afraid.
 And the angel said unto them, Fear not: for, behold, I bring you good tidings of great joy, which shall be to all people.
 For unto you is born this day in the city of David a Saviour, which is Christ the Lord.
 And this shall be a sign unto you: Ye shall find the babe wrapped in swaddling clothes, lying in a manger.
 And suddenly there was with the angel a multitude of the heavenly host praising God, and saying,
 Glory to God in the highest, and on earth peace, good will toward men.*

Luke 2, v.8-14



Lowe Electronics
 wish all licensed
 Radio Amateurs
 and Short Wave
 Listeners the
 Season's
 Greetings
 and best
 wishes for
 the New
 Year.

With special thanks
 and appreciation
 to our thousands
 of customers
 who have
 supported
 us in
 1991.

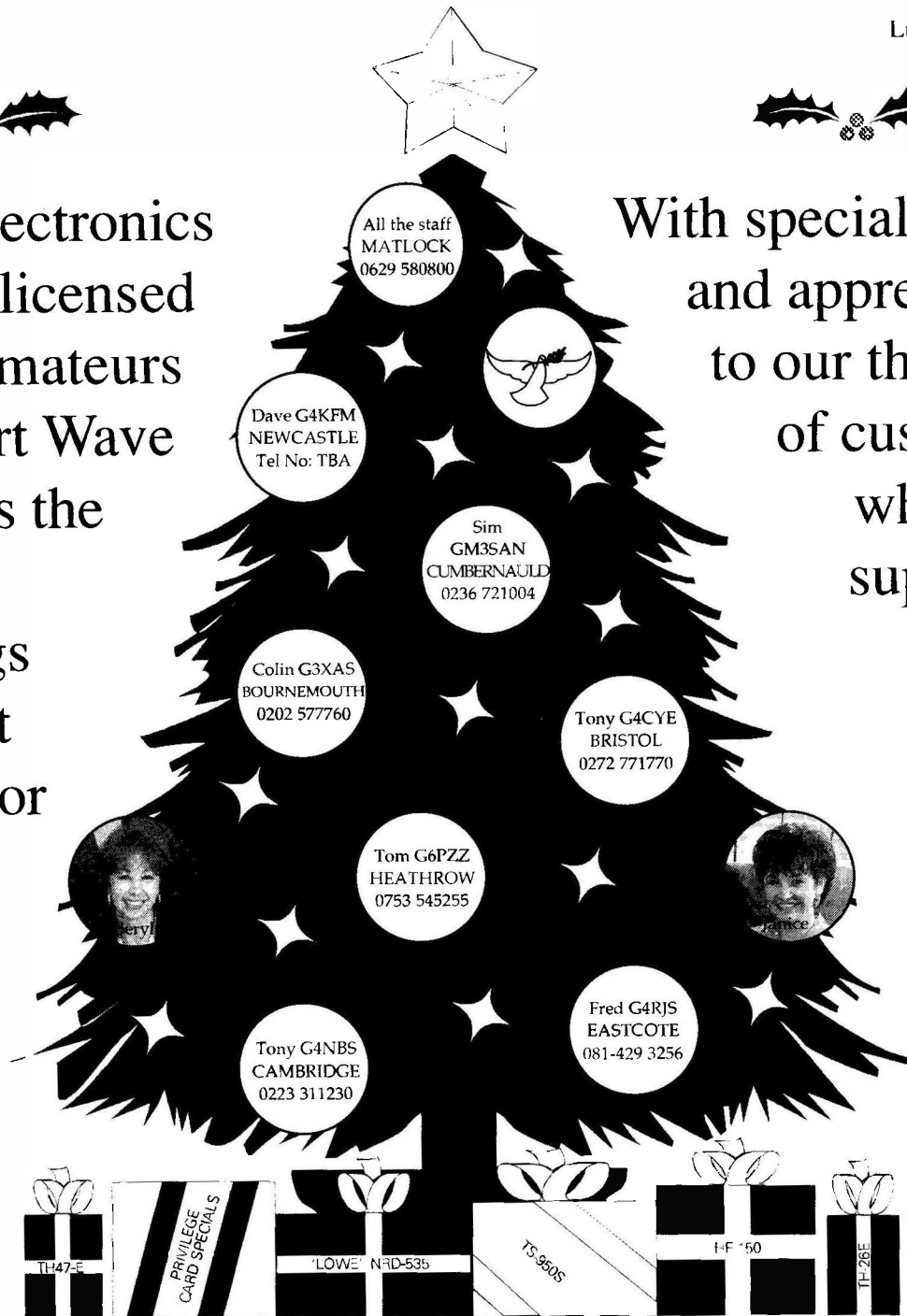

LOWE ELECTRONICS LTD
 Chesterfield Road, Matlock, Derbyshire DE4 5LE
 Tel: 0629 580800 Fax: 0629 580020



Radio Times

*When I twiddle the knobs on my old wireless set,
Through the crackle and whines funny programmes I get.
Though reception is fading and quality's harsh,
I'd swear I can hear Much Binding in the Marsh.*

*Yes, old Kenneth Horne's joking and Murdoch is witty,
And even Sam Costa is singing a ditty.
But next on the dial, in the Light Programme slot,
Dick Barton and pals are receiving their lot.*

*Will they get out of prison or will snakes get them first?
No, Dick, Snowy and Jock all break free with a burst.
A quick flick of the wrist and we travel in time
To Mrs Dale's Diary - a programme sublime.*

*She's worried to bits about dear hubby Jim,
But all will be well once mixed him his Pimm.
It's five o'clock now and nice Uncle Mac's here.
Yes, it's Children's Hour time - hide the fags and the beer.*

*In Toy Town we listen to Larry the Lamb
Sipping hot Ovaltine, eating bread, marg and Spam.
Then with nice Wilfred Pickles we all Have a Go
Before proving with Brains Trust there's loads we don't know.*

*But next on the air in a voice loud and clear
Come the words "Mr Handley, it's Mrs Mopp here."
"Can I do you now sir", and, "TTFN"
Then it's over to laugh with Beyond our Ken.*

*I turn to the Home Service to see what is on,
But Appointment with Fear has just ended and gone.
So on through the wavebands till music we hear
It's In Town Tonight full of Henry Hall cheer.*

*The programmes are endless, the talent is great,
And for Educating Archie I can hardly wait.
Paul Temple is solving a strange murder tale.
And Life with the Lyons for me just cannot fail.*

*So if I feel lonely you safely can bet
I'm happy to twiddle with my wireless set.
My friends will all join me, their message is clear,
I know they'll all help me to Take it from Here.*

David Leverett

How many different radio programmes are referred to, directly or indirectly, in David Leverett's poem? List them all on a piece of paper and send it to: Radio Programme Competition, *Short Wave Magazine*, Enefco House, The Quay, Poole, Dorset BH15 1PP to arrive no later than 9 January 1992. You must enclose the Radio Programme coupon from the foot of the Contents Page of this issue with your entry. The first correct entry drawn out of the 'hat' will win a prize of a replica vintage radio. The Editor's decision is final and no correspondence will be entered into in respect of this competition.

Educational Software for Basic Electronics

Part 10

J.T. Beaumont G3NGD continues with Pythagoras' Theorem, Energy, Heat and Temperature and Resistivity.

Pythagoras' Theorem

Knowledge of Pythagoras' Theorem is of importance to students involved in Electrical engineering. The Theorem is used when solving problems associated with Impedance, Reactance, Tuned Circuits, Power factor, etc.

When the program is RUN the student is presented with a menu. After the data has been entered a triangle is drawn, to scale, on the screen. This has a two-fold advantage. In addition to finding the third side of a right angles triangle, there is the opportunity to measure the angles using a protractor. The triangle is drawn on the screen using a procedure called Proc-draw and is located at line 600 in the program. (S24.)

Energy, Heat and Temperature

This program is used for revision purposes. When the program is RUN the following options are presented on the screen:

1. Introduction to Energy.
2. Introduction to heat.

3. Transmission of Heat.
4. Introduction to Temperature.
5. Calculations.

The material includes: joules, watt-seconds, kilowatt-hours, specific heat capacity, conduction, convection and radiation, Celsius, Fahrenheit and Kelvin.

The calculation section converts the following:
Degrees Celsius to Fahrenheit and Kelvin.
Degrees Fahrenheit to

Celsius and Kelvin.

Degrees Kelvin to Celsius and Fahrenheit.

One of the screens, showing formulae, is shown in S25.

Resistivity

When this program is RUN the following options are presented on the screen:

1. Resistance and conductor length.
2. Calculation by Ratio, Resistance to Conductor

length.

3. Resistance and Cross-sectional Area.

4. Resistivity.

5. Resistivity Calculation information.

6. Resistivity Calculation.

7. Exit the Program.

In this program graphics are used to compare the ratio of resistance between conductors of rectangular cross-section and those of circular cross-section.

Two calculation options are available to enable students to check their answers. These are:

Calculation of Resistance ratio.

Calculation of Resistivity.

A typical screen is shown in S26.

The complete suite of programs is available on a 5¹/₄in 40 or 80 track floppy disk direct from *Short Wave Magazine*. The software is only available for the BBC Computer, price £8.95 post free. Please remember to specify 40 or 80 track.

```

Pythagoras' Theorem
-----
DO YOU WANT TO CALCULATE:
1. The Hypotenuse
2. The Vertical Side
3. The Base
4. or EXIT from the program

      Hyp      Side
       / \     /
      /   \   /
     /_____\ /
    Base

Press the number key to select
-----
    
```

S24.

```

-----
To convert °C to °F
-----
°F = 9/5 °C + 32

-----
To convert °F to °C
-----
°C = (°F - 32) * 5/9

-----
To convert °C to Kelvin
-----
Kelvin = °C + 273

Press the space-bar to continue
    
```

S25.

```

RESISTIVITY
-----
Material      Resistivity Ωm
-----
Aluminium     2.7 x 10-8
Brass         7.2 x 10-8
Copper        1.7 x 10-8

The formula to calculate resistance is

R = ρ * l / a

R is the resistance in ohms Ω
l is the length in metres
ρ is the resistivity in Ωm
a is the area in square metres

Press the space-bar to continue
    
```

S26.

A.R.E.

COMMUNICATIONS

6. ROYAL PARADE
HANGER LANE
EALING
LONDON W5A 1ET
ENGLAND

Tel: 081 997 4476
Fax: 081 991 2565



NOW OPEN SUNDAYS 9 a.m - 12 UNTIL XMAS

OPENING HOURS:
Mon - Fri: 8.30 - 6 p.m.
Saturday: 9 - 5 p.m.

NOT ONLY THE ONLY AMATEUR RADIO SHOP TO BE OPEN ON SUNDAYS BUT ALSO...

★ UNBELIEVABLE! THEY'VE DONE IT AGAIN!
★ INCREDIBLE!



SPECIAL OFFER!!

AMAZING!
★ BLIMEY!
★ ASTONISHING!
★ GOOD OL' A.R.E!
£50 on...

WITH EVERY PURCHASE OVER £500 -

YOU GET 6 NIGHTS **FREE HOLIDAY ACCOMODATION VOUCHER** for 2 ADULTS plus 2 KIDS !!

Valid at 200 SUPERB BRITISH HOTELS + OTHER BENEFITS WORTH £500 plus!

CHECK THESE OUT - **ONLY AVAILABLE from A.R.E**

ALL YAESU MODELS IN STOCK

ICOM
NRD 535
OR 48 MONTHLY PAYMENTS OF £35.83
£995
Available Now

COFFEE & Home made CHOC CHIP BISCUITS



Now Being Served!

ALINCO HAND HELDS IN STOCK
STANDARD ★
MOTOROLA ★

IC-R7100 WITH H-F



£1049 -
OR 48 MONTHLY PAYMENTS OF £37.78 (NO DEPOSIT)



IC-R100 WITH S-S-B
500 HZ - 1800MHZ
100 Memories

£510 -
OR 48 MONTHLY PAYMENTS OF £18.37 (NO DEPOSIT)

2M hand helds from £139

IC-R1 WITH S-S-B
100 KHZ - 1300 MHZ

£399 -
OR 48 MONTHLY PAYMENTS OF £14.37 (NO DEPOSIT)

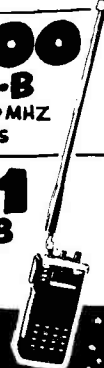

IF YOU HAVE ANY UNIT TO SELL OR PART EXCHANGE - COME TO US FOR A TERRIFIC DEAL!

CS28 NOW IN STOCK
£359 - OR 48 MONTHLY PAYMENTS OF £12.93

H-P AVAILABLE
ALL EASY TERMS ARE BASED ON AN APR of 34.4%
Check out our local competitors - THEY CHARGE MORE!

We CARRY A FULL RANGE of KENWOOD PRODUCTS - AT UNBEATABLE PRICES!

WE CAN OFFER **INSTANT CREDIT** SUBJECT TO STATUS

WE LOVE EXPORT ENQUIRIES!

FOREIGN STAMP
Go A.R.E. Communications England

A.R.E. COMMUNICATIONS
EASY PARKING AT REAR



A NEW TOOL FOR A NEW TECHNOLOGY

Scanmaster

Spectrum Planning? Surveillance? Management?

Activity Monitoring? System Engineering?

Why not upgrade your Scanning Receiver with the
New SCANMASTER™ II Controller?

Scanmaster™ II is a "black box" which plugs into the Remote Socket on your Scanning Receiver and takes over control of the Radio. No programming is required to use SM2™ as it has its own powerful commands to perform Searching, Memories, Remarks, Logging, Activity Reports, and many other things. It generates INFORMATION and you can control what sort and how. This information can be uploaded, downloaded, printed, stored, etc. You talk to SM2™ with a Terminal via an RS232 Serial Port. This would usually be ANY Computer running a simple terminal/comms program. Anything to or from the terminal is automatically stored in spare memory, backed with a lithium battery, and can be viewed at any time, even if SM2™ has been turned off for a while. SM2™ uses the latest microprocessor technology and is designed to be User Friendly. SM2™ has its own Clock/Calendar with a lithium battery so it keeps the date/time even when turned off. SM2™ has a powerful Scheduler so that jobs can be set up to run on a certain date/time, at date/time intervals, for a date/time duration, or for a number of times. SM2™ runs from 12V D.C. and is ideal for vehicle or portable use. It is LOW-COST so every Radio Engineer should have one!

SM2™ is designed to be upgradable, and will run many different radios with just a change of software and connecting leads. It will accept Plug-In Boards to further expand its power and usefulness. Once you have used SM2™ you will wonder how you ever used a Scanning Receiver without it !!

- Powerful Activity Reports
- Over 1300 Memories
- Clock/Calendar (Lithium)
- Versatile Lockouts
- Output for Databases (Comma Delimited)
- Powerful Scheduler
- Assign Remarks
- Low cost, easy to use
- Sophisticated Logging
- User Friendly Commands
- Large Memory + Battery
- Remote/Unattended Use
- Parallel Printer Port
- Status Indicator Panel
- Many Search Bands
- Tape Recorder On/Off
- Extensive User Manual
- Takes Plug-In Boards
- P.C. Upload/Download

Many more features !! Ask for more information.

SM2™ is supplied complete with connecting leads and a software package fitted to drive one the following Scanning Receivers:

AR3000 AR2002 CHASE IC-R7000 IC-R9000 FRG9600
(Upgrades are available from time to time)

How to Order: (Specify type of Receiver & Computer)
Send Cheque, Bank Draft, or Mastercard/Access/Visa No. & Exp. Date. Official Orders accepted from Gov'n't, Education, Large Co.s, etc.

Special Price....£249.99

Delivery: Ex Stock, subject to availability

28 Day Money-Back Guarantee if not entirely satisfied.
Life-Time Service Guarantee (Subject to conditions)

EMP

L I M I T E D

51 High Street, Portland, Dorset

DT5 1JQ, England

Phone: (0305) 826900



Overseas
Agents Wanted

Scanmaster™ II Plug-in Boards

SM2™ is able to take extra internal plug-in boards & software packages to further expand its power and usefulness. All boards except ROMCARD™ contain their own operating software and will work with any of the main SM2™ software packages thereby allowing the various boards to work with any Scanning Receiver supported by us.

Available Now...

ROMCARD™ enables SM2™ to hold up to 8 different software packages so that SM2+ROMCARD can drive up to 8 different Scanning Receivers with only a change of connecting leads. Upon performing a cold start, SM2™ is able to detect if ROMCARD™ is fitted and if so, it displays all the software packages fitted on ROMCARD™ on a menu for user selection. Supplied with one software package and set of connecting leads for **£49.99**
Software available for:

AR3000 AR2002 CHASE IC-R7000 IC-R9000 FRG9600

Available Soon!!

TONECARD™ is able to Decode & Encode a variety of signalling tones including DTMF, SELCALL, CTCSS & FFSK. (MPT1317, etc) and also decode and action signalling protocols such as TRUNKING (MPT1327, etc), JRC Band, BANDIII, etc. SM2+TONECARD can drive a transceiver if you want. SM2+TONECARD can control more than just Scanning Receivers!

JRC ROM™ is an optional software package for TONECARD and is tailor made to support the new JRC Band signals used by the Gas & Elect. Co.s. Many powerful features for diagnostic and engineering uses.

CELLCARD™ contains the same modem/filter chipset as a cellular telephone and SM2+CELLCARD™ can decode the signalling protocols used on the UK TACS system and optionally, the AMPS system. It can decode data and commands and can do channel hopping and other things. CELLCARD™ can be used as a powerful diagnostic tool and is available to **AUTHORISED USERS ONLY !!**

SCANMASTER™ I ??

The Old Original, still going strong and still available for the

AR2002, IC-R7000 & FRG9600

for only **£153.26**

Brief Thoughts on the ATU

Modern receivers are designed to 'look at' an unbalanced (coaxial) antenna feeder, either by way of antenna and earth terminals, a coaxial socket, or even both. Most people just hang their antenna and earth wires onto these terminals and set off to explore the bands. Paul Essery offers some thoughts on the subject of antenna tuning units.

If you visit one of the dab hands at short wave listening, you will probably find that he has a box labelled 'antenna match' or 'Z-match', 'a.t.u.' or something similar, with the antenna and earth connected to the receiver through it. The box may provide for alternative antennas to be switched into use - my own provides for two coaxial-fed antennas to be fed directly to the receiver and in addition an end-fed wire is transformed into 50Ω by an a.t.u. circuit. There is a dummy load in the box as well.

What is the a.t.u. doing?

The antenna has a property called its 'impedance', which can be summed-up as being like resistance plus, in series or parallel, either capacitance or inductance. The values of resistance, capacitance (or inductance) vary between wide limits. Now, if we are to suck from the antenna the maximum signal impressed on it by the distant transmitter, we must transform this impedance to be the same as the nominal impedance of the receiver input. To do this, any capacitance must be balanced out by the equivalent inductance, or vice versa as the case may be. Further, the resistive component must be transformed to equal the resistance of the receiver input circuit. What does this mean in practice? Imagine that you have an old-fashioned

transmitter with the pi-tank output on Top Band, and no a.t.u., feeding a 20m end-fed wire; this is about $1/8$ long. You tune up and are surprised to find the output capacitor, instead of being almost fully meshed, is almost out of mesh. The rest of the capacitance is, in fact, lurking up the antenna! Now imagine you have a change-over switch which changes the wire over to the receiver. Lo! the capacitance up the antenna is now shunting the receiver. Now, you wouldn't expect to hang, say, a 1000pF capacitor between antenna and earth terminals of the receiver and still have the receiver performing as it could if properly matched, would you? Obviously most of your signal would take the line of least resistance and go to earth through the invisible shunt capacitor!

So - that's what an a.t.u. will do; tune out the reactance so that everything the antenna can give is not shunted away. In addition it does a similar service for the resistive component, so all that the antenna can give is swallowed by the receiver. If, like most of us, you have an end-fed wire of random length, we can say that, depending on the frequency we choose to listen to and the length of the wire, we gain up to three S-points by correct a.t.u. adjustment. If we have an accurately cut and pruned coaxial-fed dipole for the

middle of, say, 14MHz, we can reckon it will cover the band nicely with minimal losses and without an a.t.u. - but only, mark you, if it has been pruned to resonance in its final home. For the transmitting amateur, that's easy; all he does is measure the s.w.r. at various frequencies and draw a graph, adjusting the length of each leg equally until the best s.w.r. appears at the middle of the band. For the s.w.l., it is a matter of getting an amateur to come and use his transmitter, or of you doing the best you can with a dip oscillator, either alone or with a sensitive s.w.r. bridge. If you haven't these tools, assume the worst and use an a.t.u.

Umpteen Circuits

Which a.t.u.? There are umpteen circuits to try and as many commercial units you could buy! About all you can say is that any circuit or unit can find itself up against an impedance combination it can't cope with. Doesn't happen often, but it happens! What to do then? Assume our end-fed piece of wire. First of

all, check that the a.t.u. can in fact 'hit the band' - hang a non-inductive resistor between the a.t.u. antenna and earth terminals, and see if you can find a setting of the a.t.u. controls where the 'sharsh' in the speaker peaks. Next consider the possibility of changing the length of the antenna itself. Let's say you are stuck with this length, thanks to a convenient chimney or whatever. You can make a wire look longer by adding a small amount of inductance in series with the antenna (i.e. between the a.t.u. antenna (\mathcal{A}) terminal and the start of the antenna), or you can make the wire look shorter by putting a variable capacitor in series. If you try this, sit the capacitor on a bit of paper so it doesn't short to the a.t.u. case! By the same token, you can also try hanging a bit of inductance or capacitance between the antenna and earth terminals of the a.t.u. (Fig. 2). Usually the amount of inductance or capacitance, whether in series or in parallel, will be quite small; use as little as you can to achieve the desired end.

Alternatively, try a different a.t.u. circuit! ■

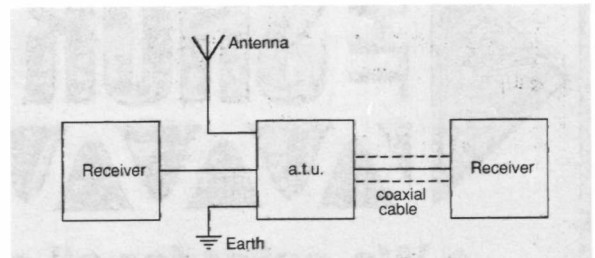

Fig. 1: The use of an a.t.u.

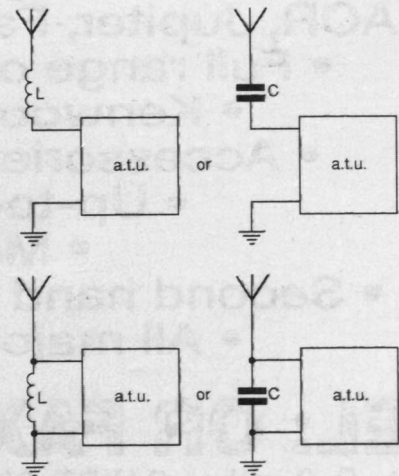

Fig. 2: When the a.t.u. cannot cope.

THE SHORT WAVE CENTRE NORWICH

- We cater for all aspects of amateur radio •
- Specializing in scanners and Receivers •
- AOR, Jupiter, Fairmate, Nevada, Alinco, ICOM. •
- Full range of amateur radio equipment •
 - Kenwood, Icom, Yeasu, Alinco. •
- Accessories/Service/Repair Facilities •
 - Up-to-date test equipment •
 - Mail order facilities •
- Second hand and part exchange welcome •
 - All major credit cards welcome •

TEL: OR FAX: 0603 788281

Prop: P. Gunther G4XBT, 95 Colindeep Lane, Sprowston,
Norwich, Norfolk NR7 8EQ. VAT No. 595 1239 21

**NEW SHOP
OPEN
NOW!**

AR1000/FAIRMATE SIDEBAND

ADDS USB/LSB MODES TO YOUR EXISTING SCANNER. A READY BUILT UNIT FULLY TESTED AND COMPLETE WITH INTERFACE LEAD AND INSTRUCTIONS. POWERED BY INTERNAL NICADS OR OPTIONAL MAINS ADAPTOR. CONTINUOUSLY VARIABLE COVERAGE. NOT TIED TO 5KHZ STEPS. £44.95 inc p&p.

SIGNAL STRENGTH METER

SMALL COMPACT DESIGN. USE FREE STANDING OR CLIP TO THE SIDE OF YOUR SCANNER. POSSIBLE USES INCLUDE DISTANCE AND DIRECTION MEASUREMENT FOR CLEARER IDENTIFICATION OF SIGNALS AND OPTIMISING OF AERIAL SYSTEMS £23.95 inc p&p.

WRITE FOR FURTHER DETAILS. SAE PLEASE. CHEQUES
POs TO:

RGW Electronics 5 Braunston Place, Rugby,
Warkwichshire CV22 5JZ

ALYNTRONICS

129 CHILLINGHAM ROAD, HEATON,
NEWCASTLE-UPON-TYNE NE6 5XL TEL: 091-2761002

THE ONLY AUTHORISED DEALER IN THE NORTH-EAST FOR

ICOM & YAESU

WE ALSO STOCK MANY OTHER ITEMS OF EQUIPMENT FROM

MFJ ★ BUTTERNUT ★ CUSHCRAFT TONNA ★ DIAMOND ★ AOR
BEARCAT ★ FAIRMATE ★ JUPITER ★ LOWE ★ TEAM

MIDLAND ★ NEVADA ★ CTE ★ WELZ

★ REVEX ★ BOOKS & MAPS ★

VISA

LICENSED CREDIT BROKER



OPEN 10am - 5.45pm TUES - FRI 10am - 4.45pm SAT

NEW!

Introducing Omnifax ...

A Superb Weather Satellite and Facsimile Display Package for PC Compatibles

This is a brand new interface and software package for the decoding and high resolution display of weather satellite, and all facsimile images - all for only **£169.50 + VAT**.

Features:

- Decodes all APT weather satellite formats up to 800 x 600 pixels
- Decodes all facsimile signals (VLF, HF, VHF, UHF)
- Interface fits any PC Compatible machine
- Printer dump - laser or dot matrix
- Fully automatic reception
- Animation of image sequences
- Interface caters for optional SSTV and Codebreaker software
- Displays amateurfax, and pressfax (incl. colour!)

Omnifax is available now, for use with your existing receiving and computing hardware, or we can supply complete systems. For further information, and details of our systems for other computers our complete catalogue is available on request.

martelec communication systems

The Acorns, Wyck Lane, East Worldham, Alton Hants. GU34 3AW.
Tel/Fax (0420) 82752

Sony WA8800 Ten-band Radio-Cassette Recorder

Mike Richards takes a look at the Sony WA8800 radio-cassette recorder with ten bands, including eight short wave ones.

The new Sony WA-8800 is an amazingly compact radio-cassette recorder that's likely to have particular appeal to the traveller. The WA-8800 features full medium wave and stereo v.h.f. f.m. coverage plus eight short wave bands. This is supplemented by a built-in auto-reverse stereo cassette recorder. All this is contained in a very stylish unit measuring a mere 250 x 81 x 39 ! I ought to add that, unlike many stereo portables, the WA-8800 includes stereo speakers - quite an achievement considering the size. Without more ado let's take a closer look at the WA-8800.

As the WA-8800 is designed as a portable unit, it comes complete with all that's necessary for normal operation. Power is provided by two AA cells, housed in a compartment at the rear. For those who need to use an external power source there is coaxial power socket on the side panel. The power requirement was very modest and Sony can supply optional adaptors for connection to mains or car battery power sources.

Although the WA-8800 is fitted with stereo speakers a 3.5mm jack is provided for connection of stereo headphones. The use of a 3.5mm jack gives the user the flexibility to use one of the very wide range of headphones that have been produced for the Walkman market.

The only other external connection was for a stereo microphone. Again this was via a 3.5mm stereo jack on the side panel. There was also a

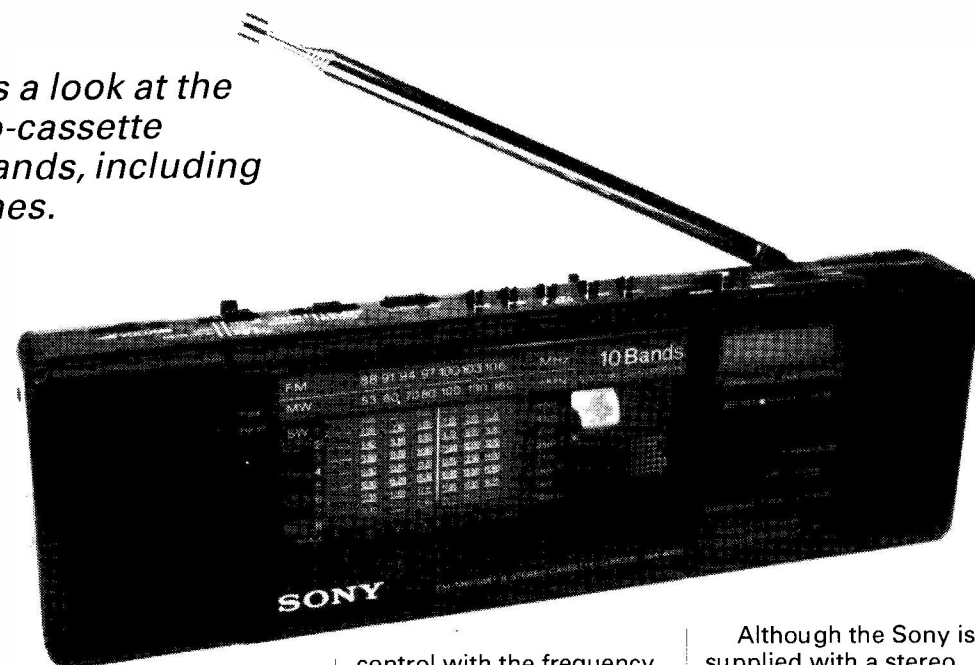

stereo lapel mic supplied with the WA-8800 which was handy for general recording.

It may be worth noting that there was no external antenna socket. However, it was possible to connect a wire antenna to the collapsed telescopic antenna to pull in those weak stations.

Operation

Sony have done a good design job in keeping operation very simple. To aid this, all the main controls are laid out along the top panel. This is backed-up by a very good instruction manual. This follows the usual multi-lingual format with instruction in English, French and Spanish, each language being allocated about twenty-five pages. There were also plenty of illustrations to clarify many of the features.

Moving back to the operation, band selection is performed using a combination of two switches. The first is used to select f.m./m.w./s.w. whilst the other is used to select one of the eight short wave bands.

Tuning is via an edge

control with the frequency indicated by an analogue dial on the front panel. In fact this analogue dial is a vital space saver as it's located in the door of the cassette deck. The volume was controlled by another edge control and was complimented by a two position tone control switch. This switch also doubled as a replay equalisation switch for the tape deck.

The tape deck was controlled by a set of six push buttons on the top panel. One useful extra was a slider that disabled the tape controls. This successfully prevented inadvertent operation while in transit. Operation of the tape deck was very simple and included a setting that automatically reversed the tape direction. When recording from the radio there's a three position switch that adjusts the bias oscillator to minimise heterodyne interference. This same switch doubles as a mono/stereo switch for v.h.f. f.m. reception.

With any travel radio it's very useful to have a clock and alarm. The Sony includes this feature along with a conventional snooze control that turns the radio off after an hour.

Although the Sony is supplied with a stereo lapel microphone, the input socket can be used to make recordings from other sources. However, you will need to be careful as this input is very sensitive at 0.2mV.

In Use

I must admit that I was quite taken by this extremely compact unit. It's ideal for taking on foreign holidays where space is at a premium. I was initially concerned at the very short tuning scale - I thought tuning on the short wave bands could be extremely difficult. In practice my fears were unfounded and I experienced no real difficulty. The only limitation was caused by the lack of a digital read-out. This meant that finding a particular station involved a certain amount of trial and error. This was far less of a problem on the m.w. and v.h.f. bands.

The stereo effect from the built-in speakers was remarkably good. This is surprising when you consider that the speakers were a mere 45mm in diameter and spaced some 200mm apart. The main limitation of the small speaker size was the lack

Sony® REDDITCH Centre



The WA8800 incorporates a built-in cassette deck to allow recording of short wave broadcasts. £229.99 inc VAT

The Travellers' Shortwave Multiband Receiver with Built-in Cassette Deck and 8 Bank Shortwave Reception • FM/MW/8 Band SW Reception • FM Stereo • Auto Reverse Stereo Cassette Deck with Auto Shut-Off • Stereo Recording Facility • Manual Dial Tuning • Programmable Timer • Sleep Function (60 minutes) • Digital Clock and Alarm • Dual Conversion System • Tape Counter • Tone Control • Tape Selector • Supplied with stereo microphone, shortwave guide, case and handstrap • Power: 2 x AA size battery 3V DC 240V AC with adaptor

SPECIALIST AIR

For specialist users, Sony provides a choice of ruggedly-constructed receivers that deliver a truly impressive array of professional features.

These two high-specification air-band models incorporate multi-way tuning, squelch control, PLL synthesized circuitry, and reception of PSB (Public Service Band) broadcasts, extending their versatility to allow monitoring of fire service, forestry, marine, highway and weather

AIR 7 - £249.99 inc VAT
HANDHELD MULTIBAND RECEIVER WITH 6-WAY TUNING AND CONTINUOUS WAVEBAND COVERAGE INCLUDING AIR BAND

FM/AM/AIR/PSB Reception • PLL Synthesized Circuitry • Continuous AM Frequency Coverage • 6-Way Tuning: 40 Memory Presets, Auto Scan, Memory Scan, Priority Tuning, Manual tuning, 10 Key Direct Tuning • Wideband Coverage • Squelch Control (Auto and Manual) • Key Protection • LCD Display with Light Function • Dual Conversion System • Record Out Socket • 4-Way Power Supply • Supplied with Helical Aerial, Shortwave Guide, Battery Holder, Earphone and Shoulder Strap • Power: 4 x AA size battery • 6VDC • 240VAC with Adaptor (Optional).

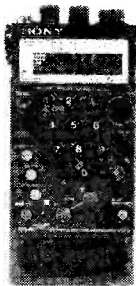

ICF PRO80 - £299.99 inc VAT
HIGH-SPECIFICATION HANDHELD MULTIBAND RECEIVER WITH FREQUENCY CONVERTOR, 8-WAY TUNING AND CONTINUOUS WAVEBAND COVERAGE INCLUDING AIR BAND

FM/FM Narrow/AM Wide/AM Narrow/VHF/AIR/PSB/UHF Reception • PLL Synthesized Circuitry • Continuous AM Frequency Coverage • 8-Way Tuning: 40 Memory Presets, Memory Scan, Define Scan, Auto Scan, Programme Memory Scan, Priority Tuning, Manual tuning, 10 Key Direct Tuning • Wideband Coverage • Squelch Control (Auto and Manual) • Key Protection • 3 Mode Scan • 2-Step Tone Control • 40 Station Random Memory Presets over 4 Memory Pages • AM/SSB Fine Tuning • LCD Display with Light Function • Dual Conversion System • Record Out Socket • Supplied with Shortwave Guide, PRO80 Frequency Converter, Telescopic Aerial, Earphone, Shoulder Strap, Carrying Case, Aerial Holder and Aerial Plug Adaptor • Power: 4 x AA size battery • 6VDC • 240VAC with Adaptor (Optional).



OBA Electronics Ltd

58 Evesham Walk, Kingfisher Centre,
Redditch, Worcestershire B97 4AH

Telephone: 0527 65005

Fax: 0527 595096

Many Radio Amateurs and SWLs are puzzled. Just what are all those strange signals you can hear but not identify on the Short Wave Bands? A few of them such as CW, RTTY, Packet and Amtor you'll know – but what about the many other signals?

HOKA ELECTRONICS HAVE THE ANSWER! There are some well-known CW/RTTY decoders with limited facilities and high prices, complete with expensive PROMS for upgrading etc., but then there is CODE3 from Hoka Electronics! It's up to you to make the choice – but it will be easy once you know more about Code3. Code3 works on any IBM-compatible computer with MS-DOS 2.0 or later and having at least 640K of RAM. The Code3 hardware includes a digital FSK Converter unit with built-in 230V ac power supply and RS232 cable, ready to use. You'll also get the best software ever made to decode all kinds of data transmissions. Code3 is the most sophisticated decoder available and the best news of all is that it only costs £299!

- Morse – Manual/Auto speed follow. On screen WPM indicator
- Packet Radio AX25 with selective call/sign monitoring, 300 Baud
- DUP-ARQ Artrac – 125 Baud Simplex ARQ
- ARQ6-90/98 – 200 Baud Simplex ARQ
- ARQ-E/ARQ1000 Duplex
- POL-ARQ – 100 baud Duplex ARQ
- FEC-A – FEC100A/FEC101
- Wirtschaftsdienst – 300 Baud ASCH F7BC
- RTTY /Baudot/Murray/ITA2/CCITT2 plus all bit inversions
- Facsimile, all RPM/ADC (up to 16 shades at 1024 x 768 pixels)
- Twinplex – 100 Baud F7BC Simplex ARQ
- SI-ARQ/ARQ-S – ARQ1000 simplex
- ARQ-N/ARQ1000 Duplex variant
- TDM242/ARQ-242 CCIR 242 with 1/2/4 channels
- FEC-S – FEC1000 Simplex
- Sports Info. 300 Baud ASCH F7BC
- Sitor – CCIR 625/476-4, Modes A/B, SBRS/CBRS FEC etc
- Autospec – Mk's I and II with all known interleaves
- ASCH – CCITT 5, variable character lengths/parity
- SWED-ARQ/ARQ-SWE – CCIR 518 variant
- ARQ-E3 – CCIR 519 variant
- TDM342/ARQ-M2/4 CCIR 342-2 with 1/2/4 channels
- Press DPA – 300 Baud ASCH F7BC
- Hellsreiber – Synch./Asynch.

All modes are pre-set with the most commonly seen baud rate setting and number of channels which can be easily changed at will whilst decoding. Multi-channel systems display ALL channels on screen *at the same time*. Split screen with one window continually displaying channel control signal status e.g. idle Alphas/Beta/RQ's etc, along with all system parameter settings e.g. unshift on space, multiple carriage returns inhibit, auto receiver drift compensation, printer on, system sub-mode. Any transmitted error correction information is used to minimise received errors. Baudot and Sitor both react correctly to third shift signals (e.g. Cyrillic) to generate ungarbled text unlike some other decoders which get 'stuck' in figures mode!

Six options are currently available extra to the above specification as follows: 1) Oscilloscope. Displays frequency against time. Split screen storage/real time. Great for tuning and analysis. £29. 2) Piccolo Mk 6. Multi-tone system that only we can decode with a PC! £59. 3) Ascii Storage – Save to disc any decoded ascii text for later processing. £29. 4) Coquelet – French multi-tone system, again only on offer from Hoka! £59. 5) 4 Special ARQ and FEC systems i.e.. TORG-10/11, SAUD-FEC/ROU-FEC, HC-ARQ (ICRC) and HNG-FEC. £69. 6) Auto-classification – Press F1 to measure the Baud speed, press F3 to Classify, press Enter key to accept. Within seconds and only three key presses you should be decoding the monitored signal; What could be easier? £59.

Please add £5 to the above prices for carriage by fully insured First Class Postal delivery (default method).

Call or write for our comprehensive information leaflet – there is just not enough room here to tell you everything about Code3!

HOKA ELECTRONICS (UK),

26 Bury Road, Shillington, Beds. SG5 2NY. Phone (0462) 711600 or Fax (0462) 711769

(Also available from our Authorised Distributor – Arrow Radio at Chelmsford, Glasgow, Wigan and Leicester)

Review

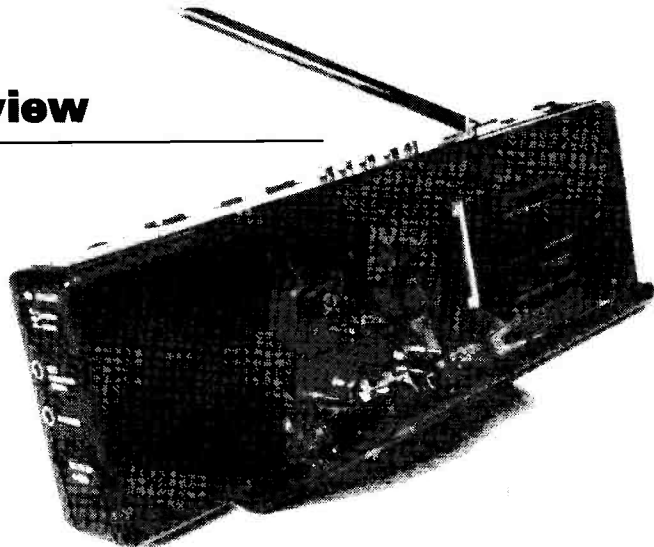

Specifications

Radio Section

Frequency Range:	v.h.f.	87.6-107MHz
	m.w.	530-1605kHz
	s.w. 1	5.85-6.35MHz
	s.w. 2	7.0-7.5MHz
	s.w. 3	9.4-9.9MHz
	s.w. 4	11.6-12.1MHz
	s.w. 5	13.5-14MHz
	s.w. 6	15.1-15.6MHz
	s.w. 7	17.55-18.05MHz
	s.w. 8	21.4-21.9MHz
Antennas:	v.h.f.	telescopic
	s.w.	telescopic
	m.w.	ferrite rod

Tape Recorder Section

System:	4-track, 2-channel stereo
Speakers:	45mm
Fast wind:	3 min 10 sec with C-60 tape
Response:	80-9000Hz (-10dB)
Inputs:	Mic low impedance stereo 0.2mV
Output:	3.5mm stereo jack 115+115mW into 8-32Ω

General

Power:	2 x R6 (AA) cells or optional AC-D2L a.c. adaptor or DCC-70 car battery adaptor
Dimensions:	250 x 81 x 39mm
Weight:	550g

of bass. However, when listening with good quality headphones the audio performance was transformed. The quality was really very impressive and there was plenty of power. The performance of the tape recorder section was well up to expectations. Recordings made using the supplied lapel mic were very good especially when played through a good quality hi-fi unit. The only problem I found was that the cassette loading was a little tricky. It wasn't a serious problem - you just needed to be careful.

Summary

The Sony WA-8800 was certainly a very impressive little unit. The combination of radio and tape in such a compact unit gives it particular appeal to the traveller. The main limitation is the small speakers but this can be rectified by using one of the add-on units readily available.

The WA-8800 is available from all Sony dealers and costs £229.99. My thanks to Sony UK for the loan of the review model.

Peter Rouse's New Book

Available Now, in time for Christmas!

Short Wave Communications
Peter Rouse GU1DKD
PW Publishing Ltd
ISBN: 1 874110 00X
187 pages, price £8.95

Available from PW Book Service, post and packing free on orders placed before 31 December 1991.

Newly published, this book, as its name suggests covers a very wide area and as such provides an ideal introduction to the hobby of radio communication. Logically laid out chapters take the reader through basic radio propagation, how to work your radio, and what the controls do. One chapter deals specifically with antennas, and another with band plans. There are many pages of useful information of where and when to listen on the bands, so you can successfully receive the service or transmissions that interest you. Using simple, understandable language throughout, the author has managed to make this book a good, basic, very readable introduction to a complex subject.

Newcomers to the hobby will be delighted to find a copy in their stocking this Christmas.

SHORT WAVE COMMUNICATIONS

by Peter Rouse GU1DKD

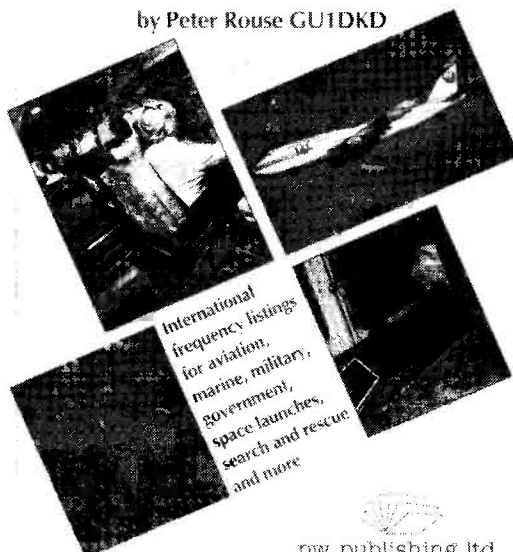

pw publishing ltd.

SWM SUBSCRIBERS' CLUB

Be sure of your copy every month and qualify for the Subscribers' Club as well. Special offers and discounts normally available to all members, including those abroad.

This month's special offer to Subscribers' Club members.

This month's special offer, the JIM PSU-101 bracket being used in conjunction with a hand-held scanner (not supplied).

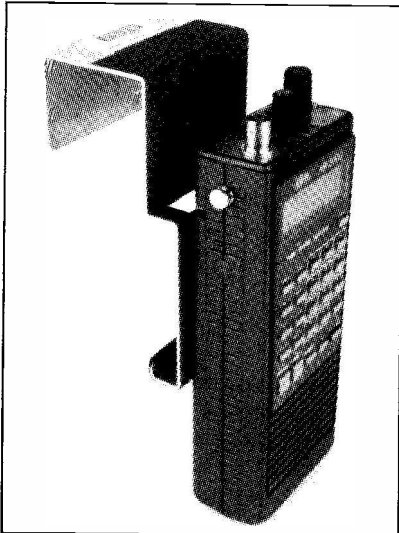

**Save
£2.75!**

This month SWM Subscribers' Club Members have the chance to buy a very useful accessory to keep radio equipment safe in the car, office or home.

Do you take your hand-held transceiver, scanner or other hand-portable rig with you in the car? Has it ever slid off the parcel shelf, fallen on to the floor or been generally 'knocked about a bit'? Well this month's little bargain is the JIM PSU-101 securing bracket.

Your radio equipment, whether it be a hand-held transceiver, receiver or scanner, can be held safely and securely on its felt-covered support frame. You can use it at home, and when you are working mobile. The JIM bracket can even be used to keep the rig secure in other locations, even in the garden. While you are digging away the rig can be safely left on the back of a garden chair and you won't miss that QSO, or an excuse to stop work!

As a member of the SWM Subscribers' Club, you can buy your JIM PSU-101 for £6.95 inc. P&P, (normal price £9.70 inc. P&P).

If you have a subscription then you will know all about the Short Wave Magazine Subscribers' Club. If you don't then read on.

Membership is free and automatic for all subscribers to this magazine, and is our way of saying thank you to all those who have had faith to pay for it 'up front'.

Each month there are Special Offers and occasional competitions with some really useful prizes to be won.

Please indicate the type of subscription required:

SHORT WAVE MAGAZINE 1 YEAR

- £21.00 (UK)
- £23.00 (Europe)
- £25.00 (Rest of World)

PRACTICAL WIRELESS 1YEAR

- £19.00(UK)
- £21.00 (Europe)
- £22.00(Rest of World)

SPECIAL JOINT SUBSCRIPTION 1 YEAR ONLY

- £34.00 (UK)
- £37.00 (Europe)
- £39.00 (Rest of World)

Prices current at November 1991

Subscription to commence with issue dated.....

Please send me THE JIM PSU-101 SECURING BRACKET at the special SWM Subscribers' Club price of £6.95 inc. P&P.

To: PW Publishing Ltd., FREEPOST, Subscriptions Dept., Enefco House, The Quay, Poole, Dorset BH15 1PP

Name.....

Address.....

.....

.....

I enclose cheque/PO (Payable to PW Publishing Ltd) £.....

Charge to my Access/Visa Card the amount of £.....

Card No.

Valid from to

Signature.....

**Credit Card Orders
can be taken on
(0202) 665524.**

**HAVING TROUBLE THINKING OF A PRESENT FOR THAT RADIO ENTHUSIAST?
READ BELOW FOR A GREAT CHRISTMAS IDEA.**

**Only a few more shopping days left
before Christmas**

Are you having trouble choosing a suitable present for a loved one, or perhaps you are the one no-one can think of an appropriate gift for? We have the answer - a Gift Subscription to Short Wave Magazine.

For just £21 we will send the recipient a Christmas card telling them about their gift and a free copy of Wires & Waves - A Practical Antenna Guide.

They also get free membership of the Subscribers' Club.

Fill in the form opposite and send it to SWM Christmas Subscription Offer, FREEPOST, PW Publishing Ltd., Enefco House, The Quay, Poole, Dorset BH15 1PP. Orders received before December 11 will be despatched by Monday December 16.

**Recipient's
Name**

.....

.....

.....

.....

.....

.....

Post Code

ICS *Shortwave and Satellite*

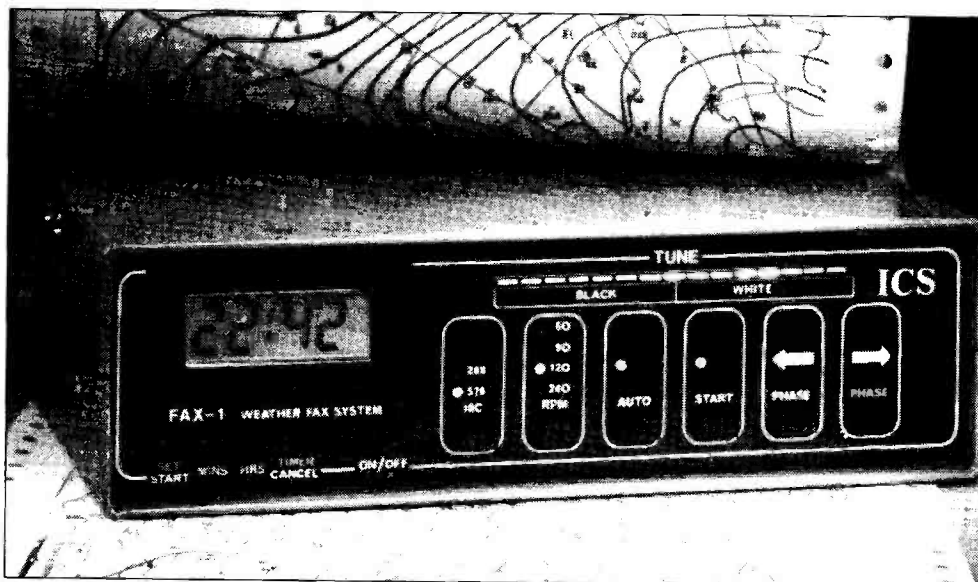

The FAX-1 is an economical means of obtaining high quality weather maps from an HF SSB receiver and a computer printer. Simply plugs into the loudspeaker output socket of the receiver and feeds any Epson compatible 9 or 24 pin printer. Automatic operation with built in timer and manual override. Prints press pictures, weather maps and radio amateur transmissions from around the world. Also receives RTTY and Navtex text transmissions. Superb image quality from a proven product that is widely used by professional weather forecasters.

FAX-1: £299.95 Post and packing: £6.00

FAX-1 with computer printer, leads and power supply (FaxPack): £449.95. Post and packing: £10.00

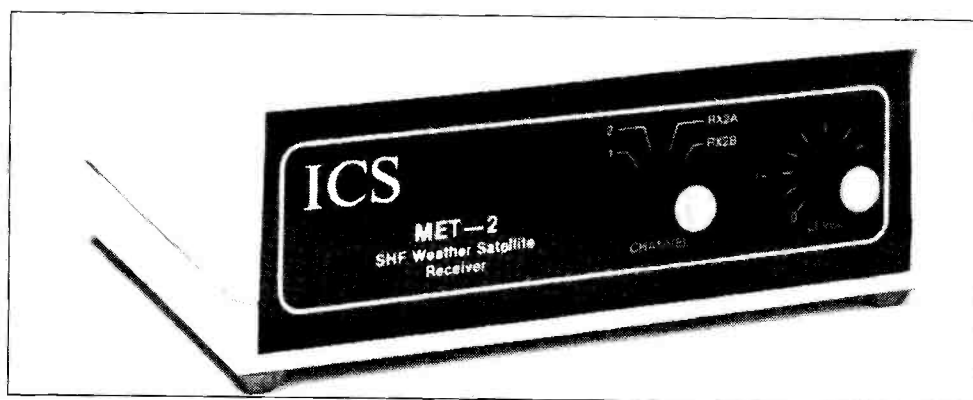

The MET-2 gives superb live cloud cover pictures on any IBM-PC compatible computer direct from the geostationary Meteosat satellite. Covers all of Europe, Middle East, Africa, as well as North and South America. Automatic animation of sequential pictures. Zoom. False colours. Stores and displays the full resolution of the satellite. Everything provided from the antenna to the software. All you need is a PC - preferably with a VGA monitor and a 286 processor or better. Can be extended to receive pictures from the low earth orbiting NOAA satellites with our optional antenna and receiver package. Send for free colour brochure.

MET-2: £822.44. Post and packing: £10.00

NOAA receiver, antenna and software: £340.69. Post and packing: £10.00

Prices include VAT at 17.5%.

Send for free Catalogue.

Office hours, 09.00 to 12.30, 13.30 to 17.30. Callers by appointment. Available direct or from our dealers.

**ICS Electronics Ltd. Unit V, Rudford Industrial Estate, Ford, Arundel, West Sussex BN18 0BD.
Telephone: 0903 731101 Facsimile: 0903 731105**

NEVADA...EVERYTHING!

UK's Largest Distributor of Scanning Receivers

YUPITERU

MVT 125 UK AIRBAND RECEIVER

A new and powerful pocket size air band radio that leaves the competition standing. Covers all the new UK airband frequency allocations

- Covers 108-142 MHz
- 30 direct entry memories
- Search, scan and keyboard operation
- Search steps 25, 50, 100 kHz
- Very sensitive receiver
- Pass and delay functions
- Supplied with UK charger

£149 NEW LOW PRICE



MVT 7000 HANDHELD

The latest in a family of Three..!

- Frequency Coverage From 8 to 1300MHz... (100kHz - 1300MHz at reduced sensitivity)
- 200 Memory channels
- Rotary or Keypad Frequency Control
- AM/FM Narrow & Wide FM Modes
- Large Easy Read Display with Signal meter.

£289

Every set comes complete with:- Full set of high power ni-cads, telescopic antenna, 240Vac mains charger, DC power lead and carry strap.

Just Arrived! MVT 8000

The new Yupiteru MVT 8000 base/mobile wideband receiver. Covers: 8-1300MHz continuous. 200 memory channels with ultra sensitive receiver. Set is supplied with mains power unit.

£299



MVT 6000

Base/mobile scanner
 • 25-550, 800-1300 MHz.
 • 100 memory very sensitive receiver
NEW LOW PRICE.....£279

SCANNER ACCESSORIES

LOW NOISE PRE-AMP

These new Pre-Amplifiers are a must for the scanner enthusiast and will allow reception of signals that were inaudible without them.

MODEL M75

For base and handheld scanners

- 25-2100 MHz.
- Low noise GaAs FET.
- Selectable filters for improved performance.
- Variable Gain Control. **£69.95**

MODEL M100

Same spec as M75 but with full RF switching, may be used with transceivers on transmit up to 5 watt o/p power. **£79.95**

MODEL M50

A new low cost pre-amp without filters or gain control. Offers low noise GaAs FET at 20 dB fixed gain. **£49.95**

DIAMOND D707 ACTIVE ANTENNA

(500kHz - 1500MHz) A base antenna with 20dB pre-amp. Approx 3.5ft fibreglass with mounting kit... **£99.00**
 D505 mobile version..... **£69.00**



MASTHEAD ANTENNA SWITCH

Select 2 antennas at the masthead remotely from one cable. Frequency- DC to 1.3GHz
 Connectors:- N Type
£49.95



FAIRMATE

As the UK distributor for Fairmate we are constantly working with them to update and produce new features and models.

FAIRMATE HP2000

- Continuous Freq. Coverage from 100kHz to 1300MHz
- 1000 Channels of memory
- Keypad or rotary control
- AM, FM and Wide FM Modes
- Search steps from 5kHz to 995kHz

EVERY SET COMES COMPLETE WITH:-

Full set of high power ni-cads. 2 antennas. carrying case. earphone. DC cable. belt clip. strap & charger. **£269**

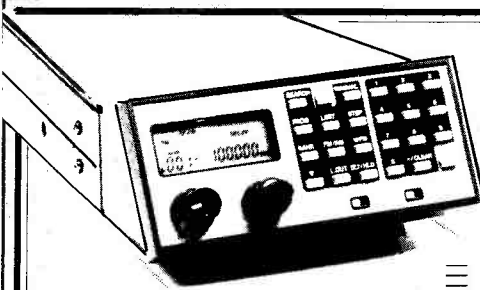

NEVADA MS1000

Modes:- AM FM WFM.
 Freq Range:- 500kHz - 600MHz, 805MHz - 1300MHz.
 ■ Switchable Audio Squelch
 ■ Tape Recorder Output Socket
 ■ Auto Signal Operated Tape Recorder Switching
 ■ All metal case for improved EMC compatibility

ALL THIS AND MORE FOR JUST **£279**

BEARCAT 200XLT

BACK BY POPULAR DEMAND!
 Yes this has been our most popular scanner over the years, its easy to use, reliable with a Sensitive Receiver.
 • 200 Memories • 66 - 88MHz, 118 - 174, 406 - 512, 806 - 956MHz
 (INCLUDING CHARGER/DELIVERY) **£229**

BEARCAT 760XLT

A mobile/base version of the popular 200XLT h/held, but with 100 memories supplied c/w AC adaptor for home use.

£235



COMMUNICATION RECEIVERS

HF225 SHORTWAVE RECEIVER

Covers 30kHz to 30MHz
 Receives all modes (FM optional) **£425**

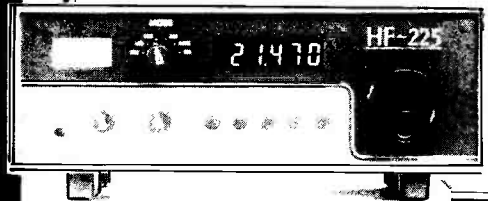

AR3000

Top of the range desk scanner. 100kHz to 2036 MHz with no gains
 PLEASE NOTE This is NOT a cheap grey import model and has the full service backup of AOR (UK) Ltd.

£765

AR 2002 NOW ONLY **£399** INCLUDING FREE DELIVERY

The PSU 101 MK4 allows convenient use of any Handheld scanner at home. It will both charge and power your scanner from the mains whilst providing a convenient desktop stand. Suitable for many models including:- Fairmate HP100, HP200, HP2000, AOR 1000 2000, Yupiteru MVT 7000, MVT5000, Uniden 50XL, 70XLT, 200XLT etc.

£29.50

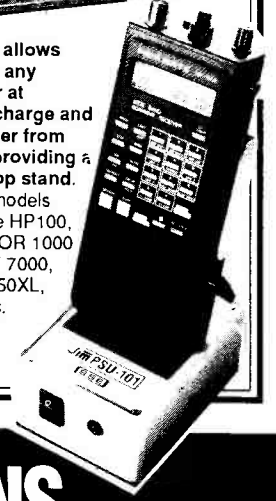

NEVADA COMMUNICATIONS

189 London Road, North End, Portsmouth PO2 9AE

FOR THE RADIO ENTHUSIAST

SONY RADIOS

We stock the complete range of Sony shortwave products - Here is a selection of the popular models.

ICF 200ID

Full coverage shortwave, VHF and airband radio. (150kHz-136MHz). Receives AM, FM, SSB. **£299.95**

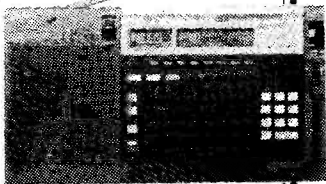

SW 77

SW77 multiband receiver (with VHF) covers 150kHz to 30.00MHz plus 76-108MHz.

- FEATURES**
- Rotary Tuning Dial
 - Upper/lower sideband reception
 - Scan tuning
 - 125 memories

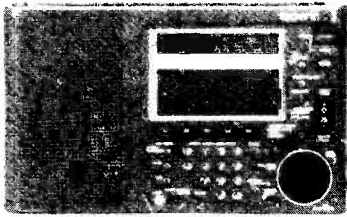

NEW MODEL SW77 £349

- ICF SWIE Pocket SW plus VHF radio £149
- AIR 7 Very sensitive airband H/held radio £229
- PRO 80 Shortwave/VHF H/held radio £299
- AN 1A external active antenna with built-in pre-amp covers. (150kHz-30MHz)..... £57.95
- SW 7600 A new pocket shortwave radio covering:- 150kHz-30MHz AM/SSB 76kHz - 108MHz FM £149

NEW RADIO FROM **DRAKE**

R8E COMMUNICATIONS RECEIVER

Drake has been America's No 1 name for communications since 1943. The new DRAKE R8E Communications Receiver goes beyond ordinary shortwave receivers - to give you the only receiver you will ever need to own!

The R8E has been designed as a "complete package". In fact the only peripherals you may want to add are a VHF converter and an external speaker. With the DRAKE R8E you get all this as standard equipment:-

- Wide frequency coverage:- 100 kHz - 30MHz (with optional VHF converter):- 35 - 55 MHz & 108 - 174 MHz

- Multi mode reception:- AM, FM, RTTY, CW, USB, LSB
- Five built-in filter bands widths 6/4/2.3/1.8/0.5 kHz
- Synchronous detector - for improved AM reception
- Non volatile memory
- RS 232C serial interface - for computer control
- Multiple scan functions
- 100 channel memory capacity
- Two operating VFOs
- Built in pre-amp & attenuator
- Timer function
- Dual time zone built in clock
- Dual mode noise blanker
- Pass band offset
- Selectable AGC
- Dual antenna inputs

Great Value!!

£965

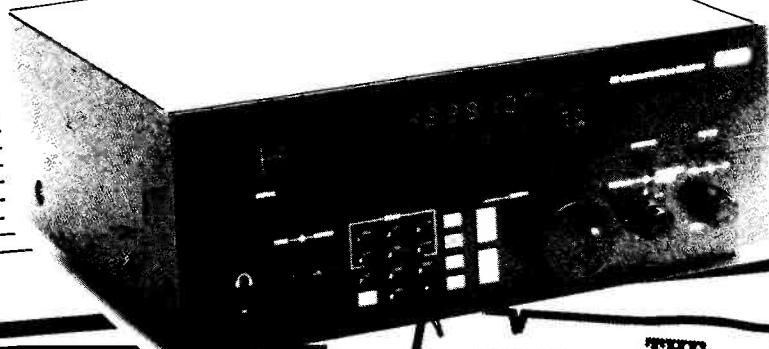

Steepletone Specialist Radios

MBR7 Multi Band 'Jumbo' Radio

Covers MW, LW, SW (2.3 - 22 MHz)
FM (88 - 108MHz)
Airband (108 - 136 MHz)
Marine Band (136 - 176 MHz)
Mains or Battery Operation.
.....**£59.95**

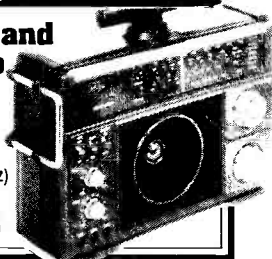

New Scanner! ALINCO DJ-XI

- 500 kHz - 1300MHz • 3 scanning speeds
 - 100 memories channels
 - AM/FM/WIDE FM • Rotary freq. control
- PLEASE NOTE - Alinco do not include batteries and charger at this price.
Full set of 6 high powered 700mA-H ni-cads.....£11.40
Alinco Charger£18.95

£269

IN STOCK NOW!

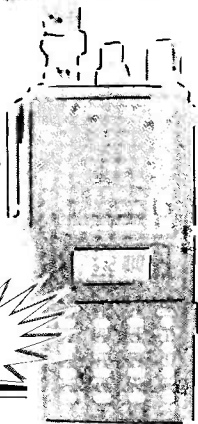

BOOKS

- Air Traffic Radio (1991 Edition) £3.95
- VHF/UHF Frequency Guide £5.95
- Flight Routings Guide 1991 £4.95
- Scanners 11 (P.Rouse) £7.95
- Scanners 3rd Edition £8.95
- Marine Frequency Guide £4.95

THE TRADING POST

We have a large selection of used equipment which is constantly changing. Here is a selection - but call to check availability before ordering

- Sony 2001 portable receiver.....avg.cond. 190.00
- Lowr SRX30 gen cov. receiveravg.cond 145.00
- AOR 2001 desk topper...25 to 550Mhz....boxed. 195.00
- Sony Air7 Portable airband and VHF 175.00
- Sony PRO80 H/held shortwave and vhf receiver 225.00
- Bearcat 200XLT.....boxed c/w 900Mhz 160.00
- SX200 16ch. base scanner am/fm switchable 125.00
- Fairmate HP100E, 1000mems to 1300Mhz, 500.00
- AOR 950 Desktop scanner boxed as brand new 175.00
- Fairmate HP200E...clean as new...V.G.C 195.00
- Yaesu FT767 GX c/w SP767.....V.G.C..... 1325.00
- MARC II receiver s/wave, VHF, UHF & above! . 225.00
- Trio TR2300 2m Port-A-Pac 125.00
- Realistic PRO 30 10ch. h/held scanner 100.00
- Realistic Pro 2006 Base Scanner 245.00
- Kenpro KT22 2m H/helds, shopsoiled..110.00
- CT1600 C/With BS25 Docking booster150.00

icom

We are one of the leading ICOM stockists carrying the full range of Receivers and Antenna Radio equipment. For help or information call Paul Martin our ICOM Specialist Now!

IC R7100

Covers 25 - 2000 MHz with all mode capability. Includes 900 memory channels with 5 different scan functions. Automatic record function.**£ CALL**

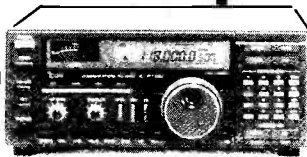

IC R72

Covers kHz - 30 MHz all modes (FM Optional). 99 memory channels and 10 dB pre-amp fitted as standard.**£663**

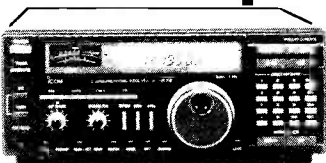

IC R 7000

Icons most popular communications receiver covers 25MHz to 2 GHz with 99 memories and all mode reception...**£ CALL**

IC RI

Pocket size Wideband handheld scanner covers 150 kHz to 1300 MHz with 100 memories.**NEW LOW PRICE...£ 359**

- IC-R1 Scanning Rx (New Low Price) £359
- IC-W2 New Dual Bander Nicad/chrgr £395
- IC-2SRE New 2m H/Held + wideband Rx £425
- IC-4SRE New 70cm H/held + wideband Rx £445
- IC-4SE 70 cms FM H/Held £295
- IC-4SE/T 70 cms Keypad DTMF £299
- IC-2SE 2 mtr H/held Nicad/chrgr £275
- IC-2SE/T 2 mtr H/Held Keypad DTMF £295
- IC-24E/T Dual Band H/Held £385

FAST MAIL ORDER
All orders received before 4pm despatched same day.

USE YOUR CREDIT

HOTLINE 0705 662145

FAX 0705 600626

The LongWave

The Long Wave Band is the oldest, most neglected, unpredictable yet fascinating, something different. Richard Q Marris describes his 'LongWave'

There is a lot of worldwide long wave activity, including a.m. broadcast stations in Europe, North Africa, the near East and Asian USSR, worldwide navigational beacons and information stations. There is also the USA low power 1750m amateur band - unlikely to be received in the UK except under freak

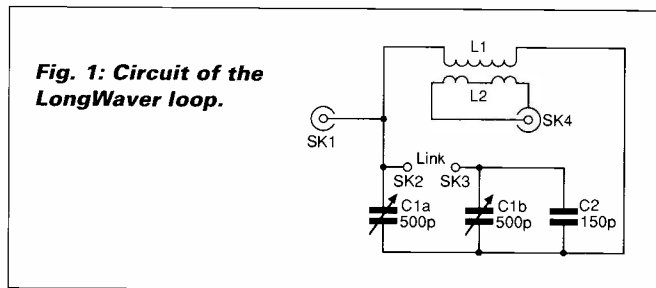

Fig. 1: Circuit of the LongWave loop.

conditions, as well as some c.w. and weird stations!

The long wave broadcast band covers from 150kHz (2000m) to 300kHz (1000m) - but, in fact, broadcast stations have been occasionally heard up to about 375kHz (800m) and may be low power Russian relay stations in Asia. On occasion an unidentified broadcast station has been heard just l.f. of 150kHz (2000m).

To get the best l.w. reception results, without using a large outdoor antenna you need a loop antenna. The trouble with l.w. loops is that few published designs exist and they need three to four times as much wire as their m.w. counterparts. This means that they are usually massive things for indoor use, and yet this is not necessary. A good l.w. loop is much more 'pick-up' efficient than a m.w. loop of similar size. It also has to be more robust because of the volume and weight of wire.

Convenient Size

The 'LongWave' has an overall width of 610mm and is 838mm high; this being the maximum convenient size to fit the available operating and storage space. It is resonated with a single control knob, and a pre-amplifier is unnecessary with my receivers. When serious listening is required it is stood on a turntable alongside the receiver. In appearance it is domestically acceptable, being neat, with all wooden parts teak stained and polished and components hidden away. The frequency range is approximately 525kHz (571m) to 146kHz (2050m), with facilities to extend well below this frequency.

Description

The circuit is shown in Fig.1. It consists of the Loop L1,

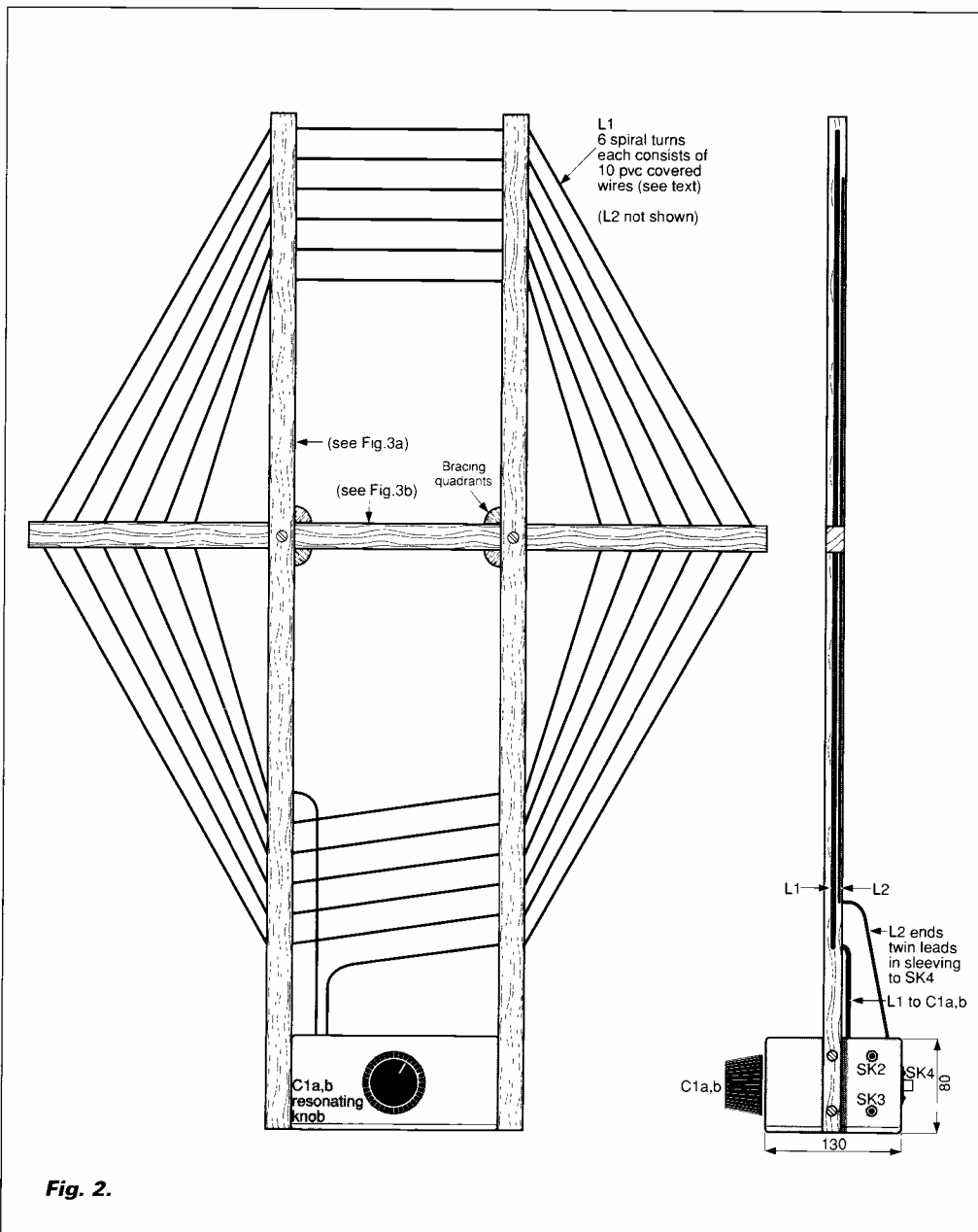

Fig. 2.

r Loop Antenna

band. There is, however, an increasing interest by enthusiastic listeners looking for a 'compact' loop, which gives excellent reception and nulling.

resonated by C1a and coupled to the receiver with L2 via a coaxial feeder. In this form it covers the above frequency range. Inserting a link into SK2/SK3 brings in C1b, plus C2, in parallel with C1a and extends the range down to approximately 100kHz. Alternative values of C2 can be substituted to extend the range even lower. The loop can also be used as a useful end-fed antenna on the h.f. bands, by using SK1. Variable capacitor C1 is a 2-gang x 500pF per section air-spaced variable capacitor and C2 is 150pF.

The loop (L1) is of unusual configuration, consisting of 60 turns of thin pvc covered wire, wound in a 6-turn spiral group, with each group consisting of 10 pile wound turns. Coupling coil (L2) is also unusual being 4 turns wound as 2 pairs in series. The framework structure is three stout wooden arms, each stained with teak wood dye and wax polished, screwed onto a plastics box into which C1 is mounted together with C2 and SK1-4.

Construction

Two vertical arms each 838mm long (21mm x 15mm section) are bolted to the specified black abs plastics box, with the lid at the bottom. A horizontal arm is fitted, with cut joints and braced with corner pieces as shown. The handyman could substitute a strong well constructed wooden box for the plastics box specified.

Holes are drilled in both horizontal and vertical arms as shown. Holes 1-6 must be drilled with a sharp 6.3mm diameter twist drill, and slightly countersunk each side. These are used for L1. Holes 7 and 8, for L2, are drilled with a 1.5mm diameter drill. The wood is then stained and

polished. The drill sizes given are important. Capacitor C1 and SK1-4 are mounted as shown.

Winding the Loop

Having assembled the structure, the winding of L2 should proceed using single strand 1/0.6mm pvc covered

wire. The colour of the pvc insulation could be chosen to match the decor of your shack!

The winding starts as hole 1, on the bottom of the left hand vertical arm and proceeds clockwise. A long-lead-out is taken through a small hole drilled in the plastics box and connected to C1a.

Ten complete turns are wound through the outer set of holes, with the tenth turn 'dropping down' one hole as it passes between the bottom of the two verticals. This is repeated for the second set of holes. When the winding is complete, at the bottom of the right hand vertical (hole 6), the wire end is taken through a hole in the box, to C1a.

In practice it was found that there is a limit to the number of turns which can be easily wound/threaded through the holes with a single length of wire. So L1 is wound five turns at a time. Five lengths of wire, each long enough to form one complete turn, are placed together and threaded through the outer holes in each arm. One length of wire is longer than the other four so as to be able to form the start of the complete winding. The next five turns are wound and four of them soldered to four of the previous five turns in the bottom space between the two uprights, pieces of heat shrink sleeve being put over each soldered joint. The fifth wire end is soldered to the start of the next set of five wires. This procedure is repeated until all sixty turns are wound and you have just the start and finish leads free.

Coupling Coil

The coupling coil L2 is wound through holes 7 and 8. Two wires are wound through each hole (7 and 8) giving 4 turns total, terminated in a 'T' at the middle bottom, with a length of heat shrink sleeving pushed up to tighten the turns. The wire ends, in the sleeving, are pushed through a hole drilled in the rear back of the box top, and connected to SK4. A short length of RG58 coaxial cable is taken to the receiver, with appropriate coaxial plugs at either end.

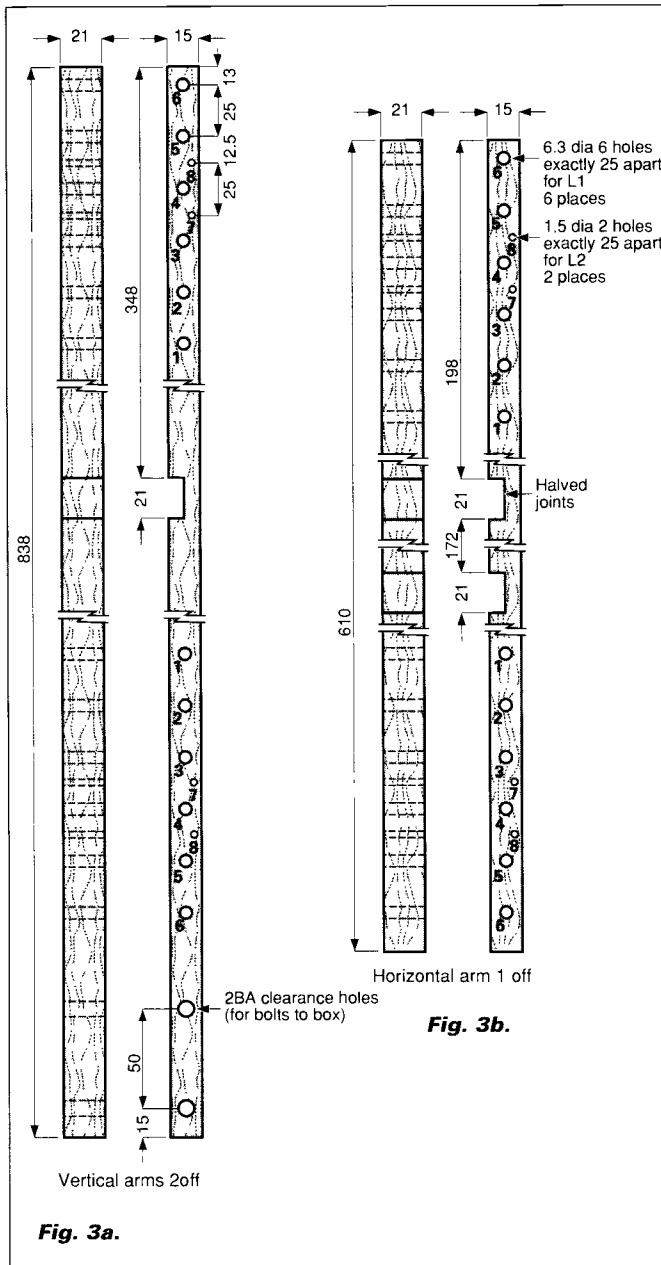

GAREX ELECTRONICS

WIDEBAND SCANNERS

All major brands available with the all-important service back-up. AOR: BLACK JAGUAR: JIL REVCO: ICOM: YUPITERU. Also good stock of secondhand sets. Ask for list.
 "SCANMASTER" Scanner Controller, versions for AOR2002, REGENCY MX8000, ICOM ICR7000, YAESU FRG9600. Built-in software expands the scanner to over 700 memories, with automatic logging and a host of features. Operates with a dumb terminal or any computer in terminal mode £153.25

WIDEBAND ANTENNAS

"REVCO" premium quality British VHF/UHF Discone (guaranteed free from exaggerated advertising claims!) SO239 connector £37.75
 N-type connector for improved UHF performance £39.80
 Optional vertical whip feature for experimenters
 "RADAC" nest of dipoles: imitated but not equalled. Guaranteed Tx capability over customer specified 6 bands in the range 27-470MHz, with excellent wideband Rx performance
 SO239 conn: £86.85 N-type £88.89
 Special VHF/UHF Airband RADAC 108-136MHz and 220-400MHz £80.75
 Top quality cable and connectors also available

WIDEBAND PRE AMPLIFIERS

NEW GAREX GA-4 SERIES: 20MHz - 1GHz instrument grade amplifiers precision stripline construction for exceptional stability: 13dB gain at 1GHz with filter to reduce HF breakthrough problems.
 GA-4MN In-line Masthead Amplifier COMPLETE with stripline DC supply unit, requires 12v DC at 30mA, N connectors £49.50
 GA-4MS, as above, but PL SO connectors, (reduced performance) £48.50
 "Local-use" versions, small die-cast box package, for 12v DC operation.
 GA-4B (BNC sockets): £35.75. GA-4S (SO239): £35.75. GA-4N (N sockets) £39.85.
 Mains adaptor for use with any of the above preamps: £8.95
 DC Supply Block: a precision stripline device for powering masthead amplifiers via the co-ax, suitable for 20MHz - 2GHz with VSWR better than 1.3:1, insertion loss less than 0.5dB. N sockets £25.35
 Also with SO239 sockets (reduced performance) £25.35

MOBILE ANTENNAS

REVCO super Mag-mount + 5/8 for 2m £35.75
 Mag-mount + 4.5dB for 70cm £35.75
 Body-mount 1/2" or 3/8" hole (state which) + 5/8 for 2m £20.35
 3/8" hole mount + 70cm coilinear (4.5dB) £20.35
 Mag-mount with 3dB 900MHz whip: improve the performance of your cell-phone or 900MHz scanner, in the car or on the office filing cabinet. £35.75
 REVCO unbeatable glassmounts, with tuned matching units for peak efficiency 2m or 70cm standard model: £40.95. Deluxe hinged whip models: £47.95. All with 4m feeder. Plugs on request.

Write, phone or fax for lists. Regular lines, components and bargains for callers. Open 10am - 5pm Mon - Fri (occasional Sats).

ALL PRICES INCLUDE UK CARRIAGE AND VAT AT 17.5%



STATION YARD, SOUTH BRENT, SOUTH DEVON TQ10 9AL

Phone: (0364) 72770 Fax: (0364) 72007

THE IDEAL CHRISTMAS PRESENT JUNGHANS RADIO CONTROLLED CLOCKS AND WATCHES

Just Arrived

Analogue Radio Controlled Wrist Watch from £299

Digital Wrist Watch still available from £149

DIGITAL CLOCKS

Digital Alarm Clock, black or white £46.50

MANTLE CLOCKS

Large face, available in white, black and grey £67.50

CARRIAGE CLOCKS

Solid brass case 18 x 18cm £149.00

WALL CLOCKS

Large white, 32cm diameter £67.50

Coloured Kitchen Clocks, 22cm diameter £69.00

Solid wood case, 26.5cm diameter from £99.00

This is just a small selection of the models available.

Send a large SAE for full details

All our clock prices include post and package

Prices subject to change. Prices shown include VAT.

AMDAT

4 Northville Road, Northville
BRISTOL BS7 0RG
0272 699352

CREDIT AVAILABLE



REALISTIC SCANNERS

PRO 2006 ONLY £249.95 (list £329.95)
 400Ch. AM/FM 25-520, 760 -1300 MHz 240/12v

PRO 2022 ONLY £159.95 (list £199.95)
 200Ch. 68-88, 107-174, 380-512, 860-960 MHz

We stock ALL Realistic scanners. AOR s now in stock. P/X welcome

All scanners include FREE p&p in the UK. 12 months warranty

GoCVZ **Link Electronics** G6YTI
 (Authorised Tandy Dealer)

228 Lincoln Road, Peterborough PE1 2NE (0733-345731) SAE for leaflet.
 Phone for latest on secondhand bargains.

ALL VALVES & TRANSISTORS

Phone for a most courteous quotation

081-743 0899

We are one of the largest stockists of valves etc, in the U.K.

COLOMOR (ELECTRONICS) LTD. 170 GOLDHAWK ROAD LONDON W12 8HJ

SCANNER OWNERS

Listen in when you are 'out' with the amazing AUTO-VOX

Connect to any receiver with a squelch control and the AUTO-VOX will automatically switch your tape recorder on and off as signals are detected. A MUST for all scanner owners.

Return to a neatly compressed tape of all the action

The AUTO-VOX may be fitted directly into larger scanners or recorders, taking its power from the rig itself, or housed separately in the free project box supplied.

Supplied as a kit with all parts and instructions or ready built and tested.

KIT £12.50 AUTO-VOX BUILT £25.00

Turbo-Charge your scanner with a little help from RADIO RESEARCH

AR 1000/2000 - FAIRMATE HP100/200 - Full coverage modification. 0.5-1300MHz.

Upgrades your rig with NO GAPS - Why pay more? £5.00

Customising Packs for REALISTIC PRO-2004, 2005, 2006 & 2022.

Full of useful mods for your set. (State pack required)..... £5.00

S-Meter Driver for REALISTIC PRO-2004, 2005, 2006 £17.50

400 Channel Upgrade for REALISTIC PRO-2004 with Super-Scan rate..... £5.00

Send a SAE for full details and prices of all our scanner upgrades

RADIO RESEARCH (SWM) 3 Pasture Close, Whitmore, Staffs. ST5 5DQ

HIGH POWER TRANSMITTER VALVES

Klystrons, Magnetrons, 4CX350A, 4CCX1000A, 4CX250B QY3-125, QY4-250, etc. One million valves in stock. Phone or fax for quote, discounts for large value inquiries. Orders from manufacturers, Govt Depts., overseas etc. welcome. **WANTED VALVES** EG. KT66, KT88, PX4, PX25, Klystrons, Magnetrons, Transistors, ICs. If possible send written list - we reply same day. Cash waiting. **SPECIAL OFFERS** - 572B Valve foreign but tested, perfect (Brand is B.E.) £30 + VAT P&P paid. Socket for 4cx250B with chimney. Used but perfect @ £20 + VAT P&P paid. 4CX250B ITT used but tested OK £20 + VAT P&P paid

BILLINGTON EXPORT, Oakendene Industrial Estate, Near Horsham RH13 8AZ. Callers by appointment only. Tel: (0403) 865105 FAX: (0403) 865106. Minimum order £50 (UK/export) + VAT.

RADIO STAND

Convert your Sony 2001D, your new Sony ICF-SW77 + Sangean and derivatives into A SECURE TABLE MODEL with the "ROOKE" RADIO STAND.

Please send cheque or P.O. for £15 (inc. £2 P&P) to:

M.S. ROOKE, 5 River Close, Formby, L37 6DJ

G2VF LOOP ANTENNAS WITH ATU FOR HF HAM BAND TRANSMISSION (SWR One to One 40, 15 and 10 One Point Five to One 80 and 20) **AND SWLS LONG AND MEDIUM WAVE FOR BCLs.** Loops 21 inches square or triangle. No special skills required. Circuits, Parts Lists sources of supply assembly data. HIGH FREQUENCY LOOP 80 to 10 Metres £5. LONG AND MEDIUM WAVE LOOP FOR BCLs £3. LONG MEDIUM SHORT WAVE LOOP 1500 to 10 METRES FOR BCL SWL £8. SHORT WAVE ATU LOOP OR LONG WIRE £4. PRE AMP LW MW S WAVE £2. PHOTOCOPY HRO MANUAL £4. MW LOOP WITH PRE AMP ATU £3. PRE AMP FOR G2VF HF LOOP OR ATU £4. SHORT WAVE ATU BUILT-IN PRE AMP FOR LOOP OR LONG WIRE £7. SAE details. All projects D.I.Y. METAL DETECTOR £2. **F. G. Rylands, 39 Parkside Avenue, Millbrook, Southampton SO1 9AF. Tel: (0703) 775064.**

Project

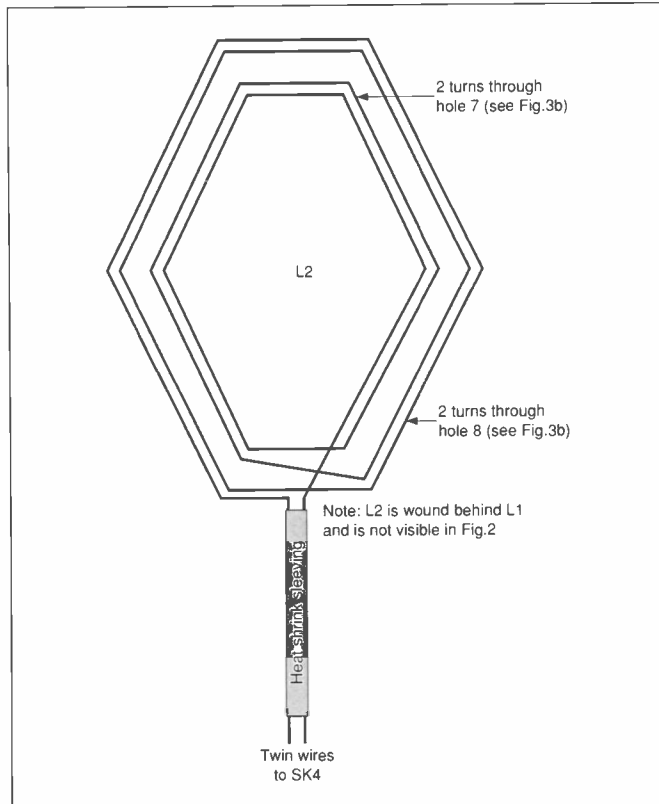

Testing

It is essential that the long wave receiver used is not be fitted with an internal ferrite rod or frame antenna, even if it is fitted with an external antenna socket. The reason being that the polar diagrams of the LongWaver and the receiver's built-in antenna, will not coincide. It is also an advantage to have the a.v.c. ON/OFF switch on the receiver.

Nulling may be difficult or impossible on the odd high power a.m. broadcast station, such as BBC Radio 4, because local relays may be used in some areas, to boost the signal; and the bearing of the relay station and parent station will be different. However the 'LongWaver' is not intended for local high power station use.

The LongWaver, without the 'LINK', covers approximately 525kHz (571m) to 146kHz (2050m) which is more than enough for many receivers. The range can be extended to about 100kHz (3000m) with insertion of a

shorting link into SK2 & 3. Experiment with higher values of C2, presently 150pF, will lower the frequency way down further.

It will be found that with the spiral style configuration loop used, the 'signal pick-up' can be quite dramatic, and stations can be received, with a good receiver, which are just not there with a goodish transistor radio with built-in ferrite antenna. Some of the older ex-military or marine, all-valve, communications receivers have much more extensive frequency ranges than the modern l.w. receiver, and they can be purchased at quite a reasonable price. Most have high r.f. gain, with one or two r.f. amplifier stages; plus r.f.o. and a.v.c. ON/OFF switches. They are ideal for serious l.w. and l.f. listening, or for experimental work with antennas.

The LongWaver can also be used as quite an effective non-tunable end-fed all-wave antenna by connecting the receiver to SK1. Adjusting C1 will only have a minimal effect, in this case. ■

YOU WILL NEED

ABS Plastics box 215x130x85mm (Circuit 21-06043); C1, 2 x 500pF ganged variable air-spaced capacitor (J Birkett); C2 150pF ceramic or silver mica capacitor (see text); Single strand 1/0.6mm pvc covered wire (o/d 1.2mm). (Marco Trading CBL/EW1/Orange); Wood 21x15mm, 2 pieces 838mm long and 1 piece 610mm long; Coaxial Sockets (2); Banana Sockets (2); Banana plugs (2); RG58 Coaxial cable fitted with coaxial plugs; Knob; 2BA nuts, bolts & washers (4); Heat shrink sleeving.

Component Suppliers

J. Birkett, 25 The Strait, Lincoln LN2 1JF. Tel: (0522) 520767.

Circuit, Park Lane, Broxbourne, Herts EN10 7NQ. Tel: (0992) 444111.

Marco Trading, The Maltings, High Street, Wem, Shrewsbury SY4 5EN. Tel: (0939) 32763.

**Be sure of getting your copy of SWM each month.
Place this regular order form with your
newsagent... today**

Dear Newsagent, Distributed by Seymour
please reserve / deliver my monthly
copy of SHORT WAVE MAGAZINE

NAME

ADDRESS

.....

Signed

**If you can't see SWM on the
bookshelf at your local outlet,
please call the Editorial Office in
Poole and we will talk to our
distributors to find out why!**

YESTERDAY'S SPY

The 128 Set was never made in great numbers, so don't be surprised if you have never heard of it - although you may have seen one! Richard Burton used one to call his HQ in the Alistair McClean thriller film Where Eagles Dare. June Stirrat takes a look at this intriguing piece of history.

World War Two gave birth to special military operations as we know them today. Airborne landings, commando raids and clandestine work by the then British SOE and United States' OSS.

Mass-produced, military radio equipment was of little use to these units. The 38 Set was an infantry field telephone with a radio range of about 2km. The famous 19 and 22 Sets were an absolute penance to use without a vehicle to carry them in. The set, lead acid battery and pedal generator had to be split between three personnel.

Clandestine service sets, such as the B2 'Polish Suitcase' radio ran 15 to 25W of r.f. This amount of power from a valved set entailed using mains supplies or generators and many readers will be familiar with the 'flickering lights' theme of many thriller films.

A set for special 'marching' operations had to be as light-weight as possible - personnel had many other things to carry. It also had to operate from modest dry batteries for sustained periods and satisfy both short and long range communication needs.

The remarkable 128 Set did this. Remarkable? Yes - in its sheer simplicity.

Biscuit Tin

The overall size of the 128 transmitter and receiver put together is about the same as an old-fashioned biscuit tin. The prototype was probably built in one. That's the way

things were done in those days.

The transmitter and receiver are built into separate light steel boxes, each 210 x 120 x 110mm deep. The receiver sits above the transmitter in a custom-made square haversack, power cable and antenna patch cord linking the circuits.

There are two large pockets on the sides of the haversack. One of these held the dry cells, the other carried headphones, Morse key, long wire antenna and copper earth spike. A flat pocket on the haversack flap held message pads and pencils and a couple of small pockets were sewn on the

inside to hold quartz crystals for the transmitter. Traces of wax on the haversack suggest operation by candle light. The haversack could be carried like a briefcase or slung on belt, back or chest with webbing attachments.

Transmitter and receiver each have two switched bands, 2-4MHz and 4-8MHz. This was the standard military 'short wave' band of the day. The 128 Set is a 'short wave radio' in the truest sense of popular imagination.

The receiver dial is calibrated every 100kHz and tuned through a 10:1 friction drive. The tuning knob also provides a 0-100 logging scale so the dial can be re-set with accuracy. The other receiver controls are very basic - a.f. gain, b.f.o. on/off and b.f.o. tune.

Crystal Controlled

The transmitter is crystal-controlled with a panel meter, variable capacitor and switch-tapped coil tuning output. A push button brings in the crystal oscillator to 'net' the receiver, although the set can work on 'split frequencies' and probably did from time to time. The on/off switch is unusual. A rotary wafer switch with nine positions: OFF, RX, TX1, spare, spare, spare, TX2, RX, OFF. The set is powered by separate h.t. and l.t. supplies - h.t. 135V at 8mA, l.t. 1.5V at 150mA. Dry cells are connected to the TX from which power is fed to the RX via an 8-way patch cord.

The antenna provided is a quarter wave, long wire cut to length and put up with 'stone and string'. This is loaded against an earth spike thrust

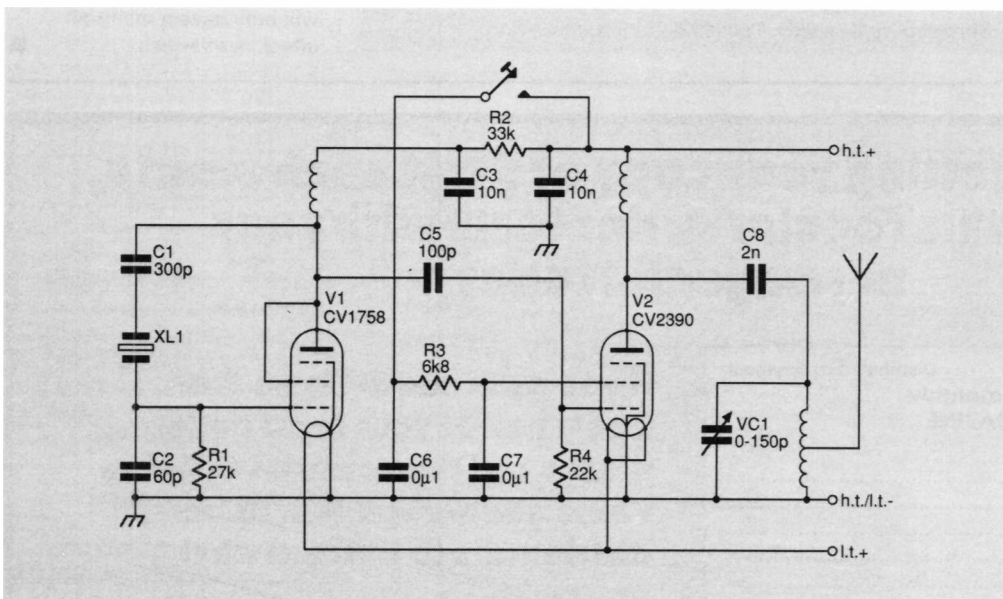

Fig. 1: Simplified circuit diagram of the 128 Set transmitter section.

SET - THE 128 SET



The 128 Set in its natural habitat.

into soft soil wetted from a water-bottle. The earth spike is only about 300mm long but, with a star-shaped cross section, it has a good surface area.

The transmitter is a simple crystal oscillator followed by a low-power amplifier. There is no side tone on send and no form of break-in keying. An interesting feature inside the transmitter is the provision of four, spare, unwired valve holders. These were used to carry spare TX valves. If the receiver was out of order, the operator could still transmit 'blind' at 'sked' times to keep HQ informed about the progress of an operation or to request an air drop.

The TX power output is less than one watt but the set has a very pleasant and distinctive tone on the air, rather similar to the sound of a wineglass. I found the c.w. tone very penetrating and unusually readable in the presence of QRM or if the transmitted signal was very weak.

The receiver is a simple superhet with five valves, one of which is the b.f.o. The receiver is not only functional but quite pleasant to listen to.

Easy to Tune

When the 128 Set was made the short wave bands were a lot less crowded than now. Even so the h.f. ends of both bands are cramped and I doubt if the receiver was ever of much use on them. By contrast, the l.f. ends of both bands are quite open and easy to tune, even in today's conditions. The 128 Set remains useful for receiving m.f. shipping and also aircraft on the 5.45MHz allocation where its s.s.b. performance is adequate.

The receiver tuning is too cramped for the set to be of anything other than novelty value on the 3.5 and 7MHz amateur bands and for any serious work the transmitter would have to be used with a better bandspread receiver.

However, the receiver does tune down to about 1.95MHz without modification. This is of limited value for calling CQ but useful enough for sked working on an amateur licence.

The 128 Set can be re-aligned to cover all of Top Band and to give better bandspread on 3.5MHz for that matter. However, this may not be worth doing on a set of this age that is more of a collector's item than anything.

The 128 Set was issued to

airborne units and others at various times. In its military role it would have provided reliable, short range c.w. links by l.f. ground wave. Despite its low power and simple receiver the 128 Set stood a good chance over 'European distances' of 240km or so when working back to high-grade receivers such as the AR88.

Low power c.w. had an obvious advantage for clandestine operations. Unless an enemy interception unit was within a kilometre or so, they might have failed to recognise the transmission as local, supposing it to come from a higher powered station further away.

The Best Secret

Some of the circumstances under which 128 Sets were actually used will probably never be known. The best secret will always be that which someone keeps to themselves. ■

First Aid

Having recently acquired a Collins TCS-12 transmitter-receiver, I discovered that the complete installation also should have a remote control unit and p.s.u. together with connecting leads. I also need four 'feet'. Has anyone got the missing items and prepared to sell? Advice on these items gratefully received.
Ian D. Wye, 113 Sweets Way, Whetstone, London N20 0NX.

I would like to thank all those people who helped me sort out a

problem I had with my FRV-7700 converter, with special thanks to GW3RJR who sent me a manual!

I now wonder if anybody can now help me with information on a Yaesu FR-101 receiver, which I have got my hands on in a sorry state. Any help would be very welcome.

Once again pass on my thanks to all those who helped me with the converter.

N. Alford, 56 Marlowe Road, Larkfield, Kent ME20 6TW.

A Short Wave Crystal Set

Crystal sets are normally associated with mediocre reception of nearby medium or long wave broadcast stations and quickly get discarded when performance is found to be marginal. This is a pity as you will be amazed at what can be heard with a short wave crystal set, such as this one described by Roger Laphorn G3XBM!

Stations thousands of kilometres away can regularly be heard with circuits whose simplicity defies belief. Take for example the circuit described here (Fig. 1). It requires a total of four components, including the earpiece!, yet pulled in stations from over thirty countries and four continents within a few hours of being built; it is capable of world-wide reception given some patience and careful listening at optimum times.

Sensitivity

Crystal sets need no batteries, deriving the power to drive the earpiece or headphones entirely from the detected signal being received at the time. The sensitivity of the circuit shown is such that the signals of about $500\mu\text{V}$ are just audible and about 1mV is needed for comfortable listening in a quiet room. This is about 1000 times (60dB) less sensitive than a modern communications receiver. This may seem a major handicap, and it is if you want to hear all that is going! However, many short wave broadcast stations now run hundreds of kilowatts and, not surprisingly, are receivable with signals strengths of over 1mV in a

50Ω receiver, i.e. audible on a crystal set.

Selectivity

The main limitation, if one is not hunting for weaker broadcast stations, is not sensitivity but selectivity. That is the ability to separate stations close together in frequency. This depends on the unloaded Q of the tuned circuit, the tightness of antenna coupling and the loading of the diode and earpiece. What is needed is the loaded Q to be just enough to ensure maximum sensitivity with acceptable selectivity.

The Circuit

The circuit couldn't be simpler and wiring it up is trivial, taking about two minutes! There are any number of ways of building the circuit, including using brass drawing pins and a piece of plywood, choc-bloc connectors or even soldering the components together. The choice of variable capacitor depends on budget, the lower cost poly-varicon capacitor, salvaged from a discarded m.w. pocket radio will have a slightly lower Q than an air-spaced component but this is unlikely to be very noticeable in

practice. The toroidal inductor used ensures a high Q can be achieved. The earpiece **must** be a high impedance crystal type - the more commonly found earpieces today are low impedance and will not work. The components specified can be obtained from Cirkit, while suitable air-spaced variable capacitors can also be obtained from J. Birkett.

Operation

With the components shown the tuning range will be from about 5.5 to 25MHz. The exact coverage will depend on the maximum and minimum capacitance, the wire diameter and ferrite permeability.

Connect an antenna, preferably about 10-20m long and as high as possible, and an earth. In my case this was just a connection to a bedroom radiator but a good outside earth should be used if possible.

Tuning across the band in the daytime it should be possible to hear between 10 and 20 stations at audible level. European broadcast stations will predominate but you will also hear some c.w. and SITOR utility transmissions between the broadcast bands, especially around 6.5-7 and 8-9MHz. In

theory, these shouldn't be detectable with an envelope detector such as a crystal set and it is probably only possible because of the cross modulation that occurs with other stations. In this way, coast radio stations have been positively identified from all over northern Europe.

With a little patience it is possible to identify the various broadcast bands from the station frequency announcements. If possible, calibrate the dial every megahertz using a signal generator. This makes station identification easier, especially of signals from utility stations.

Some of the signals received will be clear of interference but many will be fighting for dominance over others in the same band. The technique is simply to keep waiting for conditions to alter, as they frequently do, until some of the other signals become audible and identifiable. In this way it is possible to hear what might be considered remarkable DX for a set with four components. Signals from as far away as Australia, on the other side of the globe, have been identified positively this way.

Some signals received are not transmitted directly from the country of origin, but are

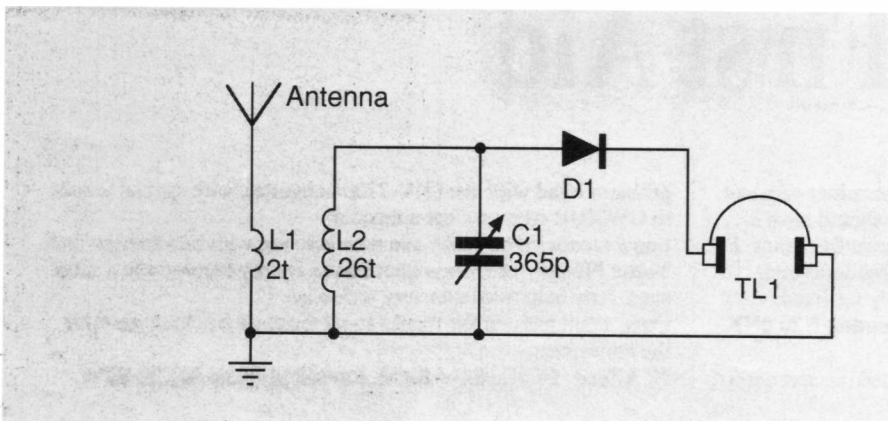

Fig. 1: The circuit diagram of the short wave crystal set.

Abbreviations

c.w.	continuous wave (Morse)
dB	decibels
DX	long distance
m	metres
m.w.	medium wave
MHz	megahertz
mm	millimetres
mV	millivolts
pF	picofarads
Q	the 'goodness' of a tuned circuit
r.f.	radio frequency
μ V	microvolts
Ω	ohms

relayed from transmitters nearer the target area. For example, Radio Japan has a relay in Gabon, West Africa and Radio Beijing has a relay in Switzerland.

The higher frequency bands will be most productive in daylight hours but may be quiet at night. After dark, concentrate on the lower frequency bands but remember that the lowest path losses are those just below the maximum usable frequency so keep and ear out just in case on the higher bands.

Improvements

There are a number of improvements possible to the short wave crystal set. These include an antenna matching unit and a full wave detector to make use of both half

cycles. However, if the most for the least is the aim then this circuit takes my prize.

One interesting idea worth pursuing is an active circuit making use of rectified r.f.

energy from all the signals apart from the one being received. I have not worked out how much power might be extractable from all the signals between 0 to 30MHz but it

would probably be a microwatt or two. This might allow a simple circuit with some amplification to be possible - and all for free.
Good crystal set DXing!

YOU WILL NEED

Variable capacitor 0 - 365pF, C1 (Cirkit 06-05250); High impedance crystal earpiece (Cirkit 43-00574); Germanium diode, D1 (Cirkit 12-00916 or 12-00476); T50-2 toroidal inductor (yellow) (Cirkit 55-00502).

Cirkit, Park Lane, Broxbourne, Herts EN10 7NQ. Tel: (0992) 444111.
J. Birkett, 25 The Strait, Lincoln LN2 1JF. Tel: (0522) 520767.

Coil Winding Details

L1: 2t wound on top of L2.

L2: 26t 0.5mm dia enamelled copper wire.

L1 & L2 are wound on a T50-2 toroidal inductor.

COMPETITION

To encourage you to build your own crystal set we have decided to run three competitions. All you have to do is build a crystal set from the circuit diagram in this article, take a photograph of it and submit a log of the stations received on it between 20 December 1991 and 20 January 1992. Each winner will receive a one year subscription to SWM.

Prizes will be awarded in the following three categories:

1. The best constructed crystal set.
2. The best log.
3. The best log from a listener under the age of 16 years.

Rules.

The best log in categories 2 & 3 will be judged on the overall quality of the entries, not merely quantity. Although QSLs are not being asked for, logs must be capable of being submitted to the stations concerned for verification in the recognised manner. The logs should contain details of each station heard including Time (UTC), frequency, SINPO rating and a detailed description of programme content. Details of the antenna used should also be given.

All logs must be signed by the entrant certifying that the stations were logged on the crystal set in the photograph.

Entries in category 3 must be countersigned by a Parent or Guardian stating the age of the entrant. Age will be taken into account in this category.

Entries in all categories must be accompanied by a photograph of the crystal set together with the Crystal Set coupon from the foot of the Contents Page of this issue.

All entries must be received at the Editorial Offices of *Short Wave Magazine* no later than 31 January 1992. The Editor's decision is final and no correspondence will be entered into regarding the competition.

propagation

by Ron Ham
Faraday, Greyfriars, Storrington, West Sussex RH20 4HE

As usual, solar observers, with their wide variety of instruments, have provided us with some first class information. For example, **Ron Livesey** (Edinburgh), using a 2.5in refractor and a 4in projection screen located 10 active areas on the sun's disc on August 22 & 25; 11 on days 19, 20 & 23 and 12 on the 17th, 18th & 20th and between 2 and 7 on the remaining days. **Cmdr Henry Hatfield** (Sevenoaks) operating his spectroheliograph, observed 3 sunspot groups, 18 filaments and 7 quiescent prominences at 1445 on September 5; 3gp, 18f & 8qp at 1138 on the 7th; 4gp, 15f, 8qp & a shallow loop prominence on the NW limb at 1025 on the 8th; 2gp, 17f, 4qp, a large 'hedgerow' q.p. on the SE limb and a medium pillar prominence on the E-limb at 1145 on the 17th and 2 double spots, 14f & 8qp at 1317 on the 22nd.

Patrick Moore (Selsey) kindly sent a drawing of the sunspots he observed at 0940 on the 9th. At his observatory in Bristol, **Ted Waring**, also projecting the sun's image, counted 22 sunspots on August 26, 20 on September 6 and 15 on the 19th. **Clive Brook** (Plymouth), with a 60mm refractor, 25mm eye piece and projection screen, located 2 sunspot groups on September 4, 5, 6, 7 and 26; 3 on days 17, 18, 20 and 22; 4 on the 8th, 9th, 10th, 21st and 25th; 5 on the 12th and 13th and 6 on the 15th. His observation times during the month varied between 0818 and 1630 depending on the amount of cloud and haze. Henry Hatfield's radio telescope recorded individual bursts of solar noise at 136MHz, on the 8th, 16th and 25th and at 1297MHz on the 8th and 25th.

Auroral and Magnetic

Ron Livesey, the auroral co-ordinator for the British Astronomical Association, received reports of auroral 'glow' overnight on August 10/11 and 11/12; 'ray bundles' on 12/13, 14/15, 18/19 and 30/31; 'active forms and light changes' on 5/6, 6/7, 12/13, 17/18, 20/21, 21/22 and 31/01 and 'coronal structures' on 30/31. In Wishaw, **Doug Smillie** heard tone-A radio signals on the 50 and/or 144MHz bands around 1645 on the 6th, 1505 on the 11th, 1115/1710 on the 12th, 1829/1913 on the 27th, 1555/1620 on the 30th and 1439/1705 on the 31st. The various magnetometers used by **Tony Hopwood** (Worcester), **Karl Lewis** (Saltash), **Ron Livesey**, **David Pettitt** (Carlisle) and **Doug Smillie**, between them, recorded most activity on August 2, 3, 4, 11, 12, 13, 14, 19, 20, 21, 22, 27 and 31.

Propagation Beacons

First, my thanks to **Gordon Foote** (Didcot), Henry Hatfield, **Ted Owen** (Maldon), **Fred Pallant** (Storrington), **Ted Waring**, **Ern Warwick** and **Ford White** (Portland) for their detailed

28MHz beacon logs from which I was able to compile the monthly chart covering the period August 26 to September 25. Henry Hatfield reports that DL01GI was 'very loud' on September 2 and 3. Ted Owen copied PT8CA on the 22nd but with the letters 'CO' on the 24th.

Judging by the number and frequency of the Australian beacons logged it seems that conditions greatly improved in that direction from the middle of September on. I see that the new Darwin beacon VK8VF is still with us and Ern Warwick tells me that he copied VK4RTL, Townsville, on 28.270MHz for the first time at 1310 on September 19. **Peter Barlow** (Wigan) uses an Icom R-72E receiver, a.t.u. and a long-wire antenna and asks about the power and upkeep of such beacons. Broadly speaking Peter, these are tiny transmitters providing a 24 hour signal from strategic sites around the world. This worthwhile international service is organised by the RSGB and the instruments are usually installed and maintained, on a voluntary basis, by dedicated radio-amateurs. Because of the scientific value of this service the sites are often provided by large organisations throughout the world such as broadcasters, military and telecommunications departments, to whom we all say a big THANK YOU.

Tropospheric

The slightly rounded atmospheric pressure readings from August 26 to

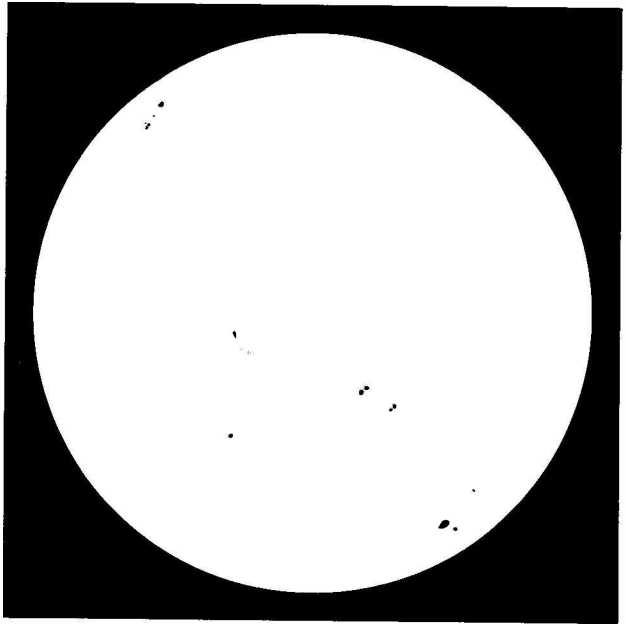

Fig. 1.

September 25 can be seen in my 'dxtv roundup' column elsewhere in this issue. Reports are still coming about that end of August opening when the weather conditions were just right for a tropospheric opening. The 30th was really 'livened up' for 14-year-old **Michael Larsson** (Cheadle) when, between 1010 and 1330 he tuned through Band II (88.75-106MHz) and received signals, both mono and stereo, from stations in Denmark and Germany and a wide variety from

England and Wales. He identified transmissions from Denmark's Radio P1 and P2; Aurich, Deutschlandfunk and Hessischer Rundfunk in Germany and his UK log of BBC and/or ILR stations specifically mentions Hull, Holme-Moss, IOM, Lancashire, Leeds Llangollen, Liverpool, Manchester, Merseyside, Moel Y Parc, Preston, Stockport, Stoke-on-Trent, Winter-Hill and Wrexham.

"Probably the best period of v.h.f. f.m. reception I have ever encountered since I first started listening 5 or 6 years ago," wrote **Leo Barr** (Sunderland) after finding Band II, 'full of foreign tongues' on the 30th. Leo, using his Matsui portable, counted more than 40 stations from Germany, Holland and Scandinavia. The opening was good enough for him to receive good stereo signals from AFN Rheinhegg, Radio Bremen and NDR-1 Aurich in Germany, NOS programme 3 from Holland and NRK programme 2 from Norway.

On August 27, **Roy Patrick** (Macclesfield) using an Audioline 415 receiver with its own telescopic rod antenna received Century Radio from Dublin and while on holiday in Caister, Norfolk, from September 7 to 14, he found Belgium's BR2 audible all week with an excellent signal on the 8th and a 'fairly good' signal from Viking Radio, Hull, on the 9th and 12th. **George Garden** (Edinburgh) while staying in Beaconsfield tuned through the broadcast band, with an elderly Philips personal stereo around 0100 on the 15th and heard BBC Radio Sussex and ILR County Sound, Chiltern Radio, Jazz FM, LBC and, a French station around 103MHz. George caught this lot while the weather was quite hot and humid at night with the prevailing high pressure keeping it settled.

Beacon	August					September																								
	26	27	28	29	30	1	2	3	4	5	6	7	8	9	10	11	12	13	14	15	16	17	18	19	20	21	22	23	24	25
DF0AAB	x																													
DL01GI	x																													
EA3JA	x																													
EA8RCM	x	x	x	x	x	x	x	x	x																					
HG5GEW																														
IY4M	x	x	x	x	x	x	x	x	x	x	x	x	x	x	x	x	x	x	x	x	x	x	x	x	x	x	x	x	x	
KC4DPC	x																													
KD4EC	x																													
KE2DI																														
KF4MS	x	x																												
KJ4X	x																													
KW7Y																														
LA5TEN	x																													
NX20																														
OK0EG	x																													
OH2TEN	x	x																												
PY2AMI																														
SK5TEN	x	x	x																											
VE2HOT																														
VE3TEN																														
VK2RSY	x																													
VK4RTL																														
VK5WI	x																													
VK6RWA																														
VK8VF																														
WA4DJS	x																													
WB4JHS																														
WC8E																														
W3VD																														
W8UR																														
W9UXO																														
ZD8HF	x	x	x	x	x	x	x	x	x	x	x	x	x	x	x	x	x	x	x	x	x	x	x	x	x	x	x	x	x	
ZL2MHF																														
ZS1LA																														
ZS5VHF																														
ZS6PW	x	x	x	x	x	x	x	x	x	x	x	x	x	x	x	x	x	x	x	x	x	x	x	x	x	x	x	x	x	
Z21ANB	x	x	x	x	x	x	x	x	x	x	x	x	x	x	x	x	x	x	x	x	x	x	x	x	x	x	x	x	x	
5B4CY	x	x	x	x	x	x	x	x	x	x	x	x	x	x	x	x	x	x	x	x	x	x	x	x	x	x	x	x	x	

Fig. 2.

ssb utility listening

Peter Rouse GU1DKD
Barcroft, Rohais de Bas, St Andrews, Guernsey, C.I.

It seems like only yesterday that I pounded the keyboard to get out the first issue of 'ssb utilities' and here we are at the end of our first year. I say 'our' because it has become as much your column as mine and over the year I have made a lot of new friends and am indebted to several readers who have gone beyond the call of duty to send in detailed information. It was nice to meet many of you personally at the Leicester Show, where the book based on this column was finally launched (you will find an advertisement elsewhere in this column should you wish to contribute to my early retirement fund!).

Most reactions to this page have been good, but there have been adverse comments occasionally and the military frequencies in the first issue attracted a lot of unwanted attention from the national media. There have also been comments about the moral aspect of listening to transmissions we are not licensed to receive.

The whole question of listening to non-broadcast communications raises several questions. On the legal front, the Department of Trade and Industry has already issued guidelines to the police in document RA/POL 3/91. It states that listening to CB, aircraft or international channel marine messages is an offence under section 5(b) (i) of the Wireless Telegraphy Act 1949 but is considered 'relatively harmless'. So what about the moral aspect? It has been put to me more than once, that the most interesting communications I come across concern disasters, warfare or similar situations and surely it is wrong that I should derive entertainment from such incidents. My answer is simple. I am not entertained by such events. On the contrary, my ability to hear a situation first hand has given me a compassion and understanding that I would never have got from the media reports.

The Tragedy of Yugoslavia

All of this leads to a letter from **Geoff Searle** of Southampton who picked up tragic messages from Dubrovnic Radio on October 1 on 2.182MHz at 1130UTC. The first warned ships and craft to stay clear of Dubrovnic because it was under attack from the Serbian navy. The second message said Dubrovnic was under attack from the air by the Serbian Air Force and on land by the Serbian Army. It urged any listeners to call their ministers and try and stop the war in Croatia. The operator went on to say that communication lines were cut and they could not connect with other towns or countries. Ironically, both messages were preceded by 'Pan-Pan, Pan-Pan, Pan-Pan' which strictly speaking means an urgent message but no lives are in immediate danger.

Your Logs

If **Paul H.** says September was a quiet month, then you know it was exactly that. It was so quiet that he wrote to me about some v.h.f. satellite frequencies and left it that. **C. McCormack** of Galway (Sony ICF-2001D) picked up an odd occurrence on the search and rescue channel on 5.680MHz on the night of September 16. At around 1055UTC he heard a male voice say "568". Five minutes later a female voice also said "568" and then proceeded to read out a string of five digit numbers. At around 1105 one of the regular stations on this channel asked for a radio check. The station that replied (with a Scottish accent) said the interference, referring to the numbers station, would stop in five minutes and sure enough it did. Mr McCormack says the female operator dropped down to three figure groups and then a string of zeros before closing down at 1110. He asks two questions: Who was the operator with the Scottish accent? Who are the numbers stations?

The first answer is easy (I think). It was Edinburgh Rescue who monitor this frequency around the clock. The second question is a real poser. I regularly monitor this channel, but have never heard this station nor do I recall any previous mention of a numbers station on this frequency. **Simon Mason** has supplied the most comprehensive list of stations so far for the so-called spy stations, but nothing on his list is anywhere near this frequency. Why they should use a search and rescue channel I do not know, but if anyone has any information or theories then let me know and I will share the information.

John Spillett who lives near Ringwood reports hearing an American Forces Network news feed on 10.5400MHz at 1900UTC in September. This is interesting as I have not seen this one logged or listed before. If you are not familiar with news feeds, then let me tell you that these are the rough and ready sound feeds fed from one point to another (not intended for reception by the public). Only at the receiving ends are the sound feeds cleaned-up, and put on tape or cartridge for broadcast. In the business this is known as 'topping and tailing'.

Despite being a quiet month some military traffic was heard. **Colin Latham** of Brentwood reports hearing a USAF transport aircraft with the callsign 60-196 talking to Croughton on 11.176MHz. The aircraft reported that the flight engineer had received puncture wounds to his thigh and they were directed to land at Naples where they would be met by a medical team. This all happened on October 7 and Colin is curious to know how the flight engineer managed to get his injuries. The only likely answer to that will come from my

HOT OFF THE PRESS!

SHORT WAVE COMMUNICATIONS

by Peter Rouse GU1DKD

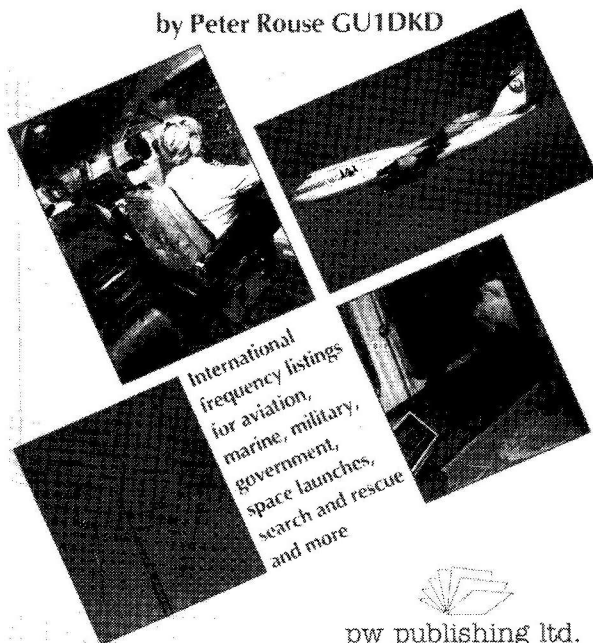

This book, written by Peter is available from the SWM Book Service for £8.95, the usual postage and packing charges are being absorbed on all orders placed before 31 Dec 1991.

old friend Paul H. who will no doubt also supply the man's wife's maiden name! (I never dare ask where his information comes from).

Still with military matters and this time the RAF. **Ron Galliers** of London uses a Philips D2935 and a Lake TU1 antenna tuning unit fed by a 30m long wire antenna. Ron has been monitoring Neatishead on 4.710MHz and wants to know what the station does. Neatishead is in Norfolk and comes under the control of RAF Coltishall and is an Air Defence Radar Unit (ADRU) and part of the NATO network that coordinates between the AWACS (Airborne Warning and Control Systems) and fighters. In other words, it vectors fighters onto likely targets. Ron asks about other frequencies for this station and the only two I can supply are 4.710 and 6.748. However, other known RAF tactical frequencies worth trying are as follows: 3.120, 4.707, 4.739, 4.743, 5.747, 6.686, 6.693, 6.715, 6.733, 6.740, 6.743 & 6.765MHz.

Ron logged quite a few operational

callsigns on the Neatishead frequency, but I have to say that past experience has shown that these have no tactical significance and change almost daily. He says stations referred to 4.710MHz as being an 'Architect' guard frequency. This is a new one on me as the latest RAF en-route supplement does not show that frequency against any Architect (Strike Command Integrated Communications System - STCICS) listing. However, the frequency has been heard carrying tactical traffic.

And Finally

From Chateau Rouse may I wish you the very best for Christmas and a hope that Santa Claus leaves some exciting goodies in your stocking. Catch you in the new year when we will look at a systematic method of station searching which may provide results for newcomers to the hobby who complain of missing a lot of the action logged by other readers.

AUSTRALIA

Greg Baker

Spring and summer have come with a vengeance here in my corner of New South Wales. The drought continues and the fire season looks like being severe. For the first time in years, the fire look-out tower on nearby Mount Budawang will be manned throughout the summer. The local Forestry Commission office is advertising for a person to spend their days scanning the nearby forests and national parks for signs of smoke. Perhaps I should apply and take some listening gear up there with me. At around 1150m, and nearly twice the altitude of my usual QTH, that could pull in quite a few new signals.

BBC in New Zealand

The BBC World Service service being broadcast on domestic transmitters in New Zealand came to an end in September. According to my New Zealand contact, the service had been broadcast in Auckland on 91.8MHz f.m. and in Wellington on 1233kHz a.m.

These two frequencies were temporary frequencies made available while the issue of frequency allocation was finalised. The company stopped broadcasting apparently because they could not get guaranteed frequency allocations.

Because the signal was pulled off satellite and then rebroadcast the signal quality was excellent. Broadcasting was 24 hours a day interrupted only by the odd frequency change.

The audience for this service in New Zealand would always be small according to my contact, but it was certainly growing. If it had been better promoted and permanent, it would probably have assured itself of around 2% of the listening audience in both centres.

BBC World Service devotees in New Zealand are now forced back to short wave where, apparently, reception is variable but reasonable in the local evenings.

Outback Emergency

Australia was kept on tenterhooks for a couple of days in late September, when distress signals were received at the Royal Flying Doctor Service (RFDS) base at Charleville in Queensland. Apparently, the signals were coming from a station hand who had come off his motor bike somewhere in

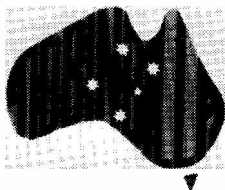

outback Queensland. His leg was injured, but worst of all he appeared to have suffered some memory loss. He could not tell radio operators his name or even where in Queensland he was. As time went by and authorities desperately tried to locate him, the RFDS manned their radio listening for the weakening signals. By the time Department of Transport and Communications (DoTC) radio direction finding expertise could be brought to bear from fixed facilities in Brisbane and portable facilities in Mackay, the signals had ceased. Since then authorities have checked all outback stations, but no-one has been reported as missing.

When I hear more I'll pass it on; in the meantime there's plenty of scope there for imagination.

Western Australian Emergency Services

Emergency services are finally getting their act together in Western Australia. Though police, ambulance and fire brigade services have operated efficient radio communications services for many years, they each operate on different frequencies and have had no common communications channel. Following negotiations with the DoTC, new frequencies have been released and several channels compatible with all three systems have been made available. In addition, the St. John Ambulance organisation in Western Australia has also been issued with licences to operate these frequencies as the 000 emergency services telephone number co-ordinating body.

Digital Audio Broadcasting

The DoTC Communications Lab in Canberra is testing a new digital audio broadcasting (DAB) system. As *SWM* readers may be aware, such a system is currently being demonstrated at Rennes in France. According to technical material from the Communica-

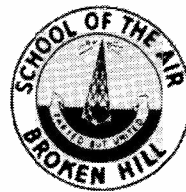

TIDBINBILLA SPACE TRACKING STATION

P.O. BOX 350, KINGSTON, A.C.T. 2604

TELEPHONE: (062) 49 0811 TELEX: AA62091 FAX: (062) 49 0845

PLEASE QUOTE:

tions Lab, DAB could be thought of as the third generation of broadcasting after a.m. and f.m. stereo.

Before recommending the introduction of such a system to Australia, the Communications Lab needs to study propagation, interference immunity and worst case ghosting.

Basically, the system allows the simultaneous transmission of up to 16 audio programs. To do this, it uses filters to divide each source signal into around 40 frequency bands covering the audible range 20Hz to 20kHz. Each frequency band is digitised into a bitstream, which is then coded with identification, error detection and error correction data. The result is several hundred digital data bitstreams each with the information needed to reconstruct a small part of one of the programs.

Each of these bitstreams modulates one of several hundred r.f. carriers occupying a total 4MHz bandwidth. The modulation technique is called 'coded quadriphase shift keying' (CQPSK) which sounds to me like an essential acronym for all *SWM* readers to remember.

Because each of the bitstreams represent only a small part of one program, the bit rate to be transmitted is low and bit length time is quite long. The advantages of this are that reflected signals arriving simultaneously at the receiver adds energy to the r.f. representation of the bit being received. Thus multi-path effects reinforce, rather than degrade, reception as with a.m. or f.m. In addition, it means that transmission area gaps can be filled with low powered transmitters pushing signals into the shadow area on the same frequency.

At the same time fading effects will be minimised because each program is spread over a wide range of frequencies. Where fading does occur, it only affects a few bits of digital data in any program and error detecting and correcting code can usually overcome the problem.

The microchips to do all this at the receiving end sound fiendishly complicated to me, but no doubt if it all turns out here and in Europe we'll be seeing a *SWM* do-it-yourself receiver in due course.

International Space Year 1992

A colleague and I are writing a teacher's resource book for the 1992 International Space Year. During our research we have interviewed many people associated with space and astronomy in this country. And we've visited quite a few establishments where fundamental research is taking place.

Our latest foray has been to the Tidbinbilla tracking station near Canberra. Part of NASA's Deep Space Network, Tidbinbilla sports one 70m dish, two 34m dishes and a 26m dish. Through these antennas the Australian staff track as many as a dozen space probes around the clock. Because it is US designed and must be strictly compatible with the two other stations in the network, those at Goldstone in California and near Madrid in Spain, the station runs on 110V 60Hz power rather than the 240V 50Hz standard in Australia. And though it is connected into the mains grid via rotary converters there is 5MW of diesel standby generation capacity ready to swing into action, particularly on critical encounters.

On the main antenna there are four feed horns to cover the S, X and Ku bands.

And for transmitting signals to spacecraft there are three transmitters. Power outputs are 20, 100 and a massive 400kW. Because the station is in a valley the nearest horizon is only a couple of kilometres away. I sure as anything wouldn't like to be standing on the valley rim when they beamed that sort of power past me.

I welcome any news and comments. In particular, I am interested in any s.w.l. information on Australian stations heard by *SWM* readers so I can chase up more details and interesting snippets from this end. My address is PO Box 208, Braidwood, NSW. 2622, Australia. For personal replies please send 2 IRCs.

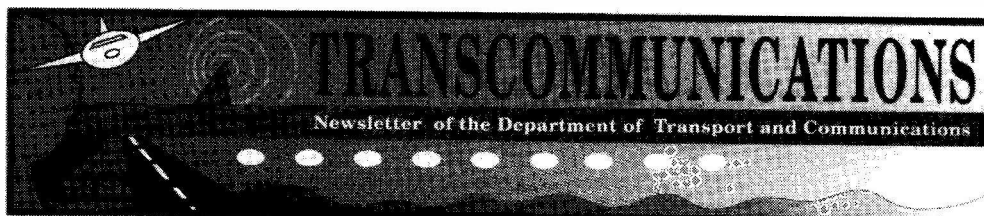

satellite tv news

Roger Bunney, 33 Cherville Street,
Romsey, Hants SO51 8FB

Following last month's report on the rescue of the rogue Olympus satellite, the craft has been seen back in service with the Plymouth Polytechnic educational programming in Telecom band and RAISAT on its DBS allocation. Signal levels in the Telecom band were at their former high strengths, suggesting that the satellite is in excellent condition following her trip round the earth. Another new signal source, available across Europe, are the programmes of the Norddeutscher Rundfunk 3 (NDR-3) from the Hamburg studio and downlinking from Astra transponder 25 (on 1B) as from September 25 for 16-18 hours daily. BSkyB have launched on an adjacent transponder their 'Comedy Channel', though for copyright reasons it is transmitted in Videocrypt and available only to their Movie Channel subscribers as a free perk.

Galavision, the Spanish language service produced in Mexico City and aimed for the Iberian audience, is now transmitting directly into that target area from PanAmSat PAS-1 - 45°W (11.515GHz horizontal). Up to the end of September, PAS-1 had been used to link Gala's European programme feed into London Teleport, where it was standards converted (525 line to 625) uplinked onto Eutelsat II F1 13°E for transmission down into Western Europe. The direct path feed over 45°W originates ex-Mexico in 625 lines PAL. Now on the vacated 13°E transponder is the 'London Teleport' idented colour bar pattern. The same pattern, at the time of writing, also appears over Intelsat V1 F4 27°W (11.505 hor) and from time to time has been involved with Scansat feeds.

Filmnet and Eurocrypt

I can confirm that Filmnet will go to D2MAC Eurocrypt at a future date as advised by a contact involved by that group, be aware of this development should you be considering a Filmnet pirate decoder that may well have a useful, but limited, life. Digital sound is still in use over Filmnet other than between film promos and to date, only 2 decoder suppliers are known to have working models available. The Scansat services are also going over to a D2MAC Eurocrypt standard on all Astra downlinks, changes should have been completed by the time this hits the bookstands.

October 1 produced tests for a suspected new Turkish channel 'Mega 10' on Eutelsat II F2 10°E at 10.98GHz with a rolling caption 'Iyi Aksamlar', 'Bu Bir Test Yayinidir', these tests are for a new channel that will be produced by the Social Democratic Party in Turkey.

Another new signal source was 'TV Campus' carried over the 10°E bird again on October 9 at 12.58GHz vertical (Telecom Band) - programme feeds

comprised yachts at sea, a marina, etc., packaged into inserts, and interspersed with colour bars. Campus TV is a 'student' channel in the French language and at the time of writing these are test transmissions. Normally, this transponder carries B MAC video and this is the first time I've seen them in the clear and unusually in PAL.

During October, I have seen the Rugby World Cup from Lansdowne Road and many news/sports feeds have been seen - outbound to Australia and New Zealand over Intelsat VI F4 27°W from London Teleport on 11.15, 11.47 & 11.51GHz vertical - both continuous match coverage and celebrity interviews from the Rugby world.

One new catch for me was the Tele X satellite 5°E with caption indicating the uplink from Aagesta Earth Station on Ch. 40 at 12.475GHz with sound sub-carrier at 6.5MHz - a good signal on a 1.5m dish despite the signal being left hand circular polarisation.

Yugoslavia

At the time of writing the conflict in Yugoslavia continues and updates can be seen out of RTV Belgrade during the evenings from around 1700UTC over Eutelsat IF5 at 11.47GHz horizontal - and on the regular programme feed of RTV Belgrade over Eutelsat IF4 7°E 11.178GHz horizontal. Regular updates of fighting with location maps are often shown (not unlike a road traffic report!) though some of the news material shown illustrates vividly the horror and brutality of war.

Reader Ken Kirkley lives in Botswana and operates mainly in C Band (4GHz) for his satellite entertainment. A 5m dish in use! Ken advises that BOP TV out of Bophuthatswana and carried over 27°W 4.053GHz will scramble its signal from November 5 as advises a caption on their output that Ken has monitored. Ringing Bop TV, Ken was told that the decoders weren't quite ready and still being tested, once Bop had confirmed that their decoders could be used outside of South Africa then one would be supplied. Another Bop' area TV service - Mabbatho TV - is airing her

output also over 27°W. Meanwhile the M-NETTV service over 66°E using MAC is experiencing problems, the satellite is in inclined orbit (i.e. it is unstable and moves within her allocated slot) and is expected to move, possibly onto 27°W. Films carried over M Net are graded for parental guidance and subscribers can nominate their decoder grading level - M Net can then over the air switch off appropriate decoders should 'X rated' material be transmitted, regrading to a higher 'X rating' level can only be achieved by writing to M Net where upon they can switch you back on! Despite the size of Ken's dish, satellite reception is becoming popular and over a dozen such installations can be seen around his area.

Orbital News

Both the Eutelsat II F3 and Intelsat K launches intended for October 24 and a winter launch respectively have been delayed pending component changes to II F3. Hopefully F3 will fly early November into a 16°E slot and operational during December. Eutelsat have also advised that the Lithuanian Republic has joined the Eutelsat organisation as from mid-October and will be able to both uplink from and receive into the Republic. Out into the Pacific and Television New Zealand is for a trial period providing a satellite born programme service into Fiji, originally the Australians had intended to provide the service but a local military coup terminated the project which now TVNZ intends to re-open for a 6 month period. TVNZ currently provides programming for the Cook Is, Niue and Nauru regions.

South Korea continues her DBS project and during the coming year launch services and 5 earth station construction contracts will be issued. On-air date is projected for 1994.

The South African channel 'M NET' which beams down a scrambled service into Southern Africa has recently announced doubled profits and with a further boost by the government allowing a 2 hour period of unscrambled programming. The SABC have announced the possible launch of a new channel with

restructuring of their TV/3 services, it's possible that M Net will be left a clear field for entertainment in South Africa if SABC return to a public service commitment.

Ted Turner, provider of the famed CNN World News service is now considering a World-wide children's channel, he's hoping to purchase the Hanna-Barbera production company and with additional acquisitions from early MGM and Warner Bros material, many thousands of hours of kids' programming will be available for his projected service. And in Japan, November 25 will see the first experiments of 'Hi-Vision' over the BS-3a satellite (the NHK version of HDTV - offered for 8 hours daily), intended for a permanent HDTV service over the BS-4 satellite series in 1994 onwards.

With the Germans proceeding with their PAL PLUS development, interesting to note the UK's DTI are to part fund the BBC's work into the improvement of PAL transmission, and to seek a common improved PAL standard throughout Europe.

GBC Gibraltar is now encrypting her programme output during BBC programmes downlinked from the BBC TV World Service but only up to 1900 hours local, apparently there have been problems with the Irish made decoders with a 10% fault rate and pending new supplies only part scrambling will be carried out, though by early November it is intended to scramble full time, using the Swedish Cryptovision standard.

'Egyptian Satellite Channel' is now available in London on Videotron cable fed via an ARABSAT downlink - the service is totally in Arabic!

Finally the OIRT (the East European 'Organisation of International Radio and Television') have agreed in Helsinki to pursue research into their SECAM PLUS - rather than adopting the common West European PAL standard. Several countries are testing variations of SECAM, there seemingly being problems in adopting PAL within their transmission system. With pressure in the West to adopt D2MAC and/or PAL PLUS, having part of Europe considering going into a SECAM PLUS will lead to further confusion.

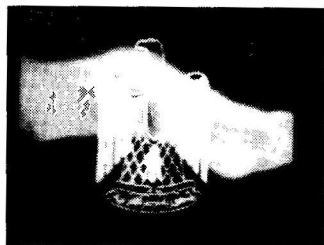
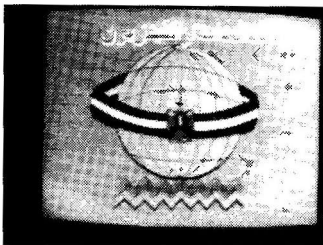

Figs. 1 and 2: Two logo identification screens from Egyptian TV as carried over the Arabsat system in S Band (2.5GHz), and captured by a reader on the south coast of England.

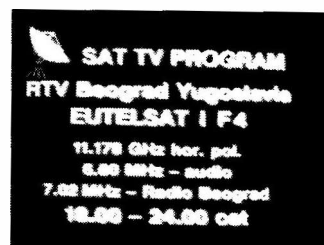

Fig. 3: Off-air details of RTV Belgrade, Yugoslavia from ECS I F4 7°E.

IF YOU ARE THINKING OF BUYING MAKE SURE YOU RING US

Part Exchange Welcome...Part Exchange Welcome...Part Exchange Welcome...Part Exchange Welcome

SANGEAN ATS 803A

(Direct Key-in World Receiver with Quartz Alarm Clock Timer)

SPECIFICATIONS & FEATURES

★ 150-29.999 continuous tuning with no gaps. Phase locked loop-double conversion Superheterodyne
★ Full Shortwave/AM/SSB 150-29999kHz No Gaps! + FM 87.5 - 108 Mono/Stereo ★ Five Tuning Functions: Direct Press Button Frequency Input Auto Scanning, Manual Scanning Memory Recall and Manual Tuning Knob ★ Built-in Clock and Alarm. Radio turns on automatically at preset time and frequency. ★ Large digital frequency display. ★ Fourteen Memories - Nine memory channels for your favourite station frequencies. Last setting of mode and waveband stored in 5 memories. ★ Direct press-

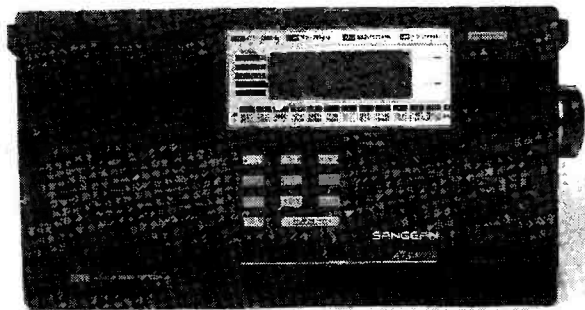

button Access to all 12 Shortwave broadcast bands. ★ Two power sources - battery or AC mains adaptor. ★ General coverage of all a.m. bands in LW/MW/SW (Dedicated Broadcast Band Coverage on all versions) Plus of course the f.m. band for quality sound broadcasts in headphone stereo. ★ SLEEP Function turns the radio on or off after an adjustable time of 10-90 minutes. ★ Separate BASS and TREBLE controls for maximum listening pleasure. ★ External antenna jack for better reception. ★ Adjustable r.f. GAIN control to prevent overloading when listening close to other strong stations or if there is interference. ★ New improved wide/narrow filter (6/2.7kHz) ★ b.f.o. control (Beat Frequency Oscillator) enables reception of SSB/USB/LSB (single side band) and c.w. (Morse Code) transmissions. ★ Illuminated display to facilitate night-time use. ★ Designed for both portable and Desk Top use. ★ Five dot LED Signal Strength Indicator.
DIMENSIONS: 29.2cm x 16.0cm (11.5in x 6.3in x 2.36in)
OUTPUT: 1200mW (10% THD) WEIGHT: 1.7kg (3.75lbs) Without batteries. Wide/Narrow Filter Switch.

£109.95 + £5 check, test and P&P.

Short Wave ATU will improve your shortwave antenna **£39.95 + £3.00 P&P**
Short Wave Long Wire complete **£10.95 + £3.00 P&P**

OR

ATU and Long Wire Normal Price **£50.90**
Package price: **£48.00 + £4.50 P&P**
AR300 XL Aerial Rotator and control. Max Load: 100lb **£39.95**
+ **£2.95**
AR201 Rotator Support Bearings provide additional support for long aerials. **£15.00 + £1.50 P&P.**

**Trade enquiries welcome.
Contact Stuart or Graham**

SKY SCAN Desk Top Antenna Model Desk 1300

Built and designed for use with scanners. Coverage: 25 to 1300MHz
Total height - 36ins - 9ins at widest point. Comes complete with 4 metres of RG58 coax cable and BNC connector fitted. Ideal indoor - high performance antenna and can also be used as a car antenna when your car is static. REMEMBER YOUR SCANNER IS ONLY AS GOOD AS YOUR ANTENNA SYSTEM!

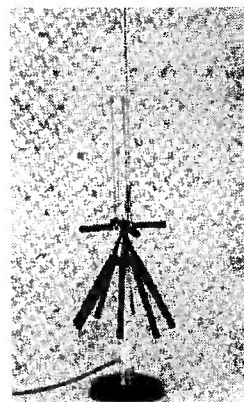

£49.00 + £3.00 p&p.

SKY SCAN V1300 Antenna

Most discons only have horizontal elements and this is the reason that they are not ideal for use with a scanner. Most of the transmissions that you are likely to receive on your scanner are transmitted from vertically mounted antennas. The Sky Scan V1300 discone has both vertical and horizontal elements for maximum reception. The V1300 is constructed from best quality stainless steel and aluminium and comes complete with mounting pole. Designed and built for use with scanners.

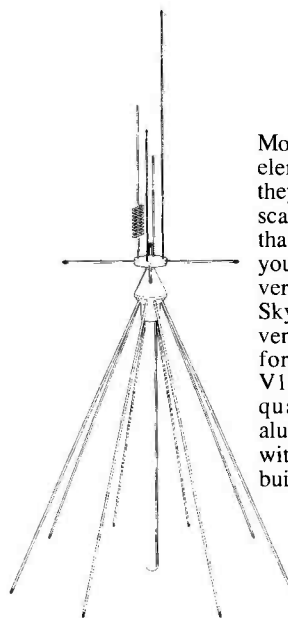

**£49.95
+ £3.00 p&p.**

SKY SCAN MAGMOUNT Mk II

For improved performance, wide band reception, 25 to 1300MHz. Comes complete with protective rubber base, 4m RG.58 coax cable and BNC connector.

Built and designed for use with scanners.

**£24.95
+ £3.00 p&p.**

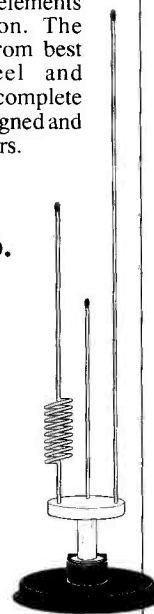

S.R.P. TRADING

BUYING A NEW SCANNER... FIRST FOR THE BEST DEAL

Part Exchange Welcome...Part Exchange Welcome...Part Exchange Welcome...Part Exchange Welcome

**NOW MAIN DISTRIBUTORS FOR GRUNDIG SW RECEIVERS.
ALINCO DJ-X1-RING NOW FOR A GREAT DEAL**

MS-1000 £279.00

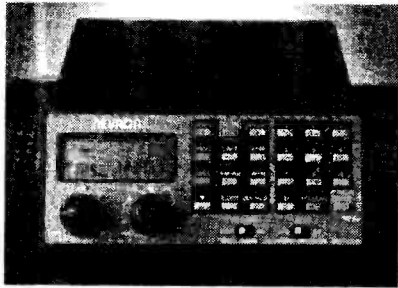

MVT-6000

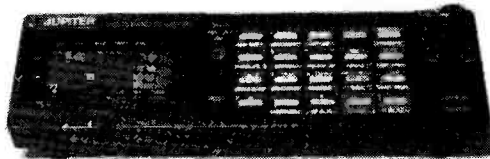

£299.00

VT-125

£149.00

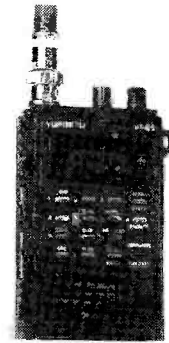

MVT-7000

£289.00



HP-2000

£269.00



AR-3000 £765.00

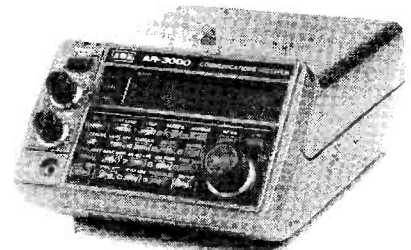

AR-2800 £395.00



AR-2000

£269.00



HP-1000AB

£229.00



BEARCAT 760

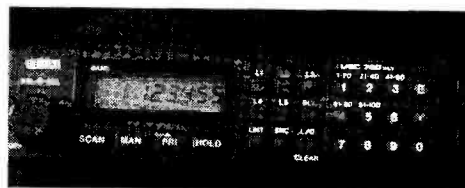

£220.00

BEARCAT

200XLT

£199.00

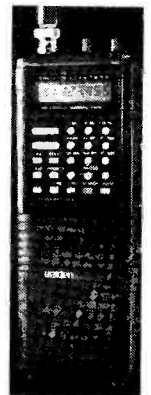

AR-2500 £419.00

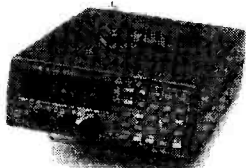

FREE

**DELIVERY ON ALL SCANNERS
DISCONE ANT WITH ALL BASE MODELS
SKY SCAN CAR MAG WITH ALL HAND HELD MODELS**

Manufacturers and distributors of communications equipment

**Unit 20, Nash Works, Forge Lane,
Belbroughton, Nr Stourbridge, Worcestershire.**

Telephone:

(0562) 730672

Fax: (0562) 731002

SHOW ROOM OPENING TIMES:

Mon - Fri: 9.00-5.30pm Sat: 9.00-1.00pm Callers welcome.



amateur bands round-up

Paul Essery GW3KFE, PO Box 4, Newtown, Powys SY16 1ZZ

Quite an eventful month, in retrospect. The ZAs didn't just appear, they flooded the bands! They seem to have appeared on all bands from 1.8 right up to 50MHz, so much so that at the time of writing there are ZA calls to be heard actually calling CQ without anyone biting!

Jeremy Ali (Preston) enrolled for RAE at the local college, and only three entrants plus the instructor appeared on the first night...so it seems his class has folded before it started. Sad. However, to be fair to colleges, for at least 25 years they have had a 'minimum number' requirement before a course will be allowed to start, and another level below which an existing course will be closed. The only advice I can offer is to join the nearest club, start studying at home, and ask the club members on any knotty points you may come across.

Computer Logging

Turning to Jeremy's list, I find he uses computer logging software, and listens at various times with an FRG-7700 and indoor Howes active antenna, with c.w./RTTY decoding by means of a Microreader Mk 2. Interestingly enough, Jeremy's log doesn't show anything of Africa or South America, though all the other continents are handsomely represented - it suggests that maybe there is something local 'blocking the way' to the south.

Brian Lucas reports from the Home Counties Training School, where he uses amateur radio listening and construction as a 'training aid'. On 7MHz SL3ZV was noted for a 'special' while on 14MHz, he noted ZA1A, 5B4SA, ES1AR, VKs, KC5WJ, ZLs, VEs, W/Ks, 4N4A, UM8NU, 4X6XZ, A71BS, 9K2YA and JE2AIN, along with Europeans. 18MHz gave K1PEO, AK1SF, UL0A, W4FLE and KA2PHQ. 21MHz yielded UH8EA, VK3RS and TK5CV and on 28MHz they came across SV0BY, RH0E, 5B4SA, TA3PB, UA6PBJ and Europeans.

CW Preferred

Eric Pickering (Blackburn) prefers the c.w. mode and 7MHz; this produced CO7MF, T77Z, 4K1B, UA700XWV (QSL via UZ9XWV), PU1LOG, VK5FE, CX3EU who was running 2W, HF0POL (QSL to SP3HLM), VS6WV, another QRPer in PY6ML and yet another in PT7VJD, HB0/Y81XH, 9H8F, UA0WB, UF6FAL, YCOUNC, 3DA0BK (Box 122 Eveni, Swaziland), a couple of ZSs, LU2XR, JW0GB DK7VWV/5B4 UJ8JMM, UA0QFC and UA0QE, both in Tiksi, Zone 19, U0AG in Krasnoyarsk, UM8NC, JW/DJ5PA, JE1CGC, UA0ABB, UL7FCG, 9K2ZZ, UI9ACQ and UI8IZ in Samarkand.

Peter Cain (Newcastle-upon-Tyne) went on 28MHz to copy AP2JZB, A25AA, A92EV, BY5RA, CE2BMU,

CX3DAV, DU1DFU, DU8AN, D44BC, FR5DX, HZ1AB, P43WLP, TR8GL, TT8GA, VP8CFM, VP8CGL, XY0RR, ZA1QA, ZP5CF, 5H3RA, 5T5HH, 9K2IC, 9K2NG, 9M8FH; while 21MHz produced AP2JZB again, BY5RA, CE2CC, CE3BFZ, CE4IEY, CO7JC, CX7BF, C53BF, DUs, FM5CD, FP9SPM, FY5EM, HC1MN, HC1OT, HF0POL, HK1PZC, HK3JH, HK0NZY, HL2KAT, HL9AA, HZ1AB, KH6XT, KP2A, KP4YA, NP2BW, OA4BCZ, OD5ET, OX3KM, PJ2MI, P29MND, QY9JD, ST0DX, TL8FT, TU2XB, VU2DNL, VU2TRC, V31SW, V51EG, WP4AZT, XY0RR, ZA1A, ZD7CRC, Z21HJ, Z27JV, 4S7JR, 4S7NMR, 5Z4DU, 6Y5DA, 7Q7LA, 8P9AP, 9J2BO, 9K2ZZ, 9L1US and 9L2JK. As for the 14MHz log, it contains such as A22BW, A35KB, AL7MI, BY4WNG, CE2EZE, CN8NY, CP6EN, CX3CE, DU1COO, DU1EIB, DX1DBT, DU9EK, FK8EB/M, FK8CP, FM5CD, FO5JV, HC2HVE, HZ1AB, J88AQ, JY3ZH, KC6DX, KH6WU, KL7KJ, NL7J, OA4OS, ST0DX, SV2ASP/A (Mt Athos), S79HX, TG9NX, VP2EXX, V63AR, V85GA, VP8CEN, VP8GAV, VU2JJQ, XE1L, XV9MA, XY0RR, Y11BGD, YJ8RN, YN1CB, ZA1A, ZD7CRC, ZP5JCY, 3B8CF/3B7, 3B8FU, 3B8GA, 4K2BCA, 7X2DG, 8R1JV, 9M2CW and 9M8LL.

P. Clarke (Eccles) has a shiny NRD-535 receiver to play with, to match this, a change to the antenna has resulted in a 120m wire through an a.t.u. for general use, plus 'slopers' made up for the 3.8MHz band. The next step is a planned 3-element wire beam for 7MHz in time for the CQ WW DX Contest. So far the listing includes such 3.5MHz numbers as VK3CR, ZB2AZ, ZL1B0Q, VK3RE, VE7ZG, VE2RP, K1ZM, N1AU, VU2GNA, VE4JK, K8EYU, N5CG, N2LVC, TA3PB, KA2TGB, N6DX, W8LZA, K9RSG, VE3POS, HJ1RZB, H80MA, CM4TIY, K60YI, W4UHI, JA4SLT, JA4WFO, PJ8AD, VK2WF, KL7XV, PY2TN, PY6OE, PY2LVI.

Now to **Gerald Bramwell** (Swinton) who uses all bands between Top Band and 28MHz, s.s.b. Top Band only gave

the odd G and EA3, but on 3.5MHz W10J, V01FG and VE1ZZ appear, along with RY7D, 5H3RA, VK2AVA and the Europeans. On 7MHz no Ws, but UL8LYA, RA9CO, UL7LS, UA9CDT, ZW5B, PY4LYS, 9M8PV, 5B4ES and HF0POL and the EUs. 14MHz bristled with Ws, mainly East Coast, and VEs, plus ZA1A, CU2YA, 9H1ALC, PT700, EA8NM, ZL1AQ, 9J2SZ, KP4AOD, HF0POL, CE60MY, 9K2YA, PY1DC, 4X4MU, PY0FF, VP8CDR, 7X2DJ, LU1PNC, ZW5B, 4X6UO, 4X1BD, CO2OM, CE9GEW, HK4YCR, VK7EK, JA9IPF, VP8CEN, EA8BN, VK6VU and CX7CB and the usual smaller fry. 18MHz yielded East Coast Ws, the odd 'zero' plus lots of EUs and relatively small-fry DX. The Ws on 21MHz include some of the Western Reaches, the zeros and sevens, VEs, VY, YV1CLM, YV1EDG, HC1OT, PU1Z, 6Y5DA, 4X1MO, HC2OM, PY2BDY, VU2WAP, WP4HHK, XV9MA, LU4LAV, CE5FSB, LU5FIC, PY1BL, CP6RW, LU3HQ, EA8RR, LU5FCI, KP4CHY, VP8CGR, and CM8DC. Turning to 21MHz, coverage appears into W6, W0, as well as the commoner Eastern states of USA, while on 24MHz we find W6s again, VEs, YB0CN, 9H1IT, ZS1ATY, VP2M/G0AZT, various PT7s, CX3CG, and the smaller beer. Finally on 28MHz we find USA well covered, plus proportionally more G/EU signals, ZW5B, PX5A, TI2CF, 5H3RA, EA8IN, TA3PB, and various local and DX stations using n.b.f.m.

John Heys (Hastings) mentioned that he has been playing around with 433MHz equipment, and at the other end of the spectrum he located ZA1HA on Top band.

Nice spread

Angela Sitton from Stevenage mentions c.w. from various Ws, ZA1HA and some Asian U stations on 28MHz, while on 21MHz there were a nice spread of Ws out to W6 and 7, plus JAs, VE3GFE, PY4BV, UV9CDC and UA9DM. Down lower to 14MHz where the scalps in-

cluded another spread of Ws, HK3RO, PR7PO, PP2JT, 4U4BVN, UV9CO, R50DPK, 4L1QRQ, and 4J4GO in Yerevan. ZA1HA, 4X4NJ, 9H3PF, 9L1US, Ws, EA6/G3VW, UL7MG, R3DIR, UA9CK and UA9CM were booked in on 7MHz; On 3.5MHz it was Europeans all the way, while on Top Band I note ZA1QA calling CQ with no takers.

Vince Cutajar (Malta) stuck to the WARC bands where he copied (24MHz) 9K2ZZ, 3X0HNU, RJ4X, PY0FF, UI8DX, HC8GR (Galapagos), VP5VEQ, YL2AG, VP9MN, VP2MR, V63AO, UF6FL, 7Z1IS, 5H3A and 4J3GM plus 18MHz loggings of OD5ZZ, UL7ACI, 9M2HB, 9K2ZZ, 4S7EA, LY1BY, YV5DEM, HK4EB, UF6FL, VP8GAV (Antarctica), 3C1EA, and VP8CFM (S. Orkney).

Nice to hear again from **Colin Bates** (Marston Magna). He has replaced his old long wire with a Dressler active antenna and finds this a great improvement, as it seems the nearby power lines were sucking signal away from the old antenna. Yeovil member XX9AW can be found at 0900 or 1000UT on 28.950MHz and glad to have UK contacts.

Don McLean (Yeovil) found EJ2VLP (Aran is) on 7MHz, and then turned to 14MHz for JT1BG, JY3ZH, P29DX, VKs, VU2PEP, VU2TDZ, XX9AW (QSL to KU9C), XY0RR, ZA1A, ZA1QA, 3B8FU, 3B8CF/3B7, 3B9FR, 3DA0AY, 4K4BG, 5H3DC and 9M8AJ. On 21MHz the log noted BY5RY, CP1FF, CP6RW, DU3RCM, ES1QD/O, FFOXX, HL9AA, OA4ANR, P29AS, P29DX, RO6/RB5FF, TI2MEN, UA0FF for Zone 19, VKs, VK2DXI/9M2, VP2VER, VP9WS, WP4AZT, XW8KPL, XY0RR, YET7, ZA1A, ZL4AAG, 3D2XV (Rotuma), 4J4DGN and 9M8FH.

VHF and UHF Bands!

I am surprised at how few of you make any reference to v.h.f. or u.h.f. activity. Given a reasonably decent antenna there is quite a lot of interest to listening above 30MHz, and not just to repeaters. A modern receiver, a 3-element or more horizontal beam on a short mast and a car-ride up on to the hills can be very rewarding indeed and good fun, though to be sure winter weather in the high places can be far more severe than lower down, as anyone who has been up, say, Snowdon in summer even, will agree. In flat territory, a similar beam well in the air or even in the loft, and made rotatable, can be very rewarding.

Finished!

That's the lot for this time; keep them coming, to arrive by December 1, Jan 10, and February 10 respectively. If you have a query which can be best answered by a direct reply, I'll be pleased to help but only if a stamped addressed envelope is included.



QSL card from I3MKH sent to the staff of Practical Wireless. I3MKH is Mizko Boscolo who lives in Venice - obviously!



ASK ELECTRONICS LTD

**MULTI-BAND RADIOS
ROBERTS**



SONY

ICF-SW1E£134.95



ULTRA-COMPACT SHORTWAVE RADIO WITH PLL SYNTHESIZER CIRCUITRY

FM/LW/MW/SW reception • PLL synthesized circuitry • FM stereo • Continuous AM frequency coverage • 4 way tuning: 10 memory presets, auto scan, manual tuning, 10 key direct tuning • Programmable timer • Sleep function • Digital clock and alarm • LCD display with light function • Dual conversion system • 2 step tone control • Key protection • Record out socket • Supplied with stereo earphones, shortwave guide and compact aerial • Power: 2xAA size battery.

ICF-SW800£94.95

ICF-SW1S KIT£195

ICF-SW20£59

AN-1 ANTENNA£49

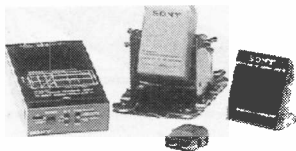

SONY SPECIALISTS 071-637-03531 071-637-0590 Fax: 637-2690

YOUR SONY SPECIALIST

Full Worldwide Guarantees from SONY! CALL THE SONY SPECIALISTS 071-637-0353/0590!!
Mail Orders Welcome. 071-637-0590/0353 Fast - Efficient - Convenient. To your doorstep!!



ICF-SW7600£134.95

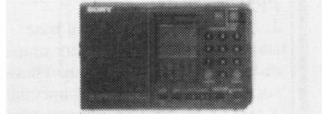

HIGH PERFORMANCE PORTABLE RECEIVER WITH PLL SYNTHESIZER CIRCUITRY AND CONTINUOUS AM FREQUENCY COVERAGE

LW/MW/FM/SW/SSB reception • PLL synthesized circuitry • FM stereo • Continuous AM frequency coverage • 4 way tuning: 10 memory presets, auto scan, manual tuning, 10 key direct tuning • Sleep function • Digital clock • Programmable timer • 2 step tone control • Antenna input socket • Headphone socket • Key protection • LCD display • Dual conversion system • Supplied with compact antenna, stereo earphones and AC power adaptor • Power: 4xAA size battery.

ICF-PRO80 Air/marine band scanner£275

ICF-AIR7£229

WA-8800 Full SW M-band stereo cassette recorder£199

CR-V21 world band receiver - fax printout, RTTY weather rec£2699

R727 5 bands - FM/MW/SW/LW/SW1-4£79.95

R747 3 bands£92.95

RF-M3 Tiny£59.95

RP-26 FM/MW/LW£81.95

RP-14 Cassette radio 4 FMs£60.95

RC-30 Mono cassette radio£51.95

AWARD WINNERS

071-637-0353/0590

AN AWARD WINNING MASTERPIECE

ICF-2001D Kit£319.95 ONLY
Finest all-round pro-receiver in the business.

FW/LW/MW/AIR multi-band reception • 32 station preset memory • Synchronous detector circuit • PLL quartz-locked synthesizer circuit digital/analogue tuning • 2-way scan tuning (memory, broadcast, define) • 2-position tone control • Direct metre band access • 4-event programmable time • AM attenuator SSB reception • External antenna for AM, FM and AIR band • 288x159x52mm (w/h/d) 1.7kg. 2001 DSYSTEM-ICF-2001D with active antenna AN-1 in one complete package.

NEW ICF-SW77 Similar specification to 2001D but with jog-shuttle dial tuning for accuracy£329

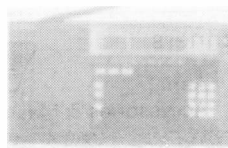

GRUNDIG

SATELLIT 650£459.00

SATELLIT 500£275.00

SATELLIT Cosmopolit£91.90

YACHT BOY 220£56.99

YACHT BOY 230£73.00

CONCERT BOY 225£36.70

**PLEASE MAKE ALL
CHEQUES PAYABLE TO
ASK ELECTRONICS AT:**

**248-250 TOTTENHAM COURT
ROAD, LONDON, W1P 9AD, UK**

PHILIPS

D2345

• Portable Radio • LW/
MW/FM/2x SW • Fine Tuning
Control • Mains/
battery supply£24.95

D1875

• Compact 12-band Portable Radio • LW/MW/FM/9
shortwave • Large tuning control • Tuning LED indicator
• Telescopic and Ferrarceptor aerial • DC supply connection
• Earphone connection • Wrist strap
• Attractive pouch£49.95

• All electrical digital world
receiver • LW/MW/FM/13
x SW • Continuous tuning
over total AM band •
Direct keyboard tuning • 9
station memory • Variable
pitch 8FO for CW/SSB
reception • Touch panel
switching • LCD frequency
display • Mains/battery supply

**STILL ONLY!
£119.95
BEST BUY!!
PHILIPS
D2935 RADIO**

CALL NOW FOR IMMEDIATE DESPATCH! MAIL ORDER LINES 071-637-0590/0353!!

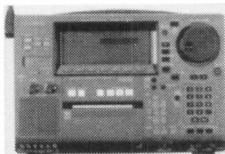

PROFESSIONAL W/BAND RECEIVERS£2699

WORLD BAND RECEIVER WITH MULTIBAND/SATELLITE RECEPTION AND RTTY/WEATHER FAX PRINTOUT

FM/LW/SW/SAT reception • Reception and print out of weather fax and RTTY weather satellite information with optional AN-P1200 aerial • Built-in printer • Triple loop PLL synthesized circuitry • 5 way tuning: 421 memory presets, scan tuning (auto, define and memory), spectrum analysed tuning (using graphical display of signal strength), manual tuning with jog dial, 10 key direct tuning • Continuous waveband coverage AM 9.29999.99 KHz, FM 87.5, -108 MHz, SAT 137.62/141.12 MHz • Synchronised detection system • Auto memory input for easy automatic storage of up to 10 stations • Priority reception • 8 Programme/1 week timer • TCXO (Temperature Compensated Crystal Oscillator) for ultimate stability of the reception frequency • Active search system • Memory list • Sleep function • Cassette player /computer interface for data storage and other uses • Built-in high resolution thermal printer using 110mm paper with horizontal resolution of 860 dots • Printer with enlargement capability • Dual power supply - AC adaptor/rechargeable battery pack • External active antenna • AF filter • Digital quartz clock • Large LCD display with contrast control • Squelch control • Key protection • AM attenuator, dual conversion system • RF gain control • Record out • External aerial sockets • Supplied with AC adaptor, Rechargeable battery pack, battery charger, active antenna with bracket and cable kit, dust cover, printer paper, shortwave guide, fax guide and operation table • Power: NP22.

AN P1200

Offset Parabolic antenna and frequency converter • Designed to augment the CRF-V21 • Capable of receiving fax broadcasts from meteorological satellites

• Size: 1.25m x 2m x 1.5m (w x h x d)£1599

SALE

**PANASONIC
RF-B900 W/BAND
RECEIVER**

YUPITERU AIR-POWER AT YOUR FINGERTIPS

VT-125 II£169.95

MVT-7000£289.95

PANASONIC

RF-B10 World band receiver - pocket size£59.95

RF-B65 S/pro multi band digital radio - memories preset ..£169.95

RF-B45 Digital m/band radio£129.95

071-637 0353/0590

ICOM

SCANNERS/TRANCEIVERS

IC-R1 15-1300 MHz

100 memories ...only £359.95

IC-2SET£289

ICR-7000£899

FULL RANGE STOCKED



MULTI-BAND RADIOS/SCANNERS/TRANCEIVERS

**LONDON'S PREMIER
COMMUNICATION EQUIPMENT
BARGAIN CENTRE**

071-637-0590/0353

SPECIAL NOTICE TO READERS

Although the Proprietors and staff of Short Wave Magazine take all reasonable precautions to protect the interests of readers by ensuring as far as practicable that advertisements in Short Wave Magazine are bona fide, the magazine and its Publishers cannot give an undertakings in respect of claims made by advertisers, whether these advertisements are printed as part of the magazine, or are in the form of inserts. While the Publishers will give whatever assistance they can to readers having complaints, under no circumstances will the magazine accept liability for non-receipt of goods ordered, or for late delivery, or for faults in manufacture. Legal remedies are available in respect of these circumstances, and readers who have complaints should address them to the advertiser or should consult a local Trading Standards Office, a Citizen's Advice Bureau, or their own solicitor.

SERVICE MANUALS

Available for most Video Recorders, Colour & Mono Televisions, Cameras, Test Equipment, Amateur Radio, Vintage Valve Wireless, Any Audio, Music Systems, Computers, Kitchen Appliances etc. Equipment from the 1930s to the present and beyond. Over 100,000 models stocked, originals and photostats. FREE catalogue Repair & Data Guides with all orders.

MAURITRON TECHNICAL SERVICES (SWM),
8 Cherry Tree Road, Chinnor, Oxfordshire, OX9 4OY
Tel: (0844) 51694 Fax: (0844) 52554



HOLDINGS AMATEUR ELECTRONICS

G3LLL for ICOM & YAESU
New & S.H. Receivers, Transceivers & Specialist service for older rigs
FT101 etc. IC-R7100 stocked. Closed all day Thursday.
45 JOHNSTON STREET, BLACKBURN BB2 1EF
5 Miles from Junc. 31, M6 Tel: (0254) 59595
BUT HOLDS? PHONE FIRST.

Short Wave Receivers & Scanners

ELLIOTT ELECTRONICS

for the Radio Enthusiast

Aerial
Accessories & Masts

Instant finance available
VISA Written details on request.



RIGS, ANTENNAS, SWR BRIDGES,
POWER SUPPLIES, TEST GEAR,
COMPONENTS, MORSE KEYS,
COAXIAL CABLES, ROTATORS,
MICS, PLUGS AND SOCKETS,
SWITCHES.



**Books for
radio amateurs**

FAMOUS "Complete Guide
to VHF/UHF Frequencies
26-2250MHz"

**JAYBEAM
AMATEUR
ANTENNAS**
APPOINTED
DISTRIBUTOR

QSY
OLD
MAN TO

Call us on LEIC. 553293
OR COME AND LOOK AROUND
AT

**60 Hinkley Road,
Leicester LE3 0RB**



SSE

HIGH QUALITY ACCESSORIES

THE CHARGER & SCANNER SPECIALISTS

FOR SCANNING MONITOR RECEIVERS

JIM PSU-101

1. **JIM PSU-101 MkIV.** A high quality UK manufactured fully regulated 220-240V AC power supply with RADIO BASE HOLDER combined. For use with FAIRMATE HP-100E/200E/2000/1000AB. AOR-1000. YUPITERU MVT-5000/7000/125. REALISTIC PRO-35/38. ICOM-R1. UNIDEN UBC50XL. BC55XLT. UBC70XLT. UBC100XLT. New unique features include 2 DC output sockets one for radio and the other for accessories. A bracket for BNC socket for antenna connection. Separate DC leads included.
PRICE £29.95.



2. **JIM BH-A3.** Universal base stand for handheld scanners-transceivers etc. convenient, safe support of radio. Adjustable front stop. Heavy duty chromed base. Bracket for BNC socket for base antenna connection. **PRICE £9.95.**

3. **JIM CH-A4.** Car mounting holder for handheld scanners- transceivers with BELT CLIP support. Safe and convenient use of scanner etc. in car, truck, boat etc. **PRICE £7.00.**

4. **JIM BC-4H.** Unique FAST Universal 4 hour + 14 hour Ni-cad charger. "auto-switch-off" timer (no more guessing). Ideal Fairmate, AOR, Yupiteru etc. Leads + 4 sizes of AA holders supplied **PRICE £19.50.**

5. Watch this space for high quality Universal S meter for scanners, CB etc!

Payment by postal order or cheque. Prices include postage

Further information on SSE products, send A4 SAE to:

SOLID STATE ELECTRONICS (UK)

6 The Orchard, Bassett Green Village,
Southampton SO2 3NA
Tel: (0703) 769598

**NEW
PSU-101 MK IV**

SHORTWAVE RADIO BOOKS

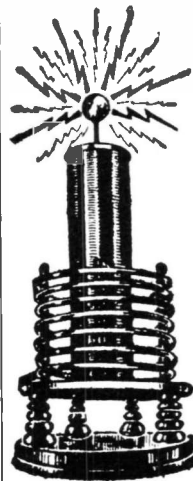

Discover one of the most incredible collections of electricity and electronics books to come along in years. You'll find scores of high quality new books and reprints of rare old books on building and collecting old time radios including spark-gap transmitters, crystal sets, regenerative and other antique receivers, early telephony and television, and more!

Tesla Coils!

Build Tesla coils, induction coils, Wimshurst and other lightning bolt generators! Rewind and repair motors! Design and build electrical generators! Get high power from auto alternators! You'll find quality books on these topics and much more.

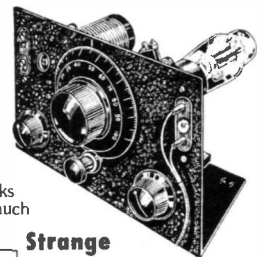

Strange Books!

Our miscellaneous section has to be seen to be believed - lost continents, robotics distilling, windmills, hypnotism, holograms, and much, much more!

Wide Variety!

You'll find plans and info on all types of unusual equipment from lasers to century-old induction coils! Build equipment your friends haven't even heard of!

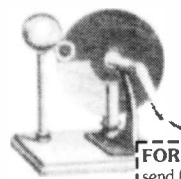

Send for our Booklist!

It's 45 A4 pages crammed with interesting books - all described - almost a magazine in its own right. As well as subjects mentioned above the Booklist includes sections on all forms of surface transportation and one of the biggest selections of engineering books you will find anywhere. Send for it today and see what you've been missing!

FOR YOUR BOOKLIST

send (no stamp required in UK) a large S.A.E. (35p stamp please) for UK addresses or 5 International Reply Coupons for overseas airmail delivery to:-

**Camden Miniature Steam
Services,
FREEPOST
13 High Street, Rode,
BATH BA3 6UB**

We'll send your copy by return!

dxtv round-up

Ron Ham, Faraday, Greyfriars, Storrington,
West Sussex RH20 4HE

I am always pleased to have reports from our overseas readers because it gives us here in the UK a chance to see what the various atmospheric disturbances do to signals in other parts of the world.

During the 1991 Sporadic-E season, **Sergei Olejnik** (Kalush, Ukraine), using an Elektron-280D receiver from a communal antenna system, received pictures from the USSR (Georgian TV) on Ch. R2 (59.25MHz) and Syria (STV) on Ch. E4 (62.25MHz) in May; Norway (Norge Gulen) on Ch. E2 (48.25MHz), Denmark (Danmark Radio), Jordan (JTV) and Norway on Ch. E3 (55.25MHz), Italy (RAI-Uno) on Ch. 1b (62.25MHz) and something Arabic, Germany (ARD), Holland (NED 1), Spain, Switzerland (French programme) and Syria on Ch. E4 in June; Finland (YLE TV1), Germany (ZDF), Holland, the Norwegian regionals (Gamlem, Greipsted, Gulen and Melhus), Spain, Sweden (Kanal1-Sverige) and Syria in July; Germany, Norway (Melhus), Spain and Sweden in August and Syria in September.

"Reception on E2 & E3 is difficult because on R1 is a very strong transmitter of Soviet TV-1", wrote Sergei and enclosed pictures of an announcer **Fig. 1**, a caption, **Fig. 2** and a weather forecast **Fig. 3**, that he received from Syrian TV during the period. While Sporadic-E disturbances were in progress on June 13, 14, 15, 22, 23, 24 and 27, **Lt. Col Rana Roy** (Meerut, India) received pictures from Bangkok TV (**Fig. 4**) on Ch. E3, Dubai TV on Ch. E2 and the USSR on Chs. R1 (**Fig. 5**) and R2. In addition to digital clocks on captions from the USSR and Teletext from Dubai, he saw cartoons, cycle-racing, discussions, football, tennis and, at times,

a number of Indian stations fighting for predominance on the screen. Around 1720 on September 7, Rana received strong, smeary and fluttering signals, typical of an 'F2' opening, in the Channel E2/R1 area. "Some of the pictures appeared to be Chinese," said Rana. However, at 1722, he logged an unidentified caption, **Fig. 6**, from South East Asia, at 1723 he saw adverts, at 1745 more from that area with clear sound which he thought was Chinese and at 1800 he heard songs on Ch. E3 that sounded like Thai.

Band I

In September, **Bob Brooks** (Great Sutton) received programmes and/or test-cards from Spain and the USSR on the 2nd, Denmark on the 3rd, Portugal (RTP) and Spain on the 4th, Spain on the 7th, Denmark on the 12th, the Norwegian regionals Bagn, Gamlem, Hemnes, Melhus and Steigen and a programme from Spain on the 13th, the USSR on the 30th and Norway Spain and the USSR on October 1. **Simon Hamer** (New Radnor), logged pictures from Norway, Sweden and the USSR on September 13 and Denmark, Finland, Iceland (RUV Island), Norway, Sweden and the USSR on October 1.

Weather

The slightly rounded atmospheric pressure readings, for the period August 26 to September 25, **Fig. 16**, were taken at noon and midnight from the Short and Mason barograph installed at my home in Sussex. In my part of the world, the atmospheric pressure was generally high with fine warm weather

from August 25 to September 14 and periodic variations produced the right conditions for DX in the v.h.f. and u.h.f. bands. During the month, I recorded 2.56in of rain, compared with 2.19in in September 1990, all of which fell between the 15th and 30th, with relative humidity levels of between 80 and 84% on days 16, 18, 23, 24, 25 and 29.

Tropospheric

While tropospheric openings were in progress on June 15, 16, 22 and 24, **Rana Roy**, received pictures, in Band III, from Bhatinda, Bhawalpur overlapping Mussoorie on Ch. E10, Delhi and Gwalior overlapping on Ch. E7, Jalandhar, Kasauli and Lahore. He saw adverts, Bugs Bunny cartoons, an Urdu play in strong colour and an announcer with a digital clock top right (**Fig. 7**) from Lahore and breakfast TV, programme schedules and weather on other stations. Rana also heard signature tunes and prayers.

Bob Brooks received pictures in Band III from Holland on September 1, Denmark on the 2nd and 3rd, Norway on the 3rd, Belgium (RTBF) on the 4th and France (Canal+) on the 5th. Soon after the BBC2 transmission from Craigkelly, on Ch. E27, had closed down early on the 5th

George Garden (Edinburgh) noticed a weak signal that was obviously from one of the stations sharing the channel. He soon realised by the adverts that it was an ITV signal and the film they were showing was John Wayne in *The Commancheros*. This was followed by *America's Top Ten* and ITN news and, through his local knowledge, one of the adverts ruled

out a transmitter in Scotland. With his usual detective work at such times, George was surprised, but sure, it was coming from the Rowridge, Isle of Wight, transmitter of Television South. He wrote immediately to TVS, in Southampton, explaining his interest and they confirmed that it was their programmes reaching the north and that the cause was due to atmospheric conditions. Well done George, you have proved that when the weather and the pressure is right there is u.h.f. DX to be found when the strong local station goes off the air.

Simon Hamer had a good tropo haul in September when he logged pictures in Band III from Belgium, Eire, France, Holland and all Scandinavian countries on the 17th, Germany (ARD/SWF1) and Switzerland (+PTT/SRG) on the 18th, and Germany (HR1 and SWF1) on October 3. Also among those days he received u.h.f. pictures from Belgium, Denmark (TV2), France, Germany (Hessen 3, RTL+, SWF3, & ZDF), Sweden (SVT2) and Switzerland (+PTT/TSI). Early on October 11, **Carl Bowen** (Strelley) received strong pictures from Lopik (PTT-NED1) on Ch. E4 in Band I, various system 'L' French stations in Band III and Belgium (BRT TV2) and Holland (Ned.1, 2 & 3). The Dutch signal on Ch. E29 was very strong in full colour and with accessible Teletext. **John Woodcock** (Basingstoke) logged pictures from France in Band III on September 22 and 29. **Craig Obrien** (Washington) is getting excellent u.h.f. pictures with his ex-car boot-sale Sony 9-90UB receiver which he hopes to use for DXing in Bands I and III. Congrats on spotting this multi-band set Carl.



Fig. 1: Syria.



Fig. 2: Syria.

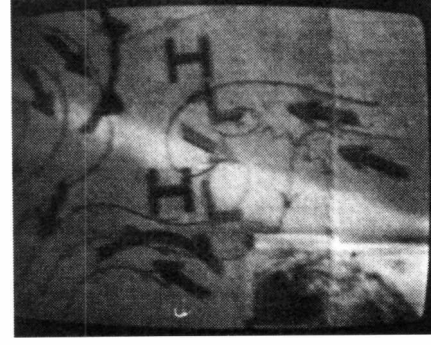

Fig. 3: Syria.



Fig. 4: Bangkok.

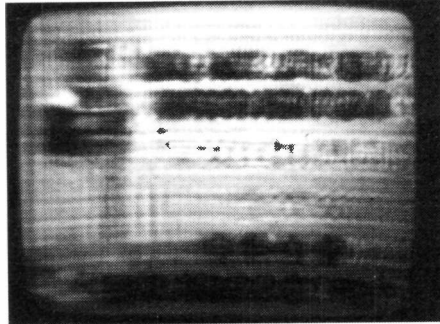

Fig. 5: USSR.

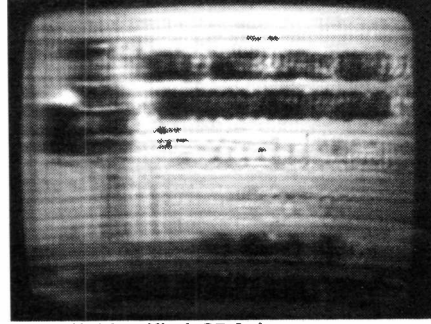

Fig. 6: Unidentified, SE Asia.

Satellite TV

Pete De Jong (Leiden, Holland) has installed an Amstrad SRX200 satellite receiver with a 600mm 'dish' antenna and recently received a news feed caption from Spain (TVE Galicia) **Fig. 8**, on Eutelsat ECS II F2 at 10°E and a test-card from Yugoslavia (JRT Beograd) **Fig. 9**, on Eutelsat ECS 4 at 7°E. Both transmissions were in good colour in the 11GHz band. My thanks to Pete for telling me that the caption, **Fig. 6**, in my October column, which I understood came from Czechoslovakia, was in fact from the USSR. The Cyrillic letters 'TCH' = 'TSN' 'Televizyonnaya Sluzhba Novostev' = TV News Service.

SSTV

During the month prior to October 7, **John Scott** (Glasgow) copied slow-scan television signals, around 14.230MHz, from stations in England, France, Germany, Spain, **Fig. 10**, the USSR and Wales. Among the ident frames were pictures of equipment **Fig. 11**, an operator **Fig. 12**, a map of Spain and such captions as 'NAME IS SLAUA' and 'OKEY VIDEO 100%'. John recently added an ERA BP12 data filter to his equipment and he tells me that the book, *SSTV Companion*, is very interesting and that, "it shows the first SSTV picture transmitted across the Atlantic by Copthorne Macdonald WA2BCW on 20 December 1959 and the received picture, received in England by John Plowman G3AST".

In Derby, an old friend, **Fred Ward G2CVV**, a past President of the RSGB, uses a TS-520 receiver, Spectrum 48K computer with the RX4 program from Technical Software to resolve SSTV pictures and an Alphacom 32 printer for the hard copy. In September, he logged 'CQ' captions from stations in Germany, **Fig. 13**, Italy, **Fig. 14** and the USSR, **Fig. 15**, around 14.235MHz. The seven horizontal lines on the right of **Fig. 13**, almost blotting out the callsign

letters 'SCY', are caused by interference to the incoming signal. Many years ago, Fred and I had the honour to be guest speakers at the annual gathering of St. Dunstan's Amateur Radio Society at Ian Fraser House, near Brighton.



Fig. 7.

Astronomical Gen

Readers who have a general interest in astronomy or are looking for specific data about the night sky, lunar and planetary happenings, eclipses, occultations and meteor showers in



Fig. 8: Spain.

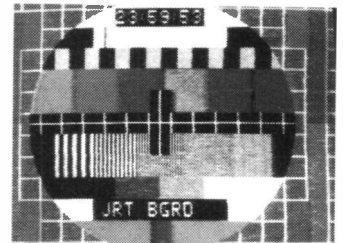

Fig. 9: Yugoslavia.

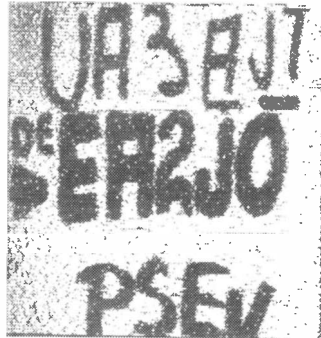

Fig. 10: SSTV, Spain.



Fig. 11: SSTV.



Fig. 12: SSTV.

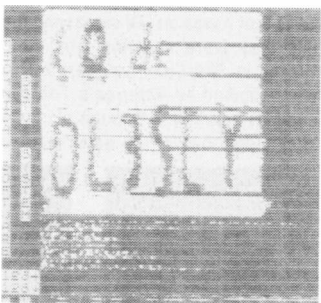

Fig. 13: SSTV, Germany.

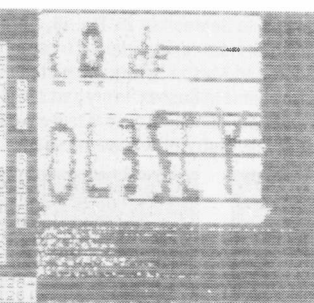

Fig. 14: SSTV, Italy.

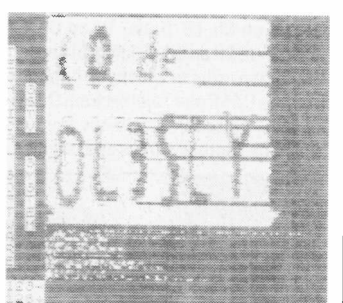
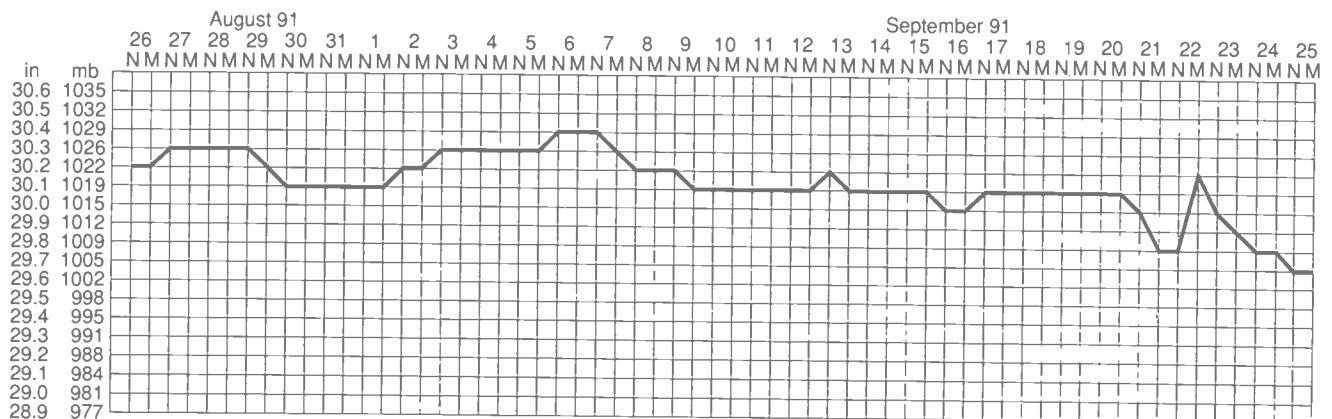

Fig. 15: SSTV, USSR.

Fig. 16.



Godfrey Manning G4GLM
c/o The Godfrey Manning Aircraft Museum,
63 The Drive, Edgware, Middlesex HA8 8PS

If you would be interested in a pleasure flight next year, please let me know. I need a sufficient number of participants before I can organise this event.

As an amateur museum curator, I do like to publicise other worthwhile ventures. Take a tip from **Tim Christian** (North Walsham) and visit the Newark Air Museum. One of the exhibits is a Hastings fitted for training Vulcan radar operators and it is open for visitors. When's my own Museum open? Ex-military air traffic controller **Ted Crease** (Bradford), and any other interested readers, can make an appointment to view by ringing 081-958 5113, weekday evenings only, please.

Radio Happenings

In September, I briefly described the satellite data link that transmits oceanic clearances to suitably equipped aircraft without them needing to speak to a controller. This has set **Dave Wright** (Sheffield) pondering about the future. My opinion is that satellites will eventually replace the inconsistent performance of the h.f. networks, certainly over the North Atlantic. Presently, the satellite only provides clearance delivery and it will take time for the conservatively-inclined aviation world to approve and convert to this new means of communication.

London Flight Information (example: 124.75MHz) covers a large area, so how can aircraft as far apart as Isle of Wight and Manchester ensure that they don't transmit simultaneously, thus making their signals unreadable to the controller? **L. Buckingham** (Manchester) wonders about this, as aircraft at 3000ft (QNH?) won't often be able to hear each other directly over that distance. My guess is that the distant transmitters relay signals from other parts of the country so that other aircraft know not to transmit. I don't know this for certain, perhaps an air traffic control expert would enlighten us?

Follow-Ups and Foul-Ups

Quick off the mark is **Denis Boshier** (Gwynedd) who immediately noticed the scrambled captions in November. Both pictures on page 51 of that issue were taken earlier this year at The

Shuttleworth Trust, Old Warden, by Chris. Top is a Tiger Moth in military colours and below is one of only two flying Miles M.14A Magisters (also known as the Hawk Trainer in civilian use) in trainer yellow scheme. Denis worked with Amy Johnson at Stag Lane in 1930 and if this de Havilland factory hadn't closed, then it would have been Edgware's own airfield! The inverted engine on Amy's aircraft suggests a Moth, predecessor to the Tiger (it also has less visibility from the front cockpit owing to different wing struts). Shuttleworth have one of these, too, and it is superfluous for me to remark that all these old types are kept in immaculate condition. Chris was particularly moved by Angus McVitie's display flying of Jean Batten's Percival Gull Six G-ADPR.

At the PFA Rally (where the photo on November's page 53 was taken), I did see one of the Moth family complete with a 'Made in Edgware' emblem on the fin. It will not have escaped readers' attentions that Edgware is my home town and my Museum is within 3km of the old de Havilland site. Denis asks about PFA - the Popular Flying Association, based at Shoreham Airport (Tel: (0273) 461616). The Association's main objective is the encouragement of good quality amateur construction of aircraft. Responsibility for inspecting such aircraft and issuing Permits to Fly is often delegated to the PFA by the CAA. If you're interested, the PFA is organised into local branches called Struts which often hold their own fly-ins.

Please note that all replies appear in this column, I don't enter into direct correspondence.

DC-10-30CF N112WA (47820) was last mentioned in November. **Paul Hilton** (Newbury) provides photographic proof that it was in World Airways (new) colours in August so this correspondence is now closed!

Your Flying Experiences

Lucky **Mrs. B.** (Isle of Man) has just returned from Orlando - having spent most of the flight in the cockpit! As previously mentioned, this is a special treat and readers should not expect this to happen as a matter of course. If, like Mrs. B., you demonstrate exten-

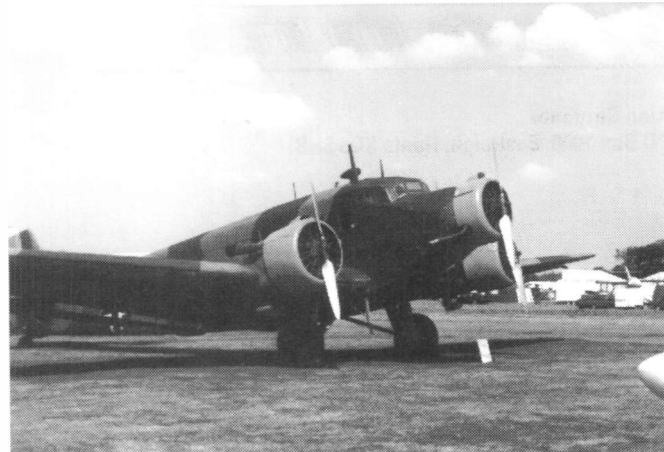

Fig. 1: Junkers Ju-52, also known as 'Iron Annie' or 'Tante Ju'.

sive knowledge of the procedures involved in the flight then the aircrew will be suitably impressed!

I'd like to devote a whole article to your comprehensive description, Mrs. B., but I just haven't the space - which is a pity. I've summarised the route elsewhere in the column, which is the least I can do. The Captain is also a reader of 'Airband', so thanks are passed on via these pages.

The route is rather to the north, near Iceland. This is because of your aircraft type: a twin-engined B.767-200, which can only cross the Atlantic under the extended range operations rules. Failure of one engine on a B.747, which has happened many times, is relatively inconsequential in the cruise, but loss of an engine on a twin is far more serious. You don't want to be too far from an aerodrome if this happens and hence the rules required you to fly a route that was never further than a specified flying time from an aerodrome. I don't remember the time - they keep extending it. Points to watch out for are whether the flying time is based on single engine airspeed, and whether or not there is an accessible alternate should the nearest aerodrome be closed due to weather. Perhaps the crew of this flight would care to contact me with the latest thinking on these operations?

Information and Equipment Sources

Tim Christian regrets that he has no more copies of his Consol guide (see October's issue). He does sell the 1991 updated issue of *World HF Aeronautical-Mobile R/T Frequency Allocations*.

Lancaster *Aries* was described in previous issues. **H.A. Lewis** (Surrey) has found this aircraft depicted on the video *Lancaster - The Story of the*

World's Greatest Bomber (DD242 from W.H. Smith, £15.30). The relevant clip starts 38min 45s into the programme. A Christmas present for someone?

Several military items have been acquired in good condition by **Tony Claydon** (London) who is making them available for sale. The bomb timers, dimmers, push-buttons, radio altimeters, etc., are even in original wraps despite being perhaps 30 years old. Make your offers directly to Tony on 081-361 8881 (day or evening). More Christmas presents?

Nick Ashby (Ruislip) discovered The Aviation Hobby Shop, 4 Horton Parade, Horton Road, West Drayton, Middlesex, to be a good source of the items and information that this column's readers will be interested in.

Hovercraft

Although the CAA are responsible for safe operations by public transport hovercraft, it is hard to call these machines aircraft. Nonetheless, I sampled the delights of one of these half-ship half-plane modes of transport. The last day of scheduled cross-Channel operations was on September 28 and I went to Calais and back on Hoverspeed's SRN-4 Mk. 3 GH-2007 *Princess Anne* (built 1969). Powered by four Bristol/Rolls-Royce marinised Proteus reverse-flow gas turbine engines (a combination I last experienced in 1968 on a Bristol Britannia) each driving a four-bladed variable-pitch propeller, and with two auxiliary power units, 400Hz electrical supplies and optional ground power, the aeronautical parallels are obvious.

The cockpit looks like an aircraft's with control yoke and rudder pedals. Instrumentation includes a directional gyro similar to that fitted to some aircraft; also an airspeed indicator, the pitot head of which sticks out forward from the cockpit roof. Unlike an aeroplane, each engine's instruments are laid out horizontally instead of in columns. The ride was slightly bumpy, waves being felt through the floor. The craft is remarkably stable and does not pitch noticeably up and down; roll is also minimal. Despite bad sea state, the hovercraft was far less conducive to motion sickness than a floating vessel would be. There was no sense of speed despite being able to cover 22nm in half an hour, but the vibration was about as bad as I remember from

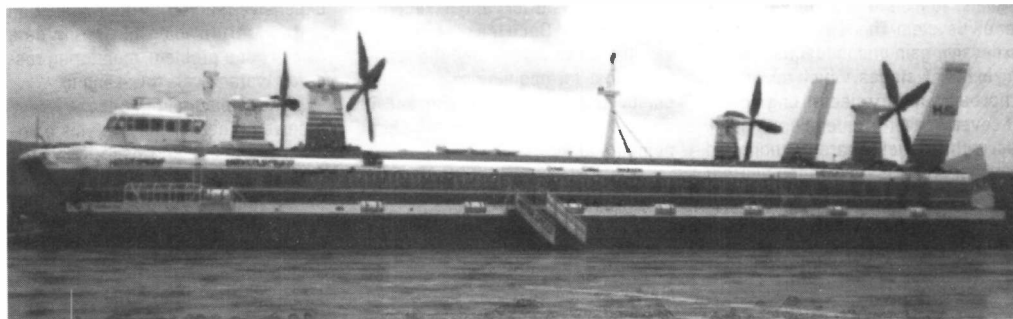

Fig. 2: Hoverspeed's SRN-4 Mk. 3 GH-2007 *Princess Anne*. Godfrey was on the final Channel crossing.

Alan Gardener
PO Box 1000, Eastleigh, Hants SO5 5HB.

Imagine my surprise when I received details of what most of been one of the best kept secrets in the scanning world - a new hand-held scanner from the company Alinco. Although the name may be new to scanning enthusiasts, many amateur radio operators already know of them and own their products. The scanner, known as the DJ-X1, has been designed to perform to the standard you would expect from a top of the range product with a frequency coverage ranging from 0.5MHz to 1300MHz, a large number of programmable tuning step sizes, 100 memory channels, detection of a.m, n.b.f.m and w.b.f.m signals with a very high degree of sensitivity, all in a case measuring 110 x 53 x 30mm which makes it about two thirds the size of its main rivals.

I don't want to say much more about it, as you will already have seen the advertisements by now, but I hope to try one of the first batch when they arrive in this country. From the brief details I have been given I would expect it to prove very popular especially at the anticipated retail price of £269. You can obtain further details from Waters and Stanton Electronics, 22 Main Road, Hockley, Essex SS5 4QS. Tel: (0702) 206835.

Tandy also have new models in the pipeline, but judging by the details I have seen so far I don't think that it is worth saying much more about them. As with most Tandy designs they seem to be based on scanners originally made for the American market and as such are not entirely suitable for use in the UK (with the exception of the PRO2004/5/6 series). I would expect these models to sell to ordinary members of the public via their high street stores as their price means that they don't compete too well against the more sophisticated models offered by other manufacturers that are advertised in magazines such as *SWM*.

In an interesting new development, Icom has announced two new amateur band transceivers offering the widest frequency coverage on receive currently available in such equipment. The Icom IC-2SRE is a 144MHz transceiver and the IC-4SRE a 430MHz transceiver both of which are capable of receiving over the range 25-950MHz. Because the equipment is capable of transmission you need an amateur radio licence before you can legally use it. The Wireless Telegraphy Apparatus (Receivers) (Exemption) Regulations 1989 (SI 1989 No.123) only dispenses the requirement for a licence from any Wireless telegraphy apparatus, "Which is inherently incapable of transmission". This would seem to be true of any of the large range of amateur transceivers offering extended receive coverage, so beware of the legal requirements before you part with your cash.

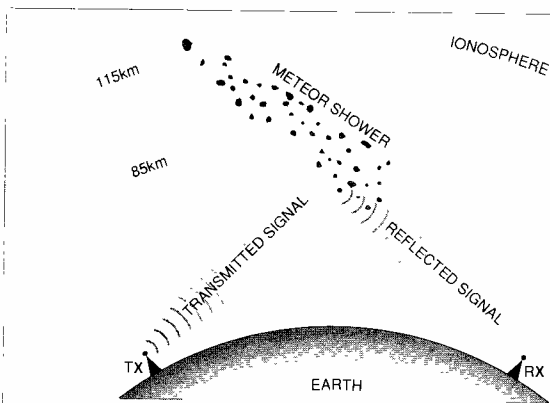

Fig. 1: Propagation by Meteor Scatter.

Law & Order

I am still going through all of the letters you have sent to me relating to the law and scanning receivers, some of which I hope to feature in a future column. Until then, I would just like to mention a point raised by a reader who is in the police force. This concerns the comment I made about chasing police cars whilst using a scanning receiver. He says that this is definitely not a good idea as you may be charged with 'going equipped' or 'being an accessory' if discovered with a scanner loaded with police frequencies at the scene of a crime. Both of which are substantially more serious than the charge of illegal listening you might anticipate receiving if caught.

Detective Work

A colleague of mine recently came across a communication system he thought would be of interest to readers of this column. The story begins when he was asked to help resolve a problem with a low power radio microphone system. This was occasionally experiencing interference in the form of a rapid machine gun type noise, which became noticeable when signals from the microphones dropped below a certain level. A quick check with a scanning receiver tuned to the frequencies used by the microphones revealed no sign of any interfering signals, so his attention turned to the receive system. This was found to have excessive gain and inadequate filtering in the r.f. stages, which resulted in it not being able to reject strong signals at several other frequencies. A quick test with a signal generator confirmed that there were many frequencies that the receiver could unintentionally receive, one of which, when monitored with the scanner was found to have a very strong pulse transmission on it.

As this was at a frequency just below 47MHz, the first thought was that it was more than likely to be an

illegal, and faulty, long range cordless telephone, many of which used to be used on farms in the area until the DTI Radiocommunications Division had a crack-down a few years ago. As tracing the source of the interference seemed an easier option than modifying the receivers - and more interesting - he decided to adopt this course of action. After borrowing some mobile direction finding equipment our hero rode off, estate car bristling with antennas, into the sunset.

After driving around in ever decreasing circles, he finally traced the source of the signal to a farm track out in the middle of nowhere - a little known village near Newbury! By this time it was getting fairly dark as he carefully made his way down the track expecting to find a farmhouse with an exotic TV antenna at the end of it. However, a few hundred yards down the road a large lattice tower loomed out of the darkness complete with four very large 3-element beam antennas aimed at each point of the compass. Rather excessive for a cordless telephone he thought!

Who could it belong to? 47MHz marks the top end of an international broadcasting band, but it has not been used in the UK for several years. The only other people using this band are the military but the installation didn't particularly look like a military installation. As he stood looking at the mast a farmer suddenly came marching down the track (or more accurately his track) and asked what was going on! Once the reason for the visit had been established the farmer was most forthcoming and supplied useful details about the site and its owners as well as a few telephone numbers to try.

Shooting Stars

To cut a long (and rather shaggy) story short, the site turned out to be the master station for a commercial communications system. This operates by reflecting signals from ionised particles

formed in the upper layer of the earth's atmosphere when meteorites pass through it. Around 10 billion meteors enter the earth's atmosphere each day. Most of these are microscopic in size and immediately burn up when they enter the earth's atmosphere.

However, a sizable proportion survive and produce the ionised trails and spectacular shooting stars you can sometimes see on clear dark nights at the peak of the annual meteor showers. As you may guess, this mode of propagation is called 'Meteor Scatter' and is frequently used by radio amateurs to provide short duration, long distance v.h.f. contacts. The 50 and 70MHz bands being particularly suitable for this purpose. As the meteor trails form at a height of around 85 to 115km above the earth this gives a potential communication range of around 2000km between stations.

How it Works

In the commercial system, the master station operates like a radar transmitter, continuously sending short duration pulses which may, or may not, be reflected back from an ionised meteor trail. If a reflection is detected, the master station then transmits a high speed data burst which will hopefully also be reflected from the meteor trail and received at the outstations. Data can be sent to, and received from, individual outstations and although the transmitted data bursts are quite rapid the actual data transfer rate is very slow. By listening to the number of data bursts occasionally transmitted instead of the more frequent pulses you can obtain an idea of the current number of meteors. The system is designed to operate effectively even during the lowest periods of activity.

By now you may be asking who would want to use such a system and why? Well there are many organisations such as water boards and oil companies who need to collect data from remote sites like mountain streams, lakes, oil platforms, meteorological sites, lighthouses, buoys and beacons, etc., all of which may be out of the range of a normal radio system especially if only a limited power supply is available. In such cases, a meteor communication system can be an inexpensive method of data collection and control providing that the low data rate is not a problem, monitoring reservoir water levels for example.

Since being told this story, I have received other similar systems operating on 40.925 and 41.650MHz, the rapid pulses of the master stations fading up and down in strength as propagation conditions changed. As I was hearing these stations at the same time as American Fire departments on 33MHz it could be that these two systems are also American. I know several systems are operating in the

YAESU
ICOM

MARTIN LYNCH

G4HKS

THE AMATEUR RADIO EXCHANGE CENTRE

ALINCO

KENWOOD

AMSTRAD

286 Northfield Avenue, Ealing, London W5 4UB. Tel: 081 566 1120 Fax: 081 566 1207

MARTIN'S MERRY CHRISTMAS SAVINGS!



AR3000



AR2000



NRD-535



AR2000



MVT-7000

R5000



AOR		
AR-2000	Hand-held scanner from the AOR stable	£249.00
AR-2800	The very best value all mode scanner	£365.00
AR-3000	The ultimate base/mobile all-mode scanner	£PHONE
ACE PAC	Computer software IBM PC for above	£119.00
YUPITERU		
MVT7000	Alternative to the AOR, very good	£269.00
VT-125	Serious airband hand scanner	£165.00
ALINCO		
DJ-X1E	Latest miniature hand scanner - in stock	£259.00
ICOM		
IC-R72E	Excellent Short Wave receiver	£579.00
IC-R71E	Still an excellent performer	£PHONE
IC-R100	A scanner to beat the competition with	£469.00
IC-R1	Caused a storm on release, still the smallest	£329.00
IC-R7100E	Successor to the 7000. Now in stock	£PHONE
LOWE		
HF225	The best receiver I've sold in years. And it's British!	£429.00
JRC		
NRD 535	Top end performance RX, now even better value	£925.00
KENWOOD		
R2000	Very popular Gen. Cov. RX offered at very special deal	£PHONE
R5000	Available with, or without VHF converter, special deal	£PHONE

In addition to new receivers and scanners, don't forget I still have the largest selection of used equipment available in the UK. I am very willing to take your equipment in part exchange - Phone with your requirements NOW!

My shop is easy to get to - it's just across the road from Northfields underground station on the Piccadilly Line. It's the closest store to Heathrow by tube and only 5 minutes from the M4/40/25 motorways and 20 minutes from the M1.

The very best of seasons greetings to all my customers who have been "Lynched" during 1991. Thank you for your support and I hope I can help reduce the burden of any surplus cash in your savings during 1992!

73 MARTIN G4HKS
GRAEME G4XOF & VALERIE G4WIS, JOHN, GEORGE, CHRIS AND THE REST
OF THE SEVEN DWARFS

Martin Lynch is a Licensed Credit Broker.
Full written details upon request. Typical APR 36.8%
PHONE 081-566 1120

For fast mail order Tel: 081-566 1120. Please add £10.50 for 48 hour delivery.
SHOP OPENING HOURS: Tuesday - Saturday 10 - 6pm.
24 hour Sales HOT LINE 0860 339 339 (after hours only.) FAX order line open 24 hours.

**BUYING
OR SELLING...
DIAL
081-566 1120
NOW!**

Extra
throughout December -
Mince pies all round
(Valerie baked 3000
of the blasted things. They were
on offer last year but I couldn't
get rid of them all). Beats
'Choc Chip Cookies' any day.
Do me a favour -
have one with
your coffee!

THE FLYING SHOP

BIGGIN HILL AIRPORT

YUPITERU VT-125

- Excellent Reception ● 108-142MHz ● 30 Memory Channels
- Illuminated LCD Display 150 or 100kHz Steps
- Search, Scan or direct frequency entry ● Keylock ● Keyboard beep tone ● LCD Signal Meter

ONLY £93.94 inc VAT

Complete with 3 AA size NiCad Batteries, 240V Mains adaptor, 12 v.d.c. cigar plug & carry strap

ALSO AVAILABLE, YUPITERU VT-125 MkII

Specification as VT-125 but with addition of 25kHz steps. £165.00 inc VAT

MAC/WIN 108

- Compact ● 108-142.975MHz ● LCD Display ● Search, Scan or direct frequency entry ● Key lock ● Priority Channel

ONLY £116.00 inc VAT

YUPITERUMVT-7000

1MHz-1300MHz

- AM-NBFM-WBFM ● Multiple steps ● Better than 0.5µV ● 200 Memories ● Rotary Dial ● S-Meter ● Fast Scan Speed ● Lockout/Priority ● NiCads ● Charger/AC PSU ● 12V Lead

The MVT-7000 is the latest from Yupiteru and provides unbroken coverage throughout the spectrum. Each one is carefully tested by us and supplied with a unique power supply that will not only recharge the ni-cads, but also run the set directly from the mains. Its beautifully styled lines and superb engineering make it the best buy for the customer who wants the widest frequency range possible.

£275.00 inc VAT

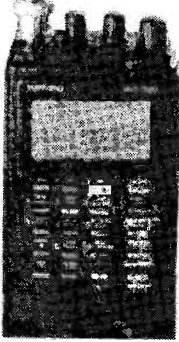

The Flying Shop, Biggin Hill Airport,
Westerham, Kent TN16 3BN

Tel: (0959) 76370 0900 - 18 00 (Mon-Sun)
(0959) 72352 0700-0900 & 1800-2000
Fax: (0959) 76711 24 Hour.



SIGMA EURO-COMM

Importers of Communication Equipment
Manufacturers of Antennas & Accessories
AMATEUR - SCANNERS - ANTENNAS - CB

★ N E W ★ AR1000 XLT HAND HELD

Frequency Coverage 500kHz-1300MHz No gaps.
AM/NFM/WFM - Supplied with the following accessories: ♦ Wide band whip aerial for VHF & UHF ♦ AC Charger ♦ 12V DC Lead & cigar lighter plug for mobile use ♦ 4x AA Nicad batteries ♦ Soft case & strap ♦ Earphone

£259.00 + p&p.



AR 2800 Mobile/Base

500MHz-1300MHz

AM/NFM/WFM & SSB £395.00 + p&p

AR2500 Mobile/Base

1MHz-1500MHz

£419.00 + p&p

MOBILE SCAN ANTENNA

Twin coil 25 to 1300MHz available with PL or 3/8 fitting.

FREE with all Scanners sold via Mail Order - DISCONE ANTENNA



SIGMA SE1300

20-1300 MHz Receive
Transmit 50, 144, 430,
900, 1200 MHz input
power rating: 200 watts
input impedance: 50 ohms.

£59.95 + p & p



SIGMA SE700

70-700 MHz Receive
Transmit 70-500 MHz
Max Power on transmit
500 watts impedance
50 ohms.

£24.99 + p & p

Mail Order: Cheques and P.O. made payable to Sigma Euro-Comm.

TRADE ENQUIRIES WELCOME

After 6pm and Weekends 021 705 3441 and 0922 414836

Sigma Euro-Comm, Unit 14, 272 Montgomery St., Birmingham Enterprise Units, Sparkbrook, Birmingham B11 1DS. Tele/Fax: 021 766 8146

DEWSBURY ELECTRONICS

NEW

EASY READER DM-1000

NEW

Introducing the all new 'EASY READER DM-1000' RTTY/CW DECODER.
In our opinion "the most simple to use decoder ever seen".

- RTTY BAUDOT 45/50/75 BAUD
- CW SPEED 2-99 WPM
- RTTY ASCII 110 and 200 BAUD
- AUTOMATIC OR MANUAL SPEED SELECTION
- ON SCREEN TUNING INDICATION
- STATUS LINE ON SCREEN GIVING MODE, SPEED IN USE AND PRINTER ON/OFF
- OUTPUT TO VIDEO MONITOR AND PRINTER (CENTRONICS/PARALLEL)
- OPTIONS: UHF TV OUTPUT RS-232 OUTPUT

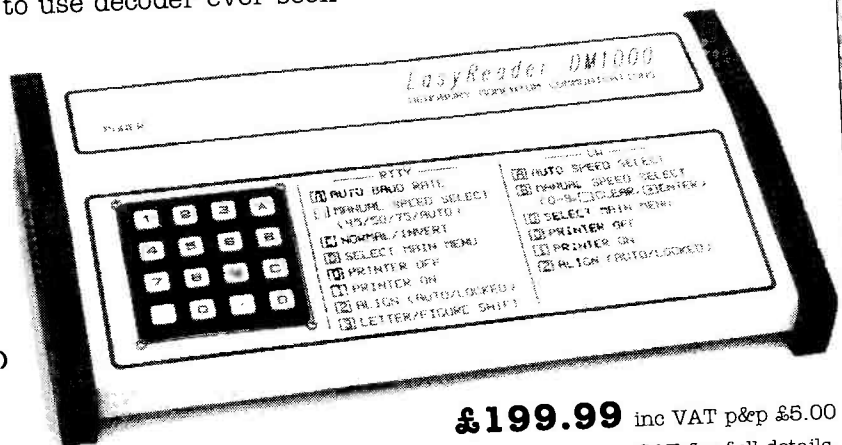

£199.99 inc VAT p&p £5.00
SAE for full details.

Stockists of DIAWA - VIBROPLEX - ICOM - YAESU - KENWOOD - JRC - WAVECOM

DEWSBURY ELECTRONICS, 176 LOWER HIGH STREET, STOURBRIDGE,
WEST MIDLANDS DY8 1TG

Tel: (0384) 390063/371228 Fax: (0384) 371228

Instant finance available subject to status. Written details on request.

Name of Shower	When Present	Peak Activity	Rate/Hour
Quadrantids	Jan 1-5	Jan 3-4	100
April Lyrids	Apr 19-25	Apr 22	12
Eta Aquarids	May 1-12	May 5	25
Piscids	May 3-10	May 7	30
Nu Piscids	May 11-14	May 12	20
Arietids	May 30- June 18	June 8	60
Zeta Perseids	June 1-16	June 8	40
June Perseids	June 22-30	June 26	30
Nu Geminids	July 9-15	July 12	60
The Perseids	July 20-Aug 18	Aug 12	65
Taurids	Oct 10-Dec 5	Nov 1	16
Geminids	Dec 7-15	Dec 13-14	55
Ursids	Dec 17-24	Dec 22	18

US where they are used by trucking companies to provide data links on long haul routes. However, as far as I am aware there is only the one system operating in the UK giving a coverage of most of Northern Europe. No doubt we will hear more systems such as this operating as the requirement for data links steadily increases during the next decade.

Long Distance Signals

Whilst we are on the subject of long distance communications the winter is now with us and so too is enhanced propagation on the lower v.h.f. bands. This is as a result of changes in the ionosphere F2 layer, which occur during the winter months. I included a description of this mode of propagation in the September 1990 column if you need more detailed information.

Most American services use

n.b.f.m. with 20kHz channel spacings, but I find it worthwhile tuning in 5kHz steps as there are many other stations operating between the US channels. These include East European transmissions on 34.2, 34.425, 34.5, 34.6 and 34.7MHz with Spanish and Italian sounding signals on 34.5 and 35.08MHz. Although I suspect that these last two signals may originate from South American countries.

I don't use any special antenna, it would seem if you can hear stations then almost any antenna will work. I have tried switching between a CB

antenna tuned to 35MHz, a 50MHz folded dipole, Datong active antenna and my normal 70-1300MHz log-periodic with only a slight difference in intelligibility, although it must be said that there was quite a big difference in received signal strengths. At some stage, I hope to experiment with a horizontal antenna in order to see if I can use its directional properties to separate stations on the same channels. The only other problem with monitoring foreign stations in this band, apart from the high level of computer-generated hash encountered in most

urban areas, is being able to understand the many different accents being used by what are nominally English speaking people.

I know that there are already several readers who regularly monitor these bands, so how about dropping me a line and letting me know what you have heard and when you heard it. Along with any other relevant information, I will include details from the most interesting letters received in future columns.

So until next month - Good listening.

➔ 53

airband

the Britannia! The cabin has aircraft-type seat tracks and 3+3 seats but there are no lap straps and there is the feeling of space only shared by wide-bodied aircraft. Big windows are fitted instead of portholes.

On the radio side, there are marine m.f. sets, two primary radars (true and relative motion), Decca Navigator and Doppler. Unlike aircraft, collision avoidance is by on-board radar. A radar operator, surrounded by black-out curtains, sits behind the pilot and feeds him information on possible conflicts. I was told that hovercraft talk to each other on marine (f.m.) Channel 33 (vessel transmits on 157.65 and receives on 162.25MHz), but I'm not sure how the full duplex works between craft as distinct from ship-to-shore. At each hoverport is a control tower that allocates parking stands on channel 35 (vessel transmits on 157.75 and receives on 162.35MHz). What a sad day that these quick, smooth, efficient and technically fascinating craft are being withdrawn.

Frequency and Operational News

GAJIL 10/91 from the CAA announces a new approach/v.d.f. frequency at Oxford: 125.325MHz. As mentioned in my review of Tim Christian's booklet, the Novair (Gatwick) h.f. circuit has ceased operations (6.654 & 10.021MHz).

Once again the CAA has revised three charts. They are UK Airspace

Restrictions and Hazardous Areas RAC 5-0-1; UK Areas of Intense Aerial Activity, Aerial Tactics Areas and Military Low Flying System RAC 5-0-1.1 and UK Winch Launched Activities RAC 5-0-2. There is also a new chart: UK ATS Airspace Classifications RAC 3-0-1. If you need these million-scale charts then they are free of charge from CAA Chart Room, Room T1120, CAA House, 45-59 Kingsway, London, WC2B 6TE but a self-addressed adhesive label is appreciated as it saves the CAA staff's time.

The new airspace classifications are worth a mention, although I doubt if readers (including pilots) will notice much practical difference compared to previously. In order to fall in line with international standards, UK airspace is now divided into seven categories. Five are controlled airspace (only four are actually used at present) and two uncontrolled. This redefines various control zones and special rules areas. For full details, which are complex, consult AIC 86/1991.

At Birmingham, the new Eurohub has caused the stand numbers to change as follows. Eurohub replaces stands C30, C32, D31 and D33 and the Common Travel Pier. Instead there are now stands 1-5 inclusive, 12-16 and 30. On the International Apron are 31, 32, 40-44 inclusive, 51-58 and 63-69. Quite logical?

JetRanger pilot Derek Roe (Reigate) saw a new miniaturised d.m.e. ground transponder at the Helitech show. British made, one's on test at Fair Oaks ('TST' channel 119Y, paired with 117.25MHz). Such a convenient device is in demand by many smaller aerodromes, but finding sufficient spare channels for them will be a problem.

G-HEMS (pictured in October) was seen to navigate by Greater London Atlas grid squares when it called in to a park in Edgware. What's more Ron Galliers (London) has found out that its call sign changes from Mike Sierra to Medivac when actually 'on a job'. Ron is puzzled by military aerodromes that use 122.1MHz. This is a NATO common standby frequency and all military aerodromes should have it. No matter what else, pilots visiting strange bases should consistently be able to make contact on this frequency. Hence it's often used to control airshows. If there's a military aerodrome traffic zone penetration service to help overflying civil pilots, then this is normally on a different (published) frequency. Not all military bases have this however - Lakenheath hasn't one, for instance.

Let me help Ron out with information on Neatishead. The h.r.t.a. is a high-intensity radio transmission area. Not only is this the controlling authority for North Sea danger areas EGD316/7, but it also provides RAF Operations on 4.710MHz. The frequency is listed in Tim Christian's book; the danger areas are shown on RAC 5-0-1; see above. Pilots needing to cross the danger areas should first telephone Neatishead for activity information (the number is also on the RAC 5-0-1 chart).

Propagation Predictions

Tim Christian suggests the following to be likely paths to the UK around now. Pacific (morning 10.048MHz; late afternoon 11.384). South Pacific (early morning 8.867MHz, improving through the winter). South America (early morning 6.649MHz, grey line).

Some from Geoffrey Powell (Tamworth). South Atlantic (morning 8.855, 5.526, 3.479MHz). China (evening 8.942MHz).

The next three deadlines (for topical information) are November 29, January 10 and February 7. Please send all correspondence intended for 'Airband,' c/o The Godfrey Manning Aircraft Museum, 63 The Drive, Edgware, Middlesex HA8 8PS.

Britannia Flight BY392A Manchester - Orlando, Florida (Boeing 767)

Extended-range twin-engined operation, outside the organised track system. Hence within v.h.f. range for so much of the flight. Cruise FL390. Route goes up to Scotland, passes Iceland and Greenland and then follows the American East Coast as follows: Manchester - Benbecula - N59W10 (Oceanic entry) - N61W20 - N63W30 - N64W40 (most northerly point) - N62W50 N60W60 - Fassa - Bangor - Boston - Richmond - Virginia - Orlando. Frequencies (MHz): Iceland 127.85; Reykjavik 125.7; Reykjavik NAT-D 132.2; Sondrestrom 121.3; Gander 124.8; Gander Centre 125.9.

Britannia Flight BY392B Orlando, Florida - Manchester (Boeing 767)

Almost the reverse of BY392A except for the Oceanic section as follows: Schefferville (Oceanic entry) - N60W60 - N63W50 - N64W40 - N63W30 - N60W20 - N58W10 - Benbecula. Frequencies (MHz): West of W30 132.6; Gander 133.9; Moncton 121.3.

Lawrence Harris
5 Burnham Park Road, Pevereil, Plymouth, Devon PL3 5QB

After a period of 'steady as she goes' (no pun intended) with the weather satellites, problems seem to have hit METEOR 3-4 during late September, and then METEOR 3-5 during October. I leave my scanner on while doing other work, and noticed that 3-4 didn't come on for the 1117UTC pass on September 26. It came back on during the evening, seeming to be a little early, causing me to suspect that its orbit had been changed. Then its infra-red transmissions ceased. On October 5, it came on as expected at about 1020UTC, but then I heard it switch off. It was travelling northbound over the Atlantic and the transmissions started again a few minutes later! This most eventful pass continued with 3-4 again switching off after two or three more minutes. As it was over the Atlantic, I don't think that it was being commanded from the Russian control centre, though I do know that there are ships that can command it. Following that pass, METEOR 3-4 remained transmitting visible light pictures but with no infra-red during the night-time part of its orbit.

I left my tape recorder set to record overnight transmissions on 137.30MHz, but there were none until on October 9 when I recorded a full tape. Playing it back, I was able to correlate the scene with my tracking program and identify METEOR 3-5. This was confirmed later when a live pass was taken. Since then, METEOR 3-5 has remained on continuously, providing both visible and infra-red transmissions. METEOR 3-4 was switched off around mid-October, at which time an apparent fault developed on 3-5 with the picture being replaced by irregular grey shadings. By October 23 its picture had returned to normal. METEOR 2-20 has been operating on 137.85MHz as usual.

OKEAN

For several weeks I had not heard, or recorded, any transmissions from either OKEAN 2 or 3, and reports from regular correspondents such as **Peter de Jong** of Leiden in Holland, also mentioned the lack of OKEAN transmissions. So the few seconds of recorded data that I found on September 29 were very welcome. It was a short radar image taken around Norway, with 'piano-key telemetry' but no numbers (which can identify the time). The next few days saw the same area being scanned with the on-board radar system, and producing very clear pictures. My tracking program suggested that it was OKEAN 3 at about 0500UTC. The typical OKEAN 3 imagery recorded by **Ron Hogben** of Dover is shown in **Fig. 2**. His picture shows the 'piano-key telemetry' section on the left and the image of south-east Greenland on the right.

METEOSATS 3 & 4

During the autumnal equinox (the period around September 23), the sun crosses the celestial equator where geostationary satellites orbit and so a ground-based antenna pointing at METEOSAT or GOES, etc., will have the sun pass through the beam at about mid-day. This is followed by the satellite itself being eclipsed by the earth's shadow at local midnight. Satellite controllers call this phenomena the 'eclipse season' and transmission schedules are adjusted to avoid using them. METEOSAT 3 continues to provide a.p.t. of excellent quality from its location near the eastern seaboard of the USA.



Fig. 1: Brian Taylor's NOAA 11 picture on August 30.

GOES Update

Here is an up-to-date summary of the various GOES satellites, taken from a BBS file kindly provided by **Paul Wilson** of Macclesfield who sends me regular files from foreign BBS.

GOES-2: This is in the stand-by position at 60°W, sometimes heard in the UK during the day, and provides WEFAX and digital broadcasts (taken by GOES-7). It is using an eight metre antenna, and transmits its operating schedule daily at 1055UTC. From western Britain GOES-2 reaches about 20° elevation around mid-day, falling to about 4° near mid-night. At 1800 and 0600UTC it is about 12° elevation. Counties further east will not get such good elevations.

GOES-3: This is also on stand-by, positioned at 174°W so cannot be heard in the UK.

GOES-6: Positioned at the GOES-West location at 136°W, so cannot be heard in the UK. It provides WEFAX and other data and its schedule is also broadcast at 1055UTC. It relays METEOSAT data as well, and uses a 13m antenna.

GOES-7: Positioned at 97°W is the prime operational satellite, but is invisible from the UK.

Coming Launches

The next few weeks should include a further METEOR WXSAT (presumably 3-6) that is scheduled for a November launch from Plesetsk in the USSR. December 10 should see the next NOAA satellite, number 13, due to be launched from the Western Test Range on an Atlas E rocket. The next Shuttle flight is *Atlantis*, currently scheduled for launch in November.

Other Satellites

Following requests from some correspondents, I periodically mention the satellites transmitting in the bands near to 137MHz. Tuning into the 149MHz band, you should hear a series of Cosmos navigation satellites:

Cosmos 2004 and 2154 on 149.94MHz

Cosmos 2142 on 150.03MHz

Cosmos 2016, 2100 and 2125 on 149.97MHz

Cosmos 2074 on 149.91MHz

There are also at least three satellites using 150.00MHz, namely Nadezhda 1, 2 and 3. All of these satellites are easy to hear and even a portable scanner used outside should pick some of them up within half-an-hour or so. My thanks to **Geoffrey Falworth** of Penwortham for providing the satellite identification. The early British satellite X3, also known as PROSPERO can still be heard on 137.56MHz, unless it has been recently switched off. Finally, MOS 1B can be heard transmitting on 136.11MHz. Its companion MOS 1 was also using this frequency but now appears to be off.

Dipole Phasing

A letter from **Peter Wade** of Sevenoaks explained about the problem that he had in getting a consistent signal from the polar orbiting satellites, even though his antenna has clear views all round. Peter described the symptoms that pointed to an incorrectly phased crossed dipole. A simple dipole can be used to test a system at ground level and this would show that good signals are available, lasting some 10 or more minutes, which could then indicate that the roof antenna connections are the wrong way round. My own antenna had a similar symptom though the fault turned out to be a broken phasing harness that the suppliers immediately replaced. A second letter from Peter told me that the fault had been located - in his receiver!

ESA

The European Space Agency publishes a number of periodicals designed to keep organisations and individuals aware of its activities. The *ESA Bulletin* is a quarterly magazine containing some technical papers as well as articles of general interest. The latest edition features pieces on Hermes, the retrievable manned spaceplane that will be able to visit MIR and FREEDOM. *Earth Observation Quarterly* is mostly

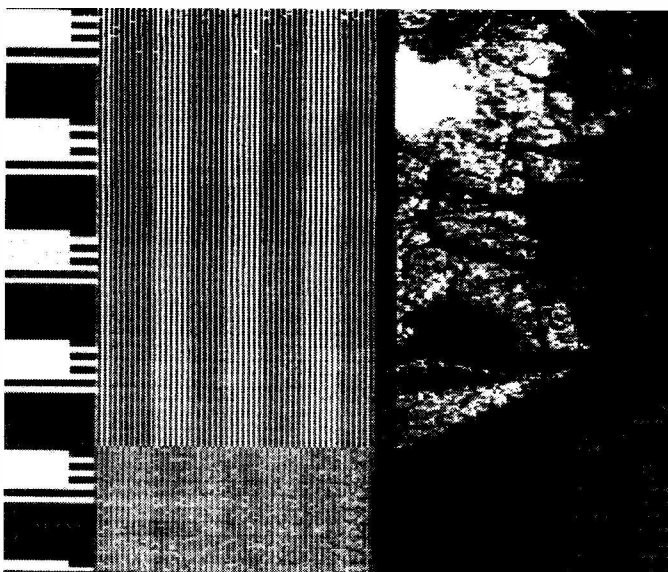

Fig. 2: Ron Hogben's OKEAN 3 picture from August 19.

about the applications of remote sensing, i.e., using the high resolution sensors on board satellites such as NOAA and METEOSAT. The articles are fascinating, if technical, and include pictures from SPOT as well as those mentioned. 'Reaching for the Skies' discusses the rocket systems used by ESA and the latest edition looks at the effect of launches on the ozone layer, currently a topic of discussion. Finally, ESA has just started a new periodical *Preparing for the Future* which is another technical publication dealing with the technology of space hardware. I will try to obtain some ESA photographs for publication in this column.

Letters

Gerard Melia of Stockport has recently set up a Cirkit receiver to feed his '286' computer running PCGOES. There will be a new version of this program soon and I shall provide details in a month or two. **Brian Dudman** of Harrow is a regular reader of this column (thanks Brian, that makes at least two of you!) and operates two computers, one for picture decoding and the other for satellite tracking. He sent me several pictures, and one from METEOSAT is shown in Fig. 3. He has recently bought Prosat 2 (a later development from PCSAT3), which I am also reviewing shortly. Brian comments that his purchases have made WXSAT monitoring an expensive hobby! He also asks about receiving OKEAN signals - they are few and far between. The best method is undoubtedly to leave a tape recorder operated by the SQUELCH control on the receiver; when a signal is heard on 137.40MHz the SQUELCH will open the circuit and start the tape recorder. There may be a long time between transmissions, however!

M Griffin GU8THM of Cardiff has recently taken an interest in weather satellite monitoring and uses an AOR 2002 scanner. As has been mentioned previously in this column, virtually any scanner that can tune into the 137MHz band should be capable of hearing WXSAT signals because they are fairly strong. Even the short whip antenna often supplied will pick up some signal when a satellite is high above the horizon. Producing a good picture though is another matter - the bandwidth used by most scanners is not optimised for WXSAT use and so that type of scanner is best used for monitoring rather than decoding. I use an unmodified Tandy PRO-2004 scanner, fed from either an external WXSAT antenna or the discone in my loft. With either antenna I can monitor a large number of satellites.

The framestore continues to be popular amongst readers of this column and **Alan Thompson G6TKM** of Nottingham has adapted his to provide

four picture animation. His receiver is the Dartcom unit and he has built a 1.2m dish which is positioned some 4m above ground level - see Fig 4. Alan has set up a tracking system for his dish, guided by a Dragon 32 computer. **J Howe** of Horsham wishes to use his Sony ICF-SW7600 receiver for FAX charts and satellite images but is unsure whether that receiver is suitable. With a good antenna and a sideband capability, fax charts should be decodable, but I also referred him to Mike Richards who is the resident *SWM* expert on FAX reception.

One of the few correspondents to write about the Cirkit receiver is **Andrew Melia** of Stockport. He comments that after some teething problems he got his first image from NOAA 11, showing almost the whole of Europe. He uses a '2086' computer.

Monitoring MIR

I must mention a letter from **R Hastie** of Exeter who was able to hear the Russians aboard the MIR space station in late September because of a broadcast from Radio Devon which had a local astronomer in their Plymouth studios. The times of MIR's flight over Britain were given and so tuning in on 143.625MHz his family were able to hear both the voices and the data transmissions. MIR's orbit has an inclination of about 51° which brings it over Britain for about five or six consecutive orbits every 90 minutes or so, followed by a gap of several hours before the next group of passes. I am glad that my broadcast was of help!

R D Matthews of Romford uses an Atari 1040 computer and Meteosat convertor, and asks about the availability of software to receive live pictures in colour rather than just blue or

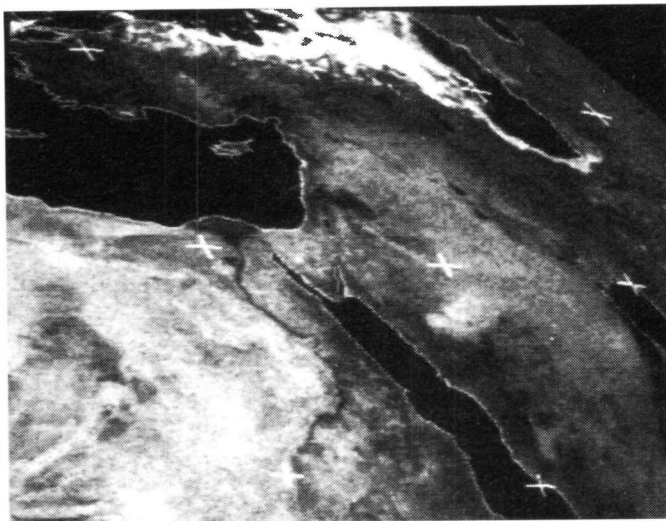

Fig. 3: Brian Dudman's METEOSAT 3 picture from August 25.

grey. I'm not sure what software he uses to produce the pictures but assume that it does not have a colour option. It is important to remember that none of the weather satellites actually transmit colour pictures. The scene below the satellite is scanned and the image is analysed for its brightness, temperature, or other component. This information is then coded and transmitted in real-time (live). It is possible to add artificial colour by allocating colours to sections of the grey scale e.g., the black section can be represented by blue shades, and intermediate greys by greens etc. Under the right circumstances a very realistic colour image can be obtained. Brian Taylor of Woking has sent me one of the best colour pictures that I have seen - see Fig 1 and use your imagination! Brian has a Dartcom/British Aerospace system.

Frequencies

NOAAs 9, 11 a.p.t. on 137.62MHz
NOAAs 10, 12 on 137.50MHz
METEOR 2-19 or 2-20 on 137.85MHz
METEOR 3-4 or 3-5 on 137.30MHz
OKEAN 2 or 3 on 137.40MHz occasionally
FENGYUN 1-2 was on 137.80MHz (keep watching)

Bulletin Boards

For those able to dial up the American BBS the number of the Celestial Bulletin Board which I understand carries recent Kepler elements, is 513-427-0674. There are also BBS in the UK which I hope to include next month after checking with the providers!

Kepler Elements

For those readers who don't have access to the electronic bulletin boards just mentioned, I will send a print-out of the latest set upon receiving an s.a.e. All known weather satellites are included, together with their transmission frequencies if operating. My set is from data kindly supplied by NASA. **Norman Darnborough** of Checkheaton asks how often one should update the elements in a tracking program. I would suggest between four to six weeks is reasonable. By that time, METEOR predictions will still be within a couple of minutes, NOAA times maybe three minutes out, and OKEAN perhaps five minutes or so. The errors are less with the higher orbiting satellites because atmospheric drag is reduced.

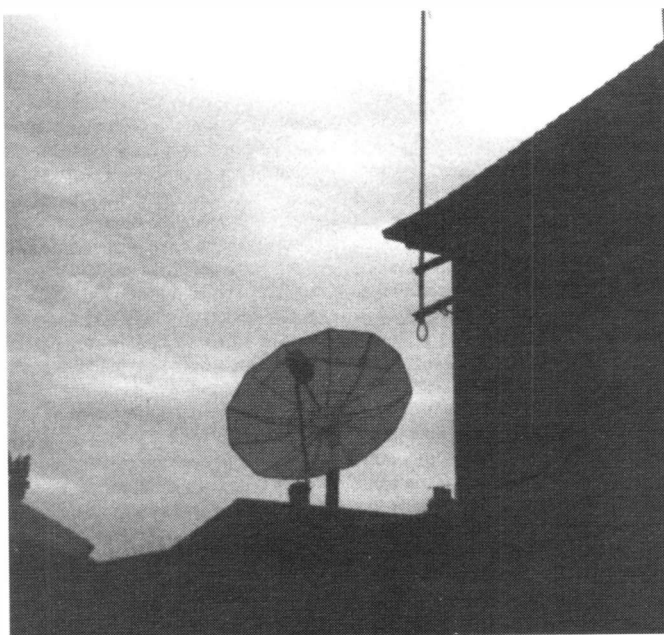

Fig 4 Alan Thompson's dish.

Mike Richards G4WNC
200 Christchurch Road, Ringwood, Hants BH24 3AS.

William Eyre of Stockport wrote some time ago asking for advice on how to solve his interference problem. He'd just changed over to an Amstrad PC-2086 computer running the Code-3 decoding package. In his letter, he reports that the final solution was to change his computer for an ICL DRS M45, this completely cured his interference problem. I have to say though that it's usually the interconnections that cause the interference rather than the computer itself. The worst offender is usually the video monitor and its connecting leads. When you change the computer, you usually end up changing all the interconnecting leads as well and this often has the greatest impact on the interference levels. With reference to the Amstrad PC-2086, I've been running this unit for some time with the Code-3 package and suffer no significant interference problems.

William is one of the first people I've heard from to QSL with the Swiss Radio International RTTY service, mentioned last month. His QSL card arrived recently.

I also have a couple of pleas for help this month. The first comes from **Victor Lateo** of Slough. He currently runs the Bonito system on his Amiga computer and would like to move-on to receive SSTV and SITOR. Does anyone know of a source of suitable software?

S. Robinston from Middlesbrough has been building-up a system from designs published in the Maplin magazine. These units have been combined to make-up a basic terminal unit for RTTY reception. The only problem he has is a lack of suitable software. His main interest is RTTY and FAX, though I suspect his terminal unit will only be suitable for RTTY type signals. Can anyone help with a source of decoding software for an Amiga 500 with 1Mb of RAM.

John Robertson of Northumberland is a newcomer to utilities and has set himself up with one of the popular ERA Microreaders. However, he wants to couple it up to his BBC B computer so he can take advantage of the larger screen. He has made the lead and loaded the program I printed a few months back. The only trouble is that the interference from the BBC B wipes out any usable signals. John has written asking if I have any tips to reduce this interference to more reasonable levels. Interference problems are never easy, but the BBC B has been well documented. The most common cause of interference is the RGB video output and colour monitor. You might like to try the using the u.h.f. output of the BBC B with a monochrome television. Other points to check is that your station is properly earthed with ONE earth point and that all signal connecting leads are screened. You could also try wrapping some of the connecting leads around lengths of ferrite rod.

Serial Data?

With the large numbers of newcomers to the world of utility listening, I think it's appropriate to include the odd tutorial in the column. For this month, I've picked on an area that many find difficult to grasp - serial data. With the majority of utility stations transmitting serial data, it's clearly an area that should be understood.

Rather than give a highly theoretical view, I'll try to keep to practical examples to simplify the explanation.

Let's start by considering how we could communicate between two computers in the same room. If the computers were both the same, we could put the information we want to send on a floppy disk and simply move the disk between computers. But what if the computers are different types with incompatible disk drives? One option would be to wire the computers together, but we need to think about what to connect and how many wires we would need.

Fortunately, there is a comparatively simple answer to this as most modern computers are supplied with a serial port, often called an RS-232 port. This port or connector operates to an internationally agreed standard so enabling different computers and auxiliary equipment to be connected together. Before we go on to examine the connection in more detail, let's take a look at the information that we want to send.

For the sake of this example, let's assume we've written a message on one computer and want to transfer it to another. Although we would have typed letters on the keyboard, the computer can only work with numbers. Because of this, the computer converts each key-press into a number and then stores the number. The conversion process operates very simply by using a look-up table to convert between letters and numbers. To make sure that all computers use the same look-up table, it's been standardised and is known as ASCII or American Standard Code for Information Interchange. The standard character set uses numbers between 0 and 127 to cover upper and lower case letters plus numbers and punctuation.

For the next stage, we need to understand a bit about the type of numbers used by computers. Although computers may appear very clever, they only use very simple logic to carry out tasks. The trick is that they operate very quickly and don't make mistakes! This simple logic results in their being only two states for the electrical circuits - on or off. This means we can't use the familiar decimal numbering system. What we need is a numbering system that can operate with two states that we'll call 1 and 0. The answer is to use the binary system which operates to base 2 instead of the base 10

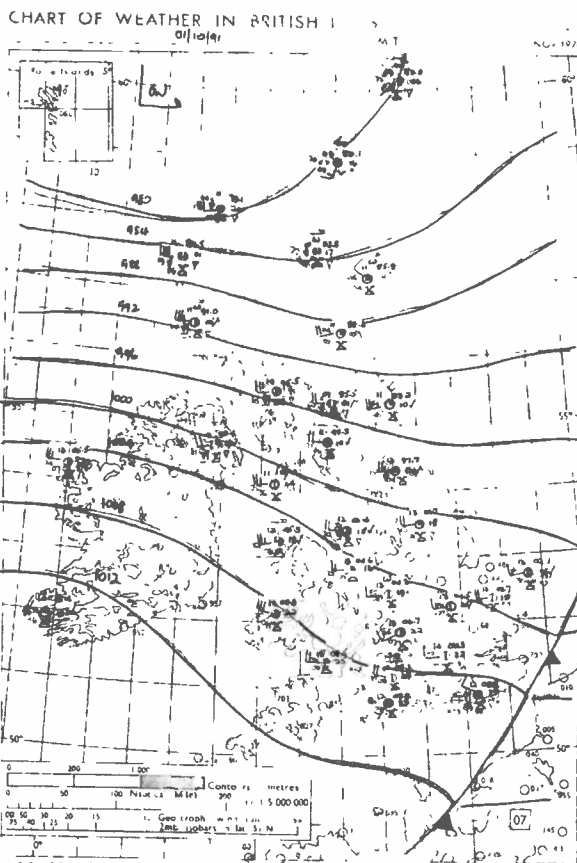

Fig. 1.

used in the decimal system. For those of you that aren't familiar with this system here's a simple (I hope) explanation.

Referring to **Fig. 1**, you will see that in the decimal system each column represents units, tens, hundreds, thousands, etc. For the binary system the principle is the same except in this case each column represents units, twos, fours, eights, etc. So the binary system will need more columns than the decimal system to represent a given number.

At this point I need to introduce some new terminology - bits and bytes. A bit is an acronym for Binary digit so each digit in a binary number is called a bit. A byte, on the other hand, is a number made up of eight bits - simple really.

Returning to the way text is stored. The ASCII look-up table uses numbers from 0 to 127 and some simple maths shows that seven bits are required to represent this numbering range. Within the computer this number is moved about using seven wires - a system known as parallel data. This is because you can imagine the signals all travelling along their own exclusive wires at the same time or in parallel.

Returning to our original problem of communicating between computers, we could do this by connecting seven wires between the two computers and sending the information as parallel data. In fact, this system is in common use for communicating between computers and printers. Whilst seven data lines is not too much of a problem over short distances, it's not so practical for longer distances. The ideal would be to reduce this to two wires - data and ground.

The way to achieve this is with serial data. Instead of sending all seven

bits of the data at the same time we send them one at a time. It's quite obvious when you think about it! However, to make the system actually work there are a few refinements required.

The first is what is called handshaking. This is needed so that the sending computer can indicate that it's about to send and the receiving computer can say it's ready to receive. The handshaking can be done in a number of ways, but I'll describe what's known as the hardware method. For this to work, we need two more connections, these are called RTS and CTS. The RTS or Request To Send lead is used to indicate that data is about to be sent. The CTS or Clear To Send lead is used to indicate that the distant computer is ready to receive. With those two formalities out of the way the transmission can begin.

However, before we can really get going we need some agreement between the computers on the following:

- 1: In what order will the data bits be sent?
- 2: How fast will they be sent?
- 3: How will the beginning and end of each number or byte be marked?

The answers to these important questions are quite straightforward.

Starting with the first one, the normal convention is to send the least significant bit (units) first, followed by the rest in ascending order.

The sending speed is where the term baud rate comes in. 50 baud means that binary 1s or 0s are being sent at 50 per second. The agreed common set of baud rates for computers are: 300, 600, 1200, 2400, 4800, 9600 and 19200 baud.

Finally, we have to mark the beginning and end of each number. This is done by adding extras bits that are

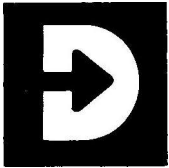

D A T O N G
E L E C T R O N I C S L I M I T E D

Clayton Wood Close
West Park
Leeds LS16 6QE
Tel: 0532 744822
Fax: 0532 742872

For products you can rely upon to give amazing results

For information on **Active Antennas, RF Amplifiers, Converters, Audio Filters, the Morse Tutor and Speech Processors** send or telephone for a free catalogue and selective data sheets as required.

All our products are designed and made in Britain.

Orders can be despatched within 48 hours subject to availability.



— VISA AND ACCESS WELCOME —

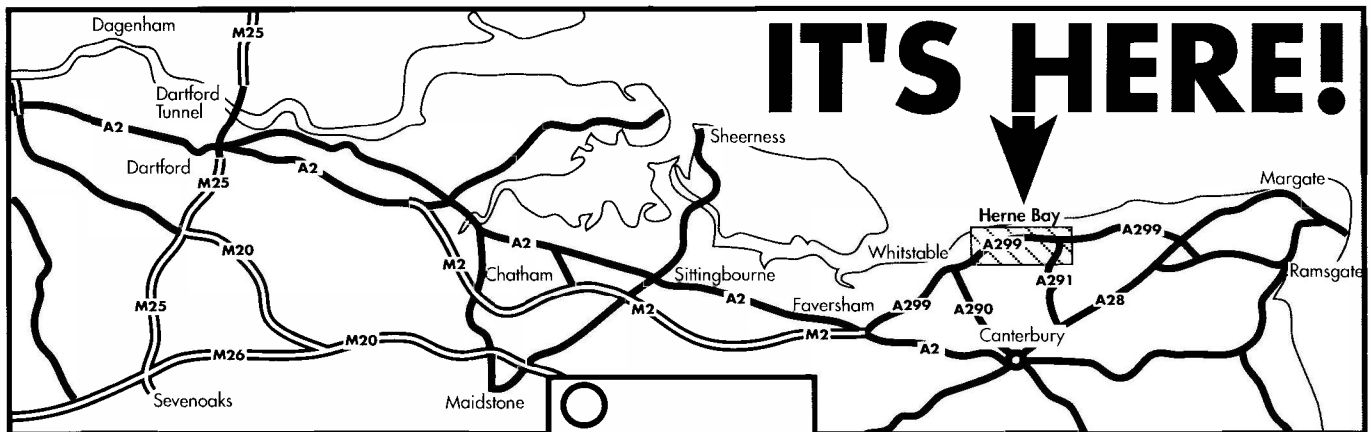
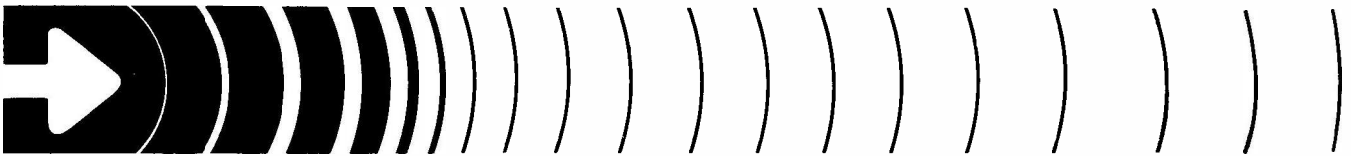

Just in case you had forgotten where we are, we thought this map might help. **Icom's Retail Shop** is easily accessible by road or rail and has been serving Amateurs in the south-east for many years.

Apart from the excellent range of ICOM equipment you will be able to compare it with Kenwood, Yaesu and other top brands. A full range of antennae and accessories are also stocked.



Chris Ridley G8GKC will make you welcome and help you choose from new and second-hand gear. Part exchange is also available.

To make your purchase as pleasant as possible we offer free carriage using the Post Office or Interlink and a one year warranty on new equipment, backed by ICOM's excellent servicing facilities. Credit card orders will be dispatched the same day if possible.

Opening Hours: 09:00 - 17:00 Tuesdays through to Saturdays inclusive

Icom Retail
Unit 8 Herne Bay West Industrial Estate Sea Street Herne Bay Kent CT6 8LD
Tel: 0227 741741 Fax: 0227 360155

called, fairly obviously, start and stop bits.

With the data all packaged-up we now really can start sending. Transmissions such as the one I've described here are known as asynchronous because both computers operate with their own timing signals and need the data to be wrapped-up with start and stop bits. An alternative, more efficient, system is synchronous data. This doesn't need start and stop bits so all the data carries useful information.

The system I've described here is in everyday use and is a proven method of communicating. I hope this has helped to improve your understanding of how computers talk to each other.

Schedules

This month I've received a couple of press schedules from **Mike Sinnott** in Belgium. Mike has also identified what might be a new press outlet in the USSR. The service calls itself **INFONOVA** and claims to be an independent news service. The frequencies identified so far are 18.61MHz and 19.83MHz. The transmission format is standard 100 baud RTTY with a shift of 400Hz. If you have any more info on this station please drop me a line.

Now for the schedules starting with Beijing, China.

English Transmissions

7.52 (BZP57) and 7.65MHz (BZR67) 0030-0300UTC
 14.367 (BZP54) and 16.136MHz (BZR66) 0630-0930 and 1030-1330UTC
 11.68 (BZP51) and 12.265MHz (BZR62) 1430-1700UTC
 7.52 (BZP57) and 7.65MHz (BZR67) 1830-2000UTC

The next schedule is for MAP Rabbat, Morocco.

French News

1000-1130UTC
 15.9999MHz (CNM69/1X) S. Africa
 18.2209MHz (CNM76/X9) W. Africa
 10.213MHz (CNM29) E. Europe
 7.8424 (CNM20/1X) and 14.76MHz (CNM61) W. Europe
 19.1711MHz (CNM85/X11) E. Europe and Asia
 15.7527MHz (CNM66/X2) N. America

1530-1700UTC
 Same as earlier except for 15.9999, 18.2209 and 15.7527MHz.

English News

18.4961MHz (CNM80/X11) Middle East
 15.9999MHz (CNM69/1X) S. Africa
 18.2209MHz (CNM76/X9) W. Africa
 10.213MHz (CNM29) E. Europe
 7.842 (CNM20/1X) and 14.76MHz (CNM61) W. Europe
 19.1711MHz (CNM85/X11) E. Europe and Asia
 15.7527MHz (CNM66/X2) N. America

My thanks to Mike for supplying these schedules. Don't forget to drop me a line if you come across any interesting schedules.

Weather Update

My weather RTTY article in the October issues certainly seems to have sparked off some interesting replies. The first comes from **Bill Nicoll** of Aberdeen who has written a weather decoding program for his BBC Compact computer. To use the program you just type in the raw numerical data and the program decodes the data and produces a translated output. By way of an example, here's the translation of the example I used back in October:

```
WEATHER REPORT
STATION NUMBER: 11036
AUSTRIA
DATE 25 OF MONTH
TIME OF OBSERVATION WAS 0600
UTC
TOTAL CLOUD COVER IS 7 OKTAS
WIND DIRECTION (COMPASS)
315-324
WIND SPEED IS 06 KNOTS
AIR TEMPERATURE +19.7C
DEW POINT TEMPERATURE
+15.5C
PRESSURE @ MEAN SEA
LEVEL(1)020.5
WIND DIRECTION SOURCE (AP-
PROXIMATE):- NORTH.WEST.
METRIC CONVERSION: 1 KILOME-
TRE = 0.624 MILES.
1 METRE = 39.37 INCHES.
PRECIPITATION NIL REPORT.
MANNED STATION.
CLOUD BASE 300-600 METRES.
VISIBILITY 20 KILOMETRES.
WEATHER REPORT: FAIR NO PRE-
CIPITATION.
```

Bill's program has been written in BBC Compact Basic so should run on any BBC machine. Bill has also very kindly offer to supply copies of the program to anyone sending a formatted 3.5in disk with return postage. The address to write to is: Bill Nicoll, 124 Hilton Avenue, Aberdeen AB22LH. Bill has also supplied a listing of the program and if you'd like a copy please send a large C4 s.a.e. to my address at the head of the column.

The next stage with the development of the program must be to write a decoding package that will allow the data to be received direct off-air. Once again thanks to Bill for his very kind offer.

My second letter comes from **Bill Clarke** of Aspatia. He has listed out the Bracknell weather RTTY transmissions which are:

```
4.489MHz (GFL26) 24hrs *
6.835MHz (GFL22) 1800-0600UTC
10.5513MHz (GFL23) 24hrs *
14.356MHz (GFL24) 24hrs
18.23MHz (GFL25) 0600-1800UTC
All these station operate with 10kVW transmitters and use 50 baud RTTY. As
```

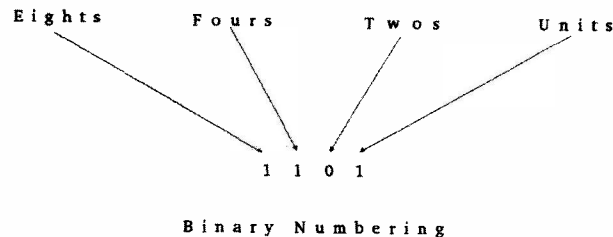
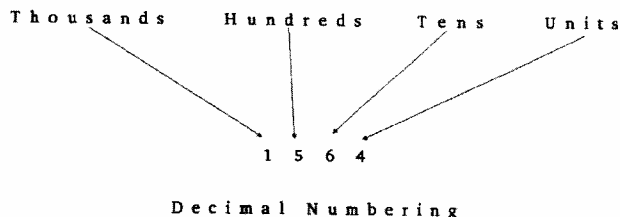

Fig. 2: Bill Clarke's weather chart.

Frequency List

a regular listener, Bill recommends the stations marked with a * as giving most consistent results in his area. Being an amateur meteorologist Bill uses the data received from RTTY weather stations to produce his own weather charts and forecasts. Bill has supplied an example of one of his charts and I've reproduced it here, in Fig. 2. As you can see the results are quite impressive.

One type of report that is likely to be particularly interesting for radio enthusiasts is the thunderstorm location reports. These reports can be identified by the prefix SFUK30. You then need to look out for the group starting with a 9. The next digit gives the number of atmospherics in a 10min period so indicating the violence of the storm. The decode for this second digit is:

- 0 = 1 atmospheric.
- 1 = 2 or 3 atmospherics.
- 2 = 4 to 8 atmospherics.
- 3 = 9 to 15 atmospherics.
- 4 = 16 to 24 atmospherics.

The next group of figures gives the location in latitude and longitude. The first four digits give the degrees whilst the final digit puts it in context according to the following.

- 0 = Whole degrees lat. and long east.
- 1 = 0.5° lat. above the reported figure east.
- 2 = 0.5° long. above the reported figure east.
- 3 = 0.5° lat and 0.5 degree long. above the reported figure east.
- 5 = Whole degrees lat. and long. west.
- 6 = 0.5° lat. above reported figure west.
- 7 = 0.5° long. above reported figure west.
- 8 = 0.5° lat. and long. above reported figure west.

Here's a couple of examples to help illustrate the process:

```
32385 = 32N 38W
58313 = 58.5N 31.5E
```

If you'd like to try your hand at plotting your own charts, the blank charts (METFORM 2216) and plotting symbols (MET 07 form 7) should be available from HMSO suppliers.

My thanks to Bill for the vast range of information he sent.

My frequency list follows the normal format, i.e. frequency, mode, speed, shift, call sign, time and notes. The list has been compiled from loggings received from listeners over the past couple of months. If you would like a copy of my main list just send three first or second class stamps to the address at the head of this column.

```
2.474MHz, RTTY, 75, -, PBC, 0359,
Dutch Navy
3.635MHz, RTTY, 100, -, -, 0444,
Grenfell Meteo
4.214MHz, SITOR, 100, 170, GKP2, -,
Portsmouth
4.217MHz, SITOR, 100, 170, SE7,
1624, ?
7.646MHz, RTTY, 50, 400, DDH7,
1711, Offenbach/Pinneberg
7.975MHz, SITOR, 100, 170, SPW, -,
Warsaw
8.44MHz, c.w., -, -, VCS, 0814, Halifax
Canada
8.4414MHz, c.w., -, -, 9HD, 0848,
Valetta, Malta
8.4435MHz, c.w., -, -, DAN, 1103,
Norddeich
8.4455MHz, c.w., -, -, WLO, 0823,
Mobile, Alabama
8.482MHz, c.w., -, -, SPH4, 1537,
Gydnia, Poland
8.515MHz, c.w., -, -, 5AT, 1949,
Tripoli, Libya
8.571MHz, c.w., -, -, JNA, 2035,
Tokyo, Japan
8.665MHz, c.w., -, -, XSG, 1538,
Shanghai, China
8.698MHz, c.w., -, -, 7TF6, 1512,
Skikda, Algeria
9.2415MHz, FAX, 60, 352, LRO64,
2340, DyN Buenos Aires
9.733MHz, RTTY, 50, 400, -, 0909,
ATA Tirana
12.315MHz, RTTY, 50, 400, RVW57,
0554, TASS Moscow
12.5895MHz, SITOR B, 100, 170,
WCC, 1238, Chatham Radio
13.92MHz, FAX, 120, 576, AXM35,
0619, Canberra Meteo
14.7MHz, RTTY, 50, 400, REB24, 0708,
TASS
16.085MHz, RTTY, 100, -, RND71,
0731, APN Moscow
16.9976MHz, SITOR B, 100, 170,
WLO, 0513, Mobile Radio
22.4005MHz, SITOR A, 100, 170, SVA,
0800, Athens Radio
23.38MHz, RTTY, -, -, MKD, -, RAF
Akrotiri
```

long medium & short

Brian Oddy G3FEX
Three Corners, Merryfield Way, Storrington, West Sussex RH20 4NS

During the year, many listeners have sent in detailed and interesting reception reports for inclusion in LM&S and I would like to express my sincere thanks to all those concerned. May I wish all readers a very happy Christmas and good listening in 1992.

Long Wave Reports

Note: l.w. & m.w. frequencies in kHz; s.w. in MHz; Time in UTC (=GMT). Unless otherwise stated, all logs were compiled during the four week period ending Oct 5.

Newcomers should note that l.w. signals from some of the more distant stations can only be received via sky wave paths after dark. Your location may determine how well you receive the ground wave signal during daylight, e.g. the long sea path enables signals from Motala, Sweden on 189kHz to reach **Kenneth Buck** in Edinburgh at S10544 during daylight, but the signal is weak or non-existent in many areas of the UK. A different situation arises

after dark, because the ionosphere reflects the high angle component of the transmitted signal, which may reach the UK.

Reception in Storrington during daylight and after dark has been compared by **Fred Pallant**. He checked each l.w. channel and found that signals from Bechar 153, Tbilisi 189, Konstantinow 225, Tipaza 252 and Topolna 270 could only be heard after dark. A similar check at your location may prove to be interesting, but remember that the sky wave paths often change.

Medium Wave Reports

Using a giant 4m square loop ahead of his receiver in Grimsby, **Jim Willett** heard signals from stations in Canada, the USA, the Caribbean and S.America. The first was CJYQ in St.John's on 930kHz, the signal peaked S10333 by 0020. Another in St.John's, VOXM on 590, was heard at 0110 and a further ten were logged over the next three



Ted Walden-Vincent's listening post in Great Yarmouth.

hours, all rated S10222. Jim is now awaiting a QSL/letter to confirm his log of WWLW in Moore, OK, which runs just 1kW on 640kHz.

Although **Tim Shirley** (Bristol) heard WINS in New York on 1010 at 2300 on Sept 15, most of his loggings were heard much later. He was delighted to get a QSL from WOSO in San Juan, Puerto Rico confirming their

signal on 1030kHz. He is still awaiting confirmation from R.Reloj in Trinidad (CMGI), which he heard on 610 at 0330.

Signals from N.Africa also reached here after dark. From Algeria: Ain Beida 531kHz (600/300kW) 2222 at 2240 by Sheila Hughes in Morden; Les Trembles 549 (600kW) 32232 at 0504 by **Ron Galliers** in N.London; Alger 891 (600/300kW) 32333 at 2140 by **Noel Carrington** (Sutton in Ashfield); also Alger 981 (600/300kW) heard by **Sid Morris** in Rowley Regis. From Morocco: Sidi Bennour 540 (600kW) 33333 at 0515 in Morden; Oujda 594 (100kW) 32322 at 0504, Sebba-Aiou 1044 (300kW) 33343 at 0512 in N.London. From Tunisia: Tunis-Djedeida 963 (200kW) 22222 at 2225 in N.London.

Low power relays in Spain have been heard here after dark. In Co.Down, **Eddie McKeown** logged COPE via Malaga on 882kHz (5kW) as 21311 at 0137, RNE5 via Burgos 1017 (5kW) as 21311 at 0152 and COPE via Valencia 1296 (5kW) as 34233 at 2349. More surprising, the 2kW relays in Castellon 1215 and Alicante 1395 were logged in N.London, both 32322 at 0115.

Many m.w. channels are shared, it may be possible to separate stations by using a loop or ferrite rod antenna with your receiver. **John Wells** (E.Grinstead) used a loop to 'null-out' R.Bedfordshire via Luton on 630kHz (200W) and log co-channel R.Cornwall via Redruth (2kW) for the first time. A similar technique was used by **John Case** in Frodsham. He rated Redruth as 23232 at 1045.

Listeners:

A: Leo Barr, Sunderland.
B: Tim Bucknall, Congleton.
C: Noel Carrington, Sutton-in-Ashfield.
D: John Case, Frodsham.
E: Sean Cooper, Wells-next-the-Sea.
F: Ron Galliers, N.London.
G: Francis Hearne, Bristol.
H: Sheila Hughes, Morden.
I: Rhoderick Ilman, Oxted.
J: Eddie McKeown, Co.Down.
K: George Millmore, Wootton, IOW
L: Sid Morris, Rowley Regis.
M: Roy Patrick, Caister.
N: Chris Shorten, Norwich.
O: Phil Townsend, E.London.
P: John Wells, East Grinstead.

Local Radio Chart

Freq kHz	Station	ILR BBC	e.m.r.p. kW	Listener	Freq kHz	Station	ILR BBC	e.m.r.p. kW	Listener
558	Spectrum R.	I	7.50	B,C,F,J*,K,L,M,P	1161	Viking R.(C.Gold)	I	0.35	B,E*
585	R.Solway	B	2.00	B,J,L*	1170	Ocean Sd.(SCR)	I	0.12	H,K,P
603	Invicta Snd(Coast)	I	0.10	E*,F,K,O,P	1170	R.Orwell	I	0.28	M,N,P
603	R.Gloucester	B	0.10	B,C,K,L,P	1170	Signal R.	I	0.20	B,C,I
630	R.Bedfordshire	B	0.20	B,D,F,H,K,L,O,P	1170	Swansea Sound	I	0.58	J*
630	R.Cornwall	B	2.00	D,K,P	1242	Invicta Snd(Coast)	I	0.32	F,L,M,O,P
657	R.Clywyd	B	2.00	B,C,F,K,L,O,P	1242	Isle of Wight R.	I	0.50	J*,K,L*
657	R.Cornwall	B	0.50	K	1251	Saxon R.	I	0.76	E*,F,J,M,N,D,P
666	Devon Air R.	I	0.34	G,H,K,P	1260	GWR (Brunel R.)	I	1.60	H,K,P
666	R.York	B	0.80	B,C,F,L*,P	1260	Leicester (GEM-AM)	I	0.29	B,L,P
729	BBC Essex	B	0.20	B,C,E*,F,K,L*,N,O,P	1260	Marcher Sound	I	0.64	B
738	Hereford/Worcester	B	0.037	B,C,F,K,L,O,P	1278	Pennine R.(C.Gold)	I	0.43	B
756	R.Cumbria	B	1.00	B,J	1305	R.Hallam (C.Gold)	I	0.15	B,C
756	R.Shropshire	B	0.63	B,C,F,K,L,P	1305	Red Dragon (Touch)	I	0.20	K,L,P
765	BBC Essex	B	0.50	A,B,C,E*,F,K,L,O,P	1323	R.Bristol (Som Snd)	B	0.63	F,L,P
774	R.Kent	B	0.70	E*,F,K,N,O,P	1323	S'thern Sound(SCR)	I	0.50	K,O,P
774	R.Leeds	B	0.50	B,C	1332	Hereward R.P'boro	I	0.60	B,C,E*,H,J*,O,P
774	Severn Sound (3CR)	I	0.14	B,K,L	1332	Wiltshire Sound	B	0.30	J*,K,L*,P
792	Chiltern R.	I	0.27	B,C,E*,F,J*,K,L,O,P	1359	Essex R.(Breeze)	I	0.28	E*,F,I,O,P
801	R.Devon	B	2.00	B,J*,K,L*	1359	Mercia Snd(Xtra-AM)	I	0.27	B,L
819	Hereford/Worcester	B	0.037	B,F,G,K,L,P	1359	Red Dragon (Touch)	I	0.20	G*
828	Chiltern Radio	I	0.20	F,O,P	1359	R.Solent	B	0.85	K,P
828	R.Aire(Magic 828)	I	0.12	C	1368	R.Lincolnshire	B	2.00	E*,P
828	R.WM	B	0.20	B,I	1368	R.Sussex	B	0.50	H,K,O
828	2CR	I	0.27	K,P	1368	Wiltshire Sound	B	0.10	K,L
837	R.Cumbria	B	1.50	B	1413	Sunrise R.	I	0.125	I,K,O
837	R.Furness	B	1.00	B	1431	Essex R.(Breeze)	I	0.35	F,K,O,P
837	R.Leicester	B	0.45	B,C,F,G,I,K,L,O,P	1431	Radio 210	I	0.14	K,P
855	R.Devon	B	1.00	K	1449	R.Peterboro/Camb	B	0.15	B,K,M,P
855	R.Lancashire	B	1.50	B,C,J,L*	1458	GLR	B	50.00	G*,K,P
855	R.Norfolk	B	1.50	E*,F,H,D,P	1458	GMR	B	5.00	B,J*
873	R.Norfolk	B	0.30	C,E*,F,H,I,K,L*,O,P	1458	R.Cumbria	B	0.50	J*
936	GWR (Brunel R.)	I	0.18	B,H,I,K,L,P	1458	R.Devon	B	2.00	P
945	R.Trent (GEM-AM)	I	0.20	B,C,F*,J*,K,L,P	1458	Radio WM	B	5.00	B,C,G,L
954	Devon Air R.	I	0.32	H,K,P	1476	C'ty Snd(1st Gold)	I	0.50	H*,J*,K,P
954	R.Wyvern	I	0.16	B,L,P	1485	R.Humberside	B	1.00	E*,N
990	WABC (Nice & Easy)	I	0.09	B,C,I	1485	R.Merseyside	B	1.20	B,J,L
990	R.Aberdeen	B	1.00	J*,M	1485	R.Oxford	B	0.50	K,P
990	R.Devon	B	1.00	K,P	1485	R.Sussex	B	1.00	H,K,P
999	R.Solent	B	1.00	F,H,I,K,P	1503	R.Stoke-on-Trent	B	1.00	B,J*,K,L,P
999	R.Trent (GEM-AM)	I	0.25	B,C,P	1521	R.Mercury	I	0.64	H*,K,O,P
999	Red Rose R.	I	0.80	B	1521	R.Nottingham	B	0.50	B,C,J*,L
1017	WABC Shrewsbury	I	0.70	B,C,K,L,P	1530	Pennine R.(C.Gold)	I	0.74	B,J*
1026	R.Cambridgeshire	B	0.50	B,E*,F,H,N,O,P	1530	R.Essex	B	0.15	I,K,O,P
1026	R.Jersey	B	1.00	H,K,P	1530	R.Wyvern	I	0.50	B,K,L
1035	Northsound Radio	I	0.78	E*	1548	Capital R. (Gold)	I	97.50	E*,J*,K,P
1035	R.Kent	B	0.50	F,K,O,P	1548	R.Bristol	B	5.00	J*,K,L*
1035	R.Sheffield	B	1.00	B,C	1548	R.City (City Talk)	I	4.40	B
1035	West Sound	I	0.32	J*	1548	R.Hallam (C.Gold)	I	0.74	B,C
1107	R.Northampton	B	0.50	F,I,K,L*,P	1557	Chiltern R.(Gold)	I	0.76	B,J*
1116	R.Derby	B	1.20	B,C,J*,L,P	1557	Ocean Sound (SCR)	I	0.50	H,J*,K,P
1116	R.Guernsey	B	0.50	H,K,P	1557	R.Lancashire	B	0.25	B
1152	BRMB (Xtra-AM)	I	3.00	C,L	1557	Tending R (Mellow)	I	?	M,P
1152	LBC (L.Talkback R)	I	23.50	H*,K,P	1584	Gatwick	I	0.10	K,P*
1152	Piccadilly R.	I	1.50	B	1584	Heathrow	I	0.10	O,P
1152	R.Broadland	I	0.83	E*,J*,P	1584	R.Nottingham	B	1.00	B,C
1161	GWR (Brunel R.)	I	0.16	H,J*,L*	1584	R.Shropshire	B	0.50	B,L
1161	R.Bedfordshire	B	0.10	P	1602	R.Kent	B	0.25	A,B,E*,J*,K,L*,M,O,P*
1161	R.Sussex	B	1.00	H,K,P					

Note: Entries marked * were logged during darkness. All other entries were logged during daylight or at dawn/dusk.

long medium & short

Medium Wave Chart

Freq kHz	Location	Country	Power kW	Listener					
520	Bilbao	Spain	20	K*	981	Ceske Budejovice	Czech	30	K*
531	Ain Beida	Algeria	600	G*,J*	990	Berlin	Germany	300	G*,K*
531	Leipzig	Germany	100	G*,K*,L,M*	990	Bilbao	Spain	10	G*,K*
531	Oviedo	Spain	10	G*,J,K*	990	Twyryn	UK	1	B
531	Beromunster	Switzerland	500	G*	999	Hoyerswerda	Germany	20	C*
540	Wavre	Belgium	150/50	C*,G*,J,K*,L,M*,N,Q	999	Madrid	Spain	20	G*,J,K*
540	Sidi Bennour	Morocco	600	G*,I	1008	Fievo	Holland	400	C*,G*,K*,L,M*
549	Les Trembles	Algeria	600	G*	1017	Rheinsender	Germany	600	C*,F*,G*,K*,M*
549	Bayreuth	Germany	200	C*,G*,J,K*,L,M*	1017	Burgos	Spain	5	K*
549	Thurau	Germany	200	Q	1026	Graz-Dobl	Austria	100	C*,K*
558	Valencia	Spain	20	C,K	1035	Milan	Italy	50	K*
567	Berlin	Germany	100	C*,K*	1044	Dresden	Germany	250	C*,G*,K*
567	Tullamore	Ireland (S)	500	C*,F*,G*,J,L,M*,Q	1044	Sebaa-Aioun	Morocco	300	G*
567	Marbella	Spain	10	K*	1044	San Sebastian	Spain	10	G*,K*
576	Vidin	Bulgaria	100	G*	1053	Zaragoza	Spain	10	K*
576	Muhlacker	Germany	500	G*	1053	Postwick	UK	10	C,F*
576	Stuttgart	Germany	500	K*,L,Q	1062	Kalundborg	Denmark	250	C*,F*,G*,K*
585	FIP Paris	France	8	L,Q	1071	Brest	France	20	L
585	Madrid	Spain	200	C*,G*,K*,M*	1071	Lille	France	40	G*,K*
585	Dumfries	UK	2	B	1080	Katowice	Poland	1500	G*
594	Frankfurt	Germany	1000/400	C*,F*,G*,K*,M*	1089	Moorside Edge	UK	150	B,F*
594	Oujda-1	Morocco	100	G*	1089	Krasnodar	USSR	300	K*
594	Muge	Portugal	100	G*	1098	Bratislava	Czech	750	C*,G*
603	Lyon	France	300	G*	1098	?	Spain	10	G*,K*
603	Sevilla	Spain	20	K*	1107	Munich	Germany	40	C*,F*,G*,K*,M*
603	Newcastle	UK	2	B,C,F*,K*	1107	Santander	Spain	10	K*
612	Kiel	Germany	10	G*	1107	Wallasey	UK	0.5	B
612	Athlone	Ireland (S)	100	C,G*,L,M*	1116	Bari	Italy	150	K*
621	Wavre	Belgium	80	C*,G*,K*,L,O,Q	1125	La Louviere	Belgium	20	G*,K*,L
621	Barcelona	Spain	10	G*	1125	?	Spain	10	K*
630	Vigra	Norway	100	C*,D*,K*	1125	Llandrindod Wells	UK	1	B,G
639	Praha	Czech	1500	G*,K*	1134	Valencia	Spain	10	K*
639	La Coruna	Spain	100	C*,G*,K*,L	1134	Zadar	Yugoslavia	1200	C*,G*,K*,L
648	BBC Dordfness	UK	500	F*,H,I,K*,L,M*,Q	1143	Stuttgart	Germany	10	G*,K*,L,M*
657	Napoli	Italy	120	G*	1143	Oublin	Ireland (S)	?	B,C*,K
657	Madrid	Spain	20	C*,G*,K*	1161	Strasbourg	France	200	G*,L,K*,M*
657	Wrexham	UK	2	B,C,G*,M*,Q	1170	Krasnodar	USSR	500	K*
666	Bodenseesender	Germany	300/180	C*,K*	1179	Murcia	Spain	5	O*
666	R.Vilnius	USSR	500	K*	1179	Santiago	Spain	10	K*
675	Marseille	France	600	K*,M*	1179	Solvesborg	Sweden	600	A*,C*,E*,F*,G*,H*,K*,L,M*
675	Lopic	Holland	120	C*,G*,L*,L,P,Q	1188	Kuurne	Belgium	5	G*,K*,L
684	Sevilla	Spain	250	C*,G*,K*	1188	Reichenbach	Germany	5	K*
693	Berlin	Germany	250	K*	1188	Szolnok	Hungary	135	G*
693	Droitwich	UK	150	B	1197	Munich	Germany	300	F*,K*,M*
693	Postwick	UK	10	C,F*	1197	Enniskillen	Ireland (N)	1	B,C,K*
702	Aachen/Flensburg	Germany	5	G*,K*	1197	Bournemouth	UK	0.5	L
702	Monte Carlo	Monaco	300	C,K*	1206	Bordeaux	France	100	C*,G*,K*
711	Rennes	France	300	C,F*,G*,K*,L,Q	1206	Wroclaw	Poland	200	C*,G*
720	Langenberg	Germany	200	K*	1215	Kaliningrad	Lithuania	500	K*
720	Lisnagarvey	Ireland (N)	10	B,C	1215	Castellon	Spain	2	G*
720	London	UK	0.5	F*,L	1215	Lisnagarvey	UK	10	C*
729	Cork	Ireland (S)	10	C,K*,L	1215	Moorside Edge,UK	100	B	
729	Oviedo	Spain	50	K*	1215	Postwick	UK	1	F*
738	Paris	France	4	C*,G*,K*,L	1224	Vidin	Bulgaria	500	C*,G*,K*
738	Barcelona	Spain	250	G*,K*	1233	Melnik	Czech	400	C*,G*,K*
747	Flevo	Holland	400	C*,F*,G*,J,K*,L,M*,P,Q	1242	Marseille	France	150	C*,K*
756	Brunswick	Germany	800/200	C*,G*,K*	1251	Marcali	Hungary	500	G*
756	Red'uth	UK	2	L	1251	Huisberg	Netherlands	10	C*,G*,K*
765	Sottens	Switzerland	500	K*	1260	Rhodes	Greece	500	C*,F*
774	Enniskillen	Ireland (N)	1	K*	1260	Valencia	Spain	20	C*,G*,K*
774	Cacores	Spain	60	K*	1269	Neumunster	Germany	600	C*,F*,G*,K*,L,M*
783	Burg	Germany	1000	C*,F*,G*,K*,M*	1278	Strasbourg	France	300	K*
792	Limoges	France	300	C,L	1278	Oublin/Cork	Ireland (S)	10	C*,F*,K,L
792	Sevilla	Spain	20	K*	1287	Litomyse/Liblice	Czech	300/200	C*,G*,K*
801	Mur-chen-Ismaning	Germany	300	G*,K*	1296	San Sebastian	Spain	5	K*
801	Burgos	Spain	10	G*,K*	1296	Dordfness	UK	500	C*,F*
801	Madrid	Spain	20	G*,K*	1305	Rzeszow	Poland	100	G*
810	Westerglen	UK	100	B,C,F*,G*,K*,L,M*	1305	Orense	Spain	5	G*,K*
819	Toulouse	France	50	K*	1314	Kvitsoy	Norway	1200	C*,F*,G*,K*,L,M*,P
819	Warsaw	Poland	300	G*,K*	1314	Valladolid	Spain	10	G*
837	Nancy	France	200	C*,G*,K*	1323	Leipzig	Germany	150	G*,K*,M*
837	Sevilla	Spain	10	G*,K*	1332	Rome	Italy	300	C*
846	Rome	Italy	540	G*,K*,L,M*	1341	Lisnagarvey	Ireland (N)	100	B,C*,F*,G*,L
855	Berlin	Germany	100	C*,K*	1350	Nancy/Nice	France	100	C*,F*,K*,L
855	R.Bucharest	Roumania	750	G*	1359	Berlin	Germany	250/100	K*
855	Murcia	Spain	125	G*,K*,L,M*	1368	Foxdale	IOM	20	B,C,K
864	Paris	France	300	G*,K*,L,M*,Q	1377	Lille	France	300	C,G*,K*,L,Q
864	Cd. Real	Spain	10	G*	1386	Kaliningrad	Lithuania	500	G*,K*,M*
873	Frankfurt	Germany	150	C*,F*,G*,J*,K*,M*	1395	Lushnje,Albania	1000	G*,I*,K*,O*	
873	Enniskillen	UK	1	B,K*	1395	Alicante	Spain	2	G*
882	Malaga	Spain	5	K*	1404	Brest	France	20	K*,L,M*
882	Pennon	UK	10	B	1413	Zaragoza	Spain	20	G*,K*,M*
882	Twyryn	UK	5	B	1422	Heusweiler	Germany	1200/600	F*,G*,K*,L
882	Washford	UK	100	F*,G*,K*,L,M,Q	1431	Oresden	Germany	250	K*
891	Algiers	Algeria	600/300	C*,G*,J*,K*,M*	1440	Marnach	Luxembourg	1200	F*,G*,J*,K*,L,M*,O
891	Huisberg	Holland	20	G*,L	1449	Squinanzo	Italy	50	K*
900	Milan	Italy	600	G*,K*	1467	Monte Carlo	Monaco	1000/400	F*,G*,J*,K*,M*
909	Moorside Edge	UK	200	B,C,F*	1476	Wien-Bisamberg	Austria	600	K*,M*
918	Madrid	Spain	200	G*,K*	1494	St.Petersburg	USSR	1000	G*,J*,K*,K*
927	Wolvertem	Belgium	300	C*,F*,G*,K*,L,M*,P,Q	1503	Stargard	Poland	300	G*,K*,O*
936	Bremen	Germany	100	C*,G*,J,K*	1512	Wolvertem	Belgium	600	F*,G*,J*,K*,L,O
945	Toulouse	France	300	G*,K*	1530	Rome	Italy	150/450	F*,G*,I*,J*,K*
945	Rostov-na-Donu	USSR	300	G*	1539	Mainflingen	Germany	700	G*,K*,M*
954	Dobrochov	Czech	400	G*,K*	1557	Nice	France	300	K*
954	Madrid	Spain	20	G*	1568	Sarnen	Switzerland	300	G*,K*
963	Pori	Finland	600	C*,F*,K*,M*	1575	Burg	Germany	250	G*,K*,M*
963	Seixal	Portugal	10	I*	1593	Langenberg	Germany	400/800	F*,G*,K*,L,M*
963	Tunis-Djedaida	Tunisia	200	G*	1611	Rome	Italy	5	K*
972	Hamburg	Germany	300	C*,G*,K*,M*					
981	Alger	Algeria	600/300	C*,G*,J*,K*,M*					

Note: Entries marked * were logged during darkness. All other entries were logged during daylight or at dawn/dusk.

Short Wave Reports

Although solar activity has remained high, there have been less disturbances than before and good DX reception was noted some days. However, many signals have been marred by heavy co-channel interference since changes were made to schedules at the end of September.

Some broadcasters are still taking advantage of the good conditions in the 25MHz (11m) band. Most days, very strong signals have reached here from the Voice of the UAE in Abu Dhabi on 25.690MHz. Their Arabic broadcast was SINPO 55555 at 1140 by **Chris Shorten** in Norwich. The Darwin signals from R.Australia 25.750 (Eng to Asia, M.East 0900-1100) have also reached us well. Often weak at 0900, the signal usually improved by 1000. In Swanwick, **Jim Cash** logged it as 44243 at 1019. In Edinburgh, it peaked SIO455 at 1050.

Also using 11m are RNI Oslo 25.730, DW Cologne 25.740, R.Moscow 25.780 and RFI Paris 25.820, but they tend to be poor here as they are beamed to areas outside Europe. In Canada, **Alan Roberts** logged the Voice of UAE as 55555 at 1230; RNI as 35333 at 1100; DW as 45444 at 1150; R.Australia 25222 at 1050, R.Moscow as 25222 at 1310 and RFI as 45444 at 1525. In September, he found propagation good on 9 days.

Some of R.Australia's 21MHz (13m) signals have reached the UK. Those to C/SE.Asia via Darwin 21.525 (Eng 0100-0800) were heard at 0700 by **Don Phillips** in Bridlington; to Asia via Carnarvon 21.775 (Eng 0100-1000) SIO444 at 0850 by **Bryan Kimber** in Hereford; to SE.Asia, M.East 21.720 (Eng 1100-1330) 24333 at 1140 in Swanwick.

Most 13m signals to Europe reach their target well. R.Japan via Moyabi 21.575 (Eng 0700-0800) was 54344 at 0735 in Norwich; R.Pakistan, Islamabad 21.520 (Eng 0800-0845) 32133 at 0800 in Co.Down; HCJB, Ecuador 21.455 (u.s.b. + p.c. 24hrs) SIO222 at 1122 by **Julian Wood** in Elgin; R.Moscow, USSR 21.465 (Russ 1200-1700) SIO444 at 1320 by **John Coulter** in Winchester; RCI via Sackville 21.545 (Eng, Fr 1400-1530) 54544 at 1425 by **John Nash** in Brighton; WCSN 21.670 (Ger, Eng, Fr 1405-1555) SIO444 at 1500 by **George**

- Listeners.
A: Leo Barr, Sunderland.
B: Tim Bucknall, Congleton
C: Noel Carrington, Sutton in Ashfield.
D: John Case, Frodsham.
E: Jim Cash, Swanwick.
F: Sean Cooper, Wells-next-the-Sea.
G: Ron Galliers, N.London.
H: Francis Hearne, Bnstonl.
I: Sheila Hughes, Morden.
J: Rhoderick Illman, Oxted
K: Eddie McKeown, Co.Down.
L: George Millmore, Wootton 10W
M: Sid Morris, Rowley Regis.
N: Roy Patrick, Caister
O: Don Phillips, Bridlington.
P: Chris Shorten, Norwich.
Q: Phil Townsend, E.London

Long medium & short

Long Wave Chart

Freq kHz	Location/Station	Country	Power kW	Listener
153	Bechar	Algeria	1000	H*, J*
153	Donebach	Germany	500	A,B,C*,D*,E,F,G*,H,J,K
153	Brasov	Romania	1200	A,C*
162	Allouis	France	2000	A,B,C*,D*,E*,F,G*,H,K
171	Kaliningrad	Lithuania	1000	A,C*,D*,E*,F,G*,H,K
171	Nador	Morocco	2000	B
177	Oranienburg	Germany	750	A,B,C*,E*,F,G*,H,K
183	Saarlouis	Germany	2000	A,B,C*,D*,E*,F,G,H,K
189	Motala	Sweden	300	A,C*,J*
189	Tbilisi	USSR	500	H*
198	Droitwich	UK	500	B,C*,D,E,F,G,K
198	Westerglen	UK	50	A
207	Munich	Germany	500	A,B,C*,E*,F,G*,H,K
216	Roumoules	Monaco	1400	A,B,C*,E*,F,G*,H,K
216	Oslo	Norway	200	A,E*
225	Konstantinow	Poland	2000	A,B,C*,D*,E*,G*,H*
234	Junglinster	Luxembourg	2000	A,B,C*,E*,F,G,H,K
234	Leninrad	USSR	1000	E*
243	Kalundborg	Denmark	300	A,B,C*,D*,F,G*,H,K
252	Tipaza	Algeria	1500	D*,H*
252	Atlantic 252	Ireland	500	A,B,C*,D*,E*,F,G,H,K
261	Burg	Germany	200	C*,F,K
261	Moscow	USSR	2000	A,B*,C*,F,G*,H*,K
270	Topolna	Czech	1500	A,B*,C*,D*,E*
279	Minsk	USSR	500	A,B*,C*,D*,E*

Listeners
 A: Kenneth Buck, Edinburgh
 B: Noel Carrington, Sutton in Ashfield.
 C: Ron Galliers, N.London.
 D: Sheila Hughes, Morden
 E: Eddie McKeown, Co.Down
 F: George Millmore, Wootton, IOW
 G: Sid Morris, Rowley Regis
 H: Fred Pallant, Storrington.
 I: Don Phillips, Bridlington.
 J: Tim Shirley, Bristol.
 K: Phil Townsend, E.London.

Note: Entries marked * were logged during darkness. All other entries were logged during daylight or at dawn/dusk.

Millmore in Wootton; R.Japan via Moyabi 21.700 (Eng, Jap 1500-1700) 45333 at 1600 by **Darren Beasley** in Bridgwater; WYFR 21.615 (Eng 1900-2145) 33323 at 1905 in N.London; HCJB, Ecuador 21.480 (Cz, Eng, Ger, Sw, Sp 1800-2230) 44444 at 1933 by **Rhoderick Illman** in Oxted; VOFC via Okeechobee 21.720 (Eng 2200-2300) 34533 at 2254 by **David Edwardson** in Wallsend.

Broadcasts for outside Europe were also heard: SRI via Schwarzenburg 21.695 (Eng, It, Ger, Fr to Pacific areas 0745-1000), SIO434 at 0745 by **Cyril Kellam** in Sheffield; R.Norway Int, Oslo 21.590 (Norw to Aust, NZ, W.Africa, S.Am 1000-1030) SIO444 at 1029 by **Philip Rambaut** in Macclesfield; BSKSA, Saudi Arabia 21.505 (Arto N.Africa ?-1700) SIO455 at 1100 in Edinburgh; SRI via Schwarzenburg 21.695 (Eng, Fr, It, Ger to Asia, Pacific areas 1315-1500) 55555 at 1500 by **Charles Beanland** in Gibraltar; R.Moscow, USSR 21.685 (Eng to Africa ?-1930) 44444 at 1530 in Morden; VOA via Tangier 21.625 (Eng to Africa 1600-2200) 44444 at 1725 by **Ron Damp** in Worthing; VOA via

Greenville 21.485 (Eng to Africa 2000-2200) 44554 at 2030 by **John Parry** in Northwich.

Some days, R.New Zealand's 17MHz (16m) signals to Pacific areas have been heard clearly here. The 100kW signals from Rangataiki, N.Island on 17.770 (Eng 2200-0630) was 34434 at 0650 by **Leo Barr** in Sunderland and 43333 at 2200 in Norwich. Some of R.Australia's signals have also reached Europe. Those to E/SE.Asia via Carnarvon 17.630 (Eng, Chin 0000-0900) were 21331 at 0737 in Oxted; to Pacific areas via Shepparton 17.715 (Eng 2200-0530) were heard at 2200 by **Sergi Olejnik** in Kalush, Ukraine.

Morning broadcasts included R.Denmark via RNI 17.765 (Da to NZ 0730-0755) heard at 0730 in Bridlington; R.Japan via Yamata 17.890 (Jap, Eng to Oceania 0600-0800) SIO333 at 0730 in Sheffield; KHBI, N.Mariana Is 17.555 (Eng to NE.Asia 1005-1155) 24332 at 1018 in Brighton.

Later, Africa No.1, Gabon 17.630 (Fr, Eng to W.Africa 0700-1600) was 55555 at 1510 in Bridgwater; RFE Munich 17.805 (Ro to Eu 1500-1755) SIO

433 at 1615 in Winchester; RSA Johannesburg 17.840 (Eng to W.Africa 1555-1800) 54444 at 1652 by Oarran Taplin in Brechley; WWCR 17.525 (Eng to USA, Europe 1500-2000) SIO444 at 1700 in Macclesfield; RCI via Sackville 17.820 (Eng to Europe 1900-?), heard in Rowley Regis; HCJB, Ecuador 17.790 (Eng to Europe 1900-2000?) SIO444 at 1915 in Edinburgh; R.Sofia, Bulgaria 17.875 or 17.825 (Eng to ? 1945-2030) 42243 at 1945 in Co.Down; Voice of Israel, Jerusalem 17.575 (Eng to ?) 44444 at 2000 in Morden; RHC, Cuba 17.705 (Eng to Eu-

rope, N.Africa 2000-2100) SIO433 at 2045 in Hereford; VOA via Tinang 17.735 (Eng to E.Asia 2100-0100) 32233 at 2217 in N.London; VOFC via Okeechobee 17.750 (Eng to Europe 2200-2300) 55454 at 2240 in Swanwick.

UK listeners have noted good DX reception in the 15MHz (19m) band. The signals from R. New Zealand Int. to Pacific areas on 15.120 (Eng 1800-2200) were 42433 at 1950 in Bridgwater. R. Australia via Shepparton 15.320 (Eng to Asia 2030-0800) 55444 at 2105 in Norwich. The domestic service from ABC via VLW15 Wanneroo, W.Australia on 15.425 (Eng 2300-0945) was logged by **Simon Hamer** in New Radnor as SIO232 at 0530.

Some broadcasts to Europe stem from HCJB, Ecuador 15.270 (Eng 0700-0830) 45554 at 0728 in Wallsend; R.Algiers via Bouchaoui 15.160 (Ar, Fr, Sp 0700-1800) SIO433 at 1515 in Winchester; FEBA, Seychelles 15.330 (Eng to Asia 1500-1600) 42333 at 1530 in Bridlington; WWCR Nashville 15.690 (Eng, Sp 1200-0000) 44433 at 1600 in Brighton; R.Sofia, Bulgaria 15.330 (Eng 1800-1830) 44444 at 1815 in Oxted; R.Korea, Seoul 15.575 (Eng 1800-1900) SIO555 at 1840 in Edinburgh; RNB Brasilia 15.265 (Eng, Ger 1800-?) 21112 at 1840 in Co.Down; HCJB, Ecuador 15.270 (Eng 1900-2000) 22322 at 1912 in N.London; WSHB Cypress 15.665 (Eng, Ger 1800-2155) 54444 at 2019 in Swanwick; RAE Buenos Aires 15.345 (Eng, Fr, It, Ger 1900-2300, also to Africa) SIO333 at 2107 in Macclesfield and 54454 at 2138 in Gibraltar; SLBC, Sri Lanka 15.120 (Eng 1830-2130) SIO333 at 2110 in Grimsby; WRNO New Orleans 15.420 (Eng 1900-2300, also to USA) SIO444 at 2245 in Hereford.

Those to other areas include VOA via Kavala 15.205 (Eng to M.East 0500-

Tropical Band Chart

Freq MHz	Station	Country	UTC	DXer	Freq MHz	Station	Country	UTC	DXer
2.350	Sarwon/Hwanghae	Korea	0240	M	4.830	Gaborone	Botswana	0036	G
2.485	ABC Katherine	Australia	2205	M	4.830	R.Tachira	Venezuela	2219	E,M
2.560	Xinjiang	China	2230	D,K	4.832	R.Relej	Costa Rica	0535	D
3.210	R.Mozambique	Mozambique	1820	I	4.832	Altai	Mongolia	2200	I
3.220	R.Togo, Lome	Togo	2240	M	4.835	RTM Bamako	Mali	1826	B,D,E,G,J,K,M
3.240	TWR	Swaziland	1800	I	4.845	RTM Kuala Lumpur	Malaysia	1445	I
3.255	BBC via Maseru	Lesotho	1730	I	4.845	ORTM Nouakchott	Mauretania	1828	B,E,J
3.270	SWABC 1, Namibia	S.W.Africa	2130	M	4.850	R.Yaounde	Cameroon	1826	A,B,C,E,G,J,K
3.280	R.Beira	Mozambique	1730	I	4.850	AIR Kohima	India	1810	B,J
3.295	Reykjavik	Iceland	2047	C,D,E,K,M	4.850	R.Tashkent 2	USSR	0046	G
3.315	SLBS Freetown	Sierra Leone	2100	M	4.860	AIR New Delhi	India	1700	K
3.325	FRCN Lagos	Nigeria	0439	G	4.865	PBS Lanzhou	China	2100	C,D,E,G,K
3.355	AIR Kurseong	India	1650	I	4.865	R.Mozambique	Mozambique	1700	I
3.365	GBC Radio 2	Ghana	2130	D,E,G,J,K	4.870	R.Cotonou	Benin	1805	B,J,K,M
3.380	R.Malawi	Malawi	2015	I,M	4.875	Super R.Roraima	Brazil	0055	C
3.905	AIR Delhi	India	1630	I	4.875	R.Tbilisi	USSR	2058	B
3.915	BBC Kranji	Singapore	1912	E,G,J,L	4.885	Voice of Kenya	Kenya	1828	I,J,M
3.925	AIR Delhi	India	1650	I	4.890	ORTS Dakar	Senegal	2000	I
3.950	PBS Qinghai Xining	China	2220	E,I	4.895	Voz del Rio Arauca	Colombia	0443	E
3.955	BBC Daventry	England	1800	E,G,K	4.895	R.Moscow (Kalinin)	Lithuania	1920	J
3.965	RFI Paris	France	2349	E,G,L	4.905	R.Regio, Rio	Brazil	2355	M
3.980	VOA Munich	Germany	1920	E,G,L	4.905	R.Nat.N'djamena	Chad	2045	B,E,J,K
3.985	R.Beijing, China	via Berne	2100	G,K	4.910	R.Zambia, Lusaka	Zambia	1828	J
3.985	SRI Berne	Switzerland	1908	E,F,G,H,L	4.915	PBS Guangxi, Nanning	China	2200	I
3.995	DW Cologne (Julich)	Germany	2350	E,G,H	4.915	R.Ghana, Accra	Ghana	2145	B,G,J,K
4.035	PBS Xizang Lhasa	Tibet	2250	M	4.915	Voice of Kenya	Kenya	1828	J
4.050	R.Frunze 2	USSR	0033	G	4.930	R.Moscow	USSR	2150	B,E,G,K
4.055	R.Moskva 1 (Kalinin)	USSR	1955	B	4.935	Voice of Kenya	Kenya	1828	D,I,J,K
4.220	PBS Xinjiang	China	2300	K	4.940	R.Kiev 2	Ukraine	2050	B,D,E,G,J,K,L
4.330	PBS Xinjiang	China	0000	K	4.950	R.Nac.Luanda	Angola	2050	J
4.500	Xinjiang	China	2200	D,G,K	4.958	R.Baku	USSR	1935	G,K
4.600	R.Baghdad	Iraq	2000	B,G,K	4.960	AIR New Delhi	India	2200	B
4.635	R.Dushanbe Tadzhik	USSR	1823	D	4.965	R.Juan	Bolivia	2330	M
4.680	R.Nac.Espejo	Ecuador	0030	M	4.975	R.Uganda, Kampala	Uganda	1830	J
4.735	Xinjiang	China	2200	D,E,G,K	4.975	R.Dushanbe	USSR	0240	D
4.740	R.Afghanistan	via USSR	0227	D	4.980	Ecos del Torbes	Venezuela	0300	M
4.750	R.Bertour	Cameroon	1823	J	4.990	FRCN Lagos	Nigeria	1831	B,E,G,J,K
4.750	PBS Xizang, Lhasa	China	2321	E	5.005	R.Nepal, Kathmandu	Nepal	1500	I
4.755	R.Maranhao	Brazil	0050	M	5.010	R.Garoua	Cameroon	1831	J
4.760	Yunnan Kuming	China	2200	E,K	5.010	R.Malagasy	Madagascar	1900	M
4.760	TWR	Swaziland	1630	I	5.010	SBC Singapore	Singapore	1500	I
4.760	R.Frontera	Venezuela	0120	M	5.015	R.Vladivostok	USSR	2325	E
4.765	Brazzaville	Pep.Rep.Congo	2000	B,E,G,J,K,M	5.025	R.Uganda, Kampala	Uganda	1940	I
4.770	FRCN Kaduna	Nigeria	1825	B,D,E,G,J,M	5.030	R.Catolica, Quito	Ecuador	2330	K
4.790	Azad Kashmir R	Pakistan	1700	I	5.035	R.Bangui	C.Africa	2052	J
4.790	TWR Manzini	Swaziland	1826	J,K,M	5.035	R.Alma Ata	USSR	2130	B,G,K
4.795	R.Douala	Cameroon	2055	E,J,M	5.040	R.Tbilisi 1	USSR	2140	B,G
4.800	PBS Xinjiang	China	2252	D	5.045	R.Cultura do Para	Brazil	2250	K
4.800	AIR Hyderabad	India	1600	I	5.047	R.Togo, Lome	Togo	1832	E,G,J,K
4.800	LNBS Lesotho	Maseru	1826	J,K,M	5.050	SBC Singapore	Singapore	2220	M
4.805	R.Nac.Amazonas	Brazil	0020	C	5.055	RFO Cayenne(Matoury)	French Guiana	0545	G
4.810	R.Moscow Yakutsk	USSR	2225	C	5.065	R.Candip, Bunia	Zaire	1936	J
4.810	R.Yerevan 2	USSR	1933	B,E,G,J	5.163	R.Beijing	China	2100	I,K
4.815	R.diff TV Burkina	Ouagadougou	1826	J	5.260	R.Alma Ata 2	USSR	2100	C,E,G,K
4.820	E.Prov.Huila	Angola	2200	I	5.290	R.Moskva 1 Krasnoyarsk	USSR	2239	E
4.820	R.Moskva 4 (Khanty-M)	USSR	1933	E,J,K	5.440	PBS Xinjiang	China	0000	K
4.825	R.Moscow	USSR	1933	B,D,E,J,K	5.451	Machupo	Bolivia	0515	C

JAVIATION

THE VHF/UHF AIRBAND SPECIALISTS

AT LAST!

Our new combined VHF/UHF frequency listing running to some 100 pages is now available. The new publication is in the same format as our previous individual lists and will be updated with the same regularity. Not only have we joined both lists together but added some extra information as well.

**VHF/UHF
Frequency
Listing:
£6.50 + £1 p&p**

I would like to thank all of you who have, over the years purchased our listings and for the many kind & constructive comments that we have received along with the many snippets of valuable informatikon that you have sent in.

Thanks.



AR2515

Available from stock supplied with FREE IBM PC software.

AR2800

Also available from stock worth giving us a call!

AR2000

In stock, supplied with FREE leather carry case. £259.00

Carlton Works, Carlton Street, BRADFORD, West Yorkshire BD7 1DA
Telephone: (0274) 732146 Facsimile: (0274) 722627

STEPHENS-JAMES LTD.

47 WARRINGTON ROAD, LEIGH, LANCS. WN7 3EA

Telephone (0942) 676790

Turn at the Greyhound Motel on the A580 (East Lancs. Road).



SHOP HOURS

Mon - Fri 9.30-5.00pm
Sat 9.30-4.30pm

24 HOUR MAIL ORDER SERVICE

ANTENNA RANGE

CUSHCRAFT	
A3 3 Element Tribander Beam	£331.00
A4 4 Element Tribander Beam	£408.75
10-3CD 3 Element 10m Monobander	£123.50
15-3CD 3 Element 15m Monobander	£143.00
20-3CD 3 Element 20m Monobander	£244.00
AP8 8 Band Vertical 25ft High	£185.50
AP5 5 Band Vertical 25ft High	£153.26
18 Element 2m Boomer Antenna	£155.94
15 Element 2m Boomer Antenna	£98.70
Ringo Ranger 2m Vertical	£46.57
New R5 5 Band half wave Vertical	£268.84
DW 10, 18, 24MHz Rotary Dipole	£190.00
A3WS 18/24MHz 3EL	£241.00

BUTTERNUT

HF 2V 80/40 metre Vertical	£143.77
A 1824 HF6V 17/12m Add on kit	£37.64

FULL RANGE OF ACCESSORIES FOR THE BUTTERNUT RANGE

HY-GAIN

TH2 Mk3 3 Element Tribander	£254.00
18AVT 5 Band Vertical	£188.00

JAYBEAM

TB3 Mk3 3 Element Tribander	£403.00
TB2 Mk3 2 Element Tribander	£270.25
TB1 Mk3 Rotary Triband Dipole	£136.30
VR3 Mk3 Triband Vertical	£94.00
DB44 & 6m Element Beam	£142.50
4Y/4m 4m 4 Element Beam	£50.00
4Y/6m 6m 4 Element Beam	£66.03
LW5/2m 5 Element 2m	£24.91
LW8/2m 5 Element 2m	£31.96
PBM14/2m Parabeam	£85.00
5XY/2m 5 Element Crossed	£43.50
8XY/2m 8 Element Crossed	£57.00

SCANNING RECEIVERS

WIN 108 Air Band	£178.80
AOR2000 Handheld Scanner	£259.00
AOR900UK	£203.32
Base Station Receiver AR2002	£497.89
NEW HF 225 General Coverage Receiver ...	£434.24
AOR 300 Base Station	£765.00

KENWOOD RANGE

TS950SD HF Transceiver	£2995.00
TS950S HF Transceiver	£2299.00
SP950 Filtered Speaker	£89.45
SM230 Station Monitorscope	£789.00
DRU2 Digital Speech Recorder Unit	£88.00
MC60 Desk Microphone	£90.00
TS450S HF Transceiver	£1150.00
TH77E Dual Band	£1298.00
TS850 HF Transceiver	£395.00
AT850 Auto Tuner	£1399.00
PS52 Heavy Duty PSU	£147.73
SP31 Speaker	£235.00
DSP100 Digital Processor	£64.84
TS450S HF Transceiver	£429.13
TS690S HF Transceiver	£1099.00
PS50 20 Amp Power Supply	£1299.00
AT250 Automatic Antenna Tuning Unit	£227.33
AT230 Antenna Tuning Unit	£373.96
TL922 HF Linear Amplifier	£213.20
MC50 Base Station Microphone	£1527.50
MC60A De Luxe Desk Microphone	£47.08
TR751E 2m Multimode Mobile Transceiver	£90.13
TR851E 70cm multimode Transceiver	£612.02
TM241E 50watt 2m Transceiver	£699.00
TM441E 35watt 70cms Transceiver	£295.25
TM702E 25watt 2m/70cm Transceiver	£325.93
TH26E 2m FM Handheld	£458.76
TM74E Tri-band VHF/UHF mobile	£254.00
TM531E 23cm Mobile 10/1 watt Transceiver	£729.00
TH702SE Dual Baner 25 watt Mobile	£415.00
TH405E 70cm Handheld FM Transceiver ...	£455.00
R5000 General Coverage Receiver	£263.00
VC20 VHF Converter 108-174MHz	£894.02
R2000 General Coverage Receiver	£170.85
VC10 VHF Converter 118-174MHz	£607.93
HS5 De Luxe Headphones	£165.46
TS790E Dual Band Transceiver	£38.35
LF30A Low Pass Filter	£1527.50
SP50 Mobile Speaker Unit	£32.96
TH77E Handheld Transceiver	£20.86
Full range of accessories stocked microphones. SWR meter, DC Leads, Antennas etc.	£395.00

G5RV full size high power	£29.50
G5RV half size high power	£27.00
G5RV full size	£18.90
G5RV half size	£16.35
G5RV 160-10M Antenna	£26.00
Dipole 80-10 kits	£26.00
6m 3 Element Beams	£27.00
50m Enam. Copperwire	£7.50
2m Slim Jim	£10.75
6m 2EI HB9CV Beam	£15.35
D130 Wideband Discone	£80.72
X-300 144/70cm Vertical	£89.00
X-500 144/70cm Vertical	£119.00
CP-22J 2m 2x5/8 Collinear	£49.95

REVEX & DIAWA POWER SUPPLIES

Postage extra at cost. Full range of insulators, clamps: aluminium tubing wall brackets.

MFJ ACCESSORIES RANGE

MFJ 1601 Random Wire Tuner	£45.00
MFJ 1701 6 way Antenna Switch	£40.00
MFJ 948 300 Watt Tuner	£129.00
MFJ 949D 300 Watt Tuner	£149.00
MFJ 948 Versatuner	£123.50
MFJ 986 High Power Tuner	£324.00
MFJ 901B Versatuner	£69.95
MFJ 300 Watt Dummy Load	£34.23
MFJ RF Noise Bridge	£84.47
MFJ-931 Artificial Ground	£81.26

ROTATORS

G400RC	£182.90
G6600RC	£240.11
T2 X Heavy Duty Rotator	£407.67
CDE AR40	£172.39
CD 451 1R	£242.15
EMOTATOR 1057SY	£162.45

We are also stockist for Global, and have a full range of publications by RSGB-ARRL and others. Our secondhand list is updated daily. Please send SAE for this or any information.

long medium & short

Transatlantic DX Chart

Freq kHz	Station	Location	Time UTC	DXer
USA				
640	WWLS	Moore, OK	0230	B
700	WLW	Cincinnati, OH	0350	B
710	WOR	New York, NY	0500	A
1010	WINS	New York, NY	2300	A
1050	WEVD	New York, NY	0250	B
1210	WOGL/WCAU	Philadelphia, PA	0255	A,B
Canada				
590	VOCM	St. John's, NF	0110	A,B
710	CKVO	Clarenville, NF	0320	B
930	CJYQ	St. John's, NF	0020	A,B
960	CFX	Kingston, ON	0600	A
1200	CFGO	Ottawa, ON	0350	B
1290	CHRM	Matane, PQ	0530	A
1570	CKLM	Montreal, PQ	0255	B
C. America & Caribbean				
610	CMGI	R. Reloj, Trinidad	0330	A
1030	WASO	San Juan, Puerto Rico	0700	A
1505	R Anguilla	The Valley, Anguilla	0400	A
1610	Caribbean Beacon	The Valley, Anguilla	0230	A,B
South America				
1220	R.Globo	Rio, Brazil	0300	B

DXers:
A: Tim Shirley, Bristol.
B: Jim Willett, Grimsby.

0700) 55544 at 0450 in Worthing; Vatican R, Rome 15.090 (Eng, Hi, Mal, Ta to Asia 1500-1545) heard in Rowley Regis; RSA, S.Africa 15.270 (Eng to Africa 1500-1800) SIO222 at 1625 in Elgin; R.Algiers via Bouchaoui 15.205 (Fr to M.East, N.Africa 0500-2200) 45554 at 1630 in Northwich; REE via Noblejas 15.375 (Eng to Africa 1900-2000) 44444 at 1900 in Morden; RSA, S.Africa 15.365 (Fr to W.Africa) SIO433 at 1937 in Storrington; AIR via Bangalore 15.265 (Eng to Pacific areas 2045-2230) 44433 at 2051 in Brenchley; TWR Ned.Antilles 15.445 (Port to S.Am 2155-2315), heard at 2200 in Kalush, Ukraine.

Good reception of some R. Australia's 13MHz (22m) signals have been noted here. Their Carnarvon transmission to Pacific areas 13.755 (Eng 1500-2100?) 35333 at 1915 by **Roy Patrick** in Derby; to Pacific areas via Shepparton 13.605 (Eng 1600-2130) SIO333 at 2000 in Edinburgh; to Asia via Carnarvon 13.705 (Th 2300-0000) 34443 at 2302 in Wallsend.

Also noted were BRT via Wavre 13.675 (Eng to Europe 0900-0925), heard in Bridlington; AWR Agat, Guam 13.720 (Chinto C.Asia 0300-1000) 24322 at 0925 in Brighton; R.Korea, Seoul 13.670 (Ger, Eng, Fr, Sp to Europe 0600-1145) 22322 at 1117 in N.London; SRI via Sottens 13.685 (Eng to M.East 1515-1700) heard by **Taff Rees** in Worcester Park; R.Austria Int, Vienna 13.730 (Ger, Sp, Eng, Fr to Europe 0400-1700) SIO444 at 1640 by **Phil Townsend** in E.London; KHBI, N.Mariana Islands 13.625 (Eng to SE.Asia, India 1600-1800) SIO242 at 1730 in Grimsby; WHRI Noblesville 13.760 (Eng to USA, Europe 1600-0000) 33332 at 2032 in Oxted and 55555 at 2132 in Gibraltar; R.Nederlands via Flevo 13.700 (Eng to W.Africa 2030-2125) 45433 at 2035 in Bridgwater; WCSN Scotts Corner 13.770 (Eng to Europe, M.East, Africa, USA 2000-2200) SIO433 at 2145 by **Aff Gray** in Birmingham; Voice of the UAE in Abu Dhabi 13.605 (Ar, Eng to N.Africa 2200-0000) 44343 at 2303 by **Robin Harvey** in Bourne.

Many 11MHz (25m) signals to Europe reach their target well. Those noted were R.Korea via Sackville 11.715 (Eng 1030-1100) 54444 at 1040 in Norwich; R.Pakistan, Islamabad 11.570 (Ur, Eng 1700-1800) heard at 1700 in Bridlington; REE via Aganda 11.790 (Eng 1900-2000) 44444 at 1905 in N.London; R.Beijing, China 11.500 (Eng 2000-2200) 34433 at 2000 in Wallsend; WYFR Okeechobee 11.915 (Eng 2000-?) 43443 at 2000 in Bridgwater; Voice of Israel, Jerusalem 11.585 (Eng 2000-2030, also to USA) SIO333 at 2010 in Birmingham; R.Damascus, Syria 12.085 (Eng 2005-2105, also to USA) 35444 at 2034 in Co.Down; R.Romania Int, Bucharest 11.940 (Eng 2100-2125) heard in Rowley Regis; R.Yugoslavia, Belgrade 11.735 (Eng 2100-2145) SIO222 at 2123 in Elgin; AIR via Aligarh 11.620 (Eng 2045-2230) 44333 at 2144 in Swanwick; VOFC via

Okeechobee 11.580 (Eng 2200-2300) SIO333 at 2205 in Hereford; R.Japan via Moyabi 11.735 (Eng 2300-0000) SIO333 at 2315 by **Francis Hearne** in Bristol.

Also noted were a few to other areas: KTWRR, Guam 11.805 (Eng to Australia 0800-1000) 25232 at 0920 in Brighton; Voice of Mediterranean, Malta 11.925 (Eng, Ar to N.Africa 1400-1600) 32232 at 1420 in Oxted; R.Beijing, China 11.575 (Ta, Pa to S.Asia 1400-1555) SIO333 at 1540 in Macclesfield; Voice of the UAE in Abu Dhabi 11.965 (Eng to USA 2200-0000) SIO555 at 2201 in Edinburgh; R.Globo, Rio de Janeiro 11.805 (Port to S.Am 0900-0300) SIO323 at 2320 by **Antonio De Abreu-Teixeira** in Durham.

Although for listeners in Pacific areas the 9MHz (31m) broadcasts from R. New Zealand Int. can often be received in the UK. Their signals on 9.700 (Eng 0630-1110) 33333 at 0810 in Worthing. Two of R.Australia's broadcasts to Asia have also been audible here: 9.770 via Shepparton (Eng 1430-?) 34333 at 1430 in Norwich and 9.860 via Carnarvon (Eng 1800-2100) as 44433 at 1851 in Brenchley. Also logged here were WSHB Cypress Creek 9.495 (Eng to USA 1000-1400), SIO544 at 1030 in Hereford; RCI via Sackville 9.755 (Eng to USA 2200-2230) 33433 at 2209 in Bourne; Voice of Israel, Jerusalem 9.435 (Eng to USA) SIO222 at 2235 in Elgin; R.Cancao Nova, Brazil 9.675 (Port 0800-0300) SIO424 at 0030 in Durham.

Programmes for European listeners stem from WCSN Scotts Corner 9.840 (Eng 0600-0800), rated 22242 at 0753 in Sunderland; HCJB, Ecuador 9.695 (Eng 0700-?) 45444 at 0800 in Derby; AWR via Sines 9.670 (Eng 0800-?, Sun only) 44444 at 0830 in Wallsend; R.Yugoslavia, Belgrade 9.830 (Cr, Eng 0900-?) 44434 at 0900 in N.London; R.Pyongyang, N.Korea 9.325 (Eng 1500-1600, also to M.East, Africa) 55534 at 1526 in Brighton; VOIRI, Iran 9.022 (Ger, Eng, Fr, Sp, Ar 1800-2230) heard at 1830 in Bridlington; R.Sweden via Horby 9.655 (Eng 1930-2030, also to M.East, Africa) 35553 at 1930 in Northwich; Voice of Vietnam, Hanoi 9.840 (Eng 1800-1830, 2030-2100) 44333 at 2042 in Swanwick; R.Beijing, China 9.920 (Eng 2000-2200) 32233 at 2108 in Co.Down; R.Budapest, Hungary 9.835 (Eng 2100-2200) heard in Rowley Regis; R.Sophia, Bulgaria 9.700 (Eng) 53553 at 2148 in Bridgwater; R.Vilnius, Lithuania 9.675 (Eng 2130-?) 44444 at 2230 in Morden; RHC, Cuba 9.710 (Eng 2200-?) SIO544 at 2230 in Edinburgh.

Noted in the 7MHz (41m) band during the morning were R.Polonia, Warsaw 7.210 (Eng to Europe 0630-0730) 43333 at 0630 in Morden; WHRI South Bend 7.315 (Eng to USA 0000-1100) SIO444 at 0700 in Hereford; R.Yugoslavia, Belgrade 7.240 (Eng, Cr to Europe 0800-?) 33333 at 0800 in N.London; R.Prague, Czechoslovakia 7.345 (Ger, Fr, Eng to Europe 0700-1300)

55555 at 0840 in Worthing.

Later, RCI via Daventry 7.235 (Eng, Fr to Europe 1900-2000) was 54444 at 1917 in Gibraltar; R.Korea, Seoul 7.550 (Kor, Ar, Eng to M.East, Africa 1700-2130) 54444 at 2055 in Norwich; R.Abidjan, Ivory Coast 7.215 (Fr to W.Africa 1700-0000) SIO222 at 2200 in Grimsby; AIR via Aligarh 7.412 (Eng to Europe 2045-2230) 44333 at 2211 in Bourne; CPBS-1 China 7.935 (Chin 1958-2330) SIO232 at 2240 in Quebec.

Many 6MHz (49m) broadcasts are directed to Europe. Among those noted in the evening were R.Sweden via Karlsborg 6.065 (Eng 1930-2030, also to M.East, Africa) 44554 at 1940 in Northwich; R.Pyongyang, Korea 6.575 (Eng 2000-2100) 44344 at 2005 in

Co.Down; Vatican R, Rome 5.895 (Eng 2050-2110) 44444 at 2050 in Morden; R.Korea, Seoul 6.480 (Eng 2030-2130) 44333 at 2100 in Norwich; R.Austria Int, Vienna 5.945 (Ger, Eng, Fr, Sp 1700-2300) SIO444 at 2145 in Bristol.

Also logged were the King of Hope, Lebanon 6.280 (Eng to M.East, S.E. Europe) at 2030 in Bridlington; PBS, China 5.800 (Uig to China 2300-0200) 24432 at 2305 in Wallsend; CKZN, Newfoundland 6.160 (Eng to USA, Canada 0930-0500) SIO232 at 2345 in Grimsby; R.Santa Cruz, Bolivia 6.135 (Sp 0900-0100) SIO342 at 2350 in Durham; R.Japan via Sackville 5.960 (Eng, Jap to USA 0100-0300) SIO444 at 0115 in Hereford.

Equipment Used

Leo Barr, Sunderland: Matsui MR4099 + r.w. in loft.
Charles Beanland, Gibraltar: Sangean ATS-803 + Howes AA2.
Darren Beasley, Bridgwater: Philips D2935 + a.t.u. + 10m wire.
Kenneth Buck, Edinburgh: Lowe HF-225 + r.w. in loft or loop.
Tim Bucknall, Congleton: Sony ICF-2001D + AN-1.
Noel Carrington, Sutton in Ashfield: Philips D2999 + a.t.u. + G5RV antenna.
John Case, Frodsham: Lowe HF-225 + 1m Sq Loop.
Jim Cash, Swanwick: Kenwood R5000 + trap dipole.
Sean Cooper, Wells-next-the-Sea: Pioneer F-656 tuner + loop.
John Coulter, Winchester: Yaesu FRG-7 + r.w.
Ron Damp, Worthing: Racal RA17 + 30m inverted V dipole.
Antonio De Abreu-Teixeira, Durham: Sony ICF-2001D + 9.5m wire.
David Edwardson, Wallsend: Trio R600 + inverted V trap dipole.
Ron Galliers, London: Philips D2935 + a.t.u. + 30m wire.
Alf Gray, Birmingham: Codar CR70 + PR30 + a.t.u. + Ex-Army whip.
Simon Hamer, New Radnor: Lafayette HE30/Grundig S1400/Sony ICF-2001D + a.t.u. + r.w. or loop.
Robin Harvey, Bourne: Matsui MR-4099 + s.w. loop.
Francis Hearne, Bristol: Sharp GFA3 cassette radio + r.w.
Sheila Hughes, Morden: Sony ICF-7600DS; Vega 206 + loop/Panasonic DR48 + 15m wire.
Rhoderick Illman, Oxted: Kenwood R5000 + r.w.
Cyril Kellam, Sheffield: Sony ICF-7600DS + AN-1 or 25m wire.
Bryan Kimber, Hereford: Zenith R7000/Realistic SX190 + 20m wire.
Eddie McKeown, Co.Down: Tatung TMR-7602.
George Millmore, Wootton, IOW: Tatung TMR-7602/Racal RA17L + v.l.f. converter + r.w. or loop.
Sid Morris, Rowley Regis: Kenwood R5000 + 31m wire.
John Nash, Brighton: Kenwood R5000 + Datong AD370.
Sergei Olejnik, Kalush, Ukraine: Ishim-003 + 70m wire.
Fred Pallant, Storrington: Trio R2000 + r.w. in loft.
John Parry, Northwich: Realistic DX-400 + 33m wire.
Roy Patrick, Derby: Lowe HF-125 + 44m wire.
Don Phillips, Bridlington: Yaesu FRG-8800 + a.t.u. + r.w.
Philip Rambaut, Macclesfield: Int.Marine Radio R.700M + r.w.
Taff Rees, Epsom: Philips D2935 + Howes AA.
Alan Roberts, Quebec, Canada: Lowe HF-225 + 11m or 31m dipole.
John Sargeant, Bolton: Lowe HF-225 + 20m wire.
Tim Shirley, Bristol: Icom R-71E or Trio R600 + loop or r.w.
Chris Shorten, Norwich: Matsui MR-4099 + 10m wire.
Darran Taplin, Brenchley: Yaesu FRG-7700 + FRA-7700 or FRT-7700 + 80m Zepp.
Phil Townsend, London: Lowe SRX-30 + loop.
John Wells, E.Grinstead: RCA AR88D + loop.
Jim Willett, Grimsby: RCA AR77 + 4m loop or a.t.u. + X dipole.
Julian Wood, Elgin: Kenwood R2000 + Yaesu FRT-7700 a.t.u. + 6m wire.

Maritime Beacons

Long Wave Maritime Beacon Listening

Brian Oddy G3FEX

Three Corners, Merryfield Way, Storrington, West Sussex RH20 4NS

A holiday in Melvick on the north coast of Scotland enabled **John Stevens** (Largs) to check the band from a new location. He says, "Taking my Icom R70 receiver up there was a revelation and when the local people found out that I was gathering information about the maritime radiobeacons transmitted from lighthouses in the area, I was besieged by a crowd of enthusiasts who thought that listening for beacon signals was great fun. As a result I was rushed round the countryside from one lighthouse to another and many people gained a smattering of Morse code into the bargain!"

During his checks, John found that the beacons on Strumberg Head (SB), Stroma Island (OM) and North Ronaldsway (NR) operate sequentially on 291.9kHz twenty-four hours a day.

If you are new to this hobby, it is important to remember that most of the maritime radiobeacons around our shores operate in groups and up to six beacons may share a particular frequency. Usually, each beacon sends its callsign in Morse code four to six times, followed by a 25 second dash

and then its callsign once or twice followed by a silent period of 5 seconds. This pattern is then repeated by the next beacon in the group. When logging a beacon it is advisable to continue monitoring the frequency, since one or more of the other beacons in the group may become audible before the original signal is heard again.

Down in Cornwall **Pat Manning** (Torpoint) compiled an interesting list for the chart during daylight over a three week period. He was surprised to find beacons to the north more difficult to receive than those from the south, since there are clear sea paths in both directions except for the 95km or so of the Devon/Cornwall peninsula. Beacons to the east were scarce, but that was expected since the ground waves have to travel over land to reach him. Pat is now using a Sony AN-1 active antenna with his Philips D2935 receiver and finds that combination works well.

My thanks to Pat for clarifying the locations of two of the beacons detailed in the SWM charts. He says, "Round Island Lighthouse is on the



The lighthouse on Stroma Island that radiates the beacon signal OM on 291.9kHz.



north side of the Scillies on Round Island, just between St. Martins and Tresco. The Channel Light Vessel is midway along a line drawn approximately between Start Point and the Channel Islands". He also mentioned that the Berry Head beacon (BHD) on 318kHz is intended for aeronautical purposes. Some aeronautical beacons can also be used for direction finding at sea, but since this is a rather grey area they are not included in the chart.

The many aeronautical radiobeacons which operate in this part of the spectrum tend to confuse DXers. Several of the beacons logged by **Tony Moore** in Barnet proved to be

aeronautical and had to be excluded from the chart. However, he heard four of the maritime ones along the north coast of France and several others. He has asked me state the limits of the maritime beacon band in this article and inform readers where they may obtain a list of the European maritime radiobeacons. Most of the maritime beacons operate between 285 and 312.6kHz, but there are a few higher up the band. Relatively few guide books cover this part of the spectrum. One of the most popular is *Reed's Nautical Almanac*. A new edition is published each year by Thomas Reed, 178-185 High Street West, Sunderland Tyne and Wear. The 1991 edition may be available for reference purposes at your local public library. It is also worth noting that Thomas Reed sell back issues at low prices.

In Bridgwater, **Darren Beasley** has been concentrating on this band after dark. Although he logged several new beacons he found that some which are normally audible during daylight disappear after dark. Unfortunately some DXers are prevented from taking advantage of the propagation changes which occur after dark by the high level of electrical noise which exists in many areas. Writing from Epsom, **Taff Rees** says, "I have tried listening after dark, but received such heavy interference that I was forced to give up. The beacons whose callsigns I was able to read were all heard during daylight." In E. London, **Phil Townsend** has severe problems with electrical interference throughout the day, but he managed to log Start Point (SP) 298.8, Grosser Vogelnd, Germany (VS) 301.1 and Pointe d'Ailly, France (AL) 310.3 for the first time.

A change in equipment can sometimes produce unexpected results. Until recently, **John Sargeant** (Bolton) used a Racal RA17 Mk 2 receiver with an active dipole and he was disappointed by results. While trying out his new Lowe HF-225 receiver with a 20m random wire he was very surprised to hear so many beacon signals. A Lowe HF-225 receiver and a 650mm square loop was used by **Kenneth Buck** in Edinburgh while compiling his list for the chart. He powered the set from batteries to prevent electrical interference from reaching it via the mains.

DXers

- A Darren Beasley, Bridgwater
- B Kenneth Buck, Edinburgh
- C Colin Jermy, Ruslip
- D Colin Jermy, Cromer
- E Cyril Kellam, Sheffield
- F Pat Manning, Torpoint
- G George Millmore, Wootton, IOW
- H Tony Moore, Barnet
- I Fred Pallant, Storrington
- J Taff Rees, Worcester Park
- K John Sargeant, Bolton
- L Tim Shirley, Bristol
- M John Stevens, Largs
- N John Stevens, Melvick
- O Philip Townsend, E London

req kHz	call-sign	Station Name	Location	DXer	Freq kHz	call-sign	Station Name	Location	DXer
287.3	BY	Bressey LH	Shetland Is	L,N	298.8	RD	Roches Douvres LH	Channel Is	F
287.3	CM	Cromer LH	Norfolk	B,D,K*	298.8	SP	Start Point LH	S Devon	F,O
287.3	CR	Channel LV	??	F	301.1	BA	Punta Estaca Bares	N Spain	F
287.3	FN	Walney Island	off Lancs	B,K*	301.1	BG	Hatteberget LH	Sweden	B
287.3	GA	Outer Gabbard LV	off Suffolk	B	301.1	CN	Cregneish	IOM	B,K*
287.3	LV	Dudgeon LV	off Norfolk	B,K*	301.1	GE	Skarvoy Eggersund	Norway	B
287.3	PS	Point Lynas	Anglesey	B,G,K*	301.1	HO	Hirsholm Main LH	Denmark	K*
287.3	RS	Rosnaes	Denmark	B	301.1	NF	North Foreland LH	E Kent	H,J,K*,O
287.3	SK	Smith's Knoll LV	off Norfolk	B,D,K*,O	301.1	SR	Skerries LH	Anglesey	B,F,K*
287.3	SL	Sletterherge	Denmark	B	301.1	SU	South Rock LV	Co Down	B,F,K*
289.6	D	Rota	Spain	L*	301.1	VS	Grosser Vogelnd	Germany	O
289.6	FD	Fidra LH	F of Forth	B	301.1	WK	Wicklow Head Light	Co Wicklow	A*,B,C,F,K*
289.6	LP	Loop Head	S Ireland	L*	303.4	FB	Flamborough Hd LH	E Yorkshire	B,K*,O
289.6	SM	Pte de St Mathieu	France	F	303.4	FP	Fife Ness Point	Fife	B,K*
289.6	TN	Thyboron LH	Denmark	B,G	303.4	LT	Longstone LH	Berwick	B,K*
291.9	CP	St Catherine's Pt	IOW	F,G,I,O	303.4	NH	Newhaven	E Sussex	G
291.9	ER	Pointe de Ver LH	N France	G,H,O	303.4	SJ	Souter Light	Sunderland	B,K*
291.9	FG	Pointe de Barfleur	N France	C,F,H,I,K*,O	305.7	CB	Corbiere	Jersey CI	A*,F,G
291.9	KD	Kinnairds Head LH	Aberdeen	B,K*,N	305.7	CS	Calais Main LH	N France	I,J,K*,O
291.9	NR	N Ronaldsway LH	Orkney Is	B,N	305.7	FS	Fall's LV	off Kent	A*,G,J,K*,O
291.9	OM	Stroma Pt LH	Caithness	B,N	305.7	KY	Oksoy LH	Norway	B
291.9	PB	Portland Bill LH	Dorset	F,G	305.7	LS	Hirtshals	Norway	B
291.9	SB	Sumburgh Head	Shetland Is	B,K*,N	305.7	SW	Skagen	Norway	B
291.9	TI	Cap d'Antifer	France	G,H,K*,O	305.7	WH	West Hinder	off Belgium	K*,O
294.2	AH	Altacarry Head LH	Antrim	B,K*,M	308.0	BD	Barra Head LH	Is of Barra	B,F,K*,M
294.2	DA	Pladda LH	Is of Arran	B,K*,M	308.0	CA	Pointe de Creach	France	F
294.2	ER	Eierland LH	Holland	G	308.0	GL	Eagle Island LH	W Ireland	B,K*
294.2	KI	Kiel LH	Germany	L*	308.0	HK	Texel	Germany	B,K*
294.2	LG	Eilean-Glas LH	Is of Harris	B,F	308.0	MZ	Mizen Head LH	S Ireland	A*,F
294.2	MW	Mew Island LH	off Co Down	B,K*,M	308.0	RC	Cabo Roca LH	Portugal	K*
294.2	OR	Ough Sgeir LH	off Is Rum	B,N	308.0	RR	Round Island LH	Nr Cornwall	A*,B,F
294.2	RN	Rinnis of Islay	Is of Islay	B,K*,M	308.0	TY	Tory Island LH	N Ireland	B,M
296.5	BH	Blaavandshuk LH	Denmark	B,K*	310.3	AL	Pointe d'Ailly LH	France	F,G,I,J,O
296.5	BN	Ballycotton	Ireland	F	310.3	DU	Dungensis LH	S Kent	C,F,G,I,J,K*,O
296.5	HM	Hanstholm	Denmark	B,K*	310.3	GD	Girdle Ness	Aberdeen	B
296.5	LA	L sta LH	S Norway	B,O	310.3	PH	Cap d'Alprech	France	F,G,H,I,J,K*,O
296.5	LS	Lundy Is S LH	off N Devon	F	310.3	VI	Cabo Vilano	Spain	F
296.5	MY	Cabo Mayor	Spain	K*	310.3	VR	Ultvaer	Norway	B
296.5	NK	Inchkeith	F of Forth	B	312.6	FN	Feistein	Norway	IB
296.5	NP	Nieuwpoort W Pier	Belgium	F	312.6	GU	Geltungane	Norway	B
296.5	NP	Nash Point	S Wales	A*	312.6	KH	Kish Bank	E Ireland	B,F,K*
296.5	OH	Old Head Kinsale	S Ireland	F	312.6	MA	Marstein	Norway	B
296.5	SB	South Bishop LH	Pembroke	A*,F,K*	312.6	NB	Nab Tower LH	off Sussex	G,I
296.5	TR	Tjaskar Rock	S Ireland	A*,F,K*,M	312.6	PT	Souter Pt	Durham	B,K*
298.8	AD	Ameland	Holland	B,K*	312.6	RB	Cherbourg	France	F,G
298.8	BL	Butt of Lewis	Is of Lewis	B,N	312.6	UK	Sunk LV	off Essex	H,K*
298.8	CW	Cape Wrath LH	Sutherland	B,N	312.6	UT	Utsira	Norway	B,L*
298.8	LK	Sule Skerry LH	off Orkney	B,N	313.5	BN	Cap Bon	Tunisia	K*
298.8	LZ	Lizard LH	S Cornwall	F	313.5	PQ	Ile Porquerolles	France	K*
298.8	MF	Muckle Flugga LH	Shetland Is	B,N	318.5	RS	Ristna	USSR	G
298.8	PE	Penlee Pt	UK	F	319.0	LEC	Stavanger	Norway	A*,B,E,H,K*
298.8	QS	Casquets LH	Channel Is	A*,F,G,K*	397.2	DHE	Helgoland Lt	off N Germany	B,C,K*

Note: Entries marked * were logged during darkness. All other entries were logged during daylight.

WANTED Parmeko transformer model 6000/8 and Leak TL25 amplifier. Tel: (0661) 852874 evenings.

FOR SALE FT-480R transceiver all mode, mint, boxed, £175. PSU, £40. CapCo RMA loop antenna, £50. RCA AR88LF receiver, £30. Tel: (0706) 33968.

FOR SALE PC SWL, £50. Tel: 041-632 2793 evenings.

WANTED Yaesu 9600 scanner or similar. Exchange for complete darkroom equipment, cash adjustment if necessary. Altree. 1 Brid Close, Bridesstowe, Devon EX20 4EJ.

FOR SALE ICS FAX-1, Navtex, RTTY decoder, mint condition, £150. Datong FL3 top of range electronic filter, v.g.c., £65. Tel: (0304) 830192 Dover.

FOR SALE Reftec home-base CB934 Autoscan, 40-channel transceiver, £200. Reftec mobile CB934 with two interchangeable antennas, £95. Cybernet mobile 40-channel, £20. Midland 3001 40-channel, £60. Would exchange for 120-80 Bass Accordion, button or piano type or £320 the lot. Mr J.V. Nicoll. 22 Sowden Park, Barnstaple, Devon EX32 8EH. Tel: (0271) 71836.

FOR SALE SEM h.f. to v.h.f. frequency converter, as new, £30. Tel: (0344) 360113 East Berkshire.

FOR SALE 1943 Canadian military transceiver model 58 MkI, £50. Trio h.f. receiver, model 9R-590, £60. Pye Reporter transceiver TX 170.8375 RX 166.0375, £50. Bearcat 70XLT with charger and case, mint, boxed, £70. Tel: (0983) 296624 Isle of Wight.

FOR SALE Reftec 934 transceiver, mag mount antenna, £150. Mustang CB3000, mag mount antenna, s.w.r. meter, £40. Prestel Modem, interface, software for Sinclair Spectrum 48K, £35. Tel: (0883) 349785 after 5pm.

FOR SALE Sony ICF-2001D receiver, 9 months old, perfect condition, all accessories, £150. Can deliver in north of England. Tel: (0274) 606078 Bradford, West Yorks.

FOR SALE or **EXCHANGE** Icom R71E receiver, f.m. board fitted, immaculate condition, £500 o.n.o. Or exchange for Amiga computer hardware/software. Tel: (0903) 506276 evenings Worthing.

FOR SALE AOR3000 scanner h.f., v.h.f., u.h.f., 100kHz-2036MHz, s.s.b., f.m., a.m., c.w., 400 memories, £585. Black Jaguar MkIII a.m./f.m., £140. Both as new, manuals, boxed. Tel: (0926) 54556 Kenilworth.

WANTED in first class condition AOR2002 or Lowe HF-225. I have a Realistic PRO206 and AOR2001 in good condition. The PRO2006 is a 400-memory scanner and is still under guarantee and is insured for three

years. H. Finney. Tel: (0782) 836787 Stoke-on-Trent.

FOR SALE Sony CRF-320 World Zone 32-band digital, one best of Sony, mint condition, boxed, £450. Yaesu FRG-7700 digital 0-30MHz receiver, like new, Manual, £250. Racal RA17L very good condition, £175. Table model RA17L, £200. Exchange possible. Tel: 081-571 5759.

FOR SALE Vintage reception set R107 1.2-17.5MHz b.f.o. audio filter r.f. gain 'phone/speaker output 240V 24 x 13 x 13in. Heavy, good working order, £30. Buyer collects. Tel: (0276) 856866 Woking, Surrey.

FOR SALE Signal R535 complete with NiCad pack, case and two antennas plus NiCad charger and power pack, £200. Plus Yupiteru MVT6000 mobile and power pack, £180. Downes. Tel: Stevenage 367535 evenings.

WANTED National Panasonic RF-9000 receiver must be in new condition. Tel: (0472) 358896 anytime.

FOR SALE AOR900 scanner perfect condition, boxed, £130. Icom O2E f.m. 144MHz hand-held transceiver, boxed, £150. Both plus postage. Tel: (0905) 355381 Worcester.

FOR SALE Sony PRO-80 hand-held receiver 150kHz-30MHz plus AIR and PSB bands with converter, excellent condition with box and manual, £175. Tel: (0452) 310394 Gloucester.

FOR SALE Trio R1000 s.s.b., l.s.b., c.w., a.m., good condition with Hamgear pre-selector, £200 o.n.o. Tel: (0222) 709456 Cardiff.

FOR SALE PRO34 scanner to 960MHz with frequency list and manual, 12 months old, £150 o.n.o. Sony ICF-7600DS boxed with frequency book and manual, perfect condition, £100 o.n.o. Tel: 051-608 1930 Wirral.

FOR SALE Computer BBC-B type with 40/80 5.25in disk drive, ROM manager, Genie pop-up diary, modem, Morely Teletext adaptor, manuals and magazines, complete, little used, new condition, starter package, bargain, £295. Tel: (0378) 560053 Epping.

FOR SALE Racal RA17L good condition, recent service, £125. Andy. Tel: (0706) 843294.

FOR SALE Racal AR88D general communications receiver, recently re-values, beautiful condition with manual. Fine example of a much sought after WWII receiver, £100 o.n.o. John G4NMV. 30 West Street, Banwell, Weston-super-Mare, Avon BS24 6DB. Tel: (0934) 823313 anytime.

Fill in the order form on page 80 in BLOCK CAPITALS - up to a maximum of 30 words plus 12 words for your address - and send it, together with your payment of £2.35, to Trading Post, Short Wave Magazine, Enefco House, The Quay, Poole, Dorset BH15 1PP. If you do not wish to cut your copy of SWM, or do not wish to use the order form provided, you must still send the corner flash or your subscription number as proof of purchase of the magazine. Advertisements from traders, apparent traders or for equipment which it is illegal to possess, use or which cannot be licensed in the UK will not be accepted.

FOR SALE Brand new Lowe HF-225 unwanted gift, £280. Yupiteru MVT5000 plus discone antenna, both boxed, as new, 18 months old, £120. Also G5RV, £10. Paul. Tel: (0705) 833402 Portsmouth.

WANTED Drake RX types RR1, RR3, DSR2, MSR2, R4245. Also NB for RR2 receiver. Any condition, working or not. Interested in any Drake professional state receivers. Will import. G3YFK. Tel: (0743) 884858.

WANTED remote control unit 310 (10L/171), working condition, your price. The RCU 310 was used in conjunction with transmitter T1509. Dick Fixter. 18 Linley Drive, Boston, Lincs PE21 7EJ. Tel: (0205) 360044 evenings.

FOR SALE Grundig Satellit 2100 short wave receiver, s.s.b. unit built-in, good working order, £85 carriage extra. Service manual for the Satellite 2100, £5. Seon. Tel: (0436) 71181.

FOR SALE AR3000 as new, boxed, £560. Tel: (0253) 725587 after 6pm Blackpool area.

WANTED ERA MkII Microreader. Will pay up to £80. Tel: 051-260 5064.

FOR SALE Marconi 995B/2 signal generator 2-220MHz in good working order with manual, £65. Buyer collects. New, unused d.f.m. 10kHz-150MHz not in case, £45. Tel: (0297) 53523 evenings and weekends Devon.

FOR SALE Yaesu FRG-7700 all mode communications receiver 150kHz-30MHz with FRT7700 a.t.u., original box and manual, v.g.c., £235. Tel: (0843) 63445 East Kent.

FOR SALE Black Jaguar BJ200 MkIII, a.m. and f.m. on all bands, covers civil, military, CB, amateur, includes case, charger, two antennas, boxed, excellent condition, £130 o.n.o. Gone CB. Tel: (0492) 875433 Llandudno.

FOR SALE Lowe HF-125 f.m. and keypad, £200. AT-1000, %0. AR1000 scanner, £150. Sony AN-1 Antenna, £30. Trio 0-30MHz signal generator, £40. All mint and boxed. Sony 2001 good condition, £100. Mark Robinson. Tel: (0925) 727889 Warrington.

WANTED Electronic warfare items APA, APQ, APR, APT, ALR or similar UK. Exchange for radio of navigation items similar age or possibly buy. R. Kidd. Tel: (0293) 883871 Crawley.

FOR SALE Sony 2001D receiver complete with manual accessories and boxed plus Rooke table top stand. All as new, £160. Tel: (07048) 77234 Formby, Merseyside.

FOR SALE Yaesu FRG-9600 fitted h.f. PAL video 'N' socket, £475. Heathkit A/ a.t.u., £40. KW Tuner, £30. Eddystone M680 100kHz-30MHz, £40. Spectrum 48K+ proper keyboard c/w RTTY, SSTV, c.w., AMTOR software, £75. Second Spectrum 48K+ complete with RX/TX software RTTY plus leads, £40. All v.g.c. Steve. Tel: (0296) 435690.

FOR SALE Yaesu FRG-8800, FRV-8800 converter, instruction manual, frequency list, earphones, very little used, 2 years old, £550 o.v.n.o. 23 Morton Crescent, Exmouth, Devon EX8 1BG. Tel: (0395) 265201.

FOR SALE Racal RA17L 0-30MHz receiver, mint condition, £200. **WANTED** IC-7000, R5000, may consider any receiver part ex above receiver or upto £500. Tel: (0332) 372696 Derby.

FOR SALE Eddystone 940, plinth mounted, one previous owner, stored ten years, excellent condition, £180. J. Poulton. Tel: (0686) 626153 Powys.

FOR SALE Pye 3 channel v.h.f. Europa c/w tone burst and crystals fitted for any simplex/repeater or packet channel(s) as required, £65 with 1 channel fitted. Further channels or info available. Tel: (0928) 717014 after 6pm and weekends.

FOR SALE Realistic PRO-2022 base/mobile scanner, 68-960MHz, modified scan/search rate of up to 60 channels/steps per second, backlight switch fitted, six months old, unmarked, £120. Tel: (0253) 694106 Blackpool.

FOR SALE Grundig Satellit receiver, f.m. stereo, a.m., u.s.b., l.s.b., two clocks, 42 memories, synchronous detector, station name store, c/w four rechargeable cells and Grundig NR90 charger, £235. Ken. Tel: 081-455 8831 NW London.

FOR SALE/EXCHANGE Technical Software RX8 (BBC Micro) currently £259 for £160. **WANTED** IBM compatible system, Timestep/ICS/Spacetch/Comar/Martelec. Cash either way. Tel: (0745) 886295.

FOR SALE AOR AR3000 100kHz-2036MHz, all modes plus auto taper control and RS232, 2 months old, boxed, £635. Derek. Tel: (0294) 217915 Ayrshire after 6pm.

FOR SALE Fairmate HP-100E MkII hand-held scanner 15MHz-1.3GHz, a.m., f.m., v.f.m., 1000 channel memory, as new, boxed, complete, £160. Tel: 0603 746085 after 5pm

**More Trading Post
on Page 70.**

trading post

FOR SALE Mosley V3 vertical antenna, £30. Sapre telescopic antenna for FT-290R Mk1, £4. 430MHz mobile collinear, £5. Scanning satellite receiver 137MHz, £50. Meteosat dish and feed, unused, £85. John. Tel: Coventry 4653286-7pm.

FOR SALE HF-225, Datong FL2, ERA BP34, a.t.u., all under 12 months old. Also Datong ANF, £560 the lot to include regulated p.s.u. May consider splitting. Tel: Leeds 683618.

FOR SALE Panasonic DR28 receiver, l.w. (needs attention), m.w., v.h.f. s.w. 3.2-30MHz in 3 bands, r.f. gain, fine tune, s.s.b., digital display, bass & treble controls, £75. Tel: Leeds 683618.

WANTED for NRD-525 CMK165 v.h.f./u.h.f. converter, CFL231, CFL232, CFL233 filters. Also wanted Uniden 2830, 28MHz transceiver, must be mint. Jon. Tel: (0326) 240721.

FOR SALE AR2500 scanner boxed, unused, will accept £350 o.n.o. Tel: 021-772 4113 day-time or 021-702 2828 evenings.

FOR SALE FRG-7000 communications receiver 0.25-29.9MHz continuous, a.m., u.s.b., l.s.b., c.w., AR2001 scanner 25-550MHz continuous, n.b.f.m., w.b.f.m., a.m., both as new, boxed with manuals either model, £200. T.W. Foster. 5 Centre Parade, Kettering, Northants. Tel: (0536) 522007.

FOR SALE Plessey 1553 30-band 0-30MHz digital readout for the DXer, £350 o.n.o. R. Sedge. Tel: (0622) 754193.

FOR SALE Z88 computer, mains adaptor, 128K EPROM, 32K EPROM, Amstrad printer, cable, various books, case, cost new over £450, accept £220 o.n.o. Ideal for packet. Kevin. Tel: (0457) 868535 Glossop, Derbys.

EXCHANGE complete camera outfit, Rollei 35S, black, 2.8 Sonnar, l/hood, 2 filters, h/book, mint, Sunpack electronic flash, mint, Voigtlander acc/shoe Rangefinder (collector's item) plus other accessories in small gadget bag for Trio 600 receiver in v.g.c. Tel: Tyne & Wear 526 7902.

FOR SALE Yaesu FRG-9600 MkV (Raycom conversion) scanning receiver, frequency range 100kHz-950MHz, multimode including sidebands, boxed with manual, cost £625 will accept £365 o.n.o. May consider 28MHz radio or CB equipment with cash adjustment. B. Williams. Tel: (0274) 880895 Bradford.

FOR SALE AEA Pakratt PK232 decoder plus parallel serial cable 'Y' and manual, £200 o.n.o. boxed, unused by present owner. Would exchange for ICS FAX-1 decoder. Tel: (0635) 48633 Newbury.

FOR SALE Panasonic RFB600 multi-band communications receiver, as new, hardly used, box, instructions, bargain, £295. Tel: 081-500 6317.

FOR SALE Yaesu FRG-880 in excellent condition, complete with FRT-7700 antenna tuning unit and FRV-8800 v.h.f. converter, in original packing with manual, £425. Peter. Tel: (0646) 695141 Milford Haven, Dyfed.

FOR SALE Eddystone marine receiver 659/670, £50, good condition, buyer to collect. Tel: (0493) 720079.

FOR SALE PRO2004 scanner, 300 channel 25-1300MHz, a.m./f.m., wide f.m., £200 o.n.o. Possible exchange for Sony 2001. Scanner boxed with instructions in mint condition. Geoff. Tel: (0222) 515269 evenings, weekends, Cardiff.

FOR SALE or **EXCHANGE** Yaesu FRG-7700, FRT-7700, FF5, excellent condition, £275. Required HF-225 with conversion and keypad or Yaesu 8800. Reason for sale, severe disablement. Keypad required, cash adjustments can be discussed. Tel: (0387) 63086 any time.

FOR SALE NRD-525 receiver, boxed, manual, £625. AR 2002 scanner, antenna, power pack, manual, boxed, £225. Sony ICF-2001D boxed with necessary, new June 1991, £200. Tel: (0752) 407664 after 6pm Plymouth, Devon.

WANTED Racal RA1770, your price paid. Also Eddystone 880 or 940. Tel: 041-649 2328.

FOR SALE Sony PRO-80 hand portable scanner 150kHz to 223MHz, a.m. (x2), f.m. (x2), s.s.b., case, manuals, etc., mint condition, £165. Tel: (0703) 283507 evenings Southampton.

EXCHANGE Fullerscopes 'Export' 6.25in Newtonian reflecting telescope, heavy equatorial mount, mains driven r.a., three eyepieces, cost £800. For Martelec Graphstore or other advanced framestore plus adjustment if needed. Paul. Tel: (0253) 826535 Blackpool.

FOR SALE Signal R-532 airband receiver 118-139.9MHz, 100 memory channels with mains power unit, mint condition £115. Tel: (04243) 5774 Cooden, near Bexhill, East Sussex.

FOR SALE Icom 71E as new, f.m. board fitted, manual, makers carton, £500. No offers. Tel: 081-556 5131 East London.

FOR SALE Trio R2000 receiver plus VC10 converter, £485. Jupiter MVT5000 hand-held receiver, £165 and Yaesu

FT-101E transceiver, £300. Tel: (0776) 5694 Stranraer between 6-9pm weekdays.

FOR SALE FRG-8800 with converter and active antenna, £525 o.n.o. Tel: (0963) 251304.

FOR SALE AOR3000 multi-band scanning receiver, a.m./s.s.b., n.b.f.n./w.b.f.m., 100kHz-2036MHz, 400 memories, £595 o.v.n.o. Standard AX700 scanner, panoramic adaptor (spectrum analyser), 50-905MHz, 100 memories, multi-scan facility, £395 o.v.n.o. AOR100 hand-held scanner, £165. All boxed with usual accessories. Peter. Tel: (0798) 872363 West Sussex.

FOR SALE DSH Slowfax-2, WEFAX framestore, SSTV, FAX decoder, £370. DSH Weathersat receiver, £100. PCSAT+ and DIGISAT WEFAX decoders for IBMPC, £95 each. Scanmaster for ICR7000, £120. Tel: (0743) 722863 evenings.

FOR SALE/EXCHANGE magazines, SWM/PE/EE/Radcom/AR/HRT/RSGB Bulletin, sell third cost price. WRTH 1973/79/80/81/82/83/84/85/86/87/88/89/90. Send s.a.s.e. for magazine list. Have Trio R-1000 handbook and reviews, offers? Mike Evans, 120 Loughton Way, Buckhurst Hill, Essex IG9 6AR.

TRADING POST ORDER FORM PLEASE WRITE IN BLOCK CAPITALS

Please insert this advertisement in the next available issue of *Short Wave Magazine*.

I enclose Cheque/P.O. for £..... (£2.35).

(Cheques and Postal Orders should be made payable to *Short Wave Magazine*).

A photocopy of this form is acceptable, but you must still send in the corner flash below, as proof of purchase.

Name

Address

.....

.....

.....

.....

.....

.....

.....

Signature Expiry date of card

SWM DECEMBER 91 TP

(30)

(42)

Weather Satellites

Timestep have been producing inexpensive weather satellite equipment for 7 years. Following our success in both the UK and North American education market, we are now bringing our expertise to the amateur satellite user. All of our equipment is designed, built and fully supported in Britain, by Timestep engineers.

Lawrence Harris uses Timestep equipment for his column in Short Wave Magazine. Les Currington who received the first Chinese Feng Yun image and presented it to Chinese Diplomats, also uses Timestep equipment.

PCSAT III

This innovative package will receive NOAA, METEOR, OKEAN, FENG YUN, METEOSAT, GOES and GMS. All images are received automatically on any PC with CGA, EGA, VGA or SVGA display.

Zoom, Pan, Contrast Stretch, False Colour, and Laser Print are just some of the features this system offers. Extensive filtering and a precision A-D are used on an internal PC Half Card, for superior image quality.

Animation from Meteosat is no mere gimmick! The atmosphere is a fluid in constant motion. Follow the dynamic progress of storms and cloud cover, on up to 100 full frames continuously animated images!

The really important feature is the ability to display in 800 pixels 600 lines and 256 colours, all at the same time. Some other systems will display 256 colours but only in far less resolution. Nearly all VGA and SVGA graphic cards are supported.

Full Satellite Resolution is received and stored by the system in a massive 512Kb file. This enables the stunning image quality and image processing.

Only £199.00 inc VAT & postage
Upgrade for £99.00 and your PC GOES in exchange.

Meteosat Receivers

Meteosat Yagi	£124.95
Meteosat Preamp	£92.00
20m Meteosat cable	£16.00
Meteosat receiver	£199.00
PCSAT III cable	£9.95
PCSAT III system	£199.00

Complete Meteosat system as above only £640.00 inc.

Polar Systems

We produce a professional scanning receiver for NOAA, METEOR, OKEAN and FENG YUN; and low cost antenna systems. INSTANT TRACK is the ultimate Polar tracking program for up to 200 satellites at £24.95 inc.

Computers

We can supply PCs to any specification at really good prices. Call us if you need details or if you want to purchase a complete "turnkey" solution.

Call or write for a full catalogue.

Timestep Weather Systems
Wickhambrook Newmarket
CB8 8QA England
Tel 0440 820040 Fax 0440 820281

RADIO SHACK

Short Wave Receivers

All of the equipment we sell has been imported by the factory authorised distributors with full warranty back-up and parts service.

Lowe HF-225	High performance compact receiver	£425.00
Kenwood R-2000	10 Memories	£595.00
Kenwood VC-10	VHF converter for R-2000	£161.00
Kenwood R-5000	Top of their range receiver	£875.00
Kenwood VC-20	VHF converter for R-5000	£167.00
Yaesu FRG-8800	Fine performing all mode set	£649.00
Yaesu FRV-8800	VHF converter for above	£100.00
Icom IC-R71E	The old favourite	£855.00
Icom IC-R72E	Icom's latest, small & excellent	£645.00
Icom IC-R9000	The set with everything	£3,995.00
JRC-535	The latest from Japan Radio Company	£1,095.00

SCANNERS FROM RADIO SHACK

SUPER BARGAINS IN REALISTIC SCANNERS!

PRO-38	10 Channel handy scanner (£99.95)	£79.95
PRO-2022	200 Channel search & scan (239.95)	£199.95
PRO-2024	60 Channel search & scan (£179.95)	£99.95
PRO-37	200 Channel handy search & scan (£249.95)	£229.95
PRO-2006	400 Channel with fabulous performance	£329.95
	with FREE disc (worth £49.95)	
AR-950	Base/mobile scanner	£249.00
AR-2000	Series II 0.5-1300, 1000 memories	£249.00
AR-2002	25-550 & 800-1300MHz	£487.00
AR-3000	All mode scanner 100kHz-2036MHz	£765.00
Kenwood RZ-1	Wide band coverage	£275.00
Icom IC-R7000	25-2000 high performance receiver/scanner ..	£895.00
Icom R-1	100kHz-1300MHz 100 memories handy	£369.00
Icom R-100	High performance base/mobile	£485.00
Black Jaguar	AM/FM handy scanner	£199.00
Bearcat UBC-200XLT	200 memories	£229.00
Jupiter MVT-7000	Hand-held 100 memories	£289.00
Jupiter MVT-6000	Base/mobile version	£299.00
Fairmate HP-200E	Wide band 100-600 & 805-1300kHz	£269.00

Carriage free in U.K. Call us for our tax free export prices.

We will be pleased to quote you for anything you require in the communications and computer field. We are pleased to hear from you and see you. We aim to give you the attention you deserve, so please call before you come along.

73s Terry Edwards G3STS

RADIO SHACK LTD

188 Broadhurst Gardens, LONDON NW6 3AY

VISA

(Just around the corner from West Hampstead Station on the Jubilee Line)

Tel: 071-624 7174 Fax: 071- 328 5066



PC GOES/WEFAX

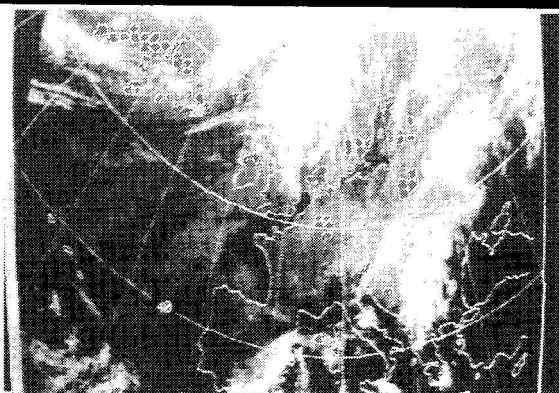

PC GOES/WEFAX enables you to receive both FAX and SATELLITE images on your PC computer.

In **FAX** mode it will display weather charts, rebroadcast satellite images, press and amateur transmissions. In **SATELLITE** mode it will capture images from both **METEOSAT** and all Polar Orbiting Satellites.

Some of its many advanced features:

Image Resolution: 640 x 800 x 16 Standard, 1280 x 800 x 256 with VGA and 1MB EMS. Super VGA Support.
 Display in Black/White, Monochrome Grey Scale, Blue/Grey, Colour or User Programmable Colour. Supports all known **FAX** and Satellite transmission modes. Start, Stop, Phasing Tone recognition and Tuning Oscilloscope. Latitude and Longitude Gridding on Polar Orbiting Images. Interactive Thermal Infra red Analysis. Polar orbiting Prediction Program, Multiframe Animation. Image Brightness, Contrast, Reversal and Rotation control.

PRICE ONLY £199.00 inc. VAT. P&P £3.25

PC HF FAX 5.0

PC HF FAX enables you to receive weather charts, rebroadcast satellite pictures, amateur and press transmissions on your PC Computer.

This new version contains many improvements and enhancements over the earlier popular version.

Displays up to 16 intensity levels with 640 x 800 resolution. IOC Rates 288, 576, 864 and 1152. Line Rates 60, 90, 120, 180 and 240. Start and Stop Tone recognition with automatic unattended capture. Storage/Retrieval and Print from Disk. Image Zoom, Reversal, False Colour. Comprehensive File Management.

PRICE ONLY £99.00 inc. VAT. P&P £3.25

PC SWL

The PC SWL is a complete package allowing reception of MORSE CODE, RTTY and FEC.

- * RTTY Baudot 45,50,57,75 and 100 Baud.
- * RTTY ASCII 75,110,150 and 300 Baud
- * CIR 476 Codes FEC, SELCAL and NAVTEX.
- * MORSE CODE 1 to 40 WPM.
- * Automatic Calibration and Code Recognition.
- * Unattended Capture and Printing.

PRICE ONLY £99.00 inc. VAT. P&P £3.25

Order PC HF FAX and PC SWL together for **ONLY £178.00 INC VAT, P & P £3.25**

CALL TODAY FOR FULL DETAILS AND BROCHURES.

COMAR ELECTRONICS

Unit 10, Samuel Whites Estate,
 Medina Road, Cowes, Isle of Wight
 PO31 7LF Tel: 0983 200308



NEW

FAX and WEATHER SATELLITES

Full resolution charts and greyscale pictures from any SPECTRUM computer to a dot matrix printer. Basic system £40 plus interface for FAX £40 or WX SATS £59.

APT-1 WEATHER SATELLITE MODULE

Enables all weather satellite signals to be displayed on any FAX system. Plugs into RX-8 system direct. £59 or £39 if ordered with RX-8.

RX-8 8 - MODE RECEIVE

Every possible feature and performance to receive FAX, HF & VHF PACKET, COLOUR SSTV, RTTY, CW, AMTOR, UoSAT and ASCII on any **BBC** computer. Reviews Oct. 89 Ham Radio Today and July 91 Rad Comm. Complete system of EPROM, interface, instructions, leads and demo cassette £259.

RX-4 RTTY CW SSTV AMTOR RECEIVE

Performance, features and ease of use make this still a best seller. Needs TIF1 interface. **BBC, CBM64** tape £25, disk £27. **VIC20** tape £25. **SPECTRUM** tape £40, + 3 disk £42 inc adaptor board (needs TIF1 also) or software-only version £25. **TIF 1** INTERFACE has 4-pole filtering and computer noise isolation for excellent HF and VHF performance. Kit £30, ready-made, boxed with all connections £40. Available only with software.

Also **MORSE TUTOR** £8, **LOGBOOK** £8, **RAE MATHS** £8 for **BBC, CBM64, VIC20** and **SPECTRUM**. **BBC LOCATOR** with UK, Europe, World maps £10. Disk £2 extra for all.

Lots of information available about everything, please ask. Prices include VAT and p&p by return.



technical software (SWM)



Fron, Upper Llandwrog, Caernarfon LL54 7RF
 Tel: (0286) 881886

THE VINTAGE WIRELESS BOOK LISTING

Published regularly containing 100s of out-of-print, old and collectable wireless, TV and amateur radio books/magazines etc. Send four first class stamps for next issue or £2.50 for next four issues.

WANTED: Pre 1960 Wireless, amateur radio and TV books and magazines.

NEW PUBLICATIONS:

The Government Surplus Wireless Equipment Handbook. Facsimile reprint. Gives detailed information and circuit diagrams plus photos for British and American receivers, transmitters and test equipment etc. Large format. Incorporated is a surplus/commercial cross referenced valve and transistor guide. **Price £13.75 including postage.**

The HF Band Frequency List. This extensive volume covers the h.f. spectrum from 2-30MHz and gives details of transmissions outside the amateur bands including details of time schedules, plus comprehensive RTTY details. **Price £7.95 including postage.**

SECRET WARFARE. THE BATTLE OF CODES AND CIPHERS By Bruce Norman. A detailed outstanding work with emphasis on the development of modern intelligence and the use of codes and ciphers. Throws light on top secret strategies of code breaking. Includes a history of codes. Including WW2 Strategies. Clear and concise, analysis. Extensive use of diagrams. One of the few books on cryptography. Previously unpublished material. Brand new. £4.95 including post. **Telephone orders accepted.**



CHEVET BOOKS (Dept SW)

157 Dickson Road, BLACKPOOL FY1 2EU Tel: (0253) 751858



COMMODORE 64 PACKET

PACKET ON THE COMMODORE, WITHOUT A TNC!

Yes, it's true, you can run packet on a Commodore 64 without the need for a costly TNC. We offer a dedicated packet modem, together with a free copy of an excellent public domain program on disc.

This really is the inexpensive way to get on the air with Packet Radio.

MODEM with FREE SOFTWARE ONLY £50.00

Send large SAE (33p stamp) for details of all our products.

J. & P. ELECTRONICS LTD.



Unit 45, Meadowmill Estate, Dixon Street,
 Kidderminster DY10 1HH Tel: (0562) 753893



RADIO AMATEURS EXAM? PASS FIRST TIME!

Before you enrol check the benefits of
RRC'S unique Home Tuition Service

RRC has helped thousands of students to success in their examinations with this unique system of postal tuition, one which guides you, step-by-step, to qualify in the shortest possible time. Only The Rapid Results College offers you all these advantages:

- | | |
|---|--|
| <input type="checkbox"/> A qualified personal tutor | <input type="checkbox"/> Free advice before you enrol |
| <input type="checkbox"/> Study material prepared by specialists | <input type="checkbox"/> Telephone Helpline |
| <input type="checkbox"/> Completely self-contained courses | <input type="checkbox"/> Free 'How to Study' Guide |
| <input type="checkbox"/> Handy pocket-sized booklets | <input type="checkbox"/> Instalment Plan |
| <input type="checkbox"/> Personal study programme | <input type="checkbox"/> Free Postage on course material |
| <input type="checkbox"/> Regular marked tests | <input type="checkbox"/> Worldwide Airmail Service |
| <input type="checkbox"/> Courses regularly updated | <input type="checkbox"/> Extra tuition free if you don't pass first time |
| <input type="checkbox"/> 48 hour despatch | |

POST COUPON TODAY FOR FREE RADIO AMATEURS PROSPECTUS
Please send me my prospectus as quickly as possible.

Mr/Mrs/Miss/Ms _____

Address _____

Postcode _____

RRC The Rapid Results College



Dept. JV116, Tuition House, London SW19 4DS. FREE ADVICE: 081 947 7272 (9am-5pm)
PROSPECTUS: 081 946 1102 (24 hour Recordcall Service quoting Dept. No. above)

FLIGHTDECK THE AIRBAND SHOP

192 Wilmslow Rd., Heald Green, Cheadle, Cheshire SK8 3BH
Telephone: 061-499 9350 Fax: 061-499 9349

ALL THE ENTHUSIAST NEEDS

Main Stockists of receivers by:
SONY, ICOM, LOWE, KENWOOD, AOR, YUPITERU,
UNIDEN, SIGNAL, WIN, FAIRMATE.
Comprehensive range of accessories,
aerials, books, aero-charts etc.

PX welcome, finance available (subject to status).

Open: Monday to Saturday 9.30 a.m. - 5.30 p.m.
We are located on the A34 (Wilmslow Road), 2 miles South from the M63
Junction 10, just 3 miles from Manchester International Airport

Send 50p for illustrated Catalogue from Dept. SWM4

Professional WEATHER MONITORING

FEATURES (depending on model)

- WIND DIRECTION
- WIND SPEED
- GUST ALARM
- GUST SPEED
- RAINFALL
- SUNSHINE
- OUTSIDE TEMPERATURE
- MIN-MAX TEMPERATURE
- RELATIVE HUMIDITY
- BAROMETRIC PRESSURE
- WOODEN CABINET
- MAINS & 12-24V DC

★ ★ All main readings at a glance ★ ★

SEND FOR
COLOUR
BROCHURE
Prices
from only
£179
inc. VAT

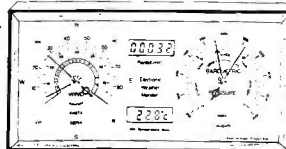

Best
IDEAL XMAS
GIFT

R&D ELECTRONICS, UNIT 19, THE ST JOHN WORKSHOPS,
MARGATE, KENT CT9 1TE. TEL: (0843) 221622

THE KITS WITH ALL THE BITS!

Guaranteed complete to the last nut!

COMPACT 80m CW QRP Tx/Rx

DTR3 Kit - £87.50 P&P £3.00 Ready Built - £140.00

★ Stable VFO ★ Sidetone ★ Audio Filter

★ Requires 12/14 VDC ★ Very detailed

instructions ★ Black steel case

★ Printed panel

40m & TOP BAND VERSIONS
ALSO AVAILABLE

ANTENNA TUNING UNITS

TU1 Kit - £41.25 Ready Built - £57.50

TU2 Kit - £51.00 Ready Built - £72.00

P&P £3.00

★ Large dia. coil ★ High grade capacitor ★ Built in balun ★ Circuits to match your antenna ★ Up to 30 Watts of CW ★ TU2 has sensitive QRP/SWR meter
★ TU1 is ideal for SWL

QRP SWR METER

★ Specially designed for QRP ★ HF 1-30MHz

★ Can be set down to 1/2 watt for FSD

★ Ideal for milliwatting ★ Low insertion loss 0.2dB

TUA1 Kit - complete with case & meter £18.00 P&P £1.00

CARLTON (Receiver)

80-40-20m Dc Rx

★ Receives USB, LSB and CW ★ Very sensitive

and selective ★ Simple modular construction

★ 12-14 volt battery operated ★ Printed fascia

Kit complete with case - £69.50 P&P £3.00

PSU 15 REGULATED

POWER SUPPLY

★ Ready built ★ Mains input ★ 13.8V @ 1.5A

output ★ Ideal for DTR3 & 'Carlton' ★ Fully

protected

Supplied ready built - £52.00 P&P £4.00

Send SAE for brochure or call Alan G4DVW on 0602 382509

LAKE ELECTRONICS

7 Middleton Close, Nuthall, Nottingham NG16 1BX
(callers by appointment only)



AERIAL TECHNIQUES

SPECIAL PRODUCTS FOR TV-DXING

New 10" Screen Multi-System
B & W TV
and Monitor

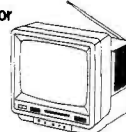

Full VHF/UHF coverage for system B/G/I/L for Europe, UK & France. 4-way power source, Mains, 12v DC, Dry batteries, also chargeable power source with rechargeable batteries. Full Video & Audio inputs via phono sockets. Unique charger circuit within the TV for re-chargeable batteries.
£149.50 inclusive of Vat.
Carriage & Insurance £6.50

NEW Compact Combined B1/3
Array for TV-DXing.
Total Length only 4ft 10in

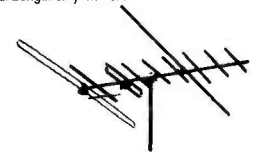

Complete with foiled dipoles for both Band 1 and Band3 for optimum performance. Covers Band 1 (47-70MHz) at 3.5dB gain. Band 3 (175-230MHz) at 8dB gain.
£44.50 inclusive of Vat.
Carriage and insurance £6.50.
VHF to UHF Upconverter, Model 3638



Vertical load carrying 45kg takes 2" main mast, 1 1/2" stub mast. £44.95 inclusive of Vat. Additional Alignment bearing £18.60 inclusive of Vat. P&P on Rotor £4.50.



Converts input band of 40-230MHz to equivalent bandwidth at UHF. Ideal for TV-DXing with a domestic TV. £49.95 inclusive of Vat. post & packing

Aerial Techniques, the company that knows the TV-DXing hobby. We stock a large range of equipment for all types of aerial installation, all detailed in our 29 page Catalogue at 75p, why not send for your copy today. We also have available Multi-standard TVs and Video recorders for all systems, PAL, SECAM & NTSC. Most makes of Satellite equipment carried together with decoders for Canal Plus, RAI UNO, RAI DUE, PAL/D2-MAC Satellite receivers now in stock, also SECAM to Pal Transcoders (SAE details)

SPECIAL PRICE!!! UNIDEN UST-92 D2-MAC to PAL Decoder£399.00 + VAT
ACCESS, VISA & AMERICAN EXPRESS
Mail & Telephone orders welcome
(24hr service)

11. KENT ROAD, PARKSTONE, POOLE, DORSET BH12 2EH
Tel: 0202 738232 Fax: 0202 716951

SWM BOOK SERVICE



0202 665524

The books listed have been selected as being of special interest to our readers. They are supplied from our editorial address direct to your door. Some titles are overseas in origin.

HOW TO ORDER

POST AND PACKING; add £1.00 for one book, £2.00 for two or more books, orders over £40 post and packing free, (overseas readers add £1.75 for one book, £3.50 for two or more for surface mail postage) and send a postal order, cheque or international money with your order (quoting book titles and quantities) to PW Publishing Limited, FREEPOST, Enefc House, The Quay, Poole, Dorset BH15 1PP. Please make your cheques payable to Short Wave Magazine, payment by Access, Mastercard, Eurocard or Visa also accepted on telephone orders to Poole (0202) 665524. Books are normally despatched by return of post but please allow 28 days for delivery. Prices correct at time of going to press. Please note: all payments must be made in Sterling.

O/P = Out of print, O/S = Out of stock.

NEW BOOKS

AMATEUR RADIO

AN INTRODUCTION TO RADIO WAVE PROPAGATION (BP293)

J.G. LEE
How does the sun and sunspots affect the propagation of the radio waves which are the basis of our hobby? They affect the ionosphere, but differing frequencies are treated differently. Find out how to use charts to predict frequencies that will be the most profitable. What effect will noise have on the signal? Find out with this book. 116 pages. **£3.95**

AN INTRODUCTION TO VHF/UHF FOR RADIO AMATEURS (BP281)
I.D. POOLE An excellent book to go with the new Novice or full call sign. Nine chapters and an appendix deal with all aspects and frequencies from 50 to 1300MHz. 96 pages. **£3.90**

W1FB'S DESIGN NOTEBOOK
Doug DeMaw W1FB This book is aimed at the non-technical amateur who wants to build simple projects and obtain a basic understanding of amateur electronics. 195 pages. **£8.50**

ORP CLASSICS
Edited by Bob Schelgen KUT6 Operating ORP is fun. This book increases the enjoyment by showing you how to build items that you can be proud of. The can hold their own against the 'Kenyaocom' rig, and come much cheaper too. Extracts from QST and the ARRL handbook, superbly packed in. 274 pages. **£9.95**

THE SATELLITE EXPERIMENTER'S HANDBOOK 2nd Edition
Martin Davidoff K2UBC The book is divided into four main sections - History, Getting Started, Technical Topics and Appendices. It provides information on spacecraft built by, and for, radio amateurs. In addition it discusses weather, TV, broadcast and other satellites of interest to amateurs. 313 pages. **£14.50**

W1FB'S HELP FOR NEW HAMS
Doug DeMaw W1FB This book covers everything from getting acquainted with new equipment to constructing antennas, station layout, interference and operating problems to on-the-air conduct and procedures. 155 pages. **£6.95**

CONSTRUCTION

COIL DESIGN AND CONSTRUCTION MANUAL (BP160)
B.B. Babani Covering audio to r.f. frequencies, this book has designs for almost

everything. Sections cover such topics as mains and audio output transformers, chokes and r.f. coils. What is the required turns ratio? This book will show you how to find out. Text and tables. 160 pages. **£2.50**

SIMPLE ELECTRONIC CIRCUIT AND COMPONENTS (BP62)
F.A. WILSON
Components, circuits, formulae and radio matters are dealt with in this book. A book to fill in the gaps that appear when taking the RAJ or the Novice course. Also eminently suitable for anyone wishing to study at home. 209 pages. **£3.50**

SHORT WAVE SUPERHET RECEIVER CONSTRUCTION (BP276)
R.A. Penfold A general purpose receiver to build from antenna to audio, described in understandable English. 74 pages. **£2.95**

ANTENNAS

ALL ABOUT CUBICAL QUAD ANTENNAS
William I. Orr W6SAI and Stuart D. Cowan W2LX
The quad antenna came into being, and popularity, over 50 years ago. This book shows you how to design build and 'test' this versatile antenna. If you just want to build one then, there are ready to go designs for bands between 7 and 50MHz. 122 pages. **£6.75**

THE ANTENNA EXPERIMENTER'S GUIDE
Peter Dodd G3LDD
Although written for Radio Amateurs this book will be of interest to anyone who enjoys experimenting with antennas. You only need a very basic knowledge of radio & electronics to get the most from this book. 207 pages. **£8.90**

FAULT FINDING

MORE ADVANCED TEST EQUIPMENT CONSTRUCTION (BP249)
R.A. Penfold
A follow on from *Test Equipment Construction (BP249)* this book looks at digital methods of measuring resistance, voltage, current, capacitance and frequency. Also covered is testing semi-conductors, along with test gear for general radio related topics. 102 pages. **£3.50**

HOW TO USE OSCILLOSCOPES AND OTHER TEST EQUIPMENT (BP267)
R.A. Penfold Hints and ideas on how to use the test equipment you have, to check out, or fault find on electronic circuits. Many diagrams of typical waveforms and circuits, including descriptions of what waveform to expect with particular faults, or distortion in audio amplifiers. 104 pages. **£3.50**

LISTENING GUIDE

FERRILL'S CONFIDENTIAL FREQUENCY LIST
Compiled by Geoff Halligey The band 4-78MHz covered in great depth. Who is using what frequency and mode, what's that call sign? These are some of the answers this book will help you find. A very comprehensive book. 390 pages. **£17.95**

SOUNDS EASY (1991 EDITION)
Compiled by Ken Davies A complete guide to the numerous local radio stations throughout the UK. If you do a lot of travelling this book is invaluable. Itemised by areas, it makes finding you kind of sounds easy. 52 pages. **£2.95**

AIR TRAFFIC RADIO
1991 Edition Ken Davies Frequencies and abbreviations used in air traffic control throughout the UK. Where to listen for tower, ground and radar control in civilian and other airports. It also includes a small section on off-shore oil related use. 84 pages. **£3.95**

INTERNATIONAL RADIO STATIONS GUIDE (BP255)
New revision by Peter Shore
As in 'Broadcast Roundup', his column in *P.W. Peter Shore* has laid this book out in world areas. There are sections covering English language transmissions, programs for DXers and swl's. Along with sections on European medium wave and UK fm stations. 266 pages. **£9.95**

THEORY

FUTHER PRACTICAL ELECTRONICS CALCULATIONS AND FORMULAE (BP144)
F.A. Wilson
Contains sections about electrical basics, electrostatics, electromagnetism, mathematics, signal processing and generation, amplifiers, noise distortion and reliability. On the radio front there are sections about e. waves, spectrum matters, receivers, antennas and transmission line calculations. Finally general formulae and conversion factors are given with a short history of electronics squeezed in at the end. 450 pages. **£4.95**

REFLECTIONS Transmission Lines & Antennas
M. Walter Maxwell W2DU This will help dispel the half-truths and outright myths that many people believe are true about transmission lines, standing waves, antenna matching, reflected power and antenna tuners. 323 pages. **£14.50**

RADIO

AIR & METEO CODE MANUAL
10th Edition, Joerg Klingenfuss
Detailed descriptions of the World Meteorological Organisation Global Telecommunication System operating FAX and RTTY meteo stations, and its message format with decoding examples. Also detailed description of the Aeronautical Fixed Telecommunication Network amongst others. 299 pages. **£15.00**

HIGH POWER WIRELESS EQUIPMENT
Articles from Practical Electricity 1910-11
Edited by Henry Walter Young
A reprint of interesting practical articles from the very early days of radio. 99 pages. **£6.85**

RADIOTELETYPE CODE MANUAL
10th Edition, Joerg Klingenfuss
This book gives detailed descriptions of the characteristics of telegraph transmission on short waves, with all commercial modulation types including voice frequency telegraphy and comprehensive information on all RTTY systems and c.w. alphabets. 96 pages. **£8.00**

RESCUE
Paul Beaver & Paul Berriff
This book follows the life and conditions of rescue helicopter crews. This is not drama, this is real life and it makes a true impression of the rescuers for the reader. There are transcriptions of air/ground and between crew dialogues, a summary of the main distress and rescue radio frequencies and helicopter base locations. 192 pages. **£9.99**

SCANNERS (Third Edition)
Peter Rouse GU1DKD
A guide for users of scanning receivers, covering hardware, antennas, accessories, frequency allocations and operating procedures. 245 pages. **£8.95**

SCANNERS 2
Peter Rouse GU1DKD
The companion to *Scanners*, this provides even more information on the use of the v.h.f. and u.h.f. communications band and gives constructional details for accessories to improve the performance of scanning equipment. 216 pages. **£10.95**

SHORT WAVE RADIO LISTENERS' HANDBOOK
Arthur Miller
In easy-to-read and non-technical language, the author guides the reader through the mysteries of amateur, broadcast and CB transmissions. 207 pages. **£7.99**

WORLDWIDE HF RADIO HANDBOOK
Martyr R. Cooke
This book lists high frequencies used by aircraft and aeronautical ground stations. Divided into sections, Military, Civil etc. The book should be easy to use. **£6.95**

1934 OFFICIAL SHORT WAVE RADIO MANUAL
Edited by Hugo Gernsback
A fascinating reprint from a bygone age with a directory of all the 1934's w receivers, servicing information, constructional projects, circuits and ideas on building vintage radio sets with modern parts. 260 pages. **£10.15**

TELEVISION

A TV-DXERS HANDBOOK (BP176)
R. Bunney
Information on transmission standards, propagation, receivers including multi-

standard, colour, satellites, antennas, photography, station identification, interference etc. Revised and updated 1986. 87 pages. **£5.95**

GUIDE TO WORLD-WIDE TELEVISION TEST CARDS
Edited by Keith Hamer & Garry Smith
Completely revised and expanded, this is a very handy and useful reference book for the DXTV enthusiast. Over 200 photographs of Test Cards, logos, etc., world wide. 60 pages. **£4.95**

THE ATV COMPENDIUM
Mike Wooding G6IQM
This book is for those interested in amateur television, particularly the home construction aspect. There is not a 70cm section as the author felt this is covered in other books. Other fields, such as 3cm TV, are covered in depth. A must for the practical ATV enthusiast. 104 pages. **£3.00**

SATELLITES

AN INTRODUCTION TO SATELLITE TELEVISION (BP195)
F.A. Wilson
Answers all kinds of questions about satellite television. For the beginner thinking about buying or purchasing a satellite TV system there are details to help you along. For the engineer there are technical details including calculations, formulae and tables. 104 pages. **£5.95**

SATELLITE TELEVISION A layman's guide
Peter Pearson
Pictures from space, that's what satellite television is all about. Orbiting satellites 35,000km high receive TV signals from stations on the earth and retransmit them back again. This book explains all you need to know to set up your own satellite TV terminal at home, dish and accessories, cable and tuner. 73 pages. **£1.00**

SATELLITE TELEVISION INSTALLATION GUIDE
2nd Edition, John Breeds
A practical guide to satellite television. Detailed guidelines on installing and aligning dishes based on practical experience. 56 pages. **£11.95**

THE SATELLITE BOOK (A complete guide to satellite TV theory and practice)
John Breeds
This book deals almost exclusively with television broadcast satellites and is a comprehensive collection of chapters on topics, each written by an expert in that field. It appears to be aimed at the professional satellite system installer, for whom it is invaluable, but it will be appreciated by a much wider audience - anyone interested in satellite technology. 280 pages. **£27.00**

WEATHER SATELLITE HANDBOOK 4th edition
Dr Ralph E. Taggart WB0DT
This book explains all about weather satellites, how they work and how you can receive and decode their signals to provide the fascinating pictures of the world's weather. There are plenty of circuit diagrams and satellite predicting programs. 192 pages. **£14.50**

THEORY

A BEGINNERS GUIDE TO MODERN ELECTRONIC COMPONENTS (BP285)
R.A. Penfold
This book covers a wide range of modern components. The basic functions of the components are described, but this is not a book on electronic theory and does not assume the reader has an in-depth knowledge of electronics. It is concerned with practical aspects such as colour codes, deciphering code numbers and the suitability. 164 pages. **£3.95**

AUDIO (Elements of electronics - book 6)
F.A. Wilson
This book studies sound and hearing, and examines the operation of microphones, loudspeakers, amplifiers, oscillators, and both disk and magnetic recording intended to give the reader a good understanding of the subject without getting involved in the more complicated theory and mathematics. 320 pages. **£9.95**

EVERYDAY ELECTRONICS DATA BOOK
Mike Tooley BA
This book is an invaluable source of information of everyday relevance in the world of electronics. It contains not only sections which deal with the essential theory of electronic circuits, but it also deals with a wide range of practical electronic applications. 250 pages. **£8.95**

FILTER HANDBOOK A practical design guide
Stefan Niewiadomski
A practical book, describing the design process as applied to filters of all types. Includes practical examples and BASIC programs. 195 pages. **£25.00**

FROM ATOMS TO AMPERES
F.A. Wilson
Explains in simple terms the absolute fundamentals behind electricity and electronics. 244 pages. **£3.50**

PRACTICAL ELECTRONICS CALCULATIONS AND FORMULAE (BP53)
F.A. Wilson
This has been written as a workshop manual for the electronics enthusiast. There is a strong practical bias and higher mathematics have been avoided where possible. 249 pages. **£3.95**

SOLID STATE DESIGN FOR THE RADIO AMATEUR
Les Hayward W7ZDI and Doug DeMaw W1FB
Back in print by popular demand! A revised and corrected edition of this useful reference book covering all aspects of solid-state design. 256 pages. **£10.95**

THE ARRL ELECTRONICS DATA BOOK
Doug DeMaw W1FB
Back by popular demand, completely revised and expanded, this is a handy reference book for the r.f. designer, technician, amateur and experimenter. 260 pages. **£8.95**

TRANSMISSION LINE TRANSFORMERS
Jerry Sovick W2FMI
This is the second edition of this book, which covers a most intriguing and confusing area of the hobby. It should enable anyone with a modicum of skill to make a balun, etc. 210 pages. **£13.50**

BEGINNERS

AN INTRODUCTION TO RADIO DXING (BP91)
R.A. Penfold
How to find a particular station, country or type of broadcast and to receive it as clearly as possible. 112 pages. **£1.95**

BEGINNER'S GUIDE TO RADIO
9th Edition, Gordon J. King
Radio signals, transmitters, receivers, antennas, components, valves and semiconductors, CB and amateur radio are all dealt with here. 266 pages. **£8.95**

ELECTRONICS SIMPLIFIED - CRYSTAL SET CONSTRUCTION (BP92)
F.A. Wilson specially written for those who wish to take part in basic radio building. All the sets in the book are old designs updated with modern components. 72 pages. **£1.75**

THE SIMPLE ELECTRONICS CIRCUIT AND COMPONENTS Book One (BP62)
The aim of this book is to provide an inexpensive but comprehensive introduction to modern electronics
208 pages £3.50

LISTENING GUIDES

AIR BAND RADIO HANDBOOK (3rd Edition)

David J. Smith
Listen to conversations between aircraft and ground control. The author, an air traffic controller, explains more about this listening hobby. *174 pages £7.50*

DIAL SEARCH

1991 Edition. George Wilcox
The listener's check list and guide to European broadcasting. Covers m.w., l.w., v.h.f. and s.w. including two special maps. *54 pages £3.95*

FLIGHT ROUTINGS 1991

T.T. Williams
Identifies the flights of airlines, schedule, charter, cargo and mail to and from the UK and Eire and overflights between Europe and America. *104 pages £5.25*

GUIDE TO BROADCASTING STATIONS

20th Edition 1989/90. Philip Darrington
Frequency and station data, receivers, antennas, Latin American DXing, reporting computers in radio etc. *240 pages £10.95*

GUIDE TO FACSIMILE STATIONS 11th Edition

Joerg Klingentuss
This manual is the basic reference book for everyone interested in FAX. Frequency call sign, name of the station, ITU country, geographical symbol, technical parameters of the emission are all listed. All frequencies have been measured to the nearest 100Hz. *408 pages £16.00*

GUIDE TO FORMER UTILITY TRANSMISSIONS

3rd Edition. Joerg Klingentuss
Built on continuous monitoring of the radio spectrum from the sixties until the recent past. A useful summary of the former activities of utility stations providing information for the classification and identification of radio signals. *128 pages £8.00*

GUIDE TO UTILITY STATIONS

9th Edition. Joerg Klingentuss
This book covers the complete short wave range from 3 to 30MHz together with the adjacent frequency bands from 0 to 150kHz and from 1.6 to 3MHz. It includes details on all types of utility stations including FAX and RTTY. There are 15807 entries in the frequency list and 3123 in the alphabetical call sign list plus press services and meteorological stations. *502 pages £19.00*

HF OCEANIC AIRBAND COMMUNICATIONS

3rd Edition. Bill Laver
HF aircraft channels by frequency and band, main ground radio stations, European R/F networks and North Atlantic control frequencies. *31 pages £3.95*

MARINE UK RADIO FREQUENCY GUIDE

Bill Laver
A complete guide to the UK s.w. and v.h.f. marine radio networks. Useful information, frequency listings and the World Marine Coastal Phone Stations. *62 pages £4.95*

NEWNES SHORT WAVE LISTENING HAND BOOK

Joe Prichard GU0WV
A technical guide for all short wave listeners. Covers construction and use of sets for the s.w. l.w. who wants to explore the bands up to 30MHz. *288 pages £14.95*

RADIO LISTENER'S GUIDE 1991

Clive Woodyear
This is the third edition of the essential guide for all radio listeners. Simple-to-use maps and charts show the frequencies for all the radio stations in the UK. When travelling or at home, the guide gives you all the frequencies you'll ever need. *56 pages £2.95*

THE COMPLETE VHF/UHF FREQUENCY GUIDE

1991 Edition.
This book gives details of frequencies from 26-2250MHz with no gaps and who uses what. Recently updated, there are chapters on equipment requirements as well as antennas, etc. *88 pages £5.95*

THE INTERNATIONAL VHF FM GUIDE

7th Edition. Julian Baldwin G3UHK and Kris Partridge G8ALU
The latest edition of this useful book gives concise details of repeaters and beacons worldwide plus coverage maps and further information on UK repeaters. *79 pages £2.85*

THE POCKET GUIDE TO RTTY AND FAX STATIONS

Bill Laver
A handy reference book listing RTTY and FAX stations, together with modes and other essential information. The listing is in ascending frequency order from 1.6 to 27.1MHz. *80 pages £3.95*

SHORT WAVE LISTENERS CONFIDENTIAL FREQUENCY LIST

Bill Laver
Covering the services and transmission modes that can be heard on the bands between 1.625 and 29.7MHz. *£8.95*

WORLD RADIO TV HANDBOOK 1991

Country-by-country listings of l.w. m.w. & s.w. broadcast and TV stations. Receiver test reports. English language broadcasts. This w.l.s. bible. *576 pages £17.95*

INTERFERENCE

INTERFERENCE HANDBOOK (USA)

William R. Nelson WA6FGG
How to locate and cure r.f.i. for radio amateurs, CBers and TV and stereo owners. *253 pages £9.50*

AMATEUR RADIO

ALL ABOUT VHF AMATEUR RADIO (USA)

W. I. Orr W6SAI
VHF/UHF propagation, including moonbounce and satellites, equipment and antennas. *172 pages £9.50*

AMATEUR RADIO CALL BOOK (RSGB)

1991 Edition
Now incorporates a 122-page section of useful information for amateur radio enthusiasts. *429 pages £7.20*

AMATEUR RADIO SATELLITES the first 25 years

Arthur C. Gee G2LJK
This souvenir publication is mainly a pictorial account of the pattern of developments which have occurred over the last 25 years in amateur radio satellite operations. *34 pages £2.25*

AN INTRODUCTION TO AMATEUR COMMUNICATIONS SATELLITES BP290

A. Pickard
This book describes several currently available systems, their connection to an appropriate computer and how they can be operated with suitable software. *102 pages £3.95*

AN INTRODUCTION TO AMATEUR RADIO (BP257)

I. D. Poole
This book gives the newcomer a comprehensive and easy to understand guide

through amateur radio. Topics include operating procedures, jargon, propagation and setting up a station. *150 pages £3.50*

HINTS AND KINKS FOR THE RADIO AMATEUR

Edited by Charles L. Hutchinson and David Newkirk
A collection of practical ideas gleaned from the pages of QST magazine. *52 pages £4.95*

HOW TO PASS THE RADIO AMATEURS' EXAMINATION (RSGB)

Clive Smith G4FZH and George Benbow G3HB
The background to multiple choice exams and how to study for them with sample PAE papers for practice plus maths revision. *88 pages £6.70*

PASSPORT TO AMATEUR RADIO

Reprinted from PW 1981-1982
The famous series by GW3JGA, used by thousands of successful RAE candidates in their studies. Plus other useful articles for RAE students. *98 pages £1.50*

PRACTICAL GUIDE TO PACKET OPERATION IN THE UK

Mike Mansfield G6AWD
Introduces the concept of packet radio to the beginner. Problem areas are discussed and suggestions made for solutions to minimise the problems. Deals with the technical aspects of packet, taking the reader through setting up and provides a comprehensive guide to essential reference material. *91 pages £6.95*

RADIO AMATEUR CALLBOOK NORTH AMERICAN LISTINGS 1991

69th Edition
Listings of US amateurs (including Hawaii). Also contains standard time chart census of amateur licenses of the world, world-wide QSL bureau and much more. *Over 1400 pages £19.50*

RADIO AMATEUR'S GUIDE TO RADIO WAVE PROPAGATION

(HF Bands). F. C. Judd G2BCX
The how and why of the mechanism and variations of propagation in the h.f. bands. *144 pages £10.95*

THE 1991 ARRL HANDBOOK FOR THE RADIO AMATEUR

This is the 66th edition of this very useful handbook reference book. Updated throughout it has several new sections covering oscilloscopes, spectrum analysers, digital frequency synthesis, phase-noise measurement and new constructional projects. *1200 pages 0/p*

THE ARRL OPERATING MANUAL

Another very useful book from the ARRL. Although written for the American radio amateur, this book will also be of use and interest to the UK amateur. *684 pages £12.95*

THE ARRL SATELLITE ANTHOLOGY

The best from the Amateur Satellite News column and articles out of 31 issues of QST have been gathered together in this book. The latest information on OSCARs 9 through 13 as well as the RS satellites is included. Operation on Phase 3 satellite (OSCAR 10 and 13) is covered in detail. *87 pages £5.95*

THE ARRL UHF/MICROWAVE EXPERIMENTER'S MANUAL

Various Authors
A truly excellent manual for the keen microwave enthusiast and for the budding microwaver. With contributions from over 20 specialist authors. Chapters covering techniques, theory, projects, methods and mathematics. *446 pages £14.50*

THE COMPLETE DX ER

Bob Locher W9KNI
Now back in print this book covers equipment and operating techniques for the DX chaser, from beginner to advanced. *187 pages £7.95*

THE RADIO AMATEUR'S DX GUIDE (USA)

15th Edition
The guide contains information not easily obtained elsewhere and is intended as an aid and quick reference for all radio amateurs interested in DX. *38 pages £2.95*

THE RADIO AMATEUR'S QUESTIONS & ANSWER REFERENCE MANUAL

4th Edition. R. E. G. Petri G8CCJ
This book has been compiled especially for students of the City and Guilds of London Institute RAE. It is structured with carefully selected multiple choice questions, to progress with any recognised course of instruction, although it is not intended as a text book. *780 pages £7.95*

THE RAE MANUAL (RSGB)

G.L. Benbow G3HB
The latest edition of the standard aid to studying for the Radio Amateurs Examination. Updated to cover the latest revisions to the syllabus. *132 pages £6.70*

YOUR GATEWAY TO PACKET RADIO

Stan Horzepa WA1LQU
What is packet radio good for and what uses does it have for the 'average' amateur? What are protocols? Where, why, when? Lots of the most asked questions are answered in this useful book. It included details of networking and space communications using packet. *278 pages £8.95*

MAPS

IARU LOCATOR MAP OF EUROPE

DARC
This multi-coloured plastics laminated map of Europe shows the AIRU I Maidenhead I Locator System. Indispensable for the v.h.f. and u.f. DXer. *632 x 872mm £5.25*

NORTH ATLANTIC ROUTE CHART

This is a five-colour chart designed for the use of ATC in monitoring transatlantic flights. Supplied folded. *740 x 520mm £4.50*

RADIO AMATEUR'S MAP OF NORTH AMERICA (USA)

Shows radio amateur, prefix boundaries, continental boundaries and zone boundaries. *760 x 636mm £3.50*

RADIO AMATEUR'S PREFIX MAP OF THE WORLD (USA)

Showing prefixes and countries, plus listings by order of country and of prefix. *704 x 711mm £3.50*

RADIO AMATEUR'S WORLD ATLAS (USA)

Seventeen pages of maps, including the world-polar projection. Also includes the table of allocation of international call sign series. *£4.50*

DATA REFERENCE

DIGITAL IC EQUIVALENTS AND PIN CONNECTIONS (BP140)

A. Michaels
Equivalents and pin connectors of a popular selection of European, American and Japanese digital ICs. *256 pages £5.95*

INTERNATIONAL TRANSISTOR EQUIVALENTS GUIDE (BP85)

A. Michaels
Possible substitutes for a popular selection of European, American and Japanese transistors. *320 pages £3.95*

NEWNES AUDIO & HI-FI ENGINEER'S POCKET BOOK

Vivian Capel
This is a concise collection of practical and relevant data for anyone working on sound systems. The topics covered include microphones, gramophones, CDs to name a few. *190 pages Hardback £10.95*

NEWNES COMPUTER ENGINEER'S POCKET BOOK

This is an invaluable compendium of facts, figures, circuits and data and is indispensable to the designer, student, service engineer and all those interested in computer and microprocessor systems. *203 pages Hardback £10.95*

NEWNES ELECTRONICS POCKET BOOK

5th Edition
Presenting all aspects of electronics in a readable and largely non-mathematical form for both the enthusiast and the professional engineer. *315 pages Hardback £10.95*

NEWNES RADIO AMATEUR AND LISTENER'S POCKET BOOK

Steve Money G3FZX
This book is an affirmation of useful and intriguing data for the traditional and modern amateur as well as the s.w. l.w. Topics such as AMTOR, packet radio, SSTV, computer rumour ratters and many other communications are all covered. *160 pages £9.95*

NEWNES RADIO AND ELECTRONICS ENGINEER'S POCKET BOOK

18th Edition. Keith Brindley
Useful data covering math abbreviations, codes, symbols, frequency bands/allocations, UK broadcasting stations, semi-conductors, components, etc. *325 pages Hardback £9.95*

POWER SELECTOR GUIDE (BP235)

J. C. J. Van de Ven
This guide has the information on all kinds of power devices in useful categories (other than the usual alpha numeric sort) such as voltage and power properties making selection of replacements easier. *160 pages £4.95*

CONSTRUCTION

HOW TO DESIGN AND MAKE YOUR OWN PCBs (BP121)

R. A. Penfold
Designing or copying printed circuit board designs from magazines including photographic methods. *80 pages £2.50*

INTRODUCING ORP

Collected articles from PW 1983-1985
An introduction to low-power transmission (ORP). This book includes full constructional details of a variety of designs by Rev. George Dobbs G3RJV for transmitters and transceivers covering Top Band to 11MHz, together with test equipment by Tony Smith G4AI. *64 pages £1.50*

MORE ADVANCED POWER SUPPLY PROJECTS (BP192)

R. A. Penfold
The practical and theoretical aspects of the circuits are covered in some detail. Topics include switched mode power supplies, precision regulators, dual tracking regulators and computer controlled power supplies, etc. *87 pages £2.95*

POWER SUPPLY PROJECTS (BP76)

R. A. Penfold
This book gives a number of power supply designs including simple un stabilised types, fixed voltage regulated types and variable voltage stabilised designs. *91 pages £2.50*

PRACTICAL POWER SUPPLIES

Collected articles from PW 1978-1985
Characteristics of batteries, transformers, rectifiers, fuses and heatsinks, plus designs for a variety of mains driven power supplies, including the P.W. 'Marlwood' giving a fully stabilised and protected 12V 3DA d.c. *48 pages £1.25*

ORP NOTEBOOK

Doug DeMaw W1FB
This book deals with the building and operating of a successful ORP station. Lots of advice is given by the author who has spent years as an ardent ORPer. All the text is easy to read and the drawings large and clear. *77 pages £4.95*

TEST EQUIPMENT CONSTRUCTION (BP248)

R.A. Penfold
Describes, in detail, how to construct some simple and inexpensive, but extremely useful pieces of test equipment. *101 pages £2.95*

50 (FET) FIELD EFFECT TRANSISTOR PROJECTS (BP39)

F.G. Rayer
50 circuits for the s.w. l.w. radio amateur, experimenter or audio-enthusiast using FETs. *104 pages £2.95*

ANTENNAS (AERIALS)

ALL ABOUT VERTICAL ANTENNAS (USA)

W. I. Orr W6SAI & S. D. Cowan W2LX
Theory, design, construction, operation. The secrets of making vertical work. *191 pages 0/S*

AN INTRODUCTION TO ANTENNA THEORY (BP198)

H. C. Wright
This book deals with the basic concepts relevant to receiving and transmitting antennas. Lots of diagrams reduce the amount of mathematics involved. *86 pages £2.95*

ANTENNA IMPEDANCE MATCHING

Wilfred N. Caron
Proper impedance matching of an antenna to a transmission line is of concern to antenna engineers and to every radio amateur. A properly matched antenna as the termination for a line minimises feed line losses. Power can be fed to such a line without the need for a matching network at the line input. There is no mystique involved in designing even the most complex multi element networks for broadband coverage. Logical step by step procedure is followed in this book to help the radio amateur with this task. *192 pages £11.95*

BEAM ANTENNA HANDBOOK (USA)

W. I. Orr W6SAI & S. D. Cowan W2LX
Design, construction, adjustment and installation of h.f. beam antennas. *198 pages £7.50*

NOVICE ANTENNA NOTEBOOK

Doug DeMaw W1FB
Another book from the pen of W1FB, this time offering new ideas for 'beginning hams'. All the drawings are large and clear and each chapter ends with a glossary of terms. *130 pages £6.95*

OUT OF THE AIR

Collected Antenna Articles from PW 1977-1980
Including such favourites as the ZL Special and 7BCX 16-element beams for 2m, and the famous 'Slim Jim' designed by Fred Judd G2BCX. Also features systems for Top Band, medium wave/long wave loop designs and a v.h.f. direction finding loop. Plus items on propagation, accessories and antenna design. *80 pages £1.80*

SIMPLE, LOW-COST WIRE ANTENNAS FOR RADIO AMATEURS (USA)

W. I. Orr W6SAI & S. O. Cowan W2LX
Efficient antennas for Top Band to 2m, including 'invisible' antennas for difficult station locations. *191 pages £7.50*

THE ARRL ANTENNA BOOK (USA) 16th Edition

A station is only as effective as its antenna system. This book covers propagation, practical constructional details of almost every type of antenna, test equipment and formulas and programs for beam heading calculations. *£14.50*

Turn to page 76 for more books.

THE ARRL ANTENNA COMPENDIUM (USA)

Volume One

Fascinating and hitherto unpublished material. Among the topics discussed are quads and loops, log periodic arrays, beam and multi-band antennas, verticals and reduced size antennas. 175 pages. £9.50

THE ARRL ANTENNA COMPENDIUM (USA)

Volume Two

Because antennas are a topic of great interest among radio amateurs, ARRL HQ continues to receive many more papers on the subject than can possibly be published in QST. Those papers are collected in this volume. 208 pages. £9.50

THE RADIO AMATEUR ANTENNA HANDBOOK

William I. Orr W6SAI & Stuart D. Cowan W2LX

Yagi, quad, quag, L-p, vertical, horizontal and "sloper" antennas are all covered. Also towers, grounds and rotators. 190 pages. £6.75

W1FB'S ANTENNA NOTEBOOK

Doug DeMaw W1FB

This book provides lots of designs, in simple and easy to read terms, for simple wire and tubing antennas. All drawings are large and clear making construction much easier. 124 pages. £6.95

WIRES & WAVES

Collected Antenna Articles from PW 1980-1984

Antenna and propagation theory, including NBS Yagi design data. Practical designs for antennas from medium waves to microwaves, plus accessories such as a.t.u.s, s.w.r. and power meters and a noise bridge. Dealing with TVI. 160 pages. £3.00

25 SIMPLE AMATEUR BAND AERIALS (BP125)

E. M. Noll How to build 25 simple and inexpensive aerials, from a simple dipole

through beam and triangle designs to a mini-rhombic. Dimensions for specific spot frequencies including the WARC bands. 80 pages. £1.95

25 SIMPLE INDOOR AND WINDOW AERIALS (BP136)

E. M. Noll Designs for people who live in flats or have no gardens etc., giving surprisingly good results considering their limited dimensions. 64 pages. £1.75

25 SIMPLE SHORT WAVE BROADCAST BAND AERIALS (BP132)

E. M. Noll Designs for 25 different aerials, from a simple dipole through helical designs to a multi-band umbrella. 80 pages. £1.95

25 SIMPLE TROPICAL AND MW BAND AERIALS (BP145)

E. M. Noll Simple and inexpensive aerials for the broadcast bands from medium wave to 49m. 64 pages. £1.75

FAULT FINDING

ARE THE VOLTAGES CORRECT?

Reprinted from PW 1982-1983

How to use a multimeter to fault-find on electronic and radio equipment, from simple resistive dividers through circuits using diodes, transistors, i.c.s and valves. 44 pages. £1.50

GETTING THE MOST FROM YOUR MULTIMETER (BP239)

R. A. Penfold

This book is primarily aimed at beginners. It covers both analogue and digital multimeters and their respective limitations. All kinds of testing is explained too. No previous knowledge is required or assumed. 102 pages. £2.95

MORE ADVANCED USES OF THE MULTIMETER (BP265)

R. A. Penfold

This book is primarily intended as a follow-up to BP239, *Getting the most from your Multimeter*. By using the techniques described in this book you can test and analyse the performance of a range of components with just a multimeter (plus a very few inexpensive components in some cases). The simple add-ons described

extend the capabilities of a multimeter to make it even more useful. 65 pages. £2.95.

OSCILLOSCOPES, HOW TO USE THEM, HOW THEY WORK 3rd Edition

Ian Hickman

This book describes oscilloscopes ranging from basic to advanced models and the accessories to go with them. £14.95

TRANSISTOR RADIO FAULT FINDING CHART (BP70)

C. E. Miller

Used properly should enable most common faults to be traced reasonably quickly. Selecting the appropriate fault description at the head of the chart, the reader is led through a sequence of suggested checks until the fault is cleared. 635 x 455mm (approx). £0.95

COMPUTING

AN INTRODUCTION TO COMPUTER COMMUNICATIONS (BP177)

R. A. Penfold

Details of various types of modem and their applications, plus how to interconnect computers, modems and the telephone system. Also networking systems and RTTY. 96 pages. £2.95

MORSE

INTRODUCING MORSE

Collected Articles from PW 1982-1985

Ways of learning the Morse Code, followed by constructional details of a variety of keys including Lamberic, Triambic, and an Electronic Bug with a 528-bit memory. 48 pages. £1.25

THE SECRET OF LEARNING MORSE CODE

Mark Francis

Designed to make you proficient in Morse code in the shortest possible time, this book points out many of the pitfalls that beset the student. 87 pages. £4.95

YORKSHIRE

Alan Hooker Radio Communications

42 Netherhall Road, Doncaster.
Tel: (0302) 325690 Open: Mon-Sat 10-5pm
Closed Thursdays.

Kenwood

YAESU

ICOM

& most
Scanners

Please mention Short Wave Magazine when replying to advertisements.

INDEX TO ADVERTISERS

AOR UK	13	Hoka Electronics	28	R & D Electronics	73
ARE	23	Holdings Amateur		RGW Electronics	26
ASK	49	Hooker, Alan	76	Radio Research	36
Aerial Techniques	73	Howes C.M Communications	77	Radio Shack	71
Air Supply	78			Rapid Results College	73
Alytronics	26	ICS Electronics	31	Raycom	16
Amdat	36	Icom (UK)	61, Cover iii	Rooke, M S	36
				Rylands, F G	36
Billington Valves	36	J & P Electronics	72	SRP Trading	46, 47
Camden Miniature Steam	50	Javiation	66	Short Wave Centre, The	26
Chevet Books	72			Sigma UK	56
Colomor Electronics	36	Klingenfuss	77	Solid State Electronics	50
Comar	72			South Midlands Communications	14
Datong	61	Lake Electronics	73	Stephens James	66
Dewsbury	56	Link Electronics	36		
Dressler Communications	16	Lowe Electronics		Technical Software	72
				Timestep	71
EMP	24				
ERA	77	Martelec	26	Waters & Stanton	18, 19
Eastern Electronics	78	Martin Lynch	55		
Elliott Electronics	50	Mauritron	50		
Flightdeck	73	Nevada	Cover i, 32, 33		
Flying Shop, The	56				
		OBA (Redditch Sony Centre)	28		
Garex Electronics	36	Practical Wireless	78		

GUIDE TO UTILITY STATIONS 1992

10th edition • 534 pages • £26 or DEM 70

7500 new coastal and fixed station frequencies!

Our bestseller covers the complete frequency range between 0 and 30 MHz. We are the very first to publish *all* new maritime frequencies world-wide in use since the gigantic global frequency transfer in July 1991! Latest military and political events such as the impacts of the Gulf War and of the recent and current revolutions in Eastern Europe are covered exclusively by our UTILITY GUIDE. Sophisticated operating methods and regular overseas monitoring missions (1991 for months in India, Malaysia, Mauritius, Reunion, Surinam and Venezuela) complete this unique book.

The completely revised new edition includes a frequency list with 19136 frequencies, and a call sign list with 3514 call signs. Up-to-date schedules of FAX meteo stations and RTTY press services are listed both alphabetically and chronologically. Abbreviations, addresses, codes, definitions, explanations, frequency band plans, international regulations, modulation types, NAVTEX schedules, Q and Z codes, station classes, telex codes, etc. — this reference book list everything. Thus, it is the ideal addition to the World Radio TV Handbook for the "special" stations on SW!

Further publications available are *Guide to Facsimile Stations*, *Radio-teletype Code Manual* (11th editions) and *Air and Meteo Code Manual* (new 12th edition). We have published our international radio books for 23 years. They are in daily use with equipment manufacturers, monitoring services, radio amateurs, shortwave listeners and telecommunication administrations worldwide. Please ask for our free catalogue, including recommendations from all over the world. For a recent *Shortwave Magazine* book review see Ian Chard in issue 2/91. All manuals are published in the handy 17 x 24 cm format, and of course written in English.

Do you want to get the **total information** immediately? For the special price of £88/DEM 245 (you save £15/DEM 40) you will receive all our manuals and supplements (altogether more than 1700 pages!) plus our **Cassette Tape Recording of Modulation Types**.

Our prices include **airmail** postage to everywhere in the world. Payment can be by £ or DEM cheque, cash, International Money Order, or postgiro (account Stuttgart 2093 75-709).

Dealer inquiries welcome — discount rates on request.

Please mail your order to:

KLINGENFUSS PUBLICATIONS

Hagenloher Str. 14, D-7400 Tuebingen, Germany

Tel. + 49 7071 62830

ENTERPRISE ERADIO APPLICATIONS ALTD.

5 Clarendon Court
Winwick Quay
Warrington
WA2 8QP
Tel: (0925) 573118

MK.II MICROREADER



The easiest way to receive CW & RTTY without all the fuss of computers. Just plug into your speaker socket and switch on. The Microreader automatically decodes both amateur and commercial stations displaying the received text on its own LCD screen. The Microreader also incorporates a MORSE TUTOR facility that allows you to check both your receiving and sending performance. **£170.00**

BP34 AUDIO FILTER

Someone once said that this filter is too good for amateur radio use. We, along with hundreds of BP34 users would disagree. The BP34 combines ease of use with a degree of performance not found in any other filter. Exceptionally sharp cut off and guaranteed 80dB stopband attenuation make this filter a must for the more serious user. **£109.50**

RS232 DISPLAY

Don't tie up your computer while monitoring. This new unit will display, store and print messages sent via the RS232 output from the MICROREADER or PACKET TNC. Text is stored in memory and at the same time displayed on the large 160 character backlit screen. A unique scrolling facility allows you at any time to scroll back and forth through over fifty screens of text messages while still receiving data. The display incorporates a PARALLEL PORT that allows printing of all or selected sections of text at the touch of a button. **£185.00**

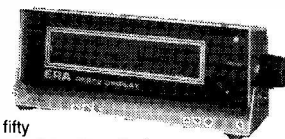

BP12 DATA FILTER

A compact low power filter specifically designed for data applications such as CW, RTTY & HF-PACKET. Both audio and TTL tone data outputs are provided. Ideal for use with computers. **£44.00**



All products are guaranteed for two years and all prices include VAT and postage and packing.



C.M.HOWES COMMUNICATIONS

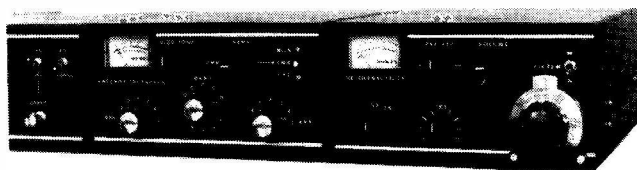

NEW HARDWARE PACKAGES

Now your home brew gear can look as good as factory equipment! With our interlinking range of kits it has always been possible to expand one of our simple receivers into a transceiver by adding the relevant transmitting kits. Now we can also offer custom made metal work to give the project a really high standard of finish.

Receiver kits start at **£15.90** for single band SSB/CW. Transmitters start at **£14.80** for single band CW. A transceiver "hardware pack" costs **£29.90**.

If you are just starting shortwave listening, studying for a Novice Licence, or an experienced operator needing a QRP rig for home or holiday use, we have a good selection of high quality, easy to build kits for you to choose from. The beauty of HOWES KITS is that you can start with a beginner's receiver and upgrade to a transceiver in easy stages. A full range of matching accessories is also available. Please send an SAE for further information. We have too many kits to even just list them here!

ANTENNAS AND PRE-AMPS

AA2 ACTIVE ANTENNA for 150kHz to 30MHz

The HOWES AA2 is the active antenna to use for general coverage HF reception. Broad-band performance that does not tail off at the higher frequencies. The neat, compact answer for those with limited space, holiday use, mobile operation etc. Two selectable gain settings, local or coax powering (12 to 14V) IP3 +38dBm. Easy to build and much liked by customers!

AA2 Kit: **£8.50** Assembled PCB module: **£12.90**

Mail order to:

**EYDON, DAVENTRY
NORTHANTS NN11 6PT
Tel: (0327) 60178**



AA4 ACTIVE ANTENNA FOR SCANNERS

The HOWES AA4 gives full coverage from 25 to 1300MHz in a neat compact package. The antenna is only just over 16 inches long, and is designed to be the answer to space/visibility problems for home or portable operation. A low noise microwave IC is used as the active element. This 'high tech' approach gives good performance with a low parts count, making construction straightforward. Reviewed in the November '90 *Short Wave Magazine*. Excellent performance in a small space!

AA4 Kit: **£19.80** Assembled PCB modules: **£26.80**

SPA4 BROADBAND PRE-AMP

The HOWES SPA4 is a low noise IC pre-amp covering 4 to 1300MHz for use with wideband passive antennas (discons etc). If signals tend to be rather weak in your area, then the SPA4 could be just what you need!

SPA4 Kit: **£14.90** Assembled PCB modules: **£20.90**



ADD-ON DIGITAL READ OUT

The new HOWES DFD4 Digital Frequency Display adds "Digital Readout" to analogue type receivers and transceivers. If you own an FRG7, FT101, TS520, etc., then we had you in mind when we designed this kit. You can even add digital readout to a surplus WW2 receiver, or domestic broadcast set.

The OFD4 can accommodate any IF frequency offset, VFOs that tune normally or "backwards" — all with a resolution of 100Hz. Versatile indeed! A small buffer module for easy connection to the radio is included in the kit. Why not give me a ring to discuss its use with your rig, or send an SAE for more details?

DFD4 Kit: **£39.90** Assembled PCB modules: **£59.90**

PLEASE ADD **£1.20 P&P** to your total kit order (£3.00 for hardware).

HOWES KITS are produced by a professional RF design and manufacturing company. They contain a good quality printed circuit board with screen printed parts locations, full clear instructions and all board mounted components. Sales and technical advice are available by phone during office hours. Please send an SAE for our free catalogue or specific product data sheets. Normally all kits are in stock and delivery is within 7 days.

72 & 73 from Dave G4KQH, Technical Manager

0692-650077

EASTERN COMMUNICATIONS

CAVENDISH HOUSE
HAPPISBURGH
NORFOLK



AOR AR2800 Base/mobile scanning receiver featuring coverage from shortwave to microwaves 500kHz-600MHz & 800MHz-1300MHz. All mode AM, FM-N, FM-W, and built-in BFO for USB, LSB, CW. 1000 memories and 10 search banks. Operates from 13.8V DC. Supplied with AC adaptor, DC lead, mobile mount and telescopic aerial. £395

PHONE FOR LATEST PRICES

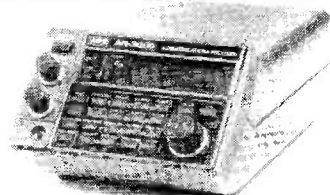

AOR AR3000. Unique top of the range wide band scanning receiver. All mode AM, FM-N, FM-W, USB, LSB, CW. Frequency coverage is 100kHz-2036MHz with no gaps. Supplied with telescopic aerial, 13.8V DC lead, and AC power supply. £765



ADR AR2000. Hand-held wide band scanning receiver. Improved specification. Continuous coverage 500kHz-1300MHz. AM, FM-N, & FM-W modes. 1000 memories and 10 search banks. Supplied with internal nicads, or can be powered by dry cells. Power and charge from a cigar lighter socket with lead supplied. AC charger and case included. £259

For the largest selection of aerials, receivers, transceivers and accessories, visit the UK's largest amateur radio showroom. We also offer a 'next day' mail order service.

APPOINTED DEALERS FOR
KENWOOD
ICOM
YAESU



EVERYTHING FOR THE RADIO AMATEUR, + FAX, PHONES, COMPUTERS, ANSWERING MACHINES & CAR PHONES
RETAIL SHOWROOMS OPEN TUESDAY - FRIDAY 9.00 - 5.30 · SATURDAY 9.00 - 4.00



AIR SUPPLY

83B High Street, Yeadon, Leeds LS19 7TA
Tel: (0532) 509581 Fax: (0532) 508772
Shop just two minutes from Leeds
Bradford Airport.

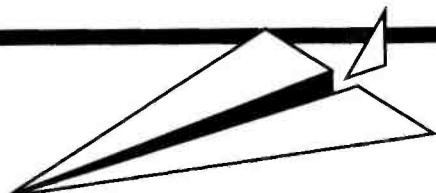

 Shop hours:
1000 - 1330
1430 - 1700



Hours do vary - CLOSED
WEDNESDAY

AIR TRAFFIC CONTROLLERS

On hand to help you towards an interesting & rewarding pastime. Specialists in **AIR BAND RADIOS & SCANNERS**. Hand held, mobile or base - AOR, Signal, Black Jaguar, Yupiteru, Icom, Uniden, Sony, Nevada: HF receivers from Sony, Icom, Lowe, Yaesu, Kenwood: wide range of accessories, aerials, plus CAA publications, maps, books, models from IMC, Wooster, Schabak, photos, souvenir products from British Airways & British Midland Airways. Large range of pilots products agents for Transair, AFE & Airtour. Plus lots more. If you would like our info pack send large SAE & stamps to value of 50p.

practical Wireless

LOOK OUT FOR OUR NEW FRONT COVER LOGO STARTING NEXT ISSUE

It's appropriate that, as *Practical Wireless* enters its 60th anniversary year, we're making sure that we do so in style. We're all very proud of the magazine's heritage, and there's a new logo starting with the next issue.

Along with the new logo, one of the biggest improvements will be a change to a higher quality glossy paper. There will be full colour and two colours available throughout the magazine. There will also be much higher quality photographic reproduction, with advantages to be had for everyone.

The new printing system will enable our art editor Steve Hunt to use his artistic expertise and the second colour to full effect. As a result technical articles with circuit diagrams, p.c.b. designs and appropriate overlays will be more attractively designed, providing a much easier read.

Rob Mackie, our photographer and technical artist, in conjunction with Steve, will be able to use many more of the production and presentation aids to produce an even better magazine for our readers.

So, we'll be entering the new year in style. There are some interesting projects under way, and I hope to be letting you have news of one or two of them very soon. In the meantime, everyone on the *Practical Wireless* team is looking forward to sharing the enjoyment of a wonderful hobby with the support of our new technology and most importantly, you the reader.

73 DE Rob Mannion G3XFD

- ✓ Practical Wireless 60th Anniversary Year
- ✓ Look out for our new logo starting from the next issue
- ✓ Higher quality glossy paper
- ✓ New two colour editorial style
- ✓ Higher quality photographic reproduction
- ✓ Attractively designed and more clearly defined p.c.b. overlays in two colours

**PW Publishing Ltd. Enefco House, The Quay,
POOLE, Dorset BH15 1PP**
Tel: (0202) 678558 Fax: (0202) 666244

INDEX VOLUME 49 1991

Theory

Educational Software for Basic Electronics	J.T. Beaumont G3NGD	Part 1	10 Jan
		Part 2	10 Feb
		Part 3	10 Mar
		Part 4	15 Apr
		Part 5	10 May
		Part 6	35 Jun
		Part 7	33 Aug
		Part 8	24 Sep
		Part 9	12 Nov
		Part 10	22 Dec

Feature

2LO is Calling Again	Jack Hum G5UM		32 Nov
5XX Wonder Station of the 1920s	Eric Westman		10 Nov
50 Countries on the 144MHz Band	P.E.W. Allely G63KJW	Part 1	27 Jun
		Part 2	16 Aug
		Part 3	26 Sep
		Part 4	32 Oct
		Part 5	27 Nov

Abraham Lincoln's Birthday	J. Edward Brown		28 Oct
Baird Televisor Revisited	R.J. Harry		12 Jan
Boy Who Met John Logie Baird (The)	Joan Ham		24 Feb
Cruising up the Amazon	Dick Moon		20 May
Dayton '92			25 Jul
Discovery of the Ionosphere	F.C. Judd G2BCX		29 Aug
DXing in Ecuador	Dick Ganderton G8VHF	Part 1	36 Aug
		Part 2	40 Sep
		Part 3	10 Oct

DXing Satellites in the USA	George Wood		19 Jun
Early Vintage Wireless Equipment	R. Coomber		41 Jul
Fifty - in the Forties (The)	Jack Hum G5UM		12 Sep
Greyline DXing	Dick Moon		33 Mar
Hello New Technology - Goodbye Short Wave?	Bill Black		12 Oct
HF Radio Wave Propagation	F.C. Judd G2BCX	Part 5	20 Jan
Improving Short Wave Broadcast Reception	R.A.W. Hill		14 Nov
Ladies on the Key	Stan Crabtree G3OXC		23 Apr
Low Voltage Power	Ron Ham		33 Feb
Make Your Reports Useful	G.P. Stancey G3MCK		12 May
Model Engineers at Chalk Pits	Ron Ham		15 May
Permit to Receive	F.C. Judd G2BCX		32 Sep
Proof of the Pudding (The)	Gary David Rawnsley		28 Sep
Pye 3017A (Export) (The)	R. Q. Marris G2BZQ		19 Mar
R210 Revisited (The)	C. M. Lindars		28 Mar
Radiation Pattern From a Half-wave Antenna	F.C. Judd G2BCX		39 Oct
Radio Times (Poem & Competition)	David Leverett		21 Dec
Repairing an HRO	Chas E. Miller		23 May
Russian Woodpecker (The)	F.C. Judd G2BCX		12 Mar
Solar Flares: Outside Broadcasts From the Sun	Robert Newman		10 Sep
Speedbird Concorde Zero One	Peter Rouse GU1DKD		10 Dec
Starting Out	Brian Oddy G3FEX		12 Feb
			38 Mar
Starting Out Index	Brian Oddy		12 Apr
Successful Reception Reporting	Tony King		16 Oct
Sunshine & Radio	C.B. Searle G4LST		34 Feb
Trans World Poster Antenna	Ernie Franke		38 Jul
Tuning in to the Secret Broadcasters	Gerry L. Dexter	Part 1	24 Oct
		Part 2	16 Nov
US Coast Guard (The)	Bill Black		10 Apr
Using an ERA Microreader Mk II	Ian Chard		19 Feb
Watching a Shuttle Launch	Roger Hall G4TNT		10 Jun
What's Around for the PC			20 Jul
Worthington's Best	John Worthington GW3C0I		18 Oct
Yesterday's Spy Set - The 128 Set	June Strrat		38 Dec

Project

Aid for the R210 Converter (An)	John L. Alton		19 May
Another Medium Wave DX Loop Antenna	John Tweeker		18 Jan
Basic RTTY Receive-only Terminal Unit	Bernard J. Greatrix G4ICZ	Part 1	38 Nov
		Part 2	12 Dec
Build Your Own PC	Dick Ganderton G8VHF		26 Jul
Calibrating the Long Arm Loop	George Millmore		23 Feb
Continuing Along the Right Lines	George Dobbs G3RJV	Part 1	27 May
		Part 2	31 Jun
		Part 3	12 Jul
		Part 4	12 Aug
		Part 5	16 Sep
Experimental VHF Receiver (An)	Ray Howgego	Part 1	23 Jun
		Part 2	35 Jul
			34 Dec
LongWaver Loop Antenna	Richard Q Marris		34 Dec
Sanguine Sangean (A)	Bill Wilson		34 Aug
Short Wave Crystal Set & Competition	Roger Laphorn G3XBM		40 Dec
Simple Antenna Tuning Unit (A)	Peter Polson GM3YAN/GM-20085		22 Oct
Small Power Supply for Valved Receivers (A)	Chas Miller		19 Apr
Switched Attenuators	Phil Townsend		23 Nov
Tuneable Sound for Satellite TV Receivers	Gareth Jones GW4 KJW		34 Sep

Special Offers

Educational Software for Basic Electronics		39 Sep
Hamdisk PC		18 Aug
Revex RA980 Wide Band Active Antenna		3 Jul

Short Wave Magazine, December 1991

Competitions

Wordsearch		20 Apr
------------------	--	--------

Review

BOSCAD Morse Master v1.0	Peter G. Rayer G-13038		16 Jul
Geoclock Program	Martin Saul G8XGT		24 Mar
Grundig Cosmopolit Receiver	Mike Richards G4WNC		36 Jun
Grundig WKC 4870RDS Car Radio	Peter Shore		40 Oct
ICS-FAXSoftware	Mike Richards G4WNC		35 Mar
Nevada MS-1000 Scanner	Mike Richards G4WNC		35 May
PC Track	Martin Saul G8XGT		36 Oct
Philips DC777 SW Car Radio	John Waite		27 Apr
Radiocom Bonito Program	Mile Richards G4WNC		33 Jul
Realistic PR0-2006 Scanner	Mike Richards G4WNC		27 Feb
Roberts R808 Digital All-band World Receiver	John Waite		10 Jul
Sky Scan DX V1300 Discone	Alf Brimming BRS 36662		29 Jan
Sony CHF-V21 World Band Receiver	Mike Richards G4WNC		23 Jan
Sony TCM-38V Cassette Recorder	Steve Whitt		22 Sep
Sony WA8800 Ten-Band Radio Cassette Recorder	Mike Richards G4WNC		27 Jan
Yupiteru MVT-7000 Hand-held Scanner	Mike Richards G4WNC		10 Aug
Yupiteru VT-125UK Airband Receiver	John Waite		22 Aug

Subscribers' Club Special Offers

Air Traffic Radio 1991 edition		77 Jul
Ferrell's Confidential Frequency List		31 May
Guide to Facsimile Stations 10th edition		26 Aug
Passport to World Band Radio 1991		26 Aug
Passport to World Band Radio 1992		68 Oct
Sounds Easy		72 Sep
Starter Tool Kit		15 Jun
Wings At War & Wings The Jet Age Videos		20 Apr

Errata

An Experimental VHF Receiver	June & July 1991	41 Aug
Reception of Low & Very Low Frequencies	December 90	49 Apr
Starting Out	Feb & Mar 1991	7 Jun
Using an ERA Microreader MkII	February 91	49 Apr

Regulars

Airband	Godfrey Manning G4GLM
40 Jan, 48 Feb, 52 Mar, 45 Apr, 48 May, 51 Jun, 55 Jul, 51 Aug, 53 Sep, 49 Oct, 51 Nov, 53 Dec.	
Amateur Bands Round-up	Paul Essery GW3KFE
34 Jan, 42 Feb, 48 Mar, 38 Apr, 45 May, 46 Jun, 51 Jul, 48 Aug, 48 Sep, 46 Oct, 48 Nov, 48 Dec.	
Bandscan Australia	Greg Baker
45 Mar, 42 May, 44 Sep, 44 Dec.	
Bandscan Europe	Peter Laughton
32 Jan,	
Bandscan Europe	Peter Shore
36 Apr, 48 Jul, 44 Oct.	
Bandscan USA	Gerry Dexter
38 Feb, 41 May, 42 Aug, 44 Nov.	
Decode	Mike Richards G4WNC
47 Jan, 52 Feb, 57 Mar, 51 Apr, 56 May, 56 Jun, 59 Jul, 56 Aug, 56 Sep, 52 Oct, 54 Nov, 60 Dec.	
DXTV Round-up	Ron Ham
37 Jan, 45 Feb, 49 Mar, 41 Apr, 46 May, 47 Jun, 53 Jul, 48 Aug, 51 Sep, 47 Oct, 49 Nov, 51 Dec.	
Editorial	
2 Jan, 2 Feb, 2 Mar, 2 Apr, 2 May, 2 Jun, 2 Aug, 2 Oct, 2 Nov, 2 Dec	
First Aid	49 Feb, 56 Mar, 34 Jun, 31 Oct, && Dec.
Grassroots	
4 Jan, 4 Feb, 4 Mar, 4 Apr, 4 May, 4 Jun, 4 Jul, 4 Aug, 4 Sep, 4 Oct, 4 Nov, 4 Dec.	
Info in Orbit	Lawrence Harris
51 Jan, 56 Feb, 61 Mar, 53 Apr, 60 May, 60 Jun, 62 Jul, 59 Aug, 60 Sep, 55 Oct, 57 Nov, 58 Dec.	
Junior Listener	Jon Jones
5 Jan, 5 Feb, 5 Mar, 5 Apr, 5 May, 5 Jun, 5 Jul, 5 Aug, 5 Sep, 5 Oct, 5 Nov, 5 Dec.	
Letters	
3 Jan, 3 Feb, 2 Mar, 2 Apr, 2 May, 2 Jun, 2 Jul, 2 Aug, 2 Sep, 2 Oct, 2 Nov, 2 Dec.	
Long Medium & Short	Brian Oddy G3FEX
55 Jan, 59 Feb, 63 Mar, 56 Apr, 63 May, 63 Jun, 64 Jul, 63 Aug, 62 Sep, 59 Oct, 61 Nov, 63 Dec	
Maritime Beacons	Brian Oddy G3FEX
68 Mar, 67 Jun, 66 Sep, 68 Dec.	
News	
6 Jan, 6 Feb, 6 Mar, 6 Apr, 6 May, 6 Jun, 6 Jul, 6 Aug, 6 Sep, 6 Oct, 6 Nov, 6 Dec.	
Off the Record Pirates	Andy Cadier
71 Jul, 67 Oct.	
Propagation	Ron Ham
30 Jan, 36 Feb, 42 Mar, 33 Apr, 38 May, 38 Jun, 45 Jul, 39 Aug, 42 Sep, 42 Oct, 42 Nov, 42 Dec	
RAE Courses	
4 Jul, 4 Aug, 4 Sep, 4 Oct.	
Rallies	
4 Jan, 4 Feb, 4 Mar, 4 Apr, 4 May, 4 Jun, 7 Jul, 7 Aug, 7 Sep, 7 Oct.	
Satellite TV News	Roger Bunney
33 Jan, 41 Feb, 46 Mar, 37 Apr, 42 May, 45 Jun, 50 Jul, 45 Aug, 47 Sep, 45 Oct, 47 Nov, 45 Dec	
Scanning	Alan Gardner
43 Jan, 50 Feb, 55 Mar, 48 Apr, 52 May, 52 Jun, 57 Jul, 54 Aug, 54 Sep, 50 Oct, 52 Nov, 54 Dec	
SSB Utility Listening	Peter Rouse GU1DKD
31 Jan, 37 Feb, 43 Mar, 35 Apr, 39 May, 41 Jun, 47 Jul, 41 Aug, 43 Sep, 43 Oct, 43 Nov, 43 Dec	
Trading Post	
64 Jan, 68 Feb, 72 Mar, 64 Apr, 71 May, 71 Jun, 80 Jul, 72 Aug, 75 Sep, 79 Oct, 79 Nov, 69 Dec	
Watching Brief	Andy Emmerson G8PTH
67 May, 67 Aug.	

Books

<i>Air Band Radio Handbook</i> 3rd Edition by David J. Smith	41	Jan
<i>An Introduction to Amateur Communications Satellites</i> BP290 by A. Pickard	44	Jan
<i>An Introduction to Radio Wave Propagation</i> by J.G. Lee	11	May
<i>Dictionary of Electronics</i> by Ian R. Sinclair	44	Jan
<i>Directory of Military Aviation Communications (VHF/UHF) Europe, North Africa, Middle East 1991</i> 1st edition	23	Oct
<i>Flight Routings 1990</i> by T.T. Williams	41	Jan
<i>Mechanics of Flight</i> by A.C. Kermode	53	Mar
<i>Monitoring the Iraq/Kuwait Conflict</i> 2nd edition by Langley Pierce	44	Jan
<i>North Atlantic Route Chart</i>	53	Mar
<i>Rescue</i> by Paul Beaver & Paul Berriff	53	Mar
<i>The DXers Guide to Computing</i> edition 4.0 by George Wood	11	May
<i>The Paper Aeroplane Pad</i>	41	Jan
<i>The Pirate Radio Directory 1991</i> edition	23	Oct
<i>The Radio Listeners Guide 1991</i> edited by Clive Woodyear	11	May
<i>The Satellite Book</i> by John Breeds	46	Apr
<i>World HF Aeronautical-Mobile R/T Frequency Allocations</i> by Tim Christian	41	Jan

News

AMDAT Open Day	7	May
ARE Communications - NRD535	6	May
ARE Communications	6	Mar
BARTG Changes	6	May
BBC World Service News	6	Feb
BBC World Service News	7	Mar
BBC World TV	7	Jun
Club European de DX Radio TV - French FM Radio	6	Feb
CQ-TV	6	Mar
CSE - Hi-fi Speakers	7	Feb
Discovery Software - Astronomers Software	7	Jan
Drake R8 Receiver	6	Jun
Dressler Communications Ltd - Mods for the AR1000	6	Jan
DSWCI	6	Sep
DUBUS	6	Apr
Dundee 800 Award	7	Mar
DX TV News	6	Oct
DX TV News	6	Sep
DXpedition to Ecuador	6	Jul
DXTV News	6	Aug
DXTV News	6	Jul
DXTV News	6	May
Eddystone User Group	6	Feb
Eddystone User Group	6	Jan
Eddystone User Group	7	Sep
EDXC Conference 1991	6	Feb
ENWARE Engineering Software - ENLOG	7	Feb
Fastnet DXpedition	6	Jul
First Novice Licences Presented	6	Oct
G4NKH Buyers & Sellers	7	Jan
GBORN	7	Apr
GB0WMF	6	Sep
GB2TSR	6	Jul
GB3SEM	7	Apr
GB50ATC	6	Jul
GB50ATC Award	6	May
Global Specialities - Breadboards	7	May
GX2BQY	6	Jul
HCJB - Free Holiday	7	Mar
HCJB Ham Radio Today	6	Sep
HCJB Programmes	6	Mar
HS Publications - DX TV Catalogue	6	Jul
Independent Radio Pocket Guide	6	Aug
Information Wanted - Titanic	7	Oct
International Short Wave League	7	May
Johnsons Shortwave Radio - Modified ICF-2001D	6	Jan
Keith Hamer - Graphics Review	7	Feb
Low at Heathrow	7	Feb

Lowe Electronics - Award Won	7	Jun
Lowe Electronics Ltd - HF-235 Receiver	7	Jan
Maplin Electronics - Multi-satellite Receiving System	7	Feb
Maplin Electronics - Starter Tool Kit	7	Apr
Maplin Electronics - Tidy-up	6	Mar
MEC A/S - Multi-function Switch	6	Aug
Media Network	7	Mar
More RAE Courses	7	Sep
Multitest Ltd - Auto-ranging DMMs	7	Jul
NAMEX - Batteries & Chargers	7	Apr
Nevada - Fairmate HP200 & MS1000 Scanners	7	Jan
Nevada - Yupiteru MVT7000 Scanner	7	Mar
New Lowe Shop	6	Mar
NT Diamond Jubilee Award	7	Apr
Obituary - Peter Brownbridge	7	Apr
Phillips - DC777 s.w. Car Radio	7	Jan
Prize Winners	7	Oct
Radio New Zealand	6	May
RAE Classes - John Beaumont G3NGD	7	May
Rapid Results College	6	Jan
Raycom Communications Systems Ltd - American Kits	6	Jul
RNARS Award	6	Jan
Satellite Newsletter	7	May
Sherwood Forest Award	6	Mar
Solid State Electronics (UK) - Power Supplies	7	Oct
Sony - ICF SW77 & ICF SW55 Short Wave Receivers	6	Sep
STC Electronic Services - Audio Connectors	6	Jun
STC Mercator - Ceramic Trimmers	6	Feb
Stewart Harding Communication Development Specialists Ltd - Power Protection	7	Jan
The Instrument Centre - Digital Multi-test	6	Mar
The Salisbury Award	6	Oct
Tiare Publications - Writers Wanted	6	Jun
Toroid Technology Ltd - Toroidal Transformers	6	Aug
Tremiver Ltd - Fuse Holders	7	Aug
TVDX News	6	Apr
Ungar - New Tools	6	Apr
Ungar - Soldering/Desoldering Station	7	Mar
Ungar - Peelable Soldering Mask	6	Oct
WACRAL Conference	6	Aug
Waters & Stanton - Jupiter VT-125	6	Jun
Waters & Stanton - Mammoth Radio Sale	7	May
Winter SWL-Feast	7	Feb

Weather Watching

Beginners' Guide to Weather Satellite Reception	Lawrence Harris	6	Apr
Here is the Shipping Forecast	Joan Ham	8	Apr
Listening to Weather Forecasts	P.C. Mitchell	10	Apr
Radio Auroras	by Charlie Newton	14	Apr
Technical Software Weather Satellite & FAX Receive System	Lawrence Harris	13	Apr
<i>Weather Satellite Handbook</i> 4th Edition by Dr Ralph E. Taggart	WB8DQT	12	Apr
Weather Satellite Reception	by Chris Hornby	14	Apr
Weather Watching Product Guide		3	Apr

International Radio Magazine

Editorial	3	Oct
Frequencies to Try	11	Oct
International Radio Station Profiles	8	Oct
Short Wave Radio Receivers	13	Oct
The European DX Council	7	Oct
Twenty Things You Always Wanted to Know About International Radio	12	Oct
Voices Waiting to be Heard	4	Oct

What Scanner

What is a Scanner		Alan Gardner	Nov
Marine band Frequencies on the Fairmate HP 100E		T.A. James	
International Scanning in the UHF Bands		David Simpson	
What Scanner, NewsScan			

THE UP-TO-DATE NEWS & INFORMATION SERVICE FOR THE LISTENING ENTHUSIAST

RADIO LINE

0898 654676

UPDATED EVERY SATURDAY

RADIO LINE

Calls charged at 34p per minute cheap rate, 45p per minute at all other times.

ICOM

From the manufacturers of the superb IC-R7000, two new wideband communication receivers, would you accept anything less than the best from ICOM!



IC-R1 Handportable Receiver

The popular IC-R1 is a pocket-size receiver with continuous 2MHz through 1300MHz, AM/FM and FM wide reception. With 100 memory channels this tiny receiver is packed full of features, 11 search step increments, clock timer, power-save, S-meter and a convenient frequency selection via the keypad or tuning knob.

IC-R100 Mobile/Base Receiver

For the enthusiast who prefers a more permanent installation the IC-R100 is ideal giving full frequency coverage of 500KHz - 1800MHz and AM/FM and FM wide modes of operation. The IC-R100 boasts 100 memory channels to store your favourite stations and has features similar to the IC-R1.

Refusing to compromise on quality can have its price but at ICOM our products reflect our style. We only make the best.

Both the IC-R1 and IC-R100 are shown full size in this advertisement.

icom (UK) Ltd.

Dept SW, Sea Street, Herne Bay, Kent CT6 8LD. Tel: 0227 741741. 24 Hour. Fax: 0227 360155.
Visa & Mastercard: Telephone orders taken by mail order, instant credit & interest-free HP.
Despatch on same day whenever possible.



HF-150

COMMUNICATIONS RECEIVER

t h e

w h o l e

w o r l d

o v e r



From the longest of long wave to the top limits of the short wave spectrum, the HF-150 is designed to give you everything you needed in a real radio receiver.

There has quite literally never before been a receiver like the HF-150, because only now have technology and engineering been combined in such an effective package.

This is innovation at its very best.

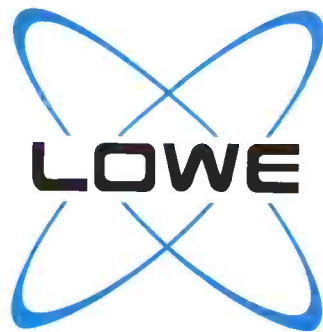

LOWE ELECTRONICS LIMITED
(HEAD OFFICE) . CHESTERFIELD ROAD .
MATLOCK . DERBYSHIRE . DE4 5LE .
ENGLAND .
TELEPHONE (0629) 580800 .
FAX (0629) 580020