

30p

The
SHORT WAVE
Magazine

VOL. XXXII

NOVEMBER, 1974

NUMBER 9



WORLD WIDE COMMUNICATION

Professional performance with KW



KW 202 Receiver.
One of the finest Amateur Band Receivers on the market. SSB filter and "Q" Multiplier. Excellent sensitivity and stability. Two-speed tuning 10-166 metres.

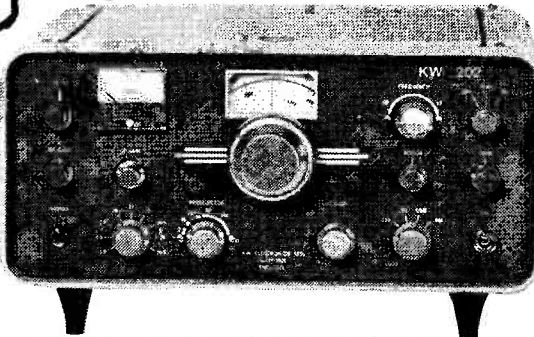

KW 204 Transmitter.
Well-known for really good audio quality (SSB) and a favourite with CW enthusiasts, 10-160 metres. Reliable PA Tubes (2 x 6146).

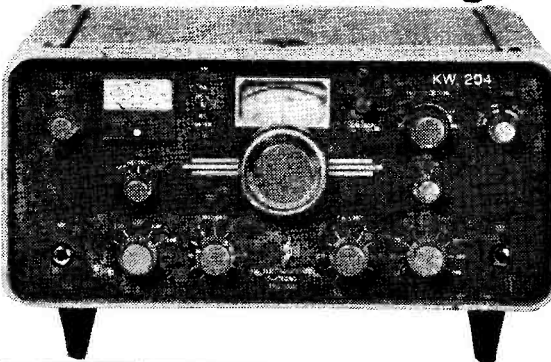

KW 108 Monitor Scope. Monitor your transmissions 10-160m. two-tone test generator incorporated to ensure optimum linearity for SSB.

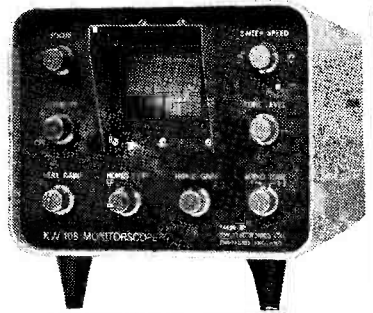

KW 107 Antenna Tuning System
Incorporates, E-Z match, SWR/RF Power meter Dummy load, Antenna Switch. A high power version KW 109 is also available.

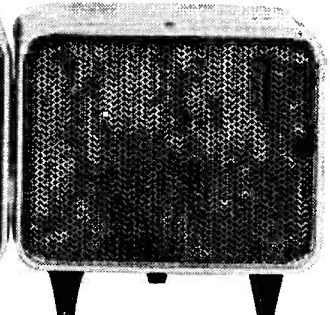
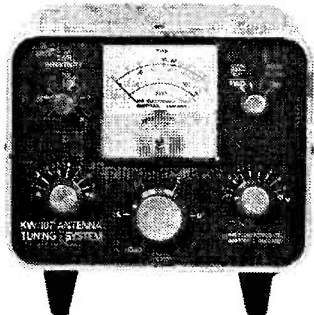

Other KW Favourites. KW 2000E Transceiver 10-160m. a quality product; KW 1000 Linear Amplifier; KW E-Z match ATU; KW 160 ATU; KW 103 SWR/RF Power meter; KW Dummy Load; KW Traps (the original and Best); KW Trap Dipoles; KW 109 Supermatch (High power version); KW Low pass Filter; KW Balun; KW Antenna Switch.

Stockists for Hy-Gain beams and verticals, CDR rotators, Shure microphones, etc.

KW Spares are normally carried for a minimum of five years after date of manufacture of equipment.

Write or 'phone for catalogue to:—

KW

KW Communications

(Decca Communications Limited)

1 HEATH STREET, DARTFORD, KENT
Tel.: Dartford 25574/219191

Easy Terms on Equipment available over 12, 18 or 24 months.

AMATEUR ELECTRONICS UK**BIRMINGHAM 021-327 1497 021-327 6313**

for **SWAN'S** LATEST SUPERB
RANGE — IMPORTED DIRECT
BY US FROM CALIFORNIA!



◀ **THE FANTASTIC 700CX
 TRANSCIVER**

700 WATTS OF PUNCH—
**BEAUTIFUL TO BEHOLD AND A
 DELIGHT TO HANDLE**

THE EXCITING NEW SWAN RANGE AS FEATURED LAST MONTH HAS ATTRACTED ENORMOUS INTEREST AND IF YOU WOULD LIKE THE LATEST FULLY ILLUSTRATED SWAN CATALOGUE PLEASE LET US HAVE 9p IN STAMPS (WE'LL PROVIDE THE ENVELOPE).

NOW EN ROUTE !**THE FANTASTIC SWAN 4 ELEMENT TRIBANDER TB-4HA**

(AN S.A.E. WILL BRING YOU DETAILS OF THE FULL SWAN ANTENNA RANGE)

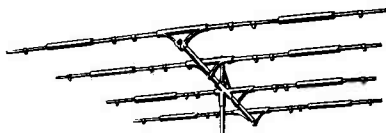

have been precision tuned and weather proofed. The Heavy Duty mechanical design of the TB-4HA means it will easily take winds up to 100 m.p.h., and give you years of rugged, reliable service in any kind of weather from the arctic to the tropics.

The Swan 4 Element Heavy Duty Multiband Beam gives you 4 working elements on each band : 10, 15 and 20 metres. That's 4 working elements on each band. Other antenna brands, advertised as 4 element antennas, and even 6 element, actually offer only 3 elements on the 15 and 20 metre bands . . . and cost considerably more than the TB-4HA. The 24ft. boom permits optimum spacing for maximum forward gain and front-to-back ratio. All traps

WHEN CUSTOMERS BUY NEW GEAR FROM US IT IS OUR PLEASURE TO TAKE THEIR EXISTING RIGS IN PART EXCHANGE AS WE EXPERIENCE AN INSATIABLE DEMAND FOR TOP QUALITY SECOND HAND GEAR.

IF YOU ARE INTERESTED IN ANYTHING IN THE SWAN OR YAESU MUSEN RANGE AND YOU HAVE AN EXISTING ITEM TO TRADE IN WRITE, PHONE OR CALL AND WE WILL GIVE YOU A FAIR PART EXCHANGE OFFER.

IF YOU WOULD LIKE OUR LATEST USED EQUIPMENT LIST PLEASE LET US HAVE A COUPLE OF STAMPS (WE'LL PROVIDE THE ENVELOPE) AND SIMILARLY WE ARE ABLE TO SUPPLY THE LATEST YAESU MUSEN CATALOGUE AND/OR A BROADSHEET OF STATION ACCESSORIES AVAILABLE FROM STOCK.

SEE IT ALL ON STAND 29 AT GRANBY HALLS

Northern Agent—JOHN ROWLEY, G3KAE, Scarborough. Tel : West Ayton 3039

Scottish Agent—RON TURNER, GMHXQ, Wishaw. Tel : Wishaw 72172

ELECTRON HOUSE, 508-514 ALUM ROCK ROAD, BIRMINGHAM 8

Goodbye to the long wait

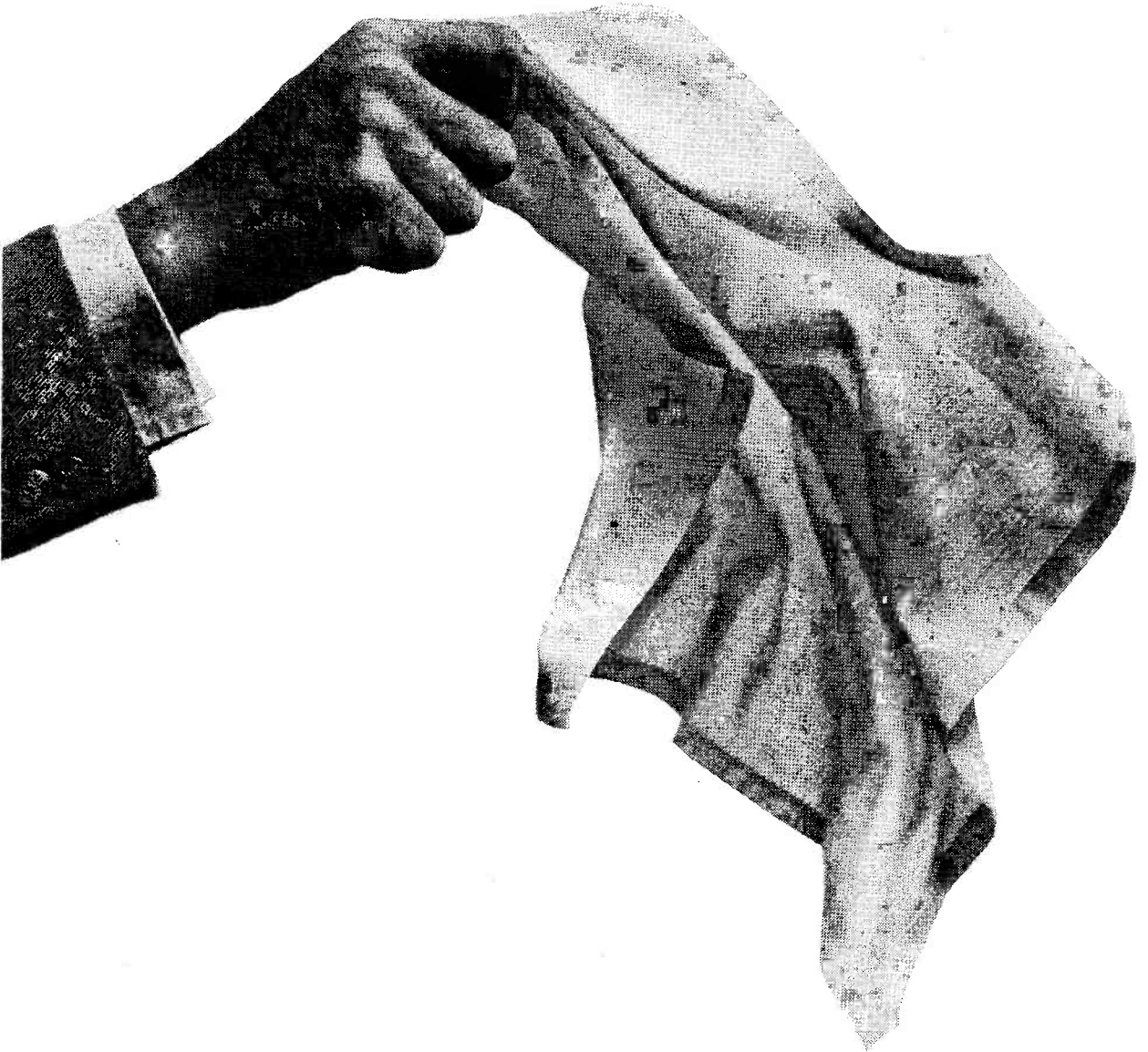

for electronic components

Now there's Doram - a completely professional electronics service for the amateur.

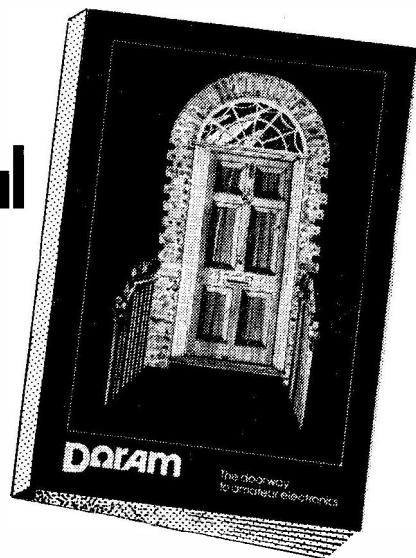

7-day service.

If you've been buying electronic components long you'll know all about the long wait.

Somehow the things you really need never turn up on time.

Well, OK, now things have changed. Now there's Doram.

Doram is a brand-new deal for serious amateurs. It's a complete door-to-door components service operated by mail order.

Millions of components.

You just buy the Doram catalogue for 25p (that's a yearly reference book for the price of a pint of lager) and then you order from it.

We can offer you stocks of millions of components. With a choice of over 4,000 different lines.

And we're so confident of our service that if we can't supply the part you want within 7 days of receiving your order, we'll give you your money back. Immediately.

So you know just where you stand. You'll never waste time hanging around while we re-order.

No-quibble guarantee.

It's just about impossible to buy a defective part from us. Because our checking is so pains-taking.

But even if the unthinkable does happen—and you're unlucky—then

we'll still make you happy quickly.

Because we offer a no-quibble replacement part service.

And our guarantee is guaranteed by the fact that we belong to the biggest electronics distribution Group in Britain.

All the goods supplied are branded goods. Produced by big-name manufacturers like RS, Mullard, SGS-ATES, Ferranti, Siemens etc.

£5 Vouchers.

As an added incentive we're giving free purchase vouchers away. To the first 50 catalogue buyers whose applications are pulled out of the sack at 12 noon on the 31st October 1974.

At that time, at the Amateur Radio Traders Exhibition at Granby Hall, Leicester, comedian Brian Rix will open our correspondence sack and make the winning selections.

The first voucher out will be a £10 voucher. The next 49 will be £5 vouchers.

All catalogues will be despatched upon receipt of coupon and remittance; coupons will then go into the correspondence sack for the draw.

So don't delay. Use the coupon. Send today for your first Doram catalogue. It can make your life a whole lot easier. And you could win a voucher if your order is one of the first 50 out on October 31st.

FREE £5 VOUCHER FOR FIRST 50 CATALOGUE BUYERS DRAWN OUT OF THE POST BAG ON OCTOBER 31st.

I ENCLOSE 25p*. PLEASE SEND ME THE NEW DORAM CATALOGUE.

*This will be refunded on orders of £5 (less VAT) or more received by us before 31st March, 1975.

Name _____

Address _____

SW/11/74

Doram Electronics Ltd.,
PO Box TR8,
Wellington Road Industrial Estate,
Wellington Bridge, Leeds LS12 2UF.

DORAM

STOP!

Are you interested in buying top performance VHF or UHF equipment? Then look no further! . . .

Our equipment and customer service are second-to-none. We note that we are still the only British amateur radio manufacturer with sufficient confidence in the robustness and reliability of our equipment to offer an UNCONDITIONAL ONE YEAR GUARANTEE inclusive of FREE SERVICE and REPAIRS. All equipment is despatched post-free by return.

144MHz Mosfet Converters

UPDATED SPECIFICATION

The overwhelming response to the introduction of our 144 MHz SSB receiver converter has indicated the requirement for a tightly specified converter for use with modern highly accurate 28-30 MHz receivers. To this end we have now standardised the design of our 28-30 MHz converter using a zener-stabilised 116 MHz crystal oscillator, giving a typical read-out error of better than 1 kHz. The converter is now available in the two versions, with and without the local oscillator output facility.

MMCI44/28 Price **£16.42** inc. VAT

MMCI44/28 LO (with 116 MHz output) Price **£17.60** inc. VAT

SPECIFICATION

Noise figure : 2.8dB max. Gain : 27dB typ.
 Image rejection : 65dB typ.
 Crystal oscillator : 116 MHz (zenered)
 Frequency error at 144 MHz : 3 kHz max.
 Power supply : 35mA at 12 volts.
 116 MHz o/p power : 5mW min (LO o/p version)

We have extended our popular range of single conversion converters to include the following I.F.s :
 9-11, 12-14, 14-16, 18-20, 24-26, 27.7-29.7, 28-30 MHz
 Price **£16.42** inc. VAT

144 MHz DOUBLE CONVERSION MOSFET CONVERTER

I.F.s available ex-stock : 2-4, 4-6 MHz. Price inc. VAT **£16.42**
 This unit was developed to meet the heavy demand for a converter suitable for use with receivers having better performance at lower frequencies. It uses two dual-gate mosfet mixers, both fed from the output of a 70 or 71 MHz crystal oscillator. Selectivity is obtained at the first IF in the 74 MHz range, thereby overcoming the usual problems associated with low-I.F. single conversion converters.

70 MHz MOSFET CONVERTER

I.F.s available : 4-4.7, 14-14.7, 18-18.7, 28-28.7 MHz.
 Price **£16.42** inc. VAT

144 MHz DUAL OUTPUT PREAMPLIFIER

This two-stage mosfet preamplifier has two separate isolated outputs, for feeding two receivers, for example. The gain is 18dB, and the noise figure is 2.8dB. The noise figure is individually optimised on each unit using our new automatic noise measuring equipment.
 Price inc. VAT **£9.72**

432 MHz MOSFET CONVERTER

I.F.s available ex-stock : 14-16, 18-20, 24-26, 28-30, 144-146 MHz.
 Price inc. VAT **£19.55**

This unit uses a dual-gate mosfet mixer for excellent strong-signal performance preceded by two BFY90 transistor RF stages for high sensitivity. All UHF tuned circuits are printed using Microstrip technology, and a crystal in the 100 MHz region is used in the oscillator chain to overcome unwanted beats in the tuning range.

1296 MHz CONVERTER

This converter has been developed using an extension of the microstrip techniques that have been well proven in our 70 cm. converter design. Two versions of the design are available using either a 96 MHz or 105.666 MHz crystal to produce I.F.s of 144-146 MHz or 28-30 MHz respectively, corresponding to the 1296-1298 MHz band. We are using crystals of a very tight tolerance to minimize the offset that would otherwise be very noticeable when using a high performance 28-30 MHz tunable receiver. The multiplier chain uses three BFY 90 transistors and the mixer is fabricated using a pair of MA 4882 Schottky diodes in a balanced hybrid ring configuration. The I.F. head amplifier uses selected low noise dual-gate mosfet to give an overall noise figure which is typically better than 8.5dB, and a gain of 25dB. Microstrip UHF circuitry ensures repeatability of this high performance design. The unit is housed in the same small die-cast box as the rest of our range of converters and is fitted with 50 ohm BNC connectors for optimum UHF performance. The converter operates from a nominal 12v. supply and is available in negative earth version only.
 Price inc. VAT **£25.92**

VARACTOR TRIPLERS

We manufacture varactor triplers for 432 and 1296 MHz. Both are highly stable, with low level harmonic output, and capable of AM operation at the 50% power level. These units are aligned using swept-frequency and swept-power drive sources, the output of each unit being monitored on one of our spectrum analysers. Great attention is paid to harmonic suppression and linearity. All harmonics are greater than 40dB down on the wanted output.

432 MHz VARACTOR TRIPLER

Maximum input power at 144 MHz: 20 watts. Typical output power (at maximum input) : 14 watts. Price inc. VAT **£18.90**

1296 MHz VARACTOR TRIPLER

Maximum input power at 432 MHz: 24 watts. Typical output power (at maximum input) : 14 watts. Price inc. VAT **£27.00**

136 MHz SATELLITE BAND CONVERTER

I.F.s available : 28-30 MHz and others. Price inc. VAT **£16.72**

MICROWAVE MODULES LIMITED

11 CRANMORE AVENUE, CROSBY, LIVERPOOL L23 0QD Tel: 051-928 1610 9 a.m.-8 p.m.

Radio Shack Ltd



London's Amateur Radio Stockists

Just around the corner from West Hampstead Underground Station

FOR THE LATEST IN EQUIPMENT AND THE BEST IN VALUE

ATLAS 180

ENTIRELY SOLID STATE
£250 + VAT

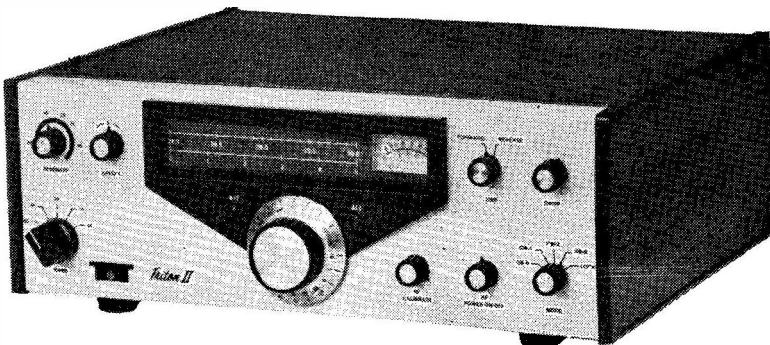
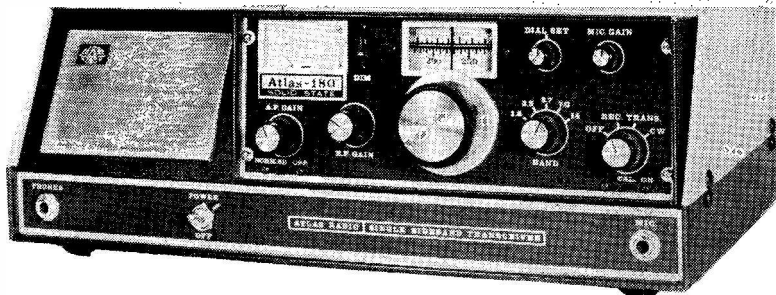

TEN TEC TRITON II

+ AC PSU
200 WATTS
ENTIRELY SOLID STATE
£430 + VAT

Also ARGONAUT 5 watts
£170 + VAT

SWAN SS-200A and PSU. 300 watts. ENTIRELY SOLID STATE. £495 + VAT
SWAN 700-CX and PSU. 700 watts. £395 + VAT

and of course, the ever popular

DRAKE TR-4C Transceiver

+ PSU
£312 + VAT

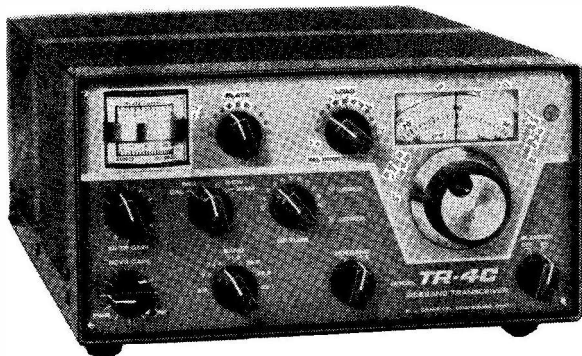

CHARGE ONE TO YOUR ACCESS OR BARCLAYCARD

MASSIVE STOCKS OF HY-GAIN ANTENNAS, CDR ROTATORS, MIKES, CABLES, CONNECTORS.

NEXT DAY DELIVERY BY SECURICOR

FULL AFTER SALES SERVICE

RADIO SHACK LTD.

188 BROADHURST CARDENS
LONDON, NW6 3AY

Just around the corner from West Hampstead Underground Station

OPEN 5 DAYS 9—5 p.m.
HALF DAY SATURDAY

CLOSED 1—2 p.m.

Telephone : 01-624 7174 Cables : Radio Shack, London, N.W.6.
Giro Account No.: 588 7151



Western

PLEASE NOTE—We've moved!

We are pleased to announce that a major re-organisation has taken place in the company and that we are now located at:

1-3 WEST PARK ROAD, SOUTHAMPTON

TELEPHONE: SOUTHAMPTON 27464 (2 lines), CABLE: WESTRONICS, SOUTHAMPTON. TELEX: 47388, WESTRONICS

The Directors of the Company wish to make it known that WESTERN ELECTRONICS (UK) LTD. is a fully independent company and is not associated in any way whatsoever with any other concern.

The new premises are merely the first phase of a redevelopment programme aimed at keeping ahead in providing you with the finest service in the country. Our new much larger showroom is right in the middle of Southampton opposite the Civic Centre Police Station. Whilst the family enjoy the excellent shopping facilities close at hand you will be more than welcome to come in and just browse around. Parking is available on our premises for seven cars and there are two car parks immediately opposite. Hope we'll see you soon.



UNITED KINGDOM DISTRIBUTOR OF
THE WORLD'S FINEST RANGE OF AMATEUR RADIO
EQUIPMENT BY

YAESU MUSEN

It's worth remembering that when you deal with WESTERN ELECTRONICS you have the best after-sales service in the country. We have the best equipped service department in the country in our trade and provide free collection and re-delivery on all warranty work. It's all part of our service!

YAESU—YOUR ASSURANCE OF QUALITY—introduce

The superbly engineered FR-101 Receiver



- ★ Entirely Solid State.
- ★ Transceivers with FL-101 (available shortly).
- ★ 23 Bands.
- ★ 160m - 2m.
- ★ Plus general coverage.
- ★ SSB/FM/AM/CW.
- ★ Digital readout option available later.

Full specification available upon receipt of S.A.E. for both models.

FR-101S, £245 + VAT.

FR-101D, £330 + VAT.

Electronics (UK) Ltd

PLEASE NOTE — WE'VE NOT GONE MAD!

We are just celebrating our move to Southampton by offering 20% discount off certain items on **cash sales only** (sorry, not on part exchange) as follows :

Yaesu, FT-401, FP-2AC, FT-2FB, FT-2 Auto, FL-50, FR-50, YC-355, FR-400SDX.
Send SAE (foolscap) for full details.
(Offer is limited until current stocks are sold out).

BE WISE, BUY NOW AND BEAT INFLATION AT WESTERN ELECTRONICS

Your 'single source' of Towers, Rotators, Antennas and Communications equipment.

NEW CDE ROTORS (Ex-Stock)

- ★ NEW CD-44 £60
 - ★ NEW HAM-2 £90
(Illustrated right)
- CDE ROTOR PRICES :
AR22R, £27.5
AR30, £25
AR40, £30
+ VAT

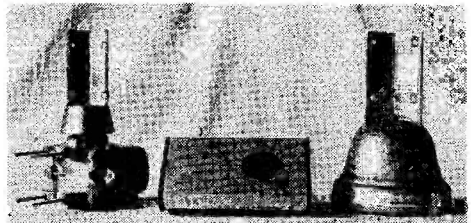
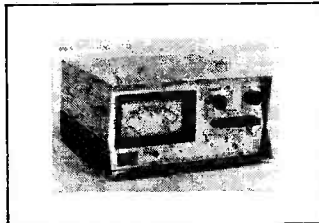

AR30, £25

+ VAT

AR40, £30

BANTEX FIBREGLASS MOBILE ANTENNAS (Carr. 50p) including base (Ex-Stock) ± VAT

70/1/2. 70 MHz, 1/2 wave ... £3.00	BGA, 144 MHz, 1/2 wave ... £6.60	Magnetic mount ... £7.50	Note. Deduct 50p from price of aerial if base is not required.
144/1/2. 144 MHz, 1/2 wave £2.85	B5, 144 MHz, 3/4 wave ... £5.00	All aerials complete with base.	

HY-GAIN (Carr. paid) ± VAT

Hy tower, 10-80m. (self-sup.) ... £132.00	LC800. 80m. coil for 14AVQ ... £9.03	TH3 Jnr., 10-20m. 3 ele. 600W. ... £62.00	203BA, 20m. 3 ele. beam £87.00
18V, 10-80m. vertical ... £15.05	TH6DXX, 10-20m. 6 ele. beam ... £117.00	Hy-Quad, 10-20m. 2 ele. £90.00	153BA, 15m. 3 ele. beam £44.00
12AVQ, 10-20m. vert. ... £20.00	TH3MK3, 10-20m. 3 ele. 2 kW ... £90.05	DB10-15 10-15m. 3 ele. £69.00	103BA, 10m. 3 ele. beam £35.00
14AVT, 10-40m. vert. ... £29.05		204BA, 20m. 4 ele. beam £96.00	LA1 Lightning arrestor ... £17.05
18AVT, 10-80m. vert. ... £42.05			LA2 Lightning arrestor ... £3.00

MOSLEY (Carr. paid) (Ex-Stock) from us for fast delivery ± VAT

Mustang, 10-20m. 3 ele. 2kW ... £56.75	TA33 Jnr., 10-20m. 3 ele. £41.55	TA32 Jnr. "E" for 2in. mast ... £30.25	SWL Listener's dipole ... £12.90
TA33 Jnr. "E" for 2" mast £42.05	A32 Jnr. 10-20m. 2 ele. ... £29.75	TA31 Jnr. Rotary dipole £19.75	

Western Electronics (UK) Ltd

Agent: G3PRR Chesham (02405) 4143

Hours of business: 9.15 - 5.00, 9 - 12.30 (Saturdays)

1-3 WEST PARK ROAD, SOUTHAMPTON

TELEPHONE: SOUTHAMPTON 27464

CABLES: WESTRONICS, SOUTHAMPTON

TELEX: 47388 WESTRONICS





Western

Announcing . . . the ATLAS 180



The above picture is HALF-FULL SIZE! And there's 180w. inside! How can we sell it! There's NO PA TUNING. There's NO PRE-SELECTOR TUNING. There's NO "NOTHING" ALMOST—but it's sensational!

The Atlas-180 Transceiver is designed for single sideband and CW communications in the 20, 40, 80 and 160 metre amateur radio bands. It employs all solid state circuitry, with modular construction. Its conservative 180 watt power input rating will provide world-wide communications from fixed, portable, or mobile installations.

Atlas Radio, Inc., is licensed by Southcom International, Inc., of Escondido, Calif., manufacturers of military and commercial radio equipment. With this agreement Atlas Radio is able to bring the most advanced, state-of-the-art circuit designs to the amateur radio market. Les Earnshaw, founder and Director of R & D at Southcom, is considered to be one of the foremost solid state engineers in the world, effectively proven by the rapid growth of Southcom International in the military and commercial radio markets of the United States as well as many other countries.

The high performance and reliability of the Atlas-180 is enhanced by the finest craftsmanship, and a most thorough quality control programme. Our staff is made up of highly skilled assembly workers, technicians and engineers, many of whom are active radio hams. Our service department, if and when needed, is dedicated to making every Atlas owner a satisfied customer.

GENERAL SPECIFICATIONS

BAND COVERAGE: 20, 40, 80 and 160 metres. **FREQUENCY RANGES:** 1800-2000, 3500-3850, 3700-4050, 7000-7350, 14,000-14,350 kc. **EXTENDED FREQUENCY RANGES:** With external crystal oscillator accessory: 1800-2050, 3400-4300, 7000-8000, 13,900-14,900 kc. **FREQUENCY CONTROL:** Highly stable VFO common to both receive and transmit modes. Tuning dial calibrated in 5 kc increments with easy interpolation to 1 kc. Tuning rate: 15 kc per revolution of the tuning knob. **EXTERNAL FREQUENCY CONTROL:** Rear socket provides for plug in of external VFO or crystal oscillator accessory for separate control of transmit and receive frequencies, or for network and MARS operation. **CIRCUIT DESIGN:** All solid state, 4 I.C.'s, 18 transistors, 32 diodes. Single conversion, 5520 kc I.F. **MODES OF OPERATION:** SSB: Lower sideband on 40, 80 and 160 metres. Upper sideband on 20 metres with 5B selector switch in NORM. position. Opposite with switch in OPP. position. CW: Offset frequency in transmit mode. **MODULAR CONSTRUCTION:** Includes making transfer or removal a simple operation. **PLUG-IN DESIGN:** Transceiver plugs into the deluxe mobile bracket, or into the AC power supply console (standard automotive system). Current drain is 300 to 500 mA in receive mode. **POWER SUPPLY REQUIREMENTS:** Operates directly from a 12 to 14 volt D.C. source with negative ground supply consoles are available for AC operation. **FRONT CONTROLS:** Tuning Dial, Dial Set, Function Switch, Band Switch, A.F. Gain, R.F. Gain, Mic. Gain, Sideband Selector, Calibrator On-Off, Dial Light Dimmer. **FINISH:** Black vinyl covered steel cabinet, anodised aluminium panel. **DIMENSIONS:** 9 1/2 in. (24.1 cm.) wide, 3 1/2 in. (8.9 cm.) high, 9 1/2 in. (24.1 cm.) deep, overall. **WEIGHT:** 7 1/2 lbs. (3.4 kg.) net. 9 lbs. (4.1 kg.) shipping weight.

RECEIVER SPECIFICATIONS

CIRCUIT DESIGN: Front end design provides exceptional immunity to overload and cross modulation, matching or out performing the best vacuum tube designs. Signals are converted directly to the 5520 kc I.F. without preamplification. Converter and product detector are double balanced diode rings. I.C.'s are employed in I.F. and A.F. stages. **SENSITIVITY:** Requires less than 0.3 microvolts for a 10 db signal-plus-noise to noise ratio (typically 0.2 microvolts). **SELECTIVITY:** Crystal Ladder Filter, 6 poles. Bandwidths: 2.7 kc at 6 db, 4.3 kc at 60 db, 9.2 kc at 120 db!! Ultimate rejection more than 130 db!! Shape output constant within 4 db with signal variation from 5 microvolts to more than 3 volts. **OVERALL GAIN:** Requires less than 1 microvolt signal for 0.5 watts audio output. (CW carrier, 1000 cycle heterodyne). **AUDIO FIDELITY:** 300 to 3000 cycles, plus or minus 3 db. **AUDIO POWER:** 2 watts to a 3 ohm speaker with less than 10% distortion. **INTERNAL SPEAKER:** 3 inch, 3 ohm, 68 ohm magnet. Rear jack permits plug in of external speaker, or high impedance headphones. When transceiver is plugged into the AC power supply console, internal speaker is disconnected automatically, and front facing speaker console becomes operative. **METER:** Reads 5 units from 1 to 9, plus 10 to 50 db. **CALIBRATOR:** Provides 100 kc check points for accurate dial setting.

TRANSMITTER SPECIFICATIONS

CIRCUIT DESIGN: Broadband design eliminates transmitter tuning. Single conversion from I.F. to output frequency produces minimum spurious and mixing products. 2 section low-pass filters on each band provide harmonic suppression equal to commercial standards. Includes ALC and infinite SWR protection. **FREQUENCY CONTROL:** Internal VFO automatically transmits on exactly the same frequency that is being received. Rear socket provides for plug in of external VFO or crystal oscillator accessory for separate control of transmit and receive frequencies, or for network and MARS operation. **POWER RATING:** 180 watts P.E.P. input, and CW input (with 50 ohm resistive load and 13.6 volt D.C. supply). Power output: 80 watts minimum P.E.P. and CW. (100 watts typical). **EMISSION:** SSB: Lower sideband on 40, 80 and 160 metres. Upper sideband on 20 metres with 5B selector switch in NORM. position. Opposite with switch in OPP. position. CW: Offset frequency. **UNWANTED SIDEBAND:** More than 60 db down at 1000 cycles A.F. input. **CARRIER SUPPRESSION:** More than 50 db down. **THIRD ORDER DISTORTION:** Approximately 30 db below peak power. **SPURIOUS AND IMAGE OUTPUT:** More than 40 db below peak power. **HARMONIC OUTPUT:** More than 35 db below peak power. **CW KEYING:** Manual send-recv. Semi-break-in with CW accessory installed in AC power supply console. **TRANSMIT CONTROL:** Press-to-talk with Mic. button, or manual transmit with function switch on front panel. Automatic voice control when VOX accessory is installed in AC power supply console. **MICROPHONE:** Dynamic or Crystal. Plug requirement: standard 1/4 in. diam, 3 circuit phone plug. **AUDIO FIDELITY:** 300 to 3000 cycles, plus or minus 3 db. **METER:** Reads power amplifier collector current, 0-16 amperes. **LINEAR AMPLIFIER CONTROL:** Rear jack provides for keying of linear, and ALC control from linear.

Electronics (UK) Ltd

The most comprehensive range of FM equipment
by a specialist VHF/UHF manufacturer
STANDARD RADIO CORPORATION

144 MHz

CV110 VFO



The CV110 is a remote VFO for the C140 Transceiver and has a centre tuning meter plus RIT (± 5 kHz) and CAL position to accurately calibrate the VFO.

C140 TRANSCIVER



2 1/2 in. high! The microphone has two switches, the normal PTT switch plus the MEMO switch. A flick of the switch and the transceiver overrides the Channel selector and you can transmit or receive on another frequency. The C140 takes the CV110 Remote VFO or SY-200 Synthesiser and comes complete with microphone, line filter and mounting hardware.

SY-200 SYNTHESISER



The SY-200 is a 200 Channel synthesiser unit plus 1 priority channel and 3 Memo channels. The size of this is the same as that of the C140.

The C140 is a 10W, 12 Channel transceiver + 1 Memory Channel and measures only 3 1/2 in. wide x **C826MB TRANSCIVER**



C146A is a 2W 5Ch. Hand transceiver with tone burst and the capability of repeater operation. Ni-cad batteries and many accessories are available (but not fitted), making this superbly built unit the finest available. Complete with leather case and fitted crystals on 145-00 and 145-15.

CV100 DUAL VFO



The C826MB is a 12 Channel 10W o/p. unit. Tone burst and separate transmit and receive crystals permit repeater operation and are readily accessible via a hinged lid underneath. Receiver sensitivity is excellent, being 0.4 uV or less (20-db quieting). Transmitter and receiver test sockets are fitted at the rear for servicing. The C826MB has provision for the CV100 dual VFO giving separate VFO's for transmitter and receiver operation. Each 826MB carries its own test certificate so you get guaranteed performance. Line filter and microphone are included. The CV100 has a centre signal meter and calibrate (CAL) position to zero the transmitter onto the receiver's frequency.

432 MHz

The C432 is a UHF 2 Watt 5 Channel Hand transceiver with a full range of accessories as the C146A. The C430 is a 10 Watt 12 Channel highly compact and efficient unit of the same size as the C140. This is the first professional 70 cm. transceiver available and will enable you to get going on 70 cm. with the advantage of smaller antennas and greater band span.

PRICES (Carriage/VAT paid)

CV100. VFO for C826MB	£30.00
CV110. VFO for C140	£40.00
C140. 2m. Transceiver	£1110.00
C146A. 2m. Hand Transceiver 5 channel	£79.50
C826MB 2m. Transceiver	£125.00
SY-200 Synthesiser	£85.00
C430. UHF Transceiver	£139.00
C432. UHF Hand Transceiver 5 channel	£99.00

ACCESSORIES

C-12/230-2 AC Charger/Spkr	£66.00
C-12/230-5AE AC PSU/SPKR, for all models	£22.00
C-12/230-6. Wall plug-in charger	£3.00
Ni-cad Batteries, set of 10	£12.00
2-205K remote speaker for all models	£9.00
CAD external antenna coupler	£1.95
CSA Base charger unit for C146	£14.00
CAT08E. Rubber flexible antenna	£2.75
CMPO8 External microphone for C146A and C432	£9.00
CMPO2 Telephone handset for all models	£24.00

The Standard Radio Corporation produce only VHF/UHF Communications equipment and in this field they excel. All transceivers have automatic final protection circuits and are very well engineered. Because of the quality, the units are not cheap but nevertheless you will find their prices highly competitive and you have many advanced design features not found elsewhere. Delivery is ex-stock at the time of going to press. We regret the Standard accessories are only available to purchasers of Standard Transceivers.

VHF EQUIPMENT (Prices Carriage/VAT paid)

BELCON. Liner 2 145-25-48 or 144-1 0-34. Ex-Stock	£132.00
BRAUN SE600 Digital 2M AM/FM/SSB Transceiver	£780.00
FDK Multi 2000	£264.00
TEMPO 6N2WE 2KW 144 MHz SSB/FM amplifier	£385.00
12v. DC Amplifiers: 502 (50w o/p)	£62.70
802 (80w o/p)	£107.80
1002-3 (100w o/p)	£130.90

Western Electronics (UK) Ltd

Agent: G3PRR Chesham (02405) 4143

Hours of business: 9.15 - 5.00, 9 - 12.30 (Saturdays)

I-3 WEST PARK ROAD, SOUTHAMPTON

TELEPHONE: SOUTHAMPTON 27464

TELEX: 47388 WESTRONICS

CABLES: WESTRONICS, SOUTHAMPTON



LOWE ELECTRONICS

CAVENDISH RD., MATLOCK, DERBYSHIRE. TEL. MATLOCK 2817, 2430. TELEX 377482

NOW SEE THE INSIDE STORY OF THE TS520

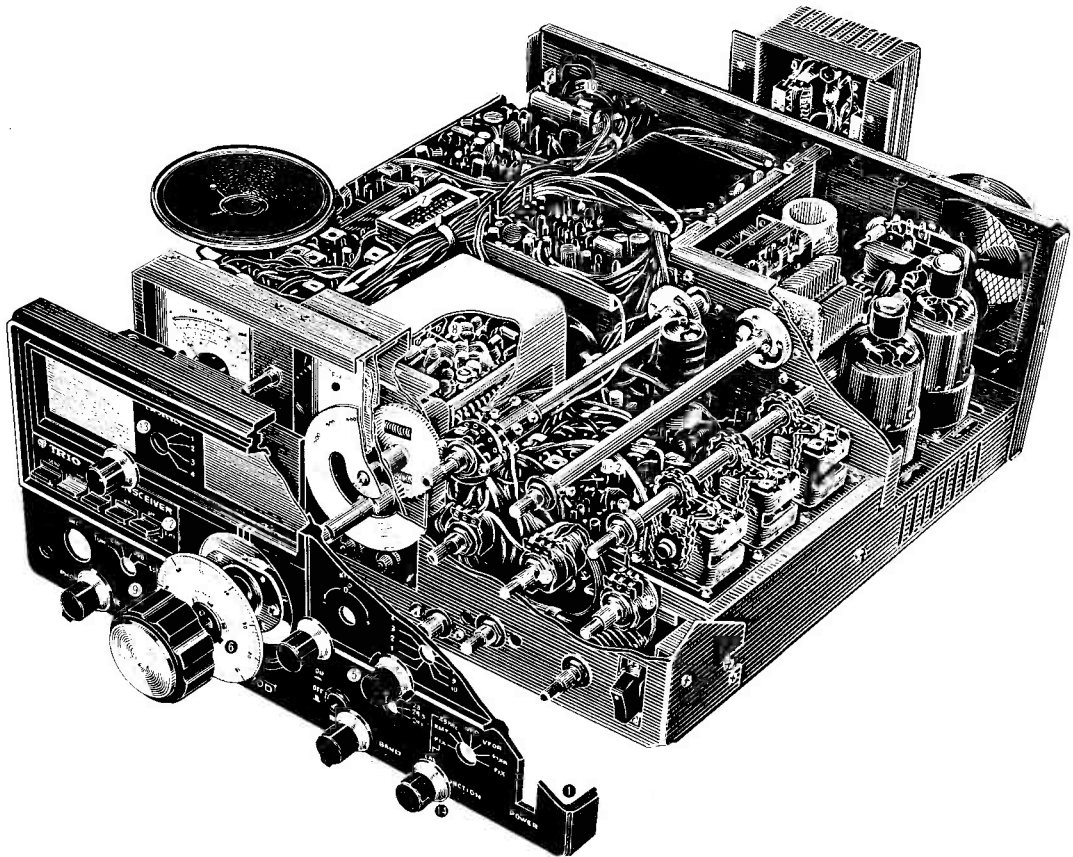

- (1) Diecast front panel for exceptional strength and stability.
- (2) Newly developed dual gate MOSFET devices for high gain, low noise receiver performance with almost complete absence of cross modulation.
- (3) 12v. DC inverter for mobile operation is included in the low price of the TS520.
- (4) L.E.D. indicators show you which VFO or crystal oscillator is selected. Also instant indication of whether R.I.T. is in use.
- (5) Built-in speech processing for that extra punchy signal. Just another TRIO exclusive feature which helps make the TS520 an outstanding buy.
- (6) Main dial calibrated 0-1000 kHz giving 1 kHz readout on all bands.
- (7) 8 pole crystal filter gives clean crisp transmit signal together with high adjacent channel rejection on receive.
- (8) TRIO super stable VFO housed in one piece deep drawn aluminium casing. Factory calibrated and sealed.
- (9) Instant frequency calibration check by push-button WWV selection regardless of band in use.
- (10) 25 kHz calibrator built-in—no extra charge.
- (11) Separate mic. gain and carrier controls for optimum CW and SSB operation.
- (12) Selectable two speed amplified AGC system for optimum performance under all conditions.
- (13) 4 channel crystal control facility for those frequently used net channels.
- (14) All remote VFO switching provided for use with VFO 520 accessory VFO.
- (15) Long life PA uses 6146B transmitting tubes for exceptional linearity and the cleanest signal on the air.
- (16) S meter reading is independent of RF gain control setting—if he is 20 over 9 at full RF gain, he still reads 20 over 9 as you turn back the gain to remove background noise.

TS520 — THE GO ANYWHERE RIG

GLASGOW MATLOCK BIRMINGHAM
041-771-0364 0629-2430 021-554-0708

PONTYPRIDD
NEWTOWN LLANTWIT 3809

WORTHING
STEYNING 814466

LEWES
RINGMER 812071

LOWE ELECTRONICS

CAVENDISH RD., MATLOCK, DERBYSHIRE. TEL. MATLOCK 2817, 2430. TELEX 377482

TRIO TR 7200 G

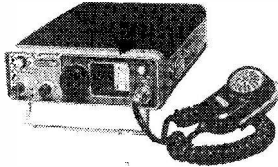

THE FM MOBILE TRANSCEIVER

- ★ 10W/1W output
- ★ 23 channels plus VFO input
- ★ Tuning fork controlled repeater access tone
- ★ Supplied complete with five channels :—

145-50	Simplex
145-525	Simplex
145-55	Simplex
145-15/75	Duplex
145-175/775	Duplex

- ★ Matching VFO (Tx and Rx) available
- ★ Superb sensitivity and selectivity
- ★ Public address facility
- ★ Exclusive RF powered indicator to show which channels have crystals fitted ; works on receive and transmit.

PRICE : £125 (VAT exc.)

TRIO TR 2200 G

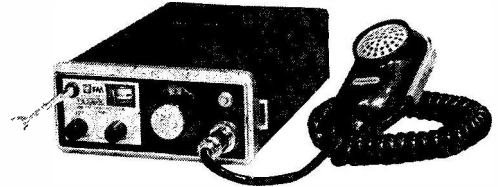

The most popular Handy-Talky 2 metre Transceiver now comes complete with tuning fork controlled repeater access tone and 12 channels.

- ★ 1W output from internal batteries
- ★ Built-in charger
- ★ Fitted with three channels as standard :—

145-50	Simplex
145-55	Simplex
145-175/775	Duplex

Most I.A.R.U. channels available : updated specification : Low price.

PRICE : £80 (VAT exc.)

LOWE MONITOR RECEIVER REC-1420C

Here is a simple, low cost FM monitor receiver which monitors up to six channels and has an excellent performance/price ratio. Ideal for mobile use and when fitted with popular FM frequencies along with a repeater or two ensures that it is in the midst of any FM activity.

No necessity for a bulky and costly tunable IF—no fiddling around when driving—just scan the channels and if there is much FM activity you are sure of hearing it. Being FM, ignition etc., suppression is not essential, and thus makes it the ideal mode for mobile. It's diminutive size (4" w. x 2½" H. x 8" D.) and weight (2½ lbs.) make it a snip for portable. In fact it is the one receiver that is cheap enough for everyone to carry around anywhere.

RF stage. Requires 12v. to 15v. DC. 6 channel capability. 4 IF stages. Double conversion. Excellent squelch.

PRICE (less crystals) £19.95 plus VAT

CRYSTALS :—	145-500	145-525	145-550	Popular calling channels
	145-725	145-750	145-775	Repeaters

£1.50 each, plus VAT

GENERAL CHAT

Well, we expected a good deal of interest to be shown in the TRIO range but we hardly expected the landslide of queries and orders which followed our initial announcement. As those of you who have spoken to us will know, most of the rigs are available only after some delay but you will have heard the first owners of TRIO transceivers on the air by now and heard their favourable comments. From our point of view, we have had virtually no problems with any of the TRIO equipment and this makes a pleasant change for our workshop staff. Incidentally, Ian Sneap, G3ZYC, joined us some months ago, and his experience and reputation as a leading VHF man are very welcome since Bill, Alan and I were brought up on a diet of HF operation and we really don't recognise some of the recent plumbing that Ian has been using.

Our quotation this month is one which I found, and could apply to many an 80 metre fan.

"Though warm my welcome everywhere,
I shift so frequently, so fast,
I cannot now say where I was
The evening before last."

W H. AUDEN

GLASGOW	MATLOCK	BIRMINGHAM	PONTYPRIDD	WORTHING	LEWES
041-771-0364	0629-2430	021-554-0708	NEWTOWN LLANTWIT 3809	STEYNING 814466	RINGMER 812071

Wind, frost or rain—
MOSLEY is the name
WE ARE THE ANTENNA

mosley makes impact

TOWERS
ROTATORS
COAX
ROPES &
LINES

BASIC
PRICES.
ADD VAT

PEOPLE

SOME ANTENNAS

MONO-BANDERS

A-310	3 Elements, 10 metres ...	£27.00
A-315	3 Elements, 15 metres ...	£30.00
Classic-203-C	3 Elements, 20 metres ...	£85.00
A-92-S	9 Elements, 2 metres ...	£14.00
D1-10	Ground Plane, 10 metres ...	£22.00
D1-2	Ground Plane, 2 metres ...	£8.00
MCQ-20	20 metre Quad ...	£53.00

DUAL - BANDERS

Elan	3 Elements, 10 and 15 metres ...	£35.00
Elan	2 Elements, 10 and 15 metres ...	£26.00
TD-2	Trap Dipole, 40 and 80 metres ...	£18.00

TRI - BANDERS

Mustang Mk 2	3 Elements, 10, 15 and 20 metres ...	£55.00
Mustang Mk 2	2 Elements, 10, 15 and 20 metres ...	£42.00
TA-33 Jr.	High Power Model incl. Balun ...	£46.00
TA-33 Jr.	3 Elements, 10, 15 and 20 metres ...	£40.30
TA-32 Jr.	3 Elements, 10, 15 and 20 metres ...	£28.50
TA-31 Jr.	Rotary dipole, 10, 15 and 20 metres ...	£18.00
Classic-36	6 elements, 10, 15 and 20 metres ...	£115.00
V-3 Jr.	Trap Vertical, 10, 15 and 20 metres ...	£13.00
MCQ-3B	Cubical Quad, 10, 15 and 20 metres ...	£85.00
EI-Toro	Vertical, 20, 40 and 80 metres ...	£12.50

QUAD - BANDERS

Atlas	Trap Vertical, 10, 15, 20 and 40 metres ...	£25.00
SWL Antennas		
SWL-7	Dipole, 11, 13, 16, 19, 25, 31 and 49 metres ...	£12.50
RD-5	Dipole, 10, 15, 20, 40 and 80 metres ...	£12.50

Send for HANDBOOK containing full details of Antennas and other technical information. 33 pages 25p. Refundable upon purchase of Antenna.

All antennas available ex works carriage and insurance extra
Administrative Address only
40 Valley Road, New Costessey, Norwich, Norfolk NR5 0BD, England



AMATEUR RADIO CHAS. H. YOUNG LTD. G3VfV

170-172 . CORPORATION STREET . BIRMINGHAM B4 6UD

021-236 1635

We specialise in the service of EDDYSTONE RECEIVERS and can accept most makes of commercially made equipment

MICROWAVE MODULES

70 MHz Converters 28-28.7 MHz IF	£16.42
144 MHz " 28-30 MHz IF	£16.42
144 MHz " 4-6 MHz IF	£16.42
144 MHz " 2-4 MHz IF	£16.42
144 MHz " 28-30 MHz IF	£17.60
with 166 MHz output	
432 MHz Converters 28-30 MHz IF	£19.55
432 MHz " 144-146 MHz IF	£19.55
1296 MHz " 28-30 MHz IF	£25.92
1296 MHz " 144-146 MHz IF	£25.92
144 MHz Pre-Amp (2 outputs)	£18.90
432 MHz Varactor Triplers	£18.90
1296 MHz Varactor Triplers	£27.00
136 MHz Converter (Satellite Band) 28-30 MHz IF	£16.42

Other IP's to order
All above post free

SOLID STATE MODULES

144 MHz Converters 4-6 MHz IF (30p)	£16.20
144 MHz Converters 28-30 MHz IF (30p)	£16.20
432 MHz Converters 144-146 MHz IF	£16.20
144 MHz Pre-amp (30p)	£7.36
144 MHz Pre-Amp PA3 for equip. (10p)	£5.94
Europa Transverter 10-2M with valves (£1)	£88.00

MICROPHONES

Shure 201	(30p)	£6.60
Shure 444	(30p)	£16.50

WE SPECIALISE IN THE SERVICE OF EDDYSTONE RECEIVERS AND CAN ACCEPT MOST MAKES OF COMMERCIALY MADE COMMUNICATION EQUIPMENT.

WE ARE ALSO INTERESTED IN PURCHASING GOOD QUALITY UNMODIFIED SECOND-HAND EQUIPMENT.

RECEIVERS and TRANSCIEVERS

Yaesu FT101B	(£3.00)	£356.40
Yaesu FR50B with cal.	(£1.50)	£75.06
Yaesu FR101S	(£2.00)	£264.60
Eddystone EC10A2/1 Marine	300-500 kHz 1.5 MHz-30 MHz (£1.50)	£212.00

ATU SWR

KW EZ Match ATU	(50p)	£21.60
KW103 SWR/Power 520HM	(35p)	£15.12
KW103 SWR/Power 750	(35p)	£15.12
KW107 ATU/SWR 520HM	(50p)	£64.80
ME11N SWR/Power 52/750HM	(50p)	£15.88
Hansen SWR3 SWR 520HM	(30p)	£6.90
Hansen SWR4 SWR 520HM	(30p)	£7.99

Multi-storey Car Park at rear of shop.

AERIALS and AERIALE EQUIPMENT

Eddystone LP1506 Active Aerial	(50p)	£26.40
Bantex 1/2 wave 2M Glass Fibre	(20p)	£3.08
Jay Beam		
2M Halo (head only)	(25p)	£1.84
2M Halo (with mast)	(25p)	£2.16
5 ele. 2m. beam	(50p)	£4.21
8 ele. 2m. beam	(50p)	£5.51
10 ele. 2m. beam	(50p)	£10.80
14 ele. 2m. beam	(50p)	£16.63
15 ele. crossed 2m. beam	(50p)	£8.10
8 over 8 2m. beam	(50p)	£10.04
5 over 5 2m. beam	(50p)	£7.78
8 over 8 2m. beam	(50p)	£10.37
4 ele. 4m. beam	(50p)	£6.70
18 ele. 70 cm. beam	(50p)	£8.86
46 ele. 70 cm. beam	(50)	£11.88
KW Traps with AT	(50p)	£6.60
KW L.P.F. Filter 520HM	(25p)	£10.26
KW L.P.F. Filter 750HM	(25p)	£10.26
Low Loss Coax 500HM	(35p) yd.	38p
Low Loss Coax 750HM	(35p) yd.	23p
3" Ribbed Insulators	(10p)	20p
AT Insulators (centre T)	(10p)	10p
ML1 100 lb. line approx 300 yds.	(30p)	£1.63
ML4 400 lb. line	(20p)	yd. 4p
KW Ant. Switch 1P 3W	(20p)	£5.40
KW Balun 1:1	(15p)	£2.70
Twin Feeder 300HM	(25p)	yd. 4p
Twin Feeder 300HM 110 yd. drum	(50p)	£3.80

● Midland Agents
for EDDYSTONE, JAY BEAM,
JOSTY KITS, AMTRON KITS

NO C.O.D. PLEASE PRINT YOUR NAME AND ADDRESS. YOU MAY ORDER GOODS BY PHONE AND PAY BY ACCESS OR BARCLAY. Enquiries S.A.E. please. Prices include VAT and are subject to change without notice.



MSI MARKETING SERVICES INTERNATIONAL

(A COOKE INTERNATIONAL ELECTRONICS COMPANY)

MOBILE RADIOS

For the 144 enthusiasts, STORNO QM13C, FM High Band, a bit soiled outside, but clean inside. Single channel, but very easily converted to six. Complete, less control box £8-00, carriage UK £2-00. Photocopy of the circuit details and diagram £1-00 extra if purchased with set. One only BASE STATION, GEC RC700, H/B, FM, Desk top set with GPO type telephone handset. Nearly new 12½ kcs bandwidth, £90-00. Can be installed and crystallised up to channel by our engineers.

CRYSTALS

Limited offer—48-0125 MHz in style K = HC-25/U, made to a very high spec! £1-25, inc. p & p. Note! Third overtone resonates at 144-0375 MHz. Frequency Standards: HC-6/U holder 50 ppm, 1 MHz £2-20, inc. p & p. Ditto 100 Kcs £2-50, inc. p & p. All other frequencies to order. SAE with your enquiry please. Xtal Filters, 10-7 MHz IF 25 Kcs bandwidth, ex-equipment, £1-25, inc. Other filters available to order. Crystals made to order in 4 weeks.

One only, Cossor Marine VHF Radio type No. 124-ME 28. Complete with manual. Second-hand, but good condition. 240v. AC mains. 28 channel. Out of MPT spec.! 50 kcs. wide. Parts alone must be worth £25-00. This equipment is heavy. Buyer collects.

CONSTRUCTORS' CORNER

The following are new components in bags, suitable for most popular transistor radio projects:

Fixed capacitors, various, useful selection	55p per bag, inc. p & p	Tag strips, assorted.	15p per bag, inc. p & p
Tuning capacitors, miniature, 4 in bag	55p " " "	Packets of solder, multicore	5p " " "
Knobs, black, small, silver insert, 6 in bag	50p " " "	Portable cape motors, 12 volt, 2 in bag	55p " " "
Ditto medium, and pointer, 6 in bag	55p " " "	Newmarket transistors, set of 7 for a seven-transistor radio, 2 packets, 14 transistors	25p " " "
Audio output transistors, 10 in a bag, various	55p " " "		
Ferrite rods and slabs, assorted, some long	50p " " "		

WIRE

Self-fluxing enamelled copper wire by BICC, ENFIELD & CONOLLY. Gauges from 26 to 44. List on request. SAE please. Miniature mains cable, grey, PVC covered 3-core 15p metre. Hook up wire 7-0076 PVC covered 10p metre. Single strand 5p.

ODDS

Ex-computer panels containing Transistors, Diodes R's and C's and some having IC's and trim pots as well, 5 boards £1-50, inc. p & p. 45 ohm 5in. loudspeakers, new in makers' boxes, 45p, inc. Large quantity of Plessey .1 µF capacitors 1000v DC/300v AC wkg., also 12 and 15 Pf. 2Kv wkg. Enquiries welcome.

We also have a large stock of television EHT leads with CRT connectors attached. Again enquiries welcome.

New motors 1/20th HP continuously rated as follows. 110v DC £1-50, carriage UK £1-00. 115v AC ditto. 220v DC £2-00 plus carriage. 240v AC £3-00 plus carriage. Fully shrouded four-hole flange fixing. Capacitor start. PLASTIC TOOL RACKS with felt insert to prevent rusting, complete with fixing screws for wall or bench. New in boxes, 25p, inc. p & p.

OUR TERMS ARE C.W.O. Accounts with Colleges etc. by arrangement. Carriage on orders under £1-00—20p unless otherwise stated. DON'T FORGET THE VAT 8 per cent please. Please note, we are SHUT MONDAYS.

ALL CORRESPONDENCE TO
RAMALLA HOUSE, ANCTON LANE, MIDDLETON - ON - SEA, BOGNOR REGIS, SUSSEX, PO22 6NJ
TELEPHONE 024-369 2849

NEW! UNIVERSAL R.F. SPEECH CLIPPER

INCREASES 'TALK POWER' — ELIMINATES 'FLAT TOPPING'

Easy to install — long battery life

- ★ Simply connect in series with your microphone lead. Needs no internal connections to your transmitter. Push-to-talk facilities are retained.
- ★ Can give increased "punch" or "talk-power" comparable to a times-ten power increase, plus improved speech characteristics.
- ★ Ideal for SSB, AM or FM.
- ★ Advanced circuit uses optimised combination of digital and analogue techniques for long-term reliability and stability.
- ★ Seven integrated circuits, one transistor, three diodes.
- ★ Separate calibrated input and output level controls.
- ★ Very long battery life; over 600 hours from one PP9.
- ★ Range of ready-made output leads also available.



£45 + VAT

See August Rad. Comm. for a review of this equipment

DESCRIPTION: The Datong R.F. Clipper brings the unique benefits of rf clipping to any conventional transmitter. It should not be confused with agc-type speech compressors or af clippers. The Datong R.F. Clipper is a complete closed-circuit ssb transmitter and receiver. Amplitude clipping of the internally generated ssb signal (at 60 kHz) greatly increases the average-to-peak

amplitude ratio of the speech input signal. This is achieved without harmonic distortion.

Price, including post and packing, only £45 plus VAT.

Write or phone for full information, including a copy of the installation and operating instructions.

DATONG ELECTRONICS LTD.

11 MOOR PARK AVENUE · LEEDS LS6 4BT · TELEPHONE 0532-755579

TELECOMMUNICATIONS INTERNATIONAL AGENCY LTD.

P.O. BOX No. 4, BROCKENHURST (NEW FOREST), HANTS.

Tel.: Brockenhurst 3434, 3430 & 2219 after 6 p.m. and weekends

PYE PILOT. 3 channel TX and RX (new condition)
£95.00 + carriage

COURIER TRADEMAN. Portapack TX and RX, aircraft band,
5 channel £75.00 inc. carriage

YAESU COUNTER YC355D. 30-200 MHz, needs slight
attention £75.00 + carriage

NEW RADIO TELEPHONES. FM or AM. High, low and
Marine bands. Catalogue on request.

LINER 2. Add on amplifier module comprising of 40 watts PEP
amplifier and preamp for the Rx. Extremely simple to use with
any liner 2, but could be easily adapted for use with any TX RX
requiring more power and better sensitivity.

With RX preamp £47.42, carriage £1.00
Without RX preamp £40.10, carriage £1.00

VALVES

QQVO3 10A	£1.50	ECC 85	40p
ECC 83	30p	EL 85	35p
KT 66	£2.00	EL 33	95p
EAC 91	£1.50	EZ80	25p
ECF 82	38p	ECC 81	22p
EF 91	33p	KT 77	£1.50
EY 84	50p	EL 84	35p
E 80 CF	40p		

BNC free sockets	22p
5 pin type B din plugs	14p
Painton 6 way plugs	12p
5 pin type B din sockets	8p

LOUDSPEAKER. Miniature 1½" 3 ohm. New £1.50, postage 8p
ELAC 5 x 3 at 8 ohm elliptical. New 75p, postage 8p

HAND SETS. New SG Brown handsets £4.94, carriage 65p

HAND PORTABLES. Cossor type CC2/8 Mk. 2. V.H.F. Walkie
Talkies. High Band. FM £60.00 + carriage

TRANSISTORS

PT 4176D 44w.	£3.00	AF 239	20p
PT 4176C 20w.	£2.23	OC 60	10p
PT 4176B 10w.	67p	OC 44	10p
PT 4176A 3w.	45p	OC 75	15p
2N 4427 5w.	67p	OC 35	25p
2N 3866	48p	OC 200	10p
ME 1001	18p	1N 91	25p
2N 5180	48p	V 100	85p
2N 2369A	15p	ACY 22	14p
BF 115	15p	ACY 20	10p
BSX 26	10p	OA 200	4p
BC 108	10p	AC 128	8p
OA 10	15p	OA 47	6p
ASZ 21	25p	OAZ 200	30p
OAZ 207	30p	CA 3011	92p

Carriage on transistors, 5p

NEW STUD UHF POWER DEVICES

TIA 6B 400 MHz 1 watt output	70p, carriage 5p
TIA 7B 400 MHz 9 watt output	£3.67, carriage 5p

MC MURDO RED RANGE

24 way plugs	40p
32 way plugs	50p
32 way sockets	50p
F. & E. plugs	45p
12v. 2.2 lamps MCC 643	10 for 10p

ULTRA FM & AM BASE STATION. 12½ kHz type approved in
extremely good condition. In working order, complete with
desk controller £66.00, carriage £1.00

NEW MURPHY PSU stabilised 12.5v. DC at 2.5 amps, chassis
only £9.00, carriage 45p

XTAL OVENS. Cathodeon 68p, carriage 5p

RELAYS. Aerial changeover 12v. DC £1.00, carriage 10p

RELAYS. Mains contact heavy duty 2v. coil 75p, carriage 10p

COSSOR MOTORBIKE UNITS (II). Lowband, incomplete.
Callers only £20.00 the lot

DESK MICROPHONE kits including 200 ohm insert
£1.80, carriage 20p

SGB CLASSIC. Ultra modern base or mobile microphone
dynamic £7.00, carriage 20p

SBG BASE MICROPHONE with stand £5.50, carriage 20p

NEW MURPHY PSU stabilised 12.5v. DC at 10 amps.
£29.95, carriage 45p

RELAYS. 24v. Octal 2 P 2W 45p, carriage 5p

OCTAL PLUGS for microphones, power units or speakers 23p

SG BROWN MICROPHONE. Stowage units. New
45p, carriage 5p

SG BROWN. Fist microphone Dynamic 300 ohms
£4.50, carriage 10p

SG BROWN DIPLOMAT. 300 ohms or 22 ohms head set, and
300 ohms or 22 ohms microphone £7.50, carriage 20p

SG BROWN DIPLOMAT head set. 22 ohms complete with
din plug £5.00 each, carriage 20p

VOLUME CONTROL BOX with jack socket 150 ohm 50p each

PBX OPERATORS PACIFIC HEAD SETS. 150 ohms,
microphone 3 k ohms. Complete with earpiece assembly kit
£7.50 each

STEREO HEADSET. 8 ohms £5.00

POWER CONTROLLER/DIMMER SWITCH complete
5 amps 75p each

6 WAY LEDEX SWITCHES. 4 pole, 12v. 50p each

DUE TO REORGANISATION, WE HAVE A SELECTION OF
VARIOUS COMPONENTS FOR SALE AT A VERY LOW PRICE.
SUITABLE FOR THE AMATEUR MARKET. CALLERS ONLY
AT ADDRESS BELOW.

ALL PRICES EXCLUDE VAT

SUBJECT TO EQUIPMENT BEING UNSOLD

Telecommunications International Agency Ltd.
Brockenhurst Studios
Fibbards Road
Brockenhurst
Hants.

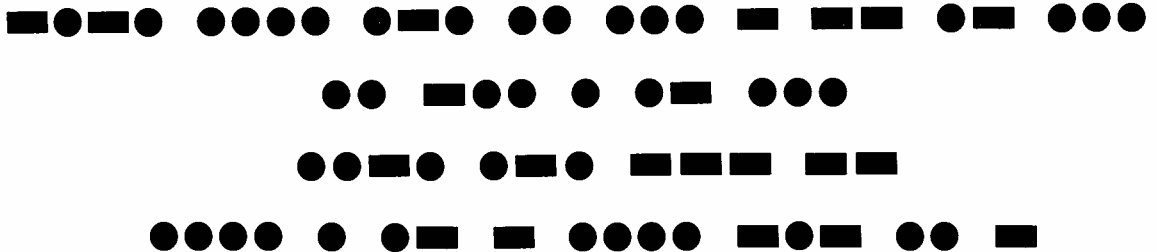

If you're wondering what you'd like from your wife or friends for Christmas. Or wondering what to give as presents yourself. We hope these suggestions will be of some help.

Please remember to order as soon as possible though, to be sure of getting your Heathkit equipment in time.

HEATH
Schlumberger

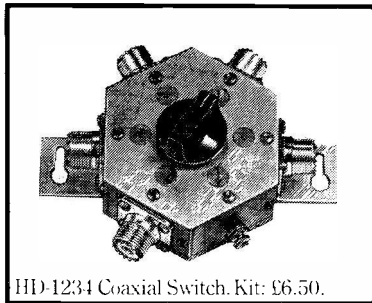

HD-1234 Coaxial Switch. Kit: £6.50.

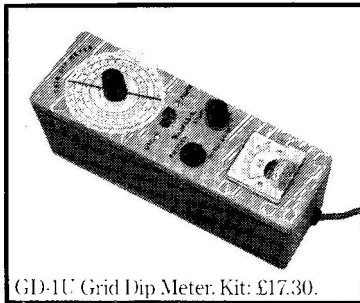

GD-1U Grid Dip Meter. Kit: £17.30.



HN-31 'Antenna' Transmitter Dummy Load. Kit: £8.10.

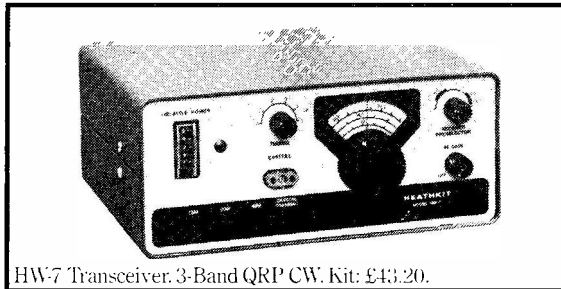

HW-7 Transceiver. 3-Band QRP CW. Kit: £43.20.

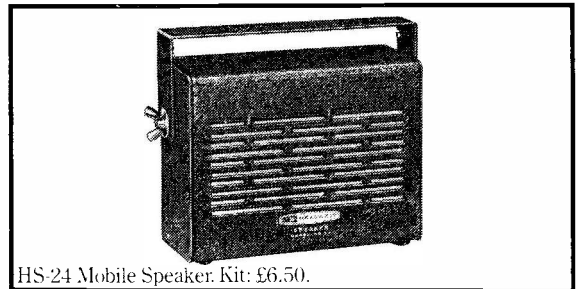

HS-24 Mobile Speaker. Kit: £6.50.

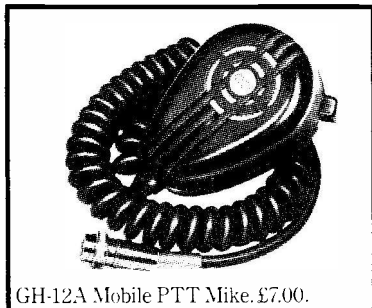

GH-12A Mobile PTT Mike. £7.00.



HD-10 Solid-State Electronic Keyer. Kit: £27.00.

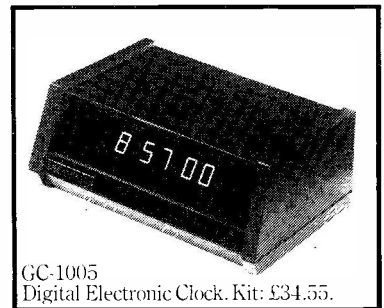

GC-1005 Digital Electronic Clock. Kit: £34.55.

All prices inclusive of VAT at 8%, and delivery within UK.

Heath (Gloucester) Limited, Dept SW-114, Bristol Road, Gloucester, GL2 6EE. Tel: (0452) 29451.

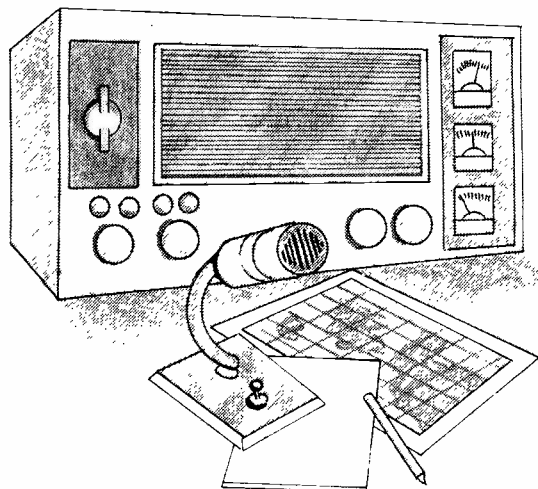

Become a radio amateur.

Learn how to become a radio-amateur in contact with the whole world. We give skilled preparation for the G.P.O. licence.

WAA

Free!

Brochure, without obligation to:

BRITISH NATIONAL RADIO & ELECTRONICS SCHOOL, Dept SWR 11/74
P.O.Box 156, Jersey, Channel Islands.

NAME _____

ADDRESS _____

(Block caps please)

TELFORD COMMUNICATIONS

TC10 "MULTIMODE" 2 METRE Tx

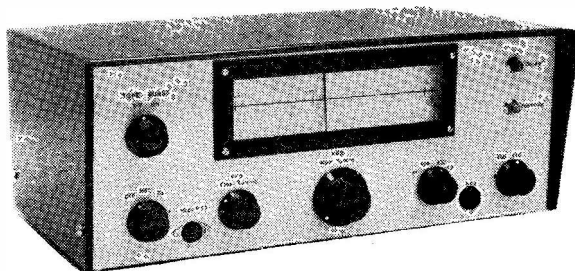

PRICE £140.40 DELIVERY 4-5 WEEKS

All modes with full 2 MHz. coverage from high stability VFO. Modular construction, mains or DC operation. Repeater tone burst on F3 Mode. One Xtal Channel, on 144.20 for A3J calling.

SPECIAL OFFER—SPECIAL OFFER—SPECIAL OFFER—SPECIAL OFFER

For the remainder of 1974 we are offering our TC9/TC7/G8AEV Converter, a complete 2-metre station package, including band-searching facility on the TC7, for the absolutely unrepeatable price of **£140.00** VAT inclusive.

Also available either ex-stock or short delivery :

TC5 2 watt Tx **£37.80**, TC6 Companion VFO **£32.40**

As reviewed by RSGB in September "Radcom" 2-metre Bandpass Aerial Filter **£5.89**. Handles up to 10 watts of RF. Why pay more ?

Lots of items and Modules are available separately, including our Solid State Aerial Changeover Relay (0.8dB I.L. at 23 cms. with 28dB isolation) **£4.50**.

All prices include VAT at 8%. Securicor delivery of larger items **£4.32** extra. HP terms available. We have full and free data on all our products which is yours for the asking. Please do. Call in here to see the gear, or, for a demo in the London area, ring **REG VINCENT ON HODDESDON 64285 (EVENINGS ONLY)**.

73 AND GOOD DX G8ARS

TELFORD COMMUNICATIONS

78B HIGH STREET, BRIDGNORTH, WV16 4DS, SALOP. Telephone 074-62 4082

SHORT WAVE MAGAZINE

ADVERTISERS' INDEX

	Page
Aero & General Supplies ...	509
Amateur Electronics (G3FIK) ...	457, 474, 503
The Amateur Radio Shop, G4MH (Huddersfield) ...	512
Antec ...	506
Ashley Dukes (Honda) ...	507
B. Bamber Electronics <i>back cover,</i>	507
J. Birkett ...	515
British National Radio School	472
C. & C. Electronics ...	508
Data Publications ...	503
Datong Electronics Ltd. ...	469
Derwent Radio ...	511
Doram Electronics Ltd ...	458, 459
Eley Electronics ...	507
G3HSC (Rhythm Morse Courses) ...	507
G3LLL Holdings ...	511
G.W.M. Radio ...	510
Hamgear Electronics ...	504
Heath (Gloucester) Ltd. ...	471
D. P. Hobbs Ltd. ...	509
Home Radio ...	513
K.W. Communications Ltd. <i>inside front cover</i>	466, 467, 504
Low Electronics ...	466, 467, 504
Marketing Services Inter- national ...	469
S. May (Leicester) Ltd. ...	509
Microwave Modules Ltd. ...	460
Mosley Electronics ...	468
Mulhall Electronics ...	514
North West Electrics ...	508
Partridge Electronics Ltd. ...	505
P.M. Electronic Services ...	509
Radio Shack Ltd. ...	461
R. T. & I. Electronics Ltd. ...	513
Small Advertisements ...	507-512
Solid State Modules ...	506
Southern Surplus Merchants South Midland Construction Ltd. ... <i>inside back cover,</i>	516
Spacemark Ltd. ...	505
S.S.B. Products ...	512
Stephens-James Ltd. ...	502
S.W.M. Publications ...	501, 514
Telecommunications Inter- national Agency Ltd. ...	470
Telford Communications ...	472
T.M.P. Electronic Supplies ...	506
J. & A. Tweedy Ltd. ...	512
Waters & Stanton Electronics ...	474
Reg Ward & Co. Ltd. ...	514
Western Electronics Ltd. ...	462, 463, 464, 465
W. H. Westlake ...	510
Chas. H. Young Ltd. ...	468

(GB3SWM)

Vol. XXXII

NOVEMBER, 1974

No. 373

CONTENTS

	Page
Editorial—Facts ...	475
Communication and DX News , by E. P. Essery, G3KFE ...	476
British Isles Counties List ...	478
Ten Watts for Ten Metres , by F. G. Rayer, G3OGR ...	480
Low-Noise Preamplifier for 70 Centimetres , by C. Bartram, G4DGU ...	484
Linear Amplifier for the HF Bands, Part II , by E. P. Essery, G3KFE ...	486
Improved Change-Over System , by R. S. Harris, G3BWZ ...	489
"SWL"—Listener Feature , by Justin Cooper ...	490
VHF Bands , by A. H. Dormer, G3DAH ...	494
The Month with The Clubs—From Reports ...	497

Managing Editor: AUSTIN FORSYTH, O.B.E. (G6FO/G3SWM)

Advertising: Charles Forsyth

Published at 55 Victoria Street, London, SW1H-0HF, on the last Friday of the month, dated the month following. Telephone: 01-222 5341 & 5342

Annual Subscription: *Home: £3.75, 12 issues, post paid
Overseas: £3.75 (\$10.00 U.S.), post free surface mail*

Editorial Address: **Short Wave Magazine**, BUCKINGHAM, MK18 1RQ.
England

Prices shown in advertising in this issue do not necessarily constitute a contract and may be subject to change.

AUTHORS' MSS

Articles submitted for Editorial consideration must be typed double-spaced with wide margins on one side only of quarto or foolscap sheets. Photographs should be lightly identified in pencil on the back with details on a separate sheet. All drawings and diagrams should also be shown separately, and tables of values prepared in accordance with our normal setting convention—see any issue. Payment is made for all material used, and it is a condition of acceptance that full copyright passes to the Short Wave Magazine, Ltd., on publication.

© Short Wave Magazine Ltd.

B. & O. E. VAT Reg. No. 239 4864 25

473

Waters & Stanton Electronics

MFJ (USA)

"THE BEST CW FILTER AVAILABLE!"

LATEST CW2-BX

The Filter the
Top DX-ers
are using
in U.S.A.

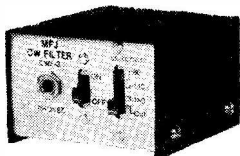

Suits all
Receivers and
Transceivers

£13 ex VAT

Look at these features:—

- ★ Razor sharp selectivity from any receiver or transceiver.
- ★ The weakest of signals stand out on their own.
- ★ No audible ringing.
- ★ QRM completely disappears (even on 40 metres).
- ★ Better than any xtal filter.
- ★ Ultra modern active filter design using IC's.
- ★ No insertion loss—actually a small gain.
- ★ Self powered from PP3 battery.
- ★ Simply plug into headphone socket.
- ★ Bandwidth 80 Hz, 110 Hz, 180 Hz (switch selectable).

SEND FOR DETAILS TODAY!

ATTRACTIVE H.P. TERMS

BARCLAYCARD

ACCESS

POSTAGE EXTRA—EXCESS REFUNDED

UNLESS STATED PRICES INCLUDE 8% VAT

Telephone (03 704) 6835

HOCKLEY AUDIO CENTRE . 22 SPA ROAD . HOCKLEY . ESSEX

Hours of Business : 9.00-5.30 MONDAY TO SATURDAY EARLY CLOSING WEDNESDAY

SWAN
ELECTRONICS

A subsidiary of Cubic Corporation

Imported by us direct from California

	Prices ex. VAT
700CX transceiver 80-10m., 700w. p.e.p. ...	£325.00
700CX/SS16 transceiver, 80-10m. ...	£369.00
230X A.C. p.s.u. ...	£56.00
230XC A.C. p.s.u./speaker ...	£79.00
508 remote vfo ...	£99.00
VX-2 Vox unit ...	£23.00
MB80A 160w. solid state 12v. transceiver ...	£174.00
2015 A.C. p.s.u. ...	£32.00

MINI-PRODUCTS (U.S.A.) MINI-BEAMS S.A.E. for gen.	
HQ-1 ...	£54.00
B24 ...	£42.12
C4 vertical ...	£24.00
TRIO LATEST QR666 Receiver ...	£140.40
LINER-2, 2m. SSB transceiver ...	£142.56
SHURE MICROPHONES, 444 ...	£14.00
201 ...	£6.00
J-BEAM ANTENNAS. S.A.E. for catalogue.	
G-WHIPS ALL MODELS. S.A.E. for catalogue.	
ROTATORS, AR30 ...	£25.00
AR40 ...	£30.00
CD44 ...	£60.00
	(all + VAT)

MICROWAVE MODULES. Full range.	
SOLID STATE MODULES. All models.	
SECOND-HAND, Yaesu Sig. 200 2m. transceiver ...	£169.00
... P.s.u. ...	£15.00
Weir 2 metre converter, 28-30 IF ...	£10.00

AMATEUR ELECTRONICS UK

BIRMINGHAM 021-327 1497 021-327 6313



Are pleased to present the new

PLANET 808

SPEECH PROCESSOR

THIS UNIQUE UNIT OFFERS A PERFORMANCE COMPARABLE TO THAT FOUND IN THE BEST RF SPEECH COMPRESSORS AND A BRIEF SPECIFICATION IS GIVEN BELOW:

Input Resistance	— 1 M ohm
Gain	— 2000 max.
Compression Ratio	— 100 : 1 max.
Output Voltage	— 1.5v. p.p. max.
Frequency Response	— 3 dB at 300 Hz and 3.3 kHz
Current Drain	— 3 mA (typ.) D.C. input

Complete immunity from overmodulation.
May be operated from either crystal or dynamic microphone.
Handsome appearance and sturdy construction.

Price: £29.90

(PLUS VAT OF £2.39 AND P/P 75p)

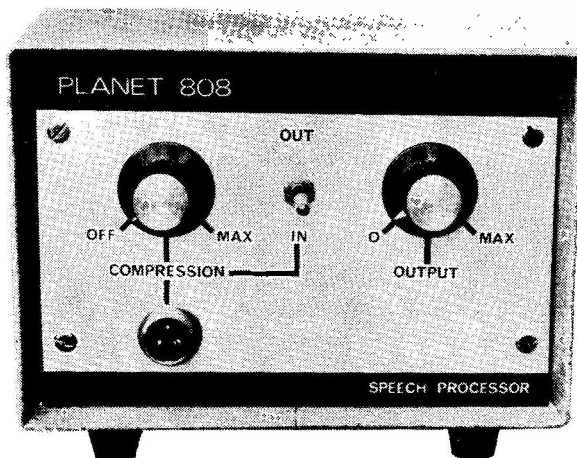

DELIVERY EARLY DECEMBER

WE SHALL BE DEMONSTRATING THIS UNIT AT GRANBY HALLS, LEICESTER

ELECTRON HOUSE, 508-514 ALUM ROCK ROAD, BIRMINGHAM 8

The SHORT WAVE Magazine

E D I T O R I A L

Facts

Readers will hardly fail to have noticed some changes in the general appearance of recent issues of *SHORT WAVE MAGAZINE*.

For instance, October looked smaller but in fact carried four more pages of editorial matter (text) than in August. Not only that, but because of the smaller type-face now being used for the regular features, it was possible to take in more technical matter than in earlier issues this year, while the area of the printed page has remained unchanged throughout.

Why, then, the apparent smaller size? The answers are simple (when you know them!)—by trimming margins all round, we are able (a) to run the extra four pages, while (b) keeping within the 4 oz. weight limit for posting. The difference in postage between just-under 4 oz. and just-over is 2p per copy second-class and 3½p first class! Multiplying this by several 1,000 copies per month, and again by twelve for the “year of twelve issues,” and we see a saving on postal copies alone running into four figures. Furthermore, the cost of general distribution is likewise reduced—meaning the parcels of varying sizes and quantities going out all over the U.K. to newsagents, through whom most of our circulation is achieved—because copies individually “weigh lighter.”

This all comes under the heading of economical management and careful business control. Readers are only affected insofar as they are now getting a copy carrying more pages of the same type area that we have always used. Thus, there has been no diminution that matters in size and the “reading area” has actually been increased.

We can guess that it will not be long before other periodicals will also be finding this way of meeting the staggering cost of postal distribution.

* * * *

Congratulations

To Professor Sir Martin Ryle, Kt., FRS, the Astronomer Royal, on the great distinction of the award of a Nobel Prize for Physics, announced on October 15. As readers may remember who have noticed our various references to him over the years, Martin Ryle is also G3CY. The writer of this piece had the good fortune—during the years of Hitler’s War—to collaborate with him on the problem of radio-countermeasures (RCM), meaning the electronic protection of the Bomber Force against the German night-fighter defences. It is in the record that RCM played a part in the winning of the electronic war.

Austin Forsyth
G6FO

COMMUNICATION and DX NEWS

E. P. Essery, G3KFE

PERHAPS the most noticeable factor about the past month has been the weather! During the ten days prior to this piece being started, approximately one third of the expected annual rainfall has fallen, much of that in two large slices with a steady old fall in between to "keep the pot boiling," as it were. To understand G3KFE's "articulate displeasure it has to be realised that in order to "restore normal service" on the LF bands, it is needful first to get the ladder at the tree, climb up it to the fork, haul the ladder up behind one, sit it with the base nicely in the fork with an inch to spare either side, and then climb to the second storey before commencing operations with cord and insulators—can anyone explain why wet bark is so darned slippery?

Top Band

A minor difficulty with the Counties/Administrative areas play on October 1 is the position with regard to the Scottish counties, which will be brought into regions on April 1, 1975. The 1975 layout, as shown in the *Geographia* County Map, British Isles, cuts slightly across our plans.

The Scottish Regions are, broadly, as follows, if we neglect Orkney and Shetland: *Western Isles*, covering Barra, South Uist, Benbecula, North Uist, Harris-Lewis; *Highlands Region* taking in Caithness, Sutherland, Ross and Cromarty, Inverness, Nairn, Argyll (North of Loch Linnhe and the Sound of Mull), Argyll (Ballachulish, Kinlochleven and Glen Coe), Banff (area south of Glenlivet), Moray (south of Dava); *North-East Region*, covering Aberdeen, Kincardine, the rest of Moray and the rest of Banff; *East Region*, including Perthshire north and east of a line running Tyndrum to Killin, northwards up the east bank of Loch Tay to about half-way, turning south to cross L. Earn, just west of Ben Vorlich, across to the junction of Stirling, Clackmannan and Perthshire, round Clacks but excluding a tiny bit of Perth now taken into Central Region; Angus, Kinross, Fife north of a line Leslie-Markinch and running round north of Largo to the sea west of Earlsferry; *Central Region*, rest of Perthshire, Clackmannan, and the northern part of Stirling, running north of Strathblane, Campsie Fells, across to the northern extremity of the enclave bit of Dunbarton. Part of the *West Region* constitutes the area we are going to call the Inner Isles, but the mainland portion includes the rest of Argyll, Bute—less Arran Isle, most of Ayrshire with the exception of the southerly part included in the S.W. Region; *South-West Region*, which embraces Wigtown, Kirkcudbright, Dumfries and the bit of Ayrshire south of a curved line from the sea north of Girvan, Carrick and across to the little kink in Kirkcudbright near Merrick. *South-East Region* covers the rest of Fife, West Lothian, Mid-Lothian north and west of the Moorfoot Hills, and East Lothian; and the *Border Region* which is Peebles, Berwick, Selkirk Roxburgh and the rump of Mid-Lothian. This leaves us only yet to define our "Inner Isles" which we do as being Arran and those islands in Argyll jurisdiction at the moment—broadly Tiree, Coll, Mull, Colonsay, Jura, and—oh, yes, of course—Skerryvore lighthouse!

You will need a good map to follow all this through—in addition to the *Geographia* map mentioned, the *Geographers A-Z* is a useful one.

As for the rest, the full tabulation of the administrative areas/counties and islands will be found on p. 478. We strongly recommend, if you intend to play, that the *Geographia* map mentioned be used as a reference—it is quite a handy one to put up on the shack wall.

Turning now to the reports, we have more in hand for One-Sixty than we have seen for a long time. G3ORP (Maidstone) found ZB2CJ, better-known perhaps to readers as G3ATU, letting it be known that he was setting up shop for Top Band CW working; a quick whistle down the garden at Maidstone turned the Windom into a T-top Marconi, and back to tune up everything still left time for ZB2CJ to be hooked on his second CQ and the latter's first U.K. contact this trip. OK1ATP and DLIFF also got into the ZB2 set within moments. Another one noted by G3ORP was PZ1BC, attracting much attention from W4, W8 and PY's but not raised, while PY1RO often peaked 599 around 2330-2359z. GDY of note were GM3PFQ and GM3LWS worked on the T-aerial with enormous signals but sudden dips from empty-over S9 to S5 every few minutes.

Also from G3ORP comes a note on the Hi-Fix beacon situation as seen from his part of the world. He has Hi-Fix stations on 1801.3, 1802.6, 1803, 1804.3, 1806.1, 1807 and 1809 kHz and suggests that W's looking for U.K. contacts would probably improve their reply-atio by avoiding those points and getting in between S7 and the S9 + 20

of the commercial CW on 1807 kHz.

A first report on activity with our new game comes in from G4AKY (Shirley, Croydon) who so far has ticked up 17 points by means of six contacts on CW and five on SSB—a nice mix indeed. Other news of interest from Dave is that 4X4NJ will be on the 160m. band during the CQ WW Contest in a few months—one presumes, the Top Band contest, not the all-band affair—and that the "EA3DA" noted on 160 metres turned out to be a pirate. G4AKY himself has made WAC on Top Band already, but one of the required cards is still outstanding.

G2HKU (Sheppey) mentions his CW contact with GM3PFQ, plus SSB to GM4ASY and PA0PN. Ted also notes the sad news that GM3FXM, one of the very active Top Band operators, died on September 29.

In a letter on other matters, G8PG (Wirral) mentions that, thanks to the U.K. and OK support, the DL's have decided that Top Band will be included, from 1975, in both the summer and winter DL AG CW contest.

G2BJY (Walsall) used his CW on the band, and reports contacts over 150 miles, including EI2BB, G2AOF down in Gosport, G3ZPN up in Hull, G3WZP, G3YMC/A, G15UR (Belfast) GM3EVB in Inverness and GM3KNX (Coatbridge, Lanark). Bear in mind that G2BJY has only the space for a relatively tiny bit of wire on the one hand, and that on the other most of those contacts will have been made in the mornings and are therefore, strictly, daylight QSO's. It is proof of the value of CW for the chap who finds he hardly gets out of his backyard on Phone.

WIBB now: First, he enclosed with his letter a picture of the aerial array at W2WLN/2 during the 1973-1974 seasons, from the USCG Centre, Wildwood, N.J. There is a 130ft. of vertical, in the way of a guyed lattice tower, and below it a total of 120 radials, each all of 300 feet long, with the whole shebang down at the seashore. Inside the shack one finds the equipment is Drake R-4C and T-4XB, and the operators W2WLN, WA2SRQ and WA3FFR.

Turning to WIBB's *Bulletin*, we mentioned the dates for the Trans-Atlantic Test (p.416, October) and now we have the full set-up for these and also the Trans-Pacific efforts. They are, this year to be basically *First-Timers'* Tests, and on both sides, T/B operators are asked to concentrate on the first-timers and help to pull them across. The dates are November 17, December 22, January 12 and February 9 and the times daily are 0500-0730z, with W's in the 1800-1805 kHz segment, the others in general 1825-1830 kHz. Turning to the Trans-Pacific series, these are for November 16, December 21, January 11 and February 8, 1330 to 1600z; frequencies, W/VE as already noted, ZL's on 1875, VK's 1800-1805, JA's 1907.5 to 1912.5 and KH6 1996 to 2000 kHz; anyone not mentioned will be either all-same W's,



Among those at this year's very successful Mobile Rally at Derby were, left to right, G4BUX, G3HQH and GW3RGE. We are told that what '4BUX and '3RGE are holding is a cup of refreshment, not goblets from the prize draw!

Running Collins gear for all bands 10 to 80m. is John Kline, K9UTN, 3302 Nottingham Way, Madison, Wisconsin 53713, U.S.A. Outside, there is a multi-band beam and he also has, on the bench, one of those elegant semi-automatic keys for working CW.



or in the area Europeans use around 1825 kHz. For both series, the W/VE's call *CQ FT* for the first 3 minutes of each 15-minute period, then listen for replies from this side for 12 minutes, calls from this side, or, of course QSO's. Repeat for each fifteen-minute period—and before you start, for Pete's sake, set your clock, watch, or whatever accurately, so that no unnecessary QRM arises through stations both sides calling at once.

For December 1, 0900-1300, the Verulam Club are offering a Top Band contest. Basically, you work at one point a contact, the only exception being that it is ten points for working G3VER. Log to include date, time, callign, RST and serial numbers both ways (001 onwards) 1974 county (or country if outside U.K.) with certificates for all entries and endorsements for winners and runners-up, both Tx and SWL. For all the rest of the doings on this effort, get in touch with Hugh Young, G3YHY, 93 Leaford Crescent, Watford WD2-5JQ, to whom also the logs are to go, postmarked not later than December 16, 1974.

Eighty Metres

Now, masters, here you have "Ham" Radio warts and all, as well as quite a lot of good snappy operating and the odd ragchew session—but still your conductor must admit to some feelings of trepidation in actually using the band! Nevertheless, people do, and they get much fun out of it, even nattering up and down the country—and, after all, that is what it is all about.

A very long letter came in from G2BON (Aldridge) which ended "73, Very Penitently." Don't know what Tom worries about—for your scribe, part of the fun of producing this offering is in deciphering letters where the language has burnt a hole in the paper and making them into material for the company to read without losing their point. In this case, the G2BON comment regarding Eighty—and we must go along with him—is connected with the number of clots who use SSB with speech clippers. Not only a bad practice in itself unless the clipping is done by translation to RF and back again (as explained by G8ENN in the October issue)—but, having got clippers, then proceeding to maladjust the clipper and the associated rig. The result resembles an electronic banyan tree (spreads every-blooming-where!) and G2BON reserves a special space in the Hot Place for the departed spirits of these operators, where Satan superheats the furnaces! And, he seems to add, will some kind person project some of them there in advance of their time, for the good of all! Motion carried, only one dissenting—the LID!

Nice to hear from G2FUX (Ringwood) again after a long while. Frank is in to mention the RAOTA Net, 3740 kHz, 1000z, officially on the first Thursday of each month, and informally on the other Thursdays; so far over 36 members and prospective members have clocked in, ranging from G2DX, first licensed in 1912, right to the new chaps who had their first ticket in 1948.

An interesting letter from G4DHF (Sheffield) fills in some of the details of the GB3HFA station during late September. For once, quite apart from the success in terms of QSO's—200 of them on 3.5 MHz and another hundred on VHF SSB—one feels the real success lay in their appreciation, both as individuals on the stand and as a group, that the prime function of an exhibition station is to communicate with the public, even more than to give contacts or enjoy a bit of /A operating. The more we can do in these events to present to the public not just a station full of expensive gear, but static exhibits of home-built cheap-and-cheerful rigs of interest to the

schoolboy and those who are put off at first by the shiny commercial expensive-looking gear—the better it will be for the image of Amateur Radio, QSO's where the stations ragchew rather than rubber-stamp and, above all, for operators to leave the rig and explain to onlookers what it's all about, and how we have licences and tests, and why "hams" in the papers are usually what we call pirates—why then, the better the chance we have of getting our point of view, on TVI or interference, planning permission, or whatever, over to those we want to convince. Looks as though the Grimsby lads tried consciously to do just that.

G2NJ (Peterborough) is still at the QRP business, and records interesting contacts with G4AYS near Burton-on-Trent, who uses a 1T4 as a CO into DL93 PA at 600 milliwatts input; G3CEL of Manchester was also a 579 signal to G2NJ at two watts input.

If you want to work YU, try 2100z January 11 to 2100z January 12, the YU DX Contest. Basically, it's the usual RST plus serial to start at 001. Score one for your own country, two for same continent, five for different continent, and ten for YU contacts. Multiplier to be the sum of the DXCC countries worked, including your own, and each YU prefix worked. Lots of awards and trophies to make it all more interesting. Logs to show date, time GMT, call sign worked, exchange both ways, country or YU prefix (if being claimed for a multiplier) and points scored. Summary sheet with signed declaration that the station has been operated in accordance with local rules, contest rules, and the "Ham Spirit." Logs postmarked before March 15, to YU-DX Club SRJ, P.O. Box 48, 11000 Belgrade, Yugoslavia. And don't forget to indicate your duplicate QSO's!

Lots of interesting points in the letter from G2BY (Ventnor, I.o.W.) not least the P.S. that on the day he posted to us he worked ZL4AC, a station first heard, as NZ-4AC, in December 1925! G2BY has all the modern SSB stuff at hand, but still finds it more fun, after starting in spark days, to paddle along with the Vibroplex. Interestingly enough, his aerials for Top Band and Eighty are all inside the loft-space, while the HF bands are covered by a 14-AVQ on a twenty-foot pole. As he is 500 feet above sea level, it may be imagined G2BY gets out quite well. He used to write in to this piece when it was conducted by the late G6QB.

G2BJY (Walsall) gives us our surprise for the month—Geoff has been using SSB! Nothing particularly DX'y, but interesting nonetheless, in the shape of E15CTC (the Curragh Training Camp), G13GRD Enniskillen, GM3JHI/A Kircudbrightshire (hope we spelt that right!) and G3RAF/A at Biggin Hill. As for the CW, there were OK30SNP and UT5GS.

Looking at the QRP side again, G8PG writes to note we seemed to have omitted G3DNF from the results (on p.419, October), Gordon having made third place against some pretty tough competition in that DL AGCW Contest. As a note of his own doings on Eighty QRP, G8PG so far has 19 countries worked with two watts input on Eighty.

Leapover continues to fascinate G2HKU, his HP1 cell "prime mover" now being down to 10.9 volts; nonetheless it was good enough to work F2DD/P, GI2DZG, SM4ZNV, SP4HEO, SP9EPY and UA3RH.

Forty Metres

G2BY might be an old-timer in the real sense of the word, but there is no loss of the vital knack. His ground-plane set-up was activated most days between 0730 and 0845 clock, and during

September this resulted in CW QSO's with 30 VK stations, 18 ZL's, LU, W7 and FO8EG. Oddly enough, although he believes there are some 70 amateurs on the Island, many of his contacts say G2BY is their "first Isle of Wight QSO"—so he wonders what the others are doing.

G3ORP got around to the delta-matching idea with his tower, mentioned last time—and now has the coax connection right near the top and fed through a variable capacitor to give a VSWR of better than 1.5 to 1. This makes a very handy aerial on Forty, particularly to South America although the houses nearby seem to soak up some of the RF in other directions. However, the main thing is that under fading conditions he can now go from the VS1AA coax-fed device to the vertical, or the other way, and use whichever one gives the best results for the propagation conditions of the moment. Thinking farther ahead, ideas are evolving for a loaded trapped vertical covering Top Band, Eighty and Forty, using very high-Q toroidal ferrite or powdered-iron traps. The VS1AA arrangement accounted for K2DNW, W9SZR/3, W3UC, W4BJE, W5AB, W3AU, W3NZ and EA3JJ, but the vertical was better when he worked PY1CMT, YV5CET, PY7YH, CX1AAC, PY1EHC and CX4CR; for KP4UW, both aeriels were level-pegging, and for VU2IN once again the VS1AA arrangement proved best. As for times, all were CW, and all between 2355z and about 0140z.

After the rush of CW and QRP on Eighty, G2HKU decided to restore the balance by sticking to SSB on Forty; this yielded, with 90 watts p.e.p. input, contacts with HK3LT, PJ2CW, YV3AGT, YV4YC and ZL3PK.

What about Twenty?

Well, *what* about it? A Very Good Question. It is said that this is where the hell-for-leather, dyed-in-the-wool DX'ers hang out and woe betide the innocent who tries his hand here first—but even G3KFE has been known to work new countries on the band, so it can't be all that fierce!

G2BON, as well as other things, tore up your conductor's argument about bandwidth in the phone context last time by pointing out how much narrower still was the CW signal even at high speeds; he added fuel to the argument by implying that soon SSB will be as dead as the dodo—it'll all be slow-scan and then what will we old SSB fossils do? To which your scribe simply says *Grrrr!* But Tom still works the stuff, and he connected with CT2BG, 9M2AP, F6CPO/FC, IH9MCP (Pantelleria), IG9BWO (Lampudusa), UK6LAZ, A7XA, 9Y4MP, HI8EJH and PY8MM (on AM with 500 watts to a two-element Quad which gave RS57 both ways), UJ8BQ, VO1LP, ZS6WV, VU2MKZ, UK9SAB and FL80M/AM at 9.500ft. over the Med. Thus, since July 1972 the score runs 123 countries worked and 95 confirmed. All the time operating time appears to have been early-morning through to tea-time at the latest—no night-owling for G2BON.

G5IU/P was known as WA2TLQ elsewhere, but is now QRP from the Scillies, running two watts on Twenty CW, netting him 26 countries so far, among them UB5LI, OH, FOAVG/FC, DM, UA9JH, OK, SVOWTT, YO9, WA1, W2, W3, W4, LU, CT1UM, VE1ASP, LZ, LA7, KV4AA, IC8, and loads of Europeans—all with the two w.a.t.s feeding into a dipole. David likes it there; less QRM than in the States and now even has ideas of making it permanent. We wonder if he has yet come across our old pal "Andy the Light," a near neighbour and of course better known on the air as G3UUZ.

Quite out of the blue, a letter came in from Alan Johns, who was once G3UKP, then 9J2KP and now holds a 7Q7 call which he doesn't even mention in his letter. Alan still has his 90 watts to a ground-plane, but finds QSO's to the U.K. rather difficult, partly due to terrain at his location, but more so due to the power-lines which beset him on three sides, giving noise levels up to S9 plus and never less than S3 to S4; however to the South, East, and West, he gets out well, with his eighty watts p.e.p. A new country worked by accident amused your conductor—it was, believe it or not another 7Q7, raised at a range of three miles when the transmitter was running about ten watts input to the *dummy load!* This was while checking the beam patterns and apparently establishing that all U.K. contacts were being made by means of reflection from Ndrriande Mountain—this at HF! What it boils down to is that to work by any conventional means the radiated and received signals have to reach the angle of almost 45° to clear local obstructions.

Right at the last moment a letter came in from G4CXM, who is now in Bristol doing a course on Industrial Electronics, and hopes to be active from there by the time we reach print, thanks to an understanding landlady—who doesn't yet know what she has been let in for! However, a few odd contacts were made from the Paignton home-station, notably CW with EA8BF and 9H1CH, with SSB

accounting for OD5MD, ZD3U (using an HQ1 mini-beam), MID, YB3AP, KP4EAX/HI8, ZB2FX, PY7VBN, YV6DU, KV4AD, WA7EQL, VE7SV, VE7CAM, VS5MC and 9M2CJ.

As usual, says G3UZ (Goring-by-Sea), more DX has been heard than worked. Notwithstanding this modesty, we notice that the old el-bug managed to wrinkle him out 9M2DW, 9M8HG, 9H1CH 9H1BM, 9H1DV, PY5CFX, PY1BN, PY7APS, PY6HA, PT2DW/5, SV1SAK, SV1SV, PY7AFA, SUIIM, UW0WY, VU2GW, VK3MR, YV5BFQ and XE1FL; odd ones noted were KX8BCF in Ohio, CX3EXD and VP2MSO.

G2BJY found some entertainment on Twenty in hooking the odd

MAINLAND COUNTIES & ADMINISTRATIVE AREAS

ENGLISH COUNTIES

Avon
Berkshire
Buckinghamshire
Cambridgeshire
Cheshire
Cleveland
Cornwall
Cumbria
Devon
Dorset
Durham
East Sussex
Essex
Gloucestershire
Greater London
Greater Manchester
Hampshire
Hereford & Worcester
Hertfordshire
Humberside
Kent
Lancashire
Leicestershire
Lincolnshire
Merseyside
Norfolk
Northamptonshire
Northumberland
North Yorkshire
Oxford
Salop
Somerset
South Yorkshire
Staffordshire
Suffolk
Surrey
Tyne & Wear
Warwickshire
West Midlands
West Sussex
West Yorkshire
Wiltshire

NORTHERN IRELAND

Antrim
Armagh
Down
Fermanagh
 Londonderry
Tyrone

WELSH COUNTIES

Clwyd
Dyfed
Gwent
Gwynedd
Mid-Glamorgan

Powys
South Glamorgan
West Glamorgan

SCOTTISH REGIONS

Borders
Central Region
East Region
Highlands
North-East Region
South-East Region
South-West Region
West Region
(Effective April 1975)

THE ISLANDS

Alderney
Caldy
Fair Isle
Guernsey
Holy Island
Inner Hebrides
Isle of Man
Isle of Wight
Jersey
Lundy
Orkneys
Outer Hebrides
Sark
Scilly Is.
Shetlands

IRELAND (EIRE)

Carlow
Cavan
Clare
Cork
Donegal
Dublin
Galway
Kerry
Kildare
Kilkenny
Laoighis
Leitrim
Limerick
Louth
Mayo
Meath
Monaghan
Offaly
Roscommon & Sligo
Tipperary
Waterford
West Meath
Wexford
Wicklow

Notes: Above is the full list of Counties and Administrative Areas to score for the SHORT WAVE MAGAZINE Top Band Ladder, from October to September 1, 1975.

Scoring: One point for each county or area worked on SSB—two pts. for each worked on CW or RTTY—and three for AM contacts. There are 42 counties in England, six in Northern Ireland, eight Welsh counties and eight Scottish Regions. In addition, the Islands to score total 15, and there are 25 counties in Eire—making a grand total of 104 scoring targets.

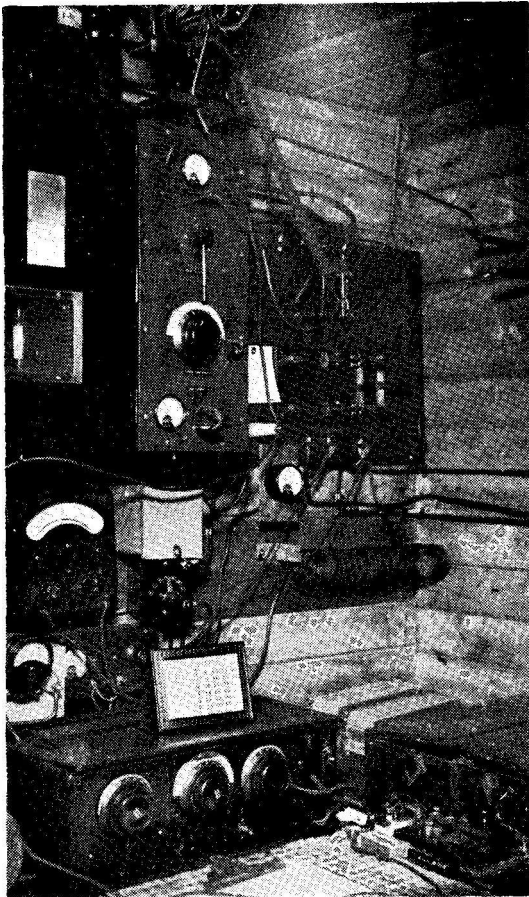

Going back a bit—to 1935-'37, in fact, when this was the station signing GWVB (a ship call) out in the Antarctic, operated by Ian Meiklejohn, now of Castle Steps, Baynards Cove, Dartmouth, Devon—his other calls were ZHY (as a shore station) and VP8C on the amateur bands. The Tx was a 250-watt job and the receiver a modified Eddystone "Kilodyne Four," a design that will be well remembered by many old timers. All this was nearly 40 years ago—and there are still VP8's in the Antarctic.

prefixes from various places, and ended up with a fine crop; four of the "DM25—" variety, the IZ2 and IZ3 prefixes, a brace of IS0, LA1K, LB1D, half-a-dozen LZ30 types, OH0AL, OH1AA, UD6BN, UG6GAJ, UH8HBF, UL7EAP, UL7JAC, UL7WH, UM8MAD, UA9LU, UA9MFM, UK9MBA, UK9WAA, SK4DM, SK7DO, SV1RT, SV1SAK and a jolly collection of W's to fill out. As Geoff says, an interesting collection of prefixes—soon it'll put one in the "rare" status if one is on the air with a normal call!

G2HKU notes that one of his contacts was with 4X4CJ, off the air for three years with illness and a broken leg, but now back in business with new Heathkit gear, and sending 73 to all old friends as a reminder. As for Ted himself, other than 4X4CJ, SSB contacts were made with SM4CGA/YV5 and ZL4FB. CW on the other hand went out to UI8IF, ZL1VN and ZL1AXM.

Points From The Post

This QRP business must be really biting; WB8OWM (Canton, Ohio) writes one of his rare cards to mention that he has sold his 75-watt machinery, and now runs an HW-7. Skip wonders whether "linears are legal in U.K.," he having seen so many photographs and adverts for them. It all depends what you mean by legal! Nothing to stop you having a ten-kilowatt job so long as you either run it

at the 600-watt peak input level, or obtain the 400-watt output level using a scope in the manner defined in the regulations. If you over-do it with your Big Boots then it isn't legal any more!

G2HKU comments on your scribe's statement about professional amateurs not really wanting to come home and start again unless they need something unobtainable off the shelf. He asks, bitterly, is there anything in the world quite so perverse as an average colour TV set? And, as if this were not enough, the "hopeful" voltage points given on the average service sheet?

G4CXM also sounds a trifle bitter—but in his case it is at the thought of having to get back to work after three months holiday! Old 'KFE would like the chance to take three months off, let alone actually doing so!

GD3ZND/EI2BB asks that we pass on the message that it is best, if you want a QSL direct from an EI station, *not* to send an s.a.e. with U.K. stamps as these are not valid in EI, and since they too have a postal increase coming up, it will cost them 5p to send a card direct, or if in an envelope, 7p. So, if you want an EI QSL direct, either get some EI stamps for your envelope or use some of those IRC's.

Back to the matter of DX. All those elusive VS6 types are about to come out of hiding. Look for them on the bands between 0900z, December 7 and 0900z, December 8—as many VS6's as possibly can will be active during that period.

Interesting letter next, from G3MHF (Eastbourne) who mentions that he had a QSO with RAEM, just prior to the latter's death in December 1971. Naturally, when that distinguished Russian amateur's passing was reported, hope of a QSL faded. However, in April, G3MHF happened to be in Moscow, and actually managed to get into Box 88 where all those millions of Russian-bound QSL cards are addressed. He was given a warm and friendly welcome, and was able among other things to see the gear used by RAEM during his Polar expedition in 1937-8. To cap it, a few months later, he got a registered letter from Moscow, containing an RAEM QSL card confirming the QSO and signed by Theodor Krenkel, RAEM's son. G3MHF says that other amateurs going to Moscow may care also to visit Box 88; Mrs. Vera Sviridova, who is in charge, would be pleased to show them round the Bureau and the museum there. Box 88 is in the Central Radio Club Hq. on the outskirts of Moscow, and can be reached by phone. To get directions as to how to reach Box 88, the phone number is Moscow 491-02-64.

An article in the Australian *Amateur Radio* tells something of life on Willis Island. A tiny blob about 13 acres in total, corrosion seems to be the main problem. Thus balun windings on the Quad lasted a month before repair and rescaling became necessary, and about a fortnight before the end of VK9ZC's six-month stay, the Quad 21 MHz loop collapsed, due again to corrosion. Willis is about 280 miles ENE of Cairns, and for entertainment for the small Met. staff, Kevin had aerials up for both Townsville and Cairns TV stations—by studying the radiosonde plot, they could usually predict whether there would be any TV viewing that night! Eventually, they got up to an average five evenings weekly by using a rhombic stack with a 200 foot axis to give a theoretical 24 dB gain at 200 MHz. As for papers and mail, a delivery once every three months or so—and even then the supply plane could drop it all in the water!

Ten and Fifteen

Here we have a situation quite unprecedented in the history of this piece—nobody reports on 21 MHz DX'ing! However, let us look into the ten-metre situation first; G2BJY has an indoor folded dipole and thirty watts of CW, which he tried during a recent SLP, to give the local listeners a break. To his surprise he worked EA8BK, JY9GR and SM0CHH, and heard CR6AL, LU3EX, LU6EF, OH1MD, three more SM's and ZS6AX—this the last weekend in September.

G4CXM also reports that his odd looks at 28 MHz were quite surprisingly profitable; he found opening to South and North America, Africa and the odd European, although the only station actually worked was 9J2DT on SSB for a new one.

As for 21 MHz the absence of correspondence is quite unusual; it is not that there hasn't been the odd item of interest about, such as, (CW) JY9GR, KG6JAR, M1C, SU1MI, YS1MV, 5T5DY and 7P8AB or, on SSB, CR4BS, OH0NI, ZD9GD, 4S7AN, 4W1GM and 5T5DY again. Doubtless, it'll be all 21 MHz reports next month!

Signing

There again it is, although we have a pile of QSL addresses and suchlike to hold over till next time, for which the deadline will be November 7 latest, and if possible a little ahead of that date, addressed as ever to "CDXN," *SHORT WAVE MAGAZINE, BUCKINGHAM, MK18-1RQ.*

TEN WATTS FOR TEN METRES

QRP Tx ON 28 MHz

F. C. RAYER, T.Eng. (CEI),
A.I.E.R.E. (G3OGR)

THIS unit runs 10 watts of AM on the 28 MHz band. Ten metres offers a wide frequency area compared, as example, with the 200 kHz of Top Band (1.8-2.0 MHz) and tuning across Ten often produces not much except a wide segment of silence. Advocates of the "use or lose" doctrine say this should not be so, but neglect and silence fosters even more disuse. For DX, the band is now rather in the doldrums, though when it peaks up there are plenty of opportunities for thousand-mile QSO's with a few watts of AM. However, when 10m. is used for local QSO's, by ground wave, these have a wonderful background of silence, compared with Top Band. In fact, because of the lack of activity, crystal control seems to be quite a practical approach. The transmitter described here offers an extremely easy way to get on 10m. The constructional work is quite straightforward and should not take long.

Using Ten

Signals originating from gear running a few watts are likely to be swamped or ignored on 20, 40 and 80m. On 160 metres, 10w. is of course the limit, so the operator must do his best with this, or perhaps use SSB or CW for the advantages they confer over AM. On 15m. occasional long-distance contacts are possible without much power, but even this band is often "closed" or, if only low power is available, gives the impression of trying to crack a coconut with a paper clip. With all this in mind, it is nevertheless possible to use the silent spaces of Ten for low power, local contacts.

The frequency means that not much space is needed for a $\frac{1}{2}$ -wave dipole. This will need only two insulators, a centre insulator or piece to anchor feeder and elements, plus feeder, some 18wg. or similar wire, and cords. The top can be cut to 16 $\frac{1}{2}$ ft. and this span should be possible in most localities, especially as for this purpose the wire can be at any convenient angle. For the feeder, 75 ohm coaxial cable is suggested, as it plugs directly into the present transmitter.

Another point is that the usual communications receiver will cover the 10m. band, so no converter is necessary, as when going on 4m. or some other VHF band. In general, all this adds up to the fact that it should be an easy matter to become active on Ten metres.

Transmitting Circuit

Fig. 1 is the whole circuit. With one or two crystals, it will be unlikely that a clear channel will not be found, and in local-net working others will know where to listen.

V1 uses 7 MHz or 14 MHz band crystals, and is a familiar arrangement where the anode can be tuned to a harmonic of the crystal frequency. With a 14 MHz band crystal, this gives twice the crystal frequency. For 7 MHz, anode tuning is times four the crystal frequency. Any crystal for 7 MHz or 14 MHz will come out on Ten metres.

VR1 allows the output of this stage to be adjusted, so as to set grid current for the following stage. For normal

settings of VR1 (that is, with 2 $\frac{1}{2}$ mA or so of grid current obtained) this has no apparent effect on the crystal-controlled oscillator function of this stage.

The required 28 MHz signal is tuned by L1 and T1. The adjacent coil L2 is similarly tuned by T2. L2 is centre-tapped, so that neutralising can be applied by T3. When adjustment is correct here, anode tuning has little effect on grid current.

VC1, with VC2/2 and L3, form a π -tank, suitable for a 75-ohm and similar loads. The output is of course quite free from any drift or spurious signals.

PA Stage

The 5763 has a maximum rating of 50 mA at 300v. at 50 MHz (15 watts), so if an alternative supply is used, this should not be exceeded. For the power supply (to be) described, input is kept to about 10 watts, as more than this is beyond the capacity of the supply and modulator. The 5763 works well on 70 MHz, and gives a good account of itself on the lower frequency of 28 MHz. It does not seem too critical of grid current, some 2 mA to 3 mA or so being satisfactory.

Metering

To avoid any need to wind shunts, the meter is a small 0-10 volt instrument. With it switched to read grid current, it is in parallel with R5, which is 1,000 ohms. The voltage drop across R5 is thus 1v. for each 1 mA of grid current (ignoring that taken by the meter). The range is thus 0-10 mA, and a reading of 2-3 on the scale will be approximately 2 mA to 3 mA.

With the switch at X-Y, the meter is across R7, which is 100 ohms. Current is then 10 mA per 1v., so the instrument reads 0-100 mA. At 30 mA, R7 results in a loss of only 3v. for the anode. With 5% resistors, both ranges are sufficiently accurate.

Other systems could of course be used if preferred. A 5 mA meter directly across R5 would give grid current indication. R7 is then a low-value shunt, selected to provide a range of 0-50 mA or 0-100 mA on the meter. The value of the shunt is: $R_m \div (N-1)$ where R_m is the resistance of the meter itself, and N the number of times the scale is to be multiplied (20, if a 5 mA instrument is to read up to 100 mA).

The meter switch must be a break-before-make type, or the HT will be shorted.

Table of Values

Fig. 1. Circuit of the Ten-Metre Tx

C1 = 10 μ F, s/m	VC2, VC3 = 365 μ F, BC type var.
C2 = 100 μ F, s/m	R1 = 100,000 ohms, $\frac{1}{2}$ w.
C3, C4,	R2 = 33,000 ohms, 1w.
C10, C11 = -01 μ F, disc cer., 350v.	R3 = 2,700 ohms, 3w.
C5 = 0.1 μ F, 350v.	R4 = 22,000 ohms, $\frac{1}{2}$ w.
C6 = 250 μ F, s/m	R5 = 1,000 ohms, $\frac{1}{2}$ w.
C7, C8,	R6 = 10,000 ohms, 1w.
C9 = -002 μ F, 750v.	R7 = 100 ohms, 1w.
T1 = 50 μ F trimmer to 1 kV	VR1 = 50K w/wound linear pot.
T2 = 25 μ F trimmer	RFC1,
T3 = 10 μ F tub. trimmer for neut'ing	RFC2 = Denco RFC.5, or similar RF choke
VC1 = 75 μ F, var., 600v. type	V1, V2 = 5763

Notes: B9A skirted holders for V1, V2. Meter 0-10v., or 0-5 mA shunted (see text). Crystals as required (see text) and holder. Switch 2-pole 2-way make-before-break. Chassis 9 x 4 x 2in. (Home Radio.)

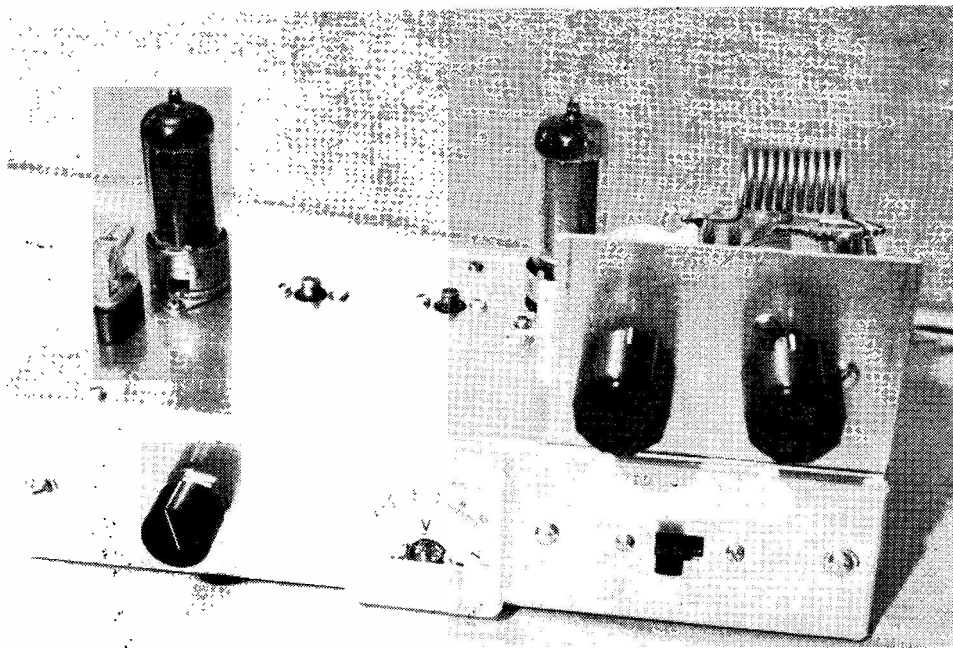

Front view of the ten-metre Tx, showing controls (left to right) for drive adjust VR1, PA tune VC1, aerial load VC2/VC3, with meter switched to read 0-10 mA grid and 0-100 mA PA current.

Chassis

The unit could be accommodated in any case which is $9 \times 6 \times 4$ inches, or larger inside, using the layout shown in Fig. 2. For equipment of this kind, a case is not essential. Its main function would be to box in the RF

circuitry, if required. Reasonable modifications to the layout should not prove to raise difficulties.

The unit shown is built on a "universal chassis" which consists of flanged sides and a flat plate for the top, and the use of an extra side provides a ready-made screen to

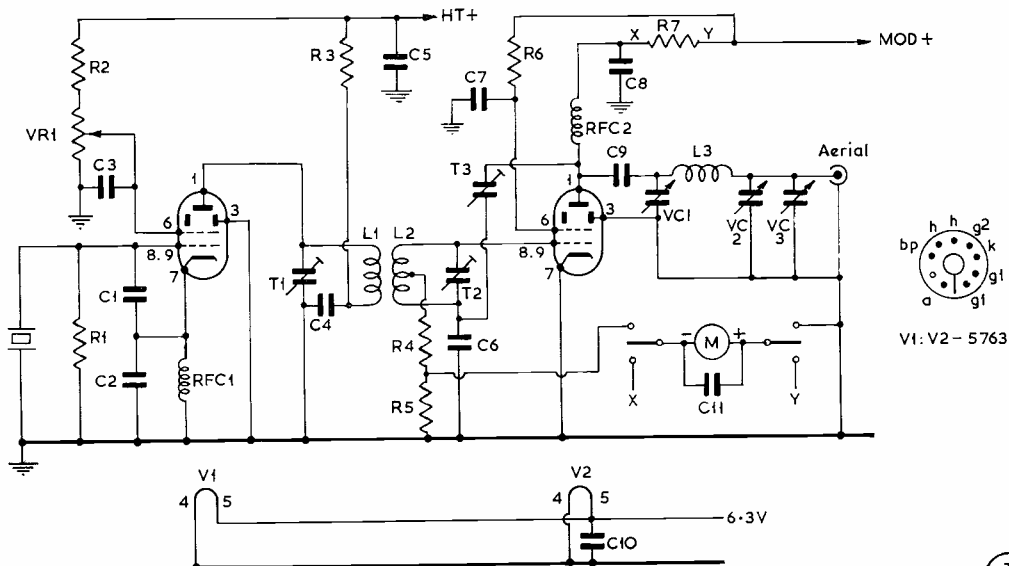
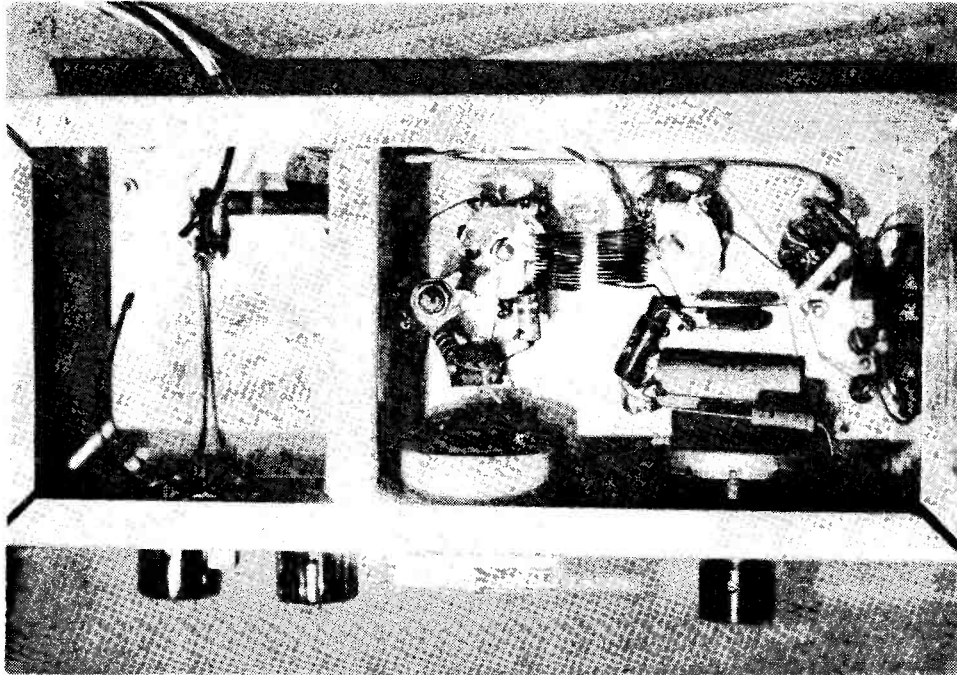

Fig.1 CIRCUIT OF THE 10 WATT 10 METRE TRANSMITTER





Under-chassis view of the QRP transmitter for 28 MHz described in the article. The crystal-oscillator compartment is at right, showing placement of L1, L2—compare drawing Fig. 2 for location of other components.

go across under the PA valveholder. This is cut away only so far as is necessary, and the holder is fixed with tags, as shown in Fig. 2. Drill holes for the meter, heater and neutralising capacitor leads in advance.

The positions of other holes will be seen in Fig. 2. VC1 and VC2/3 are mounted on a bracket cut from a spare flanged side. VC1 needs to be 25pF or larger, and should have 600v. spacing. VC2/3 can be a single or

ganged component, with a total of 250pF or greater, and can be a normally spaced BC type.

T1 is grounded to the chassis (to avoid HT on the spindle) but T2 is insulated from the chassis. This is so with the type of trimmer having two dead bushes for 6 BA bolts.

All connections should be stout, short and direct round the tuned circuits and PA holder. In some places

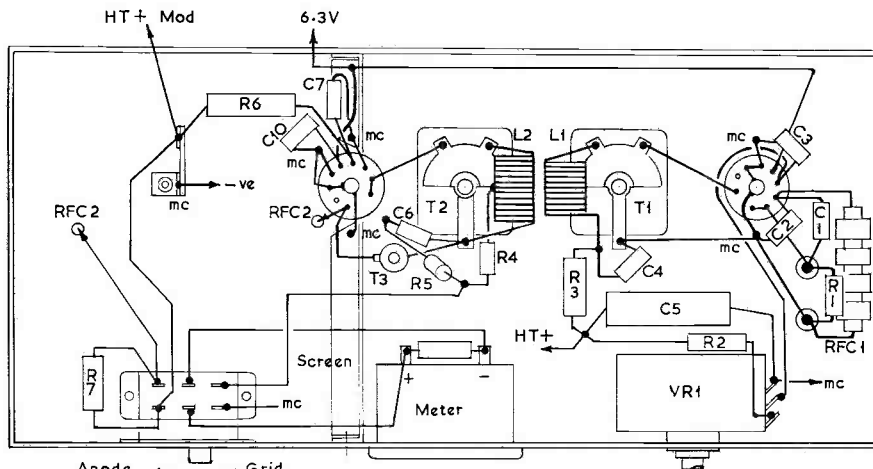
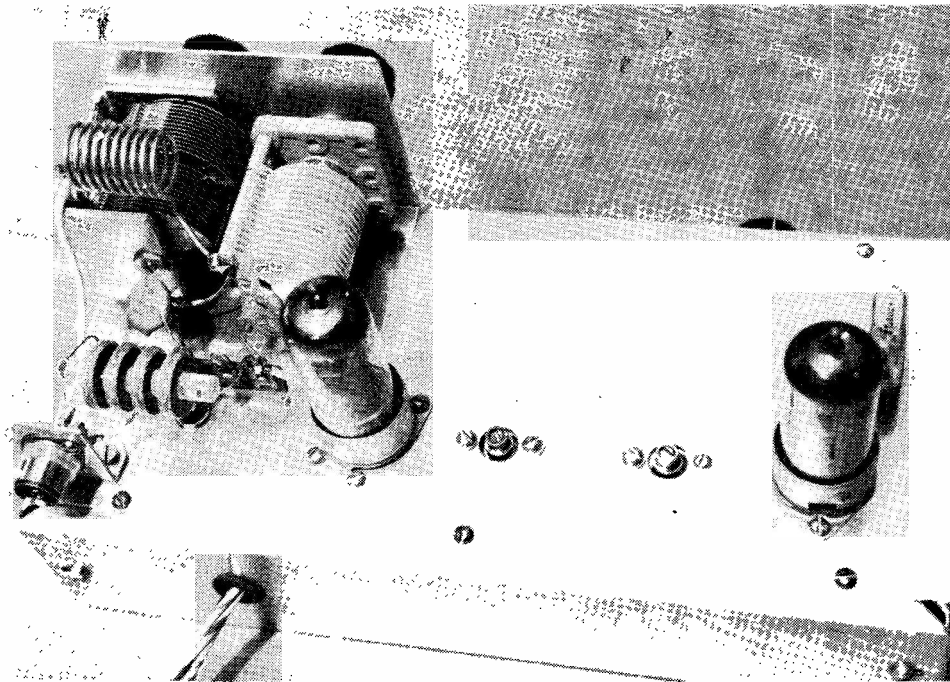

Fig. 2 WIRING AND COMPONENTS UNDER CHASSIS



Half-rear view of upper-chassis layout, with PA assembly at left. The CO valve is at right, with the crystal holder, and slots of trimmers T1, T2 in line with the valves.

tag strips are used to support components.

One tag of the neutralising capacitor is joined to T2. A lead from the other tag passes through a hole in the screen about level with it, and to V2 anode tag. From here, a lead runs through the chassis to RFC2, this and associated items being on top of the chassis. If final adjustments are made with HT on, remember this when setting T3.

Upperside wiring is also kept short, with direct chassis returns for the variable capacitors. The coaxial socket is bolted to a small bracket formed for the purpose.

L1 and L2 are wound with 24g. wire, and are $\frac{1}{2}$ in. outside diameter. L1 has 13 turns, spaced over $\frac{1}{2}$ in. L2 is of 14 turns, and is $\frac{5}{8}$ in. long. When winding L2, form a loop at the centre, to which R4 is soldered. If these winding details are followed fairly closely, there should be no need to prune or adjust L1 or L2. They are placed about $\frac{1}{8}$ in. apart.

L3, the tank coil, is wound with 18g. wire, and has seven turns. It is $\frac{7}{8}$ in. long and has an outside diameter of $1\frac{1}{4}$ in. Resonance in the 28 MHz band should be obtained with VC1 only slightly closed.

A 4-core cord is required for chassis, heater, HT positive, and modulated HT circuits. Cans are not fitted to the valves.

Trimming

With whatever PSU is in use, provide means to remove HT from V2. With the meter switched to grid current,

T1 and T2 are peaked for maximum indication. With a 14 MHz band crystal it is unlikely a wrong harmonic can be reached, but it is as well to make a check with a wave-meter, and this should certainly be done with a lower frequency crystal. With a 260v. HT supply, grid current was around 4 mA with 14 MHz crystals, and $2\frac{1}{2}$ mA with 7 MHz crystals, depending somewhat on the exact distance between L1 and L2. The aim is to secure maximum grid current, turning back VR1 to reduce this. The settings of T1 and T2 interact slightly.

Neutralising

The PA does not "take off" without this, but adjustments to VC1 cause quite wide changes in grid current. As the neutralisation was not found to be very critical, it can be done with no HT on V2.

With VC2/3 about half open and a 75-ohm load connected, swinging VC1 should produce a *small* dip in grid current at resonance. (This can be more easily seen if a larger test-meter is temporarily clipped across R5.) T3 is adjusted, with an insulated tool, until this small dip has almost or completely vanished. The measured capacitance of T3 when the circuit is neutralised was 8pF. (Note this depends also on the value of C6.) With neutralising correct, there is little change in grid current, with V2 operating, when VC1 is adjusted.

Working

The frequency which will be in use can be found on the receiver by applying HT to V1 only. An artificial

load for modulation or other tests can be a domestic lamp, or carbon resistors to total about 75-100 ohms or so and dissipate the expected wattage.

TVI Points

Interference with the reception of TV or other programmes depends so much on local circumstances that it is only possible to comment upon what was actually found in those conditions under which the Tx has been used. The transmitter was operated directly into a 10m. dipole (which is a relatively poor radiator of even harmonics). This dipole was about 25ft. distant from Band I and Band III TV aeriels, and about 10ft. distant from the loop aerial of a Band III portable. No interference at all was heard or seen at any time on the Band III receivers,

on any channel.

With the older Band I receiver, reception on Ch. 4 was not marred, but it was possible to upset vision severely or obtain the Tx signal on sound, by deliberately tuning off the channel, to the Tx 2nd harmonic. All items were on the same house mains circuit.

When the Tx was built it was hoped that three 28 MHz tuned circuits would keep 2nd harmonics to negligible proportions, but a 2nd harmonic at a level of a few milliwatts can be detected. It is thus wise to remember this is the equipment is used in proximity to a TV receiver using channels near twice the Tx frequency. It may be found that one crystal is clear, but another not, and if so the clear frequencies should be marked for future use.

LOW-NOISE PREAMPLIFIER FOR 70 CENTIMETRES

USING THE BFR90

C. BARTRAM (G4DGU)

THE ready availability of transistors capable of very low-noise performance at 432 MHz and above has created a demand for suitable circuitry. The circuit described here is in use at G4DGU with excellent results. With typical BFR90's a noise factor of less than 3 dB with a gain of about 15 dB should be obtainable. Although the BFR90 is relatively expensive (about £3.50 from *Burns Electronics*), it should be possible to build the complete preamp. for less than £4.50 and improve the performance of all but the very best 70 cm. converter.

Simple microstripline techniques are employed in the RF circuitry—see Fig. 1. After passing through a blocking capacitor, C1, the 50-ohm source impedance is transformed to the transistor input impedance in the network C2, L1, C3. Another, similar, network, C4, L2, C5, transforms the output impedance of the device back to 50 ohms.

DC supplies are taken via RFC1 and R3. The device

DC conditions at 3 mA and 5v. are optimum for noise performance.

The bias network may seem unfamiliar, but it does enable the emitter to be grounded directly, very important at this frequency, and provides excellent DC stability. Zener stabilisation protects the device both from over-voltages and reverse polarity connection.

An FX1115 ferrite bead is wound with six turns of 34g. enamelled wire to make the RF choke. The writer has found this technique very successful; the absence of spurious resonances helping stability considerably.

Table of Values

Fig. 1. Circuit of the 432 MHz Preamp.

C1, C6 = .001 μ F min. disc ceramic	Ft2 = 300 μ F feed thru ceramic
C2, C3, C5 = 10-40 μ F min. ceramic trimmer	R1 = 680 ohms
C4 = 4.7-20 μ F min. ceramic trimmer	R2 = 3,900 ohms
C7 = .01 μ F min. disc ceramic	R3, R4 = 1,000 ohms
	R5 = 220 ohms
	RFC1 = see text
	D1 = BZY88, 9V1
	L1, L2 = see Fig. 2
	Tr1 = BFR90

Ft1,

Notes: Essential requirements are a FX1115 ferrite bead (see text), copper laminate board 16th-inch, and two single-hole BNC sockets.

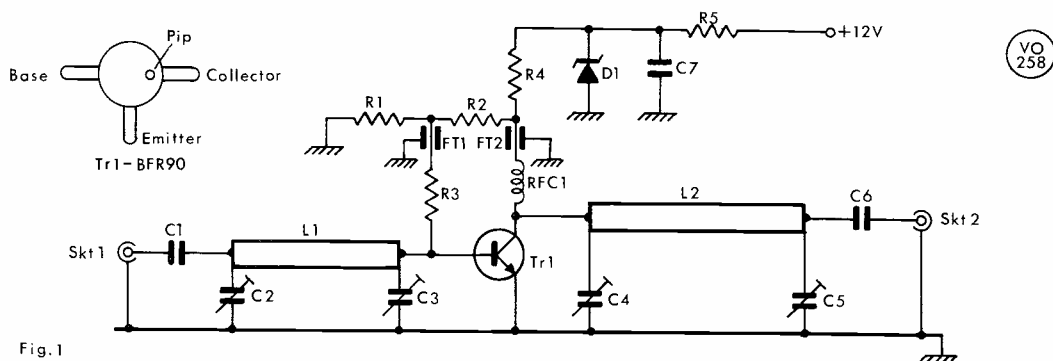

Fig. 1

Fig. 1. Circuit of the Preamplifier

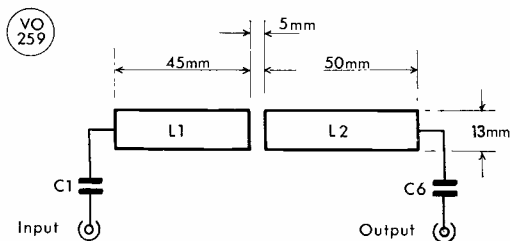

Fig. 2

Fig. 2. Micro-stripline dimensions

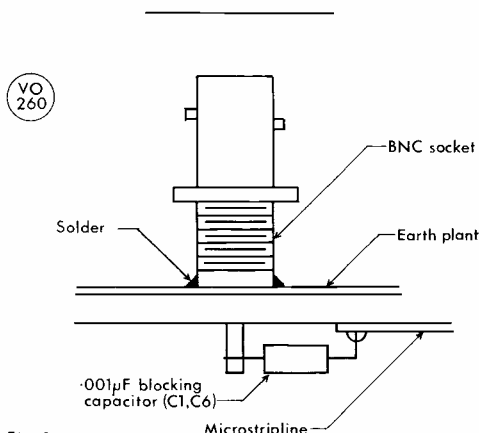

Fig. 3

Fig. 3. BNC socket mounting detail

Construction

Construction *must* be on 1.6 mm. ($\frac{1}{16}$ in.), double-sided, glassfibre, copper laminate board. This normally has a permittivity of about 5; the circuit should, however, work with boards of permittivities from about 4.5 to 5.5. Prior to etching one side is masked-off completely. This will be the earth-plane for the microstriplines (*see* Fig. 2) and the mounting for the BNC sockets, trimmers and feed through capacitors. The reverse has the lines drawn on it in the etch-resist. (The author used a Dalo pen and ruler to achieve a neat finish.) Single-hole fixing BNC sockets are modified by carefully removing the p.t.f.e. insulation from around the solder-spill to flush with the metal of the socket. This enables the socket to be soldered directly to the earth-plane, thus reducing losses due to the impedance "bumps" caused by odd lengths of connecting cable. At 432 MHz, BNC connectors are very much to be preferred to the TV type or so-called UHF connectors.

The trimmer capacitors are miniature ceramic units currently available from several sources. The use of such high values may seem rather alarming at first but, apart from providing the correct impedance match, they help

maintain stability. The trimmers are soldered directly to the earth-plane side of the board by their stator tags using minimum lead length, whilst the rotor contacts are soldered to the lines on the far side of the board *via* 1.5 mm. holes countersunk on the earth-plane side.

Other capacitors may be used, but, it should be borne in mind that physically large components can introduce excessive stray reactances, upsetting the transformations of the impedance matching networks.

Although designed for 50-ohm systems the matching networks will retune to accept 75-ohm inputs and outputs.

Setting Up

Tune-up is simple: Connect the preamp. to the converter, plug in the aerial, and peak the output for maximum noise from the BFR90. Tune in a weak AM phone station and adjust the input circuit for best signal-to-noise ratio. Should signs of instability be noticed, try shunting the collector choke with a small carbon resistor of a few hundred ohms, selecting the highest value that gives stability.

A word of warning! Putting a high gain preamp. in front of a converter perhaps already possessing two RF stages is a sure way of causing all sorts of strong signal intermodulation and cross-modulation problems! Some consideration should be given to, perhaps, bypassing an existing RF stage or using some sort of attenuator, although the latter would at least partially negate the benefits of the preamp.

Modern transistors, along with the rapid spread of SSB, are beginning to demonstrate the potential of our 432 MHz allocation. It is hoped that this design will help stimulate activity on what is truly "the gentleman's band."



Seen at the Derby Mobile Rally were Richard Butterfield, G3VYB (left) and Richard Porter, G3VXK. They are the principals in the well-known firm of Microwave Modules.

LINEAR AMPLIFIER FOR THE HF BANDS

PSU CIRCUITRY AND CONSTRUCTION —SETTING UP THE LINEAR— TESTING

Part II

E. P. ESSERY, G3KFE

CARRYING on from Part I of this article, concluded on p.428 of the October issue of *SHORT WAVE MAGAZINE*, we come now to the Power Supply Unit, circuit as in Fig. 2 herewith.

While it is totally uncritical as to layout, everything must be arranged to leave adequate air-gap between any point at high voltage and any earthy point. The latter of course is not just the chassis, but includes such things as the cores and cases of the transformers, the lamp-holder, and any other bit which is DC-connected to ground. To enable the computer-grade electrolytics used in the 900-volt line to be fixed to something and yet be above earth, they were all built up on a sheet of perspex which was then stood off the chassis on stand-off pillars.

Circuit points are not many on the PSU; the use of the high-voltage winding in bridge presupposes that the transformer used is man enough to stand having its centre-tap on the secondary connected other than to earth; this should be the case with any decent unit, but beware of any uncased transformer that appears to have come out of a radio or TV, as these often don't have an adequate margin of insulation. Also, using the transformer in bridge means that the reverse voltage on the diodes is reduced—connected as shown, the diodes should be pretty well immune to surges on the mains, but as extra protection a varistor was added; it could be left out if difficult to obtain. The mains lamp in the primary circuit is there for the benefit of both the diodes and the electrolytics on the high-voltage supplies—in the "tune" position the lamp is in circuit and reduces the current surge from the mains when the unit is first switched on from cold. As S1, or its equivalent in the linear, also S1, is open-circuit when the station is at "receive" this simple precaution prevents the electrolytics being damaged by surge currents.

Testing

This equipment is both high-voltage and high-power; therefore treat it with respect. First, on completion, the whole PSU should be carefully inspected for dry joints, or long-drawn "tails" on any soldered connections, which latter could give rise to corona troubles. Then, go right over the whole thing with meter on the ohms range, or buzzer, and satisfy yourself the wiring, point-to-point, is exactly what the circuit says it should be, and that diodes and electrolytics are wired in right way round.

Now, set S1 open, S3 open, *no* output connector to Linear, bulb fitted at ML1, and switch S2 "on," when the lamp should light up instantly and then die down to a dull glow. If nothing happens instantly, and no noises

are heard, leave the PSU on for a few minutes, observing its behaviour the while, and pray that nothing smells. Then switch off, going round after switch-off cautiously feeling for signs of undue warmth in any parts, investigating them as needed.

The next step is to switch on the power supply again and note that once again the lamp flashes bright and then dims. Now close the "tune" switch—this is the operating condition—and let it run. Measure voltages, with an assistant at hand to switch off the mains at S2 instantly if anything should go wrong—you don't have time to put the AVO down if you have put your finger on the EHT! Now let the supply run for an hour or more, listening for any of those odd noises which might indicate something breaking down, or voltages flashing over or brushing. If there are any, switch off and investigate. If none, you may now set to work and make up a connecting lead to connect your PSU to the Linear proper. This should be made with due respect for the high voltages, and if a different connector from the one in the original is used, spare pins may be utilised to carry some parallel heater wires to cut down the voltage drop in the connecting lead. In any case, the heater leads and the earth lead should be of at least 40/0076 or stiffer wire.

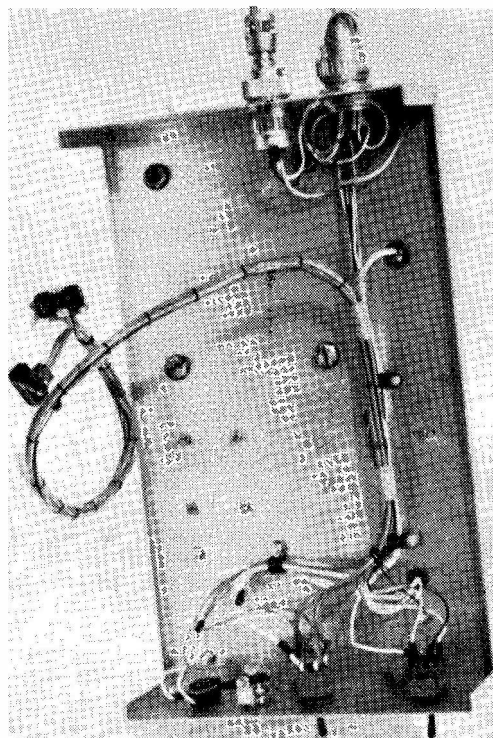

Underneath the PSU chassis

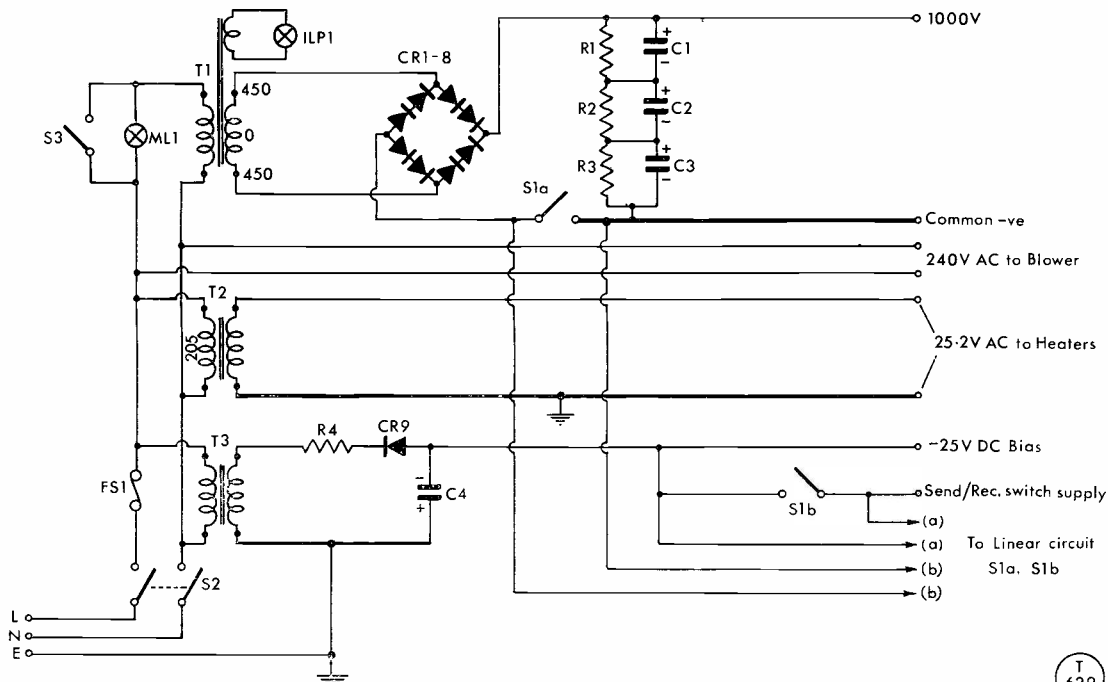

Fig. 2 1000 VOLT POWER SUPPLY

T
629

Fig. 2. Circuit of the PSU to match the Linear Amplifier

Testing the Linear

Of course, the real testing time will come when the Linear is coupled to the PSU, but at this point we can do some other things. The next move is to decide on the location of the Linear with respect to the PSU elsewhere, and to make up the interconnecting power-lead running between the two to the proper length, and not much more—we don't want low heater voltages to contribute to the early demise of our expensive 6KD6's. In addition we can make up the lead which parallels S1A/S1B on the PSU with the S1 on the Linear front panel—if the shack layout is such that the PSU is out of convenient reach. If it is to be alongside the Linear, then S1 can be deleted from the Linear, and that on the PSU used as send-receive switch. This lead runs along the underside of the Linear like a spinal column, and can be seen branching out of the cableform underneath the PSU—it is broken in the middle and joined by means of, in the original, a couple of those old-fashioned mains-lead combiners on each side to give four connections through; while this is, strictly, unnecessary, you will realise the advantage the first time you try to lift the Linear off the operating table with the PSU still attached!

Having made up the power lead, and the switching lead if desired, again run up the PSU for a few moments to settle, and now measure the voltages at the pins of the connector which will plug into the Linear. Everything

Table of Values

Fig. 2. Circuit of the PSU

C1, C2, C3 = Each 100 + 64 μF in parallel, 450v. elect., Radio-spares	CR9 = BY100
C4 = 100 μF, 35v. elect.	T1 = 450-0-450v., 250 mA
R1, R2, R3 = 47,000 ohms, 2w.	T2 = Heater xformer to give 26v.
R4 = 15' ohms, 1w.	T3 = To give -25v. DC
CR1-CR8 = Rec. 53A, Radio-spares, or similar	ILP1 = 6.3v. (red) indicator lamp
	ML1 = 60w. mains lamp
	S1, S2 = DP mains
	S3 = SP mains
	FS1 = 7 amp fuse

should be as you would expect, save the high-voltage line. Throw S3 to the "operate" position, with the lamp ML1 now short-circuited by S3. The high-voltage will rise to about 1260 volts—recall there is for the moment no load on it. Leave it for an hour in this condition, monitoring for any signs of distress or heat. Now switch off and lay aside, turning to the Linear proper. Check all wiring carefully, for dry or pointed soldered joints, look for adequate clearances on the HT line to the anodes *via* the RF choke, check that your made-up power cable pins mate to the correct ones on the Linear input connector. Check that the anode current meter M (Fig. 1, p.426, October) is shunted to read one ampere full-scale, shunted if necessary to 1000 mA, using the ordinary

*PSU construction and
layout—upper view*

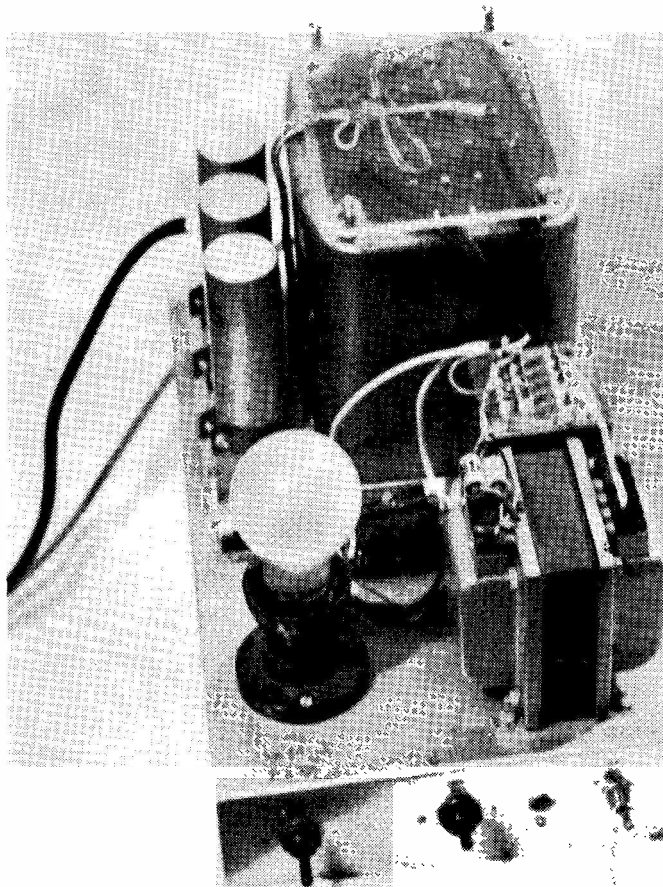

procedure for shunts.

Now, turn the Linear upside down, blocking up the back if necessary so that the fan-blades can churn round in peace. Set RV1-RV4 (see Fig. 1, October) so that in each case the slider is rotated as far as possible towards the bias-voltage (as far as they can be away from the earthy end of their tracks).

Now, you have, in a moment, to measure the volts-drop across R5, R6, R7, and R8 successively. Note how this can safely be done, and if needed make up some leads for your test-meter terminated in croc-clips specially for this task—you don't want a prod flapping around loose while the HT is on! Unplug the valves, interconnect with the PSU, leaving S1 on the Linear *and* the PSU "off," the switch S3 open-circuit, and the mains switch at "off."

Now, switch "on" the mains at S2. The fan should start to spin, and at this time you can make any last little adjustments to make sure it runs quietly. Switch the mains off again, but not before flipping S1 on the Linear and then on the PSU and noting that the relay flips over and back each time you operate either S1. Plug in the valves, switch the mains back on again, and note that the heaters light up to proper brilliancy. If they get too bright or refuse to light, switch down again and find out

why.

At this time, no reading should show on M. Now close S3 on the PSU, the mains lamp will go out, the ILP1 will glow a little brighter, and no current should appear on M, or at worst only a tiny almost invisible movement.

Connect the test meter, set to its lowest range, or that which is nearest to 0.2 volts full scale, across R5. Adjust RV1 to give a volts drop of 0.2 volt. Repeat for R6, adjusting RV2, R7, adjusting RV3, and R8 for which RV4 is the adjustment. Repeat for all four in turn, and leave all to stew for a couple of minutes, watching out for any signs of rising anode-current on M—it should sit at 80 mA or so while this procedure is gone through. After a couple of minutes, repeat the test on R5 to R8 successively, twice, and you should be all set up and ready to go. Switch off, disconnect leads, and box up.

Connect the output of the exciter transceiver to the input connector of the Linear, and the output socket to the low-pass filter and ATU; mate up the power and control leads again. Connect to a dummy load, wind in some audio on the exciter, tune it up into the Linear on, say, 14 MHz, then dip and draw the Linear just like a normal PA. It is suggested that this is done, initially at

least, with just a whiff of drive—just enough to lift the anode meter off its standing current mark. Tune for maximum output like this, then wind up the drive to 800 mA, dip and draw. Maximum output should coincide with minimum dip, and not on one or the other side of dip—the latter condition indicates a need for neutralisation, in other words, bad layout!

Now, as to power output, this Linear is capable of an output far above the allowed maximum. This was deliberate, in the prototype, so that if at any time the operator gets a bit excited, although the output allowed may be momentarily exceeded (and this can happen with *any* Linear, if the term “output exceeded” is taken to mean either maximum power output or the maximum allowable power output, whichever is the less) the Linear will not splatter and compound the offence. Therefore, it is suggested that the builder borrow an oscilloscope if he does not already own one and set up 400 watts output power as called for by the GPO regulations; then the meter readings reached at peaks can be noted and subsequently the Linear “talked up” to no more than this subsequently; as the meter damping and the operator’s voice are the unknowns in this equation, the test can be done on any band for which the scope will give a usable trace, and taken as accurate on all other bands.

It will be found that, if the constructor contrives to obtain a meter which is very dead-beat, so that the dip

has to be looked for by slow rotation of the tuning capacitor, another meter may be very lively indeed. What it boils down to is that the meter reading on speech peaks for a given DC output power is a function of (a), The operator’s voice characteristic, and (b) The degree of damping of the meter itself. However, what matters is that if the owner goes a wee bit “over the top” for any reason, this Linear will not splatter.

Conclusion

This Linear will give the full allowable power output permissible under the U.K. licence regulations with admirable linearity, and a bit in reserve. However, as far as TVI goes, and considering this TVI in terms of Channel I, it could probably cause TVI. However, this is due to the non-Linear loading of the driver stage—that is, the output amplifier of the exciter, which in the writer’s case happens to be a KW-2000B. No doubt, a low-pass filter, in addition to the one in the aerial circuit, between the KW-2000B and the input to the Linear will solve the problem, as indeed it has at this QTH.

With the layout given, running the Linear at full power (or more than the legal input) into the screened dummy load causes no patterning on a Ch. I TV set, despite the absence of extra screening. And it *does* seem to bring back the DX, with excellent reports on signal quality.

IMPROVED CHANGE-OVER SYSTEM

FOR P-T-T AND BREAK-IN

R. S. HARRIS (G3BWZ)

UPON recently building a transmitter for 160m. and 80m. it was decided to incorporate a press-to-talk facility (p-t-t). This was done mainly because previous SSB contacts had been spoiled by a slight frequency change when clunking the rather large Tx/Rx switch over. The mechanical vibrations had travelled through the chassis, and into the VFO and hence a beat was set up at the receive end. A hole was drilled in the chassis for a handy 12v. relay. One set of contacts was changed for a heavier pair more suited to carrying HT current. Then came the problem of how to power the relay. A 12v. separate battery, accumulator or PSU was a little bothersome, so the 6.3v. AC heater supply was decided upon. As most 12-volt relays will operate quite happily at about 8v. it was found that by rectifying the heater supply and smoothing it, enough voltage was produced to operate the relay comfortably.

After this, the idea of break-in for keying was evolved by adapting a diode trick read about somewhere, and found to be very successful.

Operation

Diode D1 rectifies the applied 6.3v. heater voltage. This is smoothed by C1. Socket 1 is one pin of a 3-way DIN socket from the microphone, arranged so that the p-t-t switch short-circuits it. Socket 2 is the key jack, normally open.

When either of the sockets is shorted across, D2 cathode circuit is made, and D2 conducts. Current flows through the relay coil, and the relay operates. Skt 1 and Skt 2, when shorted, also complete the cathode circuit of D3. As the cathode(s) of the PA valves are connected to D3 anode, when D3 conducts PA cathode current is permitted to flow. If both sockets are open, both the relay and the PA valves are “off”.

As soon as the p-t-t or key is pressed, the capacitor C2 is short-circuited through D2. When these are released, C2 immediately starts to charge up to supply potential. Consequently, current continues to flow through the relay coil only for a brief period until the current drawn by C2 is no longer sufficient to hold the relay in. As soon as this state is reached, the relay goes to “receive.” The delay on the circuit as shown is approximately 0.75 seconds. This value can be easily changed by altering the value of C2 by a few thousand micro-farads.

These additions have proved most useful in the author’s equipment, and it is hoped that others may find them equally helpful.

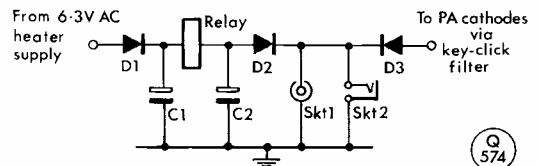

The C/O circuit suggested by G3BWZ. Values can be: C1, 5000 μ F, 25v.; C2, 3000 μ F, 25v., or as required (see text); D1, D2, D3, BY100; Skt. 1, part 3-pin DIN mic. socket (see text); Skt. 2, normally-open key jack Relay, any 6-12v. GPO type, with contacts to suit transmitter.

• • • SWL • • •

SHORT WAVE LISTENER FEATURE

By Justin Cooper

VARY YOUR LISTENING TIMES — SPURIOUS RESPONSE PROBLEMS — NOTES ON RECEIVER OPERATION — OBSCURE CALLSIGNS AND PREFIXES — READER NEWS AND QUERIES —LATEST LADDER POSITIONS

OFTEN one hears a complaint of "inability to find new prefixes" from a chap who is fairly well down the table. Or you may hear a long-time SWL saying he has never, ever, heard a VK or ZL station. A glance at the set-up shows that there is certainly nothing which would have such an inhibiting effect in the station or its aerials. What, then, is the matter?

Usually, the problem is a simple one—the chap has steady habits, and can be warranted to be at the receiver at certain definite times of the day and the week. Thus, normal propagation is always to the same places every time he listens, and only a change of listening time will make any real improvement. If your normal time is the evening, try an early-morning session or two, using headphones to keep the noise in the house down while the sluggards still lie abed. Try the small hours once in a while—after midnight much of the QRM goes to bed, which in itself could be enough to reveal new wonders. And, if you keep a good log, try extracting from it over a period a breakdown by hours of the day, band by band; this of course will reveal to you much about the pattern of the bands, so that, should you wish to hear so-and-so DX-emption, a look at your chart will indicate to you the best times of the day or night to listen for them, and maybe will indicate also where you may expect the QRM to be largely from. It then is a fascinating exercise in trying to understand, from the patterns, what mode of propagation is involved when you hear a station roaring in for a few minutes at a totally wrong time of day—anomalous propagation.

Various people write this month to say they are now fully-licensed and to all of them our congratulations. Long may they be able to enjoy Amateur Radio, and no doubt G3DAH and G3KFE would be pleased to record their results in their respective columns—after all, the new licensee who has earlier been a keen HPX hunter with a decent score will know what it is all about and most likely make a pretty good mark on the band with the transmitter.

Some of the New Boys

M. F. Simmt (Brussels, Belgium) has been a reader since 1971; he is a professional in that he used to be an R.A.F. telegraphist, and has always been interested in the Amateur Radio side—indeed, after becoming a member of the MP4TCE Club, he did in fact obtain his own call as MP4TDB in 1969 and worked many good DX contacts with it. Now he has a Trio 9R59DS with Joystick, the Joystick ATU and the Joymatch artificial earth arrangement to help to pick up signals from a third floor flat in Brussels where he has now settled. On a different tack, Mike wants suggestions on a good CW receiver with adequate bandspread to help him keep up his CW abilities at about 22 w.p.m. Personally, your old J.C. would strongly suggest that the quick answer to this is simply to add a Q-Multiplier outboard of the existing receiver which will sharpen the response plenty—this is what J.C. does on CW with his own Rx.

R. Mackean (Liverpool 4) reached the ripe old age of twelve last March, and now finds himself an avid SWL, using a Lafayette HE-40 receiver, bought from Stephens-James the local amateur radio traders. However, Robert's pleasure is somewhat damped by his inability to resolve an SSB signal no matter what he does with the BFO. This is probably just an operating problem; what you have to do is to tune in the SSB signal without BFO on, until it gives the maximum S-meter indication, or sounds loudest. Then turn the RF/IF gain down until the signal all but disappears, at the same time turning the volume-control (or AF gain) control to its maximum. Now, switch the BFO on and slowly tune it to resolve the signals. This should not raise any problems of serious nature, provided the BFO control works properly—if you haven't any BFO signal you won't resolve the Sideband! To satisfy yourself on this last, tune in a signal on any band, without the BFO on, in the normal way; no whistles should be heard if the station is on a clear channel, and if there is some carrier

QRM it will produce a whistle of constant pitch. Now switch on the BFO and repeat the exercise. If you sit the receiver tuning on the signal and twiddle the BFO tuning you should be able to generate a whistle whose pitch, musically, varies as you twiddle. Likewise, leaving the BFO on and at a set point should result, when tuning the main tuning, in a whistle, changing from high pitch to low to zero to low and back to high pitch as you go through each station; and effect absent, as noted, when the BFO is not switched on. However, if any reader has a copy of the instruction book on the HE-40 to spare or who could copy it by Xerox or similar process, if they send it to your scribe, he will pass it on.

R. J. Renard (Redditch) agrees with all we said about QSO-reporting last time; he enclosed a copy of his own duplicated report form, which has the scale for a signal strength-vs-time graph already printed, together with the necessary space for a time-scale and other details of interest to the recipient, all in a space no bigger than that of a normal double-sided QSL card. In addition from R.J.R. there is a first HPX Ladder claim, along with some details of his station which runs a CR-70A, a PR-30 presclector, and an R.107 receiver, all of which can be fed either from a three-band dipole up in the loft for the HF bands or a 130-foot curtain-rail aerial.

J. L. W. Trevett hails from *Broadstone, Dorset*, and has a Trio 9R-59DS receiver. However, he has a bit of a problem insofar as the current interest is in 144 MHz for which band there is an eight-element Yagi at 35 feet, into a Sentinel pre-amp and a Sentinel converter. The difficulty seems to be largely with the amount of "sharsh" coming out of the receiver at all times on Two. This is largely a problem of increased gain due to the presence of the converter and the pre-amp. One would feel that with a good aerial such as this the pre-amp is quite unnecessary to get down into noise, while the extra gain given by pre-amp and converter is such that the basic front-end receiver noise is being amplified to an intolerable amount, quite apart from worsening the receiver system performance in respect to blocking and cross-modulation.

J. D. Porter (Boslow) sent in his first list, taken with a Trio 9R-59DS, a multi-band dipole for 14-21-28 MHz and thirty metres of wire for the lower bands.

Technical

P. Rooney (Liverpool) has a couple of problems. The first one is the presence of several BC stations in the 14 MHz band as heard on his FR-50B; he wonders if these are normal spurious responses with his receiver. To this we can only say (not having had anything to do personally with the FR-50B) that every superhet receiver has a tendency to spurious responses, the frequencies in question being a function of the frequencies of the first and second IF's used, and their level being defined in the specification. Of course, these tunable responses should be well enough down not to be troublesome, but high-powered BC stations do sometimes appear strongly enough on the aerial to be a nuisance; tuning the aerial by an ATU, or using resonant aerials on the desired bands will help to keep them down.

On the question of using a crystal calibrator, Philip wonders whether it is possible to assume the calibration will be linear between two adjacent calibrator pips and so to read out frequencies accurately after setting to the nearest point. Generally, yes, but if the dial calibration of the receiver has a scale which is noticeably non-linear then one has to be a little cautious. For example, by taking the nearest calibration pip on the KW-2000B, or the Eddystone 888, the dial can be read to better than a couple of kHz, which is near enough, and much closer than this near to a calibration point, but some other receiver dials are sufficiently non-linear to make it clear that some correction should be applied if accuracy is vital. However, even these are usually "near enough" for all practical purposes.

R. C. Wodley (Ashbourne) raises a point unwittingly when he says that one of these days "when I have more practical experience" he will try the constructional side. Actually, the way to tackle construction is to begin with something simple, such as for example a one-band ATU, and gradually to progress to bigger things as confidence is gained. A good thing to do is to start by acquiring a multi-range test-meter of a reasonable grade; the Japanese ones are quite good

enough as long as one takes care of it. Then one can progress, first by building a simple audio oscillator using a couple of transistors. Follow this with one of those little square-wave gadgets used for receiver checking which were always being built a few years ago into old ball-point pen cases—but use a bigger case like one of those metal one which come with 35 mm film cassettes. A simple transistor tester can come next and will always be useful; follow it by a simple signal generator using transistors, and maybe a valve or FET “valve voltmeter” with an RF probe head. By this time you will have gained a bit of confidence and at the same time built up a useful array of test-gear for the time when more difficult projects need to be tackled. Richard incidentally decided to give up smoking when he realised how much it was costing him, and bought his present FRDX-400 out of the savings so made!

D. J. Gregory (Plymouth) regards S-meter readings as not giving a useful guide to a station's real signal potency, and instead offers his own “Overall Efficiency Factor” which he obtains by dividing the power output against the distance—miles over watts, in other words. Of course this is to some considerable degree true, albeit not taking into account the aerial system and other factors involved. After all the giving of an S-unit report only says the signal strength is so much and no more—it is more useful when coupled with the Readability (R) figure, as a signal worth RS25 is a better signal at the receiver than one which is RS25. Although now licensed as G8JDX (Just D X!) much SWL'ing is still done with the best gotaway as an EP station heard at 0324 one morning on Eighty with the Trio 9R-59DS receiver.

J. Hesman (Great Barr, Birmingham) claims to be very non-technical, but nonetheless finds himself fascinated by aerials and their ins-and-outs, partly because of the mathematical nature of the basic concepts—yes, very true, and J.C. will confess to being himself more interested in the way an aerial is working than what it actually puts into the log in the way of DX.

R. Carter (Blackburn) has a receiver which has gone on the blink—his HA-700 works OK on bands down to Eighty, but from there on is dead, on the amateur 7, 14, 21, 28 MHz bands and the BC bands in this area too. Sounds rather as if the local oscillator of the first mixer stage has gone sick on the higher bands; J.C. wouldn't know whether it uses a separate local oscillator valve, or a combined oscillator-mixer, but a first move would certainly be to check this stage and see if the valve is far enough “down” to be only marginal in its operation. Alternatively, it could be just dirty switch contacts!

D. J. Reynolds used to be a regular correspondent until he eventually became G3ZPF (Dudley). Now he writes in answer to the problem noted by *S. Eldridge (Crawley)* last time out, anent the image of 14 MHz on the CR-70A receiver being stronger than the signals in the proper place. David says he too found this to be so, and checked the receiver to be operating OK. He then thought a bit more, and realised that he could turn the effect to good use, as the image range on the dial has about 50% more bandspread than the marked area, so he calibrated the 13:1 to 13:6 MHz range on the dial to read out the 14 MHz frequencies. G3ZPF himself, having had three years' licensed experience, now finds he has, with a dipole at fifteen feet only, over 200 countries worked with his FT-DX560 rig, but still he reckons the best receiver for the SWL is a simple home-brew direct-conversion job—indeed, for CW operation it has some advantages over the “big rig” in that one can settle on either side of the signal whereas with the other the BFO is fixed on one side or 'other.

L. W. Craven (Alvechurch) has a couple of questions: The first one concerns the U.S. Citizens' band—this can be heard, in all its awfulness, whenever Ten is open, between the 27 and 28 MHz area of the dial on the receiver. His next one concerns receivers—why some signals get louder when the AVC is switched off. AVC is a misnomer; it is not automatic volume control but automatic gain control, and when the AGC is in operation it acts to reduce the receiver overall gain. Thus, provided blocking does not set in, cutting AVC off should make the signal louder. Also, having the BFO and the AVC on together can have a similar effect—the BFO signal leaks into the IF chain, is amplified, and appears at the AVC diode as a big signal to reduce the receiver gain. The only type of AVC in the true sense is that derived from the audio recovered from the incoming signal, after detection.

Now technical terms: Image and harmonic are not the same thing by any means. A harmonic of a signal is a multiple of it—the second harmonic of 7 MHz is 14 MHz, the third harmonic 21 MHz, and so on. The image signal, on the other hand is the signal which can appear in the receiver output from a frequency different to that desired, the relationship being determined entirely by the intermediate frequency in use in the receiver. Consider a wanted signal at, say, 1.5 MHz, and a receiver IF of 500 kHz. The local oscillator will be at 2 MHz, and the signal frequency minus the oscillator frequency will come out on 500 kHz. However, if a big signal exists at 2.5 MHz, and can

HPX LADDER
(All-Time Post War)

SWL	PREFIXES	SWL	PREFIXES
PHONE ONLY		PHONE ONLY	
W. Bingham	(Carrickfergus) 1553	Mrs. J. B. Jane (East Looe)	761
R. Shilvoek (Lye)	1448	C. K. Verstage (Old Basing)	733
T. Rootsey (Ilford)	1405	S. Eldridge (Crawley)	731
S. Foster (Lincoln)	1377	P. Barker (Sunderland)	717
K. Kyzor (Perivale)	1295	L. Craven (Alvechurch)	679
J. Fitzgerald		B. Cushing (Hove)	668
(Gt. Missenden) 1194		C. L. Lee (Ilford)	657
R. Carter (Blackburn)	1160	D. Sharred (Birmingham)	632
A. W. Nielson (Glasgow)	1142	A. Buckman	
L. A. S. Poole		(Jamaica, NY, USA) 618	
(London, N.21) 1090		G. F. Gullis	
M. J. Quintin		(Ogbourne St. George)	618
(Wotton-u-Edge) 1082		G. Lucas (Kennoway, Fife)	609
H. Alford		J. R. Cowan (Rochford)	591
(Burnham-on-Sea) 1049		M. F. Parry (Shrewsbury)	586
P. C. Jane (East Looe)	1023	M. Eccles (Lancaster)	572
B. Hughes (Worcester)	1003	M. Rodgers (Harwood)	559
G. W. Raven		B. J. McCartney	
(London, S.E.13) 975		(Wokingham) 559	
J. H. Sparkes (Trowbridge)	970	M. Kitchener (Hitchin)	549
A. West (Herne Hill)	961	P. Rooney (Liverpool)	526
R. H. McVey		M. Smith	
(Weston-Super-Mare) 897		(Matamatta, New Zealand) 512	
M. Cuckoo (Herne Bay)	895		
N. Henbrey (Northiam)	857	<i>CW ONLY</i>	
N. Askew (Coventry)	855	A. Glass (Plymouth)	1041
A. R. Holland (Malvern)	845	T. Rootsey (Ilford)	723
K. A. Whitley (Castleford)	830	W. B. Taunton (Meopham)	675
H. M. Graham (Harefield)	825	H. A. Londesborough	
E. W. Robinson		(Swanland) 635	
Bury St. Edmunds) 810		G. Richards (Aberdeen)	381
H. A. Londesborough		S. Sharred (Birmingham)	341
(Swanland) 798		A. W. McNeil (Newbury)	319
B. Thomas (Pontefract)	787	A. F. Roberts	
J. Gravel (Burry Port)	775	(Kidderminster) 301	
E. Parker (Hove)	771	W. Hutchinson	
		(Hornchurch) 282	

Starting score 500 for Phone, 200 for CW. Listings include only recent claims.

ANNUAL HPX LADDER
(Starting date January 1, 1974)

SWL	PREFIXES	SWL	PREFIXES
J. Bell (Hampstead)	466	S. McHugh (Pontefract)	345
R. Swan (London, S.E.19)	455	J. D. Porter (Baslow)	341
R. C. Woolley (Ashbourne)	432	D. J. Porter (Doncaster)	336
K. Salter (Newton Abbot)	421	A. C. Roberts (Shepshed)	319
S. Sharred (Birmingham)	413	C. Davies (Norwich)	311
W. H. Smyth (Hartlepool)	412	A. J. Gullis	
J. Hesman		(Ogbourne St. George)	306
(Birmingham B42) 390		S. H. Bandy (Luton)	288
M. L. Peters (Newbury)	369	W. McFaul (Londonderry)	271
M. Peirse (Liverpool 18)	368	G. George (Woodmancote)	270
N. N. Graham (Gosforth)	362	B. Russell (Runcorn)	264
S. Lawrence			
(Market Harborough) 353			

Starting score 200, in accordance with HPX Rules. All Prefixes in this list to be heard in 1974. When a score of 500 is reached, transfer to the All-Time Table will follow.

ride through the tuned circuits to the mixer grid, then it will beat with the 2.0 MHz local oscillator frequency and the difference will be 500 kHz. Thus, in the receiver IF, there are the wanted signal at 1.5 MHz and an unwanted one at 2.5 MHz which both convert to 500 kHz, and are now inseparable. Design of good superhet receivers is largely a question of making sure that such spurious responses as this, and other types, are kept to an absolute minimum.

ATU and preselector; These can be combined in one unit, but basically an ATU is a device to suck the most out of an aerial, and a preselector an amplifier used to amplify signals fed to it by the aerial or the ATU before passing on to the RX proper. Condenser is an obsolete word for capacitor, still much used colloquially. And as for it being too far to go from Alvechurch to Birmingham, your old J.C. did just that exactly when he took his R.A.E. course, more years ago than he likes to think about!

Prefixed

Last time we let Justice slumber in the matter of OG7AA—he now appears to come from Kuopio in Finland where the Club station has the normal call OH7AA; so it looks to have been a genuine callsign generated for some local event. Thanks to H. A. Londesborough (Swanland) for his researches on the subject, and others. However, one problem being cleared up he now raises another one—this problem calls itself "SFINK." We know nothing about this and feel that, in the absence of any word to the contrary, it should be taken to be a dud.

M. Kitchener (Hitchin) hadn't seen a copy of *SHORT WAVE MAGAZINE* on his local bookstall since last May until he came across one in late August, bought it and found he was still in the Ladder. This being the case, he got "stuck in" to the bands and made additions which are recorded elsewhere. However, HK0BKX worries him a little—he can't find it either in his atlas or Prefix List map. Answer is: Just East of the coast of Nicaragua, at about 12½°N., 82°W. of Greenwich. As for its size, it is certainly not very big, although larger than some areas of wet sand which have been dignified by the title "country" by DX'ers.

J. H. Sparkes (Trowbridge) mentions his hearing of LI2A/MM on August 9, giving his position on that date as 29° North, 34°-and-a-bit West, which would put him in mid-Atlantic, west of the Azores roughly. It seems pretty well established that LI2A is a genuine licence and station, but to date no-one has been able to tell J.C. what the activity is about, although one could make a shrewd guess.

B. J. McCartney (Finchampstead) has built a 144 MHz converter to run into his FR-50B receiver, and so has pensioned-off the old super-regen "squish box." This has improved matters a bit, although the beam sitting up at forty feet must help some in such a poor VHF site. It is also clear that the same rotator is made to work for its living—there is a TA33 beam on the stub mast as well! All his queried calls are OK; but perhaps it would be good enough for everyone to mention the Desroches situation where they were signing VQ9BP/D, for example, just recently. One feels that, from the point of view of the HPX Rules as they stand, we have a borderline case; and we therefore make an arbitrary ruling that VQ9BP/D shall be treated in accordance with Rule 3 and count, therefore as a D9.

A. C. Roberts (Loughborough) found a station signing LE7DB, spelling it out quite clearly with standard phonetics and in the clear, but again, in the absence of any further evidence J.C. would place him into the list of duds. Back to that /AM business we have been talking about, reader Roberts found one of the real Amateur Radio aeronauticals, with a proper amateur call, in the shape of 6Y5DE/AM.

E. W. Robinson (Bury St. Edmunds) has, along with several others mentioned 7SL2AN, which sounds a bit as though a real amateur has been bitten by a TTL integrated-circuit! Nonetheless, the general situation seems to be that this monstrosity of a callsign was OK, commemorating the 350th anniversary of something or other.

LI2A is still a suspect in the view of R. Swan (Upper Norwood) mainly because of his propensity for using Italian vernacular, working Italian stations, and getting in a twist with the phonetics of his own callsign. Fair comment, as far as it goes, but on the other hand recall that both the LI2B expeditions, Ra and the earlier Kon-Tiki were calls given to the expedition, not the operator, who indeed was not Norwegian on Ra. No, the evidence is all in favour of LI2A being OK.

Who lives in Market Harborough and calls himself Stephen? Whoever he is, he wants to add 78 to his score, and to query the R5B callsign—this was one of the Russian anniversary jobs, and quite OK.

G3WTV appears at this point, to clarify the position of SV1CH/C. It is the Club call of the "Radio Amateur Union of Northern Greece" which has about 180 members, and all sorts of facilities. However, the main point is that the authorities made the Club call out of that of the secretary, SV1CH, by hanging the /C on the end. The same group is responsible for the calls SV1CH/IFT last year and SV1IFT

HPX RULES

(1) The object is to hear and log as many *prefixes* as possible; a prefix can only count once for any list, whatever band it is heard on.

(2) The /M and /MM suffixes create a new series; thus G3SWM, G3SWM/M and G3SWM/MM all count as prefixes, and where it is known to be legal, /AM also.

(3) Where a suffix determines a *location* the suffix shall be the deciding factor, thus W1ZZZ/W4 counts as W4. Where the suffix has no number attached, e.g. VE1AED/P/SU, VE2UJ/P/SU, they are arbitrarily counted as SU1 and SU2 respectively, and the same holds good for similar callsigns.

(4) When the prefix is changed both the old and the new may be counted; thus VQ4 and 5Z4 both count.

(5) The object is to hear *prefixes* not countries, thus there is no discrimination between say MP4B and MP4K which count as one prefix.

(6) Only calls issued for Amateur Radio operation may be included. Undercover and pirate callsigns will not be credited, nor may any MARS stations be claimed.

(7) G2, G3, G4, etc., all count separately, as do GW2, GW3, GW4, etc., and in the same way K2, W2, WA2, WB2, WC2, WN2, all count separately, even though they may be in the same street.

(8) Send your HPX list, in alphabetical and numerical order showing the total claimed score. With subsequent lists, it is sufficient to quote the last claimed score, the new list of prefixes, and the new total. Give your name and address on each sheet, and send to "SWL," *SHORT WAVE MAGAZINE*, BUCKINGHAM, if possible to arrive before the SWL deadline for that particular month.

(9) Failure to report for two consecutive listings, i.e. four months, will result in deletion from the Table, although there is no objection to a "Nil" report to hold your place.

(10) Starting score 200. Phone Table is mixed AM/SSB, with a separate CW Table. No mixed Phone/CW Table, nor will AM-only or SSB-only entries be accepted.

(11) Lists will be based on those shown in the current *SHORT WAVE MAGAZINE* list of Countries and Prefixes, dated September 1973, and with the current edition of the *DX Zone Map*.

Cost of the "DX Zone Map," with the latest Prefix List as a loose supplement, is £1.20 post free. The Map is for wall mounting, 35 x 25 ins., in four colours. Prefix List alone is 25p. Orders to Publications Dept., Short Wave Magazine Ltd., 55 Victoria Street, London, SW1H 0HF.

this year, at the International Fair of Thessaloniki.

Now G3UZ, who has enclosed a card from a Citizens' Band station calling itself Radio Antares, P.O. Box 23, 10091 Alpignano (Torino) Italy. Reading it through, one notes that it is a report on G3UZ's contact with DM4FF on Twenty C.W. If anyone has any idea of the status of Radio Antares and of CB in Italy, G3UZ (and J.C. for that matter) could bear to know.

K. A. Whiteley (Castleford) has found an old batch of QSL cards, and by this means can add in such prefixes as ZC6, heard back in 1956—Palestine in those days.

General Chat

Specific points having taken up so much of our space allocation, we shall have to deal rather briefly with the remaining letters.

A week before he wrote, M. Crimes (Exeter) became the owner of a Yaesu FR-50B receiver, which brought back the HF interest which previously had been rather waning in favour of VHF; doubtless we shall receive an HPX entry in due course. On a different tack, many people heard and remarked on the IF0XRR/P5 station; Michael for some reason doubts this chap's authenticity, although J.C. sees no reason to worry.

G. George (Woodmancote) is one of several who got through R.A.E., and he has applied for a Class-B ticket while he gets his Morse up to speed—with G2FWA so near we suspect Gareth will be pressurised into passing in very quick time for his A licence.

D. J. Porter (Doncaster) seems to have been helped quite a lot by G3MWN despite not being able to attend the latter's R.A.E. class at Mexborough Tech.

N. N. Graham (Newcastle-upon-Tyne) recently re-discovered his enthusiasm for SWL, first generated around 1947 when he was an NCO in Royal Signals. Since then, the pressures of, first, the University syllabus, and more recently just plain business, have rather dimmed the lamp—but recently the decision was made to give the receiver a definite allocation of time each day, and the FR-50B receiver has backed up the effort well. The latter is fed from dipoles for 28-21-14 MHz, a Joystick and ATU, and an 85-foot wire, the latter presumably end-fed. As for the queries, listed separately (thanks!) they all seem to be pretty good ones, and some are good DX at that.

A long letter from F. G. Shepherd (Portsmouth) harks back to a previous letter from D. Jewell (Leicester) in which the latter mentions problems with his Trio 9R59 oscillating at certain positions of the RF trim control. This, outlandish as it may seem, was cured by simply changing the output valve, from 6AQ5 to EL95! The reason is that the screen voltage on the output valve varies as the RF gain control is turned, says F.G.S.

Talking about the HRO was C. W. Sutcliffe (Rochampton Village) who, despite being a senior citizen, is considering having a bash at the R.A.E., in which idea we wish him luck. Sad to say, Charles' HRO has been "played with" and its innards converted into a rats-nest by a previous owner, and is therefore a non-runner which he is going to rebuild first and then modify for today's conditions.

G. Lucas (Kennoway) has passed his R.A.E. and now wonders whether to take out a GM8 ticket or bide his time and go for the full GM4—he has heard lots of arguments in both directions. Well, J.C. would think that for the average chap, who has no idea what it's all about until he first comes on the band, the Class-B ticket lets him blunder about on VHF where he can't do a lot of harm. However, anyone who has a tidy score in HPX, honestly heard, should have no qualms about not knowing what to do on the operating side, and it would be worth his while to bypass VHF in favour of going straight after an A-licence.

Talking about R.A.E., W. Trenchard (Bridgwater, Som.) who is now G8IYT, thanks to much help and encouragement from the late G8AGZ. While he clearly put in a lot more hours of study than many people would care to do (and was prodged along by G8AGZ, G8DAM, G8GHL and others who were, as it were, on the touchline shouting encouragement) but, at the age of 54, and with no academic background to speak of, Bill Trenchard became G8IYT—and if Bill can do it, and many others of similar age, anyone who cares to apply themselves to the problems involved can also get a licence; but conversely, G8IYT is also saying, and rightly, that you won't get a ticket without working for it, whoever you are.

An interesting point, which J.C. must admit to not having previously considered, is the status for HPX purposes of 7SL2AN—whatever we do will be quite arbitrary, so we will allow it to count as a new prefix, as its owners doubtless intended.

Another most interesting letter came in from I. Meiklejohn (Dartmouth) who has several claims to fame, not least that of being the first Army officer to hold a PMG Maritime certificate; this was used when Ian was on the British Grahland Antarctic expedition, 'way back in the 1934-1937 era. However, he is now retired—he did

so with the firm intention of having nothing whatever to do with communications!—and of course the listening bug came to life again. Now he uses a Barlow-Wadley XCR30 Mk. II, in conjunction with the CWF-2BX filter for CW reception, or alone for SSB. Incidentally, if anyone has done any useful modifications to this receiver to improve its performance, Ian would like to know about them. As J.C. would also like to hear of anything in this line, too, pass them on in your next letters, please, and J.C. will forward.

R. H. McVey (Weston-super-Mare) remarks on the usefulness of the G3RAF slow Morse transmissions at 1930 each evening—on Eighty?—which he reads with some ease as they are transmitting from a site a bare half-mile away with 400 watts p.e.p. into a vertical aerial. Father G3GMC is now set up for 144 MHz, and so Roger hopes soon to have a converter available with which to listen in on the band.

A. West (Herne Hill) has been with us quite a while now; but soon he will be operating on VHF as G8JH. On a different tack, he is a little unhappy about the slowness of notification of some SWL contests; he came fifth in a local (U.K.) one and has not yet received his certificate.

Lots of work on the SS/TV front is being done by P. Barker (Sunderland) despite his commitments to HPX and as Secretary of the local Club; his slow-scan TV score now is up to 67 prefixes in 32 countries, and all continents save Oceania. His own monitor is entirely solid-state apart from the CRT itself, and local activity is quite high with a couple more SWL's equipped for the mode—enthusiasm is always an infectious disease!

R. Smye (Shrewsbury School) is naturally pleased to have passed both R.A.E. and Morse, the latter on the second attempt—good! His father is now G4DHC. As Dad's eyesight is none too good he has purchased an FT-501 digital readout job, which means the KW rig will go to Shrewsbury, and father and son will be able to have a regular evening session on Eighty.

A certain amount of envy at his brother's score of countries on Top Band is evinced by D. Sharred (Birmingham) who can only claim 21 as against 30. However, for both of them there is quite a way to go yet—Stew Perry, W1BB is now up to (at the time of his last letter to CDXN) 117 countries worked post-war!

L. A. S. Poole (St. Ives) is partly settled into his retirement home but fears that a 14-AVQ aerial and its radials will be socially unacceptable and very awkward to feed into a bedroom shack. The vertical itself shouldn't raise any real problems, and the radials can be made of thin wire, say 28g., while the matter of getting the coaxial feeder into a bedroom shack is just a question of letting it drop across the tiles and over the side to the appropriate window and then drilling through the frame or just beneath it where it is "packed" into the brickwork to seal any gaps between frame and bricks. This approach seems to work for J.C., and he has never had a cross word from his neighbours, who think it is "a clever TV aerial to stop the aircraft flutter"—and why should he disabuse them?

A sharp one is H. M. Graham (Harefield) who noticed "VP20AI" on August 28 saying he was "in St. Lucia." Probably an ill-informed pirate who didn't realise he should have thought of a call with the letters VP2L, not VP20. No one else seems to have come across him, so we must regretfully give him the thumbs-down signal.

Quite a problem exists for C. Davies (Cringlesford). Every time he wants to use his half-wave dipole, he has to drape it right through the house to get to the rig, much to the annoyance of parents, understandably. The answer is another length of coax, a couple of connectors, one male and one female, and drape it over the roof. The joint where the two cables meet can be made off by means of the extra connectors, and then the overall joint slathered all over in good old black sticky Bostik until it is watertight.

The Rest

Despite some vicious swings of the pruning-hook we still have run out of space. This is the time to acknowledge, then, the letters, the chat, and the Table scores from, first, an unsigned letter from "Magnolia Close, Shrewsbury," plus M. Eccles (Lancaster); S. H. Bandy (Luton); Bert Glass (Plymouth); Alex and George Gullis (Ogbourne St. George); a long letter from J. Bell (Hampstead); M. Cuckoo (Herne Bay); D. Brown (Hill); P. C. Jane (East Loos), Mrs. J. Jane (East Loos); A. W. McNeill (Newbury); K. Salter (Newton Abbot); R. Shilcock (Lye); B. Thomas (Pontefract); M. Rodgers (Harwood); B. Cushing (Hove); A. F. Roberts (Kidderminster); C. L. Lee (Ilford); G. W. Raven (London, SE13); W. McFaul (Londonderry); A. W. Nielson (Glasgow); and T. S. Rootsey (Ilford).

Close Down

J. C. has now "pulled the big switch" on another "SWL" but it still remains to allocate a deadline for next time, at November 21 to arrive by first post, addressed "SWL," SHORT WAVE MAGAZINE, BUCKINGHAM, MK18-1RQ. Till then, good luck, es 73.

Auroral Notes

THE two-metre aurora of September 15 seems to have been widespread and intense. (Must have been because your scribe was out fishing and missed the lot!) Unusually, there appears to have been three phases to this particular manifestation, the first during the afternoon starting at about 1430z and finishing around 1830z, the second during the evening from about 2200z to 0100z and the third following quickly on the heels of the second from about 0230z until after 0400z. As usual, stations in the North were getting the best of it, but even Southerners like G8FUF in Essex (who had 40-odd contacts on SSB) were able to get in on it. Here are a few extracts from reports covering widely spaced areas:

Up in Aberdeen, GM3E0J first became aware of the opening around 1500z and between then and 1820z worked G, GW, SM, ON, DM, OK, PA and SQ2 at strengths varying between S5 and S9. During the second phase he worked all these prefixes again and added GM, SQ1, F, DL, GI, GD, EI and UP2 for a very useful bag. He reports 4m. as being lively but nothing was heard on 70 cm.

GM3BQA (North Berwick) worked a goodly number of Continentals, although no F, and his log includes the capture of two UR2 as well as SM and LA. He found the optimum beam heading to vary between NE and N.

GM4CXP (Roxburgh) timed the first phase as 1440-1820z and was able to work G, GM, GW, DL, DM and F with PA and ON as "got-aways". The second phase appeared at about 2230z and closed at 0215z during which time he booked in GI, G, GM and GW and heard UR2. Optimum beam heading during both phases was ENE.

Paul Quast, EI5BH (Athlone) really had a ball between 1700z on the Sunday until 0100z on the Monday and sends in an impressive list of stations worked. He heard, but was not able to work, UR2DZ, UA1J., DA2., and ON.. He also noted auroral activity on the band the following day between 1200z and 1330z.

In Co. Antrim, Steve Ruff, GI8EWM was not ble to log any Continental DX, but he worked 36 British stations between 1515z and 1815z with reports up to S9 at times. He also found the optimum beam heading to be NE.

GW8FOL (Holyhead) first observed the aurora at 1440z and lost it at 1815z. He worked 23 stations in all with the best DX as F1JZ in QRA AJ67g. He heard, but was unable to work, DK, PA, DM and OZ. GW8FKB (Anglesey) caught the first phase at 1518 hrs. through to 1735 hrs. and worked five GM, two GI, eleven G, two PA and one DK. He observed the second phase between 2259-0300 and added six GM and one GI to his bag. He also reports an aurora the following day at 1200z when further GM's were worked. GW8HVP (Haverfordwest) latched on to the opening at 1530z and noted the end at 1820z during which time he worked G and GI. He found the second phase very much weaker than the first; his optimum beam heading varied from NE to NNE. GW3KGD, also in Haverfordwest, had 12 contacts to give him several new countries.

A fantastic score of 203 contacts in 15 countries, with best DX as UR2, is reported by GD3UMW (Kirk Michael, I.O.M.). He worked during two phases of the aurora

VHF BANDS

A. H. DORMER—G3DAH

only, the first 1500-1900z and the second over 2245-0300z and filled eight pages of logbook doing so. Only 10 QSO's were made on SSB, the remainder being on CW. He says that the aurora was visible in the Isle of Man at 2100z.

G8EOP in Dewsbury had Ar contacts with G8AGU (Devon), G8AAZ (Jersey) and LX1DB. Beam heading was varying quite a bit from NE to NW. His first QSO was at 1455z and the last at 1830z. He had a go on 70 cm. with G3ZYC but no signals were heard either way. In Walsall, G4BPY had a couple of good contacts with SM7BAE (another who never misses an aurora) and SM5BSZ in QRA JT41f which is a fair old haul. He recorded the fade-out at 1820z and was just able to get in a contact with EI5BH before the band folded. G4DHF (Grimsby) became aware of the aurora at 1515z and found both activity and QRK high. Although he does have CW, he made most of his contacts on SSB, in spite of the inevitable distortion when using that mode. Nevertheless, he had 18 contacts in five countries, the greater proportion being GM. The second phase started for him at 2303z but he found it considerably weaker and activity lower. G3BW (Whitehaven) got in with SM and LA and found the second phase to be better than the first in that it produced seven SM, one LA, two PA, DC, EI and a couple of pages of log of G and GM. Nice going!

Altogether, this looks like one of the better aurorae and bears out the observation that Spring and Autumn are the most likely times for this phenomenon to affect two metres.

VHFCC Awards

Only one Award this month and that to Paul Davies, G8HBQ of Leeds. He commenced on two metres in February, 1973 with 10 watts of AM to a QV03-10, VXO controlled, and an 8-ele. beam at 24ft. Reception was via a H-B mosfet converter and the FR-100B. He came on SSB in December, 1973, with a Yaesu FT-200 prime mover and a solid-state transverter driving a QV06-40A. He also has about 10 watts of AM on 70 cm. with a Multibeam and is planning SSB on that band also. He gets Award No. 227.

The Scottish Scene

Main event of the month was undoubtedly the VHF Convention in Dundee which

brought some 200 amateurs together for the Convention itself, and about 140 stayed on for the Dinner. Fortunately, the Wx was kind, and it was noticeable that many of the ladies were able to take advantage of spare time in looking around the City and spending some of their husband's hard-earned cash.

The main Convention opened at 1445 hrs. with a presentation by Geoff Stone, G3FZL, who spoke on VHF/UHF affairs including a report on the two-metre band plan, which showed that, by and large, it was working out well.

The talk, well illustrated with slides, by a member of the Andrews Corporation, brought us up-to-date with the latest techniques in microwave antenna systems, after which the lectures were divided into two streams. Sandy Olyphant, GM3SFH, (his father GM2FLQ is still active) dealt in a most erudite way with the effect of the sun on the earth environment and propagation, while GM3DXJ demonstrated and talked about some of the equipment, which he, GM8BKE and GM3OXX had carried when setting up their recent 3 cm. records. They used paraboloid antennae and the popular Gunn diode for both transmission and reception. The diode with a 7v. supply, a bypass capacitor and a tuning screw are mounted in a small section of WG16 waveguide and produce power at 10 GHz of the order of tens of milliwatts only, but this is quite adequate for line-of-sight paths. Their latest achievement is a 100% contact over a path of 81 km. GM3OXX and GM8GEC were on North Berwick Law and GM8BKE and GM8HBU on the Kilsyth Hills. They made it sound all rather easy, but many will still be put off having a go on this band because of the metal-bashing required. They are planning further forays to extend this range, and already have a profile for a new path which will significantly improve on their previous successes. Incidentally, George Burt, GM3OXX, has sent along some interesting statistics to show what is involved in his portable operations. Between January and August this year, he has:—Operated /P on 25 weekends; Biked 40 miles; Walked 122 miles; Bussed 298 miles; Boated 120 miles; Climbed 49,530ft. (the total vertical height of all the hills he has scaled); and travelled 1,896 miles by car (and he doesn't even own one!) so if you are thinking of having a go, you had better start a bit of training!

Following the Convention Dinner and speeches, the Jock Kyle Trophy was presented to GM3OXX, GM3DXJ and GM8BKE jointly for their microwave work. Tom Wratten, GM4CAU, was awarded the Trophy for the best piece of home-built gear. He made an excellent job of the digital keyer for GB3LER, the Lerwick beacon.

Congratulations must go to Findlay Baxter, GM3VEY, who chaired the Dinner and to Frank Hall, GM3BZX, who did most of the organisation of this, another excellent Scottish Convention.

One unfortunate sidelight to the Convention is that G3BW had all four hub caps removed from his car which he had parked nearby. This is carrying enthusiasm for microwave paraboloids too far! Other News: The question of how, for the purpose of claims and Awards, the disappearance of the existing Scottish counties

in April, 1975 and their replacement by Districts and Regions would affect the issue, was discussed at Dundee and, rather surprisingly in view of previous information received, there appeared to be a large body of opinion in favour of counting Districts. This view will be taken into account before any firm decision is taken, but the situation is complicated because of the overlap between Region, District and County. Our December issue will contain all the necessary gen.

Readers may recall the extensive series of tests some years ago between VE2AJO and TF3EA on which we reported at the time. TF3EA is, unfortunately, no longer with us, but Geoffrey Mackenzie-Kennedy has now left Canada and returned to the land of his fathers, where he hopes to get a GM call before too long. Your scribe had the opportunity to hear some of the recordings he has made of anomalous, metre-wave propagation in Canada and the States, as well as reception of the Iceland beacon, TF3VHF, and South American stations, which were a real eye-opener when one comes to consider the distances involved. One would expect Geoff to be much in demand by Clubs and Groups to expound on his observations.

Equipment for the Central Scotland repeater is now well under way, and it is hoped to have the device in service early in 1975. The FM Group is still a bit short of funds for this project and any contributions would be gratefully received by the Treasurer, GM4DJJ, at his new QTH at 39, Marionville Road, Edinburgh, EH7 6AG. It looks as if a good case could be made out for operating two repeaters in the South of Scotland, one to serve the Glasgow/Clyde Valley area and a second to cover Edinburgh/Forth Valley, since the site selected in the Kirk o' Shotts/Black Hill region will give poor coverage beyond the Western outskirts of the Capital. An installation up on the hills to the south of Edinburgh should not only give good coverage of the City itself, but should also be usable by mobiles coming up the main routes from the South. It might be interesting to get Jack McVicar's, GM8GEC, views on the subject since he has much experience of commercial mobile operation in this area.

Now that Charlie Sherrit, GM3EOJ, has retired from the Police he has found time to get quite a lot of re-building done and is now QRV on 4m., 2m. and 70 cm. On the lower frequency, he has the SSB rig almost ready to energise the 4-ele. Yagi and will use this as a transverter to drive the 70 cm. translator which should be ready to go in a month or so. The 150 watts, 2m. SSB Tx is now operational and feeds the 10 ele. Yagi. So if you are looking for Aberdeen...?

GM4BIP (Dundee) has AM/FM from a Pye base station in addition to his SSB from a Liner, and very nice quality it is. George Heriot's School Club is now in full swing and is promising to give their traditional rivals at Watson's a good run for their money. Firhill School should also be on the air shortly under the tutelage of their senior physics master, GM4BYF.

Contests

Results: Not much of an entry for the June 70 MHz event, but this was probably due to factors outside the control of the participants. G3JYP/P, operating from near Walsingham in Co. Durham, led the field comfortably followed by GW3WRA/P in Brecon.

(cont'd p.496)

THREE BAND ANNUAL VHF TABLE

January to December 1974

Station	FOUR METRES		TWO METRES		70 CENTIMETRES		TOTAL Points
	Counties	Countries	Counties	Countries	Counties	Countries	
G3NHE	53	6	74	17	56	11	217
G3DAH	50	8	63	18	35	9	183
G5DF	44	7	65	16	37	6	175
GD2HDZ	38	6	78	13	32	7	174
G4AGE	27	3	67	11	41	8	157
G3XDY	22	4	70	12	18	8	134
G8EOP	—	—	66	13	39	10	128
G3FIJ	30	4	44	13	15	4	110
G3BW	—	—	65	10	22	4	101
G4CZP	—	—	79	14	—	—	93
G3OHH	39	7	27	6	11	2	92
GW8FOL	—	—	75	16	—	—	91
GW8FKB	—	—	77	10	1	1	89
G8GHZ	—	—	67	10	9	1	87
G4AEZ	11	2	46	11	11	2	83
G3SHY	15	3	27	6	23	5	79
G8GNE	—	—	40	10	23	3	76
GM4CXP	—	—	65	11	—	—	76
GW3KGD	—	—	60	15	—	—	75
G2AXI	21	3	32	8	9	1	74
G8ECO	—	—	49	9	12	2	72
G3AFB	—	—	51	10	7	1	69
GW8BXQ	—	—	52	12	1	1	66
G4DHF	—	—	56	9	—	—	65
G8DGR	—	—	50	10	2	1	63
G8FMK	—	—	25	2	33	3	63
GM3ZBE	—	—	44	8	4	6	62
G8FWB	—	—	51	10	—	—	61
G8GGP	—	—	50	9	—	—	59
G8HHI	—	—	47	10	—	—	57
GW8HVP	—	—	48	8	—	—	56
G8EKP	21	7	15	4	2	2	51
G8FUI	—	—	35	8	5	2	50
G18EWM	—	—	39	9	1	1	50
G8CBU	—	—	42	5	—	—	47
GW4BXE	12	2	20	11	—	—	45
G8HQA	—	—	37	7	—	—	44
G8GLS	—	—	36	6	—	—	42
G8BBP	—	—	37	5	—	—	42
G8GQQ	—	—	31	4	5	1	41
G8GXE	—	—	29	5	1	1	36
GW3XJQ	—	—	27	9	—	—	36
G3FKP	—	—	29	2	—	—	31
G8HYH	—	—	27	4	—	—	31
G8BPJ	—	—	23	2	1	2	28
G3SXX	—	—	21	6	—	—	27

Notes:

1. Claims should be on the basis of the OLD county boundaries until December 31, 1974.
2. The Table shows claims to date from January 1, 1974 and will close on December 31, 1974.
3. Claims should be sent to "VHF Bands," *SHORT WAVE MAGAZINE* BUCKINGHAM, MK18 1RQ.

Reports: Conditions were pretty poor for the UHF/SHF contest over the weekend of October 5/6. As for VHF/NFD, it was a story of high winds and general bad weather, and this must have kept many portables indoors—several well-known call signs were missing. It was surprising again that there was so little CW on 70 cm. in view of the poor propagation—65% of the contacts made at G3DAH were with other than G8/3 operators and of these, only four (including the best DX) were on the key, and these were the only four heard using this mode. Continental contacts were difficult to come by, the best signal heard being that from ON4PB/P (operated by that master of the metre-waves, ON5FF). On 23 cm., things were no better, although highlighting the advantage of CW, G3NHE (Sheffield) made it with G3DAH (Herne Bay) over a 264 km path in spite of the poor propagation. The drop in pressure to below 1,000 mb on the Sunday afternoon, coupled with the rain and wind, reduced propagation even further and gave an apparent decrease in activity generally, although this was at no time very high.

Forthcoming Events: November 2/3 for the 144 MHz CW event. December 8 for the 144 MHz Fixed Station contest. Don't overlook the 4m. and 70 cm. Cumulatives for which dates were given in the last issue.

Beacons & Repeaters

It seems that GB3GEC is to be re-activated shortly from a site near Boreham Wood, Herts. It will run about 100 watts output with a 4CX250B in the final. Further details when equipment and site finalised. This should prove a very useful indicator of propagation on 70 cm. and will supplement the Sutton Coldfield beacon and GB3DM in Durham in due course. Proposals have also been formulated for a new 70 cm. beacon at Crowborough, Sussex, with the call sign GB3UJ. The device will be designed, installed and operated by the West Kent Radio Society. The call sign has been selected in memory of Bert Allen, G2UJ, who did so much, not only for the Club, but for Amateur Radio generally.

GB3GM on 2m. is to be closed down and GB3LER brought back into service shortly. GB3GW is still off the air. For the time being, beacon frequencies remain unchanged, but in accordance with the new band plan for 2m. some transmissions will be moved into the beacon sub-band of 144.13-144.15 MHz as soon as possible. Consideration is also being given to the operation of low-

power beaconry just below 145.0 MHz.

The mystery of the poor reception in the Midlands of the 4m. beacon, GB3SX, is now solved. The antenna is a ground plane and not a directional beam as scheduled. This is a temporary situation only.

On the repeater front, GB3LO should soon have completed tests at the Epsom site for moving to the Crystal Palace location. Preliminary reports confirm very reliable and satisfactory operation. GB3MH in the Malvern Hills should be in operation when these notes appear and GB3BC, in the Bristol Channel area, continues to operate successfully on Channel R7. GB3SN at Alton, Hants., is nearly ready to go.

Oscar 6 continues to function, albeit spasmodically, exceeding by one year its planned life. Latest launch date given for Oscar 7 is October 29. We'll believe it when we hear it!

News Items

Twenty Three: Preparations are in hand at GD2HDZ for this band. He has the *Microwave Modules* converter and a 13-ele. Yagi, and has heard (possibly) G3KMS in Bolton. This will be a good one to get, good DX for most of us, and two for the price of one as far as countries/counties chasing is concerned. G3NHE (Sheffield) is now QRV on 23 cm. using a 2C39A tripler from 70 cm. and a 34-ele. Yagi, which is a great improvement over the corner reflector he had been using. Rx side is a BFR90 pre-amp and a *Microwave Modules* converter.

G3JVL in Hayling Island has now added G3ZYC near Matlock to his score on 23 cm., and has had several QSO's with G3KMS in Bolton over a 332 km path! He got 801 points from the first of the 23 cm. Cumulatives and 797 from the second, which is very good going in view of the propagation conditions prevailing at the time. He is one of the fortunate ones who does not have to work out distances every time he makes a new contact—he has a computer programme running which does it for him, and which will provide answers for QRA's out to 1,000 km.! He feels that direct 23-23 cm. calling without the use of 70 cm. for setting up the contact is to be encouraged, and, indeed, this practice is bound to increase as band population rises and equipment becomes more reliable. Mike also comments on the relationship between boom length and the gain of long Yagis and quotes from his experience that doubling the boom length can produce a gain of nearly 3 dB. It looks as if there is a field for some useful, further investigation here.

G3ZYC (Matlock) is QRV again with two watts of RF from a solid-state driver to a 4ft. dish at 70ft. The receive set-up comprises a BFR90 pre-amp to a *Microwave Modules* converter, feeding an FT-101B. G4BEL (Camps.) is now ready to operate on VHF/UHF/SHF again from the home QTH in Littleport, having won a local battle about antennas. G4ALN (Romford) has added G4BGU/P (Berks.) to his total in the 23 cm. Table and G3DAH has added G3ZYC (Matlock) and G3NHE (Sheffield) to his.

Seventy Cms.: A step which has all the appearance of being able to do for 70 cm. what the Liner has done for Two has been taken by the *Microwave Modules* team. They have now produced a solid-state transverter for the band with an output of 5 watts p.e.p. at a price of around £65. Don't all rush at once though, they are not in full production yet!

G3BW (Whitehaven) is pressing on with his 4CX250B "louden boomer" for the band, and already has the 2C39A buffer stage going. EI5BH (Athlone) expects to have 70 cm. gear ready in time for the launch of Oscar 7, and will be available on the band outside orbit times. G8FHO in Cheshire is now ready to go with a Varactor tripler and 46-ele. beam, and is active most evenings on 433.44 MHz from 2100z onwards. He has a 23 cm. tripler under construction and has stoked the 2m. line up to 120 watts p.e.p. Two Metres: GW3XJQ reports a continuing increase in SSB activity from Pembroke; GW3KGD, GW3LXI, GW4AKO, GW8BXQ and GW8HVP are all active from what used once to be a pretty rare county. '3XJQ himself runs a FT-100 driving a *Europa* transverter with an 8-ele. Yagi at 30ft. He has a Liner and an HW-202 to a 5/8 whip in the car. GW8FKB reports that G13JLA (ex-EI6AS) is now living in Co. Tyrone and has 200 watts of SSB to a 10-ele. Yagi. Several GW correspondents have commented on the good propagation into France on September 20. GW8FOL (Holyhead) made it with F6CCT in QRA ZI72b and with F1AJD/P in QRA AF32h. He also reports hearing what he believes was CT1NB in QRA WB28, but something seems a bit wrong with either the call or the QRA locator as CT1NB is listed in the callbook as in Lisbon, whereas WB28 is right in the North of Portugal. Assuming that one or the other bits of information is correct, this is a most interesting item as reception of CT1 on two metres has not been previously reported. GW3VHG is now active from Anglesey with a Trio TS-700. We wish GW3KGD a speedy and complete recovery after his recent spell in hospital.

G8GHZ in Northampton is looking for contacts with Dorset and Glamorgan for a complete set of G/GW counties. He now has RTTY on the band. G4BUU reports that the Star Short Wave Club in Leeds is now active every weekend from their /P site at Guiseley, 10 km north of the City with a Liner and a Vanguard feeding a 10-ele. beam. They are also QRV from 8 p.m. on each Wednesday evening from the Club premises, using a Liner; their call is G3ZWA. Four Metres: G13WTG is back on the 4m. air with SSB from Co. Armagh. G5DF (Reading) is temporarily QRT on the band having lost the mains transformer for his Pye base station which now emits no AC but just a nasty smell! GW3XJQ (Tenby) expects to be on four metres very shortly with SSB to a 3-ele. beam. G3DAH is still looking for Carmarthen to complete his 60 counties on the band. He missed GW3XBY/P the other weekend, but was pleased to hear that Dale managed to give several other stations a new county.

Hail & Farewell

It was with regret that it was learned that our respected colleague, Jack Hum, G5UM, will no longer be reporting on matters VHF in *Radcom*, but we take this opportunity to welcome his replacement Martin Dann, G3NHE, already well-known as one of our correspondents.

Deadline

That's the lot this time. Deadline for the next issue is November 8. Please send your news, views, claims and comments to: "VHF Bands," *SHORT WAVE MAGAZINE*, BUCKINGHAM, MK18 1RQ. BCNU es vy 73 de G3DAH.

TWENTY-THREE CENTIMETRES

ALL-TIME TABLE

Station	Counties	Countries	Total
G4BEL	24	7	31
G3JVL	19	4	23
G3DAH	20	3	23
G8ARM	20	2	22
G4BYV	15	5	20
G3COJ	15	3	18
G3JXN	17	1	18
G4ALN	15	3	18
G3EHM	14	2	16
G8AOD	11	1	12
G5DF	11	1	12
G8FMK	9	1	10
G8FJG	7	1	8
G3NHE	2	1	3
G8EOP	1	1	2

THE MONTH WITH THE CLUBS

By "Club Secretary"

(Deadline for December issue: November 6)

THERE is just time for a last reminder about MCC; November 16-17 are the dates, and the rules appeared in the October issue, p.439. Please pay particular attention to Rules 4 and 7. There is nice time to fix up the aerials, organise the operators (and the rig!) and be in there doing battle to see which Club can come out on top, both overall and, of course, geographically. And may the best group win—it goes without saying that this Contest is always a keenly played and sporting affair, of considerable value in welding members of a group into a keen and active whole.

To change the subject a moment, may we discuss the question of Club reports sent in to this piece. Any club that writes in, or sends a copy of the News-Letter, will *certainly* receive a mention, wherever or wherever they may be. However we need the information posted to *SHORT WAVE MAGAZINE, BUCKINGHAM, MK18-1RQ*; not, please *not*, to 55 Victoria Street, as this can mean delay especially if a weekend intervenes. When a Club sends its information in to the proper address but too late for inclusion in the current month's listings all such reports are taken in at the first opportunity, provided they are received by us in the first place.

On your report, please indicate the details for the relevant date of the month in question; your next lot will thus include the *December* doings. In addition, please give the venue, name and QTH of the hon. secretary (also call sign where applicable), particularly if a change has occurred, and a telephone number if there is one.

Apart from keeping the Secretaries Panel up to scratch, there is also the point that many newcomers write in asking about a Club near them, and we like to be sure that we have the latest information. A careful card index is kept of Club data.

Westerlies

Our first stop in this region is with Cornish who are, on November 7, back in their old home again, at the SWEB Clubroom, Pool, Camborne. As to the matter of the entertainment, they have a natter session and a Sale of Surplus Equipment.

Now to Yeovil where the meeting is every Thursday, at The Youth

Centre, 31 The Park, starting at 7.30 p.m.

Alternate Wednesdays from October 9 is the form for the coming months at Newquay, and on the programme we see talks on such topics as an SL600-series IC transceiver, a two-metre Transverter, Ignition Interference and an SWR meter for VHF use. Incidentally, this is one report which missed last month's deadline.

At Port Talbot, the arrangements have been altered somewhat. The earlier organisation of that name has been, on paper, wound up and a new one formed as a part of the British Steel Corporation Sports and Social Club, subtitled Port Talbot Amateur Radio Section. By doing this they gain in various ways—better facilities for a Club station, a more suitable meeting-place and, in consequence, the chance to go after more members. Every Thursday evening they can be found at the B.S.C. Social Club, Margam, but the first Thursday of each month is set apart for a general meeting.

Hereford hold their gatherings at the County Control, Civil Defence Headquarters, Gaol Street, Hereford, on the first and third Fridays in each month, and they try to have something going on each time. Our programme in fact goes to November 1 only, when a tape-and-slide lecture on "The Human Machine as a Radio Operator" will be shown.

South & East

Looking at the November doings of the Maidstone YMCA clan, we find that on November 1, 15 and 29, G3XUN does his stuff instructing beginners. However, this is not enough—he is whipped to the rostrum again on November 8, to talk about "Gimmicks and Gadgets." This leaves November 22 to be filled, by way of a tape-and-slide lecture. Although this is possibly one of the best-equipped Clubs in the country as to the facilities available at Hq., there is always something which can be bettered—in this case it is improvements to the antenna system.

Every Friday at the Sea Cadets Hq. in Woodlands Road you can find the Harrow chaps. Practical Nights come up on November 1, 15, and 29, in each case accompanied by some other activity such as running the Club station or talking about the next group project, or whatever. November 8 will be a popular night—it's a junk sale! Then, on November 22, G8BJO will be talking about Shadow Masks—doubtless something to do with colour TV.

Bishops Stortford are a once-monthly lot, the selected date being always the third Monday in the month. For November, this gives the 18th, and the activity the home-construction contest. The Hq. is in Windhill, at the Hq. of the British Legion.

G3CCD is the speaker at Acton, Brentford and Chiswick on November 19; his subject is the TAA570 Integrated Circuit and the use he has made of it. Venue, as usual to be at Chiswick Trades and Social Club, 66 High Road, Chiswick. (over)

Interesting group-picture at a recent meeting of the Peterborough Radio & Electronics Society—left to right, standing, G6JP, G13GXP and old-timer G2NJ; seated are GW8NP and G4BBA (in wheel-chair). We are not told what the occasion was but it must have been unusual in view of the call signs.



What a night for an informal natter-meeting—November 5, Firework Night! One wonders how many fireworks will be fizzing away during their deliberations at Reigate. This one is at the Marquis of Granby, Hooley Lane, Redhill, while the formal session on November 19 is held in Reigate itself, at the St. Mark's Church Hall, Alma Road, at 8 pip-emma sharp. All welcome, of course.

For Echelford the programme calls for them to foregather at St. Martin's Court, Kingston Crescent, Ashford, Middlesex on the second Monday and the last Thursday of each month; however, our copies of the August and September *Newsletters* only take us through October, which means we cannot tell you what has been laid on for either of the November dates.

A new meeting-place is to be noted for Milton Keynes who have their booking on the second Monday of every month at the Lovat Hall, Silver Street, Newport Pagnell. A rather good idea occurs on November 11, in that the talk is entitled "How to Become a Radio Amateur," and the general public are invited to hear G3HIU's lecture.

The four evenings weekly routine at Barking continues successfully, Mondays being down for construction, Tuesdays for Morse classes, Wednesday for the Club station working and Thursdays the general evening. On November 7, the lads are "playing away" with a visit to the P.O. Radio Station at Ongar. The home QTH is at Westbury Recreation Centre, Westbury School, Ripple Road, Barking.

Watling Community Association is at 145 Orange Hill Road, Edgware, and is the venue, on November 14 and 28, for the get-together of the Edgware group. For the former date, they have booked Pat Hawker, G3VA, who will discuss "Television Aerial Topics" and no doubt provide lots of talking-points for the informal session on the 28th.

Thames Valley's Hq. is at St. George's Hall, Portsmouth Road, Esher. G3BPM is in the hot seat on November 6, giving a talk and demonstration on the subject of "Repeaters." Looking forward a little, to the December 4 date, we see they have G6OPB/T showing and talking about his amateur television transmitting activities and

rig.

If you are in the Tunbridge Wells area, then the Club for you is West Kent. They assemble on alternate Fridays, which this month implies November 15, for a Junk Sale, and November 29, when a speaker from Redifon will give a talk on Frequency-Synthesised Solid-State Equipment. Both meetings are held at the Adult Education Centre, Monson Road, Tunbridge Wells.

Another Junk Sale falls to be mentioned; this one is on November 20, at Sutton and Cheam, which it should be noted is a *Wednesday* instead of the more usual Tuesday. As for the address, look for The Library, Cheam.

One of those fringe activities which can impinge on the shack scene is bookbinding, especially if you want to keep your periodical back-numbers in any sort of order. G4CCM will be telling the Grafton lads all about how he does it on November 1. November 8 sees G3ZKE talking on the question of Receivers and Short Wave Listening, but the group will be out on the 15th, with a limited-numbers visit to the IBA transmitter at Croydon. RAEN is the subject for G3GJW, and the month is rounded off by an illustrated talk about Field Days—this should interest the newcomers and sound a note of nostalgia for the more senior members. As for the venue, Archway Annex to Holloway Institute is in Highgate Hill, London N.19, pretty well opposite the delightfully named pub, the "Whittington and Cat."

Unfortunately we have, at the time of writing, only the October activities for Stevenage, but it looks as though the form is to meet on the first and third Thursday in each month at the Hawker Siddeley Dynamics canteen in Gunnels Wood Road. More details, and more up-to-date, can doubtless be obtained from G4BPG—see Panel.

If there is one thing certain about the *Southgate Newsletter* readers it is that they know the address at which the meeting is held, the time of the start, and the speaker's name and call. But—on what date? We have to refer you to the secretary for that vital bit of information! The Hq. is at the Scout Hut, Wilson Street, Winchmore Hill Green, for the G6QM Trophy home-construction contest.

North Kent members see on the front cover of their *Newsletter* that their activity evenings are the second and fourth Thursdays in

Names and Addresses of Club Secretaries reporting in this issue :

ACTON, BRENTFORD & CHISWICK: W. G. Dyer, G3GEH, 188 Gunnersbury Avenue, Acton, London, W3-8LB.

BARKING: R. E. Clark, G8BXC, 62 Waltham Road, Woodford Bridge, Woodford Green, Essex, IG8-8DN.

BISHOPS STORTFORD: C. Harlow, G8BTK, Thorn Cottage, Old Mead Lane, Henham, Elsenham, Bishops Stortford, Herts.

BRITISH RAIL: L. C. Carter, G3ILC, 35 Barnfield Gardens, Kingston-upon-Thames, Surrey, KT2-5RH.

B.S.C. PORT TALBOT: A. J. Glassford, GW3ACF, 13 Sunningdale Road, Baglan, Port Talbot, Glam. (*Criton Ferry 812475.*)

BURY & ROSSENDALE: C. Kirby, G8HQW, 2 St. Peter's Place, Haslingden, Rossendale (*4915*), Lancs.

CORNISH: H. Webster, G3XTF, Crandale, Gillyfields, Redruth (*6905*), Cornwall.

CRAY VALLEY: P. F. Vella, G3WVP, *address wanted.*

CRYSTAL PALACE: G. M. C. Stone, G3FZL, 11 Liphook Crescent, London, SE23-3BN. (*01-699 6940.*)

DERBY (Nunsfield House): I. Cage, G8GBV, 25 Petersham Drive, Alvaston, Derby, DE2-0JU.

ECHELFORD: A. J. M. Wenham, G3ZXA, 28 Pinewood, Sunbury-on-Thames (*86440*), Middx., TW16-6SG.

EDGWARE: A. J. Masson, G3PSP, 62 Coldharbour Lane, Bushey, Herts., WD2-3NY. (*01-950 6827.*)

GRAFTON: H. du V. Ashcroft, G8AYU, 86 Avondale Avenue, Finchley, London, N12-8EN. (*01-445 8477.*)

HARROW: L. Light, G3KDL, 22 Old Chippenham Avenue, Wembley, Middx. (*01-902 2570.*)

HEREFORD: S. Jesson, G4CNY, 181 Kings Acre Road, Hereford.

MAIDSTONE YMCA: G. H. Taylor, G4BNI, 26 Valley Drive, Loose, Maidstone (*43976*), Kent.

MELTON MOWBRAY: R. Winters, G3NVK, 32 Redwood Avenue, Melton Mowbray (*3369*), Leics.

MID-LANARK: D. H. Plumridge, GM3KMG, 7 Waterside Gardens, Hamilton (*28759*), Lanarks, MK3-7PY.

MIDLAND: A. L. Walton, G3ZKQ, 243 Barnes Hill, Birmingham, B29-54J.

MILTON KEYNES: T. M. Rabbitts, G8HUH, 39 Vandyke Close, Woburn Sands (*583706*), Milton Keynes, Bucks., MK17-8UU.

NEWQUAY: A. G. Johnson, G3THT, 41 Cranbrook Street, Newquay, Cornwall, TR7-1JJ.

NORTHERN HEIGHTS: A. Robinson, G3MDW, Candy Cabin, Ogden, Halifax (*64329*).

NORTH KENT: R. Wells, G4ARQ, 12 Bullbank Road, Belvedere.

NOTTINGHAM: S. F. Claringburn, G8HLD, 49 Fernleigh Avenue, Westdale Lane, Nottingham, NG3-6FN.

R.A.I.B.C.: S. R. Boakes, G3HXN, Cambridge Villa, Bristol Road, Cambridge, Gloucestershire, GL2-7BQ.

REIGATE: F. H. Mundy, G3XSZ, 2 Conifer Close, Reigate (*43130*), Surrey.

SHEFFIELD (Amateur Radio Club Association): P. Day, G3PHO, 39 St. Albans Road, Sheffield 10 (*306956*).

SILVERTHORN: C. J. Hoare, G4AJA, 41 Lynton Road, South Chingford, London, E4 9EA. (*01-529 2282.*)

SOLIHULL: L. G. Boswell, G4AEJ, 170 Kestrel Avenue, Yardley, Birmingham B25-8QX.

SOUTH BIRMINGHAM: R. J. Thompson, G8GDZ, 23 Fox Hill, Selly Oak, Birmingham, B29-4AG. (*021-472 0533.*)

SOUTHGATE: B. Oughton, G4AEZ, 48 Morley Hill, Enfield. (*01-366 7166.*)

STAR (Leeds): T. Leeman, G4BUU, 115 Asket Drive, Seacroft, Leeds, LS14-1HX.

STEVENAGE: C. Barber, G4BGP, 473 Canterbury Way, Stevenage, Herts., SG1-4EQ.

STOCKPORT: G. R. Phillips, G3FYE, 6 Ross Avenue, Davenport, Stockport.

SUTTON & CHEAM: A. Keech, G4BOX, 26 St. Albans Road, Cheam, Sutton, Surrey.

THAMES VALLEY: R. J. Blasdell, G3ZNW, 341 Walton Road, West Molesey, Surrey, KT8-000.

THORNTON CLEVELEYS: F. Hill, G3YWH, 45 Preston Old Road, Blackpool FY3-9PR.

VERULAM: H. Young, G3YHY, 93 Leaford Crescent, Watford (*25633*), Herts., WD2-5JQ.

WEST KENT: M. Stanton, G4CCQ, Sweetbourne Cottage, Hastings Road, Lamberhurst (*393*), TN3-8JG.

WEST OF SCOTLAND: K. Drinkwater, 41 Southesk Avenue, Bishopbriggs, Glasgow. (*041-772 3085*).

WHITE ROSE: K. R. Robson, G3VTY, Flat 7, 34 Saint James Drive, Horsforth, Leeds.

WIRRAL: F. Smith, G3YGL, 72 Church Road, Bebington.

YEovil: D. L. McLean, G3NOF, 9 Cedar Grove, Yeovil, Somerset.



Each year the Silverthorn Radio Club organise their own summer camp for members, when they go out for a long week-end at Lambourne End, Essex, with GB3SRC on the air. At left is the aerial erection party and above the operating tent, with G2HR (extreme left) the originator of the whole idea, looking on—he is one of those who has done a great deal for Amateur Radio.

the month, at the United Reformed Churches Hall, Bexleyheath Clocktower, the entrance being in Chapel Road. November 14 sees portable activity for the 23 and 70 cm. bands, under G4ALN, while on the 28th, the sales manager of Adcola is to give the talk.

The Cray Valley newsletter *QUA* is a well-produced four-page compilation, with a lot of interesting information—including an article, digested from *Nature*, leading to the unhappy conclusion that the next sunspot peak will not be until 1982—and a note to the effect that "the next mid-monthly meeting will be on October 17," which does not help us at all! Anyway, what we can say is that their well-attended meetings are held at the Reformed Church Hall, Court Road, Eltham, S.E.9, on Thursday evenings. We have the name/callsign of the hon. secretary, but not his address, as required for the Secretaries' Panel. In the meantime, he is assumed to be *QTHR*.

For Silverthorn, meetings are on a Friday evening at Friday Hill House, Simmons Lane, Chingford, with G3SRA/G8CSA active on all bands. Their next get-together is November 15.

Saturday, November 6 at Emmanuel Church Hall, Barry Road, London S.E.22 is the date for Crystal Palace for a Technical Film Show. Looking back a bit, they had a bit of a disaster on VHF/NFD, apart from the awful weather that hit most groups, in that their newly-repaired generator ran a big-end after five minutes, putting its con-rod through the crankcase side—the big-end bearings were picked up five feet away!

It should be an interesting evening for the impecunious types on November 20 at Verulam, because G3IKG is going to give a talk on the restoration of old communications receivers, and in particular, continental ones. On December 18, we are warned, comes the AGM, at which the attendance of all members is requested—both meetings are at the Market Hall, St. Albans, and visitors are welcome, 7.30 for 8 p.m. They have open contests on Two Metres (November 24) and Top Band (December 1st). Rules and information from the hon. secretary, G3YHY, address as in Panel.

Looking North

Up in Leeds, one of the local groups is the Star Short-Wave Club, with Hq. in the New Inn, Bramley Town Street, every Wednesday evening. A specially important event comes up on November 13 with the Annual Film Night for which some interesting stuff has been booked. In addition, now the club has a Liner-2, they put it on 144 MHz on club-nights, and also each weekend they take it to a site just north of Leeds, Guiseley, where they operate from 1,000 feet above sea-level with a ten-element beam, the gear being in a caravan.

Throughout the year, says their publicity chap, the West of Scotland crowd get together on every Friday; the programme through the coming months is to run talks, visits and film-shows and so forth in the Club room at 81 Virginia Street, Glasgow G11.

Right to the Southern border of the area now, to Bury and Rossendale and the Mosses Community Centre, Cecil Street, Bury, where they can be found on the second Tuesday of each month, and informally on any other Tuesday. There is a Club station set up, and the recent purchase of a multi-band vertical aerial means it should by now be activated.

It is some years now since any "combined operation" by a consortium of Clubs, as a regular thing, has occurred. It has come up again, in Sheffield where the University group, the Polytechnic chaps, and the Sheffield ARC have set up shop together. A common meeting with a really first-class speaker is held on the first Monday in the month; both November 4 and December 2 are at Room 3107 in the Polytechnic, but this is not an invariable rule. On November 18, member Club Sheffield will be running a home constructor contest with two prizes, one of which, last year, went to a device built into a baked-beam can, for resourcefulness! For all the information on the Association and the member clubs, contact G3PHO—see Panel.

Back across the border again, to Mid-Lanark. On November 8, there is a talk on Slow Scan TV, given by GM3ULP, and on November 22, GM3OXX shows the way to get started on 10 GHz—3 centimetres no less—with no more than a reasonable aptitude with a soldering-iron. If what he says is true (and one does not think of GM3OXX as being at all likely to have to eat his words) then this should be turned into a tape-and-slide lecture and passed round the country to encourage others. On the other Fridays, the informals give a chance for a natter, for Morse practice, and for operating the club FT-250. Look in on them at Wrangholm Hall Community Centre, Jerviston Street, New Stevenston, Motherwell.

Another good scheme—they always seem to come in batches—is the suggestion put forward by the White Rose crowd; they propose to activate the Club station on 3735 kHz at 10 a.m. on November 3, and every succeeding first Sunday in the month, specifically to try and work the stations of other Clubs, for an interchange of news and views. For themselves, they could say they can be found on any Wednesday evening at 83 Town Street, Armley, Leeds, with a "special" session when G3VTY will talk about home wine-making—

MCC FOR 1974

The Magazine Top Band Club Contest, the 29th in the series, takes place over the week-end November 16-17. Rules appeared on p.439, October. Check them carefully and start getting ready now.



Crowd scene at the Derby Mobile Rally, organised each year by the Derby & District Amateur Radio Society. This photograph was taken on August 11—can you see yourself?

nd there is a hint of some samples to test!

A new HQ falls to be mentioned, for the Thornton Cleveleys chaps, who now assemble at the St. John Ambulance Hall, Fleetwood Road North, next to the Gardeners Arms, Thornton. They will be there on the first and third Wednesday in each month starting at 8, but with a half-hour of Morse practice before, from 7.30.

Northern Heights join us again, with meetings scheduled for November 6 and 20th, still regularly at the Peat Pitts Inn, Ogden, with a good turn-out, according to their indestructible hon. secretary, our old friend G3MDW.

Midlands

A really lively group is based on Nunsfield House Community Association, Nunsfield House, Boulton Lane, Alvaston, Derby. The big event for them recently was that they now have a room of their own, instead of needing to put away all the tackle after each session. Outside, there is already a Versatower with HF and VHF beams up aloft, the shack is being re-decorated, and an amateur television station is well on the way to completion, part of the shack being used as a studio for this purpose. November 1 is an important night, as it is the AGM; otherwise you can visit them on any Friday evening.

An interesting variation on the normal sort of arrangement is noted for South Birmingham. Their routine is to have a formal meeting on the first Wednesday in each month at Hq. However, every Friday evening the Club shack is open to members and visitors; the place to aim for is West Heath Community Centre, Hampstead House, Fairfax Road, West Heath, and the next formal session is on November 6, when there will be an AGM *plus* a Constructors Contest.

Not so very far away is Solihull who have booked G3TFA, Secretary of the Coventry outfit, to come along and talk about the theory of D/F working, illustrated by slides, on November 19. This will be at the Manor House, High Street, Solihull.

It is not very often that we hear from the lads at Melton Mowbray, but on the odd occasions when they do pop up, things always seem to be running nice and smoothly. On November 15, they have a series of slides and commentary entitled "Moonshot" obtained by H. Miles on his recent trip to Zeiss in Germany. The usual place for them to foregather is the St. John Ambulance Hall, Asfordby Hill. In addition to the routine meetings there, plans are afoot for some outside visits to places of interest, and for a lecture programme after the beginning of the New Year.

Although the current copy of M.A.R.S. *Newsletter* doesn't look far enough ahead for your scribe, the secretary covered the position by adding his own letter. It seems that the Midland Surplus Sale is on November 19, at Hq., which is the well-known Birmingham and Midland Institute in Margaret Street.

On Thursdays, the members of the Nottingham group all head for Woodthorpe House, Mansfield Road, which is the Club Hq. November 3 is a Forum, the 10th a Junk Sale, 17th an Activities Night, and on the 24th you are asked to bring along your VHF gear. Finally, on the 31st, the month ends with a tape-and-slide lecture. Incidentally, if you are within the catchment area of this group and in need of Morse training, get to them quickly, as another course, starting from basics, is about ready to begin.

Stockport next, where they can be "contacted" by attending at Blossoms Hotel, Buxton Road on meeting-nights, as follows: November 13, when G3MYT is going to talk about KL7-land, otherwise known as Alaska; and November 27 is down for a talk about a Noise Bridge, to be given by G3PEK.

At Wirral the *Newsletter* editorial discusses the case of a member who made serious criticisms of the Club over the air. Frankly, had it happened in your scribe's own group, good care would have been taken to see the offender booted out, in view of the allegations made. By now the AGM will have been held, and maybe the members will have paid him out by electing him to an office to do his penance—but we suspect that he wouldn't be within miles of Hq. on AGM night if he thought there were any risk of having to *do* anything to help run the Club! However, regardless of such nonsense, the majority turn up as always on the first and third Wednesdays of each month at the Sports Centre, Grange Road West, Birkenhead.

Homeless

No, we don't mean that too literally; we refer of course to the organisations which are national or international in character.

The first one on this clip is British Rail who have their "meetings" by correspondence in the *Newsletter*. This one is open to all amateurs and SWL's belonging to British Rail and its subsidiary organisations; for details, get in touch with the secretary at the address in the Panel.

Of course there is one lot who come into this category who must never be forgotten; we refer to R.A.I.B.C., who cater for the needs of the invalid and bedfast radio types, both SWL and licensed amateur. If you know anyone like this, get them signed up; and while you are at it sign up yourself, either as a representative, to help actively, or as a supporter with your subscription. All the details can be obtained from G3HXN, as Panel.

Finale

For this month, anyhow. Your next month's letters and newsletters should contain the story for December, and should be posted to arrive by first post on November 6, for the January issue it will be December 5—addressed as always to "Club Secretary," *SHORT WAVE MAGAZINE*, BUCKINGHAM, MK18-1RQ. Meantime, Good Luck in MCC.

Technical Books and Manuals

(ENGLISH AND AMERICAN)

AERIAL INFORMATION

ABC of Antennas	O/S
Aerial Handbook (Briggs)	93p
Antenna Handbook, Volume 1	£1-84
Antenna Round-Up, Volume 1	£1-55
Antenna Round-Up, Volume 2	£1-85
Beam Antenna Handbook, 4th Edition	O/S
Quad Antennae, 2nd Edition	£1-87
Simple Low Cost Wire Antennas	£1-80
Vertical, Beam and Triangle Antennas (E. M. Noll, "73")	£2-60
Dipole and Long-Wire Antennas (E. M. Noll, "73")	£2-38

BOOKS FOR THE BEGINNER

Amateur Radio (Rayer)	£1-68
Beginners Guide to Radio (7th Edition)	£1-20
Beginners Guide to Transistors	£1-20
Beginners Guide to Colour TV	£2-13
Beginners Guide to Electronics	£2-08
Better Short Wave Reception, 3rd Edition	£1-88
Course in Radio Fundamentals	£1-21
Fascinating World of Radio Communications	£1-83
Foundations of Wireless and Electronics	£2-13
Guide to Amateur Radio	90p
Ham Radio (A Beginners Guide) by R. H. Waring	£1-75
How to Become a Radio Amateur	70p
Learning the RT Code	33p
Morse Code for the Radio Amateur	27p
Radio, by D. Gibson	92p
Radio Amateur Examination Manual	95p
Simple Short Wave Receivers (Data)	95p
Understanding Amateur Radio	£1-47

GENERAL

ABC of Electronics (by Earl J. Waters)	£1-68
FM & Repeaters for the Radio Amateur	£1-70
ABC of FET's	£1-40
Easibinder (to hold 12 copies of "Short Wave Magazine" (together)	£1-25
FET Principles, Experiments and Projects	£2-25
Making Transistor Radios (R. H. Waring)	O/S
Guide to Broadcasting Stations (7th Edition)	88p
Ham (Radio) Notebook	£1-76
Having Fun with Transistors	£1-67
110 Semi-Conductor Projects for the Home Constructor (Iliffe)	£1-90
How to Listen to the World (8th Edition)	£1-98
110 Integrated Circuit Projects for the Home Constructor (Hard Back)	£1-98
Know Your Oscilloscope (by Paul C. Smith)	O/S
Practical Transistor Theory	£1-60
Practical Wireless Circuits	£1-41
Prefix List of Countries	25p
Radio Engineers Pocket Book (Newnes) (N.E.)	£1-31
Shop and Shack Shortcuts	O/S
The Fascinating World of Radio Communications	£1-82
Test Equipment for the Radio Amateur	£2-10
Telecommunications Pocket Book (T. L. Squires)	£1-38
World Radio and TV Handbook, 1974 Edition	£3-15

Dictionary of Telecommunications	£2-45
--	-------

HANDBOOKS AND MANUALS

Amateur Radio DX Handbook	£2-25
Electronic Circuit Handbook, Vol. 1	£1-50
Electronic Circuit Handbook, Vol. 2	£1-50
New RTTY Handbook	£1-90
RTTY Handbook (Tab)	£2-68
Radio Amateur Handbook 1974 (ARRL)	£2-94
Radio Amateur Handbook 1974 (ARRL) (Hard Cover)	£3-74
Radio Amateur Operators Handbook	82p
Radio & Electronic Handbook	O/S
Radio Communication Handbook (RSGB)	O/S
RTTY Handbook	£2-64
RTTY A-Z (CQ Tech. Series)	£2-35
Surplus Conversion Handbook	£1-45
Slow Scan Television Handbook	£2-25
Television Interference Manual (G3JGO)	92p

USEFUL REFERENCE BOOKS

Amateur Radio SSB Guide	£1-65
Amateur Radio Techniques, 4th Edition	O/P
Care and Feeding of Power Grid Tubes (Elmas Division of Varian)	£1-69
Engineers Pocket Book, 6th Edition	£1-55
UK Call Book 1975, New Edition	£1-20
Hams' Interpreter	85p
Hints and Kinks, Vol. 8 (ARRL)	70p
Radio Amateur Examination Manual (N.E.)	95p
Radio Data Reference Book (3rd Edition)	£1-10
Radio, Valve and Transistor Data (Iliffe) 9th Edition	O/S
Service Valve and Semiconductor Equivalents	40p
Single Sideband for the Radio Amateur (ARRL) 5th Edition	£1-75
Single Sideband Theory and Practice by H. D. Hooton	O/S
Sun, Earth and Radio, by J. A. Ratcliffe	98p
Transistor Pocket Book	£1-64

TRANSISTOR MANUALS

ABC of Transistors	£1-40
Field Effect Transistors (Mullard)	£2-05
Having Fun with Transistors	£1-68
Handbook of Transistor Circuits	£2-45
Transistor Audio & Radio Circuits (Mullard)	£2-05
Transistor Fundamentals: Basic Semi-Conductor, Vol. III, and Circuit Principle, Vol. 1	each £2-02

VHF PUBLICATIONS

VHF Handbook, Wm. I. Orr	£2-65
VHF Manual (ARRL)	£1-45
VHF/UHF Manual (RSGB)	O/P

Amateur Radio Awards (RSGB)	£1-45
Questions and Answers on Radio and TV	90p
Integrated Circuit Pocket Book	£2-72
International Transistor Data Manual (Semicon)	£5-75
Teletypewriter Handbook (RSGB)	T.O/S

O/P (Out of print)

THE ABOVE PRICES INCLUDE POSTAGE AND PACKING

T. O/S (Temp. out of stock)

Many of these titles are American in origin

Available from

SHORT WAVE MAGAZINE

Publication Dept., 55 Victoria St., London SW1H 0HF - 01-222 5341

(Counter Service. 9.30-5.15. Mon. to Fri.)

(Nearest Station: St. James's Park)

(GIRO A/C. No. 547 6151)

STEPHENS-JAMES

LTD.

70 PRIORY ROAD, LIVERPOOL, L4 2RZ

Telephone: 051-263 7829

G3LRB - G3MCN

THE NORTH WEST'S
LEADING STOCKISTS OF AMATEUR
RADIO EQUIPMENT

YOUR CHOICE OF VHF EQUIPMENT - FM, CW, SSB, AM

FDK MULTI 2000 TRANSCIVER

Full coverage 144-146 MHz (148 MHz on receive). Separate I.F. strips for SSB/CW and FM. Antenna impedance 50 ohms. AC or DC operation. R.T. noise blanker. Tone call. 10 watts or 1 watt output. Deviation 3.5 kHz but adjustable up to 15 kHz. Carrier suppression better than 45 dB. Sideband suppression better than 50 dB. Complete with microphone. Digital read-out. PRICE **£291.60.**

MICROWAVE MODULES

2m. AM Transmitter ... **£35.10**
2m. Converters (state I.F.) ... **£16.40**
4m. Converters ... **£16.40**
432 MHz Converters ... **£19.44**
432 MHz Varactors ... **£18.90**
1296 MHz Converters ... **£25.92**
1296 Varactor Tripler ... **£27.00**
144 MHz Dual output Preamp ... **£9.72**

LINER 2 TRANSCIVER

2 metre SSB transceiver. 144-10-144-34 MHz. Electronically protected, P.A. Switched. Combines the advantage with direct frequency read-out, with the ability to tune between channels with the VXO. In addition the provision of R.I.T. which enables the Rx to be tuned to a kHz or two either side of the Tx frequency. DC operated. PRICE **£156.00.**

SOLID STATE MODULES

2m. Converter ... **£14.95**
70 Cm. Converter ... **£14.95**
PA3 Dual Mosfet Pre-amp ... **£5.94**
2m. FET Pre-amp ... **£7.31**
Europa SSB Transverters complete with valves ... **£88.00**
Transverters. Less valves ... **£74.00**

J BEAM

2m. 5 Element ... **£5.21**
2m. 8 Element ... **£6.51**
2m. 10 Element ... **£11.80**
2m. 14 Element Parabeam ... **£17.64**
All prices of beams include carriage. Send S.A.E. for full catalogue of rotators, beams, masts, clamps, etc.

ANTENNA ROTATORS

AR22R ... **£29.70**
AR30 ... **£27.00**
AR40 ... **£32.40**
CD44 ... **£64.80**
HAM-M ... **£85.32**

YAESU

FT101B Transceiver ... **£356.40**
FT401 Transceiver ... **£334.00**
FT200 Transceiver ... **£232.20**
FT75 Transceiver ... **£144.00**
FR400SDX Receiver ... **£226.80**
FL400 Transmitter ... **£208.44**
FL2100 Linear ... **£210.00**
YC355D Frequency Counter ... **£137.16**
SP400 Loudspeaker ... **£14.04**
FR101 Receiver ... **£356.00**

KW ELECTRONICS

KWV2000E Transceiver ... **£313.00**
KWV202 Receiver ... **£189.00**
KWV204 Transmitter ... **£226.00**
KWV1000 Linear Amplifier ... **£162.00**
KWV107 Antenna Matching Unit ... **£64.80**
KWV108 Monitorscope ... **£75.60**
KW E-Z Match ... **£21.60**
KW 160m. Tuning Unit ... **£17.28**
KW Balun ... **£2.75**
KWV 3 way Antenna switch ... **£5.40**

KW103 SWR/Power Meter

KW103 SWR/Power Meter ... **£15.12**
KWV109 Antenna Tuning Unit ... **£81.00**
KW Traps ... pair **£6.48**

HY-GAIN ANTENNA RANGE

12AVO 1-15-20m. Vertical ... **£21.60**
14AVT/WB 10 to 40m. Vertical ... **£31.91**
18AVT/WB 10 to 80m. Vertical ... **£45.86**
TH3MK3 Tribander Beam ... **£97.74**
TH3JNR Tribander Beam ... **£67.75**
LC80Q Loading Coil ... **£10.44**
BN86 Balun ... **£10.26**

AMTRON

Send S.A.E. for latest catalogue and price list on these exciting kits.

SPACEMARK

S.S.T.V. Monitor ... **£140.40**

COPAL CLOCKS

Model 228 24 hour alarm ... **£10.00**
Model 601 day/date 24 hour ... **£12.50**

G-WHIP MOBILE ANTENNA RANGE

Tribander Helical 10-15-20m. ... **£13.53**
40m., 80m. and 160m. coils, each ... **£4.51**
Telescopic whip for coils ... **£1.21**
Basemounts ... **£1.81**
Multimobile 10-15-20m. ... **£15.73**
40m., 80m. and 160m. coils ... **£4.51**
Telescopic whip for coils ... **£1.21**
Flexiwhip 10m. basic with basemount ... **£10.45**
Coils for 15m., 20m., 40m., 80m., 160m. each ... **£4.67**
Send S.A.E. for literature on this range.

MICROPHONES

Yaesu 844 Desk Microphone ... **£16.12**
Yaesu 846 Hand Microphone ... **£6.30**
Shure 201 Hand Microphone ... **£6.00**
Shure 444 Desk Microphone ... **£16.00**
Shure 444 Desk Microphone ... **£16.00**
Electro-Voice 619 Desk Microphone ... **£28.35**
Electro-Voice Desk Microphone ... **£14.25**
Electro-Voice 715 Hand Microphone ... **£7.45**

BARLOW WADLEY

XCR-30 Mk. 2 Solid State Receiver ... **£124.20**
TR801 FM Tuner ... **£17.15**

ACCESSORIES

Single Meter SWR Bridge ... **£6.60**
Twin Meter SWR Bridge ... **£11.00**
Diamond SR435 VHF/UHF SWR Bridge ... **£18.70**
Omega Noise Bridge TE701 ... **£14.85**
Omega Noise Bridge TE702 ... **£21.45**
B & W 5-way Antenna Switch ... **£9.00**
MF100 Audi Generator ... **£22.00**
3" Ceramic Insulators ... **20p**
2 1/2" Ribbed Plastic Insulators ... **10p**
Egg Insulators ... **8p**
PL259 Plugs ... **40p**
SO250 Sockets ... **40p**
Cable Reducers ... **14p**
Line Connectors ... **8p**
B/Lee aluminium co-ax plugs ... **10p**
300 ohm twin feeder ... **8p**
75 ohm twin feeder ... **8p**
UR43 50 ohm Co-Axial cable ... **16p**
UR67 50 ohm Co-Axial cable ... **40p**
UR203 75 ohm low loss Co-Axial cable ... **14p**
Morse Practice Oscillators ... **£2.75**
QSL Card Holders. Holds 120 cards ... **40p**
Tech 15 Grid Dip Meters ... **£20.00**
Multimeters ... from **£5.00 to £30.00**

SWAN

700CX Transceiver ... **£426.00**
508 Remote VFO ... **£106.00**
300B Transceiver ... **£307.00**
1200X Linear Amplifier ... **£189.00**
4 Element 20 metre beam available. Full range of Swan Accessories Direct from U.S.A.

SECONDHAND EQUIPMENT

Eddystone EB35 with AC PSU ... **£65.00**
Heathkit HR10 Rx ... **£50.00**
Yaesu FTD401 Transceiver ... **£245.00**
Yaesu FT200 Transceiver ... **£200.00**
Heathkit SB310 Receiver ... **£97.00**
M. Modules 2m Converter 4.6 I.F. ... **£12.00**
M. Modules 2m Converter 2.4 I.F. ... **£12.00**
M. Modules AM Transmitter and Receiver ... **£70.00**
Eddystone 680x Rx ... **£75.00**
Lafayette HA350 Rx ... **£54.00**
Sommerkamp FL200 Tx ... **£75.00**
Heathkit SB310 Receiver ... **£97.00**
Drake TR4 Transceiver. Remote VFO. HB Ac PSU ... **£225.00**

Due to heavy postal charges please forward S.A.E. with all general enquiries. All our prices include VAT. Postage extra on small items. Carriage charges by arrangement. We can arrange delivery and collections in some areas. We pay cash for good second-hand receivers, transmitters, transceivers. Send full details and the price you require. Our second-hand range changes quickly. Please let us have your requirements. If we do not have the model you want in stock, we will let you know as soon as we do. Full after sales service on all equipment. Three months guarantee on second-hand equipment.

PART EXCHANGES WELCOME

On the spot HP facilities. One third deposit, balance payable over 6, 12, 18 or 24 months. Credit terms 10% deposit and balance over 9 months.

Shop Hours—9.30 till 1 p.m., 2.15 till 6 p.m. Half-day Wednesday.

SEE OUR FULL RANGE AT THE AMATEUR RADIO RETAILERS ASSOCIATION EXHIBITION
GRANBY HALLS, LEICESTER, OCTOBER 31st, NOVEMBER 1st and 2nd, 1974

AMATEUR ELECTRONICS UK

BIRMINGHAM 021-327 1497 021-327 6313



An important announcement

AMATEUR ELECTRONICS UK ARE PLEASED TO ANNOUNCE THAT FOLLOWING A VISIT FROM MR. S. HASEGAWA, PRESIDENT OF THE YAESU MUSEN COMPANY, A MAIN YAESU MUSEN DISTRIBUTORSHIP HAS BEEN GRANTED TO US.

ALL THE YAESU RANGE WILL BE EXHIBITED AT THE LEICESTER SHOW, INCLUDING THE LATEST EXCITING NEW MODELS.

FULL DETAILS OF THE YAESU MUSEN RANGE WILL BE PUBLISHED IN NEXT MONTH'S ISSUE.

(BE SURE TO SEE OUR ADVERTISEMENTS ON OTHER PAGES)

ELECTRON HOUSE, 508-514 ALUM ROCK ROAD, BIRMINGHAM 8

RADIO & ELECTRONICS CONSTRUCTOR

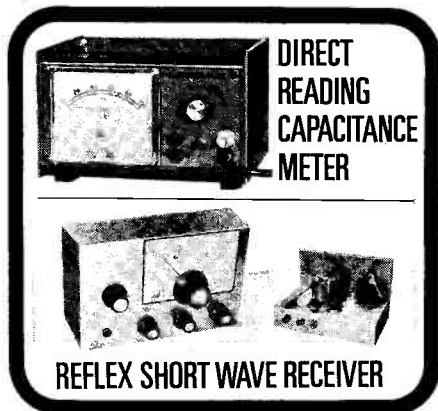

DIRECT
READING
CAPACITANCE
METER

REFLEX SHORT WAVE RECEIVER

NOVEMBER

Issue features

DIRECT READING CAPACITANCE METER

Employing 3 integrated circuits, this instrument measures the values of both non-electrolytic and electrolytic capacitors up to 10uF.

REFLEX SHORT WAVE RECEIVER

Intended for a crystal earphone or crystal headphones, this simple receiver can be initially constructed in the form of a single transistor circuit.

MANY OTHER ARTICLES

ON SALE 4th NOVEMBER

25p

ORDER NOW!

LOWE ELECTRONICS

SOUTHERN



TRIO · QR666

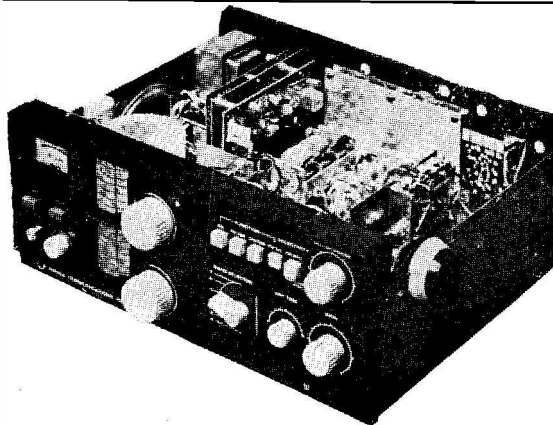

If you are north of London, Matlock is an easy motorway journey away but if you are rich enough to live in the stockbroker belt south of the river ("what river?" they all cry), then a trip to Steyning in Sussex is a must if you want to see the best in amateur radio gear.

Dave Pink will offer friendly assistance and genuine advice. The surroundings, although temporary, are comfortable and

quiet and you are assured of a warm welcome.

Wide ranges of new and second-hand equipment always in stock. If Dave hasn't got what you want, it will soon be there from Matlock.

Dave's place is in Goring Road, Steyning. Just off the A283 on the Shoreham side of the village. Half way down the road, look out for the tower on the left.

GORING ROAD · STEYNING · SUSSEX

Tel.: Steyning 814466

HAMGEAR ELECTRONICS

Introduce two new models for the winter season:—

P.M.IIFM, a 32 dBs preselector/antenna tuner with built-in calibrator. Preselector covering 1.5/34 MHz and the calibrator outputs are individually switched at :—1 MHz, 500, 100, 50, 10 kHz. Having a "bleep" tone modulator for easy and positive identification of the markers, giving a very pleasant and distinctive "two per second" "bleep" when switched in. Mains powered and priced **£28.50**.

P.M.IXA, separate calibrator, mains powered with individually switched outputs at :—1 MHz, 500, 250, 100, 50, 25, 10, 5 kHz, again with "bleep" tone modulator, priced **£25.50**.

The rest of our range being :—

P.M.IID, battery operated 32 dB preselector/antenna tuner, 1.5/34 MHz, priced **£11.50**.

P.M.IIDX, mains operated version of the P.M.IID, priced **£16.50**.

P.M.IIF, mains operated 32 dB preselector/antenna tuner, 1.5/34 MHz with built-in calibrator having individually switched outputs at :—1 MHz, 500, 100, 50, 10 kHz, no modulation, priced **£24.50**.

P.M.IIFB, mains operated 32 dBs preselector/antenna tuner, 1.5/34 MHz, with built-in calibrator having individually switched outputs at :—1 MHz, 500, 250, 100, 50, 25, 10, 5 kHz, no modulation, priced **£31.50**.

All our units :

- ★ Have identical 32 dBs preselector/antenna tuner sections, Fet front end followed by two Bipolars in cascade with negative feedback.
- ★ Will do a good job on your ant/receiver, especially with poor antenna situations, making the most of hard to hear DX stations.
- ★ Have the same new livery, bronze hammer surround with "teak" wood effect front panel.
- ★ Have the calibrator oscillators set to within 2 hz of absolute at 5 MHz.
- ★ Have the same minimal connections to your receiver, just a piece of screened lead to your receiver ant/earth terminals.

Prices plus 30p postage, please send 3½p stamp for details

HAMGEAR ELECTRONICS
2 CROMWELL ROAD, SPROWSTON, NORWICH, NOR 65R.

CW IS STILL VERY MUCH ALIVE!

SAMSON ELECTRONIC KEYSERS

—the choice of Ships and Coast Stations the world over.

Two different models:—

ETM-2b TRANSISTORISED KEYSER

Developed from the well-established ETM-2. Printed circuit, 11 transistors, 6 diodes. Ratio Control. Single paddle. Speed control, 8-50 wpm. Sidetone oscillator. Almost-inaudible sealed reed relay. Grey case 4" x 2" x 6". Powered by four ZM9 mercury batteries available world-wide. (Price includes batteries.) Well-engineered keying lever, fully adjustable gaps and tensions.

ETM-2b — with make-break relay contacts, (Ratings: 1A, 400V., 30W max.) Complete with mercury batteries, **£34.16** (or with penlite batteries, **£32.73**).

ETM-2bs — with spdt changeover relay contacts, (Ratings: 0.5A, 250V, 10W max.) Complete with mercury batteries, **£38.72** (or with penlite batteries, **£37.30**).

ETM-3b INTEGRATED CIRCUIT SQUEEZE-KEYER

Printed circuit with 4 ICs and 13 semiconductors. Twin paddles. Constant 3:1 ratio. Speed control, 8-50 wpm. Operate/Tune button. AC mains power supply, 110/220-240v. Almost-inaudible sealed reed relay. Grey case 4" x 2" x 6". The renowned SAMSON keying lever movement with fully adjustable gaps and tensions. Can be used either as an iambic mode squeeze-keyer (characters made with fewer paddle movements—you can make a "C" with one squeeze!)—or as a normal electronic keyer.

ETM-3b — with make-break relay contacts, (Ratings: 1A, 400v., 30W max.), **£37.85**.

ETM-3bs — with spdt changeover relay contacts, (Ratings: 0.5A, 250v., 10W. max.), **£42.36**.

— OR IF YOU LIKE IT STRAIGHT ...

JUNKER PRECISION HAND KEY

A superbly engineered straight hand key used for many years by professionals afloat and ashore. With this key you can't help but send good morse.

Free-standing—it does not have to be screwed to the operating desk. Good weight distribution and large rubber feet stop it sliding or rocking. Weight: 2½ lbs. Front and back contacts of precious metal, with fine adjustment of contact gaps by positive click-stop action. Lever-action spring tension adjustment. Spring pigtail at keying arm pivots ensures good contact. Insulated keying arm, moulded knob with rubber anti-slip insert. 3-way terminal block and cable clamp at rear. Key-click filter (L, C & R) built into base. Rear-hinged cover (with spring catch) and other metal parts finished in attractive hammertone grey. Base area: 3¼"W. x 7½"D. Overall height: 2½", **£16.29**.

BAUER KEYING LEVER UNIT

We have imported this popular unit for many years for inclusion in home-built electronic keyers. Adjustable contact gaps and spring tensions. Single paddle on moulded base 1½" x 2". Height: 1" (excluding paddle), so is compact enough to go inside most keyers, **£5.77**.

BUILDING CW FILTERS ?

Don't let RTTY and SSTV hog the **88 mH TOROIDS, 41p** each.

ALL PRICES INCLUDE VAT

All goods post-paid U.K. Send stamp for Catalogue SP5.

SPACEMARK LTD. THORNFIELD HOUSE, DELAMER ROAD, ALTRINCHAM, CHESHIRE.
(Tel. 061-928 8458)

IT'S HERE ! THE SUPER PARTRIDGE PACKAGE COMPLETE RADIO COMMUNICATION STATION FOR THE HOME — CAMPING — BOATING — ETC.

THE TREND LEADER, TRIO'S LATEST **QR666** SOLID STATE GEN. COVERAGE RECEIVER **£139.62** del. FREE (our risk), with FREE MATCHING HEADPHONES—OR—COMPLETE STATION. On the air in seconds from ANY LOCATION—DEL. FREE (our risk) **£157.58**.

THE SUPER PARTRIDGE PACKAGE comprises—

- QR666 Receiver, 170 kHz-30 MHz, ALL BANDS, ALL MODES, AM, SSB, CW (opt. FM) for Mains, Batteries, DC ext. supply. A TRULY BEAUTIFUL RECEIVER—EXTENDED BANDSPREAD—NO THERMAL DRIFT—MECH. AND CERAMIC FILTER—DUAL GATE MOSFETS. SINGLE AND DOUBLE CONVERSION—AND SO SIMPLE AND PLEASANT TO OPERATE.
- FREE MATCHING HEADPHONES, lightweight, comfortable, hygienic.
- World Record ALL BAND patented VFA aerial in beautiful gold stove enamel, hammer finish (7ft. 6in. long).
- Made to match, the QR666, the JOYMATCH 111B A.T.U. (also gold stove enamel).
- All necessary cables. THE COMPLETE RADIO STATION FOR ANY LOCATION. **£157.58 del. (our risk)**

JOYSTICK VFA + JOYMATCH 111B (SYSTEM "A") for modern communications receivers	£29.58 del.
JOYSTICK VFA + JOYMATCH LO-Z500, with RF meter, transmitting 500w. PEP (SYSTEM "H")	£36.27 ..
JOYSTICK VFA + JOYMATCH LO-Z500X with no RF meter, transmitting 500w. PEP (SYSTEM "J")	£33.59 ..
JOYMATCH tuned AERIAL SYSTEM for ANY MW and SW communications or Solid State receiver	£5.87 ..
JOYMATCH Artificial Earth for MW and SW, as used on North Sea Oil Rigs	£5.87 del.
Communications HEADPHONES, 8 ohm. Suitable most modern comm. receivers	£3.39 ..
VALVES: Complete replacement set for 9R59DS and 9R59DE	£4.75 ..
AERIAL WIRE, heavy duty 16 SWG enamelled aluminium. Per 10 metres	£0.59 ..

Send 4½p stamp for complete details of PARTRIDGE PRODUCTS AND TRIO QR666.



BOX 4 **PARTRIDGE ELECTRONIC LTD.**
BROADSTAIRS, NENT ENGLAND

G3CED — G3VFA
FOR EXPERT ADVICE AND INFORMATION
Telephone: 0843 62535 or 62839
evenings and weekends

SOLID STATE MODULES

**63 WOODHEAD ROAD, SOLID, LOCKWOOD
HUDDERSFIELD, HD4 6ER**

Telephone: 0484-23991

Manufacturers and Suppliers of Communications Equipment

MEMBER OF THE A.R.R.A.

NEW—SM 71 70 cms. PRE-AMPLIFIER

As a result of a contract to manufacture a very high performance pre-amplifier in the 70 cm. region for government use, we are now releasing these for 70 cm. Amateur Band use. This is a two stage FET pre-amplifier with an 18 dB gain and 3.5 dB noise figure. It also adds much greater selectivity to the average 70 cm. converter. Size 2½ in. x 4 in. x 1½ in. Price **£9.72**.

SEE YOU AT GRANBY HALLS, LEICESTER, WHERE WE'LL HAVE PLENTY OF STOCK FOR YOU. WE SHALL BE WITH THE AMATEUR RADIO SHOP, G4MH, IN THE MIDDLE OF THE HALL, IF YOU WANT ANY INFORMATION, PLEASE ASK.

I'll do a little plugging for the firm this month, if you want more information on the products, you can look at other Magazines, or ask us.

We have been concentrating on the manufacture of Amateur VHF gear for nearly seven years now, and if you look back at the adverts in Amateur Radio magazines over the years, you'll find that our competitors come and go pretty quickly. This has been achieved, not by anything that I have said, but by what you, the customer, says, in other words, our equipment has sold itself.

We've done our bit by following a policy of constant development. When one thousand units have been aligned, a fault may come to light which only appears on one in fifty units and these we can design out. To help with this we have bought thousands of pounds-worth of test gear, this helps us too, of course, by speeding up development and alignment, and giving us confidence in the products we make. This confidence, and the fact that we want to keep in touch with our customers, all over the country, is why we invite queries in our adverts. You won't find many manufacturers inviting comment before and after sales.

Finally in answer to the question which most people ask when they come here, "Do you do it all yourself?" The answer is no, we have full-time sales, development, administration and production people.

Prices including VAT;

THE EUROPA 10 to 2 metre or 4 metre transmit and receive converter	£88.00 complete
	£74.00 less valves.
4 metre J Beam...	£6.70 plus £1.50 carriage
Additional 12, 6V a.c. transformer for FT401, FL400 etc. £3.24
OR in a case matching the Europa £6.37
2 metre Sentinel low noise FET pre-amplifier	£7.36
2 metre miniature dual gate Mosfet pre-amplifier PA3... £5.94
2 metre Sentinel dual gate Mosfet converters £16.20
2 metre Sentinel "X" dual gate Mosfet converter with a.c. PSU £21.06
2 metre Sentinel M.F. medium wave converter £20.25
SM70 70 cm. FET converter £16.20
SM71 70 cm. FET pre-amplifier £9.72
2 metre Sentinel converter kit (28-30 MHz only) £11.00

To obtain any of our products. We can despatch by return of post. We give same day COD Service (£50 limit). You can call in here to look at the gear. Queries? Write or ring if you have any questions. 12 months' guarantee on our products. Paul G3MXG.



In addition to our normal range of
MOBILE ANTENNAE
we announce a new series of
WINDOW CLIP ASSEMBLIES

For 2 metres :

"C Plane" 5/8 wave window clip assembly (CPW58). A 5/8 wave radiator with integral ground plane, which can be used away from the vehicle when required **£8.24** inc. VAT

For 4 metres :

"C Plane" ½ wave window clip assembly (CPW14). A ½ wave radiator with integral ground plane, terminated to 50 ohms. This can also be used away from the vehicle when required **£6.14** inc. VAT

Carriage on either unit:
Inside the U.K. (exc. N. Ireland) **£1.00**
Northern Ireland **£1.50**

MORE IN THE PIPELINE, SO KEEP WATCHING

ANTENNA & ELECTRONIC CONSULTANCY

74 Upper Sherborne Road, Basingstoke, Hants., England
Telephone : Basingstoke 27527

T.M.P. ELECTRONIC SUPPLIES

The full range of Sommerkamp equipment, accessories and spares can now be supplied, including the FT277B transceiver, which can also be demonstrated by appointment using a 3 element beam on 10, 15 and 20m, and a dipole system on the other bands. All genuinely interested persons will be welcome, but please do write or telephone in advance.

Carriage: On new and the used equipment below it will be a pleasure to deliver personally to most areas of Wales and the border counties at the cost of fuel, buyers can collect of course but Securicor or BRS Red Star can be used.

Used items in as new condition

FT200 and FP200	£180.00
Eddystone 830/7	£330.00

Finance can be arranged on all equipment where required.

For Sommerkamp price lists, toroidal core data and prices, etc., send a foolscap s.a.e. to the office address below.

: BRYN CLYD, LEESWOOD, MOLD, CLWYD, CH7 4RU
Tel.: Pontybodkin 846 STD Code 035 287

SMALL ADVERTISEMENTS

("SITUATIONS" AND "TRADE")

6p per word, minimum charge £1.00. No series discount. All charges payable with order. Insertions of radio interest only accepted. Add 50% for Bold Face (Heavy Type). Box Numbers 15p extra. No responsibility accepted for transcription errors. Replies to Box Numbers should be addressed to The Short Wave Magazine, 55 Victoria Street, London, SW1H 0HF.

QSL CARDS and G.P.O. approved logs (hard back), prompt delivery. Send 5p s.a.e. for samples.—Lintree Press, Looe, Cornwall, PL 13-1JT.

QSL CARDS: £4.75 per 1,000. Send for samples. — Chas. Baker, 52 Roundwood Road, St Leonards-on-Sea, Sussex.

QSL CARDS: Full range, send s.a.e. for samples.—R. J. Craven, 6 Broadtree Close, Mellor, Nr Blackburn, Lancs.

DECEMBER issue: Due to appear November 29. Single copies at 36p post free will be sent by first-class mail for orders received by November 27, subject to supplies being available. — Circulation Dept, Short Wave Magazine Ltd, 55 Victoria Street, London, SW1H-0HF.

SUPER CONSTRUCTOR'S PACK: Containing 50 assorted spacers, 4 and 6 BA clearance and threaded types; two 6-in. extension shafts; two couplers; two 2-in. extension shafts with couplers attached; twelve-inch lengths each of 2-4-6 BA brass studding (3ft.); 20 tag strips; two trimmer converters; 100 mixed self-tapping screws, plus a free gift. The lot a bargain at £1.65, including postage.—Electro-Mech Products, 7 Chantry Avenue, Bideford, Devon. (Tel: 6820).

IMPORTANT Announcement for Yaesu owners: Send s.a.e. for free/sample "FT Newsletter", essential reading for Yaesu owners.—G3LLL, Holdings Ltd., 39-41 Mincing Lane, Blackburn, Lancs. B52 2AF. (Tel: 59595/6).

W18, eighteen-inch Wall Brackets, with U-bolts, price £3.30 plus part carriage 70p. — Ballards, 108 Camden Road, Tunbridge Wells, Kent, TN1 2QX. (Tel: 31803).

READERS ADVERTISEMENTS

3p per word, minimum charge 50p payable with order. Add 25% for Bold Face (Heavy Type). Please write clearly, using full punctuation and recognised abbreviations. No responsibility accepted for transcription errors. Box Numbers 15p extra. Replies to Box Numbers should be addressed to The Short Wave Magazine, 55 Victoria Street, London, SW1H 0HF.

MANUALS: Most makes available, s.a.e. for list of 250.—Brooks, 5 Farrant House, Winstanley Road, London S.W.11.

FOR SALE: Braided terylene, breaking strain 600-1,000 lbs., ideal for guy ropes or halyards, 1½p per yard. Postage/packing any order, 10p. Send s.a.e. for sample.—French, Post Office, Groomsport, Co. Down, N. Ireland.

WANTED: HW-12 with HP-23 AC power supply. Also pair of walkie-talkies working on 27 MHz. Details and price please.—Hayes, G3JBU, QTHR.

EXCHANGE: Mint condition Liner-2, pre-amp. with mic. and battery PSU; also 4 and 8 element J-Beams, and halo. FOR: HW-101 or similar 80-10m. transceiver.—Brown, G3NXX, 3 Honister Drive, Kendal, Cumbria.

WANTED: General coverage receiver, such as SX-100, SX-122, 940, 730/4, Drake, or similar. Also half or three-quarter size billiard table. Can collect. FOR SALE: Hammarlund HQ-100, £62. CR-70, £16. Grundig SW, £16. All in excellent condition. — 12 Malton Way, York. (Tel: York 59035).

WALKIE-TALKIE 14 valve 4 channel No. 88 ex-WD transmitter/receiver unit, £6.50, p/p 75p. No. 19 ex-WD used transmitter/receiver, £6.50, p/p £1.50. **SALVAGE TELEMETERS** multi-valve receiver, speaker, amplifier and tape unit, vast value, sealed cartons, new, £4.50, p/p 50p. **PADDED** moving coil ex-WD earphone, £1.25, p/p 25p. **STEEL BOXES**, hinged, clasped, ex-WD, 31" x 13½" x 2½" ideal security, £2, p/p 75p. A bargain. **A.C. 110v. SMALL** geared and un-gearred motors, £1.25 pair, p/p 25p. **HELETS**, steel ex-WD unused, £1.25, p/p 37p. **MOBILE** 12 volt ex-WD transmitter/receiver type 88 AFV set, £13.00, carriage £1.40. **EYESHIELDS** anti gas goggles, 36 packet, £1.00, p/p 25p. **GRUNDIG** valved Stenorette units, £4.00, p/p £1.00. Office, tape, speech recorders. **REMINGTON** valved office speech recorders. Vast value, £4.00, p/p £1.00. **SPEAKERS**, 8" x 5", 3Ω, 2 for £2.50, p/p 50p. **CARSEAT** Britax 2 point safety belts, new, 2 for £5, p/p 50p. A bargain. 16 kV. New ex-WD meters 3½", £4.50, p/p 25p. **CARBON** power microphone unit, 45p, p/p 15p. **AUTO TRANSFORMERS**, 110v. 75w., £1.00, p/p 25p. **COUNTERS** new ex-WD 4 figure 2300Ω, 2 for £1.00, p/p 25p. **EX-WD** 4ft. tank aerial top sections, 3 for £1.00, p/p 50p. Vast stocks of ex-WD and factory surplus at

SOUTHERN SURPLUS MERCHANTS LTD.

66/68 London Road, Kingston-upon-Thames, Surrey

Callers welcome 9-6 Monday to Saturday

HONDA GENERATORS

AT COMPETITIVE PRICES

Models 300-4000 watts A.C. and 6, 12 and 24 volts D.C.

IMMEDIATE AVAILABILITY MORE LIKELY BEFORE THE WINTER.

For full details, terms and **COMPETITIVE PRICES WHICH INCLUDE FREE DELIVERY IN THE UNITED KINGDOM**, Call, Write or Phone **GODALMING 23279**. Open Tues. - Sat.

Ashley Dukes

FARNCOMBE STREET,
FARNCOMBE,
GODALMING,
SURREY

25p MULTITESTMETERS

EX-GOVT. TEST METER No. 1, size: 3½" x 3¼" x 2½", wt. 1½ lbs. 0-15v., 0-3v., 0-60 m/a, 0-5,000Ω, room inside for extra ranges. Movement OK but need servicing—most needles sticking, 25p + 2p VAT + 23p carr.

1 watt Audio Amp. I.C. with data, 40p + 4p carr.
Wide Band Amp. and FM Discriminator I.C. and data, 25p + 4p carr.
Optical Couplers (Light and LDR) for Audio A.V.C. or sound light conversion with data, 45p + 4p carr.
Decca Marine True Motion Radar, £28 to clear.
Echo Sounders, £11. Buyer collect last 2 items.

ELEY ELECTRONICS

102 BEATRICE ROAD, LEICESTER

MORSE MADE EASY !!!

FACT NOT FICTION. If you start **RIGHT** you will be reading amateur and commercial Morse within a month. (Normal progress to be expected.)
Using scientifically prepared 3-speed records you automatically learn to recognise the code **RHYTHM** without translating. You can't help it. It's as easy as learning a tune. 18-V.P.M. in 4 weeks guaranteed. For Complete Course 3 Records & Books send £4.95 including P.P.I. etc. (overseas £1 extra.)
For further details of course Ring 01-660 2896 or send 4p stamp for explanatory booklet to:—S. BENNETT, G3HSC (Box 14) 45 GREEN LANE, PURLEY, SURREY

WANTED

PYE RADIOTELEPHONE EQUIPMENT

Top Prices Paid

B. BAMBER ELECTRONICS

20 Wellington Street, Littleport, Cambs.

Tel. ELY (0353) 860185

C. & C. ELECTRONICS

MAIL ORDER CRYSTALS

50 ppm fundamental crystals 4 MHz to 21 MHz in HC6/U, HC18/U, HC25/U	£2.93
50 ppm overtone crystals 21 MHz to 105 MHz in HC6/U, HC18/U, HC25/U	£2.95

Normal delivery time 5 weeks

STOCK CRYSTALS

Suitable for Pye Cambridge FM10B/D and other equipment.

Repeater Channel R5 TX 4-03125 MHz RX 45-00833 MHz

Repeater Channel R6 TX 4-03194 MHz RX 45-01666 MHz

Repeater Channel R7 TX 4-03264 MHz RX 45-02500 MHz

145 MHz TX 4-02777 MHz

145.5 MHz TX 4-04166 MHz RX 44-93330 MHz

145.55 MHz TX 4-04306 MHz RX 44-95000 MHz

Suitable for Pye Cambridge AM10B/D and Storno Viscount TX

Repeater Channel R5 TX 8-06250 MHz

Repeater Channel R6 TX 8-06389 MHz

Repeater Channel R7 TX 8-06528 MHz

Storno Viscount RX crystals

Repeater Channel R5 RX 10-37643 MHz

Repeater Channel R7 RX 10-38000 MHz

145 MHz RX 10-3246 MHz

145.5 MHz RX 10-36036 MHz

All the above crystals are in HC6/U, price £2.50 each.

For any other crystal specification send s.a.e. for price quote 10% discount on orders of 5 or more crystals

Add 10p for post and packing on orders under £12

TRADE ENQUIRIES WELCOME

C. & C. ELECTRONICS

10 WEST PARK, LONDON, SE9 4RQ

WANTED: Mast and aerial for 10 to 160m.—Ring Saefer, Street 2170 (Somerset).

WANTED: Drake T-4X or T-4XB with AC4, must be in mint condition.—McAlister, G3YFK, The Holmes, Kinton, Nesscliff, Salop.

SALE: Philips 4-track tape recorder, £20. Pye QQQV03/10 RF unit on two metres, £6. Pye Ranger on 4 metres, £4. 160m. Tx, £5. Two PSU's, £2.50 each. "G3LKG" 2-metre converter, £6. HRO-Jr. with PSU and GC coil packs, £10. Marconi 52 Set Rx, coverage 1.75-16 MHz, with PSU, £7.50.—Woolley, G2FRO, QTHR. (Tel: Draycott 2598).

SELLING: FT-75 transceiver with mobile PSU, £110. Magnum Six, suitable for Drake T-4X, T-4XB, etc., £55. Hy-Gain 40m. compact beam, £80 or near offer. Drake T-4X with PSU, £180.—Bennett, G3WJN, 654 Rvesham Road, Crabbs Cross, Redditch, Worcs B97 5LJ. (Tel: Astwood Bank 3339).

FOLLOWING Interesting Items for sale: Hartley double-beam oscilloscope, Type CT-436, a very high quality instrument, £50. **AR88D** with speaker and manual, very clean, £40. **Two J-Beam** 14-le 75-ohm Parabeads, brand new, the latest type, £12 each. **National NCX-5 VFO** and calibrator, £40. **T.W. Phase-2 Transverter**, 10-2m., possibly nicest ever made, with PSU, QQV06/40A output, NuVistor receive, all relays, dummy load, metering etc. all built-in, just plugs into your 10m. transceiver, £50. **High voltage PSU components:** Transformers 1000-750-500-0-500-750-1000v. at a very generous 300 mA, £7; 500-0-500v. at easy 250 mA., £4. Chokes: 10 Henry 650 mA., 5 Henry 430 mA.; swinging chokes 8-27 Henry, 50-500 mA., £2 each.—Warner, G3SAR, QTHR. (Tel: Haldenborough 2424 office hours, or Sevenoaks 58743 evenings).

WANTED: Morse keys, photographs, good detail close-ups of old type GPO Morse keys showing top and bottom. Good price paid. (London).—Box No. 5366, Short Wave Magazine Ltd, 55 Victoria Street, London SW1H-0HF.

CRYSTALS: For two and four metres, many frequencies 7791 to 7850 in FT-243/CR6U, or 8001 to 8160 kHz in CRIA/AR-10XJ, £1 each post paid, stamp for list. **UHF Transistors:** For 70 and 23 centimetres, BF378 (Ft 2.3 GHz, NF 2.5 dB at 500 MHz) £1.25. Also 2N3866, 50p. All new. — Elliott, G3FMO, Oatlands, Southend Road, Howe Green, Chelmsford (71604), Essex.

SELLING: Collins S-Line items—75S-3B transmitter with 516F-2 PSU, £350; 32S-3 receiver with 800-cycle CW filter, £250; 30L-1 linear amplifier, with 4/572B's, £185; 312B-4 control unit wattmeter, £85. Or the complete package £800.—Lewis, 271 Popes Lane, Ealing, London, W5. (Tel: 01-567 6389).

DECEMBER Issue: To appear November 29, single copies at 36p post free will be despatched first-class mail on receipt from printers. Orders by November 27, with remittance to: Circulation Dept, Short Wave Magazine Ltd, 55 Victoria Street, London, SW1H-0HF.

SELLING: Trio 9R-59 receiver, with mechanical filter, stabilisation, and manual, as new, £31. Pye two-metre AM transceiver, 6 watts out, tunable receiver, 12v. operation, with crystals, £16.75. Digital El-Bug, with regulated PSU, less cover, sends perfect Morse, £7.95. Wien cassette recorder, battery/mains operation, less mike, £8.75.—Harrow, G4BWZ, QTHR.

CRYSTALS: 145 MHz Receive, 51.9 x 3/10.7, HC-6U type, suit "Westminster", "Cambridge", etc., 60p each, including post/packing. Also other frequencies near 145 MHz, such as 51.9166, 51.8333 at 35p; send s.a.e. for list.—Hodgson, G3YKB, 234 Gillingham Road, Gillingham, Kent.

WANTED: Services Textbook of Radio, Vol. 5, "Transmission and Propagation." Also KW-110 Q-multiplier.—Thomas, Gordon House, Ham Common, Richmond, Surrey.

North West Electrics

ALL PRICES ARE INCLUSIVE OF VAT

UNITS EX R3673 less Valves with circuit.

CONVERTER. 20 to 90 MHz. Uses 1-6J6. 2-EF91's. 75p, postage 25p.

PULSE CHASSIS, size 7½in. x 5½in., with 8-B7G PTFE valveholders. Res/Cap. etc., 50p, post paid. Good value.

IF STRIP, 7.5 Mcs. 1 Min. relay, twin 500 ohm coil. 50p, post 30p (uses 6-EF91, 1-EB91, 1-EL91).

ROLLER COIL. Silver-plated wire, 22 turns, 2½in. dia., 75p, post 35p (Paxolin former).

MODULATOR, RAF, Ex TRI986. VHF Transmitter. EF92-EL91. Pair of 6C4's. Circuit supplied, 75p, post 35p.

MAINS POWER SUPPLY FOR GEIGER COUNTER. Unit replaces battery holder. £2, post 35p.

COAX LINK LEAD. 8ft. 6in. Cable, with 2 Burndept/Londex Coax plugs, 35p each, post 25p (50 ohm imp).

14mfd STARTER CAP. 450V AC 7in. high x 4½ x 4½in. with conduit outlet. £1 each, post paid.

GPO COUNTER. 500 ohm coil, 4 digits, lin. square front, 4in. deep, 47p, post 25p.

OUTPUT TRANSFORMER. To match Power transistor (OC28) Car Radio type. 8 ohm 3 watt. 50p, post 15p.

We welcome all enquiries, however small. Stamped addressed envelope please. Hours of business: 9.30 a.m. - 6 p.m., Tues. - Fri.; 9 a.m. - 5 p.m. Sat. Closed all day Mondays.

NORTH WEST ELECTRICS

769 STOCKPORT ROAD, LEVENSHULME
MANCHESTER 19 Phone: 061-224 4911

MEMBER OF THE RADIO AMATEUR RETAILERS ASSOCIATION

FOR SALE: Heathkit SB-102 transceiver with CW filter, SB-600 speaker with PSU, microphone, Collins power/VSWR meter and spare valves, never used but some attention required, £120.—Stevenson, 71 Helston Road, Walsall (34654), Staffs.

SHACK CLEARANCE: Gem-Quad two-element aerial for 10/15/20m., nearly new, £55. Muirhead K.156B PSK to AM converter (FAX), £45. Creed 7B teleprinter with another machine for spares, £15. Marconi Type 1041C VVM, £25. Siemens Halske Hellschreiber machine, £15. Marconi Type CT-218 signal generator, not working, £5. Marconi telegraph test generator, no power unit, with handbook, £7. Kleinschmidt 160 teleprinter and reperforator/transmitter, £30 the pair. Clarks pneumatic pump-up mast, telescopic, 8-ft. closed and 40-ft. extended. £120. Labgear motor-tuned whip aerial, vehicle mounting, 2-15 MHz, £8. A.T.E. Ltd. Type 5A TDMS, £4. Marconi Type CT-208 VVM, £20.—Phillips, 155 Franklands Village, Haywards Heath, Sussex. (Tel: 0444 50265).

WANTED: DX-100 spares, or transmitter considered if in reasonable condition. Details please.—Ring Loudon, 021-327 5937.

EXCHANGE OR SELL: B.40, modified for SSB, with 3-ohm speaker etc., first class, sell or exchange for good HRO, preferably with bandspread coils. — Dickson, 32 Culliford Way, Littlemoor, Weymouth.

WANTED: Pye Cambridge, dash-mounting, prefer Rx tunable on 2m. Details and price please.—Barwood, 41 Wingfield Road, Knowle, Bristol 3. (Tel: Knowle 772804).

WANTED: All models of Hallcrafters and National receivers, incomplete and non-working considered if in good condition; particularly interested in Hallcrafters SX-42, SX-62A, SX-28A, SX-25 and S.20R. Also Eddystone 730/4 which must be in top condition and unmodified. Details and prices please.—Wise, 55 Longacre Drive, Porthcawl (2635), Glam.

WANTED: Marconi Type WQ.4572.EDA combining unit. Also Wilcox-Gay variable frequency oscillator. State condition and price. (Kent). — Box No. 5367, Short Wave Magazine Ltd., 55 Victoria Street, London, SW1H-0HF.

SALE: FT-101 Mk II, covers 160m. and includes fitted fan, new impeccable condition, an unrepeatable bargain, £225.—Elvy, G3BD, QTHR. (Tel: Canterbury 66232).

WANTED: Manuals, circuits and other information on R.308, R.1359 and T.1015 (serial No. C.1055) receivers; CT-82 noise generator; Cossor 1035 'scope. Also required: Mullaard Type 4009G CRT; valves S130 or S130P, VR102. German type RV2P/800; 50 Hz mains transformers for Marconi TP-984 No. 1 spectrum analyser (A.M. ref: 10S/16147), or would consider defunct unit containing these items.—Clyne, 78 Halford Road, Ickenham, Middlesex UB10 8QA. (Tel: Uxbridge 30006. weekends).

FOR SALE: Heathkit HW-17A 2-metre transceiver and HWA-171-1 12v. PSU. with handbooks. £50.—Howard, G8ANV, QTHR. (Tel: Stafford 52693).

SALE: "G2DAF" Tx and Rx. with PSU's. £50. BC-221, £12 R-divert 211, £10 HRO-5T, £20. HRO-MX, £10. ME.11B SWR. £6. EK-9X key. £7. EK-108A key. £25 Class-D wavemeter £6. Mobile Tx/Rx. 160m., with aerial and PSU, £10.—Jones, G3RCU, QTHR. (Tel: 09367-4117).

WANTED: Direct conversion Rx, commercial or home-built. Also looking for a Grundig TK-35 tape recorder.—Ring Handy, Coventry 2201.

OFFERING: LG-300 transmitter with matching PSU modulator. R.1155 receiver. Type 193 Crystal Tester. BC-221. Headphones. Codar receiver. Avometer. VHF receiver. All s.a.e.'s answered. (Lancs.). —Box No. 5368, Short Wave Magazine Ltd., 55 Victoria Street, London, SW1H-0HF.

G3ACQ offers:

XTALS AS USUAL. s.a.e. please. Solid state Modules Europa for 4 metres, another F.B. unit from a proven stable. Aerials by Bantex, J Beam, Hy-gain. YAESU FT 75. Large SW BRIDGES, £11.00. 1.8 to 150 MHz. 75Ω can be used as F.S. Meter. STOCKS CHANGE PLEASE ENQUIRE.

STOP PRESS—NEW TRIO RX IN STOCK.

S. MAY (Leicester) LTD.

12/14 CHURCHGATE, CITY CENTRE,
LEICESTER, LE1 4AJ
Telephone : 58662

G3HEO

G8FAL

D. P. HOBBS LTD.

Most components for the Radio Amateur, including Microwave Modules Converters, "J" Beam Aerials, Bantex Whips, Test Meters, Resistors, Condensers, etc.

Communications Receivers, etc., purchased for cash.

This month's BARGAIN OFFER: Min. Neons in Bakelite Holder, 2 pin 70 volt, 10p each
24 MHz Coils in Cans, 15p each
72 MHz Double Tuned Coils in Cans, 18p each
All New ex-Pye Equipment
Prices include Postage, add VAT at 8%

11 KING STREET, LUTON

Telephone 20907

DISCOUNT DIGITAL CLOCKS

AT WELL BELOW TRADE PRICE

It's true, so hurry whilst stocks last

COPAL	Rec.	Our price
	Holder, 2 pin 70 volt, 10p each	inc. VAT
"227" Alarm in White or Red	£10.90	£6.45
"227" Wood Grain finish	£11.66	£7.00
"702" Snooze Alarm	£18.25	£9.75
"801" Large with 2in. x 2in. Digits	£38.88	£25.00

(Wall mounting or free standing)

All mains 24-hour and fully guaranteed 12 months

INSURED POSTAGE 35p ALL CLOCKS PLEASE

OUR clocks are all carefully tested and sent return post

Full refund guarantee if you are not completely satisfied

Aero & General Supplies

NANAIMO HOUSE, 2 RINGWOOD AVENUE
LEEDS LS14 1AJ Telephone 658568

P.M. FOR CRYSTALS

We have now added the following repeater frequencies to our list of stock frequencies (MHz - HC6/U):

R2 4.0291 or 8.0583 (TX 145.050) £2-10	44.9833 (RX 145.650) £2-30
R3 4.0298 or 8.0597 (TX 145.075) £2-10	44.9916 (RX 145.675) £2-30
R4 4.0305 or 8.0611 (TX 145.100) £2-10	45.0000 (RX 145.700) £2-30
R5 4.0312 or 8.0625 (TX 145.125) £2-10	45.0083 (RX 145.725) £2-30

Pye Pocketfone (PF-1) Crystals for 433.2 MHz (HC18/U) per set of RX 12.0333 and RX 84.50 £7-62

For full details of our stock list please see our advertisement in last month's Short Wave Magazine

P.M. ELECTRONIC SERVICES 7A ARROW PARK ROAD, UPTON,
WIRRAL, MERSEYSIDE, L49 0UB

Telephone 051-677 8918 (until 7.30 p.m.)

WE WILL BE EXHIBITING ON THE MICROWAVE MODULES STAND AT THE ARRA EXHIBITION AT THE GRANBY HALLS, LEICESTER, OCTOBER 31 to NOVEMBER 2

G. W. M. RADIO LTD.

All prices include VAT and post/carriage.

CRYSTAL OVENS. 12v. complete with 100 kc/s. octal based crystal £2. Small fans 115/230v. with 24" impeller, £1-50.

REED RELAYS. 4 pole normally open, 5v. DC coil as used in recent Electronic Keyer design, 16p each (plus 10p post for any number). Also reed inserts 18" overall (body length 1-1"). Diameter .14". Max. ratings 250v. DC and 500 mA. Gold clad normally open contacts, 69p per dozen, £4-12 per 100, £30-25 per thousand.

JB 4 gang 500 pf variable capacitors, ceramic insulated, 1/2" shaft, £1-27.

JB 72-1 slow motion drives. Friction/spring loaded gear type complete with 1 1/2" lead flywheel, 1/2" shaft, 75p.

250v A.C. **INDUCTION MOTORS** 48 watt with gear box, output 50 r.p.m., £1-55.

RELAYS. 240v. AC SPCO contacts handle 25 amps., £1-25.

RECEIVERS. Marconi HR55N 70-100 mc/s. A.M., £7. Matching transmitters HT55N. QV06-40 PA, 2 x 5B254M Mod., £10. Both 19" rack chassis in good quality table top case. Built-in power units for 100-250 A.C. Carriage is costly—much cheaper for callers.

OSCILLOSCOPES. Soloratron CD1014 (CT436). Double beam, D.C. to 6 Mc/s., 10mV per Cm. sensitivity, clean and good order, £55 by Securicor.

RADIO TELEPHONES. Sorno Viscount CQM39-25 L/B FM, 12v., £15. Sorno 10 watt 230v. AC with desk control box and cable, L/B FM, £20. Sorno CQM13C/12 H/B FM with cable, box and mike, £12-50. All less channel crystals.

RACAL. Frequency standard and power unit for Channelizer MA150. Comprises mains power unit giving outputs of 6-5v, 11-5a, negative 78v. and 250v. stabilised (transformer rating is 450 ma). Also contains 12v. crystal oven for 100 kc/s. crystal. Clean, untested, £8. RACAL SSB adaptors RA218 for RA17 and RA117 Receivers, clean, untested, £30.

AERIAL INSULATORS, EGG type. White china 1 1/2", 6 for 55p, Pyrex 2 1/2", 55p each.

All Receivers and Test Equipment are in working order at time of dispatch Carriage charges included ore for England and Wales only

Telephone 34897

Terms: Cash with order. Early closing Wednesday.

40-42 PORTLAND ROAD, WORTHING, SUSSEX

Constructors Month . . .

Sorno Viscount transistor, 455 kHz IF boards, brand new with data, £1-50, p/p 15p. Ditco ex-equipment, 90p, p/p 15p.

Sorno Rx Rf boards, ex-equipment, HB with valves and data, £1-50, p/p 20p; without valves, 80p.

Sorno Ac c/o relays, nice jobs with integrated SO259 socket, 50p, p/p 10p.

Sorno FM discr. boards, with relay, ex-equipment, £1-00, p/p 15p with data.

Ex-Pye Vanguard AM25B High Band with data.

455 IF boards, transistor, 75p, p/p 10p.

Mic amp boards, 75p, p/p 10p.

Mod OP board, 40p, p/p 10p.

Squelch boards, 15p each, post 10p any number.

Rx audio board, 40p, p/p 10p.

Modulation transformers, PP NKT 404 to QV03/20a, £1-10, post 20p

Toroidal Inverter transformer, 12v. DC input, 170/375v. at 160 ma, out, £1-50, p/p 20p.

Relays, 12v. types, double make, 30p, or 4 c/o contacts, 35p, post 10p any number.

Valve bases, for 3/20a or 40 types, 50p each, p/p 10p.

HB Vanguard Tx PA output stage, 3/20a to 50 ohm Ae, 60p, p/p 15p.

Block filters for Cambridge/Vanguards, 50 kHz, 50p, p/p 10p. High or low impedance. Dirc 10 kHz, high impedance only, 70p, p/p 10p.

Carriers for Vanguards, 50p, post 25p any number.

Transistors, ex equipment, NKT 404/ADY23/ASZ15, 10p each, post 5p any number.

Valves, ex-equipment, 6AK5/6BH6/ECC88/EC91/ECC81/6CB6, 10p each, post 10p any number.

QV03/10, 45p; QV03/12, 45p; QV03/20, £1-50; QV06/20, 50p; post 10p any number. Brand new 815s, 50p, p/p 10p any number.

20 mixed of the above 10p. Valves for only £1-00, post 25p.

Valve screening cans, mixed, 50 for £1, p/p 15p.

BARGAIN PARCELS of the above and other mixed components, boards/plugs/transistors, both new and used, £6 worth for £2, post 30p.

Complete Units. Sorno 33C base stations FM LB in excellent order, mains operated, less control unit, data supplied. Only £6 each, Carr. £2.

Ex-Police, Hudson FM118 base Tx and controls, speaker, etc., 100 MHz, neat and well made, clean but a few minor parts may be missing, scrap price, £6, carr. £2 each.

Ex-Police Dec. battery chargers for 12 x 18v. batteries, clean and nice but only £3 each, post 75p. Cost over £60 when new.

Brand new aerials by radac, s/steel mobiles with bases, £3 each, p/p 25p state frequency required. Magnetic bases for above £10 each, p/p 25p.

XTALS, the following HC6U at only 40p each, 8-958/8-971/9-447/9-448/9-451/9-531/12-700/12-679/12-885/12-881/37-275/37-287/51-5916 for 2m.

Rx x3-107, post 10 mixed air-spaced trimmers, some butterfly for £1, p/p 10p. 10 mixed smaller chokes and transformers for £1, p/p 30p.

W. H. WESTLAKE

West Park, Clawton, Holsworthy, Devon, EX22 6QN

Tel. Holsworthy 253758

H.O. Registered Engineer

SELLING: Complete station, comprising FT-DX500 with matching VFO and speaker, also TA-33Jr. masts, key, mic. etc., £225 or near offer.—Sullivan, G8KYF, QTHR. (Tel: Wigston 6473).

FOR SALE: Yaesu FR-400SDX receiver, coverage 160-10m., 4m. and 2m., AM/FM, SSB/CW, all extras, mint condition, £160. Eddystone EC-10 Mk. I general coverage receiver, excellent condition, £43. Codar 70A communications receiver, excellent condition, £43. Codar 70A communications receiver, with Hamgear PM.11D preselector, speaker and headphones, mint condition, bargain £27. — House, 10 Leigh Close, Kenilworth, Warks. (Tel: Kenilworth 54556 after 6 p.m.).

WANTED: Mobile amateur band transistor converter, 160-10m., or W-H-Y? Details and price please.—Lowson, 39 Lordbuan Place, Forfar (4169), Angus, Scotland.

SELLING: DPKB.105 5-band trap vertical, unused in original packing, bargain £30. Carriage extra.—Ring Bowen, 06333 66699, evenings.

FOR SALE: AR88LF receiver, with fitted meter and manual, in excellent condition, £30 or near offer.—Ring Billington, 01-656 9882 after 8 p.m.

SALE: Drake T4XC and AC-4 power supply, in original condition, £295 or near offer. Inclusive of delivery by Securicor. (Worcs).—Box No. 5369, Short Wave Magazine Ltd., 55 Victoria Street, London, SW1H-0HF.

FOR SALE: Eddystone 888 Rx in good condition, with instructions and circuit, £48. Buyer inspect and collect, please.—Hurst, 31 Avondale Road, Fleet (5831), Hants.

SELLING: B.44 Mk. III with 12v. battery, as new, £15. Buyer collects. — Ring Adkins, 01-794 2294 (London N.W.3).

SALE: RTTY: Indicator tuning frequency shift visual AP67980A (CRM-1 tuning indicator), by A.T.E., as brand new and in original box, £15. Carriage by arrangement. — Michaelson, G3RDG, QTHR. (Tel: 01-455 8831).

FOR SALE: Codar AT-5 Tx with mains PSU and 12v. mobile PSU. Also Codar T.28 Rx, £36 the lot. Heathkit DX-100U Tx, 160-10m., £32 or near offer.—Walters, G8JGF, 55 Wharf Road, Pinxton, Nottingham. (Tel: Ripley 810280).

SELLING: FT-101B, two months old, £320 including Securicor delivery. Eddystone 888A, very good condition, £65. (Derby).—Box No. 5370, Short Wave Magazine Ltd., 55 Victoria Street, London, SW1H-0HF.

SALE: Trio 9R-59DS, bought Jan. '74, unused, £38 or very near offer. Will deliver approximately 50 miles.—Codman, 70 Hartshorn Court, Caerphilly, Glam. CF8 1QY.

SELLING: Heathkit test equipment: MM-1U multi-meter (wide range), £9; IM-13U vacuum volt meter, £17; C-3U capacitor-resistor bridge, £9; 0-12U laboratory oscilloscope, £19. All recently calibrated and complete with manuals. — Ring O'Neill, Ely-Valley 3192 (Glam.).

FOR SALE: The property of the late G3OV. DX-60B Tx, £50; Trio 9R-59DS Rx, £38; Joystick together with transmitting ATU, £8. All in mint condition.—Parker, 92 Panfield Road, Abbey Wood, London S.E. (Tel: 01-310 4079).

SALE: Trio 9R-59DE Rx, with speaker, phones and Joystick VFA, good condition throughout, £38. Tape head de-magnetiser, £3. (Stafford). — Box No. 5365, Short Wave Magazine Ltd., 55 Victoria Street, London, SW1H-0HF.

WANTED: Trio JR-599 and TX-599. Also UHF base for 4CX250B.—Foulger, G8DEN, 31 Woodsley Avenue, Cleethorpes, S. Humberside.

WANTED: K.W. Viceroy. Sphinx or similar SSB Tx. Also circuit and manual for SX-24 Rx. — Smith, G4DKC, 9 Harcourt Drive, Canterbury, Kent.

SELLING: G.E.C. BRT-400 general coverage communications receiver, very good condition, £55.—Lucas, 29 Myton Crescent, Warwick. (Tel: Warwick (0926) 42196).

WANTED: Valved audio amp. and pre-amp., 15-30 watt, mono or stereo, working and in good condition. Details and price please.—Williams, The Farmhouse, Bledington, Kingham, Oxford.

FOR SALE: K.W. Viceroy Mk. II Tx; new 6146B's; "G2DAF"-type receiver; BC-221; LPF; Joystick antenna. £100 complete.—James, G3ZMY, QTHR.

WANTED: Codar T-28 receiver, must be in good condition. Details and price please.—Tee, G8UA, 33 Red Lees Road, Cliviger, Burnley, Lancs.

FOR SALE: Sommerkamp FT-277B, as new, maker's box, with mobile mount, Multimobile antenna and Mosley trap dipole, £300 the lot, saving £112.—Ring Parr, Sandiacre 398995.

WANTED: Suitable PSU for BC-221 heterodyne wavemeter.—Smye, G4DHC, Windle Marsh, Manorial Road, Parkgate, Wirral L64 6QW. (Tel: 051-336 2386).

SALE: FT-DX560 transceiver, 560 watts input, immaculate condition, unmarked and unmodified, £225.—Ring Clayton, Medway 362730 (evenings and weekends).

WANTED URGENTLY: AR88D, must be in good condition. Details and price please.—Swan, 6 Patterson Court, London, SE19 2LG. (Tel: 01-387 0858, office hours).

WANTED: National HRO, with power pack, coils and calibration charts, in good condition.—Forbes, 8 Cambridge Street, Stalybridge, Cheshire. (Tel: 061-338 3075).

WANTED URGENTLY: Buy or borrow manual for G.E.C. BRT-400 Rx. Photocopy would be OK.—Cox, 10 Main Street, Newcastle, Co. Dublin, Eire. (Tel: Dublin 589117).

WANTED: AR88D, in good condition with no major modifications. Details and price please.—Watson, 111 Trent Road, Beeston, Nottingham. (Tel: Nottingham 254831, office hours).

SELLING: FT-2F, 2-metre, FM, very sensitive, with 6 channels including London repeater, £80.—Selman, 25 Hereford House, 370 Fulham Road, London S.W.10.

SALE: Tiger Z-match, 75-ohm, coverage 80-10m., switch for two antennas, £15. Tiger SWR meter, £5. Home-built dummy load; Morganite 75-ohm resistor; RF meter, 0-2½ amps., £8. Or £25 the lot, post paid. Also TTC B.3 crystal microphone, with p-t-t and stand, £2; 38-6667 MHz crystal, wire ended, £1.50.—Michaelson, G3RDG, QTHR. (Tel: 01-455 8831).

WANTED: Pye Westminster. Calibrated VHF signal generator. RF watt-meter. Frequency counter (200 MHz).—Green, G3TRL, QTHR. (Tel: 051-355 2017).

SELLING: Complete VFO-controlled two-metre station, comprising Telford TC-9, TC-7 and converter, £110. Will separate.—Hardy, G8EYV, QTHR. (Tel: Nottingham 251455).

WANTED: HF beam, TH-3 or similar; also FV-101. VFO and KW-107 Supermatch, SELLING: EA-12 Rx with plinth speaker, £120.—Heddings, G4DGM, 106 Goldthorn Hill, Wolverhampton.

SALE: Well worn BRT-400, £12. Labgear LG-300 and home-built power pack, £15. Buyer collects.—Williams, G2DQW, QTHR. (Tel: 021-784 1745).

SELLING: Brand new KW-2000E transceiver with guarantee, £250. Barlow-Wadley receiver, £50. Quad electro-static speakers, as new, two available with Harrison touch pad 100-watt amplifier, £200 complete.—Ring Goodbody, G3YQE, Romford 61191 (evenings), or 01-592 7800 (daytime).

WANTED: R.216 VHF Rx with PSU. Can exchange Lafayette HA-55A aircraft Rx.—Roberts, 28 Mumbles Road, Blackpill, Swansea (24146), Glam.

DERWENT RADIO

5 COLUMBUS RAVINE, SCARBOROUGH. Tel. SCA 65996
Showroom open Tuesday/Thursday/Friday/Saturday

KW 202 Rx and Spkr.	£19.78	Reducer	10p
KW 104 transmitter	£230.58	Double sided copper clad	9p
KW 107 match	£65.66	Transistors 2N3819	35p
KW 108 match	£15.55	2N3053	26p
KW 103 swr and power	£15.55	RCA 3N140 & 141	85p
KW aerial switch	£5.62	BC 107 108 109	12p
KW Balun	£3.08	Dosemeters	12p
KW Atlanta vfo	£39.00	10PF variable capacitor	17p
TE15 GDO	£18.50	50PF Differential	19p
Sentinel 2m. converter	£15.12	Litup lamps, 6v. or 12v.	8p
Sentinel 4m. converter	£15.12	Large Car type crocs	8p
Sentinel 70cm. converter	£15.12	Mono/Stereo headphones	£2.85
Sentinel 2m. pre-amp	£7.15	Decon printed cct. pen.	95p
Microwave Modules:		300 ohm twin feeder yd.	8p
2m 5w AM transmitter	£35.75	Telephone pick-up coil	38p
2m. converter	£16.72	Veroboard assortment	60p
2m converter & 116 out	£17.93	Veropins .1 or .15	17p
2m dual output preamp	£9.90	Egg insulators	17p
432 MHz varactor tripler	£19.25	Panel "S" meter 2"	£1.80
1296 MHz converter	£26.40	R substitution box	£1.80
2,000 ohm headset	£1.40	C substitution box	£1.65
1-20v. D. C. p.s.u. 1A stab.	£11.80	Carbon breast mic.	40p
2" speaker 8 ohm	38p	Panel meters neon	20p
3" speaker 8 ohm	48p	Meter test prods and leads	38p
6 BA bolts pack	11p	In line fuse holder	8p
6 BA nuts pack	11p	SWR bridge	£6.60
G Whip tribander	£11.58	Twin meter SWR bridge	£11.00
G Whip	£4.40	AR22 rotator	£30.25
G Whip flexiwhip	£9.46	Crystal tapel mic.	48p
Coils	£4.67	36" chrome Whip aerial	44p
G Whip basement	£1.59	56" chrome Whip aerial	88p
Wightraps standard	£3.00	Mini push switches	13p
Wightraps high power	£4.10	All boxes 2½" x 4" x 1"	27p
Dynamic 50K ohm P.T.T.	£3.25	2½" x 4" x 1"	27p
"J" Beam Halo	£1.82	2½" x 5½" x 1½"	27p
4 digit impulse counter	12p	2½" x 4" x 1½"	29p
50 resistors	17p	2½" x 3" x 1½"	27p
50 ½w. resistors	22p	7" x 4" x 1½"	48p
50 capacitors	35p	3" x 4" x 1½"	40p
50 disc ceramics	35p	3" x 5" x 1½"	33p
20 wire wound resistors	15p	Aluminium cabinets	
10 mixed potentiometers	50p	7" x 4½" x 2½"	75p
10 mixed wafer switches	80p	5½" x 4½" x 2½"	60p
10 croc. clips	40p	Wander plugs black or red	4p
10 mixed sleeving pack	15p	Banana plugs black or red	5p
14 and 16 way DIL sockets	17p	Phone jacks	7p
Amphenol SO239	40p	Ferric chloride 1lb. bag	35p
Amphenol PL259	40p	10-1 mixed 400v. capacitors	17p
SO239 single hold fixing	40p	10 mixed silver micas	12p
Line connector	80p	Morse practice oscillator	£1.20

Second-hand equipment:		Codar AT5 and p.s.u.	£26.00
Sentinel 2m. converter	£12.00	Class D wavemeter	£7.00
Trijo 9R9DS	£42.00	Eddystone S640	£27.00
Trijo 9R9DE	£38.00	Eddystone 680X	£70.00
R.F. test oscillator	£11.00	Codar CR70A	£22.00
Codar AT5 tx rough	£14.50	Pye 6 ch. Ranger	£8.00
Heath RF sig gen	£14.00	Trijo JR310	£55.00
KW600 linear amp	£70.00	KW Viceroy IV	£80.00
Minimitter 2-7 Tx	£20.00		

OUR PRINTING DEPARTMENT OPEN FOR THE PRODUCTION OF QUALITY QSL CARDS. LET US HAVE 10p STAMP FOR SAMPLES AND PRICES. WE HAVE RECENTLY TAKEN OVER THE STOCK AND EQUIPMENT OF G5YV OF MORLEY WHO IS NOW PRINTING QSL CARDS.

Sorry we can't make the Leicester show this year. The shop will be open as usual.

WE ARE LOOKING FOR GOOD CONDITION MODERN TRANSMITTERS AND RECEIVERS ETC. AND WILL PAY CASH OR GIVE GOOD TRADE-IN PRICES. PLEASE LET US HAVE DETAILS WITH S.A.E. FOR OFFER. DES WOOD, G3HKO

QSL POCKETS for 20 cards 44p incl. VAT/Post.
PLEASE ADD EXTRA FOR CARRIAGE. S.A.E. FOR LISTS

BETTER THAN A LINEAR AND ¼ OF THE PRICE

At last a distortion-free RF Clipper. Fits in minutes and really works. YAESU SB Filter fitted. Only for FT.101. Giving up to 6 times or more effective talk power gain, plus extra RX selectivity and gain. Not to be confused with audio type distortion producing clippers, or compressors.

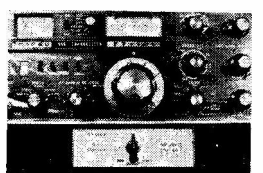

FT.101 + RF Clipper still the best
G3GZX—"Have done exhaustive tests with Nets where comparison with other mobile signals has been available. Members have commented on excellent communications ability of FT.101 plus G3LLL's Clipper."
GSRP—"In terms of cost effectiveness, the best investment I have made for years."
DA1YR—"When I'm JM the clipper certainly helps the readability of my rather weak signal."
WA2AOQ—"Unit works so well have given up plans to buy a Linear."
Full details from—

G3LLL, HOLDINGS LTD.
39/41 MINCING LANE, BLACKBURN, BB2 2AF. Tel.: 59595/6

THE AMATEUR RADIO SHOP 64MH

13 CHAPEL HILL, HUDDERSFIELD

Telephone: 0484 20774

LOOK FOR US AT THE AMATEUR RADIO EXHIBITION, GRANBY HALLS, LEICESTER OCTOBER 31 - NOVEMBER 1, 2

Large selection of Second-hand and new equipment. KW, EDDYSTONE, YAESU, J BEAMS, ANTEC, SOLID STATE MODULES.

SECOND-HAND EQUIPMENT WILL INCLUDE:

Bring your Px gear with you			
Collins 390A Rx, perfect	£375.00 inc. VAT
Racal RA 117 Receivers	£385.00 "
Racal RA 17 Receivers	£350.00 "
Hamarlund SP 600 Receivers	£120.00 "
Mamconi Atlanta Receivers	£120.00 "
JR599 Receivers	£140.00 "
RCA 8516L Receiver	£200.00 "
AR88 Receivers	from £40.00 "

Also many others: FR50B, JR310, Heath GR78, etc., KW2000A, Vespa II, Viceroy, etc.

NEW: The T.A. Electronics Speech Compressor at the Show Price £22.50 inc. VAT

SHURE MICROPHONES: 201 £6-20, 401, £7-20, 444 £13-50, 444T £15-50.

The Trio KA2002A Amplifier HiFi Stereo. Special Price £42.00. SWR IND, GDOs, Antec, Whips, many, many components at give away prices at the Show.

The 4 MH 2 MTR Tx, 15 watts input and the matching modulator, both units £12-50 each, inc. VAT.

2 MTR Xtal's FT241 : at £1.00 each. 8001-43, 8002-5, 8006-67, 8008, 8013-53, 8020, 8037-25, 8044, 8046-67, 8050, 8058-28, 8060, 8064-28, 8071-43, 8078-57, 8080, 8090-77, 8092-50.

WE WILL BE ON THE PHONE AT THE SHOW. THE NUMBER CAN BE OBTAINED FROM THE AMATEUR RADIO SHOP, HUDDERSFIELD 0484 20774.

ALL PRICES INCLUDE VAT
C.U. AT "THE" SHOW

BARCLAY CARD ACCESS CARD

J. & A. TWEEDY (Electronic Supplies) Ltd.

SPECIALISING IN AMATEUR RADIO EQUIPMENT

G3ZY Lincolnshire

G3YBO Derbyshire

Receivers, Transmitters and Transceivers by YAESU, KW Communications and Swan.

SWAN 700CX CHAMPION TRANSCEIVER

Here is all the dynamic powerful performance needed to punch through QRM, without the need of that high cost linear. The SWAN 700CX lets you enjoy a more responsive value-packed amateur radio station, for less cost-per-watt, than any other ham rig in its class. Cross-modulation and front-end overload will not plague or frustrate your communications with a SWAN 700CX Champion in your corner.

Whether you select the 700CX for your home station, its portability, or for mobile use—you can count on this Champion to give superior performance—every time. SWAN 700CX, £349.00, AC PSU £85.

SECOND-HAND EQUIPMENT

Heathkit SB 301	... £85	Heathkit SB 610	... £35
Trio JR 310	... £68	Eddystone 888A	... £68
Heathkit RA 1	... £25	KW 2000	... £85
KW Vespa Mk. I	... £75	Eddystone EA 12	... £115

Prices include VAT but not carriage

The Chesterfield Shop is open Tuesday to Saturday 0900-1700

We can arrange demonstrations by appointment in the Lincolnshire area—Telephone Woodhall Spa 52793 where G3ZY will be happy to be of service. The 6-8 p.m. telephone number is still Chesterfield 863755 where G3YBO will be available.

79 CHATSWORTH ROAD, CHESTERFIELD
DERBYSHIRE, S40 2AP

WANTED: BC-221 with calibration charts, manual and 240v. AC/PSU. Offering £17 if in good condition.—Hutchinson, 171a Belton Lane, Grantham (4400), Lincs.

FOR SALE: Trio JR-310 with 10.AZ filter, excellent condition, £56. — Stevens, 4 Heathlands, Westfield, Sussex.

FOR SALE: Eddystone 940 with speaker, mint condition, £110. Eddystone 770U, coverage 150-500 MHz, £95. Pye AM-25B Vanguard, High and Low band, working condition, £12 each. FM-10B Cambridge Low-Band, 6-channel, £18. Low-Band AM "Handi-Cambridge" with rechargeable battery pack, £25. Joystick aerial and tuner, £10. Avo transistorised 500v. Megger, £15. Narco 28-channel aircraft band Tx/Rx, 12v., £30.—Ring Meyer, 061-456 4186 (evenings).

SALE: Trio JR-310 Rx, excellent, with mechanical filter, OA2 stabiliser, 31m. band, manual, £67-50. Hamgear PM.1 preselector, 1.8 to 30 MHz, 4-stage aerial attenuator (0-50 dB.), 100 kHz xtal calibrator, with instructions, 240v., £7-50. 1971 "ARRL Handbook" 1972 "Amateur Radio Techniques," both £2-50. Two 115/230v. transformers, 150w., new, both £3. All plus carriage at cost, or collect.—Davies, c/o 27 Roe Park, St Asaph (583333), Clwyd.

FOR SALE: Creed teleprinter Model 85 B/M print reperfector, 110/250v. DC, with terminal unit, as new, £18. Teleprinter terminal unit Mk. IV, used, £2-50. TEST EQUIPMENT: Marconi No. 2 FM deviation meter, 2.5-100 MHz, £25. CT-208 No. 3 valve voltmeter, AC/DC 1-150v., 100 MHz, £12-50, or with X10 probes, £15. British Physical Laboratory No. 2 Mk. III capacitance bridge, 0-2-2500 micro-farad, fair, £10. SHF No. 1 frequency/power meter, 100-750 mW., 4-5-4.8 GHz, new, £15. Plessey Ts.ZD-00438 microphone receiver, £15. R.3683 receiver, Type 10D/18313, VHF. 250v. AC input, £10. Tinsley T.4500 galvo movements, complete, new, £2-50. New sealed 12v. batteries, 25 amp-hr., non-spill, £4-60 each. Cressol sliding rheostats, 4000-ohm, 0-25 amps., £1-50. F.95 camera control units with 1 mA. F.S.D. meter, etc., £1-50. 1½-in. dia. mounted photo cells, £1. Half-inch computer tape, 2400-ft. reel and can, £2. 6J/1625 servo unit elevator, new, £5. All items plus postage and packing, or collect. C.W.O.—Walton, 2 Billy Mill Avenue, North Shields, Northumberland. (Tel: 089-44 23553 office hours, or 089-45 79887 evenings).

G3EKX S.S.B. PRODUCTS G3EKX

★ QUARTZ CRYSTALS ★

Large stock available by return post. Send a list of your needs and alternatives. We will reply by return if you enclose a S.A.E. All new metal types up to 111 MHz.

Eddystone 680X and speaker	£78-00
Eddystone EC10 Mk. 2. As new	£88-00
H.R.O.5T. Power supply, Speaker, 5 coils (4 B/S)	£45-00
Cossor 343. V. Modulator. A.C. 1/P	£19-00
Jasen A.G.10. Audio generator	£24-00
Grundig G.D.O. Type 701. 1.7 to 250 MHz	£24-00
A.V.O. Electronic Testmeter Mk. 4	£45-00
R.C.A. Orthophonic F.M. Tuner	£8-00
H.R.O. 20 metre Bandspread coil	£5-00

★ PLEASE ADD ONLY CARRIAGE / PACKING EXTRA ★

Matched Pairs R.C.A. new, boxed. 6HF5, £6 ; 6146, £6-20 ; 6146B, £7-20. By return. Add 40p P. and P.

Compactron 6HF5. 6KD6 Bases 40p ea. (6p)
12v. Relays H/D contacts ideal for Linears £1 ea. (20p)
Ceramic 2-bank 6 pole 3w. SW's 1½" dia. 50p ea. (10p)
Linear Pots. 1K, 10K, 18M/M ; 1K, 10K, 25K, 30 M/M ; 5 for £1 (12p)

I FRANCES STREET, TURO, CORNWALL
Telephone : 0872-862575

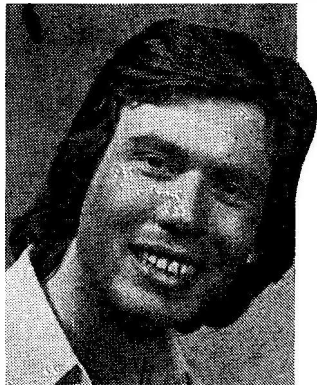

*I've often wondered -
How CAN you compare one
catalogue with another?*

After all, few firms can give more than a brief description. Take the Home Radio Components Catalogue for instance. They could have said that the cover is in full colour and shows Barbara Hepworth's beautiful "Theme on Electronics." Or that it consists of 240 pages of art paper, has over 1,700 illustrations, and lists about 6,800 different items. What really counts however, is the organisation behind the catalogue, and I give full marks to Home Radio Components, because from my experience they really care about helping their customers. But don't take my word for it—find out yourself. The best way is to get a copy of their catalogue right away. Just send them a cheque or postal order for 98 pence (65p for the catalogue and 33p for postage, packing and insurance).

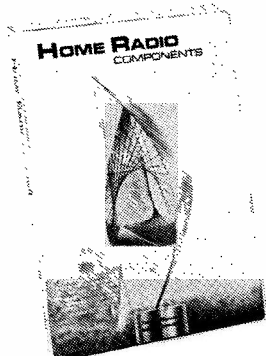

By the way, they include 14 coupons in the catalogue, each worth 5 pence if used as directed, so you can get the cost of the catalogue back and 5p towards the postage. It's just one of the ways Home Radio Components think of their customers. Send for your catalogue today—you'll never regret it.

65p plus 33p Post and Packing
Send the coupon today

Please use block capitals

Name

Address

HOME RADIO (Components) LTD. 912966 London
Dept. SW, 234-240 London Rd, Mitcham, CR43HD

R. T. & I. ELECTRONICS LTD.

where equipment is fully overhauled

HEATHKIT RAI Receiver	£38.00 (£2.00)
HEATHKIT GR64 Receiver	£25.00 (£2.00)
HEATHKIT SB300 Receiver	£95.00 (£3.00)
HEATHKIT DX100 Transmitter	£50.00 (£5.00)
HAMMARLUND SP-600-JX Receiver	£160.00 (£3.50)
HAMMARLUND HQ-170 Receiver	£120.00 (£3.50)
KW202 Receiver	£140.00 (£3.00)
KW YESPA Mk. II, with A.C. P.S.U.	£105.00 (£4.00)
KW2000B Transceiver, with A.C. P.S.U.	£220.00 (£4.00)
LAFAYETTE HA-600-A Receiver	£45.00 (£2.00)
EDDYSTONE EA12 Receiver	£160.00 (£3.50)
STAR SR-550 Receiver	£50.00 (£2.00)
YAESU-MUSEN FR-400-SDX, with 2 & 4 metres	£160.00 (£3.00)
EDDYSTONE 730 Receiver	£95.00 (£3.00)
HEATHKIT SW-717 Receiver	£30.00 (£2.00)
R.216 Receiver, V.H.F. Receiver	£105.00 (£3.50)
NATIONAL NC.121 Receiver	£55.00 (£3.00)

WE CAN ALSO SUPPLY ANY MAKE OF NEW EQUIPMENT—and have pleasure in giving a few examples which are normally in stock:—

AVOMETERS. Model 7, Mk. 2, £46.50; Model 8, Mk. 5, £49.80; Model 40, Mk. 2, £46.50; Model 72, £19.12; Multimeter Mk. 4, £16.55; Standard Leather Carrying Case (Models 7, 8, 40), £9.32; Ever Ready ditto, £10.80; Multimeter Leather Case, £4.82; 10KV D.C. Multiplier for model 8 or 9, £7.50; 30KV D.C. ditto, £12.50; Pair of Long Reach Safety Clips, £1.75; Model EA113 Electronic Avo, £92.00; Model 272 Electronic Avo, £32.90; Model TT169 Transistor Tester, £19.80. All above post free in U.K. Trade and Educational enquiries invited. All other AVO and TAYLOR products available, ask for quote.

S. G. BROWN'S HEADPHONES. Type "F" 120 ohm, 2000 ohm, 4000 ohm, £7.00 (30p); Rubber Earpads for same, 50p per pr. (5p); Type 3C/1100 Noise Excluding (with superb fitting) high quality, electro-dynamic, £7.55 (30p); Standard Jack plugs, 24p (4p).

EDDYSTONE EQUIPMENT. Please enquire.
CODAR EQUIPMENT, PR40, £11.00 (60p). Leaflets on request.

In present conditions we regret that all prices are subject to alteration without notice.

NOTE: 8% VAT must be added to all prices, new and secondhand, inc. carr. and packing.

Carriage for England, Scotland and Wales shown in brackets. Terms: C.W.O., Approved Monthly Accounts, Hire Purchase and Part Exchange. Special facilities for export.

At R.T. & I.

- ★ We have full H.P. facilities.
- ★ Part exchanges are a pleasure.
- ★ We purchase for cash.
- ★ We offer a first-class overhaul service for your electronic equipment, whether you are an amateur or professional user.
- ★ We have EASY Parking facilities.
- ★ We welcome your enquiries for specific items which although not advertised, may very well be in stock.

FREE SHURE MIC. WITH EVERY KW TRANSMITTER or TRANSCEIVER purchased

PARTRIDGE "JOYSTICKS" "New Lightweight VFA" £12.10 (60p); "JOYMATCH" III, Aerial Unit, £12.10 (60p); LO-Z500, £17.60 (60p); ATU kit, £5.00 (50p); ATU assembled, £6.05 (50p); Artificial earth, £6.00 (50p); Aerial Bandswitch, £6.00 (50p). Literature on request.

TRIO EQUIPMENT. Receivers: TR7200, £129.50 (£1.00); TR2200, £79.50 (£1.00); 5R59DS, £49.50 (£1.00); JR 310, £75.00 (£1.00); JR 599, £160.00 (£1.50); Transmitter TX-599, £160.00 (£3.00); Transceiver TS 515 and PS 515, £210.00 (£3.00); Loudspeaker SP5D, £4.50 (50p); Headphones G54 (equivalent), £6.00 (20p); Stabiliser, 60p (5p). Leaflets available.

SHURE MICROPHONES, 444T, £15.00 (40p); 444, £13.00 (40p); 401A, £6.50 (30p); 201, £5.40 (30p); 202, £6.00 (30p). Full details on request.

KEYNECTORS, piano key mains connector units, £4.25 (40p). Trade enquiries welcome.

VALVES. Please state your requirements.

ADVANCE TEST EQUIPMENT—we are agents—your enquiries please.
TMK METERS: TMK500, £11.75 (50p), TW20CB, £15.00 (50p), TP55N, £8.25 (50p), Model 700, £26.00, also cases for same.

PHILIPS PM2403 ELECTRONIC MULTIMETERS, £53.00 (60p), etc., etc.

We also supply **PHILIPS & LABGEAR COLOUR TV TEST EQUIPMENT**, including Colour Bar Generators, Cross Hatch Generators, Degaussing Coils, Oscilloscopes, CRT Testers, Transistor Testers, etc. etc.

KW EQUIPMENT: (Don't forget your FREE mic. with every Tx. and Txcr. I.) KW2000E & P.S.U., £290.00 (£3.50); KW202, £175.00 (£2.50); KW204, £210.00 (£3.00); KW1000 Linear, £160.00 (£4.00); KW107, £60.00 (£1.50); KW E-Z MATCH, £20.00 (80p); KW160, £16.00 (80p); KW109, £75.00 (£1.50); KW ATLANTA, £210.00 (£3.50); REMOTE VFO for Atlanta, £38.00 (70p); KW108 Monitor Scope, £76.00 (£3.00); Speaker for KW202, £11.00 (50p); KW103, £14.00 (50p); KW Low Pass Filter, £10.50 (30p); KW Antenna Switch, £5.00 (25p), etc., etc.

R. T. & I. ELECTRONICS LTD.

Ashville Old Hall, Ashville Road, London, E11 4DX Tel : 01-539 4986

NEAREST STATION: LEYTONSTONE (Central Line)

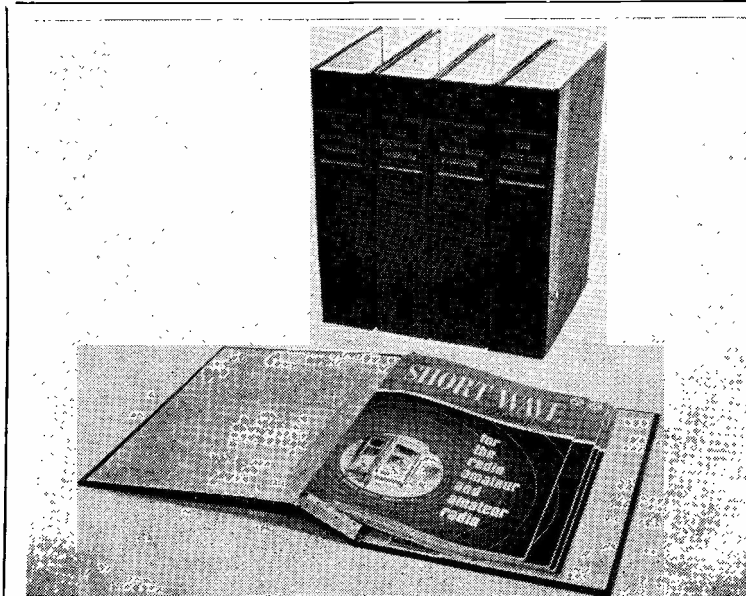

CREATE YOUR OWN REFERENCE LIBRARY

The "EASIBINDER" is designed to bind 12 copies of the Magazine as you receive them month by month, eventually providing a handsomely bound volume for the bookshelf.

No need to wait until twelve copies are assembled. As each copy is received, it is quickly and simply inserted into the binder. Whether partially or completely filled, the binder is equally effective, giving the appearance of a book, with each page opening flat.

Strongly made with stiff covers and attractively bound in maroon Leathercloth and Milskin, the binders have only the title gold blocked on the spine.

Price £1.25 post free.

(Available end of February 1974)

PUBLICATIONS DEPARTMENT
SHORT WAVE MAGAZINE
55 VICTORIA STREET
LONDON, SW1H 0HF

*Subscription rate to Short Wave Magazine is
£3.75 for twelve issues.*

REG. WARD & CO. LTD.

(G2BSW)

WE ARE OFFICIALLY APPOINTED K.W. AGENTS FOR THE SOUTH WEST (Somerset, Dorset, Devon, Cornwall)

KW 160 Top band A.T.U.	£16.00
KW 108 Mon. scope	£70.00
KW Atlanta with p.s.u.	£210.00
KW 2000B with p.s.u.	£240.00
KW 2000E TCVR ; & A.C. p.s.u.	£275.00
KW 202 Receiver with matching speaker	£170.00
KW 204 Transmitter	£170.00
KW 101 VSWR Meter (52 or 75 ohm)	£8.26
KW 103 VSWR Meter and Combined Power Meter	£14.00
KW E-Z Match, 10-80m, ATU	£20.00
KW 107 Combined E-Z Match, VSWR and R.F. Power Indicator, Dummy Load and Antenna Switch for 4 Outlets	£60.00
KW Trap Dipole Coaxial Feeder	£22.00
KW Trap Dipole with Balun	£26.00
KW 3-way Antenna Switches (for coax)	£5.00
YAESU	
Yaesu FT101B Tcrr.	£330.00
Yaesu FR400DX	£155.00
FR50 — Cal. WVVV	£67.00
FT200 Transceiver and FP200 A/C PSU	£215.00
FR400SDX Rx. (with 160 and 2m.)	£210.00
SP400 Speaker	£11.00
Sentinel 2m. Preamps and 2m. Converters	
SHURE MICROPHONES	
Model 444, £13.50 ; Model 201, £5.70.	
USED EQUIPMENT :	
Park Air 2m A.M. TX 4 XTAL channels. Comp. with H/book, spare valves and Shure desk mic.	£69.00
Eddystone EA12 with H/book. Ex. cond.	£140.00
VALVES for YAESU, etc. 6BMB, 6BZ6, 6U8, 6EJ7, 6AV6, 6KD6, 12AX7A, 12BY7A, 12AU7, R.C.A. VALVES for KW and Heathkit equipment, 6146, 6146B, 6HF5, 6LQ6, 6G6S, 6EA8, 6G6WB, 6GK6, 6CM6, 6CL6, 6CB6, 6BN8, 6HS6, 6EW6, 12BA6, 12BE6, 12B26, 6J56C, etc., and many other types.	
J Beams and Stolle Rotators ; 140ft. 14g. enam copper ant. wire ; Ribbed and T-insulators ; 52 and 75 Ω co-ax, and U.H.F. plugs and sockets.	

TRADE INS WITH PLEASURE. OUR STOCK OF GOOD SECOND HAND EQUIPMENT CHANGES DAILY—LET US KNOW YOUR REQUIREMENTS.

Due to currency fluctuations prices of imported equipment are liable to alteration. Add 8% VAT to all prices except used equipment.
HP TERMS AVAILABLE CARRIAGE EXTRA ON ALL ITEMS

AXMINSTER - DEVON

Telephone: 33163

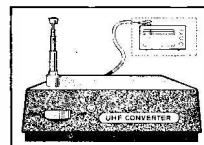

UHF TO VHF CONVERTER

As most high level transmissions are now moving to UHF this unit enables their reception without the necessity of an expensive receiver.

The unit will receive frequencies in the range 420-470 MHz or to customers' requirements and allows any VHF radio to receive UHF transmissions.

To operate : Connect crocodile clip to any VHF radio aerial, in the down position, switch connector on, tune VHF radio to 100-108 MHz on dial and receive UHF communications band.

The converter is of rigid metal construction and housed in a strong plastic case. The circuitry uses tuned lines in oscillator and RF circuits facilities are made for peaking I.F. output between 100-108 Mc/s. Power supply is from an internal 9 volt battery.

Unit dimensions : App. 6" x 3" x 1" ; aerial 6".

An interesting feature is that the converter can be used to feed several VHF radios enabling a number of UHF channels to be received simultaneously.

CONVERTER, ready to use — £25.50

Mail Order or C.O.D., P & P 45p

MULHALL ELECTRONICS

ARDGLASS, Co. Down, BT30 7SF

Telephone : 039 684461

TRANSMITTERS, WALKIE TALKIES, RADIO MICROPHONES, PAGING SYSTEMS

J. BIRKETT *Radio Component Suppliers*

25 THE STRAIT . LINCOLN . LN2 1JF

Telephone: 20767

BC 110 ... 10p	BC 153 ... 20p	BC 195 ... 20p	BF 115 ... 20p	BF 238 ... 18p
BC 113 ... 12p	BC 157 ... 12p	BC 204 ... 15p	BF 117 ... 22p	BF 240 ... 25p
BC 114 ... 15p	BC 158 ... 12p	BC 207 ... 15p	BF 119 ... 50p	BF 244 ... 25p
BC 115 ... 15p	BC 158 ... 12p	BC 209 ... 15p	BF 121 ... 25p	BF 245 ... 10p
BC 116 ... 15p	BC 159 ... 12p	BC 212 ... 15p	BF 123 ... 27p	BF 254 ... 10p
BC 116A ... 25p	BC 160 ... 30p	BC 213 ... 15p	BF 127 ... 30p	BF 256 ... 20p
BC 117 ... 15p	BC 167 ... 10p	BC 221 ... 20p	BF 152 ... 22p	BF 257 ... 20p
BC 118 ... 15p	BC 168 ... 10p	BC 225 ... 22p	BF 153 ... 22p	BF 258 ... 30p
BC 121 ... 18p	BC 169 ... 12p	BC 237 ... 15p	BF 154 ... 30p	BF 259 ... 30p
BC 124 ... 18p	BC 170 ... 12p	BC 238 ... 15p	BF 156 ... 10p	BF 262 ... 20p
BC 126 ... 15p	BC 171 ... 12p	BC 251B ... 20p	BF 158 ... 23p	BF 263 ... 60p
BC 134 ... 10p	BC 172 ... 12p	BC 259A ... 30p	BF 160 ... 15p	BF 271 ... 20p
BC 135 ... 10p	BC 175 ... 50p	BC 261B ... 15p	BF 163 ... 35p	BF 274 ... 20p
BC 136 ... 12p	BC 177 ... 15p	BC 262 ... 18p	BF 180 ... 25p	
BC 137 ... 12p	BC 178 ... 20p	BC 268 ... 15p	BF 181 ... 25p	
BC 138 ... 37p	BC 179A ... 16p	BC 270 ... 15p		
BC 142 ... 20p	BC 181 ... 16p	BC 287 ... 18p		
BC 143 ... 20p	BC 182 ... 15p	BC 302 ... 15p		
BC 147 ... 10p	BC 183 ... 15p	BC 323 ... 22p		
BC 148 ... 10p	BC 184 ... 15p	BC 327 ... 15p		
BC 149 ... 10p	BC 186 ... 15p	BC 334 ... 20p		
BC 152 ... 15p	BC 187 ... 20p	BC 337 ... 20p		

400 PIV 10 amp STUD MOUNTING TRIACS at 88p each.
100 2 Watt ZENERS untested at 50p. 100 400mW ZENERS untested at 50p.

INTEGRATED CIRCUIT AUDIO AMPLIFIERS TBA 800 at £1.20, SN 76013NP at £1, TAA 611B at 65p.

TRANSISTORS SPECIAL OFFER BC 107, BC 108, BC 109, BC 308, BC 177 at 6 for 50p.

SPECIAL BRANDED SEMICONDUCTOR ASSORTMENT CONSISTING OF :-

- 5 Sprague Transistors
- 16 Japanese 2SB and 2SA Type Transistors
- 4 NKT Transistors
- 10 Assorted Transistors
- 15 Zener Diodes
- 45 Signal Diodes
- 2 Integrated Circuits
- 6 1N4001 1 amp 400 PIV Diodes

Total 103 Pieces for £1.08

DIVIDE BY 2 300 MHz COUNTERS with data at 80p

DIVIDE BY 4 180 MHz COUNTERS with data at £1.10.

DUBILIER TAG ENDED ELECTROLYTICS 500uf 50v.w. 2" x 1" at 4 for 25p. 2000uf 50v.w. 4 1/2" x 1 1/2" at 25p. 5000uf 25v.w. 4 1/2" x 1 1/2" at 25p. 10000uf 12v.w. 4 1/2" x 1 1/2" at 20p. 10000uf 25v.w. 4 1/2" x 1 1/2" at 40p.

DUBILIER GREYCON MINIATURE METALLISED PAPER CAPACITORS. .01uf 400v.w. at 15p doz.

DUBILIER 250 Volt A.C. FILTERS Type SBN2CF at 20p each.

CERAMIC TRIMMERS SUB-MINIATURE 3.5 to 8pf. 3 for 12p, 4.7 to 20pf at 3 for 10p, MICRO-MINIATURE Type 3.5 to 8pf at 3 for 12p.

DUAL GATE MOS FET's 40601 at 55p, 40603 at 55p, 40673 at 55p, MEM 616 at 50p.

N CHANNEL FET's 2N 3819 at 25p, BF 244 at 25p, MPF 105 at 44p, 2N 5457 at 33p, SPECIAL OFFER OF 2N 3819's at 6 for £1.

TEXAS HIGH SPEED DIODES Type 1N 3881R. 200 PIV 6 amp at 20p.

1000pf 500 v.w. DISC CERAMICS at 16p doz.

MULLARD COLOUR DELAY LINES at 50p.

250 Volt AC SOLENOIDS (TV Line Change-over Type) at 40p.

BD 112 ... 25p	BD 124 ... 67p	BD 138 ... 71p
BD 115 ... 75p	BD 135 ... 43p	BD 140 ... 70p
BD 116 ... 43p	BD 136 ... 49p	BD 144 ... £2.32
BD 121 ... 75p	BD 137 ... 55p	

ZN 414 Radio I.C. at £1.20.

SOLDER-IN FEED-THRO's 1pf, 2pf, 10pf, 15pf, 18pf, 22pf, 300pf, 1000pf. All at 15p doz.

COMMUNICATION SERIES OF I.C.'s untested with data consisting of 1 x R.F., 3 x I.F., 2 x VOGAD, 2 x AGC, 1 x Mike Amp, 2 x Double Balanced Modulators, 1 x Mixer. The 12 I.C.'s for £3. Separate I.C.'s at 27p.

AF AMPLIFIER and VOGAD CIRCUIT with Side Tone untested with data at 30p each.

TRIPLE DEMODULATOR AM, SSB, FM, I.C. untested with data at 3 for £1.

SSB DEMODULATOR AM DETECTOR, AGC GENERATOR untested with data at 30p each.

TANTALUM BEAD CONDENSERS 1uf 35v.w., 2uf 25v.w., 2.2uf 35v.w., 4.7uf 25v.w., 4.7uf 35v.w., 5uf 25v.w., 6.8uf 25v.w., 6.8uf 35v.w., 10uf 16v.w., 15uf 10v.w., 20uf 6v.w. All at 8p each.

GENERAL PURPOSE PLASTIC NPN TRANSISTORS. 12 for 40p.

GENERAL PURPOSE PLASTIC PNP TRANSISTORS. 12 for 40p.

DIL I.C. SOCKETS 8 Pin, 14 Pin, 16 Pin. All at 15p each.

2000uf 30v.w. Can Type size 2 1/2" x 1" at 15p.

UNMARKED GOOD ZENERS 1.5 watt 3-3, 4-25, 5-25, 5-75, 6-25, 7, 8, 9, 10, 11, 12, 13, 20, 30 volt. All at 15p each.

SPECIAL OFFER OF 20 ASSORTED BRANDED 250mW ZENERS at 75p.

150 MHz NPN TRANSISTORS ZT89, 40p per doz.

PLASTIC TYPE BC 107 TRANSISTORS 85% Good at 40p doz.

PLASTIC TYPE VHE 200 MHz NPN TRANSISTORS 85% Good at 40p doz.

GENERAL PURPOSE NPN-PNP MIXED TRANSISTORS 85% Good, 50 for 50p.

1000pf 500v.w. TUBULAR CERAMICS at 15p doz.

1000pf 500v.w. DISC CERAMICS at 15p doz.

5 ASSORTED TRIACS. Unmarked Good at 80p.

LOCKFIT TRANSISTORS. Untested PNP or NPN at 16p doz. 10 Untested Sub-Miniature 10 amp SILICON BRIDGES. Untested at £1.25.

SILICON DIODES 1N 4004 400 PIV 1 amp, 6p each. 5 for 25p.

SUB-MINIATURE TOGGLE SWITCHES SPCO at 35p, DPDT at 44p.

MULLARD 10 Watt AUDIO MODULE LP 1173 at £2.16.

X BAND GUNN DIODES with data at £1.65.

X BAND DETECTOR DIODES similar to SIM2 at 15p, 1N 23 at 25p.

8 to 1 VERNIER DRIVES 1" at 88p, 2" at 99p, 2 1/2" at £1.25.

250mW PRECISION REFERENCE DIODES 6.6v., 9.8v., 11.6v. All at 15p each.

BY 103 SILICON DIODES 1300 PIV 1 amp at 15p each.

50. 1N 4000 Series SILICON DIODES untested at 50p.

TUNING CONDENSERS with Slow Motion Drive. 300 + 300 at 33p, 365 + 365 + 365pf at 66p, 500 - 500 + 20 + 20pf at 33p. With Direct Drive. 6pf at 11p, 10pf at 30p, 25pf at 25p, 25 + 25pf at 45p, 250 - 180pf at 30p.

DUAL 2GHZ NPN TRANSISTORS untested with data. 3 pairs for 55p.

GENERAL ELECTRIC (USA) SEMICONDUCTORS 200 PIV 25 amp Push Fit S.C.R. at 20p, CI40B. 200 PIV 25 amp Stud Mounting S.C.R. at 35p, CA0A. 100 PIV 25 amp Stud Mounting S.C.R. at 25p, CS0B. 200 PIV 110 amp S.C.R. at £2.

DISTRI PROGRAMMABLE UNIJUNCTION at 30p, TV DIODES AF 102 at 30p, BA 148 at 10p, BA 144 at 10p, BA 154 at 5p, BA 156 at 5p.

STEREO DECODER I.C. Type SN 76110 (MC1307) at 85p each. SANYO 15 Watt AUDIO I.C. MODULE with data at £3.

SMC LTD

**YOUR
YAESU MUSEN
DISTRIBUTOR**

SMC has been manufacturing Communications equipment since 1958. In 1971 Western Electronics (U.K.) Ltd. was formed to be part of our group but we no longer have any connection with any company of that name. So call on us at Totton and you will receive the usual cheerful assistance from all the permanent staff, including our YL's, Mary, Sheila and Daphne, and rely on the customary efficiency, and courtesy, of our Sales Manager, Nigel Curzon, Service Manager, Chris Webster and all at S.M.C.

FT-220 in Totton

(Ex-stock)

Yaesu's traditional quality
now available in a 2 metre
Multi Mode Transceiver

£264.00 Plus VAT

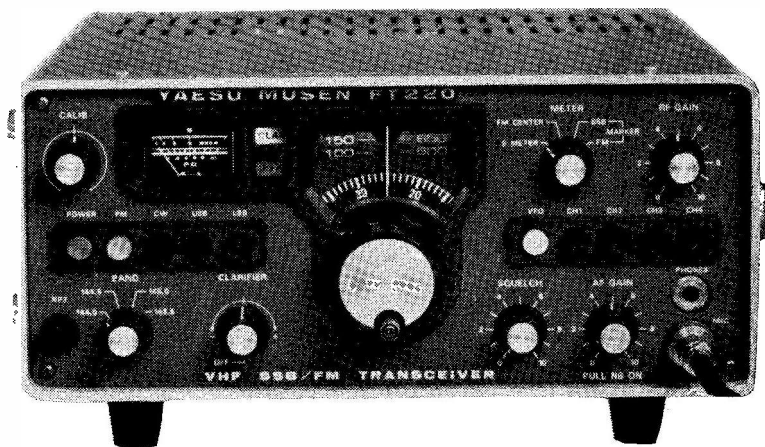

USB, FM, CW, LSB (ready for Oscar 7).
10W. R.M.S. (more P.E.P.!) output.
Mains and 12v. DC operation (0.6A RX and 3A TX.).
Full 2 MHz coverage (in 4 500 kHz Bands).
VFO tuning with 1 kHz readout.
4 crystal control channels.
Repeater Tone Burst and 600 kHz shift on both crystal
and VFO possible.
Pre-mix VFO (effective single conversion from 10.7
MHz generator) insures clean output.

Built-in 100 kHz crystal calibrator.
Electronic calibration adjustment makes FSK, RTTY
easy.
Meter functions as P.O. on TX and as "S" on SSB
and FM Receive or FM centre zero.
Hand mic. supplied.
Noise blanker fitted.
Double conversion FM RX with squelch.
High Sensitivity Receiver.

Modern band pass filter design insures uniform performance across the band with no plate tune—loading controls—
or preselectors to waste time.

YAESU all Ex-stock (Carriage paid + VAT)

FT-101B ...	£330.00	SP-101B ...	£13.00	FR-50B ...	£80.00	YC-355 ...	£99.00
FV-101B ...	£42.00	FT-220 ...	£264.00	FL50B ...	£79.00	YC-355D ...	£127.00
YO100 ...	£93.00	FR-101D ...	£330.00	FT-200 ...	£170.00	YD-844 ...	£14.75
FL2100B ...	£195.00	FR-101S ...	£245.00	FP-200 ...	£45.00		

KW (Carriage 50p + VAT)

Antenna switches ...	£5.00	KW103 ...	£13.00
Dummy loads (52 ohm) ...	£8.50	EZ Match ...	£20.00
KW107 ...	£60.00		

SECOND-HAND LIST, although 'phone for latest items (Carriage £1 extra + VAT)

Heathkit HW100 with mic ...	£110.00	FT2F AUTO ...	£115.00
Trio 2200 ...	£60.00	AR40's unboxed ...	£27.50
FR400SDX (with 12v. inverter) ...	£155.00	Heathkit Scope OS2 ...	£30.00
Codax AT5 with mains and DC PSU ...	£27.00	Liner II ...	£120.00

SMC LTD

FOR THE LARGEST RANGE AND STOCKS OF MASTS

TOTTON

TELOMAST WITH TA 33

30' SELF SUPPORTING TOWER

A self-supporting, fully galvanised steel tower for H.F., V.H.F. or commercial use, easy to install, can be erected by one person. From **£88.50 + VAT**. Also available THE SLIM LINE 40' and guyed commercial masts to 150'

Telescopic galvanised masts 10' section length. Prices carriage paid

	Mast only	Mast with Rigging
30'	£15.00 + VAT	£29.00 + VAT
40'	£20.00 + VAT	£39.00 + VAT
50'	£25.00 + VAT	£49.00 + VAT

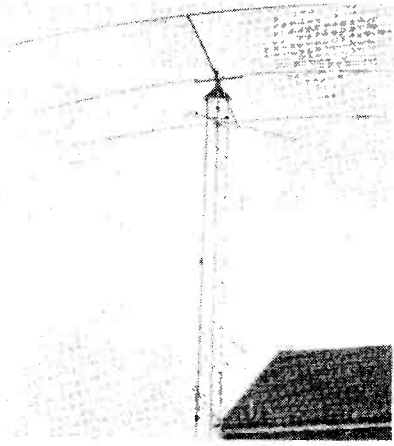

VERSATOWERS

TILT OVER AND TELESCOPIC WITH BUILT-IN HEAD UNIT FOR ROTATORS SUPPLIED WITH WINCHES AND GROUP FITTINGS.

Post mounting (ex-stock):
Type P40—40', type P60—60'
Wall mounting:
Type W60 and W40
85', 101' and many other types available.

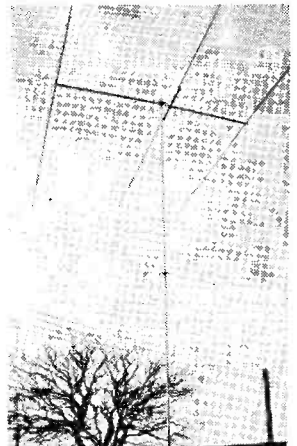

ALIMASTS

(Carriage paid)
6 metres to 21 metres in 1.5, 2 or 3 metre section lengths supplied with mast bands. These masts suitable for V.H.F. and U.H.F. antennas.

Prices from **£11.60**
Rigging wire and fittings available.

ROTATORS: EX-STOCK



THE NEW CONTROL UNIT FOR THE CD44. **£60 + VAT**
HAM 2 **£90 + VAT**

Illustrated right
THE NEW SILENT AR30 and AR40, replacing the AR20 and AR22. Control Cable (ex-stock), at 18p/m. plus VAT plus carriage (5 wave band).

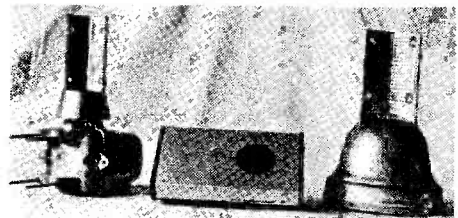

AR30 **£25 + VAT**

AR40 **£30 + VAT**

BANTEX FIBREGLASS VHF MOBILE ANTENNAS (Carriage 75p)

B5 ½-wave 144 MHz 3.4 dB gain ...	£5.00 + VAT
BGA ½-wave 144 MHz ...	£6.60 + VAT

B5U 432 MHz ½-wave ...	£5.00 + VAT
70 MHz ½-wave ...	£3.00 + VAT

Magnetic mount saves hole in car, fits the above, **£7.50**.

G WHIPS. The British Mobile HF Antennas Range (Carriage 75p)

Tribander—10, 15, 20 ...	£12.30
Multimobile "71," 10, 15, 20 ...	£14.30
Flexiwhip Basic 10m. mast with base	£9.50
Basemounts ...	£1.65 + VAT

LF40m. LF80m. or LF160m. ...	£4.10 each all + VAT
MM40, MM80 or MM160 ...	£4.10 each all + VAT
F15, F20, F40, F80 or G160m. ...	£4.25 each + VAT
Telescopic Whips for Coils ...	£1.10 + VAT

COAXIAL CABLE AND PLUGS—The Largest stocks in the Country:

Coaxial cable (Carriage up to 20m. 40p., over, 50p. All + VAT)			
50 Ω R8U/UR67 ...	33p metre	75 Ω BICC 3278 ...	22p metre
75 Ω UR57 ...	33p metre	50 Ω UR43/UR76 ...	15p metre
75 Ω UR39 ...	25p metre	75 Ω Economy ...	10p metre

PLUGS (Carriage 20p + VAT):

PL259 ...	42p	U.H.F. "T" ...	£1.30	PL259A (specify cable) ...	54p
"N" ...	82p	Adaptors ...	12p	Sockets U.H.F. Chassis ...	33p
Inline double female ...	66p	BNC ...	42p	U.H.F. Angle ...	90p

MOSLEY BRITISH ANTENNAS (Carriage paid + VAT)

Mustang 10—20m. 3 ele. ...	£55.00	TA33E Jnr. 10—20 3 ele. ...	£39.80
Mustang 10—20m. 2 ele. ...	£42.00	TA32E Jnr. 10—20 2 ele. ...	£28.50

S.M.C. TRAP AND OTHER DIPOLES (Carriage paid + VAT):

Types Trap dipole 10—80m. ...	£16.00	Type HP (1 kW pep) ...	£17.25
Type P Portable using copper/terylene braid and winding spools with coaxial cable		£18.50 + VAT

WIGTRAPS (Carriage 25p):

Standard ...	£2.85 + VAT	High Power ...	£4.10 + VAT
--------------	-------------	----------------	-------------

J BEAM: Complete range stocked.

SOUTH MIDLANDS CONSTRUCTION LTD.

OSBORNE ROAD, TOTTON, SOUTHAMPTON SO4 4DN

Telephone: 04 216 TOTTON 4930 or 2785 CABLES: AERIAL SOUTHAMPTON.

Hours of Business—Totton: Monday—Friday 9.0—5.30. Saturday 9—12.30 p.m.

AGENT:

G3ZUL
DROITWICH
(09057) 4510.

SPECIAL 50p PACKS

Valve Bases B9G ceramic, 2 for 50p.
TO5 Heatsinks, star type, 10 for 50p.
Belling Lee TV Plug, 6 for 50p.
Standard Jack Plugs, 4 for 50p.
STC Telephone inserts Rx., 50p.
Pye Mike inserts, new, 50p.
Carbon Mike inserts, 50p.
Valveholders, assorted, 10 for 50p.
Mullard Tubular Trimmers, 1 18pf, 6 for 50p.
Rubber Grommets, mixed bag, 50p.
Silicon Rubber Sleeveing, Imm. bore 50 yds., 50p.
5 pin Din Sockets, 270 deg., 5 for 50p.
Reed Relays, 12v. 400 ohm, 2 pole make, 2 for 50p.
Min. Switches 4 pole 2 way, rotary spindle dia. 4mm., 2 for 50p.
Bulbs, 6.3v. 3A capless, 20 for 50p.
Capacitor Clips, mixed sizes, 10 for 50p.
Valves, min. CV types, 20 for 50p.
Bandpass Filters, 25-32.5 MHz RT type, 50p.
Pots, 10 different values, 50p.
Miniature slider switches, 2 pots, 2 way, 5 for 50p.
Stereo Jack Sockets, 2 for 50p.
Self-adhesive foam pads, 30mm. x 20mm. x 3mm. thick, large roll, 50p.
Min. 4 core Screened Cable, 10m. for 50p.
Ceramic tag strips, 10 for 50p.

SPECIAL £1 PACKS

2N3055 Power transistors, new, unmarked, 5 for £1.
BY185 Rect. Sticks, 35kV at 2.5mA, ideal for scopes or SSTV monitor, £1.00.

VALVES

QQVO2-6 (ex-equipment), £1.00.
DET22 (ex-equipment), £1.00.
2C39A (ex-equipment), £1.10.
2C39A Ceramic (ex-equipment), £1.60.
4CX250B (ex-equipment), £2.20.
6BH6 (ex-equipment), 2 for 50p.
EF80. New, 25p.
QQVO3-10 (ex-equipment), 75p.

IMPORTANT NOTICE

To all our Mail Order Customers
We regret that we have to raise the Post/Packing/Handling charge on all small orders under £10.00 (except where marked) to 50p. Orders over £10.00 are now POST FREE (except where marked). This is due to the ever increasing postal overhead, labour and packaging material costs (i.e. postal charges alone will average over 40p per package). This will take effect from 1st November 1974.

CURLY LEADS, 4 core telephone type. 18in. closed, approx. 5ft. extended, 2 for 20p.
FERRITE RODS, 5 $\frac{1}{2}$ in. x $\frac{3}{16}$ in. dia. with Med. and Long wave coils, 15p each.
MINIATURE UNISELECTOR BASES (42 pin), 40p each.
CRYSTALS type B7G glass 54 kHz, 55p.
COMPUTER TAPE, lin., on 14in. spools, last few, to clear, £1.00 reel, carriage 50p.
DIN SPEAKER SOCKETS, 2 pin (flat and round), 4 for 30p.
XTAL OVENS, 80 deg. or 10 deg., 40p each. Bases, HC6U or 2XHC25U, 10p.
VIDICON SCAN AND FOCUS COIL ASSEMBLIES, modern type, no details, £6.00 each.
MOD. TRANSFORMERS (ex-equipment) with data, P.P. EL84/6V6 to QQVO3-20A, £1.50 each.
20-25 kHz XTALS, glass B7G, for 405-line SPG, new, £2.20 each.
lin. VIDEO TAPE SPOOLS, empty, 9in. dia., 80p each.
MAINS ISOLATING TRANSFORMER, 375VA, tapped primary, 240V output, new, £5.50, carriage 50p.
MAINS ISOLATING TRANSFORMER (ex-equip.), in metal cases, totally enclosed, tapped mains input, 110-240V, etc., output 240V at 3A + 12V at 0.5A, £11, carriage £1.
AS ABOVE, output 240V at 12A + 12V at 3A + 22V at 2.5A, £27.50, carriage £2.
RADIOSPARES 500 - WATT AUTO TRANSFORMER, 100/110/150/200/220/240/250V tapped input and output, step up or step down facility, ex new equip., £5.50, carriage 50p.

TRANSISTORS (NEW)

AFZ11, 50p; AFZ12, 50p; OC200, 20p; NKT0032, 25p; NKT0032, 25p.
VTR BOXES, GOOD BREAKDOWN VALUE, containing 2 x 12v. 4 pole C/O relays, plus bases, rotary switch, transistor pcb, with presets, components, etc., min. transformer, 4 x Belling Lee TV sockets, 5 pin Din plug, 2 x 3 pin Din sockets, etc. All built into a 4 $\frac{1}{2}$ in. x 3 $\frac{1}{2}$ in. x 2 $\frac{1}{2}$ in. cast box, brand new, ONLY £1.00 each.
NEW HIGH GRADE ELECTROLYTIC CAPACITORS, 25v. at 6800 mfd., with screw terminals, complete with capacitor clip for vertical mounting, 60p each, or 2 for £1.00.
GREENPAR PTFE SO239 SOCKETS, brand new, 54p each, or 5 for £2.50.
GREENPAR PTFE PL259 PLUGS, brand new, 54p each, or 5 for £2.50. Reducers to fit above, 10p each (only supplied with plugs).
SILICON RECT. BLOCKS, bridge type, 50V at 6A, £1 each, 100V at 10A, £1.50 each.
ISEP RACKING, 19in. wide x 6 $\frac{1}{2}$ in. high x 15in. deep, with two-thirds adapted to take 5in. high panels, new, £2.50, carriage 50p.
SELF-TAPSCREW PACK, mixed sizes, 30p.
4BA HANK BUSH PACK (ideal for making aluminium cases, just drill $\frac{1}{16}$ in. hole, push in, and hammer over reverse side), 30p.
MODERN TELEPHONES, with dial; fawn and grey, £3.00, carriage 50p.
REELS OF 16 STRAND COPPER WIRE. Pink PVC covered, 0.5mm, ideal for long wave antennae, 100 metres, £1.10 per reel.
TWIN HEAVY DUTY CABLE, PVC covered, 50/0.25mm., ideal for mobile LT supply leads, 15p per metre or £11 per 100 metre reel (carriage £1).
20-25 kHz XTALS, glass B7G, for 405-line SPG, new, £2.20 each.
HASH FILTER (for use in mobile supply leads), 20p each.

PHILIPS PROJECTOR LAMPS A1/220, 12v. 50W, quartz type, miniature 2in. x $\frac{1}{2}$ in., 50p each.

CARBON MIKE INSERTS, telephone type, brand new, 50p.
TIMERS, 0-60 secs, mains operated, 4 switched change-over centers, dial size 3 $\frac{1}{2}$ in., brand new, boxed, £5.00 each.

FM IF/DISCRIMINATOR PCB (from Pye Cambridge FM10), 455 kHz, £3.00.

HONEYWELL, min. single pole c/o Microswitches, $\frac{1}{2}$ in. long $\frac{1}{2}$ in. wide by $\frac{1}{2}$ in. high, with roller trigger, brand new, ideal for Press-to-talk mikes, 25p each.

CRYSTALS, type HC6U in kHz, £2.10 (post free)

9015 9018 9021 9025 9028 9031 9034 9037 9038 9040 9043 9050
9053 9056 9059 9060 9065 9100 9137 9172 9222 9227 9255 9261
9276 9284 9287 9294 9316 9319 9341 9344 9411 9412 9431 9433
9438 9459 9481 9465 9477 9479 9480 9481 9484 9486 9487 9493
9494 9497 9505 9526 9527 9543 9551 9552 9559 9563 9566 9569
9572 9573 9575 9581 9590 9591 9594 9600 9602 9604 9605 9603
9611 9612 9631 9634 9753 9718 9723 9728

CRYSTALS, type HC6U in MHz (X3-10.7 for 2M Rx), £2.10 (Post free)

51-575 51-5866 51-59166 51-600 51-6916 51-71667 51-7208
51-725 51-72916 51-7416 51-75 51-75833 51-800 51-825
51-8333 51-9333 51-9750 51-98333 51-9916 52-0916 52-125
52-1333 52-1416 52-1750 52-1833 52-19167 52-200 52-2166
52-2333

NOTE: When ordering Xtals please send cheques or open postal orders, as these can be returned if out of stock, also state alternative if acceptable.

MAINS TRANSFORMERS

All 240V input, voltages quoted approx. RMS. (Please quote Type No. only when ordering.)

TYPE F27BS (ex-Pye F27 base station Tx) 500V at 350mA, 6-3V at 8A, £5.50, carriage 50p.

TYPE 40/2 40V at 2A, 80p each.

TYPE 18/8 18V at 8A, £4.00 each, carriage 50p.

TYPE 16/6 16V at 6A, 45V at 100mA, £3.50, carriage 50p.

TYPE 28/4 28V at 4A, 125V at 500mA, £3.50, carriage 50p.

TYPE 63/1 6.3V at 1A, 70p each, 2 for £1.25.

TYPE 125BS 125V at 30mA (ideal for linear bias V), 50p each, 5 for £2.00.

TYPE 129 400V at 20mA, 200V at 10mA, 6-3V at 500mA, £1.00.

TYPE 72700 600V at 20mA, 18V at 1A twice, 50V at 25mA, 6-3V at 1.5A, £1.00.

TYPE 72703 400V at 10mA, 200V at 5mA, 6-3V at 400mA, £1.00.

TYPE 72705 14V at 4A, £1.00.

HIGH QUALITY SPEAKERS

6in. x 4in. elliptical, 2in. deep, 4 ohm, 90p each, 2 for £1.70.

8in. x 6in. elliptical, 2in. deep, 4 ohm, recess magnet, rated up to 10V, £1.50 each, 2 for £2.75.

IDEAL FOR VARICAP TUNED RECEIVERS...

BECKMAN, DUODIAL, Min. counting turns dial, $\frac{1}{2}$ in. dia., with locking lever, 0-100 on main dial, with 0-14 on hundreds dial, for standard $\frac{1}{2}$ in. spindle, brand new, boxed, £1.50 each.

AS ABOVE... $\frac{1}{2}$ in. dia. dial, $\frac{1}{2}$ in. spindle, £2.00 each.

MULTITURN POTS (for use with counting dials above) 2 Kohm, 100 Kohm, 400 Kohm, 10 turn, available only, Linear, $\frac{1}{2}$ in. spindle.

CALLERS WELCOME BY APPOINTMENT
S.A.E. FOR ALL ENQUIRIES, PLEASE

TERMS OF BUSINESS: CASH WITH ORDER

PLEASE NOTE: ALL PRICES INCLUDE VAT (at current rate)
Post/Packing: Orders under £10.00, 50p (except where stated)
Orders over £10.00 Post Free (except where stated).

B. BAMBER ELECTRONICS

20 WELLINGTON STREET, LITTLEPORT, CAMBS.
PHONE: ELY (0353) 860185 (Tues. - Sat.)

Printed by The Courier Printing Co. Ltd., Tunbridge Wells for the Proprietors and Publishers, The Short Wave Magazine Ltd., 55 Victoria Street, London, S.W.1. The Short Wave Magazine is obtainable abroad through the following: Continental Publishers & Distributors Ltd., William Dawson & Son Ltd.; AUSTRALIA AND NEW ZEALAND - Gordon & Gotch, Ltd.; AMERICA - International News Company, 131 Varick Street, NEW YORK. Registered for transmission to Canada by Magazine Post. November, 1974.

NOVEMBER 1974