

25p

The
SHORT WAVE
Magazine

VOL. XXX

JUNE, 1972

NUMBER 4



WORLD WIDE COMMUNICATION

NORTH WEST ELECTRICS

769, STOCKPORT ROAD,

LEVENSHULME,

MANCHESTER, 19.

Phone: 061-224 4911

G3MAX

**EDDYSTONE AND TRIO RECEIVERS. DIECAST BOXES.
JACKSON CAPACITORS AND DRIVES. DENCO COILS.
"RADIO SPARES" TRANSFORMERS AND COMPONENTS.
"Q" MAX CUTTERS.**

INTEGRATED CIRCUITS AND COMPONENTS FOR FREQUENCY COUNTERS AND CLOCKS

7490N 86p, 7400N 22½p, 7473N 55p, 74141N £1.12, 72710N 46p NEW TEXAS

HOLDERS for 14 way and 16 way 15p each

DECADE COUNTER BOARD 12 way .15 uses 7490 and 74141N 37½p

DECADE COUNTER BOARD with fitting for Quad latch, 16 way .1 60p

NUMERICATORS FOR DIGITAL READOUT. £1.50 each. ZM1020 with base. End viewing 1" dia. GNP 7AH side viewing 1½" high, ¾" dia. Miniature type A7001. 1½" high, ½" dia. POST 5p on any item. Excess will be refunded

POT CORE. .666 dia. With bobbin on ¼" Aladdin former. Type 10D, 14p, post 5p.

POLYPROPYLENE ROPE. 500lb. strain. 100 yd. reel, £1, post 15p.

BARGAIN OFFER. 100 yard drum 75 ohm high power coaxial cable. Attenuation per 100ft: 2.8 dB 200 MHz, 4 dB 600 MHz, 5.3 dB 800 MHz, £6.75, carriage £1.

DENCO COILS. All ranges in stock. 32p each, post 5p each coil. Please state valve or transistor type when ordering.

COAX LINK LEAD. 8' 6" cable with 2 Burndept/Londex coax plugs, 35p each, post 15p (50Ω impedance).

5" DESYN INDICATOR, 75p, post 25p.

3" DESYN INDICATOR. 62p, post 20p. Compass degrees and corrector on 5" Desyn only.

VIBRATORS. 12 volt synchronous. Type No. 12SR7, 50p each. Special offer 3 for £1, postage 15p.

CONVERTER CHASSIS. New spares for transistorised UHF tuner. Contains 4 gang min. var. cap. 4 tube trimmers, in screened sections, 25p, post 15p.

PRINTED CIRCUIT BOARD for Digital Clock. Printed Circuit Board for 4 Digit Readout. Size of boards 4" x 3". £1.50 each. Stamped Addressed envelope for details.

JACKSONS 6/36 slow motion dial and drive, £1.55, post 15p.

WE WOULD BE PLEASED TO RECEIVE QSL CARD FOR DISPLAY

TUNER UNIT. 2-Roller coils, 1½" dia. 5½" long. 3-Miniature D.C. motors. 3-Sangamo relays 200-0-200 micro amp movements. 6-700 ohm sealed relays. 3-170 ohm sealed relays. 1-500 uA meter, £3.00, post 65p.

IF STRIP. Ex R3673 Rx. 7.5 MHz with circuit. Less valves. 8 B7G PTFE holders. Sealed relay twin 500 ohm coil. 12-pin plug and socket, 50p, post 20p.

CONVERTER 20 to 90 MHz. 7.5 MHz IF. Ex 3673 Rx. 2/EF91's, 1-616 Osc., £1.25, post 20p. Some less valves, 75p, post 20p.

TRANSFORMER. Specially wound for Digital instruments. 200 volt 40 mA HT. 6 volt 1A. Two windings LT. Will supply 6v. 2A. or 12v. 1A. CT 2½" x 2" x 2¼", £1.50, post 25p.

CV416 (6F17) VALVE, 30p each, post 5p, or 4 for £1.20, post paid.

SPECTRUM ANALYSER, MARCONI OA1094. Frequency range 0-10 kHz. 200-800 kHz. 3:1 to 30 MHz. Complete on trolley. 1 only, £250. with Handbook.

ALI. MINI BOXES. With fitted lid. Post 5p per box.

3" x 2" x 1", 33p 5½" x 4" x 1½", 43p

4" x 2½" x 1½", 38p 4" x 2½" x 2", 38p

4" x 4" x 1½", 38p 5" x 2½" x 1½", 38p

INSTRUMENT CONTROL KNOBS. Black with bright Ali. centre. ¼" brass insert with grub screw. 1", 1½" and 1¾" dia., 15p each, post 5p each. Any excess refunded.

Business Hours: Tues.-Fri., 9.30 a.m. to 6.30 p.m.

SATURDAY: 9 a.m.-5 p.m. OPEN ALL DAY.

CLOSED ALL DAY MONDAY.

WE WELCOME ALL ENQUIRIES HOWEVER SMALL

Stamped addressed envelope please for special offer list

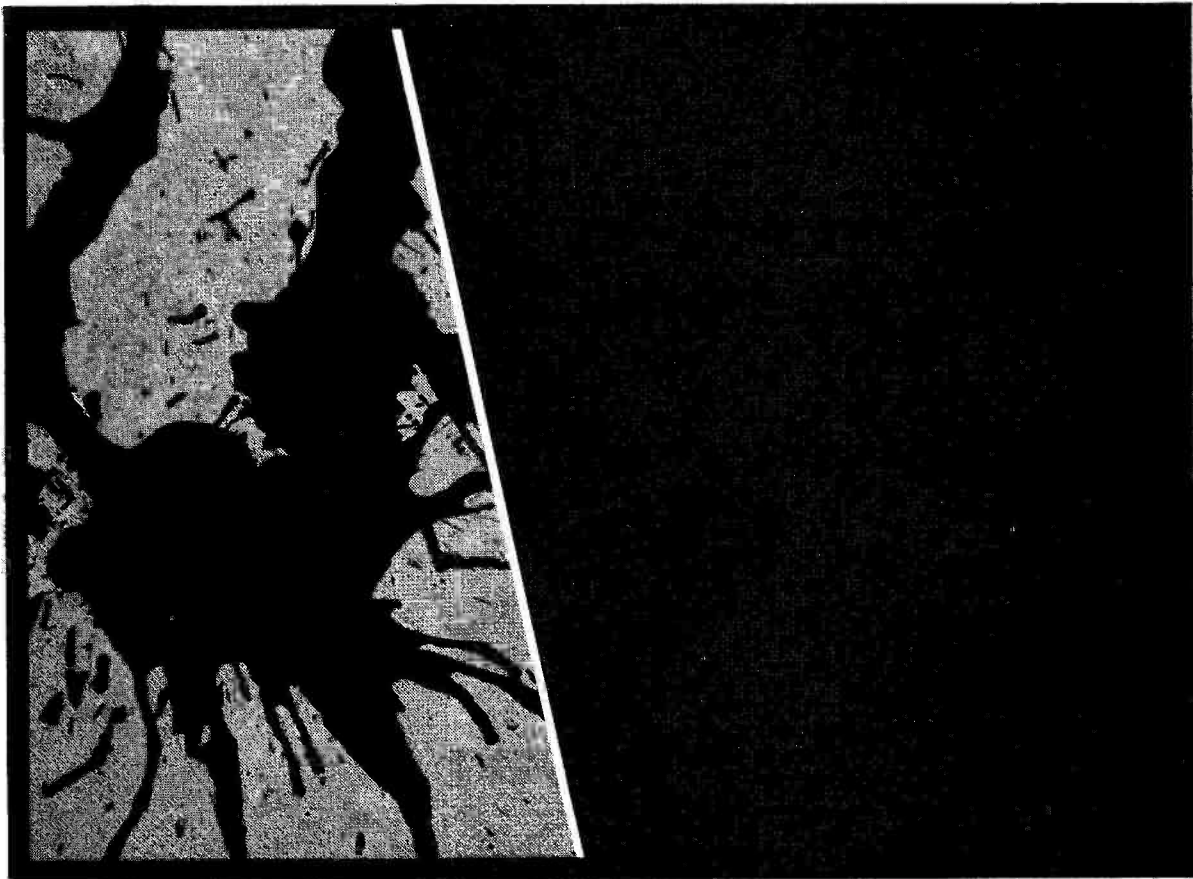

SSB-ers:

increase talk power, cut "splatter"



Our 444 base station microphone not only gives you increased talk power, but cuts "splatter" (and QRM complaints) to an absolute minimum! It has superbly tailored response, with sharp cutoffs below 300 and above 3,000 Hz and a rising response characteristic for maximum intelligibility. The 444's rugged, reliable Controlled Magnetic element has been proved in safety communications, and other tough professional communications applications. It delivers a clean signal to the transmitter at levels as high as crystal units! (And, unlike crystal and ceramic units, the element is totally immune to the effects of temperature and humidity.) The 444 also features an adjustable height stand that makes for comfortable "ragchewing" sessions, an optional-locking bar for push-to-talk or VOX operation, and a practically indestructible Armo-Dur case. Write:

Shure Electronics Limited
84 Blackfriars Road
London SE1 8HA, England





OUR AESU MUSEN MAIN DISTRIBUTOR

When you buy YAESU from their U.K. main distributor you get the best engineering standards in the world and superb performance too. All items carry the YAESU 12 months guarantee. We also do free labour on warranty claims, and carry an excellent stock of spares. Remember, we were FIRST to offer YAESU on the UK market and FIRST to give you SECURICOR 24-hour delivery; a standard of service which cannot be surpassed.

WESTERN

SHE'S A LITTLE BEAUTY! The FT-75 that is!
A 10-80m. SSB TRANSCEIVER for ONLY £80 (carr. pd.)

FT-75

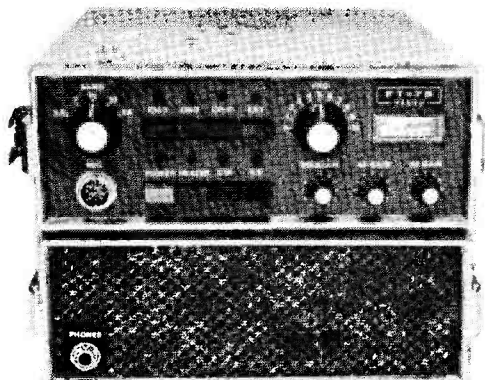

This latest addition to the ever expanding YAESU range is a real winner! Having tested it we can say the receiver side is very good and output power was not less than 15w. R.M.S. on any band. Operation could not be easier! You simply select the band, press the channel button and talk!

SPECIFICATION :

Receiver : Sensitivity : 0.5 μ V for 10 dB. S/S+N.
Selectivity : 2.3 kHz (-6 dB.), 4.5 kHz (-60 dB.);
Audio o/p : 1.8w.

Transmitter : Modes : SSB or CW. Power : 20w. p.e.p.
Carrier suppression : better than -40 dB. at 1,000 Hz.
Unwanted sideband : better than -40 dB.
Response : \pm 3 dB., 400-2,700 Hz.

General : VXO swing : 3.5 MHz, 3 kHz ; 7 MHz, 6 kHz ; 14 MHz, 3 kHz ; 21 MHz,
20 kHz ; 28 MHz, 12 kHz.
Size : 210w. x 80h. x 300d. m.m. Weight : 3.8 kg.
Current drain : AC DC
Standby 50w 1.4 amp.
Heaters on 50w 3.5 amp.
Transmit 80w 5.5 amp.

Microphone included and 4 crystals (1 on 80, 40, 15 and 10m.)

FT-75 You are welcome to test the FT-75 at Totton

AND HERE'S THE NEW 2m. FT-2 AUTO SCANNING TRANSCEIVER £129.00

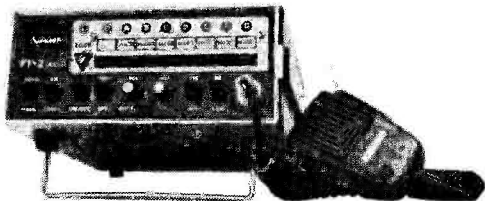

The receiver automatically scans the 8 channels and will indicate on which one there is a signal.

Power output : DX, 10w. Local, 1w.

Frequency Coverage : 144-146 MHz.

Weight : 4.2 kg.

Size : 210w x 95h x 270d m.m.

Mode : F3.

Power requirements : AC, 100, 110, 117, 200, 220, 234v.

DC, 13.5.

NEW IN THE U.K.!

FL-50B TRANSMITTER

FR-50B RECEIVER

FV-50B VFO

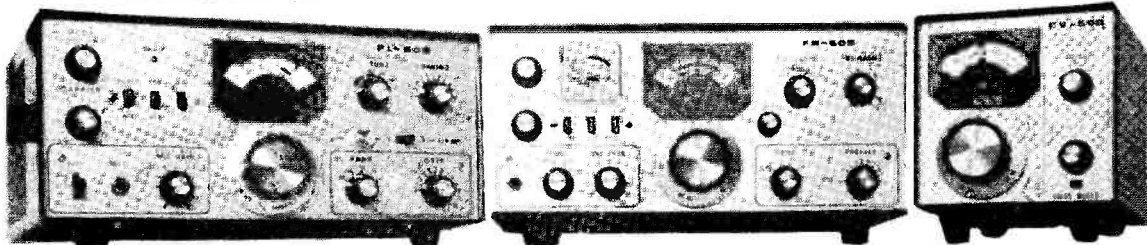

THE FR-50B AMATEUR BANDS RECEIVER AT ONLY £52.00

The FR50B low-cost YAESU amateur bands receiver covers 3.5-3.8 MHz, 7.0-7.5 MHz, 14.0-14.5 MHz, 21.0-21.5 MHz and 28.0-29.2 MHz. Sensitivity : CW/SSB, less than 0.5 μ V for 10 dB S/S+N. AM, less than 1 μ V for 10 dB S/S+N. Selectivity : \pm 5 kHz, -50 dB, \pm 1.8 kHz, -6 dB. Image ratio ; better than -50 dB. Speaker is built-in.

THE FL-50 SSB-CW TRANSMITTER £61.00

The FL-50B Transmitter operates on SSB/AM and CW. Power input is 50w. p.e.p. 80-10m. Carrier suppression, unwanted sideband and spurious radiation are all -40 dB. The unit is VXO controlled or will transceive with the FR-50. With the FV-50 VFO control is possible.

THE FV-50B REMOTE VFO for FT-75 or FL-50, £26

ALL THE ABOVE MODELS CAN BE SEEN AT OUR PREMISES

ELECTRONICS (UK) LTD

THE SUPERB FT-101 (Ex-Stock) (with 160m., £15 extra).

MATCHING FL-2100 LINEAR (Ex-Stock)



Deposit £24 followed by monthly payments as follows: 3 at £21, 9 at £20 or 5 at £15, 13 at £14 or 6 at £12, 18 at £11 or 14 at £10, 16 at £9 or 9 at £9, 27 at £8



The FT-101 is a 260w. p.e.p. SSB/AM/CW transceiver with an amazingly sensitive receiver. You'll hear signals which are inaudible on many other equipments. It comes complete with speaker and microphone, AC and DC P.S.U.s built-in. There's nothing to touch it for value!

The FL-2100 is designed to match the FT-101 and runs 1200w. p.e.p. If it's a linear you require for some other exciter, compare the FL-2100 with 2 fans, AC and HV safety interlock and fully screened input circuitry. You'll not find better value!

PRICE REDUCTION! NOW ONLY £79.50

YC-305 30 MHz FREQ. COUNTER

Since YAESU have reduced the price of the YD-305 we are pleased to pass this on to our customers.



This compact digital frequency counter which is equally suitable for laboratory, industrial or amateur applications has the following specifications: Compact design by advanced IC technique to count wide frequency range 5 Hz-30 MHz. Dual range system provides 8 digit measurement with MHz and kHz indicators. 240v. AC/12v. DC dual power pack built-in; accuracy ± time base stability +1 count, gate time 1 m.s. or 1 second; input Z I Ω, low 56 Ω; input capacity - less 20pF; max. i/p 60 v.p-p less than 10 sec. 20v. p-p continuous; time base frequency 1000 kHz crystal controlled; stability 0.0005 per cent at 25°C., 0.0025 at 40°C. Dimensions: 8½" x 3½" x 10½". Weight: 8 lbs.

YAESU PRICES. CARRIAGE PAID BY SECURICOR. MANUFACTURERS 1 YEAR GUARANTEE.

FT101 fitted 160m.	£255.00	FR400DX receiver	£120.00	AM filter FR400	£7.50	YC-305 Frequency counter...	£79.50
FT101 transceiver	£240.00	FR400S DX Receiver, 160-2m.	£160.00	FT560 Transceiver	£195.00	FT2F 2m. transceiver	£84.00
FV101 Remote VFO	£38.00	FL400 Transmitter	£140.00	FV400S remote VFO	£38.00	FP2AC AC PSU for FT2F	£25.00
FL2100 Linear Amplifier	£135.00	SP400 speaker	£10.00	FT401 Transceiver	£215.00	FP2AC/B AC supply with batteries	£34.00
SP101 Speaker for FT101	£10.00	FL2000B Linear amplifier	£135.00	FV401 Remote VFO	£38.00	Crystals for FT2F	£1.50
Fan FT101	£8.00	FM Unit for FR400	£7.50	SP401 Speaker	£10.00	FF50DX Low pass filter	£6.50
FT200 Transceiver	£134.00	FC2 2m. converter	£12.00	FL2500 Linear amplifier	£118.00	Mobile mount FT101	£5.00
FP200 AC supply for FT200....	£38.00	FC6 6m. converter	£12.00	YD846 Hand microphone	£5.00	CW filter: FT101, FT401, FT560	£15.00
DC200 PSU for FT200	£45.00	CW filter FR400	£12.50	YD844 table microphone	£12.00		
FV200 Remote VFO for FT200	£38.00						

MIDLANDS AGENT. Contact Andy Martin, G3UDR, on Shipston-on-Stour 61839 who has most YAESU items available for immediate collection.

NEW VHF POWER AMPLIFIERS/TRANSVERTOR

The FMB-20C. This is a 240v. AC mains operated amplifier switchable from linear to non-linear operation for SSB/AM/FM. The drive required is 1W/10W for 50W/90W output (approx.). This unit also provides 12v. DC to enable your 12v. FM transceiver to be mains operated. It features IC regulation of the DC output. Price: £105.00.

The FMB-2F. This is a 12v. DC operated FM amplifier giving nominally 90W output for 10W input. Price: £86.00.

The TA10-CN is a 144 to 432 MHz transvertor. On the transmitter side your 144 MHz transmitter frequency is tripled to give 432MHz+. For receive, 288 MHz is mixed with 432 MHz to provide output at 144 MHz. Power required is 11.6-16v. Price: £77.63.

PRICE REDUCTIONS ON CASLON CLOCKS!

The finest digital clock available
The CASLON 601

Features: 24hr. 220v. AC 50c. Built-in diffused light. Noiseless operation, superb styling. Easy-to-read digital face indicates date, day of the week, hour and minute. 5 second intervals marked on rotating wheel. Different colour for each day of the week.

Price: NOW ONLY £14.95

CASLON model 222, 24hr. clock, NOW ONLY £7.50. Trade enquiries invited.

OSKER POWER METER

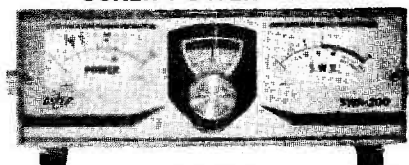

DO YOU KNOW YOUR POWER OUTPUT?
(No! You're not the only one!)

Then you need the OSKER POWER METER
Features: Switchable for 52 or 75 ohm systems. Each instrument is individually calibrated. Four ranges: 0-2, 0-20, 0-200 and 0-2kW., 3-200 MHz. Excellent styling. Price: £18.50.

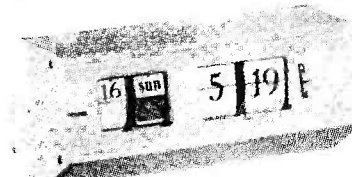

Hours of business: Monday-Friday, 9-5.30 p.m. Saturday, 9-12.30 p.m.

CATALOGUE. You ought not to be without your copy listing towers, masts, antennas, rotators, Yaesu equipment and a host of other items. Send 15p only (no s.a.e.)

OSBORNE ROAD, TOTTEN, SOUTHAMPTON, SO4 4DN, ENGLAND
TEL.: TOTTEN 4930 and 2785. CABLES: 'AERIAL, SOUTHAMPTON'

GREAT NEW RANGES OF ANTENNAS!

THE FINEST FROM JAPAN

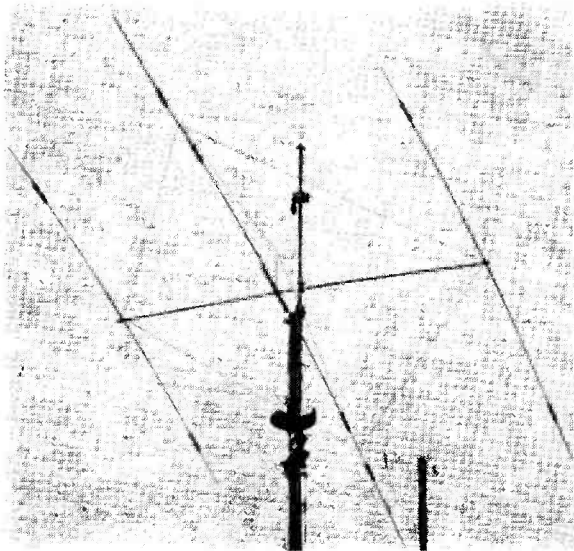

AS-3340

The ASAHI range of ANTENNAS

40m.-20m.-15m.-10m.

A 4-BAND BEAM!

The AS-3340 at only £76.50. Forward gain up to 8 dB. F/B 20 dB.

All ASAHI antennas are rated at 2kW pep.

AS-3340. 10-40m. 3 ele.	£76.50
AS-33. 10-20m. 3 ele....	£62.50
AS-23. 10-15m. 3 ele....	£42.00
AS-203W. 20m. 3 ele. wide-spaced	£57.00
AS-154W. 15m. 4 ele.	£40.00
AS-153W. 15m. 3 ele. wide-spaced	£32.70
AS-104W. 10m. 4 ele.	£33.90
AS-103. 10m. 3 ele.	£29.95
ECHO-8G. 10-40m. Vertical 1 kW.	£17.25
AS-2HG. 2m. Ground plane ...	£9.60
AS-303A. 10-80m. Mobile ...	£33.00

SWR/POWER METERS

ME-11B	£7.20	ME-11N	£13.40
--------	-------	--------	--------

THE FINEST FROM CANADA

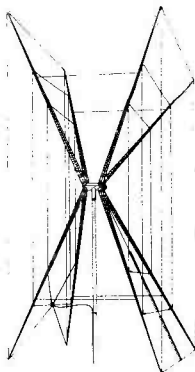

GEM-QUAD £65.00

for 10, 15 & 20m.

- ★ Weighs only 21 lbs.
- ★ Withstands 100 mph winds.
- ★ Forward gain up to 8 dB.
- ★ Balun included.
- ★ Converts to 3 or 4 element quad.
- ★ Fibreglass tri-dectic spreaders.
- ★ Front/back ratio 25 dB.
- ★ Low angle radiation.

THE FINEST FROM THE U.S.A.

HY-GAIN

HY-GAIN 18AVT/WB THE GREAT NEW WIDE BAND VERTICAL SELF SUPPORTING FOR, 10-80m. (ex-stock) £33.00. Take the wide band, omnidirectional performance of Hy-Gains famous 14AVQ/WB add 80 mtrs. plus extra heavy duty construction and you have the new 18AVT/WB ★ True 1/2-wave resonance on all bands ★ 52 Ω 1P ★ SWR of 2:1 or less at band edges ★ 1 kW (AM) ★ Radiation pattern has an outstandingly low angle ★ Roof or ground mounting.

Hy-tower, 10-80m.	£99.50
18V, 10-80m. vertical	£10.90
12AVQ, 10-20m. vertical	£16.50
14AVQ, 10-40m. vertical	£18.50
18AVT, 10-80m. vertical	£33.00
LCBOQ, 80m. coil for 14AVQ	£6.70
TH6DX, 10-20m. 6 ele. beam	£88.00
TH3MK3, 10-20m. 3 ele. 2 kW	£69.50
TH3 Jnr., 10-20m. 3 ele. 600w.	£48.00
Hy-Quad, 10-20m. 2 ele.	£62.50
DB10-15, 10-15m. 3 ele.	£51.00
204BA, 20m. 4 ele. beam	£80.00
203BA, 20m. 3 ele. beam	£67.50
153BA, 15m. 3 ele. beam	£33.00
103BA, 10m. 3 ele. beam	£26.50
18TD, Reeltape portable dipole	£41.00
LA1 Lightning arrestor	£14.50
LA2 Lighting arrestor	£2.50

MOSLEY (Carr. pd.) (Ex-Stock)

Mustang. 10-20m. 3 ele. 2kWV ...	£41.50	TA33 Jnr., 10-20m. 3 ele. ...	£34.50	TA32 Jnr. 'E' for 2" mast ...	£25.90	Atlas Vertical 10-40m. guyed ...	£20.90
TA33 Jnr. 'E' for 2" mast	£35.00	TA32 Jnr. 1-20m. 2 ele.	£24.50	TA31 Jnr. Rotary dipole	£15.40	SVL Listeners dipole	£10.90

BANTEX FIBREGLASS MOBILE ANTENNAS (Carr. 50p)

70/4. 70 MHz, 1/2 wave	£3.00	BGA, 144 MHz, 1/2 wave	£6.15	Magnetic mount	£4.95	Note. Deduct 50p from price of aerial if base is not required.
144/4. 144 MHz, 1/2 wave	£2.75	B5, 144 MHz, 1/2 wave...	£4.35	All aerials complete with base.		

ANTENNA ROTATORS. Immediate delivery from Stock

AR20 (p & p 40p) ...	£20.00	AR22R (p & p 65) ...	£25.00	TR44 (p & p 75p) ...	£47.00	HY-GAIN, 400 (p & p £1) ...	£98.00
				HAM-M (p & p 80p) ...	£70.00		

TELOMASTS (Carr. pd.) (Ex-Stock)

These galvanised steel masts telescope down to 10'. They can be extended up to 30', 40' or 50' with antennas up to TA33 jnr. size and can be rotated from the ground. Prices are carr. paid. England and Wales, Scotland plus £1, Channel Isles plus £2.

Most only		with full Rigging kit	
30'	£14.40	30'	£19.95
40'	£16.50	40'	£25.50
50'	£19.50	50'	£31.50

TOWERS, VERSATOWER, HAMTOWER, TELETOWER (Ex-Stock)!

CATALOGUE 15p please (no sae required).

★ Your 'one-stop' single source for masts, towers, rotators, antennas and equipment

★ Largest stock range in the U.K.

★ Money-saving packaged deals.

WESTERN ELECTRONICS (U.K.) LTD.
OSBORNE ROAD . TOTTON . SOUTHAMPTON

TELEPHONE: TOTTON 4930 or 2785
CABLE: 'AERIAL, SOUTHAMPTON'

THE HEATHKIT HIGH POWER ECONOMY PAIR

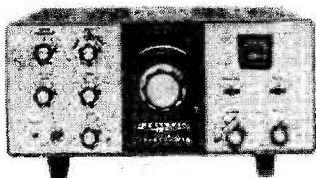

Heathkit HW-101 Transceiver . . . £129.50

Carriage 80p

- Better than 0.35 μ V sensitivity for 10 dB/S + N/N
- Image & IF rejection better than 50 dB
- Rock-solid tuning 80 through 10 metres

The HW-101 is a further refinement of the widely acclaimed HW-100 Transceiver . . . with improved receiver circuitry and dial drive and added front-panel SSB/CW filter selection. Sensitivity better than 0.35 μ V for 10 dB S + N/N has been obtained by refinements in the receiver circuit. Image and IF rejection are better than 50 dB. 36-1 knob to dial ratio in a new ball bearing drive mechanism delivers 34 smooth revolutions per 500 kHz band segment. This feature, coupled with new preselector circuitry and thermal stabilized FET VFO with 5 kHz readout, gives you rock-solid drift-free tuning from 80 through 10 metres. Built-in 100 kHz crystal calibrated and zero reset button provide accurate, stable calibration. Front-panel crystal filter selection lets you convert the HW-101 to CW reception at the flick of a switch. The optional SBA-301-2 crystal filter installs in minutes, giving you the same remarkable two-way capability provided by its big brother, the Heathkit SB-102. CW filter offers razor sharp 400 Hz selectivity to carve a QSO out of the QRM. Built-in SSB crystal filter delivers 2.1 kHz selectivity at 3 dB down for superior SSB copy.

Kit HW-101, 21 lbs. £129.50 Carr. 80p

Kit HP-23A, AC p.s.u., 19 lbs. £23.50 ,, 80p

Kit HP-13A, DC p.s.u., 7 lbs. £37.50 ,, 40p

SBA-301-2, 400 Hz filter, 1 lb. £11.00 ,, 30p

WRITE TO US FOR FREE SPECIFICATION SHEETS AND FULL DETAILS

Heathkit SB-200 1 kW Amplifier . . . £127.50

Carriage £1.00

- 1200 watts PEP input SSB; 1000 watt CW
- 80 through 10 metre band coverage
- Built-in SWR meter; ALC

Brawny partner of the "Economy Kilowatt" pair, the SB-200 is a completely self-contained, compact desktop rig with built-in solid-state power supply that sets you up with 1200 watts SSB, 1 kW CW with 80 through 10 metre band coverage. And since it requires only 100 watts PEP drive, it's the ideal mate for the Heathkit HW-101 and almost all other popular transmitters and transceivers. A pair of 572B/T-160-L are used for amplification, fan cooled and shielded for maximum TVI protection. Other noteworthy features include a pretuned cathode input circuit for efficiency, low distortion; ALC output for automatic exciter control; circuit breaker protection; built-in SWR meter and antenna relay that automatically switches to the exciter when the linear is off; 120/240v. AC operation.

Sturdy, lightweight construction is another plus feature. The SB-200 is designed around a heavy-gauge, one-piece aluminium chassis, partitioned for extra strength and proper isolation of components and circuitry. Well planned circuit design, coupled with clear, concise assembly instructions means you can have your SB-200 on the air 15 to 20 hours after you start the kit with normal bench tools, and a VOM for alignment.

Kit SB-200, 50 lbs. £127.50 Carr. £1.00

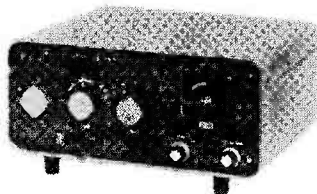

ATTRACTIVE CREDIT FACILITIES AVAILABLE 10% DEPOSIT 12-24-36 MONTHS

Please note that on any credit agreement the service charge will be refunded if you complete payment within 3 months. After 3 months an early settlement discount of 5% on the outstanding balance is given.

HEATHKIT

Schlumberger

HEATH (Gloucester) LTD., GLOUCESTER GL2 6EE

LOWE ELECTRONICS

119 Cavendish Road, Matlock, Derbyshire. DE4 3HE

Tel: Matlock 2817 or 2430 9 a.m. - 9 p.m.

Bill: G3UBO

Alan: G3MME

MAIN DISTRIBUTOR FOR YAESU MUSEN EQUIPMENT

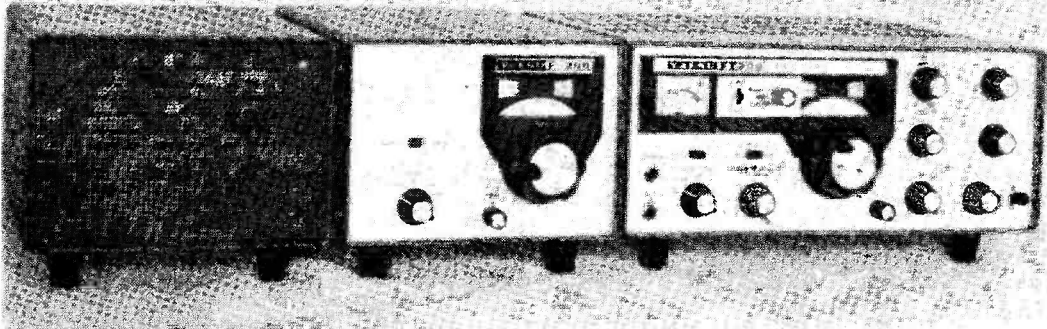

There are several reasons why we feel the Yaesu FT200 is such a good buy. No attempt has been made to permit a CW filter to be fitted. The designer has not allowed any switching around the filter and thereby achieves maximum isolation between filter input and output. This accounts for the incredibly good skirt selectivity of the FT200. Skirt selectivity which, in our estimation is, for SSB, the best of the Yaesu range. We also like the pre-mixed oscillator chain which gives the superior signal handling and low noise capabilities of a single superhet while at the same time retaining a 9MHz I.F. with its superb image rejection. Lots of other things add up to an unmistakable best buy. Stable, accurate, gear-driven solid state VFO, VOX, break-in CW, CW sidetone monitor, RIT, 100 kHz marker, 300W SSB speech peaks, half microvolt sensitivity, etc. etc. All in all, at £250 it would still be a good buy. At £134 (plus A.C. psu £38) it's INCREDIBLE.

FT101 Transceiver	£240.00
FT101 fitted 160m.	£255.00
FT101 fitted 160m. and new PA coil	£255.00
SP101 matching speaker	£10.00
FV101 remote VFO	£38.00
FT101 mobile mount	£5.00
FL2100 Linear	£135.00
FRdx400 super de luxe Receiver	£160.00
SP400 speaker	£10.00
FLdx400 transmitter	£140.00
FL2000B Linear	£135.00
FT-2F 2m. FM	£84.00
FT-2 Auto	£129.00

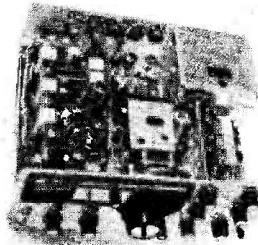

FT200 Transceiver	£134.00
FP200 AC p.s.u./speaker	£38.00
FV200 remote VFO	£38.00
DC200 mobile p.s.u.	£45.00
FTdx401 Transceiver	£215.00
FV401 remote VFO	£38.00
SP401 speaker	£10.00
YC305 counter	£79.50
FT75	£80.00
FP75	£20.00
DC75	£20.00
FR-50B receiver	£52.00

The above equipment is ex-stock and apart from sundry spares which go first-class mail, we send all equipment by Securicor, who almost invariably deliver within 24 hours and, more important, treat the gear gently. There is no extra charge for this service, nor for the fact that all equipment is thoroughly checked before despatch. Plus of course our unbeatable 12-month guarantee and our money-back guarantee.

Other new equipment: (post paid)

Plain morse keys, ball-bearing pivots, £1, Katsumi EK-9X electronic keyers £8.20, Asahi twin meter SWR meters £6.80.

Dummy Load/Wattmeters: please do not confuse these with the cheap and cheerful so-called power meters which are frequency conscious, impedance conscious and of dubious accuracy. These are Wattmeters (a horse of somewhat different colour!), they are neat and compact (approximately 5" x 5" x 10" deep), but MORE important are accurate and MOST important present a substantially constant 50 ohms impedance over the frequency range of 3 MHz to 500 MHz. They are switched to read F.S. 20 or 120W and give useful readings as low as 1W. The SWR is better than 1 : 1.2 over the entire range and no serious VHF operator should be without one, particularly at this price, £32.

Valves: Postage Extra: 6AH6 80p, 6 AQ5 75p, 6BZ6 42p, 6U8A 80p, 6CL6 50p, 6AN3 74p, 6EV6 75p, 6EH7 45p, 6BM8 50p, 6AW8A £1.75, 7360 £2.10, 12 BY7A 70p, EF183 45p, 6GK6 92p, 6JS6A/B/C £1.75, 6 KD6 £1.75, 6I46B £2.60, 6JM6A £1.25, 6LQ6 £2.25, 572B £8.00.

Please include lots for postage on valves—we'll refund any excess.

Antennae:

Asahi Echo-8G.40 to 10m. trap vertical. Self-supporting, handles 1kW p.e.p. SWR better than 1.5 : 1. This vertical can be mounted on a post at ground level, in which case radials are not necessary, although they are always beneficial, or it can be mounted up aloft, in which case it can be treated as a ground plane with radials as per instruction sheet. £17.50, carriage paid.

Digital Clocks:

Copal 222 £7.50, Digitor £5.50.

Mikes, filters, mobile whips, connectors, coax, rotators, etc. etc. Everything for the complete station.

2m. Equipment

2m. Converter. We stock a very nice 2m. converter designed and manufactured by Sim, our Northern Representative. It features a dual gate 3N159 r.f. amp and dual gate 40602 mixer. It requires 12v. d.c. and the I.F. is 23-30 MHz. Quite honestly, I don't think you'll find a better converter at the price, **£13-50.**

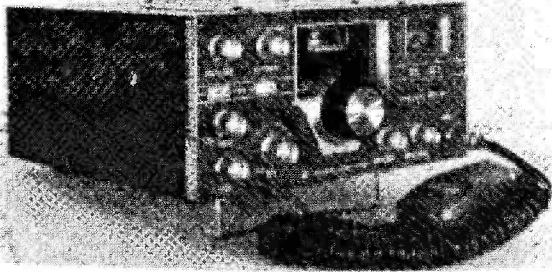

By the time you read this ad, strikes, etc., permitting, we should have the matching VFO which plugs directly into the IC-21 and tunes the Rx but leaves the Tx xtal controlled, **£30.**

We also have the IC-20 in stock. This is similar to the FT-2F described below. Price **£94.**

IC-21

All transistor 25W input 2m. FM transceiver, fixed station or mobile.

Power supply : 12-13.5v. d.c. (negative earth) or 234v. a.c.

24 channel : 144-48, 144-60 and 145-00 fitted as standard, but other channels available.

0.4 microvolt for 20 dB quieting. Adjustable deviation, built-in SWR meter, RIT. Complete with PTT dynamic microphone, **£120.**

FT-2F

An ideal all transistor mobile 25W input 2m. FM rig. Power supply : 12-13.5v. d.c. (negative earth). 12 channels crystal controlled : 144-48, 144-60 and 145-00 fitted as standard. Other channels available. Adjustable deviation. Double superhet Rx with 0.3 microvolt sensitivity. 6 $\frac{1}{8}$ " x 2 $\frac{1}{2}$ " x 10" deep, **£84.**

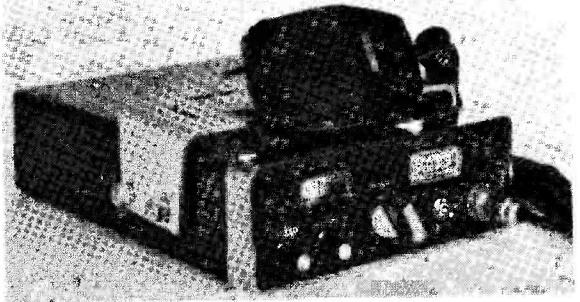

There is no doubt that this mobile FM gear is becoming more and more popular. Quite rightly, so because of the advantages of FM. Lack of TVI, broadcast quality speech (except the nit who shouts into the mike of course!), noise-free reception, etc., etc. The fact that they are crystal controlled is not the drawback you might expect—they all use the same channels and hence, wherever you are, you have every chance of working someone with similar equipment. The IC-20 and FT-2F are small enough to fit in any car without major surgery and are the complete answer for a compact mobile rig at a reasonable price. Any of the above can be fitted with an extra internal AM detector incorporating its own I.F. and A.G.C. system for **£10 extra.**

Second-hand Equipment

All mint, fully checked, serviced where necessary and complete with manual. Each one carries our comprehensive guarantee. Please note that carriage by Securicor is £1.75 extra on all second-hand gear.

Receivers :

Hallicrafters SX110, **£60.** Heathkit RAI, Q mult, speaker and xtal calibrator, **£30.** Inoue IC-700R, **£65.** KW201, **£75.** Trio JR500S, **£50.** Trio JR310, **£60.**

Transmitters :

Sommerkamp FL-200B, **£80.** Yaesu Musen FL-1000, **£65.** KW Vespa Mk. I, **£70.**

Transceivers (with p.s.u.'s) :

National NCX-5, **£175.** Drake TR3, RV-3 remote VFO, A.C. p.s.u., D.C. p.s.u., **£190.** KW2000A, **£150.** Inoue IC-700, **£100.** Swan 500, **£175.**

Low Electronics

119 CAVENDISH ROAD, MATLOCK, DERBYSHIRE, DE4 3HE
Tel. Matlock 2817 or 2430 (9 a.m. - 9 p.m.)

Bill G3UBO, Alan G3MME. Hours : Tuesday to Saturday 9.5.30 (closed for lunch 1-2 and all day Monday)

SERVICE AND SALES (evenings and weekends only) : John G3JYG, 16 Harvard Road, Ringmer, Lewes, Sussex. Tel : Ringmer 812071. Sim GM3SAN, 19 Ellismuir Road, Baillieston, Nr. Glasgow. Tel : 041-771 0364. Alan GW3YSA, 35 Pen y Waun, Efail Isaf, Nr. Pontypridd, Glam. Tel : Newton Llantwit 3809.

SERVICE ONLY (evenings and weekends) : Dave Dryden, G3BKQ, 205 Main Street, Thornton, Leics. Peter Ward G3XWX, 47 Radstock Avenue, Ward End, Birmingham, B36 8HD.

Sim, John and Alan will be happy to demonstrate New Yaesu Gear by appointment. They also have a pretty good selection of second-hand trade-ins at the right price.

Radio Shack Ltd



London's Amateur Radio Stockists

Just around the corner from West Hampstead Underground Station

Drake	H3JK 3 element Beam 10, 15, 20m.	£46.50
2-C Receiver-SSB, AM, CW, RTTY	TH2MK3 2 element Beam 10, 15, 20m.	£48.00
2-AC Crystal Calibrator for 2-C	HY-QUAD 3 Band 2 Element Quad	£61.00
2-CS Matching Speaker for 2-C	DB10-15A 10 and 15m. Beam	£50.00
2-CQ Q-Multiplier/ Speaker for 2-C	204BA 4 element 20m. Beam	£68.50
2-NB Noise Blanker for 2-C	203BA 3 element 20m. Beam	£66.50
R-4B Receiver-SSB, AM, SW, RTTY	153BA 3 element 15m. Beam	£32.00
MS-4 Speaker for R-4B, TR-4, SW4A	103BA 3 element 10m. Beam	£23.00
SW-4A Receiver-AM, INT, SW	257 Mobile Mast	£8.50
AL-4 Loop Antenna for SW-4A	252 80m. Coil and Tip Rod	£8.75
SPR-4 Receiver-General Purpose	256 40m. Coil and Tip Rod	£8.00
Amateur Band Xtal Kit for SPR-4	255 20m. Coil and Tip Rod	£6.50
5NB Noise Blanker for SPR-4	253 10m. Coil and Tip Rod	£5.50
SCC-4 100kHz Calibrator for SPR-4	492 Coil and Tip Rod Spring	£1.50
Transceiver Adaptor for SPR-4, T-4XB	499 Flush Body Mount	£4.75
DC Power Cord for SPR-4	417 De Luxe Spring	£3.50
DSR-4 Digital Receiver	TE-7-01 Antenna Noise Bridge	£13.50
TR-4 SSB Transceiver	TE-7-02 Antenna Noise Bridge	£19.50
4-NB Plug-in Noise Blanker TR-4	BN86 Ferrite Balun	£7.75
AC-4 P.S.U. for TR-4, T-4XB	RG-8A/U Heavy duty coax. 52 ohm	£0.37
DC-4 12v. P.S.U. TR-4, T-4XB	PL259 Connectors	£0.35
MMK-3 Mobile mounting kit for TR-4	KL25B Adaptors	£0.90
RV-4 Remote VFO for TR-4	LA-1 Lightning Arrestor	£14.25
FF-1 Xtal control for TR-4	LA-2 In-Line Lighting Arrestor	£2.50
MC-4 Mobile Console	J-Beam	
T-4XB-SSB Transmitter	2/4Y 4 element 2m. dipole Yagi	£2.65
L-4B Linear Amplifier and Power Supply	2/8Y 8 element 2m. dipole Yagi	£3.80
MN-4 Antenna Match Network	2/10Y 10 element 2m. Long Yagi	£8.20
MN-2000 Antenna Match Network	2/12 double 6 slot-fed Yagi	£6.15
W-4 RF Wattmeter 2-30 MHz	2/HM Halo mobile antenna	£1.50
WV-4 RF Wattmeter 20-200 MHz	70/MBM46 46 element multibeam	£9.60
C-4 Station Control Console	KW Electronics	
729SRD Cardioid Microphone	101 VSWR meter	£9.25
TC-2 2m. Transmitter Converter	103 VSWR meter/Power meter	£12.50
SC-2 2m. Converter	107 Matching Unit	£40.00
SC-6 6m. Converter	E-2 Match 10-80m. A.T.U. Mk. 2	£15.00
CPS-1 P.S.U. for SC-2 and SC-6	Dummy Load 52 or 75 ohm	£7.00
SCC-1 VHF Xtal Calibrator	Balun 1:1 ratio dual impedance	£1.95
CC-1 Converter Console TV-1000LP Low Pass Filter	Low Pass Filter 52 or 75 ohm	£5.50
Spare Drake Operating Manuals	Antenna Switch 3 position	£3.75
Crystals for 2-C R-4B, SW-4A, T-4XB	CDR Rotors	
Fixed Frequency Crystals CA-1 Stacking Cabinet Adaptor	AR20 suitable 2 and 4 metre beams	£20.00
Crystals for SPR-4	AR22R suitable 3 band beams	£25.00
HY-Gain	TR44	£40.00
18HT 6-80m. Vertical Hy-Tower	Ham-M	£70.00
12AVQ 10-20m. Trapped Vertical	Polyquad	
14AVT/WB 10-40m. Trapped Vertical	2 element Poly Tri Quad	£37.50
18AVT/WB 10-80m. Trapped Vertical	3 element Poly Tri Quad	£56.50
18V 10-80m. Vertical	4 element Poly Tri Quad	£75.00
12RMQ Roof Mounting Kit for 12AVQ	Spare Instructions Manual	£1.00
14RMQ Roof Mounting Kit for 14AVQ/WB	Ten-Tec	
LC80Q 80m. Loading Coil for 14AVQ/WB	PM-2 low-power 40 and 80 CW Transceiver	£29.50
TH6DXX 6 element Beam 10, 15, 20m.	PM-3A low-power 20 and 40m. Transceiver	£39.75
TH3MK3 3 element Beam 10, 15, 20m.	KR40 Electronic Squeeze Keyer	£45.00

Shure Microphones	Model 201 ceramic	£5.65
Model 202 noise cancelling ceramic	Model 444 controlled magnetic	£6.60
Robot SSTV	Model 80. Camera and Lens	£260.00
Monitor		£255.00
Trio	9R-59DS Receiver	£57.50
JR-310 Receiver	JR-599	£83.50
SP-5D Matching Speaker	10AZ Filter for JR-310	£4.50
Calibrator Unit for JR-310	100 kHz calibration xtal for JR-310	£14.67
B1016 Hand Microphone	TW205A Table Microphone and Pre-amp	£7.34
Yaesu Musen	FT401 Transceiver	£215.00
FT101 Transceiver	FT101 Transceiver fitted with 160m.	£240.00
FT200 Transceiver	FL2100 Linear Amplifier	£255.00
DC200 P.S.U. for FT200	SP101 Speaker for FT-101	£135.00
FP200 AC Supply for FT200	FL2000B Linear Amplifier	£45.00
SP40 Speaker	FR400 SDX Receiver	£140.00
FV200 Remote V.F.O. for FT200	FR401 Transmitter	£140.00
FL2000B Linear Amplifier	FV400 Remote V.F.O.	£38.00
FR400 SDX Receiver	SP401 Speaker	£10.00
FR401 Transmitter	FT2-Auto Transceiver	t.b.a.
FV400 Remote V.F.O.	FT2-2F 2m. Transceiver	£84.00
SP401 Speaker	FP2CA VY P.S.U. for FT-2F	£25.00
FT2-Auto Transceiver	FP2CA/B AC Supply with batteries	£34.00
FT2-2F 2m. Transceiver	YC-305 Frequency Counter	£79.50
FP2CA VY P.S.U. for FT-2F	YR44 Table Microphone	£12.00
FP2CA/B AC Supply with batteries	YDB46 Hand Microphone	£5.00
YC-305 Frequency Counter	CW Filter for FT101, FT401, FT560	£12.50
YR44 Table Microphone	Crystals for FT-2F	£3.20
YDB46 Hand Microphone	Superox	
CW Filter for FT101, FT401, FT560	CQ Communications Headset 16 ohm	£9.50
Crystals for FT-2F	CQ Communications Headset 1:1 ratio dual impedance	£10.50
Carlingella	ACS-11 Communications Headset 16/600 ohm	£12.55
ACA-1 Audio Compressor	MBH-3 High impedance boom mic for all above Headsets	£6.20
ACA-1 Audio Compressor Kit	Hammarlund	
STR-1 Standard Time Rx. 5, 10, 15 MHz	ACA-1 Audio Compressor Kit	£36.30
STR-1 Standard Time Rx. Kit	STR-1 Standard Time Rx. 5, 10, 15 MHz	£25.50
Dot-Line Mobile Communications Filters	STR-1 Standard Time Rx. Kit	£52.50
CB-330 Tuneable Generator Filter	Hammarlund HQ-215 Rx. 10-80m.	£38.95
VF225 Voltage Regulator Filter	General coverage	£115.00
AF-104 Alternator Filter	KW Viceroy Tx. Mark 4. AR88 cabinet	£60.00
C-40 Bulkhead Feedthru coax filter	Nordmende Globetrotter Amateur	£60.00
C-70 Bulkhead Feedthru coax filter	Inoue IC700R Rx. 10-80m.	£60.00
C-20A Bulkhead Feedthru coax filter	Johnson A.T.U. 600w. PEP. 10-80m.	£45.00
C-20 Feedthru Coax Filter	Hammarlund HQ-180 Rx. General coverage	£150.00
C-10 Bypass Capacitor Filter	KW Viceroy Mk. 4 AM and SSB Tx.	£75.00
Valves	Sommerkamp FLDX500 Tx.	£100.00
3-500Z	KW1000 Linear Amplifier BC-1031-A Panadaptor 455 kHz	£95.00
3-400Z	KW160 Transmitter	£35.00
811A	Heathkit SB-220 Linear Amplifier	£20.00
575B	Swan VX-2 Vox	£160.00
Many other types available.	Swan VX-2 Vox	£12.50

Halicrafters	SR200 Transceiver and P.S.U.	£785.00
SR400 Transceiver and P.S.U.	HA-1 Keyer	£475.00
HA-1 Keyer	HA-20 V.F.O.	£59.50
HA-20 V.F.O.	Swan	£95.00
500CX3 Transceiver and P.S.U.	500CX3 Transceiver and P.S.U.	£350.00
Sundries	Hy-Gain 531 Quick Disconnect Unit	£1.75
Wightraps 10-80m. 500 watts	High Power Wightraps 1000 watts	£2.50
T-pieces	End Insulators per pair	£3.50
High Pass Filters type 35A	Medco Filters 52 ohm	£0.25
Dummy Load Resistors	Osker Power Meter	£18.00
Tinsley Tx capacitors 500v. 30-1500pf	Apollo 1kW Dummy load/Vattmeter	£2.50
Dual impedance mono headphones	Low impedance mono headphones 16 ohm	£7.50
B & W coax switch 590G. 5-way	B & W coax switch 375 6-way	£5.50
Used Equipment	Drake TR-3 with P.S.U. & MS-4 Speaker	£9.00
Heathkit SB-101 with HP-23, SB-600	KW Atlans and P.S.U.	£195.00
KW2000A and P.S.U.	National NCX-5 Transceiver and P.S.U.	£175.00
Sommerkamp FTDX500 and P.S.U.	Sommerkamp FTDX150 AC and DC	£175.00
Sommerkamp FTDX150 AC and DC	Swan 500 and P.S.U.	£145.00
Swan 500 and P.S.U.	Eddystone 740 Gen. cov. Receiver	£210.00
Eddystone 740 Gen. cov. Receiver	GEC RC/410 Digital Rx. 2-32 MHz	£150.00
GEC RC/410 Digital Rx. 2-32 MHz	Sommerkamp FRDX500 Rx. 160-2m.	£350.00
Sommerkamp FRDX500 Rx. 160-2m.	Heathkit SB-301 Rx. Amateur Bands	£120.00
Heathkit SB-301 Rx. Amateur Bands	Heathkit SB-300 Rx. Amateur Bands	£125.00
Heathkit SB-300 Rx. Amateur Bands	Heathkit GR-7B Rx. General coverage	£95.00
Heathkit GR-7B Rx. General coverage	Hammarlund SP601X Rx. Receiver. Gen. cov.	£60.00
Hammarlund SP601X Rx. Receiver. Gen. cov.	Halicrafters SX-122 Rx. General coverage	£75.00
Halicrafters SX-122 Rx. General coverage	Hammarlund HQ-170A Rx. 160-10m.	£125.00
Hammarlund HQ-170A Rx. 160-10m.	Hammarlund HQ-180 Rx. General coverage	£75.00
Hammarlund HQ-180 Rx. General coverage	KW Viceroy Tx. Mark 4. AR88 cabinet	£115.00
KW Viceroy Tx. Mark 4. AR88 cabinet	Nordmende Globetrotter Amateur	£60.00
Nordmende Globetrotter Amateur	Inoue IC700R Rx. 10-80m.	£60.00
Inoue IC700R Rx. 10-80m.	Johnson A.T.U. 600w. PEP. 10-80m.	£45.00
Johnson A.T.U. 600w. PEP. 10-80m.	Hammarlund HQ-215 Rx. 10-80m.	£150.00
Hammarlund HQ-215 Rx. 10-80m.	KW Viceroy Mk. 4 AM and SSB Tx.	£75.00
KW Viceroy Mk. 4 AM and SSB Tx.	Sommerkamp FLDX500 Tx.	£100.00
Sommerkamp FLDX500 Tx.	KW1000 Linear Amplifier BC-1031-A Panadaptor 455 kHz	£95.00
KW1000 Linear Amplifier BC-1031-A Panadaptor 455 kHz	KW160 Transmitter	£35.00
KW160 Transmitter	Heathkit SB-220 Linear Amplifier	£20.00
Heathkit SB-220 Linear Amplifier	Swan VX-2 Vox	£160.00
Swan VX-2 Vox	Swan VX-2 Vox	£12.50
Swan VX-2 Vox	Swan 270 Transceiver	£15.00
Swan 270 Transceiver	Collins 7553-B Receiver	£200.00
Collins 7553-B Receiver	Collins 516F-2 P.S.U.	£315.00
Collins 516F-2 P.S.U.	Collins 312B-4 Console	£350.00
Collins 312B-4 Console	Heathkit HP-13 DC Power Supply	£70.00
Heathkit HP-13 DC Power Supply	Halicrafters HA-16 Vox for HT-46	£25.00
Halicrafters HA-16 Vox for HT-46		£5.00

Carriage extra on all items. H.P. 10% deposit and balance up to 3 years. S.A.E. with all enquiries please. Open 6 days 9 till 5, closed for lunch between 1 and 2.

RADIO SHACK LTD.

Member of Amateur Radio Retailers Association.

182 BROADHURST GARDENS LONDON, NW6 3AY

Just around the corner from West Hampstead Underground Station

Telephone: 01-624 7174

Cables: Radio Shack, London, N.W.6.

Giro Account No.: 588 7151

Radio Shack Ltd



London's Amateur Radio Stockists

Just around the corner from West Hampstead Underground Station

R. L. Drake's Magnificent 4B

T-4XB Transmitter and R-4B Receiver

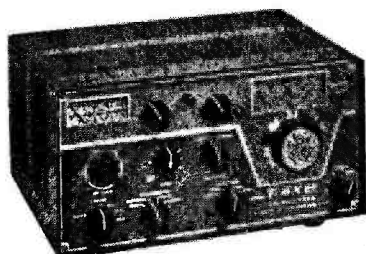

T-4XB £219.50
AC-4 p.s.u. £46.95

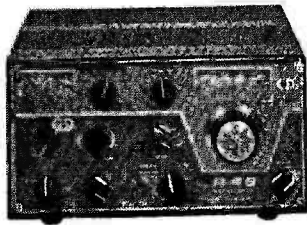

R-4B £212.50

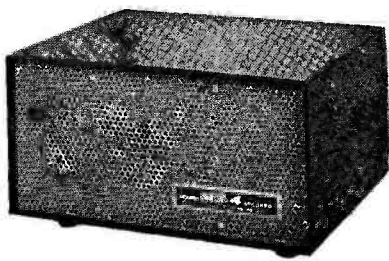

MS-4 £9.95

All the rest of the Drake equipment including the TR-4 transceiver.

RADIO SHACK LTD.

182 BROADHURST GARDENS, LONDON, N.W.6.

Just around the corner from West Hampstead Underground Station

Telephone: 01-624 7174 Cables: Radio Shack, London, NW6-3AY.

Giro Account No.: 588 7151



SKYWOOD CX203 COMMUNICATION RECEIVER

Solid state. 5 bands 200-420 Kc/s. and -55 to 30 MHz. Illuminated slide rule dial. Bandspread, Aerial tuning. BFO. AVC. ANL. 5" meter. AM/CW/SSB. Integrated speaker and phone socket. 220/240v. A.C. or 12v. D.C. Size: 325 x 266 x 150 mm. Complete with instructions and circuit, £28.50. Carr. 50p.

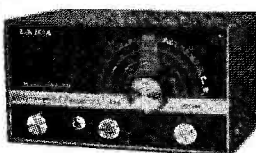

UNR-30. 4 BAND COMMUNICATION RECEIVER

550 Kc/s.-30 Mc/s. Incorporates variable BFO for CW/SSB reception. Built-in speaker and phone jack. Metal cabinet. 220/240v. A.C. brand new, with instructions, £15.75. Carr. 37½p.



LAFAYETTE HA.800 SOLID STATE AMATEUR COMMUNICATION RECEIVER SIX BANDS 3-5.4, 7-7.3, 14-14.35, 21-45, 28-29.7, 50-54 Mc/s.

Dual conversion on all bands. 2 x 455 Kc/s. mechanical filters. Product detector Variable B.F.O. 100 Kc/s. crystal calibrator. "S" meter. Huge slide rule dial. 230v. A.C. or 12v. D.C. Size: 15" x 9½" x 8½" Complete with instruction manual, £57.50. Carr. paid (100 Kc/s. Crystal £1.97½ extra).

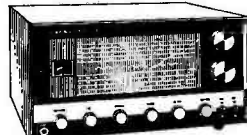

LAFAYETTE SOLID STATE HA600 RECEIVER

5 Band AM/CW/SSB amateur and short wave 50 Kc/s.-400 Kc/s. and 550 Kc/s.-30 Mc/s. F.E.T. front end. 2 Mechanical filters. Huge Dial. Product detector. Variable BFO. Noise limiter, 5 Meter. 24½" Bandspread. 230v. A.C./12v. D.C. Neg. earth operation. RF gain control. Size: 15" x 9½" x 8½". £50. Carr. 50p.

HANSEN SWR-3 BRIDGE
Impedance 52 ohms. Also operates as field strength indicator, complete with telescopic aerial, £4.25 each. P.P. 17½p. PL259 plugs to suit 37½p each.

HAMGEAR PRESELECTORS
PMIIA £9.20 and PMIIB, £8.25. P.P. 20p.

TE15 TRANSISTORISED GRID DIP METERS
Six ranges. 440 Kc/s.-280 Mc/s. Operates on 9v. battery. Full instructions, £12.50. P.P. 17½p.

LATEST CATALOGUE

Our 6th edition gives full details of a comprehensive range of HI-FI EQUIPMENT COMPONENTS, TEST EQUIPMENT and COMMUNICATIONS EQUIPMENT. FREE DISCOUNT COUPONS VALUE 50p. 272 pages, fully illustrated and detailing thousands of items at bargain prices.

SEND NOW! STILL ONLY 37½p. P. & P. 10p.

TRIO 9R59DS

4 band covering 550 Kc/s. to 30 Mc/s. continuous and electrical bandspread on 10, 15, 20, 40 and 80 metres. 8 valve plus 7 diode circuit. 4/8 ohm output and phone jack. SSB-CW + ANL. Variable BFO. 5 meter. Sep. bandspread dial. IF frequency 455 Kc/s. audio output 1.5w. Variable RF and AF gain controls 115/250v. A.C. Size: 7" x 13" x 10" with instruction manual, £57.50, Car. paid.

SPECIAL OFFER!
Matching SP5D speaker supplied free with above receiver.

FULL RANGE OF OTHER TRIO IN STOCK.
TS150 with p.s.u., £180; JR310, £77.50; JR599, £190.

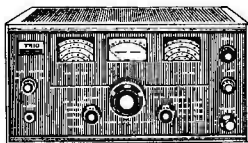

TRIO 2 METRE FM TRANSCEIVERS 144-146 Mc/s.

TR7100 Car Transceiver 10 watt output £99.50 each.

TR2200 Hand Transceiver 1 watt output £69.95 each.

Full details on request.

G.W. SMITH & CO. (RADIO) LTD

10 TOTTENHAM CT. RD. LONDON, W.1
27 TOTTENHAM CT. RD. LONDON, W.1
3 LISLE STREET, LONDON, W.C.2
34 LISLE STREET, LONDON, W.C.2
311 EDGWARE ROAD, LONDON, W.2

Tel: 01-637 2232
Tel: 01-636 3715
Tel: 01-437 8204
Tel: 01-437 9155
Tel: 01-262 0387

CALLERS WELCOME
MONDAY TO SATURDAY
9AM-6PM

All Mail Orders to-
11-12, Paddington Green,
London, W.2
Tel: 01-262 6562.

AMATEUR ELECTRONICS

BIRMINGHAM 021-327 1497 021-327 6313

MEMBER OF THE AMATEUR RADIO RETAILERS ASSOCIATION

As we go to press we are still in process of changing over to our new premises and we should like to express our apologies for any delays experienced by customers in dealing with correspondence due to this. Normally we give a prompt reply to postal enquiries but we trust that customers will bear with us for the next two or three weeks until we are reorganised in our new abode. As previously advertised we carry extensive stocks of **YAESU MUSEN, KW** and **TRIO** equipment, all of which is available on demonstration in our showroom without obligation, and for our Southern customers can also be demonstrated at the home QTH by Jeff Harris, G3LWM, our Southern agent, whose address appears below.

We are pleased to announce two new items this month in the new **TRIO TS-515 TRANSCEIVER** and the **SANSEI SE-406 MINI SWR METER**, both of which are available from stock, full details appearing below. This month we have a very large selection of used equipment, a selection of which we show below. Please note all items listed are priced to include carriage/postage, unless otherwise stated.



- YAESU MUSEN FTDX-400 TRANSCEIVER.** Truly mint condition ... £165.00
- EDDYSTONE 680X RECEIVER.** Exceptional condition ... £82.50
- KW201 AMATEUR BAND RECEIVER.** Again, exceptional ... £82.50
- EDDYSTONE 770R / I VHF RECEIVER.** Excellent condition in all respects ... £100.00
- HEATH CR78 RECEIVER.** Factory built. Mint ... £61.00
- TRIO TS510 TRANSCEIVER.** Unmarked and excellent ... £150.00
- TRIO JR500SE AMATEUR BAND RECEIVER.** As new ... £55.00
- EDDYSTONE 888 AMATEUR BAND RECEIVER.** Very good condition ... £61.00
- EDDYSTONE 940 RECEIVER.** Late model, mint ... £112.50
- EDDYSTONE 940 RECEIVER** with plinth speaker, excellent
- SWAN CYGNET TRANSCEIVER.** Absolutely as new ... £170.00
- TRIO 9R59DE RECEIVER.** Absolutely mint ... £42.00
- TRIO 9R59DE RECEIVER.** Marginally less brilliant ... £40.50
- TRIO 9R59DS RECEIVER.** A few weeks old only ... £47.50
- TRIO 9R59DS RECEIVER.** In practically new condition ... £46.00
- EDDYSTONE 840C RECEIVER.** Excellent electrically but used condition ... £35.00
- HEATH SB300 and SB400 SEPARATES (CW filter on RX).** ... £180.00
- HEATH SB301 and SB401 SEPARATES.** Unmarked and FB ... £240.00
- HEATH SB300 RECEIVER.** Fitted CW filter, unmarked ... £87.50
- HEATH SB-610 MONITOR SCOPE.** Truly mint ... £48.00
- HEATH SB-610 MONITOR SCOPE.** Unmarked ... £46.00
- HEATH SB-101 TRANSCEIVER** with **SB-600 SPEAKER** / PSU ... £162.50
- HEATH SB-301 RECEIVER.** Very good condition ... £110.00

- LAFAYETTE HA-350 RECEIVER.** Very good condition ... £62.50
 - RACAL PRESELECTOR TYPE 1978** with manual ... £67.50
 - RACAL SSB ADAPTOR TYPE RA218** with manual ... £80.00
 - HAMMARLUND SP600 RECEIVER.** Good general condition ... £85.00
 - HEATH OS-2 OSCILLOSCOPE.** Professionally built ... £32.50
 - HEATH HM/2 SWR/POWER METER.** As above ... £15.00
 - HEATH MOHICAN RECEIVER.** With mains PSU, factory built ... £42.50
 - HEATH MOHICAN RECEIVER.** As above ... £38.50
 - NEW FROM TRIO—the TRIO TS-515 TRANSCEIVER.** The latest and improved version of the famous TS-510. New features including blow cooling ... £235.00
 - NEW FROM SANSEI—the SE-406 MINI SWR/POWER BRIDGE.** Excellent miniature construction handles up to 1 kW but really is ideally suited due to its size for incorporation into mobile installations ... £3.80
- Please remember that we carry excellent stocks of HY-GAIN antennae and all types of Rotators including the well-known Ham-M, as detailed in our last advertisement.
- J-BEAM ANTENNAE.** Once again the full range from stock and we shall be pleased to send you the latest J-Beam catalogue upon receipt of a largish S.A.E.
 - OSKER BLOCK POWER METERS.** The de-luxe SWR/Power Meter for the man who must have the best ... £18.00
 - MEDCO FILTERS, FL50A and FL75A** Belling Connectors ... £6.00
 - MEDCO FILTERS, FL50B and FL75B, PL259** Connectors ... £6.50
 - MEDCO FILTERS, FH40** High Pass ... £2.10

We carry large stocks of components and accessories. A large S.A.E. will bring you our comprehensive stock list. Excellent credit facilities, with on-the-spot transactions.

Southern Agents — J. H. Associates Limited, Cricketfield Lane, Bishops Stortford, Herts. Telephone : 0279-56347 Telex 81553

ELECTRON HOUSE, 510-514 ALUM ROCK ROAD, BIRMINGHAM 8

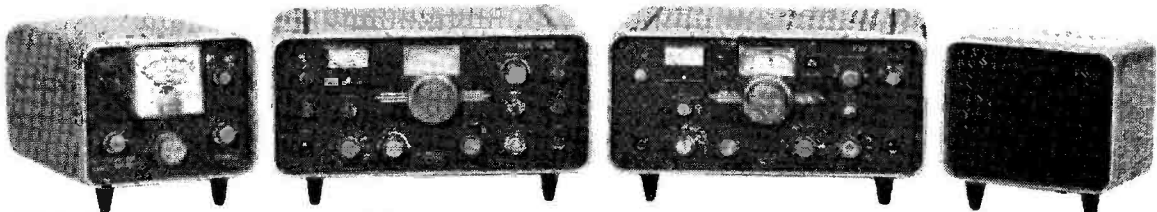

KW 107 ANTENNA Tuning SYSTEM

KW 202 RECEIVER, 10-160 metres SSB /AM /CW, with Mechanical Filter, built-in 'Q' Multiplier (Peak & Null), 500 kHz VFO covering all Bands.

KW 204 TRANSMITTER, 10-160 metres SSB /AM /CW. Successor to the famous KW "Vespa"—Perfectly matches the KW202 Receiver and is similar in appearance. 180 watts p.e.p. from trustworthy 6146's. Built-in Power Supply. Provides "side tone" CW monitoring. A beautiful compact efficient unit. Price £145 carriage extra.

KW 202 SPEAKER

Two Speed VFO Drive. Excellent Sig./Noise and sensitivity performance. Very attractive (similar in appearance to KW2000B). 100 kHz Crystal Calibrator price £140 carriage extra.

2 Great Transceivers DELIVERY IMMEDIATELY, FROM STOCK

- KW2000B** 10-160 metres SSB TRANSCEIVER: 180 watts PEP 10-160 metres, complete with A.C. p.s.u., VOX P.T.T., I.R.T./I.T.T.
- KW ATLANTA** 10-80 metres. KW Atlanta and A.C. p.s.u.

£240 carriage extra.

£210 carriage extra.

or separate units

Matching **KW1000 LINEAR AMPLIFIER** for KW 204 and KW 2000B—also available. 1200 watt pep max. Pair T160L/572B tubes including 2.5kv Power Unit built-in to KW2000B style cabinet £135 carriage extra. **KW 101** Standing-Wave-Ratio meter, £9.25. **KW 103** SWR/Power meter 0-100 & 0-1000 watts £12.50*. **KW103** with Dummy Load and Coax Lead, £20.50*. **KW 107** Antenna Tuning System including E-Z Match, SWR Ind., Dummy Load, Antenna switch, 5 position, £40.00*. Also KW Trap Dipole with twin feeder and 4 other types (only the original Trap from KW is good enough for you). KW E-Z Match ATV, KW Low Pass Filters, KW & HZP Baluns, etc. *Carriage extra.



ELECTRONICS LIMITED

TRADE-IN EQUIPMENT AND MANY IMPORTED ITEMS AVAILABLE WRITE FOR DETAILS TODAY

All Equipment Available through accredited agents

K. W. ELECTRONICS LIMITED: 1 HEATH STREET, DARTFORD, KENT
Tel.: Dartford 25574 Cables: Kaydublew Dartford

EASY TERMS ON EQUIPMENT AVAILABLE OVER 12, 18 OR 24 MONTHS

SOUND BARGAINS



GIANT POWER MULTI-WAVEBAND COMMUNICATIONS RECEIVER

WITH 3 IN 1 AC/DC POWER SUPPLY SYSTEM
MAINS/BATTERY plus BUILT-IN BATTERY BOOSTER



VHF, FM, AM, A.F.C., AIR BAND, PUBLIC SERVICE AND WEATHER BANDS

OUR PRICE **£10-50**

+ 40p P. & P.

THIS NEW 1972 RADIO.

No less than 3 VHF BANDS.

Picks up Aircraft Transmissions, Pop Pirates, Taxis, Ambulances, Local Radio, Continental and all BBC, VHF Stations plus fascinating Public Service Transmissions we are not allowed to mention! Even TV sound in certain areas.

BATTERY CHECK INDICATOR

PLUS A SPECIAL WEATHER-BAND

Frequency ranges : MW540-1600 kHz, FM88-108 MHz, Airband 109-145 MHz, VHF 145-175 MHz, 23 semi-conductors,

12 transistors, 11 diodes and thermistors. Automatic frequency control. 31" telescopic aerial, Runs off mains AC 230-250 volts or off 4 U2 batteries, or use re-chargable nickel alkali cell. Finished in strong leather grained case with carrying handle. Approx. size 10 1/2" x 6 1/2" x 3 1/2". Written guarantee. Special magnetic ear-piece for personal listening, dry batteries FREE. HURRY! Limited quantity only from Marktyme. Money back guarantee.

TUNE INTO THE WORLD WITH THIS AMAZING COMMUNICATIONS RECEIVER.

A truly exceptional unit in performance and looks—leatherette with stainless steel trim. Looks good anywhere. Use either as a portable with standard batteries or plug it directly into 220-240 volt domestic mains supply. 14 Transistors : 9 diodes : 1 thermister. Internal ferrite rod antenna plus telescopic aerial. Separate tone, volume and tuning controls with push-button selectors for the 8 WAVEBANDS. Complete with Hi-Fi earphone for personal listening.

Frequency ranges : Long wave 150-350 Kcs. Medium 353-1605 Mcs. Marine 1.6-4.5 Mcs. Short Wave 12-24 Mcs. FM/VHF 88-108 Mcs.

Aircraft 109-135 Mcs. PUBLIC SERVICE BANDS 135-174 Mcs. Fully guaranteed.

OUR PRICE

£28-95

+ 50p P. & P

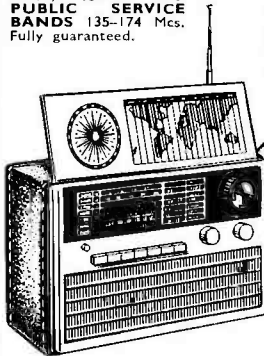

8 WAVEBANDS AND WORLD MAP & TIME ZONE DIAL

SAVE NEARLY £14

on this DELUXE CASSETTE

TAPE RECORDER and PLAYER



OUR SLASHED PRICE **£13-95** PLUS 30p P.P.P.

MADE TO SELL AT RECOMMENDED LIST PRICE OF **£26-97**

MAINS/BATTERY

It's true! Less than half the recommended price. Accepts 30, 60 and 90 minute Philips Cassette Tapes. Separate volume control, rapid re-wind and input socket for remote control microphone. Only £13.95 + 30p P. & P. Send £14.25. C60 Cassette and battery 45p extra. Now available Battery Cassette Recorder, £12.99 + 30p P. & P.

N.B. The Ministry of Post & Telecommunications has pointed out that a licence (not generally available to the public) is required for reception of transmissions by Fire Brigade, Aircraft, Shipping, etc.

(Dept. SW2), 372 EDGWARE ROAD, LONDON, W.2.

Tel. 01-723 0094

Callers welcome Monday to Saturday 9 a.m. - 6 p.m.

MARKTYME

GO MOSLEY BRITISH AND BEST

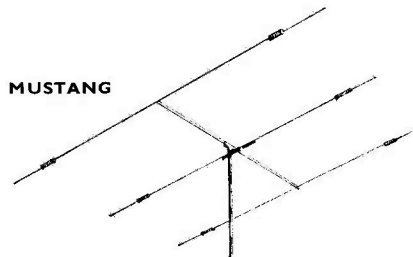

MUSTANG

SHORT WAVE LISTENERS. Get the best Antennae as used by most commercial users for monitoring :

- Broadcast Short Wave Bands : SWL7
- Ham Bands, 11-18 metres : RD-5
- Rotary Dipole, 10, 15 and 20 : TA-31 Jr.

Buy direct for Best Service.

WE ARE THE ANTENNA

Rotators, Towers, Polythene cord and rope, Coax cable, Control cable, Twin feeder.

PEOPLE

ATLAS		
ELAN	V-3 Jr.	A-310
TA-33 Jr.	VTD-3 Jr.	A-210
TA-32 Jr. A-315	TD-3 Jr.	TW-3X
TA-31 Jr. A-215		

Administrative Address only

Mosley Electronics Ltd. 40, Valley Road, New Costessey, Norwich, Norfolk Nor. 26K

SOLID STATE MODULES

Telephone: HUDDERSFIELD 23991

63 WOODHEAD ROAD,
SOLID, LOCKWOOD,
HUDDERSFIELD, HD4 6ER

MANUFACTURERS AND SUPPLIERS OF COMMUNICATIONS EQUIPMENT

Call in any time and inspect our own manufacture gear, also our range of Yaesu Musen and second-hand gear. All the gear should be in stock, but you can always ring for confirmation. We are on the A616 about one mile from Huddersfield centre.

THE SENTINEL 2 AND 4 METRE CONVERTER

- ★ Low noise figure 2dB.
- ★ Gain 30dB.
- ★ Dual gate MOSFET's in the RF amplifiers and mixer for excellent overload and cross modulation characteristics.
- ★ Size only 2½" x 3" x 1½" aluminium case—silver hammer finish with black trim.
- ★ Stock IFs: 2-4 MHz, 4-6 MHz, 8-10 MHz, 9-11 MHz, 14-16 MHz, 18-20 MHz, 23-25 MHz, 24-26 MHz, 27-7-29-7 MHz, 28-30 MHz.
- ★ 4 metre IFs: 4-4-7 MHz, 25-25-7 MHz, 28-28-7 MHz for 70-70-7 MHz input.
- ★ Price: £13-75.

NEW—THE SENTINEL X DUAL GATE MOSFET CONVERTER

This new 2 metre converter is a de luxe version of our well established Sentinel converter. It has the same basic specifications but may be used with an internal mains P.S.U. and with battery supplies. It features an RF gain control to reduce cross modulation and overload of the main receiver and may be switched between mains and battery. Size is 5" x 1½" front 4" deep. IFs from stock 28-30 MHz and 4-6 MHz. Price £16-50 less mains P.S.U. £19-50 including P.S.U. The Power Supply unit may be added easily in future.

Want to pep up your present 2 metre receiver?

THE SENTINEL LOW NOISE FET 2 METRE PRE-AMPLIFIER

- ★ Low noise figure 1dB.
 - ★ Gain 18dB.
 - ★ Price £6-50.
- Want to receive 70 cms. cheaply but well?

SM70 70 cms. CONVERTER

- ★ Low noise figure 4-5dB.
- ★ IF output 144-146 MHz. By using the 70 cm. converter with a 2 metre converter you can have a high performance 70 cm. unit at a low price—£13-75.

THE SPITFIRE 2 METRE A.M. TRANSMITTER

- ★ 5 watts input. At least 2 watts output.
- ★ 12 volts operation.
- ★ Modulation wave shaping gives good, clean 100% audio.
- ★ Audio monitoring point for headphones.
- ★ Size 4½" x 2½" x 5½".
- ★ Front panel meter indicates R.F. output and modulation. Price £22-00.

THE SPITFIRE MODULATOR

- ★ Same size and appearance as the transmitter.
- ★ 100% modulates our transmitter.
- ★ Price £10-00.

SOLID STATE 9 MHz SSB GENERATOR

- ★ Selectable USB, LSB and CW.
- ★ 0-2 volts into 80 ohms output.
- ★ Sideband suppression 45dB. Carrier suppression 50dB.
- ★ A sound basis for your SSB transmitter.
- ★ Price £11-00 less filter and carrier crystals.
- ★ XF-9A filter £11-00. Carrier crystals £1-50 each.

T.B.C. 1 CONVERTS TOP BAND TO MEDIUM WAVE 600-800 kHz

- ★ Internal battery—switches straight through when off.
- ★ Ideal for car radio use when mobile. Price £7-50.

YAESU MUSEN GEAR FROM STOCK

FT101 £240 plus top band, £255. FT200 Transceiver £134. AC supply £38. FT401 Transceiver £215. FT560 Transceiver £195. FR400 Super de luxe receiver £160. Loudspeaker unit £10.

This we offer with service facilities at our premises—often carried out while you wait, as we do with our own equipment.

SECOND HAND GEAR

KW2000A £150. HA350 £55. THE ORIGINAL G2DAF Mk. II. Built by G2DAF himself only £50. LG50 as new £27-50.

KVG filters, SL600 series ICs and components as previously advertised.

YOUR MIDLAND STOCKISTS

● AERIAL EQUIPMENT

Full range of "J" BEAMS in stock. 2 Mtr. and 70 cm. Please allow 50p for carr.

STOLLE ROTATOR. Type 2010, £24-50. Carr. 50p.

SUPER AERAXIAL CABLE 75 ohm, very low loss, 13p per yd. Also 50 ohm 300W, 25p per yd. P. and p. either 29p.

RIBBED CERAMIC INSULATORS, 12½p. **DIPOLE CENTRE PIECE,** 12½p. **TRANSPPOSITION BLOCKS,** 5p. P. and p. 16p.

COPPER AERIAL WIRE H/D 14G and 7/029 Stranded, also 32/0-2 mm. covered, 140ft., £1-87; 70ft., 95p. Other lengths pro rata. (Lengths approx., sold by weight). P. and p. 25p.

TOUGH POLYTHENE LINE 100 lb. B/S ML1, 63p 100 yds. 200 lb. B/S ML2, £1-25 100 yds. 400 lb. B/S ML4, 2½p per yd. P. and p. (any quantity) 16p.

● EQUIPMENT

EDDYSTONE EC10

Mark II £79-00
TRIO 9R59DS £57-50
TRIO 9R59DS with Cal. £60-00
TRIO JR310 £83-50
KW2000B £240-00
KW202RX £140-00
KW204TX £145-00
KW 107 MATCHING UNIT £40-00
KW 103 VSWR UNIT £12-50
KW EZEE MATCH £15-00
TRIO SP5D SPEAKER £4-50
RAYMART SUPER BAND CHECKER 1-8-35 Mc/s. £5-25
 P. & p. 25p

CALSON DIGITAL CLOCKS:
 222 24 hour £8-00
 601 24 hour £17-65
 701 24 hour £13-35

Carriage paid

● AERIAL EQUIPMENT

HALSON WHIPS, £7-40—COILS ONLY, £4-40.

G WHIPS RANGE EX STOCK—LIST.

AR22 ROTATOR, £25-45. Carr. 50p
AR10 ROTATOR, £18-40. Carr. 47p
AR44 ROTATOR, £40-55. Carr. 50p

KW TRAP DIPOLE, £15-00. P. and p. 25p.

KW TRAPS and INS., £4-50. P. and p. 10p.

HI GAIN 14AVQ VERTICAL £19-50 carr. 50p.

300 ohm FEEDER, 4p per yd. 75 ohm FEEDER, 4p per yd. or 100 yd. DRUM, £2-50. P. and p. 25p.

KW BALUNS, £1-95. P. and p. 10p.

BRANDED CASSETTE TAPES C60: 53p. C90: 75p. C120: £1-10. P. and p. 8p.

FULL RANGE OF DIE-CAST BOXES, CHASSIS, PUNCHES, METERS, PLUGS, SOCKETS. S.A.E. WITH ENQUIRIES PLEASE.

AMATEUR RADIO
CHAS. H. YOUNG LTD.

At your service G2AK, G3LAY & G3VVF

Please print your address. No C.O.D. under £1.

The Widest Range of Components in the Midlands

Fast Mail Order

CHAS. H. **YOUNG** LTD.

170-172 Corporation Street,

Birmingham B4 6UD

'phone 021-236 1635

**ADVERTISERS
INDEX**

SHORT WAVE MAGAZINE

(GB3SWM)

Vol XXX

JUNE, 1972

No. 344

CONTENTS

	<i>Page</i>
Editorial—Social	207
Communication and DX News, by E. P. Essery, G3KFE	208
Specially on The Air	213
The Mobile Scene	215
Identify Yourself on The Car, by G. Denby, G3FCW	218
C.U.W.S. Expedition to Switzerland, <i>by R. Wainwright, G3YMH/HBØXIX</i>	219
V-Beam as Multi-Band Aerial, by F. G. Rayer, A.I.E.R.E., G3OGR	222
Items of Interest	223
JR-310 Top Band Modification, <i>by G. J. Bennett, B.Sc., Ph.D., G3DNF</i>	224
More About the Personal Portable for Two Metres, by J. R. Hey, G3TDZ	225
Improving the HW-100, by D. Bedford, G4ABS	227
All-Transistor Ten-Watt Transmitter for Top Band, <i>by M. Rathbone, G3ZII</i>	229
VHF Bands, by A. H. Dormer, G3DAH	232
The Month with The Clubs—From Reports	238
Visiting East Anglia	242
New QTH's...	243

	<i>PAGE</i>
Amateur Electronics (G3FIK)	202
John R. R. Baker	246
Belding & Bennet (Morse)	256
B.I.E.T.	245
J. Birkett	244
Birmingham City Police	255
"BoomMike"	255
Burns Electronics	244
C.D. Telecomms	255
Derwent Radio	245
E. & E. Services	247
Echelford Communications	250
Eddystone Agents	253
Eley Electronics	244
General Merchandise Credit, Ltd.	252
G.W.M. Radio	246
Hamgear Electronics	246
Heath (Gloucester) Ltd.	197
Holdings Photo-Audio Centre (Trio)	247, 255
Imhofs	251
John's Radio	249
K.W. Electronics	202
K.W. Developments, Ltd.	249
Lowe Electronics	198, 199
May (Leicester) Ltd.	255
Markham Electronics	252
Marktyme	203
Metropolitan Police	206
Mosley Electronics	203
Newbery, Graham	250
North West Electrics	<i>inside front cover</i>
P. & P. Developments	<i>back cover</i>
Partridge Electronics, Ltd.	248
Radio Shack, Ltd.	200, 201
R. T. & I. Electronics, Ltd.	206
Senator Crystals	247, 255
Shure Electronics, Ltd.	193
Small Advertisements	249-254
Smith, G. W. (Radio)	201
Solid State Modules	204
Sontronics	246
Spacemark, Ltd.	244
SSB Products	248
Stephens-James	248
Strumech Engineering	251
S.W.M. Publications	<i>inside back cover, back cover, 245, 254, 256</i>
Taurus Electrical Services	246
The Amateur Radio Shop	255
The Trading Post	255
Western Electronics, Ltd.	<i>194, 195, 196</i>
Chas. H. Young (Amateur Radio), Ltd.	204

Managing Editor: AUSTIN FORSYTH, O.B.E. (G6FO/G3SWM)

Advertising: Maria Greenwood

Published at 55 Victoria Street, London, SW1H-0HF, on the last Friday of the month, dated the month following. Telephone: 01-222 5341 & 5342

Annual Subscription: Home: £2.75 (£3.00 first class) post paid
Overseas: £2.75 \$(7.00 U.S.), post free surface mail

Editorial Address: Short Wave Magazine, BUCKINGHAM, England

AUTHORS' MSS

Articles submitted for Editorial consideration must be typed double-spaced with wide margins on one side only of quarto or foolscap sheets. Photographs should be lightly identified in pencil on the back with details on a separate sheet. All drawings and diagrams should also be shown separately, and tables of values prepared in accordance with our normal setting convention—see any issue. Payment is made for all material used, and it is a condition of acceptance that full copyright passes to the Short Wave Magazine, Ltd., on publication.

© Short Wave Magazine Ltd.

Work as a RADIO TECHNICIAN Attached to Scotland Yard

You'd be based at one of the Metropolitan Police Wireless Stations.

Your job would be to maintain the portable VHF 2-way radios, tape recorders, radio transmitters and other electronic equipment which the Metropolitan Police must use to do their work efficiently.

We require a technical qualification such as the City & Guilds Intermediate (telecommunications) or equivalent.

Salary scale : £1,271 (age 21) rising by increases to £1,741, plus a London Allowance of £175 or £90 p.a.

Promotion to Telecommunications Technical Officer will bring you more.

For details of this worthwhile and unusual job write to:

**METROPOLITAN POLICE, Room 733 (RT/SW),
New Scotland Yard, Broadway, London SW1H 0BG
or telephone 01-230 1212 extension 3122 (24 hour service)**

R. T. & I. ELECTRONICS LTD.

where equipment is fully overhauled

NATIONAL NCX-5 and p.s.u.	£230.00	(£3.00)
KW200B and p.s.u.	£220.00	(£3.00)
SWAN 250C and p.s.u.	£250.00	(£3.00)
TRIO TS510 and p.s.u.	£160.00	(£3.00)
EDDYSTONE EB 35 Mk. 2	£65.00	(£1.50)
EDDYSTONE EC 10 Mk. 2	£65.00	(£1.50)
EDDYSTONE S 640	£25.00	(£1.50)
EDDYSTONE 680 X	£90.00	(£1.50)
EDDYSTONE 940	£135.00	(£1.50)
EDDYSTONE 840A	£25.00	(£1.50)
EDDYSTONE EA12	£52.00	(£1.50)
EDDYSTONE EA12	£160.00	(£1.50)
EDDYSTONE 770R	£150.00	(£2.00)
DRAKE 2A c/w spkr.	£80.00	(£1.50)
LAFAYETTE HA 350	£65.00	(£1.50)
LAFAYETTE HA 800	£48.00	(£1.50)
HALLCRAFTERS HQ 170	£150.00	(£2.00)
ECHEL COMM 2 Transmitter & p.s.u. etc.	£40.00	(£1.50)
KW77	£80.00	(£1.50)

WE CAN ALSO SUPPLY ANY MAKE OF NEW EQUIPMENT—and have pleasure in giving a few examples which are normally in stock—

STOCKISTS OF YAESU MUSEN EQUIPMENT.

AVOMETERS, Model 7, Mk. 2, £37.60; Model 8, Mk. 4, £40.90; Model 9, Mk. 4, £40.90; Model 40, Mk. 2, £37.60; Multimeter, Mk. 4, £13.50.
Standard leather carrying case (Models 7, 8, 9, 40), £6.50; Ever-Ready ditto, £7.40; Multimeter leather case, £3.30; 10KV D.C. Multiplier for Model 8 or 9, £6.10; 30KV D.C. ditto, £9.90; Pair of Long Reach Safety Clips, £1.50; Model EA113 Electronic Avo, £82.00. All above post free in U.K. Trade and Educational enquiries invited.

S. G. BROWN'S HEADPHONES, Type "F" 120 ohms, 2,000 ohms, 4,000 ohms, £4.95 (25p); Rubber earpads for same, 45p per pair (5p). Type 3C/1100 Noise-reducing (with suzerb fitting), high quality, electro-dynamic, £7.55 (25p). Standard Jack Plugs, 24p (4p).

EDDYSTONE EQUIPMENT, Receivers, 830/7, £389.00; EA12, £205.00; EC10/2, £79.00; EC10/1, £64.50; 924 A.C. mains p.s.u., £7.75 (50p); Doublet Aerial, 731/1, £7.50 (50p); Plinth Speaker, 906, £6.20 (50p); General Purpose Speaker, 935, £5.55 (40p); Edometer, 902 Mk. 2, £29.50 (50p); Telescopic Aerial, LP3126, £2.50 (25p); Dicast Boxes from 45p (10p). Brochure on request.

CODAR EQUIPMENT, ATS Mk. II, £22.50 (50p); PR 40, £8.50 (30p); 250/S, £11.00 (65p); CR70A, £22.50 (65p); T28, £17.50 (25p); PR30, £7.50 (25p); PR30X, £9.50 (25p); 12M/S, £11.50 (40p); 12/RC, £2.50 (15p); RQ10X, £9.00 (35p). Leaflets on request.

Our latest list of over 50 receivers, and many other interesting items sent free upon receipt of your s.a.e. Carriage for England, Scotland and Wales shown in brackets. Terms: C.W.O. Approved Monthly Accounts, Hire Purchase and Part Exchange. Special facilities for export. Enquiries invited.

At R.T. & I.

- ★ We have full H.P. facilities
- ★ Part exchanges are a pleasure
- ★ We purchase for cash
- ★ We offer a first-class overhaul service for your electronic equipment, whether you are an amateur or professional user
- ★ We have EASY parking facilities
- ★ We welcome your enquiries for specific items which, although not advertised, may very well be in stock.

PARTRIDGE "JOYSTICKS," "New Lightweight VFA" £12.99 (30p). "JOYMATCH" III. Aerial Tuning Unit, £12.99 (30p). Literature on request.

TRIO EQUIPMENT. Transceiver, TS-510 + PS-510 a.c. p.s.u., £180.00 (£2.00); VFO-5D for above, £25.00 (50p); Receivers, JR-599, £199.00 (£1.00); JR-310, £83.50 (£1.00); JR-500-SE, £65.00 (£1.00); SR-59-DS £7.50 (50p); SP-5D Loudspeaker, £4.50 (40p); Headphones, HS-4, £5.97 (20p). Leaflets available.

SHURE MICROPHONES, 444T, £15.00 (40p); 444, £13.00 (40p); 401A, £6.50 (30p); 201, £5.40 (30p); 202, £6.00 (30p). Full details on request.

KEYNECTORS, piano key mains connector units, £2.75 (25p).

VALVES. Please state your requirements.

TMK METERS; TMK500, £8.25 (25p); TW20CB, £10.25 (25p); TP50SN, £5.75 (25p); 700, £16.50 (25p); also leather cases.

PHILIPS PM2403 ELECTRONIC MULTIMETER, £49 (25p).

We also supply PHILIPS and KORTING COLOUR TV TEST EQUIPMENT, including Colour Bar Generators, Convergators, etc.

KW EQUIPMENT, KW2000B + A.C. p.s.u., £240.00 (£2.00); D.C. p.s.u. for KW2000B, £44.00 (50p); KW 2000B only, £200.00 (£1.50); KW ATLANTA + A.C. p.s.u., £210.00 (£2.00); Remote V.F.O. for Atlanta, £34.00 (50p); VOX unit for Atlanta, £7.50 (25p); Remote V.F.O. for 2000B, £36.00 (50p); KVV1000 Linear amplifier, £135.00 (£1.50); KW202 Receiver with calibrator, £140.00 (£1.50); KW 202 Matching Spkr., £8.00 (80p); KW204 Transmitter, £142.00 (£2.00); KW105 combined E-Z Match; VSWR indicator, dummy load, and ant. switch (4 outlets) 52 or 75 ohms, £36.00 (50p); KW103, VSWR and power meter, 52 ohms, £12.50 (45p); KW101, VSWR meter, 52 or 75 ohms, £9.25 (30p) 0 KW 107, £40.00 (50p); also E-Z match, dummy load, trap dipoles, etc., etc. Details on request.

R. T. & I. ELECTRONICS LTD.

Ashville Old Hall, Ashville Road, London, E.11 Tel: 01-539 4986

The SHORT-WAVE Magazine

EDITORIAL

Social

It is often said that most radio amateurs are content to sit in their stations, working or listening to their fellows, with no desire whatever to make personal contacts outside their own particular circle of intimates. This is probably still fairly true of the majority but the pattern is beginning to change.

While in the early pioneering days most amateurs were only too glad to meet and discuss with others what were then problems common to them all, this tendency became less evident as methods and techniques became more standardised, with the latest ideas available to all, bringing far more stations on the air. At that time, too, it was quite unknown for there to be any feminine interest or presence at amateur gatherings, unless the lady happened to hold a callsign in her own right when, of course, she was welcomed—but only because she was qualified to be within the fold.

And here, too, there has been a significant change. Not only do amateurs get together far more than they used to even ten years ago, but on such occasions nowadays it is usual for them to be accompanied by their wives, girl-friends or eldest unmarried daughters. And, of course, there are now far more of the latter who are licensed.

Unquestionably, the main reason for this change in the social habits of radio amateurs is the great increase in the mobile interest, in its turn brought about by the far wider possession of cars. This has led on naturally to an increasing circulation of people on occasions such as Mobile Rallies, which have become in effect family outings.

Whether or not this trend is a good one is a matter of opinion—those who don't like it can always keep away—but we can foresee another tendency developing, which would be a reversion to the pre-war form: That of confining certain radio amateur occasions to "holders of callsigns only." For one thing, the organisation is so much less complicated!

Austin Fox, G6FO.

WORLD-WIDE COMMUNICATION

COMMUNICATION and DX NEWS

E. P. Essery, G3KFE

As your conductor sits at his typewriter, on a tolerable May evening, the KW-2000B is on the low end of Twenty, listening to what passes for Morse from some stations and the bedlam surrounding it, knowing that it is only exceeded by the revolting noises at the 'phone end of the band; and he wonders what odd quirk of chemistry makes us go in for these mad occupations. And then, just as he was going to the thing to switch it off, up comes a Klub station with a reasonable note, and an operator who is sending good Morse at about 8 w.p.m., and pretty obviously having his first QSO—you can almost hear the chap frantically turning round to the old-timer, and yelling "What the blazes do I send next?" at various moments during the over—and then even the QRM sounded almost human, as your scribe sat and thought back to *his* first QSO, and all the operators who stopped to put him right, in similar circumstances. So Amateur Radio is not so bad, after all!

Round-up

As to Twenty, being a representative sample of the bands, one could, as usual, say that conditions have been everything from "Whack-o" to just plain "Ugh!" with most gradations between, and QRM seasoning *not* to choice. However, on occasion one does find paydirt at the bottom of this pan.

The Contest Caper

This month, of course, there is the one contest of the year when the average club member becomes a participant on the HF Bands with some degree of both enthusiasm and freedom from TVI worries, namely NFD. Whilst overseas stations may not enter, it is perhaps worth pointing out that certificates are awarded to the portable station in each continent submitting a *check-log* which shows the most points given to NFD competitors.

Also on NFD weekend, there is the

48-hour Argentina Contest, for both phone and CW, single and multi-operator stations. The time-scale is 0001 GMT on June 3, to 2359 on June 4, swapping RS(T) plus a QSO number, for 3 point per LU worked or one point for anyone else. Final score is the QSO points plus a multiplier of one for each LU state and each country worked—one's own country does *not* count for QSO points but may be worked for a multiplier. Logs to be mailed by July 31, to Radio Club Argentino, LU DX Contest, P.O. Box 97, Buenos Aires, Argentine.

The weekend June 24/25 sees the ARRL Field Day, which should liven the CW ends up somewhat, and for the SSB buffs the YV's have their Phone shindig over July 1/2. For the U.K., the form is to work YV's and other American countries, swapping RS plus serial number starting at 001, for a point a time, or two if the victim is at YV. Score is total QSO points times a multiplier of one for each YV call area, each W call area and each American country worked. This is of interest to certificate collectors, as there is a nice one going for anyone who works five YV's and five other American countries, although applicants are asked to send a dollar or its equivalent in IRC's. Entries and applications, postmarked no later than August 1, to be addressed: Radio Club Venezolano, Independence Contest, P.O. Box 2285, Caracas, Venezuela.

Thanks to WIWY, as ever, for the regular contest advance information—it it's anywhere in the world, Frank knows about it!

Top Band

At the time your scribe wrote the preamble to his piece, Twenty was alive but noisy; by now, with thunder overhead after a day of mixed weather, the aerials are firmly down to earth, just in case of accident. But at the same time, it summarises Top Band conditions at this season, so we may as well start by looking

at WIBB's admirable bulletin. Stew himself is still out in front, the recent Caribbean DX-pedition having helped him to reach 112 countries on Top Band. On a different tack, WIBB takes up the question of the "random" CQ-DX call, where it is possible for two stations to be busily CQ'ing in synchronism—Stew suggests it would be a good thing for such calls to be accurately timed to the first two minutes of each five-minute period, with the remainder of each period for listening over 1800-1807 kHz for weak signals, which might otherwise be lost under more local QRM. A good thought, this, especially as more people seem of late to be able to get out to real DX with random CQ calls on 160 metres.

As a band marker, WCC on 2036 kHz was aye a useful aid to the brethren, and it is nice to hear that it is once again in operation. And, talking of markers on the band, one would think K6DDO would be one—he has, apparently, got a *full-sized Quad* aerial up on *Top Band*, with the intention of making his first European QSO on Top Band and so completing a WAC. Some aerial, that!

On a sadder note, VERON's DX-press advises that the "HZIKE" heard on Top Band is a pirate, he having received this news through 7Z3AB—and this is confirmed as fact by GM3XNE, who is out in Riyadh, Saudi Arabia and is in touch with Ken Ellis, HZIKE /G5KW. At least, if you hear JT0AE, you will have the consolation of knowing that—if some buffoon does not try to pinch *his* call—a QSL to OK1AQW should result in due course in a card in return.

The more domestic news now: GM3YOR (Kirkcaldy) and his little party had a rough time. The first weekend there was no operation as they were washed out of camp, while on the second weekend they could not get the farmer's permission to use the hill-tops as it was lambing

time. However, there are some more weekends-out in prospect, so it is quite likely that if you come across GM3YOR/A he will be somewhere interesting.

This goes also for any signals from GM3VPE/P between June 18 and 29, when Henry, along with G3IKR and G3ZXO, will be up in the North and North-West of Scotland.

G2HKU (Sheppey) seems to be in poor shape—but poor shape or no, CW accounted for HB9BE, GM3ANO, GM3FXM and SSB for GW3UPK, GB2AC and PA0PN.

A first report from GM4BBL (Lerwick) shows him to be on and active from *Shetland*, usually in the 1860-1880 kHz area and after 2100z. Roger runs a KW-2000 to an end-fed half-wave worked against a ground comprising *half-a-mile* of wire fencing—a bit different from his old Leeds situation as G8CUW!

Anyone for the Isle of Man? A quartet of G3GKF, G3FTQ, G3TWJ, and G3XMW, are all off to activate the Island between June 22 and July 7, with three transceivers for HF, and VHF gear as well. On the aerial side there will be Quads for HF, a Vee-beam on Eighty, and an inverted-Vee on Top Band, along with other multi-band machines, generators and whatever.

G4ALG (Reading) has changed his rig since last we heard, and is now the proud owner of a Vespa Mk. II, which is used on 160m. with an AR88D and a top-loaded forty-foot vertical—although he gets out well as it is, he should shortly be in the Monster category, as there are plans for lots more radials when the family aren't looking!

The Table

There has not been all that number of entries, as a glance shows, although we know there is quite a lot of interest in comparisons against one's own score—so how about some of the people who use it this way putting in an entry? Tables are not much use unless they are supported.

Seriously, there aren't enough indications of popularity to avoid scrapping it, unless more support is forthcoming, so if you want to keep it, make an entry!

Eighty

G2HKU is top of the pile, and



Impression of the station of Ed. Kelly, VP9GE, P.O. Box 1555, Hamilton, Bermuda, who has it all for working the DX, including RTTY. Everything worth having in the way of gear seems to be included in this picture!

offers C31FA and LX1BW, both on SSB—which prompts the thought, has anyone heard of C31EF, *alias* W4WFL, of late?

His studies have cut severely into the time available to G4AMJ (St. Ives, Cornwall), not to mention the time lost in playing the VP9 contest. However, Eighty did give SSB contacts with VE, W, VP9 and Europeans.

A new correspondent to this piece is G3RFG (Lower Stondon) who seems to operate all bands, although less on Eighty, where VE1ATJ on CW was the only DX signal.

G3FYR (Petts Wood) runs a KW trap dipole, and alongside it a parallel resonant half-wave on Eighty—which accounts for him having trouble working GW4AFK in Carmarthen on Eighty, as the resonant wire was soaking-up the RF. Moral, says G3FYR, is to be careful and remember to ground unwanted aerials!

Not much activity is reported by G2DC (Ringwood) again, due to various types of QRM. However, it was not much loss on Eighty at least, as there was little CW beyond W/VE through the night times.

Forty Metres

A very good band for DX, is this, with virtually no TVI to worry about, and no problem of searching large areas for DX—always pro-

viding you possess (a) A 40m. rotary beam, (b) Crystal-filter ears, (c) A capacity for losing sleep, and (d) A receiver completely immune to cross-modulation. So why don't more people come on the band?!

G3RFG seems to have used his CW a good deal on 40m., Stan being quite a dab hand at this key-bashing business and possessed of crystal-filter ears to boot. Between them these attributes brought home K2BV, K5RFJ, OX3ZO, PY1LQ, PY7PJM, VE3CMO/W4, W2EEA, W2IFG, W8UM and W8ZCK.

For G2HKU, there was a balance in favour of SSB—CW accounted only for PY7AES, but there were also mentions of EA8FF, PY6JM, PY7PO and UA9MAI.

Unfortunately, the beam at G4AMJ does not cover Forty, but even so, he made contact with Europeans, some VP9's in their contest, and EP2TW, all being on SSB.

The early-morning period is still favoured by G4AMT (St. Buryan) when he is not poking fun at G4AMJ. Thus it came about that the log for Forty includes CW with W7JLU, W8VKU, W3EAX and VO1FL, while SSB added VK5PB.

Quite a long letter from G8HX (Mansfield) "making his number" after a longish silence. All that TVI nonsense on Forty with the Rediffusion sets is over, only for a new menace to appear, in the shape

of a UHF-only set next door, on which sound and vision go missing as soon as G8HX fires up. Seems as though a ferrite-ring filter in the mains lead or the TV aerial might do the trick. Frank has used his time on Forty to work for a 7 MHz DLD-200 award, which will be the first one he has ever tried for, after 35 years licensed!

What Price Twenty?

Definite signs of summer conditions, but still we struggle on. For G3KFE there was not much of interest, he having spent much more time listening to the CW end than transmitting. However a UF6 did come to the rescue one night when your conductor was pointing out "how easily an amateur can talk to somewhere else," which is an open invitation to Murphy's Law...

A note from G2FKS (Cambridge) says that Dave was the operator on 5N2KPT at Kaduna Polytechnic, Nigeria, until his return—the station is now QRT for lack of someone in 5N2 to run it, so if anyone has ideas about this and is going to Kaduna,

they should contact the Polytechnic authorities and 5N2ABG. For the moment, Dave is right up to date with 5N2KPT QSL chores, although he can oblige if anyone is missing a QSL from the station, with the exception of SWL reports, which cannot be verified in detail as the log is still in Kaduna.

G3RFG seems to have done quite a lot of CW operating on Twenty, and his offering includes such as CX1AAC, K6SL, K6QF, PY2EIO, VE7QH, VE7TT, VK2A00, VK2AXR, VK3MR, VK5QB, W6KG, W6NWI, ZD8DLG, ZL1CO and a whole host of lesser DX lights.

Similarly, most of G2HKU's operating on this band was mainly SSB, to HK3BAE, EL2AU, KZ5PW, ZL1VN, ZL3SE, VK3ND, VK3AOR, 9L1GP and 9H1BY/A, only VK2QL representing the brass-pounder's art.

Although on the LF's, G4AMJ stuck largely to SSB, on Twenty the split was much more even. Taking CW first, we observe QSO's with VP9GK, UL7EAL, PT2MI, PY's, KG4CS, FM7WP, CX1AAC and CR4BV, while SSB accounted for PZ1DR, VP9's, CN8DB, VE8RCS, VK9KA in Papua, 6WØ/WB2AQC, VU2TVA, TI2RT, PZ9AC, HV3SJ *et al.*

Conditions to the Pacific were rather disappointing, in the view of G2DC, with the morning possibilities quite changeable. One day, plenty of VK/ZL/JA signals, on another W6, W7, VE6, VE7 fill the band to the exclusion of most else. However, Jack was able to book in DU1EJ, DU6RH, JA1-Ø, JD1ADA, JY6FC, KH6IF, KH6FF, UPOL19 (a Soviet ice-station, QSL's for which go to UW3HY, c/o Box 88, Moscow), VK2-7, VK9LV, ZL1-4, and all W call areas.

The list from G3ZPF (Dudley) is divided into two pieces, the one being goodies and the other the space-fillers! Goodies first, and this means SSB with FP8DG, KW6HB, 5X5NK, KL7HDB, KS6DV, FY7AG, 3AØEA, CR4BC, 5K4DF, OG3SA, 4NØDX, JX3DH, DU1FH and W4IZ/KV4. Among the small fry, David includes OD5's, VE's, VK's, ZL's, JA's, OHØ, YV's, HBØ's, ET3ZU, VU2TVA and 4S7AB.

After a spell of silence, the return

of G3OJV (Hockley, Essex) to the scene is the more welcome. CW for Peter meant working VK2, VK7, VK3, KS6CG, KV4AA and JA7FS, while SSB made the grade with VK2, VK3, VK4, YN2DX, ZL2BE, TI2FCD, VP2MZ, 6Y5SR, 9Y4T, VP9GO, XE11IJ, TF3EB, JA4HMJ/S and JH2KIS.

G8DI (Liverpool) is taking his comeback quite seriously, and raised UM5ØA and VP9BDA as numbers 96 and 97 for this year on the key; there was also 3AØGA (at 1345z) HP1IE at 2236, and a string of the U5Ø-stations as they became available.

G2NJ (Peterborough) is still accumulating/MM stations—by now he must have quite a collection! For this month, we note JA7HX/MM, who at the time was in the Arabian Sea. On a more domestic note there were a couple of interesting QSO's, one with a chap calling "CQ G," who when replied to said he was G3-- at home, and the other one who explained that "DA is Belgian in DL Germany"—we live and learn!

The Things We Say

A serious note is brought into the piece by G8HX, when Frank disputes the contention that "personalised" Morse, as sent by a good operator on a straight key, is necessarily a bad thing, as was suggested in the article by G3FCW last month. Frank quotes a case (that of his QSO with an SM) where the chap had a T9 signal, and was lost for a few moments in QRM which developed on frequency. The signal was retrieved by G8HX purely because the SM was making slightly long dashes for the speed he was sending, his Morse thus being thus being imperfect but immediately recognisable. G8HX goes on to say he uses a Vibroplex, with which he has enough control to be able to stress as needed, while being keen on always sending Morse as good as may be. Perhaps he has a point—G3KFE uses an el-bug most of the time he is on CW, but has a straight key wired in parallel, and a switch to make the el-bug behave as a plain bug-key, even though he has one of the latter in the cupboard and can drive it. However, the difficulty is that many people who believe they have good Morse would

BRIEF DX DATA

Call	Details
9M6AB	G3WUW hopes to be there for a year. Try 14245 kHz SSB, around 1400z. QSL via JA2KLT.
ZF1AA	Now a Silent Key, outstanding QSL's via K2MUB.
9L1GC	is Ross, G3DYY. Look for him around 28025, 21025 kHz CW.
HKØBKK	Often QRV in Pandora's Box DX Net (14227 kHz SSB from 0430z). Francisco, P.O. Box 43, San Andres Isla, Colombia.
BV-	BV2AB is reported closed down by Government. BV2AA and his QSL Manager JH1HWN, are reported looking for Europe around 14245 kHz SSB at 1700 or 1730z, also 14032 kHz CW about 1940, Tuesdays.
W5OLG	QSL Manager to VR6TC, now reported as a Silent Key.
S2-, S3-	Callsign issue S2A- to S3Z-, allocated to Bangladesh by ITU.

be, as G3KFE was, unpleasantly surprised to hear their keying on tape as the DX would hear it. However, for most people the prime thing is the reduction of operator fatigue which follows on using an el-bug, over-riding all else.

Fifteen Metres

It has to come sooner or later—G3ZPF has modified his 14 MHz half-wave into dipoles for 14, 21 and 28 MHz on a common feeder. The way he has done it merits comment: Each dipole is part of a length of ribbon feeder, the upper leg being resonant on Twenty, the two middle ones being strapped together in many places and soldered before being trimmed to resonate on Fifteen, while the lowest leg is cut to resonate on Ten. SWR is good on 14 and 21 MHz, but rather "sharp" on Ten, for some reason giving only 400 kHz bandwidth to the 1:2 SWR frequencies. David had a quickie with G3YJH to prove the SWR satisfactorily, and then booked in JA7LZG, JW8IL, CX2CX, VQ9R, WJ4AZF, 9H1M, JY6AMM, VP9BDA, VE3GNM, VE1AJI and UQ5ØC on his first session on the band, plus MP4BHN on CW in reply to a CQ-DX.

For G8DI, CW did the trick with XE2BG, OA4AHO, VP2SN, 9L1GC and VP9BDA, all in the evenings.

Fifteen for G3OJV meant applying his KW-2000B and 14-AVQ to ZL3US and ZL3UY on SSB, while CW accounted for 5Z4KL, VK7CH, ZC4CB and VP2AAA.

Local SWL's reported to G2DC that there was some activity from the Pacific around 1100z, so Jack hung around in hopes of filling in his "vacancies." In the event, there was no luck, but there were good openings to the Far East between 1100 and about 1230z. CW accounted for KR8BY, PT2MI, TY1ABE, TJ1AJ, UKØQAE, VK200, VK8HA, VU2HH, all W call areas, VE1-7 and VP2's.

Another CW addict is G3RFG—Stan made the grade to JAIHZN, JA1KRU, JA1ONV, JA1WOA, JH1MDJ, JH1WIX, JA2DV, JA6FBQ, JA6MJV, JA8AXL, JR1EBZ, KX6EB, UAØBL and VE5RI.

At G4AMT, the view is that the band dropped off badly during the

month under review, with few U.S. stations in the afternoons, although the southward path to Africa seemed quite good. Thus we find his SSB used to work 5X5NA (several times), 5Z4MO, 5Z4KL, 5Z4LW, 9J2SS, 9J2HI, W1-5, W8-Ø, SVØWMM (Crete), UM8MAA, 7XØGA, JY6FC, VE3AIU, VQ9R (on both SSB and CW), ZE2KL, ZS6QK, JA1DJL, JA8BLR, JA8CRQ, JA4KAD, JH1BBI, JH6CBB, ET3GK, EL2AU and 9M2DQ.

G4AMJ has to keep his nose ahead of G4AMT in their feud! On SSB, he raised VS6CY, JA's, JW2IK, EA6BH, EL2DF, VP9's, VQ9NEW, 5B4ES, and 9L1VW; CW accounted for the rest, among

them WNØGZL, WNØDLT (worked just before midnight) KR6BB, EO2PR, JA's, 4X4's, and several other WN's in call areas 1-3, 8, and Ø.

Even Ten

Nice to hear from G3VPS (Hailsham) who lately seemed to have sunk without trace. However, he worked the VHF and gardening bugs out of himself, and returned to Ten, with a bit more power from a FT-DX401. The list includes, on SSB, 5B4IS, PJ9JR, YV, 5H3, 4X4, SVØ, CR6, CR7, ET3, ZS3AW, 9M2DQ, 9J2, VU and OD5, while CW gave him JY6FC, XW8BP, 5X5NK and OD5; it added up to three new all-time countries and

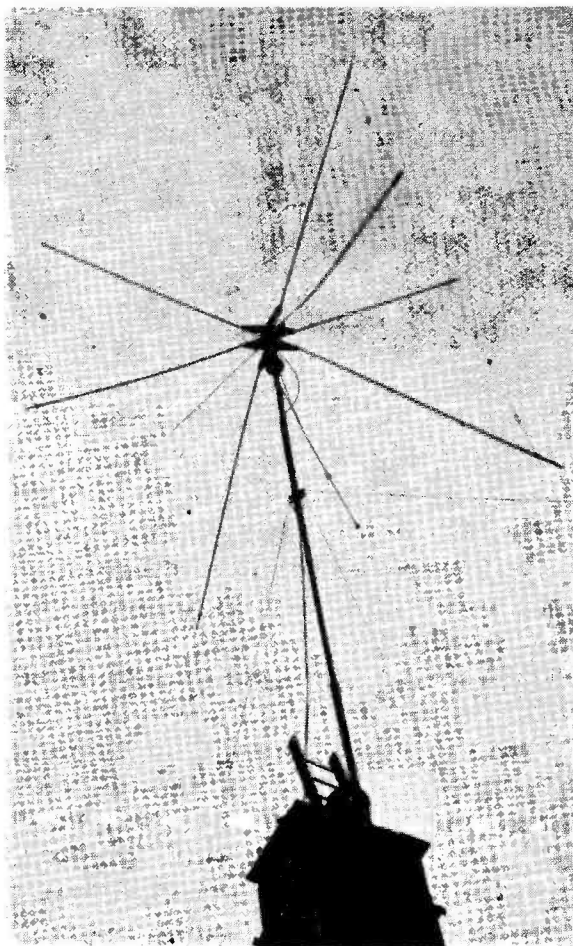

What a three-band Mini-Quad can look like—the installation at G3UCV, the station of Ron Cartwright, 5 Manston Gardens, Crossgates, Leeds, 15. His shack picture appeared on p.85 of the April issue.

some for the band.

A couple of SSB stations fell into the net waved over 10 metres by Peter at G3OJV, namely OD5GU and DU1AK. Rather better fortune attended the CW of G2DC, who mentions the band as still "giving" to Africa and South America around 1130z, and peaking West about 1530z, which enabled Jack to pick up TY1ABE, TU2NU, LU2ESE, PY1-7, W1-5, VE1-3, 5Z4, 7Q7 and 9J2.

As for G3RFG, we note his CW contacts, among which were FG7TG, PY5ASN, UA9CAL, UK3SAF, UK5GAK, UK6LDZ, VE1IN, W2BWI, WB2VVA, 9J2HE and 9L1GC.

Having seen how G4AMJ has the drop on him as far as Ten goes—because of the difference in locations—G4AMT tried the effect of tuning his Quad to Ten and putting out a CQ straight into the nearby hill—this immediately resulted in a QSO with 5Z4JE at RS-57 and, what is more, an airmail QSL card arrived three days later. Just to prove it was not a flash in the pan, Terry tried again, raising 5Z4JE, 9J2DT and 5B4ES twice, FL8DJ, ZE1BP and 3B8DG.

Here and There

Should you perchance come across UK1ZFI, don't turn up your nose—in fact, it is quite a good call, origi-

nates from Franz Josef Land, and is an expedition by UR2AR and UR2DW; at the time of writing they are going great guns on 80 to 15 metres. The QSL address, naturally enough, is Box 88, Moscow.

Another one which may puzzle some folk is 4U4ITU—a special operation by the lads at 4U1ITU, which will be over by the time this piece reaches the bookstall.

If you are stuck for Zone 2, look out of VB1AA or VB2KOC; for the former QSL by way of VO1FX, while the latter's cards can be sent to VO2AI.

KC6WS and KC6YL, have now received their logs from the Carolines, so if anyone is still short of the desired piece of pasteboard, they can write to W. Sendore, W5SZV, 3224 Bob-o-Link Lane, Denton, Texas 76201, U.S.A.

WA2BAV and WB2AQC, on holiday in those parts, have been activating a variety of West African spots, and at the time of writing were signing TU4AC and TU4AB

respectively; *all* QSL's for their West African tour should be sent to their home—George and Eva Pataki, 34-24, 76th Street, Jackson Heights, New York 11372, U.S.A.

Another interesting variation on the UA1 theme is UA1GZ/M—the /M does *not* mean mobile, but is the Russian suffix indicating that the station is in Antarctica—UA1GZ/M is in fact at Vostok.

The KH6GLU DX-pedition which was scheduled to visit Fiji, Tonga, Minerva Reef, KS6 and home again has been put off for the time being, pending the outcome of the ARRL DX Advisory Committee decision to delete or retain such "countries" as Minerva Reef, Spratley, and Geyser Bank. This problem about the definition of a "country" is ever with us!

If you are outstanding a QSO with the Galapagos Islands—and who reading this is not!—you will be interested to know that HC8CI (SSB) and HC8DX (CW) are scheduled to be on till June 10, with QSL's going *via* DL2GG.

Those QSL's

There are devoted correspondents who go to the trouble of listing some QSL addresses for the benefit of others trying to place their cards where there will be the likelihood of a reply. G4AMT offers 9H3D, *via* SM7DXX; SV0WMM, through WB2JGZ; 7XOGA, Box 2, Algiers; VQ9R, to Box 193, Mahé, Seychelles; FL8DJ, to Box 157, Djibouti, T.F.A.I.; EL2AU, to WB2AQC. G2HKU adds a rider to the effect that 9L1GP cards also go to WB2AQC, while G8DI says KS6CG is Box 692, Pago-Pago, Samoa.

The Question of Power

Various people have been making disgruntled noises about the U.K. peak power output level, as though we were so very far down on the rest of Europe—but not saying whether in these countries the power level

Reporting the HF Bands



"... Using a balloon-supported aerial here..."

refers to input or output. There is a sight of difference. For example, an exciter your conductor knows of has *three pentodes in parallel* to achieve the enormous output of *fifty milliwatts* with adequate linearity when fed by a cathode follower! On the other side of the coin, how much stress, for example, would one put on the relative worth of a beam over a full-power linear? After all, the linear RF amplifier applied to the existing aerial, could bring you to the point where you can call, with some hope of success, stations who are weak in your receiver—but the beam will *direct* power in the desired direction, resulting in bigger signals both ways, as well as reduction in QRM, both to the station and the people in the nulls of the beam—though the operator will now find he still hears stations who are too weak in the receiver to justify a call. Imagine, then a chap with an exciter and a vertical, who knows his DX onions as an operator, and can do one or the other—should he go for a beam, or a linear (a) If he is at DX or (b) If he is, say, in the U.K. or similarly situated in a well-populated country. If enough people express views, we may even find room in CDXN next time to air them, in both contexts.

The End

And so it is for another month; your offerings for next time round—including an entry for the Top Band Ladder, if you can—should be in by **June 12**, latest, addressed to CDXN, SHORT WAVE MAGAZINE, BUCKINGHAM.



Frank Clarke, G3XWZ, 149 Somersall Street, Mansfield, Notts. is an all-band operator with a keen interest in CW contest and DX working, mainly on 40/160m., the Tx for Top Band being a KW-160 and for the others a DX-100U. Main Rx is a much-modified Eddystone 840C. Good aerial installations are possible at a site 470ft. a.s.l., and W's have been worked on 160 metres.

SPECIALLY ON THE AIR

When setting up an amateur station to give the public an impression of what it is all about, it is very important to try to arrange siting out of the zones of any possible local interference, *e.g.*, it is useless having the Amateur Radio stand next door to, or even near, that occupied by the model railway enthusiasts.

The public needs to hear, with a reasonable degree of clarity, what is going on and will not be at all impressed by strangled voices drowned in a barrage of QRM—in fact, it is better, so far as possible, to avoid contacts with weak stations unable to produce some degree of noise over-ride. This may well have to be at the expense of working what would otherwise be spectacular DX. Usually during daylight hours there are plenty of strong phone stations on 80m. and 20m. and, if 15m. is open to the States, good QSO's can be obtained in that direction.

Always get the distant station to announce, clearly and often, his actual location. A W4 in, say, Arlington, Va., with an American accent and a good strong signal is a more impressive contact for the onlooker than a scratchy noise (to the uninitiated) under QRM that has to be explained as "coming from Singapore"—or wherever.

As beams do not help much with the suppression of local-noise interference, it is worth trying dipoles well in the clear even if then they have to be connected through 100's of feet of feeder.

EI4MSA, June 3-5: On the air from Ballybunion, Co. Kerry, this station is to celebrate the Marconi 70th Anniversary and will operate from one of his original sites. Bands to be activated, by the Limerick Radio Club, will be 10-80m., CW/SSB. QSL's are solicited and all contacts. will be acknowledged by card.—

COUNTIES TABLE

TOP BAND

Callsign	Counties CW	Counties Phone	Total Score
GM3YOR	58	61	119
G3VLX	20	39	59
G3YPT	44	8	52
G4ALG	31	17	48
GW3WSU	—	44	44
G4AXP	—	33	33
G3DCS	14	—	14

This Table will run till December 31, 1972. Starting date January 1, 1972. Any mode goes.

T. Deegan, EI4BK, 90 Finian Park, Shannon, Co. Clare, Eire.

GB3HCF, June 4: Put on for the Hereford Cider Festival, The Racecourse, Hereford, by the local Amateur Radio Society, running SSB on 10-15-20-80m. and AM/RTTY on two metres.—S. Jesson, 181 King's Acre Road, Hereford.

GB3CRC, June 10-24: Organised by the Chad Radio Club to commemorate the 13th centenary of St. Chad of Lichfield, running all bands 10-80m. and 2m., 7.30 p.m. onwards each evening and all day on Sundays. All contacts will be confirmed by special QSL card.—G. Benson, G8FBL, 2 Saxon Walk, Lichfield, Staffs., WS13-8AJ.

GB3FK, June 23-24: As part of the Festival of Kidderminster, two stations to be on the air, HF bands and two metres, also demonstration of CC/TV. Location Brintors Park, Kidderminster, at which visitors will be very welcome.—D. Hicks, G8EPR, 10 Birmingham Road, Kidderminster, Worcs.

GB2MHC, July 15: Fête at Rossall School, Fleetwood, Lancs., in aid of the National Society for Handi-

capped Children, with all-band activity and talk-in on 160/2m. for the event—visitors are invited for the main fête attractions. QSL direct for stamp or s.a.e.—R. Bellerby, G3ZYE, Physics Laboratory, Rossall School, Fleetwood, Lancs.

GB3WCS, July 7-9: At the Comprehensive School, Bilston Road, Willenhall, Staffs., to demonstrate Amateur Radio and the work of the School to the public. Operation will be AM/160m., CW/SSB on 10-80m. and two-metre AM/NBFM on 145.26 MHz, with special QSL cards.—C. J. Pedley, B.Sc., G3YHN, at the School.

G3CAR, September 2: For the annual Wycombe Show, organised by the Chiltern Amateur Radio Society, operating on all bands 10-80m., AM/CW/SSB. Contacts will be confirmed by special QSL card, and visitors welcomed for the occasion.—A. C. Butcher, G3FSN, 70 Hughenden Avenue, High Wycombe (24835).

For notes on the reporting of Special Activity stations and other relevant information, see p.153, May issue SHORT WAVE MAGAZINE.

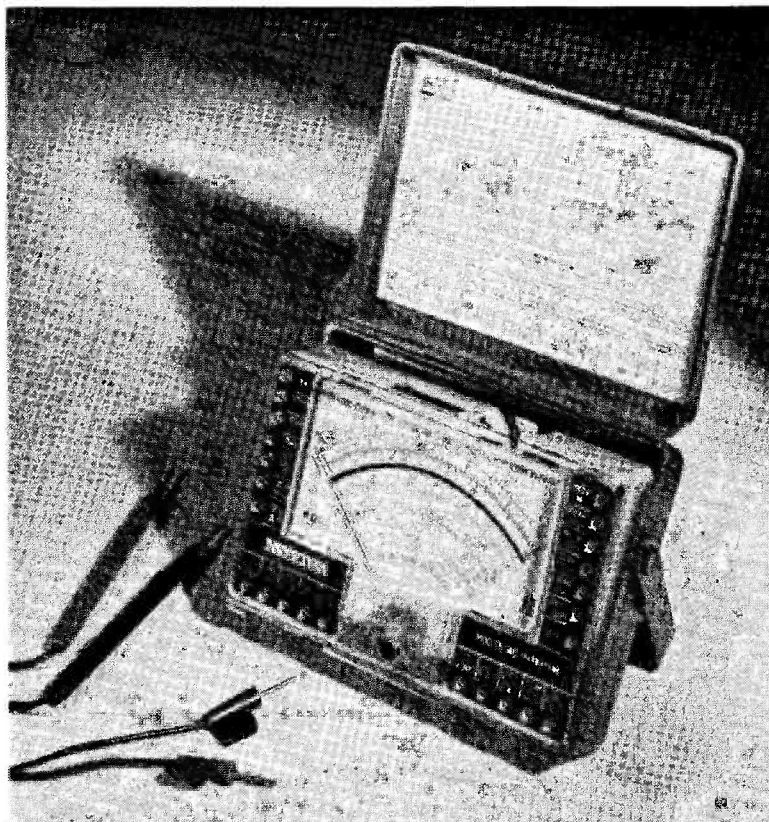

The neat new TS-140 Test Meter, factored by West Hyde Developments, Ltd., gives 50 well-spaced ranges covering not only AC/DC from low to high values, but also low frequency and capacity measurements and dB relationships from 25 to 70 dB. Accessories are available to increase ranges considerably.

* * * **THE MOBILE SCENE** * * ***SEASON OPENS WELL — SOME INTERESTING PICTURES**

It seems that there is some chuntering going on about Mobile Rally organisers aiming only to make a profit. Of course, they must "make a profit".

To stage a well-organised Rally takes not only time, effort and hard work on the ground (always given free by supporters) but also a certain outlay in terms of use of the ground facilities, the hire and erection of marquees, local sign-posting and traffic control (in the case of the larger events), the PA system on the ground, and many other incidental expenses as well.

If the event results in a deficit, it is met without complaint by the Club responsible for laying it on. If a profit is made, quite properly it is credited to that Club's annual accounts, or paid over to some charity. This is as it should be.

No event such as a Mobile Rally (or even the Club's own annual dinner) can be made to balance exactly in terms of "loss-no loss"—this is a theoretical concept that in practice never happens (it would be suspect if it did!). Rally organisers are quite right to protect themselves against the possibility of loss—but what they must *not* do is to make excessive charges in order to over-insure. This would be "exploiting their public" and is what some people are beginning to complain about in the Rally context.

* * *

Though we have received no direct report, it seems that the White Rose event at Leeds on April 2 was again very successful. We are unable to quote attendance figures, number of mobiles worked by the talk-in stations, or other interesting information that would be relative to this feature.

We ask Rally organisers to take note of the comments at foot p.151, May issue—there is always next year, for which you may be wanting the right sort of publicity!

* * *

The Midlands Amateur Radio Society (MARS) and the Stoke-on-Trent Amateur Radio Society (STARS) got together on Sunday, April 16 to organise what must be one of the largest Rally events in the country. More than 150 mobiles came in and it is estimated that the attendance totalled some 4,000. The fine weather permitted those visitors who were not primarily interested in Amateur Radio to enjoy the other amusements and amenities available.

Situated in the Midlands, with easy access to the main trunk routes, this obviously is an ideal location for such gatherings and it attracted amateurs from Europe as well as from Scotland and Wales. This is the fifth occasion upon which the event has been staged at Drayton Manor Park, and the support which it continues to receive shows that the move from the old venue at Trentham has been in the right direction.

Some 26 exhibitors brought their wares along and were displaying almost everything of interest to the radio amateur, from £250 transceivers to six-for-5p component. In agreement with the newly-formed Amateur Radio



Familiar scene at any well-attended Mobile Rally—the main hall, just after 2.0 p.m., on the occasion of the White Rose Mobile Rally at Leeds on April 2. This was actually the first of the Season's Rally fixtures.

Retailers' Association (details of which were given on p.109 of the April issue of *SHORT WAVE MAGAZINE*) the organisers had allocated trade stand space which allowed plenty of elbow room. Even with two halls available for display the throng was very soon three deep and snapping up the "goodies".

The Top Band talk-in station was provided by Stoke members and the 2m. station by G8AMD of Midland. Between 9-10.30 a.m., while the VHF station was being set up on site, talk-in for mobiles was by G3BA (signing G3MAR/A from his home location) and it was very encouraging to see how a combination of good operating, firm control and co-operation from operators of local fixed stations kept the mobile calling frequency of 145.0 MHz clear for its intended purpose. The gear at the ground was quite simple, consisting of a T.W. "Communicator" and a QV06-40A PA feeding crossed slots on a *Versatower*; this set-up gave steering information to a large number of mobileers.

MARS president Roy Day, G8ADV; STARS president Vernon Bloor, G3UD; and STARS chairman John Brindley, G3DML, and their many helpers, are to be congratulated on a first class Mobile Rally.

Footnote

Rally organisers who have not yet been in touch with the Amateur Radio Retailers' Association mentioned here would be well advised to do so in the early planning stages. The contact can be made through G3TED of Taurus Electrical Services, 26-28, Nottingham Road, Loughborough, Leics.—See p.87, April *SHORT WAVE MAGAZINE*.

* * *

THE RALLY CALENDAR

May 28: Chiltern Amateur Radio Club Rally at West Wycombe, Bucks., at the Dashwood home near High Wycombe, on the Oxford road just outside the town. This event will coincide with the Steam Rally and



The joint efforts of G8ADV (left) and G8BHE helped to bring together a large crowd for the Drayton Park event on April 16.



Two-metre talk-in station, signing G3MAR/A, for the North Midlands Mobile Rally at Drayton Park on April 16.

the Model World shows. Details from: P. Perkins, G3OUV, Loakes House, Loakes Park, High Wycombe, Bucks.

May 28: Hull & District Amateur Radio Society's first Mobile Rally, in the grounds of the East Riding College of Education, Bishops Burton, on the A.1079, York-Beverley. A great effort is being put into this event. The site is ideal and the programme is to provide entertainments and attractions for the whole family. There will be Trade stands, a bring-and-buy stall, raffles and a junk sale, ending with a "barbecue tea round a camp fire". Talk-in will be given on Top Band (G3AMW, 1980 kHz) and on two metres, 145.00 MHz dead, by G8EAH. Information: L. D. Colley, G3AGX, *QTHR*.

June 17 (Saturday): Verulam Amateur Radio Club Mobile Rally at Salisbury Hall, London Colney, near St. Albans on the A.6. Contact: H. Young, G3YHY, 93 Leaford Crescent, Watford, WD2-5JQ, Herts.



Seen at the North Midlands Mobile Rally — extreme left, G6LD, far right GM3BQA, and centre G3BA, with his XYL. It was a long journey for GM3BQA (North Berwick) now active again in the Amateur Radio retail trade.

June 18: Anglian Mobile Rally, at the Suffolk Show Ground, Ipswich. The form as in previous years, with overnight caravan stands and entertainment on the ground for all comers. GB3AMR will be in operation on all bands, either to give talk-in on 80/160m. or 2m./4m. or, separately, to work DX on the HF bands (quite a commitment!) The organisers' objective for this Rally is as outlined on p.151, May, *i.e.*, to bring together people having common interests. There will be a bring-and-buy stall (radio equipment only!), a model passenger-carrying railway, a grand prize draw, radio-controlled models (in the air and on the ground), and many other side-show attractions for the family. There will be a licensed bar, and refreshments available—and the sea is not far away. For those wanting bed-breakfast accommodation, the organisers will endeavour to send lists on application (*s.a.e.*, please). Contact: D. W. Thomas, G3ZLN, 9 Burlington Road, Ipswich, Suffolk, IP1-2EU (Tel: Ipswich 55200).

June 18: Sheffield Amateur Radio Club Annual Picnic at Riber Castle Zoo, Matlock, Derbyshire. Details: G. B. Neale, G8NN, 10 Birley View, Worrall, Sheffield, S30-3AL.

June 25: The fifteenth West of England Mobile Rally at Longleat, near Warminster, Wilts., which (we are told) promises to be their best yet. Due to the heavy demand, the number of trade stands has had to be limited and at least 20 are assured, under tented cover. Talk-in will be by G3TAD, 1885 kHz; G3OLB, 3750 kHz; and on 144-24/145-00 MHz by G3XOD. Refreshments will be available on the ground. This is one of the loveliest parkland sites in the South-West, being the home of the Marquis of Bath, with plenty of space, and also his famous animal park on show. There are charges for admission because the site is a show-place. Further information from: D. Iles, G3COP, 23 Dryleaze Road, Stapleton, Bristol.

July 2: Annual Mobile Rally at South Shields, Co. Durham, taking place at Redwell School, Prince Edward Road (B.1300), South Shields. Access on to B.1300 from either the A.183 or the A.1055. Talk-in on Top Band and two metres, with trade stands, competitions, a prize draw and refreshments locally available. Information from: F. Harrison, G3SFL, 42 Woodlands Road, Cleadon, Nr. Sunderland, Co. Durham.

July 9: Cornish Radio Amateur Club Rally at Truro Rugby Football Ground. Details: M. Locke, G3NKE, *QTHR* (Tel: Camborne 2419).

July 16: Rally laid on by Scarborough Amateur Radio Society at Burniston Road Barracks, as last year. Information: J. Cutter, G3VAN, *QTHR*.

July 16: Upton Mobile Rally organised by the Worcester & District Amateur Radio Club, at Upton-on-Severn, Worcs. There will be the usual activities, including events for the children. Talk-in by G8JC/A on 1910 kHz, and G3GJL/A on 70-26 and 145-00 MHz. Further details: B. A. Jones, G8ASO, 12 Woodside Road, Larkhill, Worcester (29208), WR5-2EG.



A mobile of long ago, probably one of the very first—F800, taken in 1925 not far from Saigon, in his 5 h.p. Citroën. The gear can just be made out on the "bread-board" in front of the operator, Richard Jamas, whose main-station picture we showed on p.83 of the April issue. His present-day calls are F800/M, F800/MM and 3A00Q/M.

July 22: Southdown Amateur Radio Society's first Mobile Rally, at Milton Gate, 2 miles W. of Polegate, near Eastbourne, Sussex, on the A.27. This is being held to coincide with the annual Polegate Steam Engine Rally, a well-known event at which all manner of steam-powered machinery is on view. All proceeds from car park and entrance fees go to local charities. Further information from: T. Seabrook, G3ZQB or E. F. Moore, G3JFM, 74 Wannock Avenue, Lower Willingdon, Eastbourne, Sussex.

August 13: Torbay Amateur Radio Society Mobile Rally at Newton Abbot Rugby Ground.

August 13: Annual Derby Mobile Rally by Rykneld Schools, as in previous years. Details from T. Darn, G3FGY, *QTHR*.

August 20: Saltash & District Amateur Radio Club Rally at Saltash Grammar School, with all the usual side-shows and activities, most of which can be under cover. Ample free parking on site. Details from: I. Aldridge, G4AJU, 302 St. Peter's Road, Manadon, Plymouth, Devon PL5 3DU.

August 26-27: Stratford-on-Avon Radio Club Mobile Rally at the National Agricultural Centre, Kenilworth, Warwickshire, Hq. of the Royal Agricultural Society of England. Contact: M. J. W. Webb, G300Q, *QTHR*, or ring Stratford-on-Avon 5973. (Further details later.)

September 24: Harlow & District Amateur Radio Society annual Rally at Magdalen Laver Village Hall, as in previous years. For details: V. Heard, 106 Vicarage Wood, Harlow, Essex.

IDENTIFY YOURSELF ON THE CAR

NEAT CALLSIGN

PLAQUES

G. DENBY (G3FCW)



WHETHER or not you run /M it is a good idea to display your callsign on the car.

Members of the great uninitiated never fail to ask what all those letters mean, and the explanation can always be turned into a little gentle public relations for Amateur Radio in general. This is always a good thing.

Even though you may be bereft of RF in the car, fellow amateurs are quick to identify themselves. The writer has received many a 73 when *en route*—by fog lamp, reversing lamp and even the horn. Returning to the parked car one day resulted in a most interesting personal QSO with a W4 and his family, and this in Halifax, of all places. (Yorkshire, that is, not VE1!)

Having decided to display your call, something a little more professional than a QSL card is needed. At the same time, it should be cheap, easily attached (and removed) from the car, need no drilling of holes, and not obscure vision. Many approaches are possible. This is just one which meets the requirements.

As shown in the illustration it is a piece of $\frac{1}{2}$ in. Perspex on to which the call letters are stuck, and the plaque fitted with a rubber suction cup to attach to the windscreen or rear window of the car.

White hard-plastic letters $\frac{3}{4}$ in. high were chosen as being legible enough without being too conspicuous. Offcuts of Perspex sheet can be had in various colours, the writer selecting sky blue which contrasts well with the letters. A piece 4 in. by 3 in. can be shaped as illustrated.

After marking out, the Perspex can be cut with a hacksaw and the corners rounded with a file. Edge smoothing is done with glasspaper, finally finishing to a gloss with metal polish. The hole for the waist of the suction cup should be drilled fractionally undersize so the cup is a tight fit and the plaque has no tendency to twist when fitted. When drilling Perspex slow speed only should be used as heat from high speed drilling will soften the plastic. The letters are cemented to the

Perspex with *Bostik* clear adhesive, or similar glue.

Costs were as follows: 10 letters at $3\frac{1}{2}$ p each, 35p; Perspex offcut, 10p; Four suction cups (2 used), 14p; total 59p.

After deciding to make these plaques, the little problems became enormous—Like where to buy a few plastic letters, a couple of rubber suction cups, and an offcut of Perspex. Once solved, these problems seemed ridiculously simple. (Why did I not think of *that* place before.) Your local D-I-Y store or Woolworth's will be worth trying.

If similar problems become insurmountable to intending constructors—an s.a.e. *QTHR* will bring the solution. Like being lost on a car treasure hunt, you can always open the "panic envelope" to find the rendezvous!

CLIFF ANDREWS, G2TP

We very much regret to have to announce the death of C. W. Andrews, G2TP, of Dorking, Surrey, on April 9 last. At one time, in the early post-war period, he was a staff member on *SHORT WAVE MAGAZINE*, until his retirement. He was typical of the genuine old timer, having been licensed in the 1920's, and was active until last winter. He was a regular visitor to the Amateur Radio exhibition and other such radio amateur gatherings.

ACKNOWLEDGEMENT AND THANKS

In spite of the difficulties outlined in the last three Editorials, *SHORT WAVE MAGAZINE* was in fact brought to press and packed for distribution right on time each month. This was due to the ready co-operation of our regular contributors, all along the line, our printers, our advertisers and readers with their news-reports. Without their help it would not have been possible to be out by the due date with the March-April-May issues.

C.U.W.S. EXPEDITION TO SWITZERLAND

FOR TOP BAND, EASTER 1972

R. WAINWRIGHT, G3YMH/HBØXIX

EVERY Easter vacation the Cambridge University Wireless Society organises a radio expedition. In the past, the Society has become well known for its operations as GD6UW and GM6UW/P. However, last October it was decided that in 1972 we would branch out and travel to foreign parts. Initially, the idea was to activate Luxembourg on the LF bands, especially 160m. However, permission for this band having been refused, we settled on an expedition to Switzerland and Leichtenstein. The primary aim of the expedition would be to activate these countries on Top Band, CW and SSB.

Six members of C.U.W.S. decided to go. These were: G3UPT/HB9XIP, G3XTT/HB9XIS, G3ZHL/HB9XIO, G4AVK/HB9XIV, G3ZNU/HB9XJB and the writer.

Planning the expedition was quite a job. We needed HB9 licences, radio gear, camping equipment, transport, food, sites in HB, etc., etc. Fortunately, the Swiss authorities were very efficient and a letter to the address published in SHORT WAVE MAGAZINE (p.494, October 1971) produced six application forms. Subsequently, on payment of the £3.50 licence fee, we each received our

callsigns, as already mentioned. The licence showed, to our surprise, that we were permitted to run 10w. output on 160 metres. QRO!

A letter to F8RU of the IARC in Geneva, enquiring whether it would be possible to operate 4U1ITU during our visit, produced a quick response. Ted was very helpful and arranged for both the 160m. and HF band stations at the I.T.U. to be made available to us, for the whole of our stay. This pleased us no end since 4U1 was even rarer than HBØ on Top Band.

Gear Used

For portable operation from HB9 and HBØ we took the following equipment.

(a) For 160m. — Sommerkamp FL-500 Tx
(modified),
Sommerkamp FR500 Rx:
160m. inverted-Vee dipole
for 160m.

(b) For HF — Heathkit SB-100 Transceiver,
with dipoles for 20/40m.

Unfortunately, the generator, which we hoped to borrow, was not available to us, on account of the power crisis during Easter. Hence, we carried 100 yards of mains lead in the hope that we might find somewhere to plug in.

Admin. Problems

Taking radio equipment abroad presents many administrative problems. The worst of these are Customs and insurance. We insured the radio gear for its full

The HB9 campsite on the Lake of Geneva, one of the locations from which the Cambridge University Wireless Society expedition operated during their successful Easter foray into foreign parts. Those involved were G3UPT, G3XTT, G3ZHL, G4AVK, G3ZNU and G3YMH, author of the article. They were allocated individual HB9 callsigns.



value against all risks (except acts of war!) for a cost of £10—a very necessary precaution. Since radio equipment must be declared at Customs posts, it is necessary to have *Carnets de Passage*, obtainable from the Chamber of Commerce in London. These documents make it possible for one to bring radio equipment into a country without paying import duty. In return, one must undertake not to sell the equipment during one's stay—a point which was indeed checked by Customs officials on our way home.

Transport

Transport was provided in the form of a Cortina estate car owned by G3UPT and a Triumph Herald estate which was bought for £58 out of the expedition fund. Both cars were nine years old and we were relying on the engineers in the party to keep them running. Hence, on March 11 at 0030z we caught the Dover-Ostende ferry on the start of the expedition. Unfortunately, it blew a gale during the crossing and we were all seasick—a marvellous beginning! Subsequently, we drove for two days, camping by the roadside, until we reached Geneva on March 13—the superstitious reader will not be surprised by what follows!

As soon as we reached Geneva the sun started shining. From that point on, the weather was glorious for the whole of the expedition: we went expecting cold and snow and so daytime temperatures in the seventies were a very pleasant surprise. On arriving in Geneva, we contacted HB9ANW, who had offered to assist us. Richard was very helpful. He showed us the station at 4U1TU and then gave us a bite of lunch before we set off to find a campsite. We drove round to the south bank of the Lake to find a site. We believed—and were later proved correct—that a take-off over the Lake towards the U.K. would be an advantage.

At a small village called Pointe à la Bise, on the south shore, we found a house with a large field and a 70ft. tree—an ideal QTH, in fact. After much discussion and many second thoughts the writer was elected to try out his French on the occupants. After all, we only wanted to camp in their garden, put an aerial in their tree and borrow their electricity supply! A knock at the door was answered by a YL who appeared to be alone in the house. She was most co-operative and gave us permission to do just that. After praising the English educational system on its magnificent teaching of the French language, we set up camp.

After dinner, three of us went into Geneva to get to work on 4U1TU. This first evening we were on CW mainly and we worked about 60 stations on 160m. It was soon found that the 4U1TU site on the north bank of the Lake of Geneva was not ideally sited for the U.K., the OK's being much stronger than the G's. However, we did work about half and half OK's and G's. The other three operating from Pointe à la Bise under callsign HB9XIP found that their position was a good deal better than the I.T.U. site and the G's were pounding in.

However, after about 15 contacts the HB9XIP power went off—father had arrived home, and he was not amused. To cut a long story short, we were informed that, we must move on early next morning. So the next day, March 14, we went over to a campsite, just outside Geneva, but still on the south bank of the Lake. The

owners of the ground welcomed us with open arms and offered us the use of a 60ft. flagpole for the aerial. This site proved to be just as good as that at Pointe à la Bise, so we remained there for the rest of our stay in Geneva. That night, conditions were better, and both 4U1TU and HB9XIO made about 60 Top Band contacts on SSB and CW. March 15 saw the callsign HB9XIS on the air along with 4U1TU, and again a successful session was enjoyed by both stations. As conditions were good, the operators at 4U1TU concentrated on SSB, giving many people their first phone QSO with 4U1 on Top Band.

During the day, in Geneva, we occupied ourselves seeing the sights and operating the superb HF-band station at 4U1TU. Also enjoyed by the members of the party was the excellent Chianti sold locally at 77p for two litres!

The plan was that on March 16, our last night in Geneva, 4U1TU would be operated by G3UPT, G3XTT and G3ZNU while G4AVK, G3ZHL and the writer would remain at camp to operate under the callsign HB9XIV. However, having made about 15 QSO's on CW, we were interrupted at the HB9 station by certain YL's who had come to help us celebrate our last night in Geneva. We then raised 4U1TU on SSB with the result that G3UPT gave up his night operating to come and help us with this. G3XTT and G3ZNU (gallant chaps) stayed on at 4U1TU to hold the fort.

Into Leichtenstein

On March 16, we moved to Leichtenstein. Originally, it had been planned to go to a mountain hut at Gaflei, about 5,000ft. a.s.l. However, having climbed the mountain, we found that the hut was locked and the owner was nowhere to be found. As night was falling, we went down to the valley, a mere 1,500ft. a.s.l. and camped at a site at Triesen. Leichtenstein is a very small country consisting of half a valley—about 15 miles along the east bank of the Rhine. On the west bank is Switzerland and over the mountains is Austria. However, as luck would have it, the Rhine, at this point, flows roughly towards Britain and we found that, from our camp at Triesen we were looking along the valley towards the U.K. Hence, we decided to set up our gear there on the campsite.

The owners were agreeable and electricity was laid on *via* "coin-in-the-slot" meters dotted around. Unfortunately, this site was not endowed with a 60ft. aerial mast—however, undaunted, we made do with a 40ft. tree, situated some 150ft. from our tents. Luckily we had had the foresight to connect 200ft. of coax to our Top Band dipole! Our first night of operation from Leichtenstein was on March 17, using the callsign HB0XIX. It was immediately obvious that the location was inferior to the HB9 site. While the OK stations were 599 the G's, when audible, were only about S5. However, as the evening wore on, the G's came up in strength until at 2120z we were able to go over to SSB. Then the pile-up really started and when we went QRT at 0230z we had worked 116 stations on 160m.

The HBO station was on the air again for the next two evenings, using the callsign HB0XJB on March 19 and HB0XIV on March 20. The results for these nights were similar to those on the first night, although activity was not so hectic. During the day, on March 20, G3ZNU

G3YMH operating 4U1ITU, Geneva, on 160 metres. As his article shows, the group from C.U.W.S. did very well on Top Band from HB and HB(—and had a very enjoyable Easter holiday while they were about it!

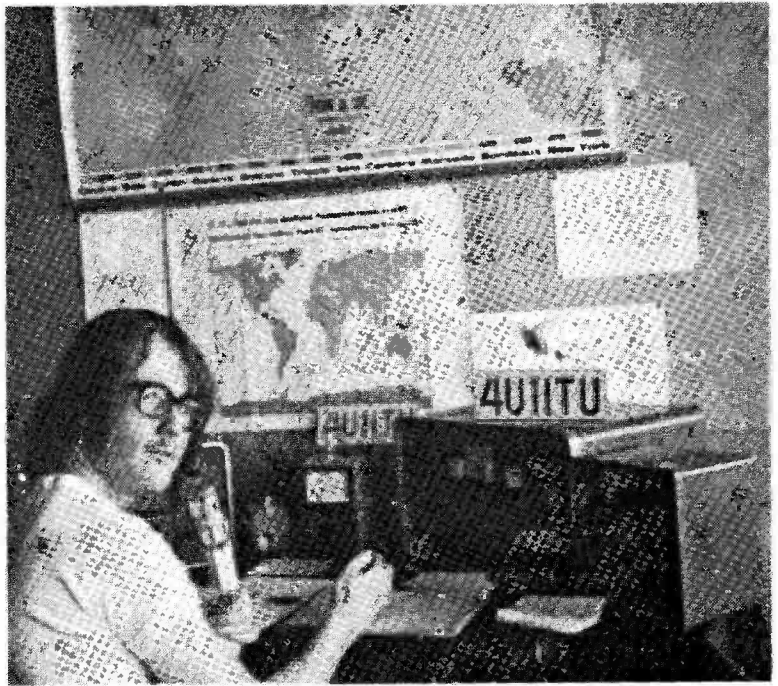

and G3ZHL put the dipole up and spent the day on 20m. SSB. This produced many interesting contacts, but naturally the HBØ prefix did not prove so attractive on 20m. as it did on Top Band.

On March 21, we packed up our gear and set off home with the feeling that the expedition had been a great success. Our main aims were: To activate 4U1ITU, HB9 and HBØ on 160-metre CW/SSB.

These, we feel, were achieved. From Geneva, where we had an excellent site, we had the satisfaction of laying down a 59 signal into the U.K. However, no less satisfying were the 57 and 58 reports we obtained from HBØ, where we were operating under far more difficult conditions.

The writer would like to express the heartfelt thanks of all the expedition members to G3TXF, F8RU and HB9ANW/G3OQF, who were a great help in arranging the trip.

SMALL ADVERTISEMENT NOTES

Our regular Readers' Small Advertisement columns continue to offer a wide range of attractive items and each month many £100's worth of equipment is offered at bargain prices—for instance, in the May issue of *SHORT WAVE MAGAZINE*, the total under the *Sale* headings came to some £5,500.

The cost of a Reader Small Adv. is 2½p per word, minimum charge 50p (giving 20 words, to include address), 25% extra if **bold face** is required. **Box Nos.** are 12½p extra. All advertisements must be accompanied by remittance—we cannot invoice small amounts, which can cost more in book-keeping time and postage than the account is worth. However, in case of doubt we can accept for filling-in a blank, signed cheque, safe-

guarded by being endorsed "Not over £2", or some such reasonable amount, which can be roughly estimated from the length of the Adv. (In such cases, we give a receipt with a note of the figure charged.)

Advertisements should be received as early in the month as possible. We usually have a large carry-over of notices that come in after the space has been allocated—so be early! Address to: Small Advertisement Dept., Short Wave Magazine, Ltd., 55 Victoria Street, London, SW1H-0HF.



"... Yes, a console certainly tidies things up a lot ..."

V-BEAM AS MULTIBAND AERIAL

INTERESTING PRACTICAL POINTS

F. G. RAYER, A.I.E.R.E. (G3OGR)

WIRE V-beams are often looked upon as single-band aeri-als. Actually, it will be found that the same V-beam can be used with success on several bands.

Fig. 1 shows a V-beam. Legs A and B are the same length. The wires are roughly horizontal, so the support points X and the apex are at about the same height. The apex is best near the shack, while the other supports will be poles, trees, buildings or whatever is available. The "angle" mentioned later is that between these two wires.

A feeder is attached at F-F. Maximum radiation is bi-directional, through the apex of the Vee.

Legs A and B perform as long wires, with the angle between them arranged so that the lobes of maximum radiation from each coincide in the directions of the arrow. As a result, a typical leg length and angle are usually exactly specified, for a chosen band. This suggests such an aerial is for only one band, and must be laid out closely as specified. This, in turn, makes a lot of work seem necessary for a single band only.

When leg length, angle, and frequency are specified, the lobes of radiation combine at a preferred low angle. These lobes are conical, with the wire as axis. So they can still combine, though at a different angle to the horizontal, when the frequency is changed. (A full examination of this is impracticable here, but the theory will be found in pages 770-871 of Terman's *Radio Engineers' Handbook*, and other textbooks.)

There are also various minor lobes, which give useful radiation in other directions.

In addition, this kind of aerial can be made with readily obtained materials—14g. or 16g. wire for the legs, 7/26g. stranded for the feeder, plus a number of insulators, spreaders, and cord.

Gain

As with a long-wire, the gain to be expected depends very much on the length in terms of wavelength. Average gains are estimated as about as follows:

WAVELENGTH (One Leg)	GAIN
1	3 dB
2	4½ dB
3	5½ dB
4	6½ dB
6	8 dB
8	9½ dB

These are very useful increases. When thinking in terms of multiband operation, the wavelengths in each leg will, of course, change with the band *e.g.*, legs two wavelengths at 14 MHz would be three wavelengths at 21 MHz and four at 28 MHz.

Angles for the estimated best combination of lobes are about as follows:

WAVELENGTH (One Leg)	ANGLE (Degrees)
1	90
2	70
3	57
4	50
6	40
8	35

In the earlier example, the angle ought to be 70° for 14 MHz, 57° for 21 MHz and 50° for 28 MHz. Instead, the actual angle would be something between about 70° and 50°, according to available supports. The listed gain and optimum radiation angle will then only arise at one frequency—but this is the price paid for multiband use.

Dimensions which may be adopted as a full-wave are: 10m.—33ft.; 15m.—44ft.; 20m.—66ft.; 40m.—132ft.; 80m.—262ft. (½-wave: 132ft.).

The longer wires are most likely impossible. But if the *total* length of *both* legs is a ½-wave, the aerial will work with good efficiency on that band. As example, 66ft. legs will each be two wavelengths on 10m. On 20m. they would each be one wavelength. On 40m. we have two ½-waves at an angle, giving good all-round results. And on 80m. the system is similar in overall length to a ½-wave dipole. It will, in fact, be found to work all bands, 10-80 metres.

Aerial Feeding

For all-band operation, an open-wire line and tuner are necessary, as for a multi-band tuned doublet. The open wire line can be of 7/26 stranded or aerial wire, spreaders every few feet spacing the wires about 4in. to 6in. apart. The impedance is 400-600 ohms or so, but is not important with tuned lines.

The need for parallel or series tuning can be estimated by considering the total length of one leg plus its feeder. If this is a multiple of ½-waves, parallel tuning is assumed. But if it is an odd number of ¼-waves, series tuning may be expected.

An advantage with open wire feeders is that the actual leg length is not critical—legs need not be pruned to resonance.

Tuner Circuit

Fig. 2 shows parallel tuning. L2 is tuned to the working frequency by VC1. L1 is an insulated coupling coil over the centre of L2. L2 could be 26 turns of 14g. wire about 2½in. in diameter and 3½in. long, for 80m., tapped for higher frequencies: Try 13 turns for 40 metres, six turns for 20m. and four turns for 15/10m., with 150 µµF for VC1, Fig. 3A.

L1 is about two turns for 10-40m., but three or four turns can often do for 10-80m. A standing-wave indicator can be put in the co-axial lead from the transmitter, Fig. 2. VC2 (500 µµF or 2 x 500 µµF) may be added, to reduce the SWR. VC1 should be wide spaced, except for low power.

When parallel tuning proves to be unsuitable, try tapping the feeders equally towards the centre of the portion of the coil which is tuned, Fig. 3B. If this proves critical, series tuning is recommended, Fig. 4. One capacitor can often be omitted. The couplings 1-7, Fig. 4, p.610 Dec. 1971 SHORT WAVE MAGAZINE, with

A
548

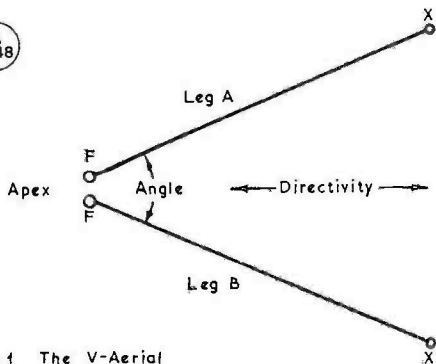

Fig. 1 The V-Aerial

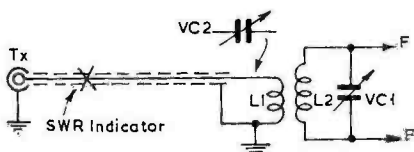

Fig. 2 Parallel Tuning

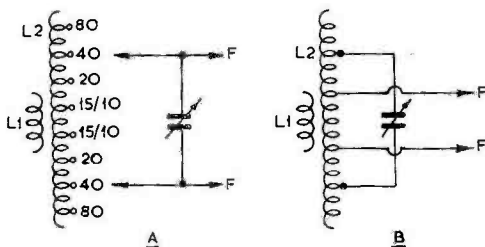

Fig. 3 Use of a Tapped Coil

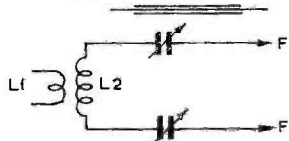

Fig. 4 Series Tuning

V was not at least as good as the dipole. At another location, a 4-wavelength V-beam gave regularly better signal reports than a three-element Yagi. (The latter was better in reducing QRM from unwanted directions, however.)

ITEMS OF INTEREST

It should be said, for the record, that the reference on p.159, May, to the originator for the dot-dash code, ought to have given his initials as S.B.F.—Samuel Finley Breese Morse, born April 1791, died April 1872, aged 81 years. (And why wasn't somebody running a special-activity station in *his* memory!) Samuel Morse constructed his first signalling telegraph in 1835, over a half-mile circuit. His triumph came in May 1844, when he was able to transmit, by line telegraph, a message in Morse between Washington and Baltimore, a distance of 40 miles. Any radio amateur, looking back in his log and finding a CW QSO made on April 2, 1972 (the centenary of Samuel Morse's death) can say that in a way he was honouring the memory.

* * *

According to their latest press notice, the I.T.A. now has a total of 100 UHF/VHF transmitting stations in operation, costing about £19m., all derived from advertising revenue during the last 17 years or so.

* * *

When ordering a subscription to SHORT WAVE MAGAZINE readers overseas often blithely add, seemingly almost as an after-thought "please send airmail"—not realising that the average airmail postage is about 25p second class, *per copy!* (This being the same as the cover price, *per copy.*) In other words, an annual overseas subscription by airmail, at the cheapest rate, costs at least £5.50 (maybe more, depending on destination) of which the Post Office takes half. The astonishing fact is that there are many readers prepared to pay as much for airmail delivery. Despatch overseas by ordinary surface mail is £2.75, as in the U.K., for a year of 12 issues, second-class—but then, of course, delivery can take weeks.

* * *

Anent the paragraph item on p.727 of our February issue, Lord Orr-Ewing, G5OG, has recently been appointed chairman of the Metrication Board, the Govt. organisation responsible for the introduction of the metric system in the U.K., through all branches and activities of commerce, trade, industry and, indeed, our daily life.

* * *

The Ministry is now carrying out an extensive propagation study in the range of frequencies 10-100 GHz (10,000-100,000 MHz), the objective being to find more traffic-handling capacity between main terminal points. A network of experimental transmitters has been set up in East Anglia for the study. It is an interesting fact that these millimetre wavelengths are much affected by weather, including blanking due to heavy rain and multi-path interference caused by temperature inversion effects—just as we know them on our VHF bands.

input circuits 1-5, Fig. 2, p.608 of the same issue, are appropriate with this type of aerial and feeder.

Practical Results

These show that practically any leg length and feeder length will work efficiently. No aerial or feeder put up was ever changed merely because it could not be efficiently coupled to the transmitter and made to radiate well.

Leg lengths actually used included 68ft., 90ft., 91ft., 96ft., 120ft., 138ft. and 151ft. Angles were 40° to 90°. All worked satisfactorily. Comparisons were made with dipoles by a change-over switch. In the best directions on the best band, stations were heard and worked which could not be heard with a dipole. In other directions, and on bands where the V was not of optimum design for the frequency, it was unusual to find a situation where the

JR-310 TOP BAND MODIFICATION

DETAILS FOR HOME-MADE COILS

G. J. BENNETT, B.Sc., Ph.D. (G3DNF)

FOLLOWING the publication of details (SHORT WAVE MAGAZINE, December 1971) for modifying the JR-310 receiver for Top Band reception, a number of readers have written to say that the *Osmor* "Q coils" specified were impossible to obtain. The manufacturers have since confirmed that these coils are no longer made, though residual stocks of the QA4 coils specified for the first stage were still available early in 1972.

It happens that the QA4 and QHF4 coils are virtually identical and are interchangeable in this modification. However, it is a simple matter to construct suitable

coils, and the purpose of this note is to provide the necessary information for doing so.

Suitable, 7mm. miniature coil formers, similar to those used in the *Osmor* "Q coils", are obtainable from *Henry's Radio Ltd.*, being listed as "Type 3", requiring "Type 3S" cores.

The grid winding (Fig. 1) is 37 turns of 36g. enamelled copper wire, close wound in a single layer. The coupling winding is 29 turns, also of 36g., wound in the same way, end-on to the grid winding with a small gap (1mm.) between the two windings. The windings should be secured with polystyrene lacquer, and protected by a layer of masking tape. Coils made up in this way can be substituted for both QA4 and QHF4 types. When winding a coil for the crystal oscillator stage, the "coupling" winding can be omitted.

For convenience the numbers assigned to the tags (Fig. 2) are the same as those on the *Osmor* coils, thereby relating directly to the wiring diagrams in the December article. However the sequence of the tags differs from that of the *Osmor* coils. This enables the coils to be attached direct to the wafers of the coil pack by means of tags 2 and 4 (Fig. 3).

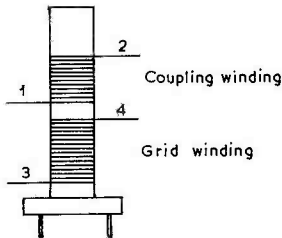

Fig. 1

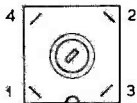

Fig. 2

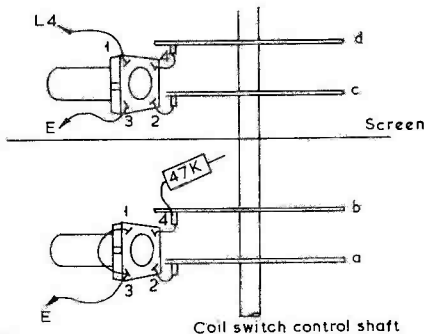

Fig. 3

Fig. 1. Top Band coil for JR-310, numbers referring to base connections. Fig. 2. Connection plan for the home-made coils—see text. Fig. 3. Positions of D-I-Y coils for Top Band in the JR-310 coilpack, showing method of attachment to switch wafers.

"FM DETECTOR AND LIMITER"

Reference this article in our May issue, we are informed by G8ANU that he should have shown the junction of C8, R4 going to pin 1, and *not* to pin 10, to which there is no connection—see Figs. 2, 3, p.155, May. The *Signetics* N5111A I.C. (if not available from any other source) can be obtained from Quarndon Electronics (Semiconductors), Ltd., Slack Lane, Derby, DE3-3ED.

"COURSES FOR THE R.A.E."

With the May R.A.E. only just done with and the summer holidays still in prospect, it may seem a bit early to be talking about next autumn's courses for the May 1973 Radio Amateur's Examination (Subject No. 55, City & Guilds of London examination syllabus). However, we have to remind organisers that, as in previous years, we shall be publishing details of Courses of Instruction for the R.A.E. during the 1972-'73 session, starting in the August issue of the *Magazine*. For that list, we should have the information during the first week of July, addressed: "R.A.E. Course", SHORT WAVE MAGAZINE, BUCKINGHAM.

RACAL JUNK SALE—JUNE 17

Following the great success of their last sale, on March 25, the Racal Amateur Radio Club are staging another such event, on Saturday, June 17, at the same *locale*—St. Sebastian's Hall, Nine Mile Drive, Crowthorne, Berks., not far from Wokingham, between the A.321 and the A.3099. This time, there will also be good commercial surplus from other companies in the Racal Group, with a large number of attractive items on offer at very reasonable prices for what is, in effect, "manufacturers' overs". Everything will be offered strictly "as seen", with no guarantee, this being reflected in the prices! The sale begins at 2.0 p.m. and there is plenty of parking space off the roads.

MORE ABOUT THE PERSONAL PORTABLE FOR TWO METRES

SOME FURTHER NOTES AND IDEAS

J. R. HEY (G3TDZ)

AN avalanche of mail following publication of the circuit for a small two-metre portable (SHORT WAVE MAGAZINE, Oct.-Nov., 1971) has indicated the extent of interest in this direction. It has been gratifying to hear from those who have such portables already built and working.

Experience gained constructing a similar model recently and whilst assisting others has uncovered a few extra points which it is considered might be helpful to anyone about to start on this project.

The First Mixer

It is suggested the bipolar mixer, Tr3 in the front end, be substituted for an FET. Our old friends the 2N3819, MPF102, etc. are most suitable; another recently tried is the BFW10, currently advertised at five for £1, a fair bargain.

The circuit of Fig. 1 shows what is required. The coupling capacitor C5 remains, but the potential divider R5, R6 is removed, a single resistor of 47K taking their place as gate leak.

Oscillator injection is now taken to the source through a 470 $\mu\mu\text{F}$ or .001 μF capacitor from either a centre tap on L5, the doubler coil, or a two-turn link wound over L5.

The original emitter resistor, now the source resistor becomes 3.3K ohms.

Crystal Oscillators

It has been the experience of some that with certain crystals, both the crystal oscillator in the receiver and the transmitter oscillator sometimes show unwillingness to start. If the BC109 is replaced by a *pukka* RF transistor, all crystals go off every time and a better output is realised. Any of the inexpensive plastic or metal television or FM radio types now available are ideal.

Second Conversion VFO

The second conversion tunable oscillator was a little troublesome on the second receiver attempted. Although quite stable off-load—that is, disconnected from the IC—when connected up it tended to die.

An odd plastic transistor of the BC109 family, added to form an emitter follower by hitching it to the conductors under the board, tucked out of sight, performed with excellent results.

Output was now healthier, remaining constant on and off load and the frequency stable. Fig. 2 shows the modified oscillator.

Q-Multiplier

G8ENN has suggested a simple Q-multiplier which when added to the tunable IF, sharpens the selectivity, so enhancing the image response by a large measure and

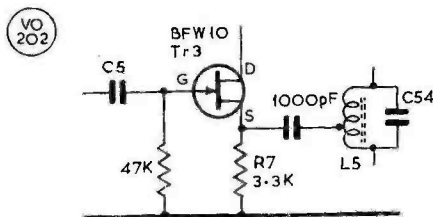

Fig. 1

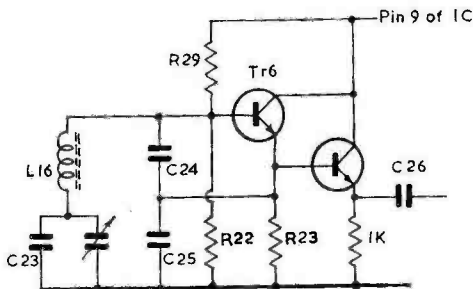

Fig. 2

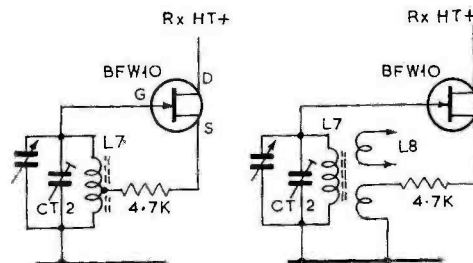

Fig. 3 a

Fig. 3 b

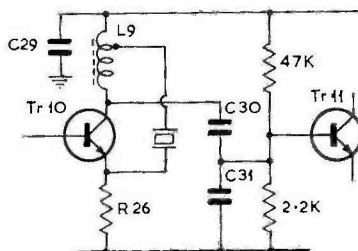

Fig. 4

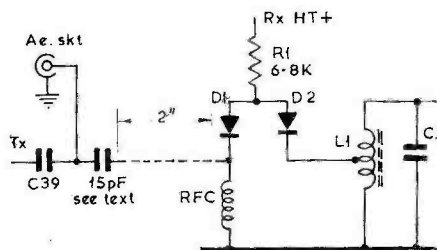

Fig.5 Solid state aerial switch with extra capacitor

when fitted to the original, lifted the gain almost an "S" point.

It will be seen in Fig. 3 that only two components are required, a 4.7K resistor and an FET, another BFW10. However, it was found difficult to put a tap on L7 (Fig. 3A) it being close-wound and well doped; a 5-turn coupling coil wound on top alongside L8 did the trick, only a slight trim of L7 being necessary. (Fig. 3B.)

Doubler Bias

Applicable to both receiver oscillator chain and to the transmitter doubler, a slight bias to help the transistor on its way is sometimes advantageous. A silicon transistor requires 0.6v. on its base before conduction can take place. Sometimes, the crystal oscillator can only just manage to turn the doubler on, so producing insufficient output. Rather than run the oscillator harder, if say 0.5 of the 0.6v. can be provided by some DC bias, more output is obtained without detriment.

The method of coupling indicated in Fig. 4 is suggested. A 2.2K and a 47K are added to produce the bias required. RFC3 in the transmitter may be removed and it is suggested that C52 across L3 in the receiver be changed to the system employed in the Tx—that is a capacity divider of 39 pF and 100 pF fitted together with the 2.2K and the 47K resistors.

Aerial Switch

The solid-state aerial switch (*see* Fig. 5) again originally suggested by G8ENN and still considered a good method, produced a curious fault in the second receiver, in which separate boards were used for transmitter and receiver. A two-inch length of wire which connected the aerial socket to the diode switch of the receiver caused the transmitter power to be reduced 60% upon contact! Obviously, something in the receiver was absorbing a lot of power. The diodes were tested and seemed normal; reverse breakdown voltage proved to be 52v., well in the clear. Next, the diodes were checked on a bridge in back-to-back series as they appear in the receiver. A capacity of 15 pF was noted.

Just to see what happened, a fixed capacitor of 15 pF was shunted across the Rx end of the two inch wire; the Tx output died as before, but when the 15 pF was placed across the aerial socket, a slight increase of output was observed.

Still (mistakenly) thinking in terms of unwanted capacity, a four-turn coil with a slug was shunted across the wire. Sure enough, it could be adjusted to resonance, the transmitter power rising to that expected. Only one snag, however—not a single station could be heard! When thought about logically it is obvious that a trap preventing transmitter power from reaching the receiver would also block, or reduce considerably, incoming signals likewise.

How about a touch of series resonance? A 30 pF trimmer, wired this time in series with the receiver aerial feed at the aerial socket, when adjusted about half-mesh produced a clear rise in received signal strength. At any setting the transmitter output looked much healthier but at the point corresponding to the rise in the receiver's performance, power reached maximum.

In practice, a fixed 15 pF ceramic capacitor was

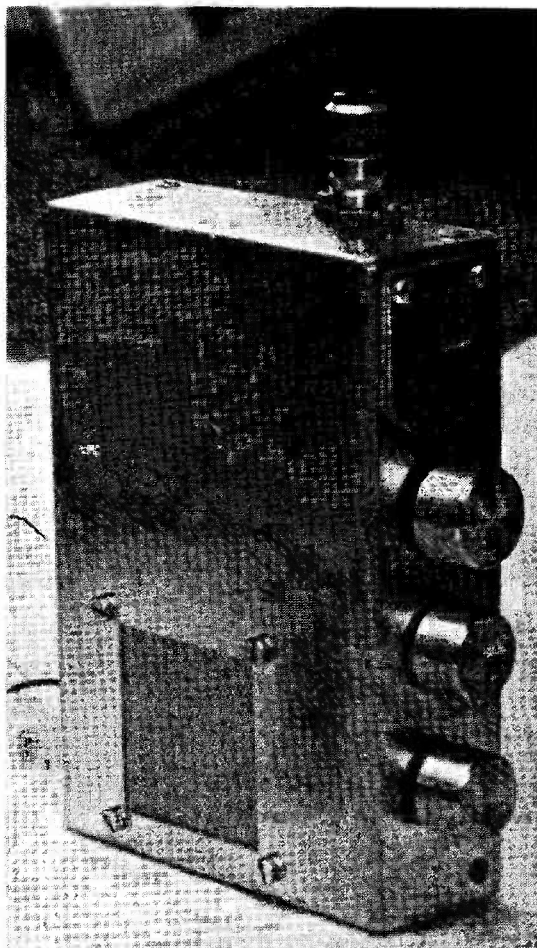

The two-metre hand-held portable as originally designed and described by G3TDZ in the October-November, 1971, issues of "Short Wave Magazine". The article here suggests some desirable modifications.

fitted replacing the trimmer. One tends to think in terms of "002 μ F at 75 ohms." In fact, in the original unit there was no capacitor at all but we have seen how lengths of wire can cause the unexpected at these frequencies, a mere 15 pF working like magic.

As many constructors will find they have longish coupling leads inside the set, it is suggested a small trimmer might be tried first before assuming no further improvement can be obtained.

Conclusions

Having experimented with other IC's during the past year, it is clear that the original circuit (pp.482-483, October '71) is hard to beat. Incorporating these few suggestions, a very fine hand-held portable, capable of excellent results, can be produced (as members of Leeds Radio Society, where all this started, well know).

IMPROVING THE HW-100

SOME NOTES ON USEFUL MODIFICATIONS

D. BEDFORD (G4ABS)

THERE are many HW-100 transceivers in use throughout the world, and a fair proportion of these are in the U.K. In the writer's opinion, they represent the best way of getting on the air with SSB for the initial outlay. It may be gathered from that remark that the station of G4ABS consists of one HW-100, built some fifteen months ago. Coupled with two good antennae, it has performed beyond expectations.

Whilst it is a very easy rig to operate, as time passed, it was realised that there were one or two little points that could perhaps be improved upon for little or no cost. These were, briefly:—(1) Cabinet did not open up easily; (2) The knob of the tuning mechanism was too slack; (3) The sensitivity of the Rx could be improved; (4) There was no Independent Receiver Tuning (IRT) facility.

The first point was overcome by removing all eight screws that fix the cabinet top to the cabinet bottom, and those that secure the backplate to the chassis. The screws that fix the backplate to the cabinet top were left in place. A $\frac{3}{8}$ in. diam. hole was then drilled through both cabinet halves, at a point approximately an eighth of an inch from the rear of the cabinet, and in line with the other holes in the cabinet sides. One spring nut and bolt were then replaced either side in these new holes, leaving out the other screws along the sides. This enables the lid to hinge back quite nicely.

However, when first tuning the rig, the sloppy fitting of the main tuning knob on the Heath Harmonic Drive unit was noted. Two washers were cut from a heavy polythene bag, and placed on the plastic boss around which the tuning knob revolves. This cuts out the sloppiness and makes a firm, smooth action when tuning. They are cut so that they cannot be seen when the knob is replaced.

It is understood that there will be available very shortly a two-speed Jackson drive unit especially made for the HW-100, requiring fitting only, with no other alteration to the rig.

When aligning the HW-100, it was found that there were two positions of sensitivity—one for maximum performance on "receive," and the other for maximum output on "transmit". Wanting both, it was found that a 6HS6 in the first RF amplifier, V10 (as now used in the HW-101) in place of the 6AU6, gave slightly increased sensitivity, moving the S-meter indications up by one S-point.

It was then discovered, from an equivalent noise resistance valve table, that the 6AU6, 6HS6 and the 6AK5 all had fairly high e.n.r., but certain valves, including the 6AK5, when connected triode-fashion, had an extremely low e.n.r. Connected in pentode, the e.n.r. of these three valves is around the 2,100-ohm mark, but the 6AK5 is only 385-ohms when connected as a triode. Whilst triode-fashion would not be acceptable,

it was decided to try the 6AK5 in as a tetrode. Not wishing to alter the rig, pin 2 of the valve was cut off and carefully inserted into the socket—care is needed because there is a gap left between the pins of the valve that is the same as the gap between pins 1 and 7. A little re-peaking of the IF's then gave a worthwhile increase in sensitivity and, more important, considerably reduced the receiver background noise. The S-meter needle is also more lively, very closely following the modulation level of an incoming signal, and now gives a more accurate indication of the signal strength on the 10 and 15 metre bands.

There is one point to bear in mind when incorporating this modification, and that is to use two 6AK5's, one in V10 and one V11. This balances out the slight difference in heater current between the 6AK5 and the 6AU6, and V10-V11 are coupled together.

The "Transmit" Side

The next thing was to re-peak the rig in the "transmit" mode for maximum output. This was done with the aid of the SWR bridge, using low power. The difference in output was sufficient to raise signal reports on the HF bands, to a consistent 5 & 7 to 8, and sometimes 5 & 9. Reports like 5 & 7 from JA's, VS6's, KG's and 5 & 9 to 9+ from ZL, using a home-built Yagi at 30ft., more than justify this modification.

One of the greatest pleasures in operating is to be in a net. Now a net, as you already know, poses its problems of difference in frequency, and in order to follow the QSO, independent tuning of the receiver is almost essential in a transceiver. This took a little thought, because spoiling the appearance of the front panel was to be avoided. It was decided that with a little care, IRT could be incorporated quite successfully.

Using a slight modification of a circuit by F5AD, a vari-cap diode alters the capacitance of the VFO. The essentials are a stabilised DC voltage of about 6-12 volts, and some means of varying this voltage and applying it to the diode. The method is shown in Fig. 1. This allows an excursion of 2½ kHz above and below the main VFO setting. Figs. 2, 3 and 4 show the arrangement adopted. Whilst the positions shown are not mandatory, there is sufficient room at these points to work comfortably. (See overleaf for diagrams.)

A pencil to mark out and a centre-punch before drilling will prevent the drill from spiralling across the paintwork. Also, careful choice of switch, lamp and knobs will enhance, rather than spoil the appearance of the rig.

Voltage for the divider network is taken from the 300v. DC source, with a 68K 1-watt resistor soldered directly to the circuit board at the 300-volt point (HW-100 handbook Figs. 1-18, audio circuit board). The hook-up wire for this, and for the relay connections, can be taken alongside the main wiring harness, and attached to it. The relay connections (spare) are for the Tx/Rx balance wire; omission of this will cause a difference in frequency when on IRT. The use of the relay allows the IRT to be cancelled out when in the "transmit" mode, and this ensures that you stay on the net frequency.

The VFO is removed by following the instructions in the handbook, taking care not to damage the plastic dial. The components to be mounted inside the VFO

box should be fitted as rigidly as possible, e.g. solder the components D1, R6 and C2 in a small triangle, and take them directly to the phono-plug earth-tag. Stiff hook-up wire was then used to make the connections to the VFO coil. Use a beehive capacitor for C1, but it was found not necessary to adjust it after installation, and a fixed capacitor of 10-20 $\mu\mu\text{F}$ could be used. This capacitor determines the amount of detuning possible.

All other components are at DC only, and DC is coupled to the VFO via the feedthro' connector. This connector is not absolutely essential, as the wire for the connection, if insulated, can be taken out of the VFO box through the small space at the side of the spade bolt. This saves drilling a further hole in the VFO box.

The positioning of the other components can be left to individual choice, but the layout used is as shown in Figs. 2, 3 and 4. If the extra dial lamp for indicating IRT is not required, an SPDT switch could be fitted, and a rotary switch would enable a Heath knob to be used, to match the IRT knob. Wanting the state of the receiver

Table of Values

Fig. 1. Circuit of the Modification

C1 = 10 $\mu\mu\text{F}$	R4 = 3,300 ohms
C2 = .01 μF	R5 = 4,700 ohms
R1 = 68,000 ohms,	R6 = 10,000 ohms
$\frac{1}{2}$ watt	VR1 = 5,000 ohms Lin.
R2 = 4,700 ohms	Z = 12v. Zener diode
R3 = 6,800 ohms	D1 = BA102 or similar

Notes: The HT connection to R1, Fig. 1 (see circuit) should go to the +300v. point, as text. The zener diode should be connected between junction R1, R2 and ground. For D1, the BY-100 (3-20 $\mu\mu\text{F}$) would substitute, or OA21 (20-75 $\mu\mu\text{F}$) would be ideal. S1 can be DPDT sub-miniature, or SPDT if extra IRT panel lamp (see text) not required; IRT lamp if used is 12-6v. sub-miniature, supply taken from main lamp line by breaking brown wire and coupling both lamps through S1. Use HW-100 manual to check on all wiring modifications and placing of new parts.

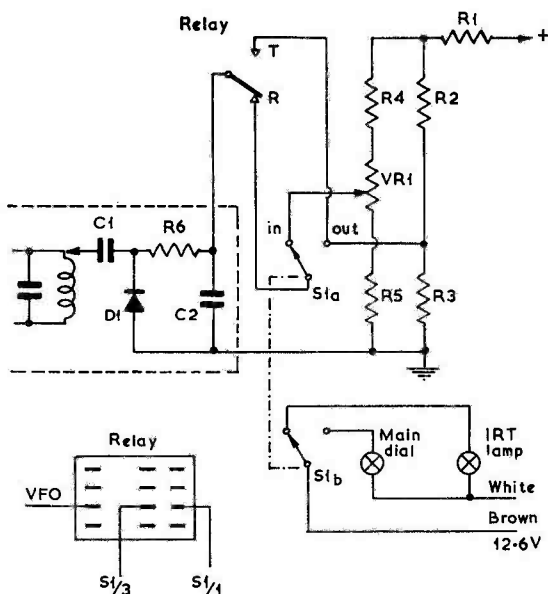

Figure 1

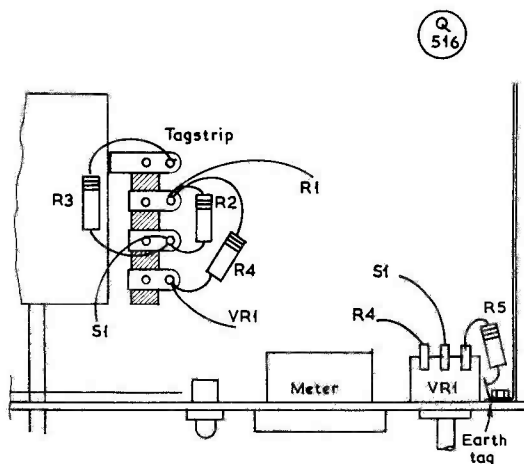

Fig. 2 IRT (Top view).

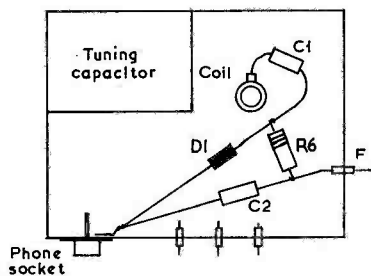

Fig. 3 VFO (Bottom view).

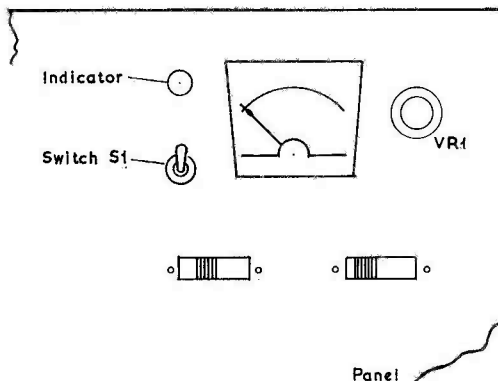

Fig. 4 Front view

to be shown at all times, and when on IRT, the appropriate indicator lights up, and the main dial lamp is switched out.

An earth tag placed under the nut of the bolt securing the frontplate to the side support plate, on the right-hand side of the meter, this provides a convenient tag for the resistor R5. The tag strip is used to support R3, R2 and R4, and as a tie-point for the connection from the relay. The 5K lin. pot. that controls the tuning is positioned at the right side of the meter, with a suitable matching knob.

It only remains then to re-set the dial in the normal way by pressing the zero-set button and using the calibrator. There is no need to re-adjust the VFO coil or trimmer.

The unit works in the following manner: A fixed voltage of 12v., regulated by the zener diode, is obtained from the 300v. source via R1, and this biases the diode D1 to a determined capacitance. The second voltage divider with the control P allows this voltage to be

varied, and in so doing the capacity of the diode is changed proportionately, so giving fine tuning of the VFO. The fixed voltage from the first divider network cancels the effect of the second divider network, and fixes the capacitance of the diode at its determined level. By coupling this first divider voltage through the Tx/Rx changeover relay, the variable network is bypassed on "transmit," thereby reverting to the main VFO frequency and allowing the transceiver to be used in the normal way, without the need to be constantly switching the IRT in and out. This facility has been used many times since installation, and the writer just wouldn't be without it.

The only other modification made to the HW-100 is to produce a much lower audio response from the speaker. A .01 μ F was put in parallel with C303 (handbook circuit) across the primary of the output transformer. This gives the necessary amount of treble-cut to make for comfortable listening.

The writer would like to thank G3ZZQ and EI3AJ for their co-operation and advice.

ALL-TRANSISTOR TEN-WATT TRANSMITTER FOR TOP BAND

RUNS OFF 12 VOLTS, BENCH OR CAR — FULL INPUT ON 160 METRES

M. RATHBONE (G3ZII)

THIS design came about as a replacement for the rather "tatty" valve rig which had been used since first being licensed. Instead of going for the old 6BW6/EL84 routine again an all-transistor job was attempted and results have exceeded all expectations. It has been found excellent for mobile working, no inverter packs or heaters being required. The current consumption is

about the same as just the heaters on the old rig and that only while actually on the air.

The Circuit (See pp.230-231)

VFO: This takes an OC170 in collector-emitter feedback though any good circuit could be used. Output from the collector goes to an emitter follower buffer to isolate the Oscillator from the following stages. Both these transistors are fed from a simple series stabiliser Tr3 with its base held at 10v. by ZD1.

All these stages are built in a box made of copper clad P.C. board soldered at the corners.

Driver Circuit: Many arrangements were tried here, including wide-band couplers and tuned circuits, but the choke coupled arrangements of Tr4/Tr5 was found to perform best; these are surplus silicon types and can be allowed to get quite warm.

Tr4 is run with some bias but Tr5 is switched by the

The 160m. battery-powered Tx fitted in a vehicle for mobile operation. By spinning off one wing-nut and pulling out aerial and power (car battery) plugs, the Tx can be quickly removed for bench operation. Box bracket mounting lined with sponge rubber prevent vibration and rattles.

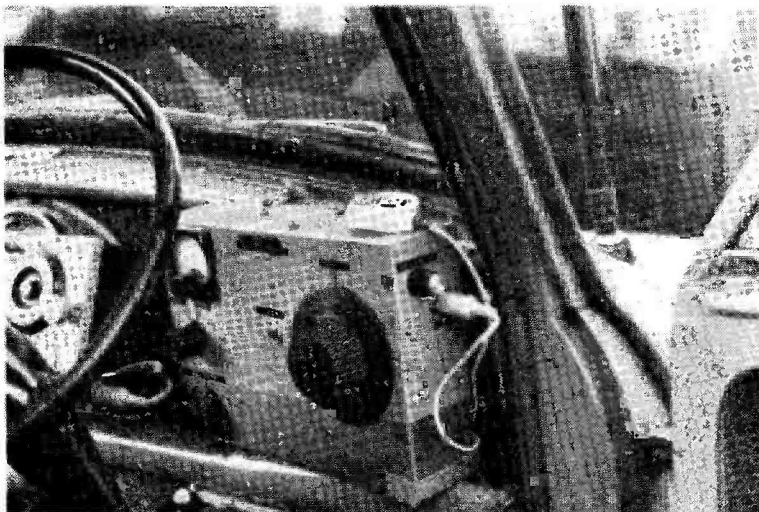

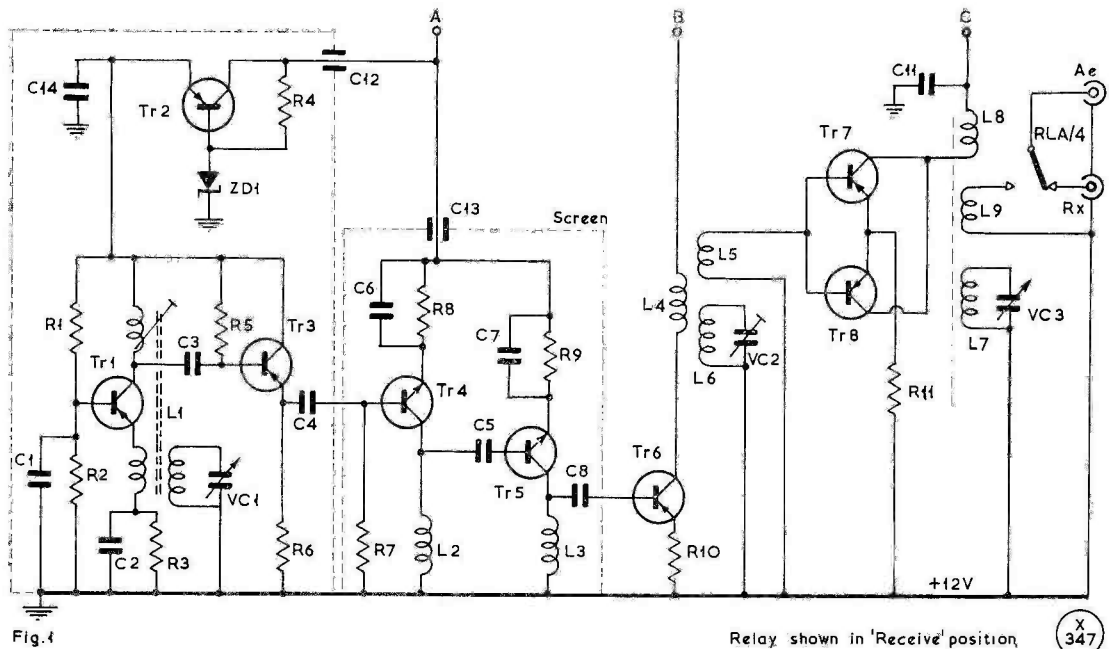

Fig. 1

Relay shown in 'Receive' position

347

Fig. 1. VFO, Buffer and Voltage Stabiliser stages, with two-stage Driver Circuits and Power Amplifier.

Table of Values

Figs. 1 and 2. Top Band AM Tx

C1, C2 = 0.1 μ F, cer.	R12 = 220 ohms
C3, C4 = 220 μ F, mica	R13 = 470 ohms
C5, C8 = 500 μ F, mica	R14 = 10 ohms
C6, C7 = 0.04 μ F, cer.	R15 = 0.5 ohm
C9 = 220 μ F, 15v. elec.	ZD1 = SZ10C, or any
C10 = 0.1 μ F, paper	T1 = 8-ohm primary,
C11 = 0.25 μ F, 50v. elec.	sec. to match
C12, C13 = 0.01 μ F, feed-thru	2/OC26's
C14 = 100 μ F, 15v. elec.	T2 = Pri. to match
VC1 = 0.25 μ F, var.	2/OC26's,
VC2 = 250 μ F, trimmer	sec. 3-15 ohm
VC3 = 500 μ F	Tr1 = OC170
R1, R7 = 22,000 ohms	Tr2 = OC81
R2 = 6,800 ohms	Tr3 = OC42
R3, R6 = 1,000 ohms	Tr4 =
R4 = 3,300 ohms	Tr5 = 2N706/708
R5 = 100,000 ohms	Tr6 =
R8 = 75 ohms	Tr7 =
R9 = 150 ohms	Tr8 = AU10
R10 = 2.7 ohm, 3w.	Tr9 =
R11 = About half-ohm (see text)	Tr10 = OC26

TABLE OF COIL DATA

- L1 = MW oscillator coil, ex-transistor radio.
 - L2, L3 = Small RF chokes, MW type, not very critical.
 - L4, L5 = 10 turns each of 18g. enam. over-wound on L6.
 - L6 = 50 turns pile-wound, 18g. enam., on $\frac{1}{8}$ in. dia. "air core" former.
 - L7 = 30 turns 18g. enam. close-wound on four $\frac{1}{8}$ in. ferrite rods, bound together.
 - L8, L9 = Three turns each, close-coupled to L7.
- Notes: M1 should be 0.1 amp. meter. RLA/4 is 4-pole changeover relay, 12v. actuation. AF module (Fig. 2) is 500 mW pre-amp panel, as advertised (and see text) or from Mazel Radio, London Road, Manchester 1. Microphone 500-ohm magnetic (see text).

drive, as are all following stages. Should any overheating occur the cure is slightly to increase the value of the emitter resistor of the stage affected. This part of the circuit is built on a piece of *Veroboard* and fitted in a metal box for screening, and a screen is essential between the two RF chokes.

Power Driver Stage: This is an AU10, bolted to the outside of the driver screen box; it is link-coupled to the PA by L4, L5, L6. The trimmer was peaked at 1900 kHz and drive was adequate over the band.

Power Amplifier: The drive from L5 pushes the PA current up to over one amp. off tune. This came down on the prototype to 0.8A when dipped, which is the correct 10-watt level. This can be varied either by adjusting the drive input or varying R11 which is a length of resistance wire wound over a resistor.

As it stands this rig will operate efficiently into low-impedance aerials. In the shack it runs a quarter-wave wire. A base loaded whip is used in mobile operation. Other lengths should be possible with the appropriate ATU.

The PA transistors are 2/AU10's in parallel. These are mounted on the heatsink plate which also carries the driver coil L4, L5, L6—see Fig. 1. The tank coil L7, L8, L9, is wound on four $\frac{1}{8}$ in. ferrite rods bound together, screened from the base coil by the PA heatsink plate.

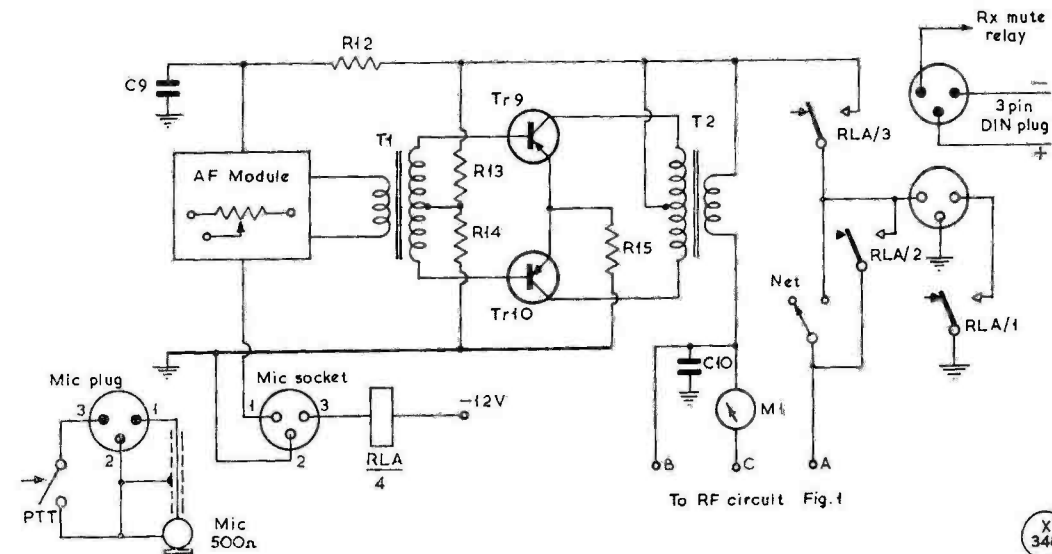

Fig. 2

Fig. 2. Modulator and change-over circuitry for the G3ZII Transistor Transmitter.

Changeover is by a 4-pole miniature relay mounted near the aerial and Rx feed coax sockets.

Modulator

This uses "Japanese Audio Board" for the pre-amp. stages with a 500-ohm moving-coil microphone for the shack and a cheap moving-iron type for mobile (of the same impedance) as it reduces background noise.

The audio board is a 5-transistor unit with an input sensitivity of about 5 mV and more than enough output to drive the modulator pair. The upper base bias in the push-pull stage of this unit can be increased to 10 or 12K, cutting the quiescent current and slightly increasing output without noticeably increasing distortion.

Audio from the pre-amp goes to the driver transformer which feeds the output transistors and thence to the output transformer, secondary of which modulates PA and driver stages. An old car radio supplied the driver and modulation transformers but it should be possible to wind them as they consist of relatively few turns of quite heavy wire. Not much difference was noticed between the 3-ohm and 15-ohm tapings in matching to the PA.

Operation

A front panel switch puts the VFO and low-level drivers on for netting and transmit/receive is by p-t switch on the microphone.

Loading is easy enough though at first it seems a bit odd to tune up on an ammeter—just tune for a dip and start talking. The PA meter will probably kick a few hundred mA on speech peaks but the outgoing signals should be strongly upward modulated with plenty in hand; on the prototype the gain control has never had to be advanced beyond halfway.

Series modulation with a series transistor was considered but such circuits usually need a higher voltage for good PA efficiency (as half the voltage must be dropped by the modulator) and they can be tricky to set up. As for mobile we only have 12v. to play with a transformer-coupled circuit was used.

Most of the components came out of the junk box, the AUYIO's being the most expensive items usually being advertised at £1.50 apiece but remember you don't need to spend anything on an inverter power supply.

Conclusion

The log-book shows more than 40 QSO's since first putting this rig on the air a few months ago. A local reported that he had gone through the signal on a selective receiver and couldn't fault it, while others have expressed much interest in the rig. Altogether, the writer has found this a most interesting project and well worth the effort involved in getting it going.

R.A.E.—MAY 1972

For the Radio Amateurs' Examination held on May 9 last, the question paper appeared fair and reasonable for those who had been adequately instructed and had done their home-work conscientiously. There was only one question involving transistors—though it is understood that the syllabus is to be revised to bring in more on the use and application of transistors. No elaborate diagrams were called for and only one question required the use of formulae directly. As has now become customary, we shall be producing "sample answers" to all ten questions during the winter R.A.E. session.

X
348

VHF BANDS

A. H. DORMER, G3DAH

IT is most unusual, not to say frustrating, that we still have not had a sustained spell of good propagation on the UHF/VHF bands by this time of the year. True, there have been the odd lifts but, by and large, conditions have been well below average for far too long. Mid-April produced some reasonable DX with EI and GI coming through on the two-metre sideband channel, and this was followed by another such temporary lift over April 22/23 when Continentals were workable with some ease on SSB, and GM3ZBE was a readable, if not easily workable, signal in the South. The night of the 25th startled not a few when EI9Q, EI6AS, GD2HDZ, GW3NNF (Anglesey) and stations in Cumberland and Northumberland were all up on two metres. 70 cm. also perked up on that day—witness the contacts by G3KMS (Bolton) with G8CBA (Mildenhall), G5DF (Reading) and G8CIT (Hampton, Middlesex). It is reported that EI9Q (Waterford) is on every Wednesday night from about 6.30 p.m. onwards. Conditions on two metres in the Midlands may have been a little better than they were in the South at this hour, as G8ACB (Wolverhampton) reports mobile contacts with G6GN (Bristol) around this date, and also fixed station contacts with GW. 70 cm. showed a bit of a lift on May 1 also, but has been pretty poor since, in spite of the warmer weather and higher pressures.

G3NHE, with others, reports

another "Italian Job", but this one looks a little more credible. On Sunday morning, April 30, an I3 was heard working a French station on 2m. SSB, although no call signs could be resolved. Can anyone supply more detail, please? This *does* look like Sporadic-E as there was coincident 4m. activity from the Continent, the times look right, and tropo. propagation on two metres was just a little up on normal.

May opened quietly, but the 6th and 7th were good for 2m. DX to the Continent.

Contests

4m. Contest—April 8: Brief comments on this event were made in the last issue, and reports received since indicate that conditions were indeed poor over most of the country. Inevitably, there were the odd patches of DX, such as the contact between GM4ALE/P, near Moffat, and G3EKP (Blackburn) but by and large things were quiet. A notable, and much to be regretted, aspect was the dearth of GI's, one supposes for reasons which are not too difficult to guess. As an indication of activity, one of the best scores heard towards the end of the contest was the "060" passed by G3FZL at 1620z.

432 MHz Contest—May 6/7: Comments on conditions during this contest varied from deplorable to unprintable. Although pressure was high over much of the country, and there had been some lifts in conditions immediately prior to the contest, propagation was poor, and even medium-distance paths subject to much fading. Since this state of affairs was obvious to most operators from the very start of the event, it is a tribute to their keenness that activity remained as high as it did, but it is still a mystery why more stations do not use CW on 432 MHz. All right—so the G8/3 can't, but for any group to go out portable, presumably with the intention of getting a good score, and not to take a CW man with them, is to write of the best DX straight away, and yet this is what happens, and even at fixed stations with the appropriate qualifications, there seems to be a reluctance to use the key. What do you reckon the odds were that GW3VER/P in Pontypool would not make it on the Sunday morning

with PA0EZ (or G3DAH come to that)? But they did—on CW!

Forthcoming Events

144 MHz Contest: Date is May 21 and the times 0900-1700z.

70 MHz Contest: Period is June 10/11 and the times 1800-1500z the following day.

Microwave Contest: June 24/25 and the times 1700z-1700z the following day. It should be noted here that only contacts on frequencies above 1 GHz count for points, but lower frequency bands may be used for setting-up purposes.

144 MHz Contest: Just in case you do not get your copy of SHORT WAVE MAGAZINE by the first of the month, dates for this event are 1700z on July 1 to 1700z on July 2.

IARU Region 1 VHF/UHF/SHF Contest

The rules for the IARU Region 1 contests this year have now been published by RSGB who will be responsible for adjudication. They are too lengthy to reproduce here—suffice it to say that the UHF/VHF Contest takes place on September 2/3 and the UHF/SHF Contest over October 7/8. The times are the same for both events—1800z to 1800z. Logs must be sent to the RSGB VHF Committee by October 23 for the September event and by November 27 for the October contest.

Looking through the rules one cannot help remarking that Britain is still the only country in the Region in which it is, almost without exception, required that QRA and QTH be exchanged by contest participants. As far as scoring accuracy is concerned, the QRA Locator is good enough—it is accepted as such by the IARU authorities—and one would have thought that by this time, whether one agrees with it or not, it would be agreed that the QRA Location map is in general use throughout the Region and here to stay. Since both distance and location are determined by the one system, it seems unnecessary to ask for what amounts to a duplicate check, unless for some reason the idea is to extend the length of the contest exchange. Only rarely does a contest operator require to know the exact address of the station he is working (and

don't let us get involved with arguments about whether it should be a QTH Locator Map) and when those circumstances arise, reference to the callbook should suffice. Just think what might happen if the Continental contest organisers insisted on both QRA and QTH. Would cross-Channel operators find it easy to copy that you live in Little-Puddlecombe-by-the-Dyke? Would you be happy to have to read, under contest conditions of QRM and possibly bad QSB, that that DL was in Oberunterbeidemgebirgegebiet? Not Pygmalion likely! So why not drop the QTH?

VHFCC Awards

Details of the equipment in use at the Chalmers University of Technology at Gothenburg, and comments on their activity on the VHF bands, were given last month. It was with pleasure, therefore, that their claims for the VHFCC Award, not only for operation from the University site (SK6AB) but also from their contest site (SK6AB/7), were received. They gain Awards Nos. 146 and 147 for two metres. There is little to add to the details of the station as given in May "VHF Bands," except to say that the 500-watt linear allocated for 70 cm. has now been used for some other purpose (it belonged to SM6CSO) and so the most that can be mustered at present is 5 watts, but with the antenna system in use (4 x 46-ele.) this represents quite an e.r.p., and they still have the 500 watts on two metres! (see picture p.235).

Award No. 148 goes to Alwyn Seeds, G8DOH (Dover) also for two metres. The claim is unusual in that it consists entirely of contacts with Continental stations. It is likely that the proximity of G8DOH to the coast has had a good deal to do with this, since the Tx used for most QSO's ran a few watts only to a QQV03-10 with an antenna in the loft. However, a 4CX250B is now in use with a DC input of 150 watts, and the beam is an 8-ele. J-Beam at 30ft. On the reception side, Alwyn has a home-built converter and a ten-valve single-conversion superhet. Although the QTH is at 250ft. a.s.l., the surrounding hills are at 450ft., which makes the claim the more astonishing. It is also the reason why 'DOH is not on 70 cm. from

home, although he does operate on that band from portable locations during VHF/NFD. He must be one of the very few operators who use a computer to keep station records!

Operating 2m. CW only, Peter Cutler, G3DAO (Chichester, Sussex) gains Award No. 149. He first came on the band in September 1970 with fairly simple equipment, but now runs 50 watts or so with a

QQV06-40A and an 8/8-ele. beam. The Rx consists of a high-gain FET pre-amp into an Emsac CN2, with an EA-12. The location has pretty good all-round coverage but, as with many coastal sites, the high winds are a menace, to say nothing of the salt which plays havoc with antenna metalwork. Peter puts in a plea for more CW on Two. It is indeed strange that so many operators with

THREE BAND ANNUAL VHF TABLE

January to December, 1972

Station	FOUR METRES		TWO METRES		70 CENTIMETRES		TOTAL pts.
	Counties	Countries	Counties	Countries	Counties	Countries	
G5DF	26	2	39	5	21	1	94
G3DAH	10	1	35	5	19	2	72
G3OHH	33	4	16	2	11	2	68
GD2HDZ	11	3	34	5	9	2	64
G3NHE	—	—	43	6	13	1	63
G8BXX	—	—	32	2	18	1	53
G8CIW	—	—	41	8	—	—	49
G3FIJ	6	1	22	5	9	3	46
G8FAG	—	—	41	4	—	—	45
G8ALN	—	—	27	4	13	1	45
G3YRH	—	—	25	4	7	3	39
G8CBU	—	—	27	2	4	1	34
GM8BDX	—	—	25	4	2	2	33
G3EKP	13	6	16	2	1	1	33
G3DAO	—	—	26	5	—	—	31
G8BKR	—	—	21	2	5	2	30
G8EMS	—	—	26	2	—	—	28
G4AJE	—	—	26	2	—	—	28
G8BMD	—	—	23	4	—	—	27
G8AGL	—	—	25	1	—	—	26
G8ERM	—	—	21	2	—	—	23
G4AVX	—	—	20	3	—	—	23
G8FNH	—	—	20	2	—	—	22
G3PQF	—	—	19	2	—	—	21
G8COG	—	—	19	2	—	—	21
GM3ZVB	—	—	16	3	—	—	19
GW3CXY	—	—	13	2	1	1	17
F6BQH	—	—	7	3	—	—	10
G8DBX	—	—	6	2	—	—	8
G8FSO	—	—	4	2	—	—	6

These Tables go through to December 31, 1972. The Three-Band Annual Tables show claims to date for the year commencing January 1, 1972. Claims should be sent to "VHF Bands," SHORT WAVE MAGAZINE, BUCKINGHAM, as they accrue. Band-by-band tables are also published from time to time as opportunity offers.

attractive DX calls (GM, GD, EI, GI and the rarer Northern counties) do not make more use of the key. On a good, modern receiver, it is possible to read a CW signal at a level where it is not showing on the S-meter at all, and that is more than can be said for phone, even when it is SSB phone!

Alan Newman is G4AVX of Portsmouth, but is perhaps better known to many as G8CXC. His Award is No. 150 for 2m. operation. All contacts were made using an HW-17A transceiver and a 14-elt. Parabeam at 21ft. The QTH is virtually at sea level and severely screened to the North by a 420ft. range of hills. This gear is due to be replaced soon with a QRO AM/NBFM/CW rig with VFO, and SSB should follow later. Plans are in hand to come on 70 cm. with a Mosfet converter and a 46-elt. Multibeam.

Group Activity

The Hereford Amateur Radio Society are offering skeds with that county on 4m., 2m. or 70 cm. at any time. Write to S. H. Jesson, 181 King's Acre Road, Hereford, with s.a.e. for details. The Society is also planning trips to local hilltops during the summer with operation on 2m., and 4m. if requested. The first of these was to be on May 26 and thereafter on the fourth Friday in every month until the autumn. The call sign to look for is G3YDD/P.

The British Amateur Television Club have now fixed the date of their next Convention for September 16, at the Hq. of the Independent Television Authority, 70 Brompton Road, London (just opposite Harrods).

The Manchester University Radio Society trip to GM was noted briefly here last month. Full details are as follows: *June 24/26*, Stirlingshire (Kilsyth Hills), or Dumbartonshire (Kilpatrick Hills); *June 27/29*, Islay (Argyllshire); *July 1/3*, Jura (Argyllshire); *July 5/7*, Dollar (Clackmannanshire). Operation on two metres will be during 0730-0900 BST and 1900 to m'night BST daily. First 15 minutes in each hour on CW, next 15 minutes tuning for phone, next 15 minutes for co-channel phone and last 15 minutes tuning for phone again. Frequencies are 144.05, 145.41 and 145.9 MHz,

with 150 watts (and 600 watts p.e.p.) input. Callsigns are GM3VUM/P, GM8FUM/P and, hopefully, GB3UM. Send s.a.e. for skeds to Peter Brown, GM3YOK, University of Manchester Amateur Radio Society, University Union, Oxford Road, Manchester 13. Closing date is *June 11*.

The next meeting of the South East UHF/VHF Group is at the Electronics Building, University of Kent, Canterbury, on June 16 at 6.30 p.m., when J. C. Ramsey, G3OZZ, will be speaking on "The Post Office and the Radio Amateur". This will also be an occasion for Group members to say farewell to their president, Jim Foster, G2JF, who has now decided to return to South Africa for good.

Meteor Scatter

For those interested in having a go at this method of communication, the following are the showers most likely to be productive of contacts during the remainder of this year:

Perseids, June 9; *Aquarids*, July 29; *Perseids*, August 11; *Quadrantids*, October 2; *Leonids*, November 16; *Geminids*, December 13.

The dates show the times of *maximum* activity. The shower could be useful for a few days on either side of the prime date.

International VHF/UHF Convention

The 18th International VHF/UHF Convention on April 22 was held, as in previous years, at the Winning Post Hotel, Twickenham. Some measure of its continuing popularity is shown by a look at the numbers attending the Convention itself and the Dinner—this year they reached a new high of over 400 and 219 respectively.

As is customary, an extensive programme of lectures had been arranged for the afternoon session, those by Ron Ham and Tom Douglas in particular attracting much attention. Tom's slogan "Ten words is a long over" was the subject of heated discussion later in the evening, and one got the impression that, whatever the Service and commercial practice might be, most amateurs preferred to "have a bit of a natter". The proposal that band planning should be on a functional rather than a geographical basis

received some support. Whatever one may think personally of the ideas which come from G3BA, there can be no denying that they are certainly original, sometimes amusing and always thought-provoking. They certainly cannot be ignored if one is interested in good operating procedures.

Trade stands were set up in the main rooms and the B.A.T.C. had an exhibit showing live, slow-scan TV. The Club issues a useful "General Information" sheet as well as their quarterly *CQ-TV*, and those who would like to know more about the Club should get in touch with Malcolm Sparrow, G8ACB/G6KQJ/T, *QTHR*, their chairman.

The judges faced a hard task in selecting the winner of the 1962 VHF Committee Cup for the best piece of home-constructed equipment. The transceiver from G8ATK, the camera steering device by G3YOA and the transceiver from G5AHK all received honourable mention, the final choice being the G5AHK entry, thus bringing Dietrich Dall his second win in this event. The Fraser Shepherd, GM3EGW, prize for work in the field of microwaves went to G3HWR, Heath Rees, who has been very much concerned with the planning of amateur bands above 24 GHz.

The guest speaker was Mr. D. E. Baptiste of the Ministry of Posts and Telecommunications, who heads the Department most closely concerned with the allocation of frequencies for amateur use. He confirmed the reduction of the 70 cm. band to 432-440 MHz, which will make it difficult for the TV boys who want to do relays of 625-line colour (although one wonders how many are able to do this). He also confirmed that authority had been given for setting up a "talk-through" station (repeater to us) on an experimental basis, so we should be seeing something going up very shortly in the Cambridge area.

Amsat-Oscar-C

In view of the fact that several of the systems under development for AMSAT Oscar-B (AOB) have fallen far behind schedule and are unlikely to be ready in time for the anticipated July launch, it has been decided to prepare a second, simplified version, which can meet the

date. This satellite will be known as AMSAT Oscar-C (*AOC*) and will use hardware which is currently available or which can be made available by July. The 2/70 and 70/2 responders are being deleted, and only the 2/10 metre linear translator will be carried for communication purposes—although, of course, the usual telemetry gear will be on board. It also seems doubtful if the "Codestore" package will be included in *AOC*. If ready in time, a beacon on 435.1 MHz will also be carried. The estimated lifetime of the satellite is one year, so that if all goes well, it should last until *AOB* is finally launched. For other details see p.107 of the April issue of *SHORT WAVE MAGAZINE*.

Several readers have queried whether "B" licensees may transmit on two metres and receive on ten metres when working through this satellite. It has been confirmed by G3FZL and G2BVN, of the RSGB, and both closely concerned with this aspect of frequency usage, that cross-band working will be permitted

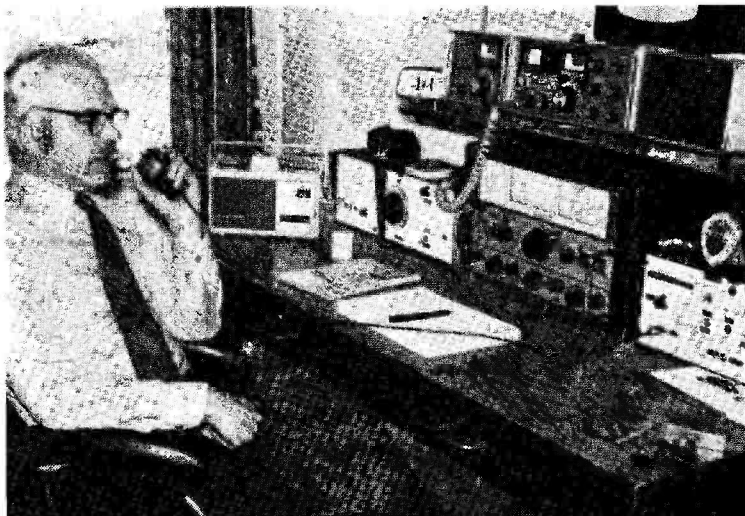

The very well-known VHF operator Tom Douglas, G3BA, in his station at 141 Russell Bank Road, Four Oaks, Sutton Coldfield, Warks. The main Rx is a G.E.C. BRT-400, used with various converters, and on the Tx side an FT-101 gives 28 MHz SSB drive for a two-metre transverter. G3BA has been on VHF since the early days and has also done much DX-portable expedition work.

by the Ministry in this particular situation.

The Scottish Scene

The opportunity for some rare DX is given by G4AZQ, *ex*-G8CKL, who becomes GM4AZQ for the month of August. He will be operating from Lerwick in the Shetlands on two metres, on 145.0 MHz, with an 8 or 10 ele. Yagi. Hope he can manage a bit of CW for the DX operators! QSL for all contacts *via* Bureau—return cards by the same route for all QSL's received. Direct QSL if s.a.e. sent to G8CKL, *QTHR*.

Rather more permanently in Shetland is GM4BBL, who was G8CUW of Leeds but who is now a long-term resident on the Island. He has 90 watts of AM and 120 watts of CW available on two metres compared with his 10 watts of AM with which he worked into Kent last year! Main frequency is 145.92 MHz, with 145.63 MHz as an alternative. The beam is a 9-ele. at 25ft. (anything higher than that is likely to suffer a bit with the 100 m.p.h. gusts up there!), with a clear take-off to the South. Despite repeated calls during the winter, no contacts have been made on two metres since the opening last summer, although the Dur-

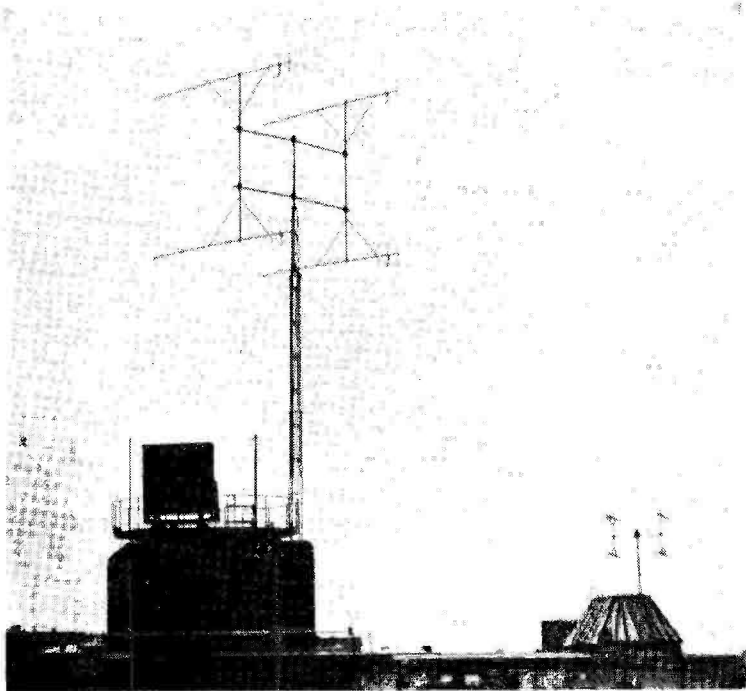

VHF aerial installation at the Chalmers University of Technology, Gothenburg, signing SK6AB, a callsign that has become familiar to many U.K. VHF operators when the two-metre band is open to the East. The 4/14 Yagi array gets 500w. from a pair of 4CX250B's. In the distance is a 4/46 beam for 70 centimetres.

ham beacon has been heard this year (March 11) at 449. So how about turning the beam that way when the Angus beacon is coming in well and having a look for Roger. You might also raise GM3HTH, QTHR, who is coming up on two metres shortly. How about it, Aberdeen? It's only 200 miles to the North for you, and it is a separate county! The address for skeds with GM4BBL is Valhalla, Westerloch, Lerwick, Shetland Islands, or write to GM3ZET, QTHR, this being the call sign of the local Club, if you want to fix up something around contest times.

Beacon Reception

The Northern Ireland 2m. beacon is being received at good level in Edinburgh, and is often to be heard at the same times as the Durham, Angus and Thurso installations. This has highlighted a point which has been brought up before—is the Thurso beacon on its allotted channel? The answer would appear to be—No. Measured on a high-grade frequency meter, the freq. comes out 7 kHz low, and this error is confirmed by the fact that the signal is 2 kHz lower than the GI beacon, which is bang on the allotted frequency of 145.990 MHz. Additionally, it does not match in with GB3ANG and GB3DM either, both of which are very close to where they should be. Perhaps this is why reception reports of GB3GM during N/S lifts are so infrequent.

NBFM and SSB

Kirkcaldy Technical College now has a Garex FM/AM Tx and this (operated by two of the College lecturers, GM8FVT and GM8FXZ) is laying down a good signal in the Edinburgh area when they conduct experiments and demonstrations with those two old timers GM8SR and GM6XI.

The popularity of NBFM grows apace, and the latest convert heard regularly in the Lothians is GM8DSX, a perfectionist if ever there was one, and his transmission quality confirms this. It is good to hear that he is now building a discriminator to go with it. Results are so much better than with slope detection, and yet the proportion of amateurs who, for one reason or another, cannot, or will not, add this very simple device to their

AM receivers, remains unaccountably high.

The use of SSB on two metres is also on the increase, with GM8BJF, GM8BKE and GM3FGJ all now running this mode, and GM6XI coming up on it at any moment. GM3OXX is in the throes of completing a double-sideband suppressed-carrier rig. It seems that it is not only in the South of England that AM stations are coming on around the SSB calling channel and creating plenty QRM. The practice appears to be growing both North and South of the Border in spite of the creation of the "window" for GM and GI, and to quote one correspondent "It would be *more* than appreciated if the Band Plan could be observed!" Hear, hear!

General

It is becoming apparent that the invasion by visitors from the South with mobile/portable VHF gear is imminent. Fine! They are welcome, but *please* don't forget to check with the locals before pinching *all* the best sites during contests!

This seems to be the antenna overhaul season with GM8CHR, GM6XI, GM3NIO, GM3OXX and GM3BQA all involved. '3BQA now has an 8/8 at 70ft. with a 10-ele. at the same height for comparison purposes (it would be *very* interesting if the findings could be made known). '3OXX has an 8-ele. on 2m. and a Parabeam for 70 cm. His QRP solid-state rig on Two is putting a signal into GW and also to G3BW in Cumberland. GM3FGJ now has AM/CW/NBFM/SSB available, all home-built with the exception of the FR-100B as IF strip; beam is a 4/4 slot fed.

Regarding the comment here recently that visitors to Scotland should note that many GM operators cannot tune below 145.8 MHz, GM3ZVB says that even those with Pye Rangers can go down to 145.5 MHz, although this was not your scribe's experience when he was operating mobile in GM last year. *Mutatis mutandis*, as they say!

General News

G3YNT is *ex*-G8AIH and will be back on 2m. SSB again shortly from Newent in Gloucestershire, *not* one of the best QTH's for VHF! G8BKR (Bristol) has been undertaking some tests with the GW lads on 70 cm. and reports that

GW3CXY of Swansea in now QRV on that band, and that GW3MFY in Bridgend is dusting off the gear. There is a great deal of 2m. activity in the Swansea area every evening; GW3DFF in particular is looking for skeds on two metres.

GD2HDZ has been getting his share of the DX recently and the highlight must surely be his ½-hour-long contact with EI9Q in Waterford. The buzz that an EI9 was up on 2m. got round the band fairly quickly, and the following evening stations were calling him from all over the country. Such a level of activity on the SSB channel has not been heard for weeks!

G3NHE (Sheffield) has now got a transverter going and has about 100 watts p.e.p. to a QV06-40A. The prime mover is an Inoue IC700 on 14 MHz. He had contacts with GD2HDZ and EI4AL during the last few days of April and suggests that conditions have several times been on the verge of being good without ever quite getting there.

Northants. on two metres, if you are looking for that county, can be provided by G4AJE (Kettering) who now has SSB. Perhaps Tooting, London, is a little easier to work than Northants., but it has been the target for EI9Q, GW3NNF (Anglesey) and GC8AWE (Alderney) with G8CIW on the other end to give some nice GDX.

G4AAH, *ex*-G8BBY, and still of Watford Gap, is working the London stations with his one watt of SSB on Two and a dipole on the shack while he is waiting to move to the new QTH. The 100ft. tower, a landmark for many users of the M.1, is already down. For those who want Somerset on 2m., a newcomer to the band is Glyn Dodwell, G8FHU, who runs 15 watts to a 10-ele. Yagi at 25ft. from 28, Summleaze Park, Yeovil, and who would be pleased to arrange skeds on receipt of s.a.e.

Another 2m. father-and-son combination for the records: G3BWC and son John, now G8GAM, are both active.

G3LQR in Suffolk runs a nightly sked with DK1KO on 144.056 MHz. The DK is looking particularly for GC and GI. If you want Suffolk on 23 cm, Simon now has a 5ft. dish and a Versa-tower. Still on 23 cm.—have you

heard the new beacon yet? Location S.E. London, callsign GB3LDN, reputed frequency 1297.90 MHz (as near as can be measured). Reception has already been reported from as far afield as Abbots Langley, Herts. (G3GDR) and Cambridge (G3SXX).

Peter Lennard, G3VPS, must surely have set up some new record with his 2,000 mobile QSO's on Four. He has now worked 246 different stations since August 1968. The equipment is the B.44 Mk. II running 10 watts to a quarter wave whip in the centre of the van roof. He plans to operate from a different county once a month for the rest of the warmer weather, starting with Worcestershire or Warwickshire on Sunday, May 28, 70.28 MHz with 70.26 and 70.375 MHz also carried. Times, hopefully, from about 1100 hrs. on, but later if the journey from the salt mines takes very long! G3SJV of Eastbourne, has at last found an SP to listen on four metres for U.K. stations—this is SP9VU, and he will confirm reception of 70.26 MHz transmissions by QSL. This arrangement will continue during the months when Sporadic-E propagation is most likely.

Why is it that so many G8/3's whose calls are not yet listed in the latest *Callbook* are so shy about giving their locations over the air? Here's a weakish signal, down in the noise—you sort out your call and the G8 bit—but he doesn't use phonetics and he doesn't say where he is—you daren't move the beam to improve copy in case you lose him altogether.

The next moan comes not from, but is directed to, your scribe, who has been attacked from several quarters for saying that if you want to check on the possible advent of an aurora on two metres, turn the beam to the North and see if the note from Wrotham sounds rough, or has a "burble" on it. It has been pointed out that the Wrotham beacon *always* has a burble on it, all the time! But let's be fair—the 50-cycle ripple, which has been there for months now, is only on the space—the mark at least is OK!

The Swiss beacon, HB9HB, continues to be received over most of the South of the country—details as on p.170 last month.

The Swedish beacon, SK1VHF,

on 145.957 MHz will QSL reception reports. The Tx is now radiating 40 watts to a halo at 180ft. a.s.l. The QRA Locator is IR41d.

News from Abroad

A one-way contact was made on New Year's Eve, 1971 between a local SWL and F8DO over a distance of 50 metres. So what? Well, the frequency was 454,000 GHz, and the Tx a diode laser modulated A3 by a carbon microphone—that's what!

DL9AR made it on 70 cm. with UR2HD on October 29, 1971 and QSL cards have been exchanged and received to prove it.

SM4CMG in HT48c heard G3LTF on 70 cm. on the same date, but no two-way contact resulted.

The following Dutch callsigns are to be heard on 23 cm.: PA0DBQ, BLB, VW, KNV, KO, HCZ, AER, GUS and WTE—all in addition to those already reported.

Class "B" licensees in France are now being issued with callsigns starting with F1C—, for example, F1CCP was worked recently. (G8GAM has now been issued in this country.)

Late Flash—Balloon Test

Just as this was going down, we had news of a balloon-transponder flight from near Angers—about 170 miles S/W of Paris and 230 miles or so from our South Coast—scheduled for 0900z on Sunday, May 28, to reach a maximum expected height of 20 km. (about 12 miles).

Called *Anjou*, the transponder will receive on 432.5 MHz and re-transmit on 145.7 MHz, both \pm 100 kHz, with an output power of 1-watt p.e.p. and Rx sensitivity of 0.4 μ V for a S/N ratio of 6 dB in 200 kHz. The Rx will accept AM/CW/FM/SSB. Additionally, a beacon signing *Anjou 1* on CW will radiate con-

tinuously on 145.90 MHz, and the same on 1297 MHz.

If you can hear the beacon(s), it will be worth trying transmission on 432.5. It is specially requested that power be kept to within 20 watts when beam gain is around 18 dB, else the receiver will saturate—it should otherwise accept 50-60 QSO's at once. It will anyway "fail dead" if over-driven.

The listen-band will be 145.6-145.8 MHz (over which many CQ's should be heard if everything works!) and if you should be able to call on 432.5 MHz, and get an answer, keep the QSO *short*, giving just callsign, RS(T) and location.

On the morning of May 28, F3UB in the 7 MHz band and F1HC on 144.20 MHz will broadcast launch news from 0800 till 0845z, and at 0850z will start a count-down to the *Go* at 0900.

Naturally, the Wx will be a prime factor in this project—deciding not only whether a launch is possible at all but also the direction of drift (which, in the nature of things, should be roughly S/W to N/E, bringing the balloon into U.K. range).

Reports will, of course, be much appreciated, both to us at "VHF Bands" and by *Radio REF*, 60 Bd. de Bercy 75, Paris 12e, France.

While it is most unfortunate that we did not get much earlier notice of this interesting experiment, obviously it is very well organised otherwise, and we hope that some G's at least will be able to take part if *Anjou* from Angers does fly.

Deadline

Deadline for the next issue is **June 10**. The address for news, views, claims and comment remains: "VHF Bands," SHORT WAVE MAGAZINE, BUCKINGHAM. Cheers for now and *vy 73 de G3DAH*.

NORTH-WEST AMATEUR RADIO CONVENTION

We are informed that a weekend residential meeting is to be held over September 23-24 at Lancaster University—"to provide an opportunity for radio amateurs to meet to discuss their common interests and problems". The all-in cost for the full weekend is £5 per head, accommodation to be in comfortable study-bedrooms and wives welcome. A full programme has been arranged and there are lesser charges for events on a per-day basis. Full details can be obtained from: Convention Secretary, Lancaster University Radio Society, Dept. of Environmental Sciences, The University, Lancaster. As the closing date for reservations is June 12, there is not much time in hand for the booking procedure.

THE MONTH WITH THE CLUBS

By "Club Secretary"

(Deadline for July issue: June 9)

(Please address all reports for this feature to "Club Secretary," SHORT WAVE MAGAZINE, Buckingham.)

PERHAPS the most important matter for consideration in the preamble this time is the fact that *every* month there are *some* news-letters or reports for this column directed to 55 Victoria Street by secretaries or p.r.o.'s—and that similarly there are always some that arrive after the piece has been completed!

All this makes things more difficult all round, and adds unnecessarily to the work load. Furthermore, while it is true to say we never omit a Club report unless we have to, it is also a fact that by the time a letter has been delayed a month by missing the deadline, much of what it contains is "history" and of no use to a reader scanning the reports to see what is going to be happening for the current month.

While on this subject, we could add to our crime-sheet the p.r.o. whose letter bears inside a dateline and some "urgent" Club information he wants us to include—but the postmark is a week or ten days later than the date on the letter!

All these being mentioned, we must now suggest how things *should* be done. Your letter or news-sheet, to be of use, should indicate very clearly the name of the club and the Hq. address. It must contain the essential set of dates, which can if preferred be mentioned as "the third Monday in the month" if this is now the date is arrived at. It must contain the hon. sec's name and address, also his phone number if he has one; it must give the dates for the month after the issue comes out, that is, for example, a secretary receiving this issue on his mat will read of the June doings of other Clubs, and instantly pick up his pen to write to us at *Buckingham*—never *Victoria Street*—with all his July items. This will be picked up by your conductor, produced as copy, and turned by the Editor into printed leaves for the July issue, ready for readers to pick up and scan for the current news. And if you have a change of address or some such to advise, for Pete's sake make sure we spot it by making it clear on your letter or News-sheet. "Club Secretary" will then indeed be a happy man, since he will be able to spare time to go on the air himself!

The Swindon Project

On p.110 of the April issue, the current Swindon Project was mentioned. This, we are informed, resulted in "an avalanche of enquiries," including invitations to visit Clubs in Scotland! It has not been possible to deal with all requests to Swindon, especially as it should have been mentioned (a fact of which we were not made aware)

that for the data offered a fee of 30p was needed with the enquiry.

G8AVG of the Swindon Club offers his apologies to those affected by the misunderstanding and informs us that a new supply of two-metre transceiver booklets (30p with enquiries) and kits of parts have been arranged for, with additional help from Club members, so it is hoped to be able henceforth to deal with all orders for the booklet (in which details regarding the kit of parts are given).

Other projects available from this enterprising group include a VHF/SWR monitor and a booklet and P.C. boards (only) for a Top Band transceiver.

The address is G. Fitton, G8AVG, Swindon & District Amateur Radio Club, 29 Okus Grove, Upper Stratton, Swindon, Wilts., SN2 6QA. He stresses that these Projects are essentially Club efforts and have been enormously successful in holding the interest of members.

The Mail

Taken as they fall this month, if only for the reason that your scribe wants to bring together seven widely separated groups having but one thing in common—this being that they all have one or more YL members serving actively on the committee. Bearing in mind the relatively small number of YL's interested in Amateur Radio, this indicates a willingness to help in the running of their Club which puts most of us to shame—a lot of members would resign rather than serve on the committee!

Since the recent AGM, *Burnham Beeches* have a new committee, says G8ENX. She goes on to mention meetings on June 1 and 15, at Hedgerley Scout Hut, starting at 8.0 p.m., the latter session being the club Annual Junk Sale. They have a good programme of talks and such lined up for the first and third Thursdays of each month for the coming year, and visitors are always welcomed.

At *Hereford* things are improving, thanks to the memberships campaign, whereby members recruit actively for new people; there are now 33 members on the books. For June, there are the meetings on 2nd and 16th, and, of course, the station at the Hereford Cider Festival, where they are to sign GB3HCF on Sunday June 4, the rig being located at the Racecourse.

Every Friday, 592 Hessele Road is the focus of Amateur Radio interest in *Hull*. As for the reasons, here are a few: June 2, G3SSA on "Hints, Kinks, and Gadgets for the Shack;" June 9, G3NVE on "Seventy-

cems"; G3RDM discusses Taping in the Amateur Radio context on June 23; while on 30th the month is rounded off by G3LIQ and his Quad Aerials.

Steadily rising membership to a current figure of sixty, no less, must mean **Torbay** have something to attract and hold just about all the local amateurs. The special date for June is the 24th, when Mr. A. Heather will present some tapes of "Hams;" one wonders whether some mysterious significance lies beneath those inverted commas! During the summer months, we gather also, the Hq. will be open on Friday evenings.

An innovation which must be to the good is noted in the **RAIBC** newsletter, *Radial*. This is that they have been invited to be present at some of the Mobile Rallies and Conventions during the year, where space and cover have been set aside for the purpose. This is a generous gesture. For most **RAIBC** members a trip out at all is a red-letter day, and to combine this with personal contact with "the staff" of the Club will make it a lasting memory.

The **Dartford Heath D/F Club Hq.** is in Broomhill Road, Dartford. However, summer is the time for hunting rather than nattering, and many of the Club's "evening hunts" are held at short notice, the routine being to have a net on 1930 kHz at 1100 clock to confirm the details if there is to be a hunt that week. Another way of obtaining the latest information would be to get in touch with G3XVC at the address in the Panel on p.240.

We nearly missed the seventh YL in our mail—she is hon. secretary of the **Nunsfield House** group in Derby, a happy crew who are to be found in Boulton Lane, Alvaston each Friday evening, looking forward to the talk or films or whatever being provided for their entertainment.

* * *

Medical Electronics is a large subject these days, so there should be plenty of meat in the talk at **Crystal Palace** on June 17, at Emmanuel Church Hall, Barry Road, S.E.22.

June is an important month for the **Southdown** chaps, as June 5 is their Annual General Meeting. The normal form here is to hold a meeting on the first Monday in each month, at the Victoria Hotel, Latimer Road, Eastbourne, starting at 8.0 p.m. One notices also the July meeting, which is to be an outdoor event, and the Rally at the Polegate Steam Engine Rally site on July 22. They must have faith in weather forecasts!

At **Bishops Stortford** they are booked in at the British Legion Club on the third Monday in each month; June is down for G3VVS to finish off the talk on Oscilloscopes which was interrupted by a power-cut some months ago.

A rather nice thought has occurred to the group at **Southampton University**. They want to compile a list of ex-members, so that they can circulate them with regard to the possibility of running skeds and may be even a reunion. To that end, all the old guard of G3KMI should drop a line to: The Radio Club, Southampton University Students' Union, Highfield, Southampton SO9-5NH.

Over to **Verulam** who are having their Mobile Rally event on June 17, at Salisbury Hall, London Colney. This venue has interests for other hobbies as well as radio—there is the aircraft museum, with the first



At GC Hq. (Cheltenham) open night on April 28, for which they had an attendance of about 140 for a most interesting evening—here we see Maurice Mason, G6VX, chairman of the Club, welcoming the visitors, with the hon. secretary, G8PEO.

Mosquito (which was developed here during the War) and in the days before that it was the home of that Sir Nigel Gresley whose engines were a byword of perfection on steam railways; there is even a ghost!

Perhaps even more important in our context, the June main meeting is put back to the 20th, and on this date G3XEG will demonstrate and describe his home-built SSB rig which is a "breadboard" in more ways than one, under the title "Every Shack should have One!"

A new Club formation makes its debut—this is **Solway**, who are to be found at the Educational Settlement in Maryport every Thursday evening. The accommodation is enough to make other Clubs green with envy—they have a shack, a room for a workshop, and two others for lecture purposes! We wish them every success in their efforts.

June 13 is a special day for the **Bury and Rossendale** chaps, as on this date they welcome Mr. Lascelles (G3AKX) of Jodrell Bank as the speaker, and his talk will lead naturally to more interest in the visit to the Observatory itself. Looking forward a little, it is noted that the July date, on 11th, is a surplus sale.

Acton, Brentford and Chiswick will be bringing out their Members Problems—all radio ones, we hope!—for discussion at the June 20 meeting, at the Chiswick Trades and Social Club, 66 High Road, Chiswick, W.4.

At **Otley** there is a Home-Construction Trophy to be won in October, so members are building frantically, in between Club evenings, which are every Tuesday at 14 Court House Street, Otley. A bit of a change will be offered on June 20, when, we gather, G8BZY will discuss his recent /P expedition to the Isle of Man, to operate and to watch the Races in T.T. week.

* * *

Some time ago the **Star** group in Leeds ran a Junk Sale in aid of **RAIBC** funds. That Junk Sale raised £160, we hear, and now they are making their prepara-

tions for another one, this time setting a target of no less than £250, again to go to the RAIBC funds, which moneys are used to provide communication gear for their blind or disabled members. If you have some gear you can spare, phone G8DPG at Leeds 656269—he runs the collection service—or write to G8BUU, as Panel below. The date of the Sale is awaited, but will be in September. As for the normal Star meetings, they are on Wednesdays at the New Inn Hotel, Bramley Town Street, Leeds.

At York, on Thursday evenings, you head for 61 Micklegate, where lies the British Legion, it being here that the York Club members foregather.

We gather there will be alternative entertainments for the delectation of Midland members on June 20—although it is an Open Night, some chaps are bringing along some bits of gear to show off and explain to those interested, while the others will start rag-chewing and slowly QSY down to the Bar! The Hq. is at the Midland Institute in Margaret Street, Birmingham 3.

The formal session of the Cray Valley crowd should be of interest to many, as it is entitled "VFO's for VHF" and will be given by I. R. Lever, G8CPJ. This is on

June 1, and the Natter on June 15—both at the Congregational Church Hall, Court Road, Eltham, London, S.E.9.

An idea worth considering appears in the Thornton Cleveleys letter. Apart from their regular first and third Wednesdays at the St. John Ambulance Brigade Hq. in Fleetwood Road North (behind the Police Station) there is also a limited-number facility for a group to do some construction in the Project Laboratory of Rossall School. To revert to the main meetings, one notes June 7 as a Ragchew and Questions session, while on the 21st, G3GED will be talking about Transistors and Things.

The weekly meetings of the Shefford group are in the Church Hall, Ampthill Road, Shefford. Here on June 1, they will be making the final preparations for NFD, but on June 8, they have a rare treat, as Frank Voyner will be talking about Satellite Antennae. June 15 is divided between a Junk Sale and the inquest on What went Wrong on NFD, while June 22 is devoted to such things as Workshop Techniques.

The Chiltern club, of late, has surely done much to increase its membership, what between the G6CJ Aerial Circus and the Hewlett-Packard talk, when members were

Names and Addresses of Club Secretaries Reporting in this issue:

ACTON, BRENTFORD & CHISWICK: W. G. Dyer, G3GEH, 188 Gunnersbury Avenue, Acton, London, W.3.
 BASINGSTOKE: P. Sterry, G3CBU, Ashley, Orchard Road, Salisbury Gardens, Basingstoke.
 BEDFORD: J. Bennett, G3FWA, 47 Ibbett Close, Kempston (2427), Bedford.
 BICESTER: D. E. Williams, 2 Poundon, Bicester, Oxon. (Stratton Audley 475.)
 BISHOPS STORTFORD: E. P. Essery, G3KFE, 17 Ascot Close, Parsonage Lane, Bishops Stortford (2501), Herts.
 BRADFORD: R. Harker, 65 Whitby Road, Bradford, BD8-9JN.
 BRISTOL (Shirehampton): E. J. Davis, G3SXY, 72 North View, Westbury Park, Bristol (33284), BS6-7PZ.
 BURNHAM BEECHES: Miss N. Appleby, G8ENX, 42 Sutton Drive, Slough, Bucks.
 BURY & ROSSENDALE: F. S. Burnett, G3RSM, 13 Rhiwlas Drive, Bury, Lancs. (061-764 7554.)
 CHELTENHAM (Group): E. Janes, G2FWA, Hillside, Bushcombe Lane, Woodmancote, Cheltenham, Glos. (Bishops Cleve 2229.)
 CHILTERN: Club Sec., Loakes House, Loakes Park, High Wycombe, Bucks. (High Wycombe 21612.)
 CORNISH: J. Farrar, G3UCQ, Elm Cottage, Ventonleague, Hayle, Cornwall.
 COVENTRY: C. Jaynes, 20 Belgrave Road, Wyken, Coventry.
 CRAY VALLEY: P. F. Vella, G3WVP, 78 Hurst Road, Sidcup, Kent.
 CRYSTAL PALACE: G. M. C. Stone, G3FZL, 11 Liphook Crescent, London, SE23-3BN. (01-699 6940.)
 DARTFORD HEATH: Mrs. M. Worbey, G3XVC, 13 Havelock Road, Dartford (22889), Kent.
 DUNSTABLE DOWNS: C. G. Powell, G8BPK, 1 Wenwell Close, Buckland Wharf, Aston Clinton (600), Aylesbury, Bucks.
 EDGWARE: A. J. Masson, G3PSP, 62 Coldharbour Lane, Bushley, Herts., WD2-3NY. (01-950 6827.)
 FURNESS: B. Bull, G4AGB, 2 Maylands Grove, Barrow-in-Furness, Lancs.
 HEREFORD: S. Jesson, 181 Kings Acre Road, Hereford (3237).
 HORSHAM: R. J. Polley, G3PYC, 81 Beech Road, Horsham, Sussex.
 HULL: Mrs. M. Longson, 4 Chester Road, Wold Road, Hull.
 LOUGHBOROUGH: M. Roberts, G8FER, OTH wanted.
 MANCHESTER (University): R. Mortimer, G3ZNS, University Union, Oxford Road, Manchester 13.
 MIDLAND: N. Gutteridge, G8BHE, 68 Max Road, Quinton, Birmingham 32. (021-422 9787.)
 NEWARK: D. Rowan, G8CUO, 13 Fleming Drive, Newark, Notts.
 NORTHERN HEIGHTS: A. Robinson, G3MDW, Candy Cabin, Ogden, Halifax (44329), Yorkshire.

NORTH KENT: M. Lee, G4BAL, 46 Harman Drive, Sidcup, Kent.
 NOTTINGHAM: S. F. Claringburn, 49 Westdale Avenue, Westdale Lane, Nottingham, NG3-6FN.
 OTLEY: H. S. Johnstone, 12 Rumble Croft, Newall Carr, Otley, Yorkshire.
 PEMBROKE: J. Hogg, GW4AKO, 2 Pembroke Road, Pembroke Dock, Pems., West Wales.
 R.A.I.B.C.: Mrs. F. Woolley, G3LWY, Woodclose, Penselwood, Wincanton, Somerset.
 REIGATE: D. Thom, G3NKS, La Collinette, 6 Bracken Close, Cophorne (2165), Crawley, RH10-3QE, Sussex.
 SALTASH: I. Aldridge, G4AJU, 302 St. Peters Road, Manadon, Plymouth, PL5-3DU, Devon.
 SHEFFORD: A. Sullivan, G2DGF, 12 Glebe Road, Letchworth.
 SLADE: J. E. Drakeley, 186 Conway Road, Chelmsley Wood, Birmingham, 37.
 SOLIHULL: A. W. Bagley, G3XPY, 266 Warwick Road, Olton, Solihull. (021-706 3683.)
 SOLWAY: F. Chidlow, G3WCM, 64 Mitchell Avenue, Northside, Workington, Cumberland.
 SOUTHAMPTON (University): D. R. Powell, G3ZXX, c/o J.C.R., The University, Southampton.
 SOUTHDOWN: A. Seabrook, G3ZQB, 6 Harebeating Gardens, Hailsham, Sussex.
 SOUTHGATE: J. Baichlor, G3XMV, 22 Faversham Avenue, Bush Hill Park, Enfield (01-360 6537), Middlesex.
 STAR: T. Leeman, G8BUU, 115 Asket Drive, Leeds, LS14-1HX.
 STOURBRIDGE: B. Powell, 17 Mill Road, Cradley Heath, Warley, Worcs.
 SURREY: S. A. Morley, G3FWR, 22 Old Farleigh Road, Selsdon, South Croydon, CR2-8PB. (01-657 3258.)
 THORNTON CLEVELEYS: R. Bellerby, G3ZYE, 4 The Cop, Fleetwood, Lancs. (Cleveleys 6826.)
 TORBAY: Mrs. G. Western, G3NQD, 10 Truro Avenue, Hele, Torquay.
 TYNESIDE: W. G. C. Austin, 33 Slingsby Gardens, Cochrane Park, Newcastle-on-Tyne (665834), NE7-7RX.
 VERULAM: H. Young, G3YHY, 93 Leaford Crescent, Watford, Herts., WD2-5JQ.
 WESSEX: A. G. Emery, G3YWG, 7 Brunel Drive, Preston (3177), Weymouth, Dorset.
 WEST OF SCOTLAND: V. T. Budas, GM3VTB, 28 Kelvininside Gardens, Glasgow, G20-6BB.
 WOLVERHAMPTON: J. P. H. Burden, G3UBX, 28 Coalway Road, Wolverhampton, WV3-7LX.
 YEOVIL: D. L. McLean, G3NOF, 9 Cedar Grove, Yeovil.
 YORK: J. A. Rainbow, G8BOK, 14 Temple Road, Bishopthorpe, York, YO2-1QN.

At the recent Northern Heights junk sale—left to right: G3MDW (their secretary for many years), G8CB and G8BML. It looks pretty good "junk" to us!



privileged to look inside one of those delightful 500 MHz counters, both the plug-in and the mainframe, not to mention trying some bits and pieces against the Hewlett-Packard Spectrum Analyser—a bit of gear which would give the average VHF operator heart-failure if he looked at his signal on one! However, for June, after NFD and their Mobile Rally, they relax, by way of a Natter Nite on June 13; on June 28 there will be a lecture (topic to be announced). Hq. is at the Ernest Turner factory, Totteridge Avenue, High Wycombe.

We have a problem where **Cornish** are concerned, as on our copy of their *Link* the ink ran short in the area of "Coming Events." This being so, we can tell you they have a monthly main meeting at Camborne, a regular Newquay group, and other activities—contact with G3UCQ, as Panel, will remedy the deficiency.

The hon. secretary of **Bedford** writes his usual cheerful letter, and this time says "we signed up some new members again, which can't be bad!" For June 1 at the Dolphin, Broadway, they have a report on the Ailsa Craig DX-pedition, and on the 8th a review of technical books; Ray Hounslow takes the limelight on June 15, to talk about the Radio Monitoring Service, and on the 22nd there will be instruction in the gentle art of chassis-bashing. Finally, on 29th, there is a talk on Planning for the SBB Field Day.

An interesting topic appears on June 20 for the **Solihull** chaps, at their Manor House Hq. in the High Street, when Mr. J. B. Moseley will try to answer the question "Why Educational Television?" As for the informal, the Malt Shovel in High Street, 9.0 p.m. on June 6, will be right in the target area.

Although the **Yeovil** crowd can be found on any, Thursday evening at the Youth Centre, 31 Park Lodge, they have high-lights on June 1, when they have the G3IOR tape lecture on DX-working and the Operator, not to mention July 6 when they are setting up a station at Stanchester School, Stoke-sub-Hamdon, to demonstrate Amateur Radio to a Leisure Convention.

A note from G3SXY informs us that the **Shirehampton** (Bristol) group is still in existence, foregathering on Friday evenings at the Hq. in Twyford House, at least during June and the early part of July, when nominally

they close for summer holidays but are meditating a summer outdoor events programme.

Now to **Slade**, at the Church House, High Street, Erdington, Birmingham, where they get together on the alternate Fridays. June 2 is down for the secretary to do an extra stint, by way of a talk on the Construction of Aerials, followed on June 16 by Charles Smart, looking at the Theoretical Design for a D/F Receiver, and on June 30 by Bert Simmonds, whose subject is SSB.

A new hon. sec. takes over at **Bicester** as a result of the recent A.G.M. They meet on Friday evenings, in the large shack at the rear of 11 Stoneburg Crescent—further details from the secretary at the address in the Panel (saving that he hopes no-one will call on Thursday evenings, because he goes to Morse classes at Princes Risborough that night).

Another field event is brought to our notice, this being the **Furness** club one, over the weekend June 17-18, from WAB area SD-27. As for the normal club gatherings, these are held at the Cavendish Arms, Dalton, where everyone is welcome.

The **University of Manchester** have a very active club, who are going to be out-and-about in GM-land at the end of June and early July; the detailed itinerary appears in "another place" and it remains for us to say that all the details of the Club meetings and activities can be obtained from G3ZNS at the address in the Secretaries' Panel, opposite.

Southgate must be one of the easiest clubs for a visitor to find—you just take the Tube to Arnos Grove, and as you come out of the station the Civil Defence Hut is on the opposite side of the road. The date is June 8, and the programme a demonstration of Amateur Television by the Dunstable Downs chaps, to include a video link between the Club Hq. and Alexandra Palace, with closed-circuit gear also working.

The hon. sec. at **Coventry** has given us the dates, but he simply says "at the usual place," which means nothing to us! However, all is not lost, as his QTH appears in its due place in the Panel. It remains for us to say that on June 2, they will be preparing for NFD (the site for which will be the Royal Agricultural Show-

SHORT CLUB NOTICES

CLUB NAME	HEADQUARTERS LOCATION	MEETING DAY MONTHLY
Basingstoke	Chineham House, Popley	June 3, 17
Bradford	10 Southbrook Terrace, Bradford 7	June 6, 20
Cheltenham (Group)	Royal Crescent, Clarence Street	June 1
Dunstable Downs	77 High Street South, Dunstable	Fridays
Edgware	51 Flower Lane, Mill Hill, N.W.7	June 12, 26
Horsham	Guide Hq., Denne Road	June 6
Loughborough	Beach Yard, Wards End	Fridays 8 p.m.
Newark	Newark Tech. College	June 1
North Kent	Congregational Church Hall, Chapel Road, Bexleyheath	June 8, 22
Nottingham	Sherwood Comm. Centre	Thursdays
Pembroke	Regency Hall, Saundersfoot	June 25
Reigate	Nutley Hall, Nutley Lane "Marquis of Granby," Redhill	June 7 June 21
Saltash	Burraton Toe H, Warraton Road	June 2, 16
Tyneside	Community Centre, Vine Street, Wallsend	Mondays
Wolverhampton	Neachells Cottage, Stockwell Road, Tettenhall	Mondays

ground, Stoneleigh), followed by a Night on the Air on June 9. On June 16, the lads will be out at Fen End, operating /A, followed by an adjournment to the Tipperary Inn—yes, this *is* the place where the song was written! Then there is another Night on the Air on June 23, and an Open Evening on the 30th to round off.

At **Wessex**, a familiar letterhead re-appears, as a past hon. secretary resumes his seat after a two-year break. Otherwise, though, all is the same—the first Friday of each month, and the Monday 17 days later, at the Cricketers Arms, Windham Road, Bournemouth. And, for the benefit of the juniors and the TT's, the club-room is *not* actually in the pub, so no problems apply.

A nice long letter from the secretary for **Surrey** tells us that G8TB has been hoisted back into the chair, and other changes made on the committee, but the hon. sec. himself has to soldier on for another year. Because of the recent A.G.M., details for the June meetings are not yet available, and so we refer you to the Panel.

And talking of "soldiering on" we notice that the hon. sec. of **Northern Heights** has taken on another year of work, despite his protestations—and so it has been in every year since your conductor started writing the piece. Arthur tells us that on June 7, they are going to visit the Baird TV works at Shipley; on June 24 there is a ragchew; and July 5 sees them all off to Halifax Police station for a look round.

The hon. secretary for **West of Scotland**, in a letter dated May 5, lists a series of meetings for *April!* We dare

not assume that he means June but anyway they are weekly and GM3VTB will no doubt be glad to supply the current details.

Stourbridge have an interesting trip planned for Sunday, July 9—on the Welshpool & Llanfair Light Railway. They hope to obtain a GB/M call sign for the occasion.

Deadline

Some final dates for copy for this feature were given at foot p.178, May. From this, we see that for next time the date is **June 9**, addressed: "Club Secretary", SHORT WAVE MAGAZINE, BUCKINGHAM.

SWL Martin East, 41 Avenue Close, Avenue Road, London, N.W.8 (01-722 7040) has copies of the *Magazine* for the period August 68 to December 69. He would be glad to dispose of these as one lot to any Club interested, free for collection, or price of postage.

VISITING EAST ANGLIA

A LARGE proportion of the holiday-makers at large at some time find themselves in the East Anglia region, either on the Norfolk Broads enjoying the "sailor's life", or seeking their pleasures by the sea itself. Radio amateurs (SWL's included) and their families are no exception. In 1970 the Lowestoft Amateur Radio Club began to encourage these visitors to the area to make known their presence, or intended presence. This often occurring as a result of a contact on the air.

The first year saw some 17 visitors to the club, many of them bringing their families along, for an enjoyable evening with "the locals".

The Lowestoft Club members themselves, numbering some two dozen, most of whom are licensed (or on the way to it!), have shown great enthusiasm for the scheme, and as soon as the "grape vine" whispers of the presence of a legitimate target, receivers are continually monitoring Top and Two, and innumerable CQ's fill the air. The one aim is the carrying off of the visitor to the Clubroom. At the same time, if the intruder is travelling /M and his car is sporting a whip or a halo, he must expect to be hailed at any time, flashing headlights, or a CQ on the horn!

So, flushed with the success of the first year, renewed efforts took place in 1971. This had the reward of catching no less than 31 visitors, mostly licensed and of both sexes, from all corners of the U.K., plus DL and LA. A PA and a W slipped through the net and others, including two HB's, were met on the air when not able to arrange their timetable to include a visit to the Club. Several of the 1971 visitors were making their second appearance, having once found what the reception was like, and these also remarked with enthusiasm on the improved set-up now at the new headquarters. From these visits, friendships have been struck, and in some cases regular skeds on the air arranged.

Any information or arranging of skeds, available from G3XSK, QTHR, or any Lowestoft Club member on the air. Come one, come all! We *know* there were over 50 visitors to the area last summer. There will be again this year. So let's make it a year to remember. K.D.

NEW QTH'S

This space is available for the publication of the addresses of all holders of new U.K. call signs, as issued, or changes of address of transmitters already licensed. All addresses published here will be reprinted in the U.K. section of the "RADIO AMATEUR CALL BOOK" in preparation. QTH's are inserted as they are received, up to the limit of the space allowance each month. Please write clearly and address on a separate slip to QTH Section.

G3CAR, Chiltern Amateur Radio Club, c/o S. H. Andrews, 21 St. Margarets Grove, Great Kingshill, High Wycombe, Bucks. (Tel. Holmer 5126.)

G4ARM, F. W. G. Hall (ex-G8FBS), 4 Redhill Court, Palace Road, London, SW2 3NP.

G4AXO, J. H. Wills, 48 Fairfield Road, Winchester, Hants.

G4AZA, R. F. Winkworth, 89 Upper Road, Kennington, Oxford, OX1 5LW.

G4AZY, A. C. Gent, 31 Warraton Road, Saltash, Cornwall. (Tel. Saltash 3413.)

GM4BBC, J. G. Leslie, 83 Hill Street, Glasgow C.3.

GI4BBE, R. F. Bolton, Ohmvilla, 69 Newcastle Street, Kilkeel, Co. Down. (Tel. Kilkeel 560.)

GM4BBI, A. R. Thackery (ex-G8CUW/GM8CUW), Valhalla, Westerloch, Lerwick, Shetland Isles.

G4BBM, A. W. Benn, 4 Copthorne Road, Keresley, Coventry, Warks., CV6 2EE.

G4BBO, J. R. Grice, 20 Hamblett's Road, West Bromwich, Staffs.

G4BBX, Solway Radio Club, Educational Settlement, Maryport, Cumberland.

GW4BCA, D. L. Tunnicliffe, 1 Clarence Drive, Craig-Y-Doit, Llandudno, Caerns.

G4BCW, N. P. Hammersley, 100 Lambly Lane, Burton Joyce, Nottingham.

G4BDI, E. R. Harris (ex-VE7CCD), Sundowners, Terrieve, Downderry, Torpoint, Cornwall, PL11-3LY. (Tel. Downderry 339.)

G6AHT/T, J. L. Wood (G3YQC), 54 Elkington Road, Yelvertoft, Rugby, Northants.

GW8FOL, G. Spencer, Tyn-Cae, Llanfwrog, Holyhead, Angelsey. (Tel. Llanfaethlu 474.)

G8FRQ, B. M. Allenstein, 78 Westpole Avenue, Cockfosters, Barnet, Herts. (Tel. 01-449 0914.)

G8FSG, R. W. G. Graves, 7 Breck-

lands, Mundford, Thetford, Norfolk. (Tel. Mundford 265.)

G8FTY, C. J. Gray, 173 Wiltshire Close, Chelsea, London, SW3 2NY.

G8FVK, P. V. Marks, 23 Abbotsford Gardens, Woodford Green, Essex. (Tel. 01-504 1564.)

G8FYK, K. G. Payne, 15 Brandon Road, Hinckley, Leics., LE10 0JW.

G8GBU, D. G. Barker, 92 Boulton Lane, Alvaston, Derby, DE2 0FE. (Tel. Derby 71018.)

G8BGV, I. M. Cage, 25 Petersham Drive, Alvaston, Derby, DE2 0JU. (Tel. Derby 71875.)

CHANGE OF ADDRESS

G2KQ, R. C. Cave (ex-9H1CU), 137 Caernarvon Road, Hatherley, Cheltenham, Glos.

G3AKU, R. A. Harding, Rawdon, Upper Packington Road, Ashby-de-la-Zouch, Leicester, LE6 5ED.

GD3CAE, R. E. C. Lord (ex-G3CAE), Cae Cottage, Cregneish, Port St. Mary, Isle of Man. (Tel. Port St. Mary 3211.)

G3FOP, R. G. Barrell, 21 Alva Way, Carpenders Park, Herts., WD1 5EE.

G3HXM, H. Barnes, The Grange, Spixworth Road, Norwich, Norfolk, NOR.32-0.

G3KPO, D. Byrne, Alverstone House, Quading Water Gate, Spalding, Lines.

G3MPN, D. E. Johnson, 42 Browick Road, Wymondham, Norfolk. (Tel. Wymondham 3382.)

G3PTZ, A. Bensley, 7 Keeble Drive, Washingborough, Lincoln.

GW3RGE, K. G. King (ex-G3RGE), Boathouse Inn, High Street, Connah's Quay, Deeside, Flintshire.

G3RMG, L. T. Taylor, Downalong, 13 Roseland Park, Cambridge, Cornwall.

GM3SSB, D. K. McDermott, 4 Cutsburn Place, Stewarton, Kilmarnock, Ayrshire. KA3 5PE.

G3SVK, F. L. Curtis, 5 Campus Road, London, E17 8PG. (Tel. 01-520 4792.)

G3TMB, J. M. Baker, 185 Amersham Road, High Wycombe, Bucks. (Tel. High Wycombe 26703.)

G3TZI, A. Senior, 79 Goldsmith Lane, Kingsbury, London, NW9 9AR. (Tel. 01-204 5828.)

G3USQ, R.A.F. Carlisle Amateur Radio Society, c/o G. W. Perkins, 35 Kingstown Road, Carlisle, Cumberland, CA3 0AB.

G3WKC, J. W. Birkbeck, 4 Tregullan View, Bodmin, Cornwall.

G3WYW, P. C. J. Bigwood, 48 Cherryburn Gardens, Fenham, Newcastle-on-Tyne. (Tel. Newcastle 33351.)

G3XCX, S. W. Clethro, B.Sc., Whitcoaks, 70 Priory Walk, Leicester Forest East, Leicester, LE3 3PP. (Tel. Kirby Muxloe 3850.)

G3XQD, R.A.F. Carlisle Amateur Radio Society, c/o G. W. Perkins, 35 Kingstown Road, Carlisle, Cumberland, CA3 0AB.

G4AVN, T. N. Thompson, 14 Third Row, Ellington, Morpeth, Northumberland.

G8CWZ, H. A. Kemp, c/o Officers' Mess, R.A.F. Catterick, Yorkshire.

G8DLH, A. J. Hall, 156 Shaftesbury Avenue, Cheriton, Folkestone, Kent.

G8DLH/A, A. J. Hall, 24 Lansdown Place, Cheltenham, Glos., GL50 2HX.

G8EVP, D. R. Dabinett, Forge Cottage, North Street, Drayton, Langport, Somerset.

AMENDMENT

G3JSB, S. B. Jeffrey, 5 Almsford Place, Harrogate, Yorkshire, HG2 8EH. (postal code).

G3YBY/A, I. D. McCarthy, 96 Newhaven Road, Orford, Warrington, Lancs. Please QSL via G3YBY. (appeared incorrectly as G3WKC/A in April issue).

10,000 INTEGRATED CIRCUITS SCOOP !

EXPERIMENT WITH NEW BRANDED I.C.'s, NOT SECONDS

Bargain pack containing :

- (a) **Linear Amplifier 709**
- (b) **Thyristor 100PIV, 0.3 amp.**
- (c) **18 Mixed DTL/TTL I.C.'s**

20 items, all marked, £1 a pack + 10p carr.

Data available 5p per type.

I.C. Tape Recorder Amplifier, 1 watt, with circuit, **40p** + 5p carr.**I.C. AM Radio**, 700 m/w. with circuit, **80p** + 5p carr.**I.C. Wide Band Amplifier and FM Discriminator**, with circuit, **35p** + 5p carr.**709, Op. Amplifiers** : TO-5, **15p** each ; DIL, **20p** + 5p carr.**7 Segment Plug-in Indicators** with base, 5v. 60 mA, **90p** + 5p carr.**N-Channel D.C. FET's** type 3UT40 with data, **35p** + 5p carr.**TRIAC** 450v. 5 amp. 3v. 50 mA gate, **60p** + 5p carr.**2N 3055 Transistors**, 115 watt N.P.N., **45p** + 5p carr.**7475, Quad Latch**, **40p** + 5p each.**7480, Gated Full Adder**, **50p** + 5p carr.**7491, 8 Bit Shift Register**, **40p** + 5p carr.**7492, Divide by 12 Counter**, **60p** + 5p carr.**7493, Divide by 16 Counter**, **60p** + 5p carr.**Resettable Overload Switches**. 200 mA, **10p** + 5p carr.

MEMBER OF THE AMATEUR RADIO RETAILERS ASSOCIATION

ELEY ELECTRONICS112, GROBY ROAD, GLENFIELD,
LEICESTER, LE3-8GL**BURNS ELECTRONICS****NEW MOSFET CONVERTER FS2/FS4 144/70 MHZ**

In order to improve receiver performance with today's crowded band conditions a new converter has been designed. Prime features are MOSFET RF stage. Schottky diode ring mixer and selective multiplier chain resulting in improved rejection of spurious responses and strong adjacent channel signals. Isolated supply rail, reverse polarity protection, 9-12 volt DC operation and dimensions as per FC2/FC4 series.

Price : £18.00

MULTIVERter MC3

A package of VHF/UHF converters with common IF output, for 432, 144, 70 MHz or HF bands as required. Up to three of our converters may be fitted. Basic unit is for 9-12 volt external DC supply but optional mains PSU available for internal fitting. Case style matches our popular Crystal Calibrator. Minimum of one converter fitted.

Price : Basic frame £6.50 plus "less case" cost of each converter. Mains PSU £3.00 extra

Crystal Calibrator CC-10 Mk. III	£25.60
Wavemeter TC-101	£18.30
Frequency Standard SD-11	£78.00
FET Converter FS2/FS4	£18.00
FET Converter FC2/FC4	£16.20
Low Pass Filter FL2/FL4	£6.20
Test Oscillator TO-701	£10.00
FM Detector FMD-1	£6.70
		Assembled and tested		£8.20

For further details on these equipments and our new comprehensive component catalogue send 10p or cash with order to :-

**THE COTTAGE,
35 BEULAH HILL,
LONDON, SE19 3LR**

SPECIAL OFFER OF RCA MOSFET's Type 3N 140 at 60p ea., 3 for £1.50.

RCA LOW NOISE RF AMPLIFIERS 700 MHz type 2N 5181 at 15p ea.

TESTED UNMARKED 2N 3055 POWER TRANSISTORS, 30p ea., 4 for £1.

TESTED UNMARKED 2N 3054 POWER TRANSISTORS at 20p ea., 3 for 50p

PLASTIC 40 watt TO 66 NPN POWER TRANSISTORS 25 volt, 20p ea., 3 for 50p

RCA HIGH VOLTAGE POWER TRANSISTOR type 40546 at 20p ea. RCA 1 watt TO 5 TRANSISTOR PNP type 40319 at 10p ea.

TRANSISTOR PACKAGE 14 Pin Dual in Line similar to RCA CA 3045 containing Three Isolated Transistors and one Differentially connected Transistor Pair untested at 5 for 50p.

2 GHZ DUAL TRANSISTORS untested in 8 Lead TO 5 Can., 4 for £1. 300 MHz Divide by Two Counters with Data, 60p ea.

Sub-Min. Solid Tantalum Condensers Suf 25v.w., 47uf 6v.w. Either type 5p ea., 6 for 25p

4.7pf or 200pf LEADLESS DISCS at 15p doz.

ARDENTE SUB-MINIATURE 2 pole 5 way 2 bank at 22p ea.

200 Assorted Transistors, S.C.R's Triacs, etc., untested at 60p.

2K MULTI-TURN TRIM POTS 10p ea., 7 for 50p.

MINIATURE ENCAPSULATED TWO POLE MAKE REED SWITCH with 12 to 18 volt coil. Price 15p.

MINIATURE ENCAPSULATED TWO POLE MAKE REED SWITCH with Dual Coils from 5 to 24 volts at 20p.

3 x 200 P.I.V. 12 amp. SILICON DIODES ON FINNED HEAT SINK at 50p.

OC 36 TRANSISTOR ON FINNED HEAT SINK at 50p.

2N 3055 TRANSISTOR ON FINNED HEAT SINK at 50p.

GENERAL PURPOSE MOSFET with application data at 10p.

BRANDED WIDE BAND RADAR I.F. AMPLIFIERS 10 to 100 MHz with data at 20p.

X BAND GUNN DIODES at £1.50 ea.

TUNING CONDENSERS WITH S.M. DRIVE. 325 + 375 + 20 + 20pf at 18p. 15 + 15 + 15 + 20pf at 30p. 300 + 100pf at 20p.

TUNING CONDENSERS WITH DIRECT DRIVE. 6pf at 10p. 10 + 10pf at 25p. 125 + 125pf at 15p. 250 + 250pf at 15p. 500 + 500pf at 25p.

MOS MULTIPLEXERS 8 Differential Channels with Sequential Access untested in 40 Lead Flat Pack, 3 for £1.

Solder-in Feed Thro's 500 v.w. 2pf, 10pf, 15pf, 18pf, 22pf, 30pf, 1000pf. All at 15p doz.

MULLARD BFV 10 VHF FET at 25p ea., 5 for £1.

BRANDED UA 709 Op-Amps at 20p ea.

J. BIRKETT

Radio Component Suppliers,
25 THE STRAIT, LINCOLN.
Telephone: 20767

Samson's Latest Models !● **ETM-2b Keyer**● **ETM-3b Squeeze - Keyer**

both with watchmaker-assembled keying movement, silent reed relay, speed control, sidetone.

ETM-2b—Successor to the well-known ETM-2, used by coast stations and big ships the world over. ● Glass-fibre printed circuit, 11 transistors, 6 diodes. ● Ratio control. ● Mercury or penlite battery supply. £22.45 (£23.80 with mercury batteries).

ETM-3b—In its latest form it now has 4 IC's, 9 transistors, 3 diodes. ● Use either as foolproof iambic-mode squeeze-keyer (characters made with fewer paddle movements—cuts effort) or as a normal twin-paddle electronic keyer. ● Constant 3 : 1 dash-dot ratio. ● AC power supply, 110/240V. £25.95.

ALSO: ETM-2bS and ETM-3bS (change-over relays) and ETM-2Z and ETM-3Z (heavy-duty relays). SAMSON STA Speaker/Amplifier for all ETM Keyers. £2.75.

JUNKER precision hand key, £8.95. **RTTY CONVERTER-KEYER** Model TTU, £115. 88mH **TOROIDS**, 75p/pair. **PRINTSET** Basi-kits. **SSB 90° AUDIO** Phase Shift Networks.

All goods post-paid UK. Send stamp for Catalogue SP5.

PLEASE NOTE OUR NEW ADDRESS:

SPACEMARK LTD.
THORNFIELD HOUSE, DELAMER ROAD,
ALTRINCHAM, CHESHIRE.
(Tel.: 061-928 8458)

CALL BOOKS

**INTERNATIONAL:
RADIO AMATEUR CALL BOOK**

"DX Listings" £3-10

"U.S. Listings" £4-10

The two together, covering the World £6-80

"G's" only 1972 60p

MAPS

AMATEUR RADIO MAP OF WORLD
Mercator Projection — Much DX Information — in colour. Second Edition 65p

DX ZONE MAP (GREAT CIRCLE)
In colour with Country/Prefix Supplement Revised to Dec. 1970 85p

RADIO AMATEUR MAP OF THE U.S.A. AND NORTH AMERICA
State boundaries and prefixes, size 24" by 30", paper 60p

RADIO AMATEUR'S WORLD ATLAS
In booklet form, Mercator projection, for desk use. Gives Zones and Prefixes 85p

LOG BOOKS

Standard Log (New Glossy Cover) 55p

Log and VHF Contest Log 40p

Receiving Station Log 45p

(The above prices include postage and packing).

MORSE COURSES

G3HSC Rhythm Method of Morse Tuition

*Complete Course with three 3 speed L.P. records with books £4-50

*Beginner's Course with two 3 speed L.P. records with book £3-30

Single 12" L.P. Beginner's with book £2-75

Single, 12" L.P. Advanced with book £2-75

Three speed simulated GPO test. 7" d.s. E.P. record 85p

Prices include postage, packing and insurance in U.K. only *Overseas orders + £1-00.

Available from

SHORT WAVE MAGAZINE

Publications Dept., 55 Victoria Street, London, SW1H 0HF 01-222 5341

(Counter Service, 9.30-5.15, Mon. to Fri.)

(Nearest Station: St. James's Park)

(GIRO A/C No. 547 6151)

SCA DERWENT RADIO SCA

63982 SHOWROOM, 5 COLUMBUS RAVINE, SCARBOROUGH 65996

KW Atlanta VFO £32-00	Trio SP5D speaker £4-00
Wightraps, pair £2-50	G Whip 160/80 £9-00
Wightraps hi power £3-50	G Whip Tribander £9-00
Hallcrafters SX 133 £145-00	G Whip basemount £1-50
Yaesu FT101 £240-00	Unica UR-1A rx. £25-00
Yaesu FT401 £215-00	Halsion mobile whip £7-50
Yaesu FL400 £140-00	Unica INR 30 rx. £14-75
Yaesu FR400dx £120-00	TE15 GDO £12-50
Yaesu FR400S £160-00	Halsion extra coils £4-40
Yaesu FT200 and p.s.u. £172-00	250 ohm carbon pot. 25p
SP 400 speaker £10-00	RSGB Logbook 45p
Codar AT5 tx £22-00	RGSB Callbook 50p
Codar Multiband 6 £11-50	Eddystone EC10 Mk. II £74-00
Codar PR40 £8-50	EC10 mains psu £7-75
Codar IRC £2-50	Chokes
Car radio tuner,	Transistor 3mH 5p
variable L 15p	Eddystone, RF 6p
Panel mains neon 10p	10mH 50ma 15p
Mains rocker sw with neon 20p	Silver mica, mixed bag 20p
Microswitch 1p	Ceramic capacitors mix 20p
m.e.s. bulbholder 1p	Wirewound resistors, mix 50p
2 pushbutton w/change switch 10p	Diecast boxes from 80p
Trimmers 10-140pf 2p	Adcola Invader Iron £1-70
Trimmers 4-40pf 15p	Sentinel 2m. Conv. £13-75
6v. a.c. relay, double c/o 30p	Sentinel 70 cm. Conv. £13-75
4 digit pulse counter 15p	100 resistors 30p
OC28 type heat sink 5 1/2" 5p	Lafayette HA600 £45-00
OC71 type heat sink 2p	Lafayette HA800 £57-00
Mains slide switch 10p	Jackson 25 pfd variable 22p
10 crystals. Our selection 80p	TTC 5 band RF meter £4-00
Small dc motor, 12v. 40p	TTC s.w.r. bridge £4-20
5 mixed relays 50p	Amphenol PL259 ptfc 30p
6 b.a. bolts, one type or mix. 18p per 100. £1 per 1,000 2p	Amphenol SO 239 25p
In-line fuse holders 2p	Amphenol reducers 5p
Xtals 3B-888 75p	Amphenol SO239A ptfc 30p
Mosfets 3N140 3N141 (RCA) 85p	RCA 6LQ6 £2-60
MPF102 2N3819 40p	RCA 6GK6 95p
OC170 AC187 AC188 25p	"3" Beam 2m halo £1-30
BF180 37p	Shure 201 £3-50
BC109 2N706 10p	Shure 444 £14-00
Transistor equivalent manual 40p	Acos Mic 45 £1-10
Tested transistor ccts. 40p	Magazine binders 75p
Transistor ccts. manual 15p	Valve and Transistor Data Guide to B/cast Stations 50p
Transistor ccts. for beginners 40p	All RCA publications in stock:
Radio servicing for amateurs 20p	Tx mobile manual £1-00
Trio JRS99 £185-00	Rx valve manual £1-25
Trio Tx 599 £185-00	Transistor manual £1-30
Trio 9R59DS £47-00	Transistor servicing £1-70
Trio JR500Se £65-00	Hobby ccts. manual £1-05
Trio JR310 £77-00	S.C.R. manual 75p
Trio TS510 transceiver £180-00	Power transistors £1-00
Trio JR500Se £55-00	I.C. applications £1-30
TS510 as new £160-00	24v. relays 10p
Trio JR 310 mint £65-00	12v. relay 15p
Labgear LG300 £30-00	50/50 MicroA £1-00
Central Electronics 100v. am/usb/fsk/Tx £150-00	Paxolin panels 8" x 7" 3p
Eddystone 840C £45-00	
Vanguard hiband £25-00	
Trio TS500 & p.s.u. £125-00	
Trio VFO-5 £18-00	
Trio 9R59DS £40-00	
Eddystone 840A £35-00	
1392 and p.s.u. £15-00	

Wanted: We are always pleased to hear about your trade-in equipment and are looking for good KW, Eddystone, and TW items in particular. We can offer cash, or radio equipment in part exchange.

TE15 GDO £10-00

AR88 Mains cap. £2-00

Eddystone 830/2 £200-00

National NC109 £35-00

BC221 freq. meter £20-00

100 resistors incl. histab 30p

100 assorted 6BA bolts 12p

Dosimeter (new) 10p

Garex Popular Inverter kit £4-50

BC348 £8-00

HW32A (20m.) £45-00

NEW POTENTIOMETERS. 100k, 50k, 1k, 2k, 500 ohm and many others. Full list with sample 10, 40p. plus postage.

LATEST: Plastic strip pockets to take 12 QSL cards for vertical wall display. One strip 3p, 10 strips 25p. Postage 7p.

Please add extra for carriage. S.A.E. lists.

28 Hillcrest Avenue, Scarborough, Yorks.

FREE

TO ENGINEERS



Whatever your age or experience you must read New Opportunities. It describes the easiest way to pass A.M.S.E., A.M.I.M.I., City & Guilds (all branches), Gen. Cert., etc., and gives details of courses in all branches of engineering Mechanics, Electrical, Civil, Auto, Aero, Radio, TV, Building, etc. You must read this book.

Send for your copy today—FREE!

B.I.E.T., B30, Aldermaston Court, Reading, RG7 4PF

Accredited by the Council for the Accreditation of Correspondence Colleges

BRITISH INSTITUTE OF ENGINEERING TECHNOLOGY

G. W. M. RADIO LTD.

RECEIVERS. MARCONI "MERCURY". 15 kc/s. to 4 Mc/s. in 5 bands. Noise Limiter, B.F.O., A.G.C., RF and Audio gains. Wide/Intermediate/Narrow bandwidths. Audio Filter. Speaker. Complete with A.C. power unit, £17, carriage paid.

NSF LEDEX 24v. Solenoid switch motors, 12-way. New and boxed, 65p, post paid. McMurdo Morse Keys. 2 1/2" x 1" key on base with Send/Receive switch. Lead and 4-pin Plessey plug, new and boxed, £1, post paid.

MURPHY MARINE SHIP TRANSMITTERS. 1.5 to 16 Mc/s. VFO or crystal. 40 watts RT or CW. Valves P.A. 3 5B/254M in parallel, modulation pair 5B/254M. Two panel meters. Size 13" x 13" x 14". Complete and clean but not tested. Less power supplies. £11 carriage paid. A few similar Pye units with same line up but 13" x 14" have calibrated VFO, same price.

REED RELAY inserts, 1.85" long (body length 1.1"). Diameter .14" to switch up to 500ma at up to 250v. D.C. Gold clad contacts, 63p per doz., £3.75 per 100, £27.50 per 1000, post paid.

100 kc/s. crystals, glass envelope on octal base, £1.25, post paid, 2 motor transmitter sub-units. Contain 2 x 6S16, 2 x 6064, QV04-7 and TT15 valves, £2, post paid. Pocket Dosimeters, 15p, post paid. Meters 1 1/2" dia. 500 microamps calibrated 0-10, 75p, post paid.

HYGROMETERS. Wet and dry bulb type, new, £1.25, post paid.

TRANSFORMERS. Unused Radiospares "Heavy Duty" 205-245v. to 350.0-350v. 150ma, 6-3v. 2.5a., 6-3 3a., 2a (tapped at 1v. 3-5a), £2, post paid. "Midget Output" 50p post. New Gardner potted 200-250v. to 12-7v. 2.5a., £1, post paid.

Used. 0-250v. to 800-700-300-200-0-200-300-700-800v. 800 and 700 at 200ma, 300 to 100ma, 200 at 50ma when used simultaneously. 5v. 2a, 4v. 7a, 6-4v. 7a, 6-4v. 1a. £4, carriage paid.

BC221 complete with charts, £16.75, carriage paid.

SCR552 Transmitter units, £3 and receiver units £2, post paid.

All Receivers and Test Equipment are in working order at time of dispatch. Carriage charges quoted are for England and Wales only.

Telephone 34897

Terms: Cash with order Early closing Wednesday

40-42 PORTLAND ROAD, WORTHING, SUSSEX

HAMGEAR ELECTRONICS

PRESELECTORS

P.M. IIA This is a preselector covering from 1-8 to 32 Mc/s. in six overlapping ranges. Having a built-in antenna coupler to tune the antenna followed by a pentode to boost the signal up to 25 dB., before it reaches the Rx. With internal power supply, mains On/Off, indicator lamp and primary fuse. Price £9.20.

P.M. IIB This is a preselector with the same spec. as above, 1-8 to 32 Mc/s. and antenna coupler except it is solid state with an F.E.T. plus Bipolar. Price £8.25.

Both these preselectors are recommended for use only with communication receivers.

CRYSTAL CALIBRATORS

Get acquainted with our calibrators:

P.M. IV 1 Mc/s. with 1,000 c/s modulation.

P.M. V 1 Mc/s. and 100 kc/s. with 1,000 c/s. modulation.

P.M. VIII 1 Mc/s., 100 kc/s. and 10 kc/s. with 1,000 c/s. modulation. This one has the ability to be tuned zero beat to a frequency standard transmission such as M.S.F.

Both P.M. V and P.M. VIII have integrated decade counters, nothing to go out of adjustment.

All the units are battery powered and as such are quite portable.

All give beats up to at least 30 Mc/s.

Priced at £5.75, £7.75 and £11.75 respectively.

Postage and packing, 25p.

2 1/2p stamp for illustrated leaflets

29 CARLYLE ROAD, NORWICH

Member of Amateur Radio Retailers Association

TAURUS ELECTRICAL SERVICES

(Prop. G3TED)
All prices include carriage

SPECIAL OFFER. Ferric Chloride Powder for printed circuit etching. Full instructions. 1 lb. bag, 40p; 3 bags, £1

CIRCUIT BREAKERS. Small 5cc or 10cc	...	50p
SMALL RECTIFIER BRIDGES. 60PV 2cc	...	25p
FIELD TELEPHONES. Tele "T"	each £4; pair	£7.50
DC MULTIPLIER UNITS for CT54, V-Voltmeter	...	30p
SMALL CONTROL BOXES with Lamp, etc. Bargain	...	25p
TRANSISTORS ACY20. New	25p or 5 for	£1.00
U.H.F. DUMMY LOAD 7715 with Cavity Capacitance Unit and position indicator. Few at	...	£5.00
RF INDICATOR 7150. Complete with 1 amp RF Meter with Loading Resistors. 50 watt with coax connections. New and good. Few at	...	£5.00
JUST ARRIVED Bf. MET. BALLOONS, new in sealed tins with valve and stopper	...	£1.00
AMERICAN VALVE TERMINAL UNITS, TA182/U. TELE TYPE KLEINSCHMIDT TT98B/FG. Good condition Teleprinters, neat looking. 115/230v. AC 50 or 60Q. 184 watts max.	...	£27.00
SMALL 4ft. FOLDING AERIALS	...	50p
AIRCRAFT MACH METERS, NEW	...	80p
AIRCRAFT AIRSPEED SWITCHES, NEW	...	70p
MIXED XTALS. Our assortment, 10 for	...	£1.00
NEW VARIABLE CONDENSERS (BOXED). Spindle both ends, two types:	...	
74PF. 4. 74PF. 750v. D.C. (Polar type 015)	...	75p
102PF Single (Polar type 012)	...	50p
MINIATURE ROTARY TRANSFORMERS. 28v. D.C. in 250v. D.C. at .06 out. Will run off 12v. giving approx. 150v. out.	...	75p
MIN. DIODE EQUIV. IN4007, 1,000 PIV at 1 1/2 amps. 18p each or	£2.00 doz.	
EPICYCLIC SLOW MOTION DRIVES. 8-1 ratio	...	20p
MAINS SMALL MOTORS. 1 REV/HR. Power full	...	50p
SPECIAL OFFER OF QV03-10's. Tested	...	55p
New 6CL6's. Tested	...	55p
6L6's. Ruggedised. New	...	80p
TELEPHONE HANDSETS	each	40p
E180C valves	...	25p
SPEAKERS -New. 1 1/2" 40Ω	...	35p
BY100's. Tested	15p ea.	£1.50 doz.
TRANS. CALL UNITS (mains intercoms.) Complete	...	£2.20
MARGIN DISTORTION TEST SETS. in new condition with handbook. Delivered	...	£7.50
OP-AMPIC's 709C. New, marked	...	20p
2N3055 POWER TRANSISTORS N-P-N. New	...	60p
POWER TRANSISTOR PROTECTION THERMOSTATS. New	...	20p
NEW GET8 POWER TRANSISTORS. Matched pair	...	30p
25 MIXED NEW VALVE HOLDERS	...	30p
NEW MULLARD NIXIE TUBES	...	£1.25

WE WILL BE AT ALVESTON RALLY, 11th JUNE and LONGLEAT, 25th JUNE.

26/28 NOTTINGHAM ROAD, LOUGHBOROUGH

Telephone 5131

TF on 70 mc/s!

Two way communication between GTFs has resulted with our 6 ele. beam 4 metres ... 6 ele. £6.75 5 ele. £5.50 3 ele. £3.35 2 metres ... 9 ele. £3.65 8 ele. £3.30 5 ele. £2.60 70 cms. multigrid reflector 15 ele. £6.00 10 ele. £3.90 7 ele. £2.95 All 75Ω, Clamps for 2" mast post paid. Low loss coax 6p yd. Ultra low loss, 11p yd. 2" galvanised masts, 10" £2.20, 16" £3.30, 20" £4.40 couplers, 95p. Full range TV aerials in stock: UHF 8 ele. £1.90, 14 ele. £2.35. All lashings, U bolts, etc. in stock.

JOHN R. R. BAKER
BONTNEWYDD CARDS, SY23-4JH

SONTRONICS' sensational BANDSCANNER, the 7 transistor monitor Rx. Covering a wider frequency range than any other unit on the amateur market. The front end comprises a high sensitivity, untuned, wide band cascade RF amplifier covering the entire RF spectrum from 50 kHz to 450 MHz. Uses UHF silicon planar transistors. Pocket sized and self-contained in a spray finished aluminium box measuring 5 1/4" x 2 1/2" x 1 1/2"; complete with telescopic aerial and miniature loudspeaker. Sensitivity preset to receive a 5 watt Tx, whether on Top band or Two, at between 100 and 200 yards. Monitor local transmissions; remember, the strongest signal predominates.

The demand is zooming, everyone has a use for the Bandscanner, the one and only "electronic ear." Send for the free data sheet—s.a.e. please! Only £8.80 each. P. and p. and insurance 20p. PP3 battery 14p extra.

Mail Order only. Official Orders Welcomed.

SONTRONICS
30 ASTBURY AVENUE,
POOLE, DORSET, BH12 5DT
Telephone: Bournemouth 58211

THE SENATOR CRYSTAL BANK

G3UGY

Phone: 01-769 1639

CRYSTALS FROM STOCK AT KEEN PRICES

SENATOR CRYSTALS: the first place to contact when you need good crystals quickly.

Here are just a few of the popular frequencies actually in STOCK now :

kHz		MHz	
100 in HC13/U	£2.50	28.045 in HC25/U	£1.60
455 in HC6/U	£1.75	28.500 in HC25/U	£1.60
500 in HC6/U	£1.75	30.000 in HC6/U	£1.60
		32.500 in HC18/U*	£1.60
1.000 in HC6/U	£1.75	34.000 in HC18/U*	£1.60
2.000 in HC6/U	£1.60	34.500 in HC18/U*	£1.60
3.500 in HC6/U	£1.75	35.000 in HC18/U*	£1.75
5.000 in HC25/U*	£1.60	35.500 in HC18/U*	£1.75
7.000 in HC6/U	£1.50	38.666 in HC18/U*	£1.35
7.520 in HC25/U	£1.80	40.000 in HC18/U*	£1.60
7.755 in HC6/U	£1.80	42.000 in HC18/U*	£1.60
9.000 in HC6/U	£1.50	70.000 in HC18/U*	£2.00
10.000 in HC6/U	£1.50	71.000 in HC18/U*	£2.00
10.245 in HC25/U	£1.60	72.050 in HC18/U*	£1.75
11.000 in HC6/U	£1.50	72.425 in HC18/U*	£1.75
19.500 in HC6/U	£1.60	72.500 in HC25/U*	£1.75
24.500 in HC18/U*	£1.60	72.525 in HC18/U*	£1.75
25.000 in HC6/U	£1.60	96.000 in HC6/U	£2.00
26.500 in HC18/U*	£1.60	116.000 in HC18/U	£2.80

* = Also in HC6/U

TWO more stock frequencies : 454 kHz and 456 kHz in HC /U, useful for side-band filters etc. at £1.75 each.

And here's our STOCK range of BRAND NEW HC6/U 8 MHz for 2M :

8-002 8-007 8-012 8-018 8-021 8-0266 8-032 8-041 8-043 8-047 8-048 8-0555 8-058 8-061 8-070 8-081 8-092 8-100 8-104 8-107

All at £1.25 each, post free. These crystals pull well when VXO'd

Here are some popular frequencies for VHF, home station, mobile channels and R.A.E.N. ALL IN STOCK :

8-0555 MHz in HC6/U for TX × 18 =	145-000 MHz 2M Mobile	£1.25
44-7666 MHz in HC6/U for RX × 3 +	10.7 MHz	
	145-000 MHz 2M Mobile	£1.80
8-100 MHz in HC6/U for TX × 18 =	145-800 MHz for RAEN	£1.25
45-0333 MHz in HC6/U for RX × 3 +	10.7 MHz	
	145-800 MHz for RAEN	£1.80
12-975 MHz in HC6/U for RX × 12 =	10.7 MHz	
	145-000 MHz 2M Mobile	£1.60
11-1916 MHz in HC6/U for RX × 12 +	10.7 MHz	
	145-000 MHz 2M Mobile	£1.60
12-0833 MHz in HC6/U for TX × 12 =	145-000 MHz 2M Mobile	£1.60

Mail Order SENATOR CRYSTALS Dept. S.W., 36 Valleyfield Road, SW16 2HR

8-7825 MHz in HC6/U for TX × 8 =	70-260 MHz 4M Mobile	£1.60
29-780 MHz in HC6/U for RX × 2 +	10.7 MHz	
	70-260 MHz 4M Mobile	£1.65
6-74666 MHz in HC6/U for RX × 12 =	10.7 MHz	
	70-260 MHz 4M Mobile	£1.60
11-710 MHz in HC6/U for TX × 6 =	70-260 MHz 4M Mobile	£1.60

You'll find the above frequencies may be suitable for your PYE Cambridge, Ranger, Vanguard and other makes of ex-commercial R/T gear for the well-used mobile call channels. Check up with crystal multiplication data and crystal spec. in equipment manuals for suitability.

116.000 MHz in HC18/U NOW IN STOCK at £2.80. Ideal for 2M converter for I.F. 28-30 MHz, thus dispensing with need for osc. multiplication.

160m. modification on the FT-101. See February 1972 Radio Communication, page 84 using 7.520 MHz in HC25/U. In stock at £1.80.

PYE Cambridge 2nd oscillator crystal-change. See January 1972 Radio Communication, page 10 using 10.245 MHz in HC25/U. In stock at £1.60.

160m. modification on the JR-310. See December 1971 Short Wave Magazine, page 601 using 7.755 MHz in HC6/U. In stock at £1.80.

70cm. Converter—See December 1971 Short Wave Magazine, page 611 using 96.000 MHz. In stock at £2.00.

"TWO MORE STOCK FREQUENCIES. 1.6184 MHz and 1.6202 MHz (1.8 kHz apart) in HC6/U useful for side-band filters etc. at £1.80 each."

New facility at SENATOR enables us to REDUCE PRICES on many made to order units, as follows :

50—	149.9 kHz in HC13/U	£4.60
150—	499 kHz in HC6/U	£3.85
450—	500 kHz in HC6/U	£3.50
501—	999 kHz in HC1/U	£4.50
1.000—	1.39 MHz in HC6/U	£3.20
1.40 —	.00 MHz in HC6/U (18/U & 25/U over 5 MHz)	£2.00**
20.00 —	59.99 MHz in HC6/U; HC18/U; HC25/U	£2.25**
60.00 —	79.99 MHz in HC6/U; HC18/U; HC25/U	£2.50**
80.00 —	114.00 MHz in HC6/U; HC18/U; HC25/U	£3.00**
114.00 —	140.99 MHz in HC6/U; HC18/U; HC25/U	£7.00
141.00 —	175.99 MHz in HC6/U; HC18/U; HC25/U	£8.75
176.00 —	200.00 MHz in HC6/U; HC18/U; HC25/U	£12.00

Under 1 MHz to .01% tolerance. 1 MHz upwards to .005% tolerance. Closer tolerances by quotation.

Advertising in "Short Wave Magazine" guarantees the largest and most effective coverage of the U.K. radio amateur interest

SPECIAL OFFER JR.310 MODS AT HALF PRICE JUNE and JULY ONLY

Top Band	Was	Now
200 kHz Cal. Unit	£5.00	£2.50
29.5-30.1 MHz for 2 metre converter use	£5.00	£2.50
	£3.00	£1.50

Offer only applies to new receivers purchased for cash from ourselves. Full details and RSGB test report

HOLDINGS PHOTO AUDIO CENTRE,
39/41 MINCING LANE, BLACKBURN, BB2 2AF.
Tel: 59595/6

2 METRE CONVERTERS

LOW NOISE R.F. STAGE F.E.T. MIXER. Xtal controlled multiplier chain. Aluminium case. Size: 4" x 3" x 1 1/4". I.F.'s 4-6, 18-20, 24-26, 28-30 MHz, £10.50 each.

2 METRE LOW NOISE CASCODED F.E.T. PRE-AMPS. Aluminium case. Size: 2 1/2" x 1 3/8" x 1 1/4", £4.50 each.

E & E SERVICES

72 ELMSTONE ROAD, RAINHAM, KENT

STEPHENS - JAMES LTD.

70 PRIORY ROAD, LIVERPOOL, L4 2RZ

Tel: 051-263 7829

Yaesu-Musen	
FT101 Transceiver	£240
FT2F 2m Transceiver	£84-00
FT200 Transceiver	£172
FL500 Transmitter	£140
FR500 Receiver	£120/£160
Remote VFO's	£38-00
SP400 Loudspeaker	£10-00
FL2000B Linear	£125
YDB44 Table Microphone	£12-00
YDB46 Hand Microphone	£5-00
FT401 Transceiver	£215
FT560 Transceiver	£195
FR50B Receiver	£52-00
FL50B Transmitter	£61-00
FT75 Transceiver	£80-00
FP75 A.C. P.s.u.	£20-00
DC75 P.s.u.	£20-00

Hy-Gain Antenna Range	
12AVQ 10-15-20m. Vertical	£15-50
14VQ/WB 10-15-20-40m. Vertical	£18-50
18AVQ/WB 10 through 80m.	£33-00
TH6DX Tribander Beam	£86-00
TH3MK3 Tribander Beam	£67-50
TH31NR Tribander Beam	£46-50
TH2 MK3 2w Element	£48-00
LC80Q Loading Coil	£6-75
BN86 Balun	£7-75
203BA 20m. 3 Element	£68-50

Asahi Antenna Range	
3 Band 3 Element Beam	£60-00
40 to 10m. Trapped Vertical	£16-50

G-Whip Antenna Range	
16m. Ranger	£7-50
160/80m. Duobander	£9-00
10-15-20m. Tribander	£9-50
Coils for LF Bands each	£4-00
Basemounts	£1-45
2 metre 5/8th Vertical	£4-20
Multimobile	£12-50

Lafayette	
HA600A Receiver	£45-00

Test Equipment	
Tech 15 G.D.O.	£12-50
OSKER/SWR/Power meter	£18-00
Sansei SWR Bridge	£4-00
TNK TW50 K Multimeter	£8-50
TMLPL436 Multimeter	£7-00
C1000 Pocket Multimeter	£3-25
Omega Noise Bridge TE701	£13-50
Omega Noise Bridge TE702	£19-50
TE16A Transistor Sig. Gen	£7-95
Tech to 2 Oscilloscope	£22-50
Medco High Pass Filters	£2-40
TE .22D Sig.-Gen.	£15-00

HP terms arranged on all orders over £25. Minimum deposit 10% on new equipment, 20% on secondhand.

MEMBER OF THE AMATEUR RADIO RETAILERS ASSOCIATION

Part exchanges welcomed. Equipment bought for cash. Shop hours 9.30 to 1 p.m. 2.15 to 6 p.m.

Full demonstration facilities.

All RSGB Publications stocked at current prices. Half day is Wednesday

G3LRB G3MCN

The Widest Range of Equipment in the North

Microphones	
Shure 210	£5-75
Shure 444	£14-00
Sentinel 2m. Converters	£13-75
Sentinel 4m. Converters	£13-75
Sentinel 70cm. Converter	£13-75

Eddystone	
EC10 Mk. 2 Receiver	£79-00
A.C. Power Unit	£7-75
898 S. M. Drive	£8-92
EB37 Receiver	£98-00

J Beam
We are now stocking the full range of J Beam antennae, at current prices. Lashing kits, masts etc.

Plastic QSL Card Holders.	
Holds 12 cards. 10 for 25p, post 6p	
Copal 222 24 Hour	£7-50
Copal 601 24 hour Calendar	£14-95
Antenna Rotator	£20, £25, £40, £70
Semi Automatic Bug Keys	£4-50
HZP Balun I	£3-00
Wight Balun	£3-25
Wight Traps per pair	£2-50
Dipole T Pieces	13p
Egg Insulators	3p
300 Ohm Twin Feeder	per yd. 5p
50 Ohm coaxial cable	per yd. 12p
75 Ohm Twin Feeder	per yd. 5p

Tunable RF meters	£4-00
PL259 Plugs	30p
Sockets	30p
Cable reducers	10p
Line connectors	90p
QQVO-3-20A	£1-75
QQVO-3-10	75p

Codar	
ATS A.C. P.s.u.	£11-50
ATS Mk. 2 Transmitter	£22-50
PR40 Preselector	£8-50

Secondhand Equipment	
National NCX5 Mk. 2	£175
Collins 755-1 Rx	£165-00
Inoue Tx and Rx	£130-00
KW201 Receiver	£85-00
Heathkit SB300 Rx.	£90-00
Hammarlund HX50 Tx.	£85-00
Trio T5510 and A.C. P.s.u.	£130-00
Trio T5510 and A.C. P.s.u. and VFO	£140-00

Sommerkamp FR500 Rx.	£100
Hammarlund SP600XJ Rx.	£85-00
Star SR200 Rx.	£35-00
Codar PR30 Preselector	£5-00
Collins 7551 Rx	£175
Eddystone EB37 with AC P.s.u.	£65-00
Trio 9R59DS	£40-00
AR8BLF (Buyer Collects)	£30-00
Eddystone EC10 Mk. 1	£52-00
Radiovision Preselector	£5-00
JR500 Receiver	£50-00
KW2000B Transceiver	£180-00
KW 600 Linear	£75-00

Full range of Eddystone die-cast boxes, Stella cabinets, Ali panels and chassis, Panel meters, plugs, valves. Full information on all products sent on receipt of L.A.R.S.E. S.A.E. Return mail order service on all stocked items. Orders under 25p respectfully declined.

Carriage/postage extra, all items. All RSGB Publications stocked at current prices.

THE SPACE AGE ANTENNA !

MASSIVE, VULNERABLE, SPACE DEVOURING, CUMBERSOME, COSTLY, COMPLICATED ANTENNA SYSTEMS—most of them IMPORTED, or produced in the U.K. by FOREIGN COMPANIES, will certainly radiate your signal.

What PARTRIDGE offer you is a 6 BAND ANTENNA SYSTEM that is EXTREMELY COMPACT—AMAZINGLY EFFICIENT—INDEPENDENT OF SPACE AND EARTH REQUIREMENTS—OMNI-DIRECTIONAL (no nulls)—NO COILS TO CHANGE—NO ROTATING MECHANISM NEEDED and NO NECESSITY for HIGH COST, HIGH POWER transmitting and receiving equipment.

BRITISH MADE by a BRITISH COMPANY—the 7ft. 6in. ANTENNA with a WORLD RECORD QRP AWARD achieved from a confined space AT THE FOOT OF A HILL!

In addition to the trend setting EXPORT RANGE we offer you the new

PARTRIDGE BUDGET LINE of extremely efficient low priced equipment.

REMEMBER PARTRIDGE ARE 100% BRITISH and whenever possible use BRITISH components and materials.

Buy British AND Save Money !

Send 3p stamp for full illustrated details, prices and full technical information to—

Box 4, PARTRIDGE ELECTRONICS LTD.

Broadstairs, Kent

Tel. (Thanet 0843 62535 (62839 between 7 and 8 p.m.))

C.O.D. orders accepted

G3EKX S.S.B. PRODUCTS G3EKX

PAIR MATCHED 6HF5's R.C.A.	(20p)	£5-50
PAIR MATCHED 6146 R.C.A.	(20p)	£5-00
PAIR MATCHED 6146B R.C.A.	(20p)	£6-20

★ OVERHAULED RX's and TX's ★

HALLICRAFTERS SX100. Superb	£95-00
EDDYSTONE 940. Mint. Boxed	£115-00
H.R.O. with 9 COILS. Power Unit. Speaker	£20-00
VICEROY TX. Power Unit S.S.B.	£65-00
COLLINS T.C.S. TX plus Manual	£15-00
INVICTA/PYE RADIO. Trawlers	£8-00
AIRMEC. RADIO. RF stage	£12-00
TRIO 9R59DS. Mint. Boxed	£48-00
MARCONI V.T.V.M. (As New)	£6-00

PLEASE INCLUDE CARRIAGE AND PACKING

EDDYSTONE EC10 Mk. 2. Latest	£79-00
EDDYSTONE 1000	Price to be announced
EDDYSTONE 935 speaker, £3-71 A.C. mains unit 924	£7-75

TRIO T5510/PS510. Latest transceiver. New	£180-00
TRIO JR310. Superb ham bands Rx.	£79-50
TRIO 9R59DS. Latest general coverage Rx.	£57-50
TRIO SP5D. Speaker	£4-37

2 METRE 5 element wide spaced BEAM with 1-24" masthead bracket. Only	(80p) £2-50
--	-------------

NEW XTALS. All metal types. Mixed, not ex-govt. 80 kc/s. to 110 Mc/s. "State your requirements." S.A.E. essential (5p) ea. 50p
R.C.A. ROTARY RELAYS. 12v. 1/p.D.C. superb job. Ideal for aerial switching (15p) ea. 55p

7 LITTLE CASTLE STREET, TRURO

Tel. DEVORAN 862575 CORNWALL

SMALL ADVERTISEMENTS

("SITUATIONS" AND "TRADE")

5p per word, minimum charge £1.00. No series discount. All charges payable with order. Insertions of radio interest only accepted. Add 50% for Bold Face (Heavy Type). Box Numbers 12p extra. No responsibility accepted for transcription errors. Replies to Box Numbers should be addressed to The Short Wave Magazine, 55 Victoria Street, London, SW1H 0HF.

SITUATION

SALES/SERVICE Engineer: An opportunity exists for an active Salesman who has the ability to undertake the testing and servicing of Hi-Fi Equipment and SSB Receivers/Transmitters.—Address applications, marked "Confidential," to: **F. W. Webb, York Photo Audio Centre, 51 Fossgate, York, YO1-2TF.**

TRADE

QSL CARDS and G.P.O. approved Logs (hard back), prompt delivery. Send 4p stamp for samples.—**Atkinson Bros., Printers, Looe, Cornwall, PL13-1LA.**

GOVERNMENT Surplus Wireless Equipment Handbook: Contains circuits, data, illustrations, valuable information on British/U.S.A. receivers, transmitters, transceivers. Includes modifications to sets and test equipment. Surplus/commercial cross-referenced valve and transistor guide. Price £2-85, post/packing 20p.—**Gerald Myers (Dept. SW), 18 Shaftesbury Street, Leeds, LS12-2BT.**

STAY AT The Cornwall Ham-Radio Holiday Centre. Self-catering furnished accommodation. Six-element beam; 65ft. tower; 90 awards.—Full details from **Bernard Broughton, G3XBR, St. Tudy, Bodmin, Cornwall.**

QSL Cards for Tx and SWL. Send s.a.e. for samples stating which type required.—**Beaumont, G5YV, 8 Ashfield Avenue, Morley, Leeds, LS27-0QD.**

QSL Cards: for Tx, G8 or SWL. One to four-colour designs; large s.a.e. for samples; good selection.—**Red Rose Publicity (Pennington), 34 Aqueduct Street, Preston, Lancs.**

JULY Issue: Due out June 30. Single-copy orders 25p, post free, to reach us by Wednesday, June 28, for posting on June 29.—**Circulation Dept., Short Wave Magazine Ltd., 55 Victoria Street, London, SW1H-0HF.**

YORK PHOTO-AUDIO CENTRE. Yaesu FT-200, FT-101, FT-400DX, YC-305, etc., all available ex-stock. **Trio TS-515** Transceiver, £235 (new models). **TR.2200** two-metre portable transceiver, £69-95. **TR.7100** two-metre car transceiver, £99-50, and all existing models available from stock. **Codar A.T.5 Mk. II, £22-50; PSU, £11-50; CR-70A Mk. II receiver, £27-50.** **Hamgear:** The full range of Calibrators, Converters and Preselectors ex-stock. **Credit terms** are available on all equipment of value £25 or over, with little or no deposit and up to 24 months to pay. We are prepared to consider your Camera Equipment in **Part Exchange** and we will accept good quality Communications Gear in exchange for Cameras or Hi-Fi apparatus. We stock Nikon, Pentax, Rollei, Minolta, Zenith, Olympus, etc., etc. and in our Hi-Fi Dept. we have B. & O., Trio, Sanyo, Yamaha, Koss, Sinclair, etc., etc.—**51 Fossgate, York, YO1-2TF, Tel: 56176, or York 25798** after hours.

S-METERS suitable for R.C.A. AR88 D/LF receivers, 2½-in. diameter, 5 mA full-scale deflection, right-hand zero, complete with detailed fitting instructions, price £4-75 each, post paid. Also available, spares for AR88 D/LF receivers, send s.a.e. for list.—**A. J. Reynolds, 5 Headland Way, Lingfield, Surrey.**

GIEGER COUNTERS (For mains or portable battery use). Latest Home Office release and probably the last, of this well known Contamination Meter No. 1, this very useful instrument is used for the measurement of Radio-Activity. Indicated on an internal Meter scaled 0-1 to 10 milli Rontgens/Hour, a socket is also provided for additional sound Monitoring on Headphones. This instrument is housed in a strong, light alloy case, placed in a carrying haversack with shoulder strap. Containing cable and hand held probe, instruction card, plus the latest plug-in Vibrator Power Unit. Which uses current small transistor radio batteries (4 Mallory long life RM12 or 4 Ever Ready H.P.7 or equivalent makes). For Mobile use anywhere. (Cost Govt. approx. £70 each). Supplied brand new in carton only £3-50, carriage 50p. An additional plug-in Power Unit for Laboratory use, operating from 100-120 volts or 200-250 volts A.V. mains is available. Supplied brand new in carton at only £2-50, post 50p. Headphones (not necessary) if required £1-50. A few Gieger Counters as above new but not boxed in cardboard carton available at only £4-50 Carr. 50p.



Meter Dose Rate Portable Trainer No. 1. This was used to train in the use of Gieger Counters. A very compact self-contained Gieger Counter, being very sensitive, radiation indicated on internal Meter scales 0 to 3 Rontgens/Hour x 10-4. Unit contained in waterproof alloy case, which is handheld. Uses internal batteries (4 Ever Ready B105 and 1 U2 or equivalent makes). Not supplied. These have had little or practically no use, supplied as new in cartons. Few only, £3-50, carriage 50p.



JOHNS RADIO
Dept. B, 424 BRADFORD ROAD,
BATLEY, YORKS.
Phone MORLEY 69696

TRANSCEIVERS. Due to warehouse clearance we have for disposal, few only Transceivers No. 62 Mk. 2, made by Pye for the Navy and Army. Using a total of 11 valves, 1 RF and 2 I.F. stages A.V.C., B.F.O. covering 1.5 Mc/s. to 10 Mc/s. (approx. 200 to 30 metres) in two switched bands. Can be used on RT or CW M.O. or Crystal. A very good internal ATU made of a rotating silver wire coil, tunable over the complete range, suitable for aerials 4ft. to 100ft., internal P.U. for 12 volt D.C. A meter is fitted for checking voltages A.V.C., etc. Housed in a metal waterproof case, approx. size 18" x 10½" x 12½". Supplied in very good used condition with headphones and mike, two spare valves, circuit, boxed. Few at £12-50, carriage £1. Airtested £1 extra. A few grade 2 sets £9-50, carriage £1. Airtested £1 extra. **CRYSTAL CALIBRATOR No. 10,** Range 500 kc/s. to 10 Mc/s., up to 30 Mc/s. on Harmonics. Size: 7" x 7½" x 4". Power 300 volts HT, 12 volts LT. The Calibrator can plug into a Power Socket on the 62 Trans-Receiver, which it was normally used with. Supplied in good used condition with circuit, £2-50, Post 50p or **BRAND NEW IN CARTON** with operating Manual and Circuit connectors to set £5, post 50p.

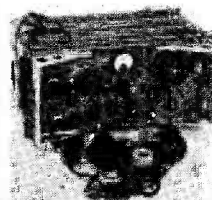

JOHNS RADIO
Dept. B, 424 Bradford Road, Batley, Yorks. Tel.: Morley 69696

F.T. 101 Transceivers, and full range of Japanese equipment from Stock. Checked by K.W. Engineers. Usual K.W. courtesy and service.

Easy terms available.

K.W. Developments Ltd.,
1, HEATH STREET,
DARTFORD, KENT.
Telephone: Dartford 25574

ECHFORD COMMUNICATIONS

11 BROADWAY,
KINGSTON ROAD,
STAINES, MIDDX.

Telephone: Staines 54401

New items in stock include:

KW 2000B Transceiver and mains P.S.U.	£240.00
KW Ezee Match ATU	£15.00
KW Trap Dipole	£14.00
KW 52 ohm Dummy Load	£7.00
KW 103 SWR Meter	£12.50
Trio 9R59DS Receiver	£57.50
Trio SP5D Speaker	£4.50
Normende Globetrotter, PRO Portable Communications Receiver	£97.50
BSR Record Decks, Stereo Headphones, Speaker Systems, etc.	
Tavasu Mobile Whips and Coils:	
Whip and base with 6ft. 50 ohm coax ... (P/P 25p)	£2.88
Whip, base, adaptor and 160m. coil ... (P/P 25p)	£5.95
J-Beam arrays—we are official London area stockist, full range in stock.	
R.S.G.B. publications, including maps, always available.	

Components available include:

6146B RCA new	(P/P 15p)	£2.75
Electrolytic capacitors, mainly new Mullard types.		
25 our choice	Post paid	£1.00
Heatsink finned black anodised 4½" x 3" x 1½"	(P/P 3p) each	17p
Jacksons 6/36 dials complete... ..	(Post paid) 6 for	£1
	(P/P 12p)	£1.63

Large range of Eagle components always in stock.

**ALL ITEMS CARRIAGE EXTRA
LARGE S.A.E. FOR LISTS**

Hours of Opening:

Monday—Saturday 9 a.m.—5.30 p.m. Half Day Thursday (1 p.m.)

H.P. Terms available on all items over £25.

A. G. WHEELER, G3RHF M. STANSFIELD, G8DNM

GRAHAM NEWBERY

(REG WARD G2BSW)

WE ARE OFFICIALLY APPOINTED K.W. AGENTS FOR THE SOUTH WEST (Somerset, Dorset, Devon, Cornwall)

KW Atlanta with p.s.u.	£210.00
Remote VFO	£37.00
KW 2000B with p.s.u.	£240.00
Remote VFO	£39.00
KW 202 Receiver	£140.00
Matching Speaker	£8.00
KW 204 Transmitter	£145.00
KW 1000 Linear	£135.00
KW 101 VSWR Meter (52 or 75 ohm)	£9.25
KW103 VSWR Meter and Combined Power Meter	£12.50
KW E-Z Match, 10-30m. ATU	£15.00
KW 107 Combined E-Z Match, VSWR and R.F. Power Indicator, Dummy Load and Antenna Switch for 4 Outlets	£40.00
KW Trap Dipole 70' 75 ohm Twin Feeder	£14.00
KW Trap Dipole 97' Coaxial Feeder	£15.00
KW 3 way Antenna Switches (for coax)	£3-75

EDDYSTONE RECEIVERS

EC10 Mk. II	£79.00
EA12	£105.00
830/7	£372-75

WE ARE THE DISTRIBUTORS OF EDDYSTONE PROFESSIONAL RECEIVERS FOR THE SOUTH WEST.

Trio Equipment Model 9R59DS £57.50

SECOND HAND EQUIPMENT in stock: Eddystone 680X, £65; 840C (general coverage), £45; 840, £30; K.W. Atlanta Transceiver £175; K.W. Vespa Pk. II Transmitter and p.s.u., £95. Lafayette HA600 General coverage Rx., £18. Trio 9R59DS (as new) £45. Star SR600 Receiver (Amateur Bands), £50. Yaesu FL200B Transmitter £80.

SHURE MICROPHONES

Model 444	£14.40
Model 201	£6.00
Model 202	£6.60

ANTENNAE Distributors for J/Beam and Joystick. Joystick ATU's etc.

R.C.A. VALVES for KW and Heathkit equipment. 6146, 6146B, 6HF5, 6LQ6, 6GE6, 6EAB, 6GWB, 6GK6, 6CM6, 6CL6, 6CB6, 6BN8, 6HS6, 6EW6, 12BA6, 12BE6, 12BT6, etc. and many other types.

TRADE INS WITH PLEASURE. OUR STOCK OF GOOD SECOND HAND EQUIPMENT CHANGES DAILY - LET US KNOW YOUR REQUIREMENTS.

WE STOCK R.S.G.B. PUBLICATIONS, LOG BOOKS, Etc.

HP TERMS AVAILABLE

AXMINSTER — DEVON

Telephone: 3163

QSL Cards. Two-colour. Attractive design, variable features, from £3.15 per 1,000 (inclusive). Send foolscap s.a.e. for samples.—A.R.A. Press, 46 Moat Avenue, Green Lane, Coventry.

WANTED: Crystals, 2 to 3 kHz spacing, range 430 to 480 kHz; qty. 50-100 at any frequency in this range required, also one-third quantity 2 to 3 kHz lower in frequency. Please quote details and price.—G3LLL Holdings, 39/41 Mincing Lane, Blackburn, BB2-2AF, Lancs.

READERS ADVERTISEMENTS

2½p per word, minimum charge 50p payable with order. Add 25% for Bold Face (Heavy Type). Please write clearly, using full punctuation and recognised abbreviations. No responsibility accepted for transcription errors. Box Numbers 12½p extra. Replies to Box Numbers should be addressed to The Short Wave Magazine, 55 Victoria Street, London, SW1H 0HF.

READERS

WANTED: Manuals for the following Wireless

Sets Nos.: 17, 18, 22, 31, 46, 48, 58, 68, 88 and R.1155; also information on American set "Wireless Station A.510," receiver AWA, 1955, serial number B396. Please state price. Postage will be refunded upon purchase.—Jenkins, 30 Gainsborough Road, North Finchley, London N12 8AG.

SALE: Inoue IG-700 Rx/Tx and PSU, 18 months old, very good condition, in original packing, £135. Fully metered QRO Linear, 80 to 10m., very well made, £35—or £160 The Lot. Buyers to inspect and collect.—Harman, G3WXO, QTHR (Tel: Stony Stratford 3346.)

SELLING: R.C.A. AR88LF, with S-meter and handbook, £25. 70cm. transistor converter, £6. Pair VHF transceivers, £4. Four-metre Tx and modulator, £6. FET FM tuner, £8. FM/AM transistor radiogram chassis, £9. 2½-inch scope, working, £3. 10.7 MHz transistor IF panel, £1. Band V transistor aerial preamp, £2. Three-speed tape recorder, tape and mike, £14. Colour TV IF panel, £3. Send s.a.e. for lists, will haggle.—Woodhall, 5 Summerville Avenue, Staining, Blackpool, Lancs. (Tel: Poulton 6159.)

FOR SALE: Eddystone 898 dial, £6. Eddystone 888A dial, slow-motion drive etc., £9. Eddystone S-meter, £6. 24in. parabolic reflector, £6. CR-100 coil box, IFT's and tuning condenser, £8. CR-100 manual, £2. R.220 4-metre Rx, £5. Four-metre 4-element Yagi, £3. Pi-Tank coil (matches 2 by 6146's), £2. Webster five-band (80-10m.) mobile antenna, £6. 6ft. 19in. rack cabinet, £5. CR-100 trimming tool, £2.50.—Giddings, G3XLB, QTHR, or ring Formby (Lancs) 71968.

SALE: Eddystone EA-12, new in box with guarantee cards, £180. Trio JR-500S receiver, Top Band and all modifications, with speaker, as new, £50.—Standing, 2 Elm Street, Colne (3326), Lancs.

FOR SALE: Swan Cygnat 260 transceiver, AC/DC PSU built-in, 10 and 15m. band sections need attention, £75—EXCHANGE Versatower, W.H.Y.?—Spivey, 24 Norfolk Avenue, Balley WF17 7AL, Yorkshire.

SALE: Hy-Gain 14-AVQ, complete with base loading coil for 80 metres, relay and radial wire (uncut). Never been used, £20.—Daw, 479 Wellingborough Road, Northampton (37944).

OFFERING: Avometer Model 7 Mk. II, £18.50.

Also CDR AR.22 Rotator, £16.50. Speaker for Eddystone 640 or 750 receiver. £1.25.—Watson, 19 Frances Road, Basingstoke, Hants.

SALE: Trio TS-510 transceiver with PSU and speaker, as new, £150 or near offer.—Gates, G3ENB, 18 High Mill Drive, Scarborough, Yorkshire.

OFFERING: Racal RA-17A Mk. II, Mosley TA33Jr., Ham-M rotator and control unit, all in excellent condition. Offers?—Williams, Tan-y-Graig, Penrhynside, Llandudno, North Wales.

SALE: Drake TR-4, with PSU and microphone, £245 or offer. "G2DAF" type linear, £20, or near offer. Marconi camera control unit Type BD626D, offers?—Ring Hawthorne, G3MCS, Princes Risborough 4343 (Bucks.)

SELLING: CR-100 receiver, with S-meter, miniature valve front-end and manual, £9. Woden 150w. modulation transformer, £5. PSU 1000v. and 500v. at ½ amp, variable negative bias 0-350v., heater supply 6-3v. and 10v. at 10 amp. all-silicon rectification, £10.—Klemperer, G3ZUY, QTHR or ring Bristol 626544.

WANTED: Receiver, HRO or CR-100, preferably unmodified.—Tee, G8UA, 33 Red Lees Road, Cliviger, Burnley, Lancs.

FOR SALE: Eddystone EC-10 receiver, complete with mains and battery PSU, in mint condition, £45, or offer?—Brownlee, G3ZGR, 11 Winifred Gardens, Wallsend, Northumberland.

SELLING: Codar CR-70a receiver, realigned but scratched, £14. Solartron CT316 'scope, X-Y-Z inputs, DC-6 MHz calibrator, £26. Manual for 62 Set, 50p. Consider EXCHANGE for good gear; letters only, please.—Ellis, 13a Lower Edgeborough Road, Guildford, Surrey.

FOR SALE due to illness: All items in absolutely mint condition. Sommerkamp FR-100B receiver, complete with extra crystals in 10-metre band and for WWV; a fine receiver with its manual, in makers' packing case, £80. American Zenith Royal 7000-Y receiver, solid-state Transoceanic, 11 bands, super sensitive, coverage short wave, long wave, AM/FM/SSB/CW/162.5 MHz, VHF/FM, with built-in AC power supply or batteries, complete with all charts, handbook, manual, owner's name plate (has not been engraved), in makers' packing case (cost £180) will accept £90. Hallicrafters CRX-102 solid-state Rx, coverage 144 to 174 MHz, with owner's guide and manual; this Rx is brand new in makers' packing (cost £21.50) selling at £15. De luxe Joystick, brand new, with ATU for Joystick 160 to 10 metres (cost £12.75) will accept £6.50.—Denning, Langcliffe Lodge, Settle, West Riding, Yorkshire.

SELLING: K.W. 201 receiver, £65. K.W. Vespa Mk. I transmitter, £65. Both in excellent condition.—Smith, 5 Varnells Terrace, Hambleton (443), Henley-on-Thames, Bucks.

WANTED: Active G8/3 urgently requires suitable QTH (flat, bed-sitter, or W-H-Y), in Cheltenham or Gloucester area. **SALE:** R.C.A. AR88D in excellent condition, with manual, spare valves and S-meter, £50. Re-built National HRO, all new components and valves, resprayed case, with five coil packs, £25.—Hall, 24 Lansdown Place, Cheltenham, Gloucestershire, GL50-2HX, or ring Cheltenham 21491, ext. 4274 (office hours).

FOR SALE: K.W. Viceroy Mk. IIIA, full lattice filter, with 6146B's in final, good condition.—Pallant, G3RNM, QTHR, or ring Great Missenden 2642 (Bucks.)

SALE: Eddystone EC-10 Mk. II, few hours' use only, £65. Cossor 339 'scope, £10. Minimitter Mercury 150w. Tx, £30. Pye Ranger converted 2 metres, £10. Minimitter VFO with WBC, 10-80m., £6.—Carter, G3ZW, 15 Goudhurst Road, Gillingham, Kent.

SELLING: Trio 9R-59DS receiver as new and in perfect working order, complete with Trio speaker, £25.—Fitch, Strathmore, Green Road, Thorpe, Egham, Surrey. (Tel: Chertsey 63597.)

WANTED: By keen CW OAP SWL, audio filter type FL8.—Eaton, 116 Downs Valley Road, Brighton (34320), BN2 6RF, Sussex.

FOR SALE: Junkers straight key, free standing, £5-50. **WANTED:** Signal straight key, solid brass base; also high-speed Morse record.—Box No. 5086. Short Wave Magazine Ltd., 55 Victoria Street, London. SW1H 0HF.

INSIST ON VERSATOWER

Acclaimed as the World's leading telescopic tiltover tower in the field of radio communication
Models from 25' to 120'

Enquiries to
Western Electronics (UK) Ltd
Osborne Road, Totton, Southampton

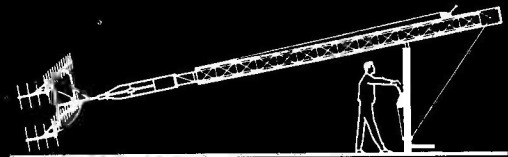

Look for the name

STRUMECH

Strumech Engineering Co Ltd
Coppice Side, Brownhills, Walsall, Staffs.

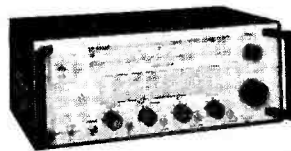

new from eddystone

Model 1000 Communications Receiver

Introducing the very latest communications receiver from the Eddystone stable. The model 1000 covers C.W., M.C.W., A.M. and S.S.B. having a frequency range of 30 MHz to 550KHz. Powered by integral battery pack (rechargeable) or A.C. mains (110-250V 50-60 Hz). Other features include single conversion using I.C., F.E. and bi-polar transistors, desensitising facilities, carrier level meter and separate fine tuning control. Variable selectivity is achieved by incorporating high grade ceramic ladder filters. A pre-production model of this remarkable new receiver can be heard and inspected in the Eddystone showroom at Imhofs.

Other outstanding winners

Eddystone EC10 Mk. 2. Still 'Top of the Pops' in the modest price range of communication receivers. Embodies features usually only found in the more expensive designs. £79-00.

Eddystone EB37. A high performance transistorised receiver with long, medium and three short wave bands. Powered by batteries or A.C. supply. £102-90 (including £18-90 tax).

Eddystone 830/7. Wide range communications receiver. A high grade HF/MF receiver covering 300 KHz - 30 MHz in nine ranges with crystal control facilities. Many satisfied users acclaim it as 'the best ever'. £389-00.

Write for comprehensive leaflets on any of the above.

IMHOFS

MAIN EDDYSTONE
DISTRIBUTORS



Dept: 11/6

112-116 New Oxford Street, London, WC1A 1HJ.

Tel: 01-636 7878
R67

MARKHAM ELECTRONICS

Technical
G3FPQ

YAESU TRANSCEIVERS

SALES
XYL

All ex-stock—delivery free—12 months' guarantee excluding valves and semi-conductors—unbeatable value—our prices and H.P. rates are the lowest available.

- FT101:** Ultra modern complete station—260w. P.E.P. input. Fully transistorised save for driver and P.A. Complete with microphone and built-in speaker **£225**
- FT200:** (Less P.S.U.), 260w. P.E.P. input. All usual operating facilities such as selectable USB/LSB, VOX, 100 kHz calibrator, clarifier ± 5 kHz are included. A modern transceiver with YAESU quality. Only **£120**
- FP200:** AC power supply and speaker unit for FT200 **£35**
- FTDX400:** 560w. P.E.P. input. Similar to FDX560 but no W.V.V. band and no provision for CW filter. Limited number only **£170**
- FTDX560:** 560w. P.E.P. input. W.V.V. band and provision for installing C.W. filter, selectable USB/LSB, VOX, 25/100 kHz calibrator, clarifier ± 5 kHz, ANL and AC power supply all built-in **£180**
- FTDX401:** As FDX560 plus built-in P.A. cooling fan, C.W. filter and sensational new noise blanker unit **£205**

FTDX400, FDX560 and FDX401 are all variations on the same basic design and represent unbeatable value for a high quality 560w. P.E.P. transceiver with built-in AC P.S.U.

**MARKHAM OAK, BUCKS HORN OAK,
FARNHAM, SURREY.**

Telephone Bentley (Hants) 3168 (evenings)

**Interested in Leasing
your equipment over
4/5 years and keeping
up to date?**

*Write or get your dealer to write
to:*

G8KA

**General Merchandise
Credit Ltd.,**

**Cranbrook,
Kent.**

Minimum package deal £200.

H.P. Terms over 3 years also.

SALE: G3HTA-type amateur band receiver with Electroniques QP166 coil pack, 898 dial, new components, working but requires alignment; no time to complete, £22-50 or offer. Also beginners' LP Morse record, £1.—Hainsworth, G3ZNK, QTHR, or ring Rawdon 4599 (Yorkshire).

DISPOSING: Hallicrafters SX-111, coverage 10-80m. bands, £65. Eddystone 840C and EC-10, each £39. New mains portable TV, Ferguson 3805, box unopened (retail price £54), sell or EXCHANGE. Part-exchange any for receiver(s), especially Eddystone 750, 888A, 680X or 940—but any Rx considered.—Snowden, Swainsea Lane, Pickering, Yorkshire.

EXCHANGE: Rack mounting Pye Base Tx, QV03-20A PA, metered, with mic., xtal, working on two metres FOR Pye "Highband" Ranger or similar, modified and working on 2 metres, with tunable Rx.—Blair, 1 William Street, Chopwell, Newcastle-upon-Tyne, NE17 7JH, Northumberland.

SALE: R.C.A. AR88D, with S-meter, £50. Trio 9R-59DS, fitted stabiliser, immaculate, £40. Type AP.61357 Rx unit (E. K. Cole), coverage 100 to 150 MHz, with power pack (needs attention), £5. Partridge Joystick, VFA, £5. Partridge Joystick III ATU, £5. Two-metre aerial, £3. Garrard SP25 Mk. II turntable and plinth, £5.—Bell, 19 Sandeman Way, Horsham, Sussex.

FOR SALE: Two ex-W.D. No. 62 Mk. II transceivers, both working and in good condition, with headphones and mics., £12 each.—Mount, Mill House, Oving, Chichester (89396), Sussex.

WANTED: Collins R389/URR, SP-600VLF or other high-grade receiver for VLF. Modern high-grade teleprinter, receive only, considered. Also Morse-to-Baudot converter, such as Frederick Electronics Model 670A.—Passfield, 30 Greenleaf Close, Tulse Hill, London, S.W.2. (Tel: 01-674 5825.)

WANTED: Electroniques transistor front ends, 1-6 MHz IF, both general coverage and amateur bands. Top price paid for units in good condition.—Philp, G3NJM, 61 Ewell Park Way, Ewell, Epsom, Surrey. (Tel: 01-393 2280, evenings).

WANTED: T.1154 transmitter, R.1155 receiver. Both less PSU, but must be in good working order all modes. Required by ex-R.A.F. W/T operator intending to take RAE. £5 offered for each item in working order. Details please.—Box No. 5087, Short Wave Magazine Ltd., 55 Victoria Street, London, SW1H 0HF.

SALE: Trio receiver JR-599 (cost £199 as new) at £140. Trio TS-510 transceiver with PS-510 power pack, £120. Robot SSTV monitor, as new (cost £245) at £200.—Montgomery, 23 Larkham Lane, Plympton, Plymouth (Tel: 0752 37003.)

EXCHANGE OR SELL: Pye Vanguard on two metres, receiver tunable, fully metered, mint condition, with mic., xtal and handbook, £33 or EXCHANGE for good receiver.—Box No. 5088, Short Wave Magazine Ltd., 55 Victoria Street, London, SW1H 0HF.

FOR SALE: Lo-Band Pye "Bantams," unused, two for £50. "Westminster" Lo-Band, new, £45. National HRO-5, with six coil packs and manual, £17-50. BC-639A, 100-150 MHz receiver, £15. Carriage extra or buyer collects.—Ring Donohue, 051-423 6851 (Merseyside.)

DISPOSING: Codar 12M/S and 12/RC, £10. R.C.A. AR88D—this Rx hasn't been kicking around for years, but was purchased brand new for £90 not long ago, no circuit mods., £60 or allow £35 on 9R-59D, or 840C, HA-600, etc. EXCHANGE: Eagle bug plus £2 for Junker.—Morris, G4HU, QTHR.

SALE: Alando compressor amplifier, £9-50. Taylor Multimeter Model 425, £7. Codar PR-30X, mains type, £6. Panda tunable LP filter, £4. Mic. xtal p-t-t, £1. Pamphonic p-t-t, £1. Morse keys: (GPO), £2; W.D.-type 75p; Japanese 50p. Manuals: KW-2000B, £1; 5X, 28, £1. Carriage extra.—Judge, GM3ZHG, QTHR, or ring 041-637 0681 (Glasgow.)

SALE: CR-100, fitted S-meter and noise limiter, vernier tuning for SSB, £16. Buyer collects. please.—Parmenter, 33 Albert Street, Whitstable, Kent.

EXCHANGE OR SELL: HA-55A aircraft Rx, mains, with manual, mint. 2N4 VHF Tx, as "RSGB Handbook," 18 watts input on 2 and 4m. AM/CW, with mic., crystals and circuits. Two-metre Emsac converter, 28-30 MHz IF; 4m. FET converter, 3.5-4 MHz IF, 12v. neg. earth; four-metre portable "Cambridge" Tx, six switched crystals, with circuits and mic., 12v. input. VHF Rx, 50-100 MHz, mains. FL8 audio filter. Yeasu YD844 table mic., new. Two-metre 6-ele J-Beam. Pye "Cambridge" on 70.26 MHz with crystals for Tx/Rx. Various other items. **WANTED:** AR22R Rotator, HF beam, KW-600 linear, or W-H-Y?—McGonigal, G13ZSC, Tielsa, Portglenone Road, Randalstown (378), Co. Antrim, Northern Ireland.

DISPOSING: R.C.A. AR88LF Rx, rough, £10. Home-built Linear 4/PL509, £10. 49 c.c. 2-stroke engine. £2. Telescopic antenna, 34 ft., £2. Radio course, £5. Buyers collect.—Reeves, G3OAB, ring 021-747 8489 (Birmingham.)

SELLING: Radar Decca-12 Marine 3cm. RF Head/Receiver/PSU/Display; near complete with handbook, £20. Transmitters: Labgear LG.50, 80-10m. AM/CW, full BK, £20; TCS-12, 160-80-40 metres. AM/CW, with mains PSU, £10. Receivers: Hallcrafters ARR5 VHF AM/CW/FM, 27-143 MHz, with mains PSU, £8; B.29 LF, less PSU, £1; PCR LW/MW/SW integral LS/PSU, £5; Portable TRX WS-62. 1-6-12 MHz, AM/CW, 12 volt, with handbook, £7. Cossor 339 'scope, with matching 343 wobulator. £5 the pair. Tous more, s.a.e. list. Buyer collects, or local delivery.—Kempt, G3NRB, QTHR. Tel: Cottered 297 (Herts.)

SALE: Brown's "F"-Type lightweight headphones, brand new. £4.—Leighton, Tangley Cottage, Womersh, Guildford (66543), Surrey.

FOR SALE: Swan 500C, 508 VFO including Vox and 230XC PSU, mint condition, £250 or offer. Trio JR-599 Rx, Custom Special, £140. LM-14 frequency meter, very good condition, £20. "Cambridge" High-Band FM, £25 or offer.—Hutchinson, G3VGH, QTHR, or ring York 769245.

SALE: Trio JR-310, as new, fitted calibrator and extra filter, with manual and original packing. £60. Trio 59-DS, as new, with SP-59 speaker and manual, £35. Park-Air Electronics two-metre transmitter, 10 watts output, four switched xtals, fully metered, Shure 444 microphone, first class order. £60.—Rance, G8AGZ, 4 Westmere Crescent, Burnham-on-Sea, Somerset. (Tel: Burnham 4635.)

FOR SALE: Eddystone 750 receiver, professionally re-aligned, fitted S-meter, in new condition. £37.50. Shure mic., £7.50. Katsumi electronic keyer, complete with monitor, £10. 2000B remote VFO. £25.—Last items in mint condition.—Rogers, 18 Maxwell Drive, Hazelmere, Bucks. (Tel: High Wycombe 34143.)

SALE: AT5/T28, with internal speaker, AC/DC PSU's, control unit, Tavasu 160m. whip, £35 or near offer. **WANTED:** (if above sold), £100 offered for good KW-2000 with AC/PSU.—Fisken, G3WZD, Tel: Haywards Heath (Sussex) 51691 ext. 403, daytime.

FOR SALE: Hudson AM-108 mobile R/T (Rx/Tx). £5. Hudson AM-105 Base Station (Rx/Tx), £10. Hudson AM200 QRO Base Station (QQV06-40A PA) (Rx/Tx and monitor receiver), £15. Pye Rangers. Rx/Tx, £5. Pye Base Station, Rx/Tx, £15. All units ideal for four metres and suitable conversion two metres; existing frequencies 70-85 MHz. In good and unmodified condition, genuine bargains. Why pay more? All enquiries answered; s.a.e. please.—Swindon, G3ANK, QTHR.



**"LISTEN TO THE
WORLD WITH
EDDYSTONE"**

**Your local Eddystone dealer
is:**

CHESHIRE

The Transistor Centre
(Wilmslow) Ltd.
Green Lane
Wilmslow 24766

CORNWALL

R. V. Heming Ltd.
(Peter Heming G3WBW)
Cliff Road, Newquay
Newquay 2191

S.S.B. Products
(Norman Birkett G3EKX)
7 Little Castle Street
Truro
Deveran 862575

DEVON

Graham Newbery
(Reg Ward G2BSW) Axminster
Axminster 3163

ESSEX

F. E. Smith
184 Moulsham Street
Chelmsford
Chelmsford 54594

HAMPSHIRE

Southern Marine Radio
(Southampton) Ltd
Solent House, Town Quay
Town Quay 22721

Wireless Supplies Unlimited
264-266 Old Christchurch Road
Bournemouth
Bournemouth 24567

IRELAND

John F. MacMahon
18, Church Street, Enniskillen
Co. Fermanagh, N. Ireland
Enniskillen 2955

ISLE OF WIGHT

Sherratt & Son
81-82-83 High Street, Newport
Newport 3358-9

KENT

G. T. & R. Wilson
12-14-16 Queen Street
Gravesend
Gravesend 63527/8

LANCASHIRE

Holdings Photo Audio Centre
Mincing Lane - Darwin Street,
Blackburn BB2 2AF
Tele. 59595

Stephen-James Ltd
70 Priory Road, Anfield
Liverpool L4 2RZ
051-263 7829

North West Electrics
769 Stockport Road
Levenshulme, Manchester 19
061-224 4911

Croftfilm Ltd
46 Friargate
Preston PR1 2AT
Preston 55244

LEICESTERSHIRE

A. K. Davey Ltd
New Street, Hincley
Hincley 2173 and 4288

LONDON

Imhofs (Retail) Ltd
112-116 New Oxford Street
W.C.1
01-636 7878

R. T. & I. Electronics Ltd
Ashville Old Hall
Ashville Road
Leytonstone, E.11
01-539 4986

Radio Shack Ltd
182 Broadhurst Gardens
London, N.W.6
01-624 7174

NORFOLK

The Record Shop
157 King Street
Great Yarmouth

NORTHUMBERL'D

Aitken Bros & Company
35 High Bridge
Newcastle upon Tyne NE1 1EW
Newcastle upon Tyne 26729

SCOTLAND

L.J. Hardie
542 George Street
Aberdeen
Aberdeen 20113

WALES

Holt High Fidelity
Picton Arcade, Swansea
Swansea 53254

Holt High Fidelity
8 Portland Street, Swansea
Swansea 41032

WARWICKSHIRE

Chas. H. Young Ltd
170/172 Corporation Street
Birmingham 4
021-236 1635

SALE: Heathkit DX-40U and VF1U; no mods., good condition, £20. Also 500v., 6.3v., high-current power supply, ex-Govt., £2.—Manns, G3NHM, Tel: 021-358 2841 (Birmingham).

WANTED: Late Eddystone 840C, EC-10, 9R-59DS (not "E"), £35 maximum. Essex delivery.—Box No. 5089, Short Wave Magazine Ltd., 55 Victoria Street, London, SW1H 0HF.

RECEIVERS: Eddystone 940, EA-12; Hallicrafters VHF BC-348, £12-50. BC-221, £10. Collins P.T.O.. £5. Bandpass filter 2-6 kHz; large UK navigation map. Meters: 20 micro-amp, 54mV; Headphones: £1 each. Please send s.a.e.—Wright, 249 Sandy Lane, Hindley, Wigan (55948), Lancs.

SELLING: Creed 54 teleprinter, £20. Creed 86 printing re-perforator, £10. Creed 6S/6M tape reader, £10.—Wigg, G6JF, Yabbacombe Farm, Kingsbridge, Devon (Loddiswell 324).

SALE: SB-200 linear amplifier, excellent condition, new valves, £90.—Box No. 5090, Short Wave Magazine Ltd., 55 Victoria Street, London, SW1H 0HF.

OFFERING: Pair transistor "Ranger" transmitters, on 4 metres, £5 each; one on two metres, £7. Four-metre FET converter, £5. Two-metre FET converter, £6. R.209 Rx, £10. HRO Rx, £12. 20-foot 2-inch diameter dural pole, £3.—Basterfield, G8EEJ, 51 Ruskin Crescent, Crownhill, Plymouth, Devon.

SALE: Pye Marine Rx 619-CAT with handbook, in excellent condition, PSU contains speaker and S-meter, built-in relay for Tx muting, gap-free coverage from 60 kHz to 31 MHz in 8 bands; dual conversion on HF ranges; half-lattice crystal filter; four selectivity positions. Price £28 or near offer. Prefer buyer collects.—Lindars, 52 Heathcote Drive, Eas; Grinstead (23950), Sussex.

SELLING: Heathkit 100 kHz xtal calibrator for Single Banders, £4; Hanson SWR-3, £3; both as new. BC-696 80m. Tx, £3; BC-456 modulator, £3; both for £5, plus circuits/notes.—Watmough, G3WXB, Tel: Watford 27499.

FOR SALE: Eddystone 888A Rx, £60. Heathkit DX-100U AM/CW Tx, £35, or offer.—Bushell, GW3OSV, Park East, Clarbeston Road, Pems.

SELLING: Brand new AR91 short wave receiver, four-band, solid-state, coverage 540 kHz-30 MHz, £15 or near offer.—Ring Boardman, 061-439 4441 (Cheshire).

SALE: Heathkit RA-1 receiver and speaker, £26. Agifold camera, f4-5, built-in exposure meter and range finder, £6-50.—Harbour, 5 Limetree Avenue, Peterborough.

FOR SALE: SSB Tx, 400w. with separate VFO and two PSU's, PA TT21's, coverage 80-10m, only £50 (or offer). Buyer collects or will deliver 50-mile radius.—Worthington, G3ZBM, QTHR, Tel: Crewe 68693.

WANTED: Heathkit HW-32A SSB transceiver in good condition (less PSU), or good home-built 20m. CW/SSB rig. W-H-Y?—Box No. 5091, Short Wave Magazine Ltd., 55 Victoria Street, London, SW1H 0HF.

FOR SALE: CR-100, £15. BC-221, £20. Cossor 339 'scope, £10. Triplet signal generator, 100 kHz to 120 MHz, £10. BC-443 receiver and tuner panel. Two Command transmitters, one modulator. American scanner unit, suit SST. AM modulators. Power units. All good condition. Offers, or £75 The Lot. Cash and carry.—Ward, G3HBM, 7 Regent Street, Burnham-on-Sea (2152), Somerset.

SALE: M. & G. three-band sideband transceiver, 160-80-20 metres, AC power supply, p-t-t microphone and speaker, £55. National HRO-5T, complete set general coverage coils, excellent performance. AC power supply, £20. New HC-6U Top Band crystals: 1.908, 1.909, 1.910 MHz, a few of each at 65p incl. post/packing. Gashed CR-100 for rebuild or parts £2-50.—Martin, G3PWM, QTHR, or ring 01-445 9772.

FOR SALE: R.C.A. AR88D, £35. R.216 VHF Rx with PSU, £50. Variac 8 amp., £6. Frequency meter CW-60 ABM, U.S.N. offers? Avo oscillator, faulty, £2. Tuning unit TU5B, £2. Step-down 10 amp. transformer, £10. Buyer collects. **WANTED:** Good SSB receiver.—Earnshaw, 12 Clarke Brow, Middleton, Manchester.

SALE: Eddystone 940, with headphones, vintage 1969 but little used, buyer collects, £100 or near offer.—Ring Tyrrell-Lewis, St. Albans 52891, evenings.

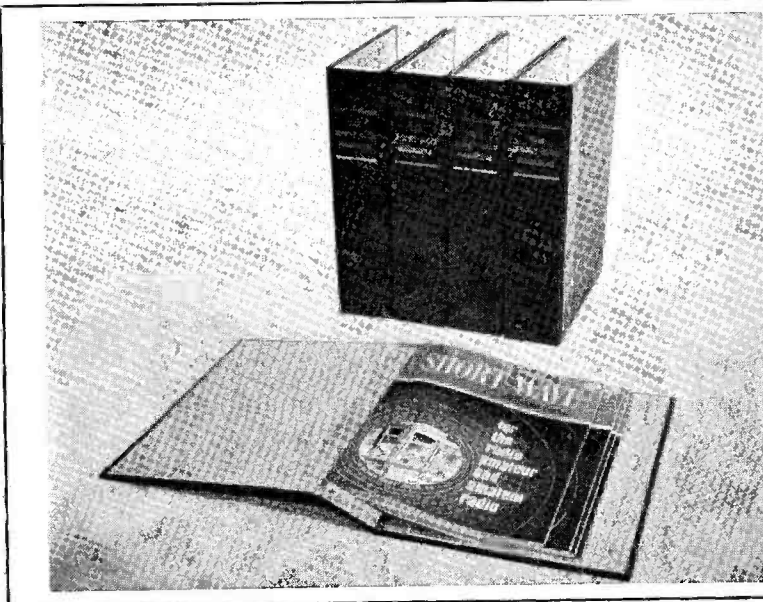

CREATE YOUR OWN REFERENCE LIBRARY

The "EASIBINDER" is designed to bind 12 copies of the Magazine as you receive them month by month, eventually providing a handsomely bound volume for the bookshelf.

No need to wait until twelve copies are assembled. As each copy is received, it is quickly and simply inserted into the binder. Whether partially or completely filled, the binder is equally effective, giving the appearance of a book, with each page opening flat.

Strongly made with stiff covers and attractively bound in maroon Leathercloth and Milskin, the binders have only the title gold blocked on the spine.

Price 88p post free.

PUBLICATIONS DEPARTMENT
SHORT WAVE MAGAZINE
55 VICTORIA STREET
LONDON, SW1H 0HF

G2ACQ offers XTALS 1.8-3.5-7.0-14.00-21.00-28.00 MHz also 6.0-9.0-12.0-35-36-70-80 MHz for VHF sorry no 35 MHz spot or 8 MHz. All at 65p post paid. TRIO-TRIO-have you heard that the TS515 transceiver is coming shortly. We still have the 9R59DS and JR310 in stock. We still have digital 24 hour clocks -GDO's-SWB-including the mini one for mobile work. LUCKY DIP XTALS 10 for £1-13, post paid.

S. MAY (Leicester) LTD.

12/14 CHURCHGATE, CITY CENTRE,
LEICESTER LE1 4AJ
Telephone: 58662

**THE AMATEUR RADIO SHOP
G4MH**

13 CHAPEL HILL, HUDDERSFIELD.
Telephone: 20774

(Member of Amateur Radio Retailers Association)

Agents for: KW, Eddystone, Yaesu Musen, Codar, Trio, J-Beams, Tavasu Mobile AE's.

K.W. Atlanta	£210	Trio TS510	... £180	FT101	... £240
2000B	... £240	JR 599	... £199	FT 401	... £215
204 TX	... £145	JR 310	... £83.50	FT 200	... £134
202 RX	... £140	9R59DS	... £57.50	AC PSU	... £38
107 ATU	... £40	MIC'S SWR ind. etc.		FRDX 400	... £160

The 4MH 2 mtr. Tx, £11.50. Matching Modulator, £11.50 (the pair for £22). Morse Practice Osc., 90p. S.S.M. Converters, RSGB Publications etc., 2 mtr. xtals.

Large selection of S/hand gear too fast moving to advertise, due to rallies, etc. (s.a.e. for lists). All guaranteed. More wanted for cash. C.U. at: Elvaston Castle, and the Anglian Mobile Rally. If you require special items, ring and we will bring them along.
H.P., Full Service, Car Park, Closed Tuesday.
Translation Service (S.A.E. details)

HEAD MICROPHONE UNITS

FOR MOBILE OR
FIXED STATION



Model C-Ceramic Unit and heat resistant at £4.95 post paid.

Model X-Crystal Unit at £4.60 post paid.

Ask your dealer about them, they may be in stock or from

'BOOMMIKE' P.O. Box 7, CHESTERFIELD, DERBYSHIRE

**CITY OF BIRMINGHAM
Police Department
WIRELESS TECHNICIAN**

Salary: Technical Grades 2/3 £1,059-£1,416 per annum or Grade 4 £1,416-£1,653 per annum according to experience, qualifications and ability.

Wireless Technician required for the repair and maintenance of mobile and personal radio sets used by Birmingham Police, Fire and Ambulance, and other Departments.

Applicants should be familiar with principles of transmitter and receiver design, and experienced in fault finding techniques. Interesting and worthwhile work with a 37½ hour week.

Applications should be received within 14 days addressed to: STAFF APPOINTMENTS, P.O. BOX 29, Council House, Birmingham, B1 1BB.

PLEASE STATE REFERENCE NUMBER 43/W/T/1/4 ON LETTER AND ENVELOPE.

(V 10523)

Quartz Crystals

ANY frequency between: 24.000 to 24.333 MHz for 2m. Made to order to .005% tolerance at 95p each, post free.

Holder choice: HC6/U, HC18/U, HC25/U.

State frequency and holder style required.

SENATOR CRYSTALS

36 VALLEYFIELD ROAD,
LONDON, SW16 2HR

Sole agents for NKD Crystal Co.

THE TRADING POST G8FET
7 CASTLE ST., HASTINGS, T. H. RANSOM
SUSSEX. TEL. HAS 4

95p inc. P.P.	2 METRE XTALS	HC6/U
24-025 MHz = 144.150		24-172 MHz = 145.056
24-038 " = 144.228		24-182 " = 145.092
24-041 " = 144.248		24-198 " = 145.188
24-058 " = 144.348		24-205 " = 145.230
24-070 " = 144.420		24-212 " = 145.272
24-085 " = 144.510		24-220 " = 145.320
24-110 " = 144.660		24-232 " = 145.392
24-125 " = 144.750		24-245 " = 145.470
24-135 " = 144.810		24-258 " = 145.548
24-142 " = 144.852		24-268 " = 145.608
24-150 " = 144.900		24-278 " = 145.688
24-162 " = 144.972		24-288 " = 145.728
24-166 " = 144.996		

SPECIAL OFFER: 1 MHz HC6/U @ 75p
XTALS CUT TO ANY FREQ. IN HC6/U
-HC18/U-HC25/U
PRICES ON APPLICATION

C. D. TELECOMMS (L'pool)

44 IMPERIAL CHAMBERS,
62 DALE STREET, LIVERPOOL, L2 5SX

Radio Telephones. Mobile 10 watts A.M. All transistorised Rx. Valve Tx. PTT mic. 12v. DC. Lo-Band. Few only at ... £23.50 (carriage paid)

V.H.F. Rxs. This is a small self-contained Rx as used by Fire, Police, Ambulance. Double-superhet multi-channel Xtal-controlled. Built-in spkr. Ideal for conversion to 2m. Mains operated ... £25.00 (carriage paid)

U.H.F. Rxs. F.E.T. Front end. Available next month. Anticipated price... £40.45

Still Available. 15 watt R/T mobiles, as advertised April S.W.M.

Terms of Business: Cash with order. Cheques, etc. made payable to C.D. Telecomms. Callers by appointment.

HOLDINGS



Swop your camera for
YAESU TRIO?

Transceivers and receivers on dem. Send large S.A.E. for R.S.G.B. test report on JR.310 with our top band, 144 MHz con. use cal. unit etc. Borrow a manual for 7 days. 12 month guarantee.

HOLDINGS PHOTO AUDIO CENTRE,
39/41 MINCING LANE, BLACKBURN, BB2 2AF.
Tel: 59595/6

BERNARD BOOKS

- COIL DESIGN AND CONSTRUCTION MANUAL 35p post paid
 HANDBOOK OF TESTED TRANSISTOR CIRCUITS 45p post paid
 HOW TO MAKE AERIALS FOR T.V. (Band 1 & 3) AND V.H.F. (Band 2) 23p post paid
 HIGH FIDELITY LOUDSPEAKER ENCLOSURES 23p post paid
 RADIO & ELECTRONIC COLOUR CODES & DATA CHART 21p post paid
 RADIO TELEVISION AND ELECTRONICS DATA BOOK 23p post paid
 TRANSISTOR CIRCUITS MANUAL No. 1 21p post paid
 HANDBOOK OF TRANSISTOR EQUIVALENTS & SUBSTITUTES 45p post paid
 HANDBOOK OF RADIO, T.V., & INDUSTRIAL TUBE & VALVE EQUIVALENTS 45p post paid
 WORLD'S SHORT WAVE MEDIUM & LONG WAVE RADIO STATIONS & FM & TV LISTING 41p post paid

Available from

SHORT WAVE MAGAZINE

Publications Dept., 55 Victoria Street,
 London, SW1H 0HF 01-222 5341/2

(Counter Service, 9.30-5.15, Mon. to Fri.)

(Nearest Station : St. James's Park)

(GIRO A/c. No. 547 6151)

RADIO COMMUNICATION HANDBOOK

Fourth Edition of the
 Original RSGB "Amateur Radio Handbook"

Price £3.15

(+ post and packing 35p.)

Available from stock

Order from

**PUBLICATIONS DEPT.
 SHORT WAVE MAGAZINE LTD.,
 55 VICTORIA STREET, LONDON, SW1H 0HF**

"DX ZONE MAP"

In four colours, on durable paper for wall mounting, 35in. wide by 25in. deep. Giving essential DX information—bearing and distance of all parts of the world relative to the U.K., the 40 Zone areas into which the world is divided for Amateur Radio purposes, with major prefixes listed separately. Distance scale in miles and kilometres. Time scale in GMT. Marking of Lat./Long. close enough for accurate plotting. Hundreds of place names, mainly the usual ones, and most of the rare islands.

With new revised Prefix List

Price 85p

including postage and special packing in
 postal tube to avoid damage in transit.

Publications Dept.

Short Wave Magazine Ltd., 55 Victoria Street,
 London, SW1H 0HF (01-222 5341/2.)

RADIO AMATEUR'S HANDBOOK

49th Edition — 1972

The only technical publication to appear in the American all-time non-fiction best-seller list—the ARRL Handbook has sold over four million copies since the first edition in 1926. Presents Amateur Radio theory and practice in terms of application—is constantly revised and brought up-to-date, with proven, practical designs covering the whole field of Amateur Radio activity.

New edition in 25 chapters, fully indexed, 700 pages, illustrated with diagrams and photographs on nearly every page.

Is a constant and reliable source of reference for all technical problems, ideas and constructional projects associated with Amateur Radio. Has been recognised as the standard text for radio amateurs for more than 40 years. Of interest both as a technical manual and recommended for easy bedside reading for anyone interested in Amateur Radio.

Available from stock at £2.85 (limp cover) or £3.65 in hard-back. Post free, immediate delivery, securely packed.

PUBLICATIONS DEPT.

SHORT WAVE MAGAZINE

55 VICTORIA STREET,
 LONDON, SW1H-0HF

(01-222 5341/2)

MORSE MADE EASY !!!

FACT NOT FICTION. If you start **RIGHT** you will be reading amateur and commercial Morse within a month. (Normal progress to be expected.)

Using scientifically prepared 3-speed records you automatically learn to recognise the code RHYTHM without translating. You can't help it, it's as easy as learning a tune. 18-W.P.M. in 4 weeks guaranteed. For Complete Course 3 Records & Books send £4.50 (overseas £1 Extra).

For Further details of course Ring 01-660 2896/01-668 3255 or send 4p stamp for explanatory booklet to :-
 G3HSC (Box 14) 45 GREEN LANE, PURLEY, SURREY.

To become a Direct Subscriber costs you (first-class posting) £3.00 for a year of twelve issues, starting any time now. Orders to Circulation Dept., Short Wave Magazine, Ltd., 55 Victoria Street, London, SW1H-0HF

GUIDE TO BROADCASTING STATIONS

16th Edition

Hiffe & Son Ltd. 164 pages 60p (inclusive of p. & p.)

CONTENTS

Long- and Medium-Wave European Stations : Some L.W. and M.W. Stations outside Europe : Short-Wave Stations of the World : Stations outside Europe : Short-Wave Stations of the World : Map of Broadcasting Regions : European Standard Frequency Transmitters : Short Wave Broadcasting Bands : Wavelength and Frequency Conversion : European Television Stations : European VHF Sound Broadcasting Stations : Internationally Allocated Call Signs.

Available from stock:

PUBLICATIONS DEPT.

SHORT WAVE MAGAZINE

55 VICTORIA STREET, LONDON, SW1H 0HF

Technical Books and Manuals

(ENGLISH AND AMERICAN)

AERIAL INFORMATION

ABC of Antennas	90p
Aerials (By D. Sjobbema)	88p
Aerial Handbook (Briggs)	87p
Amateur Radio Antennas (Hooton)	£1-87
Antenna Handbook, Volume 1	£1-77
Antenna Round-Up, Volume 1	£1-47
Antenna Round-Up, Volume 2	£1-77
Antenna Handbook, 12th Edition	£1-40
Beam Antenna Handbook	£2-10
Ham Antenna Construction Projects	£1-47
Quad Antennae	£1-80
S9 Signals	87p
73 Vertical, Beam and Triangle Antennas (by E. M. Noll)	£2-40
73 Dipole and Long-Wire Antennas (by E. M. Noll)	£2-20
SWL Antenna Construction Projects	£1-38

BOOKS FOR THE BEGINNER

Amateur Radio (Rayer)	£1-60
Beginners Guide to Radio (7th Edition)	£1-12
Beginners Guide to Electronics (N.E.)	£1-10
Beginners Guide to Transistors	£1-12
Beginners Guide to Colour TV	82p
Better Short Wave Reception	£1-80
Course in Radio Fundamentals	62p
Foundations of Wireless and Electronics Guide to Amateur Radio	£2-02 50p
How to Become a Radio Amateur	59p
Morse Code for the Radio Amateur	15p
Learning the RT Code	27p
Radio, by D. Gibson	85p
Radio Amateur Examination Manual (N.E.)	89p
Short Wave Listener's Guide (N.E.)	O/P
Simple Short Wave Receivers (Data)	89p
Understanding Amateur Radio	£1-37

GENERAL

ABC of Electronics (by Färl J. Waters)	£1-20
ABC of FET's	£1-35
ABC's of Short Wave Listening	£1-02
ARRL Calculator, Type A	92p
ARRL Calculator, Type B	72p
Building Your Amateur Radio Novice Station (by W7OE)	£1-57
Easibinder	90p
Easibinder (to hold 12 copies of Short Wave Magazine together)	90p
FET Circuits (by Rufus P. Turner)	£1-52
FET Principles, Experiments and Projects	£2-15
Guide to Broadcasting Stations (16th Edition)	60p
Having Fun with Transistors	£1-59
How to Listen to the World 1971—Edition	£1-37
Know Your Oscilloscope (by Paul C. Smith)	£1-80
Practical Ham Radio Projects (by W6NJV)	O/P
Practical Integrated Circuits (Newnes-Butterworth)	£1-01
Practical Transistor Theory	£1-10
Practical Wireless Circuits	£1-34
Radio Engineers Pocket Book (Newnes) N.E.	£1-26
RCA Receiving Tubes Manual	£1-77
RCA Transistor Manual (N.E.)	£1-75
RCA Transmitting Tubes	£1-35
Shop and Shack Shortcuts	£1-75
Single Sideband: Theory & Practice (by H. D. Hooton)	£3-47
Television Explained Vol. I	£1-35

Television Explained Vol. II	£1-37
Telecommunications Pocket Book (T. L. Squires)	£1-32
World Radio and TV Handbook 1972 Edition	£2-80
110 Integrated Circuit Projects for the Home Constructor	£1-22
49 Easy Transistor Projects	£1-01
110 Semi-Conductors Projects for the Home Constructor (Iliffe)	£1-37

HANDBOOKS AND MANUALS

Amateur Radio DX Handbook	£2-17
Electronic Circuit Handbook, Vol. 1	£1-42
Electronic Circuit Handbook, Vol. 2	£1-42
Mobile Handbook, CQ	£1-40
Mobile Manual, ARRL	£1-40
New RTTY Handbook	£1-80
Radio Amateur Handbook 1972 (ARRL)	£2-85
Radio Amateur Handbook 1972 (ARRL) (Hard Cover)	£3-65
Radio Amateur Operators Handbook, 12th Edition	53p
Radio Communication Handbook (RSGB)	£3-50
Rtty A-Z (CQ Tech. Series)	£2-25
Surplus Conversion Handbook	£1-37
Transistor Substitution Handbook No. 10	£1-12

USEFUL REFERENCE BOOKS

Amateur Radio SSB Guide	£1-59
Amateur Radio Techniques (N/E)	O/S
Amateur Radio Construction Projects	O/P
Amateur Radio Circuit Book	70p
Guide to Amateur Radio	50p
Engineers' Pocket Book—6th Edition	£1-48
'G' Call Book 1972	60p
Hams' Interpreter	63p
Hints and Kinks, Vol. 8 (ARRL)	62p
Radio Amateur Examination Manual (N.E.)	89p
Operating an Amateur Radio Stat.	25p
Radio Data Reference Book (3rd Edition)	£1-00
Radio, Valve and Transistor Data (Iliffe), 9th Edition	89p
Service Valve and Semiconductors Equivalents	35p
Single Sideband for the Radio Amateur (ARRL), 5th Edition	£1-67
Single Sideband (Theory & Practice) by H. D. Hooton	£3-47
Sun, Earth and Radio by J. A. Ratcliffe	91p
Surplus Schematics (CQ)	£1-22
Transistor Pocket Book	£1-57
Q & A on Audio	54p

TRANSISTOR MANUALS

ABC of Transistors	£1-33
Handbook of Transistor Circuits	£2-35
Transistor Fundamentals: Basic Semi-Conductor and Circuit Principles, Vol. 1	£1-92
Transistor Fundamentals: Basic Transistor Circuits, Vol. 2	£1-92
Transistor Fundamentals: Electrical Equipment, Circuits, Vol. 3	O/P
Transistor Fundamentals: Student's Workbook	£1-92
Transistor Substitution Handbook, No. 10	£1-12
Using 'Scopes in Transistor Circuits	£1-77

VHF PUBLICATIONS

VHF Handbook, Wm. I. Orr	£1-79
VHF Manual (ARRL)	£1-37
VHF/UHF Manual (RSGB) N/E	£1-80

The above prices include postage and packing.

Many of these titles are American in origin.

Available from

Publication Dept., 55 Victoria St., London SW1H 0HF

(Counter Service. 9.30-5.15. Mon. to Fri.)

SHORT WAVE MAGAZINE

01-222 5341

(Nearest Station: St. James's Park)

(GIRO A/C. No. 547 6151)

P. & P. DEVELOPMENTS

Havant 72657
Shop Hours

WE SPECIALISE IN VHF EQUIPMENT
FOR THE PROFESSIONAL AND AMATEUR

Cosham 74695
Evenings, Weekends

END OF YEAR CLEARANCE SALE

LOW BAND FM BASE STATION. Ideal for 4 metres. Immaculate condition. Complete but less control box ... £20 P.P. £1

LOW BAND GEC FM COURIERS. Personal R.T. units. Modern design and appearance. Double superhet receiver 1.5 uv at 15 dB sig/noise transmitter 500 mw rf output. Complete with mic, earpiece and circuit diag. ... £18 P.P. 75p

GEC LANCONS. Mid band RT's FM not less than 250 mw rf output, double superhet receiver luv sensitivity at 15 dB sig./noise. £10.50 P.P. 50p

HUDSON VHF FM BASE STATION. Complete low band TX/RX. Ideal 4 metre. Good condition ... £25 P.P. £1

GEC LOW BAND BASE STATION. QQV03-20A in final complete TX/RX in unused condition ... £30 P.P. £2

MARCONI OCEANPHORES. High band F.M. base stations, 16 channels QQV06-40A in final, complete mic handset £32 P.P. £2

COSSOR CC40 BASE STATION. Complete high band base station. Includes RX, TX and RF adaptor, which includes another TX modules. In cabinet but less connecting leads ... £30 P.P. £12

PLESSEY TX/RX. Similar to the 20002 high band £10 P.P. 50p

TRANSMITTER INVERTER SUPPLIES. As new.

24v. D.C. input, 425v. D.C. output, 125 watts ... £4.50 P.P. 50p

24v. D.C. input, 600v. D.C. output, 125 watts ... £4.25 P.P. 50p

24v. D.C. input, 500v. D.C. output, 250 watts ... £5 P.P. 50p

MARCONI ELECTRA. General coverage Rx. ... £15 P.P. £1

PYE CAMBRIDGE 12½ kHz. AM108 high band 6 channel. Complete with all accessories ... £60 P.P. £1

STORNO COMBI MOBILE. High band F.M. TX/RX. Complete with handset and control box ... £17.75 P.P. 50p

BCC BASE STATION. AM high band QQV06-40A in final. Mains operation ... £30 P.P. £2

PYE BANTAM. High band FM complete in very good condition. £39.50 P.P. 50p

B44 Mk. III. Ideal 4 metre ... £8 P.P. 50p

COSSOR CC15. Boot mounted low band mobiles, QQV03-20A in final. Ideal 4 metre, complete with mic, control box and leads and speaker ... £22.50 P.P. 75p

REDIFON GR 286. VHF high band TX/RX. Mains operation, 36 channel. Complete with hand set ... £32 P.P. £1.50

PYE WESTMINSTER. Low band F.M. complete with speaker, leads, mic., etc. Brand new and complete ... £70 P.P. 50p

HEATHKIT DX 100U. Very clean ... £35 Carriage paid

VHF FIBRE GLASS WHIP AERIALS. Ideal for cutting to ¼ wave on 2m. ... £1 carr. paid

MULLARD CERAMIC TRIMMERS. Type COQEA/6E, 0-6pf as used in many converters ... each 13p

UNMARKED CERAMIC TRIMMERS. 0-10 pf ... each 5p

EAGLE EQUIPMENT. S.A.E. for catalogue.

We can now supply Yaesu Musen and KW equipment. Trade-ins with pleasure. HP or personal loans easily arranged. S.A.E. for lists of other equipment in stock.

Terms of business: Mail Order only, CWO, min. order 25p. Carriage prices for delivery outside England and Wales will be extra. Viewing of equipment by appointment.

Agent: GBDOW, 20 Selhurst Way, Fair Oak, Eastleigh, Hants
19 LONE VALLEY, WIDLEY, COSHAM, PORTSMOUTH, HANTS.

For some recommended titles, taken from our main list of publications in "Short Wave Magazine" every month and briefly described when space allows, see May '72, pages 136 & 184.

WORLD RADIO/TV HANDBOOK 1972

The World's only complete reference guide to International Radio & Television Broadcasting Stations. It includes: Frequencies, time schedules, announcements, personnel, slogans, interval signals and much more besides of value to the listener.

Lists all International short-wave stations, including frequencies, for each country; foreign broadcasts, long and medium wave stations (AM broadcast Band), TV stations and domestic programmes. Long recognised as the established authority by broadcasters and listeners. It is the only publication that enables you to identify BC stations quickly and easily. Enables you to fill more pages in your log book on the SW BC bands and helps you add more BC-station QSL cards to your collection.

£2.80

(The above price includes postage and packing).

from:

SHORT WAVE MAGAZINE
55 Victoria Street, London, SW1H 0HF

"CALLBOOK"

The "Call Book" proper is now published only once a year, in December, in two parts, "U.S." and "DX Listings."

Supplements to both editions appear at quarterly intervals, obtainable by prior order direct from the publishers.

We supply the "Call Book" as an annual publication, as required at any time during the year. We shall not be handling the quarterly supplements. These will be available only direct from the publishers.

This comprehensive reference lists about 300,000 licensed radio amateurs in the United States Directory and 160,000 or more in the rest of the world (contained in the "DX Section"). In the U.S. Section, licence classifications are shown with revised listings of new licences, names and addresses. The CALLBOOK also includes much incidental DX information. Every amateur operator and SWL needs the CALLBOOK to get the most out of Amateur Radio.

DX Listings £3.10

US Listings £4.10

The two together, covering the World, £6.80

The above prices include postage and packing.

Your order to:

Publications Dept.,

SHORT WAVE MAGAZINE

55 Victoria Street, London, SW1H 0HF

01-222 5341