

The SHORT WAVE Magazine

VOL. XXI

SEPTEMBER, 1963

NUMBER 7

K.W. ELECTRONICS for all your Amateur Radio Requirements

THINK OF THE ADVANTAGES OF S.S.B.

TVI problems diminished — much easier DX — no heterodynes — no phase distortion — less band occupancy, etc., etc.

The KW "VICEROY" SSB Transmitter and KW77 Receiver make a fine pair. FOR EXTRA POWER the KW500 LINEAR!

DO NOT DELAY — GO SSB TODAY.

Why not consult us at KW.

WE ALSO STOCK:

KW "Vanguard" Transmitters.

KW 160 Top Band Transmitters.

ROTATORS—CDR AR22 and "HAM-M"

BEAMS—Mosley, Hy-Gain, MHC 2 inerec curtain.

AERIALS—K.W. & Mosley, GIFF & Webster Band-spacer (mobile).

VFO's—Geloso, Shure, Acos.

FILTERS SSB—McCoy Crystal and Kubota Mechanical.

FILTERS—High Pass and Low Pass.

RELAYS—Dow Key Co-axial type.

SIG. GENERATOR—Nom-brex Transistorized.

CABLE—Co-ax 75 and 52 ohm, 15 s.w.g. enamelled copper.

POLYTHENE CORD—280 lb. and 350 lb. strain.

SWR - INDICATOR — KW Match 75 or 52 ohm.

CONVERTER — Front-end KW, Geloso.

PLUGS, SOCKETS, PI COILS, R.F. CHOKES, etc.

JUST ARRIVED! TOKAI "Walkie-Talkie" all Transistorized Transceiver. TX and RX crystal controlled on 28.5 mc/s.

Range 3—4 miles across town, line of sight 10 miles. Ideal for Emergency Services, Mobile operation, Rallies, Beam adjustment, etc. Size 6 $\frac{1}{2}$ " x 2 $\frac{5}{8}$ " x 1 $\frac{1}{2}$ ". Weight 1 $\frac{1}{2}$ lb.

Complete with telescopic aerial, in leather case, with batteries £19 - 10 - 0 each (plus 5/- carriage and insurance).

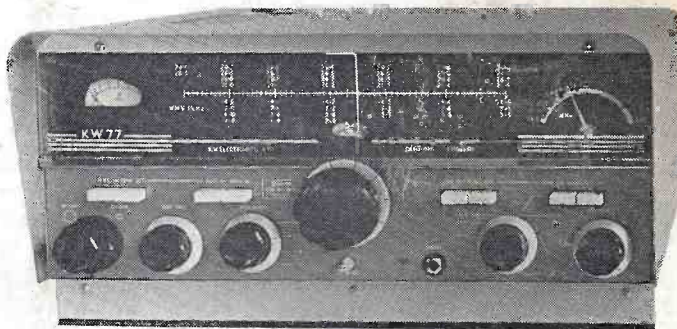

The KW77 Receiver

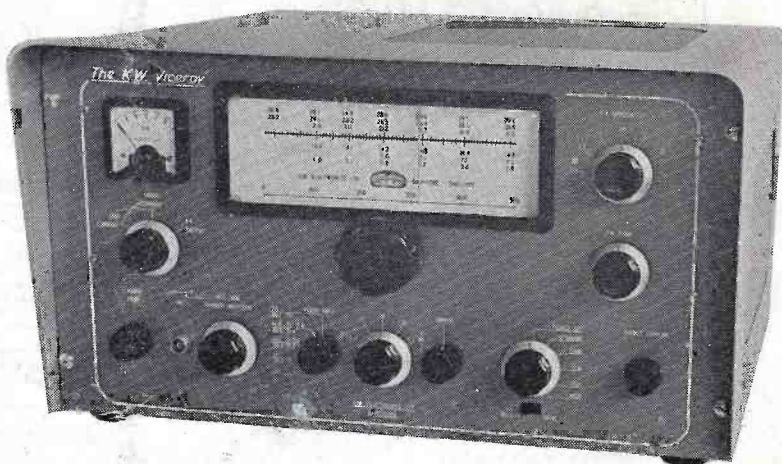

The K.W. 'Viceroy' (Mark III)

EASY TERMS AVAILABLE

Importers of U.S.A. Equipment.

KW

ELECTRONICS LTD Vanguard Works

1 HEATH STREET, DARTFORD, KENT

Cables: KAYDUBLEW, Dartford

Phone: DARTFORD 25574

EVERYTHING FOR THE ENTHUSIAST

AERIAL EQUIPMENT

TWIN FEEDER. 300 ohm twin ribbon feeder similar K25 6d. per yard. K35B Telecon (round) 1/6 per yard. 75 ohm twin feeder 6d. per yard. Post on above feeders and cable, 1/6 any length.

COPPER WIRE, 14G, H/D, 140 ft., 17/-; 70 ft., 8/6, post and packing 2/6. Other lengths pro rata.

RIBBED GLASS 3" AERIAL INSULATORS. 1/9 each, P. & P. 1/6 up to 12.

SHELL INSULATORS 2" 9d. each, P. & P. 2/- up to 12.

FEEDER SPREADERS. 6" Ceramic type F.S., 10d. each. Postage 1/6 up to 12.

CERAMIC CENTRE PIECE for dipoles, Type AT, 1/6 each, P. & P. 1/-.

2 METRE BEAM, 5 element W.S. Yagi. Complete in box with 1" to 2 1/2" masthead bracket. Price 49/- P. & P. 3/6.

SUPER AERIAL, 70/80 ohm coax, 300 watt very low loss, 1/8 per yard, P. & P. 2/-.

FOR THE DX ENTHUSIAST MOSLEY TRAP BEAMS

Vertical 3 Band V3 ... £7 10s.
3 Band 3EL Beam TA 33dr. £24 15s.
Also the **NEW Single Band Power Beams.** Send for details.
50 ohm, 300w. 1/2" coax Low loss. Ideal for Mosley and other beams, 1/9 per yd. P. & P. 2/-.

BARGAIN TRANSFORMER OFFER. Made by Parmeko, half shrouded with screened primary, 200-240v. tapped, 200-0-200v., 40 mA., 6.3v. 3Amp. Only 12/6, P. & P. 2/6. These are not Ex W.D.

FOSTER DYNAMIC MICROPHONES. Type DFI, HIZ, 50k. with stand and halter. Superb quality 52/6 P. & P. 2/-.

METERS. 3 1/2" Round 2 1/2" Scale, 2 Types 0-10 mA. and 0-100 mA. 15/- each, P. & P. 1/6. 0-1/2 Amp. Thermo 2 1/2" 7/6 each, P. & P. 1/6.

TRANSMITTING VARIABLES. Type TS 80S 80pf, Split Stator 80pf. per section .070 spacing, 22/6 each, P. & P. 2/6.

NEUTRALISING CONDS. Type N.C. 15, 15pf. max. .090 spacing, 4/6 each, P. & P. 1/6.

MIC 40 XTAL HAND MIKES. New Boxed, 19/6, P. & P. 1/6.

B.I. 8 MFD. 1200v. D.C. W/kg. Capacitors, 12/6 each. Post paid.

SCREENED MICROPHONE CABLE. 1st grade, 9d. yard. Plus postage.

10 CORE (5 PAIRS) SCREENED CABLE. 1/8 yard. Alt. plus 2/6 P. & P.

ROTARY TRANSFORMERS. 12v. input 490v. 65 Ma, output, 17/6 each. P. & P. 3/6.

FERRITE BEADS for the S Band Aerial, 50 for 15/- or 100 for 30/- post paid.

150 OHM VERY LOW LOSS BEADED COAX. 20 yard lengths, only 10/- each. Post free.

TOUGH POLYTHENE LINE. Type MLI (100 lbs.) 2d. per yard or 12/6 for 100 yards. Type ML2 (220 lbs.) 4d. per yard, or 25/- per 100 yards, post free.

ABSORPTION WAVEMETERS. 3.00 to 35.00 Mc/s. in 3 Switched Bands. 3.5, 7, 14, 21 and 28 Mc/s. Ham Bands marked on scale. Complete with indicator bulb. A MUST for any Ham Shack. ONLY 22/6 EACH. Post free.

VARIABLE CONDENSERS. All brass with ceramic end plates and ball race bearings. 50pf, 5/9, 100-6/6, 160, 7/6, 240, 8/6 and 300pf, 9/6. Extension for ganging, P. & P. 1/-.

RACK MOUNTING PANELS: 19" x 5 1/2", 7", 8 1/2", or 10 1/2", black crackle finish, 5/9, 6/6, 7/6, 9/- respectively. P. & P. 2/-.

EDDYSTONE TRANSMITTING VARIABLES. Type 611, 25 x 25 pF, .08" Gap, 612, 50 x 50 pF and 725, 100 pF. Diff. All 10/- each. Post free.

GELOS VFO UNITS. 4/102 with new dial and escutcheon. Outputs on 80, 40, 20, 15 and 10. For 2-807 or 6146 Tubes. Only £8 13 6. 3 valves to suit, 24/- ALL POST FREE.

SHADED POLE MOTORS, 230 v. or 110 v. operation, ideal for fans, blowers or models. Single Unit 12/6 plus 2/- P. & P. or Pair £1 plus 2/6 P. & P.

AMATEUR RADIO
CHAS. H. YOUNG LTD.

170-172 CORPORATION ST.
BIRMINGHAM 4
Telephone No.: CEN 1635

LASKY'S RADIO

COMMUNICATIONS RECEIVER Model S.R.40

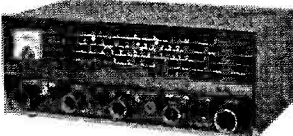

Covers medium waveband and 1.6-4.4 Mc/s, 4.5-11.0 Mc/s, 11.0-30.0 Mc/s in separate switched band spread ranges. Controls include B.F.O., Sensivity, A.N.L., Receive-Standby Switch, Tone Switch, S-Meter. For 200/250v. AC/DC. Internal loop and telescopic antennas fitted. Valve line up, 12B6E, 12BA6, 12AV6, 50C5, and metal rectifier. BRAND NEW and BOXED.

LASKY'S PRICE

£24. 15. 0

Carr. and ins. 15/-
Instruction manual included.

first again—now offer the home constructor

FULL SHORT WAVE COVERAGE

The "SKYROVER" and the "Skyrover de luxe"

GENERAL SPECIFICATION :

7 transistor plus 2 diode superhet, 6 waveband portable receiver. Operating from four 1.5 torch batteries. The SKYROVER and SKYROVER DE-LUXE covers the full Medium Waveband and Short Waveband 31-94M, and also 4 separate switched band-spread ranges, 13M, 16M, 19M and 25M with Band Spread Tuning for accurate Station Selection. The coil pack and tuning heart is completely factory assembled, wired and tested. The remaining assembly can be completed in under three hours from our easy to follow, stage by stage instructions.

SPECIFICATION

Superhet, 470 Kc/s.
Uses 4-U2 batteries.
Easy to read Dial Scale.
500 MW Output.
All Mullard Transistors and Diode.
5 in. Ceramic Magnet P.M. Speaker.
Band Spread Tuning.
Telescopic Aerial and Ferrite Rod Aerial.

WAVEBAND COVERAGE :

180-576M ; 31-94M and Band Spread on 13, 16, 19 and 25 metre Bands.

ALSO AVAILABLE FOR HOME CONSTRUCTION

The Realistic '7', £5. 19. 6. The Realistic '7' de-luxe, £6. 19. 6. Post and Packing 4/6. Battery 3/9 extra. The Sprite, £3. 19. 6. Post and Packing 3/6. Real calf leather case, wrist strap, personal earphone and case, and battery 12/6 the lot extra. The Carover '6', £5. 7. 6. Post and Packing 4/- extra. Batteries 1/4 extra. All data instructions separately 2/6, refunded if parcel purchased. (All components available separately.)

The SKYROVER

Controls: Waveband Selector, Volume Control with on/off Switch, Tuning Control. In plastic cabinet, size 10 x 6 1/2 x 3 1/2 in. with metal trim and carrying handle.

Can be built for

£10. 19. 6 P. & P. 5/- extra

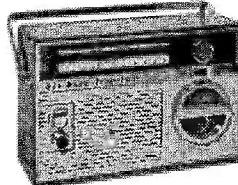

The SKYROVER de luxe

Tone Control Circuit is incorporated with separate Tone Control in addition to Volume Control. Tuning Control and Waveband Selector. In a wood cabinet, size 11 1/2 x 6 1/2 x 3 in., covered with washable material, with plastic trim and carrying handle. Also car aerial socket fitted.

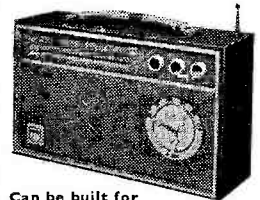

Can be built for

£12. 19. 6 P. & P. 5/- extra

Data for each receiver: 2/6 extra. Refunded if you purchase the parcel. Four U2 batteries, 2/8 extra. Four Leak-proof batteries, 3/4 extra. (All components available separately.)

207 EDGWARE ROAD, LONDON, W.2.

A few yards from Praed St.
PADddington 3271/2

Both above addresses open all day SATS. Closed 1 p.m. THURS.

33 TOTTENHAM COURT ROAD, W.1.

2 mins. Oxford St. Nearest Station, Goudge St.
MUSeum 2605

152/3 FLEET STREET, LONDON, E.C.4.

FLEEt St. 2833

Open all day THURS. Closed 1 p.m. SATS.

Please address all mail orders and correspondence to HEAD OFFICE :—207 Edgware Road, London, W.2.

FREE INSIDE EVERY COPY!

PRACTICAL WIRELESS Ohm's Law Calculator for d. c. circuits

Presented Free with the
'Practical Wireless'
October, 1963

SCALE	POINTER	RESISTANCE	WATTS
1000	1000	1000	1000
100	100	100	100
10	10	10	10
1	1	1	1
0.1	0.1	0.1	0.1
0.01	0.01	0.01	0.01
0.001	0.001	0.001	0.001

To extend range, use
or total as above

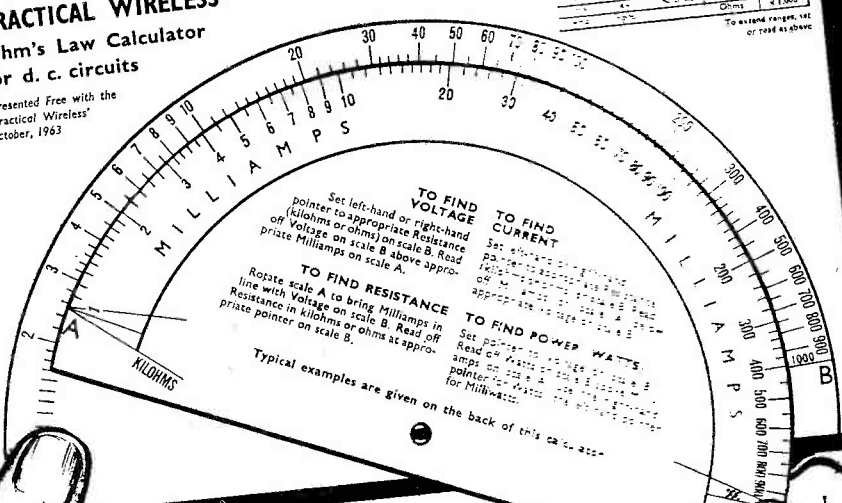

FOR CURRENT, VOLTAGE,
RESISTANCE AND WATTAGE

OHM'S LAW Calculator

Here's a *must* for radio constructors. Presenting Ohm's Law in concise, easy-to-use form, this specially designed Calculator gives the answers to most basic problems, enabling you to make at-a-glance calculations for Circuit Design, Fault Tracing, Circuit Testing and Component Selection. Don't miss yours — FREE inside the October PRACTICAL WIRELESS.



PRACTICAL WIRELESS

OCTOBER ISSUE
ON SALE SEPT. 6-2/-
Make sure of your copy!

Technical Publications— Short Wave Magazine

Magazines by Subscription

	<i>One Year</i>
73 MAGAZINE.....	30s. 0d.
CQ, RADIO AMATEUR'S JOURNAL.....	44s. 0d.
QST, ARRL.....	48s. 0d.

Post free, ordinary mail only

Easibinders for Short Wave Magazine, holds 12 issues (one volume) 13s.

LATEST ISSUES

Radio Handbook (16th Edition)

Published by *Editors & Engineers*, W6-U.S.A. 800 pages. Durable publishing. A magnificent book in every way.
Price 78s. post free

Radio Amateur Call Book

The CALL BOOK is published in two parts: *American* Section only, at 45s. post free; *Foreign* (non-American) Section at 27s. post free. Both Editions appear quarterly and include latest call sign/address listings for all countries, with much DX data. The only complete directory to the radio amateur stations of the world.

American Section, Summer Edition 45s.; *Foreign* (non-American) section, Summer Edition, 27s.

The two together at 65s. post free. Fall Edition end of September.

Radio Amateur's Handbook

1963 EDITION — 740 pages fully indexed. All Amateur Radio.

Published by the American Radio Relay League

Price: Standard Binding 37s. 6d. post free.

Bound in Buckram, de luxe, 47s. 6d. post free.

DX Zone Map (Revised October 1962)

(Great Circle, centred U.K., size 25ins. by 35ins. A "must" for every DX operator and SWL).

Linen Backed (*de luxe*) 11s. 0d. post free

Amateur Radio Map of the World

Much DX Information — In Colour, 8s. 6d. post free — Second Edition

World Short Wave Radio Map

(General SWL and BC coverage, with handbook) 8s. 6d. post free

Radio Amateur's World Atlas

A new publication, for desk use. Gives Zones and Prefixes.
8s. 3d. post free.

Available from Stock

Post Free

AMATEUR RADIO HANDBOOK (<i>new Publication by R.S.G.B.</i>), 550 pp.	36s. 6d.
AMATEUR SINGLE SIDEBAND (<i>Collins</i>)	30s. 0d.
ANTENNA ROUND UP (<i>by CQ</i>)	25s. 0d.
ANTENNA HANDBOOK (<i>A.R.R.L., 9th Edn.</i>)	19s. 0d.
A COURSE IN RADIO FUNDAMENTALS (<i>4th Edition</i>)	10s. 6d.
AUTOMOBILE ELECTRICAL EQUIPMENT	57s. 0d.
BASIC MATHEMATICS FOR RADIO AND ELECTRONICS	18s. 3d.
BEAM ANTENNA HANDBOOK	24s. 6d.
BETTER SHORT WAVE RECEPTION	24s. 0d.
CALL BOOK (<i>U.K. only</i>), 1963 Edition	5s. 0d.
CHART OF INTERNATIONAL FREQUENCY ALLOCATIONS — GENEVA, 1960 (<i>Official</i>), 10 Kc to 40 Gc, 51" x 34", wall mounting	8s. 3d.
COMMAND SETS (<i>Published by CQ</i>)	
Information on conversion of many Command Transmitters and Receivers	12s. 6d.
COMMUNICATION RECEIVERS	3s. 0d.
CQ ANTHOLOGY (the Best of CQ 1945—1952)	16s. 9d.
CQ ANTHOLOGY (1952-59)	25s. 0d.
DXERAMA (<i>3rd Edition</i>)	16s. 0d.
DX GUIDE	16s. 9d.
FOUNDATIONS OF WIRELESS	17s. 3d.
GUIDE TO AMATEUR RADIO	4s. 0d.
GUIDE TO BROADCASTING STATIONS (<i>13th Edition</i>) 112 pp.	4s. 0d.
HAMS INTERPRETER (<i>Published by OH2SQ</i>) (<i>4th Edition</i>)	8s. 6d.
HINTS AND KINKS, Vol. 6	11s. 0d.
HOW TO BECOME A RADIO AMATEUR★	5s. 0d.
HOW TO IMPROVE YOUR SHORT WAVE RECEPTION	14s. 9d.
HOW TO LISTEN TO THE WORLD, 1963/4	15s. 0d.
HOW TO GET THE BEST OUT OF YOUR TAPE RECORDER	9s. 1d.
LEARNING MORSE	1s. 9d.
LEARNING THE RADIO TELEGRAPH CODE	4s. 6d.
LOG BOOKS Spiral bound (<i>Published by A.R.R.L.</i>)★	7s. 6d.
MOBILE HANDBOOK (<i>Published by CQ</i>) (<i>2nd Edition</i>)	24s. 0d.
MOBILE MANUAL (<i>Published by A.R.R.L.</i>)	24s. 6d.
NEW RTTY HANDBOOK	32s. 0d.
NEW SIDEBAND HANDBOOK (<i>Published by CQ, latest issue</i>)	25s. 6d.
NOVICE HANDBOOK, Tx and Rx, 150 pages	23s. 6d.
OPERATING AN AMATEUR RADIO STATION (<i>Published by A.R.R.L.</i>)★	2s. 8d.
PORTABLE TRANSISTOR RECEIVER	3s. 0d.
QUAD ANTENNAS	23s. 0d.
RADIO AMATEURS' EXAMINATION MANUAL (<i>2nd Edition</i>)	5s. 6d.
RADIO CONTROL MANUAL	25s. 0d.
RADIO CONTROL FOR MODELS (<i>F. C. Judd</i>)	16s. 0d.
RADIO DATA CHARTS	11s. 3d.
RADIO DATA REFERENCE BOOK	14s. 0d.
RADIO DESIGNERS HANDBOOK (<i>4th Edition</i>) 1,498 pp. (<i>G. Langford Smith</i>)	57s. 6d.
RADIO AND ELECTRONIC LABORATORY HANDBOOK (<i>7th Edition, by Wireless World</i>)	57s. 3d.
RADIO INTERFERENCE SUPPRESSION	11s. 3d.
RADIO VALVE DATA 4,800 types listed	7s. 0d.
S-9 SIGNALS	8s. 6d.
SERVICING TRANSISTOR RADIOS	43s. 6d.
SCATTER PROPAGATION THEORY AND PRACTICE (<i>H. W. Sams</i>)	25s. 0d.
SHORT WAVE RECEIVERS For The Beginner	6s. 6d.
SHORT WAVE AND THE IONOSPHERE	11s. 9d.
SINGLE SIDEBAND FOR THE RADIO AMATEUR (<i>A.R.R.L.</i>) (<i>3rd Edition</i>)	18s. 6d.
STEREO HANDBOOK	11s. 4d.
SURPLUS SCHEMATICS (<i>Published by CQ</i>)	21s. 0d.
SURPLUS HANDBOOK (<i>See p.420, Oct. '61</i>)	24s. 0d.
SURPLUS CONVERSION MANUAL	
Vols. I, II and III, each	24s. 0d.
TELEVISION EXPLAINED	13s. 6d.
THE RADIO AMATEUR OPERATOR'S HANDBOOK (<i>Data Publications</i>)	5s. 0d.
TRANSISTORS: THEORY AND PRACTICE (<i>Published by Gernsback</i>)	23s. 0d.
TRANSISTOR THEORY AND PRACTICE (<i>Published by World Radio Handbook</i>)	9s. 6d.
TRANSISTOR TECHNIQUES (<i>Gernsback</i>)	12s. 6d.
UNDERSTANDING AMATEUR RADIO	19s. 0d.
VHF HANDBOOK (<i>Orr W6SAI</i>)	24s. 0d.
VHF FOR THE RADIO AMATEUR (<i>CQ</i>)	28s. 0d.
WORLD RADIO HANDBOOK, 1963 Edition	22s. 0d.
(★ Not strictly applicable under U.K. conditions)	

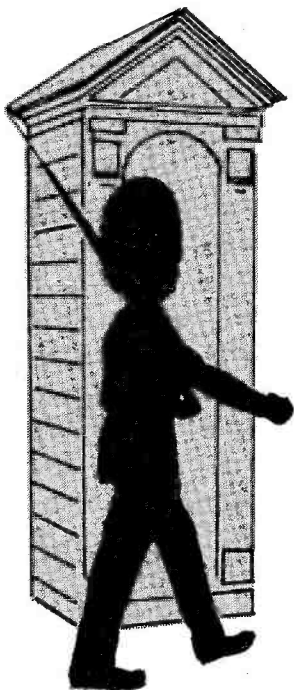

As Dependable as The Guards! Mosley Commando II

■ SINGLE SIDE BAND TRANSMITTER ■

BRITISH PATENTS NOS. 906,636 906,637

- ▶ 180 Watts P.E.P.
- ▶ AM/SSB/CW Modes.
- ▶ Lattice Filter Exciter.
- ▶ Pi Tank Output Circuit.
- ▶ Vox and Manual Operation.
- ▶ 10-80 Metre Bandswitching.
- ▶ Full Vision Eddystone Dial.
- ▶ Ideal for RTTY by Tone Injection.
- ▶ Selectable Upper and Lower Side-band.
- ▶ Three Change-Over Contacts for External Switching Functions.
- ▶ Adequate Output to Drive the Beefiest QRO Linear.

COMMANDO II incorporates many features which makes it *The Outstanding Transmitter Buy Today!* Only reliable "air-tested" circuitry is used. Power Supply is the latest cool-running Silicon Rectifier, fuse protected and conservatively rated. Power Amplifier employs two 6146 Tetrodes operating at 750 Volts Class AB₁ Linear Amplifier Service to give maximum I.C.A.S. rating at 180 watts P.E.P. The Pi-Tank circuit 10-80 metres band-switched gives efficient loading into low impedance coaxial lines. Sideband generation at 435 KC with half-lattice crystal filter for 45 dB sideband/carrier rejection. Sideband switch in "normal" position is correct for band in use, with an "inversion" switch to give choice of alternative sideband.

£140.0.0

It's MOSLEY AERIALS...

...For The BEST DX!

Amateurs, throughout the world, know that an outstanding signal depends, primarily, on the best aerial. When completing your dream station, install an aerial known the world over for its performance and craftsmanship. Mosley aerials are unequalled and consistently, give the frequency commanding signal necessary for top-notch, two way communication. Whether you work Local or DX, Insist On The Best, Rely On Mosley.

3 BAND BEAM AERIALS
FOR 10, 15 & 20
METRES.

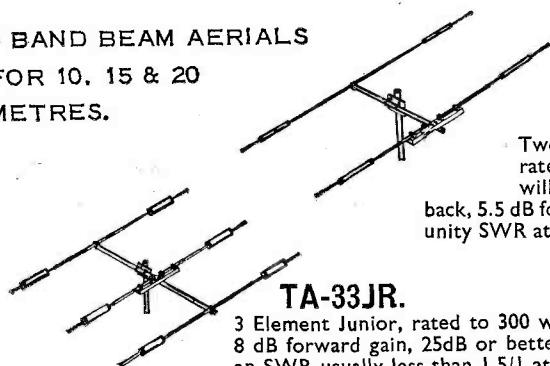

TA-32JR.

Two Element Junior, rated to 300 watts, will give 20dB front-to-back, 5.5 dB forward gain and near unity SWR at resonant frequency.
£17. 10. 0

TA-33JR.

3 Element Junior, rated to 300 watts, will give up to 8 dB forward gain, 25dB or better, front-to-back and an SWR usually less than 1.5/1 at resonant frequency. This aerial will give your signal real authority.
£24. 15. 0

Mosley

Electronics Ltd.

Representative in U.K.

O. S. CHILVERS, G3JOC
40 Valley Road, New Costessey,
NORWICH, Norfolk.
NOR.26.K.
Tel : Norwich 22147



A Subsidiary of
MOSLEY Electronics, Inc.
Bridgeton, Missouri, U. S. A.

Why not make good use of your spare time

AND JOIN THE

ROYAL NAVAL RESERVE COMMUNICATION BRANCH



Men and women between 16 and 26 may join but men with previous experience of this branch of the Royal Navy may be accepted up to the age of 45. Training takes place 2 or 3 evenings a week with opportunities for training at sea which might well entail visits to foreign ports.

You will not be out of pocket as Pay, allowances, bounty and uniform are provided.

Although we take our work seriously there is a social side giving you the chance to meet people with the same interests in a friendly atmosphere. There are Communication Centres and Units in many towns throughout the country.

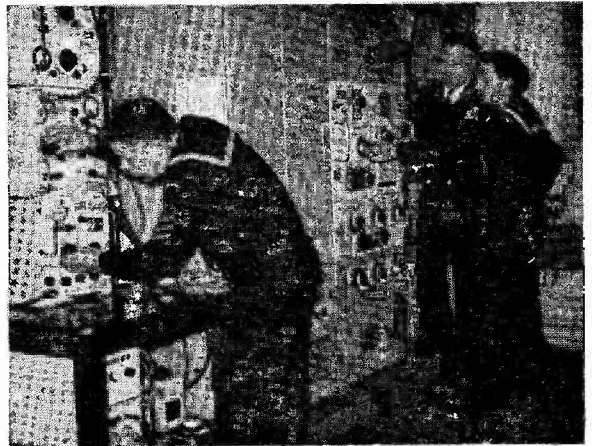

Write for full details of this interesting service to:-

**ADMIRAL COMMANDING RESERVES,
EMPRESS STATE BUILDING, LONDON, S.W.6.**

or ask at your nearest Royal Naval Careers Office.

The "SONAR" SSB Transceiver

for PERFORMANCE, RELIABILITY PLUS, no equipment can compare with SONAR'S specification and price.

- ★ 200 watts PEP input. 180 watts CW.
- ★ The RCA 7360 and Collins Mechanical Filter provide the ultimate in SSB selectivity and rejection of unwanted responses.
- ★ RECEIVER SENSITIVITY. 0.2 μ V for 10db s/n ratio.
- ★ STABILITY BETTER THAN 100 c/s. ★ 100 kc/s. Calib.
- ★ No BCI-TV1 with the SONAR.
- ★ BREAK-IN CW OPERATION.
- ★ SILKY-HAIRLINE TUNING ACCURACY.

PRICE £200

or **£20 deposit and 18 monthly payments £11**

DC 10, 12v. P.U. **£54.6.0** AC 10, **£54.6.0**

G. & D. 160m. and 2m. SSB ADAPTORS available soon, also Inexpensive Heavy duty P.S.U.'s for SONAR.

For further specifications please write stating interest to

GREEN & DAVIS
5 WEIR HALL GARDENS
LONDON, N.18

All Eagle Products and Components available as previously advertised

SILICON RECTIFIERS
New, 800 piv, 550 mA,
6/9 each. P.P. 6d.

GREEN & DAVIS 2 METRE NUVISTOR CONVERTER MkIII THIS VHF CONVERTER

is engineered to give YOU complete control over ALL signals, weak-strong-narrow-broad. It is designed as an INTEGRATED part of YOUR receiver system. There is no other converter on the market like it today.

- ★ EXCEPTIONALLY SENSITIVE.
- ★ LOW NOISE FACTOR. BETTER THAN 3.5db.
- ★ SHIELDED WIRING. ★ ANY IF OUTPUT. Conservatively rated P.S.U. COMPONENTS.
- ★ 4-VALVE LINE UP. 6CW4 - EF95 - EF95 - ECC91.
- ★ SEE IT AT YOUR LOCAL STOCKIST.
- ★ LONDON AGENT : WEBB'S, OXFORD STREET.
- ★ AVAILABLE EX-STOCK.

PRICE £8.19.6 including P.S.U.

(Write for Details)

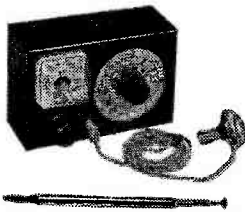

FIELD STRENGTH METER

1-250 Mc/s. 5 switched Bands. Dial calibrated in megacycles. 200 μ A basic movement. Magnetic base for convenient mounting. Very attractive design. Supplied with signal monitoring earpiece, and detachable 4 section telescopic aerial.

Now Ex-stock Only 69s. 6d.

Recommended by Partridge Electronics—"Joystick" manufacturers for use with their Ant.

★ We have solved your ANTENNA PROBLEM!



reg. trade mark

Are you a flat dweller, or do you live in a city centre with no space for antennas? With the "JOYSTICK" for 6 bands, INDOORS or outdoors, for mobile, boat, tent, caravan, field day, DX-peditions, etc. THIS... is the ANTENNA YOU'VE BEEN LOOKING FOR!! Be ON THE AIR IN SECONDS WITH THE MOST VERSATILE AND COMPACT 6 BAND ANTENNA IN THE WORLD!!

- Works ALL BANDS, 160, 80, 40, 20, 15, 10 metres, used INDOORS, or outdoors with longer feeder.
- Overall length 7ft. 6in. (4ft. 4in. collapsed for travel). Indoor Feeder supplied.
- No traps, radials, co-ax or other gadgets.
- Comes apart in seconds. Assembled and on the air in seconds. Will handle a KW.
- NO COILS TO CHANGE.
- Omni-directional radiation.
- THE IDEAL RECEIVING ANTENNA.

For peak output we recommend the RF40 FIELD INDICATOR AND PHONE MONITOR, available from stock 69/6.

Fantastic performance figures on request, e.g., VQ9A and JAs on 15m. by G3NFV ("JOYSTICK" INSIDE BUNGALOW); 5 and 8/9 report from GM2CPC on 40m. by GB3WRC using "JOYSTICK" standing on ground; Regular 5 and 9 reports received by G3HVI running 5 watts on 80m, with an INDOOR "JOYSTICK"; G3BKT exchanged 579 with OKIZC on 160m. and gets excellent reports on 80 CW with 4 watts (all with an INDOOR "JOYSTICK"). G3OTX worked all W Call areas in 14 days on 21 mc. using a "JOYSTICK" 20ft. high. The following appeared in *Radial*, May, 1963—"Jack Thomas of Anglesey, with the "JOYSTICK" upright by the side of the shack, found that on 80 and 160 reception equalled his 67ft. long wire, and on 20 metres it surpassed the L/W, bringing Stateside and Russian Stations 37-9 and on 15 metres he logged two ZBs that he could not hear on the L/W... From the XYL's angle I must praise the neatness and unobtrusive appearance of the antenna, surely even the most house-proud XYL could not object to having it adorning the house." (G3LWY).

Detailed additional reports available on request.

PRICE : £3/10/-, or £4/10/- for De-luxe model with all copper RF elements. Carriage and packing FREE by passenger train Great Britain and N. Ireland. Indicate if indoor or outdoor version is required.

SPECIAL "JOYSTICK" A.T.U. 10/-, plus 1/6 p. & p. unless ordered with Joystick

Enquiries invited from overseas

**PARTRIDGE
ELECTRONICS LTD**
Telephone: THANET 62535

7 SOWELL ST.
BROADSTAIRS
Kent

TOP QUALITY—LOW COST  **AMATEUR RADIO EQUIPMENT**

**CR 66 COMMUNICATIONS
RECEIVER KIT**

SPECIFICATION

Frequency range 540 Kc to
30 Mc in 4 ranges.

Band 1 30 Mc-11.5 Mc.

Band 2 11.5 Mc-4.2 Mc.

Band 3 4.3 Mc-1.5 Mc.

Band 4 1.5 Mc-540 Kc.

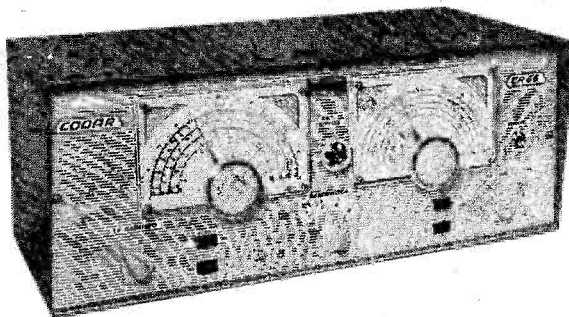

- Separate electrical bandsread
- Coil Unit wired ready and I.F. Trans. factory aligned
- Oscillator Coils fitted temperature compensated trimmers
- Regenerative I.F. Stage for maximum gain and B.F.O.
- Panel Aerial Trimmer
- Cathode Follower for Tape Recorder, etc.
- Panel Phone Jack, separate Speaker Switch
- 3 Watts Output for external 2-3 Ohm Speaker

Valve line-up:—ECH81 Frequency changer, EBF89 I.F. amp./Det./AVC/BFO, ECC81 A.F. amp./Cathode follower, EL84 output, EZ80 full wave rectifier, EM84 tuning indicator (Optional extra). Modern styling in silver grey cabinet, 16" x 6½" x 8¾". Complete kit with 17 page instruction manual, £18 5s., carriage 6/-. Tuning indicator parts with EM84, 17/6. H.P. Terms available on request.

★ **P.R. 30. R.F. PRESELECTOR** ★

Frequency range 1.5-30 Mc/s.

Substantially improves the performance of any superhet receiver

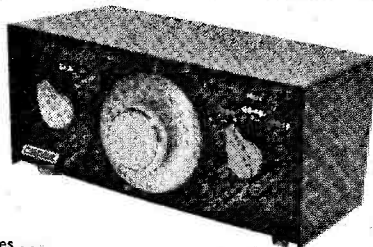

G2LU writes . . .

You are to be congratulated on turning out a very fine piece of equipment. Several of the Coventry "gang" have heard the P.R.30 in use and all have expressed their amazement at the gain obtained and the absence of background noise . . . You may use any remarks I have made in this letter as I am so delighted with the Unit.

G3RIA writes . . .

The results in conjunction with my Eddystone 888 are amazing. Signals are twice as strong with much higher signal/noise ratio. A first class product well worth the money.

G3ADZ writes . . .

I feel I must congratulate you upon your P.R.30 Preselector. It is more than refreshing to find:— Equipment well up to stated specification and performance . . . very well made and finished . . . at a fair price for Amateur . . . and care in packing.

G4HZ writes . . .

I am delighted with it, it improves my Eddystone 640 in all respects. The difference with the Preselector is fantastic, a weak signal on 15 metres about S2 changed to S8. On the L.F. Bands, unwanted noise and mush is cut out.

The P.R.30 Preselector uses EF 183 Frame Grid R.F. Amplifier and provides up to 20 dB gain. Outstanding features include vernier tuning, gain control, selector switch for either dipole or end fed antenna. Smart styling in grey and black, 8½" x 4" x 5". External power supplies (obtainable from Rx). Complete, ready for use, with all plugs, cables, £4/17/6. Carr. 3/-.

In answer to many requests, a self powered version is now available, Cat. No. P.R.30X. This is identical in size and suitable for 200-250 volts A.C. An accessory socket is fitted to provide up to 25 Ma at 200 volts H.T. and 6.3 volts at 1 amp. for other accessories. Price complete, £7/2/0. Carr. 3/-.

Coming shortly: Completely NEW "Q" Multiplier Cat. No. RQ 10, watch for details.

CODAR RADIO COMPANY

BANK HOUSE, SOUTHWICK SQUARE, SOUTHWICK, SUSSEX

Canadian Distributors: **JAYCO ELECTRONICS, TWEED, ONTARIO**

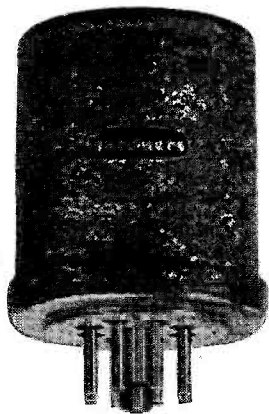

the
right
move...

AUDIO TRANSFORMERS

... and your next move towards better reproduction is to write for a copy of our new leaflet "Audio Transformers". It contains details of a new range of Plug-in Octal-based fully screened microphone and line matching transformers for professional use. The frequency response of these transformers is 0.5 dB, 30 to 20 kc/s. This informative leaflet also contains details of a new range of standard microphone transformers (frequency range 1 dB, 50 to 10 kc/s) new modulation transformers up to 100W for studio and telecommunication use, and many new output transformers for modern audio circuits. *If you are professionally engaged in the electronics industry, we will also be pleased to send you a copy of the Gardners Industrial Catalogue, containing details of over 1,000 types of transformers and chokes. This publication will be kept up-to-date with amendments and additions as they are issued. Write today for your copy on your company's letter-heading.



to crow is one thing — to produce is another!

Gardners

GARDNERS TRANSFORMERS LIMITED · SOMERFORD
CHRISTCHURCH · HANTS · TEL: CHRISTCHURCH 1734

The SHORT-WAVE Magazine

EDITORIAL

Consequences

In our last, attention was drawn to the political background against which Amateur Radio now finds itself. Since radio on the world scale is governed from Geneva by the International Telecommunication Union, of which the emergent nations can be members, it follows that the same voting difficulties can arise at an I.T.U. conference as are now being experienced in New York at the United Nations — the proliferation of new members, whose policies are based on prejudice and ignorance rather than realities, reduces the effectiveness and dilutes the experience of the more advance nations.

While this could mean that the amateur position as regards frequency allocation might become difficult, if not untenable, the fact remains that with large numbers of licensed amateurs in practically all civilised countries, the mere wilful closing of amateur bands would not, in practice, be so easy. If 300,000 amateurs were to be suddenly deprived of, say, all frequencies below 28 mc, it is a fair certainty that at least one-third of them would simply ignore the prohibition, carry on as if nothing had happened, and chance the consequences. And there would be so many carrying on, apparently unmolested — because even in the U.K. it would take the authorities years to bring some thousands of "piracy" actions before the courts — that others would be encouraged to join in and do the same. In the end the result would be chaos, with a very large number of unlicensed stations on the air, of which there would be no official record. This is just the situation that any government would wish to avoid — the point being that though you may take away an amateur's licence and his callsign, you cannot deprive him of his know-how nor his urge to indulge it.

The administrations of the more enlightened countries are well aware of all this, apart from the fact that with many of them it is government policy to encourage Amateur Radio. At the same time, they could be out-voted on the matter of frequency allocations, and any compromise reached could only be on the basis of more sharing of bands — which is, indeed, much the pattern of what is actually happening unofficially at the present time.

Hence, the probability is that while there will be no significant loss of amateur allocations in the formal sense, there will be more encroachment, official and unofficial, on our bands.

The picture that emerges, then, is that whatever happens a radio amateur licensing system must continue, in the Western world at least; that frequency areas will have to be allocated to make these licences usable for long-distance communication; and that these bands, while continuing to be provided on paper, will cease to be exclusive, even officially.

This is not as bleak a prospect as it might seem, for reasons that we will attempt to explain here next time out.

*Austin Fobler
G6FO.*

SIMPLIFIED CASCODE CONVERTER FOR TWO METERS

DESIGN AND CONSTRUCTION

From Notes by G3NBQ

THE details on which this article is based appeared in the Coventry Amateur Radio Society's *Newsletter* for April last, in which G3NBQ described a two-metre converter intended as a prototype for copying by C.A.R.S. members who might have had no previous experience of VHF construction and circuitry. Several such converters have been built from his design, which is essentially simple and easy to get going—nevertheless, it is capable of giving very good results with the minimum of setting-up difficulty.

Fig. 1 is the block diagram, showing a cascode RF stage (E88CC) into a mixer (6AK5) with a twin-

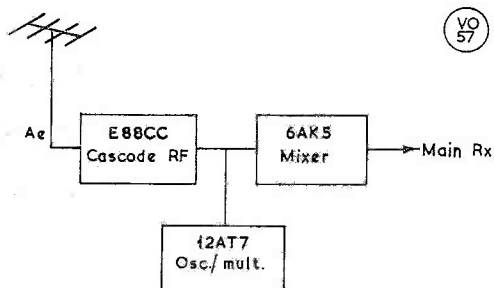

Fig. 1. Block diagram of the G3NBQ two-metre converter, which is easy to build and get going.

triode (12AT7) oscillator-multiplier—just about as basic a layout as you could get for an efficient crystal-controlled job on two metres.

At Fig. 2 is given the circuit in detail. The oscillator-multiplier chain is designed to knock out at 118 mc, near enough, from a 6.5555 mc crystal, giving the IF tuning range of about 26-28 mc to cover the (two-metre) band 144-146 mc. The crystal frequency is *times/3* in the first half of the 12AT7 and then *times/6* in the anode of the second half. Provided beats are not thrown into either the IF tuning range of the receiver or the 144-146 mc signal frequency coverage of the converter, any tunable IF can be used by changing the crystal frequency and the order of multiplication in the oscillator chain—but in fact the arithmetic will show that there are relatively few fundamental crystal frequencies that can be used without this sort of interference occurring. The figures given here are to avoid “birdies” in the tuning range.

Constructional Points

The general appearance of the finished job, as built up by G3NBQ, is shown by the photographs. To simplify the constructional work, he hit upon the ingenious idea of using 18g. tin-plate, with tin screens, as the mounting, this assembly then being dropped into a standard aluminium box chassis. The advantage of using clean tin-plate, rather than aluminium, is the very important one that soldered joints can be made direct to the chassis. Moreover, since at the constructional stage the “chassis” consists of no more than a piece of flat tin, 5 $\frac{1}{2}$ ins. by 3 $\frac{7}{8}$ ins., to which the screens (two inches deep) can be soldered, the work

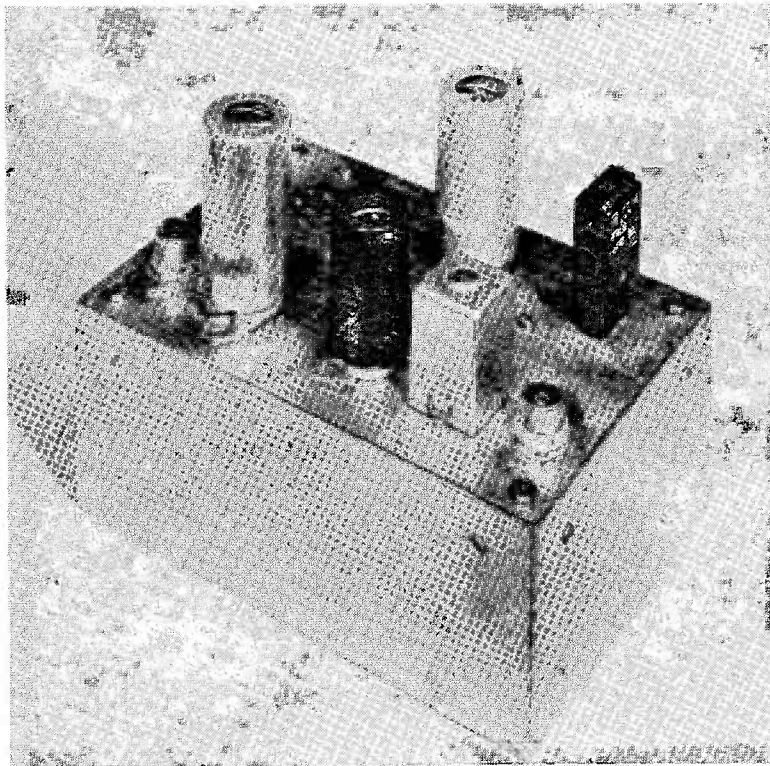

General view of the two-metre converter designed by G3NBQ and described in the article. It was produced specifically as a prototype to be easily repeatable by any experienced home-constructor wishing to make a start on VHF with a good CC converter. It is understood that several have now been built in the Coventry district, with good results and no snags. In this shot, the input end is at upper left and the IF socket at lower right. As a simplified, though sound, basic design to the circuit given in Fig. 2, it can be relied upon to give satisfactory results for anyone without previous two-metre experience.

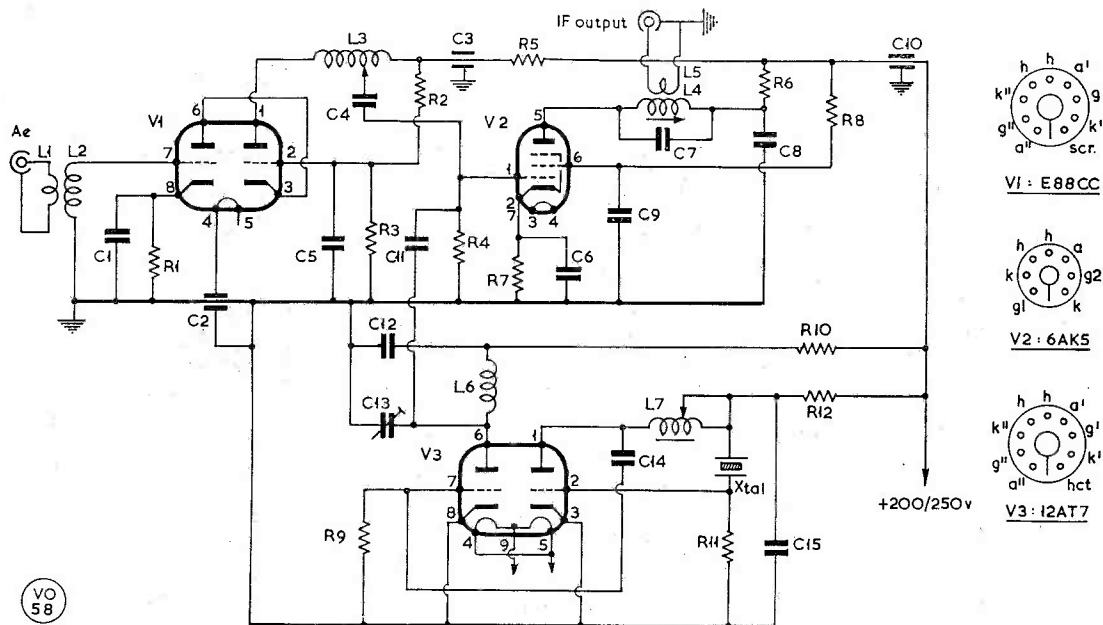

Fig. 2. Circuit of the two-metre converter designed by G3NBQ, and described in the article. V1 is in cascode and the twin-triode at V3 multiplies a third-harmonic ("overtone") crystal frequency by 6, to give an injection frequency of approximately 118 mc, for a tunable IF range of 26-28 mc. Other oscillator-IF combinations can be worked out to suit individual requirements, provided oscillator beats are not thrown into the receiving chain. The photographs show the simplified form of construction devised by G3NBQ, and the article explains the equally simple alignment procedure.

is much more accessible than when building inside a small box chassis.

One screen is fitted along the centre-line of the mounting plate, and the other is placed at right angles to form a 1½-in. compartment at the input (V1) end—see under-chassis photograph—to screen the two halves of the cascode stage. This under-chassis view also shows how the wiring is simplified, and from it and a study of Fig. 2 starting from the V1 end, most parts can be identified.

After construction, it will be found that the mounting plate with its screens will fit neatly into an aluminium box 6 ins. by 4 ins. by 2½ ins. deep, and can be bolted in by self-tapping screws.

Alignment

After doing a thorough wiring check, apply power. On connecting the converter into the main Rx, sharsh should be heard; if this is not so, then look over the mixer wiring. When noise is obtained, check the CO grid current by disconnecting R11 at the chassis end and putting in a low-range milliammeter; this should show a pronounced peak reading on one setting of the slug in L7; if this does not happen, put a 10 µµF fixed capacity between ground and pin 1 of V3; if the grid current still will not peak, rewind L7 with a few taps, and determine which tap gives greatest current. You are aiming to get a grid current reading of 0.5-0.75 mA, and when this is obtained, the meter can be taken out and R11 re-connected to the chassis.

If C13 is now adjusted, a noise-peak should be

Table of Values

Fig. 2. Circuit of the G3NBQ Cascode Converter

C1, C5,	R1 = 68 ohms
C12 = .001 µF, disc cer.	R2 = 220,000 ohms
C2, C3,	R3 = 330,000 ohms
C10 = .001 µF, feed-thro	R4 = 100,000 ohms
C4 = 47 µµF, tub. cer.	R5 = 10,000 ohms
C6, C8,	R6, R9 = 47,000 ohms
C9, C15 = .01 µF, disc cer.	R7 = 220 ohms
C7 = 5.6 µµF, tub. cer. (see coil data)	R8 = 1 megohm
C11 = 2.2 µµF	R10, R12 = 4,700 ohms
C13 = 2-8 µµF, beehive trimmer	R11 = 22,000 ohms
C14 = 100 µµF, mica	Xtal = 6.5555 mc × 3
	V1 = E88CC (ECC88)
	V2 = 6AK5
	V3 = 12AT7 (B309)

NOTE: All resistors rated ½-watt.

COIL DATA — Two-Metre Converter

- L1 — One turn round L2, of 20g. tinned copper, to ½-in. diameter.
- L2 — Four turns ⅜-in. diameter, 20g. enam., spaced over ½-in. winding length.
- L3 — Four and three-quarter turns ⅜-in. diameter, 20g. enam., spaced over ½-in. winding length, with C4 tapped on one turn from C3 end.
- L4 — 25 turns 24g. enam., close wound on ½-in. diameter IFT-type slugged former, fitted in can. Tuned to 27 mc by slug and C7. (These details for 26-28 mc IF).
- L5 — Five turns of flexible lead over earthy end L4.
- L6 — Two and three-quarter turns ⅜-in. diameter, 20g. enam., spaced over ⅜-in.
- L7 — For 6.5555 mc xtal: 25 turns 24g. enam. on ⅜-in. diameter slugged former, with tap at 3½ turns.

VO
58

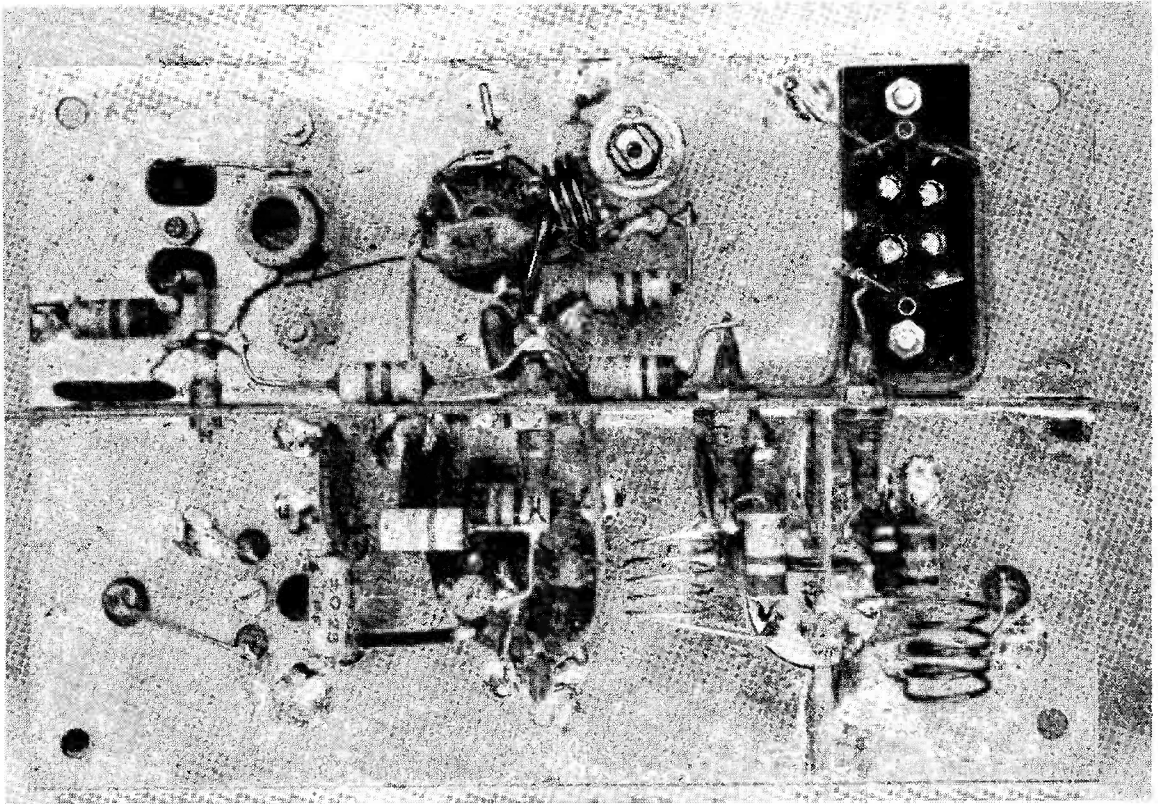

Under-chassis view of the G3NBQ 2-metre converter. The main dimension is $5\frac{1}{2}$ ins. and the "chassis" is actually a mounting plate, with screens, made of 18g. clean tinplate which simplifies the wiring because earth connections can be soldered. Two screens as shown are fitted (by soldering), the smaller one at right angles being 2 ins. deep with a slot cut for the valveholder, and placed to give a $1\frac{1}{2}$ -in. space for the V1 input assembly. The finished converter on its mounting plate then drops into a standard $6 \times 4 \times 2\frac{1}{2}$ in. box chassis, and is secured by self-tappers at the four corners. The approach devised by G3NBQ greatly facilitates construction. In this view the aerial input end is at lower right, and the IF output coax socket at left. The placing of most of the parts can be worked out by reference to Fig. 2 on p.347.

heard; no difficulty will be encountered here, as C13 shifts the resonant frequency of the tuned circuit through quite a wide range. Careful adjustment of L3, by spreading out or squeezing in its turns, should peak up the sharsh even more.

On connecting the aerial, something should now be heard from outside, even if it is only ignition noise (which can be very useful for preliminary adjustment of any converter!). There may even be a few signals on the band and if you happen to be within comfortable range of the beacon GB3VHF on 144.5 mc, you have a transmission on which the signal circuits can be peaked by manipulation of L2 and L3, while fiddling with the configuration of L1 with respect to L2 may give you a further gain in signal. For the 26-28 mc tuning range on the main receiver, the IF winding L4 should be peaked at 27 mc.

If having reached this happy condition, with

something coming in on two metres, the converter appears to go quite dead after switching on again, it will be because the crystal has not picked up. This is a very annoying and not uncommon fault, and can only be prevented by careful adjustment of the CO in the first place; it may even be necessary to move the L7 tap a little, to increase the feed-back. In any case, the crystal should be checked out as a healthy oscillator before it is plugged in. The probability is that a strong CO beat will be found somewhere on the tuning range of the main receiver (right outside the two-metre band, that is) and this can always be used as a reference point for the activity of the crystal.

It is understood that those converters built to the recipe by G3NBQ, as discussed here, are giving entirely satisfactory results, and went off first time without difficulty. The design can be confidently recommended to anyone thinking of making a start on the two-metre band.

COMBINATION MEASURING UNIT FOR THE AMATEUR STATION

S-METER, GDO, F/S METER AND ABSORPTION WAVEMETER

W. H. FLETCHER, B.Sc. (G3NXT)

MEASURING instruments are an essential part of many amateur's equipment, both to enable him to keep within the terms of his licence and to check on the effects of experimental adjustments to his equipment. Unfortunately, good meters are no longer as readily available or as cheap on the surplus market as they used to be, and the more the measuring units which can be designed to share one meter, the cheaper these instruments are to construct—the idea being, of course, to use one good meter movement for a variety of purposes.

The S-Meter

The basic unit used at G3NXT consists of a valve-voltmeter type S-meter, as shown in Fig. 1. It is housed in a sloping-front meter case measuring 6ins. x 6ins. x 5ins. and is on the right in the picture. Its controls are, from left to right, the GDO sensitivity control; S-meter sensitivity; and meter switch, which should preferably be a good quality ceramic item. The meter used in the prototype is 3in. 0-1 mA moving-coil but any 0-1 mA or 0-500 μ A meter with a clear scale is equally suitable.

The valve V1 is mounted on an L-shaped bracket fitted to the rear panel of the meter case by the bush of the balance potentiometer R3. The circuit is conventional, except that the sensitivity control R5 is placed in series with the meter, rather than using a potentiometer across the AVC line. This arrangement protects the meter from overloading whilst still giving a useful reading on weak signals.

The AVC voltage can be derived from any convenient point on the receiver AVC line. In the prototype it was picked up from one of the inter-sectional coupling boards in the author's R107, and fed *via* screened cable to the front panel socket originally intended for the operator's lamp, having first removed and taped the lamp leads. A length of screened lead, fitted with wander plugs may then be used to connect the unit to the

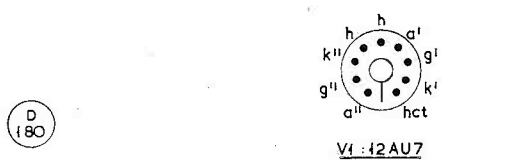
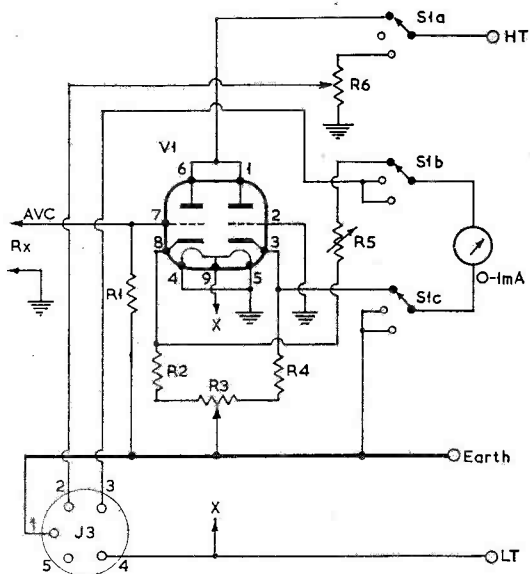
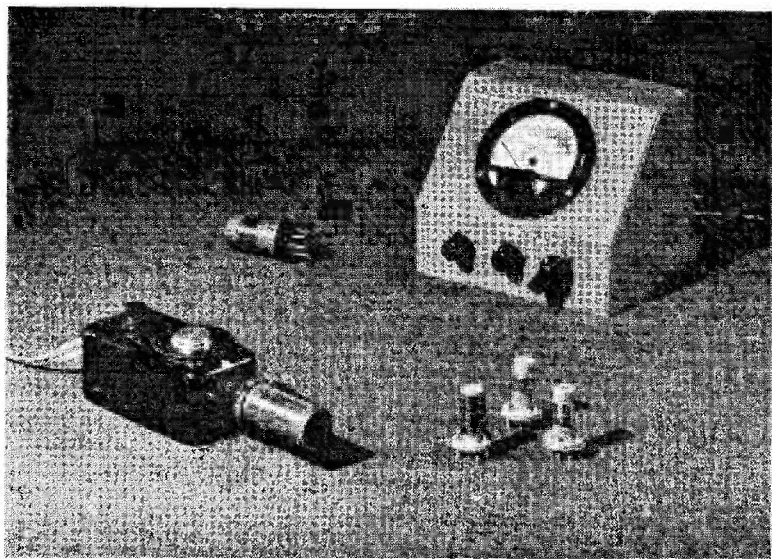

Fig. 1. Connections for the S-meter circuit, applicable to any Rx with the AVC drive accessible. The 0-1 mA meter movement is separately connected to the 5-way socket J3, so that it can be picked up by an externally connected GDO or Absorption Wavemeter.



The apparatus described by G3NXT in his article. The S-meter panel instrument is used also for the GDO (left foreground), for which plug-in coils are used. The idea, basically, is to make the most of one really good panel instrument — in this case, a 3-in. 0-1 mA moving-coil meter. The circuitry shows how this is done.

Table of Values

Figs. 1, 2, 3. S-Meter, GDO and Absorption Wavemeter

C1, C4 = 50 μ F var.	R7 = 22,000 ohms
C2, C3 = .001 μ F, cer.	RFC = 2.5 mH RF choke
C5 = 100 μ F, s/m	J1 = Panel mounting coax socket
R1 = 4.7 megohms	J2 = Phone jack
R2, R4 = 500 ohms	J3 = 5-way socket (see text)
R3 = 500-ohm bal. pot'-meter	S1 = 3p. 3w. cer wafer.
R5 = 10,000 ohms, S-meter sensitivity	CR1 = OA81, or similar
R6 = 100,000 ohms, 4w., GDO sensitivity	V1 = 12AU7, ECC82, or similar
	V2 = 6C4, L77, EC90

receiver.

With the CR-100, AVC voltage is most conveniently derived from the AVC line end of the resistor (marked R1 in the CR-100 manual) which feeds the first RF stage; this is located in a vertical position at the rear of the RF compartment.

Circuit Action

When a signal causes the receiver to develop an AVC voltage, it is applied to g1 of the double triode V1. This reduces the current flowing through V1a and unbalances the bridge formed by the cathode resistors R2, 3, and 4 and the two sections of the double triode V1—causing a current to flow through the meter, which therefore gives an indication of relative signal strength.

To set up the S-meter, the meter switch S1 is set to the appropriate position and the receiver aerial terminal shorted to earth. The balance potentiometer R3 is adjusted to give a zero meter reading. Next connect an aerial to the receiver and tune in a strong local signal. The sensitivity control may be adjusted for full scale deflection (S9+). The author used his Top Band transmitter feeding a separate aerial for this adjustment. After a little experience the user will be able to interpret the deflection in terms of S-points.

Auxiliary units to make fuller use of the meter can be plugged into a five-pin Belling-Lee socket J3 mounted on the rear panel. HT and heater voltages are supplied as well as a direct connection to the meter. With the range switch in the centre position, the meter is connected directly to pins 1 and 3 and is available, for measurements, in addition to the primary purpose of providing an absorption wavemeter.

Absorption Wavemeter

The absorption wavemeter may be built into a small plastic, bakelite or paxolin box of similar dimensions to the case used for the grid oscillator.

The same coils are used as with the GDO. They plug into an octal socket in the end of the box, and are tuned by a 50 μ F air-spaced variable condenser mounted in the top of the box and fitted with an 180° scale; this can be directly calibrated.

The crystal diode CR1 is connected to the coil tap in order

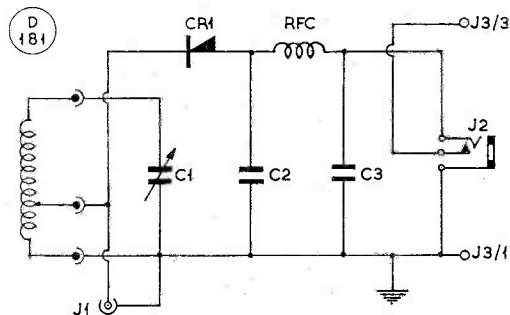
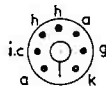
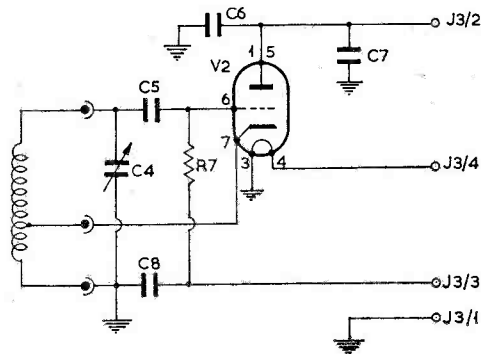

Fig. 2. Circuit of the Absorption Wavemeter using a diode rectifier. For panel meter indication, a plug connects to socket J3 in Fig. 1.



V2: 6C4

Fig. 3. The GDO circuit used by G3NXT, with a 6C4. The unit derives its power and gives a meter indication by plugging it in as marked to J3 in Fig. 1. The sensitivity control for the GDO is R6 in the Fig. 1 circuit—see page 349.

to obtain more efficient energy transfer between the high-impedance tuned circuit and the low impedance diode.

COIL DATA
Wavemeter and GDO

Freq. Range (mc)	Turns	Wire gauge	Diameter ins.	Turns/inch	Tap at
1.7-3.4	100	30 enam.	1"	close-wound	25
3.3-6.7	38	30 enam.	1"	close-wound	12
6.2-12	38	30 enam.	1/2"	close-wound	14
11.5-21	32	22 enam.	1/2"	close-wound	12
20-40	15	22 enam.	1/2"	16	5
38-84	4	22 enam.	1/2"	16	1 1/2

If a small aerial is plugged into J1, a standard coax socket, the unit will function as a Field Strength Indicator. And if a pair of high-impedance phones are plugged into J2 phone can be monitored.

For use as an absorption wavemeter, the unit is held with the coil near the tuned circuit under investigation and the 50 $\mu\mu\text{F}$ variable condenser adjusted for maximum meter reading. The coupling should be kept to the minimum necessary to obtain a sharp reading, in order to minimise pulling between the two circuits.

If the instrument range switch is in the left hand position (see Fig. 1) a Grid Dip Oscillator may be plugged into the auxiliary socket.

Grid Dip Oscillator

The Grid Dip Oscillator, shown on the left of the photograph on p.349, uses a 6C4 in a Hartley circuit with plug-in coils.

The prototype was constructed in a 4in. x 1½in. x 1½in. ex-AM pressed steel-case, but an Eddystone die-cast box would be more suitable.

The valveholder for the 6C4 is on an L-shaped bracket in the centre of the case, whilst an octal valveholder is mounted in the end of the case, to take the plug-in coils. The coils are wound on Denco ¼in. poly' octal plug-in formers for ranges 3-6. The coils for ranges 1-2 are on short lengths of 1in. dia. paxolin tube glued into octal valve bases.

The tuned circuit is completed by a 50 $\mu\mu\text{F}$ variable condenser mounted between the coil socket and the B7G valveholder. RF leads should be kept as short as possible for the VHF ranges.

The sensitivity control R6 mounted on the main unit (see Fig. 1) controls the HT voltage to the oscillator. Some adjustment is necessary to compensate for variation of grid current with frequency, i.e., on change of band.

The GDO will check the resonance of tuned circuits by noting the frequency at which a dip occurs in the grid current when the oscillator coil is coupled to an unknown circuit. It may also be used as a signal generator for testing receivers and converters.

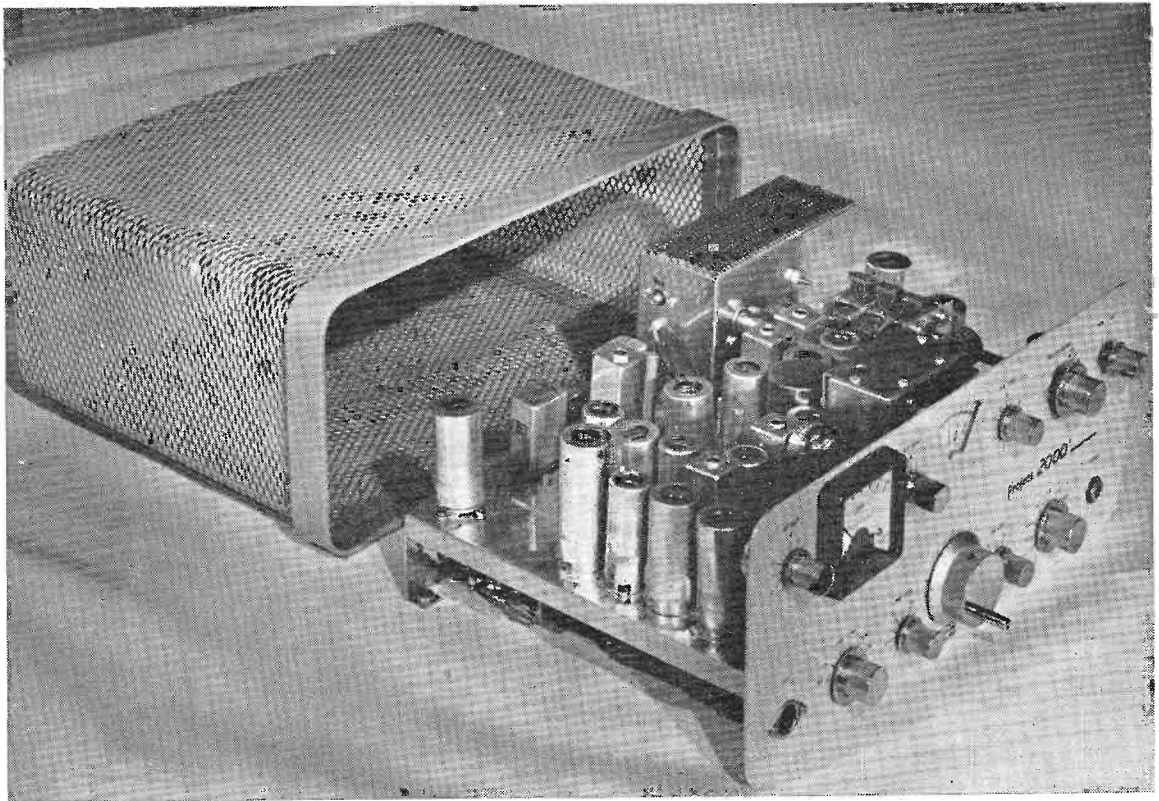

The new K.W. "2000" SSB Transceiver now going into production has been specifically designed for mobile operation. To this end, the construction has been made compact and strong, yet light. The main dimension is only 13½ inches. On the Tx side, 10 valve stages are involved, up to a 6146 PA capable of giving 90w. p.e.p. The features include selectable sidebands, voice control, variable aerial loading, built in c/o relay, and power supplies for either mains or mobile DC (6/12v.). The receiver tunes with the transmitter, but is arranged to give a 7.5 kc sweep either side of the Tx frequency. The tuning accuracy is within 500 cycles, sideband suppression 40 dB, and carrier suppression 60 dB; the SSB generator uses a 2.1 kc mechanical filter. The Rx is a double superhet, giving speaker output and the switching is arranged to double the panel instrument as an S-meter or for reading PA plate current on transmit. After the manner of transceivers, some of the 20 valves in the set have dual functions. There can be no doubt that this fine new example of K.W. engineering will arouse a great deal of interest, both as a mobile transceiver and for home-station operation.

DESIGN FOR CABINET MAKING

THE WRAP-OVER LOOK FOR HOME-BUILT GEAR

H. N. KIRK, A.M.S.E.E. (G3JDK)

TO the writer, one of the saddest things about home-constructed gear is that it looks home-constructed. Even with all the facilities available today, one still sees modified surplus in modified Oxo tins and, at the best, home-built gear housed in cases that resemble water tanks. One may get hours of satisfaction from filing brass bar, drilling and tapping brass angle and shearing tin plate, but in the writer's opinion the result is generally a modified water-tank coated in black japan! You don't believe it? Try installing such a piece of gear in the living room and see what the XYL says!

Some may prefer water-tank construction methods, but to those who yearn for an indoor shack and the XYL's approval—read on! This introduces the "wrap-over" construction. It is simple to achieve—even on the kitchen table—and the finished appearance equals that of many of the commercial jobs on the market today.

At G3JDK, two such cases have been constructed, one to house a Top Band Z-match unit and SWR bridge, and the other to re-house a commercial kit VFO. The results have been extremely satisfying and worth while—as may be agreed when referring to the photographs opposite.

Basically the design rests on two modified U-sections, one forming the front panel, bottom and rear apron and the other the sides and top. The back plate is fixed to the cover by small aluminium rivets when the bending is complete.

Procedure

The chassis/panel assembly was constructed from 16 gauge half-hard aluminium, and the cover from 20g. aluminium. Bending of the 90° angles is easily done by means of two straight angle irons and a couple of clamps, the metal being carefully "teased" over by the use of a soft leather hammer—or if not available, an ordinary hammer against a piece of flat hard wood. The radius'ed corners of the case are bent to 90° over a brush handle or piece of dowel. It will be found that the 20 gauge aluminium is easily bent by this method—the 90° sharp flanges being bent afterwards on the angle irons. If you are doubtful as to your ability to bend the cover to fit the chassis, bend the cover first and take the chassis dimensions from it. (A little practice will soon make perfect.) Should you wish to mount a second chassis within the case, cut out a corresponding aperture, similar to that found on domestic radio and TV sets, and fit with a cover plate.

Q
278

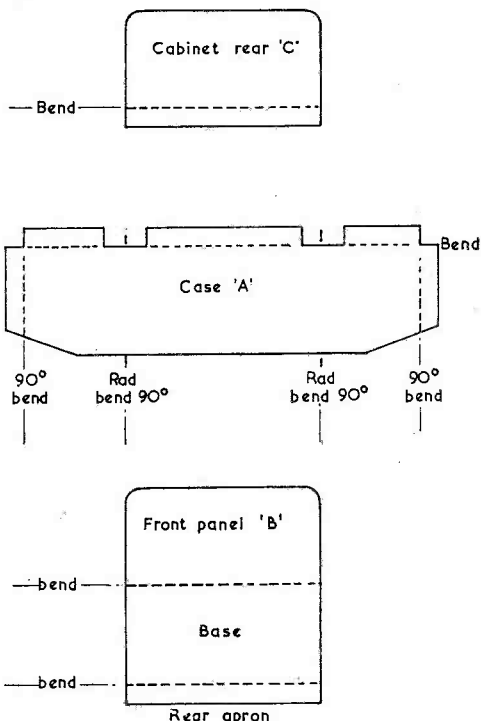
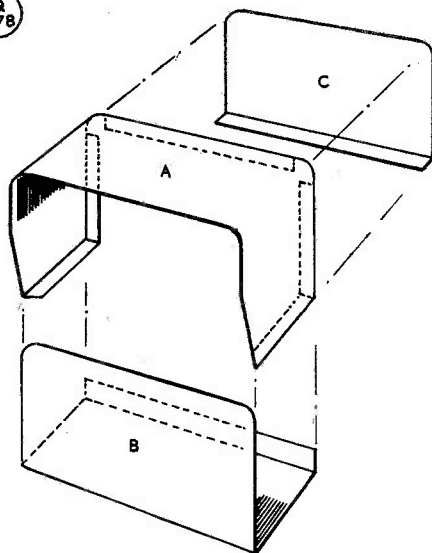

Developed lengths of A-B-C

Sketches to show the general form of construction for one of the cabinets, as described by G3JDK in his article. The material used is light-gauge aluminium or sheet tin, and an excellent finish can be obtained—see photographs.

The two sections of the case are fixed by means of small self-tapping screws and, of course, the "B" section (*see* drawings) is fitted with four plastic feet, available from most chain stores.

Colour Spraying

Having constructed the case, the next step is to paint it. Here it is possible to ruin the whole job with one brushful—the answer being not to use a brush at all! Most ironmongers, bicycle shops and garages today sell the small *Aerosol* touch-up spray canisters. These are ideal for spraying small areas, and a good range of colours is available. Today, gloss

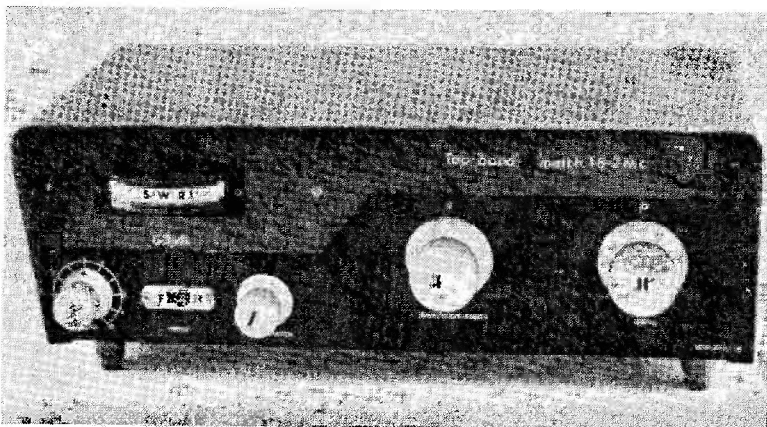

Example of amateur cabinet craft in metal, showing what can be done "on the kitchen table" if some trouble is taken. The principles are explained by G3JDK in his article and this particular piece of equipment is Z-Match f or Top Band, with an SWR meter

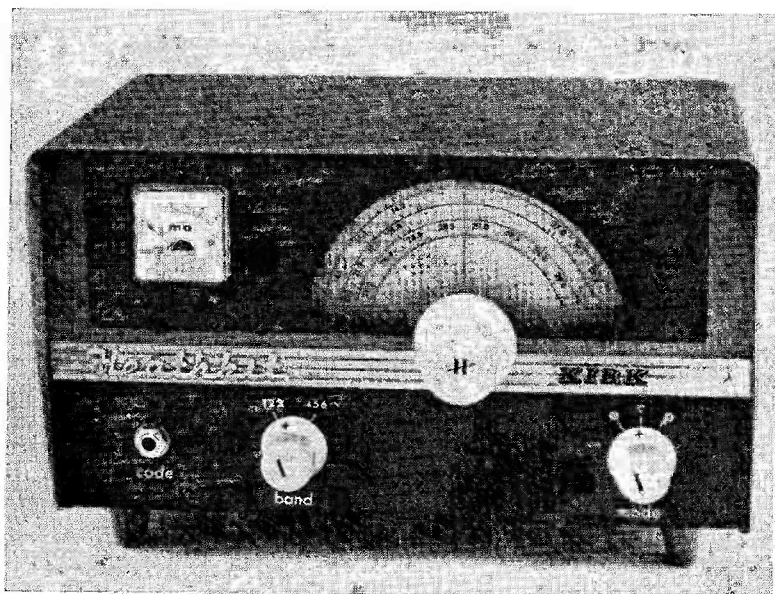

A commercial kit VFO housed in a cabinet made by G3JDK. Sheet aluminium is used, and the colour finish is sprayed, not brushed, on by using the *Aerosol* type of touch-up spray which can nowadays be obtained at garages and do-it-yourself stores. These sprays are cheap and economical, as they are widely used by motorists for touching up body-work — and they are available in a wide colour range.

finishes and black crackle are "out" if the gear is to please the distaff side! And one must be very careful with the chrome screws.

The two units shown in the photographs were finished "two-tone"—dull, or semi-matt, black and blue-grey. The covers in both instances were sprayed smoke grey wrinkle; a semi-gloss grey could have been used with equal effect. The control knobs were turned from aluminium bar, but commercial products can be selected from the catalogues.

After spraying, the controls were identified by the use of readily available transfers, so completing a very interesting project. One can, of course, add various trimmings to the basic idea, but care must be taken not to over-dress the panel and so spoil the contemporary impression. The writer is now wondering whether he can improve the appearance of his flash American 1962 receiver!

NET FOR TEENAGERS

A large proportion of our more recently-licensed readers are in that happy category known as teenager—and here we use the term in its best sense. G3OAG and G3RVR are proposing a "Teenage Net", to operate on or about 3700 kc from 11.30 clock time on Sunday mornings. Any amateur under 20 years of age is invited to take part, either by breaking in or getting in touch with S. J. Gilbert, G3OAG (19½), 3 Charlbury Avenue, Prestwich, Manchester.

MOSLEY ELECTRONICS, LTD.— U.K. SUBSIDIARY

Consequent upon the sudden and lamented death of Jack Russell, G3BHI, of Norwich, on July 19, at the early age of 49, new arrangements have been made for the carrying on of the Mosley business from Norwich. Owen Chilvers, G3JOC, 40 Valley Road, New Costessey, Norwich, Norfolk, NOR.26K, has been appointed the Mosley representative for the U.K. The works and office telephone number is now *Norwich 22147*, and the postal address is as given here for G3JOC.

RTTY Topics

DISTINGUISHING TELEPRINTER EQUIPMENT FROM AUTO-MORSE MACHINERY — NOTES AND NEWS ABOUT AMATEUR T/P OPERATION

W. M. BRENNAN (G3CQE)

SUMMER and the holidays again and with many of the RTTY fraternity taking time out from the shack there has been a falling off in 80-metre activity. As one correspondent puts it, "My XYL is now quite used to her suggestions for a run out in the car meeting with a total lack of enthusiasm—but she's persistent"! In spite of the usual summer distractions, most of the regulars seem to have been putting in an appearance for a keyboard session from time to time. At least, there are no reports of anyone having received a "get well" card—which is the usual way that a temporarily inactive RTTY man is coaxed back on to the air by those who like to QSO him!

Twenty metres has been very good as far as RTTY is concerned, although reports from outside Europe seem to agree that the German RTTY stations are the most active Europeans on this band. A new country now available on both 15m. and 20m. is Argentina; LU1AA has been worked by many U.S.A. stations, moreover, LU3BAC, LU9KA and LU5AZ are also said to be active. Another new country is Liberia—EL5B operating on 14110 kc accounts for this one. I1ZZG has also joined in the RTTY dust that is already being well kicked up by IIRIF and IIBNO from Italy. His first RTTY QSO was with K3GIF, who reports another new one in the shape of ET2USA, from Eritrea. ZS6UR writes in to mention that he has managed to get hold of one of the ex-Army T.U.'s (ZA39384) mentioned in the June issue and is busy getting it working; he complains about the commercial RTTY stations that are invading 20m. These appear to be mostly American Service stations, though Peking on 14330 kc is also very strong in S. Africa with its news broadcasts. ZS6JO and ZS6ARL are two recent additions to the active ZS list. ZS6UR says that the RTTY gear problem is not too bad in South Africa—in fact he has a couple of surplus Creed 7Bs! Certainly looking at the DX side of RTTY, the prospects for the RTTY Sweepstakes Contest in the autumn appear very good and quite a few people mention re-organisation of RTTY gear or aerials before the event.

Morse or RTTY?

In the early days of RTTY in this country it was not uncommon to hear some misinformed amateur claim that he could read RTTY signals aurally. Any such statement was quite untrue, of course, and in all probability the individual concerned was confusing the Teleprinter Murray Code, used by amateur and commercial stations for RTTY, with high-speed automatic Morse which is used by many commercial stations. Both types of transmission commonly use frequency shift keying and at certain speeds the Morse does sound like an RTTY transmission. Apart from this, of course, the two transmissions have nothing in common. It is just not possible to read a plain language RTTY transmission aurally. But it is possible to identify a regular series of characters, such as a long train of RYRYRYRYRY's or, say, a line of CQ's—with a little practice. A trick used by some RTTY DX operators when calling on a regular DX schedule during poor conditions is to transmit a pre-arranged series of characters which produce a very distinct keying rhythm. This can be more readily picked out of the noise or QRM by the operator at the other end, aurally at first and then finally, when filters are switched in, it can be fully identified on the printer. This is just about the limit of reading RTTY signals without a machine. To add to the confusion between Morse and teleprinter signals there is the fact that both automatic Morse and T/P transmissions are produced with the aid of machines which quite often have the same sort of names. This has been a pitfall for more than one amateur anxious to obtain some RTTY gear. One such reader recently bought a "Reperforator" and subsequently found that it did not tie in with anything he had read about such machines. A little correspondence revealed that he had in fact got a Great Northern Telegraph Co. Ltd. Reperforator Model 451, which is, as you have guessed, a Morse reperforator. Such a mistake is easily made since both a Teleprinter Reperforator and a Morse Reperforator produce punched paper tape and the only difference in the finished product is the width of the tape, the number of perforations and the actual code! Even surplus dealers have been known to purchase and sell automatic Morse equipment as teleprinter gear—in all good faith!

To take the matter a little further, the tape for automatic Morse transmission is prepared on a machine called a Morse Keyboard Perforator—just as the tape for automatic T/P transmission can be punched on a machine called a T/P Keyboard Perforator. In both cases this tape is fed into a machine known as an "Auto-Transmitter" which produces the required electrical signals. At the receiving end Morse can be decoded in two ways—one by feeding the electrical signals into a machine called an "Undulator" (which traces the actual dots and dashes on to a paper tape ready to be decoded visually by the receiving operator) or, secondly, the received electrical signals may be fed to a machine called a Morse Reperforator which then produces a perforated tape similar to the original; this tape can

then be fed into a Morse Printer which translates the tape perforations into printed characters on either a continuous strip of paper tape or alternatively an 8in. wide sheet. The T/P signal can of course be received either directly on to a tape or a page printer or can be reproduced as perforated tape by a machine called a "Reperforator." And so the two systems have machines with similar names.

These automatic Morse machines may look like teleprinter equipment to those who are unfamiliar with them and the would-be buyer of RTTY gear would be well advised to read the maker's label very carefully before investing in any strange machinery. Even T/P gear that is not in common use may not be a "good buy," since spare parts may not be readily available from surplus sources and the manufacturer's price list can come as quite a shock to someone requiring even a small new part for their machine.

Hellschreiber equipment is also sometimes mistaken for T/P gear since such a machine has a keyboard for the transmitter and on the receiving side, it obviously prints the message on a paper tape. The printing is, however, carried out by an inked helix. The received "Hell" signal causes the angle of this helix relative to the tape to vary and the character is almost painted on the paper. The T/P and the Hellschreiber systems are completely incompatible and whilst a few Continental stations are equipped for both systems, there is little interest in Hellschreibers outside of Germany.

All this may all be a little discouraging to the potential owner of a teleprinter but in actual fact, though not everyone can recognise a Model 7B at one hundred feet, all these machines do carry a maker's nameplate which gives the model number, the serial number and often a customer's marking. For example, a Creed Model 85R that is produced for the GPO has the customer's marking as "Printing Reperforator No. 2." All that is required, therefore, is a little careful label reading and a good idea of the model numbers of the various machines. The following list gives these numbers and a short description of each item of equipment most likely to be found in this country. Obviously, as Creed & Co. Ltd. produce most of the T/P gear used over here, it is their equipment which is most commonly available.

Creed & Co. Models

Model 3A (X,W,Y). This is the cheapest T/P at present available to amateurs. It is a tape printer and until a few years ago it was in widespread use by the G.P.O. Inland Telegraph Service. Though there is a certain amount of incompatibility between the keyboard of this and other T/P's in amateur use (see "RTTY Topics" p.312 Aug. 1961, SHORT WAVE MAGAZINE) in practice, amateurs using other machines make allowances for this when working anyone who is using a Model 3. Another slight disadvantage of this machine is that the typehead inking is carried out by two felt rollers (as distinct from a typewriter ribbon) and these rollers have to be re-supplied with ink from time to time. On the whole, this is a good machine to start off with on RTTY. The variations

of this model (3A, 3X, 3W and 3Y) are minor modifications which in no way affect the performance of the machine for RTTY purposes.

Creed Model 7A, 7B and 7C. This is a later model of teleprinter, still in widespread commercial use. Here the model variations do indicate significant variations as far as RTTY is concerned. These differences are all in the length of the stop-pulse which the machine transmits and must receive for correct operation. The 7A transmits and should receive a 1.5 unit stop pulse; the 7B transmits a 1.5 unit stop pulse but will operate with full margin when receiving a 1 unit pulse; the 7C transmits a 1 unit stop pulse and operates at normal margin when receiving the same type of pulse. Thus, a 7A will operate perfectly well to a Model 3, a 7B and with a very slight loss of margin to Teletype equipment (which transmits a 1.42 unit pulse) but it will show quite a loss of distortion margin when operating to a 7C. The 7B machine can transmit and receive normally in conjunction with any of these machines. The 7C will receive perfectly well from any T/P but does transmit the shorter stop pulse. However, there are very few Model 7C machines.

The 7B, which is obviously the best all-round model, is by far the commonest, but the 7A is perfectly good in practice, too. The carriages of all these models are quickly removable; there are three types of carriage, two are page carriages and the other a tape carriage. Thus, the Model 7 can be either a page of tape printer.

Model 8. This is a receiving-only T/P and is in fact a Model 7 with the keyboard removed. To attach a keyboard is a job taking only a few minutes and spare keyboards can sometimes be found.

Model 10. Also a receiving-only T/P made for various wartime purposes. It is not possible to add a keyboard to this model. It is a tape printer and relatively small; very few have been available to amateurs.

Model 11. A tape printer and is the one which superseded the Model 3 in the G.P.O. service. It is unlikely that any of these will be for sale for some years!

Model 54. This is an improved version of the Model 7 and is in widespread use for Telex services, plant automation and computer read-out purposes. The chances of finding one of these collecting dust in a surplus shop are pretty remote, too.

Model 75. Just for the sake of interest, this is the latest model from the Creed factory, a very small page T/P in use in top commercial circles but strictly in the "pipe dream" class as far as amateurs are concerned.

Reperforators

The Creed Model 7TR is a non-typing reperforator. These are on the market from time to time with various minor modifications, some indicating slightly different switching arrangements for the motor or different dust covers; all are suitable for RTTY. A typical type number is Model 7TR/B/2 and the G.P.O. title is Reperforator No. 2. A more up-to-date machine that is also available is the Creed

85R. This is a Typing Reperforator developed from the Model 7 T/P. In place of the carriage on the T/P a punching mechanism is added. Some of the 85R's that are available have in fact been Model 7B's which have been modified and this is usually recorded on the manufacturer's plate, thus "Model No. 85R (Ex No. 7B Teleprinter)." This machine produces semi-perforated tape and in addition types the recorded message on to the tape. The G.P.O. term for this machine is "Typing Reperforator No. 2." It is, of course, an excellent machine for RTTY purposes and is a handy source of "Emergency Spares" for the 7B!

Auto-Transmitters

These are perhaps the least available of all pieces of RTTY gear, though recently the situation seems to have eased a little. Those encountered are usually the Creed Model 6S or "Transmitter Auto No. 1B" (there are again one or two modifications with corresponding differences in the model number, e.g., 6S/1). Later versions of this machine have a smaller motor than the earlier ones and are also fitted with silencing covers. The 6S/4 is one of these and it also goes by the name "Transmitter Auto No. 2A." The actual transmitting mechanism (often called the Auto Head) can be quickly removed from the main body of the machine merely by loosening one screw. A point to watch out for is that this auto head is not missing and also that it is in fact a 7.5-unit head and not a 7-unit one. The difference is again in the length of the stop pulse transmitted and usually the head is engraved with the appropriate figures.

Perforators. There are two types of perforator available, the Perforator No. 44 and the Perforator No. 45. The Model 44 has already been described in these columns (see "RTTY Topics" p.411, October, 1962, SHORT WAVE MAGAZINE) and the Model 45 is a later version using a motor.

Other Makes Of RTTY Gear

There is not a great deal of Teletype Corp. equipment in amateur stations in this country, but occasionally it is available. It is in widespread use by amateurs in the U.S.A. where it is extremely cheap and though this is of little help to us in this country, it does mean that spares are available to anyone who does buy Teletype equipment here. Teletype Model 14 is not a model number for one type of machine, but for several different units and so a little confusion can arise. The various units are: Model 14 Tape Printer; Model 14 Transmitter Distributor (Auto-Tx); Model 14 Non-typing reperforator; Model 14 Typing Reperforator.

This last unit may or may not be fitted with a keyboard since there is a send/receiving model and a receiving-only version. The Teletype Model 15 (or TG7A, or TG7B) is a straightforward page teleprinter and this is the machine that is commonly used in the U.S.A. Most of these machines available here are fitted with AC governed motors, but it is worth checking on this since such a machine with a 60 c/s synchronous motor would require another motor fitting.

The Teletype Model 19 equipment consists of a Model 15 page machine that has been fitted with an additional perforating attachment plus one or more items of the Model 14 gear, usually the Transmitter Distributor. Later Teletype equipment is possessed by a few amateurs in the U.S.A. and is of course in use by the U.S. Forces in Europe. From time to time a few Lorenz T36LO tape printers are sold; these are very similar to the Teletype Model 14 Tape Printer and are usually fitted with an AC governed motor. Lorenz also produce a Model 15 which is to all intents and purposes identical with the Teletype Model 15.

This is roughly the limit of the various machines available in the United Kingdom and the would-be purchaser of a machine that is not mentioned here should make a few enquiries about it before buying!

All That Glitters . . .

One correspondent writes that whilst looking round the cars at a recent Mobile Rally he was astonished to see a Creed Model 3 nestling on the front passenger's seat of a car which was obviously well equipped with mobile gear. Further enquiries revealed that the owner had merely collected the 'printer on his way up to the Rally! Nevertheless, the meeting turned into a discussion about transistorised T.U.'s and possible /A operation in GC, GD and GW at a future date. This of course only goes to show that one should always wear a 7B keyboard at any amateur function! See you in November; 73 de G3CQE.

BRITISH AMATEUR TELEVISION CLUB

Those interested in amateur TV and the B.A.T.C. should note that the Club address for all communications is now: B.A.T.C., 4 Inwood Close, Shirley, Croydon, Surrey.

RE-ISSUE OF PRE-WAR CALLSIGNS

In certain cases, those who held full two-letter callsigns in earlier days, and then gave up for one reason or another, can get either their own old call back again (if not issued to someone else), or an unallotted "vintage callsign." A case in point is G2YX, who was originally G2YC, some 40 years ago. His interest in Amateur Radio having been reawakened by the activities of his son G3RDW, on application to the Post Office he was offered G2YX, the nearest available to G2YC, now held elsewhere. In general, however, new people get new callsigns, and have to wait till it comes up in sequence if they want some fancy combination of letters.

CHECK THE BOOK LIST

Our current book list is published in each issue of SHORT WAVE MAGAZINE—see p.338 this time—in which you will find a wide range of text books, manuals, maps and handbooks, specially selected as being worth having by AT station operators and SWL's at all levels of knowledge and experience. We would recommend readers to look carefully over this list from time to time, as new titles are constantly being added.

• • • The Mobile Scene • • •

STRADISHALL, DARTMOUTH AND DERBY RALLIES REPORTED—

GOOD ATTENDANCES IN FINE WEATHER—MORE THAN 1,400 U.K.

MOBILE LICENCES NOW ISSUED—SEPTEMBER RALLY PROGRAMME

WE are informed by the Post Office that on the last count, to July 31, there were 1,402 U.K. amateurs licenced /M—or nearly 14% of the total of G-station tickets now in issue. The figure for mobiles represents a nett increase of 118 in the four months to end-July.

A good many of them must have been at **Stradishall** on **July 28**, for the Rally held at the R.A.F. Station, which is the home of No. 1 Air Navigation School. This was a most successful event, with perfect weather and an approach through the lovely Suffolk countryside, in itself contributing largely to the enjoyment of many of the visitors. The attendance came to about 2,000 people in 300 cars, of which 116 were actually fitted mobile—and GB3RAF on Top Band worked no less than 110 of them, a marathon effort if ever there was one. On two metres, the count was 18 /M's worked, which is a higher proportion than usual—it seems that more people are going mobile on VHF, for which gear is readily available, with a neater and simpler aerial system.

The prizes, which were presented by Mrs. D. Clare, wife of the Station Commander, R.A.F. Stradishall, went to: G3OGB from Ilford, in a Morris Oxford, for the best home-built installation; G3JEQ (Leatherhead) for the VHF rig in his Morris Traveller; G3HCK of Hurst Green, Sussex, in a Citroën, for the safest mobile equipment; and to G5WZ/M for the longest distance travelled, from York. The prizes for the draw totalled 97 and included a wide range of attractive items. Numerous demonstrations and sideshows had been arranged, all accommodated in a large hangar, and the organisers had the assistance at the stands of several officers of No. 1 Air Navigation School, who had given up a free day to help in entertaining visitors. The continuous cinema show attracted a packed house, despite the glorious weather! But they were showing some exceedingly interesting films. The Cambridge group of the B.A.T.C. put on an enterprising ATV demonstration, with live cameras and interviews, and the West Suffolk police had an audience all the afternoon for their radar speed trap (they call it "speed check") demonstration; people were able to test their speedometers against the apparatus (which produced results of disconcerting accuracy).

Moving spirit in the organisation for this most enjoyable Rally was F/Lt. Gordon Moore, G3MCY

assisted by F/Lt. A. McMillan, F/Lt. N. F. Cutter (G3PQG) and S/Ldr. Tyson, who are to be congratulated on their success. As permission to hold the Rally on the Station was by way of being a special dispensation (about which there was at one time a little difficulty with higher authority—and we all know what that means) the Editor of **SHORT WAVE MAGAZINE** wrote to Gp./Capt. D. Clare, D.F.C., R.A.F., the Station Commander, to thank him, on behalf of the visitors, for having smoothed away the difficulties.

* * *

Yet another Service establishment features in the next report. On **August 11**, the R.N. College, Dartmouth, was the *locale* for a Mobile Rally run jointly by the Torbay Amateur Radio Society and the Britannia (R.N. Coll.) Radio Club. A glance at the map will show that **Dartmouth** is a pretty remote place to get at, but, nevertheless, they had a total attendance of about 350, with 50 vehicles fitted /M; of these, 43 were worked on Top Band by G6VJ, the R.N. Coll. Club's own station, and six on two metres by G5ZT/P, who provided his gear for the purpose. The competition winners were: For longest distance worked with 2m. control, G3NUE (Worcester) from 25 miles out; for longest distance on 160m., G3IWW (Bournemouth), at 85 miles; for the best home-constructed /M rig, G3OCB (Truro); and for the best /M installation overall, G2HJV (Leamington Spa). Though DJ2SR was an EDX visitor, the greatest distance travelled for the Rally was by G3GRA, who came 212 miles from Crawley, Sussex. The mobile treasure hunt produced G5UG, G3XC and G3OCB in the first three places. The local Civil Defence authorities co-operated enthusiastically in the organisation of this Rally, providing seven VHF talking links back to the control station in connection with the motoring event, and (by way of an exercise for their own purposes) dispensing free food, which was excellent, and tea, described as "good drinkable stuff"! The prizes were handed out by G5UH of Bristol, who also assisted G5SY in judging the mobile installations. The organisers, G3NBR of B.R.N.C. and G3ABU on behalf of T.A.R.S., feel that from their point of view the occasion was a success—and this is amply borne out by what we have heard since.

* * *

[cont'd p.361]

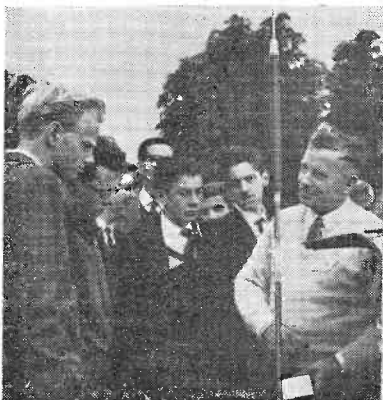

The well-known mobileer G5PP, of Coventry, was at the Chiltern Mobile Rally and is here seen (at right) discussing his /M aerial system with some keen types.



One of the locals at Stradishall was G3PFJ (left) who is a Top Band operator. G3IRM (Bury St. Edmunds) works CW only on the HF bands.



A helix aerial for /M, seen at Stradishall.



At the Stradishall Mobile Rally, the West Suffolk police demonstrated radar speed trapping. The apparatus to look out for is the black box, standing beside the van! Second from right (wearing glasses) is G4DC, taking it all in.



The talk-in station at the R.N. College, for the Dartmouth Rally, signed G6VJ (the College's own original callsign), and was operated by G3LKJ. Some 43 /M's were worked on Top Band.

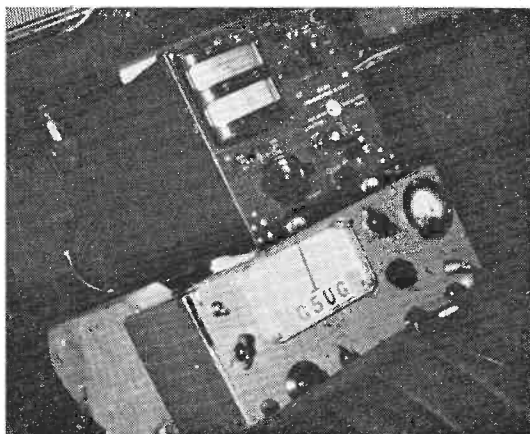

G5UG/M from Weston-s-Mare was at the Dartmouth Mobile Rally. He has a six-band mobile rig, and the car is a Vauxhall Victor.

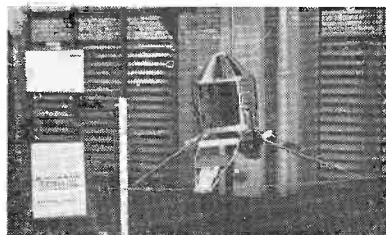

One of the exhibits at the Stradishall Mobile Rally was a mock-up of "UK3", the first all-British satellite.



Mrs. D. Clare, wife of the Station Commander, R.A.F. Stradishall, presented the prizes at the very successful Rally held there on July 28. G3JEQ (Leatherhead) was getting the prize for the best mobile home-built VHF installation (as usual) when this was taken.

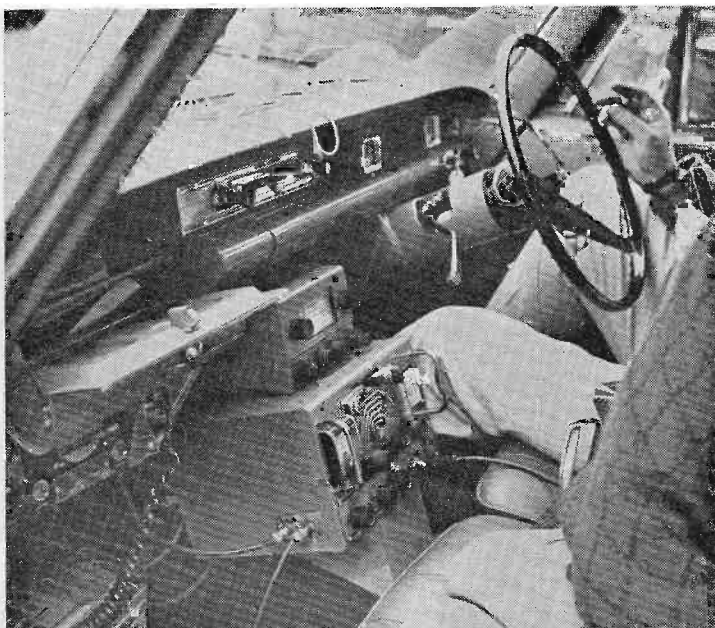

G3NXV /M of Hollywood, Birmingham, is not only operational mobile on all bands 10-160 metres, with Elmac gear, but is also fitted for the two-way business-radio band at 460 mc. G3NXV strikes a new note in amateur /M working in that he can record all his contacts on the tape-recorder at lower left. The car is a Ford Classic and is about as fully radio-equipped as it reasonably could be!



The prize-giving at the Dartmouth Mobile Rally was presided over by G5UH (Bristol), assisted by G3ABU (microphone) and G3NQD (right) who is Mrs. Western of Torquay. When G3GMN took this shot, G3OCB (Truro) was stepping up for his prize.

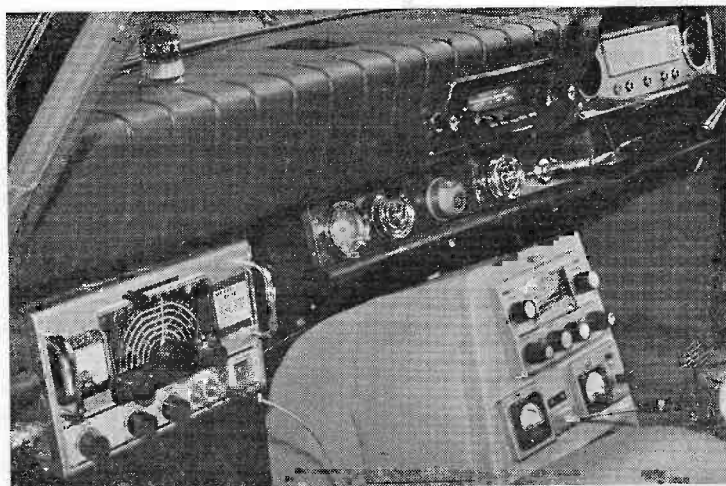

At the Dartmouth Mobile Rally on August 11, G2HJV (Leamington Spa), /M in a Ford Zodiac, was judged to have the best mobile installation. Rx and Tx are Elmac units, with a flip-switch for send-receive control.

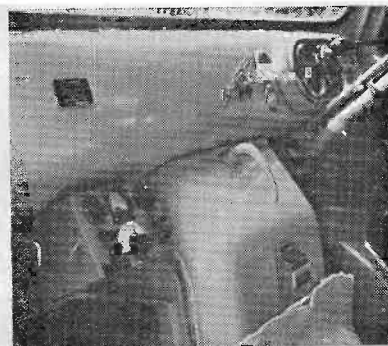

Neat home-built Tx for 80/160m. mobile fitted by G6NW/M in his Bedford Utile-brake. The PA is a 5763 taking 10 watts.

Photographs in these pages from the Chiltern, Stradishall and Dartmouth Rallies

Supplied variously by G3GMN, G3MCY, G3PJG/T, G5CP and G6FO.



At the Stradishall Mobile Rally on July 28 — left, G8QM of Newmarket, who is /M on all bands and a keen CW operator, with G3GJZ, also of Newmarket, who will be remembered as one of the first two-metre stations regularly active in Suffolk.



G3LQR (left) and G3NJO/T were at the Stradishall Rally. Both are active on 70 centimetres.



Responsible for the Stradishall Rally organisation — left to right: F/Lt. McMillan, F/Lt. Moore (G3MCM), F/Lt. Cutter (G3PQG) and S/Ldr. Tyson. They put on a very good show, under perfect weather conditions. And they would like to thank their visitors, not only for coming, but for leaving Stradishall so tidy. The fatigue party had very little clearing up to do.



G3POP/M was at the Stradishall Rally from London, N.22. Left to right: G3POP, G3HOU and G3FS.



The Hounslow and District Amateur Radio Club's contingent to the Chiltern Mobile Rally, on July 14.



General view of the locale for the Chiltern Mobile Rally. The edifice on the hill-top is a famous local landmark.

The annual Rally organised by the Derby and District Amateur Radio Society is always a well organised event, attracting a large attendance—but this year broke all records, for at **Derby on August 18**, they had 4,000 people checked through the gates and the 620 cars in which they came just about taxed the car parking spaces to the limit! The mobile count was 124 vehicles on Top Band and 16 on two metres—of which G3ERD/A on 160m. worked 53, and G3EEO/A nine on two metres. There were some very good prizes for the competitive events, and among the winners were G3DSA/M (York), G3NAO/M (Dewsbury), G3OAR/M (Wakefield), G3HLC (Solihull), and G3BDS (Worcester). For the raffle, 40 prizes were given—and the holders of *pink* 1709, 3779, 3998 and *green* 3685 can claim on G3KQF (*QTHR*) up to October 16 if they still have their tickets. In addition to some interesting trade stands, the programme included a band concert, Judo demonstration, various events for the juniors, a display by the local Fire Brigade, and a monster Junk Sale (which always goes down well). All these events were timed to take place between 2.0 p.m. and 7.0 p.m. We are informed—and can well believe it—that the organisation for this Rally involves about five months' preparation. G3KQF, organiser and chairman of the Derby Society's Rally Committee, can rest content that the effort was well worth while.

* * *

END-OF-SEASON RALLY PROGRAMME

There is a pretty full calendar for the rest of the month—but note that the Thames Valley event previously notified for September 8 has since been cancelled. The programme now is:

September 14: Hamfest and Mobile Rally arranged by Whiteness Radio Club, at Whiteness Manor, Kingsgate, Broadstairs, Kent. Opening at 2.0 p.m., with free admission, car park, teas, games and prizes. The 160m. talk-in station will be G3PNI/A. Further details from: The hon. secretary of the club.

September 15: VHF Fox-Hunt (2m. D/F) near Brussels—*see* p.296 August issue.

September 15: Hamfest and Mobile Rally organised by the Lincoln Short Wave Club, at North Kesteven Grammar School, Moor Lane, North Hykeham, Lincoln, on the A.46. Cafeteria refreshments, plenty of parking space, and a programme for everybody. Assembly is for 1.30 p.m., and the talk-in stations—G4BU on 160m. and G3MZB on 2m.—will be on the air from 11.0 a.m. Further information from: Mrs. L. E. Woolley, G3LWY, Rochmount, Saxilby, Lincoln.

September 22: Red Cross Centenary Mobile Rally at Brussels—*see* p.296 August issue.

September 22: RSGB Mobile Rally at Woburn Abbey, near Bletchley, Bucks., opening at 12.30 p.m. Reserved car parks and ample catering facilities; entrance charge to Park. Talk-in by GB3RS on Top Band and two metres.

September 28: Midland Radio Contest Club Mobile Rally at the Birmingham Association of Youth Clubs' annual fête at Windmill House, Weather-oak, Wythall, Birmingham. Admission by reduced-price programme 1s. 6d., obtainable in advance, with details, from: J. Lockyer, G3OVA, 23 Beechwood Road, Kings Heath, Birmingham, 14. Note that this is a *Saturday*.

ALAN WOOD, G5RZ—1923/63

It is with the deepest regret that we have to record the passing—after a very trying illness against which he put up a great fight—of Alan Wood, G5RZ, of Leighton Buzzard, Beds. He died on August 25, at the age of 59.

G5RZ had been licensed and active for about 40 years, and was one of those "non-professional" amateurs to whom Amateur Radio was a lifelong hobby-interest. Not only did he build much of his own gear but he was a frequent contributor to *SHORT WAVE MAGAZINE*, both in his own name and under pseudonyms—he was the "A. A. Mawse" of the very successful Amateur Radio for the Beginner series of twelve articles in the 1955-'56 issues of the *Magazine*, which to this day are being quoted. With experience over the years from Top Band to the UHF's, latterly his main interest had been LF-band working. Indeed, his last transmission, on June 16 this year, was on 160 metres.

Alan Wood will be remembered as one of the best of radio amateurs—quiet, unassuming, generous, always interested in the latest developments, with all the true amateur's grasp of the essentials and capacity to improvise.

He was a principal in a well-known firm of leather manufacturers, with wide business connections. He leaves a widow and a grown-up son and daughter, who will have the sincere sympathy of all who knew G5RZ.

HEATHKIT ON DISPLAY

Though Daystrom, Ltd. do the bulk of their Heathkit business by mail order, and have built up a fine reputation for quality and service, they welcome any opportunity to meet customers and demonstrate Heathkit equipment. To this end, Daystrom, Ltd. have taken stands at the Do-It-Yourself Exhibition at Olympia, London, W.14 (open till September 14, Stand 112), and also at the Midlands Ideal Homes Exhibition at the Bingley Hall, Birmingham, where they will be on Stand 34 from September 25 until October 19.

DX COMMENTARY

L. H. THOMAS, M.B.E. (G6QB)

OF course there is no doubt that the competitive side of Amateur Radio is both popular and important. How else can one check the efficiency of one's gear, in every phase of the hobby, except by comparing one's *results* with those of others? Every time a new piece of equipment shows up in a clubroom, the first question asked is "What have you worked with it?"

This is no reason, though, why the present pattern of contests, ladders, awards and so on should be regarded as either perfect or inviolable. A little less regard for tradition and a little more for sanity might even be a good thing.

As an example—how can one have worked 300 "countries" when there are hardly more than half that number in the world? And has one "worked" one of these places by sending "559" and hearing the other man, who may have travelled there by coracle or dhow or space capsule, send "559"? And then left the place for ever? Is that what is really meant by "working" a country? (We're only asking!)

If you want an alternative yardstick for showing how clever or cunning you are, take United Nations members only. Your first job is to work them all, one station in each. Then you can jump on the roundabout again and work a second one in each—and so on. But it must be a QSO and not just a "contact." If you are one of the really big boys, how about producing a QSL with a "5 & 9" report from every one of the United Nations countries?

How about those rather neglected *Zones*? Too easy, most of you will say . . . everyone who is someone worked all 40 *Zones* long ago. We agree—on *Twenty*, perhaps. But how many have done it on Ten, or Forty, or Eighty? And how many *Zones* have you worked on One-Sixty? Starting next January we are going to run a *Zone-Band* table, the scoring figure for competitive purposes being the total of the *Zones* worked on each of the six bands, Ten to One-Sixty. At least there will be no argument about whether such-and-such a *Zone* "counts" as a new one.

The man with 300 or more countries to his credit must, to do him justice, have an outstanding signal and a reasonable operating technique. But he must also have a pretty good location, and he must have the time to get on the air when all these fly-by-night types run their short-duration DX-peditions. Without that he is permanently behind in the race. (For instance, those who didn't work Socorra, XE4, a few years back may well be for ever condemned to be one down on those who did—who were very few indeed).

Similarly, with these big-scale week-end contests, the winners must have a big signal, good gear, good operating ability . . . but they must also have (a) the week-end off; (b) someone able to cook and brew coffee for them; (c) the ability to go without sleep for 48 hours without being sacked from their job on the following Monday; and the time and inclination to write or type a log with several thousand entries.

How could these latter events be modified? One suggestion is that the multiplier should be everything, and that only *one* contact per country, per band

should be required. This, to our mind, should give every country in the world an equal chance to win, but would be hard on individual operators in countries where the population is thick. (One G, having worked the one-and-only XT2, would have virtually closed him down as far as all the other G's were concerned!)

Another suggestion is that only a QSO involving the passing of some real information should count; but what do you do about that XT2, for instance, with 300,00 W's all QRX for him? The fundamental question is—*why* should so many stations, spread all over the world, apparently be delighted to make a ten-second contact and exchange two or three figures with someone they have probably worked before and may well QSO again? Because about 90 per cent of them don't send their logs in, anyway. It must be the thrill of working (or whatever you call it) a vast number of stations in the relatively short time. Some of these dedicated types would still do it if one of the conditions were that they were to be chained to the rig for 48 hours. (Whereas most of us old greybeards only find long-duration contests tolerable because it feels so nice when you switch off and take the dog for a walk and some fresh air!)

One thing is certain: With both the amateur population and the commercial intruders increasing so rapidly, something's got to give, sooner or later. It will be interesting to see what it is. All ideas welcome, as always.

DX News from Far and Wide

The DX-peditions have been so many and so rapidly-changing that a slight sense of dizziness prevails. The incomparable Gus, having

REPORTING ACTIVITIES ON SIX BANDS

worked hundreds of stations from AC5A, was next heard with a very much bigger signal; then signing AC5A/M; then AC5A/AC4 (yes, he really did!); and no doubt by now AC3 will have come into the picture. We wouldn't put it past this amazing character to operate from inside Red China . . .

A bunch of OH's were busy activating Aland Is. (OHØ) once more; three JA stations turned up from Torishima, signing with the suffix JB8 (though it is reputed that new country status has not yet been granted); GC2HFD/A was on from Alderney, as well as the other GC types notified last month; JTI's seemed to popping up all over the place; PX1GA (F7GA) came on from Andorra and KG6SE from Saipan; 4WIAZ suddenly appeared on 7 mc and seemed to be genuine, but only there for about five days. So . . . the types with their ears pinned well back found no shortage of exercise.

Other good DX reported to be on includes the following: VP2MM from Montserrat (though probably QRT by now); 3A2CP (G3HPH) on AM and SSB until September 15; VR3E, 14030 kc CW, from Christmas Is.; ZD8WF on 14050 kc CW, 2200; VK2ADK doing the rounds of ZC5, VS4 and VS5—SSB. And Angus, 5N2AMS, has received the following calls for his Middle East operations: MP4BEF (Bahrain), MP4QBD (Qatar), MP4MAP (Muscat) and MP4TAX (Trucial States), whence he was due to start on behalf of the Hammarlund expedition. The other set of Hammarlund equipment was said by VK6RU to be on the way to Christmas Island (the VK9 one, not VR3). VK4JQ on Willis Is. was active erratically around 14150 SSB.

Other initiators of pile-ups included TU2AU (W8HML, c/o American Embassy, Abidjan, Ivory Coast, and there for two years, so what's the hurry?); HS1P, TA2BK, EP2RV (so popular you'd think he was a real rarity), VP4VP (14010 kc CW), and two or three AP5's in East Pakistan.

The persistent ZA1AK, who has been saying "QSL via OK

Bureau" as long as we can remember, is still at it . . . F8FC/FC and F9RY/FC were still there at the time of writing . . . ZS2MI puts Marion Is. on the map every so often but seems to have reception difficulties.

One could go on like this for several columns, but there just isn't space, so we will turn to the snippets forwarded by readers.

DX News from Readers

From G3DO: VP8GQ (Peter in the South Orkneys) is now on SSB, 14 mc; also VK9DR (Christmas Is.) and ZD7BW. 5T5AD is said to be around, same mode, best time apparently 1700.

From VS9OC: Very active from Masirah (Muscat and Oman) and on the air 1500-1800 GMT on AM and CW, 14 and 21 mc. The operator (Jeff Rackstraw) says that the previous users of the club station seem to have been pretty slack with QSL's. The old logs are still there, so send a card direct—Jeff Rackstraw, Twynham Eleven, R.A.F. Masirah, BFPO 69.

From G2DC: Gus was only heard signing /AC4 on August 16; he went SSB, was expected to show up again on CW, but no more was heard . . . The JA gang on Torishima, there for one week only, said QSL via JARL or JA1CRR . . . Reported that the Kuria Muria Is. will be given country status, therefore the VS9 gang will activate them, probably in September.

From GW3AHN: Confirms the Kuria Muria story, but suggests that the DX-pedition is likely to be in October or November . . . W8JJE, who operated from CR8AA and then from CR5AA, now reported to be heading for another one, possibly CR4.

From SWL Dave Gray (Easington): The PX1IK operation (by HB9KU) resulted in 5700 contacts, 105 countries and the consumption of 250 gallons of petrol . . . UA1CC/UJ8 very active in early August with 200 watts SSB and an 18-transistor receiver . . . HI8CLU on 14310 kc SSB (2130); QSL via K4BMS . . . G3PEU going strong from ZD7BW, 14310 kc SSB.

Around the Bands

The LF bands are becoming much more lively, and one or two correspondents suggest that the autumn season has already begun. The holidays have brought out a wonderful profusion of Top Band mobiles and portables, but no real DX has shown up except the occasional W for those who have been out of bed at the right time. However, we will begin on One-Sixty, with a much-condensed version of the terrific amount of correspondence that band has brought.

Top Band Summary

W1BB's summer bulletin makes the following points: DHJ is now peaking at 0130 GMT . . . ZS2FM worked W6ML in the late Spring, and W1BB on July 18 . . . ZE3JO expects to be in full cry this

FIVE BAND TABLE

Station	3.5 mc	1.8 mc	7 mc	14 mc	21 mc	Countries Worked
G3FPQ	120	28	139	273	258	301
G3FXB	105	9	164	290	270	314
G2DC	103	14	150	292	273	313
G2YS	75	22	99	187	131	210
G3DO	73	10	64	301	223	313
G3NFV	57	17	44	112	125	177
G3IGW	53	28	102	132	127	184
G3HZL	52	11	94	159	125	187
G3KMQ	47	13	65	189	77	210
G2BLA	40	10	77	100	99	153
G8VG	38	12	88	160	88	182
GW3CBY	37	20	56	81	34	103
G3NOF	33	2	23	204	186	248
G3PEK	32	12	69	103	47	115
W6AM	30	8	59	316	87	321
G3PEU	26	4	22	134	72	154
GW3PSM	26	1	38	56	25	77
G3RFE	25	1	4	67	69	112
G3IDG	17	11	27	53	64	94
G3RFS	9	2	48	98	10	105
G3PMR	5	10	20	37	21	48

(Failure to report for three months entails removal from this Table. New claims can be made at any time.)

season . . . K1KSH/KG6 worked W6ML and also made a "brief contact" with W1BB . . . VE2UQ operated from Baffin Island during July—made many contacts with VE's and W's during the midnight-sun period.

The following GDY-peditions are mentioned, and thanked, by numerous readers: GM2ASF/P, GM3ABG/A, GI3PDN/A, GI3PLL/P, GM3JEQ/P (from many places), GW5BK/P, GM3COV/P, GB2GC, GC3PSH/P, GW3RRU/P, G3JFS/A, GC3RPB/P, GM3OWM/P. Many complimentary remarks were made about their friendly co-operation and good operating . . . quite a change from the rat-race on the HF bands, which brings in nothing but vituperation!

Booked for the near future are: G3KBC/P (Pye Telecoms. Amateur Radio Group), who will be on phone and CW from Cumberland, September 21-22. If you want more details, contact G3PSA (QTHR). And G3MWZ will be operating portable from Anglesey (September 16), Cardigan (17th), Radnor (18th) and Montgomery (19th). Frequencies 1818 and 1875 kc; times roughly 1900-2300 daily. (It strikes us that when he isn't operating, he'll be driving!).

G3RHM, when he wrote (August 18) was just off to Hunts. to work portable—he had found so many stations short of that county that he hoped to be busy. GM3OGJ was disappointed with his results from Kinross, as he only worked 38 stations during the whole three weeks he was there. Thunderstorms and TV line-oscillators were the main trouble, but he says that many G's having local natters and complaining about lack of DX, didn't turn their gains up to see what was around.

G3PEK, the only station to report on six bands this month, says that up there in Cheshire their SSB is known as "semi-sideband"—the locals mostly use half-lattice high-frequency filters and don't get too much suppression. He runs about 10 watts peak input to a TT-11 in grounded grid, excited in "Natterbox" fashion.

High scores in the New Boys' Table, which was unfortunately crowded out last month, now see G3REA on top with 90, and G3RRU with 88. Most people's country score has gone up by one, also, since ARRL divided GC into two!

G3PVK, off the band for some time, was shaken badly when he returned and found the QRN level so high. Then he had a wonderful time with all the expeditions . . . Others who worked lots of them were G3RFT, G3REA, G3PWY, G3PPE, G3NPB and GM3KLA.

G3RHM remarks that all the locals around Middx. way seem to be using verticals, or about to put them up. As he says, they are logical for short-garden stations—and they work.

G3NPB has worked all 98 at last, and intends to send in his WABC for endorsement to that effect! . . . GM3KLA is quivering on 93 . . . G3RQT worked OZ2IP on 160m. and wonders if it is a "first" (G6QB did it in 1925, as a matter of interest!) . . . G3RQT also adds that ZL3RB sent over a tape of his Top-Band QSO with G3OQT; other G's were also heard on the tape, by the local (Basildon) club members. He thinks SSB should be possible there, or perhaps even AM!

G6VC is another who has made the 98 mark, and awaits one card . . . G3PDM reports a PAØ station, on a static-ridden night, calling "CQ S9 stations only" . . . SWL Roger Western logged W1AW, way back in June, giving an ARRL bulletin at 0400 GMT (RST 229-339) . . . G3RQX heard K3MBF on July 14 at 0245, 339, and also reports that he has worked over 1000 different stations on the band (including 63 different OK's) during his seven months of operation.

The Fourth "CQ" 160-metre CW Contest

Top scorers, as quoted in "Stop Press" on p.320 last month, but possibly missed by some readers, were GI6TK (17232), GW3II (16104), G3IGW (13685), G5JU (12210) and EI9J (10395). DL1FF topped Europe with 20880. There were 1167 stations from 28 coun-

tries taking part—731 from the U.S.A. and 253 from the U.K. Top scorers for the States were W9EWC (37524), W3GQF (30300), W8HGW (29680), W4KFC (28254) and W2FYT (25380). The OK's sent in the biggest European entry (50% more than the U.K.) but their highest scorer was OK1ZC (5820).

Eighty Metres

Things are looking up and the DX is being worked again but most of the CW types complain about the way the DX'ers hug the bottom 10 kc, making things more difficult for themselves and everyone else. Why not spread out a bit? This edge-hugging business was a bug-bear in the pre-war days, but surely it isn't necessary now? G3PEK worked VE1ZZ (0007) and VQ4IV (2230); heard HC1DC, 5N2JKO and W/VE

TOP BAND COUNTRIES LADDER

Station	Confirmed	Worked
<i>CW and Phone</i>		
G2NJ	98	98
G6VC	97	98
G3NPB	93	98
G3LWQ	93	95
GM3KLA	90	95
G3OLN	86	92
G3RFE	85	90
G3NFV	85	87
G3PLQ	83	93
G3PDM	74	82
GM3IKD	60	67
G3RHM	59	65
GM3PPJ	52	69
G2BP	52	56
G3IDG	50	53
G3HZL	25	52
<i>Phone only</i>		
G3FS	86	86
G3NPB	85	86
G3RHM	55	60
G2NJ	49	50
G3OLN	36	49
G3LHJ	27	31

(Failure to report for three months entails removal from this Table. New claims can be made at any time.)

stations. G3PIT raised VQ4IV (2245), VS1LP (2320), PY1BTX (0125), 6O1ND (0149), FP8CB (0229), PY1ADA (0409) and 5N2JKO (0417). The WAE Contest stirred many of these up, and showed that some DX stations are only slightly weaker on Eighty than on Forty at the same time.

G2DC worked HC1DC (S7) and VE1ZZ (S8 at 0600) as well as KV4CI, KP4ARE, W1-4 and 8-9 and VE 1-3. He says lack of activity on the band is due to "lack of incentive." (So what's lack of incentive due to—lack of activity, of course! So the only thing to do is to get on to an unpromising band and call "CQ DX" . . . and then every YU, LZ and YO on the band will come back to you. Truly, you can't win.)

Forty Metres

The last remarks apply also to Forty. Call CQ, and you are submerged beneath a mass of creepy-crawlies; listen for the DX, call it, and everyone else calls too, whether they can hear it or not (except the ultimate lids, who call *you!*) Never mind—press on; someone's always working the stuff.

Such as G3PEK, who found conditions excellent to all continents. From his long list we quote UM8KAA (0017), EP2BQ (0224), VS1LP (2140), VQ4IV, 5N2JKO, 5A3CJ, ZS6BHT and 6O1ND (all between 2100 and 2200); KV4CI (2220), FP8CB (0600), VE's, W's, many PY's and VP8GQ (2100-2200), HC1DC and HK4DP (0350): Leaving Oceania until last—VK5KO, worked on twenty evenings in the month around 2145, VK5ZP and 5JE (similar time) and VK3JF (0640). ZL3VM and 3AAP were heard in the early mornings.

G3PIT raised 6O1ND (2110), VS9MB (2245), VE3/SU (2347), CX1OP (2355), VP3YG (0012), CP5EZ (0045), VS9AAA (0405), VP2MM (0420) and TG9AD (0628), as well as VK's (both short and long path) and many other South Americans (0400-0500).

G2DC booked in 6O1ND for a new one, as well as HC1DC, UA9, UM8, UL7, VQ4IV, VK3TL, W1-Ø and VE1-4.



Station of G3NUP, owned and operated by J. L. D. Targett at Tarabb, Rectory Terrace, Pulham Market, Diss, Norfolk. Having been a professional wireless operator since the age of 16, he decided on retirement in 1960 to keep his hand in by taking out an AT station licence—and he took the R.A.E. and the Morse Test in the usual way to qualify for G3NUP. His Tx is a Heathkit DX-100U, the main receiver an HRO with R.1155 as stand-by, and a 3-in. scope is coupled to the PA to give a modulation envelope. Other items include a field-strength meter and a SWR meter, from the design in the July '62 issue of the Magazine. G3NUP keeps his QSL cards in polythene bags. The shack here is a converted coal cellar, which necessitated flooring, wall boarding and damp-proofing.

G2YS worked VE1ZZ and VK5KO . . . G8VG raised CP5EZ . . . many others list Asian UA's, Middle East and so on. Plenty of variety on the band these days.

As a working guide we quote from the log of SWL John Bluff (Kenton), which makes a change because it covers three modes. (All the foregoing were on CW). On *AM phone*, CO2FM, HI8TEP, HK1EL, LU's (all between midnight and 0200), also PY4-8 and YV1FH, 5BFY, 8AG and 9AF. On *SSB*, CX2CO, OA4OS, many VK's, VS1LP (7037 kc at 2315), W's, VP9, VE3, ZL2WF (0630) and VK2AVA, outstanding both at 0645 and 2045. *CW* yielded EP's, FP8CG, KV4CI, VK's, VQ4IV, VS1LP, YV2AH and 5BMQ, and 6O1ND. SWL Bluff's comment—"I have heard almost as much DX in the last month as I would normally expect in December or January."

Twenty Metres

Twenty seems a bit tame after all that LF-band DX, because you *expect* the stuff there, and merely grumble when you

don't find it. Roughly half the days in the month have yielded something pretty good; the rest have been mostly frustration. Reference to the various DX-peditions and rare ones has already been made.

GW3AHN sends a colossal list of SSB worked, from which we quote AC5A, AP2MI, CR5AA, JA1BRK, JT1CA, KG6IJ (Iwojima), WA6FXO/KP6, TA1AS, TU2AU, VK9BH, 9DR, 9LA, 9NT, VR4CU, ZD7BW, ZP5CF, 5T5AD, 9N1DD and IMM. CW accounted for AC5A, JA1BRK/JB8, KP6AZ and ZD8HB.

VS1GC is around at 1600 GMT most week-ends, but having trouble with pile-ups, according to K. W. Pond (Alnwick) . . . AM phone was heard from VQ1JD, 9G1EC and 9K2AJ; SSB from HC1LG and ZP5CF—B. J. Turner (Westcliff).

G2YS made it on CW with VS1LD, TI2PZ, ZD6OL, PX1IK, VU2VDZ, JA3AOV and TN8AF . . . G8VG raised PJ2AA on SSB . . . G3PEK, after spending most of his time on Forty and Eighty, worked VS1LP, 6W8AC, JA1VX,

KR6BQ, VP2MM, VP8GQ and VE8's.

G3DO, on SSB, cleaned up AC5A, CR5AA, DU1IK, EL8AF, MP4TAV, OA1J, TI6CAL, VK9DR and 9NT, VP4TI, VP8GQ, VR2BZ, VR4CU and ZD7BW. G2DC, on CW as ever, was one of the very few who report working Gus as AC5A/AC4, together with JA1WU/JB8, BY1PK, CE1SI, CX1OP, FB8ZZ, HC1DC, JT1CA, HL9KS, KH6 ("ump-teen"), TI2PZ, OA4CG, VR2BK, VU2HK, VS1's, W6FAY/KP6, XE1VI, ZK1BV, ZL4JF (Campbell) and 6O1ND.

G2DC writes "For night owls all is well on this band, and if one cares to get on between 0100 and 0200 GMT, beaming SW, a very pleasant hour of DX'ing can be obtained, practically free of all QRM. I did sit up one night, and in just over the hour I roped in the following, in the order shown: OA, VK3, VK5, KP4, ZL4JF, HC, VK2, YV5, HK, LU, CE and VP8."

G3NOF stayed with SSB and worked CR5AA, FG7XN, HK's, KL7, KV4, MP4BCC, OA's, PJ3AR, PZ1AG, 1AX, 1BW, 1CE, TI6CAL, TU2AU, VP7, 8 and 9, VS1LV, VS9's, TA1AS, ZD7BW, 5N2's, 6O1WF, 9G1DY and 1EO. Heard, but not raised, were HL9KHR, K6CQV/KS6, KG6AJB and 6IJ, and ZK1BS. VK's and ZL's were heard around 2300 as well as in the early mornings, the latter being well down on previous years.

Fifteen Metres

It seems that not many people even bother to check the state of Fifteen; but during the WAE Contest there was no shortage of activity there. G2DC, on CW, raised AC5A, CR6BX, CR7IZ, CR9AH, EP2RC, EL8AF, KG4AG, PY's, VQ4IV, VK9NT, ZS61W, 6W8DD and 9Q5TJ—all during WAE.

G3PEK spent little time in these parts, but worked 9Q5TJ, PY1ADA, KP4CC, CR7IZ and 6W8DD—all early evening. GW3AHN stuck to CW and and winkled out CR6FW, EP2BQ and 2RC, HC1DC, KP4CC, PY's, TL8AC, 5N2JKO and 2RSB and 6W8DD.

G2YS swapped CW with 9Q5TJ, 6O1ND and 5N2JKO . . . G8VG worked FL5A (same mode). Others merely mention that they were on the band!

Ten Metres

Alas, poor Ten! It tries hard to play at being a DX band, but lets everyone down as soon as they show some interest. G8VG says it was open to Europe (DL's on SSB) on August 4 . . . G3PEK worked a DL7 (just so he could make a six-band report!) . . . G3IDG logged 25 countries—24 of them on CW—but only a single DX station (5N2JKO), who was worked. G3IDG wonders why DM3IGY can so often be heard when no other DL's are audible, and also finds that groups of countries come in together—LA, SM, OZ; CT, EA; DL, OE; HB9, I; and so on. Typical of Sporadic-E propagation, of course.

G3NOF says that only Europeans were heard until August 18, when, around 1230, he logged CR6BA, 6DU and 6VR, ZE8JY, 5H3IW and 6O1KH, all with very strong AM signals. He worked CR6VR, but the band quickly faded out again. The only way to work DX on Ten is never to leave the band! G3IDG says he has found it going great guns as early as 0640, and he has also heard it open as late as 2140. He, too, thinks the lack of activity forms a vicious circle, with everyone listening, hearing nothing, and going QRT. More stations calling would give a truer impression of what the band is really like.

Our suggestion is that everyone who dislikes week-end contests (and there is no shortage of them) should get down to it and warm up *Ten*, particularly on Sundays. Make every Sunday a special activity day on the band. The hardened DX-chasers wouldn't do it, anyway (they might miss something on Twenty) but the others might well have a go. Which is the worse kind of frustration—listening on Ten and hearing practically nothing, or listening for DX on Twenty and hearing every square mile of Mittel-Europa several times over?

General News Items

Another DX-pedition to the Aland Is. will take place during the SAC Contest. OH2EW/OHØ will be there, on CW, 1500 on September 14 until 1800 September 15. Operators OH2EW and OH2SB; two transmitters, 200 watts each; QRV all bands. QSL manager, W2CTN.

As the WANA (Worked All Netherlands Antilles) award has become almost impossible to obtain, the Aruba Amateur Radio Club have now introduced the "Aruba Ariba" award. Work three members (since January 1, 1963); most PJ2's and PJ3's are members. Send list, not cards, and ten IRC's or one dollar. (Box 273, San Nicolas, Aruba, Netherlands Antilles).

G3BHL writes "Turkey is OK—with TA2VY—QSL via W6VY" . . . G3RJS writes from the m.v. *Crystal Sapphire*, off Lourenco Marques, where he has been listening only. His impressions are that it is much easier to hear the

TOP BAND LADDER

(G3P-- and G3R-- stations only)

(Starting Date, July 1st, 1962)

Station	Counties	Countries
G3REA	90	16
G3RRU	88	16
G3PLQ	87	14
G3RBP	85	21
G3PVK	83	15
GM3PPJ	77	11
G3PWY	76	12
GW3PPF	67	12
G3RFT	64	8
G13RCS	61	9
G3PPE	57	11
G3RJH	56	10
G3RHM	56	9
G3PRT	53	10
G3RQT	52	11
G3PMR	46	10
G3RJM	45	10
G3RJI	45	5
G3RDQ	42	8

(NOTE: This ladder will continue until the end of 1963, but no new contestants will now be accepted.)

Far East and the Pacific from there than from the U.K. Apart from a strange 5Y1A/MM, he heard JT1CA, BY1PK, JA's, HL9TF, KH6EDD, KG6AJI and others on 14 mc; JA's very strong while working W's on 7 mc. Off East Africa, G's could be heard working 9G1, 9Q5 and so on, on Fifteen.

G3LQI, formerly ZB2Q and then DL2SW, is now back home and looking for old friends, mostly on 7 mc CW. His home address will be Lancing, Sussex, with operation also from Lincs.

G3FPQ, whose regular reports have been missed for some time, writes "Not much activity, as I have just acquired an XYL! Hope to be active from a new QTH in a few months." (So it seems as if the XYL has been indoctrinated . . . best wishes to them both.)

Quotes

Two notes on Gus, from the *The DX-er* (NCDXC): "He was so loud I could almost hear him" (W6SAD); and "Yes, Gus is on; I can recognise his voice, but I can't read anything he says" (K6ERV).

"I imagine that almost every DX-chaser has, at some time, been helped to work a rare one, and we should adopt a little tolerance when we hear others being 'helped over the stile'—provided certain basic standards are met" (GW3AHN) . . . "I heard some of the so-called VK9BH 'QSO's,' and could only get a few odd words from VK9BH. I was puzzled at some of the signal reports given" (G3NOF) . . . "The various bodies and magazines should stop making gods out of DX-peditioners, the 'over-300' merchants, tables, contests and the like, and let us have more personal information about 'the little man' and his way of life" (G3IDG).

"I like working DX and only DX, because excursions into non-DX bring me into contact with the upstage, the critical and the sharply didactic, and I don't go into the shack for all this when I've already got astronomy. I haven't yet got my average monologue below about ten minutes, and I am in a state of conscious

wonder that the other fellow is still awake when I turn it back . . . this compels search for new insomnia cases further afield" (G3NWT).

"Every real amateur just loves to brag about his hobby, but have you noticed how subtle some of them are getting? It even creeps into print, and G3--- didn't test his super-duper Bandsplatter Tx with a couple of W2's but enlisted the help of ZM6YY and VR6QQ, both of whom were raised on the first call. This sort of thing leaves me cold, and just the other day I heard ZL1ABZ complaining of it, and both ET3JK and KB6CP mentioned it when they QSL'd, and Gus was saying . . ." (SWL Dave Gray, Easington).

"K3QVB, who emigrated from GM-land a few years ago, was telling me about conditions in the States on 7 mc CW. His main grouse is the number of killer-watt DX-ers who sit on the low end of the band, call CQ DX perpetually, and rarely go back to stations answering them. And there is a practice in some quarters of only tuning 7000-7010 kc. All the DX-peditions operate as close to the band-edge as they can. The European CQ DX-ers, some of whom confess to running 500 or 750 watts, also tend to stick in the first 10 kc or so. Surely it would be no hardship to spread out and tune over at least 30 kc?" (G3PIT).

"In this country, only about one person in 10,000 is an active amateur; and, of those, only about one in 100 is keenly interested in rare DX. This means that if you stopped on the roads and said to the first million people you met 'Gus is in AC4 to-day,' it is just possible that *one* would know what you were talking about" (G3BDQ).

"CQ" World Wide DX Contest

The dates are now out for this, perhaps the most popular contest of the year. The Phone section runs on October 26 and 27; the CW event on November 23 and 24. The old idea of beginning at 0200 is abandoned, and start and finish are at midnight. Rules and scoring remain as detailed in the October issue (p.416). And the

best of luck to you all!

Prefixes, Old and New

Last time we published a full list of countries by prefixes was in January 1962. Since then there have been at least a score of changes and additions, and (if only they will keep still for a moment) we are aiming at producing a new one, corrected up to December 1963, and published as early in the New Year as possible.

Late Flashes

"Gus in AC4" was worked on CW by G2DC, G13NPP, GW3AHN; on SSB by G3AWZ, 8KS, G13IVJ and GW3AHN. There may have been others, but not many . . . VP2MM at present being activated by a team of W8's. Operation from Anguilla was hoped for, but now 'unlikely' . . . VS9ADV will operate from MP4M and MP4T, mid-September, early mornings and evenings only . . . YA1AN and YA1AW both reported on 14 mc SSB (high end) . . . ZD7BW on SSB daily, 14115 and 14310 kc . . . ZD8HB heard on CW, 14060, but no details available . . . ZK1AA, 1AR, 1BS and 1BV all known to be active.

There is a project on hand for Harvey, VQ9HB, to visit all the VQ8 islands—and the prospect of an exciting trip for someone who answers to the description of "first-class CW and SSB operator, good sailor, current G licence." Contact G8KS for details.

Sign-Off

So that concludes the summary of another pretty busy month. Things should now be getting better, rather than worse, so keep an eye on all bands, and pass along your findings. Thanks and acknowledgments, this month, to the *WGDXC Bulletins*, the *NCDXC's DX-er*, W1BB for his Top Band news, and, as ever, to our regular news-hawks and DX-hounds who contrive to spot most of what is happening. Deadline for the next issue is **first post on Monday, September 16**; address your letters to "DX Commentary," *Short Wave Magazine*, 55 Victoria Street, London, S.W.1, and don't be late! Until then, we wish you Good Hunting, 73 and—BCNU.

SWL • • • • •

CW RECEPTION — NOTES ON DX/TV — READERS' OPINIONS — NOTES AND COMMENTS OF SWL INTEREST

IT is good to see that so many readers are coming out with strong opinions of their own; so much so that this month's mail is more of a symposium on the state of Amateur Radio than a mere description of receivers used and DX heard. Many regular correspondents have now run through the entire gamut of "being a typical SWL"; with their first letter they told of having heard a couple of DL's on the broadcast receiver—and now they have taken the R.A.E. and, in many cases, collected their call-sign and left us in order to get on with the business of working DX.

All as it should be . . . and we still say, as always, that the young man who has served a few years' apprenticeship as an SWL will make the best job of being a transmitting amateur. Judging by some of the good sense in this month's mail, we feel more and more certain of this.

Enthusiasm for CW

It is pleasant to report several additions to the CW section of the HPX Ladder, although the Morse enthusiasts still form only a small percentage of the whole. However, if the increase continues, they may one day be able to hold their own. *Roger Western (Torquay)*, who heads the CW listing, addresses *H. G. Shaw (Heswall)*, at the top of the Phone Ladder, as follows: "I am chasing him on the Phone List (39 new ones this month), so why doesn't he have a go at me on CW?"

SWL Western adds that he picked up the code several years ago and worked up to 25 w.p.m. simply and solely by listening to amateurs; and one reason why he enjoys it is that you can find DX on CW when the phone bands are practically dead.

D. Beaumont (Manchester) says he doesn't know why so many people complain about the "Mittel-Europen Klots"—some of them are very good operators and work plenty of the DX. They seem to be regarded as the majority of motorists look upon women drivers, who are not all bad, by a long way.

J. Cowley (St. Helens) writes: "Nothing gives me more satisfaction than digging a really weak CW signal out of the QRM, and the phone boys with all their weird procedure just leave me cold." He adds that an SWL who hears a phone signal on an expensive commercial receiver has done *nothing* for himself, but a CW listener with the simplest gear can feel that he has achieved something.

J. F. Hudson (Birmingham) is even more outspoken: "The amount of utter nonsense which is pumped out on telephony makes it a sheer waste of

time, and therefore I stick to CW . . . but even the CW end of Twenty is being swamped by Europeans whose idea of Morse is completely at variance with that of the originator."

Many others send in their CW lists without any comment, so it is obvious that some still enjoy it. We look forward to a further increase in numbers. Remember, if a "ticket" is your goal, you will have to master CW sooner or later—why not start now?

R.A.E., G.C.E. and All That

Edwin Taylor (Birmingham) took R.A.E. in May, and is still hoping . . . *Mike English (Yeovil)* is studying for his B.Sc. in Electronic Engineering, and is away at Bangor for 30 weeks of the year, but happens to be sharing digs. with G3PMR . . . *Phil Stevens (Donnington)* sends his "final" HPX list, having become G3SES on July 18. He says "Please send my 73 to all SWL's, especially CW enthusiasts."

A temporary cessation of "G.C.E. QRM" is reported by *C. M. Palmer (Birmingham)*, *A. L. Davidge (London, E.12)* and *D. S. Smith (Stanmore)*. We hope the results are also QRM-free. SWL Palmer says "what with all the new prefixes like 7X2, 6N5 and so on, one doesn't know whether a station is a pirate or a legitimate one with a new weird call." Too true — they're appearing all the time.

Starting Young

A. R. Nelson (West Lothian) is a fourteen-year-old writing in for the first time. His progression was: One-valve battery receiver, all-wave mains receiver and now an R.107 fitted with an S-meter and used with an 18-foot wire plus whip. He has already collected a hate — operators who "talk on and on about nothing at all." And he actually heard a GM, on Eighty, say "This is the first phone QSO I've had with you since our last" . . .

David Farman (Enfield), also fourteen, has been with us for a year. Having been listening with an R.109, he now wants a good receiver for the HF bands, but finds his alternatives limited (by finances) to home-brew or something like the BC-348. He would like to see brief specifications of ex-Government receivers, for the guidance of inexperienced SWL's. (We are bearing that one in mind).

Peter Etheridge (Hull) is only thirteen, but has just taken up the SWL game and has a Codar one-valver and an R.1155, which have already put him on the HPX Ladder.

DX-TV

Some support this month for *Charles Rafarel (Poole)* in the TV sphere. He himself says the DX has been as good as that of 1961 and 1962, and can now claim 84 TV stations verified in 21 countries, the latest being two from Switzerland and one each from Denmark, Czechoslovakia and Italy. Outstanding on-the-spot news items have included the Russian space flights, the Papal ceremonies and Mr. Khrushchev's visit to East Berlin, all direct from the appropriate stations.

Roy Patrick (Derby) thinks things must be a bit

harder in the centre of England than on the South Coast, but he was getting the TV sound transmissions from French stations on July 14 (channels F2 and F4), also some Italian sound on 59 mc.

J. H. Duxbury (Accrington) converted his TV set last year, and, now, without any special aerial systems, finds he can get identifiable pictures from Italy, Germany, Sweden and Poland — all between Channels 1 and 3. He says "Now whenever I hear a 'buzz' on the B.B.C., I'm off to the attic!" Quite a thrill to see a picture of a woman holding a shield and to see, on the left of the screen, "Telewisia Warszawa."

D. Boniface (Ripon) started on this DX-TV business about a month ago, and has received test cards from Italy, Spain, Portugal, Russia and Czechoslovakia. His aerial is a plain "X" about twelve feet high. For ordinary SWL purposes he uses an MN-26C receiver with converters covering all bands from 21 mc to Top Band, and an RF-27 for four metres.

D. A. Pickup (Preston) says that two of his friends have been receiving Sporadic-E television on Band I from France, Netherlands, Sweden and Spain, using ordinary X aerials, and one of them held a Spanish picture for five hours on June 23, using a horizontal dipole. They have found that good times for DX-TV always coincide with a ten-metre opening to Europe.

On VHF

The VHF types are now outnumbered by the TV-fanciers. *Bob Towers (Nottingham)* caught the big opening on June 8-9 and the lesser one on July 20-21; he completed a converter within a week of returning for the vacation, and it worked first go. The beam in the loft, still pointing north, is being replaced by a 7-element affair.

M. I. Vincent (Cheltenham) who was credited with 12 countries on Two, modestly points out that it should have been *counties*. His 3-element beam is tied to a rotatable post by string, and is described as "18 feet up, in the clear, and very unsafe!" For the HF bands an ATU has been added, giving a gain of five S-points in some cases . . . and CW listening is now going strong.

Others mention ATU's, including *Chris Boulton (Uttoxeter)*, who has one of the "you produce it, we'll load it" variety, which brings in DX on a half-pint tankard! *Vincent Lear*, a fourteen-year-old from Walasey, uses a Z-match type of coupler, but is puzzled to find that he gets much better results with a direct earth than with a 126-ft. counterpoise that he ran along the garden fence. He, too, is chasing CW.

Stray Comments

"I have now built a single-conversion superhet with RF amplifier, by adding successive stages on to a TRF receiver. Each stage is in a separate unit, the units interconnected by octal plugs and sockets." So writes *D. H. Doff (Wallington)*, who adds that the advantages are that the initial outlay is not large

and additions can be made when you like; and that the instructional value is far greater than if you try to build a whole receiver on one chassis. (The "unit-construction" scheme was very popular during the late 1920's, when receivers had only three sections — RF, detector and audio).

"May I suggest a new HPX Ladder to commence on January 1, 1964, or some other new competition starting then?" (*Dave Whitaker, Clitheroe*) . . . "Why do amateurs persist in time-wasting by spelling out every other word when they have been given a 5 and 9-plus-20 report?" (*M. J. Summers, Market Harborough*).

"I have passed the R.A.E., much to my relief, but as Morse is only just becoming seriously studied, I doubt if I will be licensed before the New Year . . . May I say that amateurs deserve more credit than they get from SWL's, especially in sending slow CW, an absolute necessity for those learning Morse." (*P. Moncaster, Goole*) . . . "Since I last wrote to 'SWL' I now hold two licences, G3PRI and DL2PB, and wish all the best to SWL's going for their calls this year." (*Dave Quigley, BFPO 16*). "Survived the 'O' levels, take 'A' levels next year, and I am now G3SDT." (*D. Allen, Cleethorpes*).

D. C. Parker (Redditch), another of the juniors, does his listening on an HRO-MX and sends a first claim for the HPX Ladder. At the other end of the seniority scale is *B. Hoddinott (Sheffield)*, who started listening in the early days of broadcasting, when the staple fare was "Two Emma Toc, Writtle" and the Eiffel Tower time signals—this puts him in the group active in the early 1920's! He now runs an Eddystone 840C, and wishes amateurs would identify themselves more clearly, especially when in net QSO's—don't we all!

DX Notes

One of the keenest DX'ers to report regularly to us is *Dave Gray (Easington)*, whose score has now jumped to 408. He does not agree with Phil Whitchurch's statement that rare DX stations don't respond to QSL's, having recently had cards direct from CE8CG, KB6CP, 4S7IW and 9N1DD, so say nothing of QSL's through the "managers" of FM7WQ, HC8CA, VR30 and ZL1ABZ (Kermadecs). But he does agree that you have to be pretty crafty



Josef Benda writes us from Olsany, Ruda nad Moravou, in Czechoslovakia. His SWL number out there is OK2-4511.

and send really helpful reports. He has found DX conditions peculiar but very interesting. If the bands are dead, you shouldn't switch off . . . ten minutes later that much-awaited rare one will arrive!

Roger Western (Torquay) — whose mother is G3NQD—acquires a good deal of DX information this way, and passes on the word, direct, that VP8GQ will be very active on One-Sixty this winter. His friend Barry Curnow (Plymouth) has acquired 35 SWL awards to date and is still chasing them. He is in favour of DX contests (most listeners are!) because they liven up the bands. SWL's Western and Curnow both have some stern things to say about sloppy and rude operators, of whom, unfortunately, there is never a great shortage.

Malcolm Warrington (Burnley) found ten metres in fine fettle for Central America some time back, when he logged KZ5BL, FG7XT and KV4DB on the band . . . Three interesting ones mentioned by R. M. Bloomfield (Crowthorne) are 9N1DD, 4U1TU (International Radio Club, Geneva) and K1EUD/MM on an Antarctic Research vessel in the Drake Passage (61°S, 63°W).

Phil Whitchurch (Bristol) was bound for Austria

HPX LADDER

(Starting January 1, 1960)

Qualifying Score—150

SWL	PREFIXES	SWL	PREFIXES
PHONE ONLY		PHONE ONLY	
H. G. Shaw (Heswall)	672	S. E. F. Howell (Hove)	243
R. J. C. Coats (Cowie)	601	D. Cree (Newark)	237
A. W. Nielson (Glasgow)	582	R. Harsant (Ware)	231
D. Douglas (Dundee)	542	A. Stone (Kidderminster)	228
R. Hunter (Kenton)	526	M. D. Otley (Crowthorne)	216
D. S. Smith (Stanmore)	475	C. G. Duncan	
B. Curnow (Plymouth)	452	(Dunfermline)	214
R. R. Loe (Colchester)	451	D. Welby (Eastleigh)	213
C. N. Rafarel (Poole)	448	A. J. Birch (Lichfield)	210
R. K. Western (Torquay)	439	M. A. French (Highbridge)	207
D. A. Whittaker		M. V. Collins (Crayford)	200
(Waddington)	412	J. R. Daws (Leeds)	200
D. Gray (Easington)	408	A. F. Roberts	
S. Foster (Lincoln)	407	(Kidderminster)	196
F. Bourne (Plymouth)	405	D. J. Dixon (Widnes)	187
P. Whipp (Enfield)	380	P. H. Moncaster (Goole)	186
D. A. Pickup (Preston)	374	B. B. Charge (Cheshunt)	183
J. E. Pither (London, W.5)	374	D. H. Doff (Wallington)	181
P. J. Lennard (Wartling)	372	D. C. Parker (Redditch)	171
M. Warrington (Burnley)	371	K. M. Duggan (York)	166
K. C. Staddon (Stroud)	369	M. Maxfield (Solihull)	164
K. Whitley (Castleford)	369	D. Beaumont (Manchester)	161
A. L. Davidge		P. R. Doughty	
(London, E.12)	353	(Loughborough)	157
C. M. Palmer (Birmingham)	347	P. Etheridge (Hull)	153
M. D. Stapleton		B. J. Turner (Westcliff)	152
(London, W.13)	342	C. G. Ivermee (Reading)	151
D. J. Aldridge (Southend)	337		
R. G. Evans (Swansea)	322		
C. H. Miller (Tayport)	308		
A. F. Huggett (Lamberhurst)	308		
M. J. Summers			
(Market Harborough)	307		
P. A. Whitchurch (Bristol)	306		
M. Vincent (Cheltenham)	294		
M. English (Yeovil)	293		
R. J. Howgego			
(London, E.11)	293		
D. J. Warburton (Dollor)	275		
G. C. Steedman			
(Huddersfield)	269		
J. T. Eden (Solihull)	267		
R. M. Bloomfield			
(Crowthorne)	258		
D. Barker (Brownville)	245		

NOTE: Listings include only recent claims. Failure to report for two consecutive issues of "SWL" entails removal from the Table. Next list, November 1963 issue, deadline September 27.

SWL • • • • •

continued

soon after writing, and had received a letter from OE1NY inviting him to visit his shack. R. Hunter (Kenton) was one of the many who heard a brand-new country through "Gus" (AC5A); but he remarks that although every station working him was giving him S7 or thereabouts, he was only about 539.

Stewart Foster (Lincoln) achieved his goal of "400 before the summer holidays" but will not be listening again until October. He does his SWL'ing at Nottingham University and packs it in during the vacations! R. J. C. Coats (Cowie) has just topped the 600 mark and reports that conditions have varied from excellent to "just the opposite."

Roger Evans (Swansea) was delighted to log AC5A, and often noticed the Far East coming in well between 1530 and 1630 GMT. Martyn French (Highbridge) has found activity high on Ten, especially from 1700 GMT onwards, mostly Europeans using ground-planes.

Charles Duncan (Dunfermline) has found Twenty so crowded with Europeans that the only time to listen for W's in comfort is mid-morning. He can't yet copy SSB on his gear, and regards it as "some mysterious mode of communication between amateurs." Regarding relations between amateurs and SWL's, he says "the one I visited was most helpful, willing and generous. He gave me many books, odds and ends and tips which I have found very valuable."

Deadline for the next instalment of "SWL" (November issue) will be Friday, September 27. By that time the holiday spirit will be somewhat diluted and shacks will be getting ready for the winter. In fact, the DX should already be improving by or before then. Good Hunting, then, and we look forward to hearing about it.

—•• ABOUT LEARNING MORSE —••

In the July issue of SHORT WAVE MAGAZINE, pp.258-259, a self-help approach was suggested to the problem of learning to read Morse. It is a method which assumes no outside aids (beyond a receiver) and if practised as explained in the July piece, will enable almost anyone to master the Code—we have to say "almost" because apparently there are some people who find it impossible to learn Morse, however they may be taught. On the other hand, those who may be doubtful about their own ability can be assured that over the years a great many amateurs have taught themselves Morse by the method advocated in the July article.

Indeed, by now there should be some readers, at least, who can read well enough to be thinking about learning to send. But here again it must be emphasised: Until you can read with some confidence and fluency, you should not even think

of trying to send. Obviously, until you *can* read, you are like the unhelpful partner; you cannot send accurately or with any sense of rhythm and spacing. But start to learn sending after you can read, and you will find it easy, quick and altogether a much simpler problem than learning to read—remember the old saying: Anyone can send Morse, but it takes an operator to read it. It is for that reason that this article is not illustrated in any way, with buzzer circuits and pictures of the right way to hold a key! The way to hold a key is the way you find most comfortable for easy wrist action, and to “make the noise” you can use either a high-note buzzer or an audio oscillator. Always monitor, aurally, your own sending, so that you can check yourself—and this applies just as much when you get on the air.

The whole emphasis of this article is on the fact that once you can buzz the letters, vocally, you can learn Morse by yourself with only a receiver capable of tuning in commercial CW stations, preferably on the short-wave bands, where they are strong and numerous. Nothing else is required to start you off. You can get your reading up to 15-20 w.p.m. without ever touching a key. Then, when you can read with fluency, you can practise sending, *knowing how it should sound*; you correct your own sending errors as you go along, aware that what you have to culti-

vate is that easy, swinging rhythm, at any speed, which makes your sending as readable as print. Morse is like music—it has style, grace and rhythm and, for the perfectionist, is an art in itself. Of course, a lot of people get by with something much less than this, but a good operator is always a pleasure to copy; moreover, he can go at speeds much higher than the stuttery 12-15 w.p.m. stuff because his spacing and timing, *i.e.*, his rhythm, are so good that he is always readable.

There are operators, and operators — from the newly-licensed G3S - - trembling on the brink of putting out his first *dah-dit-dah-dit dah-dah-dit-dah*, to the professional telegraphist able to take the French official press straight on to a typewriter, in English! Just think of the simultaneous mental processes that would be involved there unless reading Morse and typing had become quite automatic, leaving his brain free to concentrate on translating the French text into English, phrase by phrase.

Bibliography

Manuals and booklets which print the Morse Code or discuss methods of learning it are: *Radio Amateur Operator's Handbook*; *Learning Morse*; *A Guide to Amateur Radio*; *Morse Code for Radio Amateurs*; and *Learning the Radio Telegraph Code*. All these are obtainable through our Publications Dept., as advertised on p.338 in this issue.

INTERNATIONAL RADIO COMMUNICATIONS EXHIBITION

This is the 1963 title for the Amateur Radio Exhibition, to be held, as last year, at the Seymour Hall, Seymour Place, London, W.1, during October 30 to November 2. We shall be there—we are now the only (paying) stand-holders who have been at every Amateur Exhibition since they were started—and as usual the Show will be organised and managed by P. A. Thorogood, G4KD. The Seymour Hall is particularly suitable for this kind of exhibition, with plenty of space off the Hall and reasonable bar and catering facilities.

INTERNATIONAL TELEMETERING CONFERENCE

The specialised branch of radio communication, industrial control and space research known as telemetry has become so important that it now rates not only as a subject on its own, but also an international conference. It is expected that more than 500 engineers and scientists will attend a week-long meeting, supported by an exhibition at which no less than 50 companies specialising in the field will be represented. The first International Telemetering Conference will open at the Institution of Electrical Engineers, Savoy Place, London, on September 23, and the accompanying telemetry exhibition will be laid on at the new Hilton Hotel in Park Lane. Nearly 20 countries are to be represented at the conference, and a long list of technical papers will be presented. The sponsoring of the whole affair is a joint Anglo-American effort, with the I.E.E. and the Brit.I.R.E. acting for the U.K.

THE AMATEUR LICENCE TOTALS

According to the latest G.P.O. figures, the total of U.K. amateur licences in issue as at July 31 was 10,185—this being a nett increase of 138 in the four months since March 31 last. The mobile permits totalled 1,402 (increase of 118) and the ATV licences, for 70-centimetre operation only, came to 138, being nine more than four months back.

SPACE NEWS BROADCASTS

To keep in touch with the latest news about satellite launching and for orbital information generally, you can get a daily bulletin known as *Spacewarn* broadcasts. Unfortunately, the time is a bit awkward for U.K. listeners—0330-0335 GMT, Tuesday-Sunday mornings—but if you are interested, the stations to tune for are WLWO on 9650 kc, or Greenville on 6105 or 9750 kc.

ARRL—NEW QTH

We are asked to announce that the new address for the American Radio Relay League, the national organisation for U.S. amateurs, and publishers of *QST* and the *Radio Amateur's Handbook*, is now: Hq. ARRL, 225 Main Street, Newington 11, Conn., U.S.A.

It is much regretted that because of heavy pressure on space this month the "Miscellany" and "For the Beginner" features have had to be held over until the next issue.

VHF BANDS

A. J. DEVON

THOUGH the appearance of HB1ADT, as a workable signal from the U.K. during the last weekend of July, was as welcome and exciting as it was unexpected, there have been other notable occurrences during the period—truly, the VHF bands, now populated by so many efficient stations and competent operators, can always be relied upon to produce *something*, however dull the immediate prospect may be.

In addition to the HB1ADT event, some remarkable work has been done by F8MX on 23 centimetres, in working G's on that band, G3MPS and G5NF figuring in this context. And as if that were not enough, G3LTF has gone right to the top of Countries Worked by reason of his meteor-scatter QSO's with HG5KBP and UR2BU—the latter, on August 13 over 0800-1030 GMT during the Perseids shower, being the G/UR "First."

For the Perseids (Aug. 10-13), G3LTF also had skeds with several other EDX stations, and his results boil down to LZ1DW and UP2ABA heard by MS, as well as the full contacts with HG5KBP and UR2BU. Distances are around 850 miles for the HG, and 1,120 miles for UR, this latter being G3LTF's seventh MS QSO at over one thousand miles.

Altogether, a very fine effort, on which he will have the congratula-

tions of all who read this piece.

Arnold of G3HBW was also there for the Perseids, with a very nice auto-CW signal, and he made it with HG5KBP on the evening of August 12/13, over the period 2230-0050, the reports being S25 out and S28 in. He had a sked with UA1DZ, likewise for the Perseids, but nothing came of it. G3HBW runs 300w. with a 28-ele Yagi and, like G3LTF, is fully equipped to make the most of any meteor-shower opportunities.

G/F on 23 Cm.

Though the 23 cm. results do not involve either great distances or exotic callsigns, they are nevertheless significant and extremely interesting. F8MX was at his summer hide-out at St. Valery-en-Caux, just across the Channel, using low power with a 2C39A tripler, into a horn-type aerial designed by F3SK, his freq. being 1297.25 mc; the F8MX converter is described as "flat-line type," from which one deduces that it is a resonant long-lines job with a xtal mixer. Anyway, it produced a 5-9+30 signal from G5NF (Farnham, Surrey). The latter was actually using 23 cm. gear (Tx freq. 1296.6 mc) built throughout by G3MPS and lent by him to G5NF for these tests.

The *aerial* is an 8/8 slot-fed array with a mesh reflector. *Receiver* set-up consists of a radial cavity mixer with a CV-2154 xtal, the oscillator chain being 12AT7 into 6J6 to 6AF4A at 635 mc, doubled in a 446A to 1270 mc; this works out to 26-30 mc tunable IF, and the xtal mixer is followed by an E88CC IF amp. and EF91 cathode-follower output. For the *transmitter*, a 12AT7-5763-12AT7-DET24 arrangement gets the crystal frequency to 432 mc, which is then tripled in a 2C39A to 1296 mc, the actual RF into the beam being about 8 watts. The DET24 anode is a tuned quarter-wave strip line, and the 2C39A output stage is fed through a coaxial cathode circuit on the input side at 432 mc, the tripler tank being a cavity, resonated by an adjustable disc.

Though G3MPS has had this 23-cm gear, all designed and con-

structed by himself, available for about two years, the lack of neighbouring activity on the 1290 mc band meant that he could not do much with it—until he got a chance contact with G2RD/P at Watlington. This inspired cross-band tests with G5NF, who then heard F8MX on the G3MPS converter; after that the obvious thing was to try his transmitter on F8MX from G5NF. Hence the QSO, on which G3MPS and F8MX are to be congratulated, as well as G5NF, from whose QTH the contact was made, on the evening of July 29. A special word is due to F8MX, because he was working in the dark, in that until he heard G5NF/G3MPS, he had nobody at all to test with on the 23 cm. band. Thus we see persistence and know-how rewarded, and with the awakening interest in 1290 mc, it should not be long before the Surrey group get into contact with the Midlands stations also working on the band.

And they could be joined by G3LQR/G3LTF, who are in touch on 23 centimetres, in the Colchester-Chelmsford neighbourhood.

Build-Up of Conditions

In the opening paragraph of the last "VHF Bands," a change for the better was hinted at for the latter part of July. We have already seen how EDX conditions developed for the period to July 22. Sure enough, the glass started to climb again about the 24th, the weather turned warm as an anti-cyclonic area formed over the U.K. and Northern Europe, and by the 27th the two-metre band was opening up nicely. Sunday 28th was the big day when HB1ADT was a terrific signal by the late evening, making many G contacts. By then, the glass was up 30.6in. in the South Midlands and, following a hot day with temperatures in the 80's, the night was cool and clear. Indeed the right Wx conditions for a good opening, and fortunately it extended far enough to bring in some interesting EDX.

This opening lasted at least until August 1st, when the glass began to go back again, since when things have been erratic and patchy, just like the glorious

August weather we have been having! (Well, we can't expect to have it good *all the time!*)

On the evening of July 27/28, late on, your A.J.D. noticed signs of Auroral reflection, with carriers sounding rough—but none of the reports for this time mention it (*must have been his converter going duff.—Ed.*). By the 31st, the two-metre band was wide open North-South, and GM2FHH of Aberdeen was getting into the southern districts of England. EI6D was giving Co. Kildare, and EI2A worked G stations right across to the south-east.

During this spell of EDX conditions, many excellent EU contacts were made, and more than a few of the newer G's on the two-metre band worked some good EDX for the first time. The result is, naturally enough, a considerable uplift in claims for the tables.

The Tabular Matter

Since the 1962-'63 Annuals have now run out and final placings cannot appear till next issue — at the moment of writing we await any last claims to August 31 — some space has become available.

So at the expense of some of the other tables, too, we are giving the Two-Metre All-Time one of its periodical airings. A very large number of claims, accumulated over the last six months, have been taken in and, so far as your A.J.D. has been advised, the All-Time as here shown is bang up to date. And balanced on the top rung at 90C is EI2W, a very fine performance from where he is. It is the outcome of 15 years of consistent activity, against a severe geographical liability; as well as keeping himself on the VHF air, Harry has enthused and encouraged a great many EI's and GI's — and in this context there is no conflict of interest whatever between Eire and Ulster; indeed, this is a perfect example of the leavening influence of Amateur Radio. And in case anyone should have the wrong notion, let it be said that EI2W is strictly a "non-professional amateur." To him, Amateur Radio is just an absorbing hobby interest. His

business activities are in quite different directions, and he is much respected in Dublin commercial circles.

The other table we show this time is Countries Worked, in which there have also been many movements, leaving G3LTF in the hot seat, at 22 countries on two metres—and what a fine record that is! There are now no "loose ones" between the first three (meaning no country none of them has worked) and so further progress is a matter of finding entirely new countries, either by MS, spor-E or under exceptional tropospheric conditions—say, EA, I, LZ, UP, YU or 5B4, all of which are within range of one or other of these propagation mechanisms. The difficulty is to get the right sort of co-operation from the other end.

Some Activity Reports— Two and Four

G3PKT (Rainham, Kent) started on two metres in October, '61, and has his 8C for the first rung of Countries Worked. He runs just 20w, to a slot-fed 8/8, is on two metres as his only band, and has worked 252 different stations. G2CDX (Cambridge) would like to raise "some near-locals such as Berks., Bucks. and Oxon." to boost the score a bit, but turns in a nice lot of EDX worked during the opening.

A sound and very consistent performer for Eire is EI2A of Navann, who gives Co. Meath. He was on for the "good period," during which he worked no less than 90 different U.K. stations; for him, the end-July opening did not extend to the EU's, though he heard, and vigorously called, several French stations. For those who may like to know, EI2A is on every evening, and after his regular sked with G3EHY, he always looks for beams that may be headed his way.

G3PBV (Wolverton, Bucks.) was one of those who registered HB1ADT—incidentally, the call-sign indicates that it was HB9ADT out /P (on Mont Tendre, in the Jura); in the ordinary way, the HB9's cannot expect to work VHF/DX from their home stations

—and Dave also got GB2GC when in Alderney. (It is understood that after starting up there, they had receiver trouble, though at the moment we are without positive news as to what happened when they were supposed to be in Jersey—perhaps the *Island Queen* missed out on her schedule.) G3PBV mentions that he is now using an R.1475 as main Rx, tuning 4-6 mc—he says that this is a very excellent receiver for the purpose, available quite cheaply as it is little known. G3PBV has just completed an all-transistor 4-metre converter, and for two metres, an exciter capable of giving drive for AM/FM/CW/SSB is under development. With

TWO METRES COUNTRIES WORKED

Starting Figure, 8

- | | |
|----|---|
| 22 | G3LTF (DL, EI, F, G, GC, GD, GI, GM, GW, HB, HG, LA, LX, OE, OH, OK, ON, OZ, PA, SM, SP, UR) |
| 21 | G3HBW (DL, EI, F, G, GC, GD, GI, GM, GW, HB, HG, LA, LX, OE, OH, OK, ON, OZ, PA, SM, SP) |
| 20 | G5YV (DL, EI, F, G, GC, GD, GI, GM, GW, HB, HG, LA, LX, OE, OK, ON, OZ, PA, SM, SP) |
| 19 | G3CCX |
| 18 | G6NB, ON4BZ |
| 17 | OK2WCG |
| 16 | G3GHO, G3KEQ, G5MA, G6RH, G6XM, PA0FB |
| 15 | G2CIW, G2XV, G3AYC, G3BLP, G3FZL, G4MW, GM3EGW |
| 14 | G2FJR, G2HDZ, G3CO, G3FAN, G3HAZ, G3IOO, G3JWQ, G3KPT, G3WS, G5BD, G6LI, G8OU |
| 13 | G2HIP, G2HOP, G3BA, G3DKF, G3DMU, G3DVK, G3EHY, G3GPT, G3HRH, G3HT, G3NNG, G3PBV, G5DS, G6XX, G8VZ |
| 12 | EI2A, EI2W, F8MX, G3AOS, G3GFD, G3GHI, G3JAM, G3NUE, G3OBD, G3WW, G4LU, G5CP, G5ML, G8DR, GW2HIY |
| 11 | G2AJ, G2BJY, G2CZS, G3ABA, G3BDQ, G3BOC, G3GSO, G3IUD, G3JYP, G3JXN, G3JZN, G3KUH, G3LAS, G3LHA, G3OHD, G4RO, G4SA, G5UD, G6XA, OK1VR |
| 10 | G2AHP, G2AXI, G2FQP, G3BK, G3BNC, G3DLU, G3GSE, G3JHM/A, G3KQF, G3LAR, G3LTN, G3MED, G3OSA, G3OXD/A, G3RMB, G5MR, G5TN, G8IC, GC2FZC, GW3ATM, GW3MFY, GW5MQ |
| 9 | G2BHN, G2DHD, G2DHD, G2FCL, G3BOC, G3BY, G3FLJ, G3FUR, G3JLA, G4LX, G5UM, G8GP, GC3EBK, GI3ONF, GM3D1Q |
| 8 | G2DDD, G2XC, G3AEP, G3AGS, G3CCA, G3EKX, G3GBO, G3HCU, G3HWJ, G3KHA, G3PKT, G3MPS, G3OJY, G3PSL, G3VM, G5BM, G5BY, G8SB |

a move to an excellent new QTH in Northampton in prospect, G3PBV is building to be active on 4m., 70 cm and 23 cm, as well as two metres.

A report from GM3LDU (Clarkston, Renfrews.) says that he hears GB3VHF on the odd occasion—the last time was on August 21, for a few minutes—and is able to claim two new counties: GM2ASF/P, the Coventry Amateur Radio Society holiday expedition to the Isle of Arran,

for Bute, and EI6D for Co. Kildare.

G3BNL (Keyworth, Notts.) moves in the 2m. Annual and 4m. All Time tables, and G3NUE (Worcester) likewise. The latter went to the Dartmouth Rally, but found the two-metre activity a bit thin on the way down—he worked only two stations, one of which was G5ZT/P, the Rally two-metre control, which got him the prize for the longest distance worked on that band. The

G3NUE /M rig runs a QQV02-6 PA, taking 4½ watts input, modulated by a 6AQ5; the Rx is 6DS4 RF, 6CW4 mixer, with a 12AT7 osc. giving 2:1 mc IF, followed by 2/EF183 at IF, CV-442 det., with EA50 for AVC and 6AL5 as NL, into EF91-6AQ5 on the AF side; his motoring aerial is a J-Beam halo. At home in Worcester, G3NUE has a QQV03-20A PA at 50w., modulated by a pair of KT88's, into a slot-fed 6/6 J-Beam at 40 ft.

TWO METRES ALL-TIME COUNTIES WORKED LIST	
Starting Figure, 14 From Home QTH Only	
Worked	Station
90	EI2W
87	G6NB
85	G3CCH, G5YV
84	G5MA
83	G3BA
80	G3AOS, G3HBW
79	EI2A, G2CIW (436)
78	G3EHY
75	G3IUD
74	G3KEQ
72	G6XM
71	GM3EGW (310)
69	G3BLP (1,061)
68	G3BW, G3GHO
67	G3HRH
66	G2OI (585), G3JWQ (569), G3KPT*, G5BD
65	G6XA (333)
64	G3DKF, G6RH
63	G2FJR (542), G3FAN (1,000), G4LU
62	G3BOC, G3CO (610)
61	G2HIF, G3HAZ
60	G3DMU, G3IOO, G3JYP
59	G4SA, G5DS (883), G8VZ
58	G3LHA, G8OU
57	G8SB, G3PBV
56	G3WW (770), G3NUE (419)
55	G2HDZ (495), G5BM, GW3MFY, GW5MQ
53	G2AJ (519), G4CI
52	G2NH, G3FZL, G3OXD/A, G6XX, GM3DIQ, GW2ADZ

Worked	Station
51	G3LTN, G5ML
50	G3ABA, G3GSE (518), G3NAQ, GW3ATM
49	G3AYC, G3JXN
48	G3FIH, G3LAR, G3OJY*, G6TA (487), GW3ATM
47	G3OJY, G5WP
46	G3MTI (242), G3OHD, G4HT (476), G5BY, G6YU, GC2FZC
45	G2AHP (647), G2DVD (362), G2HOP, G2XC, G3BJQ, G3GFD, G3MPS, G5JU, G6GN, G13ONF
44	G2BHN (261), G3BK, G3DVK (282), G3GSO, G3NBQ (218), G8DA
43	G2DDD, G2FCL (322), G3BNC, G3COJ, G3DLU*, G3HWJ, G3KHA (262), G3KQF, G3KUH, G3NNG, G3WS, G4RO, G5DF
42	G2AXI, G3DO, G3IER, G3JHM/A, G5UM (918), G6CI (220)
41	G2DHW/P, G2CZS (282), G2FQP, G3FIJ (465), G3JAM (481), G3JLA, G3LAS
40	G3CGQ, G3FUR, G5MR (366), G8KL
39	G2IQ, G3GBO (434), G3LTF, G3NOH, G3OSS, G3VM, G8IL (325)
38	G3APY, G3CKQ, G3HTY, G8VN (190)
37	G2FNW, G2FZU (180), G3DLU, G3MAX, G3OSA, G8DR (482), GC3EBK (260)
36	G2DCI (155), G3CXD, G3DLU*, G3IIT, G3OBD, G3PSL, G6CB (312), G8IP, GM3LDU
35	G3FYY (235), G3HCU (224), G3HWR, G3IOE, G4LX, G5TN
34	G2AHY (295), G3AEP, G3ILD, G8IC, G8NM
33	G2BDX, G3DVQ, G3HHY (125), G3ICO, G3PTO, G4J/A

Worked	Station
32	G3BYY* (274), G3HIL, G3NNK (325), G3OBB, G3PTM, G8QY, G8VR
31	G3HXO, G3KPT (180), G5RP
30	G3FRY, G3GOP (208), G3GVF (129), G3IRA, G3KEF (110), G5NF, GW8UH
29	G2CVV, G3AGS, G3AKU
28	G3ITF, G3NPF, G8DL, GM3BDA
27	G3CVO (231), G3DAH, G3ISA (160), G3JGY, G3LDY (102), G3LTF/A, G6GR, G13CQB, GW3GWA
26	G2BRR, G3CFR (125), G3KGU (315), G3MED, G3SM (211), G3YH, G4MR (189)
25	G2BLA (138), G3JHM, G3JMA, G5SK, G6PJ
24	G3FD, G3FEX (226), G3FXG, G3FXR, G3PKT(252).
23	G3BDQ, G3CWW (260), G3HSD (168), G3OPR (144), G5PY, G8VN (125)*
22	G2DRA, G3AGR (135), G3ASG (150), G3BPM, G3GVV, G5AM, G5UM/P, GC3OBM
21	G2AOL (110), G3IWJ, G6XY
20	G3CCA, G3EYV
19	G2HDR, G3GCX, G5LQ (176)
18	G3DBP, GC2CNC
17	G3EGG, G3MHD (195)
16	F3XY (200), G3FRE, G3MLS
15	G3IWA
14	G3CYY, G3IOE*

Note: Figures in brackets after call are number of different stations worked on Two Metres; starting figure for this classification, 100 stations worked. QSL cards are not required to verify for entry into this Table. On working 14C or more, a list showing stations and counties should be sent, and thereafter added to as more counties accrue.

* New QTH

Mon Dieu, quel signal was what G3HRH (Welwyn, Herts.) got when finally he raised HB1ADT, after listening to the HB working a string of EU's. Ray first found the HB on his image, and even that was S8 on the meter; on HB1ADT's true frequency, the S-meter was pinned to the stop, and later he was found to be S8 on the G3HRH/M halo. As G3HRH got the GB2GC boys on Alderney and Sark, and also SM6PU for Sweden, he goes up several pegs in the tables.

G3OWA/G3PRQ of Kingston, Sy., are among the 4-metre representatives this time, being at 16C and 8C respectively for that band (they are brothers, who operate the same rig under their own calls).

GW3MFY (Bridgend) got HB1ADT, and is now at 55C in the All-Time, with GB2GC worked on the two Islands. G3PTM (Solihull) was, understandably, very pleased to raise HB1ADT, as he has only been on two metres since January this year. And with seven more counties, he has 49C for the Annual — not a bad start on VHF! He runs 35w. with a slot-fed 6/6. G3LAS (Berkhamsted) claims for the tables, and is now on 11C in Countries. G3OHH (Macclesfield) has got a few more on four metres, and is at 26C on that band. G3EHY (Banwell, Som.) has got to 36C on 70 mc.

In less than three months, G3SAR (Sevenoaks) has worked 27 counties. G3CKQ (Leicester) makes it 30C for the Annual. G3NPF (Southend - on - Sea), through recent inactivity, can only move up one in Counties. G2BJY (Walsall) mentions G2YU, in Norfolk, as a new one for him, and has also worked GW5BI for Glamorgan. G3DVQ (Purley, Sy.) continues to make progress, with G3ILD of Co. Durham worked for both tables.

G4LU (Oswestry) was around and about during the opening, and pursued HB1ADT diligently — but it was not until he moved LF and tried what Stan calls his "best school cert. (fail) standard" French that a QSO resulted. In fact, the HB was never very

strong up there, and G4LU was simply fighting it out with southerly G's who were showing HB1ADT much bigger signals. Much good GDX was worked from G4LU on July 28, including G3OCB/P in Falmouth and G3MDH in Southampton; F8MX was also raised. The breakfast hour on July 29-30 found a number of other G's also looking for DX, and six good QSO's were made during these periods. All this has, of course, pushed the G4LU scores along nicely.

From Bexley, Kent, old-timer G6RH is regularly active again, after a rebuild, and adds four new counties to his score. He was unfortunate with the GM3KXA/P expedition, spending hours calling them in various Lowland counties; he also missed GB2GC on Sark, but got them on Alderney.

G3EDD (Cambridge), on a business trip to VK/ZL, where he met many of the local VHF types and found it all most interesting, was away for the July opening, but was back in time to work the GB2GC boys on both Islands. In the other direction, we are informed that G3PYE/P will be in Cumberland during the Sept. 21/22 weekend; they will be in the local zone frequency area.

On four metres, the Manchester stations have been doing very well, and an outstanding QSO for some of them was with G3KEU/P, near Southampton. G3PMJ also reports a contact with GW3AYT/M for Caernarvon, and G3IUD has again worked with GM3EGW. G3PJK, another of the 4-metre group up there, made a holiday visit to G3EHY, to meet him after many QSO's, and mentions GW2OI/M in Anglesey on 4m., as well as GW3AYT/M.

G3OSE (Hereford) now has his two-metre 6/6 up to 45 ft., and can get a signal any time from GB3CTC at 170 miles — but nothing from GB3VHF, and very little from the North. He is hearing many of the Cornish and South Wales stations—but having at the moment only 5w. of chirpy CW (144.46 mc), he is finding it difficult to attract attention. G3OSE would be glad to arrange

for occasional skeds with anyone interested (*QTHR*).

G2CIW (Birmingham) keeps at it, and on two metres during the July opening he worked—as well as HB1ADT — GM3EGW, GM3LDU, GI5AJ and PAØFB, with a number of other EI, GI and GM stations heard, also F8MX and GC2FZC. Jack now has his 23 cm. Rx working properly, and has heard G3KFD — so they should be in two-way QSO on 1290 mc when the rest of the gear has been built.

G3IIT (Cambridge) did very well with the EDX when the going was good—he worked DL7IE, OZ2RD, OZ4AU, SM6PU and SM7ZN which, with HB1ADT, makes him up to 13C in the Countries table, eleven of these being confirmed. G3IIT, who has been on two metres for several years now, runs 80w. to an 829B, his beam being a slot-fed 8/8, and the converter a 6CW4 job into an AR88 tuning 24-26 mc. He also mentions the PTC-113 fixed channel Pye equipment as being very suitable for 2m. mobile—it has 2/6C4 in the PA, and the Rx is a 6AK5-6AK5 arrangement which, in G3IIT's case, feeds into a BC-454 tuning 4-6 mc. With an aerial consisting of a bent dipole, G3IIT has had some good contacts using this rig under /M conditions.

Important Reminder

For the North-West VHF Convention and dinner in Manchester on October 5—see p.264 July issue for details, and *book now* with G3AGS.

And in Conclusion

Don't forget that both the Annuals (two metres and 70 cm) opened again w.e.f. September 1st, for the year to August 31, '64. The new tables will be started just as soon as enough claims have been received; in any event, the final placings for last season will appear next month. And for the October issue, please let us have your report, and any claims, by **Friday, September 20, latest**. Address all VHF material to: A. J. Devon, "VHF Bands," *Short Wave Magazine*, 55 Victoria Street, London, S.W.1. Till October 4, then—73 de A.J.D.

NEW QTH's

This space is available for the publication of the addresses of all holders of new U.K. call signs, as issued, or changes of address of transmitters already licensed. All addresses published here are reprinted in the U.K. section of the "RADIO AMATEUR CALL BOOK" in preparation. QTH's are inserted as they are received, up to the limit of the space allowance each month. Please write clearly and address on a separate slip to QTH Section.

G2FQF, E. Lancashire, 115-A Houghton Road, Thurnscoe, Rotherham, Yorkshire. (*AA licence pre-war*).

G2YX, A. Kendrick, 1 Longwood Road, Barr Common, Walsall, Staffs. (*Tel.: Aldridge 52100*). (*Originally G2YC, 1922*).

G3RJW/T, G. F. Marshall, 23 Hemphaw Avenue, Woodmanstern, Surrey.

G3RTY, H. Meers, 57 Thames Road, Blakenall, Walsall, Staffs.

G3RXJ, E. J. Letts, 87 Meadow Lane, Burgess Hill, Sussex.

G3RYY, N. Penketh, 38 Devon Street, St. Helens, Lancs.

G3SBL, Radio and Electronics Society, English Electric Co. Ltd., Lichfield Road, Stafford.

G3SCJ, D. W. Power, Chapel Green, Fillongley, Nr. Coventry, Warks.

G3SDG, J. J. Bottom, 86 Halliwick Road, Muswell Hill, London, N.10.

G3SDH, P. D. Kelly, 25 Windwhistle Lane, Weston-super-Mare, Somerset.

G3SDI, F. L. J. Goree, 34 Heath Grove, Maidstone, Kent.

G3SDL, D. I. Court, 9 Greenwood Close, Petts Wood, Orpington, Kent. (*Tel.: Orpington 22830*).

G3SDS, South Dorset Radio Society, c/o C. E. Biggs, 54 Prince of Wales Road, Dorchester, Dorset.

G3SDU, K. Eastell, 9 Prod Lane, Shipley Glen, Shipley, Yorkshire. (*Tel.: Shipley 53545*).

G3SDX, J. J. Oxley, 129 Bush Elms Road, Hornchurch, Essex.

GW3SEI, G. Thomas, 24 Penylan Avenue, Porthcawl, Glam.

G3SEJ, E. C. John, 69 Knaresborough Road, Wallasey, Cheshire.

G3SEL, F. Powell, Highwinds, Conway Road, Biddulph, Staffs.

G3SEN, R. Dawes, 6 Sea View Park, Whitburn, Sunderland, Co. Durham.

G3SEQ, J. Crossfield, 311 Marsh House Avenue, Billingham, Co. Durham.

G3SEV, K. T. Adkins, 72 Courtenay Avenue, Harrow, Middlesex.

G3SFA, T. A. Plant, 59 Eastbrook Drive, Romford, Essex.

GW3SFC, A. Richards, 30 Well Place, Cwmbach, Aberdare, Glam.

G3SFN, R. R. Diamond, 102 Chatsworth Road, Hazel Grove, Stockport, Cheshire.

G3SFO, R. H. Jones, 5 Springcroft Drive, Scawthorpe, Doncaster, Yorkshire.

G3SGD, G. L. A. Douce, 45 Bradstock Road, Kings Norton, Birmingham 30, Warks.

G3SGH, J. Hewitt, 11 Old Dover Road, Canterbury, Kent.

CHANGE OF ADDRESS

G2HDU, C. W. Cragg, Willow Green, Brockampton, Swindon Village, Cheltenham, Glos.

G3AEC, A. J. Janes (*ex-GM3AEC*), Rowlands, Bournebridge Lane, Stapleford Abbots, Romford, Essex.

G3AET, J. N. Watson, Tully Crine, Corpaskus, Mabe Burnthouse, Penryn, Cornwall.

G3EFR, F. Simpson, 49 Eppleworth Road, Cottingham, E. Yorkshire.

G3EKX, N. J. Birkett, 92 Belper Road, Derby. (*Tel.: Derby 42961*).

GW3ENN, G. W. King, 95 Cornerswell Road, Penarth, Glam.

G3ESP, W. Farrar, Wentwood View, Ackworth, Pontefract, Yorkshire.

G3GGL, A. W. Graeme Wormald, Top Orchard, Merricks Lane, Bewdley, Worcs. (*Tel.: Bewdley 3372*).

G3HRP, T. J. Wright, 1 Trinity Road, Chancel Estate, Bottesford, Scunthorpe, Lincs.

GW3IEM, D. M. Lewis, 9 Heaslands Place, Dunvant, Swansea, Glam.

G3KCF, R. M. Kent, Winterton, Carlton Avenue, Hornsea, E. Yorkshire.

G3KCF/A, R. M. Kent, 173 Carisbrooke Road, Newport, Isle of Wight.

G3KCI, A. H. Webb, 69 Lalleford Road, Vauxhall Park Estate, Luton, Beds.

G3LJT, J. W. Hayter, 35 Denys Drive, Basildon, Essex.

GM3LML, W. Farquhar, Denhead Cottage, Kennoway, Fife.

G3LQI, S. G. Williams (*DL2SW*), 24 Brighton Road, Lancing, Sussex.

G3LQI/A, S. G. Williams, R.A.F. Station, Digby, Lincs.

G3MMG, D. Noon (*ex-G3MMG*), 23 Westlands, Crossgar, Co. Down.

G3MNV, P. W. F. Darragh, 44 Jervis Crescent, Streetly, Sutton Coldfield, Warks. (*Tel.: Streetly 3012*).

G3NMC, C. J. Randle, 47 Marsh Lane, Stone Cross, West Bromwich, Staffs.

GW3NNF, A. M. Mills (*ex-G3NNF*), Caerffynnon, Talsarnau, Merioneth. (*Tel.: Penrhyn 209*).

G3NUN, A. E. L. Brown, 10 Approach Road, Parkstone, Poole, Dorset.

G3OUQ, H. B. Bird, 53 Watling Street, Nuneaton, Warks.

GM3PMK, J. C. Buick, 51 Queen Street, Carnoustie, Angus.

G3PNF, D. A. Bowden (*ex-DL2AB*), R. Signals, Army Apprentices School, Harrogate, Yorkshire.

G3PQT, Mrs. Penny Jones, 49 Grove Road, Hoylake, Wirral, Cheshire.

G3PYU, P. Jones, 49 Grove Road, Hoylake, Wirral, Cheshire.

G8JR, N. P. Haskins, The Neuk, Dippenhall Street, Crondall, Hants.

AMENDMENT

G3RZF/A, (*QTH given July issue now cancelled*).

THE MONTH WITH THE CLUBS

By "Club Secretary"

(Deadline for October Issue: September 13)

(Address all reports for this feature to "Club Secretary")

EVERY week-night, every week, every year, it is happening somewhere. With no attempt at concealment, almost, one might say, with a kind of bravado, the Members are assembling. Unidentifiable in any crowd . . . looking, in fact, like any ordinary citizens . . . they make their unobtrusive way to the Grammar School, the Scout Hut, the Union Headquarters, the Community Centre, the Room Above the Sweet-shop, the Speech Therapy Clinic, the Technical College, the YMCA, the Congregational Hall, the Railway Hotel, the College of Further Education, the Science Museum, and "the local."

Members of the public have no idea that this Thing exists; yet it is right in their midst. With them, but not of them. Except in relatively few cases, even habitual television viewers are quite unaware that within a few megacycles of their channel of communication exists *another one*, so carefully guarded as to be quite meaningless to them.

Meanwhile the meetings grow in number; the devotees arrive silently, and as silently depart. Dedicated men, and potentially dangerous. No conviviality is here; no alcoholic beverages are consumed, and the sound of laughter is seldom heard. This Thing must be serious . . . if only the public knew of its existence, they would leave no stone unturned to find out the meaning of it all. And even this they would discover to be virtually impossible.

A hidden microphone at one of these sinister meetings would merely reveal that practically all the business was conducted in a strange code. Furthermore, to confuse possible enemies, it would emerge that even the code itself is deliberately distorted in meaning . . . and yet every one of these strangely-dedicated men knows what is meant, and will respond to chosen groups of three letters in a predictable manner.

Perhaps the purpose of it all might be revealed by a study of the localities most affected . . . but no, they turn out to be merely the larger cities, where, by virtue of the population density, one would expect it. It has been said that activity is slightly greater in regions where the science of electronics is practised extensively . . . where factories are making valves, transistors, components urgently needed for our national defence. But why should this disquieting movement and assembling of inscrutable men also take place in small villages, health resorts, quiet market towns, university cities and even within a few schools and colleges?

One day we shall be able to unmask the secret,

and the public will read their papers over the breakfast table with a new sense of foreboding. It will have been revealed that yet another of the regular twice-yearly ceremonies has been concluded, and nearly one thousand new recruits to the mystery movement have been let loose in the country. Many of them, too, will be joining in the quiet walk to the assembly-place on a carefully-hidden but regular time-table . . . first Thursday, second Monday, third Wednesday, sometimes 7 p.m., sometimes 7.30 p.m. This is no mystery story . . . these things are *really happening now*.

The Works of the Scribes

The clubs who now boast some sort of a regular publication are now almost as numerous as those who do not. They come in all sizes and shapes; some are merely informative as regards meetings, while others seem to mention everything else, but maintain complete silence on that subject. All are very interesting to read through, for they give a good cross-section of what happens these days within the club movement.

Mitcham (*Newsletter*, August) will be meeting for a Junk Sale on September 13, and a Film Show by G3LCH on October 11. They are also co-operating with the Mitcham District Scouts for the Jamboree-on-the-Air (October 19-20).

Reigate (*Feedback*, July) played a big part in the town's Centenary Year Carnival, with G3REI/A and G3BBR/A on the air. Ten of their members recently "invaded" a meeting of the Crawley club, and more recently, at the Town Bank Holiday Show, G3REI/A and G3NKT/A took the air and attracted much attention with a display of vintage receivers (1920-1930) lent by G3PNA. Next meeting, September 21, at The Tower, Redhill, to hear G3FZL talking on VHF.

Surrey (*SRCC Monthly News*, August) are looking forward to September 10, when Mr. Frank Hyde will journey from Clacton to talk to them about Radio Astronomy. A two-metre D/F Hunt is organised

"MCC" — MAGAZINE CLUB CONTEST

The Eighteenth Magazine Top Band Club Contest will take place during the week-end November 16/17. Rules in full will appear in the next issue. General form of the Contest will be as last year, when more than 90 Clubs took part. Start your planning now!

for September 22, and a Junk Sale for October 8.

Cray Valley (*Newsletter*, August) recently heard a full description of the new Racal fully transistorised SSB receiver, as well as a quick run-through of the better-known RA-17. An interesting summary of the talk appears in the Newsletter.

Loughton (*Newsletter*, July) intend to go ahead with this new publication, the first number of which met with general approval. No. 2 contains general news, reviews of recent meetings, and the future programme (which, unfortunately, stops short of the dates we require for prior notification). However, they appear to have been meeting on alternate Fridays, which puts the next ones at September 13 and 27.

Purley (*Splatter*, August) have been continuing their regular fortnightly meetings, and the next are on September 6 and 20—at the Railwayman's Hall, Whytecliffe Road, Purley, 8 p.m.

Crystal Palace (*Newsletters*, July and August) report much local activity and two successes in the recent R.A.E. Their monthly meeting, which falls on September 21, was to have been a Film Show, but they had this on August 17 and the next meeting is still to be announced.

Radio Club of Scotland (*GM Magazine*, July) really do circulate the news in this 17-page issue—Top-Band Topics, VHF Comment, DX Bands, Mobile Column, SSB, Local Meetings, Trade Notes and their regular feature “Meet the Members (This is Your Life)” in which one member is pretty fully described and documented each month.

South Hants (*QUA*, July and August) include some technical information on RTTY, and we gather that they have quite a few stations down there who

are using this mode on VHF. They recently ran a station in connection with the Great Southampton Show, which attracted a record attendance of over 37,000 (the show, not the station!). GB3SS made over 200 QSO's during the operation. Next meeting is on September 14.

Midland (*News Letter*, July) have been very active out of doors, with VHF as well as mobile activity. On September 6 and 7 they will be very busy on their stand at the Birmingham Show, and on the 13th they will be holding their Annual Dinner.

West Kent (*QLF*) have an intriguing title for their meeting on September 13. It is “100 Years of Wireless—The first of a series of talks and discussions on the last hundred years of our hobby.” During August they held a picnic for members and their families, and earlier they visited the BBC at Tatsfield.

North Kent (*Newsletter* No. 70) took part in the Erith Bank Holiday Show and Sports, displaying a station signing GB3ENT. Their September meetings will be on the 6th and 20th, at the Congregational Church Hall, Bexleyheath, 8 p.m.

Wirral (*Newsletter*, Vol. 16, No. 7) have had good attendances throughout the summer, and continue their debate on home-built equipment *versus* commercial with some telling points on both sides. They have a Junk Sale on September 4, a talk on Valve Applications on the 18th, and the AGM on October 2.

New and Re-organised Clubs

It is proposed to form a radio society for the **Leyton, Leytonstone and Walthamstow** areas. The first meeting will be held at Leyton Senior Institute, Essex Road, London, E.10, at 7.30 p.m. on

Names and Addresses of Club Secretaries reporting in this issue :

ACTON, BRENTFORD & CHISWICK: W. G. Dyer, G3GEH, 188, Gunnersbury Avenue, W.3.
 BLACKPOOL & FYLDE: J. Boulter, G3OCX, 175 West Drive, Cheveleys, Blackpool.
 BRADFORD: E. G. Barker, G3OTO, 63 Woolcot Avenue, Baildon, Shipley.
 CHELTENHAM: J. H. Moxey, G3MOE, 11 Westbury Road, Leckhampton, Cheltenham.
 CORNISH: W. J. Gilbert, 7 Poltair Road, Penryn.
 CRAWLEY: R. G. B. Vaughan, G3FRV, 9 Hawkins Road, Tilgate, Crawley.
 CRAY VALLEY: S. W. Coursey, G3JJC, 49 Dulverton Road, London, S.E.9.
 CRYSTAL PALACE: G. M. C. Stone, G3FZL, 10 Liphook Crescent, London, S.E.23.
 DERBY: F. C. Ward, G2CVV, 5 Uplands Avenue, Littleover, Derby.
 DORKING: J. Greenwell, G3AEZ, Eastfield, Henfold Hill, Beare Green, Dorking.
 EXETER: A. T. James, G3RUV, 18 Lonsdale Road, Heavitree, Exeter.
 GRAFTON: A. W. H. Wennell, G2CJN, 145 Uxendon Hill, Wembley Park, Middx.
 HALIFAX: J. Ingham, G3RMQ, Lambert House, Greetland, Halifax.
 HOUNSLOW: R. T. Heywood, G3NHH, 383 Whitton Drive, Isleworth.
 I.H.C.: H. James, G3HZZ, 7a South Avenue, Egham, Surrey.
 ISLE OF WIGHT: Capt. E. C. Dolling, Sweet Briars, New Road, Wootton Bridge.
 KEELE UNIVERSITY: V. J. Reynolds, G3COY, Department of Communications, University of Keele, Staffs.
 LOUGHTON: J. Atkinson, G3OPA, 6 Rochford Avenue, Loughton.
 MELTON MOWBRAY: D. W. Lilley, G3DFD, 23 Melton Road, Ashfordby Hill, Melton Mowbray.
 MIDLAND: C. J. Haycock, G3JJD, 360 Portland Road, Birmingham, 17.

MIDLAND R.C.C.: J. Lockyer, G3OVA, 23 Beechwood Road, Birmingham, 14.
 MITCHAM: A. Thurley, 50 Bruce Road, Mitcham.
 NORTHERN HEIGHTS: A. Robinson, G3MDW, Candy Cabin, Ogdon, Halifax.
 NORTH KENT: B. J. Reynolds, G3ONR, 49 Station Road, Crayford.
 PEMBROKE: D. Williams, GW3RPR, 4 St. Peters Road, Pembroke Dock.
 PURLEY: E. R. Honeywood, G3GKF, 105 Whytecliffe Road, Purley.
 R.A.I.B.C.: Mrs. F. E. Woolley, G3LWY, 10 Sturton Road, Saxilby, Lincs.
 READING: R. G. Nash, G3EJA, 9 Holybrook Road, Reading.
 REIGATE: F. D. Thom, G3NKT, 12 Willow Road, Redhill.
 ROYAL SIGNALS A.R.S.: Capt. A. C. Earl, G3FGN, R. Sigs., Army Apprentices School, Harrogate.
 SCARBOROUGH: P. Briscoe, G8KU, Roseacre, Irton, Scarborough.
 SCOTLAND: A. Barnes, GM3LTB, 7 South Park Terrace, Glasgow.
 SHEFFIELD: D. A. Justice, G3PYL, 9 Leslie Road, Sheffield, 6.
 SOUTHGATE: K. Spicer, G3RPB, 22 Clifton Road, London, N.3.
 SOUTH HANTS: P. A. L. Shoosmith, G3MDH, 7 Fairfield Close, Hythe, Southampton.
 SOUTH YORKS: R. H. Jones, G3SFO, 5 Springcroft Drive, Scawthorpe, Doncaster.
 SURREY: S. A. Morley, G3FWR, 22 Old Farleigh Road, Selsdon, South Croydon.
 SUTTON COLDFIELD: K. H. Varney, G3DMV, 149 Whitehouse Common Road, Sutton Coldfield.
 W.A.M.R.A.C.: Rev. A. Shepherd, G3NGF, 121 Main Street, Asfordby, Melton Mowbray.
 WEST KENT: H. F. Richards, 17 Reynolds Lane, Tunbridge Wells.
 WIRRAL: A. Seed, G3FOO, 31 Withert Avenue, Bebington, Wirral.

September 24. All interested are cordially invited to be there.

A new club is being formed in **Bristol**, and its first meeting will be held on September 9, 7 p.m. in the University Settlement, 43 Ducie Road, Barton Hill, Bristol 5. Subsequent meetings will be on Mondays and Thursdays. SWL's and others who are interested in acquiring licences will be specially welcome. Further details, if required, from H. W. Leonard, G4UZ, 47 Windsor Road, Bristol 6.

The very old-established club known as the **Wimbledon and District Radio Society** is being re-formed. A temporary committee will hold office until Christmas, after which a properly elected committee will take over. Premises have been obtained at the Community Centre, St. George's Road, Wimbledon, S.W.17, where meetings will be held on the second Friday of the month at 8 p.m. The hon. sec. (*pro. tem.*) is R. G. Baker, G6QN, 1 Boundary Road, Colliers Wood, S.W.19, to whom all enquiries should be addressed.

Clubs with no Clubroom

The **International Ham-Hop Club** (*Newsletter*, July) has its members in more than fifty countries, and national representatives in nearly twenty of them. This club now runs some regular nets on the air, but of course most trips by members have to be planned well in advance (three months' notice is recommended). However, the nets may be found on 3660 kc at 1830 on Wednesdays and 1200 on Sundays; also on 7090 kc at 1300 on Saturdays (G local time in all cases).

The **Radio Amateur Invalid and Bedfast Club** (*Radial*, July) continues to keep its members in touch with each other by a good proportion of personal news. From this, too, it is obvious that much good work is being done in the way of making it possible for members actually to meet each other, by helping out with transport. Mrs. Frances Woolley, G3LWY, does a first-class job for their journal, *Radial*.

The **World Association of Methodist Radio Amateurs and Clubs** (*WAMRAC Circular Letters* 32 and 33) is now truly a worldwide organisation, and news from members in many countries is published each month. The second "Wamfest" is arranged for October 5, afternoon and early evening, at Wesley's Chapel, City Road, London, E.C.1.

Royal Signals Amateur Radio Society (*Mercury*) keeps members *au fait* with recent technical developments over a wide field—Receiver Design, Loading Short Aerials, "Brain Teasers" are included in the current issue. The inevitable postings keep the staff on the move.

Royal Air Force Amateur Radio Society (*RAFARS Newsletter* No. 9) also labours under the disadvantage of postings in and out, but the mobility of its members is one of the reasons for its existence, and the Newsletter supplies much useful information about changes of address. Their new committee consists of G3GNS, G5DV, G3HRY, G3IRK and G3GJQ. The Hq. station, G8FC, maintains regular watches and contacts as many members as possible.

"MCC"—MAGAZINE CLUB CONTEST

The Eighteenth Magazine Top Band Club Contest will take place during the week-end November 16/17. Rules in full will appear in the next issue. General form of the Contest will be as last year, when more than 90 Clubs took part. Start your planning now!

Forthcoming Meetings

Exeter will meet at their new headquarters (George and Dragon, Blackboy Road, Exeter) on September 3 at 8 p.m. **Isle of Wight**, also, have changed their venue and now have their own premises at Unity Hall, Wootton Bridge, where they will meet on September 13 and 27. Visitors welcome.

Blackpool, who run weekly meetings, have an Open Night on September 9, a talk by G8OY on Transistorised Equipment on the 16th, and two more Open Nights (for building field day gear) on the 23rd and 30th.

The **Midland Radio Contest Club** will meet at their Hq. (Windmill House, Weatheroak, Whythall, Birmingham) on September 6 (publication day) at 8 p.m. **Reading** will be hearing G8SC on Transistor Power Supplies on September 28, and on VHF/UHF Equipment on October 26.

Bradford open their new session with a meeting at Cambridge House, 66 Little Horton Lane, on September 10. **Scarborough** have normal meetings on September 19 and 26, but on the 12th they will be visiting the local shacks of G8KU, G3NRI, G3NRS and G3JTG.

Crawley, on September 25, will be hearing from G3HGE about the T.W. lines of VHF equipment. **Derby**, on September 11, leave radio for a while to hear about Plastic Foam—its manufacture and uses—with a supporting film, by Mr. P. G. Skilton.

Southgate, at Atlata Lodge, Tottenham Road, N.13, will meet on September 12 for a lecture on SSB by G3DZW. **Dorking** will be hearing G2FTB in his well-known talk on Electrolytics, September 24. They will also be active at the Model Railways and Engineering Exhibition in Dorking Halls, October 3, 4 and 5, where the club station G3CZU will be in operation—in much local QRM!

Melton Mowbray, on September 19 in the St. John Ambulance Hall, will hold their AGM and discuss and compile their winter programme. **Sutton Coldfield**, meeting at 92 The Parade (7.30 p.m.) on September 12, will hear about Cross Modulation from G3MCB. On the 26th they hold their own "Club Natter Night."

Acton, Brentford & Chiswick, on September 17 at the AEU Club, 66 High Road, Chiswick, will hear G3IGM's talk on Receivers. **Cheltenham** (who ran a very successful expedition with GW5BK/P in Anglesey during the holidays) hold their AGM on September 11, and ordinary meetings every Wednesday, in St. Mark's Community Centre, Brooklyn Road, Cheltenham.

South Yorkshire lost the services of the former secretary, G3JLZ, through a "posting," and the

chairman, G3SFO, is filling the gap for the time being. Meetings are weekly, alternately formal and constructional, and on September 26 they are visiting a local steel works, where a great deal of electronic equipment is in use.

Northern Heights are holding a weekly CW course on Monday evenings, and G3FDC will be running an R.A.E. Course (at the Percival Whitley College of Further Education) on Tuesdays. On September 25 there will be a lecture on Lightning, by G3IKS, who will demonstrate a two-foot discharge from a 500 kV generator—ought to be fun!

Cornish report continued good attendances, and welcome all holiday visitors to their meetings, first Thursday of the month at the S.W.E.B. Recreation Hall, Pool, Cornwall.

Halifax have had two meetings at the Fairbank Harding recording studios in Leeds, where members have been able to hear their own transmissions reproduced on Hi-Fi equipment, and also to watch an actual recording session. The AGM is at the Beehive and Crosskeys on October 1.

Hounslow report that they are being completely re-organised, and now meet at The Canteen, Main Drainage Depot, Mogden Works, Isleworth, on alternate Mondays (September 9 is the next date). They would like to see more support from local licensed amateurs.

Sheffield will be hearing "An Introduction to Amateur Radio" by G3PHO, who, as "SWL Peter Day," used to figure frequently in the columns of "DX Commentary," and should be well-qualified to give such a talk. (He is now P. E. H. Day, B.A., G3PHO.) On September 27 the usual monthly meeting will be held.

Grafton start the new season on September 6, and hold a Junk Sale on the 13th. September 20 is

a Practical Evening, the 27th the AGM, and October 4 is booked for G6CJ's "Aerial Circus." R.A.E. and Morse classes re-commence on September 23.

Pembroke had a fine day for their Bucket-and-Spade Party, to which several visitors travelled over 60 miles; and during August they went on a camping expedition on the Prescelly Mountains—not so kindly treated by the weather, but technically interesting, as all bands from One-Sixty to Two were covered.

New students preparing to enter the **University of Keele** are reminded that there is a Radio Society in the Students' Union, and it is hoped that among the "freshers" there will be a few licensed amateurs (who are invited to bring their gear with them!). Enquiries to G3COY (see panel, or phone Keele Park 371, Ext. 34).

EARTHING THE AERIAL

This has been a recent topic in "Miscellany", and in connection with it an interesting practical suggestion comes from G3NPB (Hexham, Northumberland), on the particular point about leaking static charges to ground. He uses a sparking-plug (ordinary motor-car type), with the aerial and lead-in connected to the insulator, and the body (which gives the spark gap), taken to earth. Nothing could be simpler, and there is the certainty that the aerial will be discharged if there is lightning about. Though there would be no losses on a low-impedance feeder line, even with high power, if the spark-gap was at a high-impedance point—as, say, when using an end-on aerial fed at voltage—there could be sparking across the gap on transmit! So the device does need a little adjusting to circumstances.



Aveley Electric, Ltd., of South Ockendon, Essex, held their first annual open day for radio amateurs on July 27, when the firm — of which the managing director is Mr. J. I. Brown, G3EUR — were hosts to a large party of visitors, for whom an interesting programme had been arranged. This photograph was taken after lunch and among those present can be seen, 2nd from left, G2AHL; 5th from left, G3BVG; 5th from right, G8KW; and near centre, G6LL. Aveley Electric, Ltd. manufacture a wide range of products for radio and electronics, and of particular interest are their transistorised power supply units.

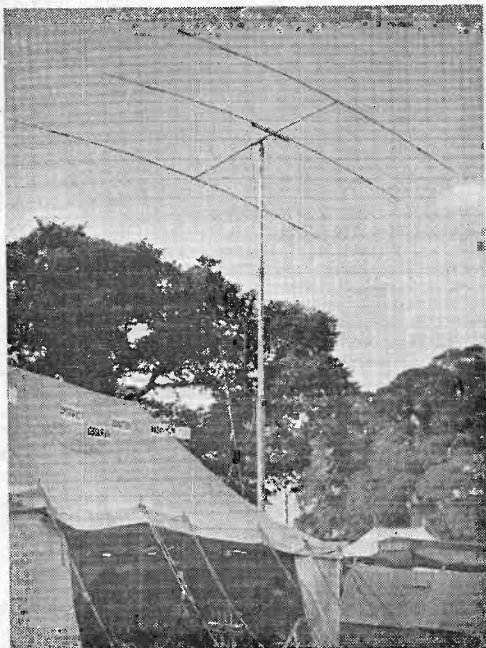

When the Stroud & District Radio Club organised their public appearance at the annual show locally, this was the set-up. Under the callsign G3SDR/A, operation was mainly on 20-metre Side-band, using a linear amplifier consisting of four 807's to get 300w. p.e.p., with a Hammarlund HQ-170 as receiver. The beam in this picture is a Mosley Tri-Bander, and at the controls when G3GMN took the photograph was G3GEW (at left).



When Angus Murray-Stone, 5N2AMS (centre) visited the Barnet Radio Club to give them a DX talk, a very high attendance figure was registered. At left and right respectively are G3GMY (hon. secretary of the Club) and G3MWG, who sends out their notices.

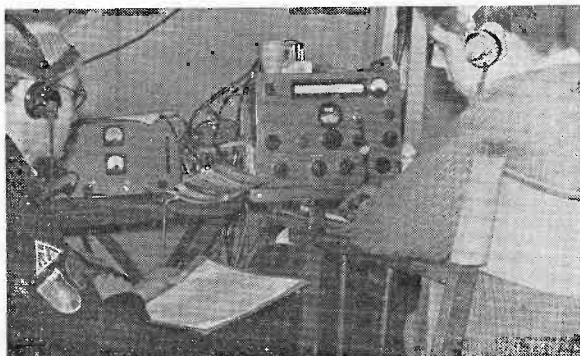

The East Cheam Wireless Society had G3OJE/P on the air for the recent 4-metre contest, running 25w. in the PA., with a 6BQ7A-CR100 Rx arrangement and a 4-ele beam. G3OJE is on the left, with G3OSC. They made 58 contacts in the course of the operation.

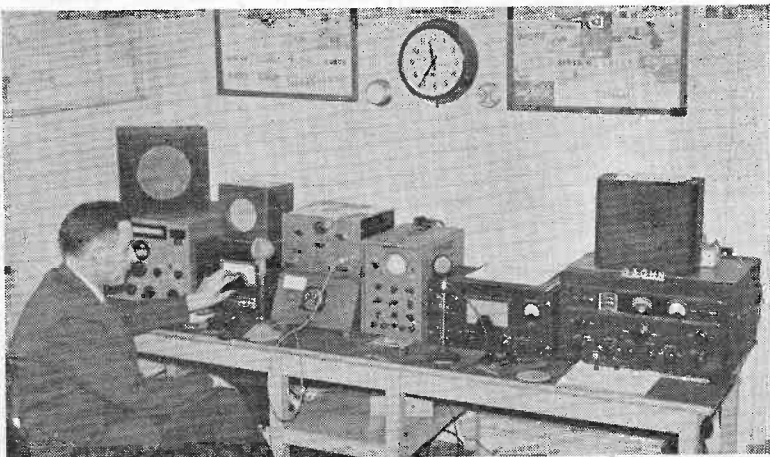

G3GHN, of the Clifton Amateur Radio Society, is located at 225 New Cross Road, London, S.E.14. On-the-air operation started way back in 1950, and over the years a variety of gear has been built from "Short Wave Magazine" published designs, the 160m. Tx used for the Club's appearances in MCC being one of these (issues Sep.-Oct. 1955). As well as being on Top Band, G3GHN is active on two metres, and at present the Club is working for both a WABG and a VHFCC, with their station on the air on Wednesday and Friday evenings. The fine array of gear shown here has been acquired by a membership-effort started years ago; out of the 60 of Clifton's members, twenty hold licences. Their main aerial is a 200-ft. end-fed, 35 ft. high, and for two metres they have a 5-ele Yagi at 50 ft., motor-rotated and with remote directional indication; the station layout is such that both bands can be worked simultaneously. G3GHN is a good example of a co-operative Club effort, and Clifton's members (treasurer Norman Moore is seen in the picture) can be proud of what they have achieved.

RADIO AMATEURS' EXAMINATION

COURSES OF INSTRUCTION

Further to the announcements on p.300 of the August issue of *SHORT WAVE MAGAZINE*, the following are the additional Courses notified for the R.A.E. to be held in May, 1964. Notes on the R.A.E. syllabus and recommended reading for the Examination, with an explanation on the general conduct of these Courses, were given in the August issue.

If your own centre was not listed on p.300 of the last issue, it may be here. If not, there would be the possibility of getting a class started by reference to the principal of the local technical college or evening institute, though this will normally depend upon a sufficient number of students coming forward and an instructor being available to take Subject No. 55 in the City & Guilds examination syllabus.

Beckenham, Kent: At the Evening Education Centre, 28 Beckenham Road, commencing September 26, 7.0-9.0 p.m. Further details from the instructor, M. D. Bass, B.Sc. (G3OJE), 42 Clevedon Road, London, S.E.20.

Birkenhead: At the Technical College, on Thursday evenings. Apply L. Roberts, G3EGX, 18 Croxteth Avenue, Liscard, Wallasey, Ches.

Cambridge: At the Chesterton Evening Centre, Gilbert Road, enrolment September 16-18. Further details from the Adult Tutor, at the Centre.

Cannock: At the Cannock Chase Mining & Technical College, on Tuesdays and Fridays, 7.0-9.0 p.m., Morse and R.A.E. Theory. Apply immediately to the College or to the instructor, C. J. Morris, G3ABG, School House, 24 Walhouse Street, Cannock, Staffs.

Corbridge, Northumberland: At Corbridge County Secondary School, on Wednesday evenings 7.0-9.0 p.m., in R.A.E. Theory and with Morse instruction. Further details from D. W. Blackford, G3NPB, Springfield, Haydon Bridge, Hexham.

Crawley: At the Evening Institute, commencing shortly, R.A.E. course for those with no previous knowledge; a limited amount of practical work will also be provided. Apply immediately to the instructor, A. J. Gibbs, G3PHG, 6 Dairyfields, Gossops Green, Crawley, Sussex.

East Ham, London: At the East Ham Technical College, starting September 23-25, in R.A.E. Theory and Morse, enrolment at the College evenings September 16-18, 7.0-9.0 p.m.

Ilkeston, Derbyshire: At the College of Further Education, Field Road, on Tuesday evenings, 7.0-9.0 p.m. Some practical instruction will also be given. Apply A. Davis, G3LXL, 76 Wendover Drive, Aspley, Nottingham.

Leamington Spa: At the Mid-Warwickshire College for Further Education, commencing in September, enrolment at the College, September 11-13, 7.30 to 8.30 p.m.

Leicester: At the College of Technology, one evening per week; commencing September 25, with G3HAN as instructor in R.A.E. Theory, and G3KKV in Morse. Enrolment at the College evenings September 9-11. Further information from A. Tranter, G3PMD, Head of Dept. of Electrical Engineering.

Stockport, Cheshire: At the Avondale Evening Institute, Edgeley, commencing mid-September. Apply in first instance to G. R. Phillips, G3FYE, 6 Ross Avenue, Davenport, Stockport. Over the last four years this course has shown successes in the R.A.E. of 70% to 90%.

Stourbridge: At the Foley College of Further Education, Hagley Road, Oldswinford, with G3BMY as instructor. Classes will be fortnightly, commencing September 17, 7.0-9.0 p.m., enrolment same date. Course fee 20s. For further information apply I. T. Cashmore, G3BMY, 105 Long Lane, Blackheath, Birmingham.

With the list on p.300 of the August issue, this now makes it a total of 31 R.A.E. instruction centres of which details have been given. Though local enquiry may elicit other courses not notified to us, no further lists will be published because the winter session at the technical colleges and evening institutes up and down the country will be well under way by the time the October issue of *SHORT WAVE MAGAZINE* appears.

SPECIAL-ACTIVITY STATIONS

It is now the end of the season for outdoor and other special events in which amateur stations can play a part in demonstrating Amateur Radio to the public locally—so the list here is shorter than usual, and will probably be the last until next year.

GB3EE, September 14: From the grounds of Finborough Hall, near Stowmarket, Suffolk, on the occasion of the Eastern Electricity Board's Open Day, operating on the HF bands. QSL address: D. A. Beales, G3MWO, 83 Abbot Road, Bury St. Edmunds, Suffolk.

GB3DEB, September 14: In conjunction with the Gala Motoring Day at R.A.F. Station Debden, Saffron Walden, Essex, an exhibition station will operate on all bands 10-160m., with a special QSL card for all contacts and SWL reports. The Gala Motoring Day is a motor-sport event open to the public, and visiting /M's will be welcome. QSL to: F/Lt. G. C. Moore, G3MCY, R.A.F. Stradishall, Newmarket, Suffolk.

GB3YHA, September 20-22, and 27-29: Operated by G3IQO and GW3LDH for the Lieder House Youth Hostel, Dolwyddelan, Bettws-y-Coed, Caerns, using AM phone on all bands 10-160m. SWL's and mobile visitors will be welcome either week-end. Information from: J. E. Taylor, G3IQO, 20 Asbridge Street, Liverpool, 8.

Announcing
the

VEE VEE

PATENT PEND. No. 16866

An Exciting New Concept in High Gain Beams

ROTATABLE DOUBLE BAY INVERTED VEE CURTAINS

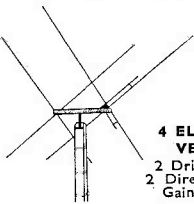

4 ELEMENT VEEVEE
2 Driven Vee's
2 Director Vee's
Gain 5 times

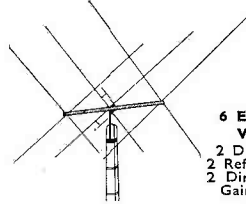

6 ELEMENT VEEVEE
2 Driven Vee's
2 Reflector Vee's
2 Director Vee's
Gain 11 times

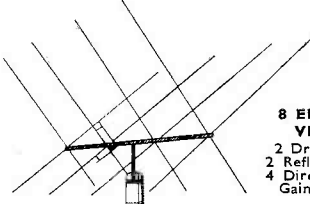

8 ELEMENT VEEVEE
2 Driven Vee's
2 Reflector Vee's
4 Director Vee's
Gain 13 times

FED AND STACKED IN LINE WITH DIRECTORS AND REFLECTORS FOR TWO BAND operation

TWO YEARS IN THE DESIGN AND PRACTICAL ON THE AIR DX TESTING, THIS UNIQUE AND HIGHLY EFFICIENT ARRAY WILL BE WIDELY WELCOMED BY ALL RADIO AMATEURS WHO DESIRE THE ULTIMATE IN PERFORMANCE, AND WHO REQUIRE A BEAM WHICH SETS NEW HIGH STANDARDS WITH :-

- * Identical high gains and performance on both bands.
- * Robust, withstands easily heavy winds and weather.
- * 3" diam. aluminium boom, 1 1/2" diam. aluminium elements.
- * Copper plated steel Vee forming supports.
- * Inverted Vee's for really outstanding DX results.
- * High gain.
- * Absolutely no compromise. Two Band operation.
- * Very low SWR.
- * Extremely low angle radiation.
- * Gamma fed, 52 ohm Coax.
- * Full size elements, no traps or compromise.
- * Pre-tuned.

INCOMPARABLE INVERTED VEE CURTAINS FOR LONG DISTANCE COMMUNICATION.

Available in following types :- 15 and 20 Metres, **TWO BAND working**

4 ELEMENT	9ft. Boom	Power Gain	5 times	(7dB)
6 ELEMENT	17ft. Boom	Power Gain	11 times	(10.5dB)
8 ELEMENT	26ft. Boom	Power Gain	13 times	(11.5dB)

(Also available in Single Band types)

The demand for VEEVEE is expected to be heavy, and to avoid disappointing delays in delivery, may we suggest you place an early order. Write for illustrated booklet, giving specification and performance details.

All enquiries to -

VEE-BEAMS (Communications), LTD., 22 Brook Road, MORECAMBE West End, Lancs.

FULLY GUARANTEED 1st QUALITY UNUSED Valves

OB3 ... 6/-	6CSGT ... 6/-	12K8 ... 10/-	C1C ... 8/-
OC3 ... 5/6	6C6 ... 4/-	12Q7GT ... 5/-	CL33 ... 9/-
OD3 ... 5/6	6CB8 ... 7/-	12SC7 ... 4/-	CY31 ... 6/-
1G6GT ... 7/-	6D5 ... 5/-	12S17 ... 5/-	E8BCC ... 12/-
1L4 ... 3/6	6EV5 ... 12/-	6E91H ... 8/-	E91H ... 8/-
1N5GT ... 9/-	6F6G ... 5/-	12SQ7 ... 10/-	E92CC ... 7/-
1R5 ... 6/-	6F7 ... 6/-	12SQ7GT 7/6	E180F ... 15/-
1S4 ... 5/-	6FB8 ... 6/6	12SY7 ... 6/-	E181CC ... 10/-
1S5 ... 5/6	6F13 ... 6/6	27M1 ... 60/-	E182CC ... 15/-
1T4 ... 4/-	6F33 ... 4/-	28D7 ... 5/-	EA911 ... 4/-
2A3 ... 5/-	6GG6 ... 4/-	42 ... 5/-	EB33 ... 6/-
2B21 ... 6/-	6J5 ... 4/6	75 ... 7/6	EC91 ... 3/-
2D7 ... 5/-	6J5GT ... 4/-	76 ... 5/-	EF37A ... 8/-
3B28 ... 15/-	6J6 ... 3/6	78 ... 5/-	EF39 ... 4/-
3D6 ... 4/-	6K7 ... 5/-	85A2 ... 8/6	EF92 ... 3/6
3S4 ... 5/-	6K7G ... 3/-	90C1 ... 8/-	EL32 ... 3/6
4D1 ... 4/-	6K8G ... 5/-	220TH ... 5/-	EN31 ... 10/-
4X150A ... 50/-	6L6G ... 6/-	715B ... 60/-	EN93 ... 17/6
5V4G ... 8/-	6L7 ... 5/-	807 ... 9/-	FW4/500 ... 7/-
5Y3G ... 4/-	6N7 ... 5/-	813 ... 55/-	GT3 ... 15/-
5Y3GT ... 6/-	6Q7G ... 3/-	829B ... 50/-	HL23DD ... 6/-
5Z3 ... 6/-	6SH7 ... 3/-	832 ... 15/-	KT41 ... 7/6
6B87 ... 4/-	6SJ7GT ... 4/6	866A ... 6/-	KTW61 ... 6/-
6AC7 ... 3/-	6SK7 ... 4/6	884 ... 10/-	PX4 ... 15/-
6AG7 ... 6/-	6SL7GT ... 6/6	931 ... 60/-	PX25 ... 10/-
6AH6 ... 11/-	6SN7GT ... 4/6	955 ... 3/-	QP25 ... 5/-
6AK5 ... 5/-	6S5 ... 3/-	956 ... 2/-	QS150/15 ... 5/-
6AK6 ... 5/-	6V6 ... 9/-	2050 ... 12/6	SP2 ... 3/6
6AL5 ... 4/-	6V6G ... 4/-	5670 ... 10/-	TT15 ... 35/-
6AL5W ... 5/-	6X5G ... 4/6	5763 ... 10/-	VI507 ... 5/-
6AM5 ... 4/-	6Y6G ... 6/-	5879 ... 12/-	VP41 ... 5/-
6AM6 ... 4/-	7Z4 ... 4/-	6005 ... 9/-	VR101 ... 12/6
6AR6 ... 6/-	11E2 ... 20/-	6060 ... 8/-	VR102 ... 12/6
6AS6 ... 5/-	11E3 ... 20/-	6080 ... 20/-	VR108 ... 3/6
6AS7G ... 20/-	12A6 ... 3/-	6146 ... 27/-	VR137 ... 4/6
6AU6 ... 7/-	12AT7WA ... 8/-	9002 ... 5/6	W81M ... 6/-
6B8 ... 5/-	12E1 ... 20/-	9003 ... 7/-	X65 ... 5/6
6BBG ... 2/6	12J5T ... 3/-	9004 ... 3/-	X65 ... 5/6
6BR7 ... 11/6	12J7GT ... 7/6	ARP3 ... 3/-	X65 ... 5/6
6C4 ... 2/6		ARPI2 ... 3/6	X65 ... 5/6

BRAND NEW CURRENT PRODUCTION FULLY GUARANTEED VALVES FOR RADIO, T.V. AND AUDIO APPLICATIONS

Quantity discount of 10% (2/- in £) on orders of £1 or more for valves in this section only

OA2 ... 6/-	10C2 ... 13/-	7859 ... 22/6	ECL86 ... 11/-	GZ32 ... 12/-	U24 ... 12/6
OA3 ... 11/-	10P13 ... 14/-	83 ... 8/-	EF40 ... 10/-	GZ34 ... 12/-	U26 ... 11/-
OB2 ... 10/-	10P14 ... 12/6	AZ1 ... 9/-	EF41 ... 7/6	KT66 ... 15/-	U191 ... 12/6
IA7GT ... 10/-	10P14 ... 12/6	AZ41 ... 9/-	EF42 ... 7/6	U251 ... 14/6	U251 ... 14/6
1H5GT ... 9/-	12AH8 ... 11/-	DAF96 ... 7/6	EF80 ... 6/6	PABC80 ... 8/6	U281 ... 15/-
IL6 ... 14/-	12AT6 ... 5/-	DF96 ... 7/6	EF85 ... 6/6	PC97 ... 10/-	U282 ... 15/-
1U5 ... 7/-	12A7 ... 5/-	DK92 ... 9/-	EF86 ... 7/6	PC84 ... 6/6	U301 ... 12/9
1X2A ... 7/-	12A7 ... 5/-	EF89 ... 7/6	EF89 ... 7/6	PC85 ... 8/-	U801 ... 20/-
1X2B ... 7/-	12AX7 ... 6/-	DL96 ... 7/6	EF94 ... 7/-	PC88 ... 13/-	UABC80 ... 8/6
2CV4 ... 14/-	12B4 ... 10/-	DM70 ... 4/6	EF98 ... 10/-	PC89 ... 11/-	UAF42 ... 8/-
3A4 ... 4/-	12B7A ... 9/-	EABC80 ... 7/-	EF183 ... 10/-	PCF80 ... 7/-	UBC41 ... 7/-
3A5 ... 7/-	12BA6 ... 8/-	EAF42 ... 8/6	EF184 ... 10/-	PCF82 ... 7/-	UBC81 ... 8/-
3C4 ... 7/-	12BB6 ... 5/-	EB41 ... 7/9	EL33 ... 9/-	PCF84 ... 13/-	UBF80 ... 8/6
3Q5GT ... 7/6	12BH7 ... 9/-	EB81 ... 7/-	EL34 ... 10/-	PCF86 ... 11/-	UBF89 ... 8/6
3V4 ... 6/-	12B7 ... 10/-	EBF80 ... 7/6	EL36 ... 10/-	PCL81 ... 9/-	UBL21 ... 13/-
5R4GY ... 9/-	19B6GG ... 15/-	EBF83 ... 10/-	EL37 ... 17/6	PCL82 ... 8/-	UCC84 ... 9/-
5U4GB ... 6/-	20P3 ... 15/-	EBF89 ... 8/-	EL38 ... 17/6	PCL83 ... 10/-	UCC85 ... 8/-
6A05 ... 5/-	25L6GT ... 8/-	EBL1 ... 11/-	EL41 ... 8/-	PCL84 ... 7/-	UCF80 ... 11/-
6A16 ... 5/-	25Z4G ... 8/-	EBL21 ... 12/6	EL42 ... 8/-	PCL86 ... 11/-	UCH21 ... 9/6
6A6 ... 5/6	25Z6GT ... 8/6	EC92 ... 6/6	EL81 ... 9/-	PL36 ... 11/-	UCH42 ... 8/-
6BA6W ... 10/-	30C15 ... 10/-	ECC40 ... 9/-	EL83 ... 7/6	PL38 ... 16/-	UCH81 ... 9/-
6BE6 ... 6/-	30F5 ... 8/6	ECC81 ... 5/-	EL84 ... 7/6	PL81 ... 8/6	UCL82 ... 9/-
6BH6 ... 5/6	30F11 ... 9/6	ECC82 ... 5/-	EL85 ... 10/-	PL82 ... 6/6	UCL83 ... 12/6
6B16 ... 8/-	30L15 ... 13/-	ECC83 ... 6/6	EL86 ... 8/6	PL83 ... 8/6	UF42 ... 9/-
6B07A ... 8/-	30P12 ... 10/-	ECC84 ... 8/-	EL87 ... 13/6	PL84 ... 8/6	UF80 ... 7/-
6BR8 ... 5/-	30P19 ... 14/-	ECC85 ... 8/-	EM34 ... 9/6	PL500 ... 16/-	UF85 ... 7/-
6BV6 ... 9/-	30P1L ... 10/6	ECC88 ... 15/-	EM80 ... 7/6	PY33 ... 12/-	UF88 ... 12/-
6CB6 ... 5/-	30P1L3 ... 10/6	ECF80 ... 10/6	EM81 ... 8/6	PY80 ... 6/6	UF86 ... 7/6
6CL6 ... 10/-	35LGT ... 8/-	ECF82 ... 8/-	EM82 ... 8/6	PY81 ... 6/6	UF89 ... 7/-
6CW4 ... 14/-	35W4 ... 6/-	ECF83 ... 6/6	EM85 ... 10/-	PY82 ... 8/6	UL41 ... 9/6
6D54 ... 15/-	35Z4GT ... 6/-	ECH35 ... 10/-	EY51 ... 8/-	PY88 ... 9/-	UL84 ... 7/-
6F23 ... 9/6	35Z5GT ... 7/-	ECH42 ... 9/6	EY86 ... 7/-	PY80 ... 10/-	UU6 ... 12/-
6X4 ... 5/-	50B5 ... 8/-	ECH81 ... 7/6	EZ40 ... 7/6	PY81 ... 10/-	UU9 ... 8/6
6X5GT ... 6/6	50C5 ... 8/-	ECH83 ... 8/-	EZ41 ... 6/6	QQV02-6 ... 6/6	UY21 ... 6/6
7B7 ... 8/-	50C5GG 25/-	ECL80 ... 9/6	EZ80 ... 6/6	QQV03-10 ... 6/6	UY41 ... 6/6
7C5 ... 12/-	50LGT ... 7/-	ECL82 ... 8/6	EZ81 ... 6/6	UY85 ... 6/6	
7C6 ... 7/-	7586 ... 22/6	ECL83 ... 14/-	GZ30 ... 10/-		

Z & I AERO SERVICES LTD.

85, Tottenham Court Road, London, W.1
Tel. LANGHAM 8403

14, South Wharf Road, London, W.2
Tel. AMBASSADOR 0151/2

Please send all correspondence and mail orders to the Head Office.
2/6 in £ should be added for postage and packing. Minimum charge 1/6.

TRANSISTORS

OC28 ... 17/6	OC35 ... 15/-	OC45 ... 5/-
OC44 ... 6/-	OC70 ... 5/-	OC71 ... 5/-
OC75 ... 6/-	OC76 ... 6/-	OC78D ... 7/-
OC78D ... 7/-	OC79 ... 7/-	OC810 ... 4/3
OC170 ... 8/-	XC101A ... 8/6	MAT101 ... 8/6
2N412 ... 4/3	MAT101 ... 8/6	MAT121 ... 8/6

Spot Transistors:

Red 2/8; White 2/8; Yellow 1/10; Green 1/6

SEMICONDUCTOR RECTIFIERS

SILICON BY100, 700 p.i.v., 450 mA ... 8/-
GERMANIUM GJ5M, 300 p.i.v., 400 mA ... 3/6
GERMANIUM GJ7M, 80 p.i.v., 500 mA ... 3/6

SELENIUM CONTACT COOLED RECTIFIERS 220v. A.C., 300 mA
Half wave 3/6 Voltage doubler 4/-

ZENNER DIODES

2.25 watt; 5% Tolerance
5.75v., 6.25v., 7.0v., or 9.0v. ... 6/6 each

PLEASE SEND 6d. STAMP FOR CATALOGUES AND PRICE LISTS OF VALVES AND MAIL ORDER ITEMS

SMALL ADVERTISEMENTS

("SITUATIONS" AND "TRADE")

9d. per word, minimum charge 12/-. No series discount: all charges payable with order. Insertions of radio interest only accepted. Add 25% for Bold Face (Heavy Type). No responsibility accepted for errors. Replies to Box Numbers should be addressed to The Short Wave Magazine, 55 Victoria Street, S.W.1

SITUATIONS VACANT

ELECTRICAL ENGINEERS. Men with O.N.C. or equivalent experience required for Test Room on a variety of instruments and equipment for H.M. Services. Suit radio technicians with experience on ground radio and radar equipment. Staff position. Salary in line with qualifications and experience. Holiday arrangements honoured. Superannuation scheme. Company station transport. Apply in writing to—Personnel Officer, Peto-Scott Electrical Instruments Ltd., Weybridge, Surrey.

CLOSED CIRCUIT TV TESTERS: We invite applications from test engineers, preferably with previous industrial experience on television equipment. Interesting work on TV cameras, camera control units and a variety of monitors including transistor equipment. Successful applicants will be offered positions on the Company's permanent staff. Salary in line with qualifications and experience. Holiday arrangements will be honoured. Superannuation scheme. Company station transport. Apply in writing to—Personnel Officer, Peto-Scott Electrical Instruments Ltd., Weybridge, Surrey.

G3FBX requires first-class TV service engineer for expanding business on South Coast. Excellent remuneration, good prospects for man of ability, experience and initiative.—A. J. Slater, 86 Cross Road, Southwick, Sussex.

TRADE

QSL CARDS AND LOG BOOKS, G.P.O. APPROVED. CHEAPEST, BEST, PROMPT DELIVERY. SAMPLES.—ATKINSON BROS., PRINTERS, LOOE, CORNWALL.

WEBB'S LOG BOOK for recording signals heard and worked; 112 pages 9½ in. x 8 in. approved format, semi-stiff covers. Excellent value; 6s. 0d. post free, or callers, 5s. 4d.—Webb's Radio, 14 Soho Street, London, W.1.

QSL CARDS: Buff, blue, pink, green, 100, 15s.; 250, 25s.; 500, 40s.; 1,000, 75s.—Samples (s.a.e.): Reilly, Panxworth, Norwich, 56.Z.

CATALOGUE No. 15. Government Surplus Electrical and Radio equipment. Hundreds of items at bargain prices for the experimenter and research engineer, 2s. 6d. post free; catalogue cost refunded on purchase of 50s.—Arthur Sallis Radio Control Ltd., 93 North Road, Brighton.

MODERN Communication Receivers Wanted.—Teleradio Co., 64 High Street, Waltham Cross. (Tel: W.S.22973.)

K.W. TESTED Eddystone 888A, £75; 888, £50; 680X, £74; S.640, £26; S840, £30; GeloSO G209, £57 10s.; G209R, £65. K.W. GeloSO Converter 10-80m., £17; HRO, £17.—K.W. Electronics Ltd., Vanguard Works, Dartford, Kent.

WANTED FOR CASH: All good-class Communication Receivers and Test Equipment.—G. W. Smith & Co., 3 Lisle Street, W.C.2.

EQUIPMENT CONSTRUCTED, modified, serviced. Enquiries welcomed, s.a.e. to—G2VV, 53 Thames Street, Sunbury-on-Thames, Middlesex.

ALL TYPES of modern and obsolete valves at low prices, s.a.e. Lists; enquiries Radio/Television; books, service sheets.—Hamilton Radio(S), Western Road, St. Leonards, Sussex.

READERS' ADVERTISEMENTS

3d. per word, min. charge 5/-, payable with order. Please write clearly, using full punctuation and recognised abbreviations. No responsibility accepted for transcription errors. Box Numbers 1/6 Extra. Replies to Box Numbers should be addressed to The Short Wave Magazine, 55 Victoria Street, S.W.1

WANTED: First-class communication receiver, good condition and performance essential, state lowest price and details; also complete R.A.E. Correspondence Course.—Box No. 2856, Short Wave Magazine Ltd., 55 Victoria Street, London, S.W.1.

BC-221AK with manual and charts, mod. output, £15. Heathkit sig. gen., well built and perfect, £8 10s. Transistor PSU 250v. 125 mA, 130v. tap, cost £10, accept £6. Grundig TK20, perfect, with 3 tapes, £20.—(Tel. BYRon 5810.)

BELIEVED first sale in England, Receiver 216, 19 mc to 157 mc, four switched bands including 21 and 28 mc; Police, Taxis, Aircraft, two and four metres, etc., £25. Also Panda Transmitter PR-120V, 150 watts, £45.—Silver Plough, Pitton, Nr. Salisbury, Wilts. (Tel. Farley 266.)

HAMMARLUND HQ-180 18 valves, triple conversion, 30 mc to 54 mc in six bands, complete with Verdik 10 watt push-pull amplifier and pre-amplifier, new condition, what offers?—Box No. 2857, Short Wave Magazine, Ltd., 55 Victoria Street, London, S.W.1.

SELSYNS! Ideal beam and indicators transmitter, receiver, dial, instructions, £2, post 7s. 6d. Meters, flush, round 100 μ A 2½ in. 30s. (cased), 1 mA, 3½ in., 35s.—Judkins, 20 Highbury Crescent, Bessacarr, Doncaster.

SET of Morse records, £2.—Wyngarth, Meriton Road, Lutterworth, Rugby, Warks.

CLEARING SHACK: Eddystone 640, needs mains trans. Home-brew Elizabethan transmitter. Salvaged Siemens ship's transmitter, OK except for meters and valves. Transformers, chokes and condensers including 1500 volt and 500 volt transformers; Woden UM3. Number of valves including 813 and two 811. For quick sale £15 the lot. Can deliver 25 miles of Newcastle.—G3BZZ, 8 Derwentwater Gardens, Whickham, Newcastle-on-Tyne.

SMALL ADVERTISEMENTS, READERS—continued

TOP BAND Command Rx, new, unmodified, £8 10s. MW model, same condition, £5. 829B, new boxed, 35s. QQV03-20A, new, 30s. Tiger TR2M high-power 2-metre Tx complete, new, very little used; offers, or exchange for good Comm. Rx SX-43, SX-100, RME54 or '84, Redifon R50M; cash adjustment either way.—Box No. 2858, Short Wave Magazine, Ltd., 55 Victoria Street, London, S.W.1.

FOR SALE: Panda Cub, mint condition, £35. (Phone Maidenhead 24859.)

TRUVOX Tape Recorder, well engineered two-speed machine in excellent condition, handbook, £16 o.n.o.—(Phone Dowling, GERard 3714 office hours.)

WANTED: A commercial 465 kc IF RTTY converter (ZA-39384, RCA, W.H.Y.?). Also wanted Creed 7B page teleprinter, CR-100 manual, LP Morse practice record other than G3HSC; R.A.E. Course with answers.—B. Robertson, 9 Holbeck Lane, Cheshunt, Herts.

EXCHANGE: Rx 1392D for best mobile Rx offered.—Smith, 15 Woodland Close, Sands, High Wycombe, Bucks.

HAMMARLUND HQ-170E, 230/250v. model, perfect condition, will deliver within 100 miles, £90.—G3FKM, 10 Knightlow Road, Birmingham, 17.

SALE: HRO modified, works FB, PSU and manual, £15. Minimitter Converter 5-band, FB condition, £6; buyer collects. Also 813 with base, £1. BC-384Q manual, 15s. Offers also invited for K.W. Vanguard Mk. II in first-class condition.—J. Tyas, G3NSG, 2 Craven Street, Barnoldswick, Nr. Colne, Lancs.

BRAND NEW HRO Rx required, with coils and P/Pack.—Carr, 21 Eastfield Crescent, Woodlesford, Nr. Leeds, Yorkshire. (Would collect 75 miles radius.)

WANTED: HRO coil packs 3.5 and 14 mc; will swap Leak TL-12 amplifier and preamp. for full set.—Box No. 2859, Short Wave Magazine, Ltd., 55 Victoria Street, London, S.W.1.

VALVES: 12AT7 at 3s. 9d. each; 6AM6 ruggedised at 2s. 9d. each. Ex-equipment unused, or unit complete with 3/12AT7 and 2/6AM6 most of components, 17s. 6d. each.—D. B. Wilson, 63 Jacey Road, Shirley, Warks.

CDR ROTATOR wanted, complete and working, reasonable price, would consider other make; offers to—Findlay, GM3RSZ, Hanover Street, Stranraer, Scotland.

CREED 3N tape teleprinter and power supply, mint, also some accessories, £15. RTTY signal generator 50-7000 cycles, £2 10s.—L. Devenish, 13 Riverside, Hendon, N.W.4.

BC-348J, extra LF, S-meter, excellent performer, £12. Collins TCS-12, first grade, £6. RU16, all coils, £4. One power pack available, £3. All o.n.o.—Cookson, 23 Newland Walk, Scunthorpe, Lincs. (Tel. 5609.) (Free delivery 30 miles.)

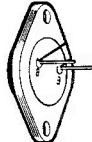

**TRANSISTORS
CRYSTALS
VALVES
EQUIPMENT AND
COMPONENTS**



CRYSTALS
Over 600 types stocked.
100 kc/s., 15/- AR88,
455 kc/s., 12/6. HC6U
miniatures, 18 mc/s. to
46.5 mc/s. 3rd overtone, 7/6.

TRANSISTORS
Over 200 semi-conductor
devices of all types stocked.

VALVES
Over 800 types. Commercial
and special purpose.

CATALOGUE
LATEST 68 PAGE FULLY ILLUSTRATED AND
DETAILED. 2/- POST FREE

SIGNAL GENERATOR
Portable all transistor. 8
bands. 149 kc/s. to 350 mc/s.
RF, AF mod. Complete,
leads, etc.
12 months guarantee.
£7. 18. 6 P.P. 2/-.
Leaflet on request.

RESIS./CAP. BRIDGE
All transistor. 1 pf. to 100
mFD. 1 ohm to 100 meg.
£7. 2. 3 P.P. 2/-

FIELD STRENGTH METER
Pocket sized. 5 bands,
1 mc/s. to 200 mc/s. Fitted
200 µA meter. Calibrated
dial, telescopic aerial. RF
indication and phone moni-
toring. Magnet base.
69/6. Post Free.

MULTIMETERS
20 k/v., 5 gns. 30 k/v. £7.
50 k/v., £10. 2 k/v. 75/-.

● LEAFLETS ON REQUEST ●

HENRY'S RADIO Ltd 303 EDGWARE ROAD
LONDON, W.2
COMPONENT SPECIALISTS PADdington 1008/9

TW MEANS V.H.F.
FINEST QUALITY — UNEQUALLED PERFORMANCE

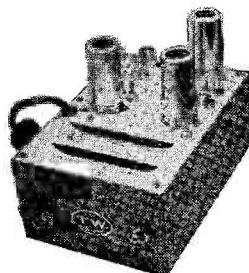

**TW
NUVISTOR (6DS4)
CONVERTER**

- Excellent noise factor
- 30 dB gain
- 70 dB I.F. rejection
- Wide Range of I.F.'s
- The TW Nuvistor Converter requires no Rx modification

£15
11 gns. Less power supply.

ALSO AVAILABLE:—

TW 2 10w. TX. Complete with Modulator ...	23 gns.
TW Nuvistor Preamplifier. Built-in P.S.U. ...	6 gns.
TW Mains Power Supply/Control Unit ...	13 gns.
TW Mobile Power Supply/Control Unit ...	13 gns.
TW 2m. or 70cm. Driver Unit ...	10 gns.
TW Halo Aerial. Neat and easily mounted ...	£2. 17. 6
TW 10 watt Modulator (P.P. EL84) ...	8 gns.

MOBILEERS! Fist Mike by S. G. Brown.
Crystal insert, positive action D.P. switch. Blue
moulded nylon. £3. 19. 6

Log Books. Especially for the car. 3,000 entries.
Top quality paper. 10/6

Over 500 TW Converters in use throughout the world

T. WITHERS (Electronics)
15b GILBERT STREET, ENFIELD, MIDDX.
G3HGE Tel. Waltham Cross 26638 G3HGE

SHORT WAVE (HULL) RADIO G5GX

Second-hand Receivers

	£	s.	d.
EDDYSTONE 740. 550 kcs. to 30 mcs. ...	27	0	0
EDDYSTONE 840A. 550 kcs. to 30 mcs. from	32	0	0
EDDYSTONE 670 MARINE RECEIVER. 110-230 v. ...	22	0	0
NATIONAL NC 188. 550 kcs. to 30 mcs. Bandspread on amateur bands ...	59	0	0
HAMMARLUND HQ120. Excellent condi- tion ...	26	0	0
MR44. Amateur bands only ...	32	0	0
HALLCRAFTERS SX101A. Amateur bands	135	0	0
COLLINS 7551. Amateur bands only—first class condition ...	150	0	0

Transmitters

PANDA PRI20's. 150 watt ...	38	0	0
HALLCRAFTERS HT37. SSB.TX ...	145	0	0
HALLCRAFTERS HT32A. SSB.TX ...	175	0	0

New Receivers

HALLCRAFTERS SX111 ...	120	0	0
HALLCRAFTERS SX140. Kit ...	32	10	0
EDDYSTONE 960. Transistor ...	135	0	0
EDDYSTONE 940 ...	125	0	0
EDDYSTONE 840C ...	58	0	0
EDDYSTONE 870A ...	30	17	6
MOSLEY CMI ...	86	0	0

Carriage extra on all the above

24a NEWLAND AVENUE, HULL

G4GZ's BARGAINS

VALVES: EA50, EF50, 1/6 each, 9/- doz. 6H6M, 6AC7M, 6K7G, 12SJ7M, 12SC7M, 2X2, 6BBG, EF50(S), 6C4, 2/- each, 18/- doz. 6AL5, 6AM6, 6J6GT, 6J6, 12A6, ARP12, AR8, EB91, EF91, EL32, TT11, VP23, Z77, 2/6 each, 24/- doz. 65N7GT, 1626, DC70, DF73, DL70, 3/6 each, 36/- doz. 6AK5, 6J7G, 6J5M, 6ST7, 12K7G, 12Q7G, 35Z4G, 3Q4, 12AT6, 959, 4/6 each, 48/- doz. 6SL7GT, 6SJ7M, 6X4, 6F6M, 80, 12CBM, 12AU6, 42, PCF82, PCC85, PY83, VR150/30, 2A3, 5/- each, 54/- doz. 12AU7, 12AT7, 12SQ7M, 446A, EC80, 836, PL82, EZ80, EZ40, 6B16, 6AU6, EZ81, UY41, 6BH6, EBF80, EAF42, 6/- each, 66/- doz. 6L6G, 6L7M, 50L6GT, EZ81, 7/- each, 78/- doz. ECC85, ECC84, EM80, 3A5, 6K8M, 6L6M, 8/- each, 90/- doz. 7B7, 757, 7C5, 5R4GY, UCH81, VL5631, 9/- each, 102/- doz. EL84, 5763, ECH42, 9/6 each, 108/- doz. 805, 3E29, 25/- each. 4E27 (HK257B), 40/- each. P/P 6d. per valve 2/6 doz. lots if under £5. See previous advertisements for other goods.

EDDYSTONE RECEIVERS. FERROGRAPH TAPE RECORDERS
—LEAK — QUAD — GOODMAN'S — WHARFEDALE, Etc.
HI-FI EQUIPMENT.

JOHN ANGLIN

385, CLEETHORPE ROAD, GRIMSBY, LINCS. Tel. 56315

JACK TWEEDY

SPEEDY AND RELIABLE SERVICE
Eddystone Receivers and Accessories Stocked

New

Eddystone 870A, £30/17/6; 840C, £58; Codar CR66 wired and tested, £22; HAMMARLUND HQ 170A, £140; KW77, £120

Used

Minimitter 5 Band converter with P.S.U., £11; Minimitter MR37 G.C. and B.S. As new £30; R308, 20 to 146 mcs. in 5 bands, £22/10; LG300 in new condition, £35; LG50 in good condition, £26/10; SX28, £27/10. Ex U.S.N. BRAND NEW TB58 TX/RX less valves, £12

New Transmitters

Hammarlund HX50, £175; KW Viceroy, £165; Packaged deal consisting HX50 TX and HQ 170A RX, £299; Gelofo VFOs. Full range in stock.

Several other items available; all can be seen and tested at your leisure
R.S.G.B. Publications

H.P. terms available, generous trade-in allowance on your used equipment.
(Please state age, condition and approximate price required)

21 Birkin Lane, Grassmoor, Chesterfield

Tel: Holmewood 506

SMALL ADVERTISEMENTS, READERS—continued

K.W. GELOSO Converter, mint, few hours' use, £18, post paid. HRO-MX modernised, 6BA6 RF, IF, 6BE6 mixer, stabiliser, half-lattice filter, six GC coils, £22, post paid.—Box No. 2860, Short Wave Magazine, Ltd., 55 Victoria Street, London, S.W.1.

VFO GELOSO 4/104 complete with valves, dial, etc. (what offers?), or exchange for Q5'er.—P. M. Williams, 22 Druslyn Road, West Cross, Swansea.

HRO SENIOR, full set bandspread coils (including 121 mc) PSU, Heathkit Q-Multiplier. A real hot rod, £25 to good home, buyer collects London Area.—Box No. 2861, Short Wave Magazine, Ltd., 55 Victoria Street, London, S.W.1.

WANTED: CR-100, manual.—J. Moore, 104 Hollyhill Road, Belvedere, Kent.

SALE: Heathkit Mohican, 6 months' old, as new, plus phones and coax, £33 o.n.o.? cash.—Grant, 114 Markland Road, Dover, Kent.

THE LATEST Johnson "Invader" SSB transmitter, special heat-stabilised VFO, 200 watts p.e.p., 10 to 80 metres (cost £285), first realistic offer accepted.—R. J. Toby, 8 Stephen Street, London, W.1. (Museum 9188.)

2-METRE CONVERTER, brand new and hardly used, 6CW4 nuvistor RF stage, xtal controlled osc. chain, built-in PSU, 28-30 mc IF, £5 o.n.o.?—Fisher, 64 Caldene Avenue, Mytholmroyd, Halifax, Yorks. (Tel. Calder Valley 3166 evenings.)

WANTED URGENTLY: Reversible surplus cowl-gill beam rotating motor, 24v. 12-15 r.p.m.—V. Perry, 6 Bute Road, Mannamead, Plymouth.

WANTED: B2 Tx complete and in good condition.—Box No. 2862, Short Wave Magazine, Ltd., 55 Victoria Street, London, S.W.1.

SALE: 13-valve double-superhet Communications Receiver, 1.7 mc to 31.5 mc with three plug-in coil-sets, many novel features, as per article in *Practical Wireless* May 1963, £25 or offer; details s.a.e.—Box No. 2864, Short Wave Magazine, Ltd., 55 Victoria Street, London, S.W.1.

WANTED: FT-241 crystals; one each of Channel 329 (32.9 mc), and Channel 45 (24.5 mc).—Borland, 6 Burnside Way, Largs, Ayrshire.

TA33 Beam for sale, complete with 20 ft. hinged steel tower, prop-pitch motor, two Selsyn motors, power supply and indicator panel, £25; buyer collects.—G3IRL, 166 Stradbroke Grove, Ilford, Essex. (CRE 3365.)

QRP Rig Transformer Pri. 0-200/20/40v., Sec. 350-0-350v. 150 mA, 6.3v. 5A, 5v. 5A, £2 18s. incl. postage, c.w.o. only, to—R. Merriman, 73 Burnside Grove, Tollerton, Nottingham.

SALE: CR-100, modified as *Short Wave Magazine* April 1960, complete with manual, £15 o.n.o.? Mullard 2-valve preamp. in box chassis, complete with control panel, £5. Collaro Mk. II Tape Transcriber, £10 o.n.o.? Offers to—J. M. Middleton, Narrow Water, Burley, Hants.

SMALL ADVERTISEMENTS, READERS—continued

K.W. VALIANT, as new condition, £22 10s. LM-14 frequency meter complete, brand new, £14 10s. Command Rx's 3-6 mc, £4 15s. MW 0.5-1.5 mc, £4 10s; both brand new and unmodified. Manuals AR88D, 25s.; BC-221AK, 20s., mint copies. 12AT7WA's (ruggedised) brand new, complete with base and screening can, 6s. 6d. each, mini. qty. 2. 250 μ A meters, centre zero, 3 in. scale, brand new, 22s. 6d. Chrome handles, 5 in., new, 5s. pair. All items plus postage.—Box No. 2863, Short Wave Magazine, Ltd., 55 Victoria Street, London, S.W.1.

MOSLEY TA-33 Jr. beam antenna, lacquered against weather, plus two spare brand-new traps, £12.—Abbott, 13 Belltrees Grove, Streatham, London.

SILICON Diodes 500 mA 1000 PIV, 9s. each. OC44, 45, 81D, 3s. 6d. each. OC170, 4s. OC171, 4s. 6d. each, plus p.p.—G3MAD, 70 Arnold Road, Binstead, I.O.W.

VIRGINIA WATER, Surrey, 30 ft. mast, swivelling on metal stanchion, £5 the two. Buyer extracts, collects. Also good SX-24, Cambridge, £15.—Wilcock, 19 Cavendish Avenue, Cambridge.

WANTED: Manual for British Army Transmitter Wireless Set No. 36.—H. G. Williamson, P.O. Box 6448, Johannesburg, South Africa.

CR-100 for sale, excellent condition, noise limiter, was station Rx of G3PNH, £15.—Wilson, 128 Canterbury Walk, Warden Hill, Cheltenham.

150-WATT Transmitter, 80, 40, 20, 15 and 10 metres, fully modulated Class-B, exciter is band passed; the whole, including all power supplies, fully metered, circuits built into a handsome 6 ft. rack. A sacrifice; many spares included, £60 o.n.o.?—A. C. Clements, G3KCA, 12 Derby Road, Eastleigh, Hants. (Or ring Eastleigh 2520 up to 6 p.m.)

SALE: Bendix TA-12C Transmitter with Modulator Unit and Two PSU's. Offers.—Thomas, GW3PXY, Bank House, Llanwrtyd Wells, Brecs. (Tel. 205.)

CODAR CR-66 Receiver, cabinet, tuning indicator, manual, etc., used only 3 months. Perfect working order; constructor ex-R.A.F. Radar Fitter. Best offer secured.—D. Eckley, 7 Belvidere Avenue, Shrewsbury.

DST-100 double-superhet Communications Receiver, 50 kc to 30 mc, good condition, £20. G4ZU Beam 20, 15, 10 metres, with ATU, 30 ft. dural mast, offers?—Harrison, 22 Ainsworth Hall Road, Ainsworth, Bury, Lancs.

LM-14 Frequency Meter with charts, excellent condition and as new, £12 10s.—J. G. Openshaw, 516 Walmersley Road, Bury, Lancs.

"SOUPED-UP" R.1155 for sale, frame-grid EF183 RF and LF stages, separate RF, IF, AF gain controls, S-meter socket, 1 mc marker, recently aligned, with power pack, £12 o.n.o.? Less same, £10 o.n.o.? Carriage, C.O.D. extra.—V. Williams, 18 Lon-Y-Mynydd, Rhiwbina, Cardiff.

SALE: SX-28, £27. Geloso, £13. Both in very good condition, or exchange both for Eddystone S.750 with S-meter for compactness, carriage extra.—D. Yeo, Top Flat Left, 9 Woodburn Terrace, Edinburgh, 10.

G. W. M. RADIO LTD.

MOBILE RECEIVERS FOR 4 METRE:

Receivers Ex-Police Car, Superhet. Crystal (not supplied) controlled in range 70 to 90 mc/s. approx. Valves 5 EF91, 3 EF92, 3 EB91, EL91 or equivalent. Internal 12 volt rotary giving 250 volts 60 m/a. Size 8" x 7" x 14", weight 16 lbs. Supplied in good clean condition with valves, 40/-, post 7/6. Matching 3 ohm speaker in crackle case, 7/6, post 2/6.

25 only B44 Transceivers, crystal controlled in range 60-95 mc/s. 12 volt vibrator and 5" speaker built in. Only need crystals to operate on 4 metres. In excellent condition and complete with installation kit, leads, phones, mike, etc. £8, carriage £1. Kit only, 45/-, carriage 10/-.

See next month's advert. for Police Car Transmitter parts, 10 watt modulation transformers, control units, P.A. chassis, etc., etc.

RECEIVERS B28/MARCONI CR100. A further delivery of this popular receiver in very good working order. Price £18/10/-, carriage £1.

H.R.O. PLUG-IN COILS, 7 to 14.4 mc/s., £1; 180 to 430 kc/s. or 480 to 960 kc/s., 10/-, post 2/6 each.

RECEIVERS RI132. 100 to 120 mc/s. tunable, in good order, £4/10/-, carriage 12/6.

TRANSMITTER POWER PACKS. 230v. A.C. input with outputs of approximately 325 volts D.C. at 200 m/a., and 6.3v. A.C. two smoothing chokes, paper capacitors. On chassis 13" x 8". Complete with two U52 rectifiers. Used, good condition, 25/-, post paid.

VALVES. New spares for 52 receiver: ARP3 at 2/6; 12Y4G at 3/6; 12SC7 at 3/6; OZ4 at 5/-, Also new 6BR7 at 3/6, post free.

HANDBOOK for 52 receiver and ZE12 power unit. Contains all information, circuits, etc. Reprinted from official handbook, 5/-, post free.

V.H.F. RECEIVERS. Approximately 80 mc/s. as May advert, £3, carriage paid.

All equipment offered is complete but not tested unless otherwise stated. Carriage charges are for Mainland only. Terms: Cash with order. Early closing Wednesday.

40-42 PORTLAND RD., WORTHING, SUSSEX

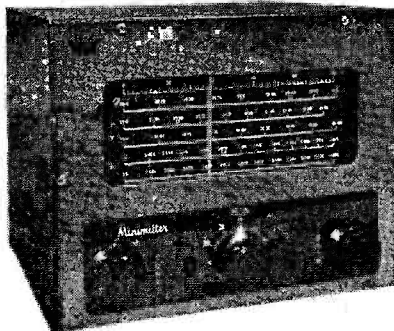

**Minimitter
The
World
Famous
Converters**

3 Superb Performance Models:—

- MC8 - 8 Band £21. 15. 0
- MC6 - 6 Band £19. 10. 0
- A.B.C. - 5 Band £18. 10. 0

Transform any receiver capable of tuning to 1.5 Mc/s (200m.) into a fully bandspread, Double Conversion Superhet. Self-powered, fixed and mobile operation.

- MR44/11 Communications Receiver £65. 0. 0
- 'Top 2-7.' 24 watt. 3 Band Transmitter £30. 0. 0
- Mobile Transmitter 20 Watts £17. 15. 0
- Transistor Power Supply £11. 11. 0
- Mobile Whip Aerials 1.8-3, 5-7.0 Mc/s £6. 15. 0
- TR7 Transistor Mobile Receiver £11. 0. 0
- G4ZU 'X20' 20 Metre Beam £11. 0. 0
- Telescopic Mast, 34 Foot £10. 10. 0
- Minimitter 'Multi Q' Unit, 465 Kc/s £5. 10. 0
- FB5 All-band Aerial. Complete £5. 2. 6

H.P. Terms Available

For full details of any of the Minimitter range, please send S.A.E. to:

THE MINIMITTER CO. LTD. Telephone: MALda Vale 5588
37 Dollis Hill Avenue, Cricklewood, London, N.W.2

R.C.A. AR.88 D. RECEIVERS

New release. Offered in excellent used condition, fully tested and guaranteed. Frequency coverage on 6 bands, 550 kc/s. to 32 mc/s. Operation 110/230 volt A.C., £45 each, carriage £2.

NATIONAL H.R.O. RECEIVERS

Senior model. Supplied with full set of 9 coils covering 50 kc/s. to 30 mc/s. Available as follows—

- Table model, as new condition, £25
- Rack model, as new condition, £22/10/-
- Table model, good used condition, £19/19/-
- Rack model, good used condition, £18/18/-

Carriage 20/- extra

Power packs to operate any of above from 110-230 volts A.C. (also sold separately), 59/6 extra, carriage 5/-.

MARCONI CR100/8 RECEIVERS

Available brand new in original transit cases, complete with manual. Frequency coverage 60 kc/s. to 30 mc/s. on 6 bands. Operation 200-250 volt A.C. £35 each, carriage £2. CR100 receivers also available in good used condition, £21, carriage £2.

HALLICRAFTER S-36 V.H.F. RECEIVERS

F.M./A.M. 27 to 143 mc/s. Operation 110 volt A.C. (transformer supplied for 230 volt operation). Available brand new in original transit cases with manual. £40 each, carriage £2.

P.C.R.2 COMMUNICATION RECEIVERS

Frequency coverage on 3 bands, 2,000-800 metres, 350-150 metres, 6 to 22 mc/s. Output for phones or speaker. Supplied in "as new" condition, fully tested, £5/19/6, carriage 10/6. The receiver can be supplied with an internal power supply to operate direct from 200-250 volt A.C. at 39/6 extra or alternatively plug in external power supplies are 35/- extra.

UNIVERSAL AVOMETERS

Guaranteed perfect condition with leads and batteries.

MODEL "D" 34 ranges, £8/19/6 each.

MODEL "7" 50 ranges, £11 each.

Registered post 5/- extra.

AVO WIDE RANGE SIGNAL GENERATORS

Frequency coverage 50 kc/s. to 80 mc/s. in six turret operated ranges. For use on standard A.C. mains. Packed in original transit cases with accessories. Supplied in "as new" condition, fully checked before despatch, £15 each, carriage 10/-.

LAFAYETTE BRAND RECORDING TAPES

Brand new guaranteed first grade American tapes: 5"-600', 8/6; 5"-900', 10/-; 5"-1,200', 15/-; 7"-1,200', 12/6; 7"-1,800', 15/-; 7"-2,400', 25/-.

Postage 2/-.

Over £3 free.

WANTED FOR CASH. ALL GOOD CLASS COMMUNICATION RECEIVERS AND TEST EQUIPMENT

Hours of Business: 3 Lisle Street, 9 a.m.—6 p.m. (Half day Saturday), 34 Lisle Street, 9 a.m.—6 p.m. (Half day Thursday).

G. W. SMITH & CO. (RADIO) LTD.

3 and 34 LISLE STREET, LONDON, W.C.2. Tel. GERrard 8204/9155

SMALL ADVERTISEMENTS, READERS—continued

G4ZU 10/15/20 metre Minibeam, unused, £12. Field strength meter, RF-40, 1 mc to 200 mc, unwanted gift, 50s. Multitester TP-10, perfect, 59s. Transformer, 0-500-1000-1500-2000v., 10 mA. 12s. Carriage extra. —Thompson, 134 Royal Oak Road, Manchester, 23. (WYT 2897.)

SALE: Temp. close down. Eddystone 960, used about 10 hours, offers over £90. Heathkit Seneca VHF Tx, mint cond., used 5 hours, offers over £70. Combined Transistor stab. PSU for 960 and control unit for Seneca, £10. Table Top 4X150 450w. Tx for 144 mc, variable power input control, offers over £30. Two RF AFZ12 Converters, 24 mc IF, £6.—Bradford, GM3DIQ, 50 Main Street, Ratho, Midlothian.

FOR SALE: Power unit Type 3, with meters, mint condition, £2. Amplifier Type N24 with two 10 in. speakers, £3.—Phillips, 19 Newbridge Road, Aberavon, Port Talbot, Glam.

WANTED: Commercial all-band AM/CW, 50-200w., Transmitter unmodified; table topper preferred. Top Band not essential, lowest price, etc.—Box No. 2865, Short Wave Magazine, Ltd., 55 Victoria Street, London, S.W.1.

WANTED: Vibroplex. El-Paddle.—G3RUX, 39 Park Lane, Pinhoe, Exeter, Devon.

FOR SALE: Hallicrafters SX-24 Skyrider Defiant, with manufacturer's manual; also R.1392 Rx with circuit and power unit Type 234A; all in good condition, £16 lot. Would exchange for valve tester in working order. Call any time after 6.30 p.m.—R. Cheasman, 14 Flint Street, Walworth, London, S.E.17.

FOR SALE: B2 Tx/Rx complete, fair condition, £7 10s. Hallicrafters HT-11B, 12v. p/pack and whip, £7. R.1471 Rx, 3-30 mc, p/pack, £7. 160m Tx and p/pack, 10s.—Morgan, 15 Western Avenue, Nantwich, Cheshire. (Tel.: 64169.)

FOR SALE: AR88LF, £22 o.n.o.? W.1191A Wave-meter with PSU, £2 10s. Buyer collects.—Sweeton, 20 Brackley Street, Oldham, Lancs.

SALE: RSGB *Bulletins* Jan. '57-Nov. '60, £2 10s. *VHF Handbook*, 17s. 6d. Ilford Advocate Camera, tripod, flash, close and UV lenses, hood, release, £17. Tx cabinet with 1 kV PSU, £7. E1 T/R Sw., 25s. 8KW LPF, £3 3s.—G3KAB, 28 The Vale, Southgate, London, N.14. (PAL 7906.)

SALE: Heathkit DX-40U with VF1U, both excellent condition, £25 pair, plus carriage.—G3AGD, Tregoddick Farm, Madron, Penzance. (Tel. Penzance 3080.)

FOR SALE: MC8 Minimitter Converter, 1.5 mc IF output, performance OK, but requires external power pack. WANTED: Tx low-pass all-band filter, 75 or 50 ohms, Channel 4; also Mosley TA-33 Jr. Beam, or similar.—Box No. 2866, Short Wave Magazine, Ltd., 55 Victoria Street, London, S.W.1.

FOR SALE: Mohican Rx, mint condition, factory aligned and tested, complete with UBE-1 battery eliminator, £28 o.n.o.? Also R.107, good condition, £8 o.n.o.? Carriage extra.—Jackson, Oakley Rectory, Basingstoke, Hants.

QUARTZ CRYSTAL UNITS

Hermetically sealed, Gold or Silver Electroded Crystals, post free at the following prices: each

Fundamental 3 Mc/s. to 15 Mc/s. at £1 5s. 0d.

Fundamental 15 Mc/s. to 20 Mc/s. at £1 10s. 0d.

Overtone 20 Mc/s. to 30 Mc/s. at £1 10s. 0d.

State holder type preferred — HC-6/U or FT243

PROFESSIONALLY MADE FOR THE AMATEUR

Send cash with order stating exact frequency and you will receive an Oscillator Circuit Diagram with your crystal.

Booklet "Guide to Specification and Use of Quartz Oscillator Crystals" 5/-.

CATHODEON CRYSTALS LTD. Linton, Cambridge

SMALL ADVERTISEMENTS. READERS—continued

SALE: AR88LF, rack model, handbook, £21. S Geloso VFO 4/102, valves, dial, £5. Type D Wavemeter, £3 10s.—Gorrie, 32 Allan Park Road, Edinburgh, 11.

SALE: R.1155A Receiver, mint condition, £5 o.n.o.? No power supply unit.—G3JZB, 15 Holm-croft Road, Stafford, Staffs.

HALLICRAFTERS SX-42 with Handbook, 540 kc to 108 mc; AM, FM, S-meter, dual grey/silver, offers £40. or exchanges Mohican and 2-metre rig, etc.—G3GRA, 11 Deerswood Road, Crawley, Sussex.

RECEIVER R.1475, good condition, £10. 200-watt ART-13 Collins transmitter, slight mods. and HT supplies needed, £5. Buyer collects.—Duncan, 12 Ivanhoe Place, Dundee.

1961 HALLICRAFTERS SX-110 Receiver, good condition, S-meter, variable selectivity, etc., £48 or exchange good 35mm. Camera or Ferroglyph Recorder.—Habesch, 19 High Street, Rhyl, North Wales.

FOR SALE: Signal Corps valve tester, Type 1-177B, excellent condition, with data book, £6.—G3ELJ, Claypole, Newark, Notts.

SALE: LG.300 with mod/PU, brand-new condition, spare 813, £50 o.n.o.? CRO (2½ in.), perfect condition, £15 o.n.o.? Eddystone bug key, £2. Various components, valves, etc. Marconi key, £1. HQ-180, perfect, £150. SB-10U, £30.—Box No. 2867, Short Wave Magazine, Ltd., 55 Victoria Street, London, S.W.1.

W.S.19 Mk. II Station with all accessories and spares, as last month, £7 10s. Amplifier RF No. 2 Mk. III, suit 19 Set, £2 10s. BC-611 Handy-Talky, £7 10s.—Hardcastle, Rigton Grange, East Keswick, Leeds. (Phone: Rigton Hill 205.)

WANTED: Tx/Rx type BP5 or similar, good price paid for set in mint condition. Also wanted AR88D or Eddystone 750. Yorkshire.—Box No. 2868, Short Wave Magazine, Ltd., 55 Victoria Street, London, S.W.1.

ARRL HANDBOOK, 12s. *Bulletins* Vol. 37, Nos. 2, 4, 6, 7, 8, 10, 1s. 3d. each. Top Band Rx (Command) with 12v. xformer and HT PSU and speaker, £6 inc. p/packing.—Livermore, 30 Johnson Road, Berrow, Bury St. Edmunds, Suffolk.

TX for sale, complete with power pack and modulator, RF needs modification, £5, buyer collects.—G6CC, 15 Cremorne Road, Sutton Coldfield, Warwickshire.

HRO really good rig consisting of power pack, speaker, 9 coils, headset, services manuals and circuits, modernised as per write-ups in *Short Wave Magazine*. View Basingstoke or Peterborough areas, £18.—Box No. 2869, Short Wave Magazine, Ltd., 55 Victoria Street, London, S.W.1.

FOR SALE: DX-100U and SB-10, American model, nearest £70, buyer collects.—Andrew, 6 Milton Avenue, Weston-super-Mare, Somerset.

BERNARDS

RADIO

RECEIVERS

- Hallicrafters SX110.** 530 kc/s.—30 mc/s. "S" meter. Band-spread £60 0 0
- Eddystone 840C.** New. Unmarked £45 0 0
- Minimitter MC8 Converter** £12 0 0

TRANSMITTERS

- Tiger 300.** 150 watt. 80-10 £80 0 0
- Geloso TR212.** 60 watt. 80-10 £45 0 0
- Labgear Topbander** £20 0 0

- Valves** 1A7, 1H5, 1C5, 5Y3, 6AL5, 6A4, 6AT6, 6AU6, 6AQ5, 6BA6, 6BE6, 6B8G, 6F1, 6F15, 6J6, 6J7, 6K7, 6L6, 6L7, 6SA7, 6SH7, 6SK7, 6SQ7, 6S7N, 6U5, 6X4, 6X5, 7B7, 10C1, 12A6, 12A8, 12AT7, 12J5, 12SJ7, 12K8, 12SQ7, 12SK7, 12SA7, 35L6, CBL1, EA50, EBC33, EB41, ECC35, ECC40, EF40, EF42, EF50, EL42, EL3(N), EM1, EM4, EM34, EK32, EL37. 5/- each. Any 5 valves for £1.

COMPONENTS

All components listed in last month's issue available. Your enquiries invited for new receivers, transmitters, aerial equipment, etc.

HIRE PURCHASE ON ALL EQUIPMENT OVER £10
Payments over 12, 18, 24, 30 or 36 months.

620 HOLDERNESS ROAD, HULL
Telephone 71949

N. W. ELECTRICS

G3MAX

TRANSISTOR POWER SUPPLY

12 volts DC Input. 300 volts 100 mA. Output. Efficiency Switching for 220 volts 80 mA Output.

Ex stock £9.19.6 pp. 2/6

STAMPED ADDRESSED ENVELOPE FOR FURTHER DETAILS

- Geloso VFO Units. Less valves £5 17. 6
- Geloso Pi Tank Coils £1. 4. 4
- Eddystone Full Vision Drive with Special Geloso Dial £1 14. 4
- Aerialite Short Wave Dipole 37/6 post paid
- SG Brown High Impedance Phones 37/6 pp. 2/-
- TCS Noise Limiter Kit 5/6 post paid
- VT90 High Power Triode. 8.5 volt Heater 3/- post paid

EDDYSTONE STOCKISTS

- National HRO Power Supplies, AC Mains Input 45/- post free
- 6 volts DC Input 25/- post free
- RCÁ Phones. Low Impedance 10/6 post free
- Dummy Load Resistors, 50 ohm 40 watt 2/6 pp. 1/-
- Dummy Load Resistors, 2 x 35 ohm (80w. 70 ohm) 2/6 pp. 2/-
- Eagle Field Strength Meter. 1 - 250 Megacycles with 200 Micro Amp Meter. Telescopic Aerial. Personal Earpiece, 69/6 pp. 2/-

- HRO 4 Gang with Gearbox, 12-225pf. £1. 0.0 pp. 2/6
- AR77 3 Gang 2 Section 100+200pf. each 12/6 pp. 2/6
- 8 Element 2 Metre Yagi with Clamp £3.17.6 pp. 3/6
- 3BP1 Cathode Ray Tube, 3 in. 25/- pp. 2/6
- CRT Indicator, 3DPI Tube 3/6AG5, 1/2X2 £1. 5.0 pp. 3/6

We welcome all enquiries, however small.

52 GT. ANCOATS STREET
MANCHESTER 4.

CENtral 6276

Two more winners from the **JOYSTICK Stables**

An extremely robust and compact
H.F. BAND AERIAL MATCHING UNIT
for all Receivers and T.Tx.'s

Unbelievably peaks all amateur and H.F. band signals,
from 30 mc/s. to Radio Luxembourg on 203 meters
You will ask yourself why you have ever done without it!

Amazing value 39/6
plus 1/6 p. & p.

Similar to above but mainly intended for the
MEDIUM WAVE BROADCAST BAND

Weak distant stations peaked up to local station level
Covers all frequencies 30 mc/s. to 530 kc/s.
(H.F. bands and Medium Wave band)

Bring those weak signals **ROARING IN !!!**
45/-
plus 2/- p. & p.

**PARTRIDGE
ELECTRONICS LTD**
Telephone: THANET 62535

7 Sowell Street
BROADSTAIRS
Kent

SMALL ADVERTISEMENTS, READERS—*continued*

SALE: American valve tester, Hickock 560, manual, charts, step-down transformer for mains O/P, or swap 19 or 22 Set working order, or W.H.Y.?—Neal, Tarn Cottages, Bolton Le Sands, Carnforth, Lancs.

POWER SUPPLIES, ADMIRALTY, 750v. 250 mA, tapped 850v., bias 200v., 6.3v. 7A, 300v. 100 mA, 19-in. rack mounting; two FW4/500, one 5Z4, £5; less valves, £4 10s. Carriage extra, weight 60 lbs.—B. L. Cedar, 2a Convent Hill, Upper Norwood, London, S.E.19. (Liv. 8489 after 7.30 p.m.)

WANTED: 2-metre station in good cond. or kit for same, overseas amateur.—E. J. Brice, 5X5AU, 6 Watling Street, East Towcester, Northants.

XTALS, 8790 1/2-in. 10XJ and 2450 3/4-in. 10X, 2s. 6d. each. Mixed, new, transistors RF and AF, Brush, 10s. per doz. Bug Key Jap, new, cost £18, £8. Valves KT88 s, 35s. pair; 866A new, 8s. 6d. each. TF-144G signal generator, £15. TF-373 LCR Bridge, slight fault, £8. VHF signal generator 1/130A, 100-155 mc, xtal or MO; above three items, callers only.—G3MVU, 212 Hunters Hall Road, Dagenham, Essex.

MINIMITTER Mercury Transmitter. TT21's PA, 80-10 metres, 240 watts CW, 150 watts AM; just overhauled by manufacturers, £55.—G3AME, Grange House, Reigate Hill, Reigate, Surrey (Tel. Reigate 46007.)

WANTED: Cabinet for AR88LF, any reasonable condition, must be cheap.—GM3PSP, 20 Merchiston Park, Edinburgh, 10.

ADVERTISER IN EIRE wishes to sell or exchange W.R.L. "Globe Scout" Tx, 75w. CW, 50w AM and VF-1U, for 150w. Commercial Tx, LG.300, DX-100U, etc.—Box No. 2870, Short Wave Magazine, Ltd., 55 Victoria Street, London, S.W.1.

MUST SELL, any offer considered if buyer collects, Minimitter 150 watt Tx, 807 mod/807 PA model, in good condition, ex-G5RA. Also Minimitter Rx MR44/II, little used since maker's overhaul. Any offer, or exchanges; possibly mobile gear, 6 volts.—Ivin, Oakville, Longden Common, Longden, Shrewsbury.

WANTED: Manual for HRO Senior, also 14 mc BS coil, details of price and condition to—J. Ball, Moss Nook Farm, Rainford, St. Helens, Lancashire.

SALE: HRO "Sixty" in excellent condition, instruction book, crystal calibrator, set ten coils, nearest to £110 or would consider exchange with SX-100.—Beard, 170 Hagley Road, Hayley Green, Halesowen, Worcs.

FOR DISPOSAL: BC-348 modified 85 kc 2nd IF, requires external power supply, £10. Avo Model 7, £8. Magazines: 95 RSGB *Bulletins*, 80 *Short Wave Magazines*, 70 *QST's*, £3 the lot. Components, Rx and Tx coils, condensers, chokes, mod. trans., etc., over 300 valves, £10 the lot. Voigtlander VITOB Camera with accessories, cost over £60, will exchange for Mohican or W.H.Y.? Buyers collect, offers.—G3BHQ, 9 Victoria Street, Old Whittington, Chesterfield.

ERSIN MULTICORE SOLDERS

for a first class joint every time

Ersin Multicore contains 5 cores of extra-active, non-corrosive Ersin Flux. Prevents oxidation and cleans surface oxides.

SIZE 1 CARTON
5/-

**HANDYMAN'S
CARTON**

Suitable for 200 average joints. **6d.**



Wherever precision soldering is essential, manufacturers, engineers and handymen rely on MULTICORE. There's a MULTICORE SOLDER just made for the job you have in hand. Here are some of them.

SAVBIT TYPE 1 ALLOY

A specially formulated alloy to reduce the wear of soldering iron bits. Contains 5 cores of non-corrosive Ersin Flux and is ideal for all soldering purposes.

SIZE 1 CARTON 5/-
Available in three specifications



**HOME CONSTRUCTORS
2/6 PACK**



The Home Constructors Pack contains 32 ft. of 22 s.w.g. 60/40 alloys, which is especially suitable for printed circuit soldering.

**BIB WIRE STRIPPER
AND CUTTER**

Strips insulation without nicking wire, cuts wire cleanly, splits extruding flex. **5/6 each**



MULTICORE SOLDERS LTD.,

Multicore Works, Hemel Hempstead, Herts

Boxmoor3636
CMMS.11a.

SMALL ADVERTISEMENTS, READERS—*continued*

PANORAMIC ADAPTOR, v.g.c., offered in part exchange for KW-160 Tx, or what have you?—G3PPK, 2 Fairfield Road, Uxbridge, Middx. (Phone 36989.)

COMMUNICATOR MARK II 2-metre Tx/Rx, almost brand new, £50. WANTED: U.S. VHF Amplifier/Converter AM913/TRC 95-220 mc, up to £20 paid; also good HF Tx.—Box No. 2872, Short Wave Magazine, Ltd., 55 Victoria Street, London, S.W.1.

EDDYSTONE 358X, full coverage, plus band-spread 40 and 20 metres, PSU, speaker, mod. 6V6 output, good condition, £10. Deliver 50 miles.—Howden, 40 Stansfield Drive, Airedale, Castleford, Yorkshire.

£10 plus 6s. postage paid for 870A (not 870); selling Eddystone mounting blocks, 7s. 6d.—Box No. 2873, Short Wave Magazine, Ltd., 55 Victoria Street, London, S.W.1.

EDDYSTONE 680X, mint condition with manual, £65.—E. Liggins, Leith Hill, Hunsdon Road, Torquay. (Phone 7089.)

PANDA PR-120V, excellent appearance and working order, £35; no offers, or exchange factory-made SB-10U adaptor. WANTED: CDR Rotator and Indicator.—D. M. Heaps, Toll Gavel, Beverley, Yorkshire. (Beverley 81460.)

WANTED: DB20 or similar self-powered unit.—Rigden, 10 Church Square, Leighton Buzzard, Beds.

EXCHANGE: In excellent condition and perfect working order, Heathkit Oscilloscope OS-1, for R.107 Communications Rx or Canadian Marconi No. 52 Rx with mains power pack.—Frank C. Anyon, Kirton, Blackkeys Lane, Neston, Wirral, Cheshire.

AR88D, immaculate condition, completely overhauled and re-aligned, £38. Eddystone S.640, very good condition, £15.—R. J. Newey, 23 Lea-House Road, Causeway Green, Oldbury, Birmingham.

FOR SALE: Hallicrafters SX-24, £12. TCS Rx with Q-multiplier, PSU, £8. Xtal calibrator Mk. VII, requires 2v + 120v, £2.—Harwood, 14 Fairway Avenue, Tilehurst, Reading.

OSCILLOSCOPE wanted; OS1, O12U or similar commercial unit, also RSGB *Bulletins* May and September, 1959.—Mason, 52 Arncliffe Terrace, Bradford, 7.

SALE: Vols. I to VI *Radio and TV Servicing*; new 813; RCA potted 10v. 5A transformer. Offers to —G3RHJ, 12 Acton Lane, Sudbury, Suffolk.

FOR SALE: 20-metre only CW and SSB 60-watt Transceiver, with PSU, £30 o.n.o.?—Box No. 2874, Short Wave Magazine, Ltd., 55 Victoria Street, London, S.W.1.

STEEL CABINETS, length 18 in., height 8½ in., depth 7½ in., grey enamel finish and two handles, 25s. inc. carr.; aluminium front panel in 14 SWG. 6s. 6d. extra. Flexible couplers, 3d. 1¼-in. dia. fluted black knobs, 6d. Postage extra.—G3PSB, Endcliffe Way, Wheatley Hills, Doncaster, Yorkshire.

FOR SALE: AR88D, mint condition, completely overhauled and re-aligned. Complete with newly fitted dB tuning meter, trimming tools and manual, £47 10s. RF-26B Unit, 50-65 mc, brand new and boxed, 35s. Command receiver 6-9 mc, new and unmodified, £3 10s.; one with damaged outer case, £3; medium-wave model, £8. Dynamotor base plates with socket, 7s. 6d. each. Eddystone power unit S445B 11.5/12.5 volts DC input. 180 volts 60 mA output, £4. Airtec Signal Generator CT-212, 85 kc-32 mc, £25. Manuals for AR88D, CR91A, HRO, 25s. each; CR-88, SX-28A, 35s. each. Spares available for AR88D/LF. Send s.a.e. for list.—A. J. Reynolds, 139 Waller Road, New Cross, London, S.E.14. (Telephone New Cross 1443 after 7.30 p.m.)

V I C T O R Y

YOU CAN BE ON THE AIR BY OCTOBER

By using the RHYTHM METHOD of Morse tuition a student, starting from scratch, has passed his Morse Test in just **13 DAYS** by faithfully following the instructions given in this fantastic course. You could pass the test **NEXT MONTH**. Why not send now?

For explanatory booklet send 6d. in stamps to:—

G3HSC, 45 GREEN LANE, PURLEY, SURREY

TAPE TO DISC TRANSCRIPTION SERVICE ALSO AVAILABLE

V I A G 3 H S C

HOME RADIO OF MITCHAM

No Short Wave enthusiast can afford to be without the new

HOME RADIO CATALOGUE

200 pages, 5000 items, 800 illustrations

Complete the coupon below and send it with P.O. for 3/6 to

HOME RADIO LTD

187 LONDON ROAD, MITCHAM, SURREY

PLEASE WRITE IN BLOCK CAPITALS
Write CATALOGUE on top left of envelope

NAME

ADDRESS

..... SWM

PETER SEYMOUR

COMMUNICATION EQUIPMENT SPECIALISTS

	£	s.	d.
EDDYSTONE 888A. 160-10 Mtrs. amateur bands only (P/P £1)	75	0	0
EDDYSTONE 770U. 19-165 Mc/s. AM/FM/CW. 110-250 (P/P £1)	135	0	0
EDDYSTONE 770R. 150-500 Mc/s. AM/FM. 110-250 AC (P/P £1)	175	0	0
EDDYSTONE 840A. 480 Kc.-30 Mc/s. AC-DC BFO. Filter, etc., with silver hammer finish ... (P/P £1)	35	0	0
ZENITH ROYAL 1000D. The Rolls Royce of portables. As new ... (P/P £1)	75	0	0
NATIONAL H.R.O. 60T. with all coils including broadcast and special 21 Mc/s. bands spread. 100 and 1,000 Kc. calibrator ... (P/P £1)	120	0	0
R107T. 1.2-18.5 Mc/s. 100-240 AC input. Built in speaker. BFO, etc. ... (P/P £1)	12	10	0
BC221 in T.U. case with power unit less charts ...	5	0	0
PANDA CUB. 160-10 Mtrs. 10/25W A3 10/45W A1 (P/P £1)	30	0	0
AR88D. 540 Kc.-32 Mc/s. Brand new with tools and manual	75	0	0
BRT400. 150-385 Kc. and 510 Kc.-30 Mc/s. 500 Kc. cal. The receiver for the discerning short wave listener. Mains input ...	75	0	0
Central Electronics Sideband Slicer, with "Q" multiplier. Built in power unit. As new ...	15	0	0
HEATHKIT DX35 with VFIU. 80-10 Mtrs. ...	20	0	0
MARCONI CR300. 15 Kc.-25 Mc/s. Built in speaker, Xtal Cal. with original power unit. Fully reconditioned	25	0	0
GLOBE LINEAR 440W. Class B or C. Built in power unit. Size 14 x 8 x 9. Metered input and output ...	30	0	0
REDIFON R50M. 13.5 Kc.-30 Mc/s. With matching power unit for 110-240 AC, S meter, variable selectivity, etc. ...	90	0	0

	£	s.	d.
SELSYNS, suitable for beam indicators. 50 Volt. per pair (P/P 2/6)	15	0	0
PYE 70 Mc/s. base station and four 12 volt mobiles. to clear (P/P £2/10)	25	0	0
HAMMARLUND HQ170E. As new ...	100	0	0
COLLINS 51J3 MINT. 30 bands, 1 Mc. per band. 5-30.5 Mc/s. dial accuracy better than 200 C/s on any band. Built in 100 Kc. cal., variable selectivity, 110-240 AC input ...	235	0	0
COLLINS R390A. I.F. strip with 4 mechanical filters. 2/4/8/16 Kc. and Xtal filter. 1-1 Kc bandwidths. Noise limiter, BFO, 3 speed a.v.c. "S" meter and small power unit with audio amp and speaker ...	65	0	0
KW LOW PASS FILTER ... (P/P 2/6)	1	5	0
BM3 MIKE with stand ... (P/P 2/6)	1	5	0
JAPANESE COMMUNICATIONS RECEIVERS. Brand new, 540 Kc.-30 Mc/s. general coverage and calibrated amateur bands. 80-10 Mtrs. fitted with "S" meter, "Q" multiplier, built in power unit. 240 AC. P/P	60	0	0
COMPUTER PANELS, with 8 OC76 numerous diodes, capacitors, etc., fitted on 12" x 5" paxolin board ...	1	0	0
SSB ring modulator diodes in packs of matched fours per pack	5	0	0
HRO COILS. 200-480 Kc., .9-2.05, 2-4 3.5-7.3 and 7-14 Mc/s. ... each	1	5	0
POWER UNIT TYPE 234A. With output/input voltmeter ...	2	10	0
BC906 WAVEMETER ...	1	15	0
THE NEW "WELLER" 250 Watt SOLDER GUN. Twin spotlight ...	7	0	0

PART EXCHANGES. URGENTLY REQUIRED GOOD USED RECEIVERS, TRANSMITTERS (SSB) AND TEST EQUIPMENT.
EDDYSTONE 750, 640; COLLINS 511/388/390/390A, ETC.

HIRE PURCHASE TERMS TO SUIT YOU ON EQUIPMENT OVER £35. FULL EXPORT FACILITIES TO ANY PART OF THE WORLD.

410 BEVERLEY ROAD - HULL - YORKSHIRE

Tel.: HULL 41938 (41166 after 7 p.m.)

Short Wave Magazine

Advertising

gives

World-Wide Coverage

in the

Amateur Radio Field

For Space Rates apply:

ADVERTISEMENT MANAGER,
SHORT WAVE MAGAZINE, LTD.,
55 Victoria Street, London, S.W.1.
(Tel.: Abbey 5341)

BLANK CHASSIS

Precision made in our own works from commercial quality half-hard Aluminium. Two, three or four sided SAME DAY SERVICE of over 20 different forms made up to YOUR SIZE

Order EXACT size you require to nearest 1/16" (maximum length 35", depth 4")
Specials dealt with promptly. SEND FOR ILLUSTRATED LEAFLETS or order straight away, working out total area of material required and referring to table below, which is for four-sided chassis in 18 s.w.g. (for 16 s.w.g. add 1/6th)

48 sq. in. 4/-	176 sq. in. 8/-	304 sq. in. 12/-
80 sq. in. 5/-	208 sq. in. 9/-	336 sq. in. 13/-
112 sq. in. 6/-	240 sq. in. 10/-	368 sq. in. 14/-
144 sq. in. 7/-	272 sq. in. 11/-	and pro rata
P. & P. 2/6	P. & P. 2/9	P. & P. 3/-

FLANGES (6" or 8" or 9" 6d. per bend.
STRENGTHENED CORNERS 1/- each corner.
PANELS. The same material can be supplied for panels, screens, etc., at 4/6 sq. ft. (16 s.w.g. 5/3) plus postage and packing

H. L. SMITH & CO. LTD.

287-289 EDGWARE ROAD, LONDON, W.2. PAD 5891/7595

SUMMER BARGAINS

G2ACC offers 50% to 75% price reductions on brand new standard catalogue items (no ex-Govt. equipment) from his illustrated catalogue, No. 12. All bargains for a limited period and absolutely unrepeatable. Apply for details stating if you already have a copy of this catalogue.

Southern Radio & Electrical Supplies

SO-RAD WORKS . REDLYNCH . SALISBURY . WILTS
Telephone : Downton 207.

G3SJ QUARTZ CRYSTALS LTD.

SPECIAL OFFER OF EX-W.D. CRYSTALS TO CLEAR

1000 kc/s. octal based for BC.221 ...	35/- each	1000 kc/s. U.S.A. $\frac{3}{8}$ " pin spacing ...	30/- each
1000 kc/s. octal based, series resonant	30/- each	200 kc/s. FT 241; DT cuts; gold plated electrodes, U.S.A. ...	10/- each

80 METRE BAND. 3510; 3520; 3550; 3570; 3580 kc/s., type BC.610 U.S.A. $\frac{3}{8}$ " pin spacing, 18/- each.

SPECIAL OFFER of practically any frequency in the range 3600 to 3800 kc/s., post-war production, AT cuts, gold plated electrodes, hermetically sealed $\frac{3}{8}$ " metal holders, guaranteed better than .005% of marked frequency, 20/- each.

40 METRE BAND. Specification as above, 7070 to 7100 kc/s. inclusive at 20/- each.

CRYSTAL DIODES. U.S.A., 10/- per dozen.

NEON INDICATORS. CV.981, 1/- each. CV.264, 1/6 each.

VALVES

at 2/- each: 6AC7; 6L7; 6K7; 6SK7; 6AB7; 6G6; 6AG5; 6J6; 6F8; 5Z3; 2C34; CV188; (110 volt stab.) 12SC7; 12SJ7; 3B24; P41; KT33C; 6U5.

at 3/- each: 6K8; 6F6; 6SG7; VR105; 80; 2D21; 8013A; PX25; DW4/500.

at 5/- each: 808; 826; PZ175; 5T4; 3FP7 (CRT).

at 7/6 each: 1616; Klystron 726A.

at 20/- each: 3C22; 725A; 5CP1 (CRT); 446B.

Stonehouse Street - Plymouth - S. Devon - Tel. 61876

K. W. ELECTRONICS

APPOINTED SOLE U.K. DISTRIBUTORS
FOR HAMMARLUND

The HAMMARLUND HX-50 SSB transmitter — filter type — compact — 130 watts P.E.P. **£175** + Inland carriage (available from stock)

PACKAGE DEAL — HX-50 plus the latest model HQ170A Receiver **£299**

A terrific offer, saving ££££'s

Also the latest Receivers HQ100A, HQ110A, HQ145X and HQ180 available from stock and on easy terms if required

We shall be pleased to quote Commercial Concerns and Universities, etc., for the Hammarlund SP600 Professional Receiver

Details from

K. W. ELECTRONICS LTD.

Vanguard Works, 1 Heath St., Dartford, Kent
Telephone: Dartford 25574

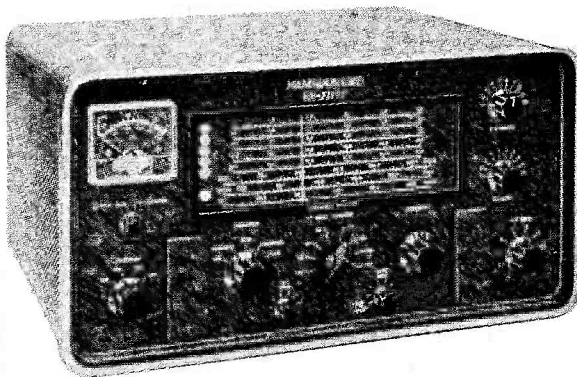

The **FABULOUS**

Hammarlund HX-50

For Highest Quality

Heathkit
DAYSTROM

at Lower Cost

Radio - Amateur Gear - Test Instruments - Educational - Hi-Fi Equipment

A wide range of over 50 different British models to choose from. Send for **FREE** Catalogue

All models are available either in kit form or assembled (kit prices are given here—**assembled prices on request**)



SB-10U

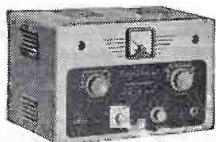

DX-40U



RA-1



DX-100U



OS-1

AMATEUR TRANSMITTER. Model DX-40U. Compact and self-contained. From 80-10 m. Power input 75 W. CW. 60 W. peak, C.C. phone. Output 40 W. to aerial. Provision for V.F.O. £33 19 0

SINGLE SIDEBAND ADAPTOR. Model SB-10U. May be used with most A.M. transmitters. Less than 3 W. R.F. input power required for 10 W. output. Operation on 80, 30, 20, 15 and 10 m. bands on U.S.B., L.B.S. or D.S.B. £39 5 0

THE "MOHICAN" GENERAL COVERAGE RECEIVER. Model GC-1U. In the forefront of design with 4 piezo-electric transmitters, 10 transistors, variable tuned B.F.O. and Zener diode stabiliser. An excellent fully transistorised receiver for both Amateurs and Short-wave listeners. See specification Sheet. £39 17 6 Suitable Battery Eliminator. Model UBE-F. £2 17 6

AMATEUR BANDS RECEIVER. Model RA-1. Covers all amateur bands 10-160 metres. Half-lattice crystal filter at 1.6 Mc/s. I.F. Provision for fixed, portable or mobile uses. Switched USB. and LSB for SSB. Send for full details. £39 6 6

OPTIONAL EXTRAS. Crystal Calibrator CL-1 £4 12 0. Matching Loudspeaker Cabinet SG-4 £1 9 6. Loudspeaker £1 4 5 incl. P.T.

AMATEUR TRANSMITTER. Model DX-100U. Covers all amateur bands from 160-10 metres, 150 watts D.C. Input. Self-contained incl. power supply, modulator and V.F.O. £74 19 0

2½in. PORTABLE SERVICE 'SCOPE OS-1. A compact, portable oscilloscope ideal for servicing and general laboratory work. Overall size 5" x 8" x 1¼" long, weight 10½ lb. £19 19 0



O-12U



V-7A



GD-1U



GC-1U



QPM-1



CM-1U



VF-1U

AVAILABLE SHORTLY! GENERAL COVERAGE COMMUNICATIONS RECEIVER. Model RG-1. A high performance, low cost receiver for the discriminating Short-wave listener. Frequency coverage from 600 Kc/s. to 1.5 Mc/s. and 1.7 Mc/s. to 31 Mc/s. Send for details. £39 16 0

GRID DIP METER. Model GD-1U. Continuous coverage 1.8 to 250 Mc/s. Self-contained. 5 plug-in coils supplied £10 19 6.

R.F. SIGNAL GENERATOR. Model RF-1U. Provides extended frequency coverage in 6 bands from 100 Kc/s. to 100 Mc/s. and up to 200 Mc/s. on calibrated harmonics. Up to 100 mv output on all bands. £12 15 6

RES. CAP. BRIDGE. Model C-3U. Measures capacity 10 pF to 1,000 µF., resistance 100 Ω to 5 M Ω and power factor. 5-450 V. test voltages. With safety switch. £9 5 0

VALVE VOLTMETER. Model V-7A. 7 D.C., A.C., r.m.s. and pk. to pk. Voltage ranges 0-1.5 to 1,500 v. £13 18 6

5in. OSCILLOSCOPE. Model O-12U. Has wide-band amplifiers, essential for TV servicing, F.M. alignment, etc. Vertical freq. response 3 c/s. to cover 5 Mc/s. without extra switching. 7/B covers 10 c/s to 500 Kc/s. in 5 ranges. £35 10 0

"OXFORD" TRANSISTOR PORTABLE. Model UXR-2. A luxury two waveband receiver, ideal for use in the home or out of doors. £14 18 0

SHORT WAVE TRANSISTOR PORTABLE. Model RSW-1. Four bands (2 short, Trawler and Medium). £19 17 6

AMERICAN HEATHKIT CATALOGUE available, with full details of Mail Order Scheme, for 1/- to cover postage, etc.

6-W STEREO AMPLIFIER. Model S-33. 0.3% distortion at 2.5 W/chnl. Inputs for Radio (or Tape) and Gram., Stereo or Monaural. £13 7 6

De-luxe version. Model S.33H. £15 17 6

VAR. FREQ. OSCILLATOR VF-1U. Calibrated 160-10m. Fund. outputs on 160 and 40 m. Ideal for our DX-40U and similar transmitters. £11 17 6

Q MULTIPLIER KIT. Model QPM-1. May be used with receivers having 450-470 kc/s. I.F. provides either additional selectivity or signal rejection. Self powered. £7 12 6

Model QPM-16 for 1.6 Mc/s. I.F. £7 12 6

HI-FI FM TUNER. 88-108 Mc/s. Tuning unit (L2 15 0 incl. P.T.) with 10.7 Mc/s. I.F. output and I.F. amplifier (L12 6 0) complete with cabinet and valves; self powered. Total £15 1 0

HI-FI AM/FM TUNER. FM: 88-108 Mc/s.; AM: 16-50, 200-550, 900-2000 m. Tuning heart (L4 13 6, incl. P.T.) and I.F. amplifier (L20 13) complete with cabinet and valves; self powered. Total £25 6 6

HI-FI SPEAKER SYSTEM. Model SSU-1. Ducted-port bass reflex cabinet "in the white." Two speakers. (With legs £11 12 0) £10 17 6

TAPE RECORDING/PLAYBACK AMPLIFIER. Thermometer type recording indicators, push-button speed compensation and input selection. Printed Circuit Board. Mono Model TA-1M £19 2 6

HI-FI EQUIPMENT CABINETS. Range now available to suit all needs. From £6 19 6 to £29 8 0

CAPACITANCE METER. CM-1U. Direct-reading 4½in. scale. Full-scale ranges 0-100 µF, 0-1,000 µF, 0-0.01 µF and 0-0.1 µF. £15 15 0

DUAL WAVE TRANSISTOR PORTABLE. Model UXR-1. Medium and long wavebands. Real hide case. £12 11 0

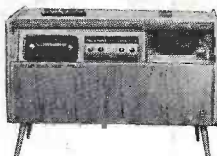

THE "GLOUCESTER" EQUIPMENT CABINET

All prices include free delivery U.K. Deferred terms on orders above £10

Please send me **FREE CATALOGUE** (Yes/No)
Full details of model(s).....

NAME.....
(BLOCK CAPITALS)
ADDRESS.....

SW9

DAYSTROM LTD

DEPT. SW9, GLOUCESTER, ENGLAND

A member of the Daystrom Group
manufacturers of the

WORLD'S LARGEST SELLING ELECTRONIC KITS