

2/6

The
SHORT WAVE
Magazine

VOL. X

NOVEMBER, 1952

NUMBER 9



WORLD WIDE COMMUNICATION

H. WHITAKER G3SJ

10 YORKSHIRE STREET, BURNLEY Phone 4924

BARGAIN PARCELS: We have a vast accumulation of component parts, held in too small a quantity to advertise, which we are once again making up into 20/- parcels. They are of primary interest to the transmitting ham, and those who have taken advantage of our previous offers, need no reminding of the outstanding value.

WODEN, POWER AMPLIFIERS. Standard 5ft. rack and panel, completely enclosed with hinged back. Two models, 30 watt and 60 watt of audio. Switched 3 band radio, mike, gram. 30 watt has monitor speaker. Recessed gram. desk, but less motor. Mike input for 15 ohm m/c mike. Ideal for music while you work, or large public address amplifiers for up to a dozen speakers. Brand new and unused, offered at a fraction of original cost, complete in every detail with all valves, 230 v. input, 60 watt, £75, 30 watt £60. Carr. forward or collect Burnley. 10in. speakers suitable for the above, 17/6. Plessey record changers, 3 speed dual switched stylus, mixed 10in. and 12in. at 78 revs., mixed ditto at 33½ revs. or 45 revs. List £23 13s., offered at 16/.

CONNOISSEUR LIGHT WEIGHT PICK-UP. Connoisseur standard light weight pick-up complete with input transformer, brand new and boxed. List price £4/10/5 inc. tax. To clear £1/6/10 each. Available in quantity for export.

TRANSFORMERS AND CHOKES. Immediate delivery from stock at Pre-increase prices of Woden; UMI 54/-, UM2 72/6, UM3 (sold out, new stock at 110/-), UM4 215/-, Mains DTM17 39/-, DTM12 48/6, RMS11 30/-, RMS12 40/-, DTM15 75/-, DTM17 109/6, Drivers DTI (sold out new stock at 40/-), DT2 39/6, DT3 34/-, Filament DTF12 2½v 10a. 38/6, DTF14 5v 4a. 31/6, DTF17 7½v 5a. 37/6, DTF18 5v 3a. 6.3v 4a. 38/6, DTF20 10v 10a. 59/6, Chokes; DCS14 12hy 350 mills 102/-, DCS20 20hy 350 mills 140/-, DCS17 20hy 60 mills 28/8, DCS18 20hy 150 mills 41/6, PCS13 5/25hy 350/50 mills 58/6. The following are by Parmeko or Gresham Transformer Co. All are post war production not Ex-Gov., they represent the highest standard of British production, and are brand new and unused, offered at a fraction of original cost. Primaries all 200/250v 50cy. Plate 2000/0/2000 at 200 mills 9½ x 9½ x 8 weight 70lb. at 75/-, 2000/0/2000 at 500 mills 13 x 10 x 7½ weight 100lb. at £6. 5800v at 800 mills tapped 2000/3000/3500/4000 16½ x 13 x 12 weight 180lb. at £6. L.T. Chokes for the above 10hy at 800 Mills 8½ x 6 x 7 weight 50lb. 70/-, 15hy at 400 mills DC res. 90 ohms 6 x 7 x 9 weight 40lb. 35/-, 3.5hy at 500 mills weight 45lb. 30/-, Swinging 13/23hy at 180/500 mills weight 45lb. at 40/-, Plate 19500/0/19500 at 6.1 KVa. Oil filled, built in rollers, 6in. stand offs, weight 6 cwt. For collection only £12. Plate 5850v at 445 mills 13 x 10½ x 7½ tapped 4450/3560/2660v. weight 85lb. at £5. Thermador 2000/0/2000 at 800 mills £7/10/-, Swing choke suitable for the above 23/10hy at 100/300 mills weight 50lb. at 70/-, Auto, 230/115v 350 watts 35/-, 500 watts 50/-, 5KVa £6. 6½KVa at £9. L.T. Filament and L.T. heavy duty. 2½v at 10 amp for 866s at 20/-, 10v c.t. at 10amp at 20/-, 22v c.t. at 30 amp 7 x 7 x 7 weight 35lb. at £2. 22v. c.t. at 15 amp 30/-, 21v at 17 amp 30/-, 11v 15 amp twice 30/-, 50v tapped at 5v at 36 amp size 10 x 10 x 10 weight 50lb. at £3. 4v at 14½ amp 4 times, 13 Kv test, 10½ x 11 x 8½ 70/-, 4v 4¼a. 4v 1¼a. 4v 2¼a. 11 x 11 x 8½ weight 35lb at £3. Most of the above heavy duty LT are also available in 360/440v primaries at similar prices, as also are the high voltage plate transformers. In addition we have large stocks of High voltage plate transformers 440v3 phase working. Parmeko driver transformers, single 6L6 to 805 grids split secondary, ditto PP 6V6s to split secondary 805 grids both 12/6 each, completely screened. Parmeko Modulation 450 watts, P.P. 805s to pair of 813s with additional winding for plate and/or screen modulation at 50/-, Woden driver P.P. 6L6s to 500 ohm line at 22/6. The following are Ex-Gov. mostly by Philips, all are 230v primaries with earthed screen 275/0/275 100 mills 4v 2¼a. 4v 5a 15/-, 265/0/265 120 mills 6.3v 7a. 4v 2¼a. 20/-, 445/0/445 at 200 mills 25/-, 265/0/265 at 30 mills, 3,300v at 50 mills, 4v 10a. 2½v 4a. 4v 1a. 10 x 10 x 10 in die cast aluminium cases at 35/-, 365/0/365 120mills, 4v 2¼a. 6.3v 42 a. 20/-, 1540v at 1.75 mills 4v 1a. 2.05v. 2a. 15/-, Fil. 4v 3¼a. 4v 7a. 14/-, Chokes. 10hy 200 mills in pot cased cast

3½ x 3½ x 4½ DC res. 150 ohms 12/6. Chokes Speaker field replacement, 15hy 150 mills, 1500, 1800, or 2000 ohm 12/6. G.E.C. Fil. 4v at 5a. 8/-, ditto 4v 5a. twice 12/6. Thermador Driver, 500 ohm line to P.P. 805 grids with split secondary 20/-, Thermador Microphone, High or Low impedance to 50,000 Secondary, for m/c or carbon mike 15/-, Both the above completely screened and potted. Miniature Screened and potted Mike transformer. Single or double button carbon mike, to single of P.P. grids 3/-, Output Potted 6SN7 anodes to 45 ohm or high impedance phones 3/-, Stancor miniature smoothing chokes 8hy 40 mills 3/-, U.S.A. Rola, potted 8hy 100 mills 7/6, Modulation, single 1625 to parallel 1625s potted, 456 modulator Command spares, 7/6.

CRYSTALS. 1,000 kc. Valpey, Bliley or Somerset, standard ½in. pin spacing, 20/-, R.C.A. 100kc sub-standards 20/-, Full range of Western I.F. freqs. 450, 465 kc, etc., 12/6 each. Amateur and Commercial bands. G3 SJ Xtals are precision lapped, and acid etched to final freq. Are available in either Ft 243 holders, ½in. British, ½in. U.S.A. or ½in. P.5 holders. Your own choice of frequency 2 Mc to 10 Mc inclusive. We will despatch to within 1 Kc of your chosen frequency at 15/- each, accurately calibrated with freq. clearly marked. Slight extra charges for decimal point freqs. We also undertake the calibration or re-grinding of your own crystals at extremely reasonable and nominal charges.

ZENITH: Variac transformer. Input 230v, for voltage stabilization 200/240v at 7½ amp., £3, carriage paid.

1155 RX. Brand new and unused in perfect condition, £12 10c.

POWER UNITS TYPE 45 and 46. The complete power supply for the I,154 Tx, £10 per pair. Carr. paid.

VALVE HOLDERS. Ceramic octal with flanges, 1/-, 10/- doz., ditto 807. 1/3, 12/- doz. British 5 and 7 pin ceramic, 4/- doz. to clear. Amphenol B7G, 7d., 6/- doz. Clix B7G complete with screen and valve retaining spring, 2/-, B8G amphenol, 6d.

STATION LOG BOOKS. A quality production. 300 pages cream laid paper, section sewn, opens completely flat like a ledger. Stout heavy cover. 18/- post free. Sample leaves on request.

RESISTORS. New and unused Erie and Dubilier, Sample 100 Assorted as follows, 20 ½-watt, 25 ½-watt, 20 1-watt insulated, 20 1-watt Standard, 10 2-watt, 5 5-watt, with a range of at least 30 standard values between 100 ohm and 6.8 Meg. 14/- post free.

SPEAKERS. Take advantage of our Tax free stocks whilst they last. P.M. Types, 6½in. 12/6, 8in. 15/-, 10in. 18/6.

FEEDERS. Henley 80 ohm twin line, 6d. per yard. 80 ohm ½in. co-ax. 1/2 yard. Telcon 300 ohm line 9d. per yard, RG52 1/- yard. Ex-Air Ministry 10in. insulators 6/- per doz. Johnson conical feed through insulators 4in. for windows, etc., 9d. each. Large U.S.A. egg type insulator for up to 8in. cable, 4/6 each. Telcon K35b circular 300 ohm at 1/6 per yard.

ANTENNA RELAYS. Price Bros., Maryland. Double double throw, suitable for 600 ohm line. 28v. DC. Piston cylinder action, with self-centring contacts. On heavy ceramic stand-offs. Will handle up to 1 Kw. of R.F., 25/- each.

BLEEDERS. 1K to 75K, 85/120 Watts, most values available at 2/- each. All the above are standard vitreous 8 to 12in.

SILVER MICA AND MICA CONDENSERS. Another outstanding offer of brand new condensers 350/1000v. wkc, consisting of 100 assorted 88 silver mica and 12 mica, 4 each at 25 different values 9pf to 6000pf. Or alternatively your own choice from the following: Silver mica 9, 10, 15, 20, 27, 40, 45, 50, 65, 82, 150, 160, 177, 206, 230, 280, 300, 310, 330, 600, 1500, 6000pf. Mica .0005, .002, .005, at 16/-, post free.



from aircraft to aircraft

Efficient contact between high-speed aircraft depends on instantaneous radio communication. Aircraft radio equipment is used under arduous conditions both in peace and war and must be available instantly throughout the 24 hours of a day.

It is not surprising, therefore, that more and more G.E.C. Quartz Crystal Units are being used, for this is the most critical component and only the best is safe and good enough.

Write for list QC 5012 (R)

SALFORD ELECTRICAL INSTRUMENTS LTD · SALFORD 3 · LANC'S

A SUBSIDIARY OF THE GENERAL ELECTRIC CO LTD. OF ENGLAND

FOR HIGH FIDELITY RECORDINGS



Careful design and rigid control in manufacture, provide the critical listener with a reliable hard-wearing tape that will help to get the very best results from any tape recorder.

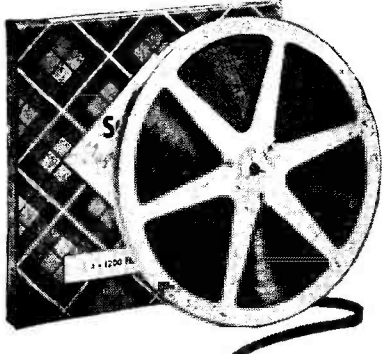

MAGNETIC DATA

Coercivity 240-260 Oersteds
 Total Remanent Flux . . . 0.4/0.5 lines $\frac{1}{2}$ in. width
 Uniformity throughout a reel ± 0.5 d.b.

FREQUENCY RANGE

50 c/s to 10 Kc/s at a playing speed of $7\frac{1}{2}$ in./sec.

Medium coercivity gives a high signal output with an extended high-frequency response, whilst still retaining an easy erasure. Signal/noise ratio is high; transfer and distortion are negligible.

PLAYING TIMES (per track)

REELS	1 $\frac{1}{2}$ " / SEC	3 $\frac{3}{4}$ " / SEC	7 $\frac{1}{2}$ " / SEC	15" / SEC
1200 Ft.	120 Min.	60 Min.	30 Min.	15 Min.
600 Ft.	60 Min.	30 Min.	15 Min.	7 $\frac{1}{2}$ Min.
300 Ft.	30 Min.	15 Min.	7 $\frac{1}{2}$ Min.	3 $\frac{1}{2}$ Min.

If you want advice on tape-recording problems, our entire technical knowledge is at your disposal.

Write to:— MINNESOTA MINING & MANUFACTURING CO., LTD., 187, Strand, London, W.C.2. Telephone: TEMple Bar 8363

2,400 ft. Professional Reels (10 $\frac{1}{2}$ ins. diameter, double sided spools) now available.



R.C.A. TRANSMITTER ET4336.

UNUSED AND RECONDITIONED

THIS MAGNIFICENT TRANSMITTER IS COMPLETE IN ONE TOTALLY ENCLOSED RACK AND INCLUDES AERIAL TUNING PANEL.

TUBE LINE UP : 807 C.O./Buffer. Two 813 P.A. Two 805 P.P. Class B Modulator. Four 866A Rectifiers. **CONTROLS :** Manual or Remote. **POWER OUTPUT :** Normal 350 watts. **FREQUENCY COVERAGE :** Normal 2 to 20 mcs continuous. **FREQUENCY CONTROL** THE TRANSMITTER HAS A DETACHABLE FRONT PANEL FOR INSERTION OF WILCOX GAY V.F.O. OR CRYSTAL MULTIPLIER.

20 page manual and circuit diagram with each equipment. **Every Instrument is Air Tested and Guaranteed perfect.**

WILCOX GAY Crystal Multiplier for use with above transmitter.
WILCOX GAY VFO for use with above transmitter. **SPEECH AMPLIFIER** British made with 500 ohm output, suitable for use with EF4336B.

R.C.A. ET4336 SPARES. Very large stocks of essential maintenance spares available.

ET4336.K. Brand New in original packing cases and in absolute mint and Factory condition. Limited quantity only. The above transmitters are available for Export only.

McELROY - ADAMS Manufacturing Group Ltd.

(Sole concessionaries U.K. for Hallicrafter Communication Equipment)

Phone Fulham 1138/9. 46 GREYHOUND ROAD, LONDON, W.6. Cables Hallicraft London.

G2AK**This Month's Bargains****G2AK****THIS MONTH'S SPECIALS:—**

GENUINE R.C.A. AR88 MATCHING SPEAKERS, fitted with louvered back, rubber feet and lead. Worth £5. Our price 65/-.

BUG KEYS. Brand new boxed by famous manufacturer, streamlined and unrepeatable, list over £4. Our price 45/-. Limited quantity only.

KNOB AND DIAL with engraved scale, 2in. dia. New and boxed, black finished, 1/9 ea.; complete with index.

SHORT WAVE PLUG-IN COILS. 6 pin standard. 2 ranges only. 3.9/1.8 Mc/s., 21.4/33.3 Mc/s. 2 for 6/-. Formers alone are listed at 6/-.

PLUG-IN VHF COILS, silver-plated wire on Ceramic base. 3 turn and 4 turn set of 3 (2-3 turn and 1-4 turn), 2/-.

AERIAL PULLEYS. Heavy galv., 6d. ea. or 5/- per doz.

COMPLETE NOISE LIMITERS. Wired on a small sub-chassis with 6H6 type valve, boxed, with circuit and instructions. Only 5/-. post free.

SPECIAL VALVE OFFER. To transmitting hams only. Not more than 2 of any type to any one person. 813 70/-. 829 80/-. 832 30/-. 866a 17/6, 807 15/- ea. or 4 for 50/-.

COMPLETE SET (14) TUBES, for AR88 Receivers, £5 10s.

TAPE RECORDING EQUIPMENT. Decks by Bradmatic, Tamsa, Lane and Qualtape. Ex. stock. Heads, Oscillator Coils, Tape and Reels always available.

Carriage paid on all orders over £1 except where stated. Please include small amount for orders under £1. Please Print Your Name & Address

CHAS. H. YOUNG, G2AK

MORSE PRACTICE SETS, with double-action buzzer, output for phones, excellent key, requires only 4½ v. battery. As new, 7/6, postage and packing 1/-.

TWIN FEEDER. 300 ohm Heavy Twin Ribbon Feeder, 5d. per yard. K24, 150 ohm, 9d. per yard. Co-ax. Cable. ¼in. dia., 50 ohm, 8d. per yard; ½in. dia., 1/3 per yard. Post on above feeder and cable 1/6, any length. K35B (Round), 1/6 yd.

POTENTIOMETERS, Carbon, 50 k., 25 k., and 2 meg., 1/6 each. 500 ohm H.D. toroidal, 3/6 each. 50 K.W.W. Pre-Set Type, 2/- each. 20 K. W.W. Pre-Set, 1/- each.

R.F. CHOKES. Pie wound, 2.5 mH., 100 mA., receiver type, 9d. each, or 7/6 per doz.; 250 mA., transmitter type, 1/- each, 10/- per doz.

PARMEKO H.D. SHROUDED CHOKES. 8H at 250 mA., weight 11lb. Beautiful job. Only 16/6 each, postage and packing 1/6.

METERS. 2½in. Flush Mounting M.C. 100 mA. 12/6 each. 0-15v., 2½in. flush, 12/6; 0.5 A. Thermo, 5/-; 4.A. Thermo, 5/-.

JUST IN! LOG BOOKS, 100 pages with heavy bound cover, 10/6 ea. Postage and packing 1/- ea.

EDDYSTONE 740 & 750 Receivers and components from stock.

SPECIAL VALVE OFFER. Kit of 4 midget 1.4 v. valves, 1 each IS5, IR5, IT4 and IS4, 35/- or 9/6 each, separately.

ALL CALLERS TO

110 Dale End, Birmingham • Central 1635

MAIL ORDERS TO 102 Holloway Head, Birmingham Midland 3254

ABOVE ALL OTHERS

WODEN
TRANSFORMER CO. LTD

**POTTED COMPOUND FILLED
TRANSFORMERS AND CHOKES**

have been designed to fulfil such a purpose, and for this reason they have been standardized by many leading Radio, Television and Electronic manufacturers and also Government Research Departments. Their choice is only made after exhaustive tests for accuracy and reliability. To merit this confidence, there is a constant need to provide components of the highest quality and our ample research and testing facilities ensure continued progress in this direction.

Send for our fully
Illustrated
Catalogue.

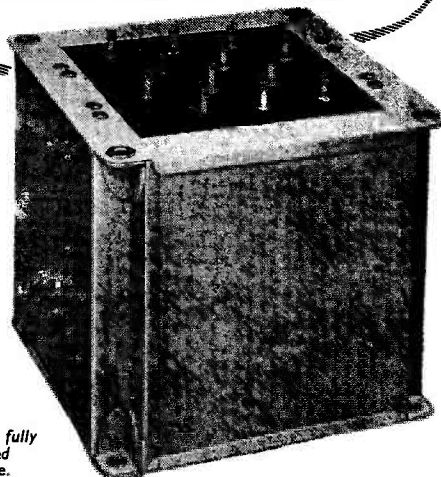

WODEN TRANSFORMER CO. LTD.

MOXLEY ROAD • BILSTON • STAFFS.
TELEPHONE • • • • BILSTON • • • • 41959

CLYDESDALE

Bargains in Ex-Services Radio and Electronic Equipment

METAL (MINE) DETECTOR NO. 3

In Original Transit Case Ref. : ZA.22755/1. Of British design and construction. Comprises : A 3-valve AF Amplifier (ARP.12's—VP.23 Mazda), with space for dry batteries (not supplied) in metal box, dim. : 10½ x 10½ x 3½in. with leads terminating in 7-way cable socket, contained in a carrying satchel, with high resistance headphones. Search Coil, ZA.22175 or Equivalent, surface area 134 sq. ins. Dim. 14½ x 10ins. Search Coil Pole, comprising : Control Box Pole and pivot-eye assembly. Pole (rear section) and Counter-weight assembly. Small Probe, Surface area 35 sq. ins. Dim. 9 x 5½ins. The whole contained in original fitted transit case, dim. : 52½ x 14 x 10½ins. Gross Wgt. 72lb. approx.

ASK FOR **£8.19.6** CARRIAGE PAID
No. SM/H856 Each

Power Requirements. Dry batteries. L.T. 6 Type "S" 1½ volt cells. H.T. 60-90 volts.

METAL (MINE) DETECTOR NO. 4

Of Cdn. design and construction, using I74 pentodes. Comprising TC. Amplifier, Search Coil, Sweep pole, Control Box, Headphones, Test Unit and Rucksack. Complete less batteries in fitted transit case.

ASK FOR **£6.19.6** CARRIAGE PAID
No. SM/H179 Each

SMALL L.F. CHOKE

30H 50mA 400 ohms. Size 2½in. x 2in.
ASK FOR **4/-** POST 9d.
No. SM/H806 Each

CARBON POWER MICROPHONE

In original carton with transformer and leads (made by Tannoy). Requires only a loudspeaker and 12-volt acc. to make a portable P.A. equipment. Power consumption approx. 2 amps., output 4-5 watts. ASK FOR No. SM/E894



45/- POST PAID

192 PAGE CATALOGUE, NEW LIST NO. 8D

Giving details and illustrations of ex-services items. Now in the press : available when ready. Price 1/6
Price credited on first purchase of 10/- or over

DUMMY AERIAL ZA10728/1

For Wireless Senders S.3.3
Comprises : 2 Morganite type 7101 Carbon Resistors, 800 ohms, 6 volts. 10in. long by 1in. dia., connected in parallel by heavy brass clamps with connecting Lugs. Overall dimension 10½ x 3in.

ASK FOR **5/-** POST 1/-
No. SM/H871 Each

FOR INEXPENSIVE TELEVISION

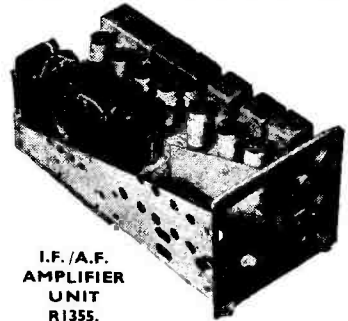

I.F./A.F. AMPLIFIER UNIT R1355.

The popular T.V. Sound and/or Vision Unit. 5 i.f. stages, 10 valves 8/VR65 (5P61), 5U4G, VU120A, etc., etc. In metal case 18in. x 8½in. x 7½in. Used, good condition.
IN ORIGINAL CASE **67/6** CARRIAGE PAID
ASK FOR No. SM/E770
2nd Grade in Transit Case, **59/6**, Carr. Paid.
3rd Grade, loose stored, **42/6**, Carr. Paid.
Circuit available at 1/3.

R3601 Receiver Unit. **£4.12.6** CARRIAGE PAID
ASK FOR No. SM/H493

R3170A Receiver Unit. **£4.12.6** CARRIAGE PAID
ASK FOR No. SM/H492

Order Direct from :—

Phone : SOUTH 2706/9.

CLYDESDALE SUPPLY 2 BRIDGE ST. Co. Ltd. GLASGOW C.5

BRANCHES IN SCOTLAND, ENGLAND AND NORTHERN IRELAND

CRYSTALS

By BROOKES

The Crystal Specialists

Type "M"

Frequency range 8 to 17 mc/s.

Hermetically sealed metal can 0.75in. high under pins, 0.75in. wide, 0.375 in. thick, with 3/32in. diameter pins at 0.490in. centres.



BROOKES CRYSTALS LIMITED

10 Stockwell St., Greenwich, London, S.E.10

Phone : Greenwich 1828.

Grams : Xtals Green, London Cables : Xtals. London

PULLIN SERIES 100 MULTI-RANGE TEST SET

The universal testing set for Service Engineers. Sensitivity-10,000 ohms per volt. Strong metal case with carrying handle, complete with leads having detachable bulldog clips and test prods. Size 9 x 5½ x 4ins.

RANGES

AC/DC Volts : 10, 25, 100, 250, 500, 1,000.
D.C. Millamps : 2.5, 10, 25, 100, 500.
AC/DC Microamps : 100 Microamps 10v. range.
Resistance ranges : 0/1 Meg (13,500 ohms mid-scale). 0/10,000 ohms (135 ohms mid-scale).

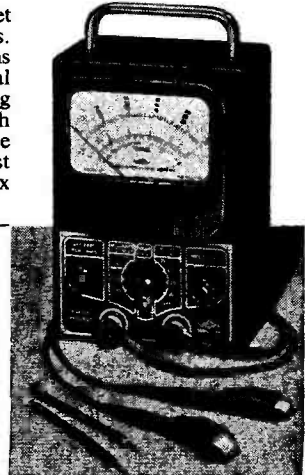

MEASURING INSTRUMENTS (PULLIN) LTD
Electrin Works, Winchester Street, London, W.3

Tel. : ACOrrn 4651/3 & 4995.

The efficiency of your
equipment depends on
the solder that you use

Just a single faulty connection may interfere seriously with reception or transmission. Make sure that every joint is sound by using Ersin Multicore—the 3-core solder that ensures complete freedom from “dry” or H.R. joints.



This is the Handyman (Size 2) Carton, specially made for use in the home. Contains enough solder for 200 average joints. Price 6d.

Illustrated above is the Size 1 carton for Service Engineers and maintenance use. Price 5/-. Both sizes are obtainable at most radio and electrical shops.

MULTICORE SOLDERS LTD., MULTICORE WORKS, MAYLANDS AVENUE,
HEMEL HEMPSTEAD, HERTS. Telephone: BOXMOOR 3636 (3 lines)

Benson's Better Bargains

VALVES: EA50, 7193, 12H6, EB34, at 2/6; VR65, VR66, 7V7, 9004, 9006, VR21, CV6, VU120, CV54, 6H6, at 3/6; 12SK7, 954, 955, 956B, 9D2, EF39, EF50, ARP12, 6SH7, 9001, ML6, 77, 78, RK34, NT37, VS70, 6C4, 12SH7, 717A, VR116 at 5/6; 6AG5, 6B8M, 6J7M, 6J5M, (GT), 6N7M, 12S7J, 12SR7, 12A6, EF54, EC52, CV66, AC5/Pen, SG215, Pen 46, 1625, ATP4, 9002, 6K7, SP4, KT2, 3Q5, 6L7M, 12SC7, EK32, PM256, 721A, VS110A, NGT1, 6AC7 at 7/6; SZ4M, 210VPT, IC5, VR150/30 at 8/6; 6V6GT, UF41, UCH42, UY41, ECL80, EZ40, EF41, PM240, 6SN7, 6A6G, EBC41, UAF42, UBC41, 35LGT, EBC33, MU12/14, 6Q7G, 6F6G, 354, 6L6G, ECC32 at 10/-; 12A7, 6AKS, PT15, at 12/6. **SPECIAL** Valve offer: at 5/6 4IMP, 42SPT, 41MPT, MS/Pen/T, 41MHL, 41MTL, 45HA, 4TSP, 4TPB, DDL4, MSPen. **METERS:** IFTS, canned, new 10/13 mcs, 2/-, 10mcs for G2IG WB Couplers, 2/9. Coilformers 2in. x 3/4in. 4 for 1/-. **R1355.** New 45/-. Good, used 35/- (carr. 6/-). Chassis only, 15/-. plus carr. **RF UNITS,** type 24, 22/6. **R3132** Store soiled, with 7/VR91, EA50, 2/VR136, VU39, VU134, VR137, 65/- (carr. 7/6). Chassis only, 15/-. plus carr. **VHF Rx, Ex-Police.** 10 x 8 x 7ins. Grey enamel case, with 10 valves, 40/- (carr. 5/-). Chassis only, 10/-, plus carr. (less xtal and power supplies). **IF AMP. No. 178.** "Rebecca," with 5/IFTs, 7/VR65, EA50, 32/6. **TX/RX No. 38, Mk. 2,** with 4/ARP12, ATP4, complete, less outside spares, 32/6. **R-3/ARR-2X, 234/258** mcs. Valves: 3/6AK5, 7/9001, 12A6, new condition, £4, less valves, 21/6. **R161A.** VHF converter, with 2/VR136, CV66, VR137, 22/-. **R159 ETC.** VHF converter, with VR91, VR92, CV66, VR65, 24v. selector, 16/6. **CAY, 47151A,** 8/1.5mcs. **TX tuning units,** 12/6 (carr. 2/-), less case. **CRT's** 3BPL, 25/-, **NEW TRANSFORMERS:** 250-0-250v. 60ma. 6v. and 5v., 11/6; at 80ma., 18/6; 350v. similar, 19/-; fully shrouded (Woden, Varley) 350v. 21/-, Combined choke, 80ma and o.p. trans. 60-1, 5/6. **VITREOUS Resistors:** 21k 15w, 3k 30w, 30k 25w, 400u 25w, 500u 5w, tapped, 2.7k., 10w, 7k tap 2k 25w, 15k 25w, 2.7k 10w, 30u, 30u 30w, 50u 20w, 2.5k 25w, 20k 50w, 350u 60w, 16+22-μ 100w. at 1/-, 1k, 100w, 20k, 120w at 2/-, Precision 1/6

1 meg. 1/6. Var. wirewound 8u 50w, 500u 15w, 100r 25w, 350r 25w, 100u 5w, 1.850u 10w, 20k 6w at 3/6, 1k 30w, 6/6. **METAL RECTIFIERS:** HW 270v 80ma, 6/-, 560v. 100ma 7/6; 600v. 30ma, 5/-; meter type bridge, 5/6. **FW.** 120v. 80ma., 5/-, 30v 60ma, 3/-, 30vAC to 15v5A, 17/6. **GENERATORS,** hand-driven, geared, 300v. and 28v. outputs, 9/-. **DYNAMOTORS:** 9v. DC to 450v. 8/6, 28v DC to 285v. small 8/6, TR1196 Rx-type 24v. 7/6, 6v. DC to 200v., 10/-. **Vibrapacks:** 12v DC to 150v 30ma, 12/6, 12 or 24v. DC to 110v 60ma DC smoothed, stabilised, 15/-. **CERAMICONS** at 5/- doz., 2, 2, 3, 5, 6, 6, 8, 10, 12, 22, 27, 33, 39, 40, 47 and 100pfs. Ceramic trimmers and padders, 9d. each. **YAXLEYS:** 3P3W2B, 2P4W4B, IP6W2B, at 2/9; 3P4V ceramic, 3/6; 2P2W, 4P2W, at 1/3. **ACCUMULATORS,** Midget, celluloid, 4 A.H., 6/-; 7 A.H., 7/6. **CHOKES,** RF 4 pie. Bulgin 9d.; RF 1.5mH 250ma (Eddystone type), 1/3. **CONDENSERS (Variable),** 75pf. Twin Ceramic (as RF26), 4/-; 75pf. Double spindle (as RF26), 2/-; or long spindle, 1/6; 500pf. 4 gang, 8/6; 25pf 3-gang Ceramic 3/6; 500pf. twin, 5/6. Panel Lampholders, ruby metal (Bulgin) for MES, 1/6, ruby moulded 1/-; **W.F. GEN.,** Case 8 x 6 x 4ins. containing 2/CV181 (6SN7 types), 1/VR91, 1/VR92, components, 25/-. **POWER PACK.** Hi-ci Case 18 x 8 x 8ins., containing 1/6V6G, 1/5U4G, 1/VR120, 2/02 8kV. conds., etc., 25/- (carr. 5/-). **R1124,** with 6 13v. valves, 25/-; **R1125,** with 2/8D2, 10/-; **AUTO-TRANS.,** Admity, 0-104-230v., 3A., 20/-; **STROBE UNITS,** with 9/VR91, 1/5Z4G: 600v met. rec., 200ma choke, and a wealth of components, 60/- (carr. 7/6). **W.F. GENs.** with 7/VR65, 3/VR56, 2/VR54, 1/VR55, many resistors; condensers, etc. 35/- (Carr. 5/-). **RELAYS G.P.O.** types. Multi-contract, 120, 765, 1k ohms, each 3/6. **POTENTIOMETERS.** Carbon, less switch, 1/9, w/w 2w, 2/6, most values. Ganged, 500k twice, 3/6. **VALVE HOLDERS:** ceramic (RK34), 1/3; BTG with car., 1/9. **METERS:** fine new collection, boxed. Type and prices on application S.A.E. **R1155's,** used, good condition, tested, £7 10s., carriage 15/-.

LISTS AVAILABLE 1½d. S.A.E.

Terms: C.W.O. CARR. PAID OVER 15/6. S.A.E. enquiries please

W. A. BENSON, 308 Rathbone Rd., Liverpool, 13 STONECROFT 1604

This is Britain's famous power amplifying tube...for laboratories; acknowledged in every country of the world to be the finest tetrode ever made. It is currently used in the Leak, Williamson, Radio Craftsmen and other fine amplifiers.

The KT66 is a versatile power tetrode with a number of useful applications. It may be used in the output stage of an audio-frequency power amplifier, either tetrode-connected for maximum sensitivity and power output or triode-connected for high quality working. In transmitting circuits using frequencies up to 30 Mc/s it may also be used as an oscillator or as a radio frequency amplifier.

A high slope, indirectly heated beam tetrode, the KT66 is suitable for either single or push-pull audio operation and may be employed as a beam tetrode with aligned grids. This alignment of the grids reduces losses in the screen and makes for the highest possible power conversion efficiency. With this system of construction high orders of power output may be obtained with a low screen dissipation, and the anode is designed to dissipate 25 watts continuously with a reliable life performance.

THE FINEST AUDIO TUBE EVER MADE!

KT66

OPERATING CONDITIONS

Single Valve A.F. Amplifier	Tetrode connected		Triode connected	
	250	400	250	
Anode and Screen Voltage	250	400	250	volts
Bias Voltage	...	-15	-19	volts
Anode Current	...	85	63	mA
Screen Current	...	6.3	...	mA
Input Voltage	...	15	38	volts peak
Bias Resistance	...	160	600	ohms
Anode Load Resistance	...	2200	4500	ohms
Distortion	...	9	7	%
Power Output	...	7.25	5.8	watts

Two Valves Push-Pull, A.F. Amplifier.
(Data per pair of valves unless otherwise stated.)

	Full load	450v. supply	250v. supply
Anode Voltage
Screen Voltage

DIMENSIONS

7-PIN "OCTAL"
 Pin 1: Not connected
 2: Heater
 3: Anode
 4: Screen Grid, g2
 5: Control Grid, g1
 6: Omitted
 7: Heater
 8: Cathode

View looking on underside of base.

All dimensions are in mm. and are the maximum except where otherwise stated.

RATINGS

	Tetrode connected	Triode connected	
Heater Voltage	
Heater Current	...	6.3	6.3
Anode Voltage	...	1.27	1.27
Screen Voltage	500

THE FAMOUS **KT66** . . . IN USE ALL OVER
 AMERICA AND ACKNOWLEDGED TO BE THE
 FINEST BEAM TETRODE EVER MADE
 IS AN **Osram** VALVE MADE IN ENGLAND

The photographic reproduction is taken from literature published in America by the British Industries Corporation and gives an entirely unsolicited tribute to this fine valve.

Distortion	about to anode	5000	80	watts
Power Output			5000	volts
			5	ohms
	† Stabilised screen supply voltage		50	%
				watts.

BRITISH INDUSTRIES CORPORATION

**INDEX TO
ADVERTISERS**

	PAGE
Adcola	576
Alpha Radio Service	572
Altham Radio... ..	569
Anglin, J. T.	572
Ashworth, H.	568
Bensons	517
Brookes Crystals, Ltd.	516
Brown, S. G.	569
Bull, J.	576
Candler System	571
Clydesdale Supply Co., Ltd.	516
Easibind	575
Electrad Radio	575
Electradix Radios	570
Elm Electric	568
E.M.I.	573
Foyle	574
G.E.C.	518
Henry's	cover iv
Hoile	574
H.P. Radio Services, Ltd.	570
Johnson's	576
Lyons, Claude	569
Lyons Radio	571
McElroy Adams	514
Miller's Radio	575
Minnesota	514
Multicore	517
Pullin (M.I.)	516
Radio Servicing Co... ..	570
Reed & Ford	574
Rollett, H.	575
Salford	513
Samsons Surplus Stores	568
S.W.M. Publications Dept. cover iii	
Small Advertisements 571 - 576	
Smith, H. L.	569
Southern Radio	570
Southern Radio & Elec.	574
Universal Elec.	568
Venner's	520
Walton's Wireless Stores	573
Webb's Radio	520
Whitaker	cover ii
Woden	515
Young	515

SHORT WAVE MAGAZINE

VOL. X

NOVEMBER 1952

No. 111

CONTENTS

	Page
Editorial	521
An Amateur Oscilloscope and Its Application. Part I, <i>by F. T. Wilson (G2XX)</i>	522
The Cure for TVI, Part II, <i>by R. L. Glaisher (G6LX)</i>	529
Parasitically Excited Vertical, <i>by S. H. Avery (G4PR)</i>	537
DX Commentary, <i>by L. H. Thomas, M.B.E. (G6QB)</i>	538
American Visit, <i>by C. R. Plant (G5CP)</i>	544
12-Element Stack for Two Metres, <i>by A. G. Wood (G5RZ)</i>	546
Beware of the 6J6, <i>by K. W. Cranfield</i>	552
VHF Bands, <i>by A. J. Devon</i>	554
Marathon VHF Contest Results	555
The Other Man's Station — G3BRV	562
The Month with the Clubs — From Reports	563

Managing Editor : AUSTIN FORSYTH, O.B.E. (G6FO)

Advertisement Manager : P. H. FALKNER

Assistant Editor : L. H. THOMAS, M.B.E. (G6QB)

Published the Friday following the first Wednesday each month at 55 Victoria Street, London, S.W.1.
Telephone : Abbey 5341/2

Annual Subscription : Inland 30s. Abroad 30s. post paid.

Copyright Reserved throughout the World.

AUTHORS' MSS

Articles submitted for Editorial consideration must be typed double-spaced with wide margins on one side only of quarto or foolscap sheets, with diagrams shown separately. Photographs should be clearly identified on the back. Payment is made for all material used, and it is a condition of acceptance that full copyright passes to the Short Wave Magazine Ltd. on publication.

THE *SHORT WAVE LISTENER* ASSOCIATED WITH THIS
MAGAZINE IS SPECIALLY FOR THE RECEIVING ENTHUSIAST

Watt/hour efficiency

- UP TO 90%

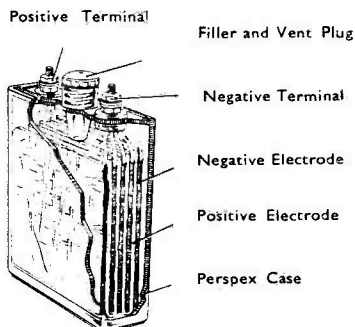

This MUST mean something to you

Savings of up to 4/5ths of the size and 5/6ths of the weight can be achieved in comparison to other storage batteries of similar capacities. Owing to their unique characteristics there are many occasions when a smaller capacity Venner cell can satisfactorily replace higher capacity lead-acid or nickel-iron types.

Write for brochure giving full details on the Venner silver zinc accumulator.

VENNER

LIGHTWEIGHT ACCUMULATORS

VENNER ACCUMULATORS LTD.

Kingston By-pass, New Malden, Surrey.

Telephone : MALDEN 2442

Weight and space saving by Venner Accumulators is *VITAL* in many projects to-day.

Webb's Radio

EDDYSTONE "740"

Communications Receiver

Recently in short supply due to large demands but the position is now easier and Webb's can usually offer ex stock.

A.C. operation 110 & 220/250 volts (also 6 volts operation from external vibrator unit 687/1, price £8 10s. 6d.).
Eight modern valves, all B8A bases.

Four bands cover 30.6 mc/s to 1.4 mc/sc continuous (9.8 to 214.3 metres) and 205 to 620 metres.

Beat Frequency Oscillator, Noise limiter, R.F. stages.

Precision tuning I40/1 with auxiliary scale giving equivalent tuning length of 60ins. for each band.

Provision for plugging in external "S" meter.

EDDYSTONE "740" COMMUNICATIONS RECEIVER : £38 15s. 0d.

Maker's details of this GUARANTEED receiver available on request. Can also be supplied under Webb's Extended Payment Scheme if desired.

WEBB'S SERVICE DEPARTMENT specialize in the renovation of complex Communications Receivers. We will undertake to bring your receiver back to a performance equalling maker's original specification figures, and we issue a test report giving sensitivity, selectivity, etc., measurements on all our jobs. Any leading make of communications receiver accepted.

WEBB'S RADIO, 14 Soho Street, Oxford Street, London, W.1.

Telephone : GERrard 2089.

Shop Hours 9 a.m.—5.30 p.m. Sats. 9 a.m.—1 p.m.

The
SHORT-WAVE
Magazine

E D I T O R I A L

QRP There are many approaches to the art and practice of Amateur Radio. One of those which these days does not get the support that perhaps it should is that of QRP, or low-power working. In fact, there is now probably a good deal less QRP operation, per 100 of the amateur population, than there used to be in pre-war days. Then, 10-25 watts was considered ample power by a large proportion of amateurs.

However, we are thinking not in terms of ten watts, or even five, but rather of 2-3 as being the sort of PA input with which a great many more amateurs of today could experiment on the LF bands, just to see what can be done with genuine QRP.

Of course, things now are very different on the bands from what they used to be 20 years ago. In terms of QRM alone, the problem is much more difficult. On the other hand, there are many well-known operators of today who, before 1930, cut their teeth on a one-lung perker, usually a single-valve Hartley oscillator with the aerial clapped right on the tank coil. And happy days they were, with problems which, to look back upon, seem almost childish in their simplicity.

Nowadays, with infinitely better receivers than we had then, it would seem that much useful work could be done with simplified transmitters, especially as the valves generally available are so much better. For instance, almost any of the modern dual triodes would alone make an excellent low-power LF band transmitter, connected as an oscillator-PA to combine both functions in the single valve. As 200 volts HT is quite enough for low-power work, and practically everyone is connected to a 230-volt supply, a source of transformerless HT using metal rectifiers is readily available.

With care and skill, two or three watts up the spout can even now do quite a lot—and, in the hands of a capable designer who is also a skilful operator, a great deal more than many might suppose.

*Austin Fobler
G6FO.*

An Amateur Oscilloscope and Its Application

CONSTRUCTION OF A SUITABLE INSTRUMENT

PART I

F. T. WILSON (G2XX)

This article shows how the Cathode Ray Oscilloscope can be used for a number of checks and measurements in addition to its more usual and better known applications in the amateur station. Our contributor discusses the design and construction of a suitable self-contained CRO unit, incorporating a wide-range timebase and all the necessary outlets and variables. It should be noted that the complete instrument can be built far more cheaply than many constructors might suppose.—Editor.

PROBABLY no test instrument ever devised is so versatile in application as the cathode-ray oscillograph, or oscilloscope. Its ability to represent graphically all the varying conditions of voltage and current in an electronic circuit with negligible delay and without appreciable loading of the circuit to which it is connected makes it an invaluable tool, not only to the research worker but also to the amateur.

It seems a little surprising, therefore, that it has not found wider employment by amateurs; even in otherwise well-equipped stations it is the exception rather than the rule to see an oscilloscope. One reason is probably the high cost of commercial instruments, most of which are fairly elaborate and therefore expensive. It is true that, on occasions, reasonably priced units have appeared on the market, but these have invariably consisted merely of a tube and power supply with no timebase or amplifiers, and so their utility has been severely limited.

As the result of some fairly extensive experience in the development of oscillographic equipment for various purposes it occurred to the writer that, taking advantage of the "surplus" still available, it should be practicable to design an oscilloscope which would provide all the facilities necessary for amateur use at a cost well within reach. Following this idea to its logical conclusion resulted in the construction, for an expenditure of thirty shillings, of the instrument to be described. Depending upon the current state of the junk box, the cost may vary in individual cases from a few shillings to a pound or so, but, even if every item has to be bought, should not greatly exceed £5.

It is not practicable here to discuss the funda-

mentals of cathode-ray tube operation and it will be assumed that readers are acquainted with the basic principles involved. Those who are not will find the necessary information in the recognised Amateur Radio handbooks and manuals.

Application

Another possible reason why the oscilloscope is not more popular with amateurs is lack of knowledge of its various applications. Most handbooks cover the use of the oscilloscope for measurement of voltage and current, amplitude modulation and frequency comparison, but very little is said about its other possibilities. On the other hand, text books about the oscilloscope provide a wealth of information but are usually written from the viewpoint of the industrial user or research worker.

Therefore, before proceeding with the constructional details, it is proposed to deal briefly with some of the less well known applications to amateur work, at the same time giving sufficient information so that the methods can be easily applied. No originality is claimed for any of this information since it has all been published before. At the same time it is scattered over a number of publications and is not always presented in a form which makes its utility to the amateur clear.

Phase Measurement

To the operator interested in single sideband technique or phase modulation, the ability to measure phase differences can be very helpful because the transmitter can be accurately set up before it is put on the air. The phase difference between two sinusoidal voltages can be

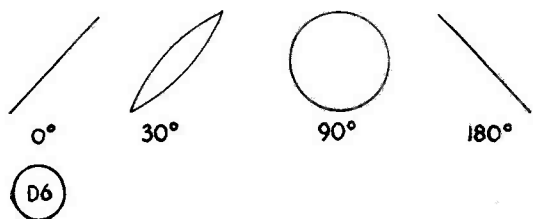

Fig. 1. Waveforms obtained in phase measurements, as explained in the text.

measured by applying these voltages to the X and Y deflector plates respectively, no time-base being necessary. The resulting picture on the tube will then be an ellipse, a circle or a straight line; Fig. 1 shows the patterns obtained with phase differences of 0°, 30°, 90° and 180°. At zero phase difference a straight line is produced; this broadens to an ellipse then to a circle and back to an ellipse as the phase difference increases. By knowing the patterns to be expected at 0°, 90° and 180° intermediate values can be closely estimated.

Component Measurements

Measurement of distortion in components is probably something which is very rarely required in the amateur station, but it can be valuable in assessing the usefulness of an item taken from the junk box for some particular application. Fig. 2 shows a method of comparing the current and voltage relationships in a component; a transformer is under test in the diagram, but any component can be connected between A and B. The resistance R should be small in comparison with that of the item being tested. Fig. 3(a) is the waveform

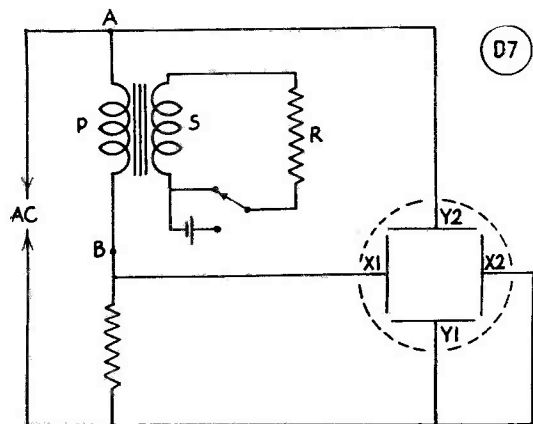

Fig. 2. Connecting the Oscilloscope to make component measurements.

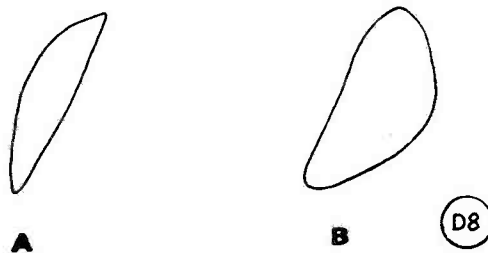

Fig. 3. Waveforms obtained with the set-up of Fig. 2.

with no DC flowing through the primary; Fig. 3(b) was obtained with DC and clearly shows the distortion occurring.

Non-Linearity Distortion

The performance of speech amplifiers and modulators or other circuits where linearity is

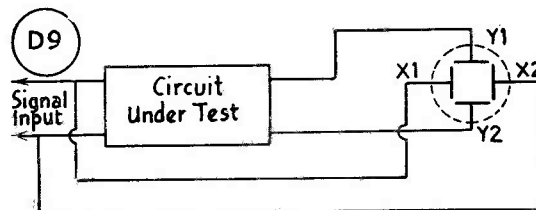

Fig. 4. Oscilloscope connections for the testing of circuits.

important can easily be checked with the oscilloscope, using the set-up in Fig. 4. In this particular case the circuit under test is a normal valve amplifier with a sine wave input of sufficient amplitude to cause overloading, thus producing harmonic distortion. Fig. 5(a) shows the pattern on the tube. If there had been no distortion the trace would be a straight line. A linear timebase may, of course, be fed to the X-plates in place of the amplifier input signal, in which case the pattern would appear as in Fig. 5(b).

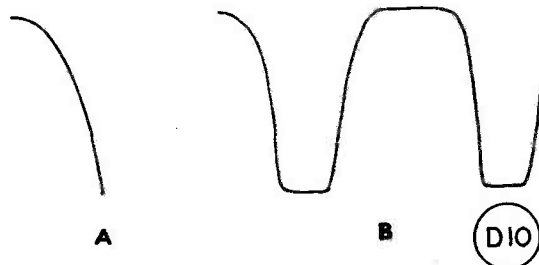

Fig. 5. Typical waveforms as obtained from an over-loaded amplifier.

Receiver Alignment

It is often very convenient to be able to display the response curves of the RF and IF circuits of a receiver on a cathode-ray tube. The oscilloscope lends itself to this application readily since the X-deflection, instead of being related to time, can be a function of frequency produced by a suitable generator. This involves the use of a ganging oscillator, or "wobulator," which is generally a mechanical device using a motor-driven condenser with specially shaped plates to vary the frequency of the oscillatory circuit. Home construction of such an instrument is extremely difficult. The same end, however, can be accomplished much more easily electronically and a block diagram of a suitable arrangement is shown in Fig. 6.

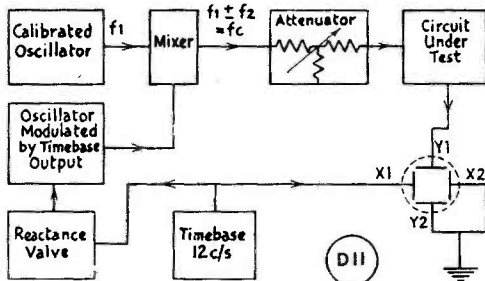

Fig. 6. Arrangement of a ganging oscillator for receiver alignment procedures.

Part of this will be familiar to users of frequency modulation.

An oscillator generating a frequency f_2 is frequency-modulated by a reactance valve, the effective value of which is controlled by the sawtooth deflection voltage produced by the oscilloscope timebase. If the circuit conditions remain constant, the X-deflection will have a definite relationship to the frequency f_2 . Manual adjustment of the mean carrier frequency is obtained by mixing f_2 with another frequency f_1 and selecting the difference frequency f_c . This frequency f_c will have the same frequency deviation as f_2 , but the mean frequency can be varied by altering f_1 .

A practical circuit for the modulated oscillator and mixer is shown in Fig. 7. The design of ganging oscillators is, of course, outside the scope of this article, but the following example, in conjunction with the diagrams, should enable any interested reader to build up a suitable unit.

We will assume that a home-built receiver has an intermediate frequency of 465 kc with a bandwidth of 4 kc at 6 dB down. Band-

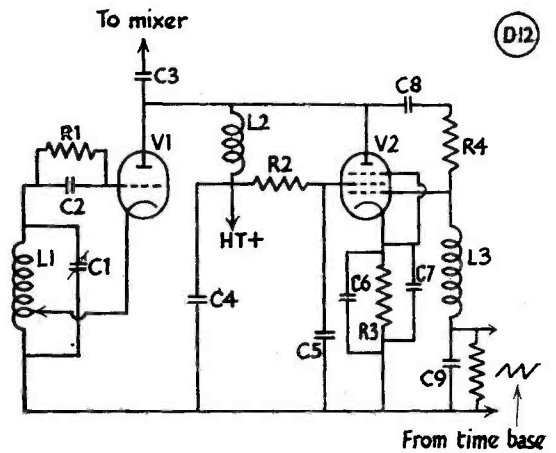

Fig. 7. Circuit of a reactance modulator and oscillator—see table for values. (Resistor across C9 should be marked R5).

Table of Values

Fig. 7. Reactance Modulator and Oscillator.

L1	} Suitable values to cover required	C7, C9	= .0047 μ F
C1, C2		R2	= 47,000 ohms
R1	} frequency range	R3	= 220 ohms
C3		= 47 μ F	R4, R5
C4, C5,	} = .001 μ F	L2, L3	= 2.5mH RF chokes
C6		= 10 μ F	V1
		V2	= 6AG7

pass circuits have been used and it is desired to examine the response curve to ensure that it is symmetrical (asymmetry sufficient to spoil the performance of a band-pass circuit does not always show up clearly when using the usual arrangement of signal generator and output meter). We require then a signal at a frequency of 465 kc with a deviation of ± 2 kc.

The calibrated oscillator producing frequency f_1 , can well be the station VFO, where this is separate from the transmitter. The reactance valve, modulated oscillator and mixer can be assembled on a small chassis as a unit. Three separate valves are shown in the circuit, but there is no reason why the oscillator and mixer

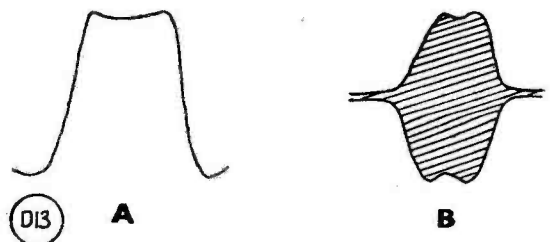

Fig. 8. Waveforms obtained from a band-pass IF stage using a ganging oscillator.

should not be combined in a triode-hexode. The reactance valve must have a high mutual conductance to ensure that sufficient deviation is obtained.

Assuming that all the units have been connected up as shown in the block diagram, the first step is to tune the oscillators. The VFO is set to, say, 3,600 kc and the modulated oscillator to 3,135 kc so that, providing the mixer is tuned to the difference frequency, f_c is 465 kc. The timebase is now adjusted to run at 12 c.p.s. It is important that the number of frequency scans per second is small compared with the lowest carrier frequency and 12 c.p.s. is about the lowest speed that can be used without objectionable flicker of the trace. Next, the amplitude of the timebase voltage fed to the reactance valve is adjusted to give the required deviation of ± 2 kc, using one of the methods applicable to FM transmitters, such as a receiver or frequency meter.

We are now feeding into the receiver a signal varying between 463 and 467 kc and the resulting pattern on the oscilloscope screen should be similar to that shown in Fig. 8(a) or (b), depending on the point from which the Y-plate signal is taken. The upper waveform is obtained after the second detector and the lower is the RF envelope from the IF circuit before rectification. In general, it is preferable to use the envelope display as this avoids any distortion that might be introduced by the subsequent circuits.

LF circuit responses can be examined in exactly the same way, but the ganging oscillator is replaced by a frequency-modulated oscillator with a suitable frequency range. Alternatively, the output from the ganging oscillator may be fed into the mixer of a BFO and a block diagram of this arrangement is shown in Fig. 9.

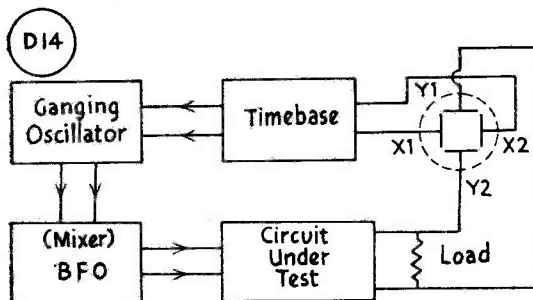

Fig. 9. Circuit arrangement for checking LF responses.

FM and PM Transmitter Measurements

In frequency and phase modulation systems the output is a carrier having a frequency f_c and symmetrical sideband frequencies, $f_c + f_m$, $f_c + 2f_m$, and so on, where f_m is the modulating frequency. The arrangement illustrated in Fig. 10 shows how these frequencies can be examined to ascertain the bandwidth, modulation index, presence of distortion, etc. The principle is that of scanning the spectrum

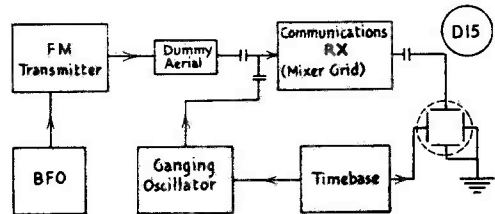

Fig. 10. Oscilloscope circuitry for checking the output waveforms of an FM transmitter.

using a selective band-pass filter, the output being rectified and applied to the Y-plates of the oscilloscope. Frequency scanning is done by providing a signal from a frequency modulated oscillator in exactly the same way as was described for receiver alignment. This signal, together with that from the FM transmitter, is fed to the input of an ordinary communications receiver from which the HF oscillator valve has been removed. The receiver IF chain, which should preferably include a crystal gate, forms the band-pass filter.

If the transmitter shown in the block diagram were amplitude modulated instead of frequency modulated, only three signals would be produced on the CRT screen—a carrier and two sidebands. The sidebands would never exceed half the carrier amplitude and the carrier would remain constant under modulation. In frequency and phase modulation, on the other hand, the side frequencies and the carrier all vary in amplitude according to the depth of modulation and with frequency modulation the amplitudes are also dependent on the modulation frequency.

Fig. 11 shows some waveforms obtained with a typical FM transmitter. The length of the trace is roughly equivalent to 100 kc and the height of the signals displayed is proportional to the peak voltage. In (a) the carrier alone is shown; (b) is the same carrier modulated by a 7 kc signal with a deviation ratio of 1; (c) indicates modulation by a 5 kc signal with a deviation ratio of 1.5; and (d) modulation by a 10 kc signal with a ratio of

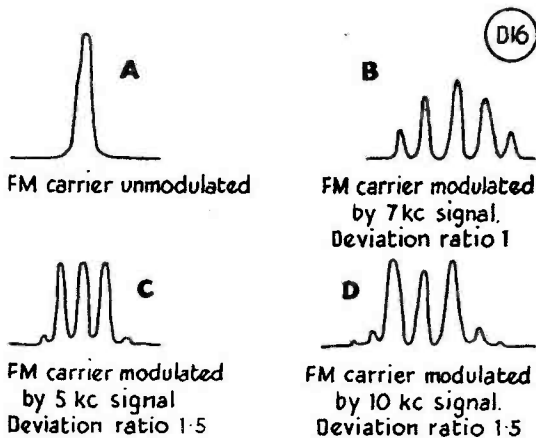

Fig. 11. Some typical FM transmitter output waveforms—
See Fig. 10.

1.5. The slight inequalities in the amplitudes of the pairs of sideband frequencies indicate the presence of amplitude modulation.

By connecting the output from a crystal calibrator or signal generator to the receiver input in place of the FM transmitter, the oscilloscope trace can be calibrated in terms of frequency; the bandwidth of the FM transmission may then be measured directly.

Impedance Measurement

Most amateurs find this necessary at some time or other, particularly where aerials and feeders are concerned. A suitable arrangement for measuring impedances over a range of frequencies is shown in Fig. 12. R1 is included to match the oscillator output and its value will depend on the output impedance of the oscillator. R2 should be approximately equal in value to the estimated impedance of the unknown quantity Z. The impedance Z is obtained from the equation

$$Z = \frac{y \cdot Y \cdot R_2}{x \cdot X} \text{ ohms.}$$

where x is the X-plate deflection constant in volts/cm.; y is the Y-plate deflection constant in volts/cm.; X is the X-plate deflection in cms.; Y is the Y-plate deflection in cms. The pattern obtained is an ellipse which also gives an indication of the phase angle.

Resonance Measurement

In conjunction with a calibrated oscillator the oscilloscope can be used effectively as a grid dip meter using the set-up of Fig. 13. The oscillator frequency is varied until a

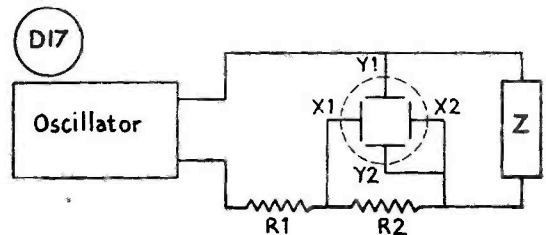

Fig. 12. Circuit layout when using the Oscilloscope for making impedance measurements.

straight line appears on the CRT: the oscillator is then tuned to the resonant frequency of the circuit under test.

Bridge Balance Indication

Fig. 14 shows the oscilloscope used as a bridge balance indicator. The advantages of the CRO for this purpose are:

- (1). It is relatively independent of frequency.
- (2). It cannot be damaged by overload.
- (3). If harmonics are present the fundamental and harmonics can be sorted out and a balance obtained on the fundamental.
- (4). Reactance and resistance out of balance can be distinguished.

There are several variations of the arrangement shown in Fig. 14, in some of which the

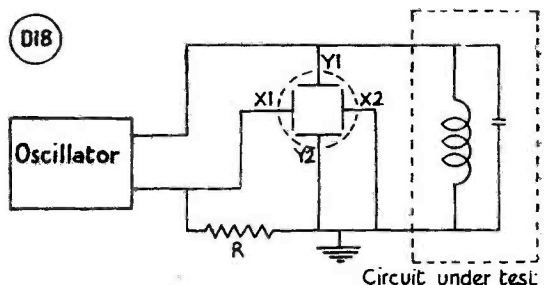

Fig. 13. Circuit for resonance measurement using an Oscilloscope.

bridge input signal is also fed to the X-plates. Where this is done balance is indicated by a straight line, but, in the case illustrated, a spot is obtained when the bridge is balanced.

"Q" Measurement

Measurement of the Q of a circuit is normally made on a Q-meter but it is quite easy to use the CRO for this purpose. The circuit to be measured is made to ring by feeding

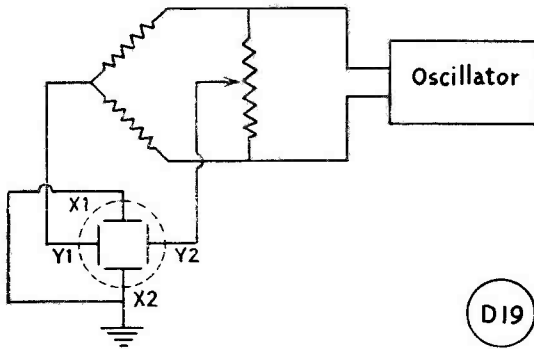

Fig. 14. Using the Oscilloscope as a Bridge Indicator.

part of the timebase sawtooth voltage into it and the damped oscillation so produced is displayed on the CRT; this waveform is then used to ascertain the Q of the circuit.

A diagram of the necessary connections is given in Fig. 15: the coupling condenser C should be as small as possible, say, 10 μ F to reduce the effect of the impulse source on the circuit under test. The resultant waveform is shown in Fig. 16 and the Q is obtained in the following manner :

$$\frac{A}{B} = \frac{B}{C} = \epsilon^\delta \text{ where } \epsilon \text{ is the base of exponential logarithms (2.718) and } \delta \text{ is the decrement of the tuned circuit.}$$

$$\delta = \frac{R}{2fL} \text{ where } R \text{ is the effective resistance of the inductance in ohms, and } L \text{ is the inductance in Henrys.}$$

The Q of the circuit is given by :

$$Q = \frac{3.14}{\delta}$$

In the example shown $\frac{A}{B} = 1.5 = \epsilon^\delta$:

therefore the logarithmic decrement δ is 0.40 and the Q is slightly less than 8. It must be admitted that this method of Q measurement can only be used where the Q value is relatively low, say below 50. With very high Q circuits the decrement of the damped wave train is quite slow and it becomes extremely difficult to measure the difference between A and B unless the cathode-ray tube has a large diameter screen. It must be borne in mind that Q measurements on a meter are normally made at a frequency of one megacycle. When

using the CRO method, however, the frequency at which the measurement is made will depend on the maximum timebase speed and the number of wave trains that can conveniently be accommodated on the screen.

Voltage and Current Measurements

So far we have been concerned with what might be termed the less conventional applications of the oscilloscope and will now consider one or two of the better known uses. A DC voltage applied to a deflector plate causes the spot or trace to take up a position on the screen from the zero setting proportional to the applied voltage, while with AC the spot traces out a wave-form proportional to the peak-to-peak voltage. Current measurements are most easily made with electromagnetic tubes although deflector coils can be fitted to

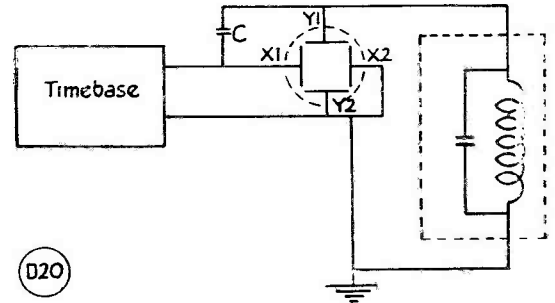

Fig. 15. Circuit layout for making measurements of Q with an Oscilloscope.

electrostatic tubes for this purpose. The easiest method of using an electrostatic tube for current measurement, however, is to measure the voltage drop across a resistor. Probably the only occasions when it is advantageous to use an oscilloscope for these purposes are when a very high input impedance is required or it is necessary to measure an AC potential which is very minute and needs amplification before measurement is possible.

Frequency Comparison

By applying the unknown frequency to the Y-deflector plate and the timebase to the X-deflector plate and adjusting the controls until the picture is stationary the unknown frequency can be measured—directly if the unknown frequency lies within the timebase range, or by interpreting the Lissajous figure obtained if it is outside the timebase range. This presupposes two factors; that the time-

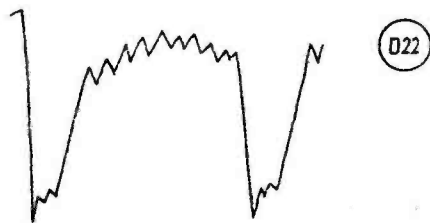

Fig. 16. Waveforms obtained when making Q measurements.

base frequency is stable and that it is accurately calibrated. (The oscilloscope is not now generally used for this purpose since a BFO is usually more reliable !)

There is, however, one case of frequency comparison in which the CRO can be very helpful, and that is in adjusting the usual crystal calibrator consisting of a 100 kc crystal and multi-vibrators. By connecting the output from the crystal oscillator to one Y-plate and the multivibrator output to the other Y-plate a "riding trace" similar to Fig. 17 is obtained. The number of pips between the main pulses shows whether the multivibrator is dividing correctly.

Conclusions

From the foregoing it is clear that there are very few measurements that cannot be undertaken by the oscilloscope. In some cases, it is true, a meter could equally well be used, but the CRO is definitely superior to a meter because of the lower inertia and its ability to

present more information in a single picture. The examples quoted are by no means exhaustive, but in selecting them the needs of the amateur have been kept in mind. Transmission line tests could, for instance, have been included. But as these require special facilities affecting oscilloscope design, it was felt that they would be out of place in an article dealing

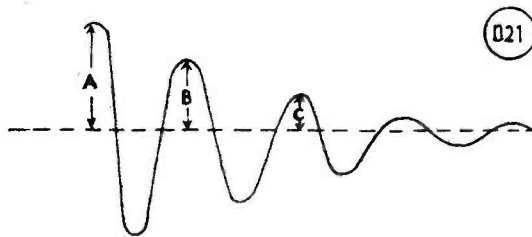

Fig. 17. Example of riding trace. Waveform is of a 100 kc crystal oscillator with output from a 10 kc multivibrator superimposed.

with the standard CRO. Amplitude modulation measurements and examination of keying waveforms have already been adequately covered in *Short Wave Magazine* and the handbooks, and no apology is offered for their omission.

The second part of this article, to follow next month, will describe in detail the design and construction of a complete CRO Unit for the amateur station, suitable for carrying out the checks and measurements discussed above.

(To be continued)

KING GEORGE VI MEMORIAL

We commend to all our readers a most worthy appeal—that for the National Memorial to His late Majesty King George VI, a great and good man who, among his many interests and activities, had time to study the art and practice of radio in the early days. It will be many years before the contribution made by King George VI to the history of our times will be fully and freely told, and when that time comes it will be found that he exerted a great and beneficent influence. It is planned to devote the proceeds of the appeal just launched to a worthy memorial, of a kind which would have been in accordance with His late Majesty's own wishes. Whether your contribution can be one shilling or one pound, send it to:—The Lord Mayor, King George VI National Memorial Fund, London, E.C.4. Contributions thus addressed can be sent free of postal charges (unstamped).

AUSTRIAN (MB9) QSL BUREAU

We are informed that many amateurs and SWL's are sending their cards for MB9 stations to the OE QSL bureau—with the result that the cards are either sequestered or "returned to sender." The reason for this is that, while MB9's are properly licensed, the OE's are Austrian civilians and strictly under cover. The correct address for all MB9 cards is: MB9 QSL Bureau, CSO Branch, Hq. B.T.A., Klagenfurt, British Troops in Austria, 2.

BROADCAST RECEIVING LICENCES

Twelve million, eight hundred and six thousand and twelve broadcast receiving licences, including 1,597,947 for television and 150,030 for receivers fitted in cars, were current in Great Britain and Northern Ireland at the end of August, 1952.

Television detection vans are continuing to tour the country to detect unlicensed television sets.

Motorists are reminded that they need a separate broadcast receiving licence for a wireless set fitted in a car.

The Cure of TVI

SHIELDING AND SUITABLE FILTER NETWORKS

PART II

R. L. GLAISHER (G6LX)

The first part of this article appeared in our issue for October, 1952. Here, the author discusses shielding and filtering, and gives much practical data on RF filter design for a wide range of working frequencies.—Editor.

CONSIDERABLE space has already been devoted to discussing the broad aspects of the television interference problem. To recapitulate, it has become increasingly evident that the reduction of spurious emissions is a problem which equally confronts the amateur living anywhere in the service area of the allocated television channels.

The amount of harmonic attenuation necessary to clear any particular case of TVI will differ over very wide limits, depending on the level of the television signal, the (frequency) channel in use, and the fundamental frequency of the amateur transmitter.

For example, it should be much easier to clear the 7th harmonic of a 7 mc transmitter causing interference to the Northern vision channel than to clear the 3rd harmonic of a

14 mc transmitter located in the London service area, under equal television signal conditions. Again, the 2nd harmonic of a 28 mc transmitter located in the Midland fringe area will require more attenuation than the fourth harmonic of a 14 mc transmitter located in the fringe area of the Scottish television transmitter.

The power input of a well engineered parasitic-free transmitter does not usually have a great effect on the degree of harmonic radiated, as the ratio of power levels between a 10- and 150-watt transmitter is only a few dB, while the attenuation necessary to suppress the spurious component of the fundamental signal is likely to range between 50 and 100 dB.

Harmonic reduction can be achieved by (1) Complete transmitter shielding, lead and RF output filtering, or (2) By modifying the transmitter RF circuits so as to reduce the number and level of harmonics generated. In many cases *all* these measures will have to be adopted to obtain a safe degree of attenuation to avoid interference to TV receivers in the locality of the transmitter, especially under fringe area reception conditions.

From experience gained by the South London Group, it seems more straightforward to screen and filter first, then if additional attenuation is required the transmitter RF circuits can be modified.

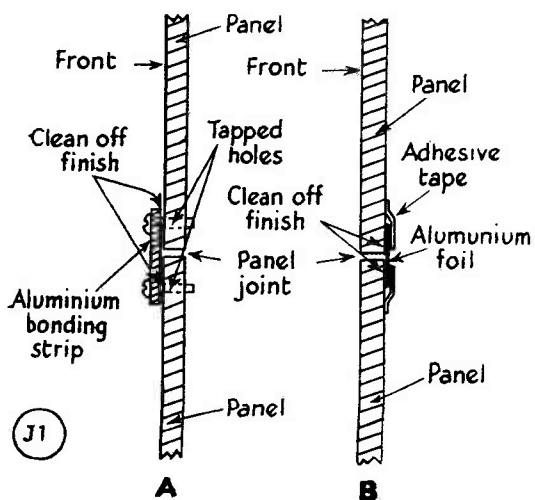

Fig. 1. Suggested methods for sealing the cracks between panels. (A) will be found useful for rack-type assemblies where access to the transmitter is via the front panel. (B) is a more permanent type of sealing.

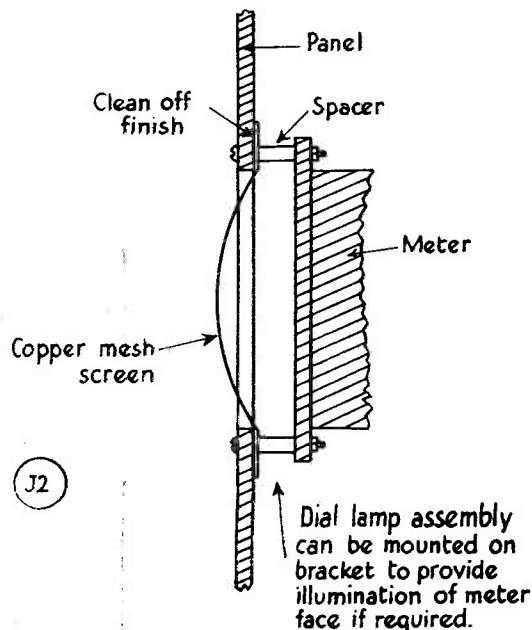

Fig. 2. Sub-mounting a meter behind a panel in order to get a good electrical seal.

Table 1. Types of RF Filters for each Class of Lead (see Fig. 3).

Type of Lead	Filter	RFC 1	RFC 2	C1	C2	C3	C4	C5, C6	C7, C8	C9, C10
Keying	Type 3A	Type 1	—	500 $\mu\mu\text{F}$	500 $\mu\mu\text{F}$	—	—	—	—	—
Microphone	Type 3A	Type 1	—	500 $\mu\mu\text{F}$	500 $\mu\mu\text{F}$	—	—	—	—	—
Bias	Type 3B	Type 1	2.5 mH	500 $\mu\mu\text{F}$	500 $\mu\mu\text{F}$.002 μF	—	—	—	—
HT + (up to 600v)	Type 3B	Type 1	2.5 mH	500 $\mu\mu\text{F}$	500 $\mu\mu\text{F}$.002 μF	—	—	—	—
Screen HT +	Type 3B	Type 1	2.5 mH	500 $\mu\mu\text{F}$	500 $\mu\mu\text{F}$.002 μF	—	—	—	—
Meter Leads	Type 3B	Type 1	2.5 mH	500 $\mu\mu\text{F}$	500 $\mu\mu\text{F}$.002 μF	—	—	—	—
Low voltage/Low current (relay supply, etc.)	Type 3A or Type 3B	Type 2	—	500 $\mu\mu\text{F}$	1000 $\mu\mu\text{F}$	—	—	—	—	—
Low voltage/High current (filament or heaters, etc.)	Type 3A (S.P.) Type 3C (D.P.)	Type 3	—	1000 $\mu\mu\text{F}$	1000 $\mu\mu\text{F}$	—	—	—	—	—
HT + (1000 v up)	Type 3D	Type 3	Type 3	1000 $\mu\mu\text{F}$	1000 $\mu\mu\text{F}$	1000 $\mu\mu\text{F}$	1000 $\mu\mu\text{F}$	—	—	—
Mains (excluding heater or filament transformer primary connections)	Type 3C	Type 2	Type 2	500 $\mu\mu\text{F}$	500 $\mu\mu\text{F}$	500 $\mu\mu\text{F}$	500 $\mu\mu\text{F}$	—	—	—
Mains connections to filament or heater transformer primaries	Type 3E	Type 2	Type 2	.005 μF	.005 μF	.001 μF	.001 μF	.001 μF	500 $\mu\mu\text{F}$	500 $\mu\mu\text{F}$

It is appreciated that this procedure differs from that usually recommended by other writers. But in practice measurements made on several well-screened unmodified 14 mc transmitters show as much as 70 to 80 dB attenuation of the third harmonic with normal type lead and RF output filters. It cannot be emphasised too strongly that, to obtain this very desirable attenuation, it is extremely important that shielding and lead filtering be as near to perfection as possible. Time spent on these points will save much hard work later in modifying RF circuits.

Shielding

The provision of shielding is likely to be one of the most difficult tasks in TVI-proofing an existing transmitter. Ideally, to obtain perfect screening the transmitter should be completely enclosed in a water-tight copper box. Contrary to popular belief, this is a practical method, and recently a satisfactory shielding job was carried out in this way by a South London amateur (G3HAS) on a 150-watt 14 mc transmitter. Band-switching is essential with this method where multi-band operation is required, because of the difficulties in providing access for changing plug-in coils without destroying the effectiveness of the screening.

It is realised that, in many cases, some form of ventilation is necessary, especially where a great deal of heat is generated, and the question then arises of how much deviation from the "ideal box" may be tolerated before the screening is destroyed.

Fine mesh copper gauze tightly stretched on some form of framework may be used in conjunction with copper or aluminium sheet as

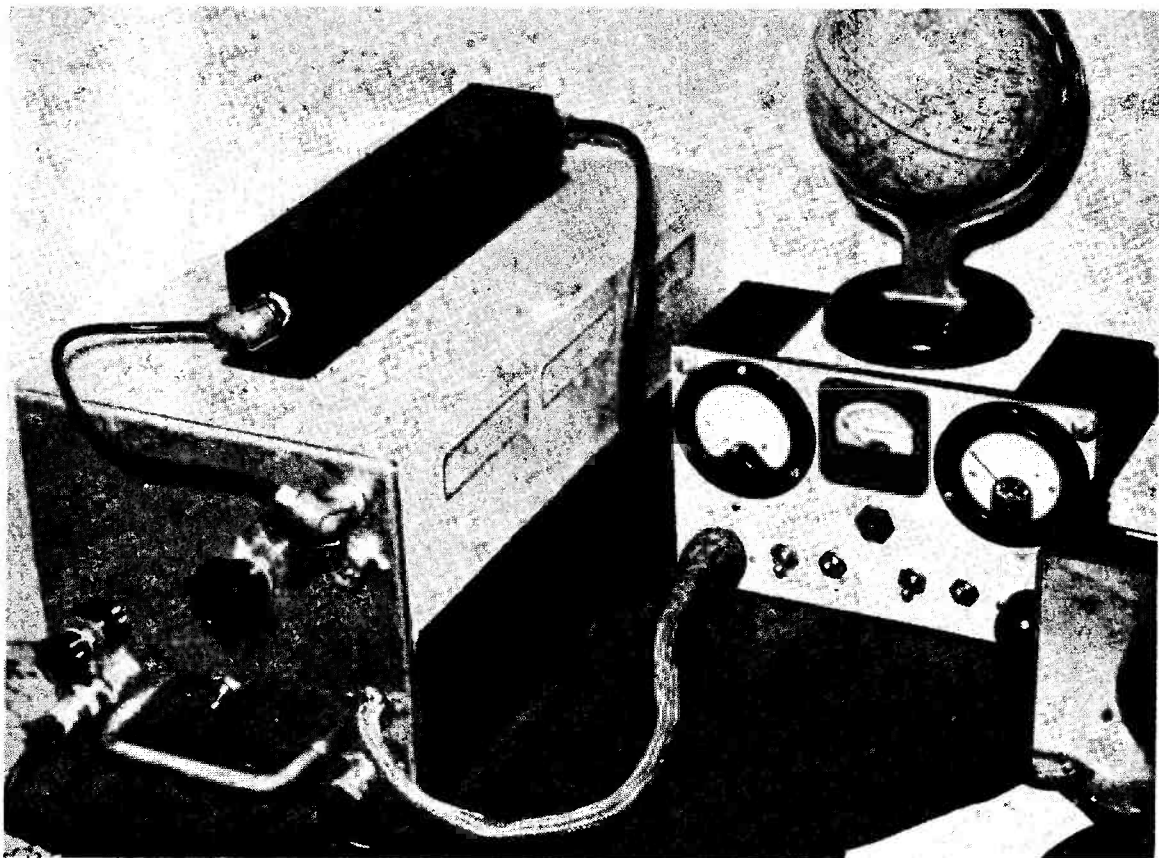

G3DPJ, Croydon. Screened transmitter (complete, less VFO and aerial tuning unit, boxed separately) running 100 watts input to paralleled 807's. This assembly produces a very low level of harmonic output.

an alternative to "solid screening," and this method has been well tested by several members of the South London Group. The results show that provided a little care is taken, fine copper mesh can be as effective as "solid screening," and furthermore requires much less mechanical work. Some typical examples

RF Choke Details for Table 1.

- RFC 1:**—5 metre receiving type choke, or 35-40 turns No. 20 SWG enamel wound on $\frac{3}{8}$ " diameter former, spaced to occupy $1\frac{1}{2}$ ".
- RFC 2:**—Channel 1: 69" of 14 SWG enamel close-wound on 1" diameter form.
 Channel 2: as for Channel 1, but $59\frac{1}{2}$ " long.
- | | | | | |
|--------|-----|--------|-------------------|---|
| " 3: " | " " | " 1, " | $54\frac{1}{2}$ " | " |
| " 4: " | " " | " 1, " | 50" | " |
| " 5: " | " " | " 1, " | $46\frac{1}{2}$ " | " |
- RFC 3:**—As RFC2, but wound with 2 parallel 14 SWG enamel wires.

of screening are shown in the photographs.

Commercial table-top and enclosed rack type cabinets, such as those used for housing the RAF T1131, Collins TCS, and similar designs, are not really screened enclosures from the TVI standpoint. There are many ways of making these cabinets satisfactory, but all necessitate a fair amount of manual labour. One suggestion, described by Rand, W1DBM, in the June, 1952, issue of *QST*, is to make use of an open-ended box constructed of copper mesh fitted over the top and bonded to the transmitter chassis. The chassis is then fitted with a bottom plate also constructed of copper mesh and replaced in the unmodified cabinet. This method can also be used for screening separate chassis mounted in a rack-type cabinet.

Shielding is only effective if care is taken in bonding and earthing all the component parts of the screened enclosure and the chassis.

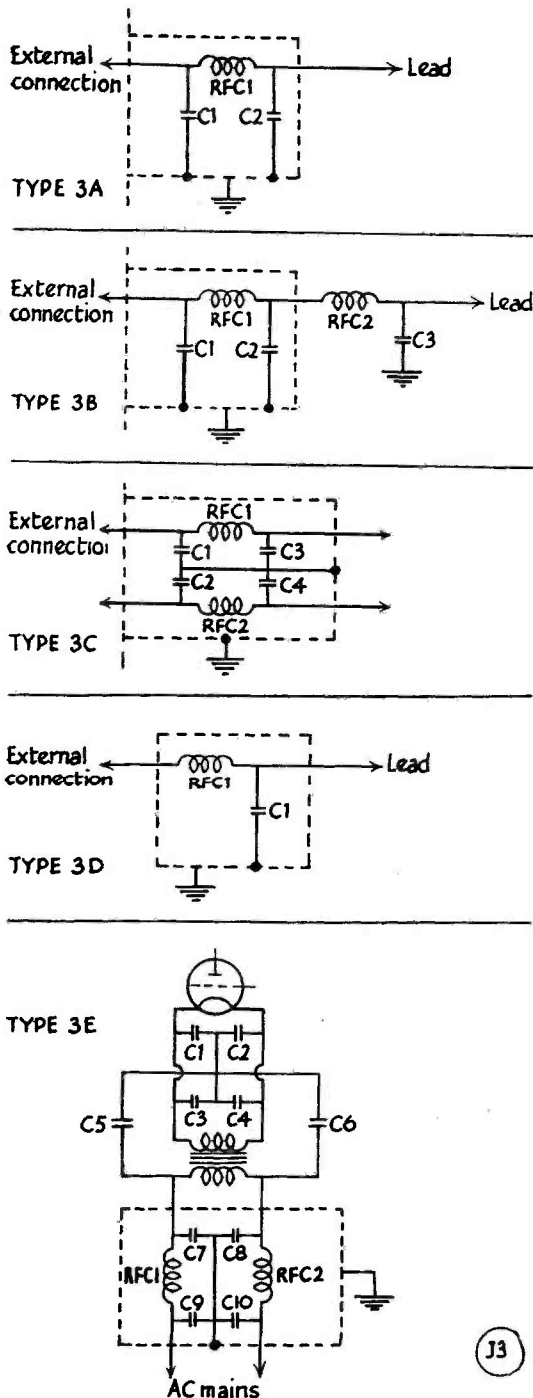

All controls projecting through the screening should be well earthed by means of a solid panel bushing. The type used on the RAF T1154 transmitter is suitable for this purpose and can often be obtained quite cheaply from surplus sources. The joints between panels mounted in a screened enclosure should be sealed. Suggested methods are shown in Fig. 1.

Wherever possible, meters should be mounted externally to the screened enclosure and all connecting leads well filtered so as to prevent the radiation of harmonics. If it is desired to retain the meters inside the enclosure, then separate screening can be used to shield the meters completely. The connecting leads must again be well filtered before entering the meter screen. Another solution that is often adopted is to sub-mount the meter behind the front panel inside the enclosure and cover the meter hole with fine copper mesh (Fig. 2). This method is usually the easiest mechanically, but does tend to obscure the meter face and make readings difficult. If necessary, pilot lamps may be mounted inside the enclosure adjacent to the meters to illuminate the faces.

The various connections to a transmitter enclosed in a screen must be properly filtered. These include key connections, meter jacks (if used) microphone, where the modulator is part of transmitter, in addition to the AC and power connections, relay leads, and so on. The RF output must also be filtered by means of a low-pass or half-wave filter. Suitable filters are described later.

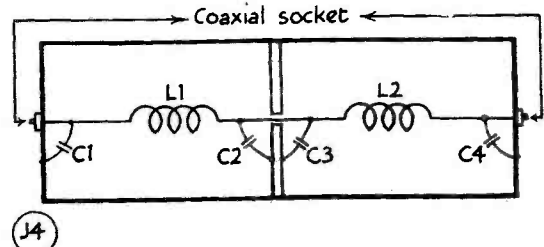

Harmonic	Attenuation
2nd	30 dB
3rd	50 dB
4th	60 dB
5th	67 dB

Fig. 4. A half-wave filter suitable for use with 50-ohm coax feed-line. The degree of attenuation to be expected is shown in the panel. See table opposite for values.

Fig. 3. Various arrangements of RF lead filter. Values and the most appropriate positions for these filters are given in the tables.

Fig. 5. Quarter-wave shorted coaxial stub assemblies for the reduction of harmonic interference.

Lead Filters

It has been shown in previous sections (of this article) that the harmonics generated by a transmitter can be radiated *via* three main routes :—(1) From the transmitter components and internal wiring ; (2) from the external connecting leads to the transmitter ; and, (3) from the RF feeder and aerial system.

The provision of "complete" transmitter screening will effectively stop direct radiation from the components and internal wiring. It is possible, by careful filtering, to reduce and in some cases completely to suppress the radiation from the other two escape routes.

The technique of lead filtering has been described in several publications and many different filter configurations have been suggested, including the pi, L, T, double-pi, and their variants. The A.R.R.L. in the 1951 *Radio Amateur's Handbook* suggest the use of screened lead for all transmitter wiring inside the RF chassis. They state that this method prevents harmonic currents from "hot" leads being coupled into other wiring and furthermore provides desirable continuous bypassing along the length of the lead. This method has not so far been tested by the writer or other members of the South London Group as up-to-date all work has been concerned with TVI-proofing the existing transmitters. From the experience gained in the U.S.A., however, this scheme should be well worth incorporating in any new transmitters under construction.

The filtering of leads can be accomplished either on a deck-by-deck basis, or in terms of the whole transmitter. In the case of the screened enclosure housing several units, it is usually better to filter only those leads which leave the enclosure. Filters should be shielded from each other and from other components

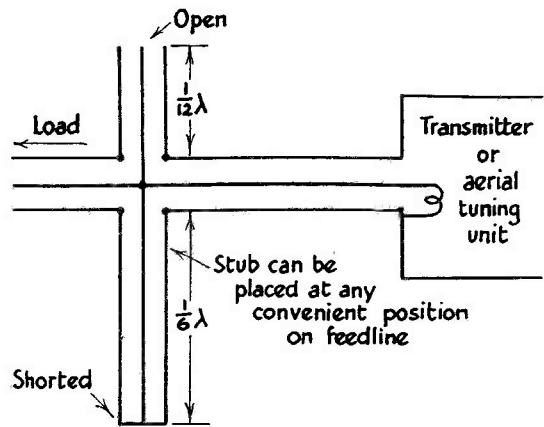

Note: Stub must be constructed of the same material as the feedline. The velocity factor must be taken into consideration when calculating stub lengths.

FIG. 5A. $\frac{1}{4}\lambda$ SHORTED COAXIAL STUB FOR REDUCTION OF 3rd HARMONIC INTERFERENCE

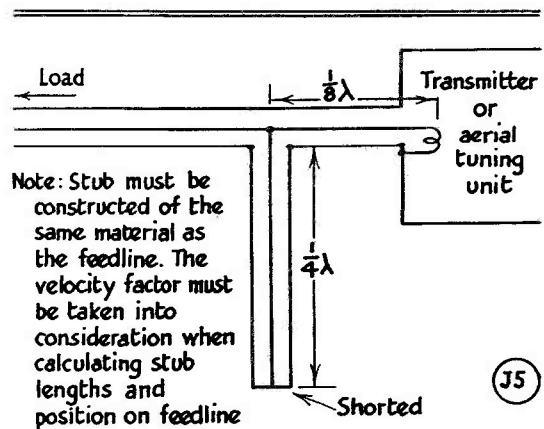

FIG. 5B. $\frac{1}{4}\lambda$ SHORTED COAXIAL STUB FOR REDUCTION OF EVEN HARMONIC INTERFERENCE

Table of Component Values for Fig. 4.

Frequency	L1 and L2 (See Text)	C1, C2, C3, C4 (See Text)
1.7 mc	4.2μH—22T No. 16 enamel 1" dia. × 2" long	1700 μμF 350V DC working
3.5 mc	2.1μH—13T No. 12 enamel 1" dia. × 1 3/8" long	850 μμF 1000V DC working
7 mc	1.1μH—8T No. 12 enamel 1" dia. × 1" long	440 μμF 1000V DC working
14 mc	0.55μH—7T No. 12 enamel 3/4" dia. × 3/4" long	220 μμF 1000V DC working
21 mc	0.45μH—7T No. 12 enamel 5/8" dia. × 3/4" long	150 μμF 1000V DC working
28 mc	0.3μH—6T No. 12 enamel 1/2" dia. × 3/4" long	110 μμF 1000V DC working

(J5)

and wiring, otherwise the harmonic is likely to by-pass the filter unit, and be radiated from the "cold" wiring.

Suitable filters for the various classes of leads are detailed in Table 1. The circuit diagrams and photographs of several lead filters constructed by members of the South London Group are shown in Figs. 3 and 5, and in the photographs.

The by-pass condensers used in lead filters should be of the low inductance type. The types listed in Table 2 have been tested and found to be satisfactory for this class of service.

Care should be taken to keep the condenser lead lengths as short as possible. This particularly applies with the moulded-mica and tubular types.

Many other types and makes of condenser should be as suitable as the ones tested. The main points to keep in mind when selecting condensers are low-inductance, voltage rating and capacity. Wherever possible, allow a safety

factor of at least 100% in the voltage rating, as lead filters sometimes have to be installed in rather inaccessible positions. In the case of a lead carrying modulated DC, the rating should be at least three times the voltage appearing between the lead and earth.

RF Output Filters

Two basic types of RF output filters for preventing the transfer of harmonics to the aerial system are in common use. These are the normal low-pass type, having a specified cut-off frequency, which can be used over a wide band of fundamental frequencies, and the half-wave filter or "Harmoniker" which is intended for single-band operation. Either type is capable of affording an enormous degree of harmonic attenuation provided that a little care is taken to ensure that the filter is operating in the correct manner.

Experience has shown that the low-pass filter or "Harmoniker" can best be installed ex-

Table 2. Suitable Condensers for Use in RF Lead Filters.

Filter *4	Voltage Rating *1	Capacity	Condenser
3A	100-250v. DC ...	500 $\mu\mu\text{F}$	T.C.C. Type CM.30 Micadisc
		1000 $\mu\mu\text{F}$	T.C.C. Type CM.20N Moulded mica
3B(*2)	100-250v. DC ...	500 $\mu\mu\text{F}$	T.C.C. Type CM.30 Micadisc
		.002 μF	Erie Type 701B 2000 $\mu\mu\text{F}$ lead-through cermaic
	250-500v. DC ...	500 $\mu\mu\text{F}$	T.C.C. Transmitting type Micadisc type CM.31
		.002 μF	T.C.C. Transmitting type Micadisc type CM.31
3C	100-250v. DC ...	1000 $\mu\mu\text{F}$	T.C.C. Type CM.20N Moulded mica
	200-250v. AC Mains	500 $\mu\mu\text{F}$	T.C.C. Transmitting type Micadisc type CM.31
			T.C.C. Type M. Moulded Mica 750v. wkg.
3D	1000v. modulated DC upwards ...	500 $\mu\mu\text{F}$	Mullard type TOK25/15 Television type ceramic 12 kV working DC (*3)
			Erie type 410 Television type ceramic 15 kV working DC (*3)
			T.C.C. type 1051 Transmitting type pot mica 3 kV RF working
3E	200-250v. AC Mains	500 $\mu\mu\text{F}$	T.C.C. Transmitting type Micadisc type CM.31
		.001 μF	T.C.C. Transmitting type Micadisc type CM.31
		.005 μF	T.C.C. type M Moulded mica 750v. wkg.

*1 Unless stated all voltages are unmodulated DC (see text).

*2 Condensers for use in meter lead filters should be rated according to the voltage appearing between the lead and earth.

*3 Both types are designed for low RF current rating, so care must be taken to ensure the RF circulating current is kept low.

*4 See table 1 and fig. 3.

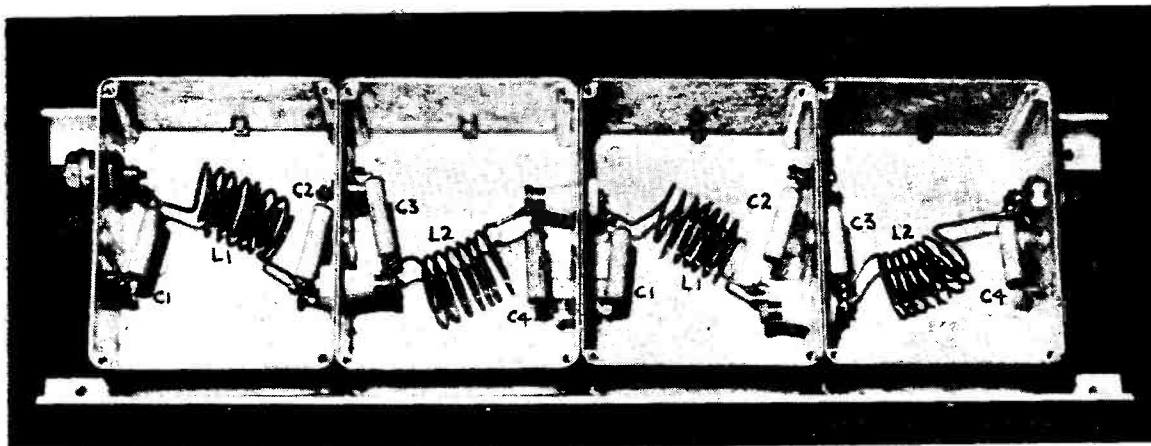

Experimental 14 mc full-wave filter constructed by G6LX. It is designed for coaxial feed-line and consists of two cascaded sections (see Fig. 4). Laboratory tests show this to have attenuation to third harmonic of about 57 dB. Tests using this filter under practical conditions have not yet been completed.

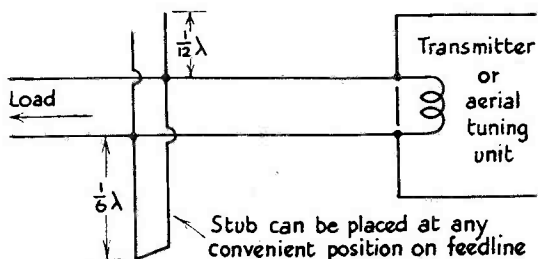

Note: Stub should be constructed of the same material as the feedline. The velocity factor must be taken into consideration when calculating stub lengths if 70 or 300 ohm ribbon feeder is used.

FIG. 6A. $\frac{1}{4} \lambda$ SHORTED STUB FOR REDUCTION OF 3rd. HARMONIC INTERFERENCE

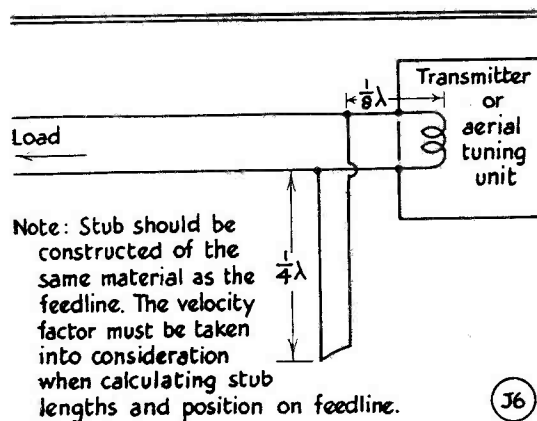

(J6)

FIG. 6B. $\frac{1}{4} \lambda$ SHORTED STUB FOR REDUCTION OF EVEN HARMONIC INTERFERENCE

ternally to the main transmitter enclosure, and that the transmission line from the transmitter should be of the coaxial type.

A separate link-coupled aerial tuning unit, or some form of unbalanced-to-balanced coupling device, can be used to match the coaxial cable to a balanced feeder system where this method of aerial feed is required. An aerial tuner also provides a measure of useful selectivity for attenuating the transfer of harmonics to the aerial system, and for this reason its use is recommended in preference to the bazooka or coaxial line balancer.

A number of well-designed high performance low-pass filters of conventional configuration have recently been described in other publications. In particular the theory and constructional aspects were explained in detail in a series of articles by Grammer, W1DF, in the 1950 February, March, and April issues of *QST*. The Fall edition of the *R.C.A. Ham Tips* also deals with this subject in detail.

A number of tests have recently been carried out by members of the South London Group, comparing various types of conventional low-pass filters with the half-wave "Harmoniker" type filter. The results of these tests show that the half-wave filter is much easier to construct and use and can give nearly as much harmonic attenuation for single band operation as the normal low-pass types.

Fig. 6. Other arrangements of shorted stub-lines for odd and even harmonic suppression.

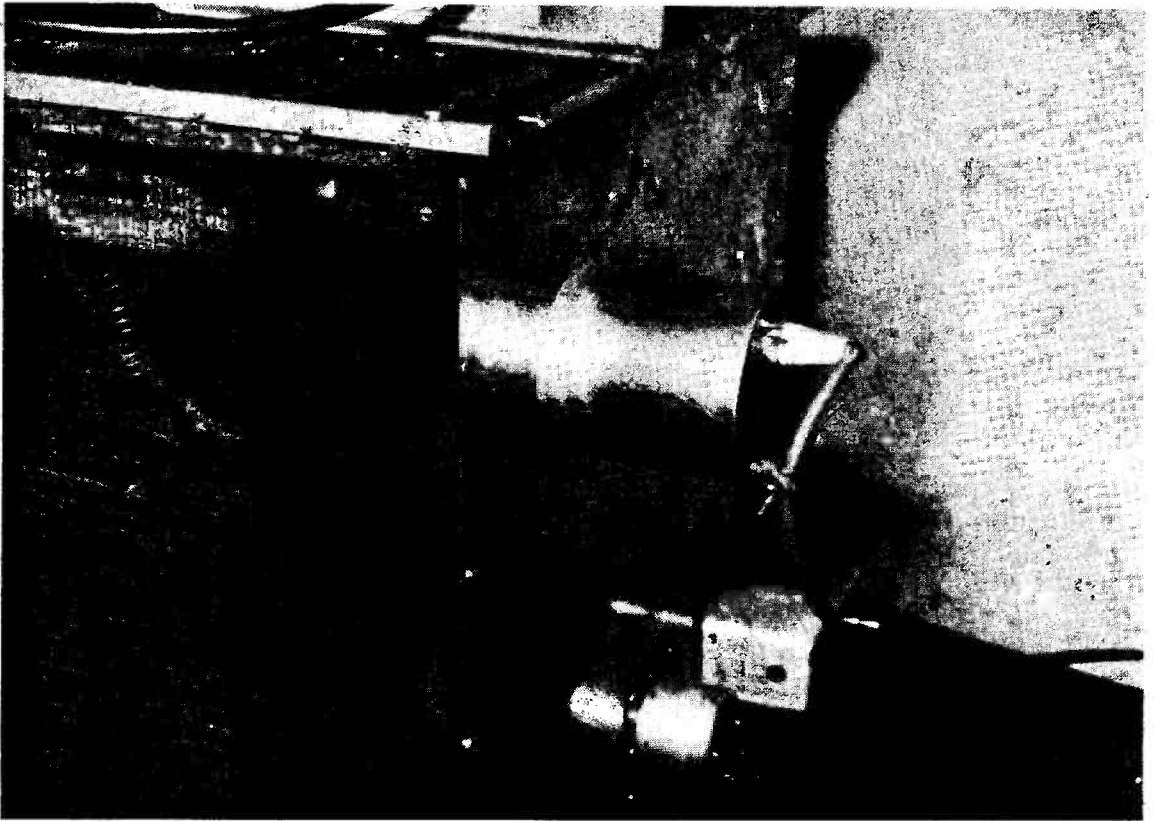

Rear view of the G6LX transmitter for experimental TVI work, showing lead filters installed on rear panel—see Fig. 3. The assemblies shown are the 1000-volt HT filter (with insulator), the mains filter (boxed, to rear) and the relay lead and keying filters (circular housing).

The basic formula for the half-wave filter was first published by W. L. Everitt in the 1st Edition of *Communication Engineering*, 1932 (McGraw-Hill Publishing Co.), and filters based on this formula were fully engineered and described in the November-December, 1949, issue of the G.E. *Ham News*, published by the Electronics Department, International General Electric Company, Schenectady, New York, U.S.A.

The "Harmoniker" is designed to work on any one amateur band and will attenuate all harmonics from a signal transmitted in that particular band. If multi-band operation is required, separate "Harmonikers" can be constructed for each band.

One great advantage that the half-wave filter exhibits over the conventional low-pass type is its ability to cope with mismatch on the feed line. By virtue of its configuration the input impedance of a correctly constructed and adjusted half-wave filter is the same as the load impedance, and this means that the filter

will operate satisfactorily under quite high standing-wave ratios providing the components in the filter are rated for operation under these conditions. The circuit and component values for an unbalanced half-wave filter suitable for use with 50-ohm coaxial cable is shown in Fig. 4.

The inductances L1 and L2 must be checked for resonance at the operating frequencies in conjunction with C1 and C4. This check can be made by soldering a low-inductance earthing strap to the lead between L1 and L2, where it passes through the shield. When the coils have been trimmed by opening or closing the turns for resonance, as indicated by a grid-dip meter, the earthing strap should of course be removed.

The working voltage specified for the condensers is based on a 2:1 mismatch for 150 watt AM telephony operation, with the exception of the 1.7 mc band where the 10 watt power limitation applies.

In common with low-pass filters, half-wave

filters should be carefully constructed to ensure a minimum of coupling between the input and output circuits and also between the separate filter sections. Under no circumstances should a half-wave filter be operated on a frequency for which it is not designed, as this will cause damage to the components.

Stubs

It has been suggested that shorted stubs connected across the transmission line to the aerial system can be used to reduce transmitter

harmonics radiated via the aerial system. This method is useful only when spot-frequency operation is contemplated, as the Q. of the stub circuits makes them very frequency conscious. Tests carried out in the South London area with 21 mc and 14 mc transmitters indicate that a stub will only work over a frequency range of about 40-50 kc from the selected frequency. Typical stubs for coaxial and balanced feed lines are shown in Figs. 5 and 6.

(To be continued)

Parasitically Excited Vertical

UNUSUAL AERIAL LAYOUT

S. H. AVERY (G4PR)

FOR the past year or so the writer had confined himself almost entirely to the LF bands with no particular desire for DX. Even the occasional run around on 14 mc brought little success. Suddenly, however, the urge to re-establish contact with the far corners of the earth manifested itself, and in spite of the XYL's fears that hideous additions to her clothes' line system were almost a certainty, a considerable amount of thought was put into the matter. Remembering the protests arising from about a hundred yards of heavy duty feeder-line meandering around the grounds of our "baronial hall," working into a rather ineffective vertical aerial, some different arrangement had to be evolved.

The radiating system in use at the station for some considerable time had been a 137-foot long wire originating from a 40ft. mast at the bottom of the garden and sloping down to a height of 15ft. at the transmitter. This aerial was quite useless for DX, especially as far as W's were concerned, as the high end was pushing towards the States and it is generally accepted that the radiation off a sloping wire is mainly from the lower end. Realising that greater low angle radiation had to be obtained, a half wavelength of wire was suspended from the high end of the aerial, separated from it by one eggshell insulator.

The results were absolutely astounding compared with any other system so far employed

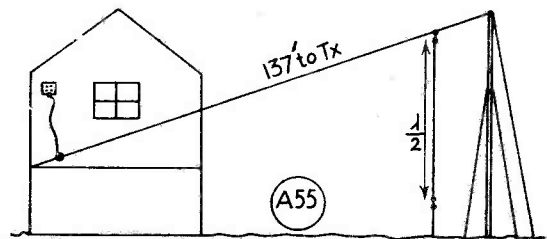

Fig. 1. Layout of G4PR's system. The vertical half-wave is not connected in any way to the main (driven) aerial. The nett result of this simple arrangement was such a change in the radiation pattern that DX never previously raised became workable with comparative ease.

at this location. Within one week (and, incidentally during a period of poor conditions) PY, VK, ZS, ZL, YI, VU, and W have been worked with inputs ranging from 20 to 100 watts, where before nothing like this was possible. The addition of the vertical section has not altered the loading or the effectiveness of the aerial on the other bands.

It is not claimed that this arrangement is better than some of the more complex systems, but it has at least proved itself very effective as an all-band aerial with the accent on DX.

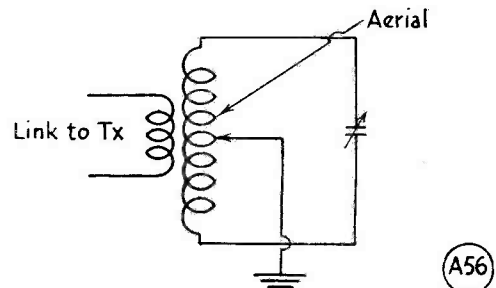

Fig. 2. Aerial tuning unit in use at G4PR, feeding the main aerial.

DX COMMENTARY

L. H. THOMAS, M.B.E. (G6QB)

IT's a remarkable thing, but we always seem fated to write these notes during a period of sub-normal conditions. We have had a good spell (in late September) and we shall doubtless have another good one before you read these words, but at the moment of writing the bands are rather lifeless. Actually, the 27-day solar cycle seems to be working pretty reliably this year, and one can predict the possible spells of good conditions within a few days. It's just too bad that the writing of your Commentary should continue to correspond with a depression!

The reasonable spell in late September affected the 21 mc band rather more than the others, and you will note from the Marathon table that scores have gone up more than somewhat. So let us deal first, as usual, with that band.

The DX on 21 mc

First prominence should be given to the arrival of the ZL's. On September 26 we heard ZL1AH working a DL, and his signals were never better than RST 229; the following day, however, he broke through at 0900 GMT with a much better signal and worked G6ZO (Edgware). On the following day, at the same time, ZO worked ZL4GA; thus his claim to first contacts on the band with both North Island and South Island is fairly secure.

VK's were coming through well at the same times—not only our regular stand-by VK9GW, but 2's and 4's as well, with 4FJ and 4HR giving about the best signals.



VESTW

CALLS HEARD, WORKED AND QSL'd

G3GUM (Formby) has been short of time, and thought the band suffered badly from the ionospheric storm in mid-September. However, round about October 12 he found it good. DX worked before the fade-out included CE3, MI3, KV4AA, ZS's and a W. The country total was swelled by SP, SM and the like.

G2BJY (West Bromwich) made his WAC with VK9GW, after having worked MI3, FA, CN8, EA9 and 3V, apart from the inevitable ZS's, PY's and a W2. G8KP (Wakefield) pushed his score up to 50, and recent new ones have been YI, CE, LU and SU. GC3EML (Jersey) found the band pretty poor and deserted it for 7 and 3.5 mc; however, he did work FA, Trieste and 5A for new ones, and his best DX was W6TZD.

G3ABG (Cannock), who worked the mysterious "X8EE" earlier on, received a QSL from LU8EE, so all is now explained. G2YS (Chester) raised VK4HR, TA3AA

and MI3KW. G5FA (London, N.11) added FA, YU and DL to his total last month.

G3FPQ (Bordon) is now QRT and in the RAF, but before his departure he did some nice work on the band, including a WAC in about five hours (on September 20). DX includes VK9GW and 4HR, YI2AM, PY, ZS, ZE, VQ4, KZ5, FF and ZP6CR for a new one. All this, by the way, with 24 watts, with which FPQ has now raised 119 countries and is waiting for a few more cards before claiming his DXCC.

The 14 mc DX

It used to be "Poor Old Forty," but nowadays it's getting to be "Poor Old Twenty." What with short-skip, commercial QRM and general bad conditions, the band is just about as bad as any of us have ever known it. Many of the one-time DX crowd have deserted it for 21 mc, and some have even been heard about on Eighty and the Top Band when Twenty has

supposedly been open for DX—a phenomenon hitherto unknown! G3GIQ (London, W.5) reports working SU5EB and CT3AF, but his Gotaways included HH3L, FR7ZA, FP8AP, HZ1MY and LZ1KAB.

G3FPQ didn't spend much time on the band, but managed to raise HZ1AB and 1MY, KA2RH, KG6AB1, KH6, KL7, VR2CK and VS6AE. G3ABG heard ZS3W, ZD9AA, VE7EW and KV4AA in one session, but otherwise found things very poor whenever he switched on.

G3HDL (Liverpool), kept away from work for four months with an injured knee, turned the time to good account and built a completely self-contained 30-watt rig which, with his indoor aerial, seems to go pretty well; KV4AA, HZ1AB, FP8AP and 5A2CC were new ones, and a bout of phone has made short-skip a pleasure instead of a bind. 'HDL has been savouring the joy of real QSO's instead of rubber-stamp touch-and-go tactics.

G31GZ (London, S.E.9) added ten new ones during the month, among them HB1JJ/HE, JA, FP8, HZ, IT, ZB2 and the like. He tells us that ZD7A is now active on 14006 and 14081 kc, and jumps from one to the other without warning when QRM gets too bad. C3AR and C3PG in Formosa have been heard, and there has also been an FD4AD active.

G8KP says, "to give the boys a laugh," that he has just bought a greenhouse and is going to try and grow some exotic tropical plants. This is a present from himself to himself, to celebrate his achievement of 200 confirmed! New ones on 14 mc were VS5ELA and LB6XD (Jan Mayen).

G3GUM says he "tiptoed in to view the body" once or twice, but he thinks someone raised the coffin-lid and took it away. His most interesting piece was PY8GZ (Manaos)—the first and only PY8 from the notorious Amazonas "graveyard."

Other stuff included EQ3TT, ZP9AW, VP6, FQ8 and AP2L (at 0900). VK2GW was the first VK worked on the band for about eight months, and VS7NS came through, using 15 watts.

G6QB was off the air for a

good deal of the month, but managed to find HR1RL (September 18, 1330) for an all-time new one. The only other DX worth mentioning was EQ3TT and KX6AI (both on September 22, mid-day) and ZS5QV, who is ex-G2QV freshly licensed out in ZS.

Top Band Topics

G3AAJ (London, E.12) says he is the only licensed amateur in the Trinity House Service, and he comes in for some pretty strong comment when a report arrives about "amateur chatter interfering with the Lighthouse or Lightship nets." But he adds the interesting news that the latter will be moved right out of the 160-metre band at the beginning of next year.

G8JC (Worcester) is now using an aerial 183-ft. long, 26 gauge wire, and 160 ft. of it only six feet high! One of the disadvantages, so he says, of being a council house tenant! But he has been working GM and GW on it. G3FQC (Worcester) took a 38 Set on his holiday and made a few phone contacts with an input of a quarter of a watt.

G2NJ (Peterborough), whose Counties score is in the fifties, tells us that the best one he has heard of is G13HFT, with 61 worked and 48 confirmed. G6ZN (Horbury) has worked 53 this year with his usual input of 3 watts. Between them, these two chaps give the following gen.: G3FUR (Stamford) is hoping to operate from Rutland and Hunts., and should be keenly sought after. GM3DJR in Caithness is a good bit of DX for the Southern boys. And HA5BT, HA5BQ and OH3NY are all active for those who want the real DX. Don't forget the Trans-Atlantics—see further on for dates and times.

Ten-Metre Activity

Last month's "nil report" stirred up some of the occupants of Ten, and we have a bit of news this time. G3GIQ says it has been open for a while on most days, and his phone contacts include CR6AG, LU, PY, OQ5RU and 5VD, three VQ2's, eight ZS's, two ZS3's, two ZE's and ZD9AA. An FQ8 and a ZD2 got away.

G3FPQ, using ten watts of phone, raised ZS6OY for his first ten-metre ZS contact of any kind.

G3HCU (Chiddingfold) refers to last month's Editorial and suggests that what is needed is an "Activity Sunday" for ten metres only, to stir up some of the sleepy ones and see what *can* be done in the way of inter-G working on the band. He has worked some 30 G's himself in a short period and suggests Sunday, December 7, from 0800 to 2000 GMT. (This clashes with the All-European DX Contest, but probably doesn't matter).

We will willingly back him up in this, so bear the date in mind and we will jog your memory again in the December issue. Get on Ten during December 7 and see what you can work, whether local, GDX or just DX.

Eighty Metres

The 3.5 mc band seems to be the "dud" this month, with hardly anyone mentioning it. However, G3FPQ worked VP9G and VQ4HJP, and heard PY7WS and ZD4AB; and G8KP raised Y13BZL (who, we understood, was QRT). We also happen to know that ZC4RX had some phone contacts with G stations on Eighty. By December it should be getting really lively, and VS7NG has promised to get cracking again.

21 MC MARATHON

(Starting July 1, 1952)

STATION	COUNTRIES
G8KP	50
G3GUM	47
G2VD	45
G2BJY	41
G6QB	39
G8OJ	31
G5BZ	29
GC3EML	29
G2YS	28
G3FXB	21
G3ABG	17
G5FA	13
G2DHW	6

More New Countries

6L6MY was our friend HZ1MY operating from Qatar—not yet acknowledged officially as a new one. Some of the MP4's licensed from Bahrein were actually operating from Qatar, anyway. 4X4BX plans operation from SV5 and SV6 some time, but we have no details. If you hear someone with a "9A1" prefix it's probably emanating from San Marino.

Almost at the moment of going to press, ZD9A showed up, accompanied by the finest display of Aurora Clottiana yet seen. There were Clots above him, Clots below him, T7 super-Clots on top of him; some calling while he was calling; some calling him on the HF side while he was actually working someone on the LF side. The prize goes to the Complete Drip who called CQ on the frequency and, on being asked to QSY, started a long non-stop call to ZD7A, obviously not even having heard him. Despite all these manifestations and many other varieties of rattling bones, one or two G's were heard to raise him (we think G3AAM was the first). Perhaps by the time this reaches you, you have *all* worked him; we hope so—then we might possibly get a look in ourselves! Rumour has it that he will also be on 28 and 21 mc—probably to escape some of these displays.

ZS6ZU/P is on Marion Island, but so far he just seems to work ZS's in reply to his CQ DX calls. It's not for want of DX replies, either.

All these new ones, and the commotion they cause, give rise to the suggestion that the best thing that could happen would be for the Isle of Wight to be allotted a separate prefix; then the active boys over there could keep some of the chasers busy while the rest of us had a quiet look round for something else.

So if you ever hear GV6QB on the air, you'll know that we have retired on pension. (V for Vectis, in case you don't know.)

The Overseas Mail

ZS6ACD (Johannesburg) sends a word or two about conditions down there. Without being very active, he managed to snag several

new ones, such as ZC4, TA, FR7ZA, KG4AF, VS9AW and EA9AP. Gotaways included KX6AR, on phone, putting in an S9 signal. 'ACD is puzzled about the KA prefix for Japan, being slightly muddled about the *former* KA for Philippines. "KA," for U.S. personnel in Japan, follows the scheme of KH for Hawaii, KG6 for Guam, and so on—but they couldn't allot KJ because it was already in use for Johnston Island.

3A2AQ was operated by F7BB, whose QTH is now Chateau Melleray, St. Denis-en-Val, Loiret.

ZL2GX (Gisborne) was the first ZL to apply to us for a Certificate; he received two—the WNACA and the WFE! He tells us that the NZART now has three awards of its own. The WAP is well known; WAD (Worked All Districts) is for all four ZL districts worked on 50 mc or a higher frequency; WAB (Worked All Branches) is for a minimum of 35 different branches of the NZART, scattered from one end of ZL to the other. The latter two are intended for ZL amateurs, but applications *have* been received from overseas.

VQ4AA (Nakuru) sends some interesting news for the Phone gang, of which he is a noteworthy example! He has deserted Twenty for Ten, on which band he has worked 37 countries in three weeks. The only area missing is VK/ZL, and it is surprising to see that he has worked such countries as KG6, VU and VS7, apart from all the South Americans and most of the Africans. KG6 is nearly halfway round the world from VQ4. There are seldom any openings from there to W, but South and Central Americans are always present.

VQ4AA suggests that on Ten (as, indeed, as on 21 mc) there is *too much* listening and not enough calling. A CQ call on an apparently dead band has, without fail, brought a reply, even at such times as 0930 and 0015, and the band seems to be open to somewhere-or-other for about 18 hours of the 24.

The gear in use at VQ4AA is only 90 watts to a pair of 807's and a vertical dipole, but it certainly gets out. General news

WAZ MARATHON, 1952

Station	Zones	Countries
G5BZ	36	149
G8FC	36	114
G3FXB	35	122
G2VD	35	118
G6QB	34	118
G3FXA	34	96
G2DPY	33	109
G6YR	33	103
G3GUM	32	100
G6QX	32	93
G3DOG	32	93
G3FPQ	32	85
GM2DBX (Phone)	29	94
G3BDQ	27	98
G3GMN	27	55
G2BW	25	85
G3TR (Phone)	25	76
G3ABG	24	86
G5FA	24	70
G3HDL	22	64
G3HZL	18	56
G5GK	17	24
G3IGZ	16	59
G2GMQ (Phone)	14	42
G2BAM	13	46
G6TC	12	37
G3FPK	11	31
G2BJN	10	37
G3HH	10	33
G2VJ (Phone)	8	12
DL2SU	4	28
G4QK	4	7
G2BP	3	15
G3GVY	2	11

NOTE: New entries in this table must not include QSO's dating back more than two months from the time of entry. Regular reporters should send in their score month by month — three months' failure to do so will be taken to indicate loss of interest and the score will be deleted.

from Bob is that VQ4RF leaves G-land on November 2 and will be on the air again before the end of the year; also that VQ4BU has now become VQ3BU; VQ3PBD is in G-land on holiday; ex-VQ4SGC is now VP55C; and VQ1 territory remains silent.

VS2CP (Kedah) has been on leave in Australia, and his rebuilding is proceeding very slowly, as he is now married! He will be on again with 120 watts and a 3-el beam unless he is moved again, and says things are somewhat warlike still, with bombs,

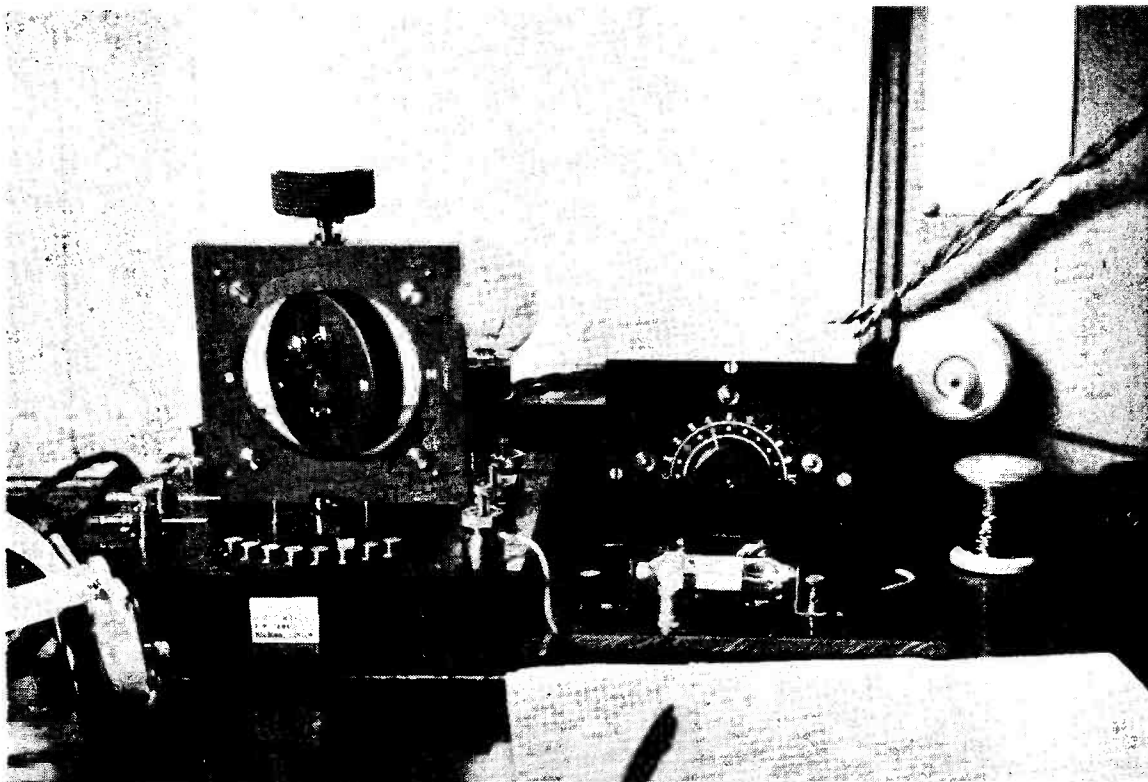

From the collection of early gear owned by G6TJ, Malvern. His first single valve reacting receiver for experimental reception, about 1920. It had tapped aerial and reaction coils and was marketed by A. W. Gamage, Ltd., the well known Holborn firm.

rockets and 25-pounders on the garden lawn.

VS2DQ, now a near neighbour of VS2CP, is none other than ex-ZC1AL. He has a B2 going, mostly on 14 mc, and says he has received G's quite well, not only on 21 mc but also on 3.5 mc!

VS9AW reports again from Aden, and says Twenty has been pretty poor out there too. He says it's wonderful how stations will queue-up for a contact, and he tries to be as fair as possible, except to queue-jumpers. DX contacts have included VQ8, CE, ZD9, lots of W's and G's and, of course, all the Africans. Note that VS9AW is not allowed to operate below 14100—his CW work is mostly on 14105; he hopes to be active on 21 mc before long.

DL2SU (BAOR) has been hearing some nice stuff on 7 mc, and he has even found 14 mc quite good between 1700 and 2100

GMT. But with his B2 he has only succeeded in raising W and 3V. He has suffered an enforced QRT due to mains failure, but will be home shortly, and on the air for a while as G3ICH.

General Patter

G5BZ (Croydon) has been working on his beams in readiness for the winter DX (if any), and has added a 2-el 21 mc beam to his 14/28 mc array. He has found general conditions very poor, the only excitement being ZD7A, who seems to work nothing but ZS's.

G3IHI (Swindon) has now got a "ZL Special" going, and finds it well worth while. But he still lacks VK/ZL for his WAC! He worked South America the hard way by raising VP3VM, after calling dozens of LU's and PY's.

G8FC (Locking) is back on the air after having a strenuous time

on the beach at Weston-super-Mare during Battle of Britain week. During that period the station was active from 1000 to 1800 in a marquee, and worked VK, KL7, KG6, KX6 and the like. Activity was on 80, 40 and 20, and the exhibition of Service and Amateur Radio included some very interesting gear. (The Light Programme was received throughout the period on a 1910-14 crystal receiver of R.A.F. type!).

SWL H. Lawton (Huddersfield), who is in the Merchant Service, tells us that he had a very interesting time in Angola with CR6AA, 6AJ, 6AR and 6CQ. He says that these chaps QSL "one hundred per," but the mails are unreliable, to put it mildly, and it is suspected that not everything that goes into the local GPO can be guaranteed to leave it! He was receiving G4VZ at R5 and S9 plus down there, although the G had a Vee-beam directed on

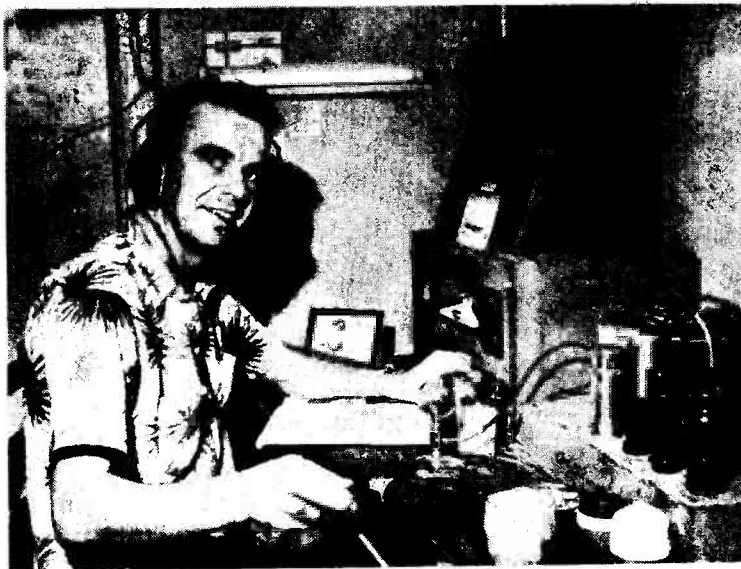

Station MP4KA1, Kuwait, Persian Gulf, is operated by ex-ZC6BF-G3CBF, who is active mainly on 14 mc. The Tx runs 50 watts to an 807, modulated by a pair of push-pull 6L6's, and his receiver is an RME-45.

Canada. Another item is that the call CR6CC does *not* emanate from Angola, since no one knows him in those parts.

G3GUM comments on the new "keep-it-dark" technique. Many people now realise that HZ1MY operates from all sorts of odd corners, but keeps to the HZ prefix to avoid a pile-up. So if you work him you may get a nice Christmas present from VQ6, FL8, 4W, YA, CR8 or somewhere telling you that you worked a new one without knowing it. We could query the ethics of this, but won't bother. However, it gives rise to a good story G6YQ (Liverpool) has a sked with JY1AJ and calls "AJ AJ AJ de G6YQ." Back comes VP8AJ!

KV4AA has told 'GUM that CE3AG will be operating from Easter Island with the call CE0AA—some time this winter. Final Funny One—a "ZC2MAC" was heard. RST 586, calling CQ. The genuine one has, of course, been back at VS7MC for some time.

Incidentally, this may be the place to say that your Commentator has, at present, the choice of three aerials, all pretty directional and reasonably reliable as regards which countries are strongest on

which aerial. From time to time DX stations are heard, giving maximum strength on the *wrong* one; for example, the one that is only really good for ZL and South America brought in a terrific signal from a type purporting to be F18AB, who was much weaker on the one pointing in that direction. Do the fortunate

owners of rotary beams find the same thing very often? It seems that a good reliable DF station operating on 14 mc could tell us some very enlightening stories.

The Top Band Trans-Atlantics

Last month's preliminary notice gave the dates of these tests—December 28, January 11 and 25, and February 8 and 22—for the *Short Wave Magazine* Trans-Atlantic Tests, Third World Series. We have now heard from W1BB that the suggestion, over there, is that the December 28 date, being so near Christmas, should be regarded as a try-out for equipment and so on, and that the really heavy schedule should be the two Sundays in January and the two in February.

Stewart Perry also gives the excellent news that these tests will, this year, receive more publicity than ever on the other side. *QST* will run a notice in their December issue. *WIAW* will broadcast details on all frequencies, and the *ARRL* are mailing the particulars to all branch officials.

With plenty of activity always assured on this side, we rely on the enthusiasm of the W's and VE's to make the Tests a success, and this year it seems that we may count on considerably increased

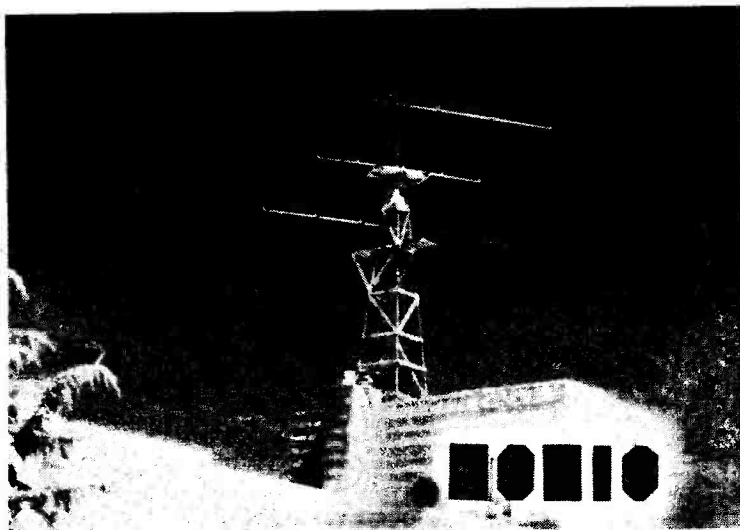

An impression of the rotary beam assembly at W6NIG, Vallejo, California.

W/VE support. Polish-up your aerial systems—they are about the only thing that matters, so long as you have ten fairly efficient watts!

By the way, rumour has it that VP5BF, VP5BH and VP7NM will be participating.

Certificates and Awards

The following are details of the holders, up to date, of the three *Short Wave Magazine* awards—WNACA, WFE and FBA. The Worked North American Call Areas Certificate has been awarded to:—

1. GM3DHD (Edinburgh)
2. G8KP (Wakefield)
3. G6LX (Croydon)
4. G2BXP (Birmingham)
5. SM5LL (Enskede)
6. G3CVG (Wakefield)
7. GW4CX (Flint)
8. G13ACV (Bangor)
9. G6BS (Great Shelford)
10. G6TC (Wolverhampton)
11. G5HS (Thame)
12. DL7AA (Berlin)
13. G5LH (Horbury)
14. G2WW (Penzance)
15. G3DOG (London, W.3)
16. GW3JI (Llandudno)
17. HB9EU (Cham)
18. 4X4BX (Lydda)
19. ZL2GX (Gisborne)
20. I1IZ (Livorno)
21. F9FS (Roubaix)
22. CN8MI (Casablanca)
23. SM5WI (Eskilstuna)

The Four-Band Award has gone to:—

1. G8KP (Wakefield)
2. G2AJ (Biggin Hill)
3. DL7AA (Berlin)
4. HB9EU (Cham)
5. 4X4BX (Lydda)
6. G2BJY (West Bromwich)

WFE ("Worked Far East") Certificates have been successfully claimed by the following:—

1. G3ATU (Roker)
2. PY1AHL (Rio de Janeiro)
3. ZL2GX (Gisborne)

And the most difficult of all, the *Magazine DX Award*, has, as yet, been credited to only one claimant:—

1. G2PL (Wallington).

Details governing the issue of



Station of G6TJ, Malvern, who is on 20-metre CW only, with a 6L6-815 CO PA transmitter using switched crystals, into a ground-plane aerial. The receiver is a BC-348. G6TJ held an "experimenter's licence" (as they were then called) in 1919, and first came on the air as 2OG in 1923.

these Certificates appeared on p.288 of our issue for July, 1952.

Deadline for next month is somewhat early—**first post on November 12**. Make a good note of this date and please don't be late; our tight schedule allows for no delays. For the following

month the date will be Monday, *December 15*—early, because of Christmas. Address it all, as usual, to "DX Commentary," *Short Wave Magazine*, 55 Victoria Street, London, S.W.1.

Until next month, 73 and Good Hunting.

OVERSEAS SUBSCRIPTION RATES

Further to the note appearing on p.496 of our October issue, and in response to enquiries, following are some other countries with the *Short Wave Magazine* subscription rate quoted in the local currency: Argentine, Ps.61.5; Australia, 38s. 6d.; Brazil, Cr.82; Chile, Ps.551.25; Denmark, Kr.30.46; Germany (West), Dm.18.625; Mexico, \$40; New Zealand, 30s.; and Norway, Kr.31.5. These rates cover all bank and collection charges and are based on the latest exchange quotation.

URGENT APPEAL

To all those who may have worked WINKW on ten-metre phone during the period 1947-'50: He has lost all his records and DX QSL cards in a fire, and would greatly appreciate it if G's and other Europeans who QSO'd him at this time would be good enough to duplicate the QSL's. At present, WINKW is incapacitated through illness, which makes his request all the more compelling. The QTH is: H. W. Ryall, WINKW, 67 Fox Hill Road, Nahant, Mass., U.S.A.

American Visit

C. R. PLANT (G5CP)

A brief account of some Amateur Radio experiences and encounters during a recent trip to the United States and Canada.

IN February this year the writer sailed for New York in the R.M.S. *Queen Mary*, making for St. Louis, Missouri, where he was to supervise the erection of specialised electrical equipment at a Coke Oven and By-Products Plant. (This contract, incidentally, was valued at over £1,000,000, bringing us some more of the much-needed dollars.)

Having been a marine radio operator (1923/29), the ship's radio equipment was of great interest and many pleasant hours were spent in the *Queen Mary's* wireless room. Here three operators kept continuous watch, covering medium, long and short wave circuits, and the radio telephone service.

Although, as an amateur, many trans-Atlantic phone contacts had been made, it was a particular thrill to put a radio telephone call through to home when half-way across the Atlantic.

A letter came aboard at Ellis Island from W2MFT (Jack Atkins, Fair Lawn, New Jersey) to say that his wife would be at the pier. The problem of identification presented some difficulty. It was overcome by fixing a QSL card to the G5CP headgear, and this, whilst causing onlookers some amusement, had the desired effect!

A pleasant three days were passed in the company of W2MFT and another local, W2PVS, who had also been worked from England, and many interesting discussions took place. One evening was spent touring Radio City, where, in company with other visitors to New York, the writer was televised on the C.B.S. System. The following day a trip was made to the top of the Empire State Building, on which there is a 150-ft. mast carrying five television transmitting aerials; these, due to the extreme elevation, give a wide service area.

W2MFT has a multi-channel TV receiver and it is possible to

select six or seven programmes at any time of the day. The quality of picture is very similar to that presented by the B.B.C., but one found the frequent interruptions, to put over high-pressure advertising material, very disconcerting. In this connection, it is interesting to note that an American company now markets a device consisting of a push-button unit and length of flexible cable which, when connected into the audio circuit, can effectively silence the voice of the advertiser!

The W0 Country

After visiting the Works Site at St. Louis, contact was made with an old radio friend, W0EET, who

is engineer-in-charge at a broadcast station.

A great deal of time was spent with W0UYC (Webster Groves, Mo.), who runs a full kilowatt on 14 mc and 800 watts on 3.5 mc. He also operates on most of the remaining bands and has a particularly fine rotating beam array for 14 and 28 mc. Many excellent QSO's were made from this station with amateurs in all parts of W. VE, VK, ZL, ZS, etc., and several old friends were surprised to hear a familiar English voice coming from an American station. During one of these transmissions a telephone call came in from W0GEK (St. Charles, Mo.), who said he had been searching for the writer for a considerable time since hearing from ZSIT that G5CP was due to visit St. Louis. He had arranged for schedules to be kept on Saturdays and Sundays, and this resulted in several pleasant visits to his week-end home in the country. The location of W0GEK was one of the

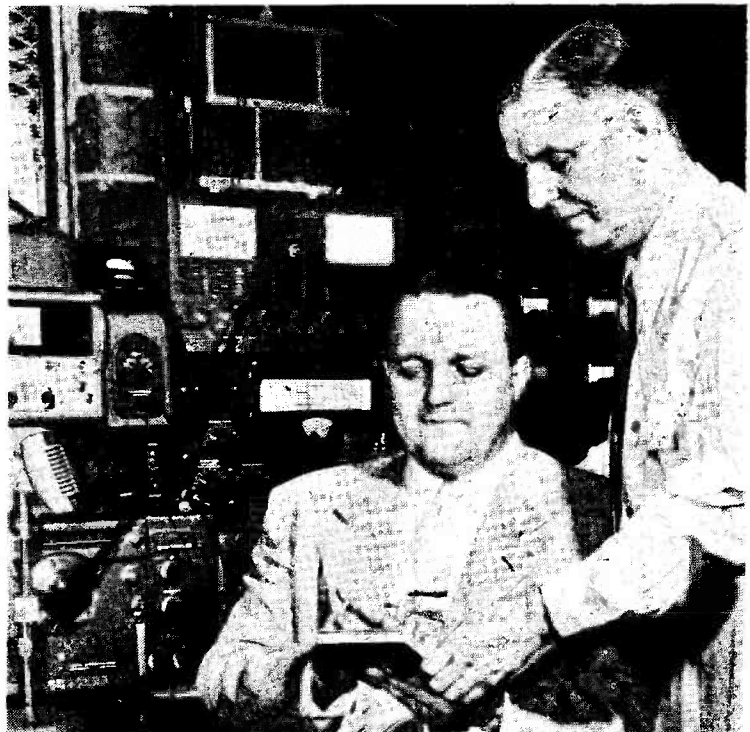

G5CP (standing) with W0UYC, Webster Groves, Mo., during a recent visit to the States and Canada.

finest seen, being situated on the top of a wooded hill overlooking the Missouri River Valley. He has a Collins 125A transmitter and a 3-element 28 mc beam. Even though conditions on Ten were very poor, several contacts were made with ZS1T, VP6YB and other old friends, including some in VK and ZL.

Mobile Operation

It was surprising to see how many of the American amateurs had mobile transmitting equipment fitted to their cars, and frequently they hold QSO's whilst driving at high speed on the main highways.

On one occasion, shortly after working a station in St. Louis 30 miles away, a car arrived bringing WØXCX and his XYL, who wanted to see what this English fellow looked like; this resulted in an invitation to visit their station, and some days later G5CP was picked up for an evening with WØXCX working round the locals on 3.5 and 14 mc.

During the stay in St. Louis, the Mississippi and Missouri Rivers overflowed their banks in the higher reaches, causing devastation to vast areas of the more Northerly States. It was interesting to hear the amateur emergency networks operating flood traffic—and easy to understand why the amateur has so high a standing in

the United States. Their highly-organised, efficient service, freely given to the country in times of disaster, is of great practical value to the community. The British amateur does not have the opportunities afforded to the Americans for public service of this kind, and this may explain why there is so great a difference between the regulations governing activities here and in the United States.

Whilst in Missouri, stations visited included W9PAM (Belle-ville, Ill.) and W9ICF (Waterloo, Ill.), both of whom had been worked from England. At W9PAM's invitation, G5CP attended the St. Clair "Hamfest," where a large number of W9's and their XYL's were present. During a short talk, he described amateur activities in Great Britain; many questions were asked about our licence conditions and power limitations. One came away with the impression that the American amateur is keenly interested in the other fellow's problems.

Into Canada

After completing the work at St. Louis, a train journey north was made *via* Chicago, Ill., and Detroit, Mich., to St. Catharine, Ontario. Here the writer was met by VE3TW (Cyril and Ethe) Williamson, who two years previously had visited England and

stayed at his home, and it was therefore a great pleasure to see them once again. Their home is unique in that it is situated in a lighthouse on Lake Ontario, at the western end of the Welland Canal. VE3TW operates on all bands, including two metres, and has a very fine system of aeri-als, with several beam arrays. From the lighthouse, radio contact is maintained with the mainland at regular intervals and, in addition, a ship's radio beacon transmits for one minute every hour and continuously during foggy weather. VE3TW has a small boat fitted with an outboard motor, and several interesting trips were made to nearby beaches. Many amateur band QSO's were made, notably with W6UHA (Maxine Willis, Los Angeles, Cal.) and stations in various parts of Canada.

During the whole of his three months' visit the writer was repeatedly entertained by amateurs in their homes, and this in no small way contributed to the enjoyment of what would otherwise have been just another business journey. In every case, kindness and hospitality were overwhelming.

It is good to know that in a world where differences of opinion exist there are organisations such as Amateur Radio which promote friendship and goodwill regardless of colour, creed and nationality.

GIFT SUBSCRIPTIONS

With Christmas drawing near and the problem of presents once more looming, consider a subscription to *Short Wave Magazine*. This costs but 30s. for a year of 12 issues, sent post free each month to any part of the world. Order on The Circulation Manager, Short Wave Magazine, Ltd., 55 Victoria Street, London, S.W.1.

DIARY FOR 1953

The well-known *Wireless World* diary for 1953 is again available and is now in its 35th year of publication. The 80-page reference section provides in tabloid form the kind of technical information so often needed by radio men, but so seldom readily to hand. The technical data includes circuitry, useful formulæ, graphical designs for coil windings and circuits, abbreviations in common use, abacs, BA screw and drill sizes, the Q-Code and Morse alphabet, component codings, mathematical signs, valve base

connections, wire tables and much other essential reference material. The diary pages give a week at an opening, and either of two bindings are available: leather at 6s. 1½d., or rexine at 4s. 7d., post free, from Hiffe & Sons, Ltd., Books Department, Dorset House, Stamford Street, London, S.E.1, or any bookseller.

PIRATE APPREHENDED

At Truro City Petty Sessions on September 22, Cyril John Tonkin, of St. Clement, Truro, was convicted of operating a transmitter without a licence. He was fined £10, with £8 10s. costs, and all his apparatus (said by the prosecution to be worth at least £100) was confiscated by order of the Bench. GPO officials described how they intercepted Tonkin's signals, and evidence was also given by a licensed operator with whom Tonkin had been in contact. The case was fully reported in the *West Briton and Royal Cornwall Gazette* of September 22.

12-Element Stack for Two Metres

EASILY CONSTRUCTED
ROTATABLE ARRAY

A. G. WOOD (G5RZ)

There are numerous different types of beam head which can be put together easily, and almost as many ways of erecting and rotating the finished assembly. The right approach would seem to be to regard the rotating mechanism and the mounting as a permanent but easily managed structure on which various beam heads can be fixed as occasion arises and the experimental urge demands. To this end, the mounting must be easy to raise or lower, preferably single-handed. The article below describes in detail the design and construction, from the mechanical point of view, of an effective two-metre beam and its mounting. It is not necessarily the "best beam," nor is the method of erection such as to suit every location — but the design as given is sound engineering and will show that VHF beam erection can be quite a simple job if tackled along the lines suggested.—Editor.

SOME form of rotating array is an essential piece of equipment for the VHF worker if the best results are to be obtained at these frequencies. The purely mechanical considerations surrounding the construction and erection of such an array for 145 mc are very much simpler than would be the case for 28 mc, for example, on account of the smaller physical size of the elements. Nevertheless, these problems still exist and it is therefore felt that the constructional details employed by the writer in the recent fabrication of a 12-element Stack might be of general interest.

This type of array was selected, as opposed to the popular 3- or 4-element Yagi, on the grounds that improved horizontal radiation of the former would well repay the somewhat more complicated construction called for.

The 12-element stack comprises three pairs of dipoles horizontally disposed and stacked vertically with half-wave spacing between each pair, backed by a similar number of parasitic reflectors with 0.15 wavelength spacing. Each driven element is end-fed, the feeders being connected to the centre pair with a phasing network so arranged that the system operates

as a colinear broadside array. With the dimensions given in this description the system can be matched very satisfactorily into 300 ohm Telcon flat ribbon feeder directly. The instantaneous current flow in the elements and phasing network is shown in Fig. 1.

In any form of rotating beam, it was felt that the main considerations, from a mechanical point of view, should be (1) extreme lightness; (2) maximum mechanical strength; and (3) low windage, and these points have been kept well in mind. So much so that the total all-up weight of the beam head to be described, complete with elements, has been kept down to something under 15 lbs.

General Construction

The main framework or "birdcage" is constructed from 1in. square straight-grained Columbian pine which, when planed down, will measure $\frac{7}{8}$ in. square, and for this purpose nine 7ft. lengths will be required. (The local saw-mills will pick you out some nice pieces if asked in the right manner.) From these nine lengths select six of the best for the main uprights and from the remainder cut 4 lengths measuring each $40\frac{3}{8}$ ins., avoiding any knot-holes or weak spots. Referring now to Fig. 2, proceed to assemble two identical units exactly to the measurements shown. Notice that the

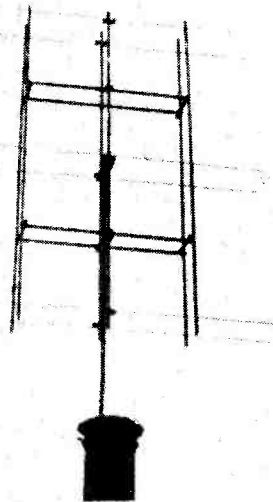

The 12-element stack, as constructed by G5RZ, in its operating position. It is rotated on its vertical axis, and there is no out-of-balance weight.

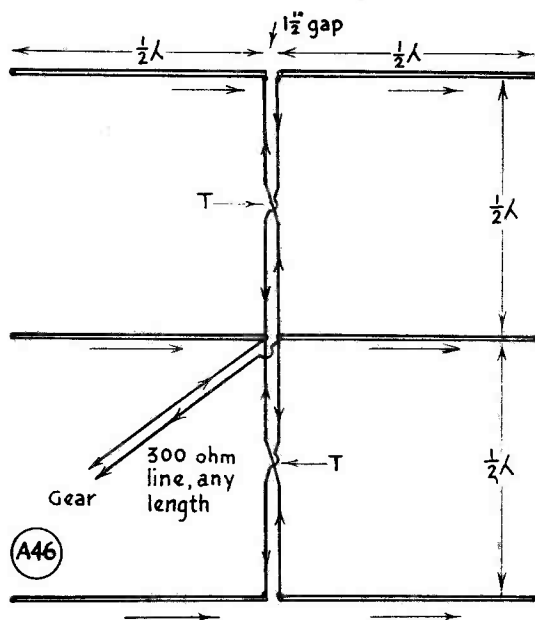

Fig. 1. Electrical layout of the elements in the driven section of the 12-element stack. These six elements are backed by an undriven set of six more, to the dimensions given in the text. Dural tube is used for the elements.

measurements given are centre-to-centre. Both the main spars and the cross-members should be slightly morticed (to the extent of $\frac{1}{8}$ in.) at their junction points, in order to improve lateral stability.

Each joint should receive a sufficiency of Durofix cement and before this has had time to set the two members should be firmly screwed together with $1\frac{1}{2}$ in. wood screws, one from each side. To avoid the risk of splitting, it is advisable to drill through the top member before screwing, using a slightly smaller drill size than the gauge of screw.

Next prepare six pieces of 3 or 5-ply wood to the dimensions shown in Fig. 3 (top). These are recessed in to the two centre uprights in the position shown in Fig. 2, and Durofixed and screwed into position, using small c/sunk screws of convenient length. All screws employed should, if possible, be of brass in order to avoid rusting, but these are not so readily obtainable at the present time, so that steel may have to suffice.

The two sides of the "birdcage" are joined together by the four short cross-members marked "A" in Fig. 2, and these are Durofixed and screwed both to the vertical and horizontal members in each case. The exact length of these cross-members will depend, however, upon certain other factors, so that this operation will follow later, as will be shown.

The twelve elements consist of $\frac{3}{8}$ in. o/d 20 gauge dural tubing. The six reflectors must be cut to exactly 40 ins. and the six driven elements to $38\frac{1}{2}$ ins. Taking the driven elements in turn, cut each one almost through exactly $\frac{1}{2}$ in. from the end, and then make a transverse cut at right angles so that you are left with an element exactly 38 ins. long having a projecting lug $\frac{1}{2}$ in. long. Clean up this lug with a fine file, drill it to accommodate a 6 BA bolt and then very carefully bend it down to form an angle of about 120° . This is the point of attachment for the feeder lines. Fig. 3 (centre) illustrates the result.

Each element is supported at two points by means of No. 1 Terry spring clips mounted on midget stand-off ceramic insulators, as shown in Fig. 3 (bottom sketch). A total of 24 mountings are therefore required, half of these being fixed to the main uprights at the correct vertical spacing: the remaining half are accommodated on the plywood brackets.

It is important that the centre-to-centre spacing between front and rear elements be

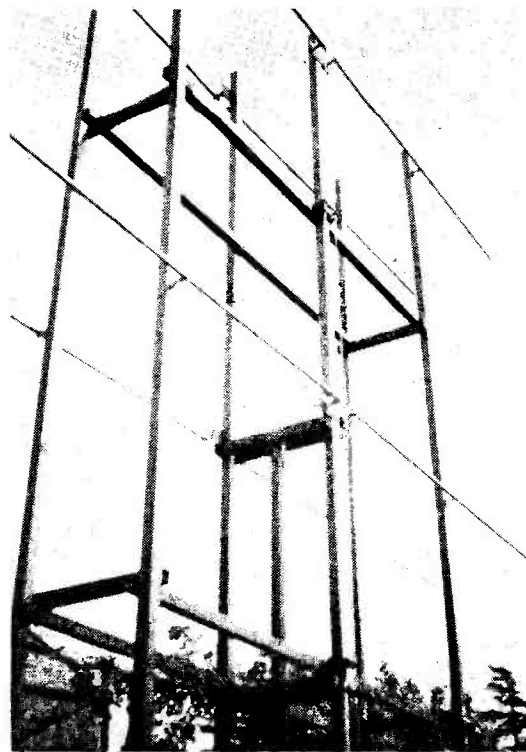

General construction of the 12-element two-metre beam, with only the middle and upper sets of elements actually visible. The framework is of light timber and mounting is at the point of balance. This open form of construction reduces whip and keeps windage to a minimum.

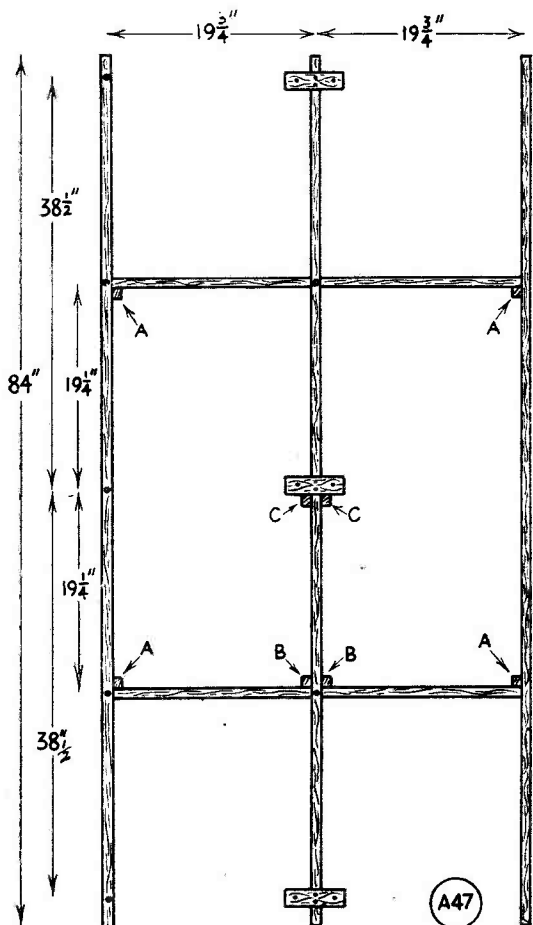

Fig. 2. Layout and dimensions of the wooden carrying frames two of which are required.

adjusted to exactly $11\frac{1}{2}$ ins., so that with a few elements temporarily clipped into position, the two sides of the "birdcage" may now be assembled and this exact distance measured off all round. (Temporary support may be provided by means of a few odd pieces of lath held in place with panel pins whilst the final dimensions of the cross-members are being determined.) Eight such lengths will be required and the four members marked "A" in Fig. 2 can now be securely attached, thereafter removing the temporary cross bracing. After a suitable period being allowed for the Durofix to harden the result should be a very rigid and light-weight structure.

The Beam Support

Next, provision must be made for receiving the supporting mast. The writer decided upon

$1\frac{1}{2}$ in. electrical conduit for this purpose having regard to the proposed height and other factors. If galvanised conduit is available this would be preferable to black enamel. Two of the remaining four spare cross-members are fixed in position "B" Fig. 2, and the remaining two in position "C." Both pairs should be radiused out at the centre so as to admit the $1\frac{1}{2}$ in. pipe.

The pipe is fixed to the top pair by means of a pair of lock nuts, the thread on the pipe end being extended for an inch or so to enable the nuts to clamp up against the top and bottom faces of the cross-members. Additional support is provided at position "B" by cross-drilling the two wooden members and the pipe to admit a $\frac{1}{4}$ in. bolt. This will transmit the radial thrust exerted by the pipe when rotation of the assembly is desired.

Before attaching the tube, the "birdcage" should be removed to a place of safety and given three good coats of creosote allowing an interval between each coat for the preservative to soak well into the grain. The plated Terry clips should also receive a coating of aluminium paint to prevent rusting. The elements do not require any treatment unless the beam is to be aloft for a term of years.

Feeder System

With the paintwork attended to and well dried off, all that now remains is to make up the feed connections. Clip the driven elements

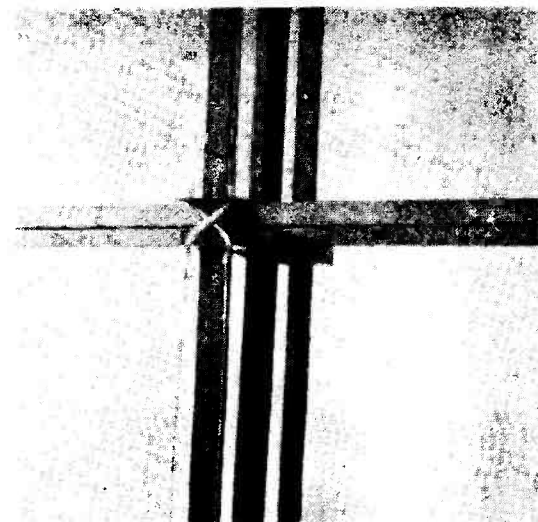

Transposition of the feeder line between each set of driven elements—see Fig. 1 for layout of elements, and Fig 4 for details of transposition block; two of these are required.

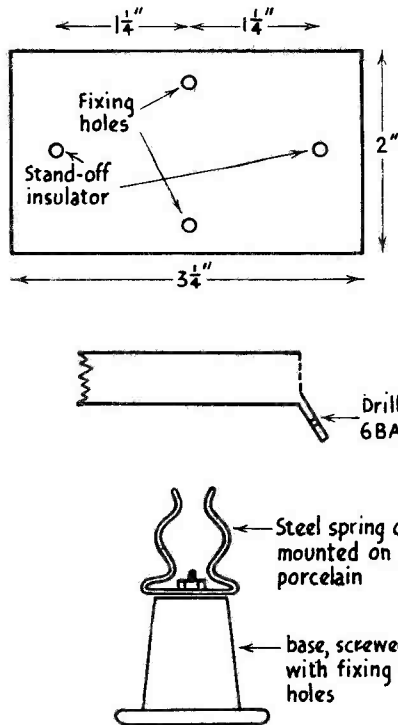

A48

Fig. 3. Mechanical details referred to in the text. Top, central element mounts. Middle, forming the connecting tag on the driven elements. Bottom, spring clip on stand-off insulator, for carrying the elements; two are required for each element, making 24 clip-insulators in all.

into position with the connecting lugs towards the centre, and start wiring up the phasing network using 16 gauge tinned copper wire. To keep the phasing correct, transposition of the feeders will be necessary at two points, as shown in Fig. 1.

The selection of suitable transposition blocks is largely a question of personal choice and availability of suitable material. The writer overcame this particular problem by using small rectangular pieces of paxolin sheet, two to each block, screwed to the cross-members with small cut-outs to accommodate the central vertical member. Cross-over insulation is provided by using short lengths of co-axial cable, with the casing, braiding and inner conductor removed, the residual length of insulating material being threaded on to the feeder wires and worked down until in the right position. See Fig. 4. Working from top and bottom towards the centre, the two pairs of wires are eventually joined together, well soldered and brought out to a small stand-off insulator screwed to the "C" cross-members, which serves as an anchor for the 300-ohm Telcon

feeder line. The feeder is taken down parallel to the conduit and held an inch or two away by means of suitable clips until it is well clear of the rotating structure.

Erection

Methods of erection of the whole assembly will doubtless vary according to individual ideas. It might be of interest to describe, briefly, the method being employed at the writer's station. A suitable chimney stack was selected—those serving the kitchen boiler are usually straight and clear of any over-hang. Two brackets were prepared by the local blacksmith. The lower consists of two U-shaped pieces, one drilled to take the 1 1/4 in. tube fitting inside the other and pivoted on two 3/8 in. bolts. The outer is drilled 1/2 in. and fixed securely to the stack at a convenient height to a 1/2 in. bolt cemented into the brickwork. The top bracket is a simple L-shape also drilled to take 1 1/4 in. and a 1/2 in. bolt into the stack, the two brackets being so disposed and of such a size that the 1 1/4 in. conduit will pass through each and be in a vertical plane. Two 1 1/4 in. set collars are used to take the down-thrust and a third fixed just below the lower bracket to prevent the mast pulling out when being lowered. A pulley block is also fixed just above the top bracket

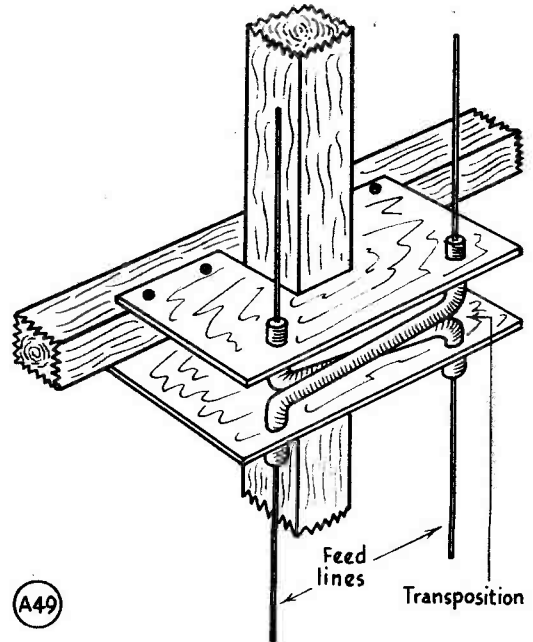

A49

Fig. 4. Detail of transposition block and feeder line—see photograph, and refer T in Fig. 1.

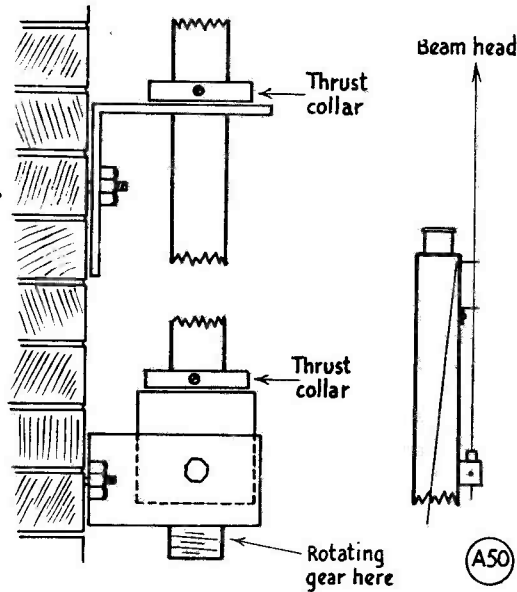

Fig. 5. General layout of beam support and rotating member. The thrust collars should be spaced as far apart as possible, with their supporting brackets accurately in the vertical.

not normally be tight and would then not retard rotation. However, in the writer's case where considerable exposure is present in a South-Westerly direction, the whole unit has successfully withstood several days very considerable buffeting without the suggested guy-wire arrangement.

Results

To date, the array has only been tested out for reception and in this respect it is giving every satisfaction, the most marked difference as compared with a random long wire being a phenomenal improvement in signal-to-noise ratio. Signals which, hitherto, were just audible above the "sharsh" level now become comfortable full speaker strength when beamed on.

The question of rotation is one which is likely to vary from individual to individual more than anything else, so much depending upon location, availability of suitable material, depth of pocket and the like. The method employed at the writer's station is only discussed, therefore, from the point of view of general interest, and, as one possible approach, in the hope that it will provide a basic outline useful to others.

through which is passed a rope, one end being looped around the conduit, the lower end being secured at ground level.

With the mast secured to the lower bracket and the beam in position, pull is applied to the rope and the whole assembly is then raised to a vertical position. It is tied thus whilst the top bracket is bolted into position and the rope is then slackened off. The procedure is, of course, reversed when it is desired to lower the assembly.

Sufficient tubing is left projecting below the lower bracket to which may be attached the rotating mechanism eventually decided upon, but not so much as to foul the fixed bracket as the assembly assumes a horizontal position. Suitable design of the brackets will take care of this point. It goes without saying that the top L-bracket should be fixed to the stack at the highest possible point in order to provide maximum support, and in exposed positions and gusty weather this may result in some degree of whip developing between top and bottom supports. This can be corrected by duplicating the top bracket *minus* the thrust collar and locating it on the stack half-way up. In very exposed positions added security and stability would be secured by staying the mast three-way with guy wires secured to an anchor plate, bearing against a thrust collar, just below and clear of the beam. These guys need

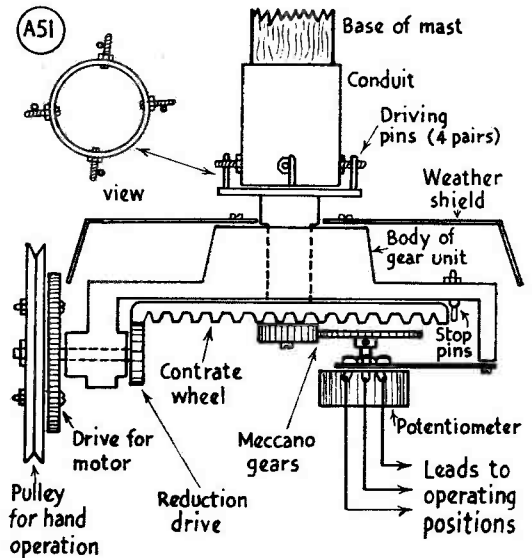
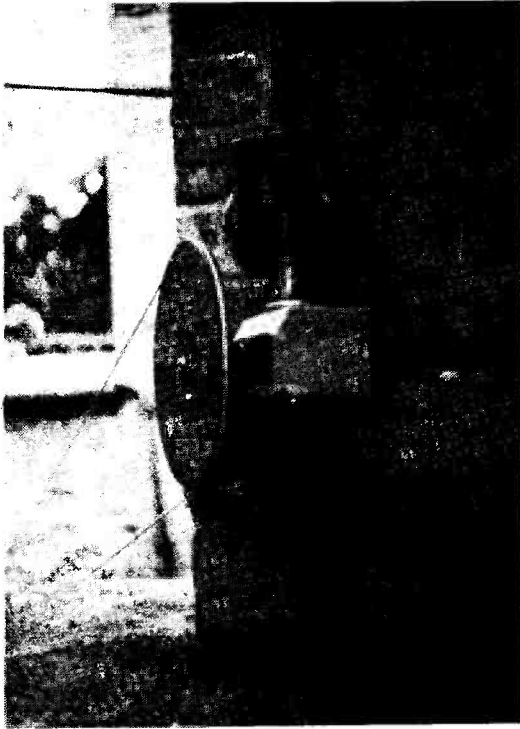

Fig. 6. General outline of driving mechanism and indicating device. The rotating control can either be rope round the large pulley, or by motor drive on the toothed wheel. The method of transferring the potentiometer settings on to the indicating device at the operating position is explained in the text—and see Fig. 7, in which R1 is the potentiometer shown in the sketch above.



Lower supporting bracket and reduction drive at the base of G5RZ's 12-element stack. This assembly rotates the mast through 350° and can carry any type of beam head. It has since been replaced by motor drive with remote control and indication.

Rotating Mechanism

The main unit consists of an unidentified piece of ex-Government equipment incorporating a right-angled reduction drive of 6:1 ratio. This is bolted to a piece of scrap steel sheet bent at right-angles to form a bracket, which bracket is secured to the wall of the stack immediately below the base of the mast. Slots instead of holes were cut out to accommodate the wall bolts so as to permit of about one inch vertical adjustment. The actual connection between base of mast and turntable is an ordinary conduit connector. At one end four holes are drilled out to take 2 BA bolts and so positioned that these bolts will engage with a similar set projecting upwards from the turntable. With the mast erected this collar is then screwed home; the drive bracket fitted to the wall and adjusted in the slots until the two sets of pins are in contact, thereafter being bolted up tight. Final drive may then be taken by a suitable motor and worm drive or else by means of the more prosaic pulley-and-string method to the shack. Fig. 6 gives a bare

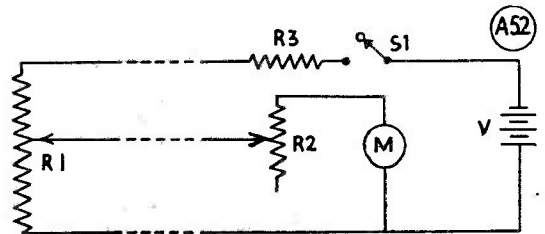

Fig. 7. Electrical layout of the beam rotation indicating device, using potentiometers, as described by G5RZ.

Table of Values

Fig. 7. Circuit for remote indicating unit.

R1 = 5,000 ohm indicating potentiometer	S1 = SPST control switch
R2 = 10,000 ohm zero-set potentiometer	M = 0.1 mA meter
R3 = 500 ohm limiting (safety) resistor	V = 4½-volt flashlamp battery

outline of the arrangement just described. An indicating device of some kind is highly desirable and the following description is one way of avoiding the expensive and hard-to-come-by Selsyns.

It should have been mentioned earlier that in order to prevent continuous rotation of the mast (with consequent fouling of the feeder cables) suitable stop-pins were incorporated in the reduction gear so that the actual rotation is limited to approximately 350°, the blind 10° area being positioned to coincide with the least-wanted area. Most potentiometers which are readily available only have an actual coverage of something slightly more than 270°, so that to overcome this trouble a little reduction gear made from junior's Meccano was built up, the small gear being fixed at the centre and to the underside of the turntable, engaging with the larger pinion which takes the place of the usual knob on the potentiometer; the latter is held in place *via* the single-hole fixing by means of a short bracket of scrap metal. By this means the available amount of potentiometer movement is not fully taken up by complete rotation of the mast. This fitting is also shown in outline in Fig. 6. Any convenient value of potentiometer can be used, 5,000 ohms being quite suitable. Three leads are then taken to the operating position in the radio room and connected up with a suitable pocket flashlamp battery, a 0.1 m/ampeter, a zero-set potentiometer of about twice the value previously chosen, and an on-off toggle switch. See Fig. 7 for circuit details. The adjustment is simple: The beam is set against the stop which leaves minimum resistance in circuit, the

toggle switch closed and the zero-set control adjusted to give maximum reading on the meter scale—i.e., 1 m amp. Rotation of the beam will then give a (more or less) linear reduction in current through the meter, and the whole device may then be calibrated with the aid of a compass, or if desired a fresh scale, marked in compass degrees, can be prepared and stuck

over the existing scale. Once adjusted the zero-set control will only require re-setting should the battery voltage be altered.

In conclusion, the writer would like to record his thanks to G6FO for the basic idea and all vital measurements with regard to the beam construction, and his helpful co-operation in over-the-air tests.

Beware the 6J6

EXPLAINING ERRATIC PERFORMANCE

K. W. CRANFIELD

It has often been found that the 6J6 is "uneven" in its performance, and it is frequently necessary to try several specimens to get the expected results. This interesting article explains why, and also shows that there are other types (such as the 12AT7) which are more suitable in circuits originally designed round the 6J6.—Editor.

THE increasing use of the 6J6 in amateur working and the recent articles by J. N. Walker (G5JU) and A. G. Wood (G5RZ), prompts the writer to add a word of warning regarding this valve which might be borne in mind by those contemplating using it in future equipment, such as push-pull oscillators and the G2IQ convertor.

Although the 6J6 is a double-triode with a common cathode, it will be found that in very few valves are the two halves balanced; this unfortunately is due to its construction, about which more later. To justify this latter statement a description of a few experiences with the 6J6 will be of interest.

Some time ago a specimen was tried as a "null" indicator in a piece of equipment, the two halves of the valve acting as the arms of a bridge with the meter across the anodes in the usual manner. It was found impossible to balance the bridge. Other valves were tried with varying success, although it was still not possible to obtain balance.

The original 6J6 was replaced and the voltage drop across each anode load resistor measured with a valve voltmeter; it was found that there was a considerable difference. This indicated that the valve sections themselves were not balanced. The characteristic curves were taken

of a few samples and these are plotted in Fig. 1 for two representative valves. From this it will be seen that if the valve is worked at near cut-off it is quite possible to obtain a very great out-of-balance voltage at the anodes of a bad sample. As an example, taking the curves for Valve 1 shown in Fig. 1, triode (b) is cut off at -4 volts, whilst triode (a) is conducting at 1.3 mA. Now, if the anode resistors were each 100,000 ohms this would constitute an unbalance of 130 volts! After testing a number of valves in this manner one was found which was reasonable; this was used in the equipment and a "null" was duly obtained on the meter.

More Trouble

This state of affairs was short-lived, however, for when the chassis was turned on end the meter reading rose to about half-scale; upon returning the chassis to the horizontal position again the meter reading readily decreased, but not back to its original value!

This phenomenon then prompted tapping the valve envelope with a finger. It nearly proved fatal to the meter, a 200 microampere instrument, by pending the pointer.

All these experiences can be accounted for if the structure of the 6J6 itself is examined.

This construction is of the power grid type and is known as the "butterfly"; it is shown in Fig. 2, which gives a perspective and plan view of the electrode assembly of the valve.

It will be seen that the cathode is at the centre and is of large flat construction since it has to feed both triodes; the grid wires are parallel to the cathode face, but have been bent at both ends to meet the supports and not stretched across them. Herein lies the main cause of the trouble, for the anodes are made in the form of a metal "U" which are supported rigidly top and bottom by the mica separators.

The kinking of the grid wires in this fashion deprives the grid of mechanical rigidity and due to the very close spacing, both of the grid

wires themselves and the grid relative to the other electrodes, it is difficult to manufacture both triodes with the same characteristic.

It will also be realised that the grid wires are liable to suffer from mechanical shock and if this is severe, to take up a permanent set, which immediately alters the capacity between the grid and other electrodes.

However, the more serious effect which was encountered—that of moving the chassis to the vertical position, or in other words lying the valve on its side—is due to the fact that if the plane of the grids is horizontal the cathode heats up the grid wires of one triode more than the other, which then sag due to gravity with the result as before: the capacity between electrodes changes, and the effect is worsened since it is a slow change which takes place as the grid wires heat up. It is minimised to some extent if the valve is rotated through 90 degrees so that both grids are vertical.

These effects take place in new and surplus valves alike and thus it can be appreciated that when using the 6J6 as a neutralised triode care has to be exercised not only in the mount-

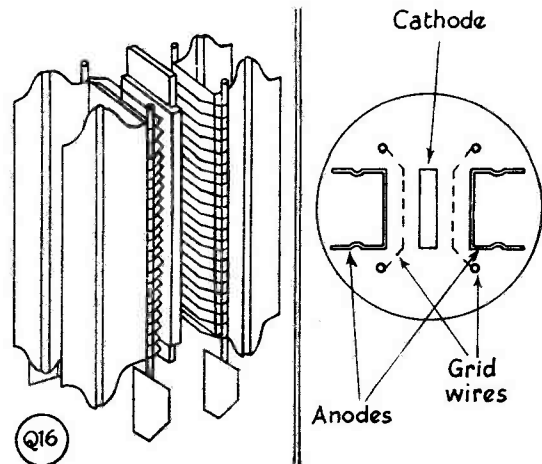

Fig. 2. Showing internal construction and element layout of the 6J6, and illustrating how a change in characteristics is possible due to alterations in the relative positions of the electrodes. At VHF these need only be very slight to cause uneven performance.

ing of the valve, which should be vertical, but when trimming the neutralising condensers. The chassis *should not* be turned on end to do this, even though it means "standing on one's head" to keep the valve in the vertical position — otherwise, the second effect mentioned will come into play and when the receiver is tried out it will still be unstable.

Always try and use valves which are as near balance as possible. However, this is often difficult, but a certain measure of adjustment can be obtained in the circuit itself by raising or lowering the inductance on one side of earth.

Neutralising

Another point about neutralising push-pull triodes in converters is that the Americans often advocate using a "dud" valve—that is, a valve with a blown filament—by applying a signal to the grid and adjusting the neutralising condensers for the least signal transfer. But from the foregoing it can be seen that this would be all right if the valve could be used in the final unit. Since, however, another valve has to be used the neutralising will not be the same since the characteristic may be different.

In conclusion, it might be said that since the original converter design by G2IQ was published, a number of miniature double triodes have appeared on the market, such as the 12AT7, 12AX7 and 12AU7. These are much more suitable, since they have separate cathodes and are built as separate triodes on standard lines of construction.

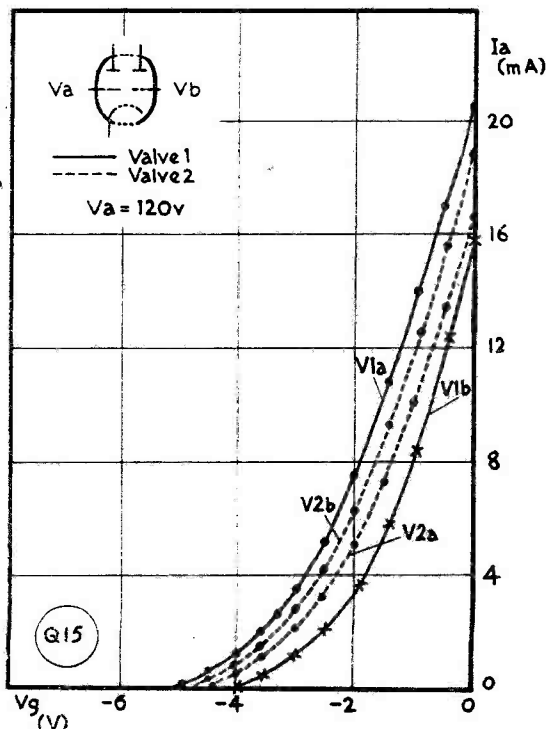

Fig. 1. Curves taken out by the author to show the differences between specimens of the 6J6, and the difference between the two triode sections of a single valve.

THOUGH, for the majority, conditions have been pretty depressing since we last appeared—the third leg of the Marathon was virtually a wash-out—your gratified preceptor sits down to write this inspired by no less than 48 report/letters on the hook, and 28 individual movements claimed in the Counties Tables for the month to October 17. So that though conditions have been rotten and activity low, enthusiasm and potential activity remain high, many operators are still making steady progress in the scoring and, as ever, there is much to discuss.

Undoubtedly, the outstanding achievement to report this time is the astonishing performance of G3WW, Wimblynton, Cambs., who (taking us up on the 40C-worked-in-a-year theme) proceeded to work his forty in the first three weeks of September! And, moreover, a few days later he produced all the cards to confirm, which some may say is a still more extraordinary feat! Anyway, this is what G3WW has done, and it is difficult to see how such a record could be bettered. When putting forward the idea (see *Short Wave Magazine*, p.430, September) of a Certificate for all VHF operators who do succeed in working 40 or more counties in a year—in the Annual Table starting on September 1st each year—we thought it would take the leaders about three months to qualify. In fact, at the time when G3WW's claim came into the office, the proposed Certificate had not even been sent to the printers. However, he will get it in due course—and so will all others who, having worked 40C since September 1st, 1952, care to send in their claims, with QSL cards to verify.

There are lessons to be learnt and conclusions to be drawn from G3WW's results. It shows just what can be done on VHF when an experienced operator sets out with the determination to get results, and also proves that the stations are there to work if one is persistent and can be patient. A lot of people will, no doubt, also ask, "How *did* he get the cards so easily and so quickly?" They were not forthcoming too easily, but they came through quickly because G3WW asked by letter

VHF BANDS

A. J. DEVON

G3WW Gains First	40C Certificate—
Conditions Poor Generally—	
Marathon Third Leg Results—	
Some Zone Plan Comments—	
Station Reports and News—	
Calls Heard and The Tables—	

for the QSL immediately after each contact. And naturally he would like to thank all those good people who responded so readily to what must have seemed to some a pretty unnecessary request for a QSL card.

Since knocking up his forty, G3WW has added two more, and the new Annual Counties Table appearing in this issue shows that he has no near challengers as yet.

Conditions, September/October

During the period to October 17, the general feeling about Ole Man Conditions has already been indicated. But the fact remains that over the four weeks or so before that date, G3EHY (Banwell) was able to work 100-mile distances practically every evening, and his 268-mile schedule with G13GQB was successfully completed on 50% of occasions—and it should be noted that they keep this schedule *nightly*, not just on those evenings when the band looks as if it ought to be good. G3EHY himself was on every

evening, early and late, so has kept a close check on things. His good dates are given as September 10, 13, 16, 21-24 and October 8—with the third leg of the Marathon (September 27/28) falling into the deepest hole in terms of conditions yet encountered on the band during the whole of this year! We do have some luck with our contest dates

With G4RO (St. Albans), G3EHY and G5YV (Leeds) were consistent GDX signals; but they were the only ones heard. For good dates, G3GHO (Rode, Northants.) gives September 13, 14 and 23, checked on regular nightly activity during that month, with 54S worked in 25C. In the first fortnight of October, however, he only managed a total of 20S, ten of them within 40 miles. At G2HIF (Wantage), E12W had not been heard since August 29, with G2O1 and G5YV both missing from September 14 onwards. On the 23rd, however, G3AGA (Falmouth) shone a hopeful light, coming through well at G2HIF.

The general picture is, therefore, that Conditions were poor to very bad for most of the period, but with some bright patches, and that schedule-keeping stations had a surprising measure of success. This brings us back, once again, to the point about careful listening and regular calls, even on what may appear to be a dead band. Then there is the suggestion about more stations keeping regular schedules over the longer distances. G3EHY, G5ML and G8IL are interested in this, as well as several others, and if a few more would care to signify, it should be possible to arrange for regular working over not-too-difficult paths during the winter season. The very interesting results obtained by those who do set out to work the GDX—G3EHY, G13GQB and G3WW—prove that we can get more out of the two-metre band if we try.

Marathon Third Leg

The analysis herewith shows the present position, with the last leg to be reported next month. Twelve gallant entries were received for the September 27/28 session, with all operators working very hard for their points. It

MARATHON VHF CONTEST

Aggregate Scores

FIRST, SECOND AND THIRD LEGS

(July 19-20, August 23-24, September 27-28)

Station	Location	Score				Aerial	Input	Converter	Zone
		1st	2nd	3rd	Aggr.				
G5YV	Leeds, Yorks ...	543	805	124	1,472	4/4 Stack ...	65	6J6/S.640 ...	C
G3EHY	Banwell, Somerset ...	633	603	172	1,408	8-ele Stack ...	120	4RF-M-Osc/BC342 ...	I
G4RO	St. Albans, Herts. ...	230	401	143	774	5-ele Yagi ...	25	4RF-M-Osc/BC348 ...	G
G5DS	Surbiton, Surrey ...	130	324	204	663	16-ele Stack ...	65	6J6 ...	J
G2BAT	Falmouth, Cornwall ...	125	405	—	530	16-ele Stack ...	100	G2IQ/AR77 ...	I
G3VM	New Costessy, Norfolk	392	—	109	501	4/4 Yagi ...	90	3RF/TCS ...	G
G3GHO	Roads, Northants. ...	139	236	122	497	12-ele T'stile	30	RF-M-Osc/R.1155 ...	G
G3HVO	Parkstone, Dorset ...	196	283	—	479	10-ele Colinear	20	3-stage/HRO ...	H
G8IL	Salisbury, Wilts. ...	—	381	56	437	4/4 Yagi ...	100	6J6/RME69 ...	H
G3GDR	Watford, Herts ...	99	328	—	427	16-ele Stack ...	20	2RF-M-Osc ...	G
G8DA	Gloucester ...	109	227	61	397	5-ele Yagi ...	25	2RF-M-Osc/S.640 ...	H
G3BW	Whitehaven, Cumb. ...	387	—	—	387	16-ele Stack ...	60	6J6/AR88 ...	C
G2FCL	Shipley, Yorks. ...	—	352	26	378	3-ele Yagi ...	60	2RF-M-Osc ...	C
G3WW	Wimblington, Cambs.	335	—	—	335	5/5 Yagi ...	140	G2IQ/BC348 ...	G
G2XC	Portsmouth, Hants. ...	—	314	—	314	4/4 Yagi ...	25	6AK5 ...	H
G4GR	Marshfield, Mon. ...	205	—	78	283	16-ele Stack ...	100	4RF-M-Osc/AR88 ...	F
G6LI	Grimsby, Lines. ...	—	240	—	240	4 st'd D'pl ...	150	Cascode ...	E
G3CQC	Newton Abbot, Devon	—	210	—	210	4/4 Yagi ...	25	3-stage ...	I
G2DSW	Southampton, Hants.	—	171	—	171	4/4 Yagi ...	55	6J6/SX28 ...	H
G5MR	Hythe, Kent ...	—	171	—	171	3/3 Yagi ...	95	2RF-M-Osc/SX16 ...	J
G3DVK	Rawmarsh, Yorks. ...	—	161	—	161	4/4 Yagi ...	22	Cascode/100CR ...	C
G5HN	Caversham, Berks. ...	—	155	—	155	16-ele Stack ...	35	5-stage/HRO ...	H
G4MR	Slough, Bucks. ...	—	94	45	139	4-ele Yagi ...	20	6J6/BC800A/RF24/R107	G
G2FJR	Sutton Bridge, Lines.	—	133	—	133	6-ele Stack/R'fr.	45	2-stage/AR88 ...	E
G6PJ	Sheffield, Yorks. ...	20	108	—	128	3/3 Yagi ...	60	G2IQ ...	C
G2DHV	London, S.E.13 ...	37	—	19	56	4-ele Yagi ...	18	5-stage/FBXA ...	J

is only too obvious from the Table that, so far, the August week-end was the best, in terms both of activity and conditions. That the stations were on, and trying, for the 3rd leg is shown by the group of locals worked by each participating operator.

G5DS (Surbiton) appears as the high scorer for the September week-end, but he would probably agree that even at that the score was disappointing. Nobody worked any GDY worth mentioning, and with the exception of the G5DS/G5YV contacts for 20 points, the logs all show a succession of 10's, 5's and singles to

score, though G4RO and G5DS both managed 17C. G3EHY worked 11 counties, but G5YV shows 8C only.

So much for the Third Leg—let us hope that the final session over October 25/26 produced more interesting and satisfying results.

New VHFCC Members

This month, we are glad to welcome as new members of the VHF Century Club the following: G3AVO/A, Royston, No. 131; G3HSC, Wallington, No. 132; G4JJ, Barnsley, No. 133 (FBC No. 196); G3GOP, Southampton, No. 134; and G3ASG, West

Ewell, Surrey, No. 135.

More About the Zone Plan

We have noticed (*not* in our own correspondence, but in a contemporary) some left-handed jabs at the Zone Plan, which one can only suppose are inspired either by jealous annoyance or wilful ignorance, or possibly by a combination of both. One reader, at least, has reacted already, and G3EHY writes to say that the perpetrator of the passage to which we refer is obviously quite unaware of the facts of two-metre working outside optical range, and equally ignorant of the

reasons for and the advantages of the British VHF Zone Plan. This was first promulgated in, and has been consistently supported by, *Short Wave Magazine*, and, of course, it is this latter fact which has always been the cause of the annoyance and the reason for the surly rumblings one hears from time to time about the Zone Plan.

So let us repeat, if possible in words of one syllable, about the Zone Plan that (a) Nobody is forced to adopt it. (b) It aims to make things easier for all. (c) By working to the Plan the whole band is used and kept open. (d) When GDX or EDX is coming through, everybody has a chance, because local QRM is minimised. (e) In no area is crowding so severe or local activity so consistently high that QRM is more than a passing annoyance to operators of ordinary competence. (f) The Zone Plan is a rational approach to band planning, applied for the first time to a band exhibiting just those characteristics which make some sort of plan desirable, if not essential, and (g) It achieves its objects by encouraging fixed-frequency working, thus avoiding the need to use VFO tactics under competitive operating conditions.

But let it be said again that, in spite of all these reasons, there is still nothing (except his own good sense) to prevent any operator, if he so wishes, to slide about on two metres using SEO gear—and making himself a general nuisance to those who see, in the VHF bands, a field for serious experimental work in the realm of communication beyond optical range.

From EI2W (Dublin) we hear that eight crystal frequencies are being allotted to VHF RSI members in Zone D (145.80-146.00 mc, the EI/GI operating area), and that, in addition to himself on 145.810 mc, G12FHN, G13AXD and G13GQB are on Zone D frequencies. Co-operation of this sort is as important as it is helpful, and it is significant that those who came to the problem with a fresh mind, free of prejudice, saw it in the light of the arguments we have consistently maintained in these pages.

Any further questions!

TWO-METRE ACTIVITY REPORT

G2BRR, London, E.18.

WORKED: G2AHP, 2AJ, 2DIO, 2DUV, 2FVD, 2HDZ, 2KF, 2MV, 2WJ, 3AEX, 3AJS, 3ANB, 3ASG, 3BEX/P, 3BVG, 3BWS, 3CNF, 3EIV, 3EYV, 3FD, 3FGB, 3FSG, 3FUH, 3FUP, 3GHI, 3GZD, 3HBW, 3HSC, 3ISA, 4DC, 5DS, 6LL, 6RH, 6TA, 6YP, 8SK (All worked August 2 to October 12)

G3IIT, Trumpington, Cambridge.

WORKED: G2ALL, 2CNT, 2FQP, 2HCJ/P, 2UQ, 2XC, 2XV, 3AKU, 3AVO/A, 3CJY, 3EDD, 3EHY, 3FAN, 3FZL, 3GGJ, 3GIT, 3HCK, 3HXO, 3IEX, 3WW, 4MW, 5UM, 8SY (During September only).

G3GHO, Roade, Northants.

WORKED: G2HCG/P, 2HIF, 2YB, 3ASG, 3FAN, 3FQS, 3FCW, 3HAN, 3IAI, 3MY/P, 3VM, 4DC, 4MR, 4RO, 4SA, 5DS, 5YV, 6FO (Marathon Third leg only).

G4RO, St. Albans, Herts. NGR. 52/147075.

WORKED: G2AHP, 2ANT, 2BM, 2RRR, 2BUJ, 2DUV, 2HDZ, 2PU, 2YB, 3ANB, 3BEX/P, 3BWS, 3CGO, 3FDD, 3EHY, 3FFX, 3FSD, 3FUM, 3FUL, 3GDR, 3GHI, 3GSE, 3HBW, 3HXO, 3HZK, 3IIT, 3IWA, 3YM, 4DC, 4HQ, 4MR, 5DS, 5UD, 6BO, 6FO, 6LI, 6RH, 6TA, 6GL, 8OU, 8FX, 8SC, 8SY, 8VZ, 8WV.

HEARD: G2DIO, 2FNW, 2FTS, 2HCG, 2HIF, 2HOP, 2MV, 3ABA, 3BKQ, 3BLP, 3BVG, 3FD, 3GBO, 3GHO, 3GWB, 3HSC, 3HWJ, 3HXS, 3IAI, 3IEX, 3MI, 3SM, 3WW, 4FB, 4SA, 5MA, 5QL, 5YV, 6AG, 6LL, 6WU, 8DV/A (September 27 to October 16).

G3YH, Bristol.

WORKED: G2BUJ, 2HIF, 3BHS, 3BLP, 3CXI, 3DJX, 3DLU, 3EHY, 3FD/P, 3FKO/P, 3HSD, 3HSD/P,

3IWA, 3WW, 4SA, 8DA.

HEARD: G2FFG, 2HCG, 2PU, 3CGQ, 3EDD, 3IAI, 3ION, 3MA/P, 3VM, 4GR, 4RO, 5BM, 5BM/P, 5DS, 6FO, 6NB, 8VZ, GWSUH (September 1 to October 14).

G8DA, Gloucester.

WORKED: G2FNW, 3EDD, 3EHY, 3IER, 3NL, 3MA, 3YH, 4GR, 5BM, GWSUH (Marathon Third Leg only).

G6PJ, Sheffield, 8.

WORKED: G2DRA, 2FO, 2HCG/P, 3BKQ, 3CGH, 3FFV/P, 3MY, 3WW, 4IJ/P, 5YV, 6CW, 6LI, 6XX, 8AO, G6W6N/P. **HEARD:** G2FZU, 2OI, 2PU, 2YB, 3APY, 3CGQ, 3ERD, 3GHO, 3GUU, 3IAI, 3WW, 4JB, 4SA, 6NB, 6UJ, G6W5MQ (September 10 to October 4).

G3DLU, Weston-Super-Mare, Somerset.

WORKED: G2AHP, 2FTS, 2FYD, 2KI, 2YB, 3AVF/P, 3BHS, 3BLP, 3CGE, 3EHY, 3FAN, 3FD, 3GOP, 3HSC, 3HSD/P, 3HWJ, 3HXJ, 5DS, 8DA, 8IL, 8OU, G6W3BNQ, 3EJM, 8UH.

HEARD: G2AAW, 2AJ, 2MV, 3BPM, 3FD/P, 3FUM, 3FWW, 3YH, 4GR, 4SA, 5MA (September 9 to October 5).

G5YV, Leeds, Yorks.

WORKED: G2CVN, 2FL, 2FNW, 3AGS, 3AMM, 3DA, 3GHO, 3HBW, 3IAI, 3MY/P, 4JB, 5DS, 6PJ, 6XX, 8GL (Marathon Third Leg only).

G3EHY, Banwell, Somerset

WORKED: G2AAW, 2AIW, 2BWV, 2FNW, 2HCG, 2HCG/P, 2HDZ, 2HGR, 2OI, 2PU, 2XV, 2YB, 3ABA/P, 3APY/P, 3AVF/P, 3DIX, 3DLU, 3DUP, 3EDD, 3ELT, 3FD/P, 3FKO/P, 3GOP, 3HSD, 3HSD/P, 3IAI, 3IER, 3IIT, 3IOO, 3MA, 3MA/P,

3MY/P, 3YH, 4GR, 4RO, 4SA, 5BM/P, 5DS, 5MA/P, 5ML/P, 8DM, 8HK, 8OU, G13GQB, G6W2ADZ, 3EJM, 8SU, 8UH (Period September 13 to October 13).

G5DS, Surbiton, Surrey.

WORKED: G2AHP, 2ANT, 2BRR, 2DHV, 2DUV, 2FTS, 2FVD, 2HDZ, 2IQ, 2YB, 2YC, 3ANB, 3ASG, 3BEX/P, 3BWS, 3CVG, 3EHY, 3EJ, 3GDR, 3GHO, 3HAE, 3HBW, 3HSC, 3HWJ, 3HXO, 3HZK, 3VM, 4GR, 4MR, 5YV, 6FO, 8PX (Marathon Third Leg only).

GW5MA/P, Bwch-y-Groes 1790ft. a.s.l., Merionethshire.

WORKED: E I 2 W, G2HCG/P, 2HIF, 2NH, 3ABA/P, 3AZT/P, 3BLP, 3EHY, 3FAN, 3GZM, 3HAZ, 3MA/P, 3WW, 4CI, 4SA, 5BM/P, 5IU, 5WP, 6NB, 6WR/P, 8DA, 8KL, 8OU, 8QY/P, G6W2ADZ. **HEARD:** G2AJ, 2HOP, 2XV, 3AVF/P, 3BK, 5ML/P (September 20 and 21).

G2HIF, Wantage, Berks. NGR 41/404885.

WORKED: G2FTS, 2HCG/P, 2HDZ, 2OI, 2PU, 2XC, 2XV, 3AGA, 3ASC, 3DKZ, 3ERD/P, 3FD/P, 3FUM, 3GHO, 3MA/P, 4SA, 5BM/P, 5ML/P, 5YV, 6FO, 8DM, 8IL, 8PX, 8VZ, G6W5MA/P. **HEARD:** G2FJR, 2XS, 3AZT/P, 3EHY, 3IAI, 6CW (September 1 to 30).

G8L, Salisbury, Wilts.

WORKED: G2AIT, 2FTS, 3BLP, 3FUM, 3GOP, 3HBW, 3HYO, 4SA, 5DS, 5OB (Marathon Third Leg only).

G4GR, Marshfield, Mon.

WORKED: 3AGA, 3BLP, 3EHY, 3GOP, 5DS, 8DA, 8OU, G6W8UH (Marathon Third Leg only).

Station Reports — West

G8DA (Gloucester) makes a start in Annual Counties, and was particularly pleased to raise G3EDD for a GDX contact; he, like many others, is interested in the new 24-element stack at G8OU (Ashted) which is putting out a particularly potent signal to the west. G8DA describes the experience of a certain west-country operator who found that though his fundamental was in the band and producing signal reports and QSO's in the ordinary way, he was also radiating a nice clean squigger outside the band, actually right on the local police trigger frequency, which set off their main station transmitter, thus re-

radiating said operator's QSO to all the county police cars! The trouble was, of course, traced to a crystal which, when over-excited, went off on two frequencies. G8DA adds that the police "were very nice about it"—so credit where it is due. He also mentions that G3AGA (Falmouth) is awaiting QSL confirmation from DL3NQ for a 623-mile QSO on August 28 last; this is a new one on us, and we hope that G3AGA will come forward with a claim.

G3DLU (Weston-s-Mare) was operating on 19 evenings during the month to October 15 and sums up his reaction by saying that "Conditions were uniformly bad, and all stations are new to me."

He has re-fixed his stack to fire N/S, and would welcome all reports. By fitting a fourth frequency changer and 85 kc IF stage. G3DLU has greatly improved receiver selectivity, with much reduced noise; the improvement is comparable to crystal-filter results.

During the month, G3EHY (Banwell) clocked up new stations in the shape of G3IER (Cheltenham), G3IIT (Cambridge) and G3IOO (Shrewsbury), and is rightly pleased with the continuing reliability of his G13GQB schedule. G3EHY remarks: "G13GQB is now the outstanding Irish station, who is doing some really worth-while work and proving that consistent GD contacts are possible. Low barometer, gales and other hazards do not deter G13GQB, who is always there to have a go. Would that there were a few more stations of his calibre on the two-metre band." G3EHY hopes that the promised EI/GI activity will duly materialise, as only thus can the "Irish boys" expect G beams to be aimed into the north-east night after night.

From the west, it is also reported that GW8SU (Porthcawl, Glam.) is now on the band and that GW3EJM (Llangorse, Brecks.), who did some useful work a year or so ago, has shown up again.

Round the North

G3MY (Sheffield), who still has to operate under /P conditions, was not able to be so active during the period, due to the shocking weather. However, he was out over the week-end September 20/21, and had quite a good run of contacts on the morning of the 21st; the more DX southerners worked were G3ABH, G3BLP, G3EHY, G3HWJ, G5BM/P and G8IL. After 12 noon, conditions deteriorated rapidly and remained poor for the rest of the day, though G3BEX/P and G3DIV/A were heard for possible contacts. In the evening, he made his best QSO of the day with G3AVF/P in Devon. During the month of September, 38 stations were worked, and a few of those heard (who may be interested) were: G2AJ, G2XC, G3IAI, G3IWA, G3WW, G5DS and G6AG. On

Sunday, 28th, G3MY was out again for the Marathon, but managed only 11 QSO's between 10.40 and 14.45, with G3BEX/P, G5DS and G6AG heard. He hoped to be on again for the last Sunday of the Marathon, October 26.

Another to mention good, but unworkable, signals from G3BEX/P is G5YV, who heard him consistently between 11.30 and 14.15 on September 28, at signal levels up to S7; many calls failed to produce any response. G6PJ (Sheffield) remarks on the many occasions on which he has called G3GHO and GW5MQ without success—yet he can reckon on working G6NB (Aylesbury) before giving up for that session. G6PJ is on most evenings, before and after TV, and would be on during TV if others would do the same! Like us, he cannot believe that every VHF operator in the country spends every evening peering at TV, nor that they all suffer from TVI. There is some mystery about this TV business to which nobody has yet found the answer.

G8KL (Wolverhampton) claims his rightful place in the All-Time Counties Table, and is there after 2230, though not every evening; his 40th county was none other than old Bob, GW5MA/P in Merionethshire.

GM3DIQ (Saltcoats) says that conditions up there have been "terrible, and activity at a very low ebb. I wish I knew how to hot things up a bit." GM3AUQ (Glasgow) has appeared on the band, but '3DIQ and 'AUQ have discovered that they can only QSO one another when they can both hear aircraft control signals in the band!

G4JJ (Barnsley) raises a good point when he says that we should give serious consideration to bringing the /P operators in on the Certificate-for-40C worked in the Annual Table. His argument runs thus: "It is all very well saying one can pick a good site and so make it easy. Don't you believe it, OM. It requires a good deal of hard work and much time to operate /P long enough to raise 40 counties, and is much more difficult than just nipping into a comfortable radio room in a nice

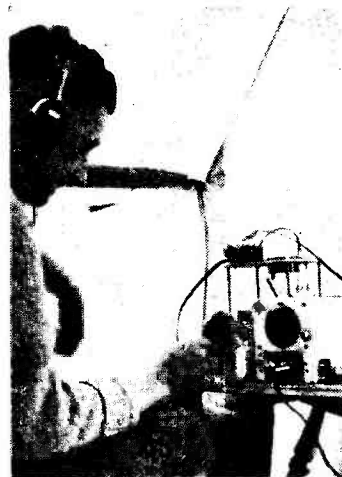

Above, G4JJ (Barnsley) when upon his P occasions in Westmorland. Below, the lovely smell of eggs and bacon on the morning air.

warm house." Which is fair enough, and would probably be endorsed by the other regular /P operators. So we think that they, too, should be covered for this Certificate, under rules as follows: All claims must be verified in respect of /P contacts only; no QSO's from the home station to count for the /P certificate; a Certificate awarded for 40C worked in one year under /P conditions to be endorsed "For Portable Operation away from the Home Station." Agreed? And the starting date is September 1st, 1952.

London and Home Counties

G4MR (Slough) reports hearing a number of stations he cannot

raise, notably G3EHY, and G5BM and G5YV wanted for new counties; but they will come. G6TA (London, S.W.12) goes up in the Counties tables; another Old Timer, G5YH of Chiswick, sends in a note to report that he is now listening on Two with a Cascode and preparing for a 70 cm receiver.

G2HIF (Wantage) raised G3ASC in Oswestry for a new county, as well as GW5MA/P from both Breconshire and Merionethshire, and G6FO for a new station, though G6CW for Notts, was missed several times. Bothered by noise getting progressively worse in the converter, G2HIF did a check round and found that changing the gas-filled stabiliser tube, used to hold the oscillator HT steady, effected a complete cure: a point worth remembering. G2HIF adds that he will dig in and remain active through the winter—unless he finds himself "beginning to hear voices in the sharsh." (We give up when the thing starts a regular high-pitched tick!)

For the week-end September 20/21, G5MA journeyed across to Merioneth once again, and perched on the summit of Bwlch-y-Groes, 1790 ft. a.s.l., the highest carriage-way in Wales. From there, Bob was able to give G2NH, G3BLP, G4CI, G5WP and G8OU their first Merioneth contacts, and also had a good QSO with G3FAN, Isle of Wight. In all, 25 different stations were worked, including EI2W on phone. It may be remembered that when GW5MA/P first tried this site, earlier in the year, only stations to the north could be raised, so that these results on the second occasion are all the more interesting. Conditions were not good, and it blew a howling gale during the night.

G4RO (St. Albans) remarks on the level of Service traffic evident on occasions around 144.6 mc, mainly from American air-to-ground stations operating landing control procedure; when they are there, they are very loud. G4RO has recently increased the urge on the 829B PA to 120 watts which, while producing lots more RF, is also causing BCI, due to mains leakage, affecting some

antiquated BC receivers in the neighbourhood. Nothing but trouble!

A welcome line from Johnny G3BLP (Selsdon) to bring his scores up to date and to explain that he has not been very active recently; however, he hopes to be on much more frequently during the next few months. G5DS (Surbiton) also goes up in the Tables, and G2BRR (London, E.18) reports that he will be on nearly every evening during the 1900-2030 period—which is just when we want lots more activity; G2BRR now has a Cascode converter and a new 3-element Yagi using a folded dipole.

G3ASG (West Ewell, Surrey) runs an SCR-522 at 11 watts, into a 6-ele. stack at about 25 feet; the receiver is 6J6-CV66-CV66-6J6M-EF50 Osc at 34.5 mc, with a 6J6 quadrupling to 138 mc and output at 7 mc into an 1155. The 6J6 RF stage was found to be very unstable until the aerial coupling was tightened considerably—which has left G3ASG wondering whether the 6J6 is really doing its best!

With G3HXO (Shefford, Beds.) the periods September 7-14 and 25-28 were found to be good, and he managed to raise seven new stations, those heard being G2ATK, G2BVW, G3GIT, G3HM and G8DM. He runs 25 watts to an 832, into a 3-ele. Yagi, 40 ft. up in a tree, and somewhat obscured to the south. G3HXO has a word to say about phone operators who tend to "rush away" from CW stations when they find the latter are unable to use phone. This seems a pity, but it is not an unusual experience.

G2AHP (Perivale) considers that last month's Editorial should have suggested Two instead of Ten! The new TVI-proofed Tx is doing him well, and G3DLU will be interested to know that he is frequently heard at G2AHP calling CQ during TV hours, but not getting much joy.

Midlands and East

G3GHO (Roade, Northants.) was glad to be able to raise G3BW on September 23, with EI2W as best DX heard. G3ABA

(Coventry) caught G2BAT (Falmouth) after stalking him for two hours one evening, and when /P on the 21st was delighted not only to work GM6WL/P at over 250 miles, but also to find it was GM3BA on the key at the other end.

G6CI (Kenilworth) has found the GDX in odd spots, now and again, and—arising from last month's comment—adds that he is not yet ready to burst forth on 430 mc, as "We old timers don't move quite as fast as we used to do"!

G3IIT (Cambridge) says he started in June last and was "On two metres before the ink was dry on the licence." His frequency is 144.8 mc, the transmitter being EL91-QVO4/7-QVO4/7-832 with 15w, and receiver a G2IQ converter, though a 6AK5-6AK5-6C4-12AT7 job, to the G4MW pattern, is under construction. The aerial, finally, is to be a 3-over-3, to which the matching is to be "Carried out with meticulous care under the guidance of G2XV and G4MW."

G6FO (Maids Moreton, Bucks.) says he comes on as often as possible, and has been heard

TWO METRES COUNTIES WORKED SINCE SEPTEMBER 1, 1952 Starting Figure 14

Worked	Station
42	G3WW
27	G5YV
26	G3GHO, G5DS
21	G4RO
17	G8DA
16	G2AHP, G6TA
15	G2HDZ, G3DLU
14	G2FCL

Note: This Annual Counties Worked Table opened on September 1st, 1952, and will run until August 31st, 1953. All operators who work 14 or more Counties during this period are eligible for entry in this Table. The first list sent should give stations worked for the counties claimed; thereafter, additions need show only stations worked in each county as they accrue. A certificate is given for all VHF operators who work 40C or more in the year, for which QSL cards must be shown. Cards are not, however, required for entry into the Table.



The gathering at Clonmel, Co. Tipperary, on the occasion of the first meeting of the VHF Research Society of Ireland, when 32 members from all parts of EI/GI attended. The group includes EI2W (President), EL3R (Chairman), EI6G (Organiser) and G13BIL and G13QB, active VHF operators from Northern Ireland.

faintly on phone—though this will be put right when there is time to connect in a new modulator; he is mortified to find himself beginning to rank as a "Got-away," in that he is being reported heard and called, but not worked, by several stations at nice distances. (It looks as if the old man's Rx wants a check-over.)

Down South

G3GOP (Southampton) reports that he has heard a number of VHF operators on bands other than Two Metres—well, that often happens when things are quiet, but it is not to be encouraged! He is now up to 122 stations worked.

G5MR (Hythe, Kent) had a most depressing experience during the third leg of the Marathon—he was on continuously from 1600 to 2315 on the Saturday and between 1030 and 1600 on the Sunday, calling CQ's and searching the band. In the whole of that time, he heard nothing identifiable at all except a semi-local carrying on a duplex QSO, a Frenchman who whistled lugubriously into his microphone without even disclosing his identity, and a police transmission at the HF end of the band. That

is what really bad conditions can do to a station unfavourably situated geographically. However, G5MR was much cheered by working G5YV on October 12, which is good GDX, and his first new county in almost a year; new stations worked during the period were G2YB (Reading) and G3HWJ (Surbiton).

News of Seventycems

While we are glad to know that there are more than a few earnest types probing the mysteries of the 430 mc band, it would be nice to hear from them occasionally so that we could record just what they are doing.

There are some reports in hand. G3ABA (Coventry), running an 832 tripler giving about 3 watts RF into a 16-ele. stack, has been heard by G2BVW (Rearsby), G2FNW (Melton Mowbray), G3BKQ (Blaby) and G3FFC (Braunstone)—all Leicestershire stations, which puts that county on the 70 cm map—but some tests G3ABA/GW2ADZ have so far proved abortive.

G3HHY and G31KR, of Solihull, Warks., have made a start by working one another on 430 mc, but are now temporarily QRT. G3HHY reports that he will be on

again for three weeks from December 20, with a CC transmitter, and would very much like to have some 70 cm schedules with the others on the band in Warwickshire and round Birmingham; his receiver is a crystal mixer in a quarter-wave line, with a 955 oscillator, feeding into a home-built 20-valve (*yes! twenty*) receiver at 7 mc.

From G3HKD (Norwich) we hear that he and local G3HUL made their first contact on September 21. From the other side of the country, Louis G3EHY reports that on October 13 he received G4GR (Marshfield, Mon.) at RST-569 on Seventycems. There are also said to be some Bristolians on 430 mc with SEO gear, the argument being that it is easier to rig up a receiver to take SEO transmissions than CC signals—which is quite true, but it is not progress.

This and That

G4JJ shows that he is still short of cards from well-known operators to whom he has himself QSL'd. He gives us call-signs, but while we know that the chaps concerned are sensible enough not to be offended were we to print their calls, it would hardly be

TWO METRES

ALL-TIME COUNTIES WORKED LIST

Starting Figure 14
From Fixed QTH Only

Worked	Station
60	G3BW
58	G3BLP
57	G2OI (349)
56	G3EHY (365), G8SB
55	GW5MQ
54	G6NB
53	G2AJ (519), G5YV (364)
51	G3WW
50	G2HIF (191)
49	G4CI
48	G3ABA (282)
47	G2NH, G5DS (393), G5WP
46	G4HT (476), G5BY, G5MA
45	E12W (132), G2XC, G5BM, G6XM (356), G6YU
44	G2HDZ (307)
43	G3BK, G3COJ, G5DF
42	G4SA, G5BD
41	G2FOP, G3BA, G3DMU, G3FAN (295)
40	G3CGQ, G3HAZ, G4RO (256), G8KL, G8OU
39	G2IQ, G3VM
38	G3APY, G8IL
37	G2FNW
36	G3CXD, G3GHO (170), G8CB (312), G8IP
35	G2PZU (118)
34	G2AHP (295), G3AVO/A, G5JU
33	G2FCL (117), G3FZL, G3HBB, G6CI
32	G2FVD, G5ML (131), G8IC, G8QY
31	G2FJR (103), G5RP
30	G5NF
29	G3AKU, G3BJQ, G6TA (194)
28	G3FJJ (143), G3HXO, GM3BDA
27	G3AGS, G3BNC, G3DAH, G3GSE, G3HCU (152), G6GR
26	G3CFR (125), G3FIH, G3GBO (289), G4MR (189)
25	G5SK, G8VR
24	G3FD, G3FNG
23	G3CWW (260), G5PY
22	G3AEP, G3ASG (150), G3BPN, G3GOP (122), G3HIL, G5MR (128), GM3EGW
21	G6XY
20	G2HOP, G3EYV, G4LN, G6PJ
19	G3SM, G5LQ (176)
18	GM3DIQ
16	G2AOL, G3FEX, G3FRE, GC2CNC
15	G2DVD, G3DLU, G3IWA
14	G2DHV, G3CYY, G3ISA

Note: Figures in brackets after call are number of different stations worked on Two Metres. Starting figure for this classification, 100 stations worked. QSL cards are not required to verify for entry into the Table. On working 14C or more, a list showing stations and countries should be sent, and thereafter added to as more countries are worked.

fair, as four of the seven stations he mentions are known to us to be most conscientious QSL'ers. This QSL business is as mysterious as the "No activity during TV" phenomenon, and one of the things about it that puzzles us is that very few calls are common to more than a small proportion of the lists of non-QSL'ers—made even more baffling by the fact that some of the operators who complain are themselves labelled as not being good at QSL'ing!

So where do we go from here? The answer seems to be to ask all who are waiting for cards to let us print *their* call-signs; those who have worked them can search their logs (and their consciences) to make sure there can be no complaint about these stations not having been QSL'd. In the general interest, and because of our own experiences in this matter, we do *not* intend to print anything in the nature of black lists of those alleged not to QSL. The known non-QSL'ers will remain immune as far as we are concerned, with only their consciences to face.

If this suggestion meets with general approval, will all those who—having themselves sent off the necessary QSL—have been waiting *six months or more* for the response, please let us have a note that they wish their call-signs published as "Awaiting QSL's from operators who shall be nameless." This should get at least a few more cards into the post, and will probably also lead to some correspondence direct between individuals as to whether or not cards have been received or sent.

That is all we can do about it—except only to repeat that those who want cards should QSL direct wherever possible, and that those receiving cards (even if unwanted) should respond immediately by direct mail.

G2FCL (Shipley) says that he has worked 117 stations and received 83 cards. G3MY/P reports that though he QSL's 100%, his return is far less than that; nevertheless, if anyone is due for a card from him, they can have it *pronto* by asking for it, preferably direct. G3EHY

considers that, in connection with the 40C Certificate, the demand for duplicate QSL's may bear hardly on operators in counties in which there are few regular stations working; this we admit, but the fact still is that there are enough stations on in more than 40 counties to spread the load, and the demand for second QSL's (for the Certificate) is not likely in practice to be very great. G6FO remarks that he QSL's only on receipt of a card, his being sent by direct mail, dated, and giving also the date on which he actually receives the other station's QSL. (But as he has not yet worked many stations, and received even fewer QSL's, this has not so far been any great hardship!)

Several of the more recently active operators on Two Metres have asked whether QSL cards to verify are wanted when claiming scores for the Tables. To which, with a stifled scream, we return an emphatic *No!*

Thanks!

Your A.J.D. would like to acknowledge with gratitude the help of all those correspondents—more than half the total—who took the trouble to send in their reports in the form suggested in this space in our last issue. We are, naturally, always glad to receive reports of any sort (some of those who write in quite regularly get all they want to say on to a post-card), but when there is anything more to talk about, the standardised form will help considerably.

And don't forget Calls Heard. This section will be of even greater value and interest during the coming months, and we hope that everyone reporting will put in a list of stations worked and heard, set out on a *separate sheet*, please, and in the form in which Calls Heard is presented to you every month.

Irish VHF Group

The VHF Research Society of Ireland (VHF RSI) held its first Belfast meeting on October 18, with Old Timer G15SJ in the chair before an attendance of no less than 40 members, ten of

TWO METRES**COUNTRIES WORKED**

Starting Figure, 8

- 12 **G3BLP** (DL, EI, F, G, GC, GD, GI, GM, GW, ON, OZ, PA).
G5YV (DL, EI, F, G, GD, GI, GM, GW, ON, OZ, PA, SM).
 11 **G2AJ, G6NB**.
 10 **G2FQP, G2HDZ, G2HIF, G3WW, G5DS, G6LI, GW5MQ**.
 9 **EI2W, G3ABA, G5BD, G6XM, G8IC**.
 8 **G2AHP, G2XC, G3BK, G3EHY, G3GHI, G3HAZ, G3VM, G5BY, G5MA, G5UD, G8SB**.

whom were EI's who had journeyed from distant parts of Eire. The meeting was addressed by EI2W, G12FHN, G13AXD, G13BIL, G13GQB and G16YW on various aspects of VHF operating, activity and the construction of apparatus. EI2G, EI3R and EI6G also spoke, in conveying greetings from the EI branch of

VHF RSI, and proposing thanks to the chairman on the organisation of such a successful meeting.

In the course of his remarks, EI2W disclosed that next summer, during the July-August period, it is proposed to set up a two-metre station on the West Coast of Ireland, with the object of attempting to QSO across the Atlantic; facilities had already been promised, and the idea would be to maintain 24-hour working with a team of VHF RSI operators.

On the subject of the Zone Plan, EI2W asked members generally to support this in the interests of all, and announced the frequencies of a long list of EI/GI operators who have already selected crystals in the Zone D area. A check made at the meeting disclosed 20 stations under construction for VHF working, a number of them ready to come on when the crystals are through.

Before the meeting closed, G13GQB was presented with the Irish Perpetual Trophy. This was in recognition of his outstanding contribution to the development of long-distance VHF communication in maintaining a nightly schedule with G3EHY, Banwell, Somerset, over their 268-mile path. As is now well known, a very high percentage of successful contacts has been achieved in the course of this schedule, under variable and difficult conditions.

Finally —

Remains now only to sign off with the usual note — Reports for December "VHF Bands" by **November 14 certain**, which will be not long after you finish reading this. Address all your VHF news, views and claims to: A. J. Devon, "VHF Bands," *Short Wave Magazine*, 55 Victoria Street, London, S.W.1. And our next appearance is on December 5.

NEW BRIMAR MINIATURE — 6BW7

The Brimar 6BW7 is a high slope RF pentode designed for use in the RF, Frequency Changer, IF and Video Stages of Television Receivers and similar apparatus.

It will operate from a 180 or 250 volt HT rail, making it suitable for use in AC/DC or AC operated equipment, and is fully screened, thus eliminating the necessity for external screening. Its mutual conductance and figure of merit are higher than contemporary types with no increase in the filament rating, which remains at 6.3v., 0.3 amp.

Two pin connections are provided for the cathode, enabling a high input impedance to be obtained when used in the recommended circuit. As an RF amplifier, it will provide efficient operation up to frequencies of 120 mc.

These factors make this valve one of the most advanced types for use in Television and VHF applications.

CALL BOOK — FOREIGN SECTION

We are glad to be able to say that once again it has been possible to arrange for the publication, separately, of the Foreign Section of the *Radio Amateur Call Book*—that is, the *Call Book* proper, less only the American amateur station listings. The new edition of the Foreign Section is the autumn issue, containing the latest and most up-to-date lists of the world's amateur transmitters, exclusive of the U.S.A., shown alphabetically by prefix, country, call-sign, name and address. A total of some 54,000

amateur call-sign addresses is shown. Zone locations and QSL bureau addresses are also given. The price of the Foreign Section is 10s., post free, and the edition is limited. Order on: Publications Dept., Short Wave Magazine, Ltd., 55 Victoria Street, S.W.1.

CORRECTION — "VOLUME COMPRESSION"

With reference to this article, in our issue for October, the value of resistor R21, in the Table of Values on p.474, should be 4.700 ohms, and not as stated.

In G2QG's article in the same issue, p.469, the last part of the fourth paragraph should read "... power gain of 2 dB over a single dipole (see Fig. 2)."

XTAL XCHANGE

Below are this month's offerings. Notices for this space should be set out in the form shown, on a separate slip marked "Xtal Xchange—Free Insertion." Negotiations should be conducted direct.

G2HIL, 73 Elvaston Road, Nottingham.

Has Brookes Type S 3558 kc crystal, certificated, ½ in. pin spacing. Wants similar type 1850-1950 kc.

G3BDW, 16 Elmsthorpe Avenue, Nottingham.

Has 7306.67 and 7340 kc crystals, ½ in. mounting, no certificates. Wants 3.5 mc frequencies.

G3GEN, 113 Stroud Road, Gloucester.

Has 6006 kc crystal for two-metre band. Wants 6840 kc frequency.

G3IHM, 67 Higher Croft Road, Lower Darwin, Lancs.

Has 3512 kc crystal. Wants any 1.7 mc frequency.

SWL, 1 Hillington Road, Edgeley, Stockport, Cheshire.

Has 5633, 6497, 6547, 6522, 7125, 7150, 7175, 7775, 7600 kc crystals, ½ in. mounting. Wants frequencies for LF areas 3.5 and 7 mc bands, any mounting.

The Other Man's Station

G3BRV



THE station of G3BRV is owned and operated by R. C. Bennison at the White Lion Hotel, Great Missenden, Bucks. First introduced to Amateur Radio in 1936 by G2GS, he became second operator to G3JJ in 1938-39, the licence for G3BRV being issued in April, 1947.

Activity covers all bands from Ten to One-Sixty, and the main transmitter runs Clapp VFO 6V6-6J5-6V6 into a pair of 807's in parallel, with the tank connected as a pi-section coupler for the 100-ft. end-on aerial. Full BK operation is possible, and for telephony working the speech-amplifier/modulator consists of EF50-6J5-6SN7-p/p 807's, with a crystal microphone. The transmitter input is 100-125 watts on

CW, and 60 watts on phone. For the Top Band, the transmitter used is a 6V6-807 VFO-PA arrangement, with the same end-on aerial as for the other bands. The receiver is an Eddystone S.640, and other items of equipment include a home-made El-Bug, with a W.1191A wavemeter for frequency control.

Our photograph shows, bottom right, the VFO for the main transmitter; the BA-Dbler-PA unit in the TU case on top of the "640"; aerial tuning unit above; the modulator on the W.1191A wavemeter, and various power supply units in the bottom left-hand corner; the main high-voltage power supply is on a shelf under the operating table. At middle left in the photograph is

the 1.7 mc transmitter.

The main interest at G3BRV is inter-U.K. working on 7 and 3.5 mc, with DX as a secondary pre-occupation; it is worked if it is there, but it is not chased. No spectacular DX achievements are claimed, though the score is more than 100 countries worked with about 90C confirmed. G3BRV himself is a member of the F.O.C., and operation is chiefly on the key. Any QSO's made on phone are "usually to convince non-Morse reading visitors that the transmitter is really working"! Much of his gear is home-constructed, and the essential activity at G3BRV is good CW operating and procedure in accordance with the standards and traditions of the F.O.C.

*Always mention Short Wave Magazine when writing to Advertisers—
It Helps You, Helps Them and Helps Us*

The Month With the Clubs

Barnsley & District Amateur Radio Club

On September 26, members of this Club paid a visit to the local Telephone Exchange, where, by courtesy of the staff, a very interesting and instructive evening was spent. On October 10, G6UF lectured on Servicing Meters. A demonstration of TV fault-finding will be given by G3AMH and G3YA on November 14.

Birmingham & District Short Wave Society

Recent talks have covered such subjects as Valve Development, Automatic High-Speed Morse Telegraphy, and Radio-Controlled Models. The October meeting heard a talk on Impressions of Earls Court, and on November 10 the subject will be An Introduction to Radar, given by Mr. R. Yates. The AGM will be held on December 8.

BTH (Rugby) Recreation Club : Radio & Television Section

The B.T.H. Group has been participating in many D-F Qualifying Contests and has also held several of its own. The last of these was on September 27. A full programme is being arranged for the winter, and construction evenings will be a regular feature. More commodious premises are now available, in the main Club House of the Recreation Club, on the Hillmorton Road.

Coventry Amateur Radio Society

C.A.R.S. supported the Low Power Field Day on September 7, and also the Two-Metre event on September 21. The AGM was held on September 15, and the

Everyone is hoping for a record entry in this year's *MAGAZINE CLUB CONTEST*, which takes place during the hours 1830-2230 from November 15 until November 22. Copies of the Rules have been circulated to all Clubs who have been reporting regularly to us during the last twelve months, and are available, on application, to the Secretaries of any other Clubs wishing to participate.

We should like to make it clear that Rule 2 (which states that Clubs must operate under their own call-signs, when allotted), is not intended to imply that a member's station cannot be used in cases where the Club Headquarters is not available during the hours of the Contest. Many are in this position, the Clubroom not being free every evening. In such instances it is intended that a member's station may be nominated and used for the Contest—but wherever it is possible to operate the Club station for the duration of the week, this should be done, using the Club's own call-sign.

We hope to hear an unparalleled amount of activity during the MCC week, and look forward to analysing the scores, which must reach us by December 1. The results will be appearing in our January issue.

This month we acknowledge the following Club journals: *Clifton Newsletter*, *G3ERD (Derby)*, *Purley and District News Sheet*, *QRP Research Society Journal*, *QLF (West Kent)*.

Next month's deadline will be a little early—*FIRST POST ON NOVEMBER 12*. Address all reports to Club Secretary, *SHORT WAVE MAGAZINE*, 55 Victoria Street, London, S.W.1. And now follow this month's reports, from 42 Clubs

following were elected: Chairman, G5GR; Hon. Treasurer, G2LU; Hon. Sec., G3FOH. October gatherings heard lectures on Two Metres, by Ray Bastin, and on The Wobulator, by G2LU. November 6 was the date fixed for the annual "Sausage-and-Mashed" event.

Dartmouth & District Amateur Radio Society

Activity has been high during the summer season, and several visitors have been welcomed. Much outdoor activity with portables has been carried out under the call G4RJ/P. The winter programme includes the annual receiving contest for the SWL's, a TV lecture and demonstration, and some talks by G3FHI.

Edinburgh Amateur Radio Club

Weekly meetings are now being held—every Wednesday at 7.30 in Unity House, Hillside Crescent, Edinburgh. Intending members and visitors will be made welcome.

Hoffman Gloucester Athletic & Social Club

The AGM was held in September, and the new officers elected.

The winter programme was discussed, and a series of lectures has been arranged to take place on the second Tuesday in each month, September to April, at 7.30 p.m. in the Staff Canteen. Apart from these, the year's programme will cover Radio Theory, fault-finding and repair, amateur transmitting and outside visits.

Purley & District Radio Club

A full list of members, with their addresses and telephone numbers, has been duplicated and circulated. The winter meetings will be held at the Railway Hotel, 7.30 p.m., on the fourth Thursday of each month, the next being November 27, when G3CU will lecture on Single Sideband. There will be no meeting in December.

QRP Research Society

This Club is catering for all those whose interests lie in the use of low-powered gear. A monthly journal is published and various contests are organised. The Hon. Sec. (see panel for address) will gladly forward full details to anyone interested.



General view of the Amateur Radio section provided by Slade and M.A.R.S. at the annual exhibition of the Sutton Coldfield and North Birmingham Model Engineering Society. Station G3HBE/A was in action on the 1.7, 3.5, 14 and 144 mc bands.

Rochdale Radio & Television Society

The Clubroom has now been decorated and electricity installed; during the coming season receivers, transmitters and test gear will be built and installed. A Morse class is starting on the first Friday in November; meetings are on Friday evenings at the Clubroom, 1 Law Street, Sudden, Rochdale.

Salisbury & District Short Wave Club

Club activities, continuing normally throughout the summer, have included participation in Romford's "Nocturnal D-F," and the re-arrangement of the aerial systems. Meetings are held every Tuesday evening, and new members will always be welcome. Recently, activities have centred on two metres, with contacts into the Southampton area — the honorary secretary would very much like to hear from VHF operators who can come up between 8.00 and 10.00 p.m. on Tuesday evenings. A busy and interesting winter programme has been arranged, and the Club Tx is ready for the MCC event.

Spenn Valley & District Radio & Television Society

Forthcoming events are as follows: November 19—Works and Technical Films (Central Electricity Board); December 3—description of Holme Moss, by the Engineer-in-Charge; December 17—High Fidelity Reproduction (Richard Allan Ltd.).

Isle of Thanet Radio Society

Meetings are now held every Friday evening at the George Hotel, Hawley Street, Margate, where two rooms have been acquired for the Club's use. One is being fitted out as a workshop, and the other is for operating the Club Tx (G3DOE) and for the weekly ragchew. Some interesting lectures are promised for the near future.

Wells & District Amateur Radio & Television Society

This Club, associated with the Wells Evening Institute, meets every Wednesday evening in its own premises in Milton Lane. Members have been building up, decorating and equipping the workshops and meeting rooms in

readiness for the winter. RAE and Morse Classes are being run, and a Club Tx is in course of construction. A visit to the BBC at Clevedon is projected for November.

West Kent Radio Society

Forthcoming events: November 12, talk on Rubber Crystals, by G2UJ—a practical demonstration of a mixer-master oscillator. November 26, Junk Sale. Meetings are on alternate Wednesdays at Culverden House, Culverden Park Road, Tunbridge Wells.

West Lancs. Radio Society

Meetings are held every Tuesday at 8 p.m. in the room over Gordon's sweet-shop, St. John's Road, Waterloo, Liverpool. Morse classes are held weekly and technical lectures monthly. Membership has increased to 46. Note new Secretary's QTH. in panel.

Worthing & District Amateur Radio Club

The Worthing group meets on the second Monday at the Worthing Adult Education Centre. New members will be welcomed, and

all interested in Amateur Radio are invited to attend the meetings. (See panel for new Secretary's address.)

East Surrey Radio Club

At the October meeting, Mr. Harry Knowles (Mullard) gave an interesting talk on Modern UHF Valves and their Characteristics. The Club hopes to welcome Mr. Knowles back for a further talk. The call-sign G3ISR has just been issued to the Club, and it is hoped that this call will soon be heard on the Top Band as well as on 80 and 2 metres.

Stoke-on-Trent Amateur Radio Society

Regular meetings continue every Thursday (7.30 p.m., at the rear of Cottage, Inn, Oakhill), and refreshments are now available at every meeting. New members have been turning up and a good winter season is assured. In October the lecture subjects were Test Meters, Radio Control of Models, Audio Amplifiers and Radio Maths. The Club Tx, G3GBU, is awaiting a rebuild.

Norwich & District Radio Club

Membership is growing, and an ambitious winter programme has been drawn up. Meetings are now held fortnightly (as from October 17), and a visit has been arranged to a nearby Decca Navigation Station on Friday, November 14, to see all those 807's in parallel! An enjoyable evening was recently spent with members of the Swanton Morley Club, taking the form of a small "Hamfest."

Ixworth Radio Club

At a recent meeting, G3WW gave a talk and demonstration on Two-Metre technique, including some tape recordings of activity at his home station. The October lecture was on the subject of FM, and the November meeting will be replaced by a week of activity (November 17-22) at the Handicrafts Exhibition in the Art Gallery, Bury St. Edmunds, when it is hoped to operate a phone transmitter on 80 metres.



Members of the Dartmouth & District Amateur Radio Society after a wet field day recently, faced with dismantling a bell-tent in pouring rain and then lugging 6-volt accs. across soggy fields. Such are the joys of /P sometimes—yet in retrospect it was always fun!

Leicester Radio Society

The first lecture of the new season was given by Mr. H. Turner, of the BTH Co. Illustrated by lantern slides, this dealt with Modern Cinema Sound Reproducing Equipment. On November 3 there will be a Surplus Component Sale, and a "Free and Easy" evening has been arranged for November 17. On December 1 members will hear a talk on FM (Part II), which will deal largely with reception. New members will be welcomed at any meeting.

Chester & District Amateur Radio Society

The Club gear is being overhauled prior to coming on Phone and CW. G3ITY is the latest member to get his "ticket," and several other hopefuls attend the Morse class on Mondays, and should soon be on the air. The winter programme includes "basic" lectures for beginners.

Brighton & District Radio Club

Attendances have improved, perhaps helped by a very interesting programme arranged by the Hon. Sec. G2CMH is rebuilding the Club Tx, and hopes to be

running QRO on 80 metres soon. Future meetings include a talk on the Williamson Amplifier (Mr. Goodsell on November 11) and one on Aerials (G6QB on November 25).

Army Apprentices' School Radio Club

Club activity is expanding, and several promising CW operators are shaping well on the key. The Club plans to enter for MCC, and a half-wave aerial is being erected for the purpose. (Note the new Hon. Secretary's QTH, in panel.)

Battersea Polytechnic Radio Society

This Club has flourished throughout the summer, but pressure of examinations now keeps the activity level rather low. The Club Tx, G3IGQ, is being regularly operated on 7 mc CW. Lectures and visits are being arranged, together with some constructional work on a Hi-Fi amplifier. Membership is restricted to those who belong to the Students' Union, but a warm welcome is assured to anyone who likes to drop in.

Bournemouth Radio & Television Society

The forthcoming season includes a number of attractive events, and

new members and visitors are invited to any of the meetings, which are held on the first and third Fridays, 7.45 p.m., at the Cricketers' Arms, Windhom Road. Future events are as follows: November 7, General Meeting; November 21, Judging of Entries in the Home-Constructed Gear Competition; November 29, Annual Hamfest; December 5, General Meeting.

Bradford

Amateur Radio Society

The winter session is now in full swing, and future attractions include the following: November 11, GPO Communications; November 25, Film Show; December 9, Constructing a Television Receiver. All meetings are at Cambridge House, 66 Little Horton Lane, at 7.30 p.m. preceded by half-an-hour's Morse instruction.

Cambridge & District Amateur Radio Club

The November meeting will be held on the 21st, when Mr. K. N. Hawke will give a talk on Quality Amplifiers. Members are also reminded to bring along their entries for the "Mechanical Skill" Contest, which will be judged, the result being announced at the December meeting. Meetings are at the Jolly Waterman at 7.30 p.m.

Clifton

Amateur Radio Society

On November 7 an Extraordinary General Meeting will be held, and the Christmas Party has been fixed for December 12. Preparations for this event have been in hand for three months, so something quite unusual may be expected! The Club Tx, G3GHN, will soon be on the air again, and a committee has been formed to organise the Club's entry for MCC this year.

Derby & District

Amateur Radio Society

Activity still runs high, and meetings are now being held weekly—Wednesdays at 7.30 p.m. The permanent installation of the Club Tx is nearly completed, and it is hoped that it will make itself heard in MCC.

NAMES AND ADDRESSES OF SECRETARIES REPORTING IN THIS ISSUE

ARMY APPRENTICES' SCHOOL: F. A. Hall, G3GBU, Tels. Dept., A.A.S., Arborfield, Reading.
ASSOCIATION OF NORTH WESTERN RADIO SOCIETIES: J. W. Swinnerton, G2YS, Manor Croft, Christleton, Chester.
BARNSELEY: P. Carbutt, 33 Woodstock Road, Barnsley.
BATTERSEA POLYTECHNIC: J. C. Watson, G3HHY, 41 Wroughton Road, London, S.W.11.
BIRMINGHAM: A. O. Frearson, 66 Wheelwright Road, Birmingham 24.
BOURNEMOUTH: J. Ashford, 3 Stevenson Court, 57 Alum Chine Road, Bournemouth.
BRADFORD: A. R. Bailey, G3IBN, Scarr Croft, Parkside, Bingley.
BRIGHTON: R. T. Parsons, 14 Carlyle Avenue, Brighton 7.
BTH, RUGBY: P. N. Prior, Electronics Engineering Dept., BTH Recreation Club, Rugby.
CAMBRIDGE: T. A. T. Davies, G2ALL, Meadow Side, Comberton, Cambridge.
CHESTER: N. Richardson, 1 Victory Villas, Upton Lane, Chester.
CLIFTON: T. Arch, 11 Boyson Road, London, S.E.17.
COVENTRY: K. Lines, G3FOH, 142 Shorncliffe Road, Coventry.
DARTMOUTH: B. Farleigh, G4RJ, Montpelier, Lower Contour Road, Kingswear, Devon.
DERBY: E. Shimmin, Leafmoor Mount, Derby Lane, Derby.
EAST SURREY: L. Knight, G5LK, Radiobne, Madeira Walk, Reigate.
EDINBURGH: C. L. Patrick, 19 Montaguery Street, Edinburgh.
GRAFTON: A. W. H. Wennell, G2CJN, 145 Usendon Hill, Wembley Park, Middx.
HARROW: S. C. J. Phillips, 131 Belmont Road, Harrow Weald.
HOFFMAN GLOUCESTER: S. R. Boakes, H-G Athletic and Social Club, Hoffman Works, Stonehouse, Glos.
IXWORTH: P. G. Wright, Thurston Road, Great Barton, Bury-St.-Edmunds.
KINGSTON: R. Babbs, G3GVU, 28 Grove Lane, Kingston, Surrey.
LEICESTER: L. Milnthorpe, G2FMO, 3 Winstler Drive, Thurmaston, Leicester.
MIDLAND: G. W. C. Smith, 84 Woodlands Road, Birmingham 11.
NORWICH: D. Youngs, 53 Salisbury Road, Norwich.
PURLEY: A. Frost, 18 Beechwood Avenue, Thornton Heath, Surrey.
QRP: J. Whitehead, The Retreat, Ryden's Avenue, Walton-on-Thames.
ROCHDALE: J. Riley, 1 Darley Bank, Britannia, Bacup.
SALISBURY: V. G. Page, G3IVP, 32 Feversham Road, Salisbury.
SLADE: C. N. Smart, 110 Woolmore Road, Birmingham 23.
SOUTHEND: G. Chapman, B.E.M., Bell Hotel, 20 Leigh Hill, Leigh-on-Sea.
SPEN VALLEY: N. Pride, 100 Raikes Lane, Birstall, nr. Leeds.
STOKE ON TRENT: J. R. Brindley, B.Sc., G3DML, 45 Rosendale Avenue, Chesterton, Newcastle, Staffs.
SUTTON AND CHEAM: F. J. Harris, 143 Collingwood Road, Sutton.
THANET: J. Barnes, G3BKT, 18 Grange Road, Rausgate.
TORBAY: L. H. Webber, G3GDW, 43 Line Tree Walk, Newton Abbot.
WELLS: W. L. Woodcraft, G3HUE, Haversham House, New Street, Wells.
WEST KENT: F. R. Freeman, 15 Queens Road, Tunbridge Wells.
WEST LANCs: B. J. Whitty, G3HFX, 46 Arge Road, Waterloo, Liverpool 22.
W.F.S.R.A. (Bedfast Club): J. Beaven, G3GJJ, 296 Fore Street, Edmonton, London, N.9.
WORCESTER: J. Morris-Casey, G8JC, 4 Kennels Road, Station Road, Fernhill Heath, Worcs.
WORTHING: R. Chidzey, 33 Bruce Avenue, West Worthing.

Grafton

Radio Society

Grafton's Tx, G3AFT, is now active on Club nights with 100 watts on 20, 40 and 80 metres, as well as the usual Top-Band 10-watter. On three nights a member is giving a series of talks on Magnetic Recorders—the final talk is on November 21.

Radio Society of Harrow

Activity continues, and the winter programme includes a series of talks and demonstrations on "How It Works." Forthcoming meetings are as follows: November 7, Miller Time-Base; November 14, Practical; November 21, Junk Sale; November 28, Practical. The annual Construction Contest for the Pikett Cup will be held on December 5. Meetings take place at the Club room, Science Lab., Roxeth

Manor Secondary School, Eastcote Lane, South Harrow, on Friday evenings.

Kingston & District Amateur Radio Society

The AGM was attended by more members than ever before, and the annual report was most satisfactory, showing a paid-up membership of 74 and a substantial cash balance in hand. A Social has been arranged for a date in January, to which YL's, XYL's and friends are invited. Next meeting is on November 19, with a talk by a representative of the Partridge Transformer Co. Morse classes are held every Friday.

Midland

Amateur Radio Society

The AGM took place recently, and the officers and committee for

the ensuing year were elected. In October the Society combined with Slade to run a stand at the Sutton Coldfield and North Birmingham Model Engineering Society's Show. The Lord Mayor and Lady Mayoress of Birmingham spent some time on the stand and obtained first-hand experience of Amateur Radio by speaking to a well-known Old Timer over the air. Meetings are held on the third Tuesday, at the Imperial Hotel, Birmingham.

Slade Radio Society

As mentioned in the above paragraph, Slade took part in the Model Engineering Exhibition, at which a wide range of equipment was on display. The event was highly successful and attracted much interest. On November 7 there will be a lecture on High-Quality Tape and Gramophone Reproduction—this meeting will be held at the Aston Technical College, Birmingham. On November 21 the AGM will be held, and on December 5 the subject will be Amateur Transmission—both meetings at Headquarters.

Sutton & Cheam Radio Society

On November 18 a G.E.C. representative will talk on Germanium Crystals. Visitors will be welcomed at The Harrow, Cheam.

at 8 p.m. The annual Christmas Junk Sale will take place at Headquarters on December 16. The Cullen Cup presentation is to take place at the TVARTS Annual Dinner in December, and preparations are in hand for MCC, for which event the Club will use the call G2BOF.

W.F.S.R.A. (Bedfast Club)

In addition to the letters of good cheer that go out each month to Bedfast Club members, it is hoped very soon to begin distribution of QSL and SWL cards bearing the Club's distinctive emblem. Books and magazines are being distributed all the time, but many more are needed. Last month's appeal for donations, however small, is again put forward, and it is hoped that the Christmas season will bring more into the kitty for the benefit of incapacitated members. All donations should be sent to G3AAU, 30 Churchbury Road, Enfield, Middx.

Worcester & District Amateur Radio Club

Attendance is now increasing after a quiet spell due to holidays, and plans are being drawn up for the winter programme, including a Morse class for the junior members. All readers in the Worcester area are invited to turn up any Thursday evening at the Club

QTH—Public Library (Basement), Foregate Street, Worcester. All meetings are at 7.30 p.m.

Association of North Western Radio Societies

This Association recently organised a lecture tour among member societies, given by Mr. Collings-Wells, of Goodmans, Ltd. Future activities include a Frequency Measuring Test on December 7 and a Receiving Contest on December 14. At the recent meeting, observers from the Southport Society were welcomed.

Southend & District Radio Society

A circular from the Honorary Secretary explains the difficulties facing the committee in finding accommodation for regular meetings, though it is hoped either to get into the Municipal College again or to be able to hire a suitable room elsewhere.

Torbay Amateur Radio Society

The Club is going forward with a winter programme of lectures and is entering MCC under call-sign G3GDW. Some members are busy with QRP gear, and an interesting lecture recently was by ex-VS7BJ. Open house is kept for visitors at the monthly meetings.

AMATEUR RADIO EXHIBITION

The Sixth Annual Amateur Radio Exhibition, sponsored by the Radio Society of Great Britain, is to take place at the Royal Hotel, Woburn Place, London, W.C.1, during the period Wednesday, November 26, to Saturday, November 29. Some 13 manufacturers have taken stands, others to exhibit being publishers in the radio field, the General Post Office, the Air Ministry and the War Office. Admission is by payment at the door, and the Royal Hotel can easily be reached by Tube (Russell Square Station) and by bus.

THE DX ZONE MAP

Readers should note that we can still supply our *DX Zone Map*, which is a five-colour Great Circle map of the world centred on the U.K., suitable for wall mounting, and a handsome addition to the QSL

collection at any station. The *Zone Map* not only gives the distance and true direction of all parts of the world relative to London, but also shows the Zone areas, with the prefix listings for each Zone. A world time-scale enables the time relative to GMT to be worked out for any part of the world. The cost of the *DX Zone Map*, third revised edition, available for immediate delivery, is 6s., post free, sent in a postal tube to avoid damage in transit. Order on The Circulation Manager, Short Wave Magazine, Ltd., 55 Victoria Street, London, S.W.1.

"NEW QTH" SECTION

We much regret that, owing to pressure on space, our usual "New QTH" feature has had to be held out of this issue. It will re-appear next month. Publication of the nearly-100 G QTH's now in hand for the *Radio Amateur Call Book* will not be delayed by the omission this month.

UNIVERSAL ELECTRONICS

We wish to buy . . .

★ TEST EQUIPMENT

By:—AVO. MARCONI. E.M.I. SIGNAL GENERATORS. TFS17. TF144G. TF390G, etc.

★ AMERICAN TEST SETS

TS3. TS69. TS148. TSE-45E. TS174/U. TS175. TS47AP. TS34AP. IE19. TS13.

★ RECEIVERS

RCA AR88-LF or D. Hallicrafters SX28. S27. S27C. S27CA. U.S.A. APR4 or APR5 receivers or tuning units TN16, 17, 18, 19, R34 complete or any parts. BC348. BC312. BC342. HT11A. TCS12-6. Collins 75A or 35V4TX.

★ TRANSMITTERS

BC610. ET4336. Speech Amplifiers. Tuning units. VFO. etc.

★ ANY VHF GEAR

Klystrons 723/AB 726. Magnetrans 2K33. 1B24 and any cm equipment.

At Your Price

(provided it is a fair one), we guarantee to pay you

Cash by return

Shop hours: 9.30 a.m. to 6 p.m. Thursday to 1 p.m.

Write, Call or Phone:

OUR ONLY ADDRESS DEPT. S Phone: GERrard 8410 (Day)
MEAdway 3145 (Night)

27 LISLE STREET,
LEICESTER SQUARE, LONDON, W.C.2

Close to Leicester Square tube station.

SAMSONS

SURPLUS STORES

S.T.C. FIELD HAND TELEPHONE SET. Complete Unit built in metal Container which can be easily held in one hand, operates from 4½ volt flat Battery. Buzzer calling device, will work efficiently up to 15 miles, on twin cable or 10 miles earth return, suitable for Offices. Farms. Building sites. Estates, etc., 65/- each Instrument P.P. 2/-.

TELEPHONE CABLE D.3 Single .1 Mile drums 55/-, Carr. 5/-.

B.C. 610 TUNING DRAWERS. Oscillator and Doubler. Freq. 3.2-4.0 mc/s or 6.35-8.0 mc/s. Brand new 25/-, P.P. 2/-.

U.S. ARMY INTERPHONE AMPLIFIER type B. C. 347C complete with 6F8 valve 15/-, P.P. 1/6.

U.S.A. MANUFACTURE HEAVY DUTY AUTO TRANSFORMERS. tapped 115, 150, 200, 230, 250 volts, very conservatively rated at 2½ K.V.A. We Rate them at well over 3 K.V.A. £10. Callers only please, too heavy for despatch. Also available large selection of Auto transformers of various ratings; write for particulars.

HEAVY DUTY SLIDING RESISTORS 20 ohm. tapered. 7.5 to 1 amp Geared drive 45/- p.p. 2/6; 0.5 ohm, 25 amp, 17/6 p.p., 1/6; 16 ohm 2 amp, 12/6, p.p., 1/6; 1 ohm, 12 amp, 12/6, p.p., 1/6; 8 ohm 5 amp, 17/6, p.p., 1/6; 50 ohm 1 amp, 10/6, p.p., 1/6.

MASTER VOLTMETERS. 0-20v, A.C. 50cy, Moving Iron 6in. Mirrored scale, by Metro-Vick, 27/6, carr. 2/-.

169/171 EDGWARE ROAD

LONDON, W.2. Tel: PAD. 7851

125 Tottenham Court Road, W.1. Tel: EUS. 4982

All orders and enquiries to our Edgware Rd. branch please
Open All Day Saturday at the Edgware Road Branch.

CASH is WAITING FOR YOU

TURN YOUR REDUNDANT AND SURPLUS
TEST EQUIPMENT INTO MONEY

We require certain types of English and American equipment in any quantity and any condition, however rough.

We give below examples of prices we pay for equipment in good condition:

- RECEIVER R.54/ARP.4 WITH TUNING UNITS TN.16, TN.17, TN.18 & TN.19. £110.
- BC.221 FREQUENCY METER. £25.
- TS.13/AP SIGNAL GENERATOR. £50.
- KLYSTRONS, TYPE 723/AB. £2.10.

Send for big list of our requirements showing hundreds of items, one of which you may have lying around and which can be turned into money.

Please write, call or phone, giving price, condition, etc.

ELM ELECTRIC CO.
175, UXBRIDGE RD., LONDON, W.7
EALing 0779

MAINS, TRANSFORMERS, SCREENED, FULLY INTERLEAVED AND IMPREGNATED

Half Shrouded—			
H.S.63.	Input 200/250v. Output 250/0/250v. 60 m/a 6.3v 3 amps, 5v 2 amps	...	18/6
H.S.40.	Windings as above, 4v 4 amps, 4v 2 amps	...	18/6
H.S.2.	Input 200/250v. Output 250/0/250v. 80 m/a	...	21/-
H.S.30.	Input 200/250v. Output 300/0/300v. 80 m/a	...	21/-
H.S.3.	Input 200/250v. Output 350/0/350v. 80 m/a	...	21/-
H.S.2X.	Input 200/250v. Output 250/0/250v. 100 m/a	...	23/-
H.S.30X.	Input 200/250v. Output 300/0/300v. 100 m/a	...	23/-
Fully Shrouded—			
F.S.2.	Input 200/250v. Output 250/0/250v. 80 m/a	...	23/-
F.S.30	Input 200/250v. Output 300/0/300v. 80 m/a	...	23/-
F.S.3.	Input 200/250v. Output 350/0/350v. 80 m/a	...	23/-
F.S.2X.	Input 200/250v. Output 250/0/250v. 100 m/a	...	25/9
F.S.30X.	Input 200/250v. Output 300/0/300v. 100 m/a	...	25/9
F.S.3X.	Input 200/250v. Output 350/0/350v. 100 m/a	...	25/9
F.S.43.	All above have 6.3-4-0v at 4 amps. 5-4-0v at 2 amps. Input 200/250v. Output 425/0/425v 200 m/a 6.3v 4 amps C.T. 6.3v 4 amps C.T. 5v 3 amps	...	51/-
H.S.6.	Input 200/250v. Output 250/0/250v. 80 m/a 6.3v 6 amps C.T. 5v 3 amps. Half-shrouded	...	29/3
	For Receiver R1355.		
Framed, Flying Leads—			
F.30X.	Input 200/250v. Output 300/0/300v. 80 m/a. 6.3v 7 amps. 5v 2 amps	...	31/9
HS150.	Input 200/250v. Output 350/0/350v. 150 m/a 6.3v 3 amps C.T. 5v 3 amps. Half-shrouded	...	30/9
FS120.	Input 200/250v. Output 350/0/350v. 120 m/a 6.3v 2 amps C.T. 6.3v 2 amps C.T. 5v 3 amps Fully shrouded	...	33/-
FS150X.	Input 200/250v. Output 350/0/350v. 150 m/a, 6.3v 2 amps C.T. 6.3v 2 amps C.T. 5v 3 amps Fully shrouded	...	34/9
	FILAMENT TRANSFORMERS		
F5.	Input 200/250v. 6.3v at 10 amps or 5v 10 amp or 10v at 5 amp or 12.6v at 5 amp. Framed Flying Leads	...	37/9
F.U.6.	Input 200/250v. 0-2-4-5-6.3v at 2 amps	...	11/-
F.29.	Input 200/250v. 0-2-4-5-6.3v at 4 amps	...	20/9
F.6.	Input 200/250v. 6.3v 2 amps	...	9/-
F.12.	Input 200/250v. 12.6v. Tapped at 6.3v 3 amps	...	18/6
F.24.	Input 200/250v. 24v. tapped at 12v. 3 amps	...	26/-
C.W.O.	(add 1/3 in the £ for carriage).		
	H. ASHWORTH (Dept. S. W.) 676 Great Horton Road, Bradford Yorks.		

WIDE ANGLE T/V

SMITH'S OF EDGWARE ROAD

Stock ALL the components :—Allen, Denco, Colvern, Dubilier, Elac, McMurdo, Morgan, STC, TCC—
for the

“ TELEKING ”

“ VIEWMASTER ” CONVERSION

and

“ MAGNAVIEV ”

(Radio Constructor).

Also TUBES, VALVES, CABINETS, ETC.

Price Lists on receipt of S.A.E.

H. L. SMITH & CO., LTD.

287/289, EDGWARE ROAD, LONDON, W.2

Radio Component Specialists

FIXED CONDENSERS OF ALL TYPES

Both Paper and Mica

Large stocks available for immediate delivery. Your specific enquiries, giving full details, will receive immediate attention. Our prices show substantial savings.

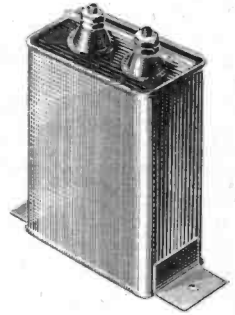

CLAUDE LYONS LTD

ELECTRICAL & RADIO LABORATORY APPARATUS

180 Tottenham Court Rd., London, W.1. Tel: MUS 3025

S. G. Brown



“A”
TYPE
HEADPHONES

The first choice of
RADIO OPERATORS
throughout the world

These headphones feature a High Permeability Reed tuned to 1,000 c/s. and coupled to a conical aluminium diaphragm. Earpieces individually adjustable while in use for sensitivity and power-handling characteristic.

D.C. Resistance : 4,000 ohms.
Impedance : 16,000 ohms at 1,000 c/s.

The S. G. Brown range of headphones covers types for many specific requirements. Details of the full range are available in the illustrated Brochure “S.”—sent on request.

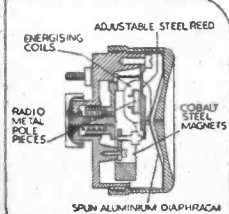

S. G. Brown Ltd.

SHAKESPEARE ST. WATFORD, HERTS.
Telephone: Watford 7241.

WE PAY TOP PRICES

FOR

American Surplus Electronic Equipment

Any quantity or condition

LOOK at THESE EXAMPLES

For equipment in good condition

Receiver R54/APR4 with tuning units TN16, 17, 18, 19 (or bought separately) ...	£110
Receiver AR88D ...	£55
Frequency Meter TS 175 ...	£80
TX/RX RT18/ARCI ...	£50

We pay similar Remarkable Prices for

- Receivers APRI, APR4, APR5, R5/ARN7, BC348, BC342, BC312, R78/APS15, APN9
- Frequency Meters BC221, TS174/U
- Test Sets TS3, TS13, TS14, TS17, TS19, TS33, TS34, TS45, TS47, TS59, TS69, TS102, TS118, IE19
- Transmitters ART13, SCR522, TRCI, TCS6-12-13, SCR300, BC1000
- Synchronisers BC1148 Modulators BC1142

Phone us immediately, transfer charge

ALTHAM RADIO CO.

BRAZENNOSE STREET, MANCHESTER 2

Tel. DEAnsgate 5387

Electradix Bargains

CONDENSERS. Special offer. 2 mfd. fixed, new surplus, sealed type 250 volts, 7/6 dzn., post 9d. 1 - 1 mfd., 6/- dzn., post 9d. 4-gang variable ceramic insulation .0005 mfd., 4/6, post 9d. Variable short wave air spaced 16 m.mfd. trolituf insulation, ball bearings, 5/-, post 6d.

MICROPHONES. G.P.O. Hand Mikes in moulded bakelite case, 4/6, post 9d., transformer 2/6 extra. G.P.O. Mike button, 1in. dia., fine carbon granules, mica diaphragm, 3/6, post 6d. Throat Mikes, 7/6. Electradix Table Mike with Transformer mounted on polished bakelite base, 12/6, post 1/6. write for leaflet. Carbon granules, fine grade, 5/- per 1/2oz. Packet.

MORSE PRACTICE SETS comprising A.M. Key and twin coil buzzer on base with space for battery, wired, 6/6, post 1/6. **PRACTICE KEY** on polished wood base, 6jin. x 6jin. with space for battery and terminals, 2/6, post 9d. **BUZZERS.** G.P.O. twin coil, new, 3/6, post 6d., practice buzzer in bakelite case, 2/6, post 6d.

MAGNETS. D.C. Electro Magnets, 6 volts, lift 4lbs., twin coil type, 5/-, post 6d. Circular Horseshoe Instrument Magnets, Swift Levick S.L.S. 36 1 1/2in. dia., 3/4in. thick, 1/2in. polar gap, drilled poles, 2/6, post 6d.

CRYSTAL SETS. The Lesdix 1952 Model, wound coil, var. condenser, Diode Detector 'phone Transformer with socket, all in neat bakelite case, 6in. x 4jin. x 1 1/2in., complete with headphones fitted headband cord and plug, 30/-, postage 2/6. Colours Maroon and Mottled Brown, all aerial tested.

ELECTRADIX RADIOS

Dept. B. 214 Queenstown Road, Battersea, London, S.W.8.

Telephone : MACauloy 2159

OUR 17th YEAR Money Saving Offers

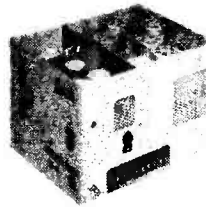

SPECIAL OFFER OF G.E.C. VHF RECEIVERS. (Illustrated). The receiver complete with 10 valves as follows. HF and 1st det stages ZA2, 954 or EF50's Local Oscillator Det 19. Three IF stages KTW63's. Det and AVC D63, LF H63, noise suppressor D63. Available in two frequency ranges, crystal controlled (crystal not supplied). (State one required), "B" 95-5-100 mcs., "C" 78.5-82 mcs. Power requirements, 6 v. LT. 270 v. H.T. Grey enamel steel case 10 x 8 x 7 in., weight 22lbs. In first-class condition. Your chance to get going on VHF. Amazingly low price due to huge purchase, 49/6, plus carriage 5/-.

1155 POWER PACK AND OUTPUT STAGE, complete with U50 and KT61 valves (not surplus). Black crackle case 12 x 8 x 5in., built-in 5in. P.M. speaker and phone jack. Operates on 200/250 v. A.C. Connections terminate in Jones plug which enables instant operation of receiver without any modification whatsoever. Made to "Wireless World" specification. Matches in appearance with receiver. Price 47/10/-, plus carriage 3/6.

NOTE OUR PRICES. OUTSTANDING VALUE FOR MONEY

H.P. RADIO SERVICES LTD.

Britain's Leading Radio Mail Order House

55 COUNTY ROAD, LIVERPOOL 4

Est. 1935

Tel.: Aintree 1445

SOUTHERN RADIO'S WIRELESS BARGAINS

TRANSMITTER-RECEIVERS. (WALKIE-TALKIE) Type 38, Mark II. Complete with 5 Valves, Microphone, 'Phones, Aerial, etc. Guaranteed Ready for the Air. Less Batteries, 46 12s. 6d. plus 2/6 post.

TRANSMITTER-RECEIVERS Type 38, Mark III. Later Model. Complete. CRYSTAL CHECK 48 10s. 0d.

TRANSMITTER-RECEIVERS. Type "18" 6-9 Mcs. Perfect. 47 10s. 0d.

RECEIVERS R.109 COMPLETE WITH ENCLOSED SPEAKER and Vibrator Pack for 6-Volts, 1.8 to 8.5 mcs. Complete with 8 Valves in Metal Case, 47 15s. 0d. plus 7/6 carriage.

MINISCOPES G.E.C. Type M861b. MINIATURE CATHODE RAY OSCILLOSCOPES. 1 1/2 inch Tube. Time Base, etc., etc. BRAND NEW IN MAKER'S SEALED CARTONS. WITH LEATHERETTE CARRYING CASE, 41s 10s. 0d. plus 5/- carriage.

LUFBRA HOLE CUTTERS. For use on Wood, Metal, etc., etc. Adjustable from 3/8in. to 3 1/2in., 5/9.

THROAT MICROPHONES. Complete with long lead and plug. Magnetic, 4/6.

PLASTIC TRANSPARENT MAP CASES. 14in. by 10 1/2in. Ideal for Charts, Photos, Display, etc., etc., 5/6.

STAR IDENTIFIERS. With Hydrographic Office Mods. A-N Type. New in cases, 5/6.

WESTECTORS. Wx6 and W112, 1/- each. 11/- per doz.

MARCONI AERIAL FILTER UNITS. Type "916" in conformity with P.O. Specifications. Full fixing instructions, 4/6.

CONTACTOR TIME SWITCHES. 10-hour movements. 2 impulses per second. Thermostatic Control. In Soundproof Case, 11/6. Remote Controls for above, 7/6.

VISUAL INDICATORS. Type 3 (10Q4). Contains two Moving Coil Microamp Meter Movements. Neons, etc. Easily convertible to efficient M.C. Meters, 11/-.

Conversion fully described in "W.W." Sept. 1951.

RESISTANCES. 100 Assorted Values. Wire ended 1/2 to 2 watts, 12/6 per 100.

CONDENSERS. 100 Assorted Tubular and Mica Condensers. All useful values, 15/- per 100.

CONTROL CABLES for Command Receivers B.C. 453/4/5. 14 feet with adaptors at either end, 10/-.

Full List of Radio Books 2 1/2d. Hundreds of more Lines for Callers.

SOUTHERN RADIO SUPPLY LTD.,
11, LITTLE NEWPORT STREET, LONDON, W.C.2.
GERrard 6653.

YOU CAN RELY ON US FOR BRAND NEW
CLEAN COMPETITIVE COMPONENTS.

VALVE MANUALS.

BRIMAR, OSRAM, MULLARD, 5/- each

VALVES : KT61, 10/-; R3, 8/6; 5V4, 9/-; 6K8gt, 10/-; 12AU7, 9/6; EL41, 10/6; 5130, 6/-; 6SN7, 9/6; 6SL7, 8/6; KT66, 9/6; 5Z4G, 9/6; 12SL7, 8/-; UB41, 8/-; EAF42, 10/6; VU111, 7/6; 12A6, 7/-; 6L6G, 10/-; 3Q4, 7/6.

BRIMAR METAL RECTIFIERS. RM1 125v 60ma./a., 4/9; RM2, 100ma./a., 5/3; RM3, 120ma./a., 6/3. Two in Series for 250v Working. K3/100, 14/8. RM4, 18/-.

FILAMENT TRANSFORMERS. 200/240v to 6.3V, 1.5a., small dimensions, 8/6; 3v to 30v at 2a. tapped 3, 4, 5, 6, 8, 9, 10, 12, 18, 20, 24, 30 volts, 24/-.

RF EHT COIL 6-11KV. Wavewound accurately on Polyester former will operate with EY51 or U25, 39/-; with U25 assembled and wired with anti-corona wire, 67/6.

4Ba BOX SPANNERS, box of five, 2/-; Terrys 2/4/6Ba Flat, 1/- set.

SPECIAL OFFER, this month only —
Twin Triode 12AX7, 6/-;
12AT7, 9/6.

METER RECTIFIERS. 1ma Bridge Westinghouse, 12/6; Half Wave Surplus, 1/-.

VOLUME CONTROLS. With switch, 4/3, less, 2/9. Standard long spindles. Midget 5/6 and 3/6.

QMAX CHASSIS CUTTERS AND KEYS. 3/4in., 12/4; 3/2in., 13/4; 1 1/2in., 13/4; 1in., 13/4; 1 1/2in., 16/-; 1 1/2in., 17/9; 1 1/2in., 17/9; 1 1/2in., 19/6; 2 1/2in., 36/9. 1in. square, 24/3.

10in. LOUSPEAKERS. Standard 3 Ohm, New, 21/-; Bin., 17/6.

VALVE CANS. Three piece for octal valves, 1/6.

'MOTEK' TAPE DECK. First quality consisting of 3 Collaro motors recording playback and erase heads, brown crackle panel, engineered to fine limits to avoid 'wow' and 'flutter.' Price 45/15/-.

RADIO SERVICING CO.

Dept. M/O 444 Wandsworth Road, London, S.W.8.

MACauloy 4155

SMALL ADVERTISEMENTS

9d. per word, minimum charge 12/- . No series discount ; all charges payable with order. Insertions of radio interest only accepted. Add 25% for Bold Face (Heavy Type). No responsibility accepted for errors. Replies to Box Numbers should be addressed to The Short Wave Magazine, 55 Victoria Street, S.W.1.

TRADE

Q SL's and LOGS by MINERVA — the best there are. — Samples from Minerva Press, 46 Queen's Road, Brentwood, Essex.

Q SL CARDS AND LOG BOOKS. APPROVED G.P.O. SAMPLES FREE. — ATKINSON BROS., PRINTERS, ELLAND, YORKS.

WANTED: NEW VALVES — 6K8, 6V6, 5Z4, FW4/500, KT33C, KT61, 6Q7, etc., etc. PROMPT CASH.—WM. CARVIS, 103 NORTH STREET, LEEDS 7.

SHORT-WAVE KITS. Television Components. Coils, Coil Packs, Valves, Speakers. Send for new catalogue free.—The Radio Equipment Company (S.W. Dept.), Castor Road, Brixham, Devon.

VALVES WANTED: Types 805, 807, 813, 829B, 832, 866A, 931A, 100TH, 250TH, TZ40, 723A/B, 2K33, 2C43, CV129, CV323.—Quantity and price, please, to: Pype-Hayes Radio, 606 Kinsbury Road, Birmingham 24. (Phone: Erdington 4942).

TRANSMITTERS: BC610, ET4336. Receivers: AR88, BC348, SX24, etc. Frequency meters, test sets, etc., wanted urgently. We pay high prices instantly.—Write/Phone: Pype-Hayes Radio, 606 Kinsbury Road, Erdington, Birmingham 24. (Erdington 4942).

Q SL CARDS: Neat, attractive; reasonable prices. Samples.—Lovedee, BRS.15643, Mill Street, Barwell, Leicester.

45/- EACH offered for new boxed 813's. Also wanted: 28D7's and 12C8's. Other new valves purchased for cash.—Details to Box 1159.

VALVES: 832, 25/- each; Z77, EF91, 8/6 each; W77, EF92, 7/-; EL91, N77, IR5, 3S4, 8/- each; EL72, 7/6; 6V6, 7/-; 1, T4, 7/- . Mail order only, please. Orders under £1, please add 9d. postage and packing.—E. Fitch, 60 Birnam Road, Finsbury Park, London.

VALVES: 6J5, 12AT7, 10/-; EF91, 6AM6, 7/6; 6C4, EF92, EAC91, 6AL5, D77, 6 6.—Skillman, Franchise Street, Weymouth.

SITUATIONS VACANT

JUNIOR TECHNICIANS are required in the Test Department of a well-known Cambridge electronic instrument company. Knowledge of operation of normal measuring instruments desirable.—State previous experience and approximate wage required to Box No. 1153.

MINISTRY OF CIVIL AVIATION.—Radio Mechanics required at aerodromes and radio stations in various parts of United Kingdom. Special training courses for keen mechanics with basic qualifications. Interesting work in progress providing electronic aids to navigation. Prospect of permanent pensionable posts. Rates of pay (London) from 109/- per week at age 19 to 143/- at 25, and rise, subject to qualifying test, to 173/-, plus pay addition of 10%.—Candidates, aged 19 or over, with practical experience of radio or radar equipment, should apply to any Employment Exchange, quoting Order No. King's Cross 576.

AMATEUR TRANSMITTING LICENCE

Pass the

G.P.O. MORSE CODE TEST

the speedy way —

Enrol for the **CANDLER SPECIAL COURSE** which includes all essential training to enable the average student to be successful. The fee is reasonable too.

Write now for the

CANDLER

"**BOOK OF FACTS**"

stating which course you are interested in

- (1) **Special Course** for G.P.O. Morse Code test for Amateur Transmitting Licence.
- (2) **Candler Junior Course** for Beginners.
- (3) **Candler Advanced Course** for Operators who desire to increase their speeds and accuracy.

Courses supplied on cash or monthly payment terms

THE CANDLER SYSTEM CO.

(Dept. 55SW),

52b ABINGDON ROAD, LONDON, W.8

Candler System Company, Denver, Colorado, U.S.A.

POWER UNITS TYPE 104. Rotary converter units for 12v. DC. input and having a twin DC. output of 250v. at 50mA, and 6.5v. at 2.5A. Can be operated in reverse from DC. mains or 6v. Totally enclosed in neat metal cases $8\frac{1}{2} \times 6\frac{1}{2} \times 4\frac{1}{2}$ ins. In good condition and working order. PRICE 10/6, post 2/-.

ACCUMULATORS 2/12 VOLTS. Assembled in metal cases $8\frac{1}{2} \times 8\frac{1}{2} \times 6$ ins. with carrying handle that folds flat when not in use. Rated at 12v. 14amp-hours. Connections from each cell terminate to a threaded stem so that it is quite easy to re-arrange connections to supply say 2v. or 6v. with, of course, a proportionate increase in amp-hour capacity. Suggested uses apart from radio are for the motor cycle, car parking lights, etc. In unused condition but outside of metal cases may be a little store soiled. PRICE 26/-, carriage 4/-.

POWER UNITS TYPE 3. A high grade unit operated from A.C. mains 200/250v. 50 cps. Outputs are 220v. D.C. at 70mA, and 6.3v. A.C. at 4A. Designed for use with the R.1132 and R.1481 but suitable for most communication receivers. Made for rack or bench mounting, panel size 19 x 7ins. and depth over dust cover 11ins. Both input and output are fused and a two section filter gives a high degree of smoothing. Front panel is fitted with 0/150 milliammeter for indicating output current. Interior metal work may be store soiled but exterior appearance good and all tested to ensure perfect working order. Supplied complete with plugs, circuit diagram and rectifier valve. PRICE 84/-, carriage 7/6.

CERAMIC ROTARY SWITCHES. 3 wafer, each wafer single pole 5 way, single hole fixing. PRICE 4/3 each or 3 for 11/9, post free.

L.T. TRANSFORMERS. Primary 200/250v. 50 cps. Secondary 3, 4, 5, 6, 8, 9, 10, 12, 15, 18, 20, 24 or 30v. for total 2 amp. loading. Excellent for model railway, accumulator charging, etc. Brand new and guaranteed all connections clearly marked. PRICE 21/-, post 1/9.

THIS MONTH'S BARGAIN OFFER

INDICATOR UNITS TYPE 182. These are fitted with a 6in. cathode ray tube type VCR 517 suitable for either TV, or scope, 3-VR91's, 4-VR65's, 1-5U4, 9-wire-wound pots, and a wealth of other useful components. Size of unit approx. 19 x 8 x 7ins. These are in good condition with C.R. Tube, TV, picture tested to ensure freedom from cut-off. PRICE 65/-, carriage 6/6.

LYONS RADIO 3, GOLDHAWK RD. (Dept. MS)
Shepherds Bush, London, W.12
— LIMITED — Telephone: SHEPHERDS BUSH 1729

G4GZ's BARGAINS

VALVES

OZ4	5/6	6AM6	10/6	6N7GT	6/6	12AX7	9/6
1A5GT	7/6	6AQ5	11/6	6N7M	8/-	12J5GT	5/-
1G6GT	6/6	6B8G6G	12/6	6Q7GT	11/6	12SQ7GT	12/6
1LN5GT	6/-	6C4	6/6	6R7GT	8/-	6Y7G	9/-
1LD5GT	6/-	6CS5GT	6/6	6SG7M	8/6	6Z4	9/-
1R5	8/6	6F7	10/6	6SL7GT	10/6	15D2	6/6
1S5	8/6	6F8G	7/6	6SN7GT	10/6	25L6GT	9/-
1T4	8/6	6F6G	8/6	6SQ7M	10/6	50L6GT	9/6
2A3	7/6	6F6M	8/6	6SJ7M	12/6	866A	17/6
2X2	5/-	6G6G	7/6	6U5	7/6	9002	6/6
3A4	8/6	6H6M	5/6	6V6G	9/6	9003	5/6
3D6	3/6	6K6G	8/6	6V6M	10/6	VS110A	6/6
3Q5	9/6	6K7GT	6/6	6X5GT	7/6	W77	7/6
5Z4M	9/6	6K8G	12/6	7A3 (Pen.)	ECL80	13/-	
5Z4G	9/6	6K8M	15/-	A4	11/6	MU12/14	9/6
6AC7M	6/6	6J5GT	6/6	12A6M	7/-	808	45/-
6AG5	7/-	6J5M	7/6	12AT7	9/6	100TH	90/-
6ALS	9/-	6L7M	8/-	12AU7	9/6	DLS10	9/6

SPECIAL VALVE OFFER! 6SH7M Metal tubes, slightly soiled ex equipment. All guaranteed. 4 for 9/6, 27/6 doz.

NEW BOXED MC METERS. 3 1/2 in. rd. fl. mtg. (2 1/2 in. dial) 0-5000/m/a 17/6. 0-10m/a, 17/6. 0-30m/a, 15/-.. 0-15v AC (1 Cal at 50 cps), 15/- and FEW ONLY 0-100 microamps, 45/-.. 2in. sq. fl. mtg. 0-200m/a, 17/6. 0-300v, 12/6. 2 1/2 in. sq. fl. mtg. FSD approx 2 1/2 m/a. Pointer zeroed to right. Ideal for conversion to "S" Meters. 6/6.

INTERESTED IN TAPE RECORDING? The NEW Lane 3 motor Tape Tables are in stock £16/10/- (Car. 7/6). The NEW Qualtape £16/16/- (Car. 2/6). Wearite Tape Decks £35 (Car. 10/6) Simon TR2B £60. Also when available Ferrograph and Reflectograph Recorders. Let us have your enquiries. 1200ft. reels Scotch Boy MCI-111 35/-.. Emitape H60/A, 35/-.. 1200ft., 21/- 600ft. Spare 7in. reels 4/6. Plastic 4/-.. GEC Joining fluid 4/9. Acos Mic-30 £4/4/-.. Lustraphone mikes, all types in stock.

All goods despatched per return of post. Please add post/packing

J. T. ANGLIN

160, CLEETHORPE ROAD, GRIMSBY, LINC'S. Tel. 56315.

ALPHA OFFERS

VALVES

VALVES	NEW	AND BOXED	SOME	GOVERNMENT	SURPLUS.		
PT25H	10/-	VU120A	4/-	154	8/6	6SR7	8/-
P27/500	10/-	KT66	10/6	155	8/6	6B7	8/6
1625	7/6	VR150/30	9/-	174	8/6	6AB7	8/6
2051	6/9	VU111	4/6	185	8/6	6SR7	8/6
5T4	9/-	VS110A	4/-	6VG6	9/6	6AQ5	8/6
8B4	7/6	SP41	4/-	65F5	8/6	6AK5	8/6
VGT12B	7/6	SP61	7/6	6AG5	8/6	28D7	5/6
S130	5/-	6SN7	11/6	6FB	7/-	1457	10/-
RL37	5/-	6SL7	9/6	65T7	7/-	CV135	7/6
5V4G	9/-	6J5	5/6	6YG6	8/-	35L6GT	9/6

MAINS TRANSFORMERS.

MT1 PRIMARY. 200-220-240v. SECONDARIES. 250-0-250v. 80M/A. 0-4v. 5A.-6.3v., 4A. 0-4v.-5v. 2A. 17/6 each

MT2 as above, but with 350-0-350 H.T. winding. 17/6 each

AUTO TRANSFORMER.

0-10-120-200-230-250v. 100 watts. 17/6 each

MT3 PRIMARY. 200-220-240v. SECONDARIES. 30v. 2 amp. with tappings at 3v. 4v. 5v. 6v. 8v. 9v. 10v. 12v. 15v. 18v. 20v. 24v.



DIAL DRUMS. 1 1/4", 1 1/2", 1 3/4", 1 7/8", 2", 2 1/8", 2 1/4", 2 1/2", 2 3/4", 3", 3 1/4", 3 1/2", 3 3/4", 4", 4 1/4", 4 1/2", 4 3/4", 5", 5 1/4", 5 1/2", 5 3/4", 6", 6 1/4", 6 1/2", 6 3/4", 7", 7 1/4", 7 1/2", 7 3/4", 8", 8 1/4", 8 1/2", 8 3/4", 9", 9 1/4", 9 1/2", 9 3/4", 10", 10 1/4", 10 1/2", 10 3/4", 11", 11 1/4", 11 1/2", 11 3/4", 12", 12 1/4", 12 1/2", 12 3/4", 13", 13 1/4", 13 1/2", 13 3/4", 14", 14 1/4", 14 1/2", 14 3/4", 15", 15 1/4", 15 1/2", 15 3/4", 16", 16 1/4", 16 1/2", 16 3/4", 17", 17 1/4", 17 1/2", 17 3/4", 18", 18 1/4", 18 1/2", 18 3/4", 19", 19 1/4", 19 1/2", 19 3/4", 20", 20 1/4", 20 1/2", 20 3/4", 21", 21 1/4", 21 1/2", 21 3/4", 22", 22 1/4", 22 1/2", 22 3/4", 23", 23 1/4", 23 1/2", 23 3/4", 24", 24 1/4", 24 1/2", 24 3/4", 25", 25 1/4", 25 1/2", 25 3/4", 26", 26 1/4", 26 1/2", 26 3/4", 27", 27 1/4", 27 1/2", 27 3/4", 28", 28 1/4", 28 1/2", 28 3/4", 29", 29 1/4", 29 1/2", 29 3/4", 30", 30 1/4", 30 1/2", 30 3/4", 31", 31 1/4", 31 1/2", 31 3/4", 32", 32 1/4", 32 1/2", 32 3/4", 33", 33 1/4", 33 1/2", 33 3/4", 34", 34 1/4", 34 1/2", 34 3/4", 35", 35 1/4", 35 1/2", 35 3/4", 36", 36 1/4", 36 1/2", 36 3/4", 37", 37 1/4", 37 1/2", 37 3/4", 38", 38 1/4", 38 1/2", 38 3/4", 39", 39 1/4", 39 1/2", 39 3/4", 40", 40 1/4", 40 1/2", 40 3/4", 41", 41 1/4", 41 1/2", 41 3/4", 42", 42 1/4", 42 1/2", 42 3/4", 43", 43 1/4", 43 1/2", 43 3/4", 44", 44 1/4", 44 1/2", 44 3/4", 45", 45 1/4", 45 1/2", 45 3/4", 46", 46 1/4", 46 1/2", 46 3/4", 47", 47 1/4", 47 1/2", 47 3/4", 48", 48 1/4", 48 1/2", 48 3/4", 49", 49 1/4", 49 1/2", 49 3/4", 50", 50 1/4", 50 1/2", 50 3/4", 51", 51 1/4", 51 1/2", 51 3/4", 52", 52 1/4", 52 1/2", 52 3/4", 53", 53 1/4", 53 1/2", 53 3/4", 54", 54 1/4", 54 1/2", 54 3/4", 55", 55 1/4", 55 1/2", 55 3/4", 56", 56 1/4", 56 1/2", 56 3/4", 57", 57 1/4", 57 1/2", 57 3/4", 58", 58 1/4", 58 1/2", 58 3/4", 59", 59 1/4", 59 1/2", 59 3/4", 60", 60 1/4", 60 1/2", 60 3/4, 61", 61 1/4", 61 1/2", 61 3/4, 62", 62 1/4", 62 1/2", 62 3/4, 63", 63 1/4", 63 1/2", 63 3/4, 64", 64 1/4", 64 1/2", 64 3/4, 65", 65 1/4", 65 1/2", 65 3/4, 66", 66 1/4", 66 1/2", 66 3/4, 67", 67 1/4", 67 1/2", 67 3/4, 68", 68 1/4", 68 1/2", 68 3/4, 69", 69 1/4", 69 1/2", 69 3/4, 70", 70 1/4", 70 1/2", 70 3/4, 71", 71 1/4", 71 1/2", 71 3/4, 72", 72 1/4", 72 1/2", 72 3/4, 73", 73 1/4", 73 1/2", 73 3/4, 74", 74 1/4", 74 1/2", 74 3/4, 75", 75 1/4", 75 1/2", 75 3/4, 76", 76 1/4", 76 1/2", 76 3/4, 77", 77 1/4", 77 1/2", 77 3/4, 78", 78 1/4", 78 1/2", 78 3/4, 79", 79 1/4", 79 1/2", 79 3/4, 80", 80 1/4", 80 1/2", 80 3/4, 81", 81 1/4", 81 1/2", 81 3/4, 82", 82 1/4", 82 1/2", 82 3/4, 83", 83 1/4", 83 1/2", 83 3/4, 84", 84 1/4", 84 1/2", 84 3/4, 85", 85 1/4", 85 1/2", 85 3/4, 86", 86 1/4", 86 1/2", 86 3/4, 87", 87 1/4", 87 1/2", 87 3/4, 88", 88 1/4", 88 1/2", 88 3/4, 89", 89 1/4", 89 1/2", 89 3/4, 90", 90 1/4", 90 1/2", 90 3/4, 91", 91 1/4", 91 1/2", 91 3/4, 92", 92 1/4", 92 1/2", 92 3/4, 93", 93 1/4", 93 1/2", 93 3/4, 94", 94 1/4", 94 1/2", 94 3/4, 95", 95 1/4", 95 1/2", 95 3/4, 96", 96 1/4", 96 1/2", 96 3/4, 97", 97 1/4", 97 1/2", 97 3/4, 98", 98 1/4", 98 1/2", 98 3/4, 99", 99 1/4", 99 1/2", 99 3/4, 100", 100 1/4", 100 1/2", 100 3/4.

EX-GOVERNMENT V/C CARBON TYPE. 5K ohms, 50K ohms, 200K ohms, 10K ohms, 20K ohms, 25K ohms, all at 1/- each.

THIS MONTH'S OUTSTANDING BARGAINS. 100k μ meg. Standard VMC with SPS. 2/9 each. 4mfid 500v. Block Condensers, 2/6 each. S.T.C. RM2, 3/10 each. 12" Heavy Duty Truvox. 15.0, £6/10/-, Carriage 3/-. 6 1/2" Plessey, 12/- each. 5" Plessey, 11/6 each. 10" Rola, 28/6 each.

TERMS—Cash with order or C.O.D., MAIL ORDER ONLY. Full list available, send 3d. in stamps. Postage 6d. to 10/-, 1/- to 20/-, 1/6 to £2. Minimum C.O.D. Fee and Postage 2/3.

ALPHA RADIO SUPPLY CO.

5/6, VINCE'S CHAMBERS, VICTORIA SQUARE, LEEDS 1.

SITUATIONS VACANT—continued

Crown Agents for the Colonies

JUNIOR WIRELESS OPERATOR required by the Falkland Islands Dependencies Administration for service in South Georgia for one tour of 18 or 30 months in the first instance. Commencing salary according to age and qualifications in scale £310, rising to £370 a year. Free board and lodging; free passages; leave on full salary. Candidates, unmarried, must hold a P.M.G. Second Class Certificate of Proficiency in Wireless Telegraphy and be able to maintain Radio Transmitters and Receivers. Creed High-Speed transmitting apparatus and Marconi Auto Alam equipment.—Apply at once by letter, stating age, full names in block letters, and full particulars of qualifications and experience, mentioning this paper, to the Crown Agents for the Colonies, 4 Millbank, London, S.W.1. quoting on letter M.29484.B. The Crown Agents cannot undertake to acknowledge all applications and will communicate only with applicants selected for further consideration.

Crown Agents for the Colonies

WIRELESS STATION SUPERINTENDENT required by the Government of Nigeria for the Posts and Telegraphs Department for one tour of 18 to 24 months in the first instance, with prospect of permanency. Salary (including expatriation pay) between £750 and £1,175 a year according to qualifications and experience. Outfit allowance £60. Free passages for officer and wife and assistance towards cost of children's passages or their maintenance in this country. Liberal leave on full salary. Candidates (under 40 years) must have had wide practical experience of modern radio techniques and equipment, in particular VHF equipment, and preferably also VHF multi-channel equipment.—Apply at once by letter, stating age, full names in block letters, and full particulars of qualifications and experience, and mentioning this paper, to the Crown Agents for the Colonies, 4 Millbank, London, S.W.1, quoting on letter M.28927.B. The Crown Agents cannot undertake to acknowledge all applications and will communicate only with applicants selected for further consideration.

Crown Agents for the Colonies

TECHNICIAN, GRADE 1, required for radio work by East African Posts and Telecommunications Administration. Appointment will be on probation for permanent and pensionable employment. Commencing salary according to age and experience in scale £687, rising to £1,050 a year (including allowance); outfit allowance £30; free passages; liberal leave on full salary. Normal tour is four years. Candidates, aged 23-36, should possess a thorough practical knowledge of the working and maintenance of modern radio transmitting and receiving equipment. General Post Office employees should apply through departmental channels.—Apply at once by letter, stating age, full names in block letters, and full particulars of qualifications and experience, and mentioning this paper, to the Crown Agents for the Colonies, 4 Millbank, London, S.W.1, quoting on letter M.29528.B. The Crown Agents cannot undertake to acknowledge all applications and will communicate only with applicants selected for further consideration.

SITUATIONS VACANT—continued

A LABORATORY ASSISTANT is required, interested in electronics, and also having some knowledge of physics, chemistry and mathematics. Previous training in proper recording of measurements and reporting of tests carried out is desirable. Salary £6 to £8 per week.—Painton & Co., Ltd., Kingshorpe, Northampton.

READERS' ADVERTISEMENTS

3d. per word, min. charge 5/-, payable with order. Box Numbers 1/6 extra. Replies to Box Numbers should be addressed to The Short Wave Magazine, 55 Victoria Street, S.W.1.

SALE: Complete Station; transmitter p/p 813, all bands, and smaller rigs. AR88LF, BC221. Test gear. Large quantity components, meters, valves, etc.—Write for details, Box 1145.

MARCONI TNS2 Transmitter; 807-807-PT15 range, 6 mc to 20 mc. Type 8 Power Pack, 1000v. 500mA, less valves, £15 or nearest.—Pratt, Hoyland Vicarage, Barnsley.

WANTED: DC/AC Valradio Convertor, 100/200 watts, 220v., fully suppressed; SCR522, working with power supply, efficient 145 mc convertor, strongly built. Q-Max Grid Dip meter. Rotary convertor, DC/AC, 220v., about 800 watts.—Offers by *airmail* to VS2DQ, Baling Estate, Kedah, Malaya. Postage refunded.

EXCHANGE: Cossor DB scope, in working order, for all wave Sig. Gen. or Universal Tester.—G2FMP, 36 St. Luke's Road, Horninglow, Burton-on-Trent.

THE RECEIVER YOU HAVE BEEN WAITING FOR. Fit for Drawing Room or Best Shack: AR88D, with S-Meter, in magnificent Console Cabinet with Locked Lid, approx. 3ft. x 2ft. x 1ft., with enclosed matched Spk. (by Sound Sales Type 66). Seen working by appointment; buyer collects. One only. QRO RIG in 6-foot rack cabinet by RCA, 250 mA 1000 pack, 350 mA 1000 volts pack, with 866 Rectifiers; Class-B Mod. with 100TH's WIDE-BAND EXCITER BY LABGEAR LTD, with suitable Power Supply. RF Pair of Lewis 4E27B's or HK257B's. Sold on same terms as above Rx. Quantity of Power Supplies, VHF Equipment RECEIVERS and Convertors, Power Transformers, Chokes, Condensers, HV Oil Mod. Transformers; RF Condensers Var. and Split-Stator, 1000 and 5000 volts, 25 to 100 µF; Neutralising Condensers; 500 mA RF Chokes. Large supply of various Tx valves, HT9 Tx, and all Coils E.C.O. inclusive. NO LISTS. Write wants, S.A.E., reply first, GW3KY, UWCH-YDON, LLANFWROG, I.O. ANGLESEY.

EXCHANGE: BC221 frequency meter (125 to 20,000 kcs.) for camera. — Details, please, to Crellin, 16 Hatfield Grove, Douglas, I.O.M.

FOR SALE: Compact, neat Ham Station; Hallcrafters SX28; good condition, with manual. Complete Transmitter, type 36, 3.5 to 14 mcs.; RT, CW, MCW, press to talk; phone 75 watts, 100 watts CW; modulator and power supplies. Also Canadian 58 MK1 walkie-talkie, complete with accessories, spare tubes, etc. Numerous other items. — Send S.A.E. for details to: 293 Dudley Road, Winson Green, Birmingham.

SALE: Signal Generator, £6; also 813 ceramic valve-holder and filament transformer, 50/-. Crystals, mikes, transformers, valves, etc.; Tx and power packs. Stamp for list of miscellaneous bargains.—57, Whinfield Avenue, Fleetwood.

FREE

THIS VALUABLE BOOK

which details the wide range of Engineering and Commercial courses of modern training offered by E.M.I. Institutes—the only Postal College which is part of a world-wide Industrial Organisation.

Courses include training for:

- P.M.G. Certificates, City and Guilds Grouped Certificates In Telecommunications;
- A.M.Brit.I.R.E. Examination, Radio Amateur's Licence, Radio & Television Servicing Certificates, General Radio and Television Courses, Radar, Sound Recording, etc. Also Courses in all other branches of Engineering.



E.M.I.

Institutes

associated with

MARGONIPHON COLUMBIA

H.M.V.

(His Master's Voice)

ETC.

COURSES FROM

£1

PER MONTH

POST NOW

Please send, without obligation, FREE book.

E.M.I. Institutes, Dept. 14, 43 Grove Park Road, Chiswick, London, W.4.

Name

Address

IC. 10E

AERIAL MASTS

Again we have been fortunate to secure a limited number of 13ft. **WOODEN MASTS**, approx. 2in. dia. slight taper and ideal for television chimney masts etc.

Price 7/6 each, Carriage 2/6 or

IN LOTS OF 4 OR OVER, 6/- each, Carriage 3/-

T. V. DIPOLE AERIALS For all channels. Heavy Bakelite Insulator and 3/8in. dia. elements for inside or outside use (Please state for which station when ordering).

15/- each, packing and carriage 2/-.

POLYETHYLENE DIPOLE INSULATORS fitted with 3/8in. dia. Brass stubs, with your own elements and a small amount of ingenuity a very highly efficient aerial system can be constructed.

Price 5/- Postage 1/6.

WALTON'S WIRELESS STORES

48, STAFFORD STREET,
WOLVERHAMTON

Send s.a.e. and 3d. in stamps for our latest list.

RADIO G200 ANNOUNCES

VALVES at 1/9: RK34, 2C34; at 2/3: EA50, DI, VR78, VR92; at 2/9: 954, 956, 2X2; at 4/6: 6H6, 6H6gt, 6K7g, 12H6, 6SH7; at 5/6: 12SH7, 4D1, 6AC7, 6J7g, 6SS7, 6SG7; at 6/9: 6K7gt, 6SK7gt, 6SK7, 12C8, 12SC7, 6U5G, EC52, 12K7, U78, 12SL7; at 7/9: 12SN7, B36, 7B7, 7C5, 7C6, 7C7, 7H7, 7R7, 757, 7Y4, DH77, W77; at 8/6: 1S4, 1T4, 3A4, 6X5gt, 35L6gt, 25L6gt, 50L6gt; at 9/6: 1R5, 354, 3Q4, 3V4, 1D5, 6V6gt, 6F6g, 6C6, 6D6, DF92, 1G6gt, 6CH6, 6BG6, 25Z4gt, 35Z4gt, D77, 6N7gt, 12AT7, 12AU7, 12AX7, X79, X78, KT81, 6SA7, 2A3, 6B4G; at 10/6: 12k8gt, 6K8gt, X61, X76, 6U4G, 5U4G, CV2; at 12/6: 12K8Y, 884, 6Z7G, 12Z3y, 45Z5gt.

ARTHUR HOILE

55 UNION STREET, MAIDSTONE, KENT.

Phone 2812

THE WORLDS GREATEST BOOKSHOP

FOYLES

★ ★ FOR BOOKS ★ ★

All new Books available on day of publication.
Secondhand and rare Books on every subject.
Large Technical dept.

Subscriptions taken for British, American and
Continental radio magazines.

119-125 CHARING CROSS RD., LONDON, W.C.2

Gerrard 5660 (16 lines) ▼ Open 9-6 (inc. Sats.)

Nearest Station: Tottenham Court Road.

BRAND NEW EX-GOVERNMENT VALVES

"A" are in Original Cartons. "B" are in plain or Service Cartons.

	A	B		A	B		A	B
5Z4G	10/6		6K8GT		12/6	11/-	EA50	3/6
6AK5		12/6	6O7GT	12/6		EB34	2/6	
6F6G	9/6		6R7	8/6		EC31	4/6	
6H6	5/6		6SH7	6/9		EF36	6/3	
6J5	5/9	6/6	6SK7	7/3		EF50	9/9	
6J5GT	6/3		6V6GT	12/6		RK34	2/6	
6J6		12/6	6V6G		9/6	HL133DD	10/-	
6J7		7/-	6O7G		10/9	TH233	7/-	
6J7G		6/6	12H6		2/9	VPI33	7/-	
6K7	7/9	6/9	80		8/9	VR135	3/6	
6K7G	6/9		954	3/6		VR150		
6K7GT	6/6	5/9	7193	3/6		VU111	10/-	

"Argus" AR60 Tungar type rectifiers—14/6 each. 2,000 Volt test, 1,000 Volt working 6 μ F Condensers, 4/9 plus postage. 25pf air spaced variable condensers with 3in. spindle, 1/1 each. 5 watt resistors, 8d. each, the following valves only: 700D, 3K, 4K, 5.6K, 12K, 20K, 30K, 200K.

"DENCO" Catalogue—price 9d.

TELE-KING 16in. TELEVISOR. CONSTRUCTORS ENVELOPE, 6/-.

Please include postage on orders less than £1.

2a, BURNLEY ROAD **REED & FORD** AINSDALE SOUTHPORT

G2ACC OFFERS YOU— TRANSMISSION LINE

Belling Lee: L336 twin 80 ohm 6d. per yd., L600 coax, 70 ohm 1/3 yd.
Telcon: K16M coax 50 ohm, 1/1 yd., K24B twin 150 ohm 9d. yd.,
K25B twin ribbon 300 ohm 9d. yd., K35B twin tubular low loss 300
ohm 1/6 yd. Siemens 75 ohm coax 1/3 yd. Samples free on request.

Postage extra on orders under £2.

60 page illustrated "Ham" catalogue No. 8, post free 9d.

Southern Radio & Electrical Supplies

85 FISHERTON STREET, SALISBURY, WILTS.

Telephone: Salisbury 2108

SMALL ADVERTISEMENTS. READERS—continued

A MERICAN Collins Auto-tuned Transmitter. Model ART13, 813 final, mod. pair 811's, working order. £50. Transmitter Type-35, Xtal/VFO, 807-807 buffer—pair 807's final, £25. Transmitter, two metres to 160 metres, complete power pack, mod. and two-metre receiver, £25. 1132 Receiver, 70/-, 1131 Filament Transformer, 25/-, 1131 Modulator, £10. 832 Valve, 20/-, 829, 70/-, Wirek wire recorder, combined record player, record disc, radio, mike, two hours' playing time, £45 (would exchange for AR88 receiver). NiFe batteries, 2.4-volt, 125-amp., each 45/-; 2250-volt 400 mA transformer, 70/-; 4336 mod. transformer, 60/-; Q5'er, 60/-.

WANTED: Any data, circuit and spares for R.107. Also *Wireless World*, August, 1945. Good prices given.—Albans, 17 Fern Road, Cropwell-Bishop, Notts.

F OF SALE: Eddystone S.504 Rx, 30 mc - 580 kc. in 5 bands; 2 RF's, 2 IF's, BFO, N/L, S-Meter, Xtal filter, small speaker, £20 (no offers).—Please write, Shrimpton, 23 Rotherwood Road, Putney, S.W.15.

T APE RECORDER required; 2-speed, twin track; at reasonable price.—Box 1155.

R 1155 and POWER UNIT; Bendix TA12D, parallel 807's in final, modulator and power unit, £12.—Sallows, 1 Shaftesbury Avenue, Dovercourt, Essex.

BC 342, 3-stage, 3-band Tx 813 final, E & V 500v. bridge megger. Offers? — G2PF, Huggett, Barlavington, Petworth, Sussex.

B2 Tx/Rx, power pack-modulator, complete 25w. Phone station for 20, 40, 80m. Offers?—G2BBA, 34 Cumberland Road, Bradford.

T ELEVISION TUBE, 9-in. GEC flat face; little used; perfect picture; £5 10s. (post, packing paid).—G3EGC, 21 Milford Road, Bolton, Lancs.

N EW VALVES: 807 (6), 6/-; KT66 (2), 6/-; 6V6G (4), 5/-; 5Z4G (2), 5/-; Syl EF50, 4/-; 6N7G (2), 4/-; 9001 (4), 2/6, 6J5G (2), 3/6; 6H6 (2), 1/-; Canada VR54 (2), 1/-, Guaranteed valves: EF54 (4), 3/-; 6SL7 (4), 3/-; 7193 (5), 1/-; EF50, 2/-; 12H6 (2), 1/-; 6L6 (2), 4/-; VR137, 2/-; 6C5G, 2/4. Add carriage, please.—G3AYX, 20 Ennismore Avenue, W.4.

F OR SALE: Ex-Army Type 19 Trans-receiver; 2.5 mc to 4 mc, and 4 mc to 8 mc CW, MCW and RT; 25 watts on CW. Also 235 mc band on RT. Complete with Variometer, harness, control-boxes, headphones, microphone set, key, mains power-pack for receiver, together with TU5 unit and spare valves, £12 0s. 0d.—J. Hainey, 25 Woodside Road, Wood Green, London, N.22.

T WO B2's—one without Rx; both excellent; £12 10s. 0d. and £8 10s. 0d. 1155 with pack, £12 10s. 0d. Canadian 58, complete, £6 10s. 0d. Exchanges wanted: 807's, 6L6's, etc., meters; also DST100.—Enion, Pendref, Caernarvon.

T CS 13 TRANSMITTER, excellent condition; exchange for suitable receiver or gear; cash considered.—F. L. Nunn, 8 Blinco Grove, Cambridge. (Tel.: 87024).

F OR SALE: AR88D with LS and phone, S-meter, first-class condition, £50; also Tx for 10, 15, 20 meters; HK54's, 150w., complete with 807's, Class B Modulator; for CW or Phone, complete with D104 mike, £40. Also Freq. Meter; Hallcrafters HF7 1000-100-10 kcs., £10. Also other ham equipment. Send for list, or what you require.—G3CSM, 4 Lowden Road, Herne Hill, S.E.24.

SMALL ADVERTISEMENTS. READERS—continued

SALE: D104 Mike. brand-new. £4; 866A (1). £12/6; 24G (2), 15/- each; P28/500 (1), 15/-; 802A (1), 5/-; Taylor 65B Signal Generator. £7 10s. 0d.—G8JK, 5 Cockpit Close, Gt. Kingshill, High Wycombe, Bucks.

QRT. POWER PACK KIT. 1500v., 250 mA. tapped 1000v., 500v., £8. Speech amp., 12w., complete with p/p, £7. Class-B amp. 811's with Thordarson 11M77 varimatch, 300-watt transformer, gives 100w. audio on 700v. HT. £5. Power pack for above, £5 (£8 the pair). New 811's, 15/-; RF26, new, £2; RCA Xtal wavemeter TEL 49, £5; Mullard AC Bridge, £5; various meters; Weston 301, 7/6; Ferranti 3in., 7/6. Other oddments—please enquire (please add postages).—Ex-G6PY, 50 Goddington Lane, Orpington, Kent.

EXCHANGE: Hornby AC train set, "0" gauge, "Royal Scot" loco, tender, trucks, variable transformer, rails, etc.; good condition; for BC221 or other equipment.—Offers, write: G3DQT, 7 Berrylands Road, Surbiton, Surrey.

PILOT control box, CRV23258 or CV23314, and dynamotor assembly, CRV21724 wanted, in good condition.—Cosgrove, Culmore Road, Londonderry.

G4ZU has for sale 150w. Table Top Tx Clapp VFO, broad-band couplers, 813 in final, £15; also 60w. Modulator, £10. Would exchange for AR88, 77, or HQ129X.—94, Shirley Way, Croydon. (Tel.: Spring Park 9130).

DYNAMOTOR Assembly for TCS6, complete all plugs and cables to Rx and Tx, 12-volt input. Reasonable offers, please?—123 Hamil Road, Burslem, Staffs.

WANTED: BC348 or other communication receiver; condition immaterial if price reasonable.—Eden, c/o Tophams, 58 Key Hill, Birmingham 18.

EXCHANGE Portable Tx/Rx 10 valves (with 10 spare in case), complete with generator, batteries, mike, key, aerial; all new, ready for use. Wanted: Good Communications Receiver. Or will sell.—Box No. 1156.

SALE: CR100, fitted full vision dial, S-meter, bandsread, calibrated, black cracked, all controls, engraved noise limiter, with speaker to match, £25. BC221D, fitted in new case with voltage controlled power supply, visual indication of resonance 14in. x 9in. x 9in., re-calibrated, £15. Hickok Electronic Test Meter, 5-in. meter, probe, etc., £15. Oscilloscope "home-built" 3½-in. tube, commercially finished, £10.—39 Kingsway, Ashton, Preston, Lancs.

SALE: S. G. Brown moving-coil headphones; Type K and matching transformers; Acos Mic 22-2 microphone; Lexington Junior Pick-up and input transformer in Mu-metal case. All as new and hardly used. What offers?—Box 1158.

AR 88D SPARES: Set of new valves, D or LF (14), £4; Neon for LF, 5/-; output transformer, 15/-; new drive, 30/-; main dial, 10/-; vernier dial, 5/-; two smoothing chokes, 10/- each; metal 6L6's, 6/- each; VT62, 10/-; VCR138, with base, 25/-; TU5B, 40/-; Amphenol American panel socket and connector plugs, screw type, 5/- pair. WANTED: 813 bases, cascode 144 mc, 6AK5 6J6 converter.—Box 1164.

FOR SALE (£15): VCR97 Television, complete with magnifier and console cabinet; excellent working order; RF27; 30/-.—G3BNW, 13 Heywood Road, Alderley Edge, Cheshire.

Urgently Required

COMMUNICATIONS RXS. HALLICRAFTERS SX. 28s A.R.88s, A.R.77s, EDDYSTONE 640s, 740, 750s, all types purchased.

TEST EQUIPMENT. AVO 8s, Model 7s, Valve Testers, Sig Gens, Bridges, etc. MC. R.I.s. Tape Recorders, Transmitters. We can arrange part exchange for any equipment we have in stock. Established 15 years. Call, write or send, phone Ger. 4638. Hours of business 10 a.m. to 6 p.m., open all day Saturdays. One min. from Leicester Square Tube Station.

MILLER'S RADIO 38A NEWPORT COURT LONDON, W.C.2.

EASIBINDERS

for the "SHORT WAVE MAGAZINE"

Bind your issues in the Easibinder. By a simple operation the journals are inserted with a steel wire, and at once become a neatly bound volume for the Bookshelf.

The Easibinder is bound in green cloth, and gold-blocked with title and year on the spine. It will hold 12 issues. (One volume).

Now available for Vol. 10 (new size) Also available for all previous volumes at 11/9 each (Post paid).

A Binder can be sent on approval if requested. When ordering please state the Vol. No. to be blocked.

EASIBIND LTD

84 NEWMAN STREET, LONDON, W.1

WHY HESITATE?

—when the introduction of our Precision Component and Alignment Service has removed the main obstacle to Single Sideband working, universally recognized as the most efficient and economical method of radio-telephony. It eliminates costly high-level modulators with their heavy-duty power supplies, and pushes your signal into areas where ordinary A.M. signals would be smothered by Q.R.M. If you are not familiar with the advantages of this system, send 6d. for leaflet, "Comparison of Modern Methods of Modulation," and don't fail to secure a copy of our booklet, "SINGLE SIDEBAND SUPPRESSED CARRIER TRANSMISSION FOR THE AMATEUR," price 2/6, post free.

VALVE BARGAINS: 807, 6V6, 8/6; 6K8, 1616, 9/-; 6AK5, F-W4/500, 10/-; 6L6G, KT66, 6E5, 9/6; OAZ, OB2, 185BT, ECH35, 12/6; 6K7G, EF36, 5/6; EL32, EF92, 6SF5, 7/6; 7C5, VR150/30, 8/6; U37, 16/-; TH22C, 15/-. Also a few QVO4/7, 446B, 829B, 813, 100TH. Please add 9d. Postage on orders under £2.

ELECTRAD RADIO

69, HIGH STREET, BELFAST, N.1

BRASS, COPPER, BRONZE, ALUMINIUM, LIGHT ALLOYS
IN ROD, BAR, SHEET, TUBE, STRIP, WIRE

3000 STANDARD STOCK SIZES

H. ROLLET & CO., LTD.

6, CHESHAM PLACE, LONDON S.W.1.
SLOane 3463

Works: 36 ROSEBERY AVENUE, LONDON, E.C.1.
BRANCHES AT LIVERPOOL, MANCHESTER, BIRMINGHAM

"No Quantity too Small"

SMALL ADVERTISEMENTS, READERS—continued

SALE: 58 and 38 Transreceivers, complete, perfect, accumulators; similar frequency ranges; practically new; £15 the pair.—Cardale, Swan Street, Preston.

CR 100. S-meter, noise limiter, excellent performance, £25; BC-221, voltage stabilised, built-in power supply, £27 10s. 0d.—G2HAC, 54 Lodge Street, Accrington, Lancs.

S. 640, in excellent condition, complete with Eddy-stone matched speaker, S-meter, and instruction book, £24 plus carriage and packing.—Box 1157.

AR 88D, 540 kc-32 mc, tuning meter, moving-coil phones, instruction manual, £35; also, 1355 + RF26; brand-new. + RF27, converted for 240 AC and Television positive output—contrast control—case—circuit 50-85 mc. £9.—53 Ashworth Street, Liverpool 7.

SALE: Pair 866A's and bases, 35/-; 1131 choke, 450 mA, 14/-; GU50 Heater transformer, 4v, C-tapped, twice, 17/6.—Adair, 12 Park Road, Blandford, Dorset.

CLEARING OUT surplus receivers, power packs, wavemeter, components and valves of all types; over 500 items. S.A.E. list. — 506 Loughborough Road, Birstall, Leicester.

SALE: Complete Receiving Station, in mint condition; many spares; £16 10s. 0d. Callers only.—Fawkes, St. Chloes, Amberley, Stroud, Glos.

FOR SALE: Eddystone 750 with S-meter; perfect order; just re-aligned and checked; £40.—Box 1160.

FOR SALE: Complete set Labgear wide-band couplers; 5-band 50-watt P/Pull Turret. What offers?—Box 1161.

ET 4336 Modulation and Plate Transformers required.—Write, stating price, to HB9HM, c/o G2AB, Albury Lodge, Cheshunt, Herts.

UMI 35/-; Woden 20H at 60 mA, 15/-; Berry's 2.5v, 10a, 5v, 3a, CT, new, £1 10s. 0d.; Webb's 5v, at 20 amp., £2 0s. 0d.; USA 650v, at 250 mA, 5v, 6.3 fil., £1 10s. 0d.; Labgear wideband couplers, 7/14/28 mc, each 12/6; Cyldon 60-plus-60 μ F, .068 gap., 15/-; Bud 35-plus-35 μ F, 7/6; 5 pairs 3 $\frac{1}{2}$ in. chrome handles, 10/-; S-meter for AR88, £1; 805 (4), each 15/-; 35T (4), each 15/-.—G2FSR, 2 Parkhill Road, Chingford, London, E.4.

EDDYSTONE S.740, new, and Radiovision 2-valve Preselector; a perfect combination. Reasonable offer accepted.—10 Moor Park Road, Northwood, Middlesex.

NEW Boxed Meters, 2in. square flush; milliamps 0-40/120, 10/-; 0-100 (scaled 0-300), 7/6; 0-5, 6/-; 0-1, 10/-; Microamps, 0-500, 12/-; amps TC, 0-2.5, 9/-; volts 0-300, 10/-. ECO M.I.19467A, modified (as per *Short Wave Magazine*), as new, £6. Woden potted chokes, 5-25 Henry, swinging 250 m/a, £1. New TU5B, 30/-; new RCA 866/A (2), 10/- each.—R. Low, Moulin, Balmoral Road, Blairgowrie.

RELAY Broadcast Receivers (2), 13-1950 metres, bandspread, oscillator stabilised (S130); RF EF54, EF39, Mixer 6K8; Osc. EC52 IF, EF39, EF39; Det/AVC EB34; Noise limiter EP34; LF 6J5; Output P/P, 6SN7-600 ohm line; Rect. 5Z4; Rack mounting; £15 each (list price £75).—Lord, Oakfield Cottage, Moat Road, East Grinstead.

EDDYSTONE 640, perfect order, £16; R1155 receiver, used, in good order, £5.—G13GDN, 27 Oakwood Place, Portadown, N. Ireland.

We Pay up to £30

for BC-312 receivers in good original condition complete with dynamotor. Box No. 1163.

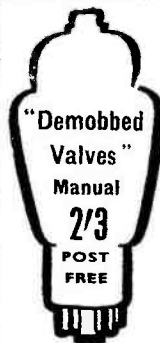

Giving equivalents of British and American. Service and Cross Reference of Commercial types with an appendix of B.V.A. Equivalents and comprehensive Price List. We have still many valves left at OLD BUDGET rates which are actually sold at the old price. A full list of Ex-Gov. and Surplus Valves brand new at lowest Prices included. Example: KTZ41 worth 25/- only 5/-.

Direct from: **John Bull**

(SW11) 246, HIGH ST., HARLESDEN N.W.10

ADCOLA (Regd. Trade Mark) **SOLDERING INSTRUMENTS**



Reg. Design No. 860302
British, U.S. and Foreign Patents

Supplied for all volt ranges from 6/7v-230/250v. Meets every requirement for radio assembly, maintenance, telecommunications, etc. High Temperature. Quick Heating, Low Consumption, Light Weight

3/16in. Dia. Bit Standard Model
1/4in. Dia. Bit Standard Model
3/16in. Dia. Detachable Bit Type

Sole Manufacturers: **ADCOLA PRODUCTS LTD.**
Sales Offices and Works: **Cranmer Court, Clapham High Street, London, S.W.4.** (MACaulay 4272)

★ SHORT-WAVE LISTENERS,
AMATEURS, ENTHUSIASTS!

If you doubt the ability of this miniature O-V-O, read what users claim. Send today for free literature, Catalogue and Testimonials, enclose stamp for postage.

THE INCOMPARABLE

GLOBE-KING

SINGLE VALVE S.W. RECEIVER

WORLD-WIDE RANGE. 11-100 metres with absolute NOISE-FREE BACKGROUND.

Sole Distributors. Home and Overseas Sales

JOHNSONS (RADIO)
46 FRIAR STREET, WORCESTER

HENRY'S

5 Harrow Road
Paddington : W.2

PADddington 1008/9 and 0401

OPEN MONDAY to SATURDAY 9-5.30 THURS. 1 o'clock SAT. 6p.m.

INDICATOR UNIT TYPE 182A.

This unit contains VCR517 Cathode Ray 6in. Tube, complete with Mumetal screen, 3 EF50, 4 SP61 and 1 5U4G valves, 9 wire-wound volume controls and quantity of Resistors and Condensers. Suitable either for basis of Television (full picture guaranteed) or Oscilloscope. Offered BRAND NEW (less relay) in original packing case at 79/6. Plus 7/6 carriage.

SPECIAL NOTE.—The VCR 517 Tube has proved to be far superior to the VCR 97 Tube (call for demonstration).

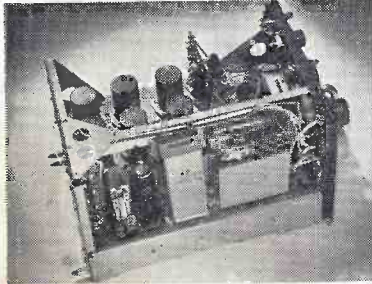
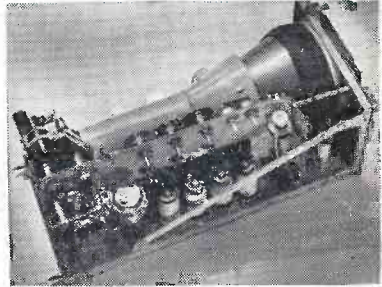

STROBE UNITS. Brand New, in sealed cartons, these contain 6 EF50s, 5 EA50s, 1 SP61, a host of condensers, resistors, transformers, chokes, relays, switches, 7 pots and 5 smoothing condensers. Size 18in. x 8 1/2in. x 7 1/2in. Only 67/6, plus 5/- carriage.

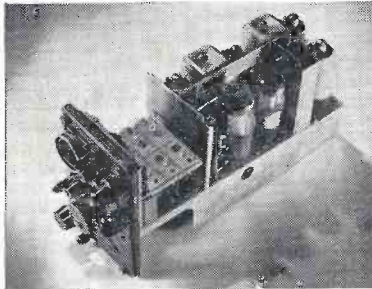

WALKIE-TALKIE TYPE "46" (case removed) complete with 6 valves. 2VP23, HL23, DD, QP25, TP25 and ATP4, aerial rods, I.F. trans., 1.6 mc/s. mike trans. in new condition, but less transmitting components and coils removed by M.O.S., 35/-, carr. paid. (Less valves, 14/-).

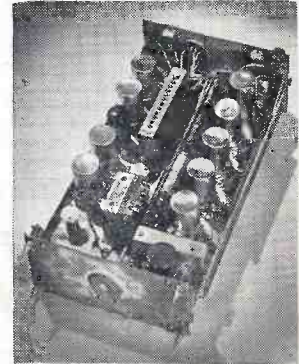

PYE 45 Mc/s STRIP. Special purchase of M.O.S. Type 3583 Units. Size 15in. x 8in. x 2in. Complete with 45 mc/s Pye Strip, 12 valves, 10 EF50, EB34 and EA50, volume controls and hosts of Resistors and Condensers. Sound and vision can be incorporated on this chassis with minimum space. New condition. Modification data supplied. Price £5, carriage paid.

— A COMBINED SIGNAL TRACER AND AUDIO OSCILLATOR —

An easy-to-build unit that can be used for I.F. and Audio signal tracing, without any switching or tuning, including variable output oscillator, for amplifier checking. Highly sensitive, responds to signals picked up from an ordinary receiving aerial. The circuit is that of a high-gain 2-stage, resistance-coupled audio frequency amplifier, employing 3 miniature 1.4 valves, with a 3in. speaker in the output of the Power Amplifier Stage. An added advantage being that as this Unit is "All-Dry" it can be used with safety on A.C. or A.C./D.C. mains and Battery sets. The complete Kit with portable cabinet (size 6in. x 7in. x 6in.) and battery weighs only 4 lbs. We shall be pleased to supply a complete Kit for the construction of the above, right down to the last nut and bolt, including 2-1T4 and 1-1S4 Valves, 3in. Speaker and Portable case and All-Dry Battery for £4/19/6. Concise instructions and circuits supplied. If preferred, circuit and instructions only can be supplied for 1/6. If required this Unit will be assembled and tested for an extra charge of 15/-. This is a highly efficient instrument and a MUST for every radio man.

BOWTHORPE CONTINUITY METER. Dual scale 0-500 ohms and 100-200,000 ohms moving coil operated from 4-volt internal battery. Size 6in. x 3in. x 4in. Original price £8 19s. Our price, brand new, £4 4s.

CONDENSERS. .1 mfd. 2,500 v., metal or bakelite, 2/6. Electrolytic 8 mfd. 450 v., 2/6; 8 x 8 mfd., 4/-; 16 mfd., 4s 6d. 3/6; 16 x 16 mfd., 450 v., 5/-. All midget tubular cans, cardboard sleeves, 60 mfd. x 40 mfd. 350 v. size 4 1/2in. x 1in., 5/-. Bias condensers 25 x 25 mfd., 50 x 12, 120 x 50, 1/6; 50 x 50, 2/-. All new stocks. NOT surplus.

TRANSFORMERS-FILAMENT. All inputs
200/250 v. A.C. 7 6
Output 6.3 v. 1.5 amps. 10 0
Output 6.3 v. 2.5 amps. 10 0
Output 6 and 12 v. 3 amps. £1 0 0
Output 6.3 v. 12 v. 2 amps. £1 5 0
N.B.—Above voltages are when "on load."

MOVING COIL METERS (Brand New):—
0-5 mA, square panel mounting, 2in. scale 7 6
0-50 mA, square panel mounting, 2in. scale 6 6
0-40 v. square panel mounting, 2in. scale 7 6
0-20 amps round panel mounting, 2in. scale 7 6
0-300 v. square panel mounting, 2 1/2in. scale 12 6
0-40/120 mA double reading round 2in. scale 12 6
2 1/2in. round flush mtg., drilled flange —
Range 0/750 v. 200 ohms per v. each £1 2 6
Range 0/1500 v. 250 ohms per v. each £1 2 6
Range 0/3000 v. 200 ohms per v. each £1 5 0
0-1 m/a desk type, 2 1/2in. scale. £1 12 6

L.T. RECTIFIERS
6 v. 1 amp. G.E.C. 4 0
12 v. 2 1/2 amp. Westinghouse 12 6
12 v. 4 amp. S.T.C. 17 6
12 v. 8 amp. S.T.C. £1 12 6

S.T.C. RECTIFIERS E.H.T.
K3/25 650 v. 1 mA. 4 7
K3/40 1,000 v. 1 mA. 6 0
K3/100 8,500 v. 1 mA. 14 8
K3/200 10,500 v. 1 mA. £1 6 0

H.T. RECTIFIERS
S.T.C. 125 v. 60 mA. 4 6
S.T.C. 125 v. 100 mA. 5 6
S.T.C. 125 v. 125 mA. 6 0
S.T.C. 250 v. 250 mA. 18 0
S.T.C. 300 v. 75 mA. 6 0

WESTINGHOUSE 14D/972, 250 v. 25 mA. 6 6

G.E.C. METER RECTIFIER, 1 mA. 11 6

WEARITE
705 Coil Pack 3 wave band £1 17 10
400B Min. I.F.T. 465 kc. pair 15 0
501 and 502, 465 kc. pair 14 0
800's pair 15 0

RECEIVER R1355. As specified for "Inexpensive Television." Complete with 8 valves VR65 and 1 each 5U4G, VUI20, VR92. Only 55/-, carriage 7/6. Brand new in original packing case. Slightly soiled, 35/-, carr. 7/6.
RF24, 25/-; RF25, 25/-; RF26, 59/6; RF27, 59/6.
Owing to limited quantities, these units supplied only with R1355's.

CATHODE RAY TUBES:
VCR97. Guaranteed full picture. 40/-, carr. 5/-.
VCR517. Guaranteed full picture. 40/-, carr. 5/-.
3BP1. Suitable for 'scopes. 25/-, carr. 3/-.

RECEIVER UNIT TYPE 159. Size 8in. x 6 1/2in. x 4 1/2in., containing VR91, VR92, CV66, VR65 and 24 v. selector switch. New condition, 15/-.
9in. ESCUTCHEON. Brown bakelite. Suitable plate glass and mask for 9in. tube, complete, 7/6 each.

No. 38 "WALKIE-TALKIE" TRANS RECEIVER, complete with throat mike, 'phones Junction Box and aerial rods in canvas bag. Freq. range 7.4 to 9 Mc/s. All units are as new and tested before dispatch. As supplied to Overseas police forces. £4/19/6, carr. 2/6.

TUNING CONDENSERS
2 gang .0005 standard 1/2 spindle, with trimmers 7 6
3 gang .0005 with ceramic insulation 1/2 spindle 7 6
Midget two gang. .000375, with trimmers. 6 6
Size 2in. x 1 1/2in. x 1 1/2in. 6 6
Midget .0005 mfd. 2 gang tuning condenser. 6 6
Size only 2 1/2in. x 1 1/2in. x 1 1/2in. 6 6
Or with built-in trimmers 7 6
Two-gang Midget. .0005 with 4-way push-button assembly. Suitable for car radio, etc. 8 6

PUSH-PULL OUTPUT TRANSFORMER, U.S.A. dotted type primary, 10,000 ohms sec., 2 ohms, 8 ohm, 15 watts, 12/6.

E.H.T. TRANSFORMER for VCR97. Input 230 v., output 2,500 v. 4v. 2-0-2. 45/-.

E.H.T. TRANSFORMER for 5CP1. Input 230 v., output 3,250 v. 6v. at 0.6 a/m., 2-0-2 v. 45/-.

MAINS TRANSFORMERS. 250-0-250, 90 mA, 6.3 v. 3 amp, 5 v. 2 amp. Input 110 v./250 v. £1, post 9d.

EX-MANUFACTURERS. 350-0-350, 100 mA, 6.3 v. 4 amp, 5 v. 2 amp Input 200/250, 25/-.

REPLACEMENT TYPE. 350-0-350, 90 mA, 4 v. 6 amps, 4 v. 3 amps, input 200/250. 18/6

DUAL PURPOSE TYPE. 350-0-350, 80 mA, 6.3 v. tapped 4 v. at 3 amps, 5 v. tapped at 2 amps, 4 v. 20/-, post 9d.

VR91 (EF50). Red Sylvania. Brand new original boxes U.S.A., 10/-; Silver, brand new original boxes, British, 8/6; red or silver ex-units guaranteed, 6/-; 6A7, 43, 12/6; VUI11, VUI20, VUI20A, at 5/-; 1S4, 1T4 at 9/-; 354, 3V4, 1R5, 1S5, 10/-; U19, 10/-.
Over 10,000 B.V.A. valves in stock. Send in your enquiries.

SEND 3d. STAMP FOR 28 PAGE CATALOGUE