

# SHORT WAVE NEWS

Vol. 2 • No. 2

FEBRUARY, 1947

*In this Issue*

**V.H.F. News**

**Around the Broadcast  
Bands**

**World News**

**Club Directory**

**On the Ham Bands**

**Around the Shacks**

**I.S.W.L. Notes**

**Component Review**

**Station List  
Modifications**

*Also*

**The R.S.G.B.**

**Power Amplifier  
Design**

**A QRP TX for 7 Mcs.**

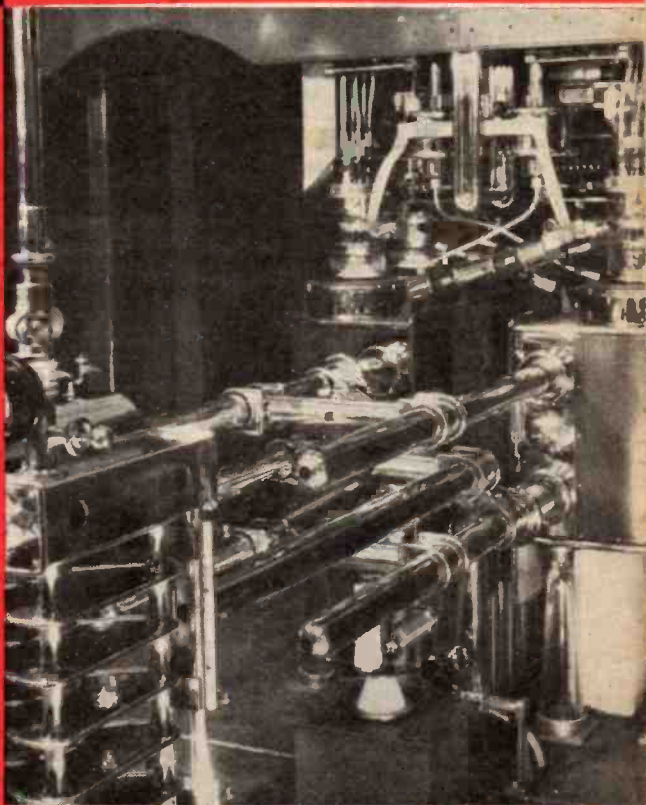

POWER AMPLIFIER AT "RADIO AUSTRALIA"

AN AMALGAMATED  
SHORT WAVE PRESS  
PUBLICATION

1/3

# Everything for the serious amateur!



## THE "Q-MAX" CHASSIS CUTTER

Does away with tiresome drilling and scraping. Holes cut easily and cleanly. Punch cuts through chassis, die prevents distortion, spanner turns bolt to cut holes. (Pat. appd. for)



Size of holes  $1\frac{1}{8}$ " (octal) 10/6  
 $1\frac{1}{2}$ " and  $1\frac{3}{8}$ " 12/6  
 (Postage 9d. extra)

**SLOW MOTION DIALS. "Q-MAX" FULL VISION SLOW MOTION DIALS FOR INDIVIDUAL CALIBRATION.** Complete with dial engraved 5 blank scales and 1 calibrated 0—180°, glass and escutcheon.

**SMDA. 9—1 Slow motion Drive with large fluted knob**  
 (dial  $6\frac{1}{2}$ " x  $3\frac{1}{2}$ " ) 15/6 (Dial only 3/-)

## THE "Q-MAX" ABSORPTION WAVEMETER & PHONE MONITOR

An Absorption Wavemeter for checking frequency harmonics and parasitics in Oscillators, Doublers and Power Amplifiers.

All amateur bands covered by plug-in inductances. Incorporated in the Wavemeter is a WX6 Westector automatically connected across the tuned circuit by inserting phone jack plug for monitoring phone transmissions.

Size  $3\frac{3}{4}$ " x 2" x 2" Price 35/-  
 (Price includes one inductance.  
 Extra inductances 3/9 each)

Applications for territorial dealerships invited

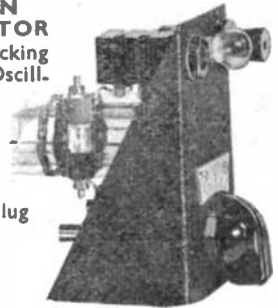

ILLUSTRATED CATALOGUE  
 "S.N." 6d. post free

All components obtainable from your local "Q-Max" Dealer or direct from:—  
**BERRY'S (SHORTWAVE) LTD**  
 25 HIGH HOLBORN · LONDON · W.C.1  
 (OPPOSITE CHANCERY LANE). TELEPHONE: HOLBORN 6231

**Taylor**  
 for the best in test equipment

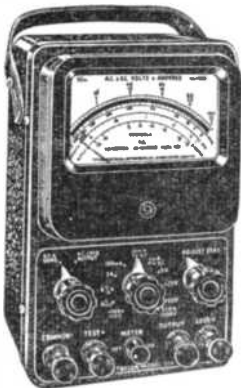

MODEL  
**90A**

## UNIVERSAL TAYLORMETER

- |                                 |                                                                    |
|---------------------------------|--------------------------------------------------------------------|
| 1 First Grade Accuracy          | 8 Current Transformer used on all A.C. ranges                      |
| 2 40 Ranges                     |                                                                    |
| 3 1000 ohms per Volt            |                                                                    |
| 4 Four-inch meter scale         | 9 Self-contained Resistance measurements from 1 Ohm up to 1 Megohm |
| 5 Mirror and Knife edge pointer |                                                                    |
| 6 Buzzer for Continuity Tests   | 10 Three Self-contained capacity ranges with external A.C. Supply  |
| 7 Automatic overload protection |                                                                    |

PRICE £15 15 0

Subject to trade discount  
 Now available for quick delivery

We also manufacture a complete range of Radio Test Equipment including Multirange Instruments, Signal Generators, Valve Testers, Output Meters, Insulation Testers, Circuit Analysers, Oscilloscopes, A.C. Measuring Bridges and Ohmmeters; also Moving Coil Instruments with scale lengths from 2" to 5"

Write for technical brochure to:—

**Taylor Electrical Instruments Ltd.**

419-424 MONTROSE AVENUE, SLOUGH, BUCKS.  
 Tel: SLOUGH 21381 (4 lines) Grams: TAYLINS, SLOUGH

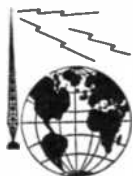

# Short Wave News

Vol 2 No 2

Annual Subscription 16/-

February, 1947

Editor: ARTHUR C. GEE, G2UK

Asst. Editor: W. NORMAN STEVENS, G3AKA

Advertisement & Business Manager: C. W. C. OVERLAND, G2ATV

## EDITORIAL

### On Station Lists

#### In General

WE have before us, copies of several station lists currently offered to the broadcast station listener. On first glance they all appear to be much the same. On second, and more scrutinising glances, differences become obvious.

Some of the data is correct; some inaccurate; one may be a reasonable, if brief, list; another may be hopeless.

Two facts of major interest have emerged from our "inquest." Firstly, none of these lists approach our list for scope and comprehensiveness. Secondly, our BC list differs basically from all others now published, in the statement of frequency.

#### Those Frequencies

In every station list we have seen, the frequencies given are those officially allocated to stations. Observant readers will have noticed that the frequencies we give vary from "listed" frequencies in very many cases.

It is, or rather it should be, a well-known fact that a goodly proportion of the world's short wave stations operate off their official channels for various reasons. We know of stations as much as 200 kcs. off their allocated channel! Some stations fluctuate throughout the year, thus a check must be kept on them.

What is the use, then, of just accepting the frequency the station is SUPPOSED to be on? The answer is obvious. Our list is the only one which gives purely the actual OPERATING frequencies, and to do this the stations must be monitored and their frequencies measured. And so we list the measured frequencies in all cases.

THE EDITORS invite original contributions on short wave radio subjects. All material used will be paid for. Articles should be clearly written, preferably typewritten, and photographs should be clear and sharp. Diagrams need not be large or perfectly drawn, as our draughtsman will redraw in most cases, but relevant information should be included. All MSS must be accompanied by a stamped addressed envelope for reply or return. Each item must bear the sender's name and address.

#### Scope

A station list running as a "series" is not really good enough! We tried the idea but found that it was impossible to keep it up-to-date as far as our readers are concerned. Against this it is also not possible to issue a complete list in an average sized magazine on the grounds of space considerations. What is the answer then? We think we have found it by our new arrangement whereby the full list appears in the "Annual" and monthly modifications in the "News." In this way, readers have a complete and comprehensive list available each month. "On the shelf" we have another idea that will even better this arrangement, and it will be put into effect at the earliest practical date.

#### Organisation

How is a station list compiled and kept up-to-date? These are the main essentials needed:—You must have wide contacts in order to obtain the latest information quickly; You must have people working on it constantly; You must have facilities for checking and monitoring—and so on.

It is definitely not a job for a one-man-band! A person single handed could not possibly produce a list of any usefulness, and keep it accurate, because he would obviously be unable to keep track of the daily variations.

That is where we score—we have the contacts, facilities and organisation. In other words we have a little something the others haven't got!!

A station list compiled without the backing mentioned above can only be a weak imitation!

W.N.S.

CLUB SECRETARIES are invited to submit details of activities for insertion in our monthly club notes, which must arrive at this office by the 15th of each month.

COMPONENT REVIEW. Manufacturers, publishers, etc., are invited to submit samples or information of new products for review in this section.

ALL CORRESPONDENCE should be addressed to "Short Wave News," 57 Maida Vale, Paddington, London, W.9. Telephone CUN. 6579.

# V.H.F NEWS

## The Month's News

**L**AST month we advised readers to watch January 19th for more 50 Mcs. DX. Whilst no further W signals have been heard, the upper frequency limit reached high levels on that day. G6DH reports that, "as expected, the upper frequency limit was high on January 18th-19th, but did not reach 50 Mcs. On December 21st, the upper frequency limit was 46 Mcs. and on January 18th, it was 47-48 Mcs. The highest frequency station heard was ODD (Lebanon) on 48 Mcs. American FM stations have been audible between 44-45 Mcs. WHAM (Rochester) has been heard regularly on 45.3 Mcs." G6DH has applied to the GPO for an experimental licence for 50 Mcs. He has the backing of the R.S.G.B. and the A.R.R.L. It is to be hoped his application will get sympathetic consideration, as there is no doubt that a few experimental stations on this frequency in this country would provide most valuable scientific data. PAOUN, PAOUM and PAOWL are all on 50 Mcs. watching for a chance to work America. YI2CA is also on 50 Mcs. and there is a high powered station on a mountain top in Palestine which may put a signal into this country on 50 Mcs. So this band is certainly worth watching. The next F2 layer peak should appear around February 16th, so watch this band on that day from mid-day onward.

## The Months' Conditions

*Tropospheric Propagation.* Conditions have continued very poor during the month. A number of temperature inversions have been recorded, but these have not been accompanied by a sufficient humidity gradient to give "tropo bending." All reports indicate that conditions have been very poor. 6DH remarks that he has had only one contact during the month!

*Ionospheric Propagation.* Nil.

## The "F" Ionospheric Layer

It is generally accepted that the recent W-G 50 Mcs. contacts have been by F2 layer refraction, so a few words on this layer of the ionosphere would seem appropriate.

The "F" layer is the uppermost layer of the ionosphere. During the night, it exists as a single layer, but during daytime it divides into two layers, the upper one being designated the F2 layer and the lower one the F1 layer. This daylight division is

more marked in the summer time than in winter time. Thus in summer time, the F2 layer forms at a height considerably above the average height for the layer as a whole, i.e., about 400 kilometres, whilst the F1 layer is much lower—at about 220 kilometres. During winter, the average for the F2 layer virtual height is 270 kilometres, whilst the average for the F1 layer is in the region of 250 kilometres.

The F2 layer differs in characteristics quite markedly from the F1 layer. In fact the variations of the F1 layer are more like those of the E layer and the variations of the F2 layer are almost exactly opposite. Thus the critical frequency for the E layer is highest in summer; for the F2 layer it is highest in winter. One would have expected DX F2 layer propagation in the Northern Hemisphere to be six months out of phase with that in the Southern Hemisphere, but in actual fact the F2 layer behaves in an anomalous manner, low values of day critical frequencies are found in June in both hemispheres. This leads to the supposition that the ionisation in the F2 layer is not entirely dependent on the ultra violet rays from the sun. The variations of the E and F1 layers on the other hand, show no such anomaly, the variations being similar in degree but opposite in phase to those in the opposite hemisphere thus suggesting that the causative agent is entirely ultra violet light (1). The F1 layer seldom acts as a refracting layer for radio waves and the F2 layer is the only part of the F layer usually considered in discussing propagation phenomena. At night the combined F layer is frequently referred to as the F2 layer, so that measurements of critical frequency, virtual height, etc., are usually said to be given for the F2 layer whether it be night or day. F2 layer propagation phenomena are most marked in the winter. In winter the upper frequency limit realises an average of 40 Mcs. and may peak to 60 Mcs., whereas in summer, 32 Mcs. is about the maximum (2).

F2 layer DX opportunities can be fairly well predicted, thus differing from the other DX conditions which may be encountered on the VHF's, viz., Sporadic E. W1HDQ in QST for January, 1947, gives some good pointers for the appearance of F2 layer DX. Best days will occur in 27 day cycles coinciding with the solar sunspot cycle. The trend of the cycle can be estimated by listening for the highest frequency heard for several days until a clear indication is obtained whether conditions are improving or deteriorating. Once a "peak" has been established, the cycle can be calculated regularly. The check for the highest frequency heard should be made in the range

(Cont. on p.40)

# The R.S.G.B.

Past :: Present :: Future

By John Clarricoats, G6CL  
(General Secretary)

WHEN the Council of the Incorporated Radio Society of Great Britain decided, in September, 1939, that the work of the Society should be continued during war-time, they recognised that an active and fully-representative organisation of radio amateurs would be required after the war to negotiate with the licencing authorities for the early resumption of amateur transmitting facilities. The wisdom of their decision has been apparent during recent months, for as the result of discussions which have taken place between the Society and the G.P.O. very favourable post-war licence conditions have been obtained for all British Isles amateurs.

## Improved Licence Facilities Obtained

It was the R.S.G.B. that suggested that officers and other ranks who served in specified Radio trades and who wish to apply for an Amateur licence, should be granted exemption from the Morse and/or Theory tests. The Society was also responsible for the suggestion that pre-war holders of an Artificial Aerial licence should be granted a full licence, subject to satisfying the G.P.O. of their ability to send and receive in the Morse Code at 12 words per minute.

The R.S.G.B. successfully negotiated for the re-issue of transmitting licences in January, 1946. The new amateur licence, with its many improved facilities, represents the results of prolonged negotiations which were initiated during the war years.

The Society was closely associated with the preparatory work necessary for the introduction of the new City and Guilds of London Radio Amateurs' Examinations, and the Council is represented on the Moderating Committee set up by the examining body.

## Society Publications

The R.S.G.B. Bulletin (official monthly Journal of the Society) is now in its 21st year of publication and although current issues are thin by comparison with those of pre-war years, the technical standard of contributions is maintained at a high level.

## War Effort

The Society's contribution to the war effort cannot be judged by a recital of

figures, suffice it is to say that all three fighting Services benefitted considerably by the presence in their ranks of qualified radio amateurs. As a matter of historical interest the R.S.G.B. sponsored the pre-war Royal Naval Volunteer (Wireless) Reserve, and the Royal Air Force Civilian Wireless Reserve, and many hundreds of its members were called to the colours at the outbreak of hostilities.

## The Future

During the years which lie ahead the R.S.G.B. will, as hitherto, continue to devote its energies towards the betterment of Amateur Radio. Plans are already on foot to establish a Headquarters station which will embody the latest technical practices. The Society's publications will be expanded as soon as the paper position improves. Proficiency awards, contests and field days—an integral part of pre-war Society activities—will be introduced at an early date.

The social side, always a strong feature, will be extended immediately the current difficulties of catering and accommodation disappear.

## Membership Growth

The growth of the Society since 1939 may be regarded as an indication of the very considerable interest which is being shown in Amateur Radio. At the outbreak of hostilities the total membership was 3,500—today the figure is in excess of 12,000 and rising rapidly. Both of the Society publications were used as instructional manuals during the war years and large quantities have been exported to all parts of the British Commonwealth.

## An Invitation

The Society extends a cordial invitation to all who are interested in the science of radio communication to apply for membership. A strong and active national Society will ensure the continuation for all time of Amateur Radio—the greatest of all scientific hobbies. The Society's address is New Ruskin House, Little Russell Street, London, W.C.1.

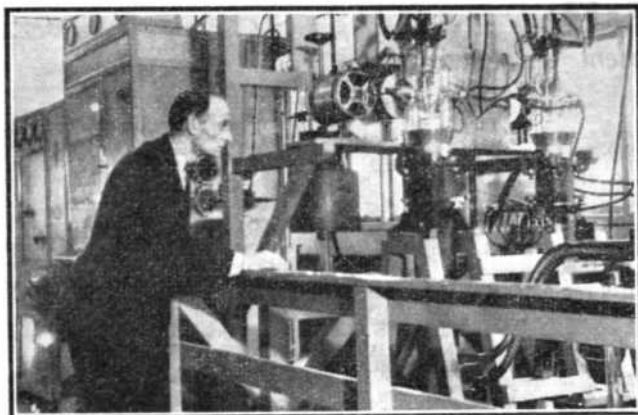

*Eddie Startz studies the PCJ amplifiers*

## Around the Broadcast Bands

Monthly Survey by  
"MONITOR"

All times are given  
in G.M.T.

**Y**OUR scribe would appreciate many more reports from readers. Let's have the news while it's "hot" O.M. Data on Station QRA's, QSL's received and schedules, especially of new stations, are welcomed for this column. DX conditions at my QRA in the West of England have been generally poor over the past four weeks. Bad QSB of the "flutter" type noticeable after 2000 especially on the higher frequencies. Very little in the way of DX has been heard. East Coast Americans have been up to standard in daylight hours.

For the benefit of our new readers to this column, the QRA for all letters is "Monitor," c/o SWN. Please mark envelopes "Broadcast Band News" in left-hand corner . . . by the 10th of the month.

N.B.—Queries cannot be answered by mail at present but via this column if possible. Lastly, your scribe wishes to thank all the readers who kindly sent cards to him at Xmas.

### ● Asia

**China.** Arthur Cushen from "down under" in New Zealand reports XORA Shanghai 11695 kcs. asking for reports to: 7 Chung Chang Road (Western). Session in English commences at 1000, with news at 1030.

**Ceylon.** Radio SEAC Colombo heard testing on 11500 kcs. according to G. K. Sutherland. Signals weak R3-4 at 1400. Your scribe heard them recently on 11770 kcs. with announcement "This is the Forces Programme" at 1615. Wiped out by GVU afterwards. Sunday evening BC to listeners in the British Isles are being received R9 on 7185 kcs. channel at 1830-2030. Re-

quests reports to be sent to: Radio Unit SEAC, c/o GPO, Colombo.

**India.** Delhi VUD4 heard on 9670 kcs. with news in English at 1430. Signals were R8 (G. K. Sutherland). VUD2 3495 kcs. often strong afternoons. English programme at 1610, VUD3 4860 kcs. peaks R8-9 from sign-on at 1700 with Eastern programme, states Sidney Pearce who uses a "Sky Champion" RX.

**Portugese China.** Radio Macao now operates on 7280 kcs. according to A. Cushen who states that they give news in English at 1100 and transmits until 1500 on Saturdays.

**Fr. Indo-China.** Radio Saigon 4810 kcs. heard at 2300 with strong signals when signing on. Gives news in French at 2330. The 11780 kcs. channel has English session from 1330-1430 (Pearce).

**Philippines.** KZRH "The Voice of the Philippines" Manila heard on 9640 kcs. from 1500 onwards with sponsored programmes. (Pearce).

**Dutch East Indies.** PMA Batavia 19350 kcs. R6 at 1330 with news in Dutch and recordings at 1345. (Pearce).

**Thailand.** HS8PD Bangkok operates on 5990 kcs. with 900 watts power. Schedule as follows: 1000-1130 also relays programmes from MW station HS7PJ at 1200-1415. Verifies with colourful card. This news comes via UR DX Club USA.

**Hong Kong.** ZBC 9575 kcs. and ZBW 9520 kcs. Former has BBC news at 1100, while latter carries English. ZBC gives Chinese after 1130. (UR DX C.).

**Turkey.** TAP Radio Ankara Ankara, 9465 kcs. heard R9 when answering listeners letters at 2130 in English. Recently announced that a new station at

Istanbul would come into operation at the end of the year with a power of 100 kW.

● Africa

J. Hughes reports "Radio Somali," Hargeisha around 1515, CW 7090 kcs. Eastern and Western type music. Signals R6-3. Severe "Ham" QRM.

● Australia

In a recent letter received by your scribe from Robin Wood, Programme Manager of "Radio Australia," the following was mentioned which should be noted by all SWL's who want VK QSL's.

"It is the policy of 'Radio Australia' to issue verification cards only when approximately fifteen minutes of programme reception data has been logged (i.e., fifteen minutes log for each individual transmitter heard). By adhering to this policy it is more satisfactory for the DXer and assists with checking our logs." (A.I.R. also have this same policy).

Mike Conners of the ABC is back with the "Overseas Children's Session" from "Radio Australia" which returns to the air at 2130 on 11770 kcs. This programme is BC specially for the English Children and it will be given every Friday.

The very first special Children's programme ever devised by a station for regular transmission to overseas destination, ABC states in a leaflet received.

G. K. Sutherland reports VLB9 9615 kcs. with R9 signals. VLC4 15320 kcs. heard afternoons R7 with some QRM. (D. O. French). Sidney Pearce lists VLA6 15200 kcs. with strong signals when signing on at 0845, VLG10 11760 kcs. also good from 0855. Both take same programme until 0910. Your scribe has logged VLC4 with very strong signals at 1500 with BC to British Isles also VLB9 R9 1500-1600 CW QRM, signals are wiped out around 1550 by Moscow station on same frequency. VLG9 11900 kcs. R7 1500-1545, VLA8 11760 R8 1500-1530. Morning BC to Brit. Is. heard R5 at 0730.

● South America

Ecuador. HC4FM "Radio Manta," Manta 6875 kcs. heard to 0600 Sundays. (A. Cushen).

British Guiana. ZFY Georgetown "The Voice of Guiana" 6000 kcs. heard R6. (J. E. Whittle). Please state times O.M. R5-6 at 0015 when closing with Ted Lewis Good-night Song and Nat. Anthem. (G. K. Sutherland).

Dominican Republic. HI1J Trujillo City 6117 kcs. has moved to 6147 kcs. and still heard to 0600 Sundays to A. Cushen.

BROADCAST STATION  
COUNTRY PANEL

No. 10: COSTA RICA

TI4NRH: Heredia. 9740 kcs. "La Voz de Costa Rica." Irregular. 750 watts. 6165 kcs.

TILS\* San Jose. "Radiodifusora Para Ti." 1000 watts. 9618 kcs.

TIPG: San Jose. "La Voz de la Victor." 2500 watts. 1215-0530 G.M.T.

TIRH: San Jose. 6150 kcs. "Radio el Mundo." 250 watts. 0230-0500 G.M.T.

TIRCC: San Jose. 6180 kcs. "Accion Catolica." 300 watts. Irregular.

TIWS\*: Puntarenas. 6065 kcs. "Ecos del Pacifico." 500 watts.

\*Temporarily discontinued.

Uruguay. CXA3 "Radio Ariel" Montevideo opens at 1000 with English song. Verifies by Air. QRA: R. M. Borde. Tech. Division, Avenida 18 Julio 1275 Montevideo. (A. Cushen).

Colombia. HJAG "Emisora Atlantico" Barranquilla verifies also by Air. Power 450 watts. Schedule 1500-0400 daily except Sundays when signs at 0600. Requests reports. (Cushen).

Chile. CE960 Santiago "Radio la Americana" has moved to 9585 kcs. Signs at 0500. (Cushen).

● Central America

Panama. Arthur Cushen has logged HOXA Panama City 15100 kcs. and says regular schedule is 1000-0400. English News at 0345. HP5J also in Panama City heard by the same reader testing Sundays at 1030. HOXA heard R6 at 1900 (G. K. Sutherland).

Guatemala. TGWA "The Voice of Guatemala" Guatemala City 9685 kcs. heard with terrific signals at 0115. Gives call every 15 minutes with frequent mention Guatemala. (J. Hughes).

● Europe

Bulgaria. "Radio Sofia" Belgrade 7660 kcs. gives news in English at 2030-2040 and answers listeners reports. Requests detailed reports and especially comparisons with 9350 kcs. channel of "Radio Rodina." (Harrison).

**Spain.** "Radio Espana Independents" heard on 15474, 13500 and 15750 kcs. approx. evenings between 1830-2152. Heavily jammed. (Harrison). (Please state times in G.M.T. O.M.)

**Sweden.** M. Forrest sends along schedule of Motala SW stations. Freq. are as follows: SBP 11705 kcs., SDB2 10780 kcs., SBO 6065 kcs., SBU 5732 kcs., SDT2 1566 kcs., SBT 15155 kcs., SBU 9535 kcs., SDT 9442 kcs.

0100-0200 on 11705 kcs. Special programme for listeners abroad.

0640-0710 11705, 15155 kcs. Swedish National Programme.

1100-1150

1500-1600 15155 kcs. Special programme for U.S.A.

1600-1730 10780 kcs. Swedish Nat. Prog.

1605-1730 15155 kcs.

1730-1755 10780 kcs. Bulletins in English, French and German. 15155 kcs.

1800-2200 10780 kcs. Swedish Nat. Prog. 9535 kcs.

### ● In Brief

B. A. Elvey ISWL/G330 would like to hear from other members of the International Short Wave League. He reports hearing a station with call Radio Station WAR testing for Police purposes which generally uses "scrambled" speech except when giving call. Signal strength was R4-5 on 31 metre band around 2045. Believe this stations is located at Brentwood, New Jersey O.M. being for Point-to-Point operation. Any views on this by any other listeners? QRA for correspondence, "Catrieff," Malvern Meadow, Kearsney, Dover, Kent.

David Owen French ISWL/G426 queries the following station heard by him: Paris between 17830 kcs. and 17870 kcs. (list only gives TPC3 on 17765 kcs.) Heard afternoons. WRUL on 15290 kcs., also on 15130 kcs. OPM Leopoldville operates occasionally on 10140 kcs. (Please state times O.M.) J. Hughes sends in some new QRA's for reception reports to ships. He states that for "Queen Elizabeth" and other British ships is as follows: International Marine Radio Co. Ltd., Connaught House, 63 Aldwych, London, W.C.2. They send letter veri thanking you for report and as the station is licensed under the WT Act of 1904 for Commercial working only, secrecy must be observed with all transmissions. P.O. (Protection) Act 1884 (Sect. II). They do not, therefore, verify but express their appreciation. J. Hughes has a letter from GBTT (Queen Mary).

Most American ships will send a card (picture of ship) and details on the back.

Have one from the S.S. "Washington" he states. Address is port of call for report c/o Chief Radio Officer, followed by name of ship.

Any reader wishing to visit your scribe should write to me c/o SWN. How about some more reports from you "Westerners"?

### ● QSL's Received

Barry Field ISWL/G404 has cards from: VLA4, VLA6, PCJ, PTAP. A. Cushen NICO (USS Mount McKinley), NCLG (USS Appalachian), both at Atomic Bomb Tests, Radio Sofia, KOFA, XTPA, AFN Frankfurt, SDB2, COBQ, HJDE, VUC2, and PHI. A. Levi ISWL/GI 38 from VLA6, WLWK, WGE0, WRCA, WNRA, WNRE, WNRI, WNRX, WNBI, CKRA, FZI. J. Hughes ISWL/G30 has had letter veries from AFRS Los Angeles (with IRC returned!) and FZI being a photo of station. State they have no cards at present. In a later report A. Cushen states he has a letter veri from XECC giving the QRA as: Ing. Angel Valera, Apt. 116, Puebla Pue, Mexico.

Your scribe has received a letter veri from Radio Monte Carlo (see Stop Press) and BFN, cards from VLR2 (black printed) also VLH5 (red printed). G. K. Sutherland ISWL/GW384 from: Radio SEAC, AFN (Frankfurt?), ZFY, HEI5 (card showing an outline of Europe in white, surrounded by blue sea with Switzerland marked in red). Sidney Pearce mentions veries from CKCS, CKLX, CKRA, COBQ, Ponta Delgada, Alicante, XORA, FXE (now sends fine card).

### ● Acknowledgements

Sidney Pearce (Watford, Herts.), Arthur Cushen (Invercargill, N.Z.), G. K. Sutherland ISWL/GW384 (Llanfairfechan, N. Wales), David Owen French ISWL/G426 (Norwich), B. A. Elvey ISWL/G330 (Kearsney, Kent), James E. Whittle ISWL/G31 (Darwin, Lancs.), J. W. Hughes ISWL/G30 (Rochdale, Lancs.), Arthur Levi ISWL/GI38 (Belfast, N. Ireland), M. Forrest (Salisbury, Wilts.), M. Harrison (Darlington, Co. Durham) U R DX Club (USA), and last but not least P. B. Jones (Watford, Herts.)

### ● Stop Press

Radio Monte Carlo, Monaco, state the following: Freq. 6130 kcs. Power 300 watts. Schedule: 0630-0830, 1100-1300 and 1800-2215. The power will be increased to 25 kW. when a new transmitter operating next July comes into service. MW station on 731 kcs. will have power of 120 kW. end of the year. QRA for reports: 16B, Princesse Charlotte, Monte Carlo, Monaco.



# POWER AMPLIFIER DESIGN

**Editorial Note:**—This is the final article in the present series by Dr. S. O'Hagan, G2CR, describing the various stages in amateur transmitters. The first article (*Crystal Oscillators*) appeared in our June, 1946, issue and *Frequency Multipliers* were discussed in the October, 1946, issue.

THE design of a powerful amplifier stage in an amateur transmitter is subject to a limitation not present in designing other stages: that the input power to the stage is limited, not wholly by electronic considerations, but by the terms of the transmitting licence. Normally the permitted power input will be either 25 or 150 watts (or 10 watts on the 1.7 Mcs. band).

The problem then is to turn the maximum proportion of the permitted input power into radio-frequency output and to feed that power to the aerial. In this connection, it will be noticed that the ratio of

$$\frac{\text{Output R.F. power}}{\text{Input (D.C.) power}}$$

is of greater interest than the ratio of R.F. output to R.F. driving power, which was the chief consideration of the earlier stages. For this reason, the use of high-gain valves in the power-amplifier is less important and the use of triodes is good practice especially where the stage is to be plate modulated. The reason for this will become apparent later.

It is possible to use a screen-grid type of tetrode or pentode as a transmitter power-amplifier: the circuit is the same as for a receiver R.F. stage. In practice a modified type of screened-grid valve, with the turns of the screen-grid wound in strict alignment, turn-for-turn with the control-grid and having a pair of metal plates between the screen-grid and the anode to reduce secondary emission from the anode, is used with great success. The well-known 807 and KT8 are of this type. They have the advantage over the orthodox screen-grid tetrode that the screen-current is very low (about 10 per cent. of the working anode current, as compared with an average of 25 per cent. for orthodox tetrodes and pentodes). This involves more than a simple saving of D.C. input power, because for telephony with anode modulation in a tetrode or pentode amplifier, it is necessary to modulate the screen-grid voltage as well as the anode voltage and the proportions of voltages on the two electrodes must remain the same with speech applied. This means that the screen must be fed, via a dropping resistor, from the anode supply or else a separate winding must be

incorporated in the modulation transformer to give correct matching of the modulator, simultaneously, to the anode and screen circuits of the amplifier. In practice, the former is generally used and this involves a wastage of audio-frequency power both in the screen-dropper resistance and in the screen circuit itself. The power fed to the screen circuit contributes nothing to the output of the stage. The implication is that, for anode-and-screen modulation of a tetrode or pentode, the modulator must supply about 25 per cent. more power for a given carrier power than would be required in the case of a triode stage. In the case of the beam tetrode the increase need be only 10 per cent. Also, it is found that beam tetrodes require very small amounts of grid-driving power. They will give a power gain of 200:1 with ease. This is both their strength and their weakness for, whilst it reduces the demand on the driver stages and simplifies their design, it renders the stage liable to break into parasitic oscillation unless the screening between the grid and anode tuned circuits is quite exceptionally good; and sometimes even then! The reason is that the drive requirement is so minute that it can be supplied from the output power in the anode circuit through even the tiny residual grid-to-anode capacitance of these valves, whilst any feedback external to the valve will only make things worse than ever. So it will be seen that high sensitivity is not an unmixed blessing.

A power amplifier stage using triodes may be expected to show a power gain of between five and ten times, so that for power up to 150 watts the drive requirements are not excessive. A typical triode is the T.20, which was widely used before the war and the craze for 813's. This valve would handle an input of 85 mA. at 750 volts and needed about 3.5 watts of drive for C.W. use.

The snag with all triodes, which initiated the present beam-tube fashion is the need for neutralization. The anode-to-grid capacitance is very many times greater than in a screen-grid valve and will feed back to the grid more than enough power to maintain oscillation, and means must be found to combat this. The usual method is to use

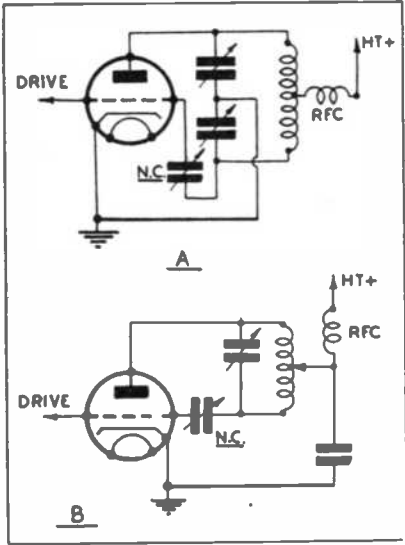

Fig. 1

Two ways of using a centre-tapped anode circuit to provide a feed-back in reverse-phase to neutralise a triode. "A" uses a split stator capacitor and "B" a tapped coil.

a centre-tapped tuned circuit in either the anode or grid circuit, with the centre-tap at earth-potential to R.F. In this case the ends of the tuned circuit take up equal and opposite R.F. voltages. Obviously then, if the anode-to-grid capacitance operating from one end of the tapped anode circuit feeds a certain amount of power to the grid circuit, then a similar capacitance from the other end of the circuit to the grid will feed an equal and opposite amount of power, which will neutralize the effects of that transmitted through the anode-to-grid capacitance. This circuit is shown as Fig. 1. The grid-neutralized circuit of Fig. 2 works similarly but in this case the neutralizing capacity is connected from the anode to the opposite end of the centre-tapped grid circuit, thus cancelling the power fed back through the valve. Where two valves are used in push-pull, as is usual for most high-power stages on the higher-frequency bands, the arrangement is that both anode and grid circuits are centre-tapped and the neutralizing capacities are connected from each anode to the opposing grid. This circuit gives the best results of all because the circuit is entirely symmetrical and un-

balancing capacitances to earth are eliminated, removing sources of possible unsuspected feed-back.

It is possible to use a "single-ended" triode stage at any frequency at which orthodox operation is possible but it becomes increasingly difficult to get stable results as the frequency is raised. Often it will be found that even slight changes will require that the stage be re-neutralized whilst band-changing makes re-neutralizing almost inevitable. For this and other reasons push-pull amplifiers are usually preferred for frequencies higher than 7 Mcs.

Typical Designs

Let us now consider the design of a typical amplifier using triodes and then pass to considering how the use of multi-element valves will modify the design.

Assume then that the input power is to be 100 watts. We must then choose either a single valve or a pair of valves that will handle this input without overloading. It becomes at once apparent that two valves sharing the power between them can be smaller in size than a single valve and, looking at the published valve characteristics we find that there are several valves that will take 50 watts input but when we look for 100 watt valves, the choice is slightly narrower. Also, the 50 watters are designed to take their rated input at a voltage lower than is required by a 100 watt type. This matter of anode voltage is important because as soon as we go above the usual run of voltages used in receivers we find that the prices of all the parts for the power-pack and for the anode circuit

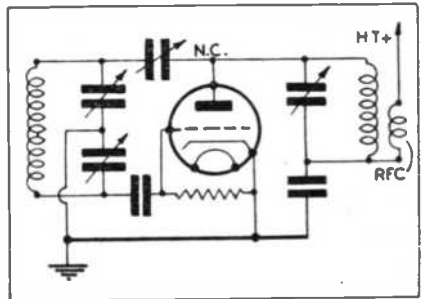

Fig. 2

Grid neutralisation of a triode. The grid circuit is split by using a split-stator capacitor, but the split coil method of Fig. 1 "A" could be used.

go up at an alarming rate. Thus it will often be found that the saving on the other components will more than pay for the extra valve. Let us then choose a push-pull circuit and a pair of fifty-watters. The type-example quoted above, the T.20 at once comes to mind, for a pair will take 105 watts input for anode-modulated phone at 750 volts and for the same service will require about 10 watts of driving power.

When used solely for C.W. the input power may be increased to nearly 120 watts and the driving power may be reduced slightly, though it would usually be convenient to run such a stage always at the phone ratings so that instant change-over is possible.

Now that we know that we are going to use 750 as our working anode voltage we can consider the components of the amplifier other than the valves.

Firstly, the supply of grid-bias and filament heating current must be provided. Filament heating will normally be from a small transformer, mounted, for preference, on the amplifier chassis; this means bringing mains current on to this chassis but the alternative is to have appreciable voltage drop between the transformer and the valve sockets. This would be intolerable in a stage intended to work at high efficiency. Thoriated tungsten filaments, as used in most of the larger transmitting valves are much more susceptible to low filament voltage than are oxide coated filaments and cathodes, so that it is essential to check the actual voltage at the socket of each valve unless the transformer is fitted close-by and is known to be accurate. Even so, post-war mains voltage seems to fluctuate enough to make a filament volt-meter a worth-while fitting wherever thoriated filaments are used.

The bias supply can be wholly derived from the rectified grid current produced by the R.F. drive flowing through a grid-leak of suitable resistance. From the makers data we see that the working bias for phone work is 140 volts and that a pair of valves should show a grid current of 36 mA., from which we see that the proper resistance would be rather under 4000 ohms. Similarly its wattage can be calculated and it is seen that a 10 watt rating will be ample.

### The Grid-tuned Circuit

This is a weak point in many amateur sets through a tendency to use too high an L/C ratio; this results in the circuit storing insufficient R.F. energy to swing the grids far enough positive to meet the needs of modulation peaks. This results in distortion

of the speech and interference outside the normal frequency band occupied by a good phone set. It is often shown by the meter measuring P.A. anode current flickering downwards with loud speech. In any set where this occurs it will pay to check the adequacy of the drive and whether in fact a suitable L/C ratio is in use in the grid circuit of the P.A. The choice of L/C ratio should be chosen in the same way as will be shown for choosing a correct L/C ratio for the anode tank circuit. Since both R.F. and D.C. voltages and currents are relatively low in all but very high power stages the grid circuits need not have higher ratings than ordinary good short-wave receiving components. Plug-in coils may be used for quick band-change.

### The Anode Tuned-Circuit

Now we come to the testing ground of components; with the orthodox circuit of Fig. 3 there is the whole steady anode voltage between the rotor and stators of the tuning capacitor and, when the amplifier is giving power, the whole R.F. voltage produced by one valve appears across one section of the tuning capacitor, thus for C.W. working the peak voltage across the capacitor vanes will reach 1500 volts in this case. If the stage is modulated, then the speech voltage will swing the anode voltage up to 1500 on peaks and the R.F. voltage will be correspondingly doubled, so that the total stress is a peak voltage of 3000 volts which calls for some thought when medium or high powered 'phone is contemplated. If the frame and rotor of the capacitor be not earthed directly but through a mica capacitor of about .002  $\mu$ F., then the D.C. and A.F. voltage is removed from the tuning capacitor and only half the spacing is required. But the fact that

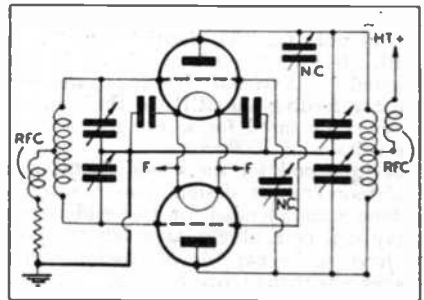

Fig. 3

*Push-pull triode amplifier, showing method of neutralising and the complete symmetry of the circuit. Tapped coil circuits could be used in either anode or grid side if desired.*

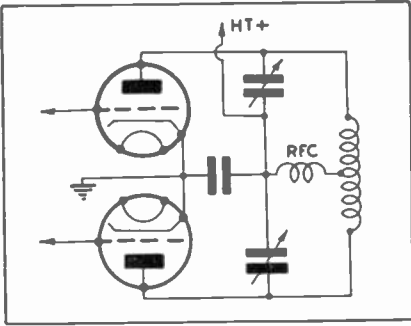

Fig. 4

Showing the use of a blocking capacitor to remove D.C. and A.F. voltages from the tuning capacitor. The frame of the capacitor is then live and must be mounted on stand-off insulators.

the frame of the capacitor is now live must not be forgotten and the spindle must have an insulating coupling inserted before passing through the panel and becoming a potential danger to life. The circuit then becomes that of Fig. 4.

Alternatively, the parallel-fed anode circuit of Fig. 5 may be used enabling the frame of the capacitor, and the tuning coil to be earthed to D.C. and A.F. voltages. This is perhaps the best circuit of all but the chokes must be of special design to be really effective in every amateur band . . . the ordinary pie-wound type are apt to become series-resonant in one or other band and to burn out either themselves or the valves if the power is not cut off immediately the signs of excessive anode current and/or smoking of the chokes is seen. The design for a choke for this type of service was discussed in *QST* for January, 1941 ("Why not parallel feed?" by T. M. Ferrill, Jr.) and such a choke is now marketed by *National*. Needless, the fixed capacitor feeding the R.F. to the tank circuit must be rated for working at the full peak voltage of 3000 volts.

The tank coil for the anode circuit must be of more robust design than the receiving type recommended for the grid circuit. It may still be a plug-in type but the plugs will have to be capable of passing several amperes without overheating. A coil diameter of two or three inches is usual for the present bands and enamelled wire of 12 or 14 S.W.G. is heavy enough. Copper tube is not necessary and may actually be inferior to wire in some cases.

The use of the optimum L/C ratio for the final tank circuit is most important for,

if too high a ratio is chosen the circuit will not adequately discriminate against the harmonics present in the output of the valves and energy might be radiated on frequencies other than the ones intended. This is most serious as even a low powered set may under certain conditions jam services operating on twice, thrice, or even four or five times its operating frequency. Apart from the risk that the G.P.O. might cancel the station's licence, any energy radiated on unintended frequencies is lost to communication and reduces the effectiveness of the transmission. There is thus every reason to avoid too high an L/C ratio. On the other hand, if it is made too low, the circulating currents in the circuit may be high enough to cause serious loss in the coil and its plugs and socket, again reducing efficiency. An effective compromise results when the ratio is such that the loaded amplifier works into a circuit with a Q of about 12. This condition will be satisfied when the effective tuning capacitance in use to resonate the circuit is that given by the equation

$$C = \frac{12500 \times \text{wavelength in metres}}{\text{D.C. resistance of the stage}}$$

This gives a figure in pF which can be used directly for the circuits of Fig. 6 (a) using an un-tapped tuned circuit between the anode of a single valve and earth (via the bypass capacitor). Where the centre-tap of the coil is earthed to R.F. as in Fig. 6 (b) the required capacitance is one-quarter of that given by the equation. The same applies to the push-pull circuit of Fig. 6 (c) whilst for the circuits of Figs. 6 (d) and (e) each half of the capacitor should be one half of the calculated figure.

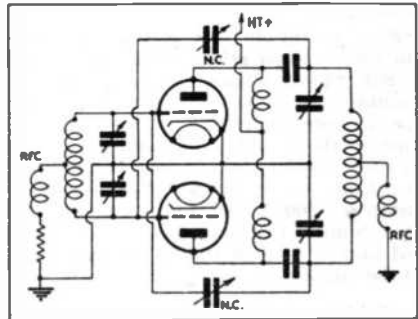

Fig. 5

Push-pull amplifier with parallel-fed anode circuit which removes the D.C. and A.F. components of the anode voltage from the tuning and neutralising capacitors.

The anode tuning capacitor should give this amount of capacitance at near its maximum capacitance for the lowest frequency on which the amplifier is to work. It should then be possible to get the correct capacitance for at least the two bands next higher in frequency, at lower settings on the dial. Once the actual tuning capacitance to be used for each band is known, the inductance required can be obtained from tables, abacs or calculation, and a coil of this inductance made.

The effective capacitance in use includes the plate-to-earth capacitance of the valve and other stray capacities which, at very high frequencies may total more than the capacity actually required. This entails lowered overall efficiency but no excess of harmonics in the output.

The capacitor must obviously be capable of standing the maximum peak voltage that may appear across it under modulation. The figures given earlier may be used but will apply only when the amplifier is coupled to a load. If it is run unloaded the peak voltage may be several times higher and flashovers may be expected, with the risk of destroying either valves or the power-pack. Therefore none but a flea-power stage should ever be run at maximum plate voltage with no load coupled.

Let us return to our typical amplifier design with the T.20's in push-pull: Here the working anode voltage is 750 and current 170 mA. for C.W., so that the D.C. resistance is 4400 ohms. C will thus be

$$\frac{12500 \times \text{wavelength}}{4400}$$

and assuming for the sake of a figure that we intend to work on ten metres, the figure for C will become 27 pF, and since we are using the split-stator type of anode circuit shown in Fig. 4 (e) each section must have half this value or 13.5 pF. The output capacity of one valve is across each section and amounts to several pF, so that the capacitor will have to have a very low minimum capacitance to provide the optimum L/C ratio for this band. For the lower frequency bands the capacitance required is doubled each time the wavelength is doubled, so that the same capacitance will tune on 20 and 40 metres in all probability, and its maximum might be high enough for eighty metres too. It is wise to use at least the estimated optimum capacitance in use on the lower frequency bands since a harmonic-radiating low-frequency set will put more interfering harmonics in populated parts of the spectrum than one working on ten or twenty.

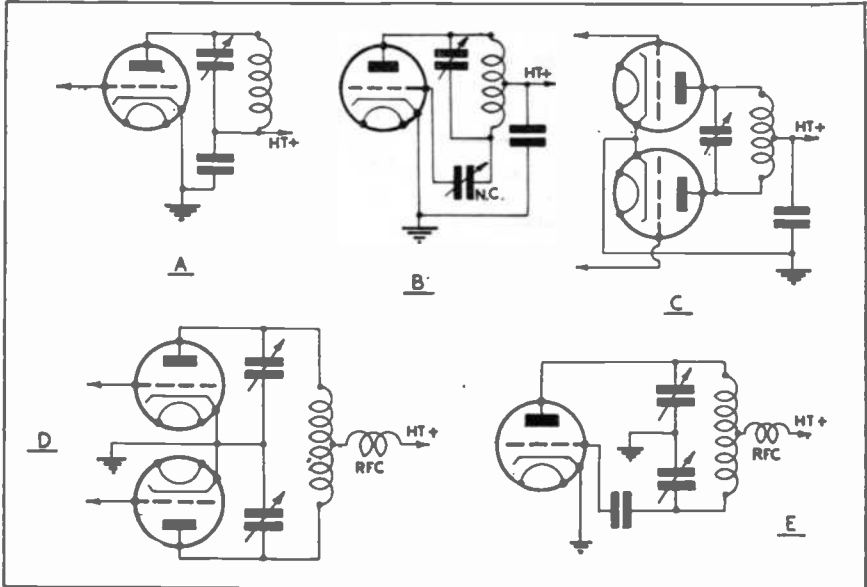

Fig. 6

Various types of anode circuit with reference to the correct choice of L/C ratio for harmonic suppression. The circuit at (a) requires the value given by the equation in text; circuits (b) and (c) require one-quarter of that value and in (d) and (e) each section of the capacitor should have one-half that capacitance.

Because of the balanced action of the push-pull stage, the centre of the coil will be at zero-potential to R.F. and it will be at that point that a link could be coupled to the tank coil. To facilitate this, the coil is often wound in two parts with a half-inch gap in the middle through which a movable link-coil can move, to vary the coupling. Although the centre of the coil is, theoretically at earth potential, slight unbalances of capacitance, inductance, or valve action may shift the true electrical centre of the coil slightly either way. If the centre of the coil were earthed through a bypass capacitor or via the power pack, a heavy R.F. current might flow between the rotor of the capacitor and the mechanical and electrical centres of the coil and upset proper working. To check this, the H.T. is fed to the coil-tap via a small R.F. choke. Since the R.F. voltage across it is small, this need not be anything special, and a 2.5 mH receiving choke will be adequate.

This completes the essentials of the design, with the exception of the neutralizing capacitors. These are connected between the anode of one valve and the grid of the other, they therefore have the whole of the modulated D.C. voltage across them plus the greater part of the R.F. voltage and also the grid bias voltage. These voltages will total something between 3000 and 4000 volts peak and the capacitors must stand this voltage without flashing-over and they must have a capacitance of rather more than the plate-to-grid capacitance of the valves, in this case 5.1 pF, so that capacitors with a range of about 3-10 pF would be suitable. (To be concluded)

### BETTER LATE THAN NEVER!

In our December issue we gave a description of ZFY, the "Voice of Guiana," in which we stated that this station was formed by the merger of VP3MR and VP3BG in 1936. Note the date! We now see that a writer on Broadcast Band subjects states that, "as he suspected," these two stations have now combined to form ZFY. We commend this "authority" on his uncanny nose for "hot news."

(V.H.F. NEWS—Cont. from p.30)

40-50 Mcs. Generally speaking, peak conditions will occur in the middle of the period when 28 Mcs. is open for the path under consideration, so that ten metre conditions are quite a good guide to VHF DX possibilities.

- (1) Radio Waves and the Ionosphere. Bennington.
- (2) Five Metre Propagation Characteristics. Heightman and Williams R.S.G.B. Bulletin. Vol. 22, No. 7.

## From our Mailbag

The Editors do not necessarily endorse the opinions expressed by their correspondents.

### THE ANNUAL

Dear Sirs,

This letter is to tender sincere congratulations on the excellence of your publication "The Short Wave Listeners' Annual," 1947 Edition.

It is a booklet of genuine usefulness to all walks of people engaged in Short Wave Listening, is informative, and covers every aspect of the Short Wave field.

We have no hesitation in recommending and confirming the opening remarks of the extremely well-written "Foreword" that this booklet has long been needed and certainly fills a long endured gap in literature of its kind.

Our best wishes to you in your new venture and greater successes than ever before in 1947.

J. R. D. Sainsbury, G8HV,  
Technical Publicity,  
ULTRA ELECTRIC LIMITED

Dear O.M.'s

Thanks for the "Annual," and congratulations on an excellent and well thought-out publication. It will fill a much needed want on short wave circles. There is no need to say "keep it up," as such encouragement is not necessary—you are already well ahead of contemporaries!

Thanks and 73,

H. H. Mansfield, ISWL/G12  
(London, W.11.)

Dear O.M.,

... I think the "Annual" is about the best thing I have ever seen for the SWL . . .  
73,

H. O. Armour, ISWL/G325 (Kings Lynn).

Dear O.M.'s,

Just a line to let you know that the copies of the "Annual" you supplied me with for my local club were all snaffled up by TRANSMITTING members!! Would be pleased to have a further supply so that the SWL element can have their copies! Incidentally my personal copy was disposed of during the stamped, hi!

Best wishes,

J. Patmore, ISWL/G7 (Mill Hill).

*(We have been almost snowed under by letters of appreciation for the "Annual," and are reproducing the above extracts as a general representative selection. Despite these congratulatory letters we are not swollen-headed, merely pleased we have supplied something that was needed. We are still human—believe it or not!—Ed.)*

**WE** detail below the latest Valve stock list comprising British and American Receiving and Transmitting valves available from stock at controlled prices, at the time of going to press:—

**AMERICAN—**

OZ4, 1A5GT, 2V3G, 1R5, 1S5, 1T4, 3D6, 5U4G, 5X4G, 5Y3G, 5Y4G, 5Z4G, 6A8G, 6AC7, 6AG7, 6A7, 6B8G, 6C5G, 6C6, 6D6, 6F6G, 6H6, 6I5GT, 6I7G, 6K7G, 6K8G, 6L6, 6Q7G, 6R7G, 6S7GT, 6S7G, 6S7H, 6V6GT, 6U7G, 6X5G, 6Y6G, 12J5GT, 14F6G, 18, 25A6G, 25Z5, 25Z6G, 25Y5, 35T, 42, 43, 77, 78, 80, 807, 8661r, 866/866A, 884, 955, 1299, 1637, VR105-30, VR150-30, T40, TZ40, RK34 8020, E1148.

**BRITISH** Equivalents to:—

VP2, SP2, PM12, PM1HL, PM2DX, PM1A, PM1HF, PM1LF, PM2, PM2A, PM202, PM252, PM22, PM22C, VP4, SP4, VP4B, VM4V, MM4V, S4V, S4VA, S4VB, 354V, 904V, AC2/HL, TDD4, TT4, Pen4V, Pen4VA, PenA4, 1W2, AZ31, DW3, DW4, FW4, VPI3C, SPI3, HLI3C, UR3C, D63, DH63, KT63, KT66, CIC, KTW63, KTZ63, L63, N63, N66, U50, U52, W63, X63, X65, X63, U31, KT61, DL63, HL2, H2, L2, P220, LP2, AC5DD, AC/P4, AC/Pen, U4, VPI322, HLI320, KT2, MX40, X42, VMP4G, VMS4, MH41, 4IMP, ML4, MV41, KT41, U18, RGI250, B2, MS4, 13VPA, MS/PenID5, APP4C, ECH35, EA50, EF50 D1, SP41, Z62.

**M.O.S.**

(Mail Order Supply Co.)

24 New Road, LONDON, E.1  
STEPNEY GREEN 2760

SEND STAMP FOR LATEST ILLUSTRATED CATALOGUE

**Get ALL the News!**



and views and valuable information sent out by the World's DX Amateurs

Be a real Ham. Learn to SEND AND RECEIVE MORSE CODE

Send for "the Candler Book of Facts". Free on request.

**THE CANDLER SYSTEM CO**

(Dept. S.N.) 121 Kingsway, London, W.C.2  
Candler System Co., Denver, Colorado, U.S.A.

**H.A.C.**

**Short-Wave Equipment**

Noted for over 15 years for Short-Wave Receivers and Kits of quality.

One Valve Kit, Model "C" - Price 20/-  
Two " " " " "E" - " 43/-

These kits are complete with all components, accessories, and full instructions. Before ordering send stamped addressed envelope for descriptive catalogue.

Note new sole address:—

"H.A.C." SHORT-WAVE PRODUCTS (Dept. SWN).  
66 New Bond Street, London, W.1

YOU MUST HAVE A COPY OF

The SHORTWAVE LISTENERS' ANNUAL

1947

2/6

NOW AVAILABLE through your local bookseller at 2/6, or direct from S. W. News at 2/9. Contains a wealth of information, much of it available for the first time in this country. YOU WILL WONDER HOW YOU EVER MANAGED WITHOUT IT!!!

# WORLD NEWS

## AMATEUR RADIO IN HUNGARY

By Peter Somssich

("S.W.N." Correspondent—Hungary)

**B**ETWEEN 1940-46, when our country was at war, most of the hams had to join the various Services. Nearly all of them were in the Signals Corps or Air Force, but others, including YL's and even boy scouts, were employed on the 'phone switchboards. As will be expected many HA hams paid the great sacrifice during these years.

Throughout this time, short wave activity was at a very low ebb, and when the Nazi occupation began, in 1944, a really hard time was beginning! The Government was forced, by German regulations, to confiscate all amateur apparatus (including receivers!) In this way we lost everything in our shacks (if we couldn't hide the gear before!), including our valued QSL cards.



*Jim Mann, VP9D, our Bermuda Correspondent and I.S.W.L. Representative, believes in taking things easy! With reference to the bottle on the table, Jim says that rum is only 3/- a bottle out there!*

It was even forbidden, under penalty of death, to listen to the BBC broadcasts. Therefore, it was not long before a "resistance organisation" began to operate against the Germans.

As it was practically impossible to buy any radio components, we either had to make our own or convert BC components. We had no crystals and couldn't operate on frequencies above 14 Mcs. as we had no suitable valves. Our receivers were all home made, mostly two or three valve "straights." Superhets (especially ones like the Sky rider, HRO, etc.) were almost non-existent and no ex-hams owned one. Our transmitters were ECO or ECO/PA, very rarely ECO/FD/PA, and all were low powered. Only 25 stations were fortunate enough to get 100 watts. As an oscillator, and in the PA, we liked 'tbe 6L6 (when we could get one!) and the 807 was a great favourite but we were hardly ever lucky enough to see one.

For aerials, we mostly used half wave doublets and Zepps, but in the cities the Eccentric Hertz was very popular.

During the war we had no SW literature to guide us in the latest developments and so we were somewhat in the dark. Operations then, and now, are on 3.5, 7 and 14 Mcs., and in fact we have only just begun experiments on 60 Mcs. (under the management of HA4H, Mr. Antalffy).

Our National Society (formerly M.R.A.O.E.—now M.R.R.E.) had 2,000 members in 1944, of which 350 had HA calls. The remainder were "observers" who held HRS or HSWL numbers. It was a stipulation that an HSWL number must be held for at least a year before an HA call was granted. We also had an examination, consisting of (a) Morse test—send/receive 60 letters per minute, (b) Electrical Theory, and (c) International calls, signs, etc. Power was restricted to 50 watts the first year and 100 watts, if proved efficient, the second year.

Although there are a number of HA pirates on the air, all amateur activity is at present forbidden, but we are looking forward to resumption in the near future. In the meantime if any G station wants reports, we will be pleased to help providing you send along your call, frequency and time of test. Our QRA is M.R.R.E., Box 185, Budapest 4.

That's all of ham conditions in Hungary, but I will be writing again from time to time. In conclusion, I send my best 73 to my old friends G6SQ, G3YL, GW4CK, G6AQ and W1MEC. And also, 73 es good luck to "Short Wave News".



# Resonant Lines

**D**ISCUSSIONS on the differences between pre-War and the current issue of licences is still a very important topic when potential transmitters foregather. Personally I try to remain neutral—not simply because it doesn't affect me however difficult it is made for newcomers—but because I feel that if anyone is really determined to get his ticket nothing will stop him.

It is true there is much to be said in favour of some modified form of AA licence to enable the lone worker to acquire practical experience, particularly so as many enthusiasts apparently carry out most of the experiments permitted under the old AA licence without the formality of approaching the Post Office. It would be more satisfactory all round if the P.O. would regularise the position of these minor pirates.

There is also much to be said, too, for the argument that the best of the old timers emerged from the very much harder conditions of the good old days when a commercially built TX was unheard of, let alone complete Service installations, and more often than not one had to get down to the problem of making or improvising one's own components. The amateur simply couldn't help being an "experimental transmitting station." However we may feel about it individually, it must be admitted that it is very easy to get on the air nowadays as far as gear is concerned, even if we disregard the complete Service jobs now available.

## Construction

Recently when chatting to G3PS and G4OO at Messrs. Radiocraft Ltd., I was surprised to learn just how much equipment they construct in their workshops for amateur requirements. My horror when I saw how extensive this demand is must have been only too evident as they hastened to explain that much of it was not due to the customer's lack of knowledge, but frequently because many amateurs are without workshop facilities or the time to do all their own construction. A few, too, apparently, like to have "something made up professionally to their own specification."

Perhaps after all the present day enthusiasts are not so "soft" as those who learned in a harder school often profess to believe.

## On Learning Code

Vast quantities of ink have been spilled on this most vexed of subjects, and far be it from me to sling another inkpot-full at the patient beginner. Yet I can claim

some qualifications to be able to put in my spoke on what so many find to be a painful and dreary business. These qualifications briefly are—

- (a) a firm conviction that I hold the World's Championship for having taken longer than anyone else when I learned it, and
- (b) part of my Service life was spent in training others in the gentle art.

With regard to the first, it wasn't only a natural inaptitude that delayed me, but my blindness in following much misguided advice on easy methods. There is no "short cut," but by methodical direction a lot of wasted effort can be eliminated.

As to (b), well, no one knew more about the difficulties and pitfalls besetting all of them. Consequently, in teaching the beginner as I had already floundered in others, I could hardly fail to achieve outstanding results. So much so that once in a flush of confidence I decided to start a Systematised Course of my own and I actually got as far as collecting a whole lot of data on methods and results towards it.

## Gallup Survey

As things have turned out I have been much too busy to get down to preparing "The Twelve Easy Lessons" so I am saving it up against a rainy day.

Once, as a matter of interest, I asked a dozen amateurs how they learned the code. Of them, six were self-taught, getting what practice they could on the air, three learned it at their local Radio Clubs, two learned it in the Services and one by a Correspondence Course.

Naturally on so limited a scale the proportions are probably far from being truly representative and no doubt if you tried it on a dozen of your acquaintances you would get a very different result.

Another interesting aspect I had noted when for a brief spell I was attached to a Canadian Army Training Establishment. The coloured lads were markedly quicker than the others in picking up Morse and becoming high speed readers, and later when I commented on this to an American Forces Instructor he admitted (rather grudgingly, I thought) that this too had been his experience.

*Bencie Yap*

---

## I.S.W.L. RUBBER STAMPS

We have just received a supply of I.S.W.L. rubber stamps, of the League emblem, and these are now available from GHQ at 2/6 each post paid.



For the past 15 years we have devoted our energies exclusively to the manufacture of Transformers and Chokes. Modern transformer technique is essentially the province of a specialist. Our technical department will be pleased to assist you in your transformer problems. Illustrated above is one of our varied range of styles shown in our catalogue—Free on request.

Telephone:

Abbey 2244

**PARTRIDGE**

**TRANSFORMERS LTD**

76-8, PETTY FRANCE, LONDON, S.W.I.

**TRANSMITTER-RECEIVERS**

(Type 58 Mk. 1\*)

The most modern version of that very fine Canadian set, the 58 Mk. 1, this "Star" Model is now offered at only  $\frac{2}{3}$  the price. They are in Original Maker's Cartons, as supplied to the Government, and are BRAND NEW & UNUSED. Each Set is supplied with 8 valves, 2 sets of headphones and microphone, 3 aerials (telescopic, sectional rod, and wire), Battle Battery, Haversack, etc. and Instruction Book. Complete and ready to switch on.—Only £10 10s. 0d. (Carriage 5/-). Illustrated leaflet available.

We can also supply, for the benefit of those enthusiasts who purchased the Mk. 1 Chassis offered some months ago, the range of accessories to complete the working unit. Prices as follows:—Set of Headphones and microphone, 22/6 each; Miniature Valves, types 1S5, 1T4, 1R5, 3D6/1299, 17/6 each; Telescopic Aerial, 15/- each; Rod Aerial, 12/6; Battle Battery, 20/- each.

Other Ex-Government Equipment offered this month:—**WAVEMETERS**, Class D, No. 1, Mk.II. Ranges: 1,900—4,000 kc/s., 4,000—8,000 kc/s., with check frequencies up to 25 Mc/s. Employs twin crystal, 100/1,000 kc/s. and ensures  $\pm 2\%$  accuracy. BRAND NEW & UNUSED IN ORIGINAL ARMY TEAK CARRYING CASE, complete with Instruction Book and SPARE VALVE & SPARE VIBRATOR, only £6 15s., or a few only without spares at 85/- (Carriage 3/6). Illustrated leaflet available.

**R.A.F. "IDENTIFICATION FRIEND OR FOE"** Radar R3002 Transmitter Receivers. Operates between 155—185 Mc/s. Complete with 10 valves, as follows: 2 type RK34; 1 type EF50; 4 type SP41; 3 type D1; and 20 watts motor generator, 12v. input, 480 volt, 40 ma. output. Only 79/6 (Carriage 4/-). Post orders only, C.W.O. S.A.E. brings current lists. Country Dealers send for particulars of our "Country Dealer's Service"

**U.E.I. CORP**

32 ST. GABRIELS ROAD, LONDON, N.W.2

**A.C.S. RADIO**

**OUR LARGE STOCK** of Short-Wave Components is detailed in our New Price List "S.N.", a copy of which will be gladly sent on request.

Among the new items we can offer this month, are the following:—

**VARIABLE CONDENSERS**

- Single 100 mmfd., ceramic insulation, brass vanes 4/6
- Single 75 mmfd., ceramic insulation, ball bearings, precision job with extended spindle for ganging 4/6
- Twin Gang Midget type, 25 x 25 mmfd., 7/9; 50 x 50 mmfd., 9/9; 75 x 75 mmfd., 11/3.

**COIL FORMERS**

RAYMART 6-pin threaded 2/2; 7-pin threaded 2/3

**CERAMIC VALVE HOLDERS**

- 4-pin British, 1/-; 7-pin British, 1/6; Int. Octal, 1/6; American Acorn, 2/6; Button Base, 1/6; UX Med. 7-pin, 2/6; UX 4-pin, 1/3; UX 6-pin, 1/- and 9-pin octal, 2/9.

We can still supply any reasonable quantity of our Ceramic Coil Formers, 2" x 1 1/2" diam., ribbed, with separate mounting strips, 5/- per dozen. (PLEASE ADD SUFFICIENT FOR POSTAGE)

We also have several Communications Receivers in stock, including NATIONAL HRO, NC81X, NC45, HALLICRAFTERS MARINE, DEFIANT and Dual Diversity, MARCONI CR100 and can frequently offer RME, HAMMARLUND and other well-known makes.

We shall be pleased to forward our current List "C.S.N." on request.

**44 WIDMORE RD BROMLEY, KENT**

Phone Ravensbourne 0156

**COILS!  
COILS!  
COILS!**

**AMATEUR  
RADIO  
PRODUCTS**

*Adjustable Iron-cored Coils*

*are now available from stock*

**AERIAL—H.F.—OSCILLATOR**

The range covers all wavebands

- 2000 Metres to 800 Metres (Iron Cored)
- 550 Metres to 200 Metres (Iron Cored)
- 206 Metres to 80 Metres (Iron Cored)
- 90 Metres to 33 Metres (Iron Cored)
- 45 Metres to 16 Metres (Iron Cored)
- 25 Metres to 9 Metres (Iron Cored)
- 15 Metres to 4.5 Metres (not Iron Cored)

**ALL AT 3/- EACH**

Above ranges also available on standard size paxolin formers, 1 1/2" x 1/2", in Aerial—H.F.—Oscillator, at 2/6 each.

**CERAMIC TRIMMERS** 30, 50, 70pF, at 1/- each

**4-WAVE BAND S/W COIL UNIT.** 206 to 9.3 metres. Fully wired and switched; for 2-valve battery-operated receiver, using 160 mmfd. condenser. 30/- complete with circuit.

All orders to Dept. "S.W.N."

**AMATEUR RADIO PRODUCTS**

50 Glaselyn Road, Crouch End, London, N.3

Telephone: MOUNTVIEW 4745

# Club Directory

---

---

- BIKENHEAD:** Meets monthly at the Y.M.C.A., Whetstone Lane.  
Sec.: B. O'Brien, G2AMV, 26 Coombe Road, Irby, Heswall.
- BIRMINGHAM (B.S.W.L.):** Meets at Hope and Anchor Hotel, Edmund Street, the first Monday of each month.  
Sec.: C. W. Thompson, 6 Caldwell Road, Stechford, Birmingham, 9.
- BLACKPOOL:** Meets on the first and third Friday of each month (7.30) at the Bellevue Hotel, Whitegate.  
Sec.: H. D. Ashworth, G4PY, 4 Albion Avenue, Blackpool.
- BOURNEMOUTH:** Meets on the second and last Tuesday of each month at the Lodge Room of the Branksome Arms Hotel, Commercial Road.  
Sec.: J. F. Squires, G2DBF, 80 Victoria Road.
- BRADFORD:** Meets every Monday evening at 1374a Leeds Road, at 7.30, a morse class being held from 7.00-7.30. Has three rooms, and holds club call G3NN.  
Sec.: V. W. Soven, G2BYC, 6 West View, Eldwick, Bingley, Yorks.
- DUBLIN:** (Practical Amateur Radio Constructors Club): Meets every Friday. Seeking permanent club room. Has library.  
Sec.: T. Keogh, 8 New Ireland Road, Rialto, Dublin.
- EDGWARE:** Meets at 20 North Parade, Mollison Way, on the first and third Wednesday of each month.  
Sec.: P. A. Thorogood, G4KD, 35 Gibbs Green, Edgware.
- GRAFTON:** Meets every Monday, Wednesday and Friday at Grafton L.C.C. School, Eburne Road, Holloway, London, N.7, from 7.30-9.30 Club's call-sign is G3AFT. Has canteen. Subscription 2/- per term.  
Sec.: W. H. C. Jennings, G2AHB, 82 Craven Park Road, London, N.15. ('Phone: STA 38991).
- HARROW:** Meets fortnightly (7.30) at the Northwick Tea Rooms, 206/208 Kenton Road. Annual subscription 10/-. Refreshments available.  
Sec.: J. F. A. Lavender, G2KA, 29 Crofts Road, Harrow.
- HOUNSLOW:** Meets on the 2nd and 4th Wednesday of each month at Grove Road School. Sub.: Life members 45, ordinary members 10/- per annum, under 21's 2/6 per quarter.  
Sec.: A. Pottle, 11 Abinger Gardens, Isleworth, Middx.
- JERSEY:** Recently formed.  
Sec.: E. Banks, "Port Rock," Tabor Lane, Route des Genets, St. Brelades.
- KINGSTON:** Meets on the second and fourth Thursday of each month at the Three Fishes, Kingston-on-Thames (near Kingston railway station).  
Sec.: J. J. Hughes, 12 Hillingdon Avenue, Ashford, Middx.
- LEICESTER:** Meets at Charles Street United Baptist Church at 7.30.  
Sec.: O. D. Knight, 16 Berners Street.
- LIVERPOOL:** Meets every Wednesday at St. Barnabas Hall, Penny Lane. Starts at 8 p.m.  
Sec.: T. W. Carney, G4QC, 9 Gladeville Road, Aigburth, Liverpool, 17.
- MAIDENHEAD:** Meets monthly at the "Toc H" behind the Technical Institute in Marlow Road.  
Sec.: J. F. Squires G2DBF, "Crendon," Lock Lane, Cox Green, Maidenhead.
- MEDWAY:** Meets at 207 Luton Road, Chatham.  
Sec.: S. Howell, G5FN, 28 Rosebery Road, Gillingham.
- N. MANCHESTER:** Meets Mondays at 8 p.m. in the Stand Grammar School for Girls, Higher Lane, Whitefield.
- READING:** Meets the second and last Saturday of each month at Palmer Hall, West Street, at 6.30 p.m. Annual Sub.: 10/6.  
Sec.: L. A. Hensford, G2BHS, 30 Boston Avenue.
- ROMFORD:** Meets each Monday at Mawney's Road Schools at 8.00.  
Sec.: R. C. E. Beardow, G3FT, 3 Geneva Gardens, Whalebone Lane North, Chadwell Heath.
- SALISBURY:** Meets every Tuesday at 85 Fisherton Street, commencing 7.45. Club room and workshop available to members ANY evening. Subscription 12/- per annum, or 3/- per quarter.  
Sec.: C. A. Harley, 85 Fisherton Street, Salisbury.
- SLADE:** Meets on the fourth Friday of each month at Broomfield Road, Slade Road, Erdington, at 8 p.m.  
Sec.: B. A. Griffiths, 34 Florence Road, Sutton Coldfield.
- SOUTHEND:** Meets fortnightly at the Art School Victoria Circus.  
Sec.: K. F. Crispin, G6MH, 27 Thurston Avenue, Southend-on-Sea.
- SOUTH SHIELDS:** Meets every Friday (8.00) at St. Paul's School Room, Westoe.  
Sec.: W. Dennell, 12 South Frederick Street.
- STOCKPORT:** Meets every Monday (7.45) at the Textile Hall, Chestergate. Annual subscription 11, junior members (under 21) 5/-.  
Sec.: G. Wood, 121 Garners Lane, Davenport, Stockport.
- STOKE-ON-TRENT:** Meets Thursdays at 7.00 at Tabernacle Church, High Street, Hanlet.  
Sec.: D. Poole, 13 Oldfield Avenue, Norton-le-Moors.
- STOURBRIDGE:** Meets on the first Tuesday of each month at King Edward VI Grammar School (Science Block).  
Sec.: D. Rock, G8FR, Flat 1, Block 1, Worcester Road, Summerfield, near Kidderminster.
- WATFORD:** Meets on the first Tuesday of the month at The Carlton Tea Rooms, 77a Queens Road.  
Sec.: J. C. Warren, 29 Market Street.
- WEST BROMWICH:** Meets every Monday (7.30) at the Gough Arms Hotel, Jowetts Lane.  
Sec.: R. G. Cousens, G3BCS, 38 Collins Road, Wednesbury.
- WEST MIDDLESEX:** Meets on the second and fourth Wednesday of each month at the Labour Hall, Southall, commencing 7.00.  
Sec.: N. Priest, 7 Grange Road, Hayes, Middlesex.
- WHITEFIELD:** Meets every Monday (7.30) at the Stand Grammar School, Higher Lane, Whitefield.  
Secretary: E. Fearn, 4 Partington Street, Newton Heath, Manchester, 10.
- YEovil:** Meets every Thursday (7.30) at the Pen Mill Cafe, Sherborne Road.  
Sec.: B. Hoyer, 57 Everton Road.

---

The Halifax Experimental Radio Society is now holding meetings at the Toc H Rooms, 32 Clare Road, Halifax, every alternate Monday evening at 7.30. The Society is applying for a transmitting licence so that a station transmitter may be built. Morse classes are a regular feature.

Much interesting work is being done in the field of remote-control and it is hoped that the model aero club will co-operate.

Full details may be had from the Secretary: L. Blagbrough, 39 Fountain Street, Sowerby Bridge, Yorks.

# ON THE HAM BANDS

## Conducted by "CQ"

### ● The Russian Prefixes

We have noticed a certain amount of confusion regarding the Russian prefixes, and this, together with the fact that the *complete authentic* list has not yet appeared in print in this country, merits its publication in this column. The second letter, by the way, will be seen to play an important part in the scheme, though this has not been thought the case by some. The true story is as follows:—

UA1/UA3/UA4: European Russian S.F.S.R.  
UA6: Transcaucasian S.S.R.  
UA9/UAO: Asiatic Russian S.F.S.R.  
UB5: Ukrainian S.S.R.  
UC2: White Russian S.S.R.  
UD6: Azerbaijanian S.S.R.  
UF6: Georgian S.S.R.  
UG6: Armenian S.S.R.  
UH8: Turkoman S.S.R.  
UI8: Uzbek S.S.R. (Uzbekistan).  
UJ8: Tadjik S.S.R.  
UL7: Kazak S.S.R.  
UM8: Kirghiz S.S.R.  
UN1: Carolian/Finnish S.S.R.  
UO5: Moldavian S.S.R.  
UQ2: Latvian S.S.R.  
UP2: Lithuanian S.S.R.  
UR2: Estonian S.S.R.

### ● Stations of the Month

Some of the more interesting stations now on the air. OZ4HF is on 28460 kcs. from Bornholm Island . . . CR4BQ is another one from Cape Verde—a 1000-watter . . . PK6sb is another newcomer, and is in Soembawa . . . The latest one from Iran is EQ21 . . . FG3IZ is on 14 Mcs. from French West Africa . . . PK4AW, Sumatra, is ex-PK6AW, PK1AW . . . W6SPK is in Korea on 14225 kcs . . . Another one active in Biak is PK6ha, and PK51k is

now going strong in Dutch Borneo . . . XZ2RK is off to Indo China and hopes to be on with the call FI8RK soon . . . VP81k is a rare 'un in the Falklands and is on 28020 kcs . . .

### ● Top Band

Many of the top band London stations, with their short wires, are not audible in the Midlands at night. But those with the long aerials are.

The most consistently strong London cw station heard in the Midlands has been G2flk (Romford) with his 8.4 watts input and 260 feet aerial. He has been 599 at 1640. G6VY (Enfield) was easily the loudest telephony station.

Remember the list of stations who had worked top band "dx" with indoor aerials? Well, here's another to be added to the list:—G3bdv (Walthamstow) got 579 from Peterborough when transmitting with 75 feet of wire indoors. Fine work o.m.

OK's have been heard but they were apparently taking part in a contest of their own.

OZlw has been one of the very few other continentals picked up.

The middle of the band has been congested and stations have QSY'd to the ends but as the writer can fully vouch, one can call one's head off there, but no one thinks to have a look!

### ● 3.5 Mcs.

The call for more reports on this band has been rewarded by more data this month. Our old friend D. L. McLeon has heard VE1EI, VO1I, W1ARV, 1BQ, 1DDK, 2MKN,



*This is the fine QSL received by Donald Tonks for his report on the signals of the "Dreamboat". We would also like to thank J. Bowes-Taylor who also sent along a card for reproduction.*

3AN, 4ALK and 4IMJ. These were all heard between 2300-0000. Nice work, O.M. A newcomer to this column, **G. F. Lanham** (Smethwick) ISWL:G153, reports W1DQ, 1M0, 1DBM, 1ZBV, 2MB, 2CSY, 2EGM, 2FMQ, 2GQR, 2SAS, 3EIG, and VO2A.

**John Clarke** has been hearing some fine DX, too. He lists VE1RF, VE1PG, VS9ar (2100), UO5vw (Kagul), UP2ha (Lithuania), LU1zx (Yacht "Gouche"—off the Canary Islands), and an unidentified SU!!

This band has certainly been producing some interesting calls during the past month, and we hear that the first post-war contact with the Antipodes took place on December 8th between PA and ZL.

**Tan Bin Hussain**, our Representative for Malaya, reminisces on his pre-war listening on the band. He heard five continents (South America missing) on 'phone and even had an arrangement with the PAO's to announce in English when they knew he was hearing them! The best catch was G5XT, using only 18 watts input. PAOAA was logged when using only a 33 foot vertical aerial, and, says Tan, "nearly toppled off his chair when he got the report"! I bet he did. Another catch was G16TK (25 watts), but G5JO "wasn't at all excited about my report"! This is all very interesting, and certainly bears out the DX possibilities of 3.5 Mcs. even though, as our friend says, "these are all ancient stories, at the time when I had little sleep and big electricity bills!"

A nice letter from VE1VB asks for reports on his and his friend's (VE1QL) signals—see "Reports Wanted"—from Europe. The rig at 1VB is a 6L6 CO running into a pair of 807's, and the aerial is a half-wave doublet, fed with 75 ohm Amphenol twin feed. The Rx is an SX-25, with a 90 foot Marconi aerial. Both 1VB and 1QL are anxious for QSO's with the Old Country, so how about it O.M.'s?

● 14 Mcs.

Although conditions have been rather erratic during the past month, with frequent fade-outs after about 2000, the band has produced its usual crop of exciting DX calls.

**D. L. McLeon** (Yeovil) sends in his usual fine 'phone log, which includes this time: EL4A, FF8FP (our old friend FG3FP using the right call prefix now!), HZ1AB (1910), OX3GC, TI2OA, VE4NT (1850), VP2GE, VP4TE, VP4TJ, VQ2HC (1830), VQ4ERR (1830), VS7RF (1850), ZE1JX (1830), ZE2JA (1740). There are also several VK, VO calls and a dozen ZS's, the latter being logged between 1800-1930.

A new contributor, **A. Baldwin** (ISWL/G193) of Leytonstone, E.11, heard these on his 1-v-1 battery receiver and 33 foot

aerial: J9AGP (Okinawa, 1300); OX1Z, 3GC; VU2XL (1610), ZS1CN, 6GV (1950). On CW:—CR7ad (2050), EP1al (1640), HI2af, PK4ks (1540), ST2am (1520), VE8ahu, 8aw, 8bs, 9bu, (between 0730-0840); VK7dw (1150), 7lz (0840); VQ4kth (1950), 8ad (1710), VS9an (1740), and several ZS, ZL and U's.

**J. Bowes-Taylor** again obliges with a neat and comprehensive log. The "cream" of the log is:—J9AAB (Q3 R4 at 1320), YI2CA (46 at 1655), CR7ad (445 at 2000), CR9ag (579, 1345), J3aad (446, 0500), OQ5av (589, 1943), VK7hj (1330), VE8mi, 8mq (Baffin Island, 566 at 1950), ZD4ab (548, 1655). Other interesting stations are VQ5jtr (Uganda, 457 at 2000, 14080 kcs.), NY4cm (579 at 2000, 14060 kcs.), and FF8wn (Dakar, 589 at 2000, 14015 kcs.)

**Martin Harrison** records EL5B, HH5PA (Q5 R3 at 2200), HZ1AB (54 at 0930), HZ4AA (53 at 0945. QRA please?), VE8's AW, ME and NM (1640-2030), VK6KW (52 at 0800), VU2DX (47 at 1650), VP4TE (58 at 1900), VP4TJ (56 at 2115, 14190 kcs.), W6OPQ/MM (Caribbean, 2135), and many other interesting items.

Another new "client" is **R. W. Collett** (Birmingham) who sends a nice detailed 'phone log. The best are CO7CX (Q5 R6 at 1925), HK3AF, SU1VL, VP4TJ (55 at 1950), VU2AP (56 at 1830), YV3AP, ZS1CN, 6GV, 6LF. Also FF8wn (569 at 1915) and ZL4ck on CW. He gives the QRA of ZS1CN as Box 277, Paarl, and ZS6GV as Box 103, Germiston.

**W. H. Harris**, G42 (East Suffolk), another 'phone DX-er reports CX8BA, OX1Z, SU1VL, VP4CJ, VP4TJ, VP9D, W9EZ/J5, ZS's 1CN, 2AF, 2BJ, 6FT and 6GV. Bill remarks on the poor conditions in the evenings and the high speed QSB often experienced. He gives the QRA of PY2PK as Box 317, Santos.

**Leslie Waine**, G328 (Yeovil) comes forward with CO8FP, VE8MQ (c/o East Arctic Patrol, Baffin Island), VQ2HC (1935), and ZS's 1CN, 1DU, 1DV, 2AF, 6DW, 6GB, 6SB (all between 1800-1930).

Our Goole Rep., **B. S. Scott**, G69, sends in a log of 125 'phone stations all heard between 1315-1730 in three days. Amongst the log we notice a call of particular interest, i.e., FR8CS of Reunion Island.

Many thanks to all the other reporters who have sent along logs and items of interest.

● 28 Mcs.

**D. L. McLeon** has a nice 'phone log, which includes:—FA8DX (QSL to W2DXF

or, W5KPI, whichever is operating), KP4AJ, PY2QK (1605), 5AQ (1355), 7VC (0940); VE5EA (1825), 7AJN (1715); VP6YB, VS9AB (0945), YI2CA (1345), ZS6GV (0915). Also some rare Wo's, W6's and so on.

R. W. Collett heard these on his TRF3: —KP4AJ (1400), UA1AA, 1AB; VS7FF (1205), W7EMP, XZ2DN (1255), YI2AT, CA; and the usual run of W, etc. He also heard W5IFM/MM, on board S.S. Huntington Hill, 350 miles West of Gibraltar.

From Nanyuki (Kenya) comes the monthly report of S/Sgt Whiting. The most interesting calls are G4qa, G4ql, G6om (1350-1515), KP4aj, OQ5ce, VU2lr (599 at 1410), VQ2pl, VS1bg (579 at 1500), YI2CA and ZS's, 5g, v, bk, bs, bz, 6j, u, bg, bv, df and iw.

● DX Target—(North Pacific)

Here is this months instalment of our "target practice". Please keep plugging at them and let us know how many bulls-eyes you score! We have omitted Hawaii and Guam from this survey, since numerous stations from these countries can nearly always be heard. Admiralty Isles: W9HCJ (28400 kcs). Palmyra Isle: K6SCJ (14180 kcs). Carlson Isle: W9NLF (14230 kcs). Swan Island: KS6AA (14 Mcs). Wake Island: W6ONP (14 Mcs), W6VBG (28 Mcs). Samoa: W6ECM (14 Mcs). Christmas Isle: W8WSY (28480 kcs). Johnston Isle: W6RMC (28 Mcs), W6GID (28 Mcs). Kwajelain: J9LG (14300 kcs), J9CRD (14220 kcs), W8LQM (14350 kcs). Tinian: W5GXX and W5KFX (28 Mcs). Iwo Jima: W7ELL (28170 and 14235 kcs). Okinawa: Most of the J9's to be heard are in this island. Saipan: W6WCN (28510 kcs), W9HJW (14200 kcs).

Well, there we are. We have picked out those stations better received from each of the islands. If you've heard these, or can supply information on others of greater "rarity" then please write.

● Query Corner

Martin Harrison, the "founder" of this feature writes that he has no queries again this month. You are slipping, O.M.! However Martin, points out that PK1VHN was W6VHN in an aircraft, heard when flying between Paris and Alexandria. He also points out my "deliberate mistake" in that LH2A is actually at Trondheim University! The operator is LA9O.

J. Bowes-Taylor heard ET1JJ but didn't get the QRA. We now know he is in Giren, Ethiopia.

The main source of enquiries this month concerns T1NS and SHS1, many readers

having written on the subject. We have a QSL from T1NS—QRA in "Pse QSL"—and he is in the Middle East, presumably in Tripoli. The station runs 100 watts, with parallel PT15's, into a full wave doublet on 14 Mcs. New QSL's will be forthcoming as soon as the printing blocks arrive.

The second station—SHS1—is operated from the radio laboratory at the Gottenberg University of Technology, Sweden. It is an experimental station operating on all amateur and commercial-experimental, frequencies, particularly the higher frequencies, from 2 Mcs. to 3 centimetres! The laboratory is now moving into a new building and four 60 foot masts are in course of construction.

Another "regular", John Clarke, queries ET2C, heard on 14 Mcs. I am afraid he is NOT in ET-land, O.M.! He is most definitely a pirate, operating from Switzerland! HZ1AB raised some doubts. Well, we have his QRA, for what it is worth, and he is an American, "somewhere in Arabia."

H.E. Edinboro heard VK6RU on 14 Mcs. at 1530 and asks if this is usual. Well, if you look at our DX Time Table in the "Annual", you will see that Oceania reception is usual between 1300-1900 for the frequency range and season. Signals do, of course, come the "other way round" to the early morning VK session and it will be noticed that the West Coast VK's are usually better heard than the East Coast during the afternoon period. Try your aerial in a different direction, O.M. if you have difficulty in hearing the VK's. It may make all the difference.

"Shouldn't stations signing /MM count as a separate country?". Thus, Martin Harrison. Well, it's a bit tricky! A station operating "Mobile Marine" may be in the China Seas or the North Atlantic, so you could hardly expect to amalgamate all the sea areas of the world and call them a "country." It is a difficult point, I know, because when you log or work an /MM station what country does it go down under?

A newcomer, Walter Savage (N.W.6.) asks about TA1T on 14 Mcs., and EQ2L, also on twenty. Regarding TA1T—you've got me, pal! See "Pse QSL" for the latter. Which winds things up for this month.

● Gossip

Information is to hand that D2's are restricted to 3500-3625 kcs. on "80."

The "old timer" record for our readers now goes to H. E. Lefebure who was operating with the call-sign OIX in 1912, using a 2 inch spark coil and crystal receiver!

C. H. Burchett, ISWL Rep. for Sierra Leone, has recently taken up an appointment in the colony. In the past he has held the call-signs YI2BT, VU2NH, VU2DX

and G3LQ. Now, he tells us, he is hoping to be on the air soon with a ZD1 call. Another country for the DX chasers!

Gunnar Granath, better known as ET3Y, would like reports, and asks reasonably that return postage be enclosed. His rig is ECO-DB-pp PA, running at 100 watts. He is operating solely on 14 Mcs. at present.

R. W. A. Mackichan, our VS6 Correspondent, whilst en route for Hong Kong visited VS1BJ in Singapore. This is a Royal Signals radio club and they have plenty of Jap gear! They seem to be well equipped and have a store room and workshops. . . VS1AE is ex-VS1AA. . . HS1SS is on the air from Bangkok. . . The KA's go in for kilowatt rigs and are R9 plus!

● Culture Corner

We are indebted to Mrs. G6DH for the following:

A Ham Will Find a Way  
(with apologies to Ken Ellis)

Can be sung to the tune of "Love will find a way"  
What 'ere befall,  
He still can call,  
With bright red-hot anodes,  
From Egypt, Cyprus, Palestine,  
And now of course from Rhodes,  
He surely does fulfill our need,  
He QSO's with lightning speed,  
He says "Hello" and then "Goodbye",  
And always QSL's!

\*But now, of course, from Arabia!

● Readers' Reports Wanted

G2DHF: 14, 7 and 3.5 Mcs., CW, 1900-2200 GMT daily, any distance: 28 Longlands Road, Sidcup, Kent.

G2DRT: 1863.5 kcs. 'phone and CW: 10 South Parade, Spalding, Lincs.

G3AYA: 7 and 3.5 Mcs. CW: 64 Cavendish Road, Kilburn, London, N.W.6.

GM3BCL: 7150 kcs.: 87 Braemar Place, Aberdeen.

VE1QL/VE1VB: 3511 and 3713 kcs.: R. J. Morrison, Coldbrook, New Brunswick, Canada.

VP9D: 14 and 28 Mcs. CW: J. A. Mann, R.N., W/T Station, Daniels Head, Bermuda.

ET3Y: 14 Mcs. 'phone and CW: Box 1191, Addis Ababa, Ethiopia.

G2UK/G2ATV/G3AKA: 28, 14, 7 and 3.5 Mcs. CW: c/o "S.W.N."

● QSL's Received

M. B. Taylor, G108: CX4CZ, LU6AJ, OZ7U, D4AKO, VE2PD, W1CCZ, W1DNS, W3AXT, W2QGZ, YV5AB, XACP.

D. L. McLeon: 14 Mcs.: HH5PB, ON4RN, PZ1A, TI2EV, W5HUU, W6IDY, VE4IF, XAAX. 7 Mcs.: ON4YJ. 28 Mcs.: GM8MJ, VQ2FR, XAAP, YI2CA.

Arthur Levi, G138: CE3CT, EI6P, I1FP, PAOLJ, PY1GM, W8SIR/VP9.

J. Bowes-Taylor, G65: HH2G, LA3GA, ST2AM (first SWL report), TI2FG, VS7ES, W1ADC, W3QR/"Dreamboat".

G. F. Lanham, G153: D2AT, D4AFC, G3LJ, G8AW, G2DPZ, GM6LS, GW8SO, LA8M, LX1BG, VE7AJN, W9ROQ.

W. H. Harris, G42: D4AKQ, GI3JP, HB9FG, W9VIZ, XE1AG.

● PSE QSL TO . . . .

New QRA's and some requested by readers.

C3YW: c/o C.N.A.C., Foochow, China.

CN8AB: P.O. Box 50, Casablanca, French Morocco.

CR4BQ: c/o British Sea Cable Station, Cape Verde Islands.

CR9AN: Adrian Roasario, Care Correios e Telegrafos, Macao.

EQ2L: c/o Iranian Airways Company, Teheran, Iran.

HH5PB: Pierre Borno, Lalue, Port-au-Prince, Haiti.

HR1MB: M. Brashier, c/o American Embassy, Tegucigalpa, Honduras.

HZ1AB: c/o J. P. Anderson, APO 788, c/o PM, New York.

J3HRP: APO 201, c/o PM, San Francisco.

K6CGK: Box 1242, Lihue, Kauai, Hawaii.

KL7AN: Box 790, Fairbanks, Alaska.

OQ5DL: Box 201, Jadotville, Belgian Congo.

OQ5AV: Box 77, Katina, Leopoldville, Belgian Congo.

OX1AN: ACB, Squad. 135, APO 858, c/o PM, New York.

OX3GC: Amateur Station OX3GC, Godthaab, Greenland.

OX5JJ: Danish Weather Station, Cape Adelaer.

OY3IGO: Ingvar Olsen, c/o Ing. F. Willejus, Thorshavn, Faeroes.

PK6SB: Sgt. F. Wiltschut, Genie 92507, 22e Batt. Inf. 4e Coy., Soembawa-Bezard, Netherlands East Indies.

PZ1J: Box 184, Paramaribo, Surinam.

SHS1: University of Technology, Gothenburgh, Sweden.

TINS: c/o Signals Officer, RAF Castel Benito, MEF1.

VK6RU: 419 Rokeby Road, Subiaco, Western Australia.

VO4J/VO4M/VO4P: Harman Field, Newfoundland.

VQ3EDD: Box 166, Dar-es-Salaam, Tanganyika.

VQ4ERR: Box 1313, Nairobi, Kenya.

VQ5JTR: Government Radio Station, Entebbe, Uganda.

VQ8AD: Paul Cavoche, Rose Hill, Mauritius.



## Around the Shacks

No. 8

**PY6AG**

**T**HE photo shows the very neat and efficient-looking rig of Walter Freire de Catvalho, better known to enthusiasts in this country as PY6AG. Walter has been a ham since 1933, firstly operating as PY1CA (in Rio de Janeiro) and then as PY8GH (in Manaus Amazonas), getting his present call in 1936. '6AG is 30 years old, married, and is a Radio Engineer in the Cia Radio Internacional de Brasil, a communications system in South America.

All the gear, with the exception of the RX, is home-built and, despite having no beam array, 6AG puts a very consistent signal into Europe. The transmitter is ECO, 6SK7/6V6, 6L6/2-6L6's and T55 in the final, running to 400 watts input. For 'phone work, the line-up is 6SF5-6C5-6C5 (pre-amplifier), push-pull 6F6's as driver and modulators Class B TZ40. The receiver is a Hallicrafters SX28A.

Walter has a novel card, as the illustration shows. The three Disney characters are in multi colours, and the caption beneath reads: "PY6AY-PY6AG-PY6AW: The Three Musqueteers of the Air"! The station QSL's 100 per cent. and apologises to anyone who has had to wait for cards, as they were delayed at the printers. The QRA of the station is Box 533, Salvador, Bahia, Brazil.



**New Catalogue:** Messrs. Radiocraft inform us that their new List TR1 is now available to readers who send in for a copy. Address is: Radiocraft Ltd., 11 Church Road, Upper Norwood, S.E.19.

**Radio Control:** Readers interested in radio control of models will be interested to hear that the Radio Controlled Models Society is now active. The new society will be pleased to co-operate with all in any radio control work and calls for a closer co-operation between radio control enthusiasts. Meetings are at present being held monthly in Manchester, at the Y.M.C.A. in Peter Street. Young, old, beginner or expert, are cordially invited to write for details to the Acting Secretary: Mr. R. Lawton, 10 Dalton Avenue, Whitefield. (Telephone: Whitefield 2781).



# International Short Wave League

H.Q.: 57 Maida Vale, Paddington, London W.9

Subscription 1/- per annum

## MONTHLY NOTES

**G**OOD news again this month—our QSL Bureau is now in operation. Again we have the honour to announce an I.S.W.L. "first", for to the best of our knowledge, no other QSL Bureau in the world (whether run by a society or a publication) has a section devoted to the Broadcast Station listener. It is strange that no one else has offered Bureau facilities to the BC fan, since he surely needs QSL services just as much as the transmitter and amateur listener. But more about this section later.

### The I.A.R.U. and its Regulations

Starting a QSL Bureau is not just a question of announcing it, as some people seem to think, and this explains why we have only just publicised the launching of the Bureau after we announced that such a service was under consideration last October. Upon investigation, a number of snags became apparent and we therefore feel that certain facts should be placed before our members.

The major amateur organisations of the world are members of the International Amateur Radio Union, formed for the purpose of general co-ordination of effort and the settling of international disputes and problems associated with amateur radio. The operative factor, as far as we are concerned, is that only one national amateur society is recognised in each country, which means of course, in this country the R.S.G.B. I.A.R.U. member societies may send cards only to the recognised I.A.R.U. society in each country. There are no objections to our sending cards to Bureaux in other countries, but cards sent to these societies by their members for transmission abroad may only be sent to the R.S.G.B.

We have, therefore, been in touch with the QSL Bureau of the R.S.G.B. and they have kindly agreed to re-direct cards for I.S.W.L. members to us. From time to time cards intended for the R.S.G.B. will no doubt find their way to us. The agreement is therefore reciprocal.

A word regarding reports and cards to G stations. The R.S.G.B., as the recognised national society, naturally can hardly be expected to place the facilities of its

Bureau at the disposal of non-members in this country, and we shall, therefore, be unable to forward reports and cards addressed to amateurs in the British Isles from G, GC, GI, GM and GW members of the I.S.W.L. There is no objection, of course, to us forwarding G reports and cards from our overseas members.

So much for the general background. Before proceeding to details, we would like to place on record our appreciation of the co-operation extended by the R.S.G.B., tangible evidence of the "Ham Spirit" which appears to be sadly lacking in some quarters. It should be clear to anyone that so far as transmitter's QSL cards are concerned there is room for only one QSL Bureau in this country.

### QSL Bureau Rules

#### Incoming

Any member of the I.S.W.L. may avail himself of the Bureau for the purpose of receiving INCOMING cards, free of charge, by the simple process of submitting a supply of SAE's of sufficient size to accommodate the average QSL card. Each member will be notified when a further supply of envelopes is required. This, by the way, applies to both amateur and BC sections.

#### Outgoing.

Members wishing to use the outgoing section will appreciate that this service entails certain expenses in the way of postage, stationery, etc. A charge of 2/6 per annum will therefore be made for each of the outgoing sections, amateur and BC. When writing please state which section, or sections, you wish to use.

The following general rules should be carefully observed:—

- (a) The use of the Bureau is confined exclusively to I.S.W.L. members.
- (b) The use of the Bureau for INCOMING cards is free of charge.
- (c) In order to obtain incoming cards, it is necessary only to submit a supply of S.A.E.'s.
- (d) A charge of 2/6 per annum will be made to members wishing to use any one OUTGOING section, or 5/- for both sections.

- (e) Reports or QSL's for amateur and BC stations should be sent in separate envelopes, addressed to the appropriate section.
- (f) Cards and reports for British Isles stations cannot be accepted from members resident in the British Isles.
- (g) SWL reports cannot be accepted for W stations, as the A.R.R.L. will not handle listener reports.
- (h) Bureau members will be notified when a further supply of S.A.E.'s is required.
- (i) S.A.E.'s submitted should be of a size suitable to accommodate the average sized QSL card and should bear the member's I.S.W.L. number in the top left-hand corner.
- (j) Correspondence to the Bureau should be confined to matters relating to it, and should be addressed in the following manner:—I.S.W.L. QSL Bureau, Broadcast (or Amateur) Section, 57 Maida Vale, Paddington, London, W.9.

#### GENERAL NOTES

Those I.S.W.L. members who have never yet made use of a QSL Bureau, will, having read so far, appreciate the benefits to be gained by doing so. The three main benefits are:—(1) That cards or reports can be forwarded to addresses which are unknown to the sender, (2) Owing to the saving in postage to the recipient, particularly amateurs, by bulk mailing of replies, the report/reply ratio is raised, and (3) A considerable saving in postage by the sender. (e.g. the 2/6 annual charge would, in the ordinary way, permit only ten reports—and this assumes that no reply postage is enclosed. The Bureau user, on the other hand, can send hundreds of cards for this same figure).

In the event of the Bureau receiving cards for non-members, the addressees will be notified in this column.

In conclusion we extend our thanks to members J. King, G415, and G. T. Lock, G420, who have kindly offered to run the Bureau for us.

#### DISTRICT NOTES

**S.E. London:** The CR reports low activity but is anxious to form a local Chapter. Local members please write to W. A. Martin (G70), 61 Silvester Road, East Dulwich, S.E.22.

**Derby:** J. F. Mathers (G452) asks for co-operation in the formation of a Chapter. Please write to him at 54 Fife Street.

**Harrogate:** P. Lumb, CR for Yorks, says

a new club has been formed in Harrogate. Support from I.S.W.L. members would be appreciated. QRA is 25 Pearl Street, Starbeck.

**Exeter:** Gordon Wheatcroft has been making some good progress and his local group has held its first meeting. Members who live in or around Exeter should lose no time in writing their TR at 7 Mount Pleasant Road.

**Darlington.** Martin Harrison, CR for County Durham, has been busy contacting local members, but says the SW fans in his area take some finding! How about it, O.M.'s? All the members in the county seem to agree that activity is low, so that is all the more reason why all members in the county should rally round. Those interested in helping should write to Martin at 36 (not 34 as published previously) Southend Avenue, Darlington.

**Lancashire:** Member Martin Illidge now licensed as G3AZF and wants reports. He is also interested in contacting local members. QRA is 181 Oakfield Road, Liverpool. Members R. Higson and J. Entwistle have obtained a joint licence under the call G2HFP and also want reports. QRA is 194 Downham Street, Blackburn. J. H. Wilcox (G60) wants contacts with Oldham members, and his QRA is 9 Poorfield Street.

The Lancs. CR, E. Whittle (2 Church Terrace, Darwen), invites co-operation from Lancs. members.

**Glamorganhire:** The CR, E. Whitby, 267 Crogan Hill, Barry, is putting in some good work and would appreciate more assistance. He is also contacting other CR's with a view to co-operation. He says that the importance of inter-county liaison cannot be over-estimated. We agree and suggest that other CR's may do likewise.

**Essex:** Ken Goodley is anxious to get a County Meeting going, and calls for Essex members to get in touch with him on the subject. Please write to 34 Blenheim Avenue, Valentines Park, Ilford.

**Wellington:** Len Stevens, G3XV, CR for Salop, has formed a local group known as the Wrekin Amateur Radio Society. More members are needed so how about it, those of you in the Wellington district? QRA is: Sunny Cottage, Donnington Wood, Wellington.

**Belfast:** Arthur Levi, is getting a local club formed and invites members in Belfast to contact him at 33 Old Cavehill Road, Belfast.

Next Month we announce further I.S.W.L. services and will give a list of newly appointed Representatives.

# A QRP TX for 7 Mcs.

By G. V. Haylock, G2DHV

This QRP oscillator has been in use at G2DHV and has been giving a good account of itself on the 7 Mcs. band. Despite its simplicity (it is easy to build and operate) it forms a very useful unit for the shack, since it can also be used as an exciter for a bigger transmitter.

The circuit is quite straightforward and is, in fact, commonly used by American amateurs. The transmitter uses a Type 53 twin triode as a push-pull oscillator. All other components are of standard type, and the anode capacitor (shown as a split stator type) may be of the ordinary receiving pattern.

Coil L1 consists of 24 turns, close wound, No. 18 s.w.g. (centre tapped) on a 1½in. diameter former. Coil L2, and C2, comprise

the usual Marconi aerial tuning arrangement. The coupling between L1 and L2 should not be too tight otherwise a chirpy note will result.

The power supply used is 350 v., and with the TX tuned to resonance the HT registers 380 v. at 20 mA. It should be noted that in this particular circuit, the crystal will oscillate irrespective of anode circuit adjustments. Using a QCC type P5 crystal, 5 watts R.F. input is obtained, with the DC input reading 7.6 watts when loaded. Tuning follows normal procedure. C1 is rotated until minimum dip is indicated in the meter. Aerial is then connected and tuned for maximum brilliance in series bulb.

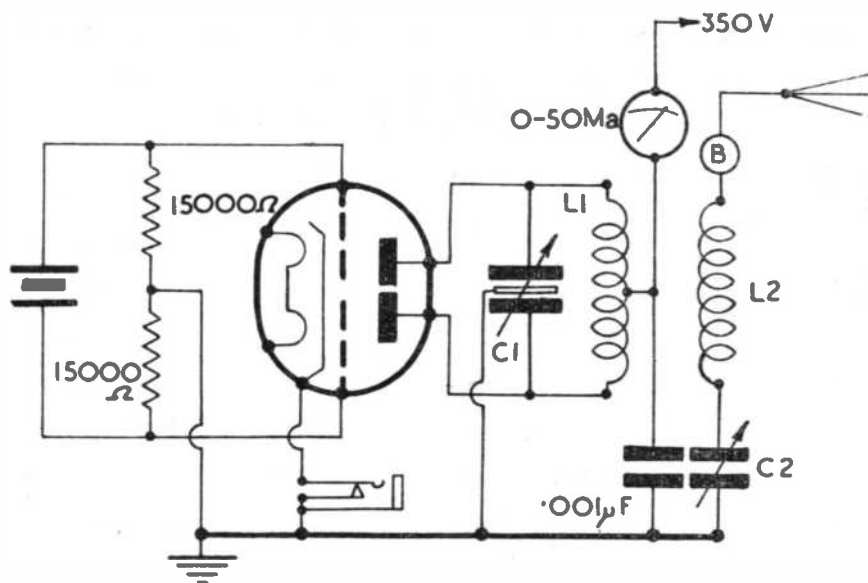

## “SHORT WAVE NEWS” BINDERS

We have now received supplies of the Spring Back Binders. The size is 11in. x 8in. and they will take anything up to the size of “Wireless World.” Price is 5/6, post paid.

Alternatively, we have now arranged for copies to be bound in cloth covered boards, with the name and volume number

printed on the front and spine. Covers may be bound in or taken out as required. The price for this is 7/6, post paid. Copies should be forwarded for binding, well packed and including the index sheet, to Mr. J. R. Dunne, 19 Helmsdale Road, Streatham, London, S.W.16.

# Component Review

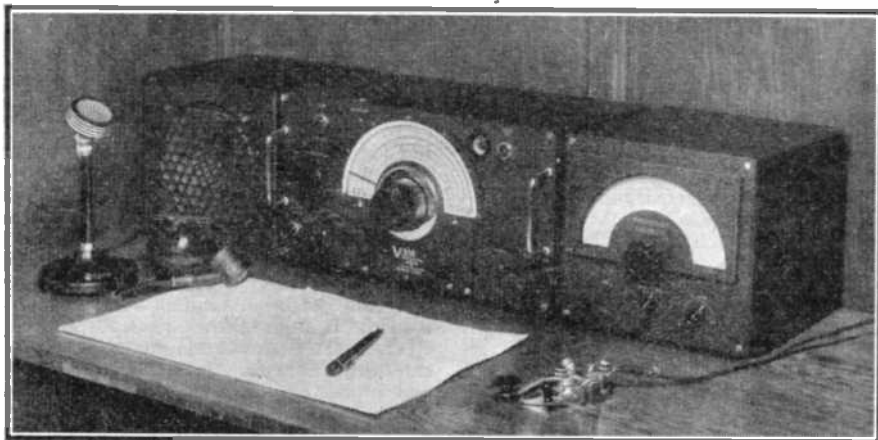

## The V55R Communications Receiver and Radiovision Expander

### Introducing Short Wave receiving equipment by RADIOVISION (LEICESTER) LTD

**T**HOSE who have handled the well-known 1155 Service type receiver will need no assurance from us of the excellence of these receivers, both for amateur band use and for general listening.

The chief objection to the ex-Service models available is that a considerable amount of work has to be put into adapting them and even after much careful thought and planning, the receiver has all the signs of "conversion" and has not the smart appearance so beloved by the majority of short wave enthusiasts.

RADIOVISION (Leicester) LTD., 58-60 Rutland St., Leicester, have had the foresight to make available a communications receiver at about as reasonable a price as could possibly be hoped for at present money values. This has been done by re-designing and modifying the 1155, simplifying the controls, removing circuits not required for communication purposes and providing a self-contained power pack and a new cabinet and front panel. Our illustration shows well the smart appearance of the V55R. The cabinet and panel are finished in good quality black crackle and all metal fittings are chromium plated. The controls on the panel are well arranged and are as follows:—Top—Send/Receive Switch; BFO Adjustment (Preset); Tuning Indicator; Mains On/Off Switch. Centre—Volume

Control; 100/1 ratio tuning dial. Bottom—BFO Switch; Wave change Switch; Phones Jack; Tone Control.

The frequency range is: Band 1—19-7.5 Mcs. Band 2—7.5-3 Mcs. Band 3—1500-600 kcs. Band 4—500-200 kcs. Band 5—200-75 kcs. The Valve Complement is: R.F. KTW61, F.C. X65, 1st IF. KTW61, 2nd IF. KTW61, 2nd Det. DL63, AVC/BFO DL63, Output KT63, Tuning Indicator Y63, Rectifier U50. The cabinet, which is well ventilated, measures 16½ in. by 9½ in. by 11½ in. deep, and the whole receiver weighs 32 lbs.

On test we found that the V55R retained all the best features of the 1155. Selectivity is excellent and the receiver could cope with the 40 metre amateur band on a Sunday morning in a way which quite surprised us. It is an ideal receiver for DX too. With an output of 50 mW. with 1 microvolt signal input, a certain level of receiver noise is inevitable, but if intelligent use is made of the volume control when using phones we can confidently say that any DX going can be heard. A special matched speaker is available and with this enough volume to fill even a large room is readily obtainable, the quality of reproduction being very good. Bandsread is generous on 3.5 Mcs. and 7 Mcs. and is perfectly ade-

quate on 14 Mcs., the 100/1 tuning dial giving all the control needed.

For general short wave listening this receiver is ideal. Its very solid construction ensures complete rigidity and mechanical stability and gives a receiver which can be tuned to a real DX broadcast station, switched off and then switched on the next day, with the certainty that the DX station will be there without any adjustment of the tuning control at all. At £29 10s., this is about the best value for money we have seen for a long time.

Realising that a general coverage receiver cannot be expected to give a good performance on the high frequencies as well, RADIOVISION have produced an "Expander" unit which will enable the V55R to cover the 5, 10 and 11 metre amateur bands. This unit has its own power pack and is built into a cabinet to match that of the V55R. However, as the unit is of

the "converter" type it can be used with any receiver which will tune to 1500 kcs. The valve complement is: R.F. EF50, Det. EF50, Oscillator 6J5, Rectifier U50. The frequency range covered is 27-30 Mcs. and 56-60 Mcs., switched coils being used, and each frequency range has its own separate aerial input sockets. Either a dipole or single wire antenna can be used.

For those whose interest is primarily in the 14 Mcs. and 28 Mcs. DX bands a further model frequency expander is available covering these frequencies only. This model is designated Model B. The price of these expander units is £18 2s. 10d. including valves.

As can be seen from our illustration, the V55R, an Expander Unit and the Matched Speaker (price £2 14s. 6d.) together form a most attractive combination, giving a receiving station of which the most fastidious could be proud.

## Broadcasting Station List

— Modifications to List appearing in the "Annual"

### Stations temporarily discontinuing broadcast services

JLG4, 7552 kcs.; JLT3, 15225; JLP3, 17835; JLG4, 15100; WNRX, 14560; HBZ, 14460; FIQA, 12127; YV5RV, 4765; VUC2, 4840; VUD3, 4860; VUM2, 4920; VUD2, 4960; Algiers, 6025, 11765 and 11880; TIIS, 6165; TIWS, 6065.

### Frequency Changes

OZH, from 15165 to 15320 kcs.; TGOA,

6494-6102; OAX1B, 5530-6197; Omdurman, 9220-9600; HI8Z, 7932-7167.

### Stations now out of commission

KU5Q: 7445, 9670, 13360 and 15930 kcs. JLU2, 9525 kcs.; JAG, 17840 kcs.; Batavia, 18135 kcs. (These three stations are now only used for commercial 'phone service.'

ZLT7, 6715 kcs. (pending new short wave service).

JZH, 6095 kcs.

### New Stations and New Channels

2330	...	ZQI	Kingston, Jamaica		200
3305	...	VUC2	Calcutta, India	All India Radio	10000
3365	...	VUB2	Bombay, India	All India Radio	10000
5990	...	HS8PD	Bangkok, Thai		
6026	...	PCJ	Huizen, Holland		60000
6100	...	VUD10	Delhi, India	All India Radio	20000
6130	...	—	Monte Carlo, Monaco	Radio Monte Carlo	300
6176	...	HOB	Panama City, Panama	Radio Panamericana	
6195	...	—	Tangier, Tangier	Radio International	
9505	...	HOLA	Colon, Panama	Radio Atlantico	
9540	...	VLB	Shepparton, Australia	Radio Australia	100000
9615	...	VLB9	Shepparton, Australia	Radio Australia	100000
9680	...	VLB2	Shepparton, Australia	Radio Australia	100000
11830	...	VUD10	Delhi, India	All India Radio	20000
11850	...	ORY	Ruysellede, Belgium	Radio Brussels	5000
15065	...	—	Addis Ababa, Ethiopia		
15200	...	VLB6	Shepparton, Australia	Radio Australia	100000
17800	...	VLB7	Shepparton, Australia	Radio Australia	100000
21540	...	VLB5	Shepparton, Australia	Radio Australia	100000
21600	...	VLB8	Shepparton, Australia	Radio Australia	100000

## SMALL ADVERTISEMENTS

Readers' small advertisements will be accepted at 3d. per word, minimum charge 3/-. Trade advertisements will be accepted at 6d. per word, minimum charge 6/-. If a Box Number is required, an additional charge of 1/6 will be made. Terms: Cash with order. All copy must be in hand by the 10th of the month for insertion in the following month's issue.

**QSL CARDS, Short Wave Listeners' and Full Call Samples Free.** Send S.A.E. to G6MN, Worksop, Notts.

**ODEON RADIO, HARROW.** All components, complete equipment, test gear and technical books for transmitting amateurs, short wave listeners and experimenters now obtainable from 56 College Road, Roxborough Bridge, Harrow (2 minutes Harrow Met.) Prompt repair and re-alignment of communication receivers Personally supervised by G4HV. Postal enquiries receive immediate attention. Open 9 to 6.30 daily, including Saturdays. Odeon Radio, Harrow.

**METERS exceptional offer!** Weston 2in. square 0.150 micro amps. Unused. R.H. Zero. With AID temperature scale 12/6 each. Scaled 0.150 17/6 each. Also Salford centre and L.H. Zero 2.5 mA. and 2 mA. Same prices. Limited stocks. J. P. Short, 87a, Upper Richmond Road, London, S.W.15.

**SEND 2d. stamp for complete bargain list.** Examples, Yaxley type switches 1/-. 1mA. Rectifiers for meters 2/6,  $\frac{1}{2}$  Amp. for chargers 5/-, 300 v. 60 mA. 5/-. Volume controls 1/-. Thermo 0.5 Amp. meter 8/6, Resistors 1W. 6d.,  $\frac{1}{2}$  W. 4d. All Short Wave Components. Carter's 67 Bell Lane, Marston Green, Birmingham.

**FOR SALE.** 9 valve battery transceiver R.A.F. TR9H. 3 valve transmitter, 6 valve receiver, straight. Excellent condition, modified for amateur use, 10 plug-in coils, 10 metres upwards, circuit, accumulator with charger, wooden carrying case, £9. Box 1014.

**REPORT PADS!** 50 sheets printed report forms for the DX listener. Complete with instructions. Indispensable to the QSL collector. Send a report that will be appreciated by the recipient! Price 2/6 post free from "S.W.N.", 57 Maida Vale, Paddington, London, W.9.

**SWAP two QCC crystals, 1883 and 1933 kcs., for any others between 1750-1815, 1845-1900 or any 3.5 or 7 Mcs. frequencies.** Cash adjustment if necessary. Write Box 1010.

**EAST ANGLIAN HAMS.** All components for receivers and transmitters, crystals, test gear valves. Authorised distributors for Hamrad, Raymart, Eddystone, Labgear. No lists yet but all enquiries dealt with promptly, send stamped addressed envelope. Newson, G3GY ex-G2GF, 28 Market Place, North Walsham, Norfolk. Telephone 219.

**QSL CARDS.** Send for free samples. G2DJA, 137 Randall Avenue, London, N.W.2.

**HOWARD 450A,** 12 valve communication receiver, dual I.F., dual aerial system,  $\frac{1}{4}$  to 550 metres calibrated in kilocycles, with band spread. B.F.O., I.F. shift, etc. £50 or part exchange. Oswald, 3 Briardale, Edgware. Mill Hill 1333.

**R.A.F. single seater rubber dinghy with sails, etc., £5 10s.** Box No. 1015.

**AMATEUR selling up,** has for sale, valves, S.W. coils, transformers, etc., etc. Send S.A.E. for full list, to D. J. Farvin, 20 The Byeways, Surbiton, Surrey.

## VALLANCES SPECIAL BARGAIN OFFER

### of Miniature Communications Receivers

Originally made for the Government, these receivers are constructed of the very best materials. All are absolutely new and unused and guaranteed to be in perfect working order.

The complete equipment consists of the following:—

1. A five-valve superhet designed for C.W. or R.T. operation, uses four 1T4 and one 1R5 valve size  $9\frac{1}{2}'' \times 3\frac{1}{2}'' \times 2\frac{1}{2}''$ .
2. Power supply which will operate on either A.C. or D.C. mains, any voltage from 97 to 250 volts, adjustable to voltage required, size  $8\frac{1}{2}'' \times 3\frac{1}{2}'' \times 2\frac{1}{2}''$ .
3. TWO combined 90v. H.T. and 7.5v. L.T. battery, size  $7\frac{1}{2}'' \times 3'' \times 2\frac{1}{2}''$ .
4. Pair of balanced armature light-weight headphones.
5. Coil packs, size  $2\frac{1}{2}'' \times 3\frac{1}{2}'' \times 1''$ .
  - (a) tunes from 100—1,600 kc/s. 1188—3,000 metres.
  - (b) tunes from 2.5—5 mc/s. 60—120 metres.
  - (c) tunes from 4.5—8 mc/s. 38—67 metres.
  - (d) tunes from 8—15 mc/s. 28—30 metres.
6. Aerial and earth wire with paxolin former and earthing clip.

This receiver can be used when out walking, as it can be easily carried in your overcoat pocket. The battery will give approximately 30 hours' continuous use, and 2 to 3 months when used intermittently. The power pack is, of course, operated in the shack to conserve the batteries for outside use. Should you require further batteries we can supply, while stocks last, at 19/3 each, post free. Sufficient power is available for working a small loudspeaker, 2" or 3" in diameter, if required.

We have found this receiver amazingly efficient on test, and all Continents can be received at S9 on phones. Backlash and frequency drift are negligible and signal to noise ratio, even when the receiver is mains operated, leaves nothing to be desired.

Just released by the Government, these sets are exceptional value for money, and cannot be repeated. Limited quantities are available. Buy yours now. Price £11 10s. 0d. post free.

## VALLANCES, 144 Briggate, Leeds, I

RECEIVING EQUIPMENT

BY

**RADIOVISION**

Should be a vital part in every Amateur Station

**THE V55R**

**ALL BRITISH COMMUNICATION RECEIVER**

For the Amateur Transmitter or Short-Wave Listener

COMPACT SENSITIVE SELECTIVE

**RADIOVISION EXPANDER**

A High Performance Converter

To cover the 5 and 10 Metre Amateur Bands

Can be used with The V55R or any Superhet or TRF Receiver

*May we send you our fully illustrated brochure?*

**RADIOVISION (Leicester) LTD.**

58-60 RUTLAND STREET, LEICESTER · TELEPHONE 20167

**PREMIER RADIO**

MORRIS AND CO. (RADIO), LTD.

**ALUMINIUM CHASSIS.**—Substantially made of bright aluminium, with four sides, 10in. x 8in. x 2½in., 7/-; 12in. x 9in. x 2½in., 7/9; 16in. x 8in. x 2½in., 8/6; 20in. x 8in. x 2½in., 10/6; 22in. x 10in. x 2½in., 13/6.

**SUPERSENSITIVE DOUBLE HEADPHONES.**—Balanced armature with reed driven aluminium diaphragm. 60 ohms, 8/6.

**ELECTROLYTIC CONDENSERS.**—Miniature metal can type, 8 mfd. 500 v.w., 3/-; 16 mfd. 500 v.w., 4/-; 8x8 mfd. 500 v.w., 6/6; 50 mfd. 12 v., 1/9.

**2-VALVE, SHORT WAVE BATTERY KIT.**—A complete Kit of Parts for a 2-valve receiver, covering 15-600 metres, including valves, coils, drilled chassis, H.T. and L.T. dry batteries, to last approximately 6 to 12 months. A pair of Double Headphones and full instructions. Price £3/10/- . An Extra Coil can be supplied, covering 600-1900 metres at 4/-.

**ROTARY TRANSFORMERS.**—Input 12 v., output 180 v. 30 mA., 4 v. 2-3 A. with 19 volts input, output is 50 per cent. higher. May be used on D.C. mains as L.T. Charger. With small conversion could operate as D.C. Motor. Original cost over £5. Employ powerful ring magnet. Price 10/- each.

**OUTPUT TRANSFORMERS.**—A super production. By means of ingenious series-parallel arrangement, all windings are used at all times. Match any tube, single or push-pull to any voice coil 2-30 ohms. 7 watts, 22/6; 15 watts, 30/-; 30 watts, 49/6; 60 watts, 59/6.

**BATTERY CHARGER KITS.**—All incorporate meta rectifiers, Input 200-250 v. A.C. 40/100 cycles.

To charge 2 v. accumulator at ½ amp. ....	Price
"    6 v.    "    1 amp. ....	15/-
"    12 v.  "    1 amp. ....	17/6
"    6 or 12 v.  "    4 amp. ....	22/6

Complete with Variable resistance and meter £3/15/-  
To charge 6 or 12 v. Accumulator at 6 amps.  
ditto .... .. £5

**H.T. ELIMINATOR AND TRICKLE CHARGER KIT.**—Consists of a complete kit of parts to construct an H.T. Eliminator with an output of 120 v. at 20 mA. and provision for trickle charging a 2 v. accumulator. Two metal rectifiers are employed. With circuit, price 30/-.

**RADIOGRAM CABINETS.**—Dignified appearance and good workmanship. Size 3½in. high, 19 in. deep, 36in. wide. Send for illustration. Cabinet only, £26. With Electric Motor and Pick-up, £32/16/-.

**ROTARY TRANSFORMERS.**—Size only 7in. by 4½in. diameter. With 6 v. input; output 200 v. 50 mA. With 12 v. input; output 400 v. 80 mA. Price 20/-

**ROTARY TRANSFORMERS.**—With 12 v. input; output 600 v. 250 mA. With 6 v. input; output 280 v. 250 mA. Price £3.

**OUR 1946 LIST IS NOW AVAILABLE.** All enquiries must be accompanied by a 2½d. stamp.

**ALL POST ORDERS TO:** Jubilee Works, 167, Lower Clapton Road, London, E.5. (Amherst 4723.)

**CALLERS TO:** 169, Fleet Street, E.C.4. (Central 2833.)

# QUARTZ CRYSTAL UNITS



## For your **FREQUENCY STANDARD**

### TYPE JCF/200 LOW TEMPERATURE COEFFICIENT BAR

Frequency . . . 100 Kc/s  
Accuracy . . .  $\pm 0.1\%$

Price . . . On Application.

Vacuum mounted for optimum stability. A high precision unit of extreme stability, the crystal being nodally mounted on fine wires soldered to the bar.

DELIVERY FROM STOCK

## For your **TRANSMITTER**

### TYPE 2 LOW TEMPERATURE COEFFICIENT PLATES

3.50/3.75 Mc/s or 7.00/7.50 Mc/s for the 30 Mc/s band

3.66/3.75 Mc/s or 7.32/7.50 Mc/s for the 60 Mc/s band.

PRICES ON APPLICATION.

Supplied for either band to random frequencies or specified frequencies at slightly increased price.

AVAILABLE FOR IMMEDIATE DELIVERY

## SALFORD ELECTRICAL INSTRUMENTS LTD.

PEEL WORKS, SALFORD 3

Telephones: BLackfriars 6688 (6 lines).

Telegrams and Cables: "SPARKLESS, MANCHESTER"

Proprietors: **THE GENERAL ELECTRIC Co. Ltd.**, of England

# Radiocraft POWER Equipment

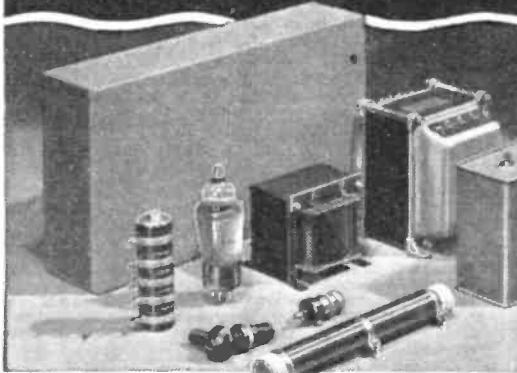

We hold in stock a range of high grade apparatus for power supply. Complete power packs can be supplied or individual components.

The following components are illustrated:—

Chassis, 14"x8"x3" . . . . . 9/6

Transformer. Providing a secondary voltage of 750 volts at 250 ma £3/7/6

Oil-immersed Smoothing Condenser. 4 mfd 2000 volt working . . . 9/6 each

Smoothing Choke. Swinging, 6/19 henry 250 ma . . . . . £2

Heavy Duty Resistor, vitreous enamelled, and adjustable types 75 watt,

50,000 ohms tapped at 10,000, 20,000 and 30,000 ohms 21/3. 75 watt with variable

adjustment, 25,000 ohms . . . . . 11/8

Mercury Vapour Rectifier. RG1/240A (two will give up to 1,500 volts at 500 ma 15/- each).

Types 2V/400A, etc. also available.

Belling Lee High Tension Plug and Socket 6/6

Indicator Lamp Holders . . . . . 2/6

For callers we are open from 9 a.m. until 6 p.m. both on weekdays and Saturdays. Our Mail Order department will give rapid and efficient service to postal enquiries and orders.

## Radiocraft Ltd

11 CHURCH ROAD · UPPER NORWOOD  
LONDON, S.E.19 Phone: LIVINGstone 4787

**NOTE**—We have absolutely no connection with any other firm trading under the same or similar name as ourselves.

TAYLOR 1183