

RADIO & ELECTRONICS CONSTRUCTOR

JANUARY 1980
Volume 33 No. 5

Published Monthly
(3rd of preceding Month)

First Published 1947

Incorporating The Radio Amateur

Editorial and Advertising Offices
57 MAIDA VALE LONDON W9 1SN

Telephone *Telegrams*
01-286 6141 Databux, London

© Data Publications Ltd., 1979. Contents may only be reproduced after obtaining prior permission from the Editor. Short abstracts or references are allowable provided acknowledgement of source is given.

Annual Subscription: £8.00, Eire and Overseas £9.00 (U.S.A. and Canada \$20.00) including postage. Remittances should be made payable to "Data Publications Ltd". Overseas readers, please pay by cheque or International Money Order.

Technical Queries. We regret that we are unable to answer queries other than those arising from articles appearing in this magazine nor can we advise on modifications to equipment described. We regret that queries cannot be answered over the telephone, they must be submitted in writing and accompanied by a stamped addressed envelope for reply.

Correspondence should be addressed to the Editor, Advertising Manager, Subscription Manager or the Publishers as appropriate.

Opinions expressed by contributors are not necessarily those of the Editor or proprietors.

Production— Web Offset.

15 METRE DELTA BEAM — "A DX Grabbing Antenna" — by F. C. Smith	270
NEWS AND COMMENT	272
USING CMOS 555's — Suggested Circuit — by G. A. French	274
ULTRASONIC REMOTE CONTROL — Sequential on-off switching; Exceptionally low receiver consumption; Portable hand-held transmitter — by R. A. Penfold	277
LOGIC TESTER — by Peter Roberts	284
SHORT WAVE NEWS — For DX listeners — by Frank A. Baldwin	286
"RING OF LED's" PRINT TIMER — Accurate Timing for the Development of Photographic Prints — by P. R. Arthur	288
THE ACCUMULATOR — Databus Series No. 6 — by Ian Sinclair	293
IN NEXT MONTH'S ISSUE	297
WIRE GAUGE MEASUREMENT — Finding Wire Diameter without a Micrometer — by C. P. Finn	298
CAN ANYONE HELP?	299
VMOS POWER DEVICES — Part 2 — by John Baker	300
BOOK REVIEW	303
RADIO TOPICS — by Recorder	304
SURFACE ACOUSTIC WAVE FILTERS — In Your Workshop	306
RECENT PUBLICATIONS	311
TOUCH CONTROL SWITCH — by R. Otterwell	312
TRADE NEWS	314
CONTROLLED VOLTAGE GAIN — Electronics Data No. 53	iii

Published in Great Britain by the Proprietors and Publishers, Data Publications Ltd, 57 Maida Vale, London W9 1SN.

The *Radio & Electronics Constructor* is printed by Swale Press Ltd.

**OUR FEBRUARY 1980 ISSUE
WILL BE PUBLISHED EARLY
IN JANUARY**

IT'S HAPPENED AGAIN!

THE PART THREE CATALOGUE IS PUBLISHED & WE HAVE MOVED TO BIGGER PREMISES.

Yes, it's here at last - the all new Part Three Catalogue. Fun for all the family, and the usual update on all that is new, worthwhile and exciting in the world of Radio and Communications. A big section on frequency synthesis techniques covering broadcast tuners, to communication quality transmitter systems. More new products than ever - RADIO CONTROL parts, crystal filters, ceramic filters for 455kHz and the new range of TOKO CFSH low temperature coefficient types for 10.7MHz. Details on new radio ICs, including the new HA11225, the CA3189E lookalike with 84dB signal to noise, and adjustable muting threshold. Radio control ICs - and an updated version of the RCM&E 8 channel FM receiver - now with an Ambit designed screened front end, with 27MHz ceramic bandpass filter. LCD panel clock/timer modules - the neatest and best LCD panel DVM yet (only £19.45 each + VAT), the new 5 decade resolution DFM3 for LW/HF/VHF with LCD readout. The DFM6 with fluorescent display to 10kHz resolution on VHF, 1kHz on SW. A 1kHz HF synthesiser with five ICs - the list is endless. Get your copy of the catalogue now. Post publication price is 60p (inc PP etc). The previous two sections are also required for a complete picture: Parts 1 & 2 £1 the pair, All 3 £1.50. And don't miss our spot the gibbon contest, together with a quiz to see if you can spot the differences between a neolithic cave drawing and a circuit diagram of one of our competitor's tuners. (* Yes, we still haven't learnt how to spell.)

Updated RCM&E FM radio control RX kit



- 8 Channel RC receiver (FM)
- Single IC RF/IF/Detector
- Single IC decoder
- 27MHz ceramic filter input
- FET RF stage with double tuned bandpass filter
- Dual ceramic filter IF
- Based on RCM&E FM system
- Best quality SLM servo connector block
- ONLY £16.10 inc VAT (kit) (includes new SLM case)

DOES YOUR ONE GLOW GREEN IN THE DARK ??

Our DFM4 does, since it uses a vacuum fluorescent display for direct readout of MW/LW/FM. Basically the same as the DFM2, (LCD Version). £24.45 kit (inc VAT) Transformer with all necessary windings for DFM4 - £2.50 inc VAT.



Not illustrated here - but also now available is the DFM6. This is a vacuum fluorescent display version of our immensely popular DFM3 (LCD). Resolution is 100Hz to 3.9999MHz, 1kHz to 39.999MHz, and 10kHz to 200.00MHz+; all standard IF offsets (inc. 10.7MHz on shortwave) are available via diode programming.

New series of radio modules in fully screened cans:

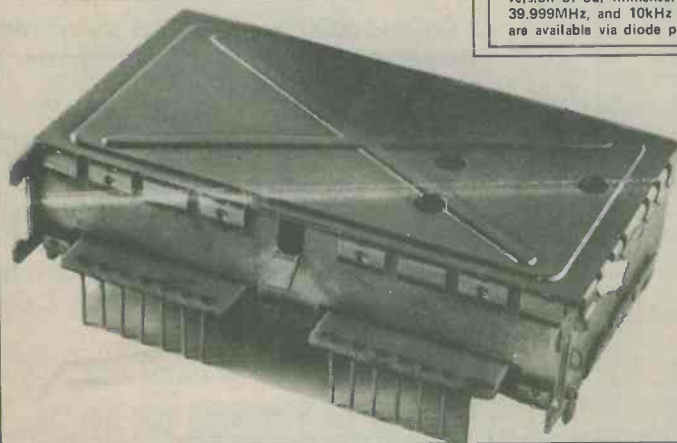

UM1181 VHF band 2 VARICAP TUNERHEAD

5 tuned circuit, with image/spurri better than -80dB, buffered LO output, MOSFET RF stage, FET IF preamp, tunes with only 1% to 8v, -9dBm 3rd order Intercept. 1off price £12.00 inc VAT. (100off/ OA)

911225 FM IF strip with all mod cons for the HiFi tuner:
All types use 80+dB S/N Hitachi IC, with muting, AFC, AGC, meter outputs for signal level and centre zero. IF preamp stage.

'A' Dual linear phase ceramic filters, with MOSFET (AGC'd) IF preamp and a 3rd narrow filter with DC filter selection. Dual tuned FM detector stage. £23.95 inc VAT (bulk)

'B' Dual ceramic filters, single tuned detector stage £14.95 inc VAT (All 'A' series units are set up with a spectrum analyzer for best THD)

91072 AM RADIO TUNER MODULES - DC TUNED and DC SWITCHED Available February '80

All include buffered LO output, mechanical IF filter (TOKO CFMO) 1-10v tuning bias, switching by a single pole to earth

A MW/LW (150 to 350kHz LW range) with ferrite rod antenna

B As 'A' but also including SW1 or SW2 (specify.)

SW1 = 1.8 to 4MHz SW2 = 5 to 10MHz

C With both SW ranges

Prices - one off inc VAT

'A' £14.43 'B' £15.90 'C' £17.50 (Custom types OA)

There is a danger - when advertizing in some magazines - that because we do not find space to list everything we sell in every ad., that some readers forget about half the ranges we stock. So to summarize the general ranges:

TOKO

Chokes coils for AM/FM/SW/MPX, Audio filters etc
Filters: Ceramic for AM/FM, LC for FM, MPX etc.
Polyvaricons

Micrometals

ICs for radio, clock LSI, radio control, MPX decoders etc
Dust iron cores for toroids for resonant and EMI filters
Toroid mounts

Hitachi

Radio/audio/mpx linear ICs
100W MOSFETs, small signal FETs, MOSFETs and bipolar

And the following groups of products from a broad range of sources:

Semiconductors - specializing in radio devices, Plessey SL1600, EUROPE's best selection of AM/FM and communications devices. Power MOSFETs, WORLD'S LOWEST NOISE AUDIO small signal transistors, BAR graph LED drivers for linear and log.
CD4000 series CMOS, TTL/LPSNTTL, standard linears (741, 301, 3080 etc). MPUs, memories. Small signal transistors from AEG BC237/8/9 families etc. (1000 off BC239C : 5.2p aa)
LEDs: AEG 3mm/5mm round, 2.5x5mm flat, red, green, orange, yellow. The best prices you will find for quality products.
MOSFETs for RF signal processing, including the BF960 UHF device, and 3SK51 for VHF. Varicap diodes for 17:1 capacity ratio tuning

FREQUENCY READOUT LSI from OKI with a one-chip answer to most digital frequency display needs (and various modules).

Crystal and ceramic ladder filters from leading manufacturers, ferrite rods, various ferrite beads and a range of crystals for 'standard' frequencies and both AM and FM radio control at 27MHz. Trimmer capacitors.

METERS - a new range of linear movement types, plus many 'indicator' types for VU, all types of tuning indicators etc.

SOCKETS - a new range that are better quality than Texas low profile, yet better priced.

Modules for AM/FM/STEREO, complete kits for tuners, audio amplifiers from Larsholt.

SWITCHES - complete low cost DIY systems for push button arrays, keyboard switches.

DOUBLE BALANCED MIXERS - MCL SBL1, replacement for MD108 etc. And cheaper.

OUR LATEST MOVING EXPERIENCE :: At last, we have moved to the address below. There is car parking for customers approaching via North Service Road (an extension of North Road Avenue, entrance opposite the Brentwood Fire Station.) Pedestrian access from the High Street (alongside 117 High Street). The new building is six times bigger than our Gresham Road offices, and we will be installing a much expanded sales counter in the fullness of time. **NEW TELEPHONE NUMBER (0277) 230909, TELEX NUMBER (as before) 995194 AMBIT G.** See you there!

200 North Service Road, Brentwood, Essex.

GREENWELD

4436 Millbrook Road Southampton SO1 0HX

All prices include VAT at 15% — Just add 30p post

BUY A COMPLETE RANGE OF COMPONENTS AND THESE PACKS WILL HELP YOU

*SAVE ON TIME — No delays in waiting for parts to come or shops to open!

*SAVE ON MONEY — Bulk buying means lowest prices — just compare with others!

*HAVE THE RIGHT PART — No guesswork or substitution necessary!

All packs contain Full Spec. Brand New, Marked Devices — Sent by return of post. V.A.T. Inclusive Prices.

K001 50V ceramic plate capacitors, 5%, 10 of each value 22pF to 1000pF. Total 210. £3.69.
K002 Extended range, 22pF to 0.1uF. 330 values £5.53

K003 Polyester capacitors, 10 each of these values: 0.01, 0.015, 0.022, 0.033, 0.047, 0.068, 0.1, 0.15, 0.22, 0.33, 0.47uF. 110 altogether for £5.07

K004 Mylar capacitors, min. 100V type 10 each all values from 1000pF to 10,000pF. Total £4.08

Total 370 for £12.57
K005 Tantalum bead capacitors, 10 each of the following: 0.1, 0.15, 0.22, 0.33, 0.47, 0.68, 1, 2.2, 3.3, 4.7, 6.8, 10, 15, 22, 33, 47, 68, 100, 150, 220, 330, 470, 680, 1000. Total 170 for £14.56

K007 Electrolytic capacitors 25V working, small physical size, 10 each of these popular values: 1, 2.2, 4.7, 10, 22, 47, 100uF. Total 70 for £3.59

K008 Extended range, as above, also including 220, 470 and 1000uF. Total 100 for £5.05
K021 Miniature carbon film 5% resistors, CR25 or similar, 10 of each value from 10R to 1M, E12 series. Total 610 resistors. £6.15

K022 Extended range, total 850 resistors from 1R to 10M £8.50
K041 Zenner diodes, 400mW 5% BZY88 etc. 10 of each value from 2.7V to 38V, E24 series. Total 280 for £16.37

K042 As above but 5 of each value £9.31

£1 BARGAIN PACKS

K101—16 BC239B N.P.N. £1.00

Low Noise

K102—15 BC349B N.P.N. £1.00

Low Noise

K103—10 BC546B N.P.N. £1.00

80 Volt

K104—18 BC182B N.P.N. £1.00

60 Volt

K105—50 IN4148 Silicon Diode £1.00

K106—18 BC184L N.P.N. £1.00

Low Noise

K107—18 BC213L P.N.P. £1.00

General Purpose

K108—8 2N5060 30N .BA SCR £1.00

K109—15 BC114 N.P.N. £1.00

Low Noise

K114—15 XK6116 (BF241) £1.00

N.P.N. 200 MHz

K115—18 SP1218 (2N3702) £1.00

P.N.P. Gen. Purpose

K117—10 BF450 P.N.P. £1.00

T.V. IF Amp.

K118—16 ME4101 N.P.N. £1.00

80V Low Noise

K124—50 .02uF Disc £1.00

Ceramics

K125—200 1k 5% JW. CF £1.00

Resistors

VU METERS

Voo2 Twin type, 2 meters 40x40mm and driver board, supplied with circuit and connexion data. £3.50

Voo3 New type, just in. Twin type moulded in one piece, 80x40mm (No driver board but suitable circuit supplied) £2.50

INVERTER

Prepare for the Power Cuts! Ready built inverter, 24V DC 290x55x37mm in, will power 6x8W fluorescent tubes. Circuit supplied. Only £2.90

THE NEW 1980 GREENWELD CATALOGUE

FEATURES INCLUDE:

- 60p Discount Vouchers
- Quantity prices for bulk buyers
- Bargain List Supplement
- Reply Paid Envelope
- Priority Order Form
- VAT Inclusive prices

PRICE 40p + 20p POST

VERO OFFCUTS

Packs of 100 sq ins of good size pieces about 4 x 3" in the following types:

K541 0.1" copper clad£1.50

K542 0.15" copper clad£1.60

K544 0.1" plain£1.50

Also pieces 2½x1" — 10/£1.20 100/£5

17x3½"x0.1" sheets — 10/£16.50

Large range of Standard Veroboard and boxes/cases in stock. Details in catalogue, 45p

SCOOP! Verobox type 2522, unused but has 3 ½" holes in one end and 1 ½" hole the other, so instead of £3.96, we are selling these at £1.85

3W AMP MODULE

Ready built and tested, this handy module will save you a lot of time in the workshop. Just requires 17V ac source (and 8R spkr) as bridge rect and smoothing cap are mounted on the PCB.

The 4 transistor circuit provides enough sensitivity for most applications. Supplied complete with circuit diagram and wiring details. Only £1.75. Suitable transformer £2.20.

BUZZERS & MOTORS

Z410 Powerful 6V DC, all metal construction, 50mm dia x 20mm 70p

Z402 Miniature type, 3-9V, only 22x-15x16mm. Very neat 65p

Z450 Miniature 6V DC motor, high quality type 32mm dia x 25mm high, with 12mm spindle. Only £1

Z451 12V high torque motor 30mm dia x 40mm high, with 10mm spindle. 65p

Z452 6V DC motor with gearbox giving final shaft speed 700 rpm. Spindle is threaded OBA. Ex-equip £1

Z453 As above, but 300 rpm and un-threaded spindle £1.

CLOCK CASE BARGAIN

Z472 Oval format, overall size 130x-68x87mm deep, with built in stand. Rear panel drilled to accept 4 switches and alarm 60p

74 SERIES PACK

Selection of boards containing many different 74 series IC's 20 for £1; 50 for £2.20; 100 for £4.

PC ETCHING KIT MK III

Now contains 200 sq. ins. copper clad board, 1lb Ferric Chloride, DALO etch-resist pen, abrasive cleaner, two miniature drill bits, etching dish and instructions £4.85

1A 400V RECTIFIERS

Plastic, like 1N4004, type 388F these diodes have preformed leads for horizontal mntg (15mm FC). Supersaver price — 100 for £2.30; 500/£10 1000/£18.

POWER DARLINGTON PAIR

Plastic power (TOP66 case) transistors type 8D695A/8D696A. Just look at the spec! 70W 8A 45V — Hfe 750 at 4A! Special low price — £1.20 per pair.

1,000 RESISTORS £2.50!!

New stock just arrived — Carbon Film 2% and 5%, ¼W and ½W, all brand new, but have pre-formed leads, ideal for PC mntg. Enormous range of popular mixed values for just £2.50/1,000, £11/5,000

£50/25,000.

Strip-fix Plastic PANEL SIGNS



★ SET 3 - Wording - WHITE

★ SET 4 - Wording - BLACK

Over 1,000 words and symbols, covering more than 300 terms, in each set

Illustration of actual size = RADIO

★ SET 5 - DIALS

6 sheets containing one Large and two Medium scales, Large Horizontal Tuning scale, Frequencies, 12 Control Panels

6 SHEETS IN EACH SET

PRICE: SETS 3 & 4 £1 per set inc. VAT
SET 5 £1.50 per set inc. VAT
p.&p. 9p per set.

To DATA PUBLICATIONS LTD.,
57 Maida Vale, London, W9 1SN

Please supply Panel Signs as follows: Set 3..... Set 4..... Set 5.....

I enclose cheque/crossed postal order for
(Tick which set is required)

NAME

ADDRESS

(BY TICK LETTERS PLEASE)

DO YOUR PROJECTS LACK THE PROFESSIONAL LOOK?

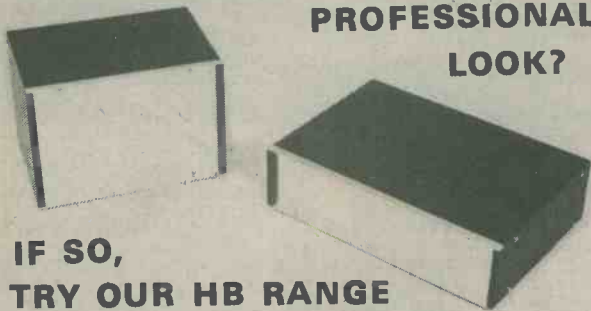

IF SO, TRY OUR HB RANGE

Instrument cases to give any project a professional look. The four separate top, bottom and end panels are made of black p.v.c. coated steel. Front panel and top and bottom trim are satin anodised aluminium for a neat finish; back panel is in plain aluminium. The whole case, including screws, comes in a flat package and may be assembled in minutes.

DIMENSIONS IN INCHES

Model	Width	Depth	Height	Price
HB1	9	6	3	£4.87
HB2	9	6	4½	£5.27
HB3	9	6	6	£5.83
HB4	12	8	3	£5.98
HB5	12	8	4½	£6.80
HB6	12	8	6	£7.26

ALUMINIUM BOXES

Aluminium box with lid and screws.

Model	Length	Width	Height	Price
AL1	3	2	1	52p
AL2	4	3	1½	62p
AL3	4	3	2	72p
AL4	6	4	2	81p
AL5	6	4	3	94p
AL6	8	6	2	£1.27
AL7	8	6	3	£1.43

(Dimensions in inches)

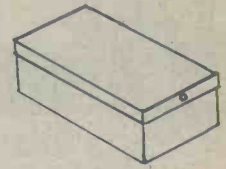

INSTRUMENT CASES

BC Range consists of black P.V.C. coated steel top cover with bevelled front edge, u-shaped aluminium chassis and two fixing screws.

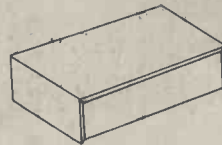

Model	Length	Width	Height	Price
BC1	6	4½	2	£1.61
BC2	6	4	3½	£1.74
BC3	8	5½	2½	£1.99
BC4	10	6½	3	£2.60

(Dimensions in inches)

SHEET ALUMINIUM

Gauge	4 x 6	6 x 9	8 x 12
16	29p	57p	£1.02
18	20p	42p	69p
20	17p	32p	52p

AXIAL CAPACITORS

1/25v	4p	125/10v	7p
2.2/63v	4p	150/25v	6p
3.3/50	4p	160/25v	6p
4.7/40v	4p	220/16v	8p
10/25v	4p	220/25v	8p
15/16v	5p	220/63v	9p
22/10v	5p	330/10v	9p
22/16v	5p	330/25v	9p
22/25v	5p	330/63v	12p
33/35v	6p	470/6.3v	9p
33/50v	5p	470/16v	12p
47/25v	5p	470/40v	15p
47/16v	5p	680/6.3v	12p
47/50v	6p	1000/6.3v	15p
50/25v	5p	1000/16v	20p
100/10v	5p	1500/25v	20p
100/16v	5p	2200/10v	20p
100/63v	8p	3300/16v	25p

4700/10v 25p

TTL

7400	10p	7438	19p	7494	43p
7401	12p	7440	12p	7495	37p
7402	12p	7441	50p	74107	20p
7404	12p	7442	38p	74121	26p
7405	12p	7446	51p	74122	34p
7406	25p	7447	43p	74123	42p
7408	14p	7450	12p	74132	48p
7409	14p	7451	12p	74141	56p
7410	10p	7470	26p	74151	38p
7411	15p	7472	22p	74153	38p
7412	16p	7474	23p	74154	60p
7414	42p	7475	24p	74160	45p
7416	22p	7476	19p	74164	60p
7420	12p	7485	50p	74174	55p
7421	20p	7486	21p	74175	55p
7427	20p	7489	£1.25	74192	48p
7430	13p	7490	32p	74193	48p
7432	17p	7491	30p	74194	43p
7437	18p	7492	30p	74196	48p
		7493	25p		

TRANSISTORS

AD161/2		BC182LB	9p	BF194	12p
MP	75p	BC183A	10p	BF195	12p
BC107	9p	BC207B	11p	BF198	15p
BC108A	10p	BC212L	10p	BF200	25p
BC148	7p	BC213LB	10p	BF750	15p
BC149C	8p	BC308	10p	TIP32B	45p
BC149S	9p	BC338	10p	2N2906	16p
BC171B	10p	BC547	11p	2N2907	18p
BC172B	10p	BD183	90p	2N3055	45p
		BF137	11p		

C280 POLYESTER CAPACITORS 250v

.01uF	4p	.068uF	5p	.33uF	8p
.015uF	4p	.1uF	5p	.47uF	8p
.022uF	4p	.1uF 400v	7p	.68uF	12p
.033uF	4p	.15uF	6p	.68uF 630v	10p
.047uF	4p	.22uF	6p	1.0uF	15p

CAN CAPACITORS

1250/50v	50p	10,000/10v	60p
2500/35v	70p	15,000/10v	60p
	15,000/16v	75p	

DIODES

BZY88c 8v2	7p	BZY88c 22v	7p
BZY83c 6v2	7p	BZY79c 68v	7p
BZY88c 7v5	7p	IN914	3p
BZY88c 8v2	7p	IN4148	2p
BZX79c 9v1	7p	IN4150	3p
BZY88c 15v	7p	IN4004	5p
BZY88c 20v	7p	IN4005	6p

OA91 4p

SUB-MIN PRESETS

Horizontal: 100Ω 220Ω 470Ω 1k, 1k5, 2k2, 4k7, 10k, 22k, 47k, 100k.
Vertical: 470Ω 2k2, 4k7,
All price: 5p

Single sided, copper clad, printed circuit board. 2½ x 8½ Price: 10p
4½ x 9 Price: 25p

25 Mixed Rubber Grommets Price 16p
16mm screw-on cab. feet. Set of four Price: 5p

14mm square self adhesive feet. Set of four Price: 15p

Din Plugs 5 pin 180° Price 10p
Din Sockets 5 pin 180°. Standard metal type Price: 10p

Magnetic earpieces with 3.5mm plug Price: 12p

Reed Switches Price: 5p
Wire Neons 90 volts Price: 4p

75mm diam. 15 ohm Speaker Price: 60p

125mm x 78mm Oval 50 ohm Speaker Price: 75p

Latchswitch 2p 2w Price: 10p
DPDT Slide Switches Price: 12p

Green Phono Plugs Price: 6p

Bridge Rectifiers Price: 25p
W005 50v 1A Price: 28p

W04 400v 1A Price: 8p
Red L.E.D.s 2 inch Price: 12p

Green L.E.D.s 2 inch Price: 12p
Ceramic Filters 6MHz, SEF 6.0MB Price: 20p

Colour T.V. Crystals 4.433619MHz Price: 90p

PP3 Battery connecting leads Price: 6p
20mm chassis mounting fuse holders Price: 6p

20mm Panel Mounting F/H Price: 17p
DL500 Displays Common Cathode Price: 75p

5 inch displays Price: 75p
1p 12w Rotary Switches Price: 41p

All prices include V.A.T. and post and packing. Send for free pamphlet on all our instrument cases, boxes and components. Discount on boxes and instrument cases only, as follows: Orders over £10 5%, over £20 10%, over £30 15%.

HARRISON BROS. P.O. Box. 55, Westcliff-on-Sea, Essex. SS0 7LQ. Telephone: Southend-on-Sea (0702) 32338.

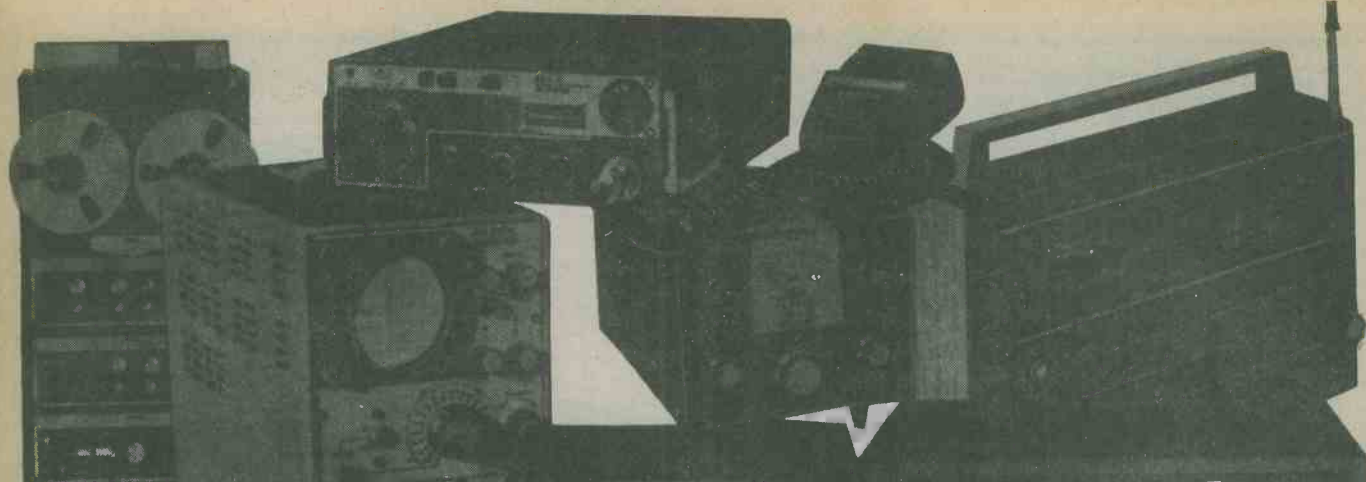

How to make a hobby

The opportunities in electronics, today, and for the future are limitless — throughout the world. Jobs for qualified people are available everywhere at very high salaries. Running your own business, also, in electronics — especially for the servicing of radio, TV and all associated equipment — can make for a varied, interesting and highly remunerative career. There will never be enough specialists to cope with the ever increasing amount of electronic equipment coming on to the world market.

We give modern training courses in all fields of electronics — practical D.I.Y. courses — courses for City & Guilds exams, the Radio Amateur licence and also training for the new Computer Technology. We specialise only in electronics and have over 40 years experience in the subject.

All the training can be carried out in the comfort of your own home and at your own pace.

A tutor is available to whom you can write at any time for advice or help during your work.

and a career.

COURSES AVAILABLE:—

- CITY & GUILDS CERTIFICATES IN TELECOMMUNICATIONS AND ELECTRONICS.
- RADIO AMATEUR LICENCE.
- COMPUTER TECHNOLOGY WITH HOME TRAINING COMPUTER.
- DIGITAL ELECTRONICS.
- BEGINNERS PRACTICAL COURSE.
- RADIO AND TELEVISION SERVICE.
- AND MANY OTHERS.

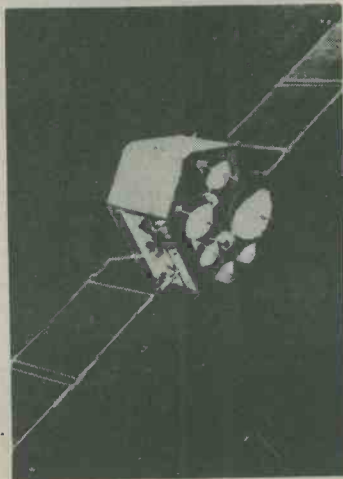

All students enrolling in our courses receive a free circuit board originating from a computer and containing many different components that can be used in experiments and provide an excellent example of current electronic practice.

Free 32 page
Colour Booklet.

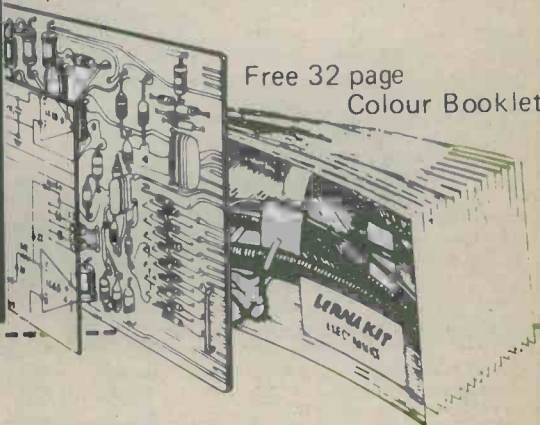

WE ARE AN INTERNATIONAL SCHOOL SPECIALISING IN ELECTRONICS TRAINING ONLY AND HAVE OVER 40 YEARS EXPERIENCE IN THIS SUBJECT

NAME
ADDRESS

Block Caps Please

Post now, without obligation, to:
BRITISH NATIONAL RADIO and ELECTRONICS SCHOOL
P.O. Box 156, Jersey, Channel Islands.

TRADE COMPONENTS

PAY A VISIT — THOUSANDS MORE ITEMS BELOW WHOLESALE PRICE. CALLERS PAY LESS ON MANY ITEMS AS PRICES INCLUDE POSTAGE. PRICES INCLUDE VAT AND ADDITIONAL DISCOUNT IN LIEU OF GUARANTEE. GOODS SENT AT CUSTOMERS RISKS UNLESS SUFFICIENT ADDED FOR REGISTRATION OR COMPENSATION-FEE POST.

OFFERS CORRECT AT 22/11/79

VALVE BASES

Printed circuit B7G	7p
Chassis B7-B7G	11p
Shrouded Chassis B7G-B8A	13p
B12A tube. Chassis B9A	13p

Car type panel lock and key 65p

Transformer 9V 4A £3.30

Speaker 6" x 4" 5 ohm ideal for car radio £1.00
4 1/2" diam. 30 Ω £1.75. 4" diam. 80 Ω £1.00
2 1/2" diam. 8 Ω 75p or 32 Ω £1.07

TAG STRIP—6-way 2 1/2p 5 x 50pF or 1000 +
9-way 4 1/2p Single 2p 300pF trimmers 35p

Aluminium Knobs
for 1/4" shaft. Approx. 5/8" x 7/8" with indicator
Pack of 5 95p

BOXES — Grey polystyrene 61 x 112 x 31mm, top secured by 4 self tapping screws 57p clear perspex sliding lid, 46 x 39 x 24 mm 10p

ABS, ribbed inside 5mm centres for P.C.B., brass corner inserts, screw down lid, 50 x 100 x 25mm orange 65p; 80 x 150 x 50mm black 97p; 110 x 190 x 60mm black £1.52.

DIECAST ALI superior heavy gauge with sealing gasket, approx 6 1/2" x 2 3/8" x 1 1/8" £1.55; 3 1/2" x 2 3/8" x 1 1/8" 99p.

VARIABLE CAMM PROGRAMMER 10, 12 or 15 pole 2 way, 50VAC motor — series with 1mf, or 3k 10W or 15W pygmy bulb for mains operation. Ex equipment £3.10.

SWITCHES

Pole	Way	Type	
1	2	Flush Wall Wh. Rocker	35p
6	2	Slide	24p
2	1	Rotary Mains	14 1/2p
2	Alternating	Micro with roller	30p
2	2	Sub-Min Toggle	62p
2	2	Toggle	40p
1	1	Sub-Min Toggle	67p
2	Alternating	2A Mains Push (1/4" hole)	43p
1	3	Slide	10p

S.P.S.T. 10 amp 240v. white rocker switch with neon. 1" square flush panel fitting 39p

1 pole 2-way 10 amp oblong clip in mains rocker appliance switch 36p

Standard thumb-wheel switch 0-9 in 1248N or B.C.D. or Comp. 1242 also 2p co 85p

Standard Lever Key switch D.P.D.T. locking plus D.P.D.T. and S.P.S.T. Heavy Duty non latching 73p

1 pole 2-way Micro; button, roller, lever or hair-trigger 15p

Push to make 15p To break 17p

4-bank of 2PCO independent 40p

5-bank of 2x2PCO, 4PCO, 6PCO, interlock plus 2PCO independent 48p

6-bank of 4x4PCO+6PCO+2PCO interlocking 58p

COMPUTER & AUDIO BOARDS/ASSEMBLIES
VARYING CONTENTS INCLUDE ZENER, GOLD BOND, SILICON, GERMANIUM, LOW AND HIGH POWER TRANSISTORS AND DIODES, HI STAB RESISTORS, CAPACITORS, ELECTROLYTICS, TRIMPOTS, POT CORES, CHOKES, INTEGRATED CIRCUITS, ETC.
3lb for £2.30 7lb for £4.30

1k horizontal preset	3" Tape Spools	5p
with knob 10 for 40p	1" Terry Clips	5p
	12 Volt Solenoid	40p

ENM Ltd. cased 7-digit counter 2 1/4 x 1 3/4 x 1 1/4 approx. 12V d.c. (48 a.c.) or mains £1.10

Auto charger for 12v Nicads, ex-new equipment £3.95

Miniature 0 to 5mA d.c. meter approx 7/8" diameter £1.25

RS Yellow Wander Plug Box of 12 40p

18 SWG multicore solder 3 1/2p foot

SAPPHIRE STYLII. 10 different; dual and single point, current and hard to get types. My mix £1

BRIAN J. REED

161 ST. JOHNS HILL, BATTERSEA, LONDON SW11 1TG
Open 10 a.m. till 7 p.m. Tuesday to Saturday. VAT receipts on request.
Terms: Payment with order Telephone: 01-223 5016

JAP 4 gang min. sealed tuning condensers 40p

ELECTROLYTICS — Hundreds more in catalogue Value/Voltage

Tant Bead .22, 47/35v 6p. .1, 1/35v, 47/6.3v 8p. .22/20v, 3.3/16v, 4.7/35v, 10/25v, 22/16v 9p. 4.7/16v, 10/3v 10p. 3.3/35v 12p.

Wire End

63v 2.2, 4.7, 10, 33, 5p. 2.5 3p. 1.5, 22, 47 6p. 100, 220 8p. 150 7 1/2p. 330 9p. 470 17 1/2p. 1000 29p. 25v 6, 6.4, 10, 12, 16, 22, 25, 30, 33, 40, 47, 50, 64 4p. 100, 150, 160, 330 6p. 220 7p. 250, 300, 470 8p. 1000 11 1/2p. 22/16, 10/50 4p. 100/10, 47/16 5p. 100/16 100/35, 220/16 6p. 470/6.3, 10/350, 470/16 8p. 1000/16 10p. 1500/6.3 7 1/2p. 2200/10 20p. 4700/10 30p. 15/160 7p. CANS 250/300, 45p. 300/450 90p. 100/275 14p. 2000/100 82p. 1000/100 70p. 8+8/450 9p. 10,000/16 50p. 2000/50 35p. Full range in catalogue.

RS 100-0-100 micro amp null indicator Approx. 2" x 3/4" x 3/4" £1.85

INDICATORS

Bulgin D676 red, takes M.E.S. bulb 38p
12 volt, or Mains neon, red pushfit 23p
R.S.—Scale Print, pressure transfer sheet 12p

CAPACITORS: up to 500v: Ceramic up to .01 2p, to .1 5p, to .68 8p. Silvermica up to 5000PF 5p, to .01 21p, Poly, etc up to .1 2p, to .2 3p, to .47 5p, to .66 7p:

.1, .22/900v 15p. .3/600v 4p. .97/160v 7 1/2p. 1mFd up to 250v 10p. 2.2mFd up to 100v 14p. 4/16v 25p. 6.8/63, 25/50 19p. 8/20v 40p. CAN 1/350 12p. 8/660 vac £2. 3/660 vac £1.75. 5/150 70p.
Pulse Tube: 8-12kV, 10, 47, 56, 82, 320pF 2p each.

Hundreds of others in Catalogue

SONNENSCHNEIN/POWERSONIC DRI-FIT RECHARGEABLE SEALED GEL (Lead Antimony) BATTERY, 6 Volt 6 amp. hr. (4 1/2" x 2" x 3") £4.25
Ex-equipment, little used.

CONNECTOR STRIP

Belling Lee L1469, 4 way polythene. 9p each

1 1/2 glass fuses 250 m/a or 3 amp (box of 12) 20p
Bulgin 5mm Jack plug and switched socket (pair) 40p

Reed Switch 28mm body length 5p
PP9 Battery Leads 8p

Aluminium circuit tape, 1/4 x 36 yards—self adhesive. For window alarms, circuits, etc. 95p

TV MAINS DROPPERS

5 assorted multiple units for 45p

100pF air-spaced tuning capacitor £1.30
5 1/2" x 2 1/2" Speaker, ex-equipment 3 ohm 65p

2 Amp Suppression Choke 10p
3 x 2 1/2 x 1 1/8" } PAXOLINE 5 for 35p
4 1/2 x 1 1/2 x 1 1/8" } 10 for 15p

Nylon clip on MES bulb holder 4p
VALVE RETAINER CLIP, adjustable 5 for 15p

Sub-miniature Transistor Transformer 35p
Valve type output transformer 90p

POT CORES with adjuster
LA2508-LA2519 43p per pair

16 Watt Power Amp. Module
35v 1A power required, giving 16 watt
RMS into 8 Ω £3.45

REGULATED TAPE MOTOR
Grundig 6V approx., 3" x 1 1/2", inc. shock absorbing carrier, or Jap 9V. 1 1/2" diam. £1.05

20mm fuse holder — chassis 4p, panel 17p.
Fane 8 ohm 3" sq. heavy duty communications speaker £1.60

RS neg. volt. regulator 103, 306-099 (equiv. MPC900) 10A, 100 watt 4-30 volt. Adjustable sort circuit protection. Sacrifice at £2.00

ACOS DUST JOCKEY Automatic record cleaner £1.30

ACOS DUST JOCKEY Automatic record cleaner £1.30

AUDIO LEADS 1 1/2yd, twin screened, 45p
3 pin din to open end, 45p
5 pin din 180° to 2-phonos, 70p
3 pole jack plug to tag ends, 4ft., 45p

RELAY 6 amp changeover. Mains coil 200µA F.S.D. level Meter 1 1/2" x 1 1/2" £1.10 £3.25

McMurdo 4 or 8 way plug and socket ex-equipment 50p

"Makswitch" 1p 10-way wafer £2.60
Wood cased 8-12V buzzer £2.60

DEAC rechargeable NICAD 450K. Capacity 6V 450 m.a.h. at 10 hour rate. Ex-new equipment £3.75.

2.5A r.f. thermo-couple and meter 2 1/2" square £3.86

Digital count unit. Counts in steps of 1, 2, 5 or 10 with total limit switch (2 x D.I.L. BCD), read relay remote output. Mains power supply, relay and delay unit. UNUSED. £5.60
Displays on 2 Minitron. 7 segments sold separately.

35p 45p
38p 35p
35p 38p
38p 35p
35p 38p
38p 35p

MORE I.C.'s
MCB46P 4p
AJ371-002 4p
930399-500 4p
243-540R 4p
MCB83P 4p

Mullard + 12-0-12V 1A, 4A stabilized, regulated, power supply. £12.50

UK — Postal Orders for same day service. Cheques require 8 days from a Monday banking to ensure clearance: export banker's draft (sterling) same day service. Foreign currency money orders etc. can lose value and take 4-6 weeks to clear.

50 ohm BNC plug + through connector 50p
TNC plug or N plug or through connector 70p

2.7V 5A Double section bobbin transformer £4.50

250 Ω 50 watt + Resistor 40p

SEMICONDUCTORS full spec. by Mullard etc. Many others in stock

AC128/175 16p	BC211 32p	BD113 57p	BFX29 15p	2N706A 13p	2N918 12p
AC128/176 16p	BD115 35p	BFX30/37 20p	BFX84/88.89 16p	2N929 16p	2N987 45p
AD161/2 match pr. 70p	BD116(BRC116T) 54p	BFX85 14p	BFX90 23p	2N1484 £1.15	2N1507 18p
AF116 21p	BD131/2 16p	BFX101 13p	8LY10 23p	2N2219 14p	2N2222A 8p
AF124/6/7 27p	BD137/8 match pr 80p	8FY50 51p	8FY90 50p	2N2412 27p	2N2420 35p
AF139 23p	BD139 17p	BFY75 15p	8RY39/56 29p	2N2412 27p	2N2483 28p
AF178/80 35p	BD140 27p	BR101 30p	BSV64 35p	2N2904 5/6/7/7A 9p	2N3053 16p
AF181 33p	AF239 35p	BSV79/80 F.E.T.s 50p	BSV81 Mosfet 75p	2N3055 R.C.A. 42p	2N3133/4062 24p
ASY27/73 35p	BD201/2/3/4 88p	BSX20/21 10p	BSY40 30p	2N3283 25p	2N3553 56p
AU110E/1.51 AU113 98p	BD232 52p	BD234 13p	BU204 + Mount Kit 78p	2N3716 23p	2N4918 16p
8C107/8/9 + A/B/C 6p	BD233/5 45p	BD238 28p	CV7042 (OC41/44) 12p	2N5484 FET 37p	2N6385 Pwr Darl 54p
8C147/8/9 + A/B/C 5p	BD237 28p	BDX77 97p	ASV63 12p		
8C157/8/9 + A/B/C 5p	BD437 35p	BD438 28p	GET111/E112 45p		
8C171B/173 8p	BF115/167/173 18p	BF178/9 23p	MA393 25p		
8C178A/B 1798 14p	BF179 23p	BF181 8p	MJE371 40p		
8C182/184/C/LC 5p	BF194/5/6/7 5p	BF180/2/3/4/5 18p	MJ481 (BDY23) 23p		
8C186 23p	BF194A, 195C 5p	BF194/5/6/7 5p	MPU131 18p		
8C204 12p	BF200 13p	BF258 17p	OC45(ME2) 13p		
8C213L/214B 5p	BF242 15p	BF262/3 29p	ON222 23p		
8C238/338 5p	BF336 31p	BF274 8p	R1039(2010) 54p		
8C327/8/337 8p	BFS28 Dual Mosfet £1.15	BFT61 40p	RZ008B 92p		
8C354/7 + A/B/C 5p	BFW10/11 F.E.T. 48p	BFW30 £1.15	TIP30 22p		
8C556/7/7B/8/9 1p	BR 48p	BFW57/58 21p	TIP48 33p		
8C671 8p	B84C 3200 48p	BFX12 23p	TIP31 24p		
8C701/2 6p			TIS43 (2N2646) 22p		

Amplifiers

1	1,600
2	140
5	100
0.6	110
2	400
2½	100
3½	100

BRIDGE RECTIFIERS

BYX10 34p
OSHO1-200 30p
Ex Equip 73p
EC433 20p
Texas £1.10
IR 48p
B40C 3200

RECTIFIERS

Amp	Volt	Price
M1	6A	5p
1N4002	50/100	3p
1N4004/6/8	4/6/8/00	3½p
1N4007/BYX94 1	1250	4½p
BY103	1,500	21p
SR100	100	9p
SR400	100	10p
REC53A	1,250	16p
LT102	30	15p
BYX22-200	300	25p
BYX38-300R	300	48p
BYX38-600	600	52p
BYX38-900	900	60p
BYX38-1200	1,200	65p
BYX49-300R	300	36p
BYX49-600	600	42p
BYX49-900	900	47p
BYX49-1200	1,200	60p
BYX48-300R	300	47p
BYX48-600	600	60p
BYX48-900	900	70p
BYX48-1200R	1,200	92p
BYX72-150R	150	42p
BYX72-300R	300	52p
BYX72-500R	500	65p
BYX72-3000	300	36p
1N5401	100	13p
1N5402	200	15p
MR856	600	24p
BYX42-900	900	92p
BYX42-1200	1,200	£1.07
BYX46-300R	300	£1.19
BYX46-400R	400	£1.75
BYX46-500R	500	£2.00
BYX46-600	600	£2.30
BYX20-200	200	72p
BYX52-300	300	£2.05
BYX52-1200	40	£2.90
RAS310AF	1.25	48p

TRIACS

25	900	BTX94-900	£3.00
25	1200	BTX94-1200	£5.00

Diode Characteristic, Equip., and Substitution Book 82p

Transistor equivalents and substitution Book 1 38p Book 2 82p

Chrome Car Radio facia 28p

Rubber Car Radio gasket 10p

DLL Pal Delaviline 90p

Relay Socket 4PCO or 2PCO: DIL sockets low profile: 8p, 16p, 28 22p

Ferrite rod 7-8" x 3/4" diam 40p

Earphone 3.5 12p, 2.5 15p, crystal 30p

Colour SHT-Tray 3000/3500 £4.05

Nylon self-locking, 3 1/2" tie clips 3p

1.5, 10, 22 or 750 μh choke 12p

Mullard Semiconductor, Valve & Component Data Book 50p

OPTO ELECTRONICS

Diodes	Photo transistor
BPX40 57p	BPX29 92p
BPX42 92p	OCF71 40p
BPY10 92p	

(VOLIAC)

L.E.O.'s
2" Red Mullard 8p
CQY24 8p
TIL209 25" red 9p or green 13p

Wire end neons 4p

PHOTO SILICON CONTROLLED SWITCH
BPX66 PNP 10 amp £1.15

3" red 7 segment L.E.D. 14 D.I.L. 0.9 + D.P. display 1.9v 19m/a segment, common anode 55p

HP .43 In yellow £1.50

RS 0.6in. green £1.77

Minitoron 0.3in 3015F filament £1.25

Infra red transmit diodes

CQY11B or LD27 High power 1.8-2v or 3-3.5v Pulse 53p

I'R5B Photon coupled Isolator

I.R. diode & NPN Photo-Darlington amp £1.05

Data Sheet 10p

Swivel aerial 6 1/2 to 36" 60p

Multicore Solder 1/2kg. 16 or 18 or 20 s.w.g. £5.20

3 inch 8 Ω speaker £1.15

New unmarked, or marked simple lead ex new equipment

ACY17-20 10p	TIC44 17p
ASZ20 10p	2G240 £1.17
ASZ21 35p	2G302 6p
BC186 13p	2G401 6p
BCY30-34 24p	2N711 28p
BCY70/1/2 5p	2N2926 6p
8Y126/7 5p	2N598/9 8p
HG1005 12p	2N1091 10p
HG5009 4p	2N1302 10p
HG5079 4p	1N1907 £1.17
L78/9 4p	Germ. diode 2p
M3 12p	2N3055 26p
OA81 2½p	IN 4001 3p
OA47 4p	IGT120 (AC128) 2p
OA200-2 4p	in 1" sq. heat sink 22p
OC23 27p	GET872 15p
OC200-5 24p	2S2320 34p
C106 THY 10p	TIS43 15p
BUY 12/13 50p	BDY30 35p

MINIATURE EDGE METERS

100μA (s.d.), scaled 0.5, 12V Illuminated blue perspex front, 35mm x 14mm £3.45

200μA level meter, clear front. 10 x 18mm 65p

TRANSFORMERS

Ferromag C core. Screens 95-105-115-125-200-220-240V input output 17v 4A x 2 + 24-0-24v 1.04A-20V 1mA. These current ratings can be safely exceeded by 50%.

Cassette Dynamic Microphone with switch and twin plug £1.35

Telephone Pickup, sucker with lead and 3.5 plug 62p

Amplifiers

1	240	BTX18-200	35p
1	400	BTX18-300	41p
1	240	BTX30-200	35p
4	500	40506	58p
15	500	BT107	£1.00
6.5	500	BT109-500R/SCR957/BRC4444	71p
20	600	BTW92-800RM	£3.40
15	800	BTX95-800R Pulse Modulated	£8.75

TYRISTORS

Amp	Volt	Price
1	240	BTX18-200 35p
1	400	BTX18-300 41p
1	240	BTX30-200 35p
4	500	40506 58p
15	500	BT107 £1.00
6.5	500	BT109-500R/SCR957/BRC4444 71p
20	600	BTW92-800RM £3.40
15	800	BTX95-800R Pulse Modulated £8.75

Digital I.C.'s

7400/1/2/4	8p
7410	6p
7420/30/50/51	9p
7406	19p
7414	36p
7417/26 15p	7432 13p
	7442 28p
	7437/38/54 12p
	7445 42p
	7473 19p
	7474 19p
	7490/82/80 25p
	7483 45p
	7488 14p
	7493 18p
	74107 16p
	74118 75p
	74122 25p
	74123 35p
	74132 44p
	74141 42p
	74151 32p
	74165 55p
	74154/164/175 35p
	74167 23p
	74173 38p
	74193 38p
	74196 36p
	74293 80p
	74490 £1.30
	744H Series £12.25
	00/01/10/40/50/73
	74L10/72/74/95 54/95 25p
	5408 15p
	5486 14p
	5476 20p
	5490 25p
	5480 22p
	54123 35p

LINEAR I.C.'s

CA3001	86p
CA3028	75p
CA3044	£1.20
CA3046	40p
CA3054	£1.10
CA3086	50p
CA3132	£2.22
CA3148	90p
CA3085	£1.00
CA3083	85p
CA3183	80p
702 52p	741 16p
710/720 28p	724 20p
7805 (TO3)	55p
2102 73p	709 15p
825129	£5.00
LM300 86p	LM309 60p
LM1303	97p
LM1458	32p
LM3900	40p
LM9311	£1.02
MC1306P	40p
MC1307P	35½p
MC1312P	40p
TAA263	75p
FAA55 Y or G	23p
TAA300	£1.00
TAA320	£1.15
TAA700	£2.30
MT300/305 8p	Yes! 8p
AY58300	36p
C500 (GIMT4)	
Calculator chip	37p
SN76396N	35½p
SN76549N	35½p

M.O.S. and Schottky see Catalogue

VEROBOARD

.15 strip approx 6" x 4" 65p

3 1/2" x 3 1/2" 34p 4 1/2" x 3 1/2" 44p

Plain 1.4 x 4 1/2" 35p

3 1/2" x 2 1/2" 25p

3 1/2" x 3" 31p

Miniature Axial Lead Ferrite Choke Formers 5 for 13p

RS 10 Turn pot 1% 250 500 Ω 1K. £1.70

Copper coated board .481" x 2 1/2" 28p

TBA800 50p any 5x5 25p

MC1314P 35½p

MC1350P 35½p

MC1349P 35½p

SN76115N 35½p

(T)CA270CW 35½p

CATALOGUE

38, 11 x 8 ins Illustrated sheets, listing approx. 5,250 items, photo printed on day requested, from constantly updated masters, to ensure latest stock position, 75p (refundable with orders) plus 27p s.a.e or label

RS Irravin high temperature wire, 19/0.16, minus 55° to 105°C, 600V 3A, white, black or red. Quarter trade price at 22½p 10M coil.

PVC QUALITY TAPE

Lasso 10m x 15mm grey 38p

33m x 33mm green £1.13p

Trimmer: Post stamp type 3-30Pf 10p

10-80Pf 10p

30-140Pf 23p

GARRARD

GCS23T Crystal Stereo Cartridge £1.20

Mono (Stereo compatible) Ceramic or crystal £1.14

Due to lack of space, items (i.e. pots, caps, etc.) can only be collectively priced. Catalogue often shows much lower individual value price

ALL ENQUIRIES, ETC., MUST BE ACCOMPANIED BY A STAMPED ADDRESSED ENVELOPE

VAT & POST PAID

MINIMUM ORDER £3. (excluding catalogue) OTHERWISE ADD 50% FOR SMALL ORDER HANDLING COSTS UNDER £1.00 TOTAL ALSO INCLUDE 10p 8.A.E.I.)

MARCO TRADING

To obtain a free copy of our 35 page list simply send a 20p postage stamp or a large SAE. This advertisement shows only a part of our range. (Our new list includes Tants, Electrolytics, Disc ceramics, etc.)

TRANSISTORS

AC128	24p	BC213	10p	BF115	32p	BFY77	22p
AD149	58p	BC213L	10p	BF127	38p	BR101	32p
AD161	45p	BC213L	10p	BF159	25p	BRY39	32p
AD162	44p	BC214	10p	BF164	22p	BSY52	36p
BC107	10p	BC2148	12p	BF166	32p	BU105/02	£1.68
TO5 leg)	6p	BC214C	12p	BF167	26p	BU108	£1.80
BC108	10p	BC214L	12p	BF178	24p	BU124	£1.82
BC109	10p	(TO5 lead)	8p	BF180	29p	BU126	£1.50
BC125	12p	BC268A	28p	BF182	29p	BU204	£1.45
BC126	14p	BC301	36p	BF183	29p	BU205	£1.35
BC147B	8p	BC307B	13p	BF194	10p	BU208	£1.75
BC149	8p	BC308A	13p	BF194A	12p	BU208	£1.75
BC153	10p	BC309	14p	BF195	10p	GET872	18p
BC161	25p	BC441	38p	BF195C	12p	GET881	15p
BC177	18p	BC460	35p	BF200	28p	OC45	30p
BC178	18p	BC547	12p	BF224J	15p	OC71	26p
BC182	9p	BC558A	13p	BF241	16p	OC72	35p
BC182L	10p	BCY42	17p	BF257	28p	OC76	32p
BC183	9p	BCY70	17p	BF259	30p	TIP29A	44p
BC183B	9p	BCY71	20p	BF262	30p	TIP31A	38p
BC183L	10p	BCY72	20p	BF263	30p	TIP32A	40p
BC184	9p	BD116	54p	BF337	30p	TIP32C	70p
BC184L	9p	BD131	35p	BFT41	30p	TIP33A	65p
BC212	10p	BD132	35p	BFX84	22p	TIP41A	45p
BC212B	12p	BD135	34p	BFX89	65p	TIP42A	40p
BC212L	12p	BD138	34p	BFY50	20p	TIP3055	65p
BC212LA	12p	BD183	75p	BFY51	20p	TIS43	34p
		BDY20	£1.05	BFY52	20p	2N3055	48p

400m/w ZENER DIODES Low Price

3V, 3V3, 3V6, 3V9, 4V3, 4V7, 5V1, 5V6, 6V2, 6V8, 7V5, 8V2, 9V1, 10V, 11V, 12V, 13V, 13V5, 15V, 16V, 18V, 20V, 22V, 24V, 27V, 30V, 33V.

Price: 8p each 100 any mix £6.00

1 watt ZENER DIODES

3V3 to 200V Full range
Price: 15p each 100 any mix £12.50

8 DIL	10p
14 DIL	13p
16 DIL	16p
18 DIL	18p
20 DIL	22p
22 DIL	23p
24 DIL	24p
28 DIL	28p
40 DIL	40p

VEROBOARD (Copper Clad)

Size Inch	0-1"	0.15
2.5 x 1	20p	N/A
2.5 x 5	55p	56p
2.5 x 3.75	46p	50p

Vero Wiring Pen (including spool of wire) £2.84

CONNECTING CABLE

Black, Blue, Green, Grey, Orange, Pink, Red, White, Violet, Yellow, Brown.
Singles 5p per metre
7/0.2mm 5p per metre
16/0.2mm 8p per metre

ROTARY POTS

LOG: 4K7, 10K, 22K, 47K, 100K, 220K, 470K, 1M, 2M2 27p each
LIN: 470Ω, 1K, 2K2, 4K7, 10K, 22K, 47K, 100K, 220K, 470K, 1M, 2M2 10 for £2.50 (Mixed your choice)

RESISTORS Low Noise 5% High Stability

1W at 40C, 1/3W at 70C. E12 series only i.e. 2.2Ω, 2.7Ω, 3.3Ω, 3.9Ω, 4.7Ω, 5.6Ω, 6.6Ω, 8.2Ω, 10Ω etc.

All at 2p each, 10 of one value for 15p, 1,000 mixed in 100's £8.00

Our well known "Special Development" pack. Special Price: £8.00

(This pack consists of 10 off each value 2.2Ω to 2M2, 730 resistors)

1W resistors available. E12 series only. 2.2Ω to 10M 5p each

2W resistors available. E12 series only. 10Ω to 10M 8p each

DIODES

OA47 10p, OA81 14p, OA90 10p, OA91 10p, OA200 5p, 1N4148 4p, 1S44 7p, 1N914 (Formed Leads) 3p, 1N4001 5p, 1N4004 6p, 1N4007 7p, 1N5392 11p, 1N5401 16p, 1N5404 18p, 1N5408 27p.

Many, many more items in stock including our new range of 63V polycarbonate close tolerance capacitors. In 63V we are now able to offer 1%, 1%, 2% and 5%. In 440V the range is still the same. Full details in our FREE list.

SPECIAL OFFERS

Power Amplifier Sanyo STK015 Brand New Full Spec etc. 10 Watts Into 8Ω. Free spec sheet with every order. Our price: £2.50 each.
Radio Spares Edge Meter Type MR100 (269-562). All new and boxed. RS price over £4.00 each. Our price: £2.50 each.

Send your orders to:

DEPT. DP12, MARCO TRADING,
THE OLD SCHOOL, EDSTASTON,
Nr. WEM, SHROPSHIRE SY4 5RJ
Tel: Whixall (094872) 464/465

Please add 25p postage and packing to each order end add 15% VAT to your total order. Export add NO VAT but add postage Air/Sea at cost.

ELECTROVALUE

CATALOGUE 10

Ready early December

Our computer has already selected thousands of our customers to whom our new catalogue has automatically been sent. If you would like a copy too, simply send us your name and address. It's

FREE

(You don't even have to pay postage)

IT'S A GOOD DEAL BETTER FROM ELECTROVALUE

● We give discounts

on C.W. orders, except for a few items market Net or N in our price lists.

5% on orders, list value £10 or more

10% on orders list value £25 or more.

Not applicable on Access or Barclaycard purchase orders.

● We pay postage

in U.K. on orders list value £5 or over. If under, add 30p handling charge.

● We stabilise prices.

by keeping to our printed price lists which appear but three or four times a year.

● We guarantee

all products brand new, clean and maker's spec. No seconds, no surplus.

● Appointed distributors for SIEMENS, VERO, ISKRA, NASCOM and many others.

OUR NEW CATALOGUE No 10

Over 120 pages. Thousands of items. Improved classification for easier selection. Valuable working information. Illustrations. Separate quick-ref price list.

ELECTROVALUE LTD

HEAD OFFICE (Mail Orders)

28(A) St. Judes Road, Englefield Green, Egham, Surrey TW20 0HB. Phone: 33603 (London prefix 87. STD 0784) Telex 264475.

NORTHERN BRANCH (Personal Shoppers Only)

680 Burnage Lane, Burnage, Manchester M19 1NA
Phone: (061) 432 4945.

<p>MOTORS 1.5-6VDC Model Motors 22p. Sub. Min. 'Blg Inch' 115VAC 3 rpm Motors 32p. 12VDC 5 Pole Model Motors 37p. 8 track 12V Replacement Motors 55p. Cassette Motors 5-8VDC ex. equip. 70p. Geared Mains Motors (240V) 2.5 rpm 75p. 115VAC 4 rpm Geared Motors 95p.</p>	<p>JUMPER TEST LEAD SETS 10 pairs of leads with various coloured croc clips each end (20 clips) 90p per set.</p>	<p>PANEL METERS Ferranti 0-600VAC 3.5" square £2.95. Japanese type 60 x 47 x 33mm clear plastic type; 50 micro, 100 micro, 1Ma, 2 amp, 25 volts, 300 VAC, 'S', 'VU', all £5.25 each. Larger type 110 x 82 x 35mm; 50 micro, 100 micro £8.35 each.</p>	<p>AEROSOL SERVICE AIDS, SERVISOL Switch Cleaner 226gm 60p. Freezer 226gm 70p. Silicone Grease 226gm 70p. Foam Cleanser 370gm 60p. Plastic Seal 145gm 60p. Excel Polish 240gm 47p. Aero Klene 170gm 55p. Aero Duster 200gm 70p.</p>	<p>TOOLS SOLDER SUCKER, plunger type, high suction, teflon nozzle, £4.99 (spare nozzles 69p each). Good Quality snub nosed pliers, insulated handles, 5" £1.45. Antex Model C 15 watt soldering irons, 240VAC £3.95 Antex Model CX 17 watt soldering irons, 240VAC £3.95. Antex Model X25 25 watt soldering irons, 240VAC £3.95. Antex ST3 Iron stands, suits all above models £1.85. Antex heat shunts 12p each. Servisol Solder Mop 50p each. Neon Tester Screwdrivers 8" long 43p each. Miyarna IC test clips 16 pin £1.95.</p>
<p>SEMICONDUCTORS C106D 400V 2.5A SCR 20p. 2N5062 100V 800mA SCR 18p. BX504 Opto Isolator 25p. CA3130 95p. TBA800 50p. 741 22p. 741S 35p. 723 35p. NE555 24p. LM3400 40p. AD181/2 70p. 2N3055 38p. ZN414 75p. BD238 28p. BD438 28p. IN4005 10 for 35p. TIL305 alpha numeric displays £2.50. TIL209 Red Leds 8p each. 0.5" 7 segment Led display. Comm. Cathode, green, full spec. 85p each.</p>	<p>TRANSFORMERS All 240VAC Primary (postage per transformer is shown after price). MINIATURE RANGE: 6-0-6V 100mA, 9-0-9V 75mA and 12-0-12V 50mA all 79p each (15p). 0-6V. 280mA £1.20 (20p). 12V 500mA 99p (22p). 12V 2 amp £2.75 (45p). 15-0-15V 3 amp Transformer at £2.85 (54p). 30-0-30V 1 amp £2.85 (54p). 20-0-20V 2 amp £3.65 (54p). 0-12-15-20-24-30V 2 amp £4.75 (54p). 20V 2.5 amp £2.45 (54p).</p>	<p>CAR STEREO SPEAKERS Shelf mounting in black plastic pods with 5" 5 watt speaker available in 4 or 8 ohms only £3.95 per pair.</p>	<p>SURPLUS BOARDS No. 1, this has at least 11 C106 (50V 2.5A) plastic SCR's, one relay a unijunction transistor and tantalum capacitors £1.95. No. 2 I.F. Boards, these are a complete I.F. board assembly made for car radios, 465Khz, full set of I.F.'s and oscillator coils, trimmers etc., 40p each. No. 3 Board with two BDY60 Power Transistors, 45p each.</p>	<p>SWITCHES Sub. miniature toggles; SPST (8 x 5 x 7mm) 62p. DPT (8 x 7 x 7mm) 62p. DPT centre off 12 x 11 x 9mm 77p. PUSH-SWITCHES, 16 x 6mm, red top, push to make 14p each, push to break version (black top) 16p each.</p>
<p>PROJECT BOXES Sturdy ABS black plastic boxes with brass inserts and lid. 75 x 56 x 35mm 65p. 95 x 71 x 35mm 75p. 115 x 95 x 37mm 85p.</p>	<p>TRIAC/XENON PULSE TRANSFORMERS 1:1 (gpo style) 30p. 1:1 plus 1 sub. min. pcb mounting type 60p each.</p>	<p>MURATA MA401 40kHz Transducers. Rec./Sender £3.50 pair.</p>	<p>POWER SUPPLIES SWITCHED TYPE, plugs into 13 amp socket, has 3-4.5-6-7.5 and 9 volt DC out at either 100 or 400mA, switchable £3.45. HC244R STABILISED SUPPLY, 3-6-7.5-9 volts DC out at 400mA max., with on/off switch, polarity reversing switch and voltage selector switch, fully regulated to supply exact voltage from no load to max. current £4.95.</p>	<p>G.P.O. Telephone handsets £1.95p. Electrolytic Caps, can type, 2,200mfd and 2,200mfd 50VDC 35p each.</p>
<p>AMP MULTIWAY IN-LINE PLUGS AND SOCKETS, 3 way 35p, 6 way 45p, 12 way 55p, per pair.</p>	<p>MICROPHONES Min. tie pln. Omnl, uses deaf aid battery (supplied), £4.95. ECM105 low cost condenser, Omnl, 600 ohms, on/off switch, standard jack plug, £2.95. EM507 Condenser, uni, 600 ohms, 30-18kHz., highly polished metal body £7.96p. DYNAMIC stick microphone dual imp., 600 ohms or 20K, 70-17kHz., attractive black metal body £7.75p. EM506 dual impedance condenser microphone 600 ohms or 50K, heavy chromes copper body, £12.95. CASSETTE replacement microphone with 2.5/3.5 plugs £1.35. INSERT Crystal replacement 35X10mm 40p. GRUNDIG electric inserts with FET preamp, 3-6VDC operation £1.00.</p>	<p>ELECTRICAL ITEMS 13 amp 3 pin plugs plastic 27p, rubber 62p, 13 amp rubber extension sockets 42p, 12 way flexible terminal blocks; 2 amp 20p, 5 amp 24p, 10 amp 33p, 15 amp 47p. Standard batten (BC lampholders 27p).</p>	<p>AMPHENOL CONNECTORS (PL259) PLUGS 47p. Chassis sockets 42p. Elbows PL259/SO239 90p. Double in line male connector (2XPL259) 65p. Plug reducers 13p. PL259 Dummy load, 52 ohms 1 watt with Indicator bulb 95p.</p>	<p>MICRO SWITCHES Standard button operated 28 x 25 x 8mm make or break, new 15p each. Roller operated version of the latter, New 19p each. Light action micro, 3 amp make or break 35 x 20 x 7mm, 12p each. Cherry plunger operated micro, 2 normally open, 2 normally closed, plunger 20mm long (40 x 30 x 18mm) 25p each.</p>
<p>CHANGEOVER REED SWITCH 2 1/2" Long 35p. Glass Mercury Switch 1 1/2" x 3/8", long leads, 35p.</p>	<p>LIGHT DIMMER 240VAC 800 watts max. wall mounting, has built in photo cell for automatic switch on when dark £4.50</p>	<p>PUSH BUTTON TV TUNERS UHF, not varicap, transistorised new £2.25</p>	<p>BUZZERS MINIATURE SOLID STATE BUZZERS, 33 x 17 x 15mm white plastic case, output at three feet 70db (approx), low consumption only 15mA, four voltage types available, 6-9-12 or 24VDC, 80p each. LOUD 12VDC BUZZER, Cream plastic case, 50mm diam. x 30mm high 63p. GPO OPEN TYPE BUZZER, adjustable works 6-12VDC 27p. 12VDC siren, all metal, rotary type, high pitched wail, £7.50.</p>	<p>PUSH BUTTON UNITS 6 way, 3 DPDT, 3 4 pole c/o 55p, 8 way, 5 DPDT, 3 4 pole c/o 70p. RANK ARENA magnetic cartridge pre-amplifier modules, new with connection details £1.95p.</p>
<p>MULTIMETERS NH55 2,000 o.p.v. IKV AC/DC. 100ma DC current, 2 resistance ranges to 1meg. £5.95. MODEL 72606 20,000 opv 1,000 volts AC/DC., 250ma DC current, resistance 3 ranges to 3meg, dimensions 127 x 90 x 32mm, mirror scale £11.75p. HANSEN AT210 100,000 opv 1.2KV AC/DC., 12 amps AC/DC current, resistance to 200 meg in 4 ranges, capacitance 200pf-0.2mfd, 1,00pf-1mfd., decibel range, internal safety fuse, dimensions 160 x 105 x 50mm, an excellent meter, £34.50p.</p>	<p>REED RELAYS Plastic Encap. Reed Relay, 0.1 matrix. 1kΩ coil, 9-12VDC normally open, 35p. Miniature encapsulated reed relay 0.1 matrix mounting, single pole make, operates on 12VDC 50p each. Continental series, sealed plastic case relays, 24VDC 3pole change over 5 amp contacts, new 65p. Printed circuit Mtg., Reed relay, single make. 20mm x 5mm, 6-9VDC. coil, 33p each. Metal Cased Reed Relay, 50 x 45 x 17mm, has 4 heavy duty make reed inserts, operates on 12VDC 35p each. Magnets 1/2" long 1/4" thick with fixing hole, 10 for 40p.</p>	<p>TELEPHONE PICK UP COIL Sucker type with lead and 3.5mm plug 62p.</p>	<p>TERMS: Cash with Order (Official Orders welcomed from colleges etc). 30p postage please unless otherwise shown. VAT inclusive. S.a.e. for illustrated lists.</p>	<p>TAPE HEADS Mono cassette £1.75. Stereo cassette £3.90. Standard 8 track stereo £1.95. BSR MN1330 1/2 track 50p. BSR SRP90 1/4 track £1.95. TD10 tape head assembly — 2 heads both 1/2 track R/P with built in erase, mounted on bracket £1.20.</p>
<p>MORSE KEYS Beginners practice key £1.05. All metal fully adjustable type. £2.60.</p>	<p>RIBBON CABLE 8 way single strand miniature 22p per metre.</p>	<p>RELAYS Plastic Encap. Reed Relay, 0.1 matrix. 1kΩ coil, 9-12VDC normally open, 35p. Miniature encapsulated reed relay 0.1 matrix mounting, single pole make, operates on 12VDC 50p each. Continental series, sealed plastic case relays, 24VDC 3pole change over 5 amp contacts, new 65p. Printed circuit Mtg., Reed relay, single make. 20mm x 5mm, 6-9VDC. coil, 33p each. Metal Cased Reed Relay, 50 x 45 x 17mm, has 4 heavy duty make reed inserts, operates on 12VDC 35p each. Magnets 1/2" long 1/4" thick with fixing hole, 10 for 40p.</p>	<p>STEREO FM/GRAM TUNER AMPLIFIER CHASSIS, VHF and AM. Bass, treble and volume controls, Gram. 8-track inputs, headphone output jack, 3 watts per channel with power supply. £14.95 and £1.20 p&p (CCT supplied).</p>	<p>MINIATURE LEVEL METERS 1 Centre Zero 17 x 17mm 75p. 2 (scaled 0-10) 28 x 25mm 75p. 3 Grundig 40 x 27mm £1.25.</p>

PROGRESSIVE RADIO
31 CHEAPSIDE, LIVERPOOL 2.
ALL ORDERS DESPATCHED BY RETURN POST

THE MODERN BOOK CO

PROJECTS IN RADIO AND ELECTRONICS by I. R. Sinclair, Price £2.50

ELECTRONIC PROJECTS IN THE HOME by O. Bishop	Price £2.50	THEORY & PRACTICE OF MODEL RADIO CONTROL by P. Newell	Price £4.50	UNDERSTANDING SOLID-STATE ELECTRONICS by Texas Inst.	Price £1.80
ELECTRONIC PROJECTS IN AUDIO by R. A. Penfold	Price £2.50	REPAIRING POCKET TRANSISTOR RADIOS by I. R. Sinclair	Price £2.55	A SIMPLE GUIDE TO HOME COMPUTERS by S. Ditlea	Price £4.00
OP-AMPS THEIR PRINCIPLES & APPL. by J. B. Dance	Price £2.50	MAKING & REPAIRING TRANSISTOR RADIOS by W. Oliver	Price £2.30	HOW TO BUILD A COMPUTER-CONTROLLED ROBOT by T. Loofbourrow	Price £5.30
PRINTED CIRCUIT ASSEMBLY by M. J. Hughes	Price £2.10	WORLD RADIO TV HANDBOOK by J. M. Frost	Price £9.25	THE CATHODE-RAY OSCILLOSCOPE & ITS USE by G. N. Patchett	Price £4.00
ELECTRONIC SECURITY DEVICES by R. A. Penfold	Price £1.65	PROJECTS IN RADIO & ELECTRONICS by I. R. Sinclair	Price £2.50	HOW TO GET THE BEST OUT OF YOUR TAPE RECORDER by P. J. Guy	Price £1.90
UNDERSTANDING DIGITAL ELECTRONICS by Texas Inst.	Price £4.00	ELECTRONIC PROJECTS IN THE HOME by O. Bishop	Price £2.50	A GUIDE TO AMATEUR RADIO by P. Hawker	Price £1.70
UNDERSTANDING MICRO-PROCESSORS by Motorola	Price £4.30	SIMPLE CIRCUIT BUILDING by P. C. Graham	Price £2.20	RADIO CONSTRUCTION FOR AMATEURS by R. H. Warring	Price £2.80
THE FIRST BK OF MICROCOMPUTERS by R. Moody	Price £3.35	110 SEMICONDUCTOR PROJECTS FOR THE HOME CONSTRUCTOR by R. M. Marston	Price £3.20	MAKING TRANSISTOR RADIOS A BEGINNER'S GUIDE by R. H. Warring	Price £2.90
HOW TO BUILD YOUR OWN SOLID STATE OSCILLOSCOPE by F. G. Rayer	Price £1.70	HAM RADIO by K. Ulliyett	Price £5.00	1979 THE RADIO AMATEUR'S H/B by A. R. R. L.	Price £7.86
THE OSCILLOSCOPE IN USE by I. R. Sinclair	Price £2.85	BEGINNER'S GUIDE TO DIGITAL TECHNIQUES by G. T. Rubaroe	Price £1.10		
AMATEUR RADIO TECHNIQUES by P. Hawker	Price £3.80				

★ PRICES INCLUDE POSTAGE ★

We have the Finest Selection of English and American Radio Books in the Country
19-21 PRAED STREET (Dept RC) LONDON W2 1NP
 Telephone: 01-402 9176

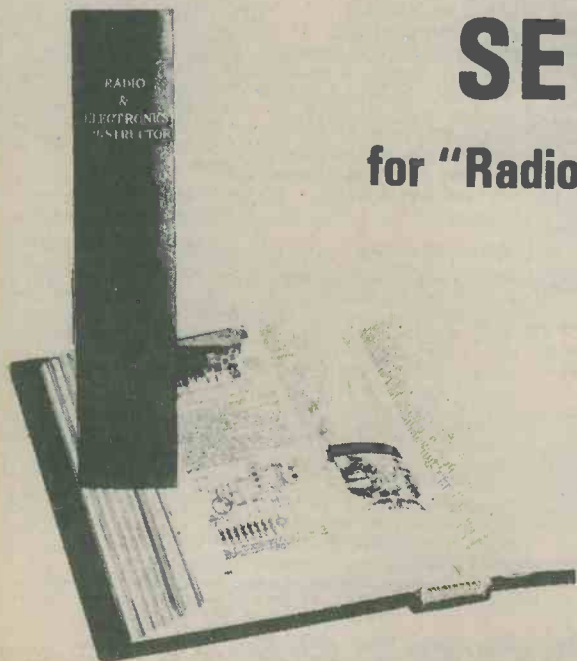

SELF BINDER

for "Radio & Electronics Constructor"

The "CORDEX" Patent Self-Binding Case will keep your issues in mint condition. Copies can be inserted or removed with the greatest of ease. Rich maroon finish, gold lettering on spine.

Specially constructed Binding Cords are made from Super Linen of great strength, very hard twisted and twice doubled. They are attached to strong RUSTLESS Springs under tension, and the method adopted ensures PERMANENT RESILIENCE of the Cords. Any slack that may develop is immediately compensated for and the Cords will always remain taut and strong. It is impossible to overstretch the springs, as a safety check device is fitted to each.

PRICE £1.95 including V.A.T. P.&P. 45p

Available only from:—

Data Publications Ltd.

57 Maida Vale, London W9 1SN

APEL POWER SUPPLIES

STABILIZED POWER SUPPLIES WITH ELECTRONIC SHORT CIRCUIT PROTECTION

AL.212 P

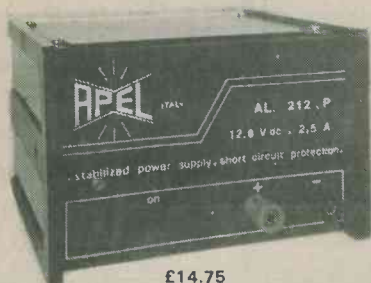

£14.75

INPUT VOLTAGE	220 V ac ± 10% 50-60 Hz
OUTPUT VOLTAGE RANGE	12.6 V dc
OUTPUT CURRENT MAX	2.5 Amp
LOAD REGULATION	<0.3% 0-2.2 Amp
RIPPLE	<5mV 2.2 Amp
DIMENSIONS (mm)	W140 x H90 x D140
WEIGHT	1.490 Kg.

AL.315 P



£29.50

INPUT VOLTAGE	220 V ac ± 10% 50-60 Hz
OUTPUT VOLTAGE RANGE	1.7-15 V dc
LOAD REGULATION	<0.2% 0-2.8 Amp
DIMENSIONS (mm)	W140 x H90 x D155
RIPPLE	3mV 2.8 Amp
WEIGHT	2.330 Kg.

AL.330 P



£46.50

INPUT VOLTAGE	220 V ac ± 10% 50-60 Hz
OUTPUT VOLTAGE RANGE	3.4-30 V dc
OUTPUT CURRENT RANGE MAX	3 Amp
LOAD REGULATION	< 5% 0-2.8 Amp
RIPPLE	10mV 2.8 Amp
DIMENSIONS (mm)	W270 x H90 x D155
WEIGHT	4.250 Kg.

STOCKISTS

Alpha Sound Service,
50 Stuart Road, Waterloo, Liverpool L22 4QT.
England.

Anson Electronics,
1133 Hessle High Road, Hull, England.

Amateur Radio Shop,
13 Chapel Hill, Huddersfield, HD1 3ED.
England.

Brent Electronics,
Seaview Street, Cleethorpes,
Lincolnshire, England.

J. Birkett,
26 The Strait, Lincoln, England.

Bradford Consultants Limited,
25 Regent Parade, Harrogate,
Yorkshire, England.

F. Brown & Co. Ltd.,
44/46 George IV Bridge Street,
Edinburgh, Scotland.

N. R. Bardwell Limited,
Sellers Street, Sheffield, England.

Casey Brothers,
235 Boundary Road,
"Saint Helens,"
Lancashire, England.

Electronic Services Limited,
33 City Arcade, Coventry CU11 HX, England.

A. Fanthorpe Limited,
6 Hepworth Arcade, Silver Street,
Hull, England.

G. W. M. Radio,
Portland Road, Worthing, Sussex.

Leeds Amateur Radio,
27 Cookridge Street,
Leeds LS2 3AG, England.

Target Electric Limited
16 Cherry Lane, Bristol, England.

New Cross Radio,
6 Oldham Road, Manchester,
England.

Progressive Radio,
93 Dale Street, Liverpool L2 2JD.
England.

R. E. Pitt Electrical Services Limited,
60/64 Bath Buildings, Mont Peller,
Bristol, England.

Peats Electronics,
Parnell Street, Dublin.

R. F. Potts,
68 Bobbington Lane, Derby, England.

Brian A. Pearson Limited,
66 Moncur Street, Glasgow, Scotland.

R M E Supplies Limited,
143 Stockwell Street, Glasgow, Scotland.

Stephan James Limited,
Warrington Road, Leigh, Lancashire.

Stewarts Radio,
4 Chance Street, Blackpool, England.

The Radio Shop,
16 Cherry Lane, Bristol BS 3NG,
England.

Q. C. Trading,
1 St. Michaels Terrace, Woodgreen M22 4FT,
England.

AL.1 P5

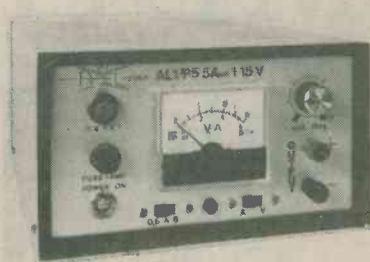

£78.00

INPUT VOLTAGE	220 ± 10% 50 Hz
OUTPUT VOLTAGE RANGE	1 ± 15 V dc
OUTPUT CURRENT MAX	5 Amp
LOAD REGULATION	< 0.1% 0-4.5 Amp
RIPPLE	< 2mV 4.5 Amp
DIMENSIONS (mm)	W210 x H155 x D250
WEIGHT	5.100 Kg.

AL.212 PS



£18.00

INPUT VOLTAGE	220 V ac ± 10% 50-60 Hz
OUTPUT VOLTAGE RANGE	12.6 V dc
OUTPUT CURRENT MAX	2.5 Amp
LOAD REGULATION	<0.3% 0-2.2 Amp
RIPPLE	<5mV 2.2 Amp
DIMENSIONS (mm)	W140 x H90 x D140
WEIGHT	1.490 Kg.
AMPEROMETER	

AL.315 P2



£54.00

INPUT VOLTAGE	220 V ac ± 10% 50-60 Hz
OUTPUT VOLTAGE RANGE	± 1.7 ± 15 V dc
OUTPUT CURRENT RANGE MAX	3 Amp
LOAD REGULATION	< 0.2% 0-2.8 Amp
RIPPLE	< 3mV 2.8 Amp
DIMENSIONS (mm)	W270 x H90 x D155
WEIGHT	4.140 Kg.

Stan Willets Limited,
37 High Street, West Bromwich.

M/S Waltons,
55a Worcester Street,
Wolverhampton WV2 4LL, England.

Distributed in the U.K.
and Ireland by:

PEAT'S WHOLESALE LTD.

Chapel Lane, Parnell St, Dublin 1, Ireland.

PHONE 741746-740678-722845. TELEX 31787.

15 METRE DELTA BEAM

By F. C. Smith

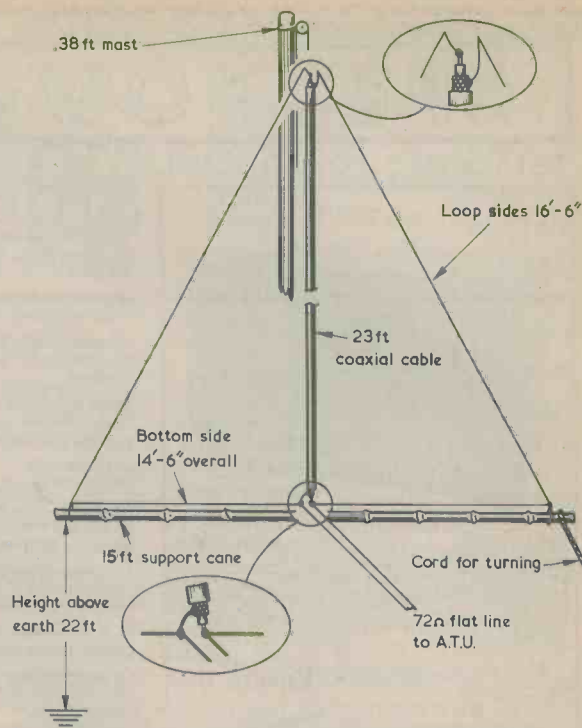

Fig. 1. The 15 metre delta beam array. Note the transposed connections, at top and bottom, to the coaxial cable

A 'DX - Grabbing' antenna which requires little outside space

The quad antenna is too well known to need description here. The delta loop antenna, although not so well known, is a worthy companion to the world-renowned quad. Both antennas can be space demanding, a condition which the writer, like many other town dwellers, is unable to satisfy.

Nevertheless, the 15 metre delta antenna described here requires very little space and is a real "Dx-grabber". Costing only a few pounds, this driven delta will work real Dx and is equivalent to a 3-element Yagi in performance. The writer has built quads over the years and finds the delta an improvement on the quad because of its greater bandwidth and sharper directivity. The delta first constructed by the writer was a single loop. Now, a single quad loop has a small gain over the dipole and, since the electrical parameters of the delta are similar to those of the quad, it follows that the delta also has a gain over the dipole.

PHASED ARRAY

The writer wanted to improve the performance of his delta loop without the addition of a space-demanding reflector and, after some thought, he came to the conclusion: why not make it a phased array? The result is the antenna shown in Fig. 1.

The two sides of the delta are each 16ft. 6in., and the bottom side has two 7ft. 3in. lengths, to give a total length of 14ft. 6in. Connected at the top to the side wires is a 23ft. length of coaxial cable of velocity factor 0.66, this being a physical half-wavelength at 21.3MHz. The lower end of the coaxial cable is

connected to the inside ends of the bottom wires. It is important that the end connections to the coaxial cable be transposed. At the top the coaxial outer connects to the right hand side wire, as shown in the diagram, and the coaxial inner connects to the left hand side wire; at the bottom the coaxial outer connects to the left hand bottom wire and the coaxial inner to the right hand bottom wire. Also connected to the antenna at bottom centre is a 72 Ω flat twin line. This can have any length and it connects to the aerial tuning unit.

CONSTRUCTION

The loop requires 16 yards of wire, and this may be 16 s.w.g. copper or plastic covered flex.

The support cane employs two 8ft. long $\frac{3}{4}$ in. bamboo canes. Having treated these for weather, they are made a tight fit into a 2ft. aluminium tube of 1in. diameter, as shown in Fig. 2. Push each cane

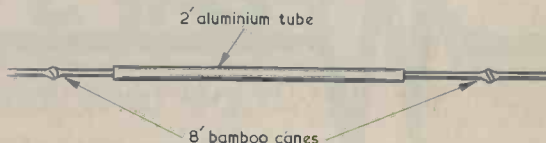
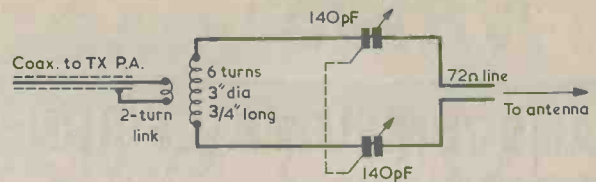

Fig. 2. The support cane consists of two 8ft. bamboo canes inserted, at the centre, in a 2ft. aluminium tube

Fig. 3. The a.t.u. employed with the delta beam



well home to ensure that there will be no sag when the array is in the air. The total overall length of the canes should be 15ft. Cut off equal excess lengths at the ends to give this overall length.

Measure out 16ft. 6in. of the wire, fix its end to an insulator at the top and secure the measured end of the wire to the support cane near one end. Run 14ft. 6in. of the wire along the cane, holding it in place with tape or small plastic curtain rings passed over the cane. Ensure that the 14ft. 6in. length of wire is centrally disposed on the cane and secure it at both ends with tape to prevent the wire slipping. The remaining length of wire is now taken back up to the top insulator. Check that the length of this second side wire is also 16ft. 6in. and cut off any excess wire at the top.

The connections to the coaxial cable at the top and bottom are made by means of two 2-way barrier strips. The 14ft. 6in. bottom section is cut at its centre and the two inside ends connected to the bottom barrier strip. The 23ft. length of coaxial cable is longer than the distance between the top and bottom of the array. Coil up the excess at the bottom and tape the coiled cable to the aluminium tube. Then connect the coaxial cable bottom end to the bottom barrier strip, making certain that the connection is transposed as just described. Also connected to the bottom barrier strip is the 72 Ω flat twin line which passes to the aerial tuning unit.

The aerial is then ready to hoist.

An important point to observe is that the bottom of the delta should be a half wave above the earth to obtain best results. A height of 22ft. will be satisfactory. Measurement of resonance can then be made with a g.d.o. or antenna bridge, which should put the antenna at 21.3MHz in the 15 metre band. The writer's antenna measured almost spot-on and needed no adjustment.

The circuit of the author's a.t.u. is shown in Fig. 3. The two 140pF variable capacitors are widely spaced physically and are ganged by way of an insulated shaft coupling.

angle vertical lobe. Single CQ's brought back KH6, W6 and W7 contacts which had previously needed to be called several times. Also, this was at a time when the 15 metre band was in poor condition. Stations at 6,000 miles were worked daily with reports ranging from Q5-S5 to Q5-S8/9. The writer has not measured the gain of the new antenna but it should be at least 3dB over the delta loop in its unphased condition. Just as important is the increase of low angle vertical radiation given by the phased array.

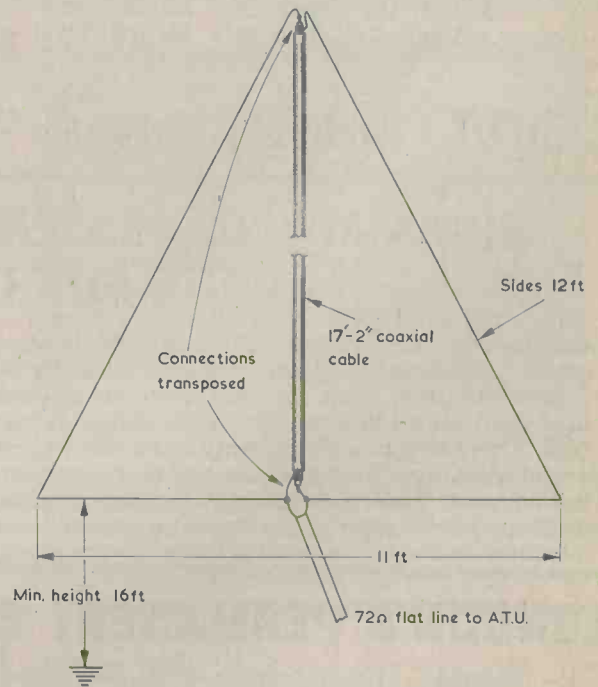

Fig. 4. Dimensions for a phased delta beam intended for working at 28.8MHz

PERFORMANCE

When first employed with the author's 150 watt "Viceroy" transmitter, the antenna produced a marked improvement over the previous single loop, which had been in use for some three months. First to be noted were Dx contacts in Japan who gave the writer signal reports two S-points up on previous reports. The new antenna also has an increased low

The antenna is very simple to construct and can be airborne in a couple of hours. The results should satisfy the most critical Dx chaser.

Finally, Fig. 4 gives details for another driven delta, this being dimensioned for 28.8MHz in the 10 metre band. ■

NANOCOMPUTER DESIGNED FOR EDUCATION

SGS-ATES are entering the training market in a big way with their Nanocomputer^(R) Training System.

The total system consists of a complete microcomputer, based on the powerful Z80 microprocessor, a solderless experiment station, specially written educationally oriented user software, many optional peripherals and, of prime importance, a three volume series of especially written training books.

The modular construction of the Nanocomputer^(R) allows it to grow with the student or alternatively allows the student to enter the course at a level commensurate with his ability.

The course caters for: students with no knowledge of computers or digital electronics — book one with the basic micro-computer; students with a knowledge of digital electronics — book two and the experiment station; students with a more advanced knowledge — book three plus the microcomputer, the experiment station, and additional software. At the very highest level of education it is possible to upgrade the Nanocomputer to a full industrial microcomputer, thus allowing individual research programs to be carried out.

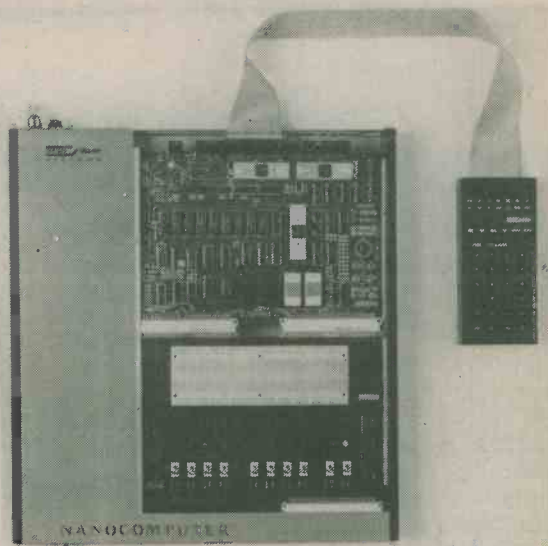

For full information contact: SGS-ATES (United Kingdom) Ltd., Planar House, Walton Street, Aylesbury, Bucks.

SUMMARY OF IBA ENGINEERING PLANS FOR THE FOURTH CHANNEL

Simultaneous launch in all ITV United Kingdom regions; 30 high-power transmitters to be ready by November 1982; Over 80 per cent population coverage from switch-on day; 18 more high-power transmitters to follow at monthly intervals; Priority to Wales: 6 main and 80 local relays from start; IBA's biggest buy: £16-million contracts already awarded; All 48 high-power transmitters to come

from Marconi and Pye; Contracts help firms plan production over four-year term; First major network to use high-efficiency klystrons; Transmitter deliveries to begin in Spring 1981; Extension of ITV1 network to continue at 70 new relays a year; Over 1,000 IBA transmitters to be supervised from four ROCs; IBA aims at ultimate 99 per cent coverage by Fourth Channel.

LONDON'S PERMANENT ELECTRONICS EXHIBITION

The National Microprocessor and Electronics Centre, has just published its schedule of mini-exhibitions.

These mini-exhibitions are held in parallel with the centre's expanding permanent exhibition which at present, consists of displays from over 50 companies.

The centre's mini-exhibitions last for 3-days and are staged at least once every fortnight. They are deliberately restricted to a single product area so that visitors have a chance to see a comprehensive selection of similar products in one place at one time.

Mini-exhibitions scheduled for December and January are:-

December 4th to 6th — Bench — Top power supplies.

December 18th to 20th — Applying Microprocessors and Oscilloscopes.

January 8th to 10th — Logic Analysis.

January 15th to 17th — Soldering and Desoldering.

January 22nd to 24th — Plotters and Chart Recorders.

The National Microprocessor and Electronics Centre, is situated in the London World Trade Centre, close to the Tower of London. It is open Monday to Friday between 10.00 to 16.00 hours.

Readers interested should contact the ME Centre, London World Trade Centre, Europe House, London E1 9AA.

COMMENT

A HELPING HAND

Under the above heading we give news from time to time of organisations connected with radio and electronics whose main concern is with helping others.

Second to none in this sphere is The Radio Amateur Invalid and Blind Club (R.A.I.B.C.) which was founded in 1954 and has been celebrating its Silver Jubilee during 1979.

Very briefly, the Club is made up of invalid and blind members interested in the hobby of Amateur Radio; their Local Representatives who undertake to help members by visiting them, assisting with repairs to and advice on equipment, and generally extending friendship; supporter members whose financial contributions enable practical help to be given.

The sole condition of membership in any of the above categories is an annual subscription of a minimum of £1.00 for 'Radial', the club news-letter which is issued every 6 weeks.

Some idea of the scope of the Club can be gained from a list of its officials — Chairman, Vice Chairman, Secretary/Editor, Treasurer, Membership Secretary, Tapes Manager, Technical Aids Organiser, Net Controller.

There are three club nets, G4IBC 80m, Cheshire Homes and the Birmingham Group. Each year a number of the handicapped members pass the R.A.E. and in due course acquire their call signs.

Glancing through 'Radial' one cannot but be impressed by the friendly and helpful nature of the Club as expressed by the activities reported and the news given of individual members.

The foregoing can only be a sketch of the good work done. Readers who would like to become associated with such worthwhile activity should write to the Honorary Secretary at the Club's HQ, 9 Rannoch Court, Adelaide Road, Surbiton, Surrey KT6 4TE.

3M ELIMINATES STATIC BUG IN CBS CASSETTES MANUFACTURE

The recently opened highly automated 25,000 sq. ft. factory plant of C.B.S. Manufacturing, Bridgend, recognised as one of the most modern cassette production centres in Europe, had a problem.

With 13.2 million standard cassettes a year to be produced the elimination of any detrimental factor is of paramount importance.

In this instance the problem was an invisible one — static electricity. A build-up of static on the leader tape, where a length of 27 inches is used for each cassette, was resulting in the tape sticking during assembly procedure and slowing down the production line.

Following contact with 3M United Kingdom Limited, a 3M '210' static eliminator bar was introduced to the 'Rockford automatic assembly machine'. The static eliminator was positioned above the leader tape, this effectively neutralising any static charge present in the atmosphere prior to its entry into newly manufactured cassettes.

The 3M '210' static eliminator, is now giving a considerable saving in materials cost and offering greater production efficiency and has been in use at the Bridgend, Glamorgan, plant for the past four months.



Positioned above the leader tape at C.B.S. Manufacturing, Bridgend, prior to it being incorporated into each newly produced cassette, the 3M Static Eliminator (marked 'replace guard') which prevents the tape sticking from static electricity build-up during assembly

**Seasonal Greetings
to all our readers**

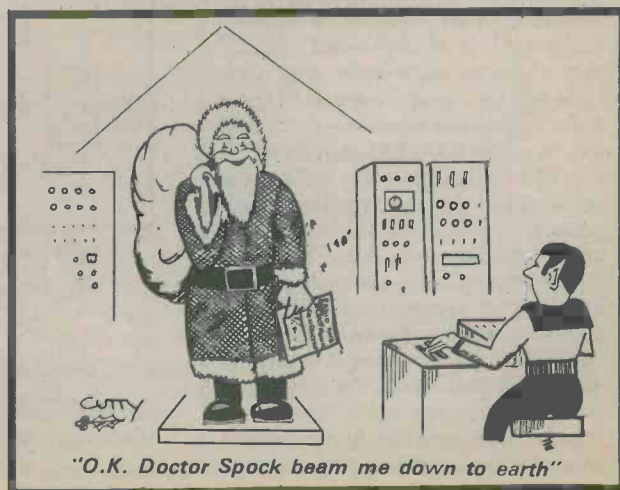



SUGGESTED CIRCUIT

USING CMOS 555's

By G. A. French

The CMOS 555 has now become available on the home constructor market. Known more properly as the ICM7555, it is fully pin-compatible with the well-established bipolar 555 i.c., but draws a much lower supply current. It is suitable for supply voltages from 2 to 18, and its output can drive both t.t.l. and CMOS devices. The trigger and threshold pins have much higher input impedances than do the corresponding pins in the 555. Whereas the 555 is capable of sinking or sourcing 200mA, the ICM7555 is specified as being able to sink 100mA with a supply of 18 volts.

Bearing in mind the widespread usage of the 555 the advent of the ICM7555 is of considerable interest to the electronics experimenter, and the author obtained a batch of these devices as soon as they first became available from Maplin Electronic Supplies. It is always helpful to obtain practical experience with new i.c.'s and he then proceeded to carry out a number of experiments to find out how the ICM7555 performed in simple circuits. It must be emphasised that the results described in this article are not taken from any manufacturers' data: they are instead the outcome of tests carried out with a random batch of the devices under home-constructor conditions. In all cases the circuits were powered by a 9 volt battery, since this is probably the most usual source of supply likely to be encountered in amateur applications.

SINK AND SOURCE

The first check to be made was of sink current performance, and the ICM7555 was consequently wired up in the circuit shown in Fig. 1(a). Pin 8 of the i.c. is connected to the positive rail as also, following usual practice, is the reset pin, pin 4. Pin 1 is the negative supply pin. Pin 2 is the trigger input for the internal comparator which responds to one-third of the supply voltage and pin 6 is the threshold input for the comparator which actuates at two-thirds of supply voltage. The output is at pin 3.

When the slider of the 10kΩ potentiometer in Fig. 1(a) takes pins 2 and 6 above two-thirds of the supply voltage, the output at pin 3 goes low. The output current sink performance at various output currents can then be found by ad-

justing the variable resistor (actually, two variable resistors switched in as required to cater for the lower and higher currents). Output current is indicated by the current-reading meter between the variable resistor and the positive rail, the corresponding voltage between pin 3 and the negative rail being monitored by the voltmeter.

Fig. 1(b) shows the results obtained with the ICM7555's checked by the writer. As sink current is increased from zero to 50mA, the voltage between pin 3 and the negative rail rises in fairly linear manner from zero to about 2 volts. Above 50mA the rate of voltage rise increases considerably, and the voltage is approximately 8 volts at 70mA. With a supply of 9 volts the useful sink current is therefore

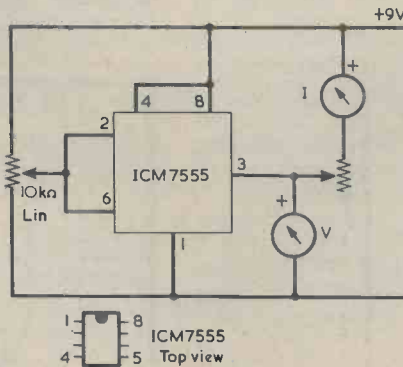

(a)

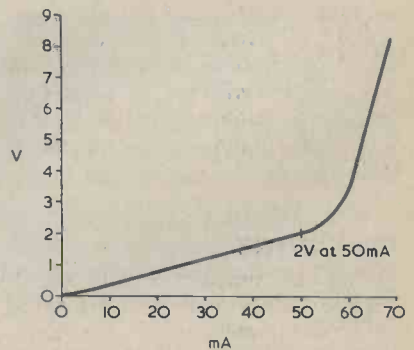

(b)

Fig. 1(a). A test circuit for checking the sink current characteristic of the ICM7555 when its output is in the low state

(b). Sink current-voltage curve for the devices checked by the author

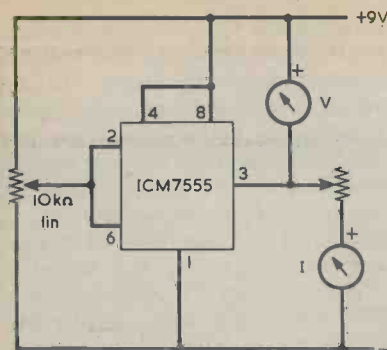

(a)

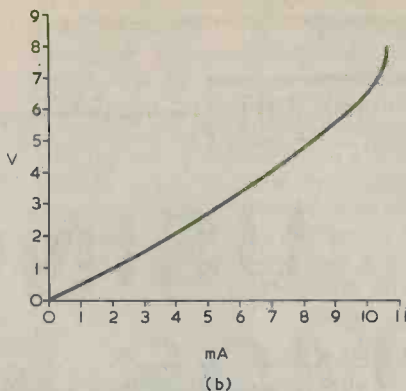

(b)

Fig. 2(a). The circuit employed for checking source current
 (b). Source current capability was found to be lower than sink current capability

about 50mA maximum, which would seem to tie in with the maximum of 100mA at a supply of 18 volts.

The circuit of Fig. 2(a) was next employed to find the source current characteristic. The output of the i.c. goes high when pins 2 and 6 are taken below one-third of supply voltage, and the variable resistor can then be adjusted for different current readings whilst the voltage between pin 3 and the positive rail is indicated by the voltmeter.

The curve of Fig. 2(b) illustrates source current performance. The current available is much lower than the sink current and the voltage dropped in the i.c. is about 3 volts at 5mA, rising to about 7 volts at 10mA. This low source current availability is perfectly acceptable for driving t.t.l. and CMOS logic. Although t.t.l. devices need a logical "0" input current of 1.6mA maximum per input, the input current for logical "1" is a matter of microamps only. At the same time, CMOS devices require extremely low input currents for both the "0" and the "1" states. Nevertheless, experimenters who have become used to the high output current capability of the 555 in both the high and low output states will need to remember that a high current is offered by the ICM7555 in the low output state only.

ONE-SHOT

The test circuit shown in Fig. 3 followed. This is a standard one-shot monostable application commonly employed with the 555. If the capacitor is discharged at supply switch-on, the output at pin 3 is high. As the capacitor charges the output goes low when the voltage across the capacitor reaches two-thirds of supply voltage. Also, the

discharge pin, pin 7, then discharges the capacitor. The time delay in seconds is equal to 1.1 times RC, where R and C are in ohms and farads, or megohms and microfarads. The current drawn by the device in Fig. 3 is monitored by the current-reading meter, and the output state is indicated by the voltmeter which is returned to the positive rail. Any voltmeter current (which becomes significant in comparison with the tiny supply currents drawn by ICM7555) is taken from the negative rail and should not have any significant effect on the current drawn by the i.c. from the positive rail.

The circuit behaved as it should, but it was found that it was rather "lively" insofar that device input current increased very noticeably if the author's hand was placed on or near the timing components or the i.c. itself. This effect is ascribed to the fact that the trigger pin 2 has no circuit connection made to it, whereupon this very high impedance input pin can pick up random noise or couple capacitively into other parts of the circuit. The ICM7555 is capable of working in

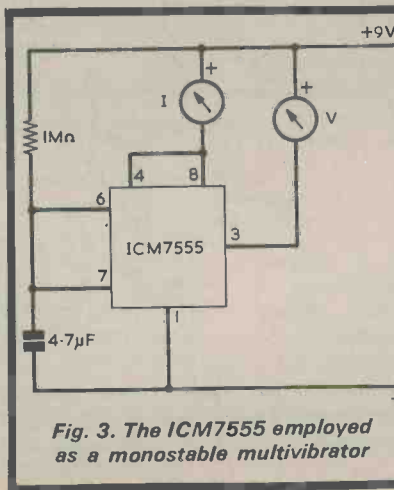

Fig. 3. The ICM7555 employed as a monostable multivibrator

microseconds and in consequence will offer gain at very high frequencies.

The current drawn by the device was approximately 50µA before and after the output transition, rising to a short-lived peak of about 2mA during the transition itself. The writer would guess that this peak is not a switching glitch, but corresponds to a period of r.f. instability as the threshold comparator passes through a linear state.

Since the circuit functioned quite satisfactorily the effect was not investigated further, but it would seem advisable, when using the ICM7555 in the monostable mode, to have fairly short wiring to the timing capacitor and to have as little metal area as possible in contact with pin 2. If the device is wired up on Veroboard it would be wise to cut the appropriate copper strip at the two holes immediately on either side of the hole to which pin 2 connects.

ASTABLE CIRCUIT

Next checked out was the standard astable circuit of Fig. 4. As with the 555, this has a frequency of oscillation which is equal, in Hz, to 1.46 divided by (RA + 2RB)C, where RA is the upper timing resistor (10kΩ in Fig. 4) and RB is the lower timing resistor (1MΩ). This calculates as 0.073Hz, and with a frequency as low as this it is possible to observe changes in currents and voltages with ordinary meters. It will be noted that the circuit causes both pin 6 and pin 2 to be coupled to the negative rail via the timing capacitor.

The circuit was perfectly stable in operation and oscillated at the correct frequency. Input current to pin 8 was about 50µA when the output was high and about 40µA when the output was low. At the output transition from low to high the input current merely increased to the

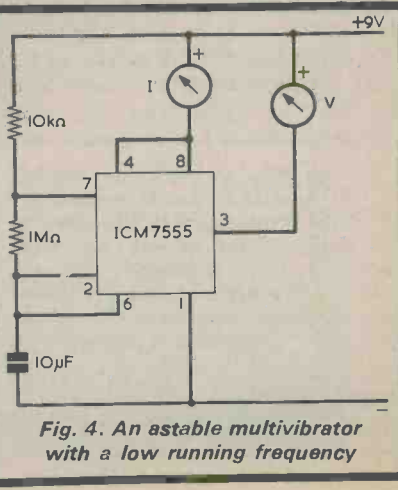

Fig. 4. An astable multivibrator with a low running frequency

higher value but at the transition from high to low the input current rose momentarily to a very brief proximately $60\mu\text{A}$.

The timing capacitors employed in the circuits of Figs. 3 and 4 were plastic foil. They could just as well have been electrolytic components with low leakage currents.

The a.f. astable circuit of Fig. 5(a) was next made up, and this has a calculated frequency of 695Hz. The circuit performed exactly as it should and the current drawn from the 9 volt supply with no connection made to the output at pin 3 was approximately $60\mu\text{A}$.

An old dodge for checking the operation of a 555 a.f. multivibrator is to hold an a.m. radio tuned to medium or long waves close to the multivibrator wiring. The radio will then pick up the transition pulses and reproduce the oscillation as an audio tone from its loudspeaker. This test not only shows that the multivibrator is running but also indicates its frequency. A 555 was fitted in the circuit (which employed an 8-way i.c. holder) and a medium wave receiver was set up such that the tone was just audible from its speaker when the receiver ferrite aerial was a foot away from the multivibrator wiring. The 555 was then removed, the ICM7555 refitted, and the check carried out again. This time it was necessary to

bring the receiver aerial some 4 inches away from the wiring before the tone could be heard. This effect is obviously due to the lower currents flowing in the CMOS device during transitions. The wiring in the author's circuit was not kept particularly short, and it is possible that if an ICM7555 a.f. multivibrator is connected up with very short wiring it may prove difficult to use the a.m. receiver test.

SPEAKERS

555 astable multivibrators running at audio frequencies are often employed to drive speakers in bleeper circuits and the like, and it was decided to investigate the performance of the ICM7555 in this application. Since the available sink current is much greater than the source current the speaker was connected, in series with a $1\text{k}\Omega$ wire-wound variable resistor, between the output of the i.c. and the positive rail as in Fig. 5(b). A 15Ω speaker was used, and the rest of the circuit was as in Fig. 5(a).

It is usually necessary to include resistance in series when a 555 output is coupled to a speaker, as the speaker inductance on its own can upset multivibrator operation. The same is true for the CMOS version. With the ICM7555 it was found that the speaker was driven

satisfactorily for all values of series resistance inserted by the variable resistor down to some 200Ω . When the resistance was taken significantly below this value oscillation became very erratic and, at low resistance levels, ceased altogether. Also, the current flowing into pin 8 increased by a very large amount, rising to well over 50mA . It follows that, for a 9 volt supply, the ICM7555 can drive a speaker provided that there is also a series resistance of about 200Ω or more. This is reasonable when it is considered that the direct current flowing in 200Ω from a 9 volt source is 45mA . There was no change in operating frequency when the ICM7555 output was coupled to the speaker and a suitable series resistance.

When replaced by a 555 it was found that a much louder output could be obtained from the speaker. This is merely because the series resistance with a 555 can be reduced to a considerably lower value before oscillator operation becomes erratic.

Finally, with the ICM7555 back in use, the effect of inserting a high value electrolytic capacitor in series, as in Fig. 5(c), was tried. This caused an almost surprisingly high degradation in oscillator performance, since it not only reduced the audible output but also altered oscillator frequency very noticeably as well. Presumably, the effect is due to the fact that the presence of the capacitor causes current to be drawn from the i.c. when its output is high whilst, without the capacitor, current is drawn by the speaker only when the output is low. The circuit of Fig. 5(b) is much to be preferred.

Summing up, it can be seen from these simple experiments that the ICM7555 is a very welcome newcomer to the array of i.c.'s available to the home constructor, its chief advantage being its very low supply current requirement. Although it is fully pin-compatible with the 555 it cannot be fitted directly into all 555 circuits, but the differences in characteristics can be readily catered for in initial circuit design work.

The ICM7555 appears to be as electrically robust as the bipolar 555. It is supplied in polystyrene foam in the same manner as bipolar devices and without pin short-circuiting material. The ICM7555 devices checked by the author were subjected to fairly rough electrical handling during the tests and were not in any way damaged as a result. ■

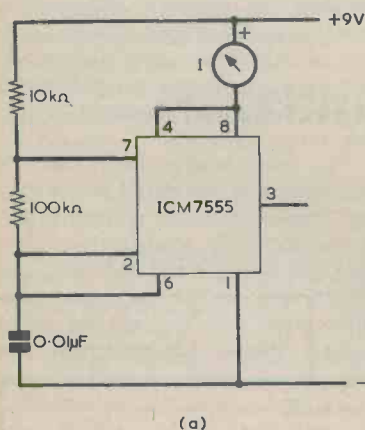

(a)

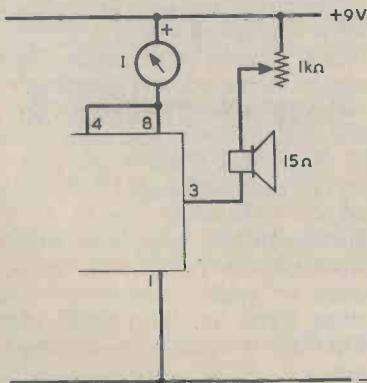

(b)

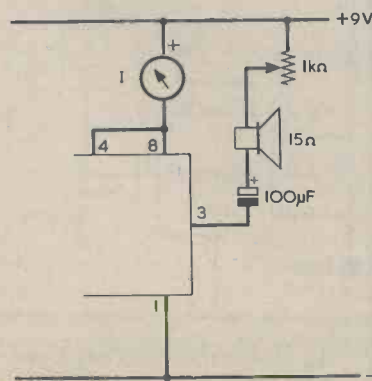

(c)

Fig. 5(a). In this circuit the i.c. runs at an audio frequency
(b). Coupling a loudspeaker to the output of the a.f. multivibrator
(c). Performance is considerably degraded if a series capacitor is added

ULTRASONIC

REMOTE

CONTROL

By

R. A. Penfold

Sequential on-off switching

Exceptionally low receiver consumption

Portable hand-held transmitter

This ultrasonic system was designed to meet the need for a remote control system which could be used to provide on-off switching for small battery powered equipment. The main requirement was for the ultrasonic receiver to have a very low stand-by current, as it would need to be continuously connected to a 9-volt battery and a current consumption of even just a few milliamps would greatly reduce the life of this battery. A current consumption of about $50\mu\text{A}$ or less was called for, and previous home constructor designs which the author has seen would seem to be totally unsuitable in this respect. It was also necessary to be able to switch the load on by momentarily operating the ultrasonic transmitter, to switch it off by momentarily operating the transmitter once more, and so on. Most previous systems switch the load on only while a signal is being received from the transmitter and need additional circuitry or a suitable actuator to provide sequential operation. The present arrangement results in a low power demand at the transmitter as well as at the receiver.

Fig. 1 shows in block diagram form the stage line-up finally adopted in the receiver. The output from the receiving transducer is amplified by a 3-

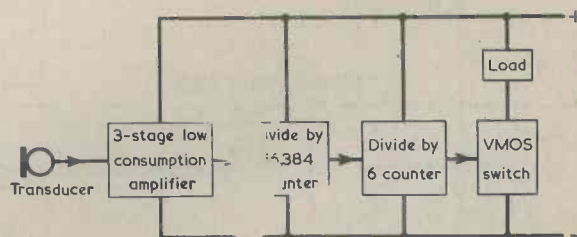
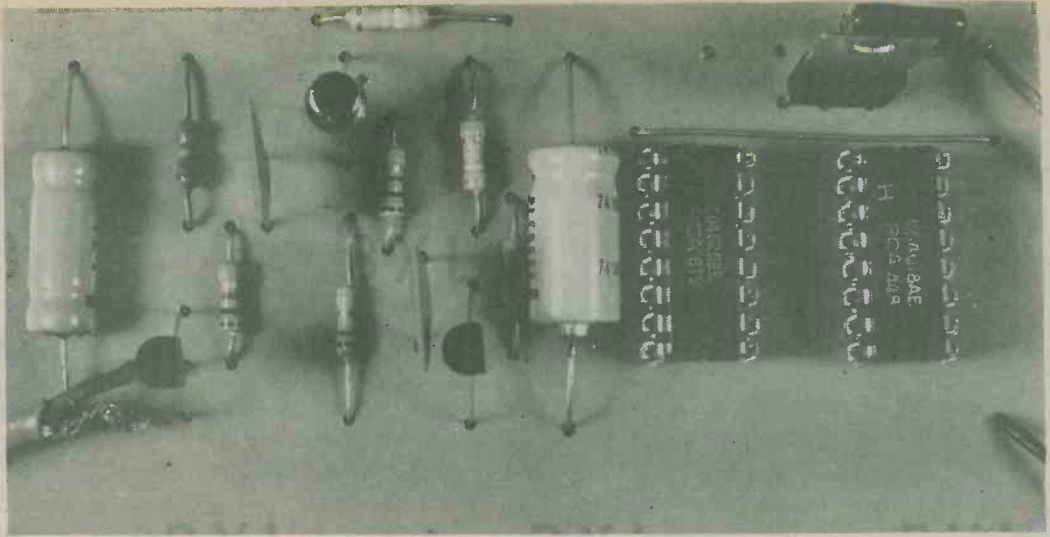

Fig. 1. Block diagram illustrating the operating principle of the receiver. After the 40kHz input from the receiving transducer has been amplified and divided, a square wave at a frequency of 0.407Hz is applied to the VMOS switch. The amplifier, logic and switch gating circuits consume a total current of about $33\mu\text{A}$ only



A close view of the receiver board. The two CMOS i.c.'s were plugged into soldercon connectors

COMPONENTS

RECEIVER

Resistors

(All $\frac{1}{4}$ watt 5% unless otherwise stated)

- R1 10M Ω 10%
- R2 270k Ω
- R3 10M Ω 10%
- R4 180k Ω
- R5 390k Ω
- R6 6.8M Ω 10%
- R7 390k Ω

Capacitors

- C1 2.2 μ F electrolytic, 10 V. Wkg.
- C2 680pF ceramic plate
- C3 680pF ceramic plate
- C4 100 μ F electrolytic, 10 V. Wkg.
- C5 0.1 μ F type C280

TRANSMITTER

Resistors

(All fixed values $\frac{1}{4}$ watt 5% unless otherwise stated)

- R1 470 Ω
- R2 100 Ω
- R3 8.2k Ω
- R4 22k Ω Pre-set potentiometer, 0.1 watt horizontal
- R5 1.8M Ω 10%
- R6 4.7k Ω
- R7 680 Ω
- R8 680 Ω

Capacitors

- C1 0.022 μ F ceramic plate
- C2 820pF polystyrene
- C3 1,500pF ceramic plate

Semiconductors

- IC1 4020
- IC2 4018
- TR1 BC650
- TR2 BC179
- TR3 BC650
- TR4 VN88AF

Transducer

- MIC1 40kHz transducer (see text)

Miscellaneous

- 9 volt battery
- Phono plug (see text)
- 2-off 16-way i.c. holders or soldercon connectors (see text)
- Materials for printed board
- Wire, solder, etc.

Semiconductors

- TR1 TIS43
- TR2 BC109
- TR3 BC109

Transducer

- LS1 40kHz transducer (see text)

Switch

- S1 miniature push-button, press to make

Battery

- BY1 9-volt battery type PP3

Miscellaneous

- Verobox type 75-1799-E
- Battery connector
- Phono plug (see text)
- Materials for printed board
- Wire, solder, etc.

transistor common emitter circuit which is designed to have a very low current drain. Normally a 2-stage amplifier would give adequate gain, but the low collector currents that must be used result in the transistors having far lower gains than usual. Furthermore, the use of low collector currents tends to cause a greater loss of gain at high frequencies than at d.c. and low frequencies. Although the operating frequency of 40kHz is not particularly high, being not far above the upper limit of the audio frequency spectrum, it is quite high enough for this factor to significantly reduce the gain. Circuitry having two stages therefore proved to give insufficient gain, whilst a 3-stage circuit operating at a total current consumption of about $33\mu\text{A}$ was found to have adequate sensitivity.

The 40kHz output from the amplifier drives a 14 stage CMOS binary divider, which divides the frequency by 16,384 times. The output of this stage feeds a divide-by-six CMOS counter, giving a total division of 98,304 times. This last stage gives an output, therefore, of 0.407Hz, which is applied to the gate of a VMOS power device used in a switching mode. The VMOS device turns on when its gate goes positive and if the 40kHz input signal were maintained continuously it would be turned on for slightly more than a second, off for slightly more than a second, and so on. In practice of course, the transmitter is only turned on long enough to switch the load from the off to the on state, or vice versa, as appropriate. It would be possible to include circuitry which prevented the receiver from cycling back to its original state if the transmitter were accidentally operated for slightly too long, but this does not seem to be a problem when the system is actually being used and no circuitry of this kind is fitted to the final design.

The use of CMOS i.c.'s to perform the logic functions and a VMOS device to act as a switch means that no significant current is consumed by these stages in the receiver circuit.

RECEIVER CIRCUIT

Fig. 2 shows the complete circuit of the ultrasonic receiver. Apart from the high resistor values that are needed to produce the required low collector currents, the amplifier is a fairly conventional 3-stage capacitively coupled arrangement incorporating one p.n.p. and two n.p.n. devices. The transistors are high gain low noise types which work well with low collector currents. A direct coupled amplifier was also tried, but it gave inferior performance and reliability when compared with the a.c. coupled circuit. TR3 is biased by R6 so that only a low collector voltage is produced under quiescent conditions, causing the input of IC1 to be in the low logic state. Any reasonably strong input signal from the transducer will produce a large enough voltage swing at TR3 collector to drive IC1 reliably.

IC1 is the binary counter and all its fourteen stages are used, the outputs from the stages of the device before the last one being simply ignored. The reset input at pin 11 is tied to the negative rail as it is not needed in the present application. The divide-by-six stage uses a 4018 "divide-by-N" counter connected in the appropriate manner. This drives the inexpensive VMOS device, TR4, which is employed as a common source switch. TR4 and the load will be switched on when IC2 output is high, and will be turned off when it is low. TR4 can handle currents of up to about 200mA or so with little voltage drop, but for higher current loads, or a.c. loads, it is necessary to have TR4 operate a relay which in turn controls the load. If this is done it is essential to incorporate a protective diode across the relay coil, as shown in Fig. 3. The diode suppresses the high reverse voltage which would otherwise be generated across the relay coil as it is de-energised, and which could damage the semiconductors. The relay can be any type having a coil energise voltage of 6 to 9 volts, a coil

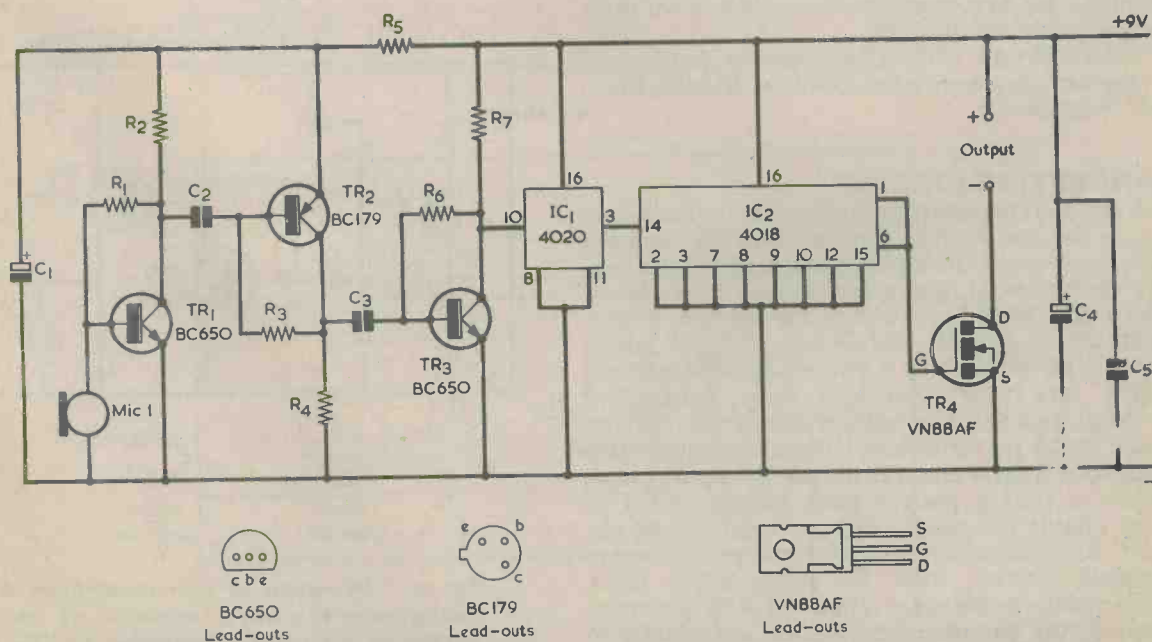
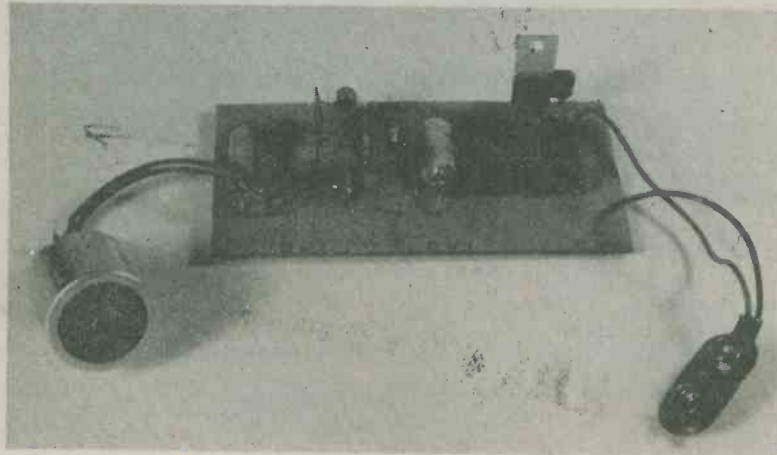
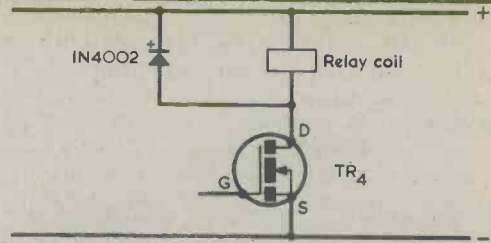

Fig. 2. The circuit of the receiver unit. TR1, TR2 and TR3 form the low consumption amplifier and are followed by IC1, a 14 stage binary divider, and IC2, which divides by 6. TR4 is the VMOS switch

Fig. 3. If the load switched by TR4 is a relay coil it is essential to add a protective diode across the coil



The receiver assembly. The receiving transducer connects to the printed board via a short length of screened cable

resistance of about 100 Ω or more and contacts of adequate rating to control the intended load. If the relay contacts switch an a.c. mains circuit, the relay insulation must be adequate for mains voltages, and the negative supply rail of the receiver must be connected to the mains earth. As is described at the end of this article, TR4 may also control d.c. loads powered from a supply other than the receiver 9 volt battery.

The BC650 and VN88AF transistors required in the receiver circuit are available from Maplin Electronic Supplies.

TRANSMITTER CIRCUIT

An efficient transmitter is essential in this system because the low current consumption requirement of the receiver inevitably makes it slightly less sensitive than normal, and a transmitter of mediocre performance would give totally inadequate results. A number of circuits were tried, most of which proved to be ineffective. A pulsed signal was found to give very poor results, a more substantial waveform such as a sawtooth or square wave giving a much better performance. Ultrasonic transmitter circuits often drive the transducer from anti-phase outputs so that a peak-to-peak voltage swing of almost double the supply rail potential can be obtained. In practice, circuits of this type work only marginally better than do single-ended ones. Indeed, best results were obtained with a single-ended circuit having a low output impedance so that loading by the transducer does not significantly reduce the peak-to-peak output voltage swing. A double-ended low impedance output circuit can offer a small further improvement in range, but not

by enough to justify the increased cost and complexity involved. The circuit of the transmitter finally employed appears in Fig. 4.

The 40kHz signal is generated by a standard unijunction relaxation oscillator incorporating TR1. This can be tuned by means of R4 to the precise

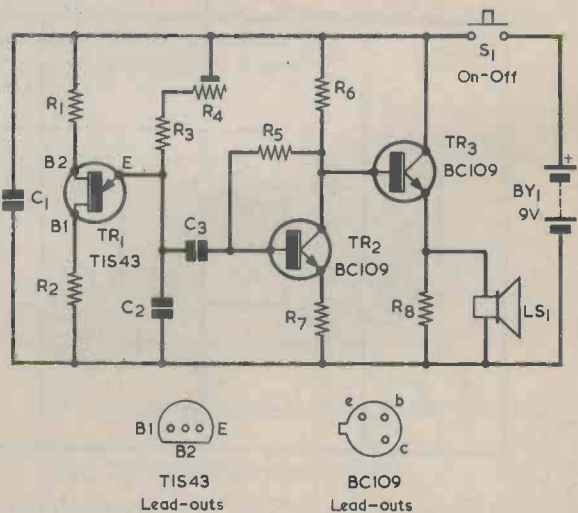

Fig. 4. The circuit of the transmitter. A near-sawtooth wave appears at the emitter of TR1 and is amplified by TR2, with TR3 producing a low impedance output. R4 is adjusted to bring transmitter frequency to the peak level for the pair of transducers employed

frequency at which the responses of the transmitting and receiving transducers are optimised. A waveform which is approximately a sawtooth is available at TR1 emitter, and this is coupled to the common emitter amplifier, TR2. TR2 clips the signal to give what is virtually a square wave of about 7.6 volts peak-to-peak amplitude. R7 provides negative feedback, boosting the input impedance of TR2 in order to prevent excessive loading on TR1. TR3 is in an emitter follower output buffer stage which gives a low impedance drive to the 40kHz transmitting transducer, LS1. The transducers are both piezoelectric devices which have very high resistances, and which do not therefore require series d.c. blocking capacitors. Various makes of 40kHz ultrasonic transducer are available at present and, although not checked by the author, any of these should work well in this system. Some types have identical transmitting and receiving units, but with others the two transducers are slightly different and optimum results will not be obtained if they are transposed. Where appropriate, the retailer's literature should make it clear which transducer should be used in the transmitter and which in the receiver.

The transducers used in the author's prototype were obtained from Ace Mailtronix Limited, Tootal Street, Wakefield, West Yorkshire, WF1.

RECEIVER CONSTRUCTION

Apart from the transducer the receiver components are all mounted on a printed circuit board, as detailed in Fig. 5. Other forms of construction could be used if preferred, but the layout of the amplifier section of the unit is inevitably rather critical, and a well conceived component layout is essential if instability is to be avoided. IC1 and IC2 are CMOS devices and the normal handling precautions should be observed when dealing with these components. If desired, they may be fitted into i.c. holders or soldercon connectors. The connection to the receiving transducer is made via a screened lead. Some transducers are fitted with a phono socket at the rear, the connection to the component then being made by way of a phono plug. Others simply have two pins to which soldered connections are made.

The receiver printed board can be housed in a suitable plastic or metal cabinet, or it may be fitted in the same case as the circuit which it controls.

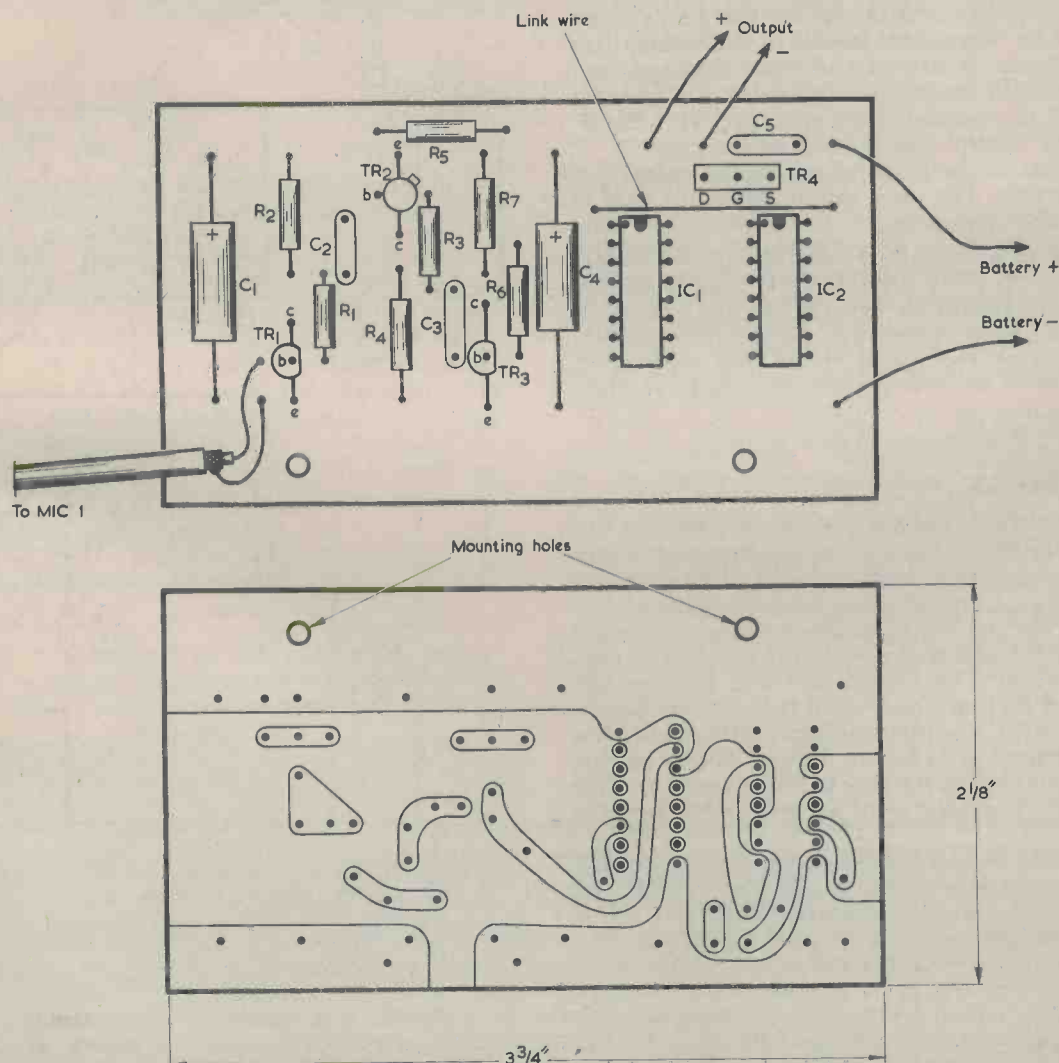
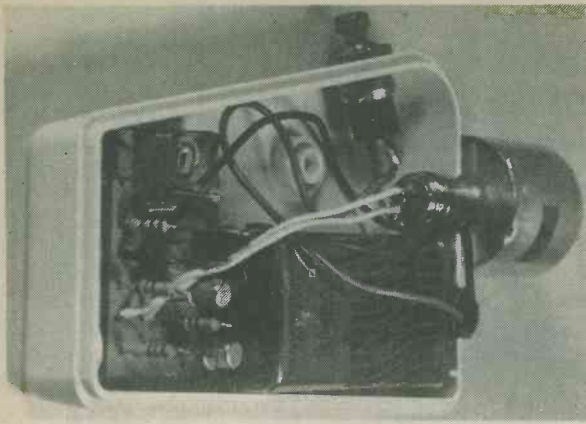

Fig. 5. The receiver is assembled on a printed circuit board with the layout given here. The board is reproduced full size for tracing



Layout inside the transmitter case. The push-button and printed board are mounted in one half of the case, to the front end of which the transducer is secured by means of adhesive

The 9 volt battery can be any type which the constructor feels will be adequate for the particular application involved.

TRANSMITTER CONSTRUCTION

Most of the transmitter components are assembled on a small printed circuit board, the foil pattern and component layout for this being given in Fig. 6. The component layout of the transmitter is not particularly critical and other forms of construction should be quite suitable, but a very compact layout is essential if the specified Vero hand-held plastic control box is used as the case.

The layout of the transmitter can be seen from the photograph. The only minor difficulty here is given by the mounting of the transducer. This necessitates the filing of a flat surface across the front of the box, since the surface is slightly angled where the two halves of the case meet. If a suitable area is filed flat the transducer will fit flush against the case, and can be glued to one half of the case after a suitable mounting hole (or holes) has been drilled.

ADJUSTMENT

It is possible to adjust the transmitter for optimum range by trial and error, the transmitter and receiver transducers being placed close together and pointing at one another, and R4 being slowly adjusted from one end of its track to the other until a setting is found which causes the receiver to continuously cycle. The transmitter and receiver are then moved further apart until the receiver ceases cycling, and R4 is adjusted slightly either side of its present setting in order to find a better setting which re-establishes the link with the receiver. This procedure is repeated until an acceptable range is obtained.

There is a much quicker method if a multimeter having a sensitivity of $20k\Omega$ per volt or better is available. This is set to a 10 volt range (or some similar low volts range) and is connected between TR3 collector and the negative supply rail at the receiver. R4 is then simply adjusted for maximum meter reading. For this adjustment the transmitting and receiving transducers should be positioned about 1 or 2 metres apart and not aimed directly at one another, so that only a fairly modest input

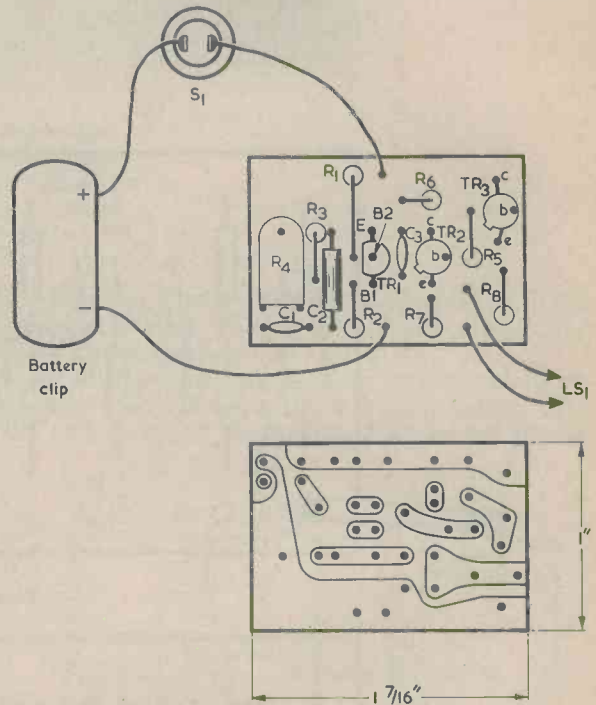
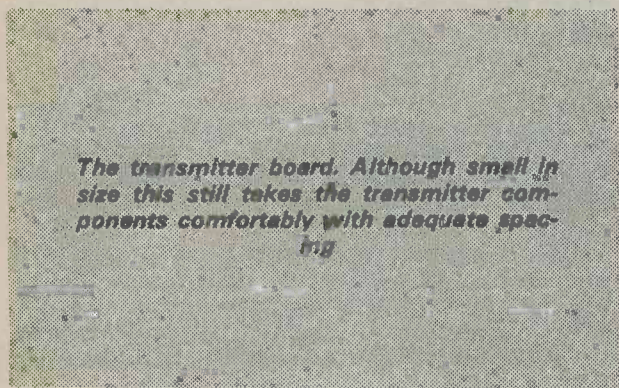

Fig. 6. The transmitter printed circuit assembly. This has to be small and compact in order that it may fit into the case specified

signal is obtained at the receiver. Otherwise the receiver will be saturated even with R4 well off tune, and there will be no setting which produces a definite peak.

The range of the system is reasonably large, being up to about 5 metres before the physical alignment of the two transducers becomes too critical, but ultrasonic systems are normally used only for

boosted by reducing the value of R5, and it can even be replaced by a link wire if the highest possible sensitivity is required. A reliable range of up to about 10 metres can then be obtained, which is as good as virtually any other ultrasonic system. However, the current consumption of the receiver will be substantially increased, being about $90\mu\text{A}$ with R5 at zero resistance.



The transmitter board. Although small in size this still takes the transmitter components comfortably with adequate spacing



short range applications. The range should in consequence be adequate for most requirements. If felt necessary, the sensitivity of the receiver can be

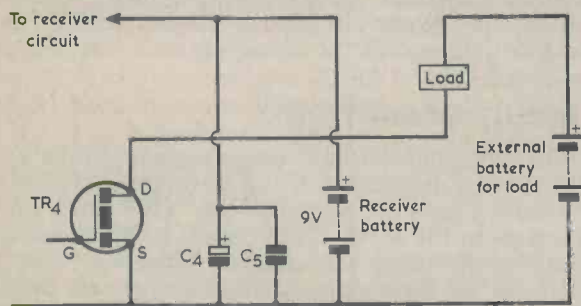

Fig. 7. If desired, an external battery can be employed to power the load switched by TR4. The output circuit is then modified as shown here

ALTERNATIVE SUPPLY

In the circuit shown in Fig. 2, the load switched on by TR4 is powered by the receiver 9 volt battery. There will be applications where this method of control is unsatisfactory, either because a load supply voltage other than 9 volts is required, or because the load supply current is high and prevents the use of a small battery for the low consumption receiver circuits.

All that is then required is to use the alternative circuit shown in Fig. 7. Here, the load is powered by its own battery, the negative terminal of which is made common with the negative rail of the receiver. The current drawn from the receiver battery then stays at the same very low level regardless of whether the load is switched on or off.

The voltage of the external battery supplying the load will probably be less than some 20 volts, which is well within the drain-source voltage rating of the VN88AF.

BACK NUMBERS

For the benefit of new readers we would draw attention to our back number service.

We retain past issues for a period of two years and we can, occasionally, supply copies more than two years old. The cost is 70p inclusive of postage and packing.

Before undertaking any constructional project described in a back issue, it must be borne in mind that components readily available at the time of publication may no longer be so.

LOGIC TESTER

By

Peter Roberts

PORTABLE TESTER DETECTS OVERLOAD, LOGIC STATE AND PULSE VOLTAGES IN T.T.L. CIRCUITS.

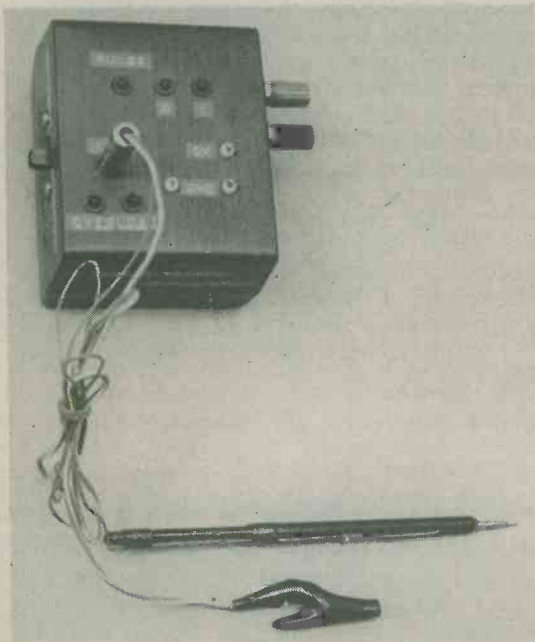

The prototype logic tester. One of the three test points on the front panel connects to the positive supply and the other two to the negative supply. Switch S1 is on the side opposite the two external supply terminals

Digital techniques involve two voltage levels, often called "high" and "low" or "1" and "0". The use of only two levels gives logic circuits a high degree of noise immunity, particularly in the transmission of data.

When building logic circuits of any complexity, some method of testing the designs becomes a necessity. Possible checking instruments are the oscilloscope and the testmeter. The oscilloscope is very expensive for the purpose and is not always the best method for measuring d.c. voltages, particularly if its calibration is in doubt. However, it can show a train of pulses very nicely. On the other hand a meter can indicate static high or low logic levels but not a train of pulses. Nor can it give reliable readings of high or low levels in the presence of pulses.

What is required is an instrument that gives a definite reading of high or low as well as indicating the presence of as little as a single pulse. Ideally, it should also include some form of protection against excessively high or low input voltages. Such an instrument, intended for checking t.t.l. circuits, is described here.

CIRCUIT OPERATION

The circuit of the logic tester appears in the accompanying diagram. A flying lead terminated in a crocodile clip is connected to the "OV" point and this clips to the earth of the circuit being checked. The "Input" point has another flying lead and a test prod for connection to the logic circuit being checked. Switch S1 selects a supply for the instrument. When set to "External", the instrument can obtain a 5 volt supply from the equipment being checked or from a suitable power supply unit. Setting S1 to "Battery" causes the instrument to be supplied by its own internal battery.

R1 is an input limiting resistor and it serves the dual purpose of input protection and limiting the current through the overload warning indicators, LED1 and LED2. If the input voltage exceeds the nominal VCC supply potential of 5 volts by the forward voltage drops of D1 and LED1 in series, LED1 lights up. Should the input go negative of earth by more than the forward voltage drops in D2 and LED2, LED2 turns on. Diodes D1 and D2 protect the overload indicating l.e.d.'s from reverse voltages which may exceed the specification of some devices. The value of R1 should not be increased to give added protection as this would prevent the rest of the circuit from responding to the various input voltages.

The logic tester employs three inverters, these

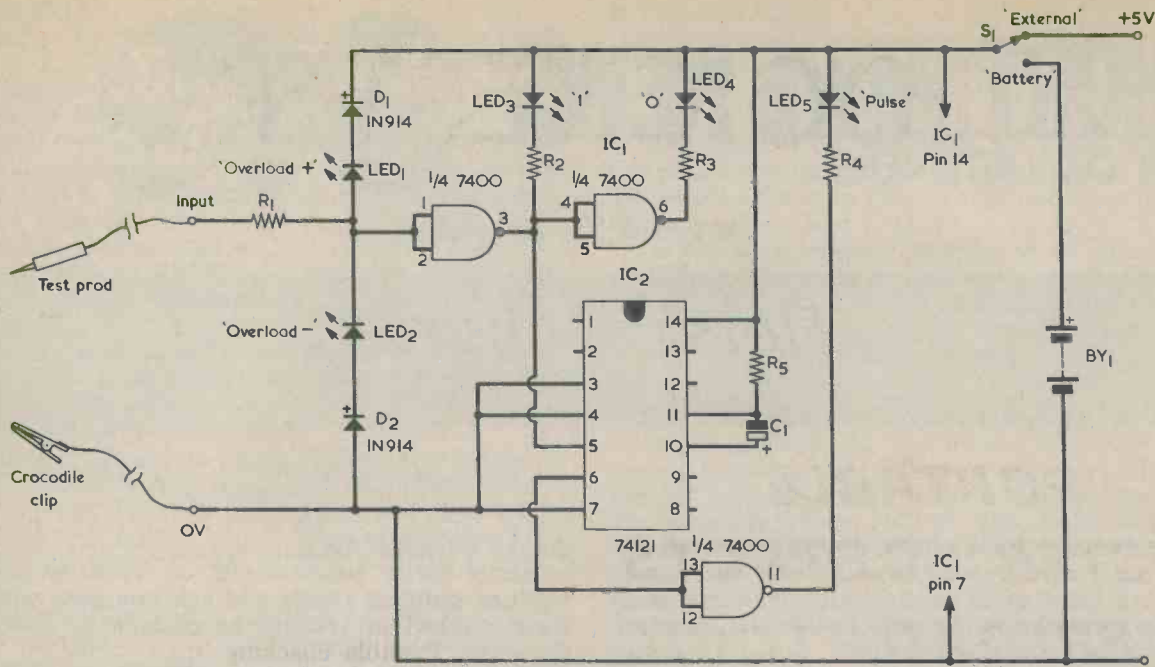

The circuit of the logic tester. LED1 and LED2 indicate overload whilst LED3 and LED4 show logic voltage state. LED5 lights up in the presence of one or more pulses

consisting of 2-input NAND gates with their inputs strapped. The three gates are part of a quad NAND gate type 7400, no connections being made to the unused fourth gate. If the "Input" test prod connects to a logic point which is high, the output of the first inverter at pin 3 of the 7400 goes low and LED3 lights up. Connecting the test prod to a low logic level causes the pin 3 output to go high and the output of the second gate at pin 6 to go low. This time LED4 becomes illuminated.

The second i.c. is a 74121 monostable multivibrator which is triggered to give a high output for a short period at its pin 6 when a positive-going pulse is applied to its pin 5. The third NAND gate inverter changes the high output to a low voltage which causes LED5 to light up. Since the pin 5 input is derived from the first inverter, the monostable fires for a negative-going pulse at the "Input" test prod.

The length of the monostable on period is governed by C1 and R5, and the monostable can be fired by a single pulse at the "Input" prod. A train of pulses spaced at less than the monostable period causes LED5 to remain alight virtually continuously.

The internal battery can be a 4.5 volt torch battery or a 6 volt battery made up from four 1.5 volt cells in series. A good choice consists of four HP7 cells, which may be fitted in a small battery holder. Current consumption is of the order of 25mA.

The author's logic tester is assembled in a plastic box measuring about 4 by 3 by 2½ in., and has the five l.e.d.'s mounted on the front panel. The "In-

Continued on Page 287

COMPONENTS

Resistors

(All ¼ watt 10%)

- R1 220 Ω
- R2 220 Ω
- R3 220 Ω
- R4 220 Ω
- R5 18k Ω

Capacitor

C1 10μF electrolytic, 10V. Wkg.

Semiconductors

- IC1 7400
- IC2 74121
- D1 1N914
- D2 1N914
- LED1-LED5 red l.e.d.'s

Switch

S1 s.p.d.t. slide or toggle

Battery

BY1 (see text)

Miscellaneous

- Case (see text)
- Test prod
- Crocodile clip
- 3.5mm. jack plug
- 3.5mm. jack socket
- Insulated terminal, red
- Insulated terminal, black
- 5 panel-mounting bushes (for LED1 to LED5)
- Wire, solder, etc.

SHORT WAVE NEWS

FOR DX LISTENERS



By Frank A. Baldwin

Times = GMT

Frequencies = kHz

Clandestine stations have always interested the writer and together with other fellow Dxers much time has been spent logging such transmissions. For the information of readers, details of some of these stations are shown below.

● VOICE OF THE MALAYAN REVOLUTION

This one operates in various languages such as Chinese (and Chinese dialects), Malay and Tamil but also in English. The English transmissions are from 0930 to 1015, 1450 to 1530 on **11830** and **15790**. The programme content is pro-Peking, anti-Malaysia and Singapore Governments. The transmitters are thought to be located near Changsha in Hunan Province, China.

● VOICE OF THE PEOPLE OF BURMA

This station is pro-Peking in policy and is the voice of the Burmese Communist Party. Thought to be located on or near the Burma/Chinese border, it operates in Burmese, Standard Chinese, Shan and Jingpaw from 0030 to 0130 and from 1200 to 1300 on **5110** and from 1030 to 1130 on **6304** (in Burmese only) but the timings of this latter transmission varies according to a monthly pattern, that shown being correct for February, April, June, August, October and December. Identification in Burmese is "Myama-pye Pey-Thu Ah-than".

● RADIO 8-1

Radio 8-1 ("Ba Yi") has been reported on **12120** at various times from 1230 to as late as 1630 with transmissions attacking the policies of the Peking government, particularly with respect to Vietnam. The transmitter is thought to be one of the Russian 'black' clandestines operating on the Chinese border and purporting to represent the views of the People's Liberation Army. Such broadcasts are usually of 10 minutes duration in order to dodge the jammers!

● HUNGARY

Radio Budapest on **7200** at 1930, OM with station identification at the commencement of the German programme for Austria, scheduled on this channel from 1930 to 2000.

● CZECHOSLOVAKIA

Radio Prague on **7245** at 1911, YL with identification after the news in the English programme for Europe, scheduled from 1900 to 1930.

● EAST GERMANY

Radio Berlin International on **7260** at 1840, news of sporting events and achievements within the Republic in the English programme for Europe, scheduled from 1800 to 1845.

Radio Berlin International on **7300** at 1915, OM with identification at the commencement of the Portuguese programme for Europe and Central Africa, scheduled from 1915 to 2000.

● CANADA

Radio Canada on **7130** at 1902, OM with the local news in English for Europe, scheduled from 1900 to 1930. This is a BBC relay from Daventry.

● INDIA

AIR (All India Radio) Delhi on **11620** at 2000, OM with the local news in English after identification in the English programme for North and West Africa, West Europe and the U.K., scheduled from 1945 to 2045.

● U.S.S.R.

Radio Moscow on **7250** at 1830, OM with a newscast in English in the World Service. Also in parallel on **7185** and **7280**, the latter channel being best for reception here in the U.K.

● ISRAEL

Jerusalem on **11655** at 2030, YL signing off the English programme for Europe after the news headlines, this being followed by the French programme. The English programme is scheduled from 2000 to 2030.

● CLANDESTINE

Voice of the Malayan Revolution on **15790** at 1400, military music, YL announcer in Chinese. This is a pro-communist transmitter — see opening paragraphs.

● WEST GERMANY

Deutsche Welle on **7285** at 0128, OM with identification after a newscast in the English programme for Asia, scheduled from 0120 to 0220.

● ALBANIA

Tirana on **7120** at 0134, YL with a newscast in the English programme for North America, scheduled from 0130 to 0200.

● ITALY

Rome on **7275** at 2025, YL with identification and news in the Arabic programme for Morocco and Algeria, scheduled from 2025 to 2045.

● BRAZIL

Radio Tabajara on a measured **4797** at 0040, YL with a love song, local pops, after it by OM in Portuguese.

Radio Difusora, Londrina, on **4815** at 0044, Brazilian pops, OM announcements in Portuguese. The schedule is from 0900 to 0400 and the power is just 0.5kW. When logging this one, don't get confused with the more powerful Colombian Radio Guatapuri. The latter station varies in frequency from **4815** to **4818** and tends to increasingly 'block' Radio Difusora as the morning hours progress.

Radio Clube do Para, Belem, on **4855** at 0054, OM with an excited sports commentary in Portuguese. The schedule of this one is from 0800 to 0400 and the power is 10kW.

Radio Cultural da Bahia, Salvador, on **4895** at 0102, YL with pop song, OM announcements in Portuguese. This one is irregular and operates on special occasions only. The schedule, when operating, is from 0800 to 0400 and the power is 10kW.

Radio Anhanguera, Goiania, on **4915** at 0107, OM announcer with recorded local pop music. The schedule is from 0900 (Sunday from 1000) to 0400 and the power is 10kW. Signal mixed with that of R. Dif. de Macapa, another Brazilian.

Radio Borborema, Campina Grande, on **5025** at 0113, OM announcements in Portuguese, Brazilian discomusic. The schedule is from 0830 to 0400 and the power is 1kW.

● DOMINICAN REPUBLIC

HISD R. TV Dominicana, Santo Domingo, on a measured **5966** at 0138, OM with announcements in Spanish, including local addresses, OM pop song and local pops. The schedule is from 0930 to 0400 and the power is 50kW.

● COLOMBIA

La Voz de los Centauros (HJOQ), Villavicencio, on **5955** at 0133, OM announcements in Spanish, short excerpts light orchestral music — but mostly talk! The schedule is around the clock and the power is 5kW. The frequency of this one is apt to vary up to **5960**.

● GUATEMALA

Radio Mam, Cabrican, on **4825** at 0047, OM with a sports commentary in Spanish. This one operates in Spanish and vernacular and is on the air from 2200 to 0300, the power being 1kW.

● SURINAM

SRS Paramaribo on **4850** at 0050, YL with pop song, OM with announcements in Dutch. The schedule is from 0815 to 0330 and the power is 10kW. Reported closing sometimes as late as 0530, languages used are English, Dutch, Spanish and Indonesian.

● VENEZUELA

Radio Libertador, Caracas, on **3245** at 0020, OM announcer in Spanish with recorded local pop music. The schedule is from 1000 to 0400 and the power is 1kW.

Radio Barcelona, Barcelona, on **3385** at 0046, OM with identification in Spanish, YL with ballad. The schedule is from 1000 to 1200 and from 2100 to 0400 and the power is 1kW.

La Voz de Carabobo, Valencia, on **4780** at 0037, local-style dance music, OM with commercials in Spanish. The schedule is from 1000 to 0400 and the power is 1kW. This one also identifies as "Onda Nueva" on occasions.

● CHINA

PLA (People's Liberation Army) Fujian Front on **3400** at 2054, YL in Chinese in a Network 2 programme directed to Taiwan and other Offshore Islands. Sign-off at 2101 without National Anthem. The schedule is from 1131 to 2100 on this channel.

Radio Peking on **3360** at 2110, YL in Chinese (Amoy) in the Taiwan Service, scheduled here from 1000 to 1900 and from 2000 to 0130.

Lhasa on **4750** at 2318, YL with instructions for physical training. This transmission was thought at first (early July) to emanate from the CPBS Hulun Boir, Heilongjiang, station which is only rarely reported. Now thought to be Lhasa in agreement with other Dxers.

Nanning on **4905** at 2028, Chinese opera replayed from Radio Peking Domestic Service 1. The schedule is from 1100 to 1735 and from 2000 to 2300.

● EQUATORIAL GUINEA

Radio Ecuatorial, Bata, on a measured **4926** at 2130, OM identification "La Voz del Partido", anthem and sign-off after programme of local music. The schedule is from 0430 to 0630, 1000 to 1600 and from 1700 to 2140 (Saturdays until 2300). The power is 5kW.

● NIGERIA

NBC Benin City on a measured **4932** at 2335, local-style music and songs — very rhythmic! The schedule is from 0430 to 2305 in both English and vernaculars but has been reported closing as late as 2345. The power is 10kW.

VON (Voice of Nigeria) Lagos on **4990** at 0430, sign-on in English, time-check, programme review and religious service. The schedule is from 0430 to 1000 and from 1700 to 2305 in English and vernaculars. The power is 20kW.

● NOW HEAR THIS

Radio Alfonso Padilla Vega, Padilla, Bolivia, on **3480** at 0147, OM's with a local-style pop song. Schedule varies from 2215 to 0245, 2315 to 0315. Frequency varies from **3478** to **3488**. The power is 0.3kW.

LOGIC TESTER *Continued from Page 285*

put" and "OV" test leads connect to a 3.5mm. jack plug which fits into a jack socket on the panel. Also provided are terminals on one side which allow connection to the external supply, and test pins on the front panel (not shown in the circuit) for supply voltage monitoring and similar purposes. Construc-

tion and layout are not at all critical, and any reasonable method of assembly may be employed.

The test prod was made from a stylus used for writing on duplicating stencils. It should be available from most good stationers very cheaply.

'RING OF LED's' PRINT TIMER

By P. R. Arthur

- *Ideal attention-catching presentation.*
- *Unique display indicates 8 segments of timing period.*

This timer is designed to provide accurate timing for the development of photographic prints. It is primarily intended for dish development, but there is no reason why it should not be used with other equipment, such as colour drums, if required.

COMPONENTS

Resistors

(All fixed values $\frac{1}{4}$ watt 5%)

- R1-R4 4.7M Ω pre-set potentiometer
- R5 6.8k Ω (see text)
- R6 3.3k Ω
- R7 1k Ω
- R8 100 Ω
- R9 18k Ω

Capacitors

- C1 0.1 μ F type C280
- C2 1.5 μ F type C280
- C3 0.047 μ F type C280

Semiconductors

- IC1 555
- IC2 4022
- D1-D8 T1L209 with panel-mounting bushes

Switches

- S1(a)(b) 2-pole 2-way miniature rotary
- S2 1-pole 4-way miniature rotary

Miscellaneous

- 9 volt battery, PP3 or PP6
- Battery connector
- Verocase type 75-1238-D
- Veroboard, 0.1in. matrix
- 2 control knobs
- 16-way d.i.l. socket (if required)
- Wire, solder, etc.

The unit is unusual for a photographic timer because it does not simply give an audible or visual warning at the end of the timing period but has, instead, a ring of eight l.e.d.'s which light successively in clockwise order during the period. The ring of l.e.d.'s display is easily seen in both good and poor lighting conditions. The required development time is indicated by one complete lap, or "revolution", of the light around the ring of l.e.d.'s and this avoids the confusion which can occur when timing by watching the sweep second hand of a clock. One may, in the dark, be unsure whether the second hand is on the first or second time round. The prototype gives nominal timing periods of 1, 2, 3 and 4 minutes, but these periods can be modified to suit individual requirements.

The ring display has the further advantage, when compared with conventional electronic timers, of indicating the approaching end of the development time. This enables one to prepare for the next processing stage. After the set time the display continues to cycle until the unit is switched off, and the subsequent cycles, can, if desired, be used for timing later processing stages.

In use, the timer is very convenient and gives good results. Like most other timers it has possible applications other than its intended one. It could for instance be employed for timing STD telephone calls, and there are without doubt many other applications.

THE CIRCUIT

The circuit of the timer is shown in Fig. 1, and it consists basically of a clock oscillator, IC1, feeding a divide-by-eight counter, IC2, which drives the eight l.e.d.'s in the ring. The "0" to "7" outputs of the counter go high successively with each positive-going input pulse edge from the clock.

The clock oscillator employs a 555 in the astable



The ring of l.e.d.'s appears on the front panel of the timer. The top l.e.d. lights up at the start of the timing period, then extinguishes as the next l.e.d. turns on. The l.e.d.'s become illuminated in turn in clockwise order and the timing period is at an end when the eighth l.e.d. gives way to the first one in the ring

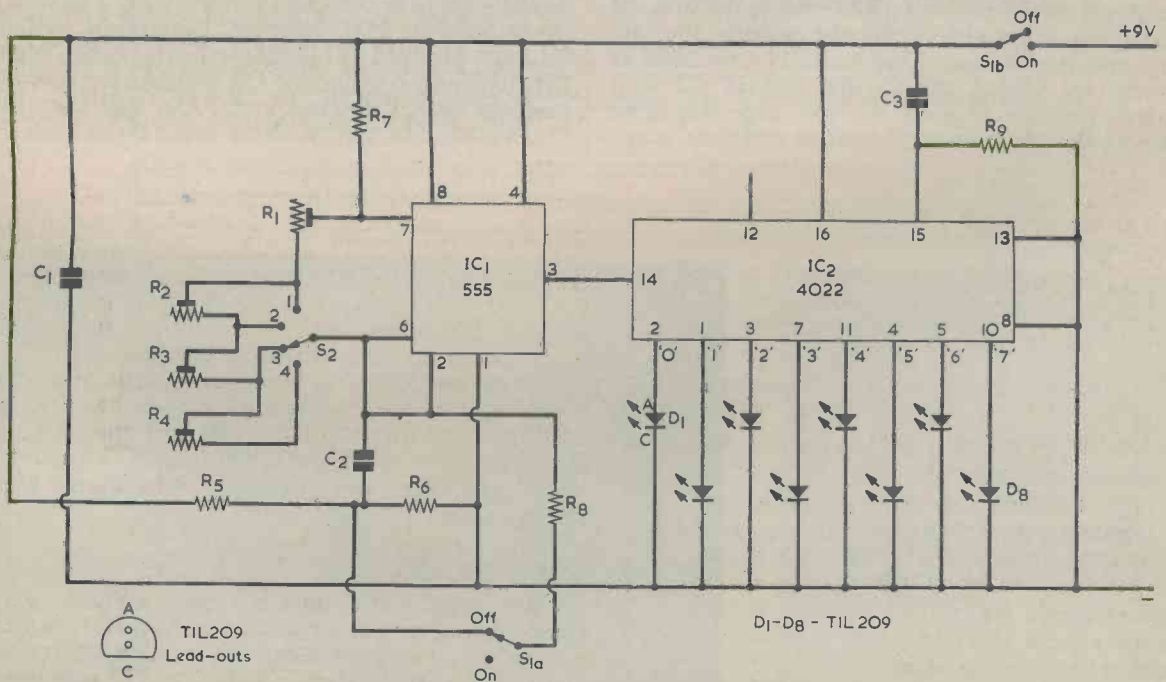
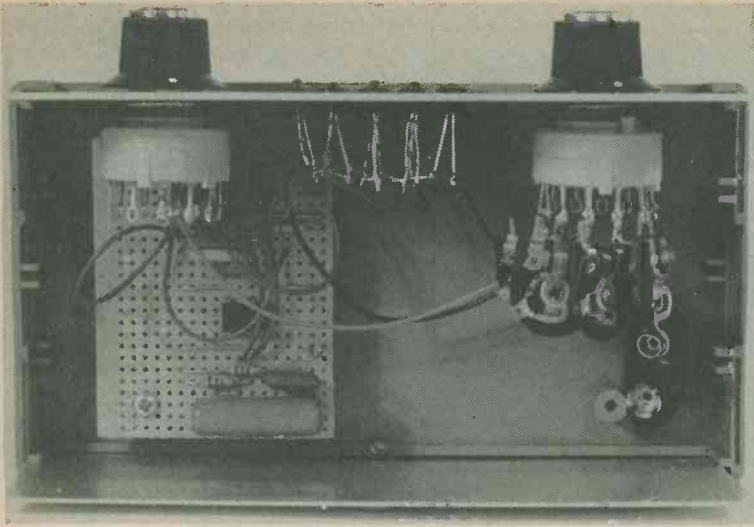

Fig. 1. The circuit of the ring of l.e.d.'s print timer. Each of the eight light-emitting diodes is illuminated in turn by IC2



Most of the components are assembled on a Veroboard panel which is positioned behind the on-off switch

mode, the four timing periods being selected by S2. As is normal with a 555 oscillator the timing capacitor, C2 in Fig. 1, is charged by way of the resistance coupling it to the positive rail until the voltage across it reaches two-thirds of the supply potential. Pin 7 of the i.c. then goes low and the capacitor discharges via the resistance coupling it to this pin until the voltage across it is one-third of the supply voltage. Pin 7 then goes open, allowing the capacitor to charge once more in the following cycle. With a normal 555 circuit, in which the capacitor is returned to the negative rail, the first charge period is longer than all the subsequent charge periods, because the capacitor has to charge from zero volts to two-thirds of supply voltage whereas in the later periods it charges from one-third to two-thirds of supply potential.

In many instances the consequently elongated initial cycle raises no difficulties, but in the present applications it would obviously reduce the accuracy and usefulness of the unit. The problem is overcome by taking the earthy side of C2 to a potential divider formed by R5 and R6. The voltage at the junction of these two resistors is ap-

proximately one-third of the supply potential, so that the timing circuit conditions are effectively the same for the first cycle as for those which follow.

Any large errors in the initial clock cycle are thereby eliminated. Although there may still be a small discrepancy it will be of an insignificant proportion.

S2 switches in four pre-set variable resistors to provide the timing cycles of 1 minute, 2 minutes, 3 minutes and 4 minutes. To obtain repeatable and consistent results, a non-electrolytic capacitor is used in the C2 position. It will still be necessary to trim the time constants of the circuit to obtain good accuracy, of course, and this is why pre-set variable resistors are employed.

The output pulses from pin 3 of the 555 are applied direct to the clock input, pin 14, of the 4022 divider. The output of IC1 will go positive as soon as the supply is switched on by S1(b). This will not be counted by IC2, however, because at switch-on its reset pin, pin 15, is momentarily taken high by the discharged capacitor C3, causing the divider to reset to zero. The first l.e.d., D1, will then be illuminated. The next positive-going pulse edge from

Two self-tapping screws, of which one is hidden below the switch here, secure the Veroboard panel to mounting pillars moulded into the case

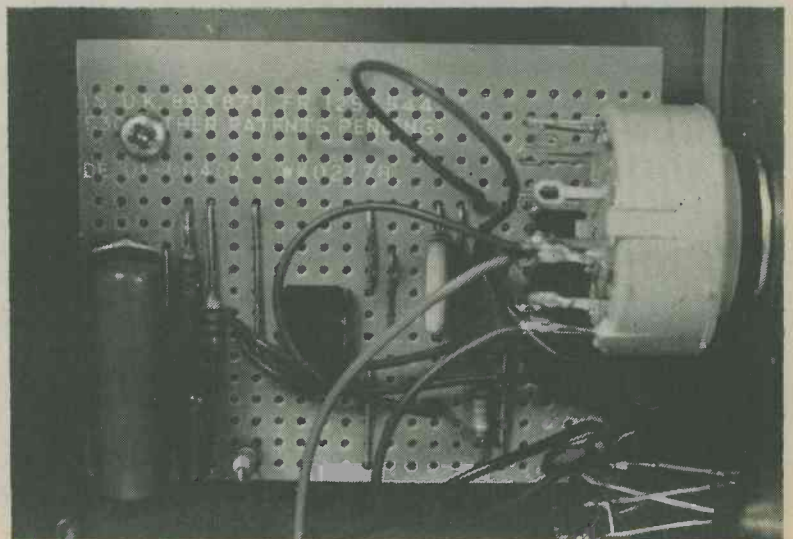

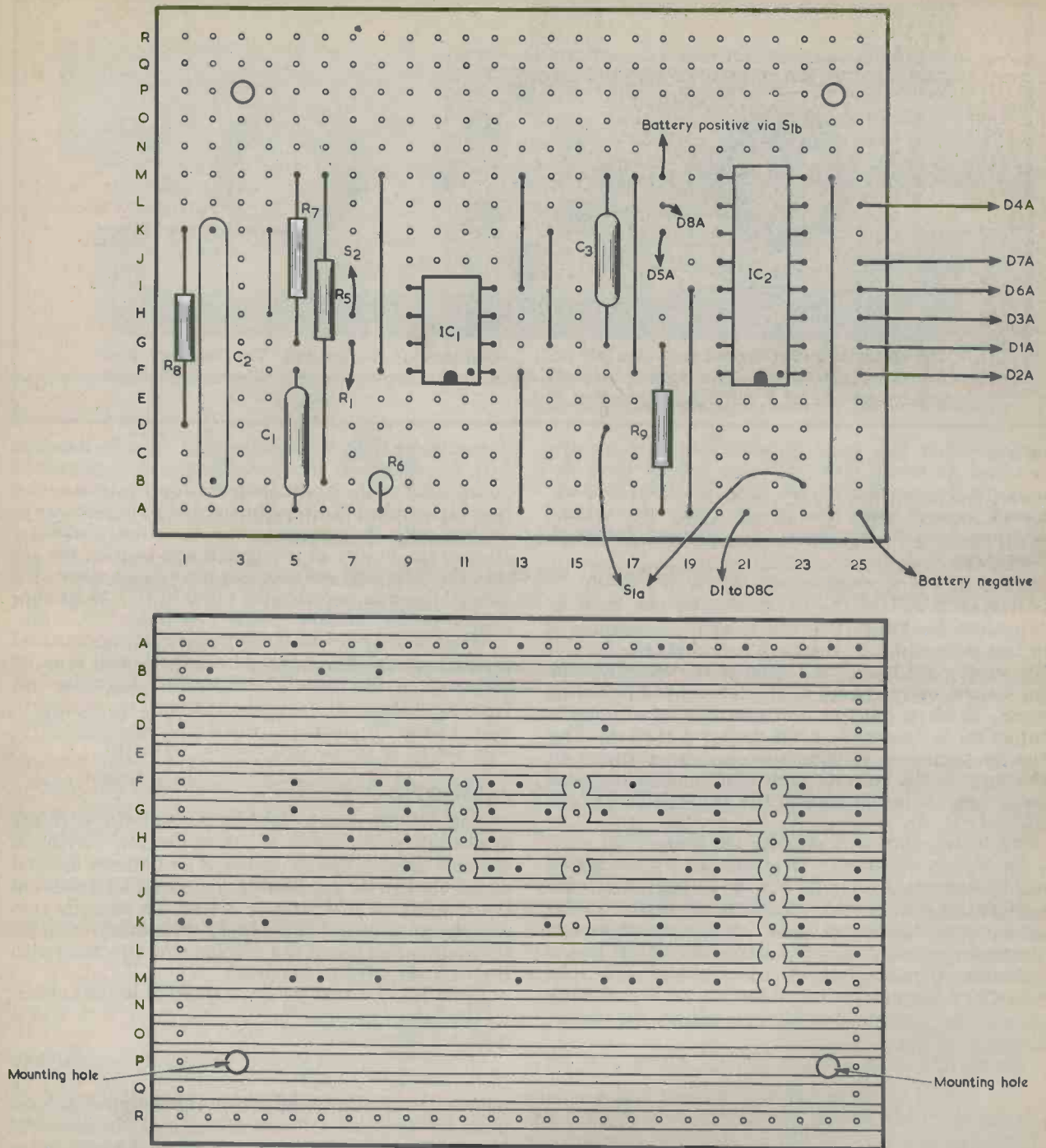

Fig. 2. Most of the timer components are assembled on a Veroboard panel. Layout details are given here

IC1 will cause D1 to extinguish and D2 to light up. The l.e.d.'s will then light up in sequence until D7 is turned off and D8 becomes illuminated. The following clock pulse will extinguish D8 and cause D1 to light up again, and the sequence will repeat. The precise end of the timing period is given when D8 extinguishes and D1 lights up for the second time. Thus, each l.e.d. is alight for one-eighth of the overall timing period. No connection is made to pin 12 of IC2, which is the "carry out" pin.

The timer is switched off by moving S1(a)(b) to the "Off" position. S1(a) then short-circuits C2 via

the low value current limiting resistor R8. No residual charge will in consequence be left in C2 when the unit is switched on again and good accuracy will be maintained.

The average current consumption of the unit is about 15mA, and this can be provided by a 9 volt battery such as a PP3 or, if the unit is to be used extensively, a PP6.

All the components are readily available. The rotary switches can be miniature types with adjustable end stops, and the small number of ways selected by each makes it possible to employ types

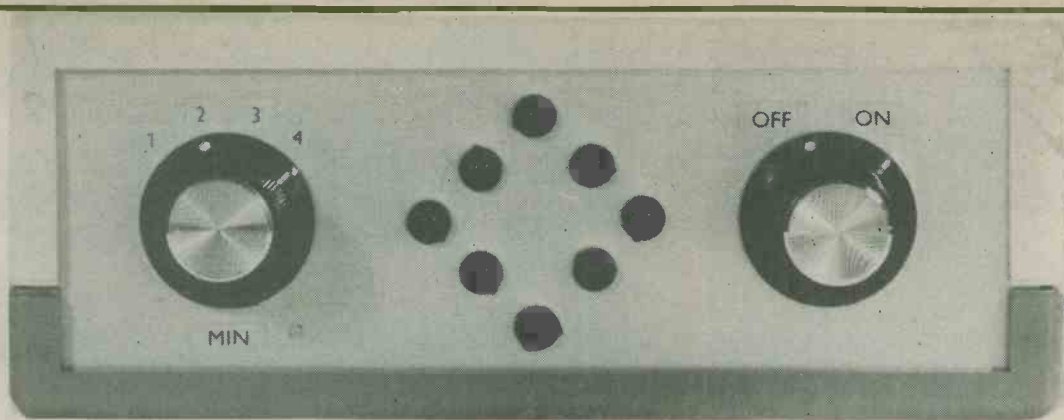

The range selector switch is to the left on the front panel, and this selects overall timing periods of 1 minute, 2 minutes, 3

minutes or 4 minutes. The legends and numbers are taken from "Panel Signs" set No. 4

having either the same number of poles as are switched or more. Obviously, no connections are made to the unused switch tags. The four pre-set potentiometers are the larger type of vertical skeleton pre-set having 0.4in. spacing between track tags.

CONSTRUCTION

A Verocase type 75-1238-D, with dimensions of 153 by 84 by 59mm., makes a good housing for the unit. The eight l.e.d.'s are mounted at the centre of the front panel with S2 to the left and S1(a)(b) to the right. D1 is at the top and the other l.e.d.'s follow in sequence in a clockwise direction. The four pre-set potentiometers are mounted direct to the tags of S2, one of each of the potentiometer track tags being soldered to the appropriate switch tag.

The remaining components are assembled on a 0.1in. Veroboard having 18 strips by 25 holes, using the layout illustrated in Fig. 2. A lead from the board connects to the cathodes of all eight l.e.d.'s, whilst eight separate leads connect to their individual anodes. A wire from hole H7 on the board connects to the arm of S2, and another wire from hole G7 connects to the slider tag of R1. Wiring around the outer tags of S2 then follows the circuit diagram of Fig. 1.

Since IC2 is a CMOS device which can be

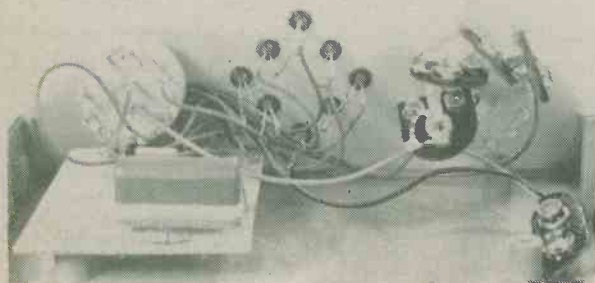

The four pre-set potentiometers are mounted by having one track tag soldered to the appropriate tag of switch S2. A single wire connects together all the cathodes of the l.e.d.'s and individual wires run from the component panel to the anodes

damaged by high static voltages it must be handled with some care. It should be the last component to be soldered to the board, and a soldering iron with a reliably earthed bit must be used. The safest way of dealing with the component is to initially solder a 16-way i.c. holder to the board and to plug the i.c. into this after all connections have been made. Incidentally, it is in order for pin 9 of IC1 to be connected to the positive rail as this is an "NC" pin.

When wiring to the front panel components and to the battery clip is complete, the board may be mounted in the case. The specified Verocase has four mounting pillars, and the board is secured to two of these by means of small self-tapping screws. The board is positioned behind S1(a)(b).

ADJUSTMENT

Initially the unit should be tested with S2 in the 1 minute position. A clock or watch having a seconds hand is used to provide a reference against which R1 can be adjusted to produce increments in the display at intervals of about 7.5 seconds (i.e. one-eighth of 60 seconds). R1 is then finely trimmed to produce one lap of the display every minute with the desired level of accuracy.

Then R2, R3 and R4 are adjusted, *in that order*, in the same manner for lap times of 2, 3 and 4 minutes respectively.

If timing periods shorter or slightly longer than the specified ranges are required it may well be possible to obtain them within the range of adjustment of the pre-set potentiometers. It must be borne in mind that, apart from R4, the resistance inserted by each pre-set potentiometer appears in the timing circuit for the longer period range or ranges. If, for example, R1 is adjusted for a short timing period on the first range, the maximum available timing period will be limited on the other three ranges.

If it is necessary to alter the timing component values, the overall timing period (one complete lap) is approximately 11 times CR where C is the value of C2 in μF , R is the resistance in $\text{M}\Omega$ between pins 6 and 7 of IC1, and the period is in seconds. The timing resistance should not exceed $20\text{M}\Omega$. It is advisable to avoid the use of electrolytic capacitors for C2 because, apart from the question of leakage current, tolerances in R5 and R6 and in IC1 could cause the capacitor to be reversed biased by a small voltage during the oscillation cycle, giving reduced reliability in timing accuracy. ■



really explains *microprocessors*

series
No. 6

By Ian Sinclair

The Accumulator

In this, the sixth article in our 12-part series on microprocessors, we take a look at the all-important accumulator.

In part 4 of DATABUS, we met some of the registers that are used in a microprocessor CPU, and discussed the 2-byte program counter and data counters. The other important register is a one-byte register called the accumulator. This is a register that is used for storing and working on numbers, so it can be connected by gates to the data input/output lines whenever required by a program.

ACCUMULATOR REGISTER

What makes the accumulator register so important is that all data numbers, as distinct from instructions, pass through the accumulator. It's true that some CPU chips allow the use of more than one register in this way, but so far as the simpler types of CPU are concerned there's just one accumulator, and every number that is acted on has at some time to be placed in the accumulator. This is a feature of calculators and computers generally, so a few rules are worth noting.

First of all, when a number byte is loaded into the

accumulator register, the byte which was in the accumulator before it is lost. You can see why if you remember that the accumulator is a register with parallel loading — each flip-flop in the register is being set to 1 or 0 by each new bit of data. A LOAD instruction to the CPU means that the byte of data which is referred to by the next byte of the instruction will be loaded into the accumulator in this way; and if the byte which is already there is needed for some purpose, it must first of all be stored in memory — this sort of procedure will be familiar to readers who have followed the recent "Tune-In To Programs" series.

There are several load instructions, depending on where the byte of data is coming from. LOAD IMMEDIATE means that the next byte in the program is a number which has to be loaded into the accumulator, so that the instruction must carry the coding which sets up the CPU to treat the next byte in from program memory as a number rather than as an instruction. Suppose we want to load in a byte taken from some part of memory which lies outside the part in which the program is stored. A different sort of load instruction then has to be used. For the simpler types of CPU this is a two-byte instruction, with the first byte carrying the load part of the instruction, and the second a displacement number. As described in Part 5, this displacement number causes a new address number to be generated, equal to the sum of the number in the program counter and the displacement number itself. The byte which is loaded into the accumulator is therefore taken from the memory position whose address is given by the program count number plus the displacement.

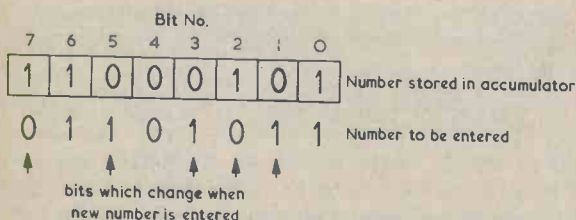

Fig. 1. Accumulator entry. When a new number is entered into the accumulator, several bits will be changed so that the old number is no longer stored

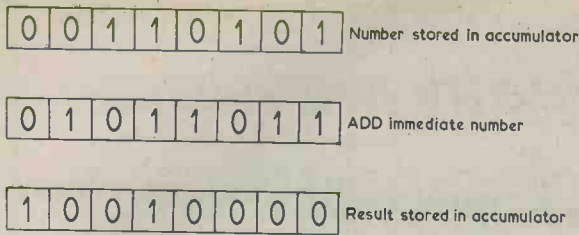

Fig. 2. The ADD BINARY IMMEDIATE operation. The number which follows the instruction ADD IMMEDIATE in the memory is added to the number in the accumulator, and the result is stored in the accumulator

The simpler types of CPU may use just these two basic types of load instruction, usually with the option of incrementing or decrementing the number in an index register at each load instruction so that each load is from a different address, one higher or lower than the previous one. Such indexed and auto-indexed arrangements have been dealt with in Part 5.

The more elaborate types of CPU use many other load instructions which can make some types of program easier to devise. Keeping at the moment to accumulator loading instructions, these CPUs can load the accumulator from any address in memory, so that two bytes of address need to follow the instruction code. These two bytes are loaded into the data counter or address register (according to the design of CPU) and form an address to memory from which the data byte will be taken to load the accumulator. In addition, however, it is usually possible to load other registers, or to shift data bytes from one register to another. The Z80, for example, has a total of 21 different single byte load instructions, and more than 14 double-byte load instructions.

BYTE TRANSFERENCE

Now what else? Obviously, if we can load a data byte from memory into the accumulator, we ought to be able to store a byte that is in the accumulator into some part of memory. Once again, the simpler types of CPU will offer one main method of doing this by the use of a displacement number relative to the program counter or to an index number in some other register. As before, the instruction code (a store instruction this time) will be followed by a displacement number which adds to the number in the program counter or other register. This new number is now used as the address of a chunk of memory which will be employed to store the data byte that is in the accumulator. This does *not* remove the data byte from the accumulator, it merely copies it into the memory location. As before, it may be possible to use a modified instruction so that the index number is incremented or decremented each time the instruction is carried out, so that data bytes can be stored into consecutive memory locations. Note, however, that all relative displacement will operate only over a limited range, -128 to +127, which is equivalent to half of an 8-bit memory "page" in each direction.

Another method which is available on some simpler CPUs is to copy the byte from the accumulator into various other registers, using a different instruction code for each different destination. The more advanced CPUs will also permit the contents of the accumulator to be copied into any place in RAM memory, using the address directly rather than by having to calculate a displacement. The addressing can also be implied, taken from a pair of bytes which themselves are stored in two consecutive memory addresses.

All this means that any CPU will have quite a large number of possible instruction codes just for the operations of loading the accumulator from memory or for storing the contents of the accumulator into memory. In general, different CPUs will have quite different binary codes for the same instruction — the only exceptions being the 8080 and the Z80, which share a large number of codes. This is the reason for using what are called mnemonic instructions — groups of letters which are shorthand for an instruction and which "translate" to a different binary code for each microprocessor. For example, the mnemonic (the m is silent, like the p in bathing!) LDI usually means LOAD IMMEDIATE, which on one CPU may be binary 11000100, and on another 10000110, but which will always mean the same thing to the user. An assembler is a circuit or program (to be described in Part 12) which does this "translation" automatically for a given CPU, so that the letters

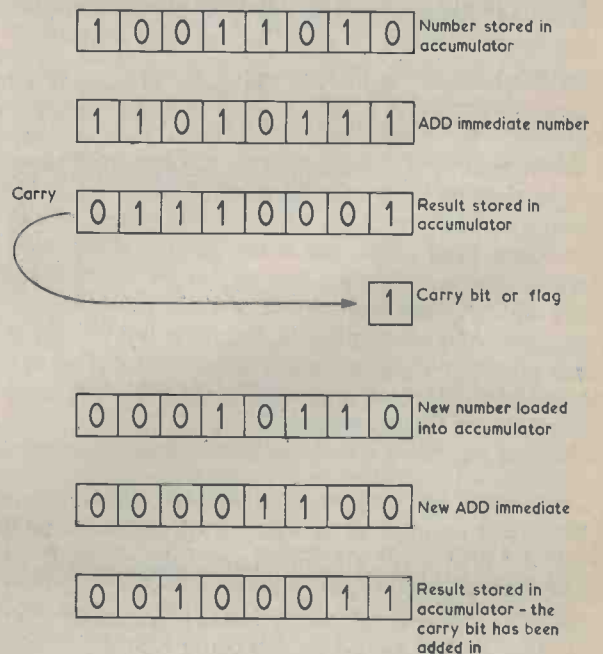

Fig. 3. The carry bit. An addition with a carry out of the eighth place causes the carry bit (or flag) to be set (to logic 1). This logic 1 is automatically added in to the least significant place of the next addition unless the carry bit is reset to zero by a program instruction

LDI could be tapped out on a keyboard which is connected to the assembler, and the correct binary code then is put out to the CPU.

INSTRUCTIONS

What else can be done using the accumulator? It's like asking what can be done with electricity! To start with, there will be a set of IMMEDIATE instructions, all of which must be followed in the program by a data byte. The instruction, ADD BINARY IMMEDIATE, for example, causes the byte that follows the instruction in the program to be added, bit by bit, to the byte that is already in the accumulator. The result of the addition is then held in the accumulator awaiting the next instruction. Sounds simple? It is, but there are complications. One is that when we add two eight-bit numbers, the result may very well need nine bits, and we can fit only eight bits into the accumulator. This problem is solved by using a bit from another register, called the status register. This bit, called the carry bit, is set to 1 if there is a carry from an addition; bits such as the carry bit are sometimes referred to as "status flags". When such a bit is at logic 1, we say that the flag is set. The reason for such a pictorial description is that this bit can't be ignored; it is part of the sum, so that its existence has to be signalled. If the addition is extended into a second byte, as it will be when we add two sixteen-bit numbers, the carry bit can be added in again (Fig. 3). There's another status flag, called OVERFLOW, which indicates another sort of carry-out — this one isn't so simple and we'll leave it for the moment.

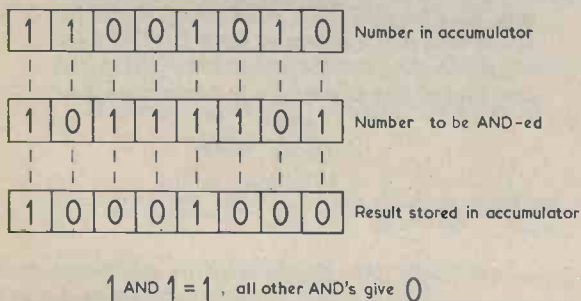
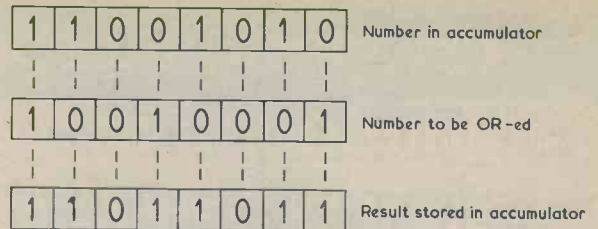

Fig. 4. The AND IMMEDIATE operation. Each bit of a byte in the accumulator is separately ANDed with the corresponding bit which is fed in from the memory place following the instruction. The result is stored in the accumulator

Staying with immediate instructions for now, we will find instruction codes for subtracting, AND-ing, OR-ing and XOR-ing the next data byte of the program with the byte that is already in the accumulator. Some CPUs also offer decimal addition, treating each byte as two decimal figures in BCD, and some Texas CPUs offer the luxury of multiply and divide instructions as well. In every case, though, when an IMMEDIATE number is added to, subtracted from, OR'd, AND'd or XOR'd with the number in the accumulator, the result is stored in the accumulator and the original number that was in the accumulator is lost, unless it exists somewhere



1 or 0 = 1, only 0 or 0 gives 0

Fig. 5. The OR IMMEDIATE operation. Each bit of a byte in the accumulator is separately ORed with the corresponding bit of the byte fed in from memory by the immediate instruction. The result is, as usual, stored in the accumulator

in memory. All the operations which are carried out by the instructions are carried out inside the CPU, using what is called a microprogram. A microprogram is a set of instructions built into the CPU, and not alterable in any way. For immediate addition, for example, the microprogram has to guide the bits stored in the accumulator and the bits read in from the program into an adder, then gate the result back to the accumulator, and place any carry bit into the status register. Microprogramming is an activity which is solely for the CPU designer, so don't be tempted to buy books on microprogramming under the impression that they deal with the programming of microprocessor systems!

USE OF MEMORY

There is also a set of instructions, similar to the IMMEDIATE instructions but involving the use of memory. We can, for example, add the byte contained in some memory location to the byte in the accumulator, storing the result in the accumulator as usual. The other operations of subtraction, AND, OR, XOR can also be carried out using bytes taken from memory rather than from program. As you might expect by now, the simpler CPUs will locate the correct memory address by using a displacement number, so that the number of the byte following the instruction is added to the number of the program counter or an index register. The more

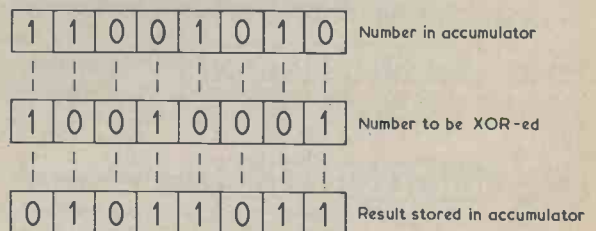

1 XOR 1 = 0 ; 0 or 0 = 0, all others 1

Fig. 6. The XOR IMMEDIATE operation. This is similar to the OR, but gives a zero result for 1 OR 1

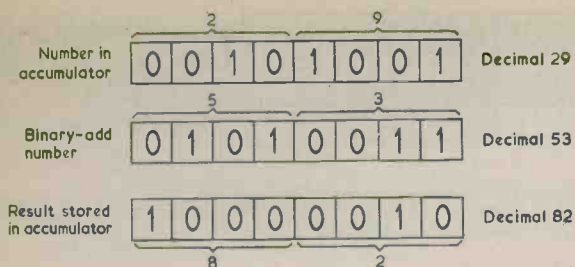

Fig. 7. BCD addition. Each byte is treated as two four-bit BCD numbers, so that the laws of addition are rather different from those used for binary arithmetic

complex CPUs will fetch a byte from memory using a memory address which has been loaded into the data register in two steps.

In addition (sorry about that!) all of these operations can be carried out using bytes loaded in from other registers and using, of course, different instruction codes. In every case, any carry from an addition will "set the carry flag" by dumping a 1 bit into the carry part of the status register. The carry bit may also be used in a subtraction operation. Are we finished yet? Not quite! There are two other sets of instructions which can be carried out on the accumulator — the shift and rotate instructions. SHIFT A one bit means just what it says, that each bit in the accumulator register is shifted by one place. Some CPUs allow only right shift, others permit left or right shift; a few allow another bit to be shifted in from another register, such as the carry bit from the status register to fill up the empty bit on one side of the register. The shift instruction is used in some CPUs as a method of shifting data out or in bit-by-bit; this is referred to as a serial input or output. Other CPUs need a separate chip to convert 8-bit bytes into serial outputs for recording or for displays.

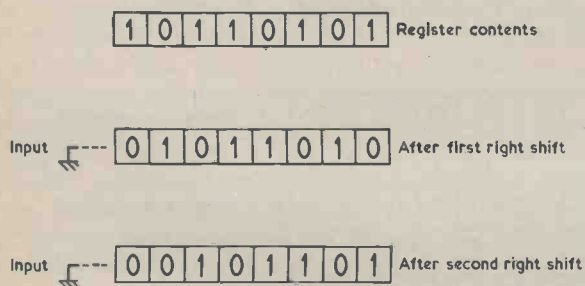

Fig. 8. A right-SHIFT operation. Each bit in the register is shifted by one place at each SHIFT instruction. Some microprocessors permit a new bit to be shifted in for an input, others simply allow a zero to be shifted in at each instruction

The rotate instruction is found on most CPUs — it means shift each bit along one place, and move the bit which "falls out" of one end of the register back into the other end of the register. A few CPUs allow only right rotation, others permit left or right rotation. Each type of rotation needs a different instruction, and only one step of shifting is carried out for each program instruction. No data byte needs to follow a shift or rotate instruction, and there is, of course, no displacement.

LOGIC UNIT

What does it all amount to? Well, this chapter shows how the microprocessor CPU can be used as

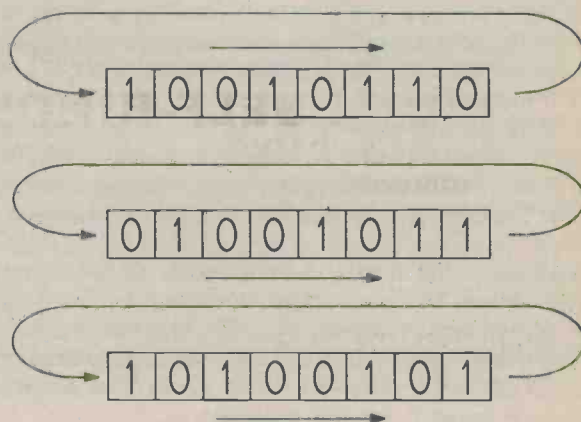

Fig. 9. The ROTATE operation. Each bit shifts one place along at each ROTATE instruction, and the bit which is forced out at one end of the register is fed into the other end

a universal logic unit. Operating on eight bits at a time, we can instruct the CPU to add, subtract, AND, OR and XOR. One set of bits to be operated on must be in the accumulator, the other can be in the program (using immediate instructions) or in a memory. By making use of the shift or rotate along with add or subtract, we can also devise programs (using blood, sweat and tears as well) to carry out multiplication and division in binary. Whatever combination or sequence of inputs we require to produce a desired output can be made to do so by a suitable program in ROM, rather than by wiring up logic chips.

There's one problem we haven't dealt with yet. Up to now, we've assumed that the CPU can mumble away to itself, crunching away at number bytes stored in program memory or in data memory (both, of course, might be in the same chip). If we're going to use the CPU for any logic jobs, we need some way of getting data in and out. That's for next time.

(TO BE CONTINUED)

RADIO & ELECTRONICS CONSTRUCTOR

Single Copies

Price 55p each, p&p 15p

Issue(s) required

Annual Subscription

Price £8.00 inland, £9.00 overseas (including Eire)

post free, commence with issue

Bound Volumes:

Vol. 27. August	1973 to July	1974	Price £3.00, post & pkg £1.05
Vol. 28. August	1974 to July	1975	Price £3.20, post & pkg £1.05
Vol. 29. August	1975 to July	1976	Price £3.50, post & pkg £1.05
Vol. 30. August	1976 to July	1977	Price £3.70, post & pkg £1.05
Vol. 31. August	1977 to August	1978	Price £5.20, post & pkg £1.05
Vol. 32. September	1978 to August	1979	In course of preparation

CORDEX SELF-BINDERS

With title, 'RADIO & ELECTRONICS CONSTRUCTOR' on spine,
maroon only

Price £1.95, post & pkg 45p

With no title on spine, maroon

Price £1.95, post & pkg 45p

With no title on spine, green

Price £1.95, post & pkg 45p

Prices include V.A.T.

DATA BOOK SERIES

DB5 TV Fault Finding, 132 pages Price £1.20, P. & P. 22p

DB6 Radio Amateur Operator's Handbook,
New edition in course of preparation

DB17 Understanding Television, 504 pages Price £3.95, P. & P. 80p

DB19 Simple Short Wave Receivers Price 80p, P. & P. 22p
140 pages

STRIP-FIX PLASTIC PANEL SIGNS

Set 3: Wording — White — 6 sheets Price £1.00, P. & P. 9p

Set 4: Wording — Black — 6 sheets Price £1.00, P. & P. 9p

Set 5: Dials — 6 sheets Price £1.00, P. & P. 9p

Prices include V.A.T.

I enclose Postal Order/Cheque for in payment for

NAME

ADDRESS

(BLOCK LETTERS PLEASE)

Postal Orders should be crossed and made payable to Data Publications Ltd.

Overseas customers please pay by International Money Order.

All publications are obtainable through your local bookseller

Data Publications Ltd., 57 Maida Vale, London W9 1SN

PLEASE MENTION THIS MAGAZINE WHEN WRITING TO ADVERTISERS

WIRE GAUGE MEASUREMENT

By C. P. Finn

Finding wire diameter without a micrometer.

There are many occasions when the constructor needs to find the diameter of a piece of copper wire but does not have a micrometer screw gauge. The author originally described the measurement method to be discussed here, which requires only a flat household ruler and a small strip of wood, in the December 1966 issue of this journal. This previous article dealt with s.w.g. sizes only but, since those days, metrication has arrived and wire is now gauged in millimetres according to a new British Standard, BS 4391. In consequence the measurement method has been updated and revised, and the present article applies to the new metric wire sizes whilst still including details of the earlier s.w.g. sizes.

THE METHOD

A small sample, say 50mm., of the wire to be measured is cut off and bent into an 'L' shape. The longer arm of the 'L' is sandwiched between the ruler and the strip of wood, as shown in the accompanying diagram. The wire is placed over one of the main divisions of the ruler with the short projecting arm pointing downwards.

With the aid of the wood strip, the wire is then rolled along the ruler for a convenient distance (say 10mm. or 50mm.) and the number of turns and part turns through which the wire passes is counted by observing the protruding arm of the 'L'.

From this number, and the distance travelled, the diameter of the wire may be readily calculated from the equation:

$$d = \frac{D}{\pi N}$$

STANDARD WIRE SIZES				
IMPERIAL		METRIC		
S.W.G.	Dia. mm.	First Choice (R10 Series) Dia. mm.	Second Choice (R20 Series) Dia. mm.	N (D)
45	.071	—	.071	45 (10)
44	.081	.080	—	40
43	.091	—	.090	35
42	.102	.100	—	32
41	.112	—	.112	28.4
40	.122	.125	—	25.5
39	.132	—	.140	22.7
38	.152	.160	—	19.9
37	.173	—	.180	17.7
36	.193	.200	—	15.9
35	.213	—	—	—
—	—	—	.224	14.5
34	.234	—	—	—
33	.254	.250	—	12.7
32	.274	—	.280	11.4
31	.294	—	—	—
30	.315	.315	—	10.1 (10)
29	.345	—	.355	44.8 (50)
28	.376	—	—	—
27	.417	.400	—	39.8
26	.457	—	.450	35.4
25	.508	.500	—	31.8
24	.559	—	.560	28.4
23	.610	.630	—	25.3
22	.711	—	.710	22.4
21	.813	.800	—	19.9
20	.914	—	.900	17.7
19	1.02	1.00	—	15.9
—	—	—	1.12	14.2
18	1.22	1.25	—	12.7
17	1.42	—	1.40	11.4
16	1.63	1.60	—	10
15	1.83	—	1.80	9
14	2.03	2.00	—	8 (50)

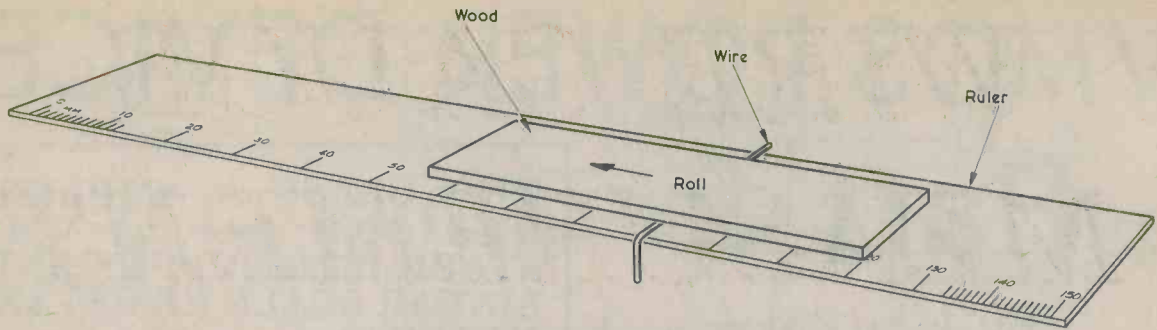

Setting up the wire for diameter measurement. All that is required is to roll the wire along the ruler for a fixed distance and observe the number of revolutions it makes

where d is the diameter of the wire, D is the distance rolled and N is the number of turns made. Both d and D are in mm.

In many cases the wire will be enamelled and will in consequence have a diameter slightly greater than the bare copper wire to which the enamel is applied. In the writer's experience the effect of the enamel thicknesses, in most instances,

is to increase the overall diameter by not quite one 'gauge'. For example, a 0.400mm. wire with an enamel coating may measure about 0.440mm.

For convenience, a table is given showing the comparison between the old s.w.g. sizes and the metric wire diameters (as per BS 4391) together with the calculated values for N , using D as 10 or 50 as appropriate.

CAN ANYONE HELP?

Requests for information are inserted in this feature free of charge, subject to space being available. Users of this service undertake to acknowledge all letters, etc., received and to reimburse all reasonable expenses incurred by correspondents. Circuits, manuals, service sheets, etc., lent by readers must be returned in good condition within a reasonable period of time.

Ferrit Rod Assembly — P.W. "Regency" — R. S. Philpotts, 75 Church Street, Highbridge, Somerset TA9 3HT — To purchase.

'Radio Constructor' May 1968 — D. M. Wallace, 23 Lyndon Head, Sandridge, St. Albans, Herts — To borrow or purchase.

Bennson CR2 1977 Car Radio — R. L. J. Windley, 88 Rugby Road, Binley Woods, Coventry CV3 2AX — Circuit or Manual to borrow or purchase.

French Communication Rec. RMH7B Ser.No.R/37 — L. A. Pearce, 2 The Ridgeway, Fleetwood, Lancs — Circuits and other details needed on loan, all expenses paid.

Jennings Organ, Model No. J1500 and Car Radio Marc NR47F6 — J. S. Fazackerley, 75 Queens Avenue, Kidlington, Nr. Oxford, OX5 2JJ. Circuit diagrams required.

Cyclops article 'R.&E.C.' September 1972 — M. Clemence, Old School House, Moor Road, Bestwood Village, Notts. NG6 8TL — Copy required.

'R.&E.C.' June 1972 issue — M. Levers, Haywin, Independent Hill, Alfreton, Derbyshire — To buy or borrow issue.

Circuit for dropping 240V a.c. to 110V a.c. for 1500W appliance, without use of transformer — J. M. R. Kennelly, 14 Southbourne Drive, Bourne End, Bucks SL8 5RZ — Circuit or information required.



Please mention Radio & Electronics Constructor when replying to advertisements

VMOS POWER DEVICES

Part 2

By John Baker

TWO CLASS A AMPLIFIER DESIGNS — A VMOS STABILIZED SUPPLY AND A LINEAR SCALE RESISTANCE METER.

In last month's article we described the basic operation of VMOS devices in the VN46AF, VN66AF and VN88AF range, and showed how they can be particularly useful in switching applications where they are driven by circuits having low output current capability. They can, for instance, be driven directly by CMOS logic. We look next at the use of VMOS transistors in audio amplifier output stages.

CLASS A AMPLIFIER

VMOS f.e.t.'s are perfectly suitable for linear circuits and are not restricted to switching applications. Their fast operating speed permits their use in r.f. as well as a.f. amplifiers. Apart from the three devices just mentioned, there are JUGFET depletion VMOS transistors such as the 2SJ50 (p channel) and the 2SK135 (n channel) which are specifically intended for use in a.f. amplifying applications, and these two devices can be used as complementary output transistors in high power very high quality audio equipment. Unlike high power bipolar transistors, which tend to have rather low cut-off frequencies and may thereby introduce slewing distortion, the VMOS

transistors have high operating speed and consequently high slew rates. However, amplifiers incorporating the 2SJ50 and 2SK135 are rather complex and expensive, and fall outside the scope of this present article, which is intended to deal with simpler applications.

The circuit of a Class A amplifier using a VMOS transistor in the output stage is shown in Fig. 4. TR3 is a common source output transistor having a constant current load formed by TR1, TR2, R5 and R6. It is driven by a Texas JFET operational amplifier which gives low levels of noise and distortion. (The TL081CP is pin compatible with the 741, and the pin numbers shown in the diagram are for an 8 pin device). R4 and R1 provide negative feedback between TR3 drain and the non-inverting input of IC1, and they set the closed loop gain of the amplifier at about 12 times. C3 is a d.c. blocking capacitor. Note that the feedback is taken to the non-inverting, and not the inverting input of IC1; this is because of the phase inversion in TR3. R7 and R3 bias the circuit and keep the quiescent output voltage central between the supply rails, and they are fed from the positive rail via the decoupling network consisting of R2 and C6. The

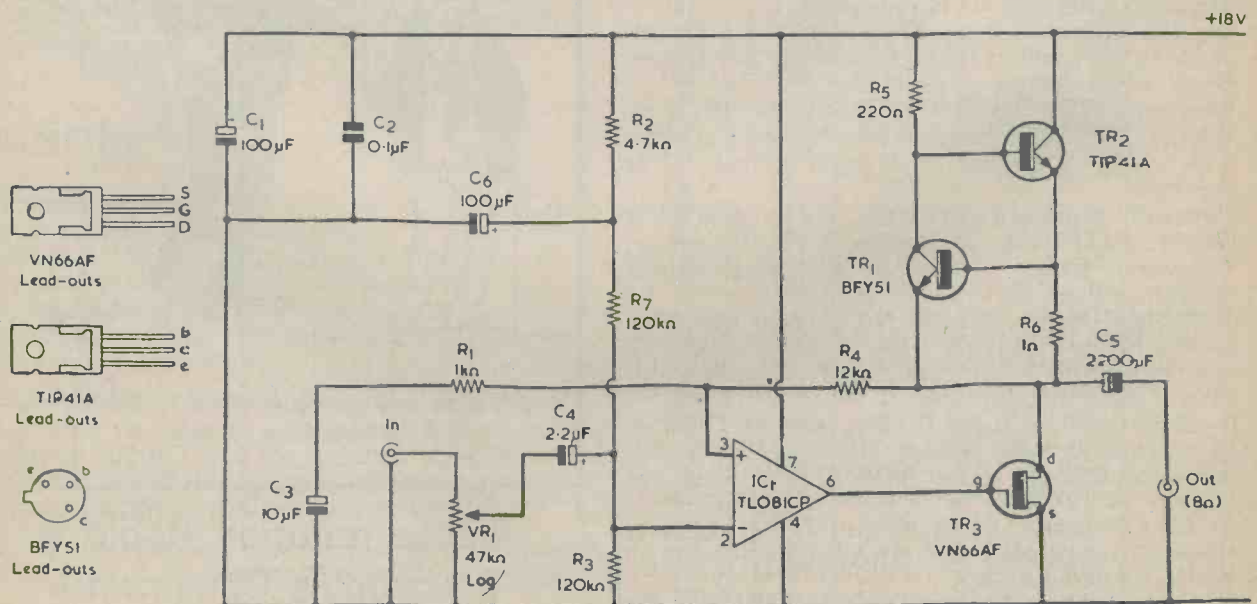

Fig. 4. Class A a.f. amplifier incorporating a VMOS transistor in the output stage. All resistors are $\frac{1}{4}$ watt with the exception of R6, which should be a 1 watt component

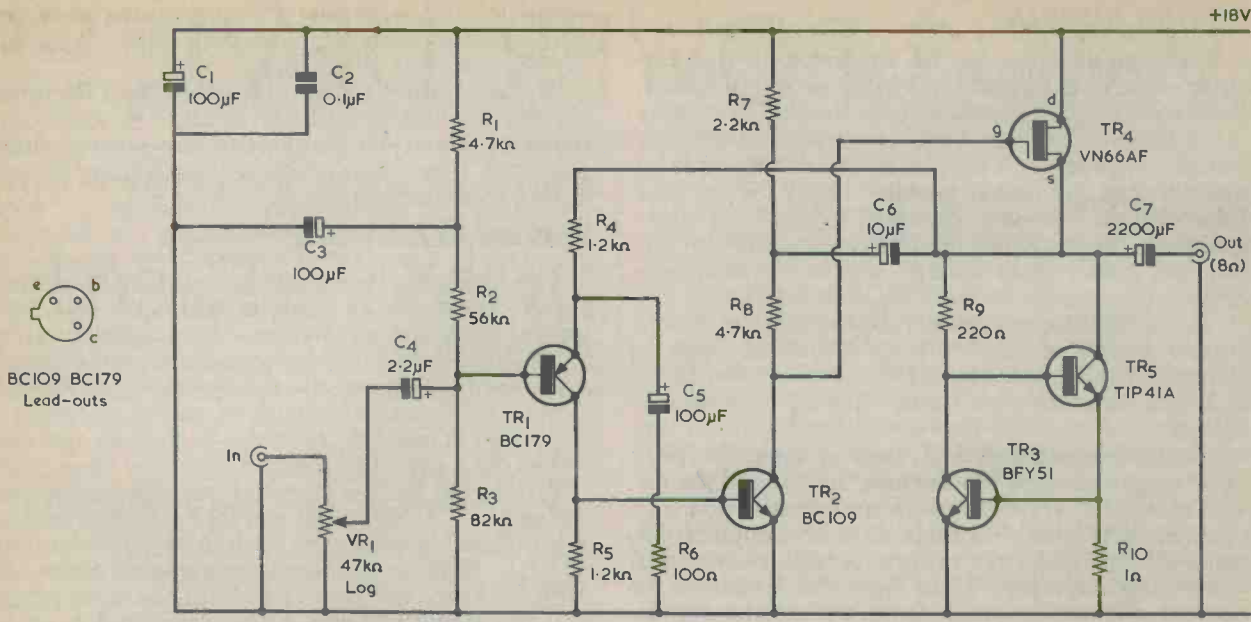

Fig. 5. In this a.f. amplifier the VMOS device functions as a source follower output transistor. Again, all resistors are $\frac{1}{4}$ watt except for the 1 Ω resistor, R10, which should be 1 watt

network gives the circuit good rejection of hum and noise on the supply lines.

The amplifier has a current consumption of about 700mA, and gives an output of 2.7 watts r.m.s. (4 watts peak). The input impedance is of the order of 25k Ω and approximately 375mV r.m.s. is required at the input to produce maximum output. The distortion is less than 1% up to the onset of clipping, whereupon the distortion rises rapidly. It should be noted that TR2 and TR3 require substantial heatsinking. The heat tab of TR3 is connected internally to its drain.

SOURCE FOLLOWER

An obvious application for a VMOS device in an a.f. amplifier output stage is as a source follower, where its very high input impedance and large current drive capability can be readily put to use. The VMOS device has the disadvantage, however, of having a substantial voltage drop of some 4 to 6 volts from its gate to its source when it is employed in this way. This is, of course, considerably higher than the voltage drop from input base to output emitter of an emitter follower stage employing two or even three bipolar transistors.

With the a.f. amplifier application this large gate to source voltage drop need not be too much of a problem, as bootstrapping can be used to effectively increase the drive voltage to the gate. Bootstrapping is employed in the a.f. amplifier circuit shown in Fig. 5, which has a performance similar to that of Fig. 4, apart from the fact that the input impedance is slightly lower. TR4 is the source follower transistor with a constant current circuit as its source load. TR1 and TR2 are in a conventional two stage common emitter direct coupled circuit, with R4 providing 100% d.c. negative feedback from the output source to TR1 emitter. At a.f., capacitor C5 exhibits a low impedance and brings R6 into the feedback loop, giving an overall a.f. gain of about 12 times. R2 and R3 bias the input voltage, with R1

and C3 decoupling the supply to these two resistors.

The bootstrapping is provided by giving TR2 a split collector load, R7 and R8, and coupling the output to the junction of these two resistors via C6. The junction of the resistors is taken more positive on positive output excursions, and on large excursions will actually be taken positive of the positive supply rail. This gives the required high drive voltage for TR4 gate, and gives a considerable improvement in the performance of the amplifier as compared with a circuit which does not include bootstrapping. Again, TR4 and TR5 require substantial heatsinking.

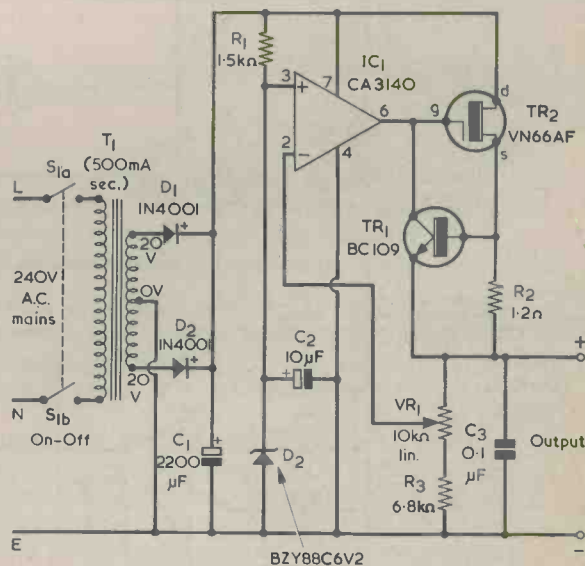

Fig. 6. Variable voltage power supply with a maximum output current rating of 500mA. The gate of TR2 imposes virtually no loading on the output of IC1. R1 and R3 are $\frac{1}{4}$ watt and R2 is $\frac{1}{2}$ watt

drain voltage goes positive until the circuit stabilizes with the same gate voltage as occurred before. This is because that voltage is the gate voltage needed to cause the drain to pass the constant current. The drain voltage is then controlled by the potential divider consisting of the test resistor and the resistor switched into circuit by S1, and the increase in drain voltage will be directly proportional to the value of the test resistor. The increase in drain voltage is indicated in the meter. R7 is adjusted so that the meter indicates full-scale deflection when the resistor under test is equal in value to the range resistor selected by S1. It only needs to be set up with one test resistor and on one range as its setting will then be accurate for all the other ranges. (After the circuit has been assembled R7 should be adjusted so that it always inserts maximum resistance into circuit. The resistance it inserts is only reduced when the time comes for it to be adjusted, as just described, for full-scale deflection in the meter). After R7 has been set up the circuit functions as a linear scale resistance meter with a zero meter indication corresponding to zero test resistance and an f.s.d. reading corresponding to a test resistance equal to the range resistance selected by S1.

A slight flaw in the circuit design is that part of the constant current from TR2 and TR3 flows through the test resistor and the selected range resistor. Since the current passed by these resistors varies with different test resistors and on different ranges there is a corresponding change in the

nominal constant current which has to be passed by the drain of TR1. This problem is reduced to an insignificant level by making the constant current from TR2 and TR3 large in relation to the highest current drawn by the test and range resistors.

The range resistors should, preferably, have a low tolerance on value. S1 should be a 5-way rotary switch having a make-before-break action to ensure that TR1 gate is always coupled to the negative rail by one or more of the range resistors.

The resistance meter requires a very stable supply voltage, and this is provided by two 9 volt batteries in series connecting to a 12 volt monolithic voltage regulator. Any 12 volt negative earth type regulator is suitable. It is found that the circuit has good thermal stability, whereupon the set zero control, R9, can be a pre-set type and does not have to be a panel control. If power is applied to the circuit with no test resistor connected the meter is deflected beyond f.s.d. with the needle pressing against its end-stop. Over a period of time this could damage the meter, although it would have no effect in the short term. The instrument therefore has a non-locking push-to-make press button as the on-off switch. This is only operated when a test resistor has been connected into circuit and a reading is required, and it ensures that the meter is not overloaded for long periods.

(Concluded)

BOOK REVIEW

T.V. REPAIRS MADE EASY. Edited by F. C. Tunbridge, B.Sc. 146 pages, 245 x 190mm. (8½ x 7½ in.). Published by TV Technic Publications.

Price £5.30 inclusive of postage & packing

This book gives servicing details for specific faults in Korting hybrid Supermatic and Vienna television receivers, Korting transistorised television receivers (including precision-in-line tube and delta-gun tube models), Kuba Florence television receivers, Grundig 5010 and 6010 television receivers and Zanussi 110 degree television receivers.

The information given will be of value to service engineers handling these particular sets. Each fault symptom (e.g. "Too Much Red", "No R-Y", "Striations") is followed by detailed instructions stating the component or components to suspect, together with any other information, such as voltages, etc., which will assist in locating the fault.

It is expected that engineers employing the book will use full size circuit diagrams as given in service manuals, but the publishers state that due to requests from their readers they have decided to include circuit diagrams in this book. They explain that the diagrams are difficult to reproduce when reduced to book format size. This has proved to be the case and whilst some of the diagrams in the book resolve small details such as component values clearly other diagrams do not.

The address of the publishers is 76 Church Street, Larkhall, Lanarkshire, ML9 1HE.

Radio Topics

By Recorder



It had to happen.

By the time these notes appear in print almost everybody will be aware that the new CMOS version of the 555 timer i.c. is with us. This, the ICM7555, is pin-compatible with the old bipolar 555, uses the same formulae for frequency and timing cycle in the astable and monostable configurations, but draws currents (apart from output sink and source currents) which are measured in microamps rather than milliamps.

Indeed, one has to think seriously about the current drawn by the timing resistors, when compared with the very low currents drawn by the ICM7555. If, in the astable mode, the upper timing resistor is $100k\ \Omega$ and the device is producing a near square wave, the current drawn by that $100k\ \Omega$ resistor on its own is at least $50\ \mu A$ with a 10 volt supply, which is comparable with that drawn by the device itself.

So, out goes the poor old 555. When did it first appear? The i.c. was originally introduced by Signetics, and my Signetics data book on it is dated 1973. At a rough guessimate, therefore, the first 555's were appearing around late 1972, whereupon its useful unchallenged life has been about seven years.

Seven years is a long time in electronics.

S.R.B.P.

There must always be newcomers to any hobby. Inevitably, they find difficulty in understanding terms and methods of functioning which the more experienced take in their stride.

One recent query we received was concerned with the term "s.r.b.p." What in heck, our reader asked, is s.r.b.p.? The answer is that "s.r.b.p." is the present unlovely

description for what used to be known by trade-names such as "Paxolin". Indeed, you may still occasionally find it referred to as "paxolin". Indeed, you may still occasionally find it referred to as "Paxolin" now and again. The letters stand for "synthetic resin bonded paper", and it is the brown insulating material which is used in Veroboard, in most tag strips and tag boards, and in most printed circuits.

Another indigestible pill for beginners is the direction of flow of an electric current. After having learnt at school that an electric current consists of a flow of electrons moving from negative to positive, the newcomer finds that electronic texts refer to current as flowing from positive to negative. Surely something must be wrong here?

Something is indeed wrong, and the error dates from the early days of electricity. In those times nobody had even heard of electrons, but they did know that they could make up electric cells and batteries of which one terminal produced one sort of electricity and the other produced another sort of electricity. Connect the two terminals together and a current flowed. An arbitrary decision was made to name one terminal of a cell or battery "positive" and the other "negative". No problems so far. Next to be settled was the direction in which electric current flowed. Their luck here was equivalent to mine with a one-armed bandit, and they chose precisely the wrong direction. From positive to negative.

All subsequent engineering work proceeded on this assumption and, when the mistake was eventually brought to light, it was too late to set things right and alter all the work that had been done.

You see, so far as mathematical treatments of the effect of current

are concerned, it doesn't matter if you *are* working to an incorrect conception of the direction of current flow provided you stick to that conception all the way through. Nevertheless, it can be irritating at times, as when one sees that current consists of actual electron movement (say, from the negative cathode to the positive anode of a cathode ray tube) to still keep referring to current as flowing from positive to negative. We ratify the situation as best we can by describing the supposed flow from positive to negative as "conventional current" flow. The term "conventional" arises because the convention is accepted that the flow is from positive to negative.

VERO TRANSFORMERS

Did you know that Vero Electronics supply mains transformers? They certainly do and two of them, standing on the odd sheet of Veroboard (what else?), can be seen in the photograph.

These transformers are competitively priced high quality components, conforming with BS2214. All the transformers are fitted with full shrouds and are varnish protected. The primary consists of two 120 volt windings which may be connected in series or in parallel for operation at 50 or 60Hz. There are also two secondary windings on each transformer, again suitable for series or parallel working. Various output voltages from 0-3 to 0-20 are available within a range from 1.2VA to 50VA.

Further details on the transformers, which are handled by the Verospeed branch of Vero Electronics, are contained in the current catalogue available direct from Verospeed, Barton Park Industrial Estate, Eastleigh, Hampshire, SO5 5RR. Enquiries about the transformer should quote the reference "Transformers AB 075".

RH AND TEMPERATURE

The neat and unusual looking instrument in the second photograph measures RH (relative humidity) and temperature. Introduced by Kane-May Instrumentation, this pocket-sized instrument has the type number KM 5001.

Kane-May consider that this hand-held digital instrument, offering the benefit of RH and temperature readings in one unit, is a valuable tool in the field of humidity

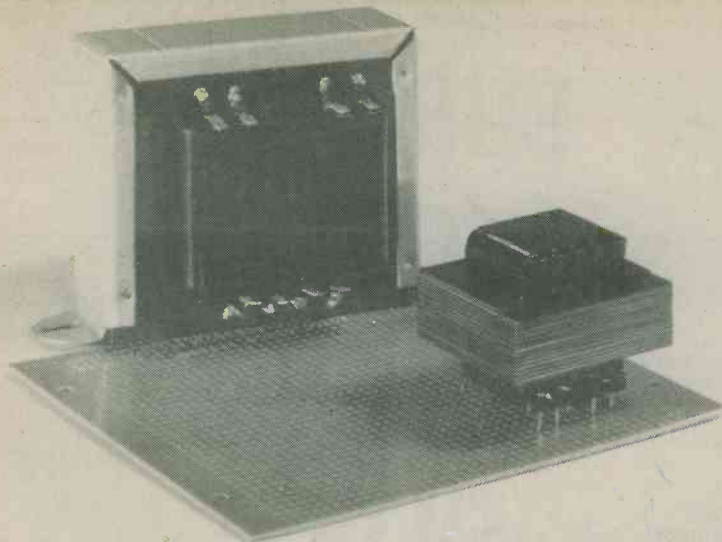

Two of the range of Verospeed mains transformers which are currently available. Suitable for 50Hz or

60Hz, the primaries consist of two 120 volt windings which may be connected in series or in parallel

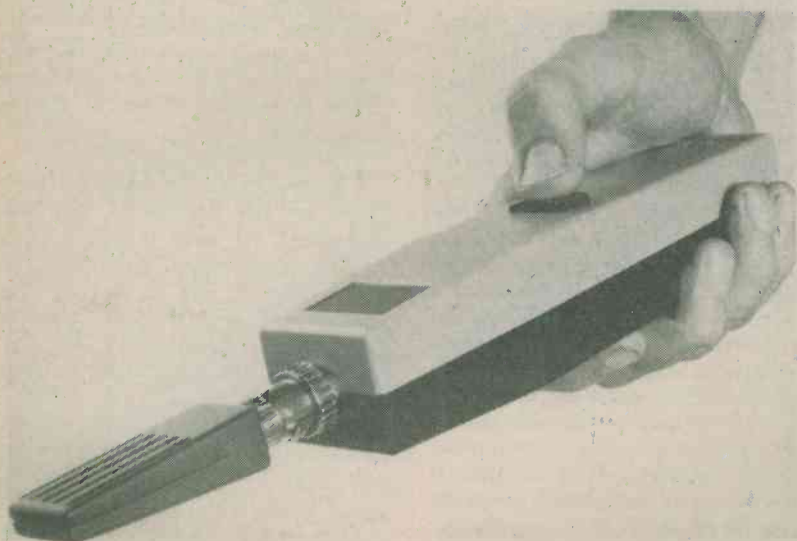

Humidity and temperature measurement in the palm of your hand. This RH and temperature measuring instrument is pocket-sized and offers readings of high accuracy by way of a digital readout

ty measurement. Weighing only 250 grams, the KM 5001 measures RH from zero to 100% with a resolution of 0.1% and an accuracy of 2%. The temperature range is from -10 to 95°C, with a resolution of 0.1°C and an accuracy of 0.5°C. The rectangular window at the end near the sensor contains a 3-digit l.e.d. display with a character height of 7.6mm. There are connection arrangements which allow for

greater flexibility in the positioning of the sensor.

The manufacturers, Kane-May Limited, Burrowfield, Welwyn Garden City, Herts, have world-wide outlets for their existing range of pocket thermometers and other temperature measuring devices, as well as instruments for the measurement of pH and rotary motion.

MORSE IMPROVEMENT

C90 Cassettes (A) 1-12 w.p.m. with simple exercises. Suitable for R.A.E. preparation. (B) 12-24 w.p.m. computer produced professional level operator material including international symbols.

Price each: complete with instruction and exercise booklets **£4.75** including postage. Morse Key and Buzzer Unit suitable for sending practice and DIY tape preparation.

Price **£4.75** including postage
Overseas Airmail **£1.50 extra.**

MHEL ELECTRONICS (Dept. R)
12 Longshore Way, Milton,
Portsmouth (UK), PO4 8LS

THE MODERN BOOK CO.

Largest selection of English & American radio and technical books in the country

19-21 PRAED STREET
LONDON W2 1NP
Tel: 01-402 9176

SAVE MONEY!

*** NOW ON ***
CASSETTE TAPES

ACADEMY C60 - Super-Low Noise/Hi-output, Cassette Tapes (Ferric Oxide) 2 x 30 mins, Recording/Playing time - 5 for **£3.00** P&P included

A.T.Z. C60 - 'Chromium Dioxide' very Low Noise/Hi-output, Cassette Tapes of high quality 2 x 30 mins, Recording/Playing time 5 for **£5.00** P&P included

Buy now at lower than pre-Budget prices

SIGTRONIC ELECTRONICS
27 Malvern Street, Stapenhill
Burton-on-Trent, Staffs. DE15 9DY

PEATS for PARTS
ELECTRONIC COMPONENTS
RADIO & TELEVISION
For the convenience of Irish enthusiasts we supply:

Radio & Electronics
Constructor Data Books
Panel Signs
Transfers

Also a postal service

PEATS
the world of electronics
25 Parnell Street, Dublin 1. Telephone 749972

In your work -shop

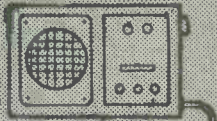

SURFACE ACOUSTIC WAVE FILTERS

"Smithy."

"Hallo!"

"What do you think is the worst thing that has arisen from modern technology?"

Smithy surveyed the contents of his disreputable tin mug. Even he had quaffed sufficient tea to satisfy his post-lunchtime thirst.

"The worst thing?" he repeated.

"Shopping bags on wheels!"

"What?"

"Shopping bags on wheels," repeated Smithy firmly. "I've only got to venture down our local High Street to get a little shopping done and I am immediately assailed on all quarters by shopping bags on wheels. Horrible tatty things they are, with nasty clattering little wheels."

"Come on, Smithy. Be serious."

"I *am* being serious. As soon as any woman trundling one of those bags spots me the light of battle gleams in her eyes like a beacon." A tone of bitterness entered his voice. "They've all got the same technique, you know; they go for the ankles every time. Those shopping bags are scaled-down versions of the old Roman chariots which had knives sticking out of the wheel centres. Only the bags haven't got knives, they've got bits of sharpened wire poking out at ankle height instead. If it wasn't for fast footwork on my part I'd have had my ankles stripped down to the bone scores of times before now."

Dick sighed.

"All right then," he said, "think of

some of the good things that have come out of technology."

Smithy pondered.

"Well," he said eventually, "there are all manner of good things coming up all the time. New integrated circuits, improved types of testmeter, Teletext transmissions, precision-in-line colour TV tubes. All sorts of things."

Not for the first time, Dick reflected on Smithy's way of life. So far as he could see, Smithy existed solely for the servicing of electronic equipment, sallying forth into the dangerous outside world only when sustenance was necessary to maintain that existence. A scene arose in his mind of a future Smithy, slowly and gradually being transformed without resistance into a potential decay until on completion of his life cycle he shuffled off his mortal coil, to be received into that great big Workshop up in the sky.

SAW FILTERS

"Quite an exciting new development has come out recently," remarked Smithy, obviously continuing his review of the latest good things to arise out of technology, "and that is the SAW television i.f. filter."

Dick pricked up his ears.

"What's that?"

"It's a new frequency selective device for the i.f. stages of a TV set. One SAW filter can replace nearly all, if not all, the i.f. tuned circuits in a television receiver, and it doesn't

have any inductive or capacitive parts whatsoever."

"Blimey, that *is* new! What does the word 'SAW' mean?"

"The three letters stand for 'surface acoustic wave'. Sometimes the filter is referred to as a 'surface wave filter'."

"How does it work?"

Smithy looked at the avid expression on his assistant's face and grinned. "If ever there's anyone who's completely committed to electronics it has to be you. I've never met anybody who asks as many questions about it as you do."

"What, *me* committed to electronics?" replied Dick, astounded. "I just have a passing interest in electronics, that's all. Give me some gen on these SAW filters, Smithy!"

"Oh all right," chuckled Smithy. "Well, to start off with, a SAW filter is fitted in the i.f. stages of the new Ferguson colour receiver type TX9. This filter is in the Plessey SW150 range. I'm rather surprised you haven't heard about it, incidentally, because there's been plenty of publicity about it in the trade press. Basically the SAW filter idea is fairly simple although there must have been a fantastic amount of development complications involved in getting it to work in practice. Come on over here and I'll see if I can show you how it works."

As Dick picked up his stool and carried it over to Smithy's bench the Serviceman pulled a ball-point pen out of his breast pocket and drew his note-pad towards him. With

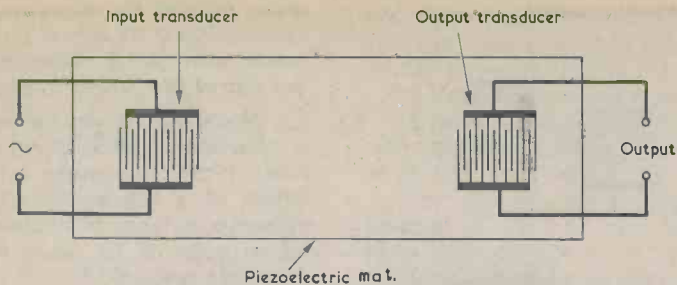

Fig. 1. Theoretical concept to introduce SAW filter functioning. Surface waves produced in the piezoelectric material by the alternating signal at the input transducer travel to the output transducer where they are reconverted to an electrical signal. The amplitude of the surface waves is much greater at one frequency than at other frequencies

Dick watching, he proceeded to draw out a sketch. (Fig. 1.)

"What we have here," said Smithy, when the sketch was completed, "is a flat piece of piezoelectric material on which have been deposited two grids of thin interleaving metal electrodes, or lines. We can refer to one grid as the input transducer and the other as the output transducer. If we apply an alternating signal to the input transducer the surface of the piezoelectric material will be deformed physically in sympathy."

"Would that be the same sort of effect that you have in a crystal earphone?"

"Roughly. The earphone has a piezoelectric crystal in it which changes shape in sympathy with the a.f. signal applied to it and reproduces the signal as sound. Which is, of course, the piezoelectric effect. Now, on the piece of piezoelectric material I've just drawn the physical distortions in the material caused by the alternating voltage at the input travel along the surface like ripples along the surface of a pond. However, they do not travel out in circles but move in two broad bands at right angles to the lines in the input transducer grid. Like this."

Smithy added arrows to his sketch. (Fig. 2.)

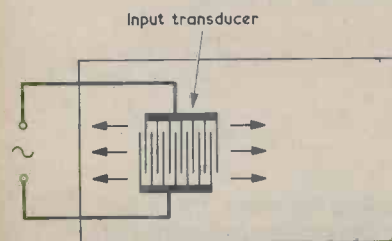

Fig. 2. The surface waves generated by the input transducer travel out at right angles to the lines of the transducer grid

"These waves," he went on, "travel along the surface of the piezoelectric material at a constant velocity. Let us for the time being assume that all the metal lines in the input transducer have the same length and that there is equal spacing between them. Now, if you think about it you can visualise that there must be one input frequency at which the amplitude of the surface waves is considerably higher than at all other frequencies. This will be given when each grid line produces a surface distortion which, after travelling to the next grid line connected to the same input terminal, finds itself subject to the same distortion all over again. All of the grid lines are producing waves which are in phase as the waves travel along inside the grid itself."

"That's the same as soldiers going over a bridge," stated Dick suddenly.

"I beg your pardon," said Smithy, puzzled.

"Soldiers are supposed to break step when they cross over a bridge," explained Dick. "If they march in step over a weak bridge it is possible for them to all put their feet down at a frequency at which the bridge has a mechanical resonance, whereupon the bridge could break up!"

"Well," said Smithy dubiously, "that isn't exactly similar to what goes on at the SAW filter input transducer, but I will agree that a large resonance can be produced by a lot of individual small excitations when they are all in phase. In the surface acoustic wave filter the deciding factors are the velocity of the surface wave and the spacing between the lines of the input transducer. At the frequency at which each transducer line augments the disturbances produced by the other transducer lines there is a dramatic increase in the

amplitude of the surface waves travelling away from the transducer grid on either side. It's not exactly a resonance as you have in a tuned circuit, but the effect is almost the same as a resonance."

OUTPUT TRANSDUCER

"Do these surface waves travel across the surface of the material to the output transducer?"

"They do," confirmed Smithy. "When they reach the output transducer the reverse piezoelectric effect takes place and they cause voltages to be produced in the lines of the output transducer grid. If the lines in this grid have exactly the same length and spacing as those in the input transducer grid a second quasi-resonant effect will take place, with in-phase voltages being produced in the lines as the surface waves travel under them. The overall result is that the output signal given by the second transducer has been through not one but two frequency selective mechanisms."

"Stap me," breathed Dick, "that's crafty. There must have been some real development work required to get these TV i.f. filters up to a stage where they could be mass-produced in quantity."

"There very definitely has been," agreed Smithy. "Manufacturers have been working on SAW filters for the last ten years at least, and these filters have become well established in military equipment. But it's only now that they've advanced to the very sophisticated level at which they can be used as TV i.f. filters. As I've described the SAW filter up to now I've said that the lines in the input and output transducer grids all have the same length. In practice the response is doctored to that required for a television i.f. filter by having differing lengths of line in the input transducer grid. Another problem which has had to be overcome is the fact that, as well as producing waves which pass along the surface of the piezoelectric material the input transducer also produces waves which pass through the body of the material as well. These are prevented from reaching the output transducer by shifting that transducer to one side, out of the way of the output from the input transducer."

Dick frowned.

"I don't get that," he remarked. "If you shift the output transducer to one side it won't receive the surface waves either."

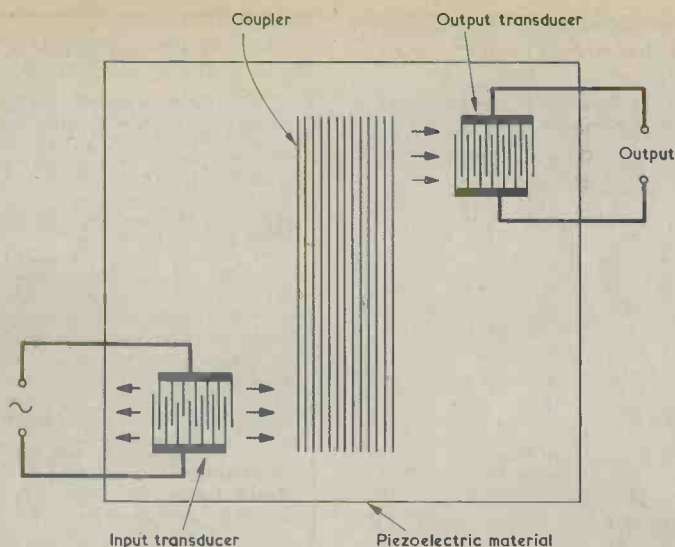

Fig. 3. To prevent it being affected by waves passing through the body of the piezoelectric material, the output transducer is displaced to one side. Coupling is then effected by way of a grid of parallel lines of metal deposited on the surface of the material

Smithy became busy with his pen once more. (Fig. 3.)

"That problem," he said, "is resolved by adding a coupler between the input and output transducers. This is done in the Plessey device and it consists of a number of equally spaced lines of metal deposited on the surface of the piezoelectric material like this. The coupler grid picks up the surface wave from the input transducer and then redirects it to the output transducer. Waves passing through the body of the material pass under the coupler and are not picked up by it."

"This," said Dick, "is getting rather complicated."

"We haven't finished yet," replied Smithy cheerfully. "One big difficulty is to get rid of surface wave paths between the input and output transducers other than the required one by way of the coupler. The first thing to attend to here is the band of surface waves from the input transducer which, in my sketch, passes out to the left of that transducer. These are taken up by a special absorbent mounting material at the edge of the piezoelectric material. Other techniques are used to ensure that there are no other edge reflections which could cause unwanted couplings between the input and output transducers."

Dick slowly absorbed this information. A thought suddenly occurred to him.

"Why," he asked, "do they call them *acoustic* filters?"

"Because," replied Smithy, "the surface wave travels across the piezoelectric material at a relatively slow speed which is more in keeping with an acoustic coupling than it is with an electronic coupling."

Dick frowned.

"Doesn't the wave pass almost instantaneously from the input transducer to the output transducer?"

"Oh no," said Smithy. "Speaking in electronic terms it takes quite a long time. With the Plessey SAW filter, the wave takes about 1.6 microseconds to travel from the input to the output. This raises further design factors."

CAPACITIVE COUPLINGS

"Such as?"

"Stray capacitive couplings between the input and output terminals of the filter. These have to be kept to an absolute minimum. If there is a sufficiently strong capacitive coupling, this will pass on to the output a signal which is 1.6 microseconds ahead of the signal

going through the filter, and it will cause a ghost to appear on the TV screen which is 1.6 microseconds to the *left* of the proper image."

"Would that be very noticeable?"

"Definitely," stated Smithy. "Off-hand, I can't remember what the length of a line in the 625 line system is, in terms of microseconds. Is our copy of *TV Fault Finding* anywhere around?"

"It's on my bench," volunteered Dick.

He hurried to his bench and returned with the battered Workshop copy of *TV Fault Finding*. Smithy took it from him and consulted the first few pages.

"Ah, here we are," he remarked brightly. "This book tells us that the total line period in the 625 line system is 64 microseconds, of which 12 microseconds are taken up by the line blanking period, leaving 52 microseconds for picture information. So, the width of the line on the picture tube screen is effectively 52 microseconds, whereupon a spacing of 1.6 microseconds would be approximately equal to one thirtieth of the picture width. A nominal 20 inch screen is roughly 16 inches wide, so that 1.6 microseconds would correspond to a spacing of, rough check, slightly more than half an inch." (Fig. 4(a).)

"Blimey," exclaimed Dick. "That *would* be noticeable."

"Because of this effect," stated Smithy, "it is necessary to use a careful layout and circuit design with a SAW filter to ensure that there are no significant stray capacitive couplings between the input and output terminals of the filter. Care has also to be taken to ensure that there are no other unwanted electronic couplings too, such as impedances common to input and output circuits, and things like that. Obviously, these requirements can be satisfactorily met in practice because the SAW filter is being used in a production colour TV receiver."

"Are there any other unwanted couplings to avoid?"

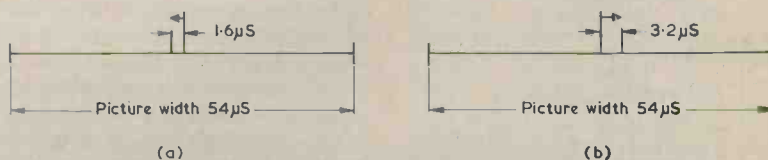

Fig. 4(a). Stray capacitive coupling between the input and output of the SAW filter can cause the appearance of a ghost displaced to the left of the proper image by 1.6 microseconds (b). A reflection inside the filter from output transducer to input transducer, and then back again, would produce a ghost 3.2 microseconds to the right of the correct image

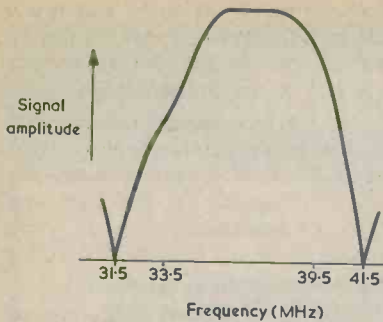

Fig. 5. Simplified presentation of a SAW filter response curve. Of most significance are the troughs at 31.5 and 41.5MHz

"There's an internal reflection effect inside the filter which has to be overcome," stated Smithy. "This occurs if the output transducer reflects a wave back to the input transducer which, in turn, reflects it back to the output transducer again. Since the reflected wave travels twice through the filter it can produce a ghost image which is about 3.2 microseconds after the required image." (Fig. 4(b).)

"Which," stated Dick, frowning, "would be equal to a spacing of rather more than an inch on a 20 inch screen?"

"Right," confirmed Smithy. "Fortunately, this particular reflection can be easily killed by simply driving the input transducer from a low impedance source, or by coupling the output transducer into a low impedance circuit. No real problem there."

"What sort of response does the SAW filter provide?"

Smithy drew out a response curve on his note-pad. (Fig. 5.)

"This is only a generalised idea of what is given," he remarked, "and is not an actual response curve, as would be given in the filter manufacturer's literature. As you know, the commonly used vision carrier i.f. in 625 line TV receivers is 39.5MHz, with the sound carrier i.f. being at 33.5MHz. The SAW filter

response covers these two frequencies and has pronounced troughs at 31.5MHz and 41.5MHz."

"Why at these two frequencies?"

"Because they represent the vision and sound carrier frequencies of adjacent channels."

"I'm getting a bit baffled here, Smithy! To start off with, how on earth can you just pluck two frequencies out of the air like that and then refer to them as adjacent channel i.f. carrier frequencies?"

"I've got accustomed to these two frequencies," explained Smithy, "because TV sets using ordinary i.f. coils have traps tuned to them. However, let me convince you of what I'm taking about."

He picked up the copy of *TV Fault Finding*, and turned to a table of u.h.f. television channel frequencies at the rear of the book.

"Now," he resumed, showing the table to Dick, "all the vision carriers in Bands 4 and 5 are spaced out at 8MHz intervals. I'll take three channels in this list at random. These can be channel 50 which has a vision carrier of 703.25MHz and a sound carrier of 709.25MHz, channel 49 which has a sound carrier of 701.25MHz, and channel 51, with a vision carrier of 711.25MHz. If we've got a TV set tuned to channel 50 the vision carrier will enter the i.f. amplifier from the tuner at 39.5MHz and the sound carrier will go into the i.f. stages as 33.5MHz. The sound carrier of channel 49 is 2MHz removed from the vision carrier of channel 50, and the corresponding i.f. is 41.5MHz. Similar reasoning tells us that the vision carrier of channel 51 will pop up in the tuner output at 31.5MHz. There you are then: 41.5MHz is the adjacent channel sound carrier i.f. and 31.5MHz is the adjacent channel vision carrier i.f."

Smithy had written the figures on his pad as he was talking, and Dick leaned over to look at them. (Fig. 6.)

"That makes sense to me now," he said in a satisfied tone. "Those frequency relationships will hold

Channel 49		Channel 50		Channel 51	
Sound	Vision	Sound	Vision	Sound	Vision
701.25	703.25	709.25	711.25	701.25	711.25
41.5	39.5	33.5	31.5	41.5	31.5

Fig. 6. Frequency relationship for three neighbouring TV channels. Below the transmitted vision and sound frequencies are the corresponding i.f. carrier frequencies. All frequencies are in MHz

GAREX

V.H.F. Receivers SR-9 for 2-metres F.M., fully tunable 144-146MHz, 2-speed slow-motion dial, also 11 xtal controlled channels. Compact, sensitive, ideal for fixed or mobile listening. Built-in L.S., 12v D.C. operation £47.15 inc. VAT. Crystals, if required: £2.60 each. All popular 2m. channels in stock. Marine band version (156 162MHz) £47.15 (xtals £2.90). Mains psu for above £11.95. Pocket VHF Receiver 12 channel xtal controlled complete with nicad and charger. 4MHz bandwidth in range 140-175MHz £57.95. Amateur and Marine xtals in stock, prices as SR-9. Amplifier module new, fully assembled 6W IC unit, 12v D.C. Low impedance (4-8 Ω) input and output for extrn. speaker amplification, with circuit £2.75. Neons min wire end 70p/10; £4.50/100 Slide switches min DPDT 20p ea; 5+: 16p Resistor Kits E12 series, 22 Ω to 1M Ω 57 values, 5% carbon film, $\frac{1}{4}$ W or $\frac{1}{2}$ W Starter pack, 5 each, value (285) £3.10 Mixed pack, 5 each $\frac{1}{4}$ W + $\frac{1}{2}$ W (570) £5.55 Standard pack, 10 each (570) £5.55 Giant pack, 25 each (1,425) £13.60 BNC Cable mtg socket 50 Ω 25p; 5+: 20p; PL259 UHF Plug & Reducer 75p; 5+: 67p; SO239 UHF Socket panel mtd. 60p; 5+: 50p; Nicad rechargeables physically equiv. to zinc-carbon types: AAA (U16) £1.80; AA(U7) £1.30; C(U1) £3.35; PP3 £5.55. Any 5+: less 10%. Any 10+ less 20%.

We stock V.H.F. & U.H.F. mobile aeri-als. s.a.e. details. Access — Barclaycard PRICES INCLUDE UK POST, PACKING & VAT Mail order only Sole Address: GAREX ELECTRONICS 7 NORVIC ROAD, MARSWORTH. TRING, HERTS HP23 4LS Cheddington (STD 0298) 668684

MORSE MADE EASY



BY THE G3HSC RHYTHM METHOD!

These courses which have been sold for over 23 years, have been proved many times to be the fastest method of learning Morse. You start right away by learning the sounds of the various letters, numbers, etc., as you will in fact use them. Not a series of dots and dashes which later you will have to transkate into letters and words. Using scientifically prepared 3 speed records you automatically learn to recognise the code, RHYTHM without translating. You can't help it. It's as easy as learning a tune 18 WPM in 4 weeks guaranteed.

The Complete Course consists of three records as well as instruction books. For Complete Course send £5.50 (overseas surface mail £1 extra).

THE G3HSC MORSE CENTRE
Box 8, 45 Green Lane, Purley, Surrey.
I enclose £5.50 or s.a.e. for explanatory booklet.

Name.....

Address.....

**BUY THIS
BEST SELLER**

**T.V. FAULT
FINDING
405/625 LINES**

MONOCHROME

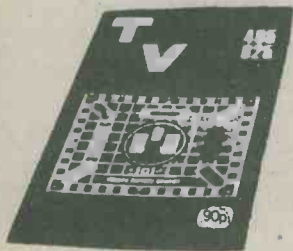

REVISED & ENLARGED

Edited by J. R. Davies

132 pages Price £1.20

Over 100 illustrations, including 60 photographs of a television screen after the appropriate faults have been deliberately introduced.

Comprehensive Fault Finding Guide cross-referenced to methods of fault rectification described at greater length in the text.

Price 120p from your Bookseller

or post this Coupon together with remittance for £1.45 (to include postage) to

DATA PUBLICATIONS LTD.
57 Maida Vale, London, W91SN

Please send me the 5th revised edition of TV Fault Finding, Data Book No. 5

I enclose cheque / crossed postal order for

NAME

ADDRESS

Block Letters Please

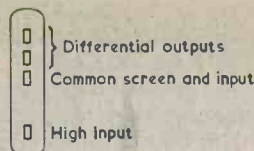

PLASTIC PACKAGE

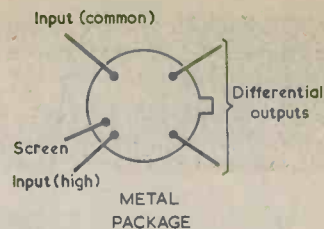

METAL PACKAGE

Fig. 7. The Plessey SW150 filter is available in a plastic or a metal encapsulation. Pinning is as shown here

good for any three neighbouring channels in Band 4 or Band 5, won't they?"

"They will. Apart, of course, from the channels right at the ends of each Band, which have only one neighbouring channel."

"What do these SAW filters look like?"

"The Plessey SW150 filter comes in two encapsulations," said Smyth. "One consists of a plastic package with four single-in-line pins. These are for input, common screen and input, and two differential outputs. The other encapsulation is a round metal case with locating tab. This has a diameter of about half an inch and has five pins. These pins give high input, screen, common input and two differential outputs. The filter which is used in the Ferguson TX9 receiver is the one with the metal encapsulation." (Fig. 7).

"Differential outputs? What are those?"

"The output terminals of the SAW filter are balanced about earth and can feed into a differential amplifier. Which is like feeding directly into the inverting and non-inverting inputs of an operational amplifier. The input, on the other hand, can be driven by a single-ended amplifier. With the 5-pin filter the amplifier couples into the high input pin, and the common input and the screen both connect to earth. The screen, incidentally, is an internal screen in the filter to reduce stray capacitive couplings between the input and the output."

"Phew," said Dick. "Well, I've certainly discovered a thing or two today. Can a SAW filter replace all of the i.f. tuned coils in a TV set?"

"So far as I know, it can," said Smyth. "But in normal use there may still be one or two tuned coils left in the circuit. Design here depends on the TV manufacturer who is using the filter. The u.h.f. tuner in the TV set will almost inevitably have an i.f. output coil and this could be coupled by a capacitor to an external coil to give a band-pass pair. After that, the i.f. signal can go through an amplifier,

through the SAW filter and then on to another amplifier before it hits the vision demodulator. So that means that there are only two i.f. coils to adjust: the one in the tuner and the one which immediately follows it. There are no other coils in the i.f. amplifier at all. No coils tuned to intermediate frequencies, no coils in adjacent channel traps, no nothing! Add to that the fact that the 6MHz intercarrier sound signal can be taken off through a 6MHz ceramic filter, and you can begin to see how drastic will be the reduction of tuned coils in the TV sets of the future."

"And that's good?"

"Good? It's excellent! To start off with, manufacturing costs are reduced because fewer coils are required and much less alignment is needed at the factory. Secondly, there can be no drift in the i.f. alignment with time, as can happen with ordinary tuned coils. And thirdly, servicing is eased because there are fewer components to go wrong. A minor disadvantage with the SAW filter is that it incurs a loss in signal level but this can easily be made good by a suitable integrated circuit amplifier."

Smyth looked at his watch.

"I see," he remarked, "that another of our lunch breaks has gone, with me nattering away as usual to satisfy your curiosity about electronics."

"Come off it, Smyth. You know you love holding forth on technical things."

"Ah yes, but that's only whilst I'm at work. How will you be spending your evening today? More electronics?"

"Well, certainly not servicing. I might while away the time with a little short wave listening. And you?"

"I'll probably pop round to my club for a jar and a natter. Their p.a. amplifier has been playing up recently, and so I might have a look at that."

The pair beamed at each other, each fondly under the impression that it was the other who devoted too much of his life to electronics.

RECENT PUBLICATIONS



BURGLAR ALARM SYSTEMS. By Vivian Capel. 159 pages, 215 x 135mm. (8½ x 5¼in.). Published by Newnes Technical Books. Price £3.95.

This reviewer, always interested in the electrical and electronic devices which lurk almost unnoticed in our midst, has for some time been mildly mystified by the presence of two round objects about an inch in diameter affixed to the bottom of the two adjacent windows of a small local shop. A thin wire connects to each of the objects, whereupon they undoubtedly represent items of electronic security; but what? The answer is given in this book: the round objects are contact crystal microphones with built-in filters designed to pass only the frequencies, of around 6 to 8kHz, which are given by breaking glass. The alarm system is activated if either shop window is broken.

This is only one item in a comprehensive and all-embracing treatment of burglar alarm systems which are dealt with in Vivian Capel's very interesting book. Security affects virtually all of us these days, whether it is aimed at preventing the shoplifter or, at the other extreme, detecting the light emitted by a thermal lance.

The book covers all currently available domestic and business intruder protection systems ranging from simple open and closed wired loops to the more complex ultrasonic Doppler and microwave beam interruption installations. A chapter deals with audible alarm units, including bells, sirens and electronic sound generators, whilst another chapter describes the manner in which closed circuit television may be used for security purposes. Also covered is the matter of installing a burglar alarm system, including meeting the all-important requirement of fitting wiring which is both concealed and protected.

Anybody requiring general information on intruder protection devices and installations will find "Burglar Alarm Systems" a useful and very helpful book.



PRACTICAL CONSTRUCTION OF PRE-AMPS, TONE CONTROLS, FILTERS AND ATTENUATORS. By A. D. M. Smith, B.Sc., C.Eng., M.I.E.R.E., M.B.K.T.S. 111 pages, 180 x 105mm. (7 x 4¼in.). Published by Bernard Babani (Publishing) Ltd. Price £1.45.

This book gives details of the circuit operation and then the construction of a large and varied range of pre-amplifiers, tone controls, audio filters and attenuators, dealing with each item on its own and using concise explanations with an absence of mathematics.

The first section of the book covers magnetic tape recording pre-amplifiers, giving two 3-transistor circuits and an integrated circuit configuration. Two microphone pre-amplifiers are described in the next section, one for high impedance input and one for low impedance input. These are followed by disc pre-amplifier circuits for piezoelectric cartridges and magnetic cartridges, and by bass cut, bass boost, treble cut and treble boost tone control circuits, as well as circuits for a comprehensive tone control and for a "presence unit". This last item applies boost or cut over a limited band of frequencies.

The book continues with filters, taking in a high pass filter, a low pass filter, a rumble filter and a scratch filter. Also included here is an interesting circuit which gives simulation of sound as passed over a telephone. Attenuators and pads appear next, and the book ends with a short section dealing with the preparation of printed circuit boards.

All but the very simplest circuits are treated as constructional projects, and are accompanied by component lists and full-size printed circuit layouts.

TOUCH CONTROL SWITCH

By R. Otterwell

Attractive presentation combined with sequential operation.

Many ideas for the construction of touch contacts for CMOS projects have been put forward since the use of these devices became widespread. Almost all suffer from at least one or more disadvantages, these being unattractive appearance, difficulty in mounting or unwarranted complexity. Common methods of providing the touch contacts have included copper areas on printed circuit boards, drawing pins or adapted phono plugs. The touch control to be described has none of these shortcomings. The materials required are inexpensive, consisting of a 3.5mm. jack plug, a short length of plastic sleeving capable of passing over the jack plug sleeve and tip, a fairly thick panel of insulating material such as tinted Perspex, and a "silver" eyelet. The last is a shiny metal eyelet having an internal diameter of about 4mm., and is available from almost all craft or hobby shops. It should be capable of taking the jack plug and sleeving in the manner to be described.

This article will also give details of a sequential CMOS switching circuit which can be employed with the touch control.

CONSTRUCTION

Fig. 1 shows the way in which the touch control is assembled. First, as in Fig. 1(a), drill a hole in the insulated panel which is just wide enough to accept the eyelet. Using a screwdriver blade, flatten the back of the eyelet to secure it to the panel. See Fig. 1(b). Next, as shown in Fig. 1(c), take up the jack plug and pass the plastic sleeving over its sleeve and tip. Solder an insulated wire to the tag which connects to the plug tip. Following Fig. 1(d), solder a second insulated wire to the rear of the eyelet, then pass the end of the plug through the eyelet so that its tip is flush or just slightly proud of the front surface of the eyelet. The tip is insulated from the eyelet, of course, by the plastic sleeving. With an eyelet having the required internal diameter, the plug will then stay fixed in position.

The front view of the completed touch contact assembly is as in Fig. 1(e). The control is actuated by bridging the plug tip and the eyelet by a finger.

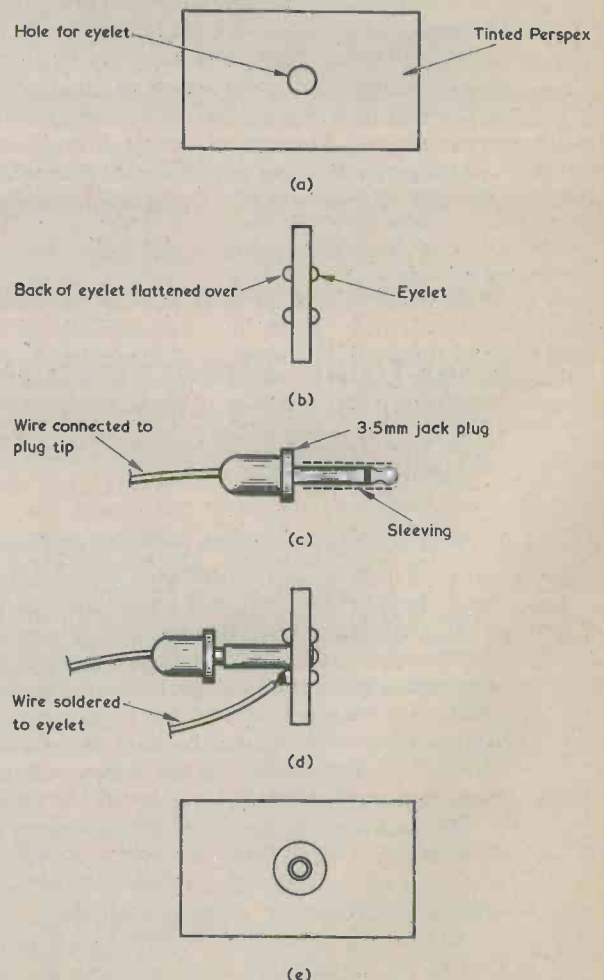
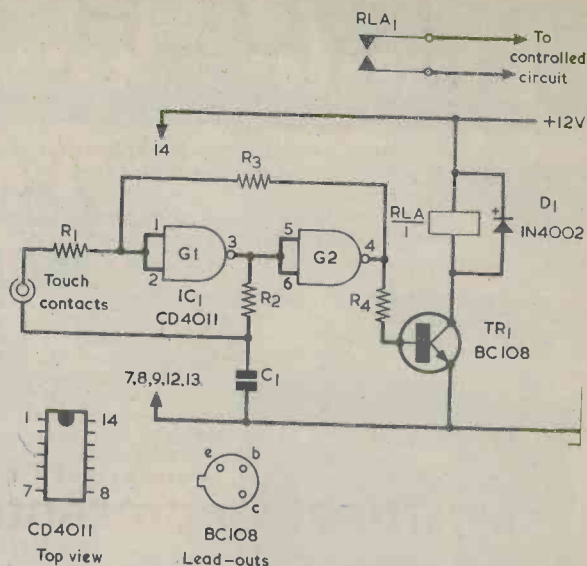

Fig. 1. Successive steps in making up the touch contact assembly

Fig. 2. The sequential touch control switch circuit. The relay energises, and then de-energises, at each successive bridging of the touch contacts by a finger



COMPONENTS

Resistors

(All $\frac{1}{4}$ watt 10%)

R1 4.7k Ω

R2 14.1M Ω (see text)

R3 9.4M Ω (see text)

R4 2.2k Ω (see text)

Capacitor

C1 0.039 μ F polycarbonate

Semiconductors

IC1 CD4011

TR1 BC108

D1 1N4002

Relay

RLA Relay (see text)

Miscellaneous

Materials for touch contacts

Wire, solder, etc.

CONTROL CIRCUIT

The sequential touch control circuit appears in Fig. 2. In this, two gates of a CMOS quad NAND gate type CD4011 are employed as inverters and make up a flip-flop. Let us assume that the flip-flop is in a state where the input to gate G1 is low. G1 output will then be high, causing G2 output to be low, maintaining the low at G1 input via R3. The low output from G2 causes TR1 to be turned off, and no current flows through the relay coil, RLA/1, in its collector circuit. The relay is thus de-energised. Because of the high voltage at G1 output, C1 becomes charged via R2.

If the touch contacts are bridged by a finger, the high voltage from C1 causes the input of gate G1 to go high. Its output goes low and G2 output goes high, keeping the flip-flop in its new state when the finger is removed. The high output at G2 turns on TR1 and the relay energises. C1 discharges through R2 into the low output of G1.

When the touch contacts are next bridged, the discharged C1 pulls the input of G1 low again, and the flip-flop reverts to its previous state, with the relay de-energised. The relay will energise once more when the touch contacts are bridged again, and so on.

The unusual values for R2 and R3 are made up of three 4.7M Ω resistors in series (for R2) and two 4.7M Ω resistors in series (for R3). With R4 at its

specified value of 2.2k Ω the output of gate G2, when in the high state, is about 1 volt below the voltage of the positive rail. The relay coil should not draw an energising current in excess of 100mA. If a fairly sensitive relay (such as the "Open Relay" with 410 Ω coil available from Maplin Electronic Supplies) is employed, the value of R4 can be increased to 10k Ω , with a consequently higher voltage at G2 output when this output is in the high state.

In Fig. 2 the inputs of the two unused gates of the CD4011 are connected to the negative rail. If desired, the circuit could be duplicated by using these two gates in a second switching circuit with its own touch contacts, transistor and relay.

The author's touch control switch was powered by a 12 volt supply. It will work satisfactorily, also, with a 9 volt supply.

STYLUS ORGAN

In this article, which appeared on page 78 of the October issue, C8 was specified as 2,200 μ F ceramic plate. The value should, of course, have been 2,200pF.

Trade News . . .

LOW COST MONITOR FOR RADIO MODELLERS



Now being marketed in the UK by Chromatronics of Coach House, River Way, Harlow, Essex, is a low-cost radio monitor which warns radio-control model enthusiasts of any potential sources of interference on the 27MHz wave band, including illegal Citizens' Band radio transmissions, other nearby radio modellers, or even sunspot activity. The early detection of such interference sources by the Chromatronics monitor receiver can help to prevent expensive models being 'shot down' or sent out of control.

Costing only £17.95 (including V.A.T. and postage and packing), the Chromatronics monitor is a 3-band superheterodyne receiver which can be continuously tuned over the whole 27MHz model band, and which also receives the normal broadcast a.m. and f.m. bands. As well as detecting potential interference, the monitor can be used to check transmitter operation. A telescopic aerial ensures high sensitivity.

The Chromatronics monitor receiver measures only 170mm x 90mm x 50mm (6½in x 3½in x 2in) and weighs 0.45kg (1lb). It is powered by a single 9V battery, and output is via a built-in 76mm speaker, with a jack socket provided for an earpiece.

The Chromatronics device was used by the organisers of the 8th Sywell Radio Controlled Model Expo at Easter, and proved invaluable in locating one interference source — a faulty portable generator on a candy-floss stall — which could have been the direct cause of at least one crash.

SUREFIRE ELECTRONIC IGNITION SYSTEMS

Surefire electronic ignition came top of all systems tested by "Which" magazine in July 1979.

Suretron have now released two new ignition kits, the C300 and ES200, to fit all vehicles up to 8 cylinders.

The C300 is a high energy capacitive discharge system incorporating a high output short circuit proof inverter, pulse processor circuit, and transient overload protection. Available in negative and positive earth versions with coil ignition. Ideal for fuel injection, sports carburation, oily engines and 2 strokes.

The ES200 is a high performance inductive discharge system incorporating a selected output darlington (Motorola), electronic variable dwell circuit to maximise spark energy at all engine speeds, pulse processor circuit and coil governor to protect the coil. Produces a long burn output and is suitable for *all* cars. Negative earth only.

The kits comprise an anodised aluminium extruded case, fibreglass p.c.b., p.c. mounted security changeover switch, static timing light, special selection Motorola power semi-conductors, capacitors and resistors etc. The prices (V.A.T., postage and packing inc.) are: ES200 — £13.95, C300 — £17.95 from Suretron Systems Ltd., Piccadilly Place, London Road, Bath BA1 6PW.

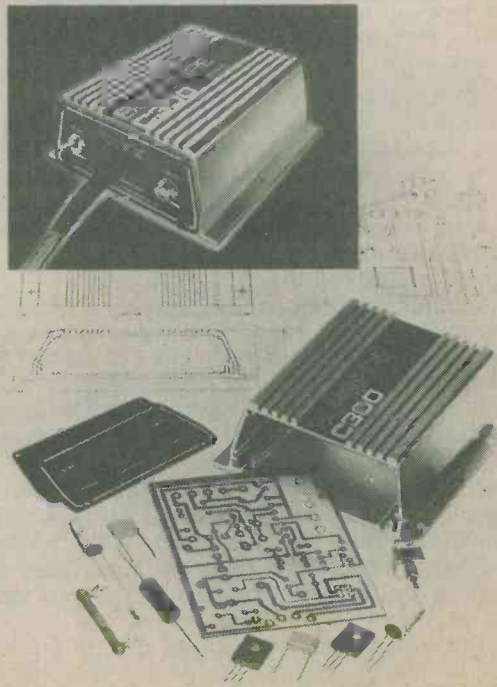

SMALL ADVERTISEMENTS

Rate: 12p per word. Minimum charge £2.00

Box No. 30p extra

Advertisements must be prepaid and all copy must be received by the 4th of the month for insertion in the following month's issue. The Publishers cannot be held liable in any way for printing errors or omissions, nor can they accept responsibility for the *bona fides* of Advertisers. Where advertisements offer any equipment of a transmitting nature, readers are reminded that a licence is normally required. (Replies to Box Numbers should be addressed to: Box No. —, **Radio and Electronics Constructor**, 57 Maida Vale, London, W9 1SN.

CONSTRUCT METAL DETECTORS: 1. £120 pulse discriminator (£12 construction cost). 2. £60 model (£6 con/cost). 3. £30 BFO (£3 con/cost). For all three together, written guaranteed d.i.y. plans, send £2. (Dept. RC), J. Lucas, 2 College Road, Grays, Essex. (Established 1973).

FOR SALE: Inverter, 12V d.c. to 240V a.c. Suitable running electric shaver, camping, boating, etc. £5.50. Box No. G355.

FOR SALE: Microwave Diodes 1N21B, 5 for £1.00. 1N23B, 5 for £4.00. Post 15p. — 49 Pennine Gardens, Harraby, Carlisle, Cumbria.

COMPLETE REPAIR INSTRUCTIONS for any requested TV, £5 (with diagrams £5.50). Any requested service sheet £1 plus s.a.e. S.a.e. brings free newsletter, details unique publications, vouchers and service sheets from 50p. AUSREC, 76 Church Street, Larkhall, Lanarkshire.

FOR SALE: 50 metres connecting wire. Five 10 metre lengths assorted colours and sizes. 95p inc. P.&P. D. Hooker, Pennywood, Clarke Road, Greatstone, Kent TN28 8PB.

CONSTRUCTORS 200 mixed components £4. 30W soldering irons £2.60. Full refund guarantees. Lists 15p refundable. Mail only. Components bought. Sole Electronics, 37 Stanley Street, Ormskirk, Lancs.

FOR SALE: *Fundamentals of Radio Servicing* by B. W. Hicks, published by Hutchinsons Educational, £2.20 post paid. *Handbook of Satellites and Space Vehicles* by R. P. Haviland, £3.50 post paid. — Box No. G366.

THE RADIO AMATEUR INVALID & BEDFAST CLUB is a well established Society providing facilities for the physically handicapped to enjoy the hobby of Amateur Radio. Please become a supporter of this worthy cause. Details from the Hon. Secretary, Mr. H. R. Boutle, 14 Queens Drive, Bedford.

FOR SALE: Complete and incomplete video tape recorders and closed circuit cameras. S.A.E. for details. Metal detector £10.00. 6 inch portable TV £75.00. Digital multimeter needing repair £17.50, with marks on case £20.00. Cassette tape eraser £10.00. Laser created 3 dimensional holograms £12.50. 25 mixed new zeners £1.00. Cassettes 75p. S.A.E. for list. Voice controlled ladybird toy £15.00. Radio controlled car £10.50. — J. Fulton, Derrynaseer, Dromore, Co. Tyrone, N. Ireland.

CLEARING ELECTRONICS LABORATORY. Numerous quality components available (95% new), inc: punched panels, boxes, wafer-switches, potentiometers, metal-oxide resistances, semiconductors, tools, etc. Unrepeatable — so hurry! Send £5 for a valuable selection worth at least £20. Money refund guarantee. M. J. Evans, 7 Shap Drive, Warndon, Worcester, WR4 9NY.

(Continued on page 317)

A CAREER IN RADIO

Start training **today** and make sure you are qualified to take advantage of the many opportunities open to the trained person. ICS can further your technical knowledge and provide the specialist training so essential to success.

ICS, the world's most experienced home study college, has helped thousands of ambitious men to move up into higher paid jobs — they can do the same for **you**.

Fill in the coupon below and find out how!

There is a wide range of courses to choose from, including:

CITY & GUILDS CERTIFICATES

Telecommunications Technicians
Radio TV Electronics Technicians
Electrical Installations Technicians
Electrical Installation Work
Radio Amateurs'

MPT Radio Communications Cert

**EXAMINATION STUDENTS —
GUARANTEED COACHING
UNTIL SUCCESSFUL**

TECHNICAL TRAINING

ICS offer a wide choice of non-exam courses designed to equip you for a better job in your particular branch of electronics, including:
Electronic Engineering & Maintenance
Computer Engineering/Programming
Radio, TV & Audio Engineering & Servicing
Electrical Engineering Installations & Contracting

COLOUR TV SERVICING

Technicians trained in TV Servicing are in constant demand. Learn all the techniques you need to service Colour and Mono TV sets through new home study course approved by leading manufacturer.

POST THIS COUPON OR TELEPHONE FOR FREE PROSPECTUS

I am interested in

Name Age

Address

Occupation

ICS

Accredited
by CACC
Member of
ABCC

To
International Correspondence Schools
Dept Q278, Intertext House, LONDON
SW8 4UJ or phone 01-622 9911 (anytime)

COMPONENT PACKS

PU1: 50 untested, unmarked t.t.l. i.c.'s (mostly 7400 series) 65p
PU2: Untested, unmarked silicon diodes, some germanium. Pack of 200 (approx.). 65p
PU4: Resistors, mixed values, various wattages. Good selection of values. Approx 100.65p
PT1: Tested, marked selection of popular diodes. Contains: 25 x 1N914, 10 x 1N4002, 5 x BY127 125p
PT4: Stranded connecting wire. Five colours each 5 metres.65p
PT5: As pack PT4 but solid conductor. 65p

... AND MORE

PT12: Pack of five reed switches 50p
PT13: Four 10kΩ mono slider pots 85p
PT14: Ten pots, assorted values and types. Good selection but no guarantee of any particular value. Hence only 85p
PT15: 100 square in. of copper clad s.r.b.p. board 65p
PT16: Hardware. Assorted nuts, bolts, washers etc. Approx 100 pieces, count by weight 65p

SPECIAL XMAS OFFER

Buy £5 worth of the above packs, and receive one pack of your choice. FREE.
Offers ends 31-12-79

BARGAIN SPOT

Whilst stocks last

Money refunded if unavailable
2,200µF 25V electrolytic 38p
AD142 Transistor 30p
S.P.S.T. Toggle switch 29p

CABLE AND WIRE

Price per metre
Single Microphone Cable 10p
Mains, 3A 3 core 15p
Twin Lighting Flex 6p

Mail order only. All prices include VAT. Please add 20p for postage (except component packs). Full list available on receipt of large s.a.e.

T. & J. ELECTRONIC COMPONENTS

98 Burrow Road, Chigwell, Essex IG7 4HB

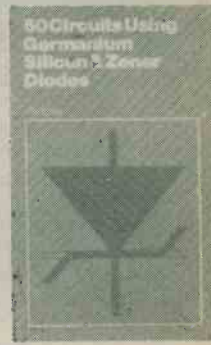
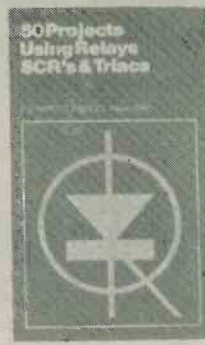
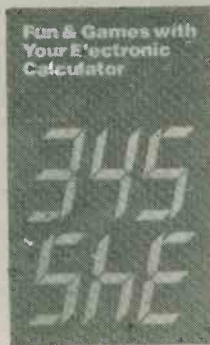
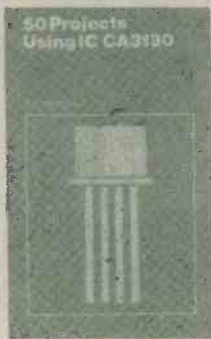
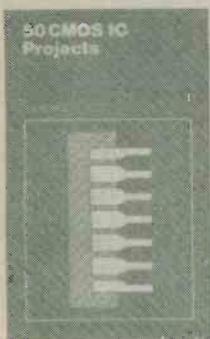

DIRECT READER SERVICE

RADIO & ELECTRONICS BOOKS

17. Solid State Power Supply Handbook	85p	35. Fun and Games with your Electronic Calculator	75p
18. 50 Projects Using IC CA3130	£1.25	36. 50 (FET) Field Effect Transistor Projects	£1.25
19. 50 CMOS IC Projects	£1.25	37. 50 Simple L.E.D. Circuits	75p
20. A Practical Introduction to Digital IC's	95p	38. How to Make Walkie-Talkies	£1.25
21. How to Build Advanced Short Wave Receivers	£1.20	39. IC 555 Projects	£1.75
22. Beginners Guide to Building Electronic Projects	£1.25	40. Projects in Opto-Electronics	£1.25
23. Essential Theory for the Electronics Hobbyist	£1.25	41. Radio Circuits Using IC's	£1.35
24. Constructors Manual of Electronic Circuits for the Home	50p	42. Mobile Discotheque Handbook	£1.35
25. 79 Electronic Novelty Circuits	£1:00	43. Electronic Projects for Beginners	£1.35
26. 52 Projects Using IC741	95p	44. Popular Electronic Projects	£1.45
27. How to Build Your Own Electronic and Quartz Controlled Watches & Clocks	85p	45. IC LM3900 Projects	£1.35
28. Two Transistor Electronic Projects	85p	46. Electronic Music and Creative Tape Recording	£1.25
29. How to Build Your Own Metal and Treasure Locators	£1.00	47. Practical Electronic Calculations and Formulae	£2.25
30. Electronic Calculator Users Handbook	95p	48. Radio Stations Guide	£1.45
31. Practical Repair and Renovation of Colour TVs (Reprinting)	£1.25	49. Electronic Security Devices	£1.45
32. Handbook of IC Audio Pre-amplifier and Power Amplifier Construction	£1.25	50. How to Build Your Own Solid State Oscilloscope	£1.50
33. 50 Circuits Using Germanium, Silicon and Zener Diodes	Zener 75p	51. 50 Circuits Using 7400 Series IC's	£1.45
34. 50 Projects Using Relays, SCR's and TRIACS	£1.25	52. Second Book of CMOS IC Projects	£1.50
		53. Practical Construction of Pre-Amps, Tone Controls, Fitters & Attenuators	£1.45
		54. Beginners Guide to Digital Techniques	95p

POSTAGE: 20p PER BOOK. IF MORE THAN 3 BOOKS ORDERED: 10p PER BOOK

To: Data Publications Ltd., 57 Maida Vale, London W9 1SN

Please send me within 21 days copy/copies

Book Nos:

.....

I enclose Postal Order/Cheque for £

Name

Address

.....

(Block Letters Please)

(We regret this offer is only available to readers in the U.K.)

SMALL ADVERTISEMENTS

(Continued from page 315)

FOR SALE: Bush cassette tape recorder, battery driven. Microphone, etc. Excellent condition. £10 plus postage. Box No. G375.

FOR SALE: C15 10MHz SCOPE. Complete with probes and accessories, plus spare parts. Excellent condition, hardly ever used. £50.00. Telephone: 051-334 4574.

FOR SALE: "Challenge of the Stars" by Patrick Moore and David A. Hardy £2.00. "Destroyers" by Antony Preston £4.00. Box No. G376.

JOIN THE INTERNATIONAL S.W. LEAGUE. Free services to members including Q.S.L. Bureau, Amateur and Broadcast Translation, Technical and Identification Dept. — both Broadcast and Fixed Stations, DX Certificates, contests and activities for the SWL and transmitting members. Monthly magazine, *Monitor*, containing articles of general interest to Broadcast and Amateur SWLs, Transmitter Section and League affairs, etc. League supplies such as badges, headed notepaper and envelopes, QSL cards, etc., are available at reasonable cost. Send for League particulars. Membership including monthly magazines, etc., £6.00 per annum. (U.K. and British Commonwealth), overseas \$12.00. Secretary ISWL, 1 Grove Road, Lydney, Glos., GL15 5JE.

SOLAR CELLS: Bits, books and bargains. Send 95p for Solar Cell booklet and Data Sheets or stamp for list. — Edencombe Ltd., 34 Nathans Road, North Wembley, Middlesex HA0 3RX.

COLLECTORS' ITEMS: Nearly 50 copies of Radio Society of Great Britain's *Bulletins* covering period 1945 to 1949. In reasonable condition. Offers to: Box No. G377.

FOR SALE: U.S. Signal Corps signal generator. 100kHz to 32MHz. Mains operated. £15. Telephone: Tunbridge Wells 28607.

WANTED: FAX equipment, manuals, service sheets, etc. G2UK, 21 Romany Road, Oulton Broad, Lowestoft, Suffolk. NR32 3PJ.

WANTED: Telford Communications TC10 "Multimode" 2 metre transmitter. Details and price please to Box No. G383.

INTERESTED IN OSCAR? Then join AMSAT-UK. Newsletters, OSCAR NEWS Journal, prediction charts, etc. Details of membership from: Ron Broadbent, G3AAJ, 94 Herongate Road, Wanstead Park, London, E12 5EQ.

P.C.B. DESIGN. Outline drawings, layouts, projects, for the constructor. Cost according to circuit complexity. D. G. Harrington, 25 Poynter Road, Bush Hill Park, Enfield, Middlesex.

FOR SALE: Metal Detector £10. S.a.e. for lists. Box No. G384.

POSTAL ADVERTISING? This is the Holborn Service. Mailing lists, addressing, enclosing, wrapping, facsimile letters, automatic typing, copy service, campaign planning, design and artwork, printing and stationery. Please ask for price list. — The Holborn Direct Mail Company, Capacity House, 2-6 Rothsay Street, Tower Bridge Road, London, S.E.1. Telephone: 01-407 6444.

FOR SALE: Non-working video tape recorders, complete £50, incomplete £30 plus £6 carriage. Closed circuit cameras £45. Commodore Pet computer £500. Stereo cassette mechanisms £10 and £15. 25 2W zeners 50p. Box No. G385.

RADIO, ELECTRONICS, TELEVISION BOOKS. Largest variety. Lowest prices. Write for list. Business Promotion Bureau, 376 Lajpat Rai Market, Delhi 110006, India.

(Continued on page 319)



Wilmslow Audio

THE firm for speakers!

SEND 30p FOR THE WORLDS BEST CATALOGUE OF SPEAKERS, DRIVE UNITS KITS, CROSSOVERS ETC. AND DISCOUNT PRICE LIST

AUDAX • AUDIOMASTER • BAKER • BOWERS & WILKINS • CASTLE • CELESTION • CHARTWELL • COLES • DALESFORD • DECCA • EMI • EAGLE • ELAC • FANE • GAUSS • GOODMAN'S • I.M.F. • ISOPON • JR • JORDAN WATTS • KEF • LEAK • LOWTHER • MCKENZIE • MONITOR AUDIO • PEERLESS • RADFORD • RAM • RICHARD ALLAN • SEAS • STAG • TANNOY • VIDEOTONE • WHARFEDALE • YAMAHA • SHACKMAN • TANGENT

WILMSLOW AUDIO DEPT REC
SWAN WORKS, BANK SQUARE, WILMSLOW
CHESHIRE SK9 1HF
Discount HiFi Etc. at 5 Swan Street
Tel: 0625-529599 for Speakers, 0625-526213 for HiFi



FIRST and STILL BEST

We've been producing our Electronics Components Catalogue for *over 20 years*. During that time we've learned a lot, not only in the art of catalogue production but in building a business that serves the needs of constructors. Little wonder that we have a reputation *second to none* for our catalogue — *and* for the service that backs it up. Experience both for yourself. Just send £1.30 with the coupon and a catalogue will come by return of post.

TREAT YOURSELF for Christmas!

- About 2,500 items clearly listed and indexed.
- Profusely illustrated throughout.
- 128 A-4 size pages, bound in full-colour cover.
- Bargain list of unrepeatable offers included free.
- Catalogue contains details of simple Credit Scheme.

HOME RADIO (Components) LTD.
Dept. RC., 234-240 London Road, Mitcham, Surrey CR4 3HD
Phone: 01-648 8422

POST THIS COUPON
with cheque or P.O. for £1.30

Please write your Name and Address in block capitals!

NAME

ADDRESS

HOME RADIO (Components) LTD., Dept. RC
234-240 London Road, Mitcham, Surrey CR4 3HD

Regd. No. 912966, London





From
Kam
Circuits
a new p.c.b.
battery
operated
Mini-
Drill

Available with or without a portable stand this new powerful precision drill will enable you to drill holes in p.c.b.'s, metal, wooden panels or anywhere that small holes are needed. Bit sizes 0.6mm, 1.0mm and 1.5mm.

Power supply 4 x UM3 batteries.

Price without stand £19.02 (inclusive of p.p. and VAT).

Stand price £8.63 (inclusive of p.p. & VAT).

Write for technical brochure now:



Kam Circuits Limited
Porte Marsh Road, Calne, Wilts. SN11 9BW
Telephone: (0249) 815262 Telex: 444218

Random Electronic

EASY DICE

Build your own 'EASY DICE' from the 5 integrated circuits and full components supplied, including box and descriptive instructions.

Complete
or
Kit



P.C.B.
Layout

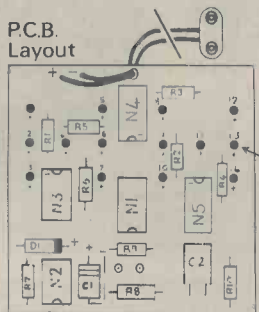

All you need is a soldering iron
TWO DICE FACES TOUCH CONTROL...

- | | | |
|---|----------------------|-------------------|
| a | * Self Assemble Dice | £3.95 |
| b | * Ready built Dice | £4.75 (INCL. P+P) |

Order now from **Fringewood Electronics Ltd**
1 Hatton Court Ipswich Suffolk O4/3 210151

Amount enclosed £ _____

Name _____

Address _____

please state amount required in appropriate box a b

Self-Binder

for "Radio & Electronics
Constructor"

The "CORDEX" Patent Self-Binding Case will keep your issues in mint condition. Copies can be inserted or removed with the greatest of ease. Rich maroon finish, gold lettering on spine.

Specially constructed Binding Cords are made from Super Linen of great strength, very hard twisted and twice doubled. They are attached to strong RUSTLESS Springs under tension, and the method adopted ensures PERMANENT RESILIENCE of the Cords. Any slack that may develop is immediately compensated for and the Cords will always remain taut and strong. It is impossible to overstretch the springs, as a safety check device is fitted to each.

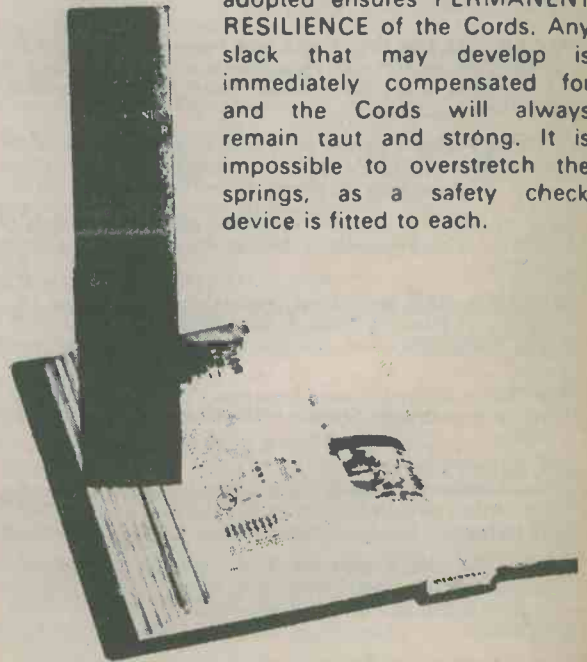

PRICE **£1.95** P.&P. 45p

including V.A.T.

Available only from:—

Data Publications Ltd.

57 Maida Vale London W9 1SN

SMALL ADVERTISEMENTS

(Continued from page 317)

SHACK CLEARANCE: Large selection of good quality new components selling cheaply. S.A.E. for lists or enquiries. Box No. G386.

AERIAL BOOSTERS — B11 VHF/FM Radio — B11A VHF 2 Metre Radio — B45 UHF Television. Price £5. S.A.E. for leaflets, Electronic Mailorder Ltd., Ramsbottom, Bury, Lancs. BL0 9AG.

WANTED: Large and small quantities of transistors, I.C.'s displays, etc., etc. Call any Saturday to: 306 St. Paul's Road, London N.1. Telephone: 01-359 4224.

WANTED: WB. HF1016 speaker. State price. Burton, 24 Holly Road, Birmingham, B16 9NH. (Telephone: 021-454-2046).

FOR SALE: Copies of *Radio Constructor*, W.W., P.W., P.E., 1956 on, from 5p plus post. S.A.E. enquiries. 1 Hazel Grove, Yelverton, Devon, PL20 6DX.

PERSONAL

JANE SCOTT FOR GENUINE FRIENDS. Introductions to opposite sex with sincerity and thoughtfulness. Details free. Stamp to: Jane Scott, 3/Con North St. Quadrant, Brighton, Sussex, BN1 3GJ.

CHI-KUNG for mental/physical health. Discover "Chi" — the life-force/bio-electricity in your body. Send stamp for your Free Literature. The Chi-Kung Society (REC39), 64 Cecil Road, London E13 0LR.

IF YOU HAVE ENJOYED A HOLIDAY on the Norfolk Broads, why not help to preserve these beautiful waterways. Join the Broads Society and play your part in determining Broadlands future. Further details from: — The Hon. Membership Secretary, The Broads Society, "Icknield," Hilly Plantation, Thorpe St. Andrew, Norwich, NOR 85S.

FOR HELP with (elementary) Computer, statistical or technical mathematics, send query, s.a.e., paper, P.O. for 50p to: Box No. G380.

BROADLANDS RESIDENTIAL CLUB for elderly people. Are you recently retired and looking for a home? We have a delightful top floor room overlooking Oulton Broad, facing south. Write to: The Warden, Broadlands Residential Club, Borrow Road, Oulton Broad, Lowestoft, Suffolk.

SPONSORS required for exciting scientific project. Norwich Astronomical Society are building a 30" telescope to be housed in a 20" dome of novel design. All labour being given by volunteers. Already supported by Industry and Commerce in Norfolk. Recreational. Educational. You can be involved. Write to: NAS Secretary, 195 White Woman Lane, Old Catton, Norwich, Norfolk.

BUILD YOUR OWN

P.A. GROUP & DISCO SPEAKERS by R. F. C. Stephens

Save money with this practical guide. Plans for 17 different designs. Line source, I.B., Horn and Reflex types, for 8"-18" drive units. £3.95 post free (\$8 overseas).

THE INFRA-BASS LOUDSPEAKER by G. Holliman

(full constructional details for versions using 15", 12" and 10" drive units.) £2.95 post free (\$6 overseas).

THE DALESFORD SPEAKER BOOK by R. F. C. Stephens

This book is a must for the keen home constructor. Latest technology DIY designs. Plans for I.B., Horn and Reflex designs for 10-100 watts. Also unusual centre-bass system. £2.20 post free (\$5 overseas).

VAN KAREN PUBLISHING

5 Swan Street, Wilmslow, Cheshire

REVOR OPTICAL & TECHNICAL

6 SICILIAN AVENUE
LONDON W.C.1
Tel. 01-836 4536

£14.91

POST
FREE

4" dia. lens

FLEXIBLE MAGNIFIER

WITH CAST IRON BASE,
PRECISION GROUND AND
POLISHED LENS, CHROME PLATED
FRAME AND FLEXIBLE TUBE.
IDEAL FOR HOBBIES, AND
DETAILED WORK WHICH REQUIRES
BOTH HANDS FREE.

CALLERS WELCOME

(Subject to price ruling at the time of issue)



RADIO MODELLER ELECTRONIC BOOKS

● MODEL RADIO CONTROL

Detailing both Theory and Practice, this book, by leading authority Paul Newell, has become the standard reference work. A brief historical survey leads up to a detailed description of proportional systems, with over 100 illustrations, including theoretical circuits and p.c. layouts for an advanced digital system. 134 pages

Price £3.35

U.K. Packing
& Postage 32p

theory and
practice of

MODEL RADIO CONTROL

development of a system
proportional control system
digital system device
practical examples and
full circuit details

ON SALE NOW
at all leading shops
or direct from:—

RADIO MODELLER
BOOKS DIVISION,
High Street,
Sunningdale,
Berkshire SL5 0NF.

IN OUR NEXT ISSUE

SIMPLE S.W. SUPERHET



- ★ 180 to 20 metres
- ★ 3 Transistors
- ★ No Alignment Problems
- ★ Very Low Battery Current

AUDIO DELAY LINE

Fairly recently introduced integrated circuits are the 'bucket brigade' delay lines, and these offer numerous possible applications to the electronics experimenter. More correctly known as charge coupled devices (c.c.d.) or charge transfer devices (c.t.d.) they enable signals covering the full audio band-width to be delayed by a few milliseconds with little loss of quality. The signal is delayed purely by electronic means, and there is no need for mechanical or electro-mechanical components such as spring lines or tape loops.

IN YOUR WORKSHOP
SHORT WAVE NEWS
NEWS & COMMENT
ELECTRONICS DATA

Bypassing and Decoupling

TELEPHONE BELL REPEATER

A useful household device designed to eliminate the problem of a ringing telephone bell being missed when working in an outbuilding or in the garden. Of course, it can also be of value on other occasions when the telephone bell is inaudible for some reason such as listening to loud music.

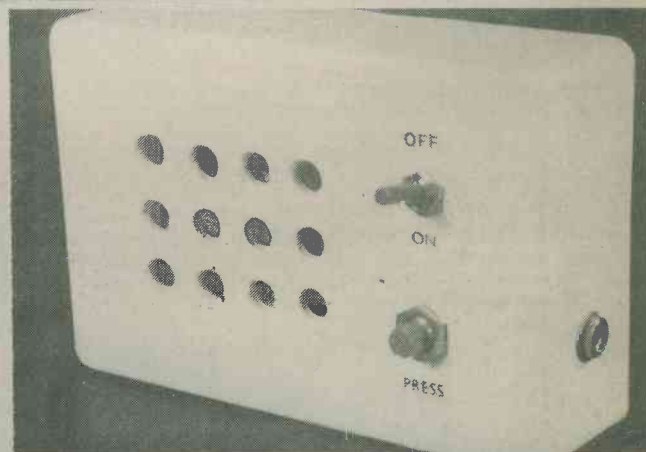

MANY OTHER ARTICLES