

# RADIO & ELECTRONICS CONSTRUCTOR

JANUARY 1979  
Volume 32 No. 5

Published Monthly  
(3rd of preceding Month)  
First Published 1947

*Incorporating The Radio Amateur*

*Editorial and Advertising Offices*  
57 MAIDA VALE LONDON W9 1SN

Telephone 01-286 6141      Telegrams  
Databux, London

© Data Publications Ltd., 1978. Contents may only be reproduced after obtaining prior permission from the Editor. Short abstracts or references are allowable provided acknowledgement of source is given.

**Annual Subscription:** £7.00, Overseas £8.00 (U.S.A. and Canada \$15.00) including postage. Remittances should be made payable to "Data Publications Ltd". Overseas readers, please pay by cheque or International Money Order.

**Technical Queries.** We regret that we are unable to answer queries other than those arising from articles appearing in this magazine nor can we advise on modifications to equipment described. We regret that queries cannot be answered over the telephone; they must be submitted in writing and accompanied by a stamped addressed envelope for reply.

**Correspondence** should be addressed to the Editor, Advertising Manager, Subscription Manager or the Publishers as appropriate.

**Opinions** expressed by contributors are not necessarily those of the Editor or proprietors.

**Production.**—Web Offset.

<b>CMOS RESISTANCE EVALUATOR</b>	278
by Bruce Woodland Linear read-out from less than 5Ω to 10MΩ — 11 Overlapping ranges — Simple low-cost "plug-in" circuitry	
<b>BILATERAL SWITCH</b>	282
by F. Bowden	
<b>NEWS AND COMMENT</b>	284
<b>"ELECTRONIC HANGMAN"</b> — Suggested Circuit	286
by G. A. French	
<b>CAR RADIO TRIM</b>	290
by R. D. Smith	
<b>RADIO 4 CONVERTER</b>	291
by R. A. Penfold	
<b>PHASE LOCKED A.M. RECEIVER</b> —	296
Part 1 (2 parts) by M. V. Hastings A phase locked loop is used for a.m. detection very successfully in this latest practical medium wave receiver	
<b>ENGINEER'S HARDWARE KIT</b>	302
<b>IN NEXT MONTH'S ISSUE</b>	303
<b>SCALE-OF-TWO COUNTER</b> — by Ian Sinclair	304
Double Decker Series No. 3	
<b>9 VOLT ELIMINATOR-SPEAKER UNIT</b> —	307
Part 1 (2 parts) by R. A. Penfold	
<b>SILICON CONTROLLED SWITCH CIRCUITS</b> —	310
Part 2 (Conclusion) by John Baker	
<b>WORLD'S SMALLEST I.F.T.s</b>	314
<b>SHORT WAVE NEWS</b> — For DX Listeners	315
by Frank A. Baldwin	
<b>SIMPLE COMBINATION LOCKS</b> —	316
In Your Workshop	
<b>RELAYS</b> — Electronics Data No. 41	iii
For the Beginner	

Published in Great Britain by the Proprietors and Publishers, Data Publications Ltd, 57 Maids Vale, London W9 1SN

The *Radio & Electronics Constructor* is printed by Swale Press Ltd.

**THE FEBRUARY ISSUE  
WILL BE PUBLISHED  
ON 4th JANUARY**

# THE MODERN BOOK CO

## THE BASIC COOKBOOK

A complete dictionary of all basic Statements, Commands, and Functions

**UNDERSTANDING DIGITAL ELECTRONICS**  
by Texas Instruments **PRICE £3.95**

**BEGINNER'S GUIDE TO MICRO PROCESSORS**  
by M. Gilmore **PRICE £4.85**

**BUILDING & DESIGNING TRANSISTOR RADIOS**  
**A BEGINNER'S GUIDE**  
by R. H. Warring **PRICE £3.30**

**FOUNDATIONS OF WIRELESS & ELECTRONICS**  
by M. G. Scroggie **PRICE: £4.25**

**TRANSISTOR POCKET BOOK**  
by R. G. Hibberd **PRICE: £4.20**

**BEGINNER'S GUIDE TO INTEGRATED CIRCUITS**  
by I. R. Sinclair **PRICE: £3.00**

**BEGINNER'S GUIDE TO T.V.**  
by G. J. King **PRICE: £2.50**

**ILLUST. TEACH YOURSELF RADIO**  
by D. Gibson **PRICE: £1.80**

**RADIO TECHNICIAN'S BENCH MANUAL**  
by H. W. Hellyer **PRICE: £4.00**

**SOLID STATE COLOUR T.V. CIRCUITS**  
by G. R. Wilding **PRICE: £8.00**

**SERVICING WITH THE OSCILLOSCOPE**  
by G. J. King **PRICE: £5.30**

**THE RADIO AMATEUR'S H/B 1978**  
by A. R. R. L. **PRICE: £7.60**

**TRANSISTOR ELECTRONIC ORGANS FOR THE AMATEUR**  
by A. Douglas **PRICE: £4.80**

**RAPID SERVICING OF TRANSISTOR EQUIP.**  
by G. J. King **PRICE: £2.80**

**RADIO CIRCUITS EXPLAINED**  
by G. J. King **PRICE: £8.00**

**ELECTRONICS POCKET BOOK**  
by P. J. McGoldrick **PRICE: £4.25**

**BEGINNER'S GUIDE TO ELECTRONICS**  
by T. L. Squire **PRICE: £2.50**

**BEGINNER'S GUIDE TO COLOUR T.V.**  
by G. J. King **PRICE: £2.50**

**T.V. TECHNICIAN'S BENCH MANUAL**  
by G. R. Wilding **PRICE: £5.00**

**ELECTRONICS & RADIO AN INTRO**  
by M. Nelkon **PRICE: £3.10**

**T.V. SERVICING H/B**  
by G. J. King **PRICE: £5.60**

**TELECOMMUNICATION SYSTEMS**  
**TEC LEVEL I**  
by P. H. Smale **PRICE: £2.80**

**PRICE £3.95**

**MINI PROCESSORS FROM CALCULATORS TO COMPUTERS**  
by D. L. Heiserman **PRICE £4.85**

**TRANSISTORISED RADIO CONTROL FOR MODELS**  
by D. W. Aldridge **PRICE: £3.30**

**PRINCIPLES & SYSTEMS FOR RADIO & T.V. MECHANICS**  
by K. F. Ibrahim **PRICE: £2.25**

**INTEGRATED CIRCUIT POCKET BOOK**  
by R. G. Hibberd **PRICE: £4.20**

**BEGINNER'S GUIDE TO AUDIO**  
by I. R. Wilding **PRICE: £3.60**

**BEGINNER'S GUIDE TO ELECTRIC WIRING**  
by F. Guillou **PRICE: £2.50**

**BEGINNER'S GUIDE TO RADIO**  
by G. J. King **PRICE: £3.00**

**AUDIO TECHNICIAN'S BENCH MANUAL**  
by J. Earl **PRICE: £3.50**

**COLOUR T.V. WITH PART. REF. TO THE PAL SYSTEM**  
by G. N. Patchett **PRICE: £6.00**

**THE OSCILLOSCOPE IN USE**  
by I. R. Sinclair **PRICE: £2.80**

**ELECTRONICS TEC LEVEL II**  
by D. C. Green **PRICE: £3.80**

PRICES INCLUDE POSTAGE

We have the Finest Selection of English and American Radio Books in the Country

**19-21 PRAED STREET (Dept RC) LONDON W2 1NP**

Telephone 01-723 4185

# Ultrasonic Transmitting and Receiving Kit...

only

**£10.95**  
+ P&P

ALL PRICES  
INCLUDE  
VAT.

"Radio Control", garage door opening, TV remote-control, secret signalling, burglar alarms... this is exciting equipment. You can invent an almost infinite number of separate applications, or incorporate these modules in a larger project.

The transmitter provides a high-frequency ultrasonic beam to the receiver, which has 3 transistors, I.C. amplifier & relay. (each works from a 12V battery, not supplied). Despite its low price (£10.95) this kit contains all components needed, namely transducers, circuits, veroboard (64mm x 95mm), layouts etc. All you require are basic tools and a soldering iron... assembly instructions are supplied, with help at the end of a 'phone if you need it.

### More of the Doram project kits:

- \* 60-205 Fluid Switch £3.25+50p p&p
- \* 60-206 Sound Switch £6.00+50p p&p
- \* 60-207 Light Switch £4.45+50p p&p
- \* 60-208 Temp. Switch £5.45+50p p&p
- 60-209 Gas Detector £10.45+50p p&p
- 60-926 I.C. Power Amp £6.75+50p p&p

\* Suitable for beginners if built under instruction.

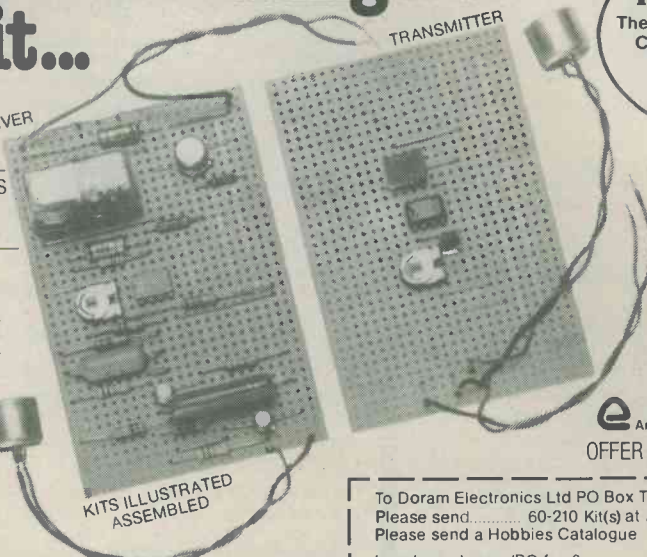

KITS ILLUSTRATED ASSEMBLED

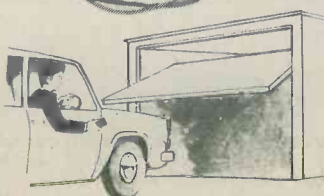

All Project kits are 2 star kits.

## REMINDER

The DORAM Electronic Hobbies Catalogue is now available.

**FREE**

Order now.

Guarantee of Satisfaction.

Send the coupon immediately. Your Kit will be delivered within 25 days. If you are not completely satisfied you may return your purchase within 30 days for a full refund.

Doram Electronics Ltd,  
PO Box TR8, Leeds LS12 2UF.

An Electrocomponents Group Company

OFFER CLOSES 14th February 1979.

To Doram Electronics Ltd PO Box TR8 LS12 2UF  
Please send..... 60-210 Kit(s) at £11.90 (£10.95 + 95p p&p)  
Please send a Hobbies Catalogue

I enclose cheque/PO for £  
I am paying via National Giro Centre Bootle Lancs to your Account  
Number 00/643/7257

Please debit my ACCESS Card No.

I expect delivery within 25 days

Signature .....

Name .....(BLOCK LETTERS)

Address .....

Doram Electronics Ltd Reg 1155856

REC 1.79



# All you want for Christmas

*Fast and Easy*

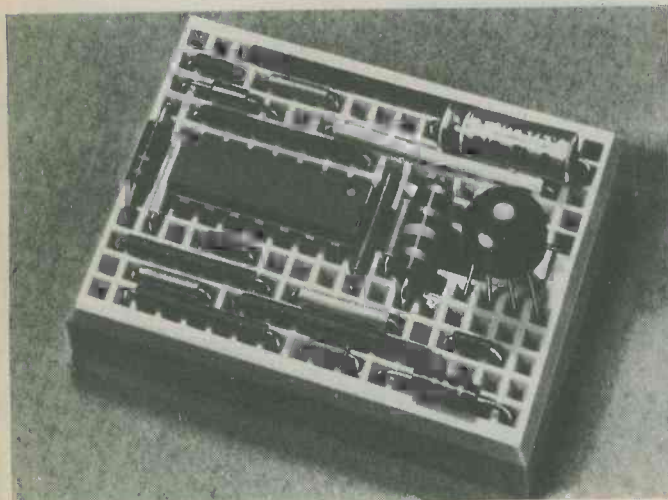

## Lektrokit Breadboards

FROM £3.25, inc p & p and VAT

Hole for hole, top value! Lektrokit breadboards are modular, so they can be linked together to form any size. With a pitch of 0.1", even the smallest breadboard—217L—can accept 8, 14, 16 or 18 pin DIL sockets. You just take a component, choose a hole, and push it in.

Model No.	Contacts	Price, each
217L	170	£3.25 <input type="checkbox"/>
234L	340	£5.75 <input type="checkbox"/>
248L	480	£6.65 <input type="checkbox"/>
264R	512	£6.65 <input type="checkbox"/>
264L	640	£8.32 <input type="checkbox"/>

(All prices include packing, postage and VAT).

## Lektrokit Super Strip SS2

ONLY £11.05 inc p & p and VAT

Super Strip accepts all DIP's—as many as nine 14-pin at a time—and/or TO-5's and discrete components. With interconnections of any solid wire up to 20 AWG.

Super Strip has 840 contact points, combining a power/signal distribution system with a matrix of 640 contacts in groups of 5. Distribution system has eight bus-bars, each with 25 contact points.

Lektrokit's policy, as you know, is the right product, whatever the project, at the right price. And it's backed by a nationwide network of retailers.

But it could be that, whoever you get to complete your Christmas, doesn't know where the Lektrokit retailers are. So we've included an order coupon to help them—and you out!

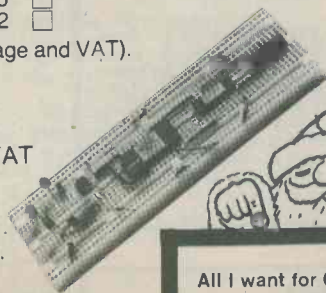

## Leave this page open where it will do the most good!

You know, almost as well as we know, where to go to get the components a home projects constructor needs to pursue his hobby.

Either your nearest Lektrokit dealer. Or direct from Lektrokit by mail order.

Because Lektrokit offer the most comprehensive range of breadboarding and testing devices on earth.

Trouble is, the nice people who might give you Lektrokit for Christmas probably haven't the faintest idea what we—or even you—are on about.

So just tick the items you'd particularly like for Christmas. And then leave this page open in a strategic place!

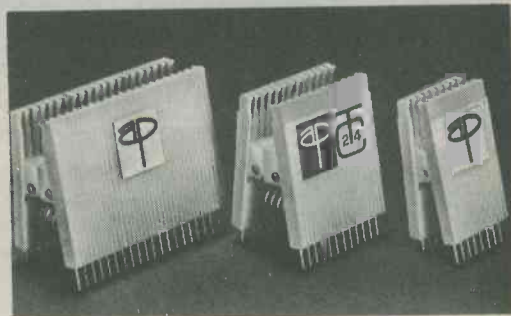

## Lektrokit IC Test Clips

ONLY £3.08 inc p & p and VAT

Ten models to fit all DIP sizes. Test clip grips IC's without slipping or shorting between pins—makes testing IC's on boards easier, aids removing and inserting DIP's without damage. Each IC pin can be brought up to a convenient contact post for hooking test leads or probe connections.

Model	Price
TC-8	£4.38 <input type="checkbox"/>
TC-14	£3.08 <input type="checkbox"/>
TC-16	£3.25 <input type="checkbox"/>
TC-24	£9.28 <input type="checkbox"/>
TC-40	£13.95 <input type="checkbox"/>

LEKTROKIT COMPLETES THE CIRCUIT—FOR CHRISTMAS!

All I want for Christmas is what I've marked above.

To Lektrokit Limited, London Road, Reading, Berks, RG6 1AZ.  
Telephone Reading (0734) 669116/7.

Please supply the above (tick items required)—IMMEDIATELY.

**CUT OUT THE COMPLETE ADVERTISEMENT AND SEND TO LEKTROKIT**

(All prices include packing, postage and VAT. All deliveries include name of nearest Lektrokit dealer—plus a FREE catalogue!)

I enclose P.O./cheque for £ .....

Name / .....

Address .....

REC3

# LEKTROKIT

## COMPLETES THE CIRCUIT



# High quality audio accessories

## AL120

**AUDIO AMPLIFIER**  
(With Integrated heat sink and short-circuit protection)

**£11.95**

+ 8% VAT p&p 35p

Introduced to fulfil the demand for a fully protected power amp., capable of driving high quality speaker systems at up to 50w., with distortion levels below 0.5%. Ideal for domestic use, Discos, PA systems, electronic organs etc. The generously rated component-sensure continuous operation at high output levels.

**50W R.M.S.**



OUTPUT POWER	50 Watts R.M.S.
SUPPLY	70 Watts
LOAD IMPEDANCE	8-16 Ohms
TOTAL HARMONIC DISTORTION	0.5% Max. (Typically 0.2%)
FREQUENCY RESPONSE	25Hz-20kHz
SENSITIVITY	500mV
MAX HEAT SINK TEMP.	45 deg. C
DIMENSIONS	192 x 89 x 49mm

## SPM120

**STABILISED POWER SUPPLIES**

SPM120/45  
SPM120/55  
SPM120/65

**£5.80**

+12 1/2% VAT  
p&p 35p

SPM120 is a fixed voltage stabiliser available with an output voltage of either 45v, 55v, or 65v. Designed primarily for use in audio applications, the stabiliser which provides output currents up to 2.5A, operates direct from a mains transformer requiring only the addition of 2 Electrolytic capacitors to complete the s/c protection.



AC INPUTS	—
SPM120/45	40-48v
SPM120/55	50-55v
SPM120/65	60-65v
OUTPUT CURRENT	2.5A
RIPPLE	1A 100mV 2A 150mV

## GE100 Mk.2

**10 CHANNEL MONOGRAPHIC EQUALISER**

**£20**

+12 1/2% VAT  
p&p 35p

Only 155mm x 65mm x 50mm including the 10 x 10K ln slider potentiometers and knobs which are mounted on a board positioned above the circuitry. In the frequency range of 31Hz to 20KHz you can cut and boost  $\pm 12$ db with the 10 sliders, each of which has its frequency marked on the circuit board. The GE100 has numerous uses including mixers, PA systems and discos. It will also greatly improve the sound reproduction of your existing audio equipment. Power supply for GE100, o/d SG30 £3.80.



CONTROL RANGE	$\pm 12$ db
DYNAMIC RANGE	110db
MAXIMUM OUTPUT	+15db
FREQUENCY RESPONSE	30Hz-20KHz ( $\pm 1$ db)
POWER SUPPLY	15-0-15v
VOLTAGE HANDLING INPUT	3v R.M.S.
T.H.D.	0.05%

## VPS30

**REGULATED VARIABLE STABILISED POWER SUPPLY**

**£7.60**

+8% VA1  
p&p 35p

This NEW versatile Regulated Variable Stabilised Power Supply with short circuit protection and current limiting, is a must for all electronics enthusiasts. It incorporates adjustable voltage from 2v-30v, with a current limiting range of 0-2A. With this module there is no need to build a separate power supply for each of your projects, with the simple addition of a transformer (o/d 2033), 0-1ma (o/d 1310 or 1305), plus a suitable shunt, a voltmeter (o/d 1311 or 1308), a 470ohm pot (o/d 1896), a 4K7 pot (o/d 1899). It can be used again and again as a self-contained bench, power supply, eliminating the use of batteries and thus saving ££s!



AC INPUT MAXIMUM	25v
VOLTAGE REGULATION	2-30v
REGULATED CURRENT	0-2A
Incorporating short circuit protection	

## PA200

**STEREO PRE-AMPLIFIER**

**£16.55**

+12 1/2% VAT  
p&p 40p

The PA200 is basically our popular PA100. Modifications have been made to make it compatible with the higher output AL120 and AL250 amplifiers.



FREQUENCY RESPONSE	20Hz to 20kHz x 1dB	
TOTAL HARMONIC DISTORTION	Less than .1% (typically .07%)	
SENSITIVITY INPUTS		
1. TAPE	100mV/100K ohms	} For an output of 500mV
2. RADIO TUNER	100mV/100K ohms	
3. MAGNETIC P.U.	3.5mV/50K ohms	
EQUALISATION	Within $\pm 1$ dB from 20 Hz to 20 kHz	
BASS CONTROL RANGE	$\pm 15$ dBs at 75 Hz	
TREBLE CONTROL RANGE	+10-20 dBs at 15 kHz	
SIGNAL/NOISE RATIO	Better than 65 dBs (all inputs)	
INPUT OVERLOAD	Better than 26 dBs (all inputs)	
SUPPLY	35 to 70V	
DIMENSIONS	300 x 90 x 33mm (less controls)	

## HEADPHONES

A top quality headphone with cushioned earpads and headband. Separate balance/volume controls. Stereo or Mono switch. Impedance: 80ohms. Frequency: 30-18,000Hz, o/n 884. £8.70 + 12 1/2% VAT, p&p 70p. A brilliant compromise between price and performance. Superb stereo reproduction for the newcomer to Hi-Fi Impedance: 80ohms. Frequency: 30-15,000Hz, o/n 885 £4.40 + 12 1/2% VAT, p&p 50p.

## BIB HI-FI ACCESSORIES

Parallel Tracking GROOV KLEEN  
The very latest in automatic record cleaning. Designed to suit all modern single play decks. Simple to fit, it is extremely efficient. Complete with two types of base and three height extensions. o/n 8101. £3.68 + 12 1/2% VAT, p&p 35p.  
Cassette Tape Editing Kit  
Enables cassette tapes to be edited and joined easily, quickly and accurately. Kit comprises: Tape Splicer (in 13.2mm), 2 Precision Tape Cutters, Tape Piercer 9 Self-adhesive Labels, Reel of Splicing Tape, 3 Winders and removers and instructions, all in a handy wallet. o/n 811. £2.40 + 8% VAT, p&p 35p.  
GROOV STAT  
The BIB Groov-Stat static reducer neutralises the static charge on records and other plastic surfaces. o/n 8103. £5.45 + 8% VAT, p&p 35p.  
Cassette Head Cleaner  
Essential for cleaning of tape heads, capstans and rollers. Pack contains Tape Head Applicator and tape head polisher tools. Plus bottle of special formula cleaning fluid and full instructions. o/n 832. £0.55 + 12 1/2% VAT, p&p 35p.

## ADAPTORS

AC-DC enables a large range of battery powered radios, recorders, calculators to be run off the mains. (220-240V AC) Switchable for 6, 7.5 or 9 volts. Current rating 2.500MA. Polarity reversing switch. Universal plug Incorporated o/n 137. £3.95 + 12 1/2% VAT, p&p 35p.  
DC-DC for use in all cars, boats etc., with pos or neg earth for a regulated output of 6, 2.5 or 9 volts DC at 1a max. For radios, recorders etc. o/n 138. £2.80 + 12 1/2% VAT, p&p 32p.

## CROSSOVER NETWORKS

2-WAY channels for high and low frequencies to correct speakers — high to tweeters, low to woofers. Complete with instructions. Frequency: 3,000Hz, o/n 1904. £1.10 + 12 1/2% VAT, p&p 35p.  
2-WAY for 80hm speakers up to 30 watts. Frequency: .3kHz, o/n 1905. £1.65 + 12 1/2% VAT, p&p 35p.  
3-WAY for 80hm speakers up to 30 watts. Frequency: 800Hz and 4.5 kHz. o/n 1906. £2.95 + 12 1/2% VAT, p&p 35p.

## CASES

TEAK 30 designed mainly for use with our stereo 30 Audio System but has proved very helpful to home constructors. Fitted with solid uncut front and back. 32x23x8mm. O/n 139. £5.45 + 12 1/2% VAT, p&p 70p.  
TEAK 60 for use with AL60/MK60 Audio Kit. Useful for the home constructor requiring an amplifier sleeve — has no front or back panel. 42x29.9mm. O/n 140. £7.00 + 12 1/2% VAT, p&p 85p.

## METERS

**Miniature Balance & Tuning Meter**

Miniature moving-coil meter for stereo balance indicator, tuning indicator for FM or null position. Pointer at centre indicates zero or null position. Robust construction. Sensitivity: 100-0-100MA. Dimensions: 23 x 22 x 26mm. o/n 1318. £1.95 + 8% VAT, p&p 35p.

**Balance and Tuning Meter**

Clear view edgeview meter. Centre zero application. Sensitivity: 100-0-100UA. Dimensions: 45 x 22 x 34mm. £2.00 + 8% VAT, p&p 35p.

**Miniature Level Meter**

Moving coil, for accurate level indication for tape recorders, amplifiers etc. Neat design, rugged construction — will withstand five times rated value. Sensitivity: FSD: 200UA. Odb: 130UA. Dimensions: 23 x 22 x 26mm. o/n 1320. £2.80 + 8% VAT, p&p 35p.

**Vu Meter**

Calibrated — 20 to +3 and 0-100%, making it suitable for use as a recording level meter or as a power output indicator. Sensitivity: 130UA. Dimensions: 40 x 40 x 29mm. o/n 1321. £2.00 + 8% VAT, p&p 35p.

## MICROPHONES

**DYNAMIC CASSETTE**

For equipment requiring a high quality microphone. Sturdy, solid moulded body in black with neat chrome surround. Pick-up pattern is omnidirectional. On/off switch, 1 metre of tough lead with floating 2.5 and 3.5mm plugs. Matching moulded strut. Impedance: 200 ohms. Sensitivity: 90db. Frequency: 90-10,000Hz. Size: 20mm dia x 120mm. o/n 1326. £1.60 + 12 1/2% VAT, p&p 35p.

**DYNAMIC MICROPHONE**

Superior quality portable cassette recorder mike with built-in remote control switch and lead fitted with 5-pin DIN plug (remote switch) and 3-pin DIN plug (microphone). Provides a direct replacement for those supplied with recorders. With detachable stand. Omnidirectional. Impedance: 200 ohms. res. response: 100 to 10,000Hz. Sensitivity: 79db at 1,000Hz. o/n 1328. £2.65 + 12 1/2% VAT, p&p 35p.

**RE - 317: DYNAMIC MICROPHONE**

Highly sensitive, high-grade desk or hand mike suitable for use with many popular cassette decks. Incorporates On/off switch and 1 metre lead with moulded standard Jack plug. Complete with desk stand. Omnidirectional. Impedance: 5,000 ohms. Freq. response: 100 to 12,000Hz. Sensitivity: (-7db at 1,000Hz). o/n 1336. £4.10 + 12 1/2% VAT, p&p 35p.

**OMNIDIRECTIONAL CARDIOD**

Powered by a 1 1/2 volt battery located within the aluminium body. Satin silver finish with chrome protection to the diaphragm housing. On/off switch. Also with 'Busby' type windshield, 'U' bracket and stem and extremely supple cable. Consumption: 0.2mA from 1 1/2 volt battery providing approx. 8-10,000 hours continuous use. Impedance: 600 ohms. Sensitivity: 70db. Frequency: 30-16,000Hz. Size: 23mm dia x 267mm. o/n 1329. £12.80 + 12 1/2% VAT, p&p 35p.

**UNIDIRECTIONAL CARDIOD**

Dist. Imp. 600 and 50,000 ohms. Response 60 to 14,000Hz. Sensitivity: 54db at 50K/ohms. Size: 1 1/2 in. dia x 6 1/2 in. long. Weight approx. 190gm. o/n 1328. £10.95 + 12 1/2% VAT, p&p 35p.

## STANDS

**GOOSENECK CHROME FLEXIBLE HOLDERS**  
Length 320mm o/n 1333 £2.40 + 12 1/2% VAT, p&p 35p  
Length 515mm o/n 1334 £3.40 + 12 1/2% VAT, p&p 35p  
**FLOOR STAND Heavy chrome.** Stays-away feet with rubber ends for maximum stability. Draws to a height of 5ft maximum. o/n 1335 £9.00 + 12 1/2% VAT, p&p 85p.  
**BOOM ARM for use with the above stand.** Heavy chromed metal. It gives 30in reach from the stand. o/n 1337 £8.00 + 12 1/2% VAT, p&p 70p.

**WINDSHIELD COVERS**

O/n 1531 Medium pair £1.20 + 12 1/2% VAT, p&p 35p. O/n 1332. Large pair £1.80 + 12 1/2% VAT, p&p 35p.

## AUDIO LEADS

- 107 FM Indoor Ribbon Aerial **£0.60\***
  - 113 3.5mm Jack plug to 3.5mm Jack plug. Length 1.5m **£0.75\***
  - 114 5 pin DIN plug to 3.5mm. Jack connected to pins 3&5. Length 1.5m **£0.85\***
  - 115 5 pin DIN plug to 3.5mm. Jack connected to pins 1&4. Length 1.5m **£0.85\***
  - 116 Car aerial extension. Screened insulated lead. Fitted plug & skt. **£1.10\***
  - 117 AC mains connecting lead for cassette recorders & radios. 2 metres **£0.68\***
  - 118 5 pin DIN phono plug to stereo headphone jack socket **£1.05\***
  - 119 2+2 pin DIN plugs to stereo jack socket with attenuation network for stereo headphones. Length 0.2m **£0.90\***
  - 120 Car stereo connector. Variable geometry plug to fit most car cassette, 8 track cartridge & combination units. Supplied with inline fused power lead and instructions. **£0.60\***
  - 123 6.6m Coiled Guitar Lead Mono Jack Plug to Mono Jack Plug BLACK **£1.50\***
  - 124 3 pin DIN plug to 3 pin DIN plug. Length 1.5m **£0.75\***
  - 125 5 pin DIN plug to 5 pin DIN plug. Length 1.5m **£0.75\***
  - 126 5 pin DIN plug to Tinned open end. Length 1.5m **£0.75\***
  - 127 All colour coded. Length 1.5m **£1.30\***
  - 128 5 pin DIN plug to 5 pin DIN socket. Length 1.5m **£0.80\***
  - 129 5 pin DIN plug to 5 pin DIN plug mirror image. Length 1.5m **£1.05\***
  - 130 2 pin DIN plug to 2 pin DIN inline socket. Length 5m **£0.68\***
  - 131 5 pin DIN plug to 3 pin DIN plug. 1.84 and 3&5. Length 1.5m **£0.83\***
  - 132 2 pin DIN plug to 2 pin DIN socket. Length 10m **£0.98\***
  - 133 5 pin DIN plug to 2 phono plugs. Connected pins 3&5. Length 1.5m **£0.75\***
  - 134 5 pin DIN plug to 2 phono sockets. Connected pins 3&5. Length 23cm **£0.68\***
  - 135 5 pin DIN socket to 2 phono plugs. Connected pins 3&5. Length 23cm **£0.68\***
  - 136 Coiled stereo headphone extension lead. Black. Length 6m **£1.75\***
  - 178 AC mains lead for calculators etc. **£0.45\***
- All above add 8% VAT + 35p p&p.

# BI-PAK

DEPT. RC1, P.O. Box 6, Ware, Herts

RADIO AND ELECTRONICS CONSTRUCTOR



SEMICONDUCTORS. ALL FULL SPEC. BC212, BC182, BC237, 8F197, BC159, all 8p each. RCA 2015, TO3 POWER TRANSISTORS (SIM. 2N3055). 35p. MRD3051 PHOTO TRANSISTORS 35p. FETs SIMILAR TO 2N3819 17p. MOSFET SIMILAR 40673 35p. 3N140 MOSFETS 50p. M203 DUAL MATCHED PAIR MOSFETS, SINGLE GATE PER FET 40p. MIN. E.H.T. SIL. RECS. 15K.V., 2.5mA, 30p. INTEL C1103 1024 BIT MOS RAMS 95p. BB 113 TRIPLE VARICAP DIODE 35p. MCT310 STEREO DECODER IC £1.20. CD4051 IC's 50p. 741 8 PIN IC's 23p. DIODES: IN4002 4p. IN4005 7p. RED LED's 0.2" or 0.125" 12p. NIXIES: ITT 5870ST 85p. GN9A 65p. MAN3A 3/mm 7 SEC. DISPLAYS 50p.

MICROPHONES: GRUNDIG ELECTRET MICROPHONE INSERTS WITH FET PREAMP £1.50. CRYSTAL MIKE INSERTS 37mm 45p. ELECTRET CONDENSER MIKES, 1K IMP. WITH STANDARD JACK PLUG £2.85. EM506 CONDENSER MIKES, UNI DIRECTIONAL, FET AMP DUAL IMPEDANCE 50K/600 OHMS ON/OFF SWITCH 30-18KHz £11.00. EM104 MIN. TIE CLIP CONDENSER MIKES, OMNI. 1K IMP. USES DEAF AID BATTERY (SUPPLIED) £4.95.

MORSE KEYS: ALL METAL HI-SPEED TYPE £2.25 PLASTIC TYPE 95p.

HEADPHONES: 8 OHM STEREO PHONES PADDED EARPIECES AND HEADBAND, CURLY CORD, 30-18KHz ONLY £3.00.

OPTO-ISOLATORS. TYPE BX504. INFRA RED LED TO PHOTO CELL. 4 LEAD 25p.

AEROSOL 'TOUCH UP' PAINT. 1 COLOUR, YELLOW/GREY. 35p 6oz can.

POT CORE UNIT, HAS 6 POT CORES INCLUDING FX2243 (45mm) x 1, FX2242 (35 mm) x 2, 3 SILICON TO3 POWER TRANSISTORS ON HEAT SINK, 3 20mm PANEL FUSEHOLDERS, 5 amp PLASTIC S.C.R. AND PANEL WITH VARIOUS TRANSISTORS AND DIODES NEW. £1.75 (75p p&p).

SOLDER SUCKERS: PLUNGER TYPE, REPLACEABLE NOZZLE, EYE PROTECTION SHIELD. HIGH SUCTION £4.95.

CRYSTALS. 300KHz 40p.

EDGE CONNECTORS: 0.1 MATRIX 64 WAY 65p. 32 WAY 40p. 0.2" 18 WAY 15p.

RELAYS: 4 POLE CHANGEOVER, 700 OHM 55p. MIN SEALED 240V AC 2 POLE C/O RELAYS 40p. 4 POLE REED RELAYS, 12 volts 20p. 24 VOLT 2P C/O SEALED RELAYS, 3 AMP CONTACTS, NEW. 55p.

SPECIAL OFFER SGS TBA800 IC's... 10 for £5.00.

NE555 I.C.'s 10 for £3.00.

AMPHENOL CONNECTORS  
PL259 plugs 45p SO239 sockets... 40p Reducers... 12p

GLASS REED SWITCHES  
28mm normally open... 50p for 10

MULTIMETERS  
LT101, 1000 ohms per volt  
0-10-50-250-1000VAC, 0-10-50-250-1000VDC  
0-1, 0-100MA DC CURRENT, 0-3K, 0-150K RESISTANCE  
£5.00

Y208, 20,000 ohms per volt  
0-10-50-250-1000VAC, 0-5-25-125-250-500-1000VDC  
0-005, -5-2500MA DC CURRENT, 0-3K, 300K, 3MEG RESISTANCE  
£9.95

40 watt 240VAC Pencil tip SOLDERING IRONS, lightweight (spares in stock) £1.95  
12VDC 15 watt PORTABLE SOLDERING IRON-£1.60

SPECIAL OFFER:  
7" x 4" 15/20 Ohm SPEAKERS, new... 75p each

POWER SUPPLIES  
Cass/Radio/Calc power supply, plugs into 13 amp socket  
3-4 1/2-6-7 1/2-9V D.C. out at 100 or 400MA (switchable)  
£3.20

Cassette Power Supply, plugs into 13 amp socket, 6-7.5-9VDC outputs at 300mA... £2.95  
DC Car Adaptor, 12VDC input, 6VDC output, fully regulated, 1 amp max. £1.90

MOTORS  
Small synchronous 240VAC Motors, with gearbox, 1/5th RPM or 1/24th RPM... 70p each.  
Crouzet 115 VAC 4 rpm Motors. New. 95p  
Heavy duty 240V A.C. Solenoids, 2" pull, 25lbs. £3.95 + 54p p&p  
Small side cutter, insulated handles... £1.35  
Small snub-nosed pliers, insulated handles... £1.35

9 VOLT BATTERY ELIMINATORS, stabilized output, at 120MA max... only £2.45

MOTORS: 1-5 TO 6V DC MODEL MOTORS 20p. SUB. MIN. 'BIG INCH' 115V AC 3RPM MOTORS 30p. 12 V.D.C. 5 POLE MOTOR 35p.

BOXES: BLACK ABS PLASTIC PROJECT BOXES, BRASS INSERTS AND LID 75 x 56 x 35mm 44p. 95 x 71 x 36mm 52p. 115 x 95 x 36mm 60p.

MAINS TRANSFORMERS, All 240VAC primary, postage shown in brackets per transformer.

6-0-6 100MA (9-0-9 75MA, 12-0-12 50MA 75p each (15p) 0-4-6-9 150MA NO MOUNTING BRACKET, 65p (20p) 12-0-12 100MA 95p (15p). 12V 500MA 95p (22p). 12V 2 AMP £2.25 (45p). 12VOLT 4 AMP 2-75p (54p) 15-0-15V 1 AMP 2-10p (45p). 30-0-30V 1 AMP 2-75p (54p). 0-12-15-20-24-30V TAPPED AT 2AMP 4-50p (54p). 20-0-20V 2AMP 3-50p (54p). 25V 1-5AMP 1-45p (54p). 18V 1-5AMP RECTIFIED 2-00P (45p). 35V 2A, 2-5V 2A TOROID 2-95p (54p). 20VOLTS 2-5A 2-20p (54p).

1 XENON/TRIAC PULSE TRANSFORMERS 30p.

BUZZERS: GPO TYPE 6-12 volts 30p. 12 volt LARGE PLASTIC DOMED RUIZZERS (50mm) LOUD NOTE 50p. MIN. SOLID STATE BUZZERS, 6-9-12 OR 24 volt. All 15ma 75p each.

U.H.F. TUNERS: PUSH BUTTON T.V. TYPE (NOT VARICAP) NEW AND BOXED £2.50.

TAPE HEADS: STEREO CASSETTE £3.00. MN1330 DUAL IMPED. R/P HALF TRACK HEADS 50p. SRP90 1/2 TRACK R/P HEADS £1.95. STANDARD 8 TRACK STEREO £1.75. TD10 DUAL HEAD ASSEMBLIES 2 HEADS, BOTH 1/2 TRACK R/P WITH BUILT-IN ERASE, MOUNTED ON BRACKET £1.20.

SPECIAL OFFER: ZN414 RADIO CHIPS 75p. LM380 80p. LM381 95p. COLVERN 3K 5W wirebound pots 20p.

METERS: 200 MICRO AMP MIN. LEVEL METERS 75p. GRUNDIG IMA BATT. LEVEL METERS 40 x 40mm £1.10. DUBILIER 1MFD 600V D.C. MIXED DIELECTRIC CAPACITORS 15p.

50 VAC CAM UNITS, WITH 10 C/O MICRO SWITCHES, SUPPLIED WITH CAPACITOR FOR 240 VAC USE. EX EQUIPMENT. £1.95 (+35p p&p)

SWITCHES: MIN. TOGGLE SPST 8 x 5 x 7mm 45p. DPDT 8 x 7 x 7mm 50p. DPDT CENTRE OFF 12 x 11 x 9mm 75p. MIN. PUSH TO MAKE OR PUSH TO BREAK 18 x 16mm 15p EACH TYPE. SLIDER SWITCHES: DPDT MIN. 12p. DPDT C/OFF 20p. MICRO SWITCHES: STANDARD SIZE ROLLER ACTION 15p. MIN. 13 x 10 x 4mm 20p. PLESSEY WINKLER SWITCHES, 1 POLE 30 WAY 2 BANK ADJUSTABLE STOP 75p. 8-WAY RIBBON CABLE, MIN. SOLID CORE, 15p metre.

8-TRACK 12 volt motors, new... £1.25  
6v Cassette motors, new... £1.35

ROSS SIREN ALARMS, operate on 6VDC... 85p

ORP81, MULLARD NEW BOXED... 30p

10MFD 600VDC BLOCK PAPER CAPS, new... 65p  
EARPIECES, 8 Ohm with 2, 5 or 3.5mm plug... 14p. Crystal 3.5mm plug... 32p  
Russian type, 3mm plug... 25p

MICRO SWITCHES  
Standard size, SPCO roller operated... 15p  
Heavy duty, 15 amps, button operated.  
SPCO. 65 x 15 x 15mm... 25p

JUMPER TEST LEAD SETS  
10 leads with insulated croc clips each end, different colours... 80p

STEREO HEADPHONE LEAD  
Black curly, 10' approx with stereo jack plug... 50p  
741S (wide bandwidth) 8-pin DIL... 35p

TIL305 ALPHA NUMERICAL DISPLAYS  
full spec with data sheet... £2.50

TAPE HEAD DEMAGNETISERS, 240 VAC with on/off switch... £2.00

TELEPHONE PICK UP COIL, suction type with lead and 3.5mm plug... 50p

2N5062 T092 S.C.R. 100V 800mA... 22p

MURATA MA401L 40kHz TRANSDUCERS, REC/SENDER, £3.25 pair

AMPLIFIERS  
OTL410 10 watt module into 8 Ohms mono, 28VDC max... £4.65  
455S stereo amplifier module, 3 watts output into 8 Ohms, 12VDC... £3.35

BELLING LEE L4305 MAST HEAD AMPLIFIER AND MAINS POWER SUPPLIES, Group 'A' UHF only... £7.50

12 AMP RUBBER TRAILER EXTENSION SOCKETS... 38p.  
LA1230 ADJ.CORE 15MM DIAM. 14MH, HI Q. 6 for 50p.

TERMS. CASH WITH ORDER (OR OFFICIAL ORDER FROM COLLEGES ETC.)  
POSTAGE 30p. OVERSEAS POST AT COST. V.A.T. INCLUDED IN ALL PRICES.  
S.A.E. PLEASE FOR NEW ILLUSTRATED LISTS

# PROGRESSIVE RADIO

31 CHEAPSIDE, LIVERPOOL 2.



## SUPERSOUND 13 HI-FI MONO AMPLIFIER

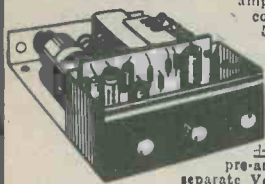

A superb solid state audio amplifier. Brand new components throughout. 5 Silicon transistors plus 2 power output transistors in push-pull. Full wave rectification. Output approx. 13 watts r.m.s. into 8 ohms. Frequency response 12Hz-30KHz  $\pm 3$ db. Fully integrated pre-amplifier stage with separate Volume, Bass boost and Treble cut controls. Suitable for 8-15 ohm speakers. Input for ceramic or crystal cartridge. Sensitivity approx. 40mV for full output. Supplied ready built and tested, with knobs, esutcheon panel, input and output plugs. Overall size 3" high x 6" wide x 7 1/2" deep. AC 200/240V. PRICE £16.00. P. & P. £1.20.

## HARVERSONIC MODEL P.A. TWO ZERO

An advanced solid state general purpose mono amplifier suitable for Public Address system, Disco, Guitar, Gram., etc. Features 3 individually controlled inputs (each input has a separate 2 stage pre-amp). Input 1, 15mV into 47k. Input 2, 15mV into 47k. (suitable for use with mic. or guitar etc). Input 3 200mV into 1 meg. suitable for gram, tuner, or tape etc. Full mixing facilities with full range bass & treble controls. All inputs plug into standard jack sockets on front panel. Output socket on rear of chassis for an 8 ohm or 16 ohm speaker. Output in excess of 20 watts R.M.S. Very attractively finished purpose built cabinet made from black vinyl covered steel, with a brushed anodised aluminium front esutcheon. For ac mains operation 200/240V. Size approx. 12 1/4" w. x 5 1/2" h. x 7 1/4" d.



Special introductory price £28.00 + £2.50 carr & pkg.

## HARVERSONIC STEREO 44

A solid state stereo amplifier chassis, with an output of 8-4 watts per channel into 8 ohm speakers. Using the latest high technology integrated circuit amplifiers with built in short term thermal overload protection. All components including rectifier smoothing capacitor, fuse, tone control, volume controls, 2 pin din speaker sockets and 5 pin din tape rec./play socket are mounted on the printed circuit panel, size approx. 9 1/2" x 2 1/2" x 1 1/2" max. depth. Supplied brand new and tested, with knobs, brushed anodised aluminium 2 way esutcheon (to allow the amplifier to be mounted horizontally or vertically), at only £9.00 plus 50p P. & P. Mains transformer with an output of 17V a/c at 500 mA can be supplied at £1.50 plus 40p P. & P. if required. Full connection details supplied.

**BRAND NEW MULTI-RATIO MAINS TRANSFORMERS.** Giving 13 alternatives. Primary: 0-210-240V. Secondary combinations 0-5-10-15-20-25-30-35-40-60V. half wave at 1 amp, or 10-0-10, 20-0-20, 30-0-30V. at 2 amps full wave. Size 3in. long x 3 1/4in. wide x 3in deep. Price £3.20 P. & P. £1.20.

**MAINS TRANSFORMER.** For power supplies. Pri. 200/240V. Sec. 9-0-9 at 500 mA. £1.80 P. & P. 65p. Pri. 200/240V. Sec. 12-0-12 at 1 amp. £2.00 P. & P. 65p. Pri. 200/240V. Sec. 10-0-10 at 2 amp. £2.70 P. & P. 90p. Pri. 200/240V. Sec. 23v. at 1.5 amp, 6v at .6 amp, 8v. at 50 mA. £2.25 + 65p P. & P.

**MAINS TRANSFORMER.** Pri. 0-110 and 240 Sec. 28V at 1.8 amps. Also tapped at 12V .3 amp. Size 2 1/2in hx 3 1/2in w x 2 1/2in d. £2.50 + 41p P. & P.

**ALL PURPOSE POWER SUPPLY UNIT 200/240V.** A.C. Input. Four switched fully smoothed D.C. outputs giving 6v, and 7 1/2v, and 9v, and 12v. at 1 amp on load. Fitted insulated output terminals and pilot lamp indicator. Hammer finish metal case overall size 6" x 3 1/2" x 2 1/2". Ready built and tested. Price £6.75. P. & P. 95p

## STEREO-DECODER SIZE 2" x 3" x 1 1/2"

Ready built. Pre-aligned and tested. Sens. 20-560mV for 9-15V neg. earth operation. Can be fitted to almost any FM VHF radio or tuner. Stereo beacon light can be fitted if required. Full details and instructions (inclusive of hints and tips) supplied. £8.00 plus 20p P. & P. Stereo beacon light if required 40p extra.



**QUALITY RECORD PLAYER AMPLIFIER MK. II**  
A top quality record player amplifier employing heavy duty double wound mains transformer, ECC83, EL84, and rectifier. Separate Bass, Treble and Volume controls. Complete with output transformer matched for 3 ohm speaker. Size 7in wide x 3in deep x 6in high. Ready built and tested. PRICE £7.00 P. & P. £1.25  
ALSO AVAILABLE mounted on board with output transformer and speaker. PRICE £8.00. P. & P. £1.30.

## MAINS OPERATED SOLID STATE AM/FM STEREO TUNER



200/240V Mains operated Solid State A/M F/M Stereo Tuner. Covering M.W. A.M. 540-1605 KHZ, VHF/FM 88-108 MHz. Built-in Ferrite rod aerial for M.W. Full AFC and AGC on AM and FM. Stereo Beacon Lamp indicator. Built-in Pre-amps with variable output voltage adjustable by pre-set control. Max o/p Voltage 600 mV RMS into 20K. Simulated teak finish cabinet. Will match almost any amplifier. Size 8 1/4" w. x 4" h. x 9 1/2" d. approx. LIMITED NUMBER ONLY at £28.00 + £1.50 P. & P.

## SPECIAL OFFERS

Mullard LP1159 RF-IF Double Tuned Amplifier Module for nominal 470KHz. Size approx. 2 1/2" x 1 1/2" x 1 1/2" 7-6V + earth. Brand new pre-aligned. Full specification and connection details supplied. £2.25 + P. & P. 20p.

**Eye VHF/FM Tuner Head** covering 88-108MHz. 10-7MHz 1 1/2" output 7-8V + earth. Supplied pre-aligned, with full circuit diagram. Connection details supplied. Beautifully made with precision-gear 3M Gang and 323 P1 + 323 P1 AM Tuning Gang only £3-15 + P. & P. 35p.

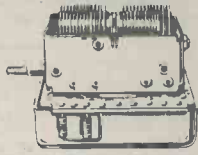

## PRECISION MADE

Push Button Switch bank. 8 Buttons giving 16 8/p C/O interlocked switches plus 1 Cancel Button Plus 3 d/p c/o. Overall size 5" x 2 1/2" x 1" Supplied complete with chrome finished switch buttons 2 for £1.80 + 20p. P. & P.

## SPECIAL OFFER Limited number only!

New but very slightly shop soiled transistor radios by well known manufacturer. Very smart and attractive, vinyl covered with carrying handle. Two models available:  
AC mains or battery operated and covering VHF/FM and MW bands. £10.00 + £1.30 p&p  
Similar to above but battery operation only. Five wavebands, MW, FM, SW and two VHF bands for reception of aircraft and some public service systems. £11.00 + £1.30 p&p  
Size (either model), 7in.H x 9 1/2in.W x 4in. D approx. Both types have telescopic aerials for VHF/FM reception and internal ferrite aerials for AM bands, also earphone socket for personal listening. Either model uses four HP11 or SP11 batteries (not supplied).

## LOUDSPEAKER BARGAINS

5in. 3 ohm £2.20, P. & P. 35p. 7 x 4in. 3 ohm £2.80, P. & P. 40p. 10 x 6in. 3 or 15 ohm £3.85, P. & P. 75p. 8 x 5in. 3 ohm with high flux magnet £1.60, P. & P. 60p. Tweeter. Approx. 3 1/2". Available 3 or 8 or 15 ohms, £2.20, 30p P. & P.

2" PLASTIC CONE HF TWEETER 4 ohm, £3.50 per matched pair + 50p P. & P.

HIGH POWER HI-FI 8 ohm Dome Tweeter. 1" voice coil. Magnet size 3/4". Suitable for use in up to 50 watt systems. £4.50 each + 60p P. & P.

VYNAIR & REXINE SPEAKERS & CABINET FABRICS app. 5 1/2in. wide. Our price £2.00 yd. length. P. & P. 50p per yd. (min. 1 yd.). S.A.E. for samples.

"POLY PLANAR" WAFER-TYPE, WIDE RANGE ELECTRO-DYNAMIC SPEAKER  
Size 11 1/4" x 14 1/4" x 1 1/2" deep. Weight 19oz. Power handling 20W r.m.s. (40W peak). Impedance 8 ohm only. Response 40Hz-20KHz. Can be mounted on ceilings, walls, etc. and used with or without bass. Send S.A.E. for details. Only £8.40 each. P. & P. 30p for one, £1.10 for two. Now available in either 8" round version or 4 1/2" x 8 1/2" rectangular. 10 watts R.M.S. 60Hz-20KHz £5.25 + P. & P. (one 65p, two 75p).

**SONOTONE STAHC COMPATIBLE STEREO CARTRIDGE**  
T/O stylus Diamond Stereo LP and Sapphire 78. Only £2.50 P. & P. 20p. Also available fitted with twin, Diamond T/O stylus for Stereo LP. £3.00 P. & P. 20p.  
**LATEST CRYSTAL T/O STEREO/COMPATIBLE CARTRIDGE** for EP/LP/Stereo 78. £2.00 P. & P. 20p  
**LATEST T/O MONO COMPATIBLE CARTRIDGE** for playing EP/LP/78 mono or stereo records on mono equipment. Only £2.00 P. & P. 20p  
**STEREO MAGNETIC PRE-AMP** sens. 3mVin for 100mV out to 35V neg earth. Eq.  $\pm 1$ db. From 20Hz to 20 KHz. Input impedance 47k. Size 1 1/2in x 2 1/2in x 6 1/2in. £2.60 + 20p P. & P.

## HARVERSONIC SUPER SOUND 10 + 10 STEREO AMPLIFIER KIT

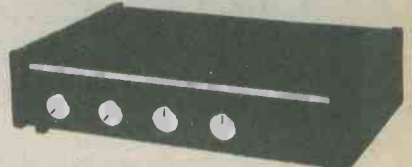

A really first-class Hi-Fi Stereo Amplifier Kit. Uses 14 transistors including Silicon Transistors in the first five stages on each channel resulting in even lower noise level with improved sensitivity. Integrated pre-amp with Bass, Treble and two Volume Controls. Suitable for use with Ceramic or Crystal cartridges. Very simple to modify to suit magnetic cartridge—Instructions included. Output stage for any speakers from 8 to 15 ohms. Compact design, all parts supplied including drilled metal work, high quality ready drilled printed circuit board with component identification clearly marked, smart brushed anodised aluminium front panel with matching knobs, wire, solder, nuts, bolts—no extras to buy. Simple step by step instructions enable any constructor to build an amplifier to be proud of. Brief specifications: Power output: 14 watts r.m.s. per channel into 8 ohms. Frequency response  $\pm 3$ db 12-30,000 Hz Sensitivity: better than 80mV into 1M $\Omega$ . Full power bandwidth:  $\pm 3$ db 12-15,000 Hz. Bass, boost approx. to  $\pm 12$ db. Treble cut approx. to  $-16$ db. Negative feedback 18db over main amp. Power requirements 30v. at 1.0 amp. Overall Size 12" w. x 8" d. x 2 1/2" h. Fully detailed 7 page construction manual and parts list free with kit or send 25p plus large S.A.E.

AMPLIFIER KIT £13.50 P. & P. 80p  
(Magnetic input components 33p extra)  
POWER PACK KIT £5.50 P. & P. 95p  
CABINET £5.50 P. & P. 95p

Special offer—only £23.75 if all 3 units ordered at one time plus £1.25 P. & P.

Full after sales service  
Also available ready built and tested £31.25. P. & P. £1.50.



**3-VALVE AUDIO AMPLIFIER HA34 MK II.**  
Designed for Hi-Fi reproduction of records. A.C. Mains operation. Ready built on plated heavy gauge metal chassis, size 7 1/2" w. x 4" d. x 4 1/2" h. Incorporates ECC83, EL84, E280 valves. Heavy duty, double wound mains transformer and output transformer matched for 3 ohm speaker. Separate volume control and now with improved wide range tone controls giving bass and treble lift and cut. Negative feedback line. Output 4 1/2 watts. Front panel can be detached and leads extended for remote mounting of controls. Complete with knobs, valves, etc., wired and tested for only £8.60, P. & P. £1.40.

**HBL "FOUR" AMPLIFIER KIT.** Similar in appearance to HA34 above but employs entirely different and advanced circuitry. Complete set of parts, etc. £8.00. P. & P. £1.40.

## 10/14 WATT HI-FI AMPLIFIER KIT

A stylishly finished monaural amplifier with an output of 14 watts from 2 EL84s in push-pull. Super reproduction of both music and speech, with negligible hum. Separate inputs for mike and gram. flow records and announcements to follow each other. Fully shrouded section wound output transformer to match 3-15 ohm speaker and 2 independent volume controls, and separate bass and treble controls are provided giving good lift and cut. Valve line-up 2 EL84s, ECC83, E280 and E280 rectifier. Simple instruction booklet 25p x S.A.E. (Free with parts). All parts sold separately. ONLY £14.50, P. & P. £1.40. Also available ready built and tested £18.00. P. & P. £1.40.

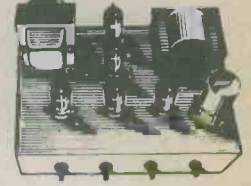

## SPECIAL LINES OFFERED SUBJECT TO STOCK AVAILABILITY

Limited number of British Manufacturer's Surplus professional 100 watt RMS Slave amplifiers. Special features: 2 separate power modules, 1 for Bass response, and 1 for mid. range/tweeter, 5 stage LED display for power o/p indication. A/c mains i/p switchable for 110 or 240V. Can easily be converted to stereo.  
AVAILABLE TO PERSONAL CALLERS ONLY—PLEASE PHONE TO CONFIRM AVAILABILITY.  
Brand new and tested only £33.75.

OUR PRICES INCLUDE VAT AT CURRENT RATES

(Please write clearly)

PLEASE NOTE: P. & P. CHARGES QUOTED APPLY TO U.K. ONLY. P. & P. ON OVERSEAS ORDERS CHARGED EXTRA.

# HARVERSON SURPLUS CO. LTD.

(Dept. REC) 170 MERTON HIGH ST. MERTON, LONDON, SW.19. Tel: 01-540 3985.

A few minutes from South Wimbledon Tube Station

SEND SAE WITH ALL ENQUIRIES. FOR PERSONAL CALLERS ONLY: WE CAN NOW OFFER A FULL REPAIR SERVICE ON ALL HI-FI EQUIPMENT, DISCO, CASSETTES, CAR RADIO, ETC.

Open 9.30-5.30 Monday to Friday, 9.30-5.15 Saturday  
Closed Wednesday.  
Prices and specifications correct at time of press. Subject to alteration without notice



# ambit international

Production of the new catalogue has been held up for a few weeks - since we have just been appointed as distributors for two of the most exciting ranges of radio components products yet: The Micrometals range of iron dust torroids cores and formers, and the OKI range of VLSI for digital frequency displays for receivers. We apologize for any inconvenience, but these two ranges are really worth the wait, and include some products you will find hard to believe, like the MSM5523 IC, an IC with less than ten external components that gives AM frequency readout to 1KHz from LW to 39.999MHz, FM frequency readout in 100kHz steps - (all usual IF offsets programmable by diodes), a 24 hour format clock with 12 hour display, independent on and off timers, time signals on the hours, stopwatch facility and a sleep timer. This costs £14 with its timebase crystal, and makes all that has gone before an expensive and time wasting exercise. Rather like the way the Intersil ICM7216 has revolutionized the instrument counter market. (See the OSTs ad.) And those of you familiar with Amidon and IG dust torroids, favoured in many new RF designs, will be pleased to know Ambit will be stocking a broad range of the Micrometals types for applications from EMI filters to RF PA stages.

OKI frequency counter ICs: details in cat2  
MSM5523 for CA LEDs with RHDP such as FND507 £14 inc xtal  
MSM5525 for 3 1/2 digit LCD AM/FM with direct segment drive, no clock or timers £11 inc xtal  
Other types for fluorescent displays etc OA

Other new semiconductor additions:  
KB4437 pilot cancel mpex decoder 4.35  
KB4438 muting stereo preamp 2.22  
HA1370 supercedes TDA2020 2.99  
TDA1090 HiFi AM/FM 3.35  
TDA1220 low cost AM/FM 1.45

PRICES DOWN ON VMOS: as expected, this new technology in power transistors is getting cheaper. 120V comp parts /100W for £10.00  
Price reduction on CA3189E .....now £2.20  
New varicaps: to add to the biggest range.....  
KV1211 2:9v bias to tune MW, like the KV1210, but a double diode £1.75  
New pilot tone filters from TOKO.....  
2088LR series, individual per channel with a 26/38kHz version for pilot cancel decoder £0.90 applications. Flat to 15kHz  
New crystal filter for amateur NB/FM.....  
TOYJO 10M4B1 with over 90dB adjacent ch. rejection for 2m NB/FM, 10 JMHz £14  
New ceramic IF filters for 455kHz.....  
CFM455B 6kHz/6dB, 15kHz max /60dB £10 ideal for MC3357 etc.

A brief summary of some of our range of ICs:  
TDA1062/1.95; TDA1083/1.95; HA1197/£1.40  
CA3123E/£1.40; TBA651/£1.81; CA3089/1.94  
HA1137/£2.20; MC1310/£2.20; HA1196/£3.95  
KB4424/£2.75; KB4423/£2.53; SD6000/£3.75  
KB4412/£2.55; KB4413/£2.75; KB4417/£2.55  
MC1495L/£6.86; MC1496P/£1.25  
LM381N/£1.81; LM1303/£0.99; ULN2283B/£1.00; LM3901/£1; TBA910A/£1.09  
TC940E/£1.80; TDA2002/£1.95;  
ICL8038CC/£4.50; NE566/£2.50; NE567/£2.50; NE568/£3.50; NE561B/£3.50; NE562B/£3.50; NE565A/£2.50  
SEE THE OSTs ADVERT FOR CMOS/TTL REGULATORS, OPTO DISPLAYS, and other types of linear devices.

Some transistors for RF specifically:  
BF256LB/0.34; 40B22/0.43; 40B23/0.51  
40673/0.55; BF900/961/0.80; BF960/1.60  
BF224/0.22; BF274/0.18; BF195/0.18  
BF240/0.22; BF241/0.22; BF362/0.70;  
BF479/0.86; BF679S/0.70; BF900/0.90

PIN and other Varicap diodes:  
BA102/0.30; BA121/0.30; ITT210/0.30  
BB104B/0.40; MVAM2/£1.48; MVAM11/£1.05; MVAM125/1.05; KV1210/£2.75  
BA479/0.35; TDA1061/0.95; BA182/0.21  
METER MADE low cost panel meters: 3 x 930 series with blanks and dry transfer sheet of scales and legends for £12.5

## At last, DIY HiFi which looks as if it isn't.

That's not to say it doesn't look like HiFi - just that it doesn't look like the usual sort of thing you have come to associate with DIY HiFi. The Mk3 outstrips and outperforms all British made HiFi tuners, and most imported ones too. Certainly at the price, there isn't one near it. But more than that, it looks superb. A small pic here would be an insult, so send an SAE for details on the kit that looks as if isn't. It's something else.....

- ★ Exceptionally high performance - exceptionally straightforward assembly
- ★ Baseboard and plug-in construction. Future circuit developments will readily plug in, to keep the MkIII at the forefront of technical achievement
- ★ Various options and module line-ups possible to enable an installation approach to the system

and now previewing the matching 60W/channel VMOS amplifier:

- ★ Matching both the style and design concepts of the MkIII HiFi FM tuner
- ★ Hitachi VMOS power fets - characterized especially for HiFi applications
- ★ Power output readily multiplied by the addition of further MOSFETs
- ★ VU meters on the preamp - not simply dancing according to vol level
- ★ Backed with the usual Ambit expertise and technical capacity in audio

## The PW Dorchester-LW, SW, & FM stereo tuner



In much the same way as we have swept away the 'old technology' in frequency/timer counters - with the OKI and Intersil single IC counters, we now offer a single IC "All Band" radio tuner. Don't confuse this one chip radio with things like the ZN414 - for this is a genuine superhet receiver with a mechanical AM IF section, covering all broadcast bands - plus the AM section employs a balanced input mixer stage, though at this price, the tuner is not intended as a "communications receiver" - although we know of many lesser designs that make that claim. The AM sensitivity is nevertheless better than 5uV, and FM sensitivity is 1.2uV for 30dB S/N. As a multiband broadcast superhet receiver, it is a unique constructor project that fulfills the requests we very frequently get for a general coverage circuit that isn't over complicated. The set has CA3089E FM performance, with mute etc., and a PLL stereo decoder with full pilot tone filtering. The tuner board - with "on board" PCB mounted switching, all components etc : £33.00 The case/cabinet with PSU, meter and mechanics etc £25.00 An SAE for full details please. See the feature article in Practical Wireless (Dec/Jan)

TERMS etc: CWO please, VAT on Ambit items is generally 12½%, except where marked (\*). Catalogue part 1:45p, part 2:50p all Inclusive. Postage 25p per order, carriage on tuner kits £3. Phone Brentwood (0277) 216029/227050 9am-7pm. Callers welcome inc. Saturdays.

## 2 Gresham Road, Brentwood, Essex.

## OSTS

Since AMBIT introduced the "One Stop Technology Shop" to our service, we have been pleased to see just how many users of electronic components appreciate our guarantee to supply goods only from BS9000 approved sources. More than ever, professional and amateur electronics engineers cannot afford to waste time on anything less than perfect pedigree products.

SEE THE AMBIT AD TOO!

## CD4000 CMOS

4000	17p	4059	563p	4522	149p
4001	17p	4060	115p	4527	157p
4002	17p	4063	109p	4528	102p
4006	109p	4066	53p	4529	141p
4007	4067	4067	400p	4530	90p
4008	80p	4068	25p	4531	141p
4009	58p	4069	20p	4532	125p
4010	58p	4070	20p	4534	614p
4011	17p	4071	20p	4536	380p
4012	17p	4072	20p	4538	150p
4013	55p	4073	20p	4539	110p
4016	52p	4075	20p	4541	141p
4017	80p	4076	90p	4543	174p
4018	80p	4077	20p	4549	399p
4019	60p	4078	20p	4553	440p
4020	93p	4081	20p	4554	183p
4021	82p	4082	20p	4556	77p
4022	90p	4085	82p	4557	386p
4023	17p	4086	82p	4558	117p
4024	76p	4089	150p	4559	388p
4025	17p	4093	50p	4560	218p
4026	180p	4094	190p	4561	65p
4027	55p	4096	372p	4562	530p
4028	72p	4097	372p	4566	159p
4029	100p	4098	110p	4568	281p
4030	58p	4099	122p	4569	30p
4031	250p	4160	90p	4572	25p
4032	100p	4161	90p	4580	600p
4033	145p	4162	90p	4581	319p
4034	200p	4163	90p	4582	164p
4035	120p	4170	104p	4583	84p
4036	25p	4175	95p	4584	63p
4037	100p	4194	95p	4585	100p
4038	105p	4501	23p		
4039	250p	4502	91p		
4040	83p	4503	69p		
4041	90p	4506	51p		
4042	85p	4507	55p		
4043	85p	4508	248p		
4044	60p	4510	99p		
4045	150p	4511	149p		
4046	130p	4512	98p		
4047	99p	4513	206p		
4048	60p	4514	260p		
4049	55p	4515	300p		
4050	55p	4516	125p		
4051	65p	4517	382p		
4052	85p	4518	103p		
4053	65p	4519	67p		
4054	120p	4520	109p		
4055	135p	4521	236p		

## Micromarket SLASHED

8216	1.95	2114	£10
8224	3.50	2708	£10.55
8228	4.78	Development	
8251	6.25	MEK6800 £220	
8255	5.40	TK80 £306	
MEMORIES			
2102	£1.70	AMI, Signetics,	
2112	£3.40	TI, Intersil,	
2513	£7.54	Harris etc. OA	
8212	2.30		
8080 series			
2102	£1.70		
2112	£3.40		
2513	£7.54		
8212	2.30		
L200 up to 3A/adjustable V&A 195p			
7800 series UC TO220 package 1A all 95p			
7900 series UC TO220 package 1A all £1			
78MUC series TO220 package ½A all 90p			
78LCP series TO92 100mA all 35p			
78MGT2C ½amp adjustable volts 175p			
78MGT2C ½amp adjustable volts 175p			
723C precision controller 65p			
MAINS FILTERS FOR NOISE/RFI etc			
1 amp in IC connector £4.83			
5 amp in 'wire in' case £3.87			
NE550A 73p			

## LINEARS non-consumer

CA3130E	84p	LM339N	66p
CA3130T	90p	LM348N	186p
CA3140E	35p	LM3900N	60p
CA3140T	72p	709HC to5 64p	
CA3160E	90p	709PC dil 36p	
CA3160T	99p	710HC to5 65p	
Op amps		710PC dil 59p	
LM301AH	67p	723CN	65p
LM301AN	30p	741CH to5 69p	
LM308H	121p	741CN 8dill 27p	
LM308N	97p	747CN	70p
LM318H	279p	748CN	36p
LM318N	224p	NE531T	120p
		NE531N	105p

7400	13	20	7455	35	24	74126	57	44	74185	134	74377	124	
7401	13	20	7460	17		74128	74		74188	275	74378	93	
7402	14	20	7463			74132	73		74190	115	92	74379	130
7403	14	20	7470	28		74133			74192	105	180	74380	37
7404	14	24	7472	28		74136			74193	105	180	74395	139
7405	18	26	7473	32		74138			74194	105	180	74396	133
7406	38		7474			74139			74195	95	137	74398	180
7407	38		7475	32	38	74141	56		74196	99	110	74399	150
7408	17	24	7476	37	40	74142	265		74197	85	110	74445	92
7409	17	24	7478			74143	312		74198	150		74447	90
7410	15	24	7480	48		74144	312		74199	160		74490	140
7411	20	24	7481	86		74145	65		74248		90	74668	110
7412	17	24	7482	69		74147	175		74249		93	74670	249
7413	30	52	7483A			74148	109		74251			90	MISCELLANY
7414	51	130	7484	97		74150	99		74251		105	NE555	30p
7415	24	7485	104		99	74151	64	84	74252		108	NE555	78p
7416	30	7486	205		40	74153	64	54	74257		153	NE558	180p
7417	30	7489	205			74154	96		74258		153	NE558	180p
7418	16	24	7490	33	90	74155	54	110	74259		420	ICM7217	950p
7419	29	24	7491	76	110	74156	80	110	74260		153	ICM7208	1495p
7421	29	24	7492	38	78	74157	67	55	74261		353	ICL7106CP	
7422	24	24	7492	38	78	74158	210	60	74266		40	LCD DVM IC	
7423	27	7493	32	99	74159	210			74273		40	LCD DVM KIT	
7424	27	7494	78		74160	82	130	74275	312		120	3 1/2 digit LCD	
7425	27	7495	78		74161	92	78	74279	52		120	display 1150p	
7426	36	27	7495A	65	99	74162	92	130	74283		120	ICL7107 LED	
7427	27	29	7496	58	120	74163	92	78	74290		90	DVM kit 2065p	
7428	35	32	7497	185		74163	92		74293		95	ICM7216 - 8 digit	
7429	17	24	74100	119		74164	104		74295		120	DVM kit 2065p	
7430	25	24	74104	63		74165	105		74299		157	10MHz DFM/	
7431	25	24	74105	62		74166	104		74302		242	timer £19.82	
7432	40	24	74107	32	38	74167	20		74304		247	for 120/60MHz	
7433	33	24	74109	63	38	74167			74305		237	(LED C.Cath)	
7437	40	24	74110	54		74169			74306		100	SCALAR ICs	
7440	17	24	74111	68		74170	230	200	74307		100	8629 150MHz	
7441	74		74112	88		74171	87	110	74308		715	divide by 120	
7442	70	99	74113			74175	87		74309		49	420p	
7443	115		74114			74176	75		74310		49	95H90DC 780p	
7444	112		74116	198		74177	78		74311		49	11C90DC 1400p	
7445	94		74118	83		74180	85		74312		49	8618 -new-divide	
7446	94		74118	83		74181	165	350	74313		77	by 100 or 10	
7447	82		74119	119		74182	165		74314		77	for 120/60MHz	
7448	56	99	74120	115		74183		210	74315		60	450p	
7449	17	99	74121	25		74184	135						
7450	17	24	74122	46									



# TRADE COMPONENTS

NO LISTS. TOO MANY ITEMS. PAY A VISIT — THOUSANDS MORE ITEMS BELOW WHOLESALE PRICE. CALLERS PAY LESS AS PRICES INCLUDE POSTAGE AND VAT AND ADDITIONAL DISCOUNT IN LIEU OF GUARANTEE. GOODS SENT AT CUSTOMERS RISKS UNLESS SUFFICIENT ADDED FOR REGISTRATION OR COMPENSATION FEE POST.

OFFERS CORRECT AT 20/11/78 APPLICABLE TO ORDERS RECEIVED DURING DECEMBER

## VALVE BASES

Printed circuit B7G	7p
Chassis B7-B7G	11p
Shrouded Chassis B7G-B8A	13p
B12A tube. Chassis B9A	13p
Speaker 6" x 4" 5 ohm ideal for car radio	£1.55
4 3/4" diam. 30 Ω	£1.75
2 1/2" diam. 32 or 8 Ω	£1.07
TAG STRIP—6 way 4p	5 x 50pF or 1000 x
9 way 6p Single 1 1/2p	300pF trimmers 35p

Car type panel lock and key 65p

Transformer 9V 4A £3.78  
**Aluminium Knobs**  
 for 1/4" shaft. Approx. 50p  
 5/8" x 7/8" with indicator Pack of 5 95p

JAP 4 gang min. sealed tuning condensers 40p

## ELECTROLYTICS Many others in stock

	63-	200-	300-	450-
Up to 10V 25V 50V 75V 100V 250V 350V 500V MFD				
10 6p	7p	7p	10p	13p
15p	26p	32p	37p	
25 6p	7p	7p	10p	13p
18p	32p	37p		
50 6p	7p	7p	12p	16p
23p	32p	37p		
100 7p	8p	13p	15p	24p
26p				
250 12p	13p	15p	22p	36p
				£1.10
1.30				
500 13p	15p	22p	30p	55p
				£1.60
1000 16p	27p	50p	60p	
				£1.05
2000 28p	47p	55p	93p	

As total values are too numerous to list, use this price guide to work out your actual requirements 8/20, 10/20, 12/20, 22/50, 47/25. Tub. Tant 24p each 16-32/275V, 100/150V, 100-100/275V 40p 50-50/385V, 2+2/200V non polar, 32-32-50/300V, 20-20-20/350V 0.1+0.1/500V AC 80p 200V, 100-200-60/300V £1.30 100-300-100-16/300V £1.85

RS 100-0-100 micro amp null indicator Approx. 2" x 3/4" x 3/4" £1.85

## INDICATORS

Bulgin D676 red, takes M.E.S. bulb 38p  
 12 volt, or Mains neon, red pushfit 23p  
 R.S. Scale Print, pressure transfer sheet 12p

## CAPACITOR GUIDE — maximum 500V

Up to .01 ceramic 4 1/2p. Up to .01 poly, 6p .013 up to .1 poly etc. 7p. .12 up to .68 poly etc. 8p. Silver mica up to 360pF 10p, then to 2,200pF 13p; then to .01 mfd 21p. .1/750 13p. .01/1000, 8/20, .1/900, .22/900, 4/16, 25/250 AC (600v/DC). 15p. 5/150, 10/150, 40/150 50p.

Many others and high voltage in stock.  
**SONNENSCHNEIN/POWERSONIC DRI-FIT RECHARGEABLE SEALED GEL (Lead Antimony) BATTERY, 6V-1 amp.hr. (3 3/4" x 2" x 3/8") £3.70.**  
 6 amp. hr. (4 1/2" x 2" x 3") £7.60  
 Ex-equipment, little used.

## CONNECTOR STRIP

Belling Lee L1469, 4 way polythene. 9p each

1 1/2 glass fuses 250 m/a or 3 amp (box of 12) 20p  
 Bulgin 5mm Jack plug and switched socket (pair) 40p

Reed Switch 28mm, body length 11p

Aluminium circuit tape, 1/8 x 36 yards—self adhesive. For window alarms, circuits, etc. 95p

## TV MAINS DROPPERS

5 assorted multiple units for.....75p

100pF air-spaced tuning capacitor.....£1.30  
 5 1/2" x 2 1/4" Speaker, ex-equipment 3 ohm 65p  
 2 Amp Suppression Choke.....10p  
 3 x 2 1/2 x 1 1/2" } PAXOLINE 5 for 35p  
 4 1/2 x 1 1/2 x 1 1/2" } 10 for 15p  
 PVC or metal clip on MES bulb Holder 5 for 30p  
 VALVE RETAINER CLIP, adjustable 5 for 15p

Sub-miniature Transistor Transformer 35p  
 Valve type output transformer 90p

POT CORES with adjuster LA2508-LA2519 43p per pair

16 Watt Power Amp. Module 35p  
 35v 1A power required, giving 16 watt  
 RMS into 8 Ω £3.45

GRUNDIG REGULATED TAPE MOTOR  
 6V nominal approx. 3 x 1 1/2". Incl. shock absorbing carrier 1.05

3.5mm metal stereo plug 30p  
 Fane 8 ohm 3" sq. heavy duty communications speaker 1.60  
 RS neg. volt regulator 103, 306-099 (equiv. MPC900) 10A, 100 watt 4-30 volt. Adjustable short circuit protection. Normally £12.50+. £6.65

**BOXES** — Grey polystyrene 61 x 112 x 31mm, top secured by 4 self tapping screws 57p clear perspex sliding lid, 46 x 39 x 24 mm 15p.

**ABS**, ribbed inside 5mm centres for P.C.B., brass corner inserts, screw down lid, 50 x 100 x 25mm orange 65p; 80 x 150 x 50mm black 97p; 109 x 185 x 60mm black £1.52.

**DIECAST ALI** superior heavy gauge with sealing gasket, approx 6 1/2" x 2 3/4" x 1 3/8" £1.50; 3 3/4" x 2 3/8" x 1 3/8" £1.25.

**VARIABLE CAMM PROGRAMMER** 10, 12 or 15 pole 2 way, 50VAC motor — series with 1mfd, or 3k 10W or 15W pygmy bulb for mains operation. Ex equipment £4.32

## SWITCHES

Pole	Way	Type	Price
1	2	Slide	15p
6	2	Slide	24p
2	1	Rotary Mains	28p
2	2	Alternating Micro with roller	30p
2	3	Miniature Slide	20p
2	1	Toggle	32p
1	2	Sub-Min Toggle	75p
2	2	Alternating 2A Mains Push (1/2" hole)	43p
2	2	Alternating Slide	15p

S.P.S.T. 10 amp 240v. white rocker switch with neon. 1" square flush panel fitting 38p; 1 pole 2 way 10 amp oblong clip in mains rocker appliance switch 38p

Standard thumb-wheel switch 0-9 in 1248N or B or Comp. 1242 also 2p co. £1.20  
 Standard Lever Key Switch D.P.D.T. locking plus D.P.D.T. and S.P.S.T. Heavy Duty non latching 82p

## AUDIO LEADS

3 pin din to open end, 1 1/2yd, twin screened 45p  
 3 pole jack both ends 4ft £1  
 3 pole jack plug to tag ends, 4ft 45p

**COMPUTER & AUDIO BOARDS/ASSEMBLIES**  
 VARYING CONTENTS INCLUDE ZENER, GOLD BOND, SILICON, GERMANIUM, LOW AND HIGH POWER TRANSISTORS AND DIODES, HI STAB RESISTORS CAPACITORS, ELECTROLYTICS, TRIMPOTS, POT CORES, CHOKES ETC.

3lb for £2 7lb for £3.70

1k horizontal preset with knob 10 for 40p	3" Tape Spools 5p
	1" Terry Clips 5p
	12 Volt Solenoid 40p

ENM Ltd. cased 7-digit counter 2 1/4 x 1 3/4 x 1 1/4" approx. 12V d.c. (48 a.c.) or mains £1.10

Auto charger for 12v Nicads, ex-new equipment £5.19

Miniature 0 to 5mA d.c. meter approx 1/4" diameter £1.25  
 RS Yellow Wander Plug Box of 12 40p  
 18 SWG multicore solder 3 1/2p foot  
**SAPPHIRE STYLII.** 15 different; dual and single point, current and hard to get types. My mix £2.

# BRIAN J. REED

161 ST. JOHNS HILL, BATTERSEA, LONDON SW11 1TQ  
 Open 10 a.m. till 7 p.m. Tuesday to Saturday. VAT receipts on request.  
 Terms: Payment with order Telephone: 01-223 5016

Digital count unit. Counts in steps of 1, 2, 5 or 10 with total limit switch (2 x D.I.L. BCD), reed relay remote output. Mains power supply, relay and delay unit. UNUSED. Displays on 2 Minitron. 7 segments sold separately. £5.40

Crouzet 30-minute timer-programmer, multi-variable contacts £7.56

ACOS DUST JOCKEY Automatic record cleaner £1.30

Mail Order Over £50 deduct 10% Over £100 deduct 20%

Burglar alarm, cord-powered for windows, doors, luggage and personal attack. Battery powered 86p

McMurdo 4 or 8 way plug and socket ex-equipment 50p

"Makawitch" 1p 10-way wafar 15p Wood cased 8-12V buzzer £2.50

DEAC rechargeable NICAD 450K. Capacity 6V 450 m.a.h. at 10 hour rate. Ex-new equipment £4.11

2.5A r.f. thermo-couple and meter 2 1/2" square £3.80



100 Electrolytics ..... £3.00  
 100 Resistors 1W ..... £2.00  
 100 Wirewound Resistors £4.50  
 Well mixed valves and voltages

100 Capacitors ..... £2.50  
 100 Resistors up to 3W £1.00  
 100 Resistors 2-5W ..... £3.00  
 100 1% & 2% Resistors £3.50

Mullard 12-0-12V, 1.4A stabilized, regulated, power supply. Approx. 8 1/2" x 4 3/4" x 3 1/2" with handbook £14.50  
 27V 5A Double section bobbin transformer £4.32

UK & EIRE — Postal Orders for same day service. Cheques require 8 days from a Tuesday banking to ensure clearance. Foreign export — banker's draft (sterling) same day service. Foreign currency money orders etc. can lose value and take 4-6 weeks to clear.

C90 Cassette Tape 62p

50 ohm BNC plug, through connector or round or flanged chassis socket. TNC plug or N plug or through connector 65p each

250 50 watt + Resistor 40p

**SEMICONDUCTORS Full spec. by Mullard etc. Many others in stock**

AC128/176 17p	8D113 57p	BFX84/88.89 20p	2N2412 80p
ACY29 22p	8D115 35p	BFY51 16p	2N2483 28p
AD161/2 match pr. 85p	8D116(BRC116T) £1.15	BFY90 57p	2N2904/5/6/7/7A 18p
AF116 20p	8D130Y £1.50	BR101 34p	2N3053 16p
AF124/6/7 28p	8D131/2/3 40p	BRV39/56 29p	2N3055 R.C.A. 60p
AF139 23p	8D135/6/7/8/9 35p	BSV64 36p	2N3133 24p
AF178/80/81 35p	BD137/138 match pr 82p	BSV79/80 F.E.T.s 90p	2N3553 56p
AF239 35p	8D140/142 35p	BSV81 Mosfet £1.00	2N4037 39p
ASY27/73 35p	8D201/2/3/4 92p	BSX20/21 16p	2N5484 FET 39p
AU110/113 £2.50	8D232/3/4/5/8 55p	BSY40 30p	2SA141/2/3/60 33p
BC107/8/9 + A/B/C 8p	8DX77 £1.15	BSY95A 14p	2SB135/6/457 24p
BC147/8/9 + A/B/C 8p	BD437 58p	BU204 - Mount Kit £1.85	2SC372/644/735 15p
BC157/8/9 + A/B/C 8p	BF115/167/173 18p	BU208 £2.26	2SC853 30p
BC178A/B 179B 14p	BF178/9 23p	CV7042 (OC41/44 ASY63) 12p	40250(2N3054) 35p
BC184C/LC 11p	BF180/1/2/3/4/5 18p	GET111 12p	
BC186/7 23p	BF194/5/6/7 8p	OC45(ME2) 13p	
BC213L/214B 13p*	BF194A, 195C 8p	ON222 23p	
BC261B 10p	BF200 258 324 23p	R2008B/2010B £2.30	
BC327/8 337/8 10p	BF262/3 35p	TIP30 31p	
BC547/8 + A/B/C 13p	BF336 31p	TIS43 39p	
BC556/7/7B/8/9 11p	BFS28 Dual Mosfet £1.15	TIS88A F.E.T. £2.85	
BCX32/36 15p	BFW10/11 F.E.T. 46p	UA7805 £1.85	
BCY31 90p	BFW30 £1.15	ZT1486 £1.15	
BCY70/1/2 14p	BFW57/58 21p	ZTX300/341 9p	
BCZ11 32p	BFX12/29/30 23p		

**BRIDGE RECTIFIERS**

Amp	Volt	8YX10 34p
1	1,600	OSH01-200 30p
1	100	Ex Equip 73p
5	140	EC433 20p
0.6	110	Texas £1.10
5	400	I.R. 48p
2 1/2	100	B40C 3200 58p
3 1/2	100	

**RECTIFIERS**

Amp	Volt		
M1	1	68	5p
1N4005/6	1	6/800	5p
1N4007/BYX94	1	1250	8p
BY103	1	1,500	21p
SR100	1.5	100	9p
SR400	1.5	400	10p
REC53A	1.5	1,250	16p
LT102	2	30	15p
BYX22-200	1 1/2	300	25p
BYX38-300R	2.5	300	48p
BYX38-600	2.5	600	52p
BYX38-900	2.5	900	60p
BYX38-1200	2.5	1,200	65p
BYX49-300R	3	300	35p
BYX49-600	3	600	42p
BYX49-900	3	900	47p
BYX49-1200	3	1,200	60p
BYX48-300R	6	300	47p
BYX48-600	6	600	60p
BYX48-900	6	900	70p
BYX48-1200R	6	1,200	92p
BYX72-150R	10	150	42p
BYX72-300R	10	300	52p
BYX72-500R	10	500	65p
BYX42-300	10	300	36p
1N5401	3	100	16p
1N5402	3	200	18p
MR856	3	600	24p
BYX42-900	10	900	92p
BYX42-1200	10	1,200	£1.07
BYX46-300R*	15	300	£1.19
BYX46-400R*	15	400	£1.76
BYX46-500R*	15	500	£2.00
BYX46-600*	15	600	£2.30
BYX20-200	25	200	72p
BYX52-300	40	300	£2.06
BYX52-1200	40	1,200	£2.90
RAS310AF*	1.25	1,250	48p

\*Avalanche type

**TRIACS**

Amp	Volt	Plastic RCA	£1.40
25	900	BTX94-900	£4.50
25	1200	BTX49-1200	£6.75

**Transistor equivalents and substitutes**

Book 1	38p	Book 2	82p
Chrome Car Radio facia	28p		
Rubber Car Radio gasket	10p		
DLI Pal Delayline	90p		
Relay Socket miniature 2PCO	20p		
28 pin d.i.l. socket low profile	38p		
Colour EHT Tray 3000/3500	£5.60		
Nylon self-locking, 3 1/2" tie clips	3p		
1.5, 10, 22 or 750 µh choke	12p		
0-30, or 0-15, black pvc. 360° dial, silver digits, self adhesive	13p		
4 1/2" dia.			
Mullard Semiconductor, Valve & Component Data Book 1976-78	50p		

**OPTO ELECTRONICS**

Diodes	Photo transistor
TIL209 Red 14p	BPX29 92p
BPX40 57p	OC71 75p
BPX42 92p	
BPY10 92p	
(VOLIAC)	
BPY68 92p	BIG L.E.D. 0.2" 2v 50mA max. 16p
BPY69 92p	RED Wire end neons 9p
BPY77 92p	

**PHOTO SILICON CONTROLLED SWITCH**

BPX66 PNPN 10 amp	£1.15
-------------------	-------

**3" red 7 segment L.E.D. 14 D.I.L. 0-9 + D.P. display 1.9v 19mA segment, common anode .95p**

**RS 0.6in. green Minitron 0.3in 3015F filament £2.25**

**CQY11B L.E.D. Infra red transmitter £1.15 One fifth of trade Plastic Transistor or Diode Holder .1p Transistor or Diode Pad 1 1/2p Holders or pads 65p per 100**

**PAPER BLOCK CONDENSER**

0.25MFD 800 volt	87p
1MFD 250 volt	54p
1MFD 400 volt	65p

**TV KNOB**

Dark grey plastic for recessed shaft (quarter inch) with free shaft extension 8p

**CHASSIS SOCKETS**

Car Aerial 11p, Coax 8p, 5 pin 180° 11p, 5 or 6 pin 240° din 8p, speaker din switched 13p, 3.5 mm switched 7p, stereo 1 1/2" jack enclosed 20p.

**McMurdo PP108 8 way edge plug 12p Multicore Solder 1/2kg. 16 or 18 or 20 s.w.g. 60/40. £5.00 3 inch 8 Ω speaker £1.16**

**MINIATURE EDGE METERS**

100µA f.s.d., scaled 0.5. 12V Illuminated blue perspex front, 35mm x 14mm	£3.45
200µA level meter, clear front. 10 x 18mm	£1.20

**OTHER DIODES**

1N916	8p
1N4009	9p
1N4148	4p
8A145	17p
Centercel	29p
BZY61/BA148/OA81	12p
BB103/110 Varicap	24p
8B113 Triple Varicap	43p
BA182	15p
QA5/7/10	17p
BZY88 up to 43 volt	10p
BZX61 11 volt	17p
AA133	10p
BZY96C 10V	34p
BZY95C 33V	34p

**NEW B. V.A. VALVES**

EB91	49p
ECL80	67p
PCC84	59p
6SN7/6K7	89p
6AT6	89p
EZ81	59p
OC3	£1.20
KT66	£6.00

**TRANSFORMERS**

Ferromag C core. Screens 95-105-115-125-200-220-240v input output 17v 1/2 A x 2 - 24-0 24V 1.04A + 20v 1mA. These current ratings can be safely exceeded by 50%. £4.90

Cassette Dynamic Microphone with switch and twin plug £1.80

Telephone Pickup, sucker with lead and 3.5 plug. 70p

**THYRISTORS**

Amp	Volt	BTX18-200	35p
1	240	BTX18-300	41p
1	400	BTX30-200	35p
1	240	BT107	£1.14
15	500	BT101-500R	£1.05
6.5	500	BT109-500R/SCR957/BRC4444	£1.14
6.5	500	BTW92-600RM	£3.40
20	600	BTX95-800R Pulse Modulated	£8.76

**INTEGRATED CIRCUITS**

TBA920	£2.20
TAA700	£2.40
TBA800	£1.24
741 di. op amp	28p
uA702 op amp	53p
(72) 709	52p
SN76013N/ND	£1.40
SN76228N	£2.03
SN76131N	£1.55
SN74107N	38p
TAD100 AMRF	£1.22
CA3001 R.F. Amp	58p
CA3132	£2.22
CD4013 CMOS	41p
CD4069	24p
TAA300 1 wt Amp	£1.15
TAA550 Y or G	26p
TAA263 Amp	75p
TAA320	£1.15
7400/7401	16p
7402/4/10/20/30	16p
7414	64p
7438/74	27p
7414	64p
7483	79p
7493	41p
LM300 2/20V reg	£1.15
LM1303N	£1.15
74154	£1.02
TBA5500	£1.80
ZN414 Radio Chip	£1.40

**SPECIAL OFFERS**

2500 mfd. 40v	56p
0.1 mfd. 350/500v	10 for 50p
10000 mfd. 15v	3 for £1.16
6800 mfd. 10v 3 for 90p	
32+32/275v 3 for 90p	
16+32/350v 3 for 90p	
8+8 mfd. 375v4 for 90p	
1 mfd. non-polar 350v 10 for £1.19	
25000 mfd. 25v	65p
12000/12v 3 for £1.16	
G.E.C. 5% HI-stab capacitors 013, 061, 066, 069, 075, 08	10 for 65p

**HANDLES**

Rigid light blue nylon 6 1/2" with secret fitting screws 11p

Belling Lee white plastic surface coax outlet box 40p

Miniature Axial Lead Ferrite Choke formers 5 for 13p

RS 10 Turn pot 1% 250 500 Ω 1K, 50K £1.70

Copper coated board 10" x 9" approx. 60p

Gearred Knob 8-1 ratio 1 1/2" diam., black 93p

KLIPPON 25A 440v TERMINAL BLOCKS Professional leaf spring clamp. twin with clip-over cover 11p

Strip of 4. 40A 440V 16p

**VAT & POST PAID** NO MORE TO ADD — Prices INCLUDE UK VAT and Post/Packing

ALL ENQUIRIES, ETC., MUST BE ACCOMPANIED BY A STAMPED ADDRESSED ENVELOPE

MINIMUM ORDER £3 OTHERWISE ADD 50% FOR SMALL ORDER HANDLING COSTS (UNDER £1.00 TOTAL ALSO INCLUDE 9p S.A.E.)



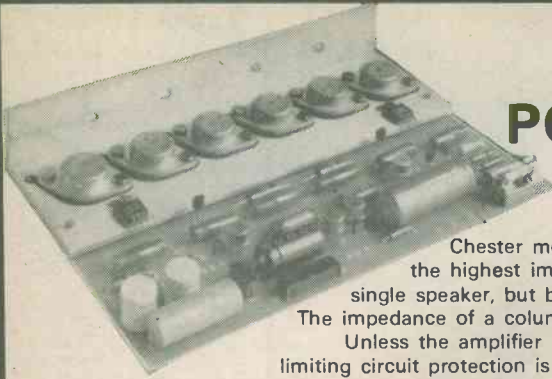

# 450 WATTS POWER AMPLIFICATION BY CHESTER LABORATORIES

Chester modules are designed for P.A. Disco, and Group amplification. Reliability is of the highest importance in this field, therefore the amplifier has to function into not only a single speaker, but banks of speakers whose impedance varies very considerably with frequency. The impedance of a column of 8 ohm speakers can go down to 2 ohms or less at some frequencies. Unless the amplifier is designed to function into 2 ohms, its reliability will be reduced. If current limiting circuit protection is used, the amp will simply clip the peaks off the signal, with a very audible effect on the music.

Our approach is to use sufficient transistors in the output stage to provide a massive reserve capability for the amplifier to drive into any load down to about 1.5 ohms. Circuit protection is not necessary. If the amp is shorted out the output current rises until the 5 amp fuse blows, without damage to the amp.

## OUTPUT POWER

The output is 32 volts into 2.5 ohms 450 Watts  
34 volts into 4 ohms 290 Watts  
36 volts into 8 ohms 170 Watts

Supply required is 140 volts at 4 amps (nominal)  
Signal to noise (unweighted) 130 dB ref 200 watts.  
Power bandwidth + or - 1dB 30hz to 25Khz at 200 watts  
Input 0db (0.775v)

T.H.D. typically 0.1% at any power at 1Khz

The module features all in one construction, six 20 amp 160 volt output transistors, and 3 amp 100 volt driver transistors. The output capacitor supplied with the amp is too large to mount on a circuit board.

P.A.450 WITH OUTPUT CAP.

**£29.00** (includes UK postage + tax etc)

POWER SUPPLY KIT

**£18.00** (includes UK postage + tax etc)

The power supply is over 7 Kilos weight so it is not always possible to send these outside UK.

*Callers by arrangement*

**CHESTER LABORATORIES**  
96 Glengall Road, London NW6

For more information send cheque or P.O. for 30p.

Our list includes information on preamps, microphone preamps etc.

# Electronics. Make a job of it....

Enrol in the BNR & E School and you'll have an entertaining and fascinating hobby. Stick with it and the opportunities and the big money await you, if qualified, in every field of Electronics today. We offer the finest home study training for all subjects in radio, television, etc., especially for the CITY AND GUILDS EXAMS (Technicians' Certificates); the Grad. Brit. I.E.R. Exam; the RADIO AMATEUR'S LICENCE; P.M.G. Certificates; the R.T.E.B. Servicing Certificates; etc. Also courses in Television; Transistors; Radar; Computers; Servo-mechanisms; Mathematics and Practical Transistor Radio course with equipment. We have OVER 20 YEARS' experience in teaching radio subjects and an unbroken record of exam successes. We are the only privately run British home study College specialising in electronics subjects only. Full details will be gladly sent without any obligation.

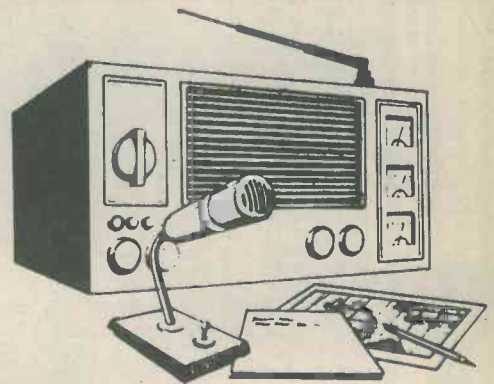

## Become a Radio Amateur.

Learn how to become a radio-amateur in contact with the whole world. We give skilled preparation for the G.P.O. licence.

REL 1/79

Brochure without obligation to:

**British National Radio & Electronic School**

P.O. Box 156, Jersey, Channel Islands.

NAME \_\_\_\_\_

ADDRESS \_\_\_\_\_

Block caps please

**Free!**



# STEVENSON

## Electronic Components

### LOUDSPEAKERS

56mm dia. Bohms	70p
64mm dia. 8 ohms	75p
64mm dia. 64 ohms	75p
70mm dia. 8 ohms	100p
70mm dia. 80 ohms	110p



### PLUGS AND SOCKETS

1mm plugs and sockets suitable for low voltage circuits. Available in red or black, Plugs 6p each. Sockets 7p each.

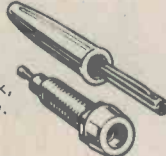

4mm plugs and sockets. Available in black, blue, green, brown, red, white and yellow. Plugs 11p each. Sockets 12p each.

Jack plugs and sockets

	unscreened plug	screened plug	socket
2.5mm	9p	13p	7p
3.5mm	9p	14p	8p
Standard	16p	30p	15p
Stereo	23p	36p	18p

Din plugs and sockets

	plug	socket
2 pin speaker	7p	7p
3 pin	11p	9p
5 pin 180°	11p	10p
5 pin 240°	13p	10p

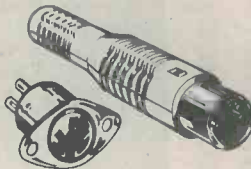

### CABLES

Connecting wire Available in packs of 8 metres (one metre of each colour) or packs of forty metres (five metres each colour).

	single	standard
Eight Metre pack	16p	16p
Forty Metre pack	76p	70p

Screened Cable	Ribbon cable
Single screened	8p
twin individually screened	11p
	10 way 58p metre
	20 way 100p metre

### ALUMINIUM BOXES

Boxes complete with lid and screws.



	Length	width	height	
AL1	3	2	1	48p
AL2	4	3	1½	58p
AL3	4	3	2	65p
AL4	6	4	2	70p
AL5	6	4	3	85p
AL6	8	6	2	116p

We now have an express telephone order service. We guarantee that all orders received before 5pm. are shipped first class on that day. Contact our Sales Office now! Telephone: 01-464 2951/5770.

**ORDERS  
DESPATCHED  
BY RETURN  
POST**

Quantity discounts on any mix TTL, CMOS, 74LS and Linear circuits: 25+ 10%. 100+ 15%. Prices VAT inc. Please add 30p for carriage. All prices valid to 30th April 1979. Official orders welcome.

BARCLAYCARD AND ACCESS WELCOME.



Mail orders to: STEVENSON (Dept RE)

# 236 High St, Bromley, Kent, BR1 1PQ, England

### TRANSISTORS

AC127	17p	BCY71	14p	ZTX109	14p
AC128	16p	BCY72	14p	ZTX300	16p
AC176	18p	BD131	35p	2N697	12p
AD161	38p	BD132	35p	3N1302	38p
AD162	38p	BD135	38p	2N2905	22p
BC107	8p	BD139	35p	2N2907	22p
BC108	8p	BD140	35p	2N3053	18p
BC109	8p	BF244B	36p	2N3055	50p
BC147	7p	BFY50	15p	2N3442	135p
BC148	7p	BFY51	15p	2N3702	8p
BC149	8p	BFY52	15p	2N3704	8p
BC158	9p	MJ2955	88p	2N3705	9p
BC177	14p	MPSA06	20p	2N3706	9p
BC178	14p	MPSA56	20p	2N3707	9p
BC179	14p	TIP29C	60p	2N3708	8p
BC182	10p	TIP30C	70p	2N3819	22p
BC182L	10p	TIP31C	65p	2N3904	8p
BC184	10p	TIP32C	80p	2N3905	8p
BC184L	10p	ZTX107	14p	2N3906	8p
BC212	10p	ZTX108	14p	2N4058	12p
BC212L	10p			2N457	32p
BC214	10p	1N914	4p	2N458	30p
BC214	10p	1N4001	4p	2N459	32p
BC477	19p	1N4002	4p	2N5777	50p
BC478	19p	1N4004	5p		
BC479	19p	1N4006	6p		
BC548	10p				
BCY70	14p				

### DIODES

1N4148	3p
1N5401	13p
1N5402	15p
1N5404	16p
1N5406	18p
BZY88 series 2V7 to 33V	8p each.

### LINEAR

A SELECTION ONLY! DETAILS IN CATALOGUE.

709	25p	LM324	50p	NE556	60p
741	22p	LM339	50p	NE665	120p
747	50p	LM380	75p	NE567	170p
748	30p	LM382	120p	SN76003	200p
CA3046	55p	LM1830	150p	SN78013	140p
CA3080	70p	LM3900	50p	SN78023	140p
CA3130	90p	LM3909	60p	SN78033	200p
CA3140	70p	MCI1496	60p	TDA8800	70p
LM301AN	28p	MCI1458	35p	TDA1022	650p
LM318N	125p	NE555	25p	ZN414	75p

### OPTO

LEDs	0.125in.	0.2in.	
Red	TIL209	TIL220	9p
Green	TIL211	TIL221	13p
Yellow	TIL213	TIL223	13p
Clips	3p		



### RESISTORS

Carbon film resistors. High stability, low noise 5%.

E12 series. 4.7ohms to 10M. Any mix:

	each	100+	1000+
0.25W	1p	0.9p	0.8p
0.5W	1.5p	1.2p	1p

Special development packs consisting of 10 of each value from 4.7 ohms to 1 Megohm (650 res.)  
0.5W £7.50. 0.25W £5.70

### CAPACITORS

HERE ARE JUST A FEW OF THE CAPACITORS STOCKED

TANTALUM BEAD	each
0.1, 0.15, 0.22, 0.33, 0.47, 0.68, 1 & 2.2uF @ 35V	9p
4.7, 6.8, 10uF @ 25V	13p
22 @ 16V, 47 @ 6V, 100 @ 3V	16p

MYLAR FILM	3p
0.001, 0.01, 0.022, 0.033, 0.047	3p
0.068, 0.1	4p

RADIAL LEAD ELECTROLYTIC	5p
63V 0.47	5p
1.0	7p
2.2	13p
4.7	13p
10	20p
20	20p
25V 10	5p
22	8p
33	10p
47	15p
100	23p
1000	23p
10V 220	5p
470	9p
1000	13p
2200	23p

### 74LS

LS00	16p	LS95	65p
LS01	16p	LS123	56p
LS02	16p	LS125	40p
LS03	16p	LS126	40p
LS04	16p	LS132	60p
LS08	16p	LS136	36p
LS10	16p	LS138	54p
LS13	30p	LS139	50p
LS14	70p	LS151	50p
LS20	16p	LS153	50p
LS30	16p	LS155	80p
LS32	24p	LS156	80p
LS37	26p	LS157	45p
LS42	22p	LS164	90p
LS43	53p	LS174	60p
LS47	70p	LS175	60p
LS48	48p	LS192	70p
LS54	48p	LS193	70p
LS55	29p	LS196	80p
LS73	29p	LS215	60p
LS74	29p	LS257	55p
LS75	44p	LS258	55p
LS76	35p	LS266	40p
LS78	35p	LS283	60p
LS83	60p	LS290	55p
LS85	70p	LS365	45p
LS86	33p	LS386	45p
LS90	45p	LS387	45p
LS93	45p	LS388	35p
		LS670	180p

### TTL

7493	34p
7494	52p
7495	52p
7496	50p
74100	12p
7401	12p
7402	12p
7404	12p
7408	14p
7410	12p
7413	25p
7414	48p
7420	12p
7427	24p
7430	12p
7442	43p
7447	55p
7448	58p
7454	14p
7473	25p
7474	25p
7475	32p
7476	28p
7485	70p
7489	145p
7490	32p
7492	35p
74121	25p
74122	33p
74123	40p
74125	35p
74132	50p
74141	55p
74148	90p
74150	70p
74151	50p
74156	52p
74157	52p
74164	70p
74165	70p
74170	125p
74174	68p
74177	58p
74190	72p
74191	72p
74192	64p
74193	64p
74196	55p
74197	65p

### CMOS

FULL DETAILS IN CATALOGUE

4001	15p	4029	60p
4002	15p	4040	68p
4007	15p	4042	54p
4011	15p	4046	100p
4013	35p	4049	28p
4015	60p	4050	28p
4016	35p	4066	40p
4017	55p	4068	20p
4018	65p	4069	16p
4023	15p	4071	16p
4024	45p	4075	16p
4026	95p	4093	48p
4027	35p	4510	70p
4028	52p	4511	70p
		4518	70p
		4520	65p

### SKTS

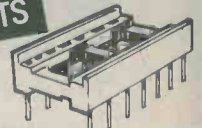

Low profile by Texas  
8 pin 10p 24 pin 24p  
14 pin 12p 28 pin 28p  
16 pin 13p 40 pin 40p  
Soldercan pins: 100: 50p  
1000: 370p

AT LAST! OUR NEW 40 PAGE CATALOGUE OF COMPONENTS IS AVAILABLE. SEND S.A.E.





<b>TRANSISTORS</b>	BD135 38p BD136 37p BD137 38p BD438 38p BD139 35p BD140 35p BF115 25p BF187 29p BF173 27p BF188 34p BF179 37p BF180 37p BF181 37p BF182 37p BF183 37p BF184 28p BF185 30p BF186 30p BF194 13p BF196 13p BF197 16p BF198 15p BF200 36p BF224 16p BF257 37p BF258 40p BF259 44p BF293 30p BF294 30p BF295 30p BF296 30p BF297 30p BF298 30p BF299 30p BF300 30p BF301 30p BF302 30p BF303 30p BF304 30p BF305 30p BF306 30p BF307 30p BF308 30p BF309 30p BF310 30p BF311 30p BF312 30p BF313 30p BF314 30p BF315 30p BF316 30p BF317 30p BF318 30p BF319 30p BF320 30p BF321 30p BF322 30p BF323 30p BF324 30p BF325 30p BF326 30p BF327 30p BF328 30p BF329 30p BF330 30p BF331 30p BF332 30p BF333 30p BF334 30p BF335 30p BF336 30p BF337 30p BF338 30p BF339 30p BF340 30p BF341 30p BF342 30p BF343 30p BF344 30p BF345 30p BF346 30p BF347 30p BF348 30p BF349 30p BF350 30p BF351 30p BF352 30p BF353 30p BF354 30p BF355 30p BF356 30p BF357 30p BF358 30p BF359 30p BF360 30p BF361 30p BF362 30p BF363 30p BF364 30p BF365 30p BF366 30p BF367 30p BF368 30p BF369 30p BF370 30p BF371 30p BF372 30p BF373 30p BF374 30p BF375 30p BF376 30p BF377 30p BF378 30p BF379 30p BF380 30p BF381 30p BF382 30p BF383 30p BF384 30p BF385 30p BF386 30p BF387 30p BF388 30p BF389 30p BF390 30p BF391 30p BF392 30p BF393 30p BF394 30p BF395 30p BF396 30p BF397 30p BF398 30p BF399 30p BF400 30p BF401 30p BF402 30p BF403 30p BF404 30p BF405 30p BF406 30p BF407 30p BF408 30p BF409 30p BF410 30p BF411 30p BF412 30p BF413 30p BF414 30p BF415 30p BF416 30p BF417 30p BF418 30p BF419 30p BF420 30p BF421 30p BF422 30p BF423 30p BF424 30p BF425 30p BF426 30p BF427 30p BF428 30p BF429 30p BF430 30p BF431 30p BF432 30p BF433 30p BF434 30p BF435 30p BF436 30p BF437 30p BF438 30p BF439 30p BF440 30p BF441 30p BF442 30p BF443 30p BF444 30p BF445 30p BF446 30p BF447 30p BF448 30p BF449 30p BF450 30p BF451 30p BF452 30p BF453 30p BF454 30p BF455 30p BF456 30p BF457 30p BF458 30p BF459 30p BF460 30p BF461 30p BF462 30p BF463 30p BF464 30p BF465 30p BF466 30p BF467 30p BF468 30p BF469 30p BF470 30p BF471 30p BF472 30p BF473 30p BF474 30p	2N1893 44p 2N217 21p 2N2219 21p 2N2369 16p 2N2483 26p 2N2484 26p 2N2905 22p 2N2906 22p 2N2907 22p 2N2926 10p 2N3053 18p 2N3054 50p 2N3055 50p 2N3702 8p 2N3703 8p 2N3704 8p 2N3706 9p 2N3707 9p 2N3710 8p 2N3711 8p 2N3712 17p 2N3713 290p 2N3866 54p 2N3904 8p 2N4061 12p 2N4062 20p 2N4123 23p	7475 32p 7476 28p 7480 46p 7485 69p 7486 24p 7490 32p 7491 45p 7492 35p 7493 34p 7494 51p 7496 52p 7496 50p 7497 138p 74100 88p 74104 50p 74105 40p 74107 25p 74109 30p 74110 46p 74116 180p 74118 82p 74120 125p 74121 25p 74122 33p 74123 40p 74125 35p 74126 35p 74127 50p 74136 79p 74141 56p 74142 200p 74145 58p 74147 110p 74148 90p 74150 70p 74151 80p 74153 50p 74154 85p 74155 52p 74156 51p 74157 51p 74160 80p 74161 85p 74162 65p 74163 65p 74164 70p 74165 70p 74166 80p 74167 180p 74173 34p 74174 70p 74175 65p 74176 23p 74177 80p 74178 80p 74180 80p 74181 145p 74182 80p 74184 110p 74190 72p 74191 72p 74192 65p 74193 64p 74194 60p 74195 55p 74196 55p 74197 58p 74198 110p 74199 110p	4007 15p 4008 64p 4009 35p 4010 35p 4011 15p 4012 15p 4013 35p 4014 60p 4015 60p 4016 35p 4017 55p 4018 64p 4019 79p 4020 60p 4021 80p 4022 55p 4023 15p 4024 45p 4025 15p 4027 35p 4028 82p 4029 80p 4030 35p 4031 40p 4041 57p 4042 54p 4043 54p 4044 50p 4047 95p 4048 63p 4049 28p 4050 28p 4056 40p 4068 20p 4069 16p 4070 16p 4071 16p 4072 16p 4073 16p 4077 25p 4078 16p 4081 16p 4082 16p 4086 58p 4501 19p 4507 40p 4510 70p 4516 64p 4518 70p 4519 60p 4520 65p 4528 55p 4578 27p 4581 82p 4585 105p	NE556 80p NE557 240p NE558 70p NE559 100p	<b>VOLTAGE REGULATORS</b> 7805 60p 7812 60p 7815 60p 7818 60p 7824 60p 7906 79p 7912 79p 7915 79p 7918 79p 7924 79p 4024 45p 4025 15p 4027 35p 4028 82p 4029 80p 4030 35p 4031 40p 4041 57p 4042 54p 4043 54p 4044 50p 4047 95p 4048 63p 4049 28p 4050 28p 4056 40p 4068 20p 4069 16p 4070 16p 4071 16p 4072 16p 4073 16p 4077 25p 4078 16p 4081 16p 4082 16p 4086 58p 4501 19p 4507 40p 4510 70p 4516 64p 4518 70p 4519 60p 4520 65p 4528 55p 4578 27p 4581 82p 4585 105p	1A100V 24p 1A200V 27p 1A400V 30 2A50V 34 2A100V 36 2A200V 38 2A400V 40	<b>OPTO/DISPLAY</b> 2N577 50p OC9P1 70p ORP12 70p DL704 115p DL707 115p	<b>ELECTROLYTIC CAP 25V</b> 1uF to 47uF 7p 68uF & 100uF 150uF 8p 220uF 9p 330uF 12p 470uF 15p	<b>RESISTORS</b> 4.7 ohms to 1 Mohm 1p	<b>POTENTIOMETERS</b> 1 Kohm to 2 Mohm Linear and Log 25p 5 Kohm to 1 Mohm Log with switch 58p	<b>PRESETS</b> horizontal 100 ohm to 1 Mohm 5p	<b>TRANSFORMERS</b> 240V primary 6-0-6V 100mA 9p, 0-6V x 2 360p, 8-0-8V 100mA 25p, 9-0-9V 1-amp 290p, 9-0-9V 2-amp 400p, 0-12V 2 amp 370p, 0-15V x 2 200mA x 2 240p.
--------------------	---	--	--	---	--	--	--	--	---	---	--	---	--

# We wish you a Happy Christmas

and suggest that one of the best ways to ensure it is to treat yourself to a Home Radio Components Catalogue.

Only £1.25 including p & p.

The best Christmas present you could buy — for yourself or for any of your electronics friends or relations

Our catalogue has 128 pages, lists over 2,500 items, many of them illustrated. With each catalogue is a free Bargain List of unrepeatable offers. Also included are details of our easy-to-join Credit Scheme which enables you to order components by phone any time of day or night, any day of the week.



Please write your Name and Address in block capitals

NAME \_\_\_\_\_

ADDRESS \_\_\_\_\_



POST THIS COUPON with cheque or p.o. for £1.25

HOME RADIO (Components) LTD., Dept. RC  
234-240 London Road, Mitcham, Surrey CR4 3HD  
REgd. No. 912966, London



# LOW COST COMPONENTS — OUR GUARANTEE IS YOUR SATISFACTION

POTS Carbon Rotary Modern Types	EXTRA SPECIAL OFFER	TESTED PAKS	TRANSISTORS
680ohm lin 15p 2K7 lin 15p 4K lin 14p 10K lin 15p 250K lin 14p 50K lin 14p 100K lin 15p 200K lin 14p 500K lin 14p Dual 100K lin 18p Dual 250K lin 19p 500K lin 16p Slider 1K8 18p	By demand we present a transistor inverter 12v dc input — 200/240v ac output 50Hz at 40 watts uncased but ready wired and assembled, transistors mounted on aluminium folded sheet, square wave output <b>£4.80</b> plus 30p postage or alternative smoothed/filtered output waveform <b>£5.80</b> plus 30p postage.	Ten mixed marked values electrolytics at 17p Eighteen mixed small resistors at 12p Fifteen assorted capacitors could be mylar, ceramic polyester etc. at 12p Twenty mixed transistors at 35p Ten mixed wirewound resistors at <b>Xmas offer 18p</b> Eighteen mixed values ceramic capacitors at 12p Ten mixed 400mw zener diodes 18p	AC128 6p BC107 4p BC108 5p BC109 5p BC549 10p BF258 34p BD131 18p BD187 32p TIP29 30p TIP31 24p TIP33 40p 2N3055 42p 2N3054 32p 2N3553 60p 2N3866 41p FET's: P/channel 12p N/channel 14p Photo transistor 16p
I.C.'s '326' and '335' both are 16 pin dil packages, dual two input dual three input, 12v rail, full spec with data 7p '370' is a quad flip flop, 16 pin dil package, 12v rail full spec, with data 7p '332' dual two input with four invertors, 16 pin dil package, 12v rail full spec, with data 8p	BOLTS 6BA plated 1/4" pk six 7p 1/2" pk of six 10p Nylon 6BA 1/2" six 14p 4BA plated 1/4" pk five 8p 3/4" five 12p	Ten mixed 2w zener diodes at 24p Six mixed value pots rotary at <b>Xmas offer 40p</b> Three mixed sizes of toroidal cores at 54p Three mixed sizes of transistor audio transformers 46p Twelve 7400 series IC's unmarked/untested at 24p Twenty silicon diodes mixed signal and power types at 10p Six FETs at 50p Six photo type transistors at <b>Star offer 40p</b>	Rubber connecting block 2-way mains type 5p Coil formers 3/8" with core 7p Solder-in tubular trimmers, 3 pf 7p 6 pf 7p 8 pf 8p 12 pf 8p TBA120S FM I.C.'s untested but with data 14p Wideband Amplifier I.C.'s untested with data 14p Vari-Cap Diodes tested at two 6p
HEATSINKS Single TO3 black anodised aluminium finned & ready drilled 2" x 1 1/2" x 1 1/2" 50p Double TO3 black anodised aluminium finned, ready drilled, 3 1/2" x 1 1/2" x 1 1/2" 74p TO3 transistor insulation covers, black nylon up to 30Kv 5p TO3 Power Skts 18p TO3 melinex/mica ins. washers 3p TO3 ins. bushes 2p	LED'S We have obtained new supplies which cost a bit more but they are still reasonable 0.2" red at 8p 1.2" yellow at 10p 0.2" green at 12p 0.2" orange at 12p	Twenty mixed BC107/8/9 transistors at 70p Twelve C280 capacitors asstc 10p	Seasonal Greetings  ORDERS VALUED £4+ Cut out this coupon and send it with your order valued at £4 or over and deduct 60p from your total order amount. Valid until Jan 24th 1979 ELECTROVANCE 125 Hazlebury Road London SW6 2LX
TOROIDAL CORES all round 21mm 10p, 25mm 12p, 27mm 13p, 29mm 14p, 33mm 16p, 39mm 21p, 48mm 28p, 52mm 33p, 58mm 38p, 68mm 54p, 78mm 52p.	DISPLAYS 0.3" economy seven segment displays, common anode, left hand decimal point. 14 pin dil package. Red 65p Yellow 70p Green 75p HP7750 display C.A. seven seg. red, 14 pin package, plus one displayed at full 0.3" 98p	AUDIO TRANSFORMERS Miniature transistor output types, 3-pin Pri-types 26p 4-pin Pri-types 26p Interstage types 24p 400mw Zener Diodes (new) 3.6v, 6.8v, 10v, 11v, 12v, 13v, 16v, 24v, 30v, 33v, all 6p each.	OPTIONAL EXTRAS Smoothed and filtered waveform circuitry £2.50; Additional 13 amp mains output socket fitted £1.20; Panel fuse/holder 20mm for mains protection fitted £1.00. All inverters are ready assembled, DC input via heavy duty cables with attached battery clips, AC mains output via a 13 amp socket.
DO NOT ADD ANY EXTRAS UNLESS INDICATED Some of the advertised components are offered below normal prices due to their being unmarked but identified and tested new and workable by ourselves, any unsatisfied customer may return goods purchased within 8 days for full refund as long as the goods are undamaged.	NEW RANGE TRANSISTORISED INVERTER UNITS AC outputs regulated at 50HZ square wave or optional smoothed and filtered wave form circuitry for sensitive equipment: 22/25 watts, cased 4 in x 3 in x 2 in £6.80 postage 85p extra; 38/40 watts, cased 4 in x 3 in x 2 in £9.40 postage 85p extra; 120/140 watts, cased 8 in x 7 in x 3 in £18.70 postage £1.40 extra; 180/200 watts, cased 8 in x 7 in x 3 in £24.60 postage £1.40 extra; 240/250 watts, cased 9 in x 8 in x 3 in £28.80 postage £1.80 extra; 350/360 watts, cased 10 in x 8 in x 3 1/2 in £34.60 postage £2.00 extra; 420/440 watts, cased 10 in x 8 in x 3 1/2 in £40.00 postage £2.00 extra; 480/500 watts, cased 10 in x 8 in x 3 1/2 in £48.20 postage £2.00 extra.		ORDER DETAILS It is helpful if you send a S.A.E. with all orders or enquiries, lists free on request. <b>ELECTROVANCE</b> Tel: 01-736 0685 MAIL ORDER ONLY P.O. BOX 191, LONDON SW6 2LS



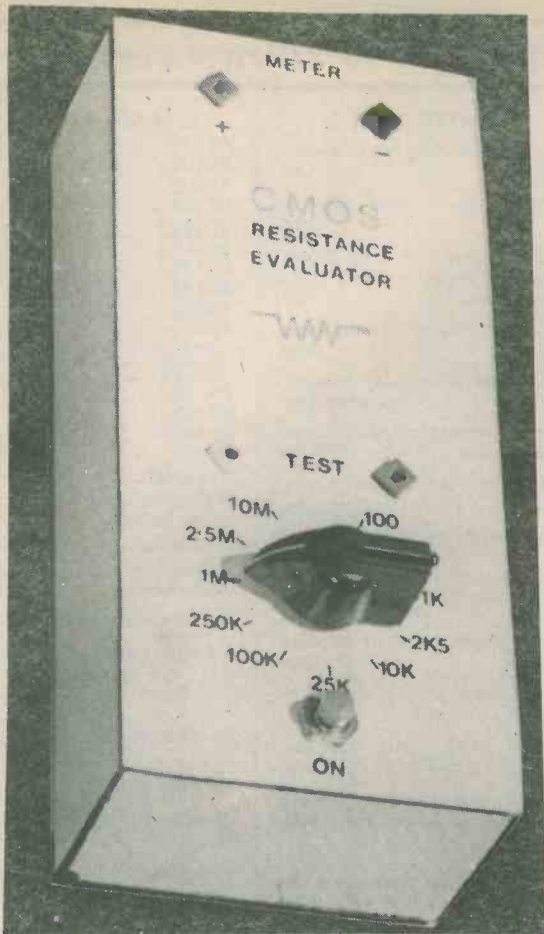

*The prototype resistance evaluator is housed in a home constructed case, with Formica covering the front panel and the sides. An external meter, which can be a multimeter switched to a suitable range, is plugged into the meter sockets when required*

An ohmmeter is an important item of equipment for both amateur and professional workers in the electronics field, its uses varying from the simple continuity tester to the selection of close tolerance resistors for specialised uses. The basic type incorporated in most commercial multimeters has a non-linear scale, and can only give accurate results when the value assessed lies around mid-range.

The unit described here is suitable for evaluating resistance values from less than  $5\ \Omega$  to  $10\text{M}\ \Omega$  with eleven overlapping ranges. The circuit is designed around two CMOS operational amplifiers, resulting in a low component count and ease of initial setting up without the drawback of a dual rail power supply.

A combination of constant current generator and high input impedance voltmeter provides linear meter scale readings. The meter movement itself is plugged in to the ohmmeter only when required, thereby ensuring that the meter is not solely committed to use with the ohmmeter. Indeed, a multimeter switched to a low current range will give excellent results.

The eleven ranges provided are listed in the accompanying table.

# CMOS \* \* \* RESISTANCE \* \* \* EVALUATOR

By

Bruce Woodland

Linear read-out from less than  $5\ \Omega$  to  $10\text{M}\ \Omega$ .

Eleven overlapping ranges,

Simple low-cost "plug-in" circuitry.

Table

RANGES	
1	0-100 $\Omega$
2	0-250 $\Omega$
3	0-1k $\Omega$
4	0-2.5 $\Omega$
5	0-10k $\Omega$
6	0-25k $\Omega$
7	0-100k $\Omega$
8	0-250k $\Omega$
9	0-1M $\Omega$
10	0-2.5M $\Omega$
11	0-10M $\Omega$



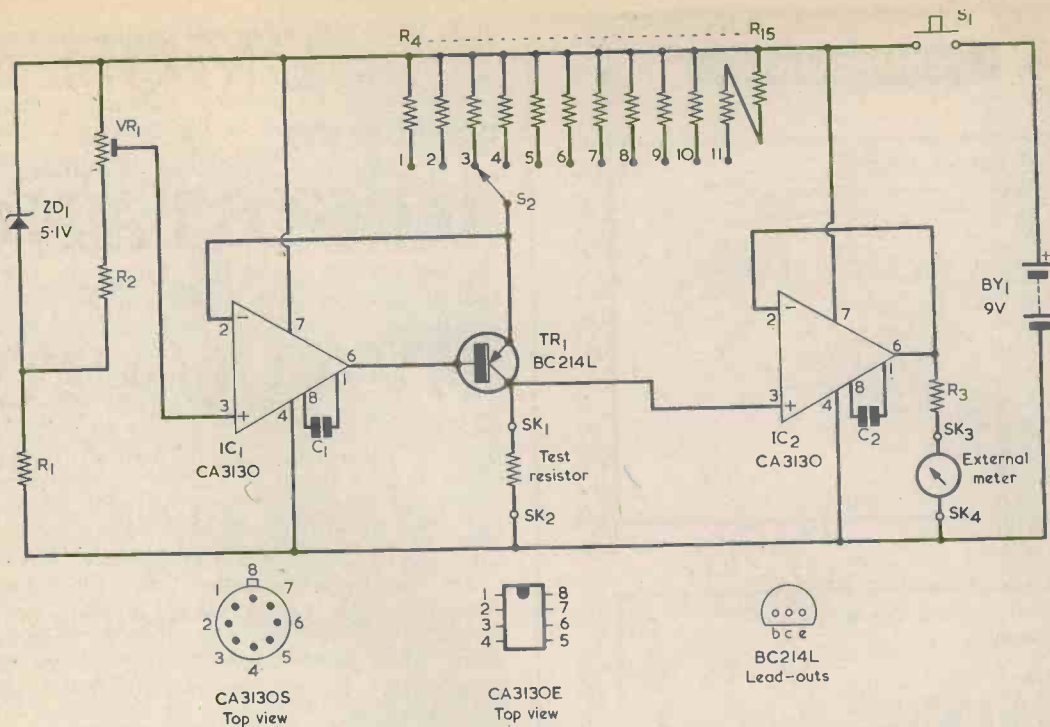

Fig. 1. The circuit diagram of the CMOS resistance evaluator. S2 selects the ranges shown in the table

### PRINCIPLE OF OPERATION

IC1, TR1 and the associated components in Fig. 1 form a very accurate constant current generator. The reference voltage applied to the non-inverting input of IC1 is nominally 2.4 volts referred to the positive rail. IC1 compares this with the voltage at TR1 emitter, at which the same voltage appears. The base-emitter voltage drop (which can vary for different emitter currents) is eliminated as a factor by the overall negative feedback in the transistor and operational amplifier circuit, whereupon the emitter voltage remains constant for all emitter currents selected. The maximum current which can be drawn from the transistor collector is therefore dependent only on the reference voltage from VR1 slider and the value of the emitter resistor selected by the range switch, S2.

The constant current generator develops a voltage across the test resistor which is directly related to the constant current and the test resistance. The range resistors R4 to R15 are chosen to produce sufficient current to develop a nominal 2 volts across the highest test resistance in the particular range selected. This voltage is applied to the non-inverting input of the voltage follower IC2, the input impedance of which is more than sufficiently high to give no significant loading on even a 10M  $\Omega$  test resistance.

The output of IC2 drives the meter via the current limiting resistor R3, this resistor having a value which gives full-scale deflection at the nominal 2 volts from IC2. Any meter with an f.s.d. requirement of 2mA or less will be suitable.

The value of R3 has to be calculated to suit the particular meter to be employed, and its value is equal to (2 minus  $V_m$ ) divided by the meter f.s.d. current.  $V_m$  is the voltage dropped across the meter at f.s.d. As an example, the meter may be a 0.1mA

panel-mounting type having a coil resistance of 150 $\Omega$  whereupon  $V_m$  is equal to 150 $\Omega$  multiplied by 0.001 amp, or 0.15 volt. R3 then calculates as 2 minus 0.15 volt, or 1.85 volt, divided by 0.001 amp, giving a resistance of 1,850 $\Omega$ . It is not necessary for R3 to have precisely this resistance, and the nearest preferred value of 1,800 $\Omega$  can be employed instead. The small error introduced is then cancelled out during setting up by adjusting VR1 for a maximum voltage across the test resistor which is slightly removed from the nominal figure of 2 volts.

A modified approach is required if the meter to be used is a multimeter switched to a low current range. This is because, due to their universal shunt current selection circuits, many multimeters offer quite high voltage drops at f.s.d. current readings, such voltage drops being in some cases as high as 1 volt. It is necessary to determine the voltage dropped across the multimeter with the aid of the circuit shown in Fig. 2. Here, the fixed current

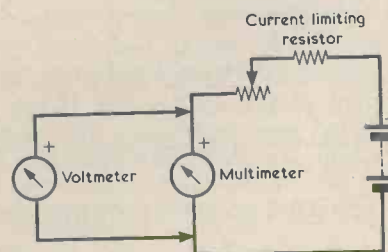

Fig. 2. When a multimeter switched to a low current range is used as the external meter the voltage dropped across it at full-scale deflection may be found with this test circuit. The value of the current limiting resistor must be such that an excessive current cannot pass through the multimeter



## COMPONENTS

### Resistors

(All fixed values  $\frac{1}{4}$  watt)

- R1 1.8k $\Omega$
- R2 1.8k $\Omega$
- R3 see text
- R4 120 $\Omega$
- R5 300 $\Omega$
- R6 1.2k $\Omega$
- R7 3k $\Omega$
- R8 12k $\Omega$
- R9 30k $\Omega$
- R10 120k $\Omega$
- R11 300k $\Omega$
- R12 1.2M $\Omega$
- R13 3M $\Omega$
- R14 2M $\Omega$
- R15 10M $\Omega$
- VR1 2.2k $\Omega$  Miniature pre-set potentiometer, 0.1 watt, horizontal

### Capacitors

- C1 220pF polystyrene
- C2 220pF polystyrene

### Semiconductors

- IC1 CA3130E or CA3130S
- IC2 CA3130E or CA3130S
- TR1 BC214L
- ZD1 BZY88C5V1

### Switches

- S1 push-button, miniature, press to make
- S2 1-pole 12-way rotary, miniature with adjustable end stop

### Sockets

- SK1-SK4 2mm. insulated sockets

### Battery

- BY1 9-volt battery type PP3 (Every Ready)

### Miscellaneous

- Battery connector
- 4-off 2mm. plugs
- 2 crocodile clips
- 2-off 8-way d.i.l. sockets
- Pointer knob
- Materials for case and printed board
- External meter (see text)
- Nuts, bolts, etc.

limiting resistor has a value which would cause a slight overload in the multimeter if the variable resistor inserted zero resistance into circuit. The variable resistor is then adjusted for an f.s.d. reading in the multimeter, and the separate voltmeter connected across it indicates the voltage dropped.

To take a further example, say that the multimeter drops 0.75 volt at f.s.d., the f.s.d. current again being 1mA. The voltage to be dropped by R3 is therefore 2 minus 0.75, or 1.25 volt, with the result that the value of R3 calculates as 1.25 divided by 0.001, or 1,250 $\Omega$ . R3 may in practice be one of the two preferred values, 1,200 $\Omega$  or 1,300 $\Omega$ .

A minor point is that it will be helpful if the meter employed has an f.s.d. marking on its scale

of 1, 10 or 100. This will enable the ranges of 0-100 $\Omega$ , 0-1k $\Omega$ , etc., to be read more easily from the meter calibration.

## COMPONENTS

The CA3130 operational amplifier, a CMOS device, has a very high input impedance of around 1.5 million megohms. This is necessary to prevent loading of the current range resistors at IC1, and of the test resistances at IC2. Moreover, the negative output swing of this device can be considered to reach, for all practical purposes, the potential of the negative supply rail. Thus a dual rail power supply is avoided in this application.

A CA3130E is nowadays obtainable, this being an 8 pin d.i.l. version of the op-amp. There is also the CA3130S, which has its lead-out pins preformed to fit an 8 pin d.i.l. holder. Either type may be employed here, and the CA3130E is available at the time of writing from A. Marshall (London) Ltd., 40-42 Cricklewood Broadway, NW2 3ET.

TR1 has been specially chosen for the resistance evaluator since it must satisfy a number of criteria. It has a very low leakage current, high minimum gain, and good current and power handling capabilities. Its substitution by other types is thus not advisable.

Of the fixed resistors R1, R2 and R3 (after its value has been calculated) may be 5% components. The accuracy of the finished instrument depends upon the quality of the range setting resistors R4 to R15. Metal oxide 2% tolerance types are recommended, but if 1% types are available they will give even better results, albeit at increased cost. Since 12M $\Omega$  resistors cannot be easily obtained, the highest value range setting resistor consists of R14 and R15 in series.

An ever-present problem with home-constructed instruments of this type is that close tolerance resistors above 1M $\Omega$  are not normally available from the large mail order suppliers. The writer has been able to locate a few close tolerance resistors higher than 1M $\Omega$  (from bankrupt clearance stocks

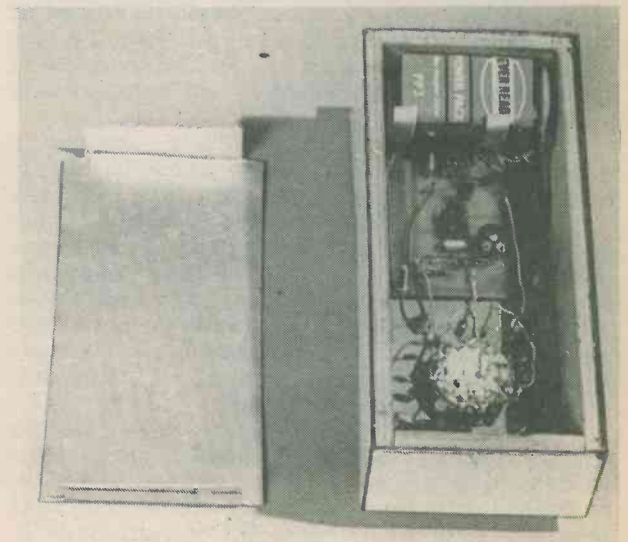

The components inside the case. Also to be seen is the case back, which simply consists of an aluminium sheet with flanges bent in the ends to provide a push fit



and the like) by shopping around various component stores, but supplies of such resistors are limited and continuity cannot be guaranteed. Readers who are prepared to accept a lower accuracy on the top three ranges may use 5% resistors for R12 to R15. R12 could, however, be close tolerance  $1M\Omega$  and  $200k\Omega$  resistors in series, whereupon only the top two ranges have reduced accuracy.

An alternative approach, which has been used satisfactorily by the author and can be carried out after the instrument has been set up, is to connect a known close tolerance resistor in the test position, and then try a number of 5% resistors in the R12 to R15 positions for maximum accuracy of readings. This does, of course, again necessitate close tolerance resistances above  $1M\Omega$  for Ranges 10 and 11, but these could consist of two close tolerance  $1M\Omega$  resistors in series as the test resistance for Range 10, and seven or more close tolerance  $1M\Omega$  resistors in series as the test resistance for Range 11.

The range switch, S2, is a miniature 1-pole 12-way rotary component with an adjustable end stop set up for 11 positions.

The unit is powered by a 9 volt battery and, since push-button operation is utilised, current is only drawn when a test is actually carried out. Thus the battery will have quite a long life. However, it should be replaced when its on-load voltage drops below some 8 volts, otherwise the accuracy of the two lowest resistance ranges may be compromised.

### CONSTRUCTION

The actual layout of the instrument is not critical, but the following points should be borne in mind if alternative forms of construction are contemplated. Flying leads from the component board should be kept short, and the leads to SK1 and SK2 should not be twisted together, or pressed against other leads. If Veroboard is used, all traces of flux must be removed between adjacent copper strips. Integrated circuit sockets should be used for IC1 and IC2, and the latter only inserted after all wiring has been completed and checked. Fig. 3 shows the printed circuit layout used by the author. R4 to R15 can be mounted direct to the tags of S2, as shown in Fig 4.

The prototype unit is housed in a plywood case having internal dimensions of  $5\frac{3}{4}$ in. long by  $2\frac{1}{4}$ in. wide by  $1\frac{1}{2}$ in. deep, the front and sides being covered by Formica. The back consists of a sheet of aluminium with flanges bent down at the ends to allow a push fit. The circuit board is mounted behind the front panel, secured by four 6BA countersunk bolts and nuts, but spaced from the

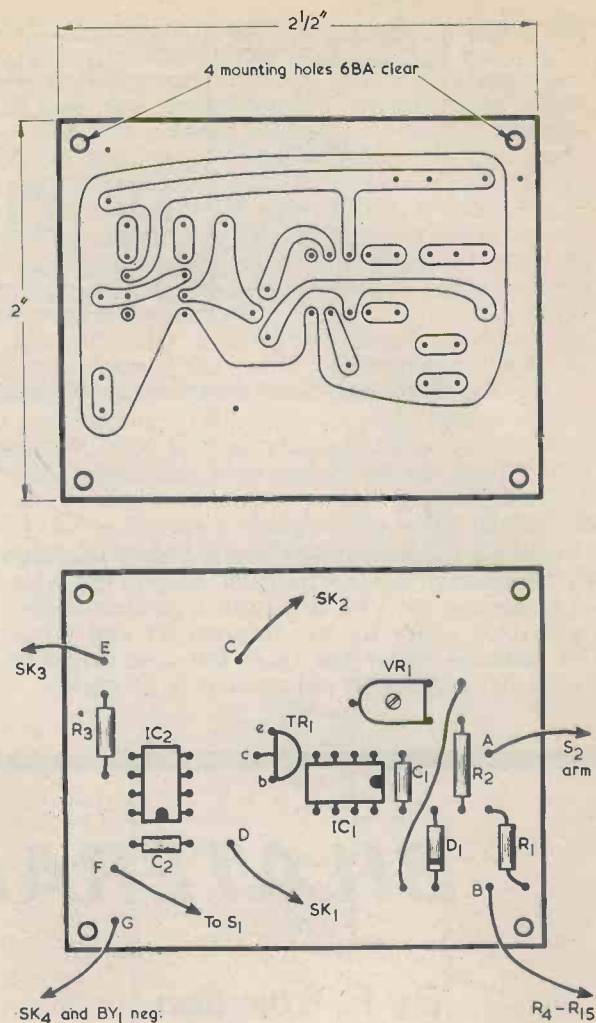
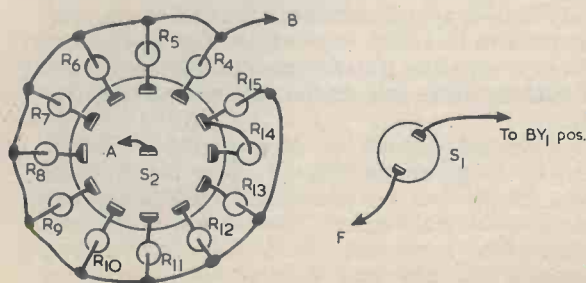

Fig. 3. The copper and component sides of the printed board, which is reproduced full size. The letter references "A" to "G" apply to corresponding references in Figs. 4 and 5

front panel by an extra nut on each bolt. The bolt heads are covered by the Formica. The sockets and switches are also mounted on the front panel. An aluminium clamp secures the battery. The layout is clarified by the photograph and Fig. 5. The test probes consist of two short flexible leads, terminating in 2mm. plugs at one end and in miniature crocodile clips at the other.

Fig. 4. Details of the switch wiring. The twelfth outer tag of S2 (not reached by the switch arm because of its end stop) is used as an anchor tag for the junction of R14 and R15. Outer tags may be located with a continuity tester



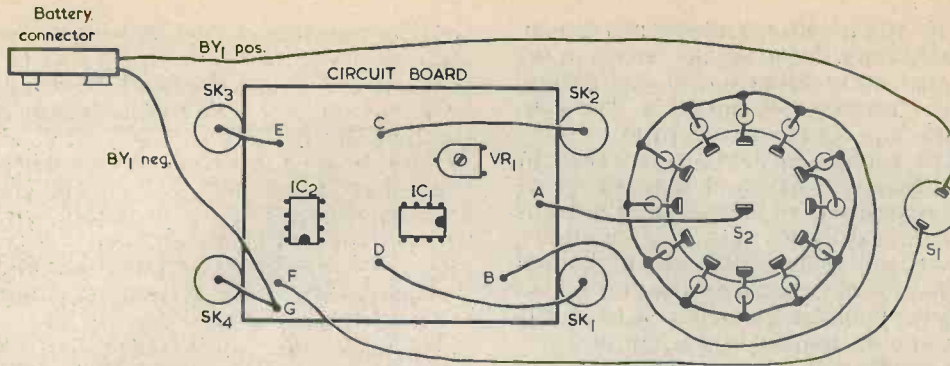

Fig. 5. Wiring between the printed circuit board and the other components in the resistance evaluator

### SETTING UP

To set up the instrument, insert a close tolerance 10kΩ resistor in the test position. Plug in the external meter and set VR1 to a central position. Select the 0-10kΩ range by S2. Depress S1 and adjust VR1 until the meter just reads full-scale deflection. No further setting up adjustment is necessary.

If S1 is pressed with the test sockets open-circuit or with a test resistance much higher than the range selected, a voltage of up to some 6.5 volts may be applied across R3 and the meter. This will cause the meter needle to swing over to its end-stop but, with any normal robust meter movement, should not cause any damage. ■

# BILATERAL SWITCH

By F. Bowden

## Lateral switching of signal voltages

One of the more interesting and useful devices in the CMOS armoury, and yet one which the writer has hardly ever seen employed in home-constructor projects, is the bilateral switch. This has a control terminal which, when taken positive up to VDD, allows both digital and analogue signals to pass from an input terminal to an output terminal. If the control terminal is taken negative, to VSS, the switch turns off and prevents the flow of signals between the input and output terminals.

### F.E.T. OPERATION

A typical example of a bilateral switch is found in the CD4016, which contains four of them. The pinout for the CD4016 is given in Fig. 1. Each of the four switches is quite separate although they all, of course, share the same positive and negative supply.

The internal circuit of one of the switches, Switch A, is given in Fig. 2. The other three switches in the i.c. are identical. The switch has two p-channel field-effect transistors, TR1 and TR4, and two n-channel field-effect transistors, TR2 and TR3. The long line at each transistor symbol is the insulated gate, and the two outside

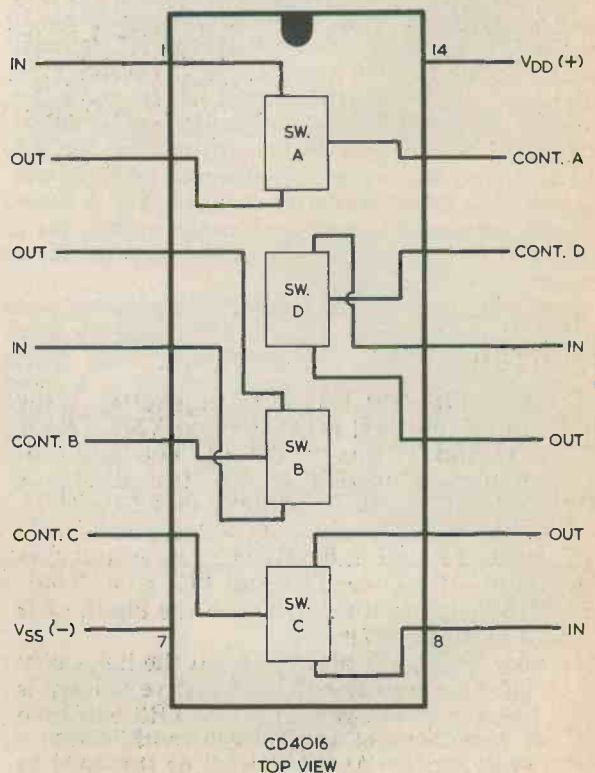

Fig. 1. Pin allocations for the quad bilateral switch type CD4016. The more recent CD4066 has the same pin connections



bars alongside it are the source and drain. The central bar is the substrate. Although not shown in the diagram, the substrate of TR3 connects to VSS and the substrate of TR4 connects to VDD. The substrates have no effect on circuit operation.

If the gate of a p-channel field-effect transistor of the type used here is at the same potential as its source, or if it is positive of the source, the transistor is cut off and exhibits a very high resistance between its source and drain. When the p-channel gate is taken negative of its source current is allowed to flow along the channel, and a low resistance is set up between the source and the drain.

The n-channel field-effect transistor has an exactly opposite performance so far as polarities are concerned. It exhibits a very high resistance between source and drain when its gate is at the same potential as its source or when the gate is negative of the source. The source-to-drain channel offers a low resistance only when the gate is positive of the source.

VDD or negative of VSS. Any signal voltage at the input is prevented from appearing at the output terminal because of the two turned off transistors.

When the control input terminal is taken positive, this positive voltage is applied to the gate of TR3, turning this transistor on when the source is negative at VSS. Similarly, the inverter applies a negative voltage to the gate of TR4, which turns on when its source is at VDD. Signals at the input terminal equal to VSS or VDD are therefore passed through TR3 or TR4 as applicable and appear at the output terminal.

If, with the control terminal positive, the signal voltage at the switch input terminal is taken gradually from VSS to VDD, the signal will initially pass through TR3, then through TR3 and TR4 together and, finally, through TR4 on its own. With a reasonably high supply voltage, say 10 volts or so, the input to output voltage graph from VSS to VDD is almost a straight line when the switch output is loaded by 100k $\Omega$ , exhibits slight cur-

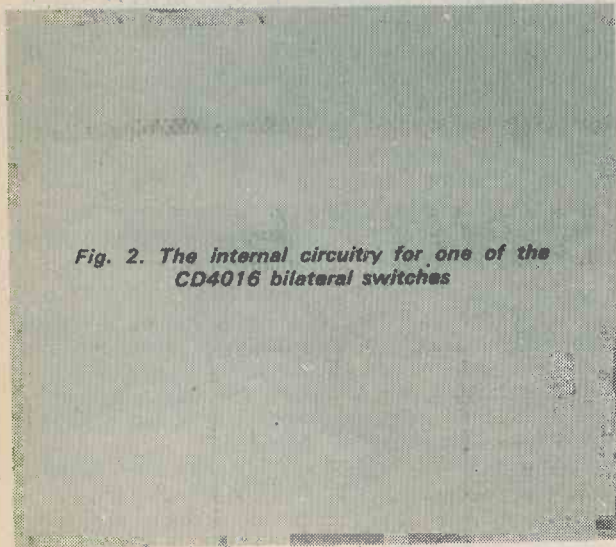
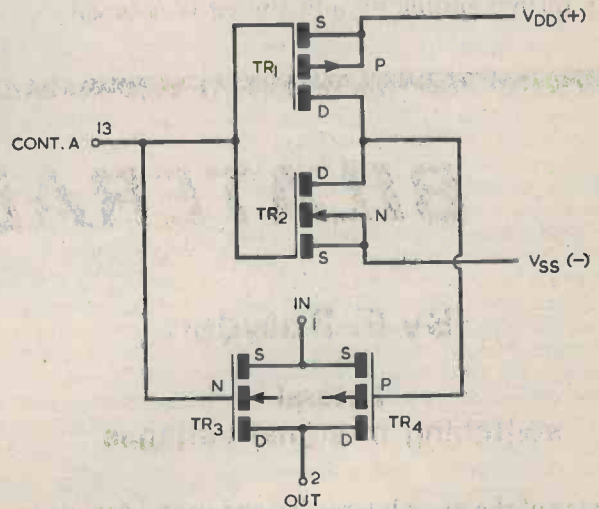

Fig. 2. The internal circuitry for one of the CD4016 bilateral switches



## INVERTER

In Fig. 2, TR1 and TR2 form an inverter. If the input control terminal is negative, at VSS, TR1 is conductive and TR2 is turned off. The output at the common connection to the two drains is therefore positive and is virtually equal to VDD. Taking the input control terminal positive, to VDD, turns TR1 off and TR2 on. The output goes negative, to VSS. Thus, TR1 and TR2 give an output which has opposite polarity to the input, as is required of an inverter.

Consider next what happens when the input control terminal is negative. This negative voltage is applied direct to the gate of TR3. TR3 will then turn off regardless of the voltage (within device limits) at its source. At the same time the inverter output applies a positive voltage to the gate of TR4, whereupon this transistor is also turned off for all voltages at its source. The two sources are connected to the switch input terminal which, to keep within the CD4016 ratings, must not go positive of

vature for a load of 10k $\Omega$  and marked curvature for a load of 1k $\Omega$ . The curvature is much more marked for the three loads when a low supply voltage, at around 5 volts, is used. So, if a CD4016 is to be employed to switch an alternating voltage signal it is advisable to use a supply voltage of around 10 volts and to avoid excessive loading of the switch output.

With a supply voltage of 10 volts, the "on" resistance of the CD4016 is typically 250 $\Omega$ . A more recent bilateral switch, the CD4066, has the same pin allocations as the CD4016, but it has a lower "on" resistance of around 100 $\Omega$  typical with a 10 volt supply.

Before concluding, it may be mentioned that the section of the circuit comprising TR3 and TR4 is sometimes described as a "transmission gate". Also, the two transistors may be considered as being symmetrical. In Fig. 2 this would allow an input signal to be applied to pin 2 and an output taken from pin 1.

## 75 YEARS OF THE 'MEGGER' TRADE MARK

Evershed & Vignoles Ltd. this year celebrate 75 years of the MEGGER trade mark, a name which has become synonymous with electrical insulation testing.

The name MEGGER was first coined by E. B. Vignoles and registered in 1903 and was derived from Megohm. The first MEGGER Tester was marketed in 1904 and at that time was the only high resistance measuring instrument which tested at or above the working voltage of the circuit and yet was self-contained in a single portable case. The d.c. test voltage was produced by a hand-wound generator and the resistance value indicated by a pointer travelling across an analogue scale, calibrated directly in Megohms. The pointer was controlled by the unique cross-coils movement invented by Sydney Evershed, which is still the basis of today's Major MEGGER and Wee MEGGER testers as well as the Battery MEGGER tester BM6. The great advantage of the cross-coils movement is that the accuracy of resistance reading is not affected by variations in generator winding speed.

Thus the MEGGER tester was just the instrument which the young electrical trade needed to ensure safety in the rapid spread of domestic use of electricity for lighting and heating. It was portable, simple to use, direct reading (no calculations) and independent of any power source.

Today the full range of



*A 1978 MEGGER Model SL2, Series 1 insulation tester alongside one of the self-contained 500V resistance testers of 1904 design. Both use the Evershed cross-coils movement*

MEGGER insulation testers comprises 23 different models, some of which generate their test voltage by battery-driven solid-state oscillators, while others retain the total independence of hand cranked generators. In addition there are low resistance ohmmeters, earth resistance testers and a line-earth loop tester.

In 1972 Evershed & Vignoles moved their production of

MEGGER testers from Chiswick to the site at Dover, which is shared with their associate companies, Avo and H. W. Sullivan. Production is at a higher level than ever before and the proportion of export sales is around 60%.

To mark the 75th anniversary, commemorative ashtrays are being distributed. These carry the 75-year emblem consisting of an inverted omega to form the figure 75.

## LEKTROKIT APPOINT NEW MANAGING DIRECTOR AND WIN NEW FRANCHISE



Lektrokit Ltd., of Sutton Industrial Park, London Road, Earley, Reading, Berks., the Unitech company that specialises in breadboarding and prototype packaging equipment, has been in an expansion minded mood during the past few months. In addition to appointing new Managing Director, Geoff Bigg, formerly marketing manager with ITT, they have also acquired several new franchises and split their operations into two distinct but related fields.

Mr. Geoff Bigg can be seen on the right in our accompanying photograph shaking hands with Mr. Horst Moll of AP Products.

Geoff Bigg's philosophy for the new style Lektrokit is summed up in two phrases: 'Two Stop Shopping for the Professional' and 'Fast and Easy for the Student and Hobbyist'.

With this activity, Lektrokit have extended their home-constructor/hobbyist business to include, under a new franchise deal, AP Products' comprehensive range of 'fast and easy' products. These simple-to-use solderless breadboards, terminal and distribution strips, connectors, pins, sockets, jumpers, i.c. test clips, heat sinks, cabling, etc. are all now available ex-stock either individually or in kit form from Lektrokit's Reading headquarters or their appointed agents/distributors.





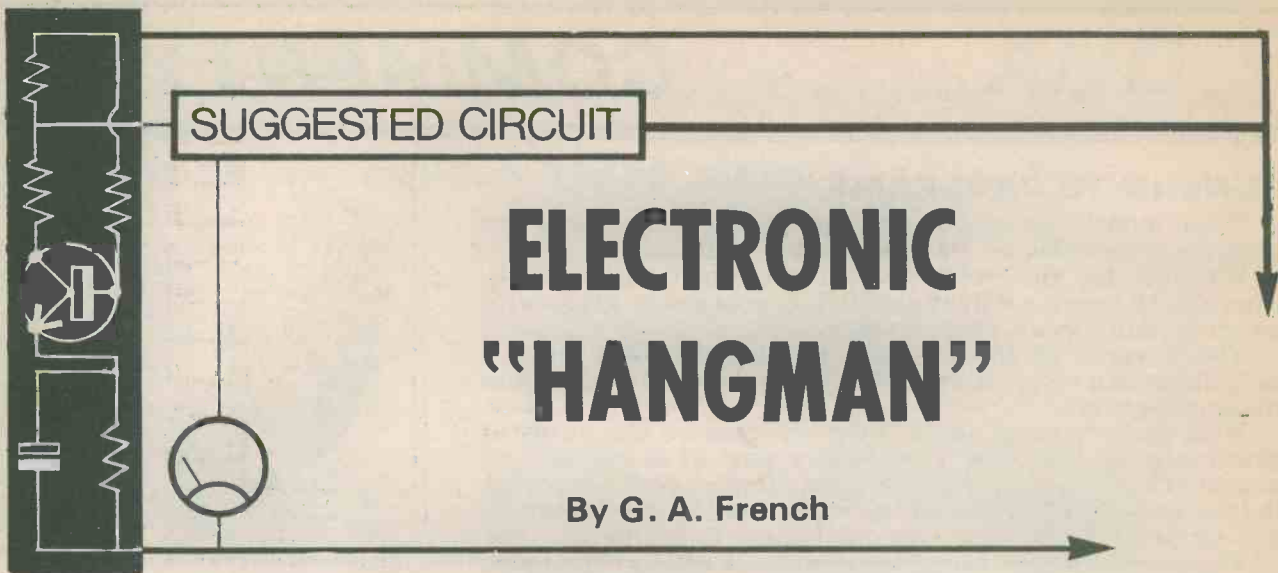

# ELECTRONIC "HANGMAN"

By G. A. French

Nearly all readers will be aware of the game of "Hangman". This is a simple word guessing game in which one contestant draws out a row of dashes on a piece of paper, each dash representing a letter in a word or phrase. The remaining person or persons then submit letters in turn which may form part of the word or phrase. When a letter is correct it is entered at the appropriate point or points along the dashes. If incorrect, the "Hangman" picture of Fig. 1 is drawn out, each line corresponding to an incorrect letter. The first line to be drawn is the upright of the gallows, the second is the horizontal beam and the third is the sloping strut. These are followed by a line for the rope, a circle for the victim's head, an oval for the body, two lines for the arms and two lines for the legs. If the "Hangman" picture can be completed, the person presenting the unknown word or phrase has won.

The number of steps needed to make up the "Hangman" picture is 10, whereupon the possibility arises that simple electronic logic may be used to provide added amusement to the game. Each incorrect letter step could be indicated by the lighting up of an l.e.d. by pressing a button, the l.e.d.'s appearing at the appropriate points in the "Hangman" picture. The first incorrect letter can cause one l.e.d. to be lit, the second another l.e.d. until, after 10 incorrect letters, 10 l.e.d.'s are illuminated and the "Hangman" picture is effectively complete.

## CMOS CIRCUIT

Since there is a total count of 10, it is appropriate to think in terms of a decade counter i.c. to light up the l.e.d.'s, and a particularly suitable choice here would be the CMOS CD4017. This device has been described in earlier issues of this magazine and need only be referred to briefly here. As is shown in Fig. 2, the device has a clock input at pin 14 and 10 decimal outputs at the pins indicated. Succeeding decimal output pins go positive at each positive-going input pulse edge at the clock input. The clock input is enabled if pin 13 is low and is inhibited when this pin is high. The counter is cleared to 0 by taking pin 15 high.

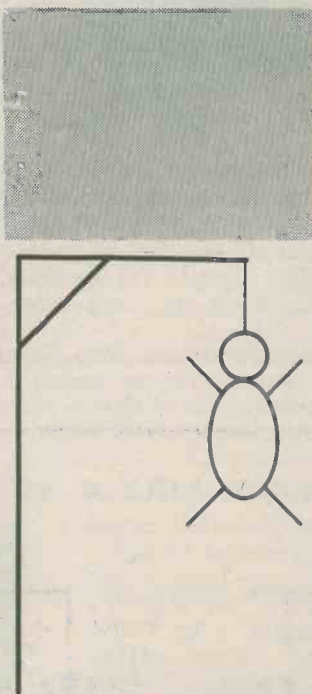

Fig. 1. The picture which is made up in the word guessing game of "Hangman". One line is drawn for each incorrect letter submitted

For the present application it is required that each of 10 l.e.d.'s lights up in turn, with the important proviso that, once lit, an l.e.d. remains lit until the whole circuit is reset. Continued illumination of an l.e.d. could be achieved by having each decimal output trip a bistable circuit, but this is not very attractive since each bistable would typically require two transistors or two inverters. The decimal outputs could alternatively trigger silicon controlled switches, such as the BRY39. However, 10 silicon controlled switches would be required and these would be expensive.

The method adopted by the author for maintaining illumination in the l.e.d.'s is rather novel, and requires only 10 additional diodes to be incorporated in a conventional transistor switching circuit. The idea could, incidentally, be employed for similar applications in which it is desired to have l.e.d.'s maintained in the illuminated state as subsequent l.e.d.'s in a chain become lit.

Fig. 3(a) shows a standard l.e.d. switching circuit for operation from a CD4017. At the start of a count, pin 3 of the CD4017, representing 0, is high, whereupon TR1 is turned on by the base current flowing from pin 3 through the current limiting resistor in the base circuit. LED1 lights up. At the next count, pin 2 of the CD4017 goes high, causing LED2 to become alight. LED1 extinguishes, however, because pin 3 of the CD4017 goes low when pin 2 goes high. At the next count, LED3 will light up on its own, and LED2 will extinguish.

Two diodes are added in Fig. 3(b). When pin 3 is high, TR1 is turned on as before and LED1 lights up. Pin 2 next goes high, turning on TR2 which not only lights up LED2 but also keeps LED1 alight by way of diode D1. At the following count pin 4 is high, and TR3 keeps all three l.e.d.'s lit up, current for LED2 flowing through D2, and current for LED1 flowing through D1 and D2. The system can be extended to any number of transistors and diodes, the only limiting factor being forward voltage drop in the diodes. This causes early l.e.d.'s in the chain to have a lower voltage applied across them and their series current



Fig. 2. The CD4017 pins which are employed in the "Hangman" project

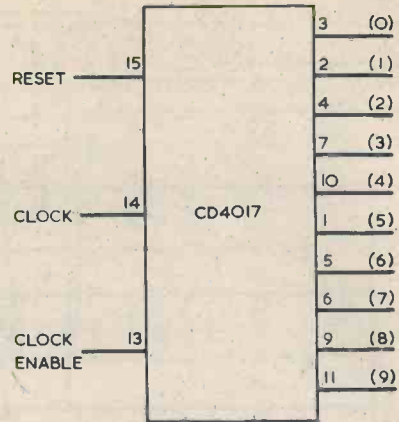

limiting resistors than have l.e.d.'s which are later in the chain.

### FULL CIRCUIT

The full circuit of the "Hangman" project appears in Fig. 4. A CD4011 quad NAND gate is used in addition to the CD4017, two of the NAND gates being employed in a conventional anti-switch bounce circuit in conjunction with the single-pole double-throw push-button S1. When S1 is not depressed, the output at pin 3 of the two gates is low; pressing S1 causes the pin 3 output to go high. This output is applied to the clock input of the CD4017.

S2(a)(b) is the reset switch. When it is put to "Reset" S2(a) allows pin 15 of the

CD4017 to go high via R3, thus clearing the i.c. output to 0, whilst S2(b) breaks the base input circuit to TR1. The clock enable input at pin 13 is connected to the output of a NAND gate at pin 11 of the CD4011. This gate, appearing at the right hand end of the circuit, is connected as an inverter. When TR10 is turned off, as it is until the last count of the decade, the inverter input is taken high by way of R24 and its output is low. S3(a)(b) is the on-off switch for the circuit.

The count is started by changing S2(a)(b) from "Reset" to "Start". The 0 output of the CD4017 is high and S2(b) allows base current to flow into TR1 via R4. LED1 lights up. Pressing S1 causes the 1 output at pin 2 of the CD4017 to go high. The upper

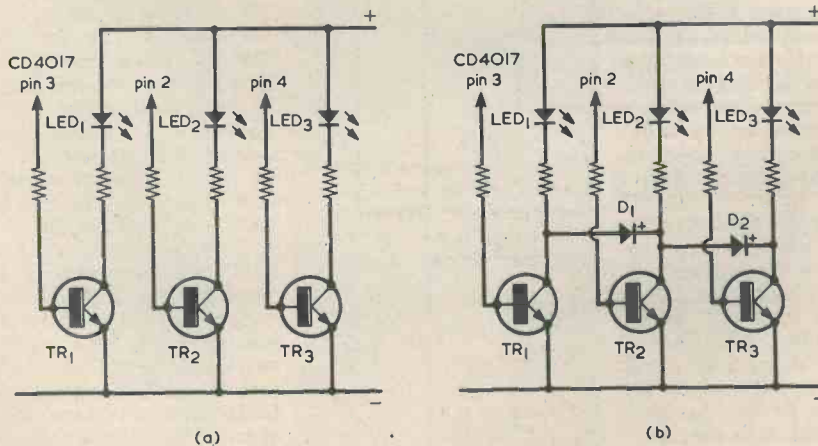

Fig. 3(a). A standard transistor circuit which enables l.e.d.'s to be lit when the decimal output pins of the CD4017 go high (b). If diodes are added, as here, l.e.d.'s which have already been lit remain illuminated as the count proceeds

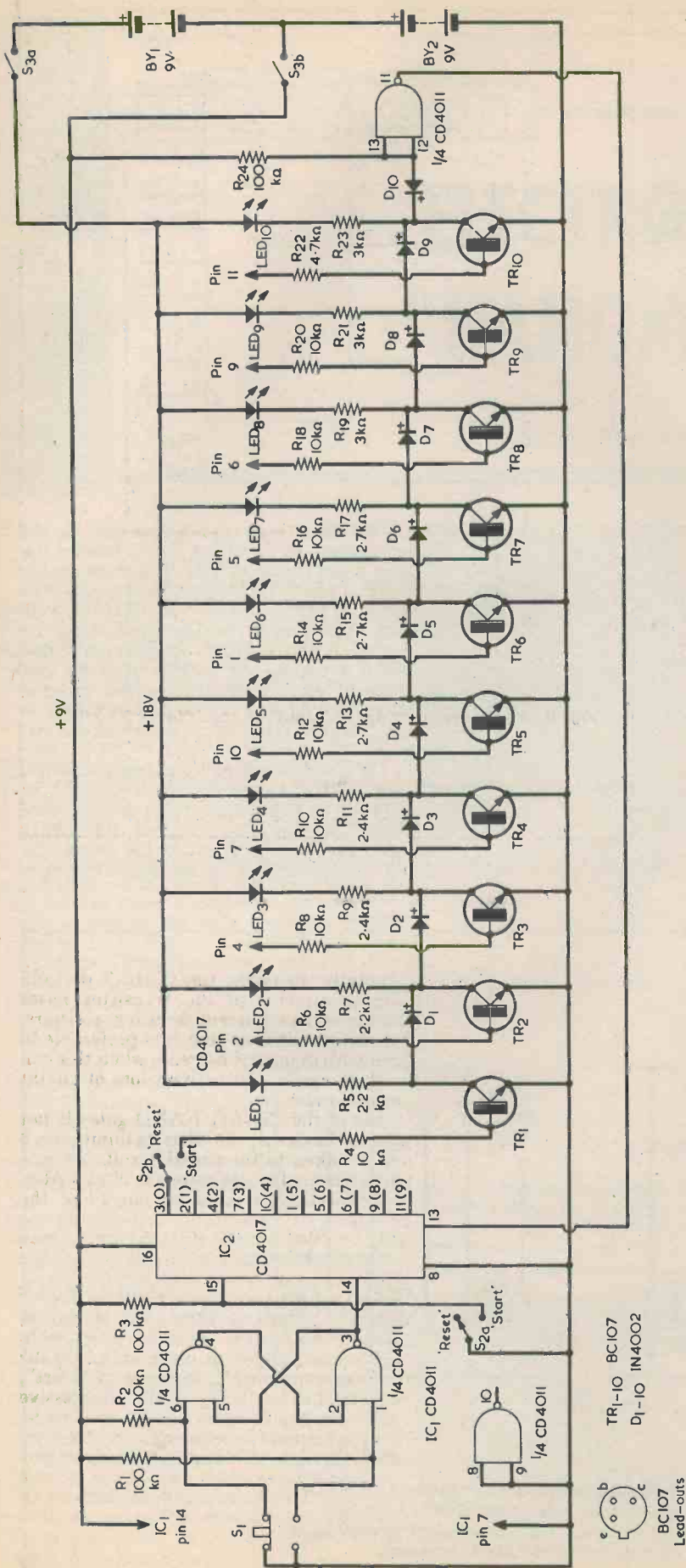

Fig. 4. The full "Hengman" circuit



end of R6 is connected to this pin and TR2 turns on. Both LED1 and LED2 are now alight. Successive operations of S1 cause the number of lit l.e.d.'s to increase, until, when TR9 is turned on, LED1 to LED9 are illuminated. All the current for these l.e.d.'s is passed by TR9 and is carried, to the left, by way of diodes D8 to D1.

Pressing S1 once more causes TR10 to turn on, with the result that all the l.e.d.'s are alight. At the same time the input to the NAND gate inverter at the right goes low via D10. Its output goes high and takes pin 13 of the CD4017 to the clock inhibit state. Pressing S1 then has no further effect on the circuit. Without the clock inhibit feature the circuit would have taken the count back to 0 at the next operation of S1.

The CMOS circuitry is powered by a 9 volt supply, whilst the l.e.d.'s are fed by an 18 volt supply. This higher voltage is necessary because of the forward voltage drop in the diodes; when TR10 is turned on the voltage at the lower end of R5 is about 5.5 volts positive of the voltage at the lower end of R23. This quite large difference in voltage is masked when the l.e.d. supply is as high as 18 volts. As will be noted, the l.e.d. series current limiting resistors have values which increase gradually along the chain from LED1 to LED10. These enable all lit l.e.d.'s to have the same brightness regardless of which transistor is turned on. It will be apparent that, as successive transistors become conductive, the brightness of, say, LED1 reduces because the voltage across it and R5 decreases. However, the effect is gradual and is not easy to discern even when it is being especially looked for.

## SUPPLY VOLTAGES

The use of two supply voltages means that care has to be taken to ensure that 18 volts is not accidentally applied to the CMOS circuitry during wiring up or when connecting the batteries. Diode D10 isolates the input of the right hand NAND gate inverter from the 18 volts supply, this input being returned to the 9 volt supply via R24.

The current drawn from the two 9 volt batteries rises as more l.e.d.'s light up, being about 45mA with all l.e.d.'s turned on. Fairly large batteries, such as the PP9, are advisable. The current drawn from BY2 by the CMOS circuitry is only about 1mA. If the voltage from BY1 falls with age the only effect is that the brightness of the l.e.d.'s reduces. The same is true for a fall in voltage from BY2 down to around 5 volts. At lower voltages it will be found that the clock input is not inhibited after a count of 10, this being due to the fact that TR10 does not turn on sufficiently hard to cause changeover in the right hand NAND gate inverter. R22 is given a lower value than the other series transistor base resistors to reduce this effect but in practice the improvement this gives is of a very marginal nature only. In any event, a 9 volt battery whose voltage has fallen to a level as low as 5 volts can be considered as being well past its useful life. With new 9 volt batteries the voltage across TR10 when it is turned on is only 0.25 volt despite the fact that it is passing current for all the l.e.d.'s. This voltage rises to about 0.5 volt when BY2 has fallen to 6 volts. (It would be in order, in-

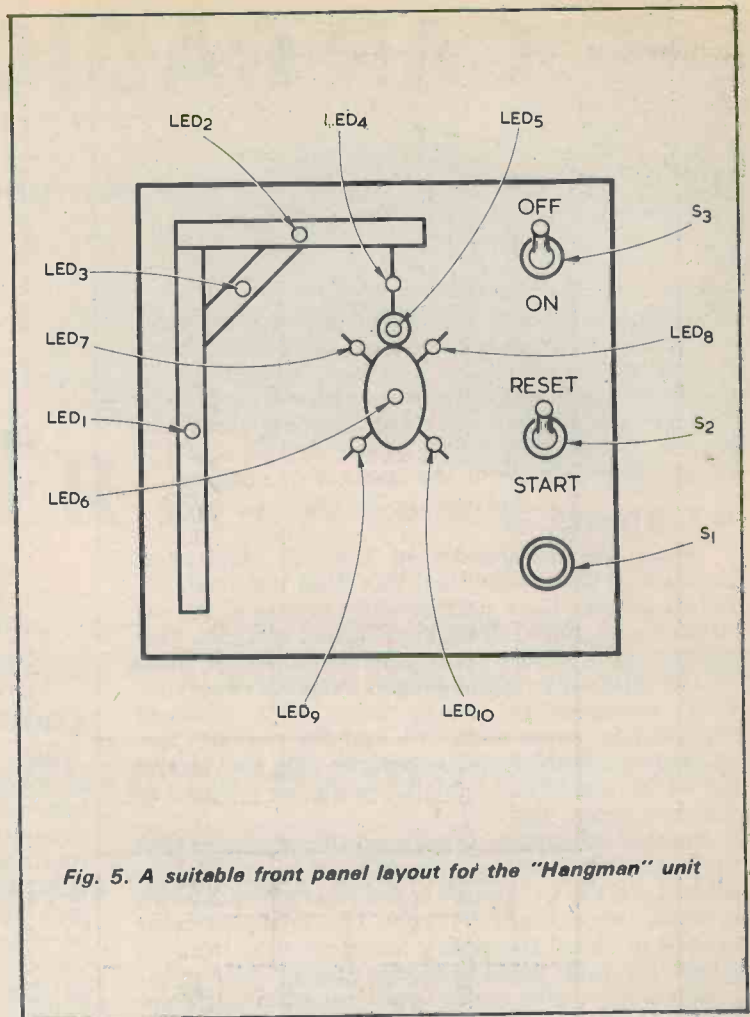

Fig. 5. A suitable front panel layout for the "Hangman" unit

identally, to apply the CD4017 decimal outputs directly to the transistor bases without series current limiting resistors, but the author feels that it is preferable to limit CMOS output currents when this can be done easily and without loss of circuit performance).

One of the CD4011 NAND gates is not used in the circuit. This has its input pins, 8 and 9, taken to the negative rail. No connection is made to its output at pin 10. Also, no connection is made to pin 12 of the CD4017.

A suitable front panel layout for the project is shown in Fig. 5. This has the "Hangman" picture drawn out on it with l.e.d.'s positioned at the various significant points. To start a game, S2 is put to "Reset" and S3, if not already closed, set to "On". The game then commences. At the first incorrect letter S2 is moved to "Start", causing LED1 to light up. Successive l.e.d.'s are then lit up in turn by pressing S1 for each further incorrect letter. If the game ends with all l.e.d.'s alight, the person putting forward the unknown word or phrase has won. The l.e.d.'s can be any small types, having whatever colour is favoured by the constructor.

# CAR RADIO TRIM

By R. D. Smith

Keep your car radio in good trim

Medium and long wave car radios differ quite considerably from the average battery operated transistor portable. For instance, since there is plenty of low voltage power available from the car battery, the a.f. output stage of a car radio can employ large transistors which deliver quite a respectable wattage to the speaker or speakers.

## R.F. STAGE

There are differences in the r.f. stage, too. Because of the mechanical vibration involved, car radios usually have permeability tuning of the oscillator and signal frequency tuned circuits, this being a more robust arrangement than is provided by the relatively fragile ganged variable capacitor. With permeability tuning there is a constant capacitance across each coil, and the resonant frequency is varied by moving an iron dust core in and out of the coil. The resonant frequency reduces as the core enters the coil.

Another advantage of permeability tuning is that the capacitance across the coil can be made low, whereupon the LC ratio, i.e. the ratio of inductance to capacitance, is always large. This is of particular benefit in signal frequency tuned circuits, because a high LC ratio tends to confer greater selectivity.

Some car radio aerial input tuned circuits are complicated, but in general they can be reduced to the very simple basic circuit shown in Fig. 1. Here, the car aerial connects via a large value d.c. blocking capacitor to a high impedance point in the tuned circuit (shown in the diagram as a tap close to the non-earthly end of the coil) by way of a length of low capacitance screened cable. A low value fixed capacitor is connected across the coil. There is also a trimmer capacitor in the receiver between the aerial input and the radio chassis. At radio frequencies the latter will be common with the metal body of the car.

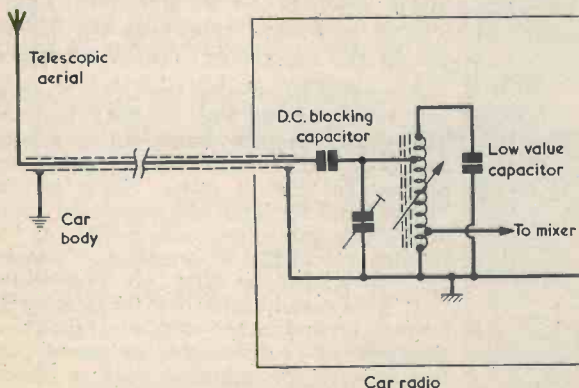

Fig. 1. Simplified version of the input tuned circuit of an a.m. car radio. The arrow through the coil indicates that it is permeability tuned.

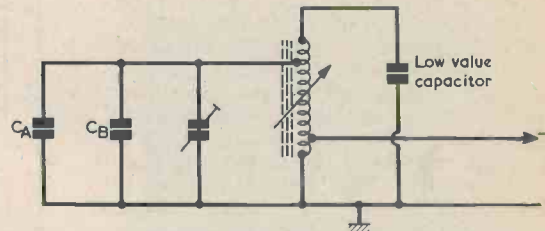

Fig. 2. Equivalent circuit in which CA is the capacitance between aerial and car-body and CB the self-capacitance of the screened cable

## EQUIVALENT CIRCUIT

Fig. 1 breaks down into the equivalent circuit given in Fig. 2, where CA is the capacitance between the aerial and the car body and CB is the capacitance between the braiding and the centre conductor of the screened cable. The ordinary telescopic car aerial gives a very low level of signal pick-up at medium and long waves, and so it must be coupled very tightly into the signal frequency tuned circuit in the radio. In practice, it is coupled so tightly that CA and CB form a significant part of the capacitance tuning the coil. The purpose of the trimmer is to ensure that the total tuning capacitance, including CA and CB, is exactly right.

In many car radios the aerial trimmer is not accurately set up, with the result that the receiver does not have the full sensitivity of which it is capable and is more likely to be subject to second channel whistles from interfering stations. A fairly useful test is to fully extend the aerial, tune in a weak station near the high frequency end of the medium wave band and, whilst standing outside the car on dry ground, touch the aerial. If signal strength goes down, the car radio input tuned circuit is probably in pretty good trim, because the added capacitance to the car metalwork of your body is detuning it. Should signal strength go up the input circuit is probably incorrectly trimmed: the added capacitance of your body is not making the trimming situation noticeably worse and you are improving signal strength by acting as an additional aerial. Unfortunately, this very simple test is not 100% reliable, but it can often give you a good idea of the state of the aerial input tuned circuit.

The aerial trimmer of a car radio should be set up when the radio is initially installed, or if the aerial or screened cable is altered. Find out from the instructions or the service manual for the radio where the aerial trimmer is situated and then adjust it as recommended by the set manufacturer. Do not attempt the adjustment without following the set-maker's advice or you may end up with a car radio having a worse performance than when you started!



# RADIO

## 4

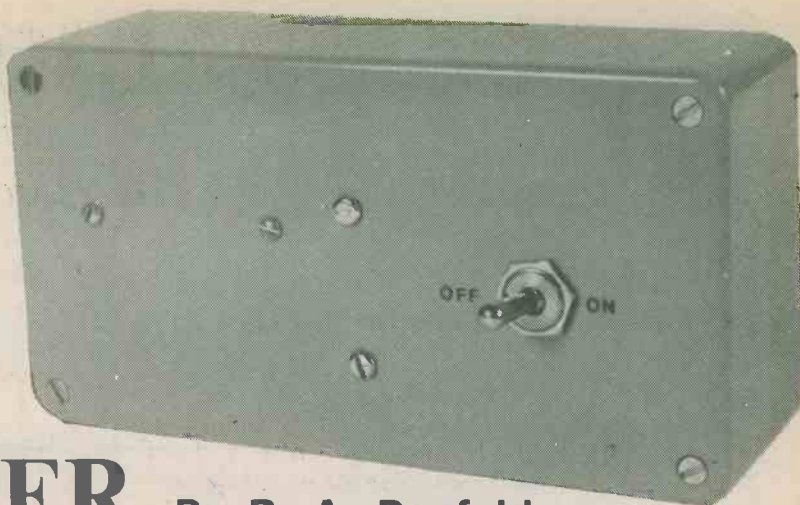

# CONVERTER

By R. A. Penfold

## *Converts 1500 metres to medium waves* *Inductive coupling - no connections* *to medium wave radio*

Many a.m. sound receivers, both home constructed and commercially manufactured, do not have a long wave band. The result, now that Radio 4 has been moved to the long wave band on 1,500 metres (200kHz), is that they cannot receive the Radio 4 signal on this channel at all.

This article describes a simple and inexpensive converter which enables a medium wave receiver to pick up the long wave transmission on 1,500 metres. The converter is self-contained, with its own internal battery and ferrite aerial. There is no need to make a direct connection between the converter and the medium wave radio as the converter radiates a local signal which is picked up inductively by the receiver on its own ferrite aerial.

### BLOCK DIAGRAM

The basic way in which the converter operates is extremely simple, and the block diagram provided in Fig. 1 shows the general arrangement. The superheterodyne principle is used to mix the 200kHz output from a ferrite aerial with a nominal 500kHz oscillator signal to produce a sum signal at

about 700kHz (200kHz plus 500kHz equals 700kHz). This 700kHz signal is fed to a tuned circuit which is resonant at this frequency, and the tuned circuit produces a local r.f. field which can be picked up by a medium wave receiver tuned to 700kHz and placed near the converter. The mixer circuit provides a certain amount of gain and so the final signal will be quite strong, provided a reasonably good coupling between the converter and the radio is obtained. The signal level from the converter is insignificant more than a few feet away from it, and there is thus no radiation which is likely to interfere with other receivers.

The heterodyning of the 200kHz input signal with the 500kHz oscillator signal also produces a difference signal at 300kHz (500kHz minus 200kHz equals 300kHz), but this will not be radiated to any significant extent by the 700kHz tuned circuit in the converter. The converter oscillator is made tunable so that the output signal can be adjusted to any convenient quiet spot on the medium wave band at a frequency in the region of 700kHz.

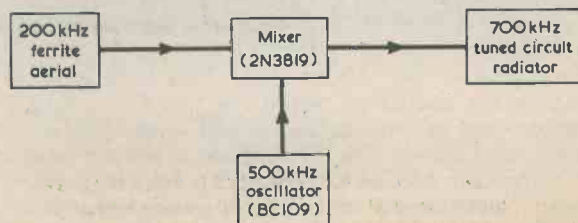
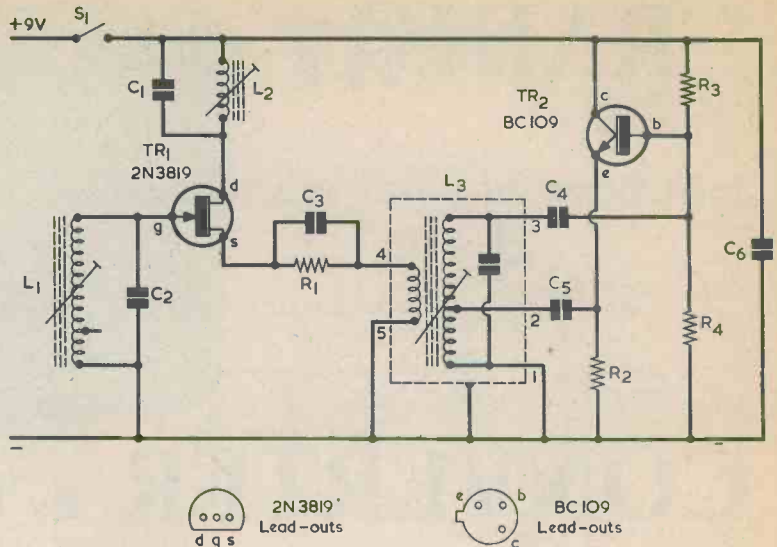

Fig. 1. Block diagrams illustrating the manner in which the converter functions. The 700kHz output signal is picked up on the ferrite aerial of a medium wave receiver

Fig. 2. The circuit of the Radio 4 converter. L1 picks up the 200kHz signal and this is heterodyned in TR1 with a 500kHz oscillator signal from L3. The resultant 700kHz sum signal is radiated by L2.



## THE CIRCUIT

The complete circuit diagram of the Radio 4 converter is shown in Fig. 2 and, as will be seen from this, the unit is based on just two transistors. TR1 is a Jufet transistor and is employed as the mixer, with L1 providing gate bias. L1 is also the tuned winding of the 200kHz ferrite aerial and is brought to resonance at this frequency by fixed capacitor C2. Tuning the circuit to precisely 200kHz is achieved by varying the inductance of L1, this being done by simply sliding the coil along the ferrite rod. The expense of a trimmer capacitor to provide tuning of the aerial circuit is thereby avoided. R1 is the source bias resistor for TR1 and C3 and its bypass capacitor, but these components are not returned direct to the negative supply line; instead they connect to the negative supply by way of the secondary winding of the oscillator transformer, L3. The oscillator signal across the secondary causes variations in the gate-to-source potential of TR1, and this in turn causes variations in the gain of this device. The oscillator signal therefore modulates the input signal and produces the required heterodyne action.

L2 and C1 are the drain load for TR1, and these form a tuned circuit which is resonant at 700kHz nominal and selects the desired output signal. L2 is actually a medium wave ferrite aerial and is tuned by the same means as L1. An r.f. choke of suitable inductance with a parallel capacitor could be used as the drain load for TR1 to provide a simple form of inductive coupling to the receiver, but in practice it gives markedly inferior results to the method finally adopted here. It is important to obtain a strong output from the unit so that any weak medium wave signals that might otherwise cause interference are completely swamped.

TR2 appears in the oscillator circuit, which is of the emitter follower Colpitts type. TR2 is biased by R3 and R4, and R2 is its emitter load resistor. An emitter follower has slightly less than unity voltage gain, and so the output from TR2 is coupled to a tap in the oscillator tuned coil via C5, whilst the upper end of the oscillator coil is coupled to the base of TR2 by C4. This gives a voltage step-up through the oscillator coil and produces sufficient positive feedback to maintain oscillation.

The unmarked capacitor across the main win-

ding of L3 is an internal fixed capacitor in the coil assembly. L3 is a 470kHz i.f. transformer, but by unscrewing its adjustable tuning core it will readily tune to frequencies of around 500kHz and even higher.

C6 is a supply decoupling capacitor and S1 is the on-off switch. The converter has a current consumption of only about 2 to 3mA, and the 9 volt battery type PP3 used to power it has a long life.

## COMPONENTS

### Resistors

(All  $\frac{1}{4}$  watt 5%)

- R1 3.3k  $\Omega$
- R2 3.3k  $\Omega$
- R3 22k  $\Omega$
- R4 22k  $\Omega$

### Capacitors

- C1 150pF ceramic plate
- C2 180pF ceramic plate
- C3 0.047 $\mu$ F ceramic plate or type C280
- C4 2,200pF ceramic plate
- C5 560pF ceramic plate
- C6 0.47 $\mu$ F type C280

### Inductors

- L1 Ferrite aerial type MW/LW5FR (Denco) with medium wave winding removed
- L2 Medium wave winding of above on ferrite rod. (see text)
- L3 I.F. transformer type IFT14/470kHz (Denco)

### Semiconductors

- TR1 2N3819
- TR2 BC109

### Switch

- S1 S.P.S.T. toggle

### Miscellaneous

- Plastic case (see text)
- 9 volt battery type PP3 (Ever Ready)
- Battery connector
- Veroboard, 0.1in. matrix
- Veroboard pins, single ended, 0.04in. diameter
- Wire, solder, etc.



## CONSTRUCTION

An inexpensive plastic case measuring approximately 150 by 80 by 50mm. is used as the housing for the prototype converter. The case must be all plastic to allow input and output signal coupling, and it must be large enough to take the components including, in particular, the two ferrite rods. The author mounted the ferrite aeriels, the on-off switch and the component panel on the lid of the case, so that no components were secured to the actual case body.

The upper part of Fig. 3 shows the general layout of the rear of the front panel, and this should be studied in conjunction with the photographs.

The 200kHz ferrite aerial, L1, is a Denco MW/LW5FR medium and long wave ferrite rod assembly with the medium wave coil removed. L1 is mounted above the component panel (as shown in Fig. 3) using a suitable mounting clip. This can be a ferrite aerial clip taken from a defunct transistor radio, an insulated cable clip of suitable diameter or a clip devised from fairly thick flexible plastic. A metal clip must not be used as it would form a shorted turn around the ferrite rod. With the author's case, the rod had to be mounted a little way in from the edge of the front panel as it was too long to fit between the two mounting pillars moulded into the case body. A lead-out wire from the long

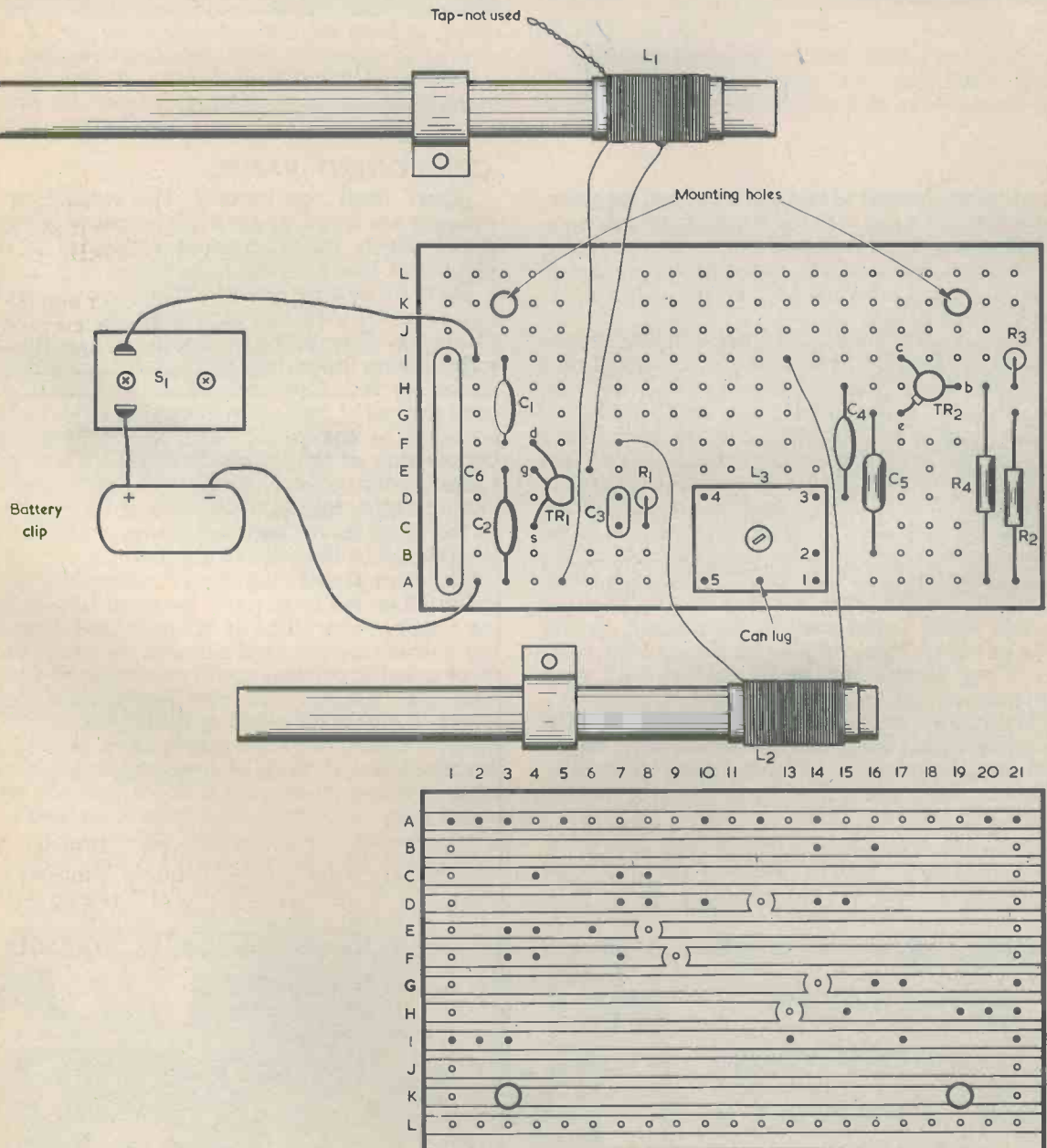
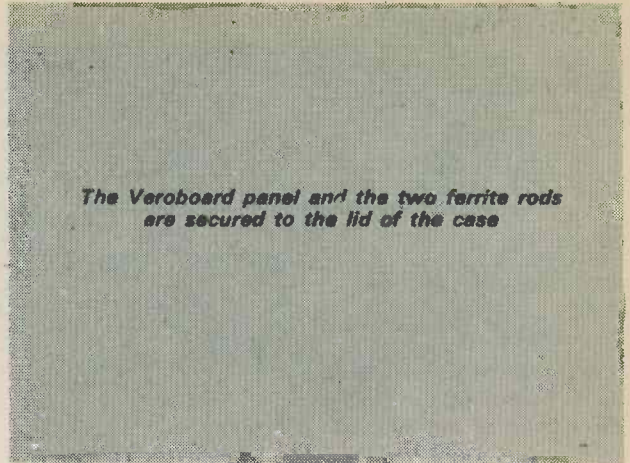
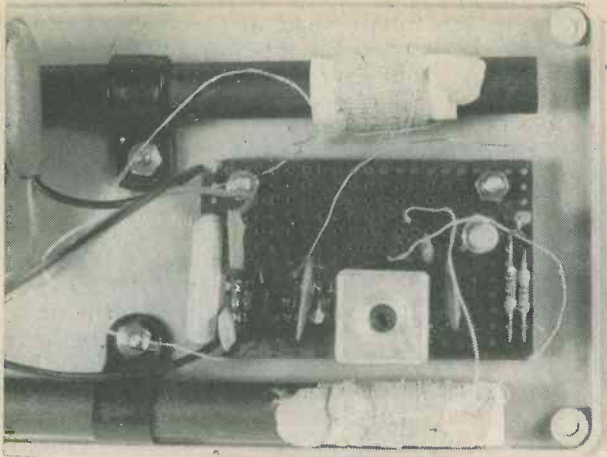

Fig. 3. Details of wiring on the component board together with the connections to L1, L2, S1 and the battery clip



*The Veroboard panel and the two ferrite rods are secured to the lid of the case*

wave winding consists of two leads twisted together. This lead-out is a tap into the winding, and no connection is made to it. It should be glued to the front panel to keep it out of the way and to prevent it coming into contact with any of the other components or wires.

L2 consists of the medium wave winding removed from the MW/LW5FR assembly mounted on a second ferrite rod. This rod should have a diameter of  $\frac{3}{8}$  in. (9.5mm.) and can have any length between 2 and 4  $\frac{1}{2}$  in. If necessary, the rod can be cut down from a longer rod, the procedure being to file a sharp V-cut around the rod at the point where it is to be broken and then rapping it lightly against the edge of the bench. L2 is mounted below the component panel (again as shown in Fig. 3) using a clip meeting the same requirements as that for L1. There is a small low impedance coupling winding on the medium wave coil which is not used in the present circuit, and its two lead-outs can also be glued to the front panel. They should not be in contact with each other.

S1 is mounted in the position shown between the two ferrite rods. This can be a standard toggle switch requiring a  $\frac{1}{2}$  in. (12.7mm.) diameter mounting hole.

### COMPONENT PANEL

Apart from the battery, the remaining components are wired up on a 0.1 in. matrix Veroboard panel which has 12 copper strips by 21 holes. Details of this are also provided in Fig. 3.

Start by cutting out a panel of the required size and then drill the two mounting holes 6BA or M3 clearance. Then make the five breaks in the copper strips before mounting the various components and soldering them into circuit. L3 will not fit direct onto the panel and so single ended solder pins are soldered to the panel, with their heads on the copper side, at the six places where L3 is to be connected to the panel. Note that one connection is to a can mounting lug. After the pins of L3 and the pins in the panel have been well tinned with solder, L3 is soldered to the pins in the panel.

The completed Veroboard assembly is then mounted on the front panel between L1 and L2 using a pair of short 6BA or M3 bolts and nuts. Spacing washers are required between the board and the front panel to prevent strain on the board when the nuts are tightened. Before finally mounting the board it should be wired up to L1, L2, S1 and the battery clip. The last connection is to solder the positive battery clip lead to the appropriate tag of S1.

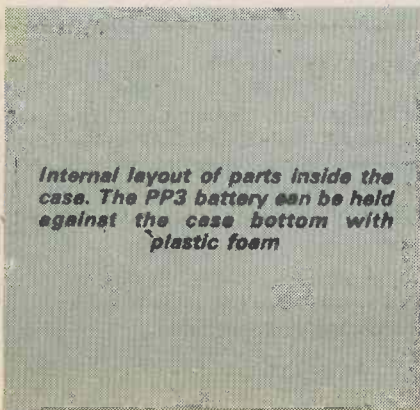

*Internal layout of parts inside the case. The PP3 battery can be held against the case bottom with plastic foam*

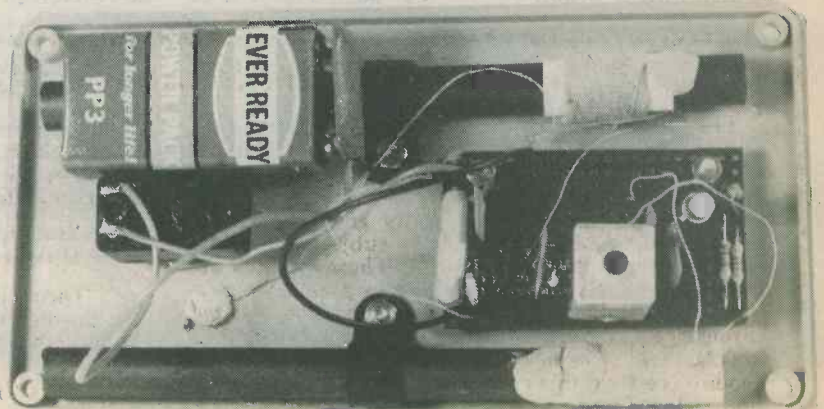



## ADJUSTMENT

Initially the core of L3 should be unscrewed somewhat, so that its upper end protrudes slightly above the top of the coil can. It is advisable to use a proper trimming tool, such as the Denco TT5, for this adjustment as a screwdriver or a similar tool can easily damage the core. L2 should only be partially pushed onto its ferrite rod, and L1 should be pushed a little way down its own rod.

When first testing the converter it is advisable to position it so that L2 is as close to the medium wave winding of the ferrite aerial of the receiver as is reasonably possible, so that there is a good signal transfer from converter to receiver. The relative orientation of the transmitting and receiving rods and coils is not too important provided that they are not at right angles to one another. The ferrite aerial, L1 of the converter has the normal directional properties of this type of aerial, of course, and maximum pick up of the 200kHz signal will occur with the rod at right angles to the direction of the transmitter.

glued to the ferrite rod at this setting. Bostik "Blue-Tak" is ideal for this purpose.

Next the converter is switched off and the receiver tuning is adjusted to search for a quiet spot on the medium wave band close to where the output from the converter was received. This should be done after dark, as what is a quiet spot during daylight hours can produce quite strong signals from distant stations once darkness has fallen. The converter is then switched on again, and the core of L3 is adjusted to bring the output of the converter onto the frequency to which the receiver is tuned. Unscrewing L3 core will raise the output frequency whilst screwing it inwards has the opposite effect.

Finally, L2 is slid along its ferrite rod to find the position which provides the best signal transfer. When this optimum setting has been found the coil is glued to the ferrite rod.

Although the author does not live in a particularly good reception area for the BBC 200kHz transmission, no difficulty was experienced in ob-

*The only panel control is the on-off switch. The converter couples inductively to the medium wave radio without any direct connections*

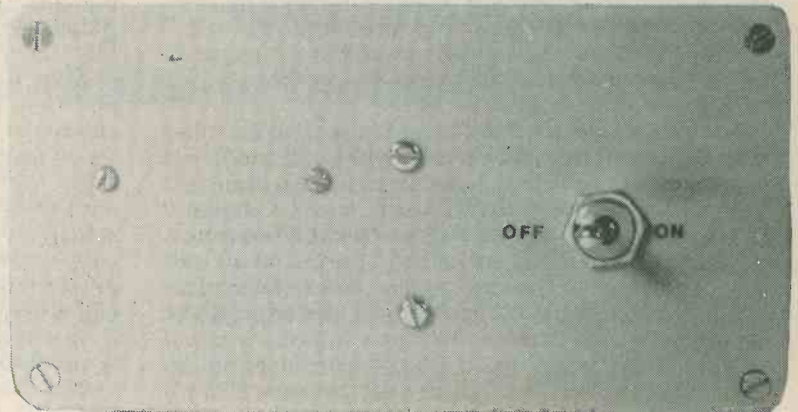

Switch on the converter and the receiver. By tuning the receiver to around 700kHz (429 metres) it should be possible to locate the 200kHz converted signal from the converter. L1 is then slid along its ferrite rod to provide the strongest possible signal. If the receiver has an a.g.c. circuit the peak setting may not be readily apparent, whereupon moving the converter away from the receiver to provide a weaker signal should overcome this problem. When the optimum position for L1 has been found it is

taining a strong output from the converter, and good results are obtained merely by placing the converter alongside the radio. It has not been found necessary to have L2 particularly close to the ferrite aerial of the receiver, and medium wave interference does not seem to be a significant problem. The author's unit even provides quite good reception of some foreign stations on the long wave band if the receiver is tuned either side of the converted 200kHz output signal! ■

## Mail Order Protection Scheme

The publishers of this magazine have given to the Director General of Fair Trading an undertaking to refund money sent by readers in response to mail order advertisements placed in this magazine by mail order traders who fail to supply goods or refund money and who have become the subject of liquidation or bankruptcy proceedings. These refunds are made voluntarily and are subject to proof that payment was made to the advertiser for goods ordered through an advertisement in this magazine. The arrangement does not apply to any failure to supply goods advertised in a catalogue or direct mail solicitation.

If a mail order trader fails, readers are advised to lodge a claim with the Advertisement Manager of this magazine within 3 months of the appearance of the advertisement.

For the purpose of this scheme mail order advertising is defined as:

"Direct response advertisements, display or postal bargains where cash has to be sent in advance of goods being delivered."

Classified and catalogue mail order advertising are excluded.



# PHAS

# A.M.

## Part 1 (2 p

### A phase locked loop is used here for a.m. detection very successfully in this practical medium wave receiver

The use of phase locked loop circuits as f.m. detectors is quite a well known technique which will be familiar to many readers. It is probably less well known that certain phase locked loop integrated circuits have the ability to demodulate a.m. signals as well as f.m. ones.

This article describes a fairly simple medium wave superhet receiver which employs the NE567 phase locked loop (p.l.l.) i.c. to provide the second i.f. amplifier and detector functions. The receiver is powered from a PP6 9 volt battery and can provide a good quality audio output of a few hundred milliwatts to an internal loudspeaker. The prototype has been constructed as a bedside or small table radio, but obviously the physical construction of the set can be altered to suit individual requirements, if desired.

The receiver was primarily designed and constructed for its interest value and will probably be of greatest attraction to those who are experimentally minded, although it is a perfectly viable alternative to more conventional designs.

#### P.L.L. DETECTOR

Most p.l.l. systems are fairly complicated pieces of electronics and the NE567 device is no exception to this. Therefore, the operation of the device will only be considered in fairly broad terms here. Fig. 1 gives details of the internal arrangement of the NE567 in block diagram form, together with basic details of the external discrete components needed to enable it to function. The device is contained in a standard 8 pin d.i.l. package and pinout details are provided in Fig. 1.

The main function of a p.l.l. circuit is to lock an internal oscillator onto the same frequency as a signal applied at the input. It also maintains the internal oscillator in phase with the input signal.

In common with virtually all p.l.l. designs, the internal oscillator of the NE567 is a C-R relaxation type and no L-C tuned circuits are used. The "centre frequency" of the internal oscillator is determined by the values of discrete resistor  $R_A$  and discrete capacitor  $C_A$ , and this is the frequency at which the oscillator runs in the absence of an input signal.

The internal oscillators of p.l.l. devices are usually voltage controlled and can be modulated slightly either side of the centre frequency by the application of a control voltage. The oscillator of the NE567 is a little unusual in that it is a current rather than a voltage controlled oscillator, but this does not alter the basic operating method.

The control input of the oscillator is fed from the output of an internal amplifier, which in turn has its input fed from the output of a phase detector (or

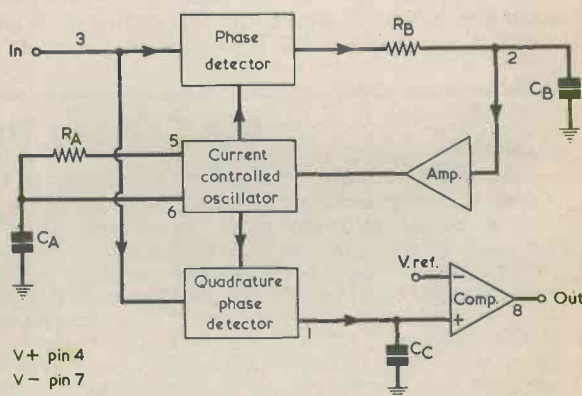

Fig. 1. Block diagram illustrating the functioning of the NE567 integrated circuit



# SE LOCKED RECEIVER

parts) By M. V. Hastings

phase comparator, as it is sometimes alternatively termed). The phase detector compares the phase and frequency of the input signal and the output from the internal oscillator.

If the output from the internal oscillator lags behind the input signal in frequency, or even just slightly in phase, the output from the phase detector swings positive. This signal is amplified and fed to the control terminal of the oscillator, where it has the effect of increasing the oscillator frequency so as to bring it not only to the same frequency as the input signal but also to produce an identical phase relationship.

If, on the other hand, the internal oscillator signal is ahead of the input signal in phase or frequency, the output of the phase detector goes negative. An amplified signal is applied to the control terminal of the oscillator, reducing its frequency and once again causing it to have the same frequency and to be in phase with the input signal.

Thus, when the input signal is within what is termed the "capture range" of the p.l.l., the internal oscillator becomes locked onto the input signal and will remain so provided that the input signal

does not stray outside the capture range or vary in frequency at a rate which is too fast for the p.l.l. to keep track with. The highest rate of frequency change which a p.l.l. can handle is known as the "maximum tracking rate", and is largely determined by a low pass filter connected between the phase detector output and the control input of the oscillator. In Fig. 1 the filter is formed by RB and CB. The filter is necessary because the output from the phase detector is actually a series of pulses, and these must be integrated to produce a d.c. control voltage.

When a p.l.l. is used as an f.m. demodulator it is the output from the low pass filter which constitutes the audio output, since this voltage rises and falls with changes in input frequency. P.L.L. devices usually make excellent f.m. detectors as they are normally designed to have good linearity between input frequency and output voltage. They also have high immunity to input noise.

As a.m. detectors p.l.l.'s have little advantage over more conventional types of circuit. However, they can provide lower distortion than an ordinary diode detector and they certainly make a very in-

*Modular design considerably eases construction of the receiver. A PP3 battery appears in this photograph, but the larger PP6 battery is recommended for normal usage*

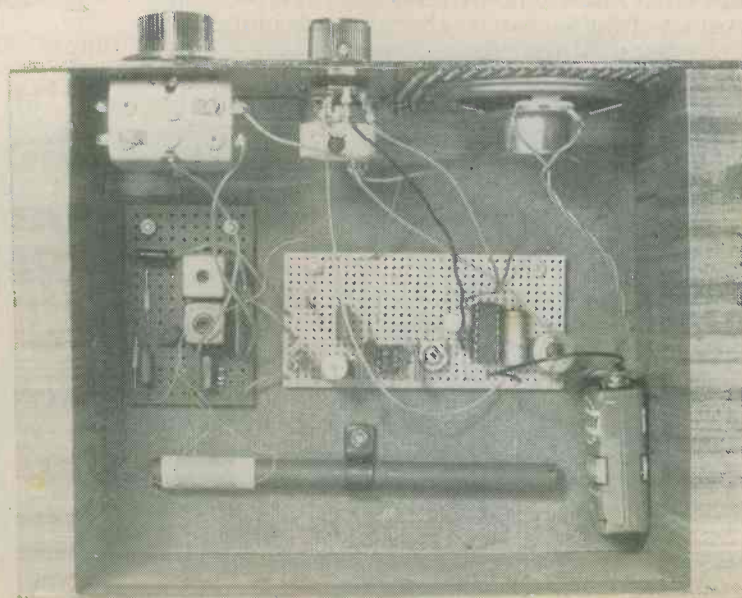



teresting alternative form of approach for the electronics experimenter.

A basic p.l.l. circuit is not suitable for a.m. detection and requires some additional circuitry. The necessary circuitry is included in the NE567 and consists of a quadrature phase detector which provides what is known as synchronous a.m. detection. Looking at this in a somewhat oversimplified manner, the output of the oscillator is used to operate a switching circuit which opens with half-cycles of one polarity and closes for half-cycles of the opposite polarity. In this way the input signal is rectified. Filter capacitor CC removes the r.f. signal content on the output, thereby giving the required a.f. signal in more or less conventional manner.

The comparator which is incorporated in the device and which has its non-inverting input fed from the demodulated a.m. signal plays no part in the present application. It is only used when the NE567 is employed as a tone detector, which is what the device is primarily designed for. In the decoder application the open collector output transistor of the comparator is turned on when the p.l.l. circuitry is locked onto an input signal. In the a.m. detector circuit no connection is made to the comparator output at pin 8.

## THE CIRCUIT

The complete circuit of the receiver is shown in Fig. 2. TR1 is used in a conventional mixer-oscillator stage. L2 is the oscillator coil and the tuned winding of this is tuned over the appropriate frequency range by VC2. C4 is a padder capacitor. The tuned winding of the ferrite aerial, L1, is tunable over the medium wave band by means of VC1. The latter is ganged with VC2, and the alignment trimmers, TC1 and TC2, are part of the tuning capacitor. The signal picked up by the ferrite aerial is coupled into the mixer input via the low impedance coupling winding of L1 and d.c. blocking capacitor C2. The 470kHz i.f. output is selected by IFT1 and fed to the i.f. amplifier stage.

An untuned i.f. amplifier is used, and this provides more than ample gain. It incorporates TR2, connected as a straightforward common emitter amplifier of the type commonly encountered in audio applications. There is very little selectivity before the detector since there are only

two tuned circuits to provide this selectivity (L1 and VC1, and the primary circuit of IFT1) but a p.l.l. a.m. detector seems to work well under these conditions. Indeed, a high degree of selectivity only makes tuning more critical, and provides no beneficial effect.

IC2 is the NE567 p.l.l. detector, and reference to Fig. 1 will show the functions of the discrete components associated with it. R7 enables the current controlled oscillator centre frequency to be tuned to the intermediate frequency of 470kHz. The oscillator centre frequency, in Hz, is approximately equal to 1 divided by CR, where C is the tuning capacitance in microfarads and R is the tuning resistance in megohms. The NE567 will work well at frequencies up to 500kHz, and so is suitable for use at 470kHz.

The operating frequency of the p.l.l. is affected significantly by variations in supply voltage, and so it must be fed from a stabilized supply rail to obtain satisfactory results. It must also be fed from an extremely well decoupled supply as the overall stability of the circuit will otherwise be very poor. The detector and i.f. amplifier stages are therefore powered from the main 9 volt supply by way of a small 5 volt monolithic regulator, IC1. The result is excellent p.l.l. frequency and overall stability.

The output from the detector is fed to volume control VR1 and thence to the inverting input of an LM 380 audio output stage, IC3. No d.c. blocking capacitor is needed between the input of the LM380 and VR1, but the r.f. filter capacitor C13 is needed to preserve stability. For the same reason the non-inverting input of IC3 is connected direct to the negative supply rail. C14 is a supply decoupling capacitor for the internal input stage of IC3.

S1 is the on-off switch and is ganged with VR1. The quiescent current consumption of the receiver is about 15mA, but as the LM380 has a Class B output stage this naturally rises considerably at high output volume levels.

## SPEAKER

Ideally a speaker having an impedance of about 16 to 25  $\Omega$  should be used, and the unit will then have a maximum r.m.s. output power of about 300mW. Unfortunately, speakers of around this impedance are sometimes difficult to obtain. An

*A closer look at the Veroboard panel on which most of the receiver components are mounted*

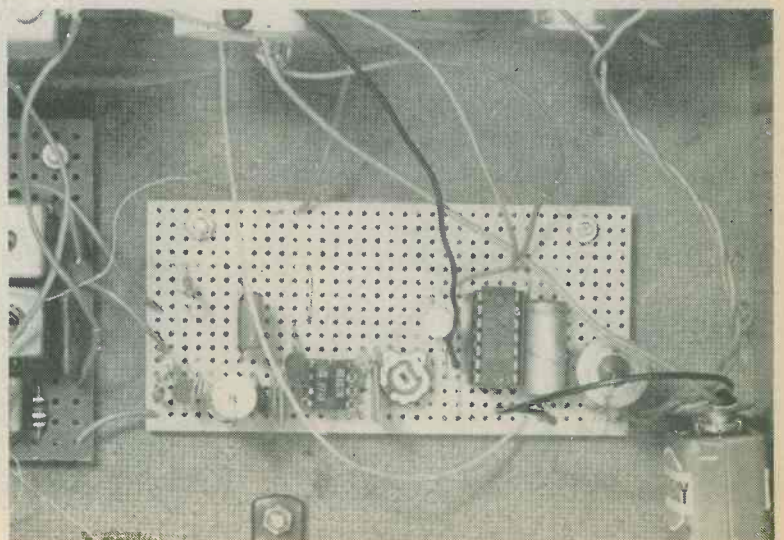



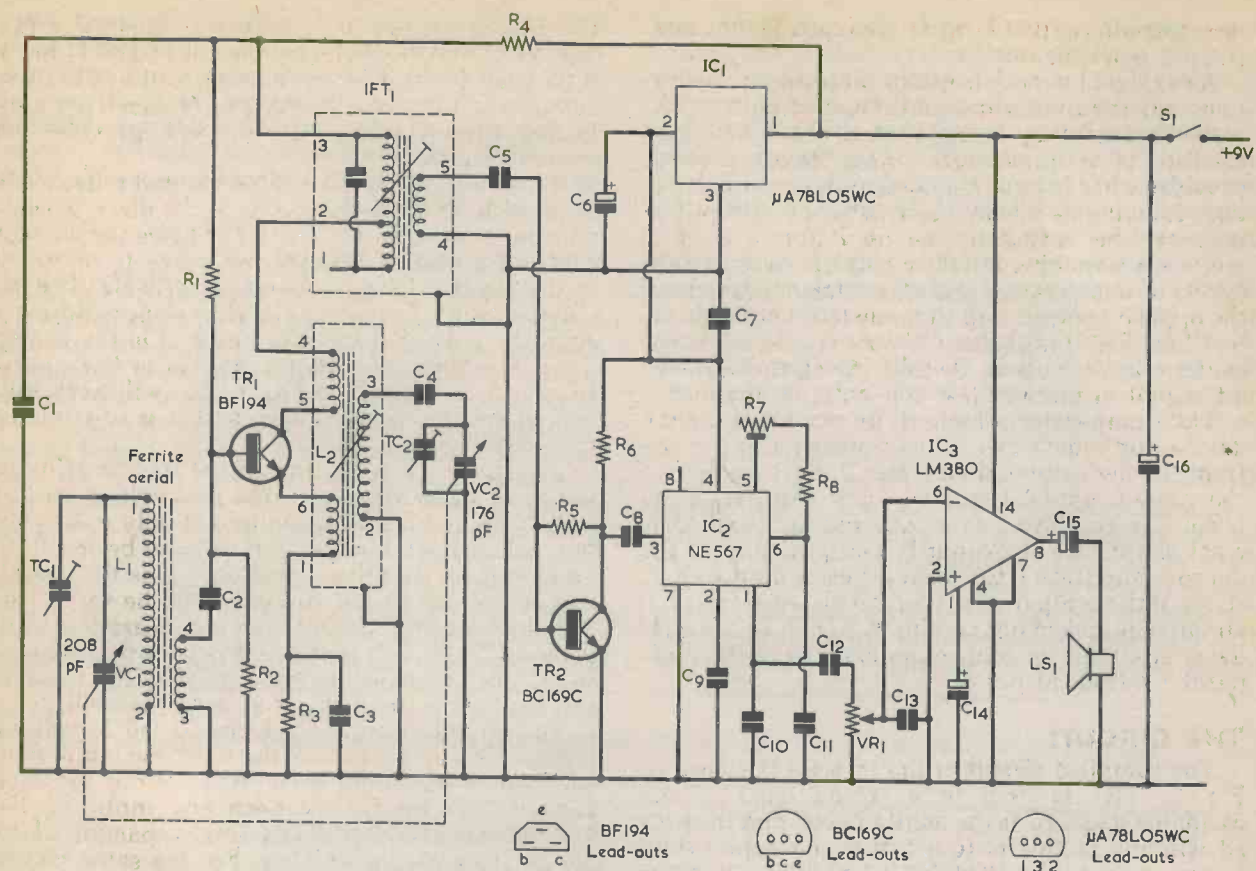

Fig. 2. The circuit of the phased lock loop a.m. medium wave receiver

### Resistors

(All fixed values  $\frac{1}{4}$  watt 5%)

- R1 18k  $\Omega$
- R2 15k  $\Omega$
- R3 3.9k  $\Omega$
- R4 33k  $\Omega$
- R5 1.8M  $\Omega$
- R6 2.2k  $\Omega$
- R7 2.2k  $\Omega$  pre-set potentiometer, 0.1 watt, horizontal
- R8 2.7k  $\Omega$
- VR1 10k  $\Omega$  potentiometer, log, with switch S1

### Capacitors

- C1 0.1  $\mu$ F type C280 (Mullard)
- C2 0.01  $\mu$ F type C280 (Mullard)
- C3 0.01  $\mu$ F type C280 (Mullard)
- C4 180pF silvered mica or ceramic plate
- C5 0.01  $\mu$ F ceramic plate
- C6 100  $\mu$ F electrolytic, 10 v. Wkg.
- C7 0.01  $\mu$ F ceramic plate
- C8 2,200pF ceramic plate
- C9 4,700pF ceramic plate
- C10 0.022  $\mu$ F ceramic plate
- C11 470pF ceramic plate
- C12 0.1  $\mu$ F type C280 (Mullard)
- C13 4,700pF ceramic plate
- C14 10  $\mu$ F electrolytic, 10 V. Wkg.
- C15 330  $\mu$ F electrolytic, 10 V. Wkg.
- C16 220  $\mu$ F electrolytic, 10 V. Wkg.
- VC1,2 208 + 176 pF 2-gang variable with trimmers, type "00" (Jackson)

### COMPONENTS

#### Inductors

- L1 Ferrite aerial type MW/5FR (Denco)
- L2 Oscillator coil type TOC1 (Denco)
- IFT1 I.F. transformer type IFT13/470kHz (Denco)

#### Semiconductors

- IC1  $\mu$ A78LO5WC
- IC2 NE567
- IC3 LM380
- TR1 BF194
- TR2 BC169C

#### Switch

- S1 s.p.s.t. toggle, part of VR1

#### Speaker

- LS1 2 $\frac{1}{2}$  to 3in. diameter speaker (see text)

#### Miscellaneous

- Veroboard, 0.1 in. matrix
- Perforatd board, 0.15 in. matrix
- 9-volt battery type PP6
- Battery connector
- 2 control knobs
- Materials for case (see text)
- 14-way i.c. holder
- 8-way i.c. holder
- Wire, bolts, nuts, etc.





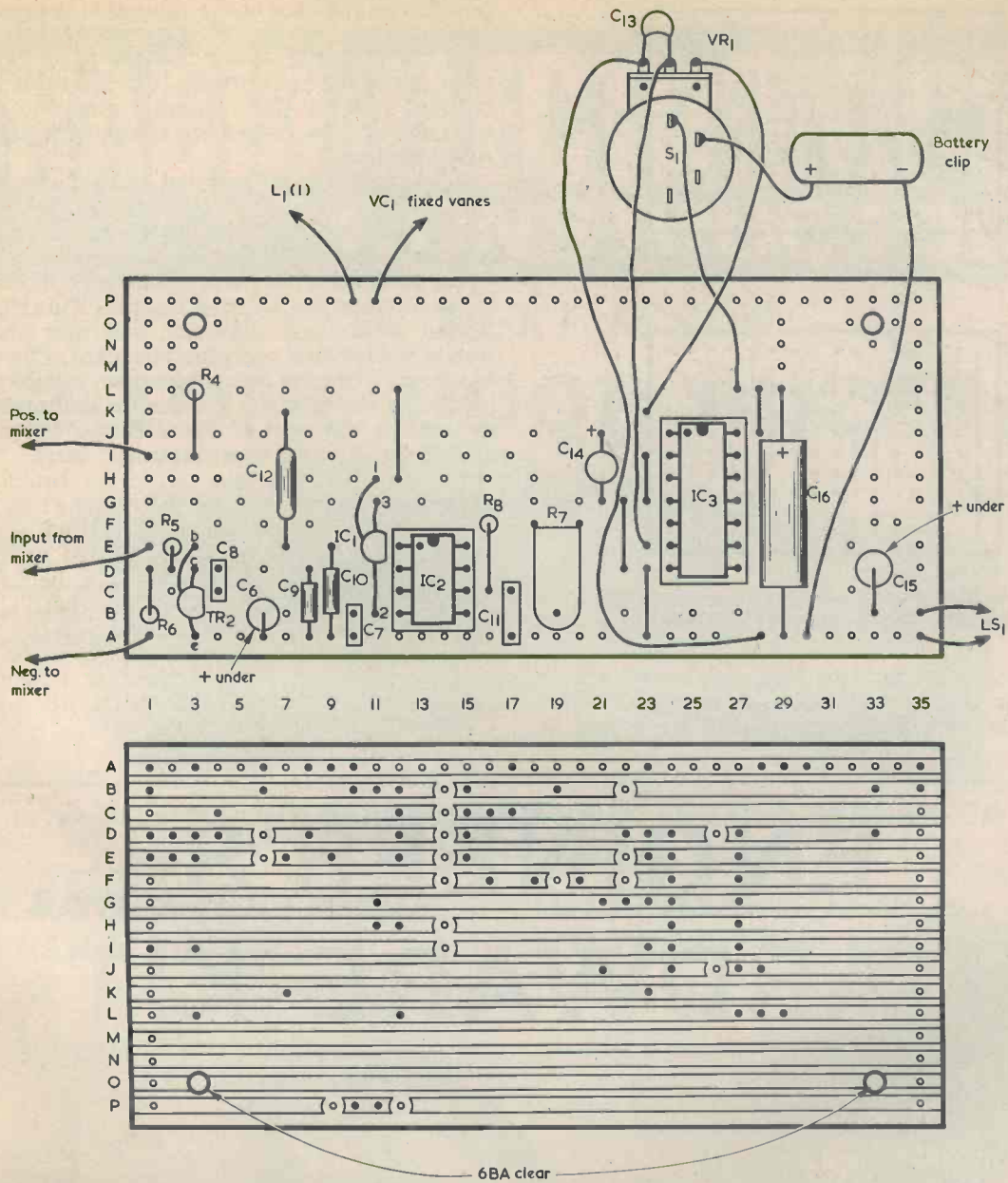
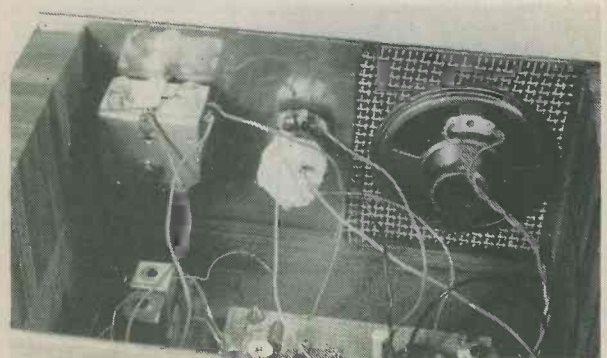

Fig. 4. The untuned i.f. amplifier, phase locked loop detector and a.f. amplifier stages are assembled on a Veroboard panel of 0.1 in. matrix

drill to enable L2 and IFT1 to be fitted in place. Note that some of the negative rail circuit is carried by way of the can mounting lugs. It should perhaps be explained that TR1 does not have the usual lead-out wires, but has pins which can be passed through the holes in the board.

The method of construction used by the author was to first complete both panels in the normal way, next wire them together and then wire the ferrite aerial to the mixer panel. It may be a little difficult to identify the individual lead-out wires from the ferrite aerial, but a visual inspection and the aid of a continuity tester should clear up any problems here. The phasing of the low impedance coupling winding is unimportant.

Next, the component panels are wired up to the components mounted on the front panel. C13 is not



Rear view showing the wiring to the components on the front panel

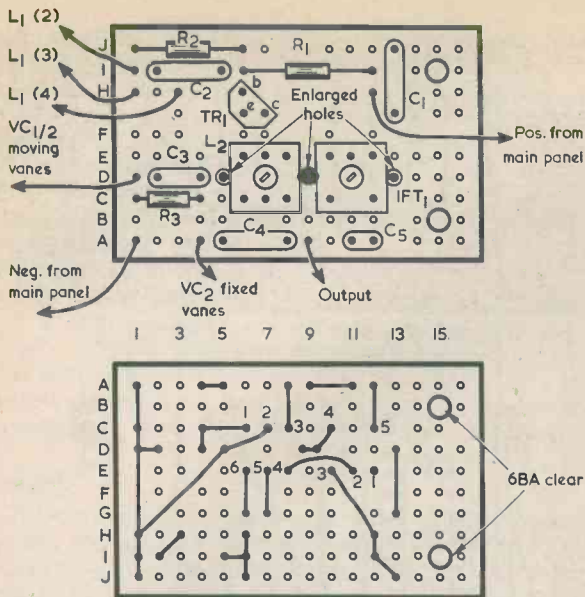

Fig. 5. A plain perforated board accommodates the components in the mixer stage

mounted on the detector and a.f. board but is soldered in place on the appropriate tags of VR1. Finally, the two component panels are bolted in

position on the base of the cabinet to the rear of the speaker and controls, spacing washers being fitted over the mounting bolts to hold the panel undersides clear of the cabinet bottom. It is advisable to mark out and drill the 6BA clearance mounting holes in the cabinet base before the component panels are wired together.

The ferrite rod is mounted on the bottom of the case behind the component panels, and then the aerial coil is fitted onto one end of it. In the prototype the ferrite rod was mounted using a clip obtained from an old transistor radio, but a small block of wood can be used instead. This should be drilled with a  $\frac{3}{8}$  in. diameter hole into which the ferrite rod is fitted and glued in place. The wooden block can then be either glued or screwed to the bottom of the cabinet. The ferrite rod must not be secured by any sort of metal clamp which would act effectively as a short-circuited turn.

### NEXT MONTH

In next month's concluding article, details of receiver alignment will be given. At the present stage, the only relevant comment to be given here is that the cores of L2 and IFT1 must not be touched, and that they should be left at the factory settings they have when purchased.

(To be concluded)

# ENGINEER'S HARDWARE KIT

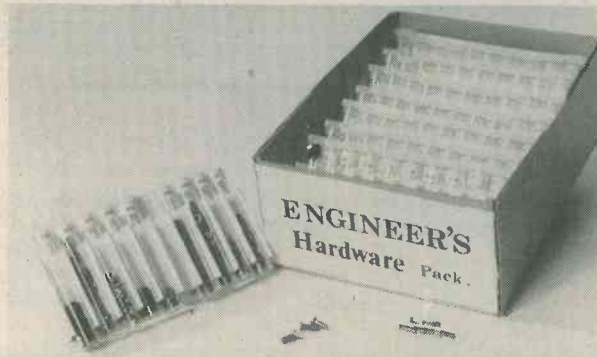

There are more than one and a half thousand items in the mouth-watering Engineer's Hardware Kit now made available by Home Radio (Components) Ltd. at £21 plus lower rate VAT and postage. Listed under Cat. No. Z304, the kit comprises virtually all the nuts, bolts, washers and solder tags that the constructor and electronics engineer is likely to require during normal work.

Screws and nuts of different lengths in all the standard BA sizes down to 8BA are provided, including a substantial proportion of nylon screws and nuts. Also to be found are millimetre screws and nuts from 2.5 to 5mm. These are augmented by a good selection of single and double ended solder tags, brass washers, shakeproof washers and

nylon washers. An imaginative addition is a range of steel grub screws from 0BA to 6BA, together with self-tapping screws from 2BA to 8BA.

All the items are contained in some 80 transparent tubes which allow the contents to be seen at a glance. The tubes have colour coded tops for identification, and a number of order forms and pre-paid envelopes are provided to enable the kit to be replenished from time to time as its contents become used up. Any constructor who has wasted his time in the past digging around for nuts and screws in odd tins will find his fingers itching to tackle his next project when backed up by the contents of the Engineer's Hardware Kit.



# RADIO & ELECTRONICS CONSTRUCTOR

IN OUR NEXT ISSUE —

## 2-TONE DOOR BUZZER

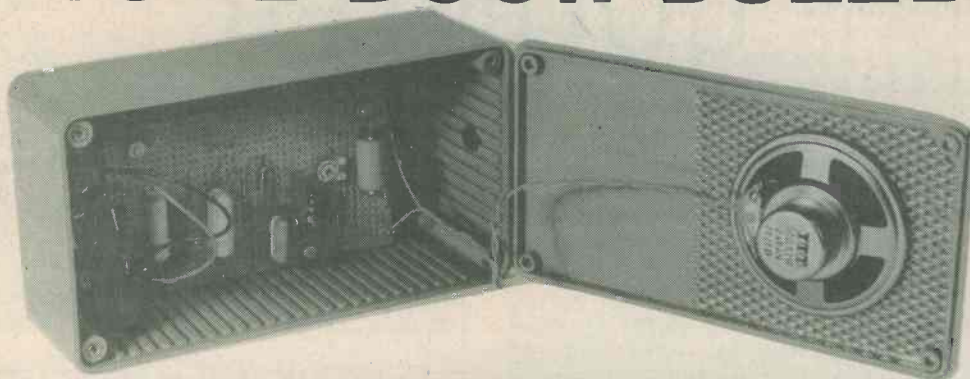

A DISTINCTIVE REPLACEMENT FOR THE OLD FASHIONED  
DOOR-BELL

### 3 BAND SHORT WAVE PRESELECTOR



A simple short wave preselector which will substantially improve the performance of most short wave receivers.

Single f.e.t. design covering 1.6 to 30MHz increases receiver sensitivity and reduces image interference.

### ULTRASENSITIVE ULTRASONIC REMOTE CONTROL



A FAIRLY SIMPLE ULTRASONIC  
REMOTE CONTROL SYSTEM  
WHICH IS EXTREMELY  
SENSITIVE.

## TUNE-IN TO PROGRAMS

### NEW EXCLUSIVE SERIES

Get to grips with programming the easy way.  
This 9 part series will guide you through programming using nothing more complicated than a readily available programmable calculator.

*SURE-FIRE CMOS LATCHES  
Suggested Circuit*

*FINDING A VIDEO OUTPUT FAULT  
In Your Workshop*

## MANY OTHER ARTICLES

ON SALE 4th JANUARY

Avoid disappointment. ORDER NOW

# SCALE-OF-TWO COUNTER

**Binary counter with steering diodes and l.e.d. monitors.**

The simple one-stage bistable is a popular circuit for a single S-Dec layout, and is a useful introduction to bistables and flip-flops generally. The simple circuit suffers from two problems, however. One is that the count is only to binary 1, which does not teach the user very much binary arithmetic, and the other is that simple on-off switches, when

used to provide the input pulse, do not give a reliable trigger pulse because of contact bounce.

### CONTACT BOUNCE

Contact bounce is a problem that afflicts all mechanical switch contacts whether hand

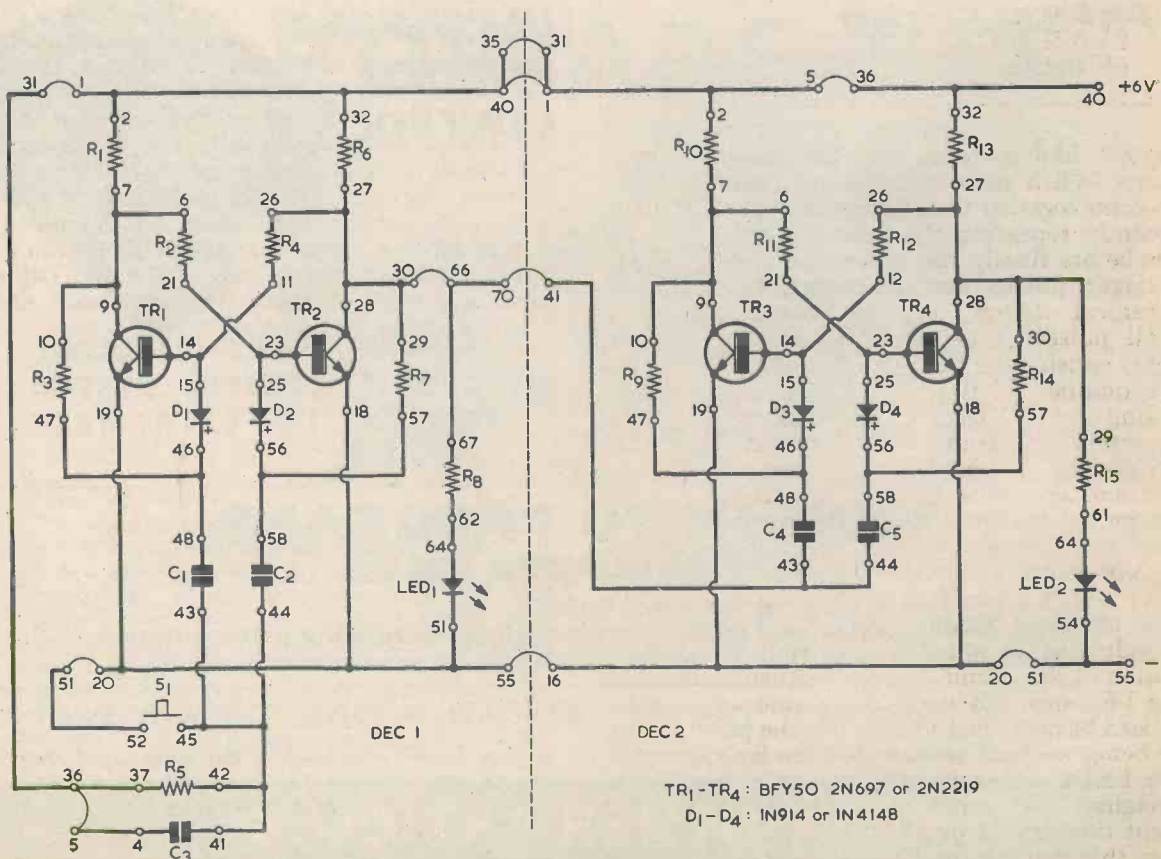

Fig. 1. The circuit of the scale-of-two counter. The numbers in the circuit indicate S-DeC connection points



## COMPONENTS

### Resistors

(All  $\frac{1}{4}$  watt 5%)

R1 1.8k $\Omega$   
 R2 22k $\Omega$   
 R3 150k $\Omega$   
 R4 22k $\Omega$   
 R5 56k $\Omega$   
 R6 1.8k $\Omega$   
 R7 150k $\Omega$   
 R8 1K $\Omega$   
 R9 150k $\Omega$   
 R10 1.8k $\Omega$   
 R11 22k $\Omega$   
 R12 22k $\Omega$   
 R13 1.8k $\Omega$   
 R14 150k $\Omega$   
 R15 1k $\Omega$

### Capacitors

C1 0.001 $\mu$ F polyester or mylar  
 C2 0.001 $\mu$ F polyester or mylar  
 C3 0.1 $\mu$ F polyester  
 C4 0.001 $\mu$ F polyester or mylar  
 C5 0.001 $\mu$ F polyester or mylar

### Semiconductors

TR1-TR4 BFY50 or 2N697 or 2N2219  
 D1-D4 1N914 or 1N4148  
 LED1, LED2 light-emitting diodes

### Switch

S1 push-button, press to make

### Miscellaneous

2-off S-DeC  
 6V battery

operated, like switches, or otherwise, like thermostats. When such switches are closed the contacts come together then briefly bounce open again, frequently repeating the bouncing action several times before finally remaining continually closed. If trigger pulses are generated by closing a mechanical switch, contact bounce can allow several pulses to be produced at each closure, thereby causing the triggered circuit to operate the same number of times, once for each bounce. Working on two S-Decs gives us enough room to incorporate a simple anti-bounce circuit that makes the triggering of a bistable much more reliable than it would otherwise be. Despite the name it's not the bouncing of the contacts that is stopped but the multiple trigger pulses that the bouncing would normally cause.

TR1 and TR2 in Fig. 1 form the first of two almost identical bistables. As either transistor can be conducting at switch-on, we shall imagine the situation in the circuit as each transistor conducts. Since TR3 and TR4 work in the same way, the action need be described only for the one pair. For the time being we shall assume that the light-emitting diode, LED1, and resistor R8 are not in the circuit.

Imagine TR1 conducting. In this state, the current through R1 produces a large voltage drop across this resistor, so that point 9 of DeC 1 is almost at earth potential (assumed to be the potential of the negative supply rail).

Because of the low voltage, no current flows through R2 into the base of TR2, which is cut off. Current through R6 flows through R4 into the base of TR1, keeping TR1 switched on. To reverse this stable state we need either a negative pulse at the base of TR1 or a positive pulse at the base of TR2.

The pulsing circuit is composed of S1, R5 and C3. With S1 open, the connection of R5 to the positive supply ensures that point 45 of DeC 1 is at 6 volts positive. Closing S1 will make the voltage at point 45 equal to zero, so generating a negative-going pulse of 6 volts amplitude, and will also charge C3 very rapidly. If the switch points open momentarily the charge in C3 cannot change rapidly enough, due to discharge through R5, for the voltage at point 45 to alter to any significant effect. The time constant of C3 and R5 is 5.6 milliseconds whereas the overall bounce time period of the switch is probably only about 1 millisecond, so that only one large negative pulse is produced when the switch is closed.

The negative pulse that is generated each time S1 is closed will be present at points 43 and 44 of DeC 1, and it is passed through capacitors C1 and C2 to points 48 and 58 respectively. We must take the trigger pulse to both transistor bases, as we must be able to change either of them over in turn. If we simply applied the pulse directly to both bases, however, the bistable would not change over, or would change irregularly, since the action would be the same at both bases. Steering diodes D1 and D2 are incorporated into the circuit to ensure that each pulse is correctly routed.

Now remember that we imagined TR1 conducting and TR2 shut off, so that the bistable could be changed over by a negative pulse on the base of TR1. The base of TR1 will be about 0.6 volt positive of earth, the voltage of a conducting silicon junction, so that the anode of D1 at point 15 will be at the same voltage. The cathode of D1 at point 46 will be at about 0.2 volt positive of earth because this will be, roughly, the voltage at the collector of the turned on TR1, and point 46 connects to this collector through R3. The potentials across D1 cause it to be forward biased but by not quite enough for it to pass current; a silicon diode requires a forward bias of about 0.5 volt before it starts to conduct. A negative pulse at point 46 will, however, cause D1 to conduct easily.

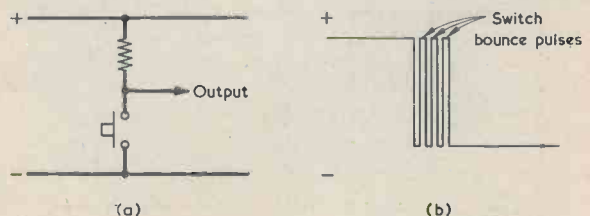

Fig. 2(a). What may, at first sight, seem to be a satisfactory method of obtaining a negative-going pulse edge

(b). In practice, switch contact bounce causes the appearance of several further pulses (shown in exaggerated form) after the initial pulse at contact closure

Now look at D2. TR2 is cut off, so that its base voltage is low, probably around 0.2 volt positive of earth because it is coupled to the collector of TR1 through R2. The collector of TR2 will be at a high voltage which (assuming that R8 and LED1 are omitted) will be close to the 6 volt positive supply rail. R7 will then cause D2 to be reverse biased by nearly the full supply voltage, so that it will need a negative pulse of rather more than 6 volts at its cathode if it is to conduct.

When S1 is closed, then, the negative pulse at points 48 and 58 affects only the base of TR1, because the pulse cannot pass through D2. The bistable then changes over. TR1 cuts off, so that its collector voltage rises, causing current to flow through R2 into the base of TR2. The collector voltage of TR2, in turn, falls so that no current flows through R4 into the base of TR1. This is the second stable state of the bistable and it consists of TR2 conducting and TR1 turned off.

With the transistor voltages reversed, the voltages on the diodes are also reversed, so that it is D2 which is now slightly forward biased and D1 which is highly reverse biased. As a result, the next negative pulse given by closing S1 passes easily through D2 but not through D1, and it will cut off TR2 and cause the bistable to switch back to its original state. Two successive pulses from the switch are needed to make the bistable return to its original setting so that the output from one collector of the bistable forms one complete pulse. Hence the alternative name of "scale-of-two".

## LIGHT-EMITTING DIODE

To monitor the state of the bistable we now introduce LED1 and R8. This light-emitting diode lights up when TR2 is off, as current then flows to it through R6 and R8. When the bistable is used for counting in the scale of two, LED1 extinguished indicates a count of 0, and LED1 alight indicates a count of 1. The presence of LED1 and R8 modifies circuit operation from the "ideal" condition assumed up to now when we said that, in the off state, the collector of TR2 rises nearly to the voltage of the positive rail. What happens now is that TR2 collector rises to a relatively high voltage, dictated by the values of R6, R8 and the forward voltage drop in LED1, which is lower than the positive rail. In practice, this circumstance does not alter the functioning of the bistable. Although it reduces the reverse voltage across D2 when TR2 is off, the voltages across the two steering diodes are still different enough for D1 to turn off TR1 at the next negative pulse from S1.

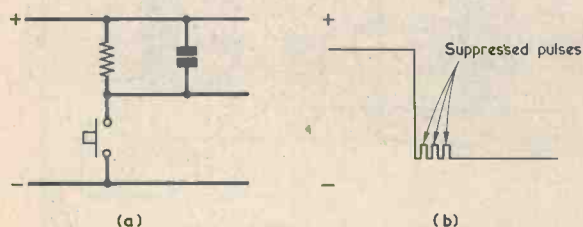

Fig. 3(a). Here, as in the scale-of-two counter, a capacitor is added across the resistor

(b). The capacitor suppresses the contact bounce pulses, limiting them to a low amplitude



Fig. 4(a). Some light-emitting diodes, such as the TIL209, identify the cathode lead-out by a flat on the l.e.d. case

(b). Lead-out identification for the transistors specified for the scale-of-two counter. The lead-outs point towards you

We make use of the second DeC to build another stage of the counter. TR3 and TR4 have exactly the same action as TR1 and TR2, though the triggering is simplified by the fact that there is no need for circuitry to suppress switch bounce, since the trigger pulse comes from TR2 rather than from a switch. Note the use of a wire link between points 70 of DeC 1 and 41 of DeC 2 to carry the trigger pulse to C4 and C5.

Each time TR2 switches on its collector voltage drops abruptly, so that a negative trigger pulse is delivered to diodes D3 and D4, only one of which conducts the pulse through to a transistor base. The second bistable will therefore be switched over each time TR2 conducts, which is on each second switch contact closure. When TR4 collector voltage is high, LED2 indicates. This time the lit l.e.d. indicates a count of 2. When the l.e.d. is off the count is 0.

We should now be able to go through a complete counting sequence. If we press the switch repeatedly until both l.e.d.'s are out, we have reset the counter to a count of 0. The first switch operation will then cause LED1 to glow, a count of 1. The second operation of the switch will extinguish LED1 and light LED2, so that the count is 2. The third pressing of the switch will light LED1 again, so that the count is 1+2=3. The fourth operation of the switch will reset the counter to 0, with both the l.e.d.'s extinguished again.

## S-DEC CONSTRUCTION

Start by clipping the S-DeCs together at their ends to form one long DeC. Now plug in the ten wire links, not forgetting the link between points 70 of DeC 1 and 41 of DeC 2 which is needed to carry the trigger pulse. A front panel can be used to carry the l.e.d.'s and the push-button switch if desired, or the l.e.d.'s can be plugged directly into the circuit and the switch operated remotely. Whichever method is used, connect these components into place next.

Now plug in the four transistors and four diodes. Note the correct connections in each case, particularly for the diodes. The capacitors can be plugged in next; all are non-polarised so that they can be connected either way round. Finally, the resistors are added to complete the circuit.

It should be noted that some of the link connection point numbers are positioned in Fig.1 away from the other circuit point numbers in the S-DeC strip with which they are common. This is done merely to ease circuit presentation. ■



# 9-VOLT ELIMINATOR SPEAKER UNIT

## Part 1 (2 parts)

By R. A. Penfold

### STABILIZED 9 VOLT OUTPUT

Although this unit was primarily designed and built for use with the "3 Band Short Wave Superhet" described in the last four issues it may also be employed with other short wave receivers requiring a 9-volt supply and an external speaker. Several have been described in earlier issues.

This power supply contains a stabilized circuit offering 9 volts output at currents up to 100mA. Current limiting is incorporated, and this prevents the output current rising more than marginally above the 100mA figure. Also fitted in the same case is a 5 by 3in.  $8\Omega$  speaker.

It should be explained that there are two important advantages given by using a separate power supply and speaker unit which is not integral with the short wave receiver. The first is the considerable reduction of possible hum links with the receiver circuitry. Such links are possible by way of stray capacitive coupling between the mains transformer wiring and the input wiring of the receiver audio stages, and it is even possible to have inductive coupling between the mains transformer and the receiver r.f. coils. All these problems are overcome by using an external supply. When the receiver is completely screened by its own all-metal case, as is the "3 Band Short wave Superhet", there is complete isolation between the receiver and the supply unit so far as hum pick-up is concerned. Indeed, no hum whatsoever can be heard on the output of the superhet when it is used with this power supply.

The second advantage is that the speaker is also isolated from the receiver. If the speaker is housed in the same case as the receiver it can couple mechanically to the receiver oscillator wiring and, in particular, to the vanes of the oscillator section of the tuning capacitor, the consequent microphony resulting in acoustic feedback. Small alterations in oscillator frequency and, hence, intermediate frequency are converted to amplitude modulation when the i.f. is applied to the skirts of the i.f. amplifier response; the amplitude modulation is then detected and re-applied to the speaker, producing an acoustic feedback loop. The effect is,

### CURRENT LIMIT AT 100mA

of course, made worse when the i.f. amplifier has a very narrow bandwidth, as occurs in the "3 Band Short Wave Superhet" when this is set up for s.s.b. and c.w. signals. As with hum pick-up, acoustic feedback difficulties are completely resolved by the use of the external unit.

The power supply circuit will also be of interest to readers who require a 9 volt battery supply for a general purpose receiver. In this instance the speaker is not required, and the power supply, on its own, may be assembled in a smaller case than that employed for the unit to be described. The constructional details given in this article will, however, apply only to the speaker and supply unit and to its use with the particular receiver for which it was designed. It is assumed that experienced constructors will be quite capable of making any simple adaptations that may be required for alternative uses.

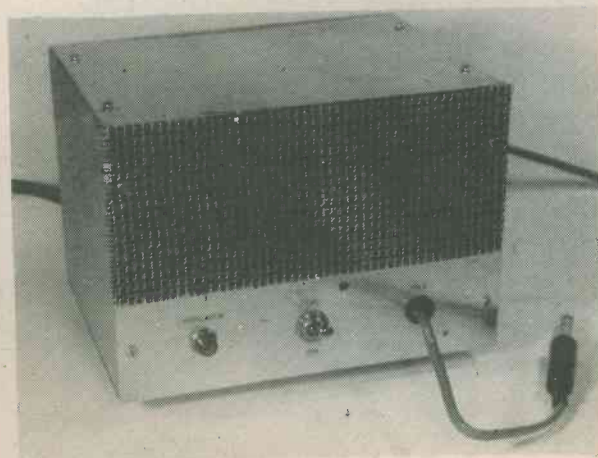

*The case of the eliminator-speaker unit is made up with aluminium and timber panels*

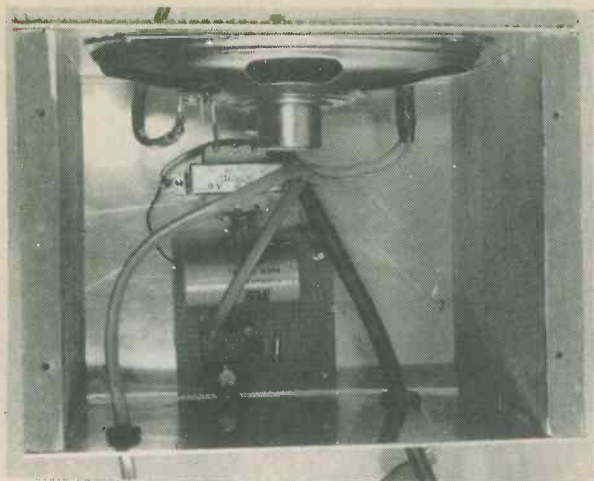

Inside the unit the mains transformer is fitted immediately behind the on-off switch. The component board then appears between the transformer and the rear panel of the case

### THE CIRCUIT

The complete circuit of the unit appears in Fig. 1. S1 is the on-off switch and NE1 is a mains neon indicator having its own integral series resistor. This must be a type intended for 240 volts a.c. operation.

T1 is the mains transformer with a 12-0-12 volt secondary winding which feeds the full-wave rectifier circuit given by D1 and D2. C1 is the reservoir and smoothing capacitor.

IC1 is a 723C regulator i.c. in a 14 pin d.i.l. package, and the lead-out functions are shown in Fig. 2. The heart of the i.c. is an operational amplifier employed as a voltage comparator, its output being fed to the output of the i.c. by way of a buffer amplifier. The op-amp non-inverting input is connected to an internal zener diode voltage reference at pin 6 which offers a nominal stabilized voltage of 7.15 volts. The inverting input is coupled to the junction of the potential divider given by R1 and R2.

### COMPONENTS

#### Resistors

- (All  $\frac{1}{2}$  watt)  
 R1  $1k\Omega$  2%  
 R2  $3.3k\Omega$  2%  
 R3  $6.8 \cdot 5\%$

#### Capacitors

- C1  $2,200\mu F$  electrolytic, 25V. Wkg.  
 C2  $150pF$  polystyrene  
 C3  $2,200\mu F$  electrolytic, 12V. Wkg.

#### Transformer

- T1 Miniature mains transformer, secondary 12-0-12V at 100mA

#### Semiconductors

- IC1 723C in 14-pin d.i.l.  
 TR1 BFY51  
 D1 1N4001  
 D2 1N4001

#### Indicator

- NE1 Panel mounting neon indicator with integral series resistor, 240V. A.C.

#### Speaker

- LS1 5 x 3in., 8  $\Omega$

#### Switch

- S1(a) (b) D.P.S.T. toggle

#### Miscellaneous

- Red wander plug  
 Black wander plug  
 Red socket  
 Black socket  
 $\frac{1}{4}$ in. jack plug  
 TO5 clip-on heatsink  
 Plain perforated s.r.b.p. board, 0.1in. matrix  
 Materials for case (see text)  
 4 rubber feet  
 wire, screws, grommets, etc.

Fig. 1. The circuit of the 9 volt eliminator-speaker unit. The speaker is in no way connected to the eliminator circuitry and may be omitted if it is desired to use the circuit as a simple 9 volt power supply unit

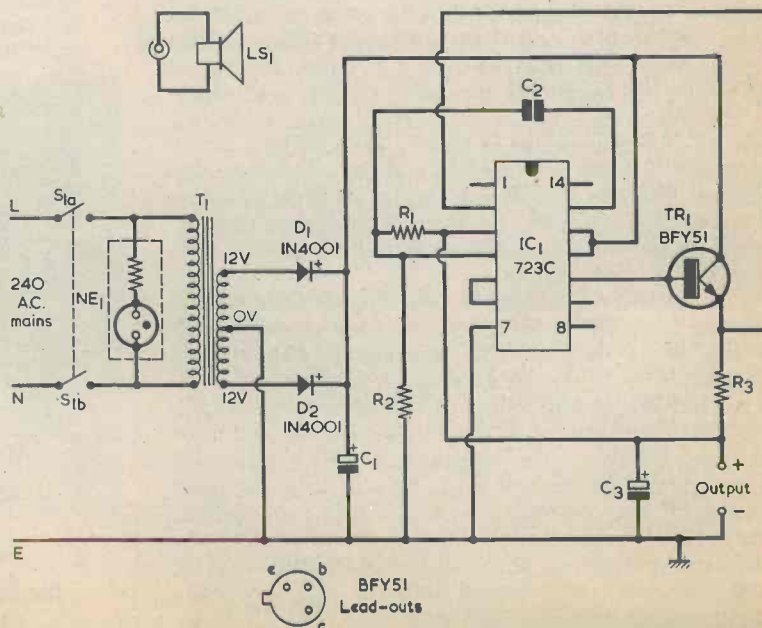



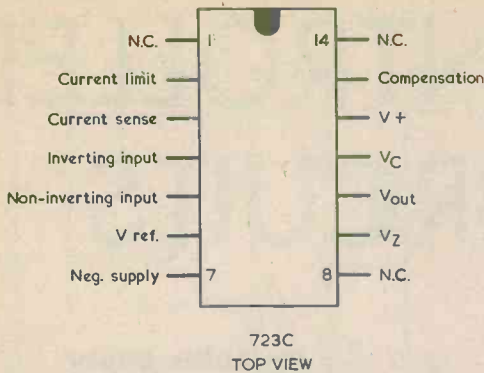

Fig. 2. Pin allocations for the 723C in its 14-pin d.i.l. package

The output voltage of the unit is stabilized at a voltage equal to 7.15 volts multiplied by the sum of R1 and R2, and then divided by R2, which calculates at 9.32 volts with the component values specified. In practice, tolerances on the zener reference voltage and, to a lesser extent, on the values of R1 and R2, could result in the stabilized output voltage being up to as much as 0.5 volt higher or smaller than the calculated figure, but this does not incur any disadvantages. During its life-span, a PP9 battery provides maximum and minimum voltages of the order of 9.6 volts and 7.5 volts respectively! The voltage stabilization is due to the high level of negative feedback between the 723C op-amp comparator input and the power supply output.

R3, in series with the output, is part of the current limiting circuit. It is connected across the base and emitter of an internal transistor in the i.c., so that when about 0.65 volt is developed across R3 the transistor turns on. It then reduces the output voltage of the internal operational amplifier and, hence, the output voltage of the power supply. With R3 at the specified value of  $6.8\Omega$  the output current is theoretically limited to about 96mA, but in practice the actual value is subject to a small amount of variation due to component tolerances.

C2 is the compensation capacitor for the operational amplifier. TR1 is a discrete emitter follower output stage. This is needed to increase the power handling capability of the circuit since the 800mW absolute maximum dissipation of the 723C could otherwise be exceeded at high volume levels in the superhet or if the output were short-circuited.

C3 provides additional smoothing at the output and it enables brief current peaks of more than 100mA to be provided by the unit. Such peaks are drawn by the Class B output stage of the receiver when it is used at high volume levels.

The loudspeaker, LS1, is kept separate from the power supply circuitry. It has an impedance of  $8\Omega$  when it is used with the "3 Band Short Wave Superhet" but, of course, other impedances may be required with other short wave receivers. Its dimensions of 5 by 3in. are nominal and it is advisable to obtain it before starting work on the cabinet, just in case the cabinet dimensions need to be modified slightly to suit the particular component chosen.

T1 is specified as having a secondary rating of 12-0-12 volts at 100mA. Miniature mains

transformers having a secondary with this rating are available from a number of suppliers, including Home Radio (Components) Ltd and Bi-Pak Semiconductors.

### CABINET

The prototype is housed in a cabinet which measures 180 by 130 by 144mm., and this is home constructed from 18 s.w.g. aluminium for the top, base, front and rear panels. The two sides are timber approximately 12.5mm. thick, the aluminium panels being simply affixed to the edges by two small woodscrews at each edge. The front and rear panels each measure 180 by 130mm, and the top and bottom panels are each 180 by 142mm. The wooden side panels are each 142 by 128mm.

The accompanying photographs show the general layout of the unit and the manner in which the cabinet is assembled. Three holes are drilled symmetrically on a horizontal line along the lower part of the front panel to take S1 at the centre, NE1 to the left and a hole for the speaker lead to its right. The hole for the speaker lead is fitted with a grommet.

A hole for the mains lead is drilled towards the lower right hand corner of the rear panel (as viewed from the rear) and another for the power supply output lead near the upper left-hand corner. Both these holes are fitted with grommets. The top, front and rear panels also each require a 6BA or M3 clear hole which will be used to fit a solder tag internally for earthing purposes. These holes may be drilled at any convenient points.

A rectangular cut-out for the speaker is made in the upper part of the front panel. This can be made with either a fretsaw or a small round file. The speaker may be mounted either by four counter-sunk bolts whose heads are reasonably flush with the front surface of the front panel or by means of a strong adhesive such as an epoxy resin. In the latter case, take care that none of the adhesive is allowed to get onto the speaker cone or its surround. The upper part of the front panel is completely covered with a piece of speaker fabric. The best approach here is to cut out a piece of material which is slightly too large and then glue it in place with a general purpose adhesive such as Bostik No. 1. When this has set, the excess fabric can be trimmed off the panel edges with a pair of scissors.

Finally, four small rubber feet are fixed near the corners of the base panel by means of adhesive or nuts and bolts.

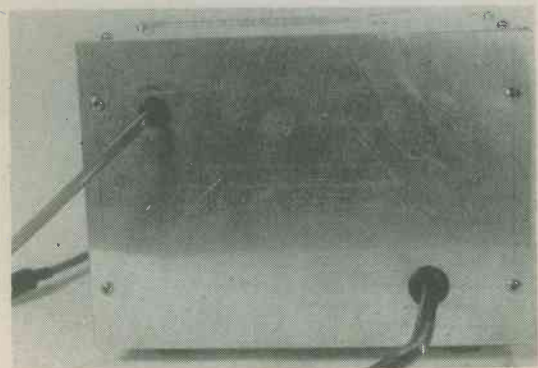

The rear of the unit. The mains input and 9 volt output leads pass through grommets in the rear panel.

(Constructional details will be given next month)

# SILICON CONTROLLED SWITCH CIRCUITS

## Part 2 (Conclusion)

by John Baker

- Metronome
- True CR Latching Timer
- Motor Speed Control
- Temperature Sensor

### P.U.T. METRONOME

Unijunction transistors are popular in electronic metronome circuits, where they are employed as relaxation oscillators. The pulse output they produce is ideal when amplified and fed to a loudspeaker. One drawback to u.j.t. circuits of this type is that in order to obtain the low pulse repetition frequency required the timing capacitor has to be electrolytic. A potentiometer is also necessary in order to obtain a control of the beat rate.

Unfortunately, neither potentiometers nor electrolytic capacitors have particularly close tolerances on value; just the opposite in fact. Potentiometers usually have a tolerance of 20 per cent whilst that of electrolytic capacitors is normally - 10 per cent to +50 per cent or even worse! As was mentioned last month, unijunction transistors have varying characteristics so far as triggering voltage is concerned and this fact combined with the wide tolerances in the timing resistor and capacitor make it impossible to obtain good

repeatability with regard to beat rate range between one metronome unit and another. To overcome this difficulty it is common for u.j.t. metronomes to cover a much wider range of beat rates than is really required, and even then it is sometimes necessary to select certain component values by empirical means.

On the other hand, a programmable unijunction transistor relaxation oscillator has its triggering voltage set by an external potential divider, and it is not then subject to the variations in triggering voltage which occur between one u.j.t. and another. The external reference voltage is, indeed, the reason why the device is called a *programmable* unijunction transistor. Good repeatability can be obtained from a p.u.t. circuit by employing close tolerance components in the potential divider, but this still does not overcome the effects of wide tolerance components in the timing network.

However if, for example, R3 and R4 of Fig. 5 (published last month) were to be replaced by a potentiometer, the latter could be adjusted to vary the frequency of oscillation and thus compensate for variations in the timing network values. When the actual values of C2 and R2 in Fig. 5 are greater than the nominal figures, the potentiometer could be adjusted so that more than half the supply rail potential was applied to the gate cathode of the s.c.s. This would compensate for the excess values since it would decrease the time taken for the charge on C2 to reach the triggering voltage. Similarly, adjusting the potentiometer for decreased gate cathode voltage would raise the triggering voltage and lower the frequency of oscillation, and such an adjustment would correct any deficiency in the timing component values which would otherwise cause too high an operating frequency.

### METRONOME CIRCUIT

A working circuit diagram in which a silicon controlled switch functions as a p.u.t. metronome is given in Fig. 8. VR1, R7 and C2 are the timing components and these provide a range of about 40 to 250 beats per minute. Pre-set potentiometer R4

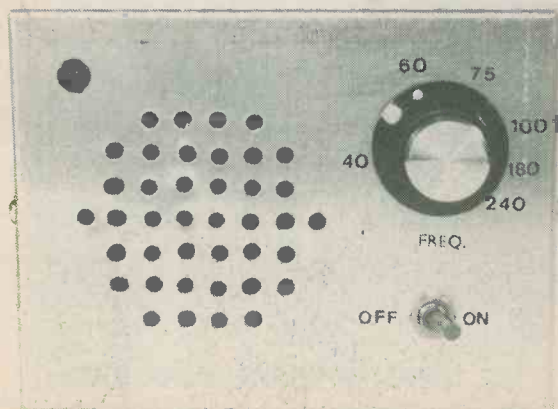

Front panel layout of the s.c.s. metronome. The light-emitting diode is upper left of the speaker grille



## METRONOME COMPONENTS

### Resistors

(All fixed values  $\frac{1}{4}$  watt 5%)

- R1 680  $\Omega$
- R2 1.2k  $\Omega$
- R3 2.7k  $\Omega$
- R4 4.7k  $\Omega$  pre-set potentiometer, 0.1 watt, horizontal
- R5 2.7k  $\Omega$
- R6 560  $\Omega$
- R7 82k  $\Omega$
- VR1 470k  $\Omega$  potentiometer, linear

### Capacitors

- C1 100 $\mu$ F electrolytic, 16V. Wkg.
- C2 4.7 $\mu$ F electrolytic, 16V. Wkg.

### Semiconductors

- S.C.S. BRY39
- TR1 BC179
- D1 TIL209 or similar

### Speaker

- LS1 50-80  $\Omega$  miniature

### Switch

- S1 s.p.s.t. miniature toggle

### Miscellaneous

- Aluminium case (see text)
- L.E.D. panel holder
- Veroboard. 0.1in. matrix
- 9-volt battery type PP3 (EveryReady)
- Battery connector
- Control knob

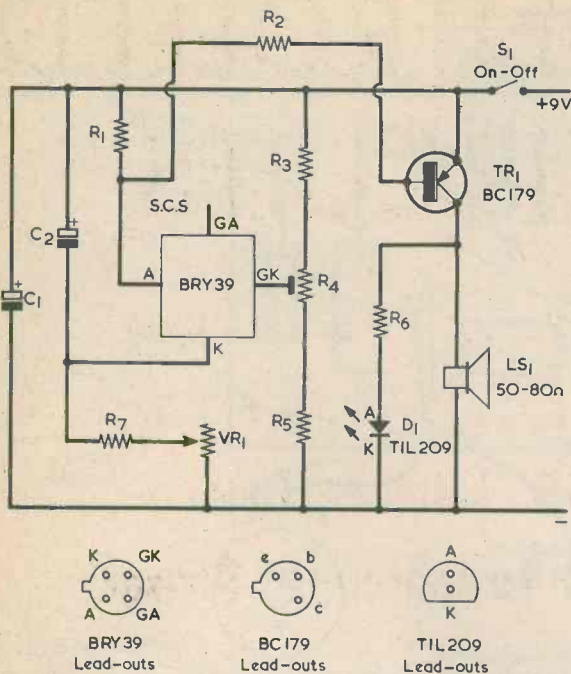

**Fig. 8. A metronome circuit incorporating a silicon controlled switch. Both audible and visual outputs are given. Despite variations in value in C2 and VR1 due to wide tolerances, very nearly the same frequency range can be given in all practical versions of the circuit by adjustment of R4**

can be adjusted to compensate for discrepancies in the timing network component values.

A negative-going pulse is developed across R1 each time C2 discharges and this is fed to the base of TR1 by way of R2. The pulse turns on TR1 and feeds a brief surge of current to the loudspeaker, thereby producing the required clicking sound.

The volume available from units of this kind is rather limited, and they can be rendered inaudible by loud playing of the musical instrument concerned. The volume could be increased slightly by decreasing the value of R2, but this is not likely to make a vast improvement as the main limiting factor to volume is the miniature loudspeaker employed, the diaphragm of which is of small size

and has a small available movement.

Obviously, a larger speaker could be used, but a more satisfactory alternative is to augment the clicking sound by a simultaneous flashing from a visual indicator. The latter overcomes the problem because it is, of course, totally unaffected by the volume of the music. In this circuit the visual signal is provided by the light-emitting diode, D1, for which the series resistor R6 provides current limiting.

In the Components List, C2 is specified as having a working voltage of 16 volts. It will be quite in order to employ a capacitor having a higher working voltage here and this may be 63 volts or even higher.

*The metronome uses a simple Veroboard module for most of the components*

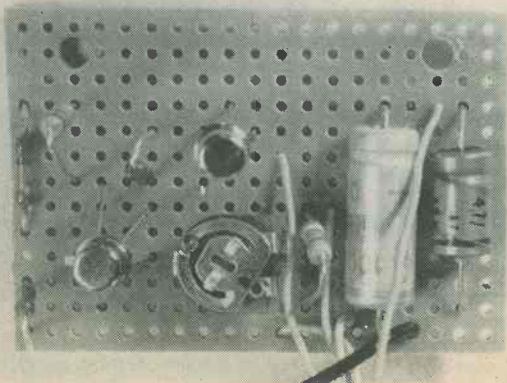
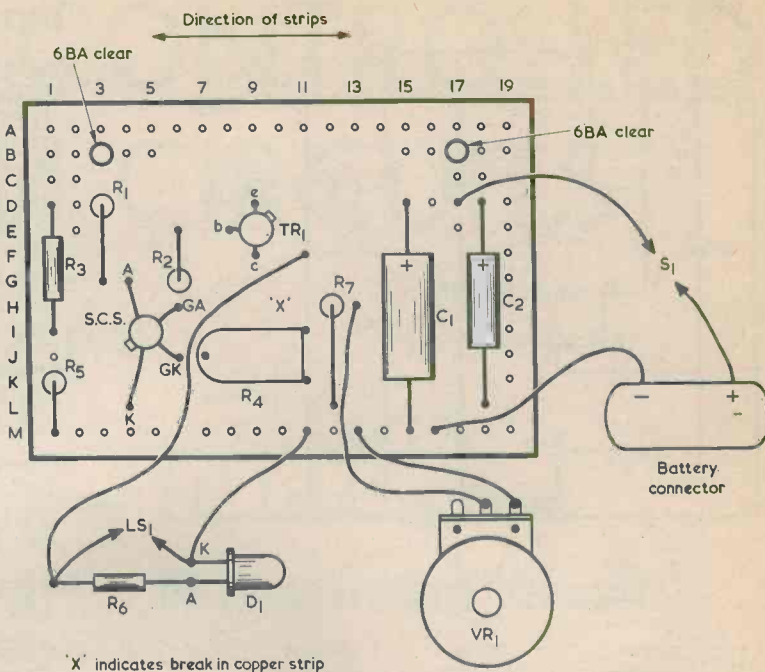



Fig. 9. The majority of components for the metronome may be assembled on a Veroboard panel having the layout shown here



## CONSTRUCTION

Most of the components are assembled on a Veroboard panel of 0.1in. matrix having 19 holes by 13 copper strips. Details are given in Fig. 9. There is only one break in the copper strips, this being indicated by the cross at hole H10. R6 is not mounted on the panel but is wired between the anode lead-out of the l.e.d. and the appropriate tag of the loudspeaker.

The prototype metronome is housed in an aluminium box which has approximate dimensions of 102 by 76 by 38mm. (4 by 3 by 1½in.). Any aluminium box of around the same, or having slightly larger dimensions may be used provided it can accommodate the particular speaker used, together with the other components. A plastic case would also be suitable.

The general layout of the prototype unit can be seen from the photographs. As these show, the speaker grille is made by drilling a matrix of holes in a regular symmetrical pattern. These are about 3mm. in diameter and are spaced about 6.5mm.

apart. The number of holes required depends upon the size of the speaker. The speaker is carefully glued in place behind the grille using a high quality adhesive such as an epoxy resin type. Care must be taken to see that none of the adhesive gets on to the speaker cone or surround. The component panel is mounted on the bottom of the case at the left below the speaker, using 6BA bolts and nuts. Spacing washers must be passed over the bolts to space the board underside away from the inside surface of the case. This prevents strain on the board and, with an aluminium case, ensures that there are no short-circuits to the underside soldering.

As viewed from the front, the light-emitting diode, which is fitted in a panel-mounting holder, is upper left of the speaker grille. On the right is frequency control VR1 and, below it, the on-off switch. There is sufficient space inside the case for a PP3 battery behind the on-off switch.

The average current consumption from the PP3 battery is only about 1mA, although a brief high current surge occurs each time a click is produced from the speaker.

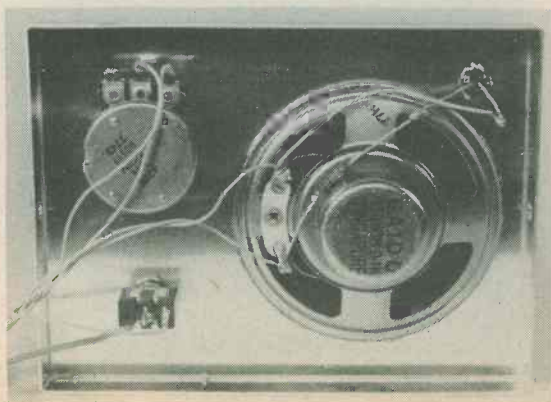

Rear view of the front panel

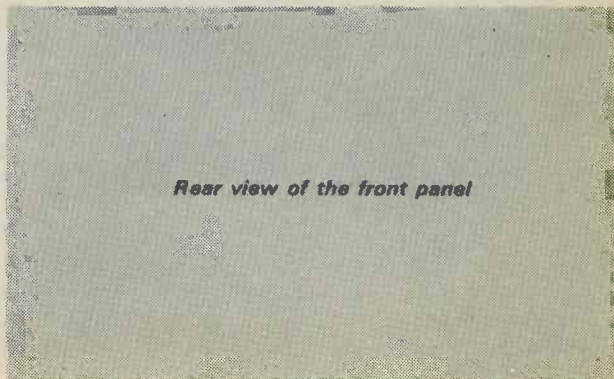



The front panel components wired up to the Veroboard panel. Interconnecting leads consist of thin flexible p.v.c. covered wires

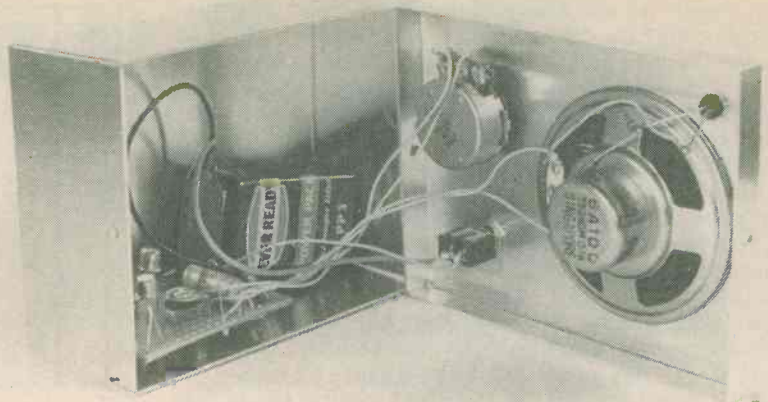

### CALIBRATION

At the outset R4 should be adjusted so that its slider is at the centre of its track. It is then necessary to establish whether or not the range of beat rates covered by VR1 is suitable. It is an easy matter to determine the beat rate, this being done by counting the number of beats produced in a certain length of time. The number of beats in, for instance, a 15 second period can be counted, and the result multiplied by 4 to obtain the number of beats per minute. To increase the beat rates provided by VR1 adjust R4 in a clockwise direction. Alternatively, adjust R4 in the anti-clockwise direction if the opposite effect is required.

When a suitable range has been obtained, a simple scale can be made up around the control knob of VR1, the individual calibration points being found by trial and error.

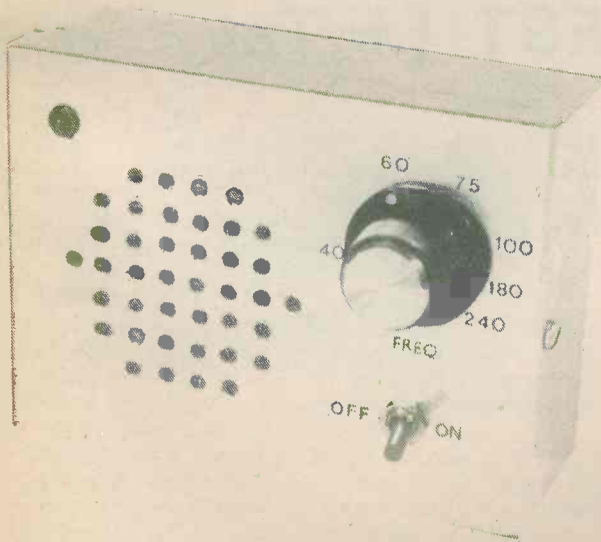

Three-quarter shot of the metronome in its aluminium case

### OTHER USES

It is of course impossible, in the limited space available here, to give details of all the various types of circuit in which a silicon controlled switch can be used. In the p.u.t. mode the device can be employed in the applications generally associated with ordinary unijunction transistors, such as tone generators, waveform generators, timers, frequency dividers and simple analogue to digital converters.

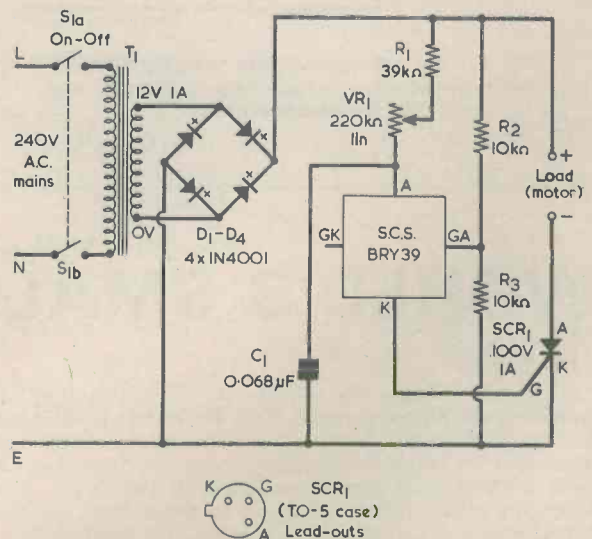

Fig. 10. A circuit in which a silicon controlled switch is used as a speed control for a small 12 volt d.c. motor. Maximum load current is 1 amp

As an example, an s.c.s. can be used as the trigger device for a simple 12 volt motor speed controller, as shown in Fig. 10. Maximum load current is 1 amp and, if the thyristor employed is in a TO-5 encapsulation, as is for instance the TAG1/100, it has the lead-out layout shown in the inset.

When used as a switch, the s.c.s. can be employed in such applications as rain alarms, burglar alarms; temperature alarms, etc. Fig. 11 shows the circuit for an over-temperature alarm in which the s.c.s. is used both as the sensor and as the switching device. This works by virtue of the fact that the voltage at what is effectively the n.p.n. transistor integral in the s.c.s. begins to turn on falls, like any silicon transistor, with increasing temperature. If VR1 is adjusted so that there is just sufficient gate cathode voltage to switch the s.c.s. on when it is at the alarm temperature, the s.c.s. will remain in the "off" state at temperatures below this level. When, subsequently, the s.c.s. reaches the alarm temperature it will turn on and latch in that state. The relay can have a coil resistance of 200  $\Omega$  or more, and an excellent choice would be the type with a 410  $\Omega$  coil which was referred to in Part 1.

The fact that the device latches in the "on" state can often be put to good use, and the simple timer

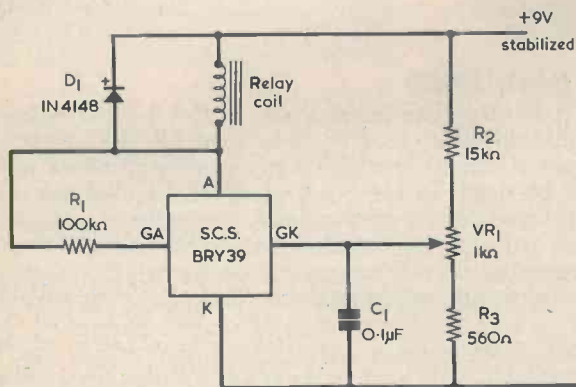
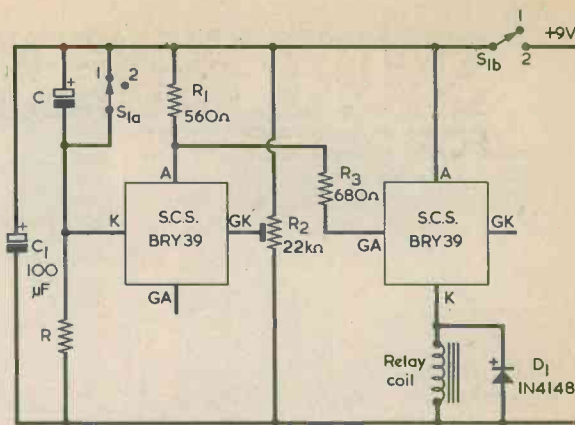

Fig. 11. An over-temperature warning circuit. The s.c.s. acts both as latching switch and as the temperature sensor



S<sub>1a</sub> & S<sub>1b</sub> positions: 1-Reset  
2-Start

Fig. 12. A timer incorporating two silicon controlled switches. The s.c.s. on the left functions as a p.u.t. and passes a negative-going pulse to the second s.c.s. This latches on and energises the relay. The timing period is governed by the values of C and R

circuit of Fig. 12 illustrates this point. Here an working as a p.u.t. produces an output pulse at the end of the timing period, and this operates a second s.c.s. which acts as a combined latch and relay driver. The timing period can, if desired, be made equal to the time constant of C and R by appropriate adjustment of R2. The value of R should lie between about 15k $\Omega$  and 1M $\Omega$ . Relay details are the same as for Fig. 11.

The silicon controlled switch is one of the most useful and versatile devices available at present and should be of great interest to the electronics experimenter. It certainly deserves wider use in home-constructor designs.

(Concluded)

## WORLD'S SMALLEST I.F.Ts

The new Toko 5S series of fully tunable i.f. transformers for frequencies from 100kHz to 15MHz are currently featured by Ambit International, and are described as being the smallest mass produced i.f./r.f. coils with in-built capacitor tuning in the world. The screening cans measure 5.5 by 5.5 by 6mm. high, and the transformers are available in a range of 2-winding combinations which include capacitor tuning of one winding together with different tapping options.

In conjunction with the Ambit International triple varicap tuning diode type KV1210, the 5S coils could be employed in a complete a.m./f.m. radio which is only 10mm. thick. The KV1210 is supplied in a "5-in-line" package (i.e. 5 pins in a single row) and is capable of tuning the medium wave band with a bias control range of only 2 to 9 volts d.c. This makes the tuning diode particularly suitable for car radios, since there is no necessity for an inverter to produce a bias voltage higher than the supply.

Further details are available from Ambit International, 2 Gresham Road, Brentwood, Essex, CM14 4RH.



The Ambit International triple tuning varicap diode type KV1210



# SHORT WAVE NEWS

## FOR DX LISTENERS



By Frank A. Baldwin

Times = GMT

Frequencies = kHz

### ● SRI LANKA

Colombo on a measured **4902** at 1740, Buddhist monks with religious chants on a full-moon evening. This is the Home Service 1 which operates from 0015 to 0230 and from 1030 to 1715 in Sinhala. Additionally on full-moon days from 1600 to 2400. The power is 10kW.

### ● PAKISTAN

Radio Pakistan on **4790** (unlisted channel) at 0015, local songs and music until 0043 when the Azad Kashmir Anthem was heard. At 0045, identification as "Radio Pakistan". All in parallel with **4736.5** (measured). All logged on three separate occasions.

### ● SINGAPORE

Radio Singapore on **5010** at 2331, OM with a newscast in English. This is the English Service, scheduled from 1030 to 1630 and from 2230 to 2400. Also to be heard in parallel on **5052**. The power is 10kW.

### ● NEPAL

Radio Nepal, Jawalakhil, on **5005** at 1547, YL with songs, local-style music in the Home Service, scheduled here from 1150 to 1720 and from 0020 to 0350 (the English programme is from 1440 to 1520) and the power is 100kW.

### ● MALAYSIA

Kuala Lumpur on **4845** at 2202, Indian-type music, YL with songs in the Tamil Service scheduled here from 0545 to 1530 and from 2130 to 0130 Monday to Friday (Saturday from 0545 to 1530 and from 2130 to 0330; Sunday from 2130 through to 1530). The power is 50kW.

### ● BOTSWANA

Gaberones on **4845** at 1822, OM's with a discussion about African affairs in English. The schedule is from 0400 to 0630, 1500 to 2100 Sunday to Wednesday and from 0400 to 0600, 1435 to 2100 Thursday to Saturday. The power is 10kW.

### ● KENYA

Nairobi on **4804** at 1812, YL with a newscast of local affairs in English. This is the Home Service in English and is scheduled from 0255 (Sunday from 0330) to 0630 and from 1300 to 2010 (Saturday until 2110). The power is 1kW.

Nairobi on a measured **4934** at 1829, OM with a talk about Kenya after Jomo Kenyatta. This is the National Service, scheduled here from 0300 to 0630 and from 1310 to 2115. The power is 100kW.

### ● BENIN

Cotonou on **4870** at 1829, OM in vernacular,

African drums and chants. The schedule is mostly on a 24 hour basis and is the Home Service in French and vernaculars. The power is 30kW.

### ● TOGO

Radio Lama-Kara on a measured **3222** at 1901, OM with announcements in French. The schedule of this one is from 0530 to 0830 and from 1630 to 2230, the power is 10kW but it is not an easy station to receive owing to the surrounding commercial interference.

### ● SAO TOME

Radio Nacional de Sao Tome on a measured **4807** at 2110, YL with songs, local-type music, OM with announcements in Portuguese. The schedule is from 0530 to 2300 and the power is 10kW.

### ● CAMEROON

Radio Garoua on **5010** at 1834, OM with a newscast in English, this being a feature of the daily schedule from 1830 to 1845. The full schedule is from 0500 to 0700 and from 1700 to 2200. The power is 30kW.

### ● TANZANIA

Dar-es-Salaam on **5050** at 1738, OM with Moslem chants in the Commercial Service, scheduled here from 1300 to 2015. The National Service in Swahili is scheduled from 0300 to 0500. The power is 10kW.

### ● MOZAMBIQUE

Radio Mozambique on **4865** at 1754, OM with a talk in Portuguese in the 'A' Programme, scheduled from 0255 to 0815 and from 1600 to 2210 (there is a programme in English from 1800 to 1815 daily). The power is 25kW.

Radio Mozambique on a measured **4896** at 1747, light music on records, OM announcer in Swahili. The schedule is from 0400 to 0700 and from 1430 to 2000. The power is 100kW.

### ● UPPER VOLTA

Ouagadougou on **4815** at 1805, OM's with a discussion in vernacular. The schedule is from 0530 (Saturday and Sunday from 0700) to 0900 and from 1600 to 2400. The power is 20kW.

### ● SWAZILAND

Trans World Radio (TWR) Mpangela on a measured **4759** at 1813, light music followed by hymns in vernacular at 1815. The schedule is from 0315 to 0600 in Afrikaans and from 1600 to 1800 in German, Portuguese and vernaculars. The power is 30kW.

*Continued on page 321*

# In your workshop -shop

## SIMPLE COMBINATION LOCKS

"This," said Smithy incredulously, as he put a tremulous hand to his brow, "is Christmas Eve. Why on earth am I in the Workshop answering your questions on Christmas Eve?"

"So far as I can remember," stated Dick, "you've always been in the workshop answering my questions on Christmas Eve."

"But I shouldn't be doing that this year," protested Smithy. "Dash it all, we finished work yesterday. I just popped in this morning a few minutes ago to pick up a record which should fit in nicely with our Christmas festivities at my club, and I now find myself answering a whole load of questions for you. Look, let's get back to the moment when I came in. And for goodness' sake take things gently when you get to the bit about the missing Father Christmasses."

Dick threw a sympathetic glance at the Serviceman.

"It sounds," he remarked compassionately, "as though you've already started your own Christmas festivities. I bumped into my uncle earlier on today and he said that things were really heaving at your club last night."

Smithy sighed. One of the banes of his life was the fact that Dick's uncle was also the steward of his club.

"Forget about last night," he said shortly. "Let's recap on this morning."

### COMBINATION LOCK

"Okeydoke," said Dick obligingly. "Well, as you say, you came in for your record a couple of minutes ago. I was already in here trying to

work out a little private job for Joe down at the Caff, and it was then that I told you he'd had nearly all his Father Christmasses pinched."

"Father Christmasses," repeated Smithy hollowly.

"They're only little Father Christmasses," explained Dick soothingly. "They're made in Taiwan."

"Father Christmasses from Taiwan," moaned Smithy. "The mind boggles."

"Old Joe," continued Dick cheerfully, "got a whole lot of them cheap and he put them out on display at his Caff. Well, you know what the blokes are like down there, and it ended up with nearly all of them getting nicked."

"At least *that* bit figures."

"As a result, Joe's decided to put all the future odds and ends he flogs in a glass case with a locked front. But with his clientele an ordinary key type lock would be asking for trouble and so he's asked me to dream up a combination electronic lock for him."

Smithy visibly brightened.

"Ah," he said, "things are beginning to get a bit more straightforward now. So far as combination locks are concerned, there's hardly any problems at all in making up one which works on electronic, or even electrical principles. The simplest way of providing a lock of the type you want is to have a combination switching circuit. Something like this."

Smithy spied his note-pad on his bench and, taking out a ball point pen, sketched out a circuit. (Fig. 1).

"That's all there is to it," he continued. "Each switch can be a single-pole single-throw panel mounting toggle type. To open the case, or whatever the lock is fitted to, all the switches have to be in the closed position. You then press the push-button, the solenoid becomes energised, and it withdraws a bolt securing the case."

"Humph," commented Dick critically. "I don't think much of that. Anybody can turn a series of toggle switches on."

"Not if the switch bodies are hidden behind a panel they can't,"

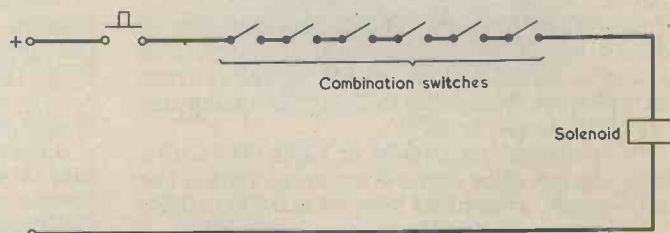

Fig. 1. A very simple but quite effective combination lock incorporating six s.p.s.t. toggle switches. All the switches have to be closed to operate the solenoid and open the lock



retorted Smithy. "You mount the switches so that some are turned on when the operating dolly is up and some are turned on when the operating dolly is down. To open the lock from the outside you have to know which switch dollies should be up and which should be down." (Fig. 2).

"To my mind," grunted Dick, "it still seems to be too easy for anyone to open the lock. You've put six switches in your circuit. How many combinations will that give?"

"Let me think a minute."

Smithy scribbled a few figures on the note-pad.

"The six switches," he said in a satisfied tone, "will give you 64 combinations, of which only one will open the lock. If you added another switch in series you'd get 128 combinations and if you added yet another switch there'd be 256 combinations."

"Blimey," said Dick, impressed, "that toggle switch idea doesn't sound so bad after all. Hey, Smithy, you seem to be quite clued-up on this combination lock business."

## SECURITY

Smithy gave a mysterious smile.

"Ah," he said darkly, "that's a result of the experience I picked up during the last war. Now that all these years have gone by I suppose that it's safe for me to mention a few of my secret activities at that time."

"Go on."

"To begin with," said Smithy modestly, "I originated not a few new technical ideas so far as security was concerned. Indeed, I was commended for some of my designs."

"Come off it," snorted Dick scornfully. "The only security designs you've ever had are designs on *Social Security!*"

Smithy turned a pained eye on his assistant.

"That's typical of present-day reactions," he stated disgustedly. "Well, if that's the sort of comment you're going to make about my wartime activities I'll pick up my record and press on home."

Dick gazed dispassionately at Smithy.

"You're miffed, aren't you?"

"Too true I'm miffed. I'm cheesed off with blokes like you taking

the mickey out of my wartime service."

"All right then, I won't do it any more. Besides, it is Christmas and the season of goodwill and all that schmaltz. So how about hanging on a bit longer and giving me some more gen on this combination lock business?"

"Oh, all right," conceded Smithy reluctantly. "What do you want to know next?"

"How do you work out the number of combinations those switches of yours will give? You said, for instance, that six toggle switches give you 64 combinations, seven switches give 128 combinations, and so on. How do you calculate that?"

"You can," said Smithy, "work it out with mathematics. But I find that the easiest way of finding the number of switch combinations is by thinking in terms of binary notation, assuming that a switch turned in one direction is equal to 0 and that a switch turned in the other direction is equal to 1. Imagine you've got three switches. All the combinations you can then get are from binary 000 to binary 111, going through the series 001, 010 and so on till you get to 111. Now, 111 in binary is 7 in decimal, so that 001 to 111 gives 7 combinations. Add the combination 000 and you then find that the three switches give 8 combinations. Do the binary business for four switches and you find there are 16 combinations. Five switches take you up to 32 combinations, and so on."

"How would it be," asked Dick, "if we used rotary switches instead? Say we had three 10-way rotary switches wired up like this."

Dick picked up Smithy's pen and drew out a circuit. (Fig. 3).

"Rotary switches," said Smithy, "will obviously give you more combinations than the same number of toggle switches. In that circuit of yours the lock will only open when the first switch is set to 6, the second to 1 and the third to 4."

"Yes, but how many combinations are there?"

"We can calculate it very easily. Since the switches are 10-way instead of 2-way we work in terms of decimal instead of binary. In the three figure decimal group from 001 to 999 there are obviously 999 combinations. Add one for 000 and you

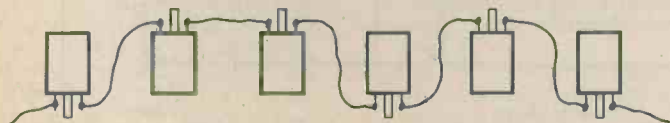

Fig. 2. The combination switches may be orientated in random fashion so that the closed dolly positions cannot be judged from the front of the panel on which they are mounted

# 5,000

ODDS AND ENDS

*Mechanical Electrical*

## CAT FREE

WHISTON DEPT R.E.C.

NEW MILLS, STOCKPORT

THE

## MODERN BOOK CO.

*Largest selection of English & American radio and technical books in the country*

19-21 PRAED STREET

LONDON W2 1NP

Tel: 01-723 4185/2926

## MORSE IMPROVEMENT

C90 Cassettes (A) 1-12 w.p.m. with simple exercises. (B) 12-24 w.p.m. computer produced professional level operator material including international symbols.

Price each: complete with instruction and exercise booklets £4.50 including postage.

Morse Key and Buzzer Unit suitable for sending practice and DIY tape preparation.

Price £4.50 including postage.

Overseas Airmail £1 extra.

MHEL ELECTRONICS (Dept. R)

12 Longshore Way, Milton, Portsmouth (UK), PO4 8LS

## PEATS for PARTS

### ELECTRONIC COMPONENTS RADIO & TELEVISION

*For the convenience of Irish enthusiasts we supply:*

Radio & Electronics  
Constructor Data Books  
Panel Signs  
Transfers

*Also a postal service*

## PEATS

the world of electronics  
25 Parnell Street, Dublin 1. Telephone 749972

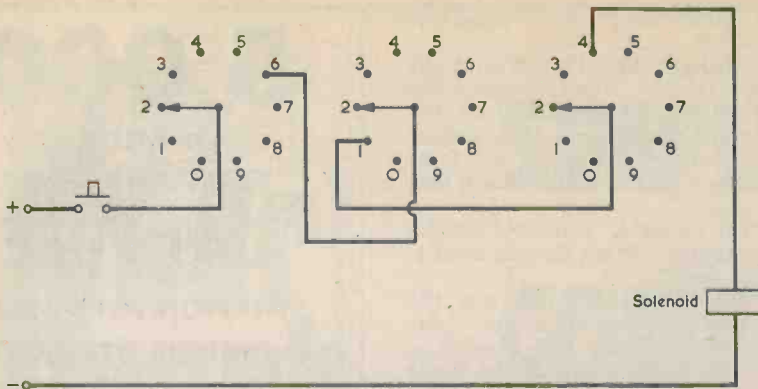

Fig. 3. More combinations are possible if rotary switches are employed. Here, the combination required to open the lock is 614

can see at once that the three switches give 1,000 combinations. If you had six rotary switches you'd get a million combinations!"

"Stap me," said Dick, awed at his prospect. "I think I'll use rotary switches instead of toggle switches for this lock of mine, then."

"As you wish," responded Smithy. "You can't normally get 10-way rotary switches but 12-way switches are quite easy to obtain. Two 12-way switches would give you 144 combinations, and three would give you 1,728 combinations. Each time you add a switch the number of combinations is multiplied by 12."

"You really are on the ball with these switch combinations," said Dick. "Was this wartime work of yours concerned entirely with security systems?"

Smithy looked round cautiously. "There's nobody else in here, is there?"

"Of course there isn't. Blow me, Smithy, who the heck would want to hide in here?"

Smithy drew himself closer to his assistant.

"We were always trained," he

said in a hushed voice, "never to take chances. To start off with, did you bring anything into the Workshop this morning?"

Dick indicated a brown paper parcel on his bench.

"Only that."

"Open it."

Resignedly, Dick picked up the parcel and tore off the brown paper. He revealed a small figurine coloured in bright red and white.

"Why, oh why," fumed Smithy, roused to a sudden fury at the sight of the figure, "do you always contrive to change the atmosphere in here from a state of solemnity to one of utter lunacy?"

"Hey, take it easy, Smithy. It's only one of Joe's Father Christmasses."

"I can see it's one of his Father flaming Christmasses. Why bring the darned thing here?"

An expression of obduracy passed over Dick's face.

"If," he said firmly, "I'm going to dream up a lock to guard Father Christmasses and things like that, I might as well have a sample of what is going to be guarded while I'm doing it."

Smithy looked at his assistant, then let his hands fall helplessly to his sides.

"I give up," he said hopelessly. "There is a random logic behind some of your thought processes which has me completely baffled. What were we talking about?"

"Your wartime exploits."

"And before that?"

### ALARM CIRCUIT

"We were talking about these combination locks. Which reminds me about something else."

"What's that?"

"Well, the circuits we've talked about up to now simply have the combination switches in series between a battery and a solenoid. Couldn't we have some form of alarm circuit, so that an alarm was given if the push-button was pressed when an incorrect combination was selected?"

"That could be done quite easily," replied Smithy. "One way would consist of wiring all the unused switch contacts together and passing them to an alarm circuit." (Fig. 4).

"But that would mean a lot of wiring up," objected Dick, "particularly if the system employs rotary switches, as I now intend to use."

"True, true," agreed Smithy. "An easier method would consist of having an electronic circuit which could sense that the circuit through the switches wasn't complete when the button was pressed. Let's see what I can think of along those lines."

Smithy settled himself at his bench and jotted down a few experimental circuits. Suddenly his brow cleared. With a decisive gesture, he tore off the top sheet of his note-pad and drew out a new circuit. (Fig. 5).

"This will give you an alarm facility," he said, "and all you need are a few extra components and a relay with two normally open con-

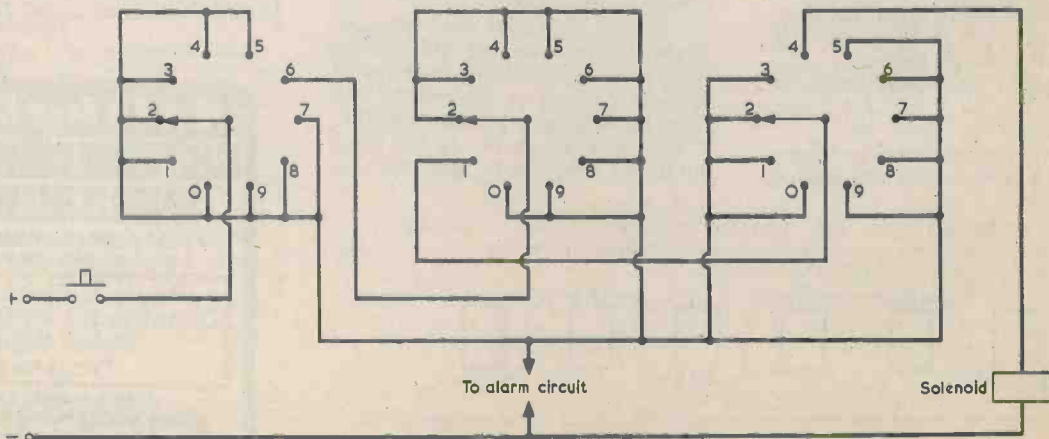

Fig. 4. An alarm facility to indicate incorrect combination switch selection can be provided by connecting all the unused contacts to an alarm circuit. This is the circuit of Fig. 3 so modified



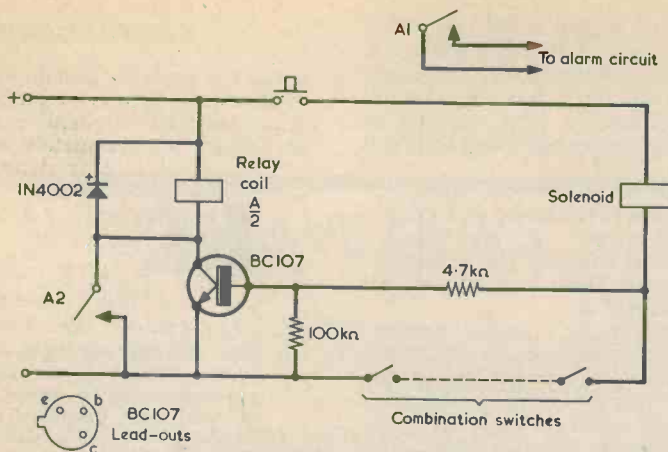
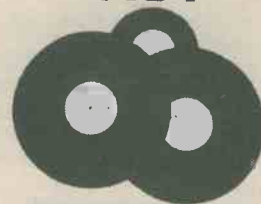

Fig. 5. An alternative circuit which gives warning that an incorrect combination has been selected. The combination switches can consist of any number of toggle or rotary switches. The relay contacts are shown in the de-energised position

## MORSE MADE EASY



### BY THE G3HSC RHYTHM METHOD!

These courses, which have been sold for over 23 years, have been proved many times to be the fastest method of learning Morse. You start right away by learning the sounds of the various letters, numbers, etc., as you will in fact use them. Not a series of dots and dashes which later you will have to translate into letters and words.

Using scientifically prepared 3-speed records you automatically learn to recognise the code RHYTHM without translating. You can't help it. It's as easy as learning a tune. 18 W.P.M. in 4 weeks guaranteed.

The Complete Course consists of three records as well as instruction books. For Complete Course send £5.00 plus part postage 50p (overseas surface mail £1 extra).

Now available Shrouded Morse Keys £2.70 inc. UK postage

### THE G3HSC MORSE CENTRE

Box 8, 45 Green Lane, Purley, Surrey.  
I enclose £5.50 or s.a.b. for explanatory booklet.

Name.....

Address.....

.....

## GAREX

V.H.F. Receivers New SR-9 for 2-metres F.M., fully tunable 144-146MHz, improved 2-speed slow-motion dial, also 11 xtal controlled channels. Compact, sensitive, ideal for fixed or mobile listening. Built-in L.S., 12v D.C. operation. INTRODUCTORY PRICE ONLY £54 inc. VAT. Crystals, if required: £2.50 each. All popular 2m. channels in stock. Marine band version (156-162MHz) £59.40 (xtals £2.79). Credit terms available, s.a.e. details.

**Amplified Mobile Extension Speaker** boosts audio from small receivers. Single compact unit, 12vDC operation, built-in 6W amplifier, with leads and jack plugs. £11.25 Neons min. wire end. 65p/10; £4/100

**Slide Switches** min DPDT 18p ea; 5+; 14p

**Resistor Kits** E12 series, 22Ω to 1MΩ

57 values. 5% carbon film. 1W or 1/2W

**Starter pack**, 5 each value (285) £2.95

**Mixed pack**, 5 each 1/2W + 1/2W (570) £5.40

**Standard pack**, 10 each (570) £5.40

**Giant pack**, 25 each (1,425) £13.25

**I.C.'s (new)** 7410 25p CD4001AE 25p

SN76660 75p NE555 55p 723(T05) 75p

709 (T05). 741 (DIL-8) Op.amps 30p;

**BNC Cable mtg socket** 50Ω 20p;

5+; 15p PL259 UHF Plug & Reducer 68p;

5+; 60p; SO239 UHF Socket panel mtd.

55p; 5+; 45p Nicad rechargeables physically equiv. to zinc-carbon types: AAA

(U16) £1.64; AA(U7) £1.20. C(U11) £3.15;

D(U2) £4.94; PP3 £5.20 Any 5+; less

10%, Any 10+ less 20%.

We stock amateur V.H.F. equipment and mobile aeriels, s.a.e. details.

Distributors for J. H. Associates Ltd.

(switches and lamps)

PRICES INCLUDE UK POST. PACKING & VAT

Mail order only. Sole Address:

GAREX ELECTRONICS

7 NORVIC ROAD, MARSWORTH,

TRING, HERTS HP23 4LS

Cheddington (STD 0296) 668684

tact sets. I've marked these contacts A1 and A2."

"How does the circuit work?"

"To start off," replied Smithy, "let's assume that the switches are all set to the correct combination. They will then cause the base and emitter of the transistor to be short-circuited together. When the push-button is pressed the solenoid will then energise and open the lock. The transistor won't have any effect and the relay will be de-energised. Okay?"

"Yes," said Dick, squinting down at Smithy's circuit.

"Next," went on Smithy, "we'll see what happens if we press the button with the switches set to an incorrect combination, so that there's no circuit from the negative supply through to the solenoid. When we now press the button, current from the positive supply will pass through the solenoid and then through the 4.7kΩ resistor to the base of the transistor. The coil resistance of the solenoid will be much lower than 4.7kΩ and so it won't have any significant effect on the transistor base current. At the same time, the relatively small current passing through the solenoid and the 4.7kΩ resistor won't be enough to operate the solenoid."

"I can see all that," broke in Dick impatiently. "Does the transistor now turn on?"

"The transistor turns on. It energises the relay whose coil is in its collector circuit and the two contact sets close. Contact set A1 causes an alarm to be sounded, whilst contact set A2 connects the lower side of the relay coil to the negative supply. The result is that the relay remains energised even if the push-button is released again. The only way of de-energising the relay is by disconnecting the supply."

"That's neat," commented Dick enthusiastically. "I suppose that the diode across the relay coil is the usual diode to stop the formation of a high back-e.m.f. when the relay is eventually de-energised."

"That's right," confirmed Smithy. "The diode protects the transistor."

"It looks," stated Dick, "as though I've got the basis now for making up a really effective electronic lock for old Joe."

At the mention of the name, Smithy's eyes automatically flickered towards the gaily coloured Father Christmas on his assistant's bench. Frowning suspiciously, he walked over to it and examined it carefully.

"Come on, Smithy," called out Dick. "The darned thing isn't bugged, if that's what you're worried about."

Smithy put the little Father Christmas back on Dick's bench.

"Back in '43," he observed, "I was nearly trapped by something like this Father Christmas of yours."

"Were you? What happened?"

"I was engaged in an undercover operation in Occupied France. In fact, I was setting up a clandestine radio in the attic of an *estaminet* near the Seine, when I observed a peculiar intermittent interference on the band we were using, which was around 50MHz."

"Gosh."

"I traced it in the end to a wire recorder hidden down below in the bedroom of *le patron*."

"Golly."

Smithy warmed to his tale.

"The recorder was very cunningly secreted in the stomach of a stuffed alligator with wires going to a small microphone fitted under the tail. The commutator and brushes of the wire recorder motor were sparking a little, and the leads to

the microphone were just the right length to form a quarter-wave aerial at 50MHz and radiate the interference!"

"Blimey. Who were you working for then? MI5?"

"Oh no," said Smyth, so quietly that Dick could just catch the words. "I was seconded to the CIA."

"But," protested Dick, "there wasn't a CIA in those day, was there?"

"It was just starting," replied Smyth hastily. "Some of us were with it right at the beginning."

## FURTHER SECURITY

Smyth moved back from his assistant and turned a stern eye on him.

"It is when I recall moments like that," he said, reverting to his normal tone of voice, "that I get angry at people who mock these wartime exploits."

"I won't do it again," said Dick contritely. "Fancy you being mixed up in all that underground business! You've certainly kept quiet about it over the years."

"There are some tales," pronounced Smyth heavily, "that are best left untold."

"Perhaps so," agreed Dick. "Anyway, thanks to you, I've got my combination lock circuit sorted out."

He glanced down at the circuit Smyth had drawn, then his brow furrowed.

"What's wrong?"

"This circuit doesn't seem to cover all possibilities."

"In what way?"

"Well," said Dick, "if the push-button is pressed for an incorrect switch combination the alarm circuit goes off all right. But this still doesn't prevent anyone who is trying to open the lock from continuing to try different switch combinations, even though the alarm has been activated."

Smyth took the circuit from his assistant and studied it.

"That's a good point," he stated approvingly. "What we want in this circuit is something which not only sounds the alarm but also disables the combination lock switches as well. Let's see what I can do about that."

Smyth sat down and, after a little thought, produced a new circuit. (Fig. 6).

"You've changed the contacts," commented Dick, looking over his shoulder.

"That's right," agreed Smyth. "I've altered contact set A2 from a normally open to a changeover set. If, with this new circuit, the button is pressed when the switches are at the correct combination, the solenoid operates as before and the transistor remains cut off. If, however, the switches are at an incorrect combination, pressing the button causes current to flow into the transistor base via the solenoid coil and the 4.7kΩ resistor once more, and the relay energises. The contact set A2 changes over and connects the lower side of the relay coil to the negative supply so that the relay remains latched in the same way as it was in the previous circuit. The important change now is that contact set A2 also breaks the negative supply connection to the switches, so that they cannot possibly cause the solenoid to be operated."

"That's the best circuit of the lot," said Dick appreciatively. "What sort of relay should I use?"

"Pretty well any relay which has the requisite contact sets will do," said Smyth, "and it's advisable to choose one which doesn't draw an excessive energising current. When the transistor is a BC107 the energising current must not exceed 100mA. In practice you should be able to find a relay with a much lower energising current. The supply can have any voltage between 6 and 12 volts or so which suits the relay and the solenoid. The current drawn from the supply when the push-button is not pressed is only

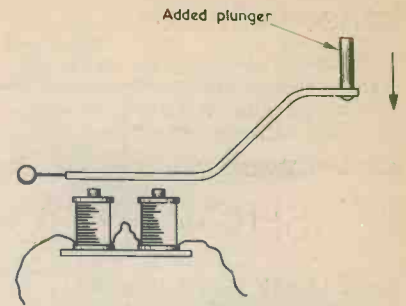

Fig. 7. For mechanically light applications, the locking device may consist of an electric bell modified as shown here. Connection is made direct to the coil of the bell

leakage current in the transistor and this will be negligibly low."

"How do I get hold of a suitable solenoid?"

"You have to use a bit of ingenuity so far as that is concerned. Solenoids are advertised from time to time by dealers of job lot components. Alternatively, you could try to make one up yourself. At a pinch you could even adapt an old electric bell by removing the gong and making a connection to the bell coil only. A small plunger could then be attached to the bit which strikes the gong. Provided there was no mechanical strain on the plunger this could function as a bolt securing a small box or case." (Fig. 7).

"That seems to button that up, then," said Dick happily. "This Christmas Eve has certainly opened my eyes for me. Not only have I now got a combination lock circuit to work with but I've also been able to hear about your secret war work. That's quite a coincidence, too, because I happened to be talking to my uncle about you and the war when I met him this morning."

A shadow crossed Smyth's face.

"Were you?" he asked anxiously.

"Yes," replied Dick. "He told me that you spent all the war working for NAAFI!"

"Zounds," muttered Smyth. "my cover is blown!"

"I'm not too sure, though," continued Dick artlessly, "what the letters NAAFI stand for."

Smyth seized his chance.

"One of the best kept secrets of the last war," he said quickly, "was the fact that there were two NAAFI organisations. One of these served out tea and cakes and things like that and, as everyone in the Services knew, the letters stood for No Ambition And Fleeting Interest. It was the second, covert, NAAFI that I worked for."

"And what did the letters stand for there?"

"Navy, Army and Air Force Intelligence!"

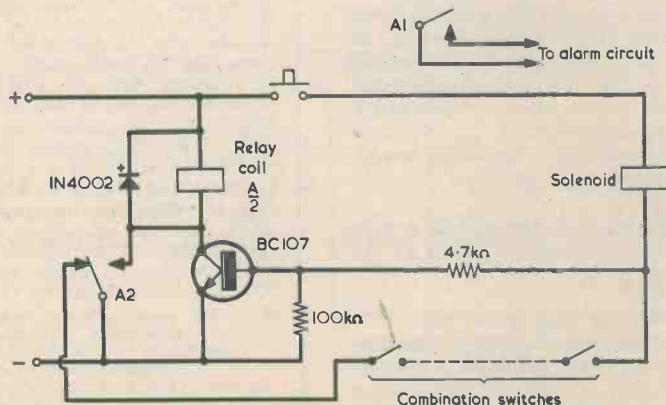

Fig. 6. An improved version which not only sounds an alarm for an incorrect combination selection but also disables the combination switches



## SEASONAL SPIRIT

Dick turned a gaze of newly formed respect on the Serviceman. "I'm certainly looking forward to working with you in the future," he

said admiringly. "Blimey, I keep forgetting that it's Christmas. So, a Merry Christmas to you, Smithy."  
"And the same to you, Dick," returned Smithy warmly. "This is just the right time, too for us to wish

a truly Merry Christmas and a really prosperous New Year to all the readers who've put up with our capers over the last twelve months."  
"God bless us," concluded Dick. "God bless us, everyone!" ■

## SHORT WAVE NEWS continued from page 315

### ● MAURETANIA

Nouakchott on **4845** at 2355, OM with Moslem chants, announcements and off at 2400 with the National Anthem. The weekday schedule is from 0600 to 0900 and from 1800 to 2310 (Friday and Saturday until 2400); Sunday from 0600 to 0900 and from 1700 to 2400. The power is 100kW and there is an English programme from 1900 to 1930.

### ● CONGO

RTV Congolaise, Brazzaville, on **4765** at 0434, OM with a talk in French. The schedule is from 0400 to 0700 and from 1700 to 2300 but the closing time can vary up to 0100. There is an English programme at 2130 and the power is 50kW.

### ● GUINEA

Conakry on **4910** at 0118, Arabic-type music. The schedule is from 1230 to 0730 and the power is 18kW.

### ● LEBANON

Radio Lebanon, Beirut, on **11965** at 0240, YL with a newscast in English in the programme directed to North America, scheduled from 0230 to 0300.

### ● COLOMBIA

Emisora Nuevo Mundo, Bogota, on **4755** at 0428, OM with a talk about Colombian affairs in Spanish. This one has a power of 1kW and radiates around the clock.

Radio Bucaramanga on **4845** at 0335, OM with a love song (heart-rendering at that!) in Spanish. The schedule is from 1000 to 0400 and the power is 1kW.

Radio Surcolombiana, Neiva, on **5010** at 0346, OM with pop song in Spanish. The schedule is around the clock and the power is 2.5kW.

### ● PERU

Radio Chinchaycocha, Junin, on **4860** at 0455, local folk music, OM with 'noticias', identification at 0501. The schedule is from 1100 to 0730 but sometimes around the clock and the power is 0.5kW.

Radio Atlantida, Iquitos, on **4790** at 0425, OM with a love song in Spanish. The schedule is from 0400 to 0600 and the power is 1kW.

### ● ECUADOR

Radio Nacional Espejo, Quito, on a measured **4679** at 0117, OM with a sports commentary in Spanish. The schedule is around the clock but it has been reported sometimes closing at 1600. The power is 5kW.

Radio Quito on **4920** at 0342, OM with news of Latin America — especially Colombia — in Spanish. The schedule is from 1030 to 0500 and the power is 10kW.

### ● BRASIL

Radio Nacional, Boa Vista, on **4835** at 0357, OM with a ballad in Portuguese, identification at 0400 followed by choral National Anthem — all four minutes of it!

Radio Jornal do Brasil, Rio de Janeiro, on **4875** at 0352, OM with announcements about 'futebol' (football) followed by a programme of typical Latin American music.

### ● NETHERLANDS ANTILLES

Bonaire on **11710** at 0459, OM with identification at the close of the English transmission to Europe.

### ● CHINA

Urumchi on **5060**, at 2340, OM with physical exercises to music in the Mongolian Service.

Radio Peking on **9860** at 1432, YL with the English programme to South Asia, scheduled from 1400 to 1500.

Radio Peking on **9440** at 1505, YL with the programme in Standard Chinese to South Asia and South East Africa, scheduled here from 1500 to 1600.

Radio Peking on **9880** at 1444, YL with the Sinhalese programme, scheduled from 1430 to 1500.

Radio Peking on **11445** at 1500, OM opening the Nepalese programme, scheduled from 1500 to 1530.

### ● YEMEN

San'a on a measured **4853** at 1825, drama in Arabic in the Domestic Service, scheduled here from 0300 to 0700 and from 1000 to 2105 except Friday when times are from 0300 through to 2105. Also to be heard in parallel on **9780**.

### ● AFGHANISTAN

Kabul on **4775** at 0135, YL with announcements, local music in the Home Service 1 programme, scheduled from 0100 to 0330 and from 1230 to 1740 (except from 1300 to 1530 when the Foreign Service operates on this channel — the English programme is from 1400 to 1430). The power is 100kW.

### NOW HEAR THESE

Radio del Pacifico, Lima, Peru, on **4975** at 0331, OM with identification, announcements in Spanish, plaintive flute music, acoustic echo on announcements.

Radio Loreto, Iquitos, on **5050** at 0439, trumpet fanfare, OM identification in Spanish, OM love song, full identification at 0500.

PLEASE MENTION RADIO & ELECTRONICS CONSTRUCTOR  
WHEN REPLYING TO ADVERTISEMENTS

### TRANSFORMERS

Primary 240V		
6-0-6V	100mA	£0.75
9-0-9V	75mA	£0.75
12-0-12V	50mA	£0.85
12-0-12V	100mA	£1.05
Post on above transformers 30p		
9-0-9V	1A	£1.80
12-0-12V	1A	£2.15
15-0-15V	1A	£2.38
6-3V	1½A	£1.80
6-0-6V	1½A	£2.20
Post on above transformers 45p		
9-0-9V	2A	£2.75
12V	2A	£2.40
Post on above transformers 86p		

### PANEL METERS

42 x 42mm — and 500uA	
£3.65 post 13p	
60 x 45mm — 50uA, 100uA, 500uA, 1mA, 5mA, 10mA, 50mA, 100mA, 500mA, 1A, 2A; 25V DC, 50V DC, 300V AC, 'S' meters, VU meters, 50-0-50uA, 100-0-100uA, 500-0-500uA	
£8.16 post 13p	
4½ x 3½ — 30uA, 50uA, 100uA, 200uA of 500uA	
£6.40 post 19p	

All above prices include V.A.T. Special prices for quantity quoted on request.

### MICROPHONES FOR TAPE RECORDERS

DM228R 200 ohm with 3.5 and 2.5mm jack plug	£1.42
DM229R 50K with 3.5 and 2.5mm jack plug	£1.60
DM18D 200 ohm with 5 and 3 pin DIN plug	£1.75
Postage on above microphones 13p	

### CARDIOID DYNAMIC MICROPHONES

Model UD-130 frequency response 80-14,000Hz. Impedance dual 50K and 600 ohm £8.02 post 36p  
 UD147 frequency response 50-15,000Hz. Impedance dual 50K and 200 ohm. £13.85 post 36p  
 6V BUZZERS 50mm diameter, 30mm high. Very loud. 52p post 9p

### MULTIMETER

Model ITI-2 20,000 ohm/volt	£11.99 post 33p
LT22 20,000 ohm/volt.	£12.32 post 33p

Send 40p for New Autumn 1978 Fully Illustrated Catalogue.

## M. DZIUBAS

158 Bradshawgate · Bolton · Lancs. BL2 1BA

# FLADAR DUAL VOLTAGE TRANSFORMERS

PRIMARY 220-240 50HZ ALTERNATIVE SECONDARY VOLTAGE AND CURRENT AVAILABLE BY SERIES OR PARALLEL CONNECTION

Type	Voltage	Current	£	p/p	Type	Voltage	Current	£	p/p
08FE06	6+6	0.5A each	1.50	50p	08FE24	24+24	0.15A each	1.80	50p
08FE06	6+6	0.6A each	1.80	50p	12FE24	24+24	0.2A each	2.00	60p
12FE06	6+6	1A each	2.00	60p	20FE24	24+24	0.4A each	2.60	70p
20FE06	6+6	1.6A each	2.60	70p	50FE24	24+24	0.8A each	3.10	70p
50FE06	6+6	3A each	3.10	70p	60FE24	24+24	1.2A each	3.60	85p
60FE06	6+6	4A each	3.60	85p	80FE24	24+24	1.5A each	4.50	1.00
06FE09	9+9	0.3A each	1.50	50p	50FE28	28+28	0.75A each	3.10	70p
08FE09	9+9	0.5A each	1.80	50p	60FE28	28+28	1.1A each	3.60	85p
12FE09	9+9	0.75A each	2.00	60p	80FE28	28+28	1.4A each	4.50	1.00
20FE09	9+9	1A each	2.60	70p	20FE30	30+30	0.35A each	2.60	70p
50FE09	9+9	2.5A each	3.10	70p	50FE30	30+30	0.75A each	3.10	70p
60FE09	9+9	3A each	3.60	85p	60FE30	30+30	1A each	3.60	85p
08FE12	12+12	0.25A each	1.50	50p	80FE30	30+30	1.2A each	4.50	1.00
08FE12	12+12	0.3A each	1.80	50p	<b>CHARGER TRANSFORMER</b>				
12FE12	12+12	0.5A each	2.00	60p	48FE12	0-8-12	4A	3.10	70p
20FE12	12+12	0.8A each	2.60	70p	66FE12	0-6-12	6A	3.80	85p
50FE12	12+12	2A each	3.10	70p	70FE12	0-6-12	6A	4.86	1.00
60FE12	12+12	2.5A each	3.60	85p	<b>MULTI-TAP RANGE</b>				
80FE12	12+12	3A each	4.50	1.00	Voltage Available: 3, 4, 5, 6, 8, 9, 10, 12, 15, 18, 12-0-12 or 15-0-15				
08FE15	15+15	0.2A each	1.50	50p	30FE30	0-12-15	1A	3.40	70p
08FE15	15+15	0.25A each	1.80	50p	24-30				
12FE15	15+15	0.4A each	2.00	60p	60FE30	0-12-15	2A	3.70	85p
20FE15	15+15	0.6A each	2.60	70p	24-30				
50FE15	15+15	1.6A each	3.10	70p	80FE30	0-12-15	3A	4.50	1.00
60FE15	15+15	2A each	3.60	85p	24-30				
80FE15	15+15	3A each	4.50	1.00	100FE30	0-12-15	4A	5.60	1.15
06FE20	20+20	0.15A each	1.50	50p	24-30				
08FE20	20+20	0.2A each	1.80	50p	<b>CENTRE TAP SECONDARY</b>				
12FE20	20+20	0.25A each	2.00	60p	FE05	6-0-6	1A each	2.00	60p
20FE20	20+20	0.5A each	2.60	70p	FE09	9-0-9	1A each	2.60	70p
50FE20	20+20	1.2A each	3.10	70p	FE12	12-0-12	1A each	2.60	70p
60FE20	20+20	1.5A each	3.60	85p	FE15	15-0-15	1A each	3.10	70p
80FE20	20+20	2A each	4.50	1.00	FE20	20-0-20	1A each	3.10	70p

### FLADAR ELECTRIC

P.O. Box 19 Westcliff-on-Sea, Essex O702-613314

Trade enquiries welcome. Please enquire for other types not shown. Payment terms: C.W.O. Cheques, Postal Orders, please add 8% VAT after post and packing.

<b>AIR CORED AUDIO CROSS OVER COILS</b>			
FE01	0.1mH	0.26	20p
FE03	0.3mH	0.26	20p
FE05	0.5mH	0.30	20p
FE10	1.0mH	0.60	25p
FE26	2.0mH	0.75	30p

## International Recruitment Services (UK) Ltd

### Design Engineers — Electronics

*The South East*

*£4,500 - £7,500*

We have been tasked to recruit 12 people to join a team of highly qualified, experienced and enthusiastic men and women. The posts offer tremendous scope to engineers with a bent for following through their own designs, from inception to post-production development in the field of electronics.

#### The Engineers

Applicants with a practical bias to design are the most suited. Age is of no concern nor is experience, since good theoretical knowledge can balance out lack of design experience. Candidates should be qualified to a minimum of HNC. Above all they should have the ambition to succeed either as pure engineers or in management as prospects are good for both.

#### The Company

One of the best known and most respected companies in its field with worldwide markets to which engineers often travel. It is situated in some of England's most attractive countryside within easy reach of both London and the South Coast. Working conditions are modern and comfortable with excellent design back-up facilities.

The terms and conditions of employment are those expected of a company of this size and generous relocation expenses will be paid. To find out more, male and female candidates should telephone us for an informal discussion as soon as they have read this advertisement on Basingstoke (0256) 51612. Please quote IRS 647.

To apply, please write giving details of age, career and qualifications to:

**International Recruitment Services (UK) Ltd**  
 48-54 New Market Sq.  
 Basingstoke, Hampshire











## SMALL ADVERTISEMENTS

(Continued from page 323)

**FIFTEEN CMOS PROJECTS** — Mystery Maze; 70 mph. Alarm; AF/RF Signal Generator; Fifteen detailed circuits plus 14-pin socket and kits Voucher. Send £1 to David Ian Designs, 47 Hampton Court Parade, East Molesey, Surrey.

**FOR SALE:** Tins of switch cleaner 50p. Please add postage. Box No. G365.

**I.C.'s ITT 7273 9099 JK Flip Flops** 10p each. Mullard 7306, Mullard 7241, Signetics S7425, LU320k. 10p each. All brand new. Add 15p post. All i.c.'s offered at 11 for £1. Jack Simpson, 35 Cattlemarket Street, Norwich, Norfolk.

**FOR SALE:** *Fundamentals of Radio Servicing* by B. W. Hicks, published by Hutchinsons Educational, £2.20 post paid. *Handbook of Satellites and Space Vehicles* by R. P. Haviland, £3.50 post paid. *FM and Repeaters for the Radio Amateur*, published by ARRL, £1.25 post paid. Box No. G366.

**ATTENTION SWL'S & DXERS.** PRS 1 RF Preselector employs silicon FET front end with silicon NPN broadband rf amp. High Q coils tuned by precision capacitor. Will substantially improve most receivers performance over 1.5-30MHz. Gives improved signal/noise ratio with an average gain of 30dbs. Also helps selectivity and image rejection. Size: 8 x 5½ x 2½ inches. 9V operation. We also manufacture items of interest to MW DXers. S.A.E. for details of all above please. AMTEST, 55 Vauxhall Street, Worcester, WR3 8PA.

**GOOD PRICES** for recent Electronics/Computing/Radio books and magazines. Projects, theory etc. — Details to M. Hart, 41 Luton Place, Edinburgh, Scotland EH8 9PF.

**JOIN THE INTERNATIONAL S.W. LEAGUE.** Free services to members including Q.S.L. Bureau, Amateur and Broadcast Translation, Technical and Identification Dept. — both Broadcast and Fixed Stations, DX Certificates, contests and activities for the SWL and transmitting members. Monthly magazine, *Monitor*, containing articles of general interest to Broadcast and Amateur SWLs, Transmitter Section and League affairs, etc. League supplies such as badges, headed notepaper and envelopes, QSL cards, etc., are available at reasonable cost. Send for League particulars. Membership including monthly magazines, etc., £3.75 per annum. (U.K. and British Commonwealth), overseas \$10.00 or £4.00. Secretary ISWL; 1 Grove Road, Lydney, Glos., GL15 5JE.

**FOR SALE:** Bound Volumes *Radio Constructor* Nos. 16-27 (1962 to 1974). £3.00 per volume ono. Box No: G367.

**100Mhz F.M. Micro-Transmitter kit.** C. 100 yds. range. Unlicensable £2.95 plus 25p p&p. P. Faherty, 4 Angus Drive, South Ruislip, Middlesex.

**WANTED:** Codar R.Q.10 (or 10X) Q. Multiplier/Filter. Telephone: Maidstone 77331.

**INTERESTED IN OSAR?** Then join AMSAT-UK. Newsletters, OSCAR NEWS Journal, prediction charts, etc. Details of membership from: Ron Broadbent, G3AAJ, 94 Herongate Road, Wanstead Park, London, E12 5EQ.

**FOR SALE:** Avometer £7.00. Electro-magnetic counters 25p, postage 25p. Key chain radio, non-working, £1.50. Cassette recorder, non-working, £3.00. Box No. G368.

**FOR SALE:** Viscount X125 electronic organ, with separate Leslie speaker, 2-manual foot pedals, percussion, rhythm box. Matching stool, £450 o.n.o. T. F. Weatherley, 16 Beverley Court, Carlton Colville, Lowestoft, Suffolk. Telephone: Lowestoft 63216.

(Continued on page 326)

# ELECTROVALUE

All the many types of components we supply are **BRAND NEW** and guaranteed and only from manufacturers direct or approved suppliers. *No surplus, no seconds*

### I.C.s — TTL 7400 series

7400	14p	7414	60p	7454	14p	7485	74p	74107	27p
7401	14p	7420	14p	7460	14p	7486	27p	74121	27p
7402	14p	7430	14p	7470	24p	7490	40p	74123	51p
7403	14p	7440	14p	7472	24p	7491	71p	74141	54p
7404	18p	7442	54p	7473	23p	7492	46p	74151	60p
7405	14p	7443	60p	7474	23p	7493	40p	74154	£1.60
7407	22p	7444	60p	7475	46p	7494	66p	74190	94p
7408	18p	7447	70p	7476	32p	7495	57p	74191	74p
7409	18p	7450	14p	7480	41p	7496	63p	74192	94p
7410	14p	7451	14p	7482	61p	74100	73p	74193	94p
7413	22p	7453	14p	7483	58p	74104	4p		

### OUR COMPUTER TAKES GOOD CARE OF YOUR ORDERS!

#### SIEMENS CAPACITORS\*

World-famous for quality and dependability.

#### PCB TYPES

— 7.5mm PCM 0.001 to 0.015 6p each; 0.022 to 0.047 7p each. 5mm PCM 0.068-8p, 0.1-9p. 0.22-12p.

#### CERAMIC

2.5mm PCM 0.01-4p. 0.022, 0.033, 0.047 5p each, 0.068-6p, 5mm PCM 0.1-7p.

#### ELECTROLYTICS

— 1/100, 10/25, 10/63, 100/25, etc. For full range see our current lists.

#### RESISTORS

½, ¼, ⅓ watts — 2p each\* metal film, metal oxide and 1 watt carbon 5p each\* — *good quantity discounts.* Magnetic field dependent from £1.50. Hall Effect from £1.23.

#### SIEMENS TRANSISTORS

Silicon npn and pnp from 8p each; LEDs, red 19p; yellow or green from 23p (3 or 5mm); Photo transistors from 76p.

#### DISCOUNTS

5% if list value of order over £10; 10% if list value of order over £25 — where cash (P.O. or cheque) is sent with order.

\*V.A.T. Add 8% to value of order or 12½% with items marked\* (No V.A.T. on overseas orders). Good sent post free on C.W.O. orders in U.K. over £5 list value. If under, add 27p per order.

#### MONTHLY BARGAIN LISTS

S.A.E. brings monthly list of bargains. Also current quick reference price list of all ranges.

### KEEN PRICES — GOOD SERVICE — WIDE RANGES

Cash with order (P.O. or cheque payable to Electrovalue Ltd) or your Access or Barclaycard number. **TRADE AND INDUSTRIAL ENQUIRIES INVITED**

For all round satisfaction — Be safe — buy it from **ELECTROVALUE LTD**

## ELECTROVALUE LTD

Dept RC1, 28 St Jude's Rd, Englefield Green, Egham, Surrey TW20 0HB. Phone Egham 3603. Telex 264475.

Northern Branch (Personal shoppers only) 680 Burnage Lane, Burnage, Manchester M19 1NA. Phone (061) 432 4945.

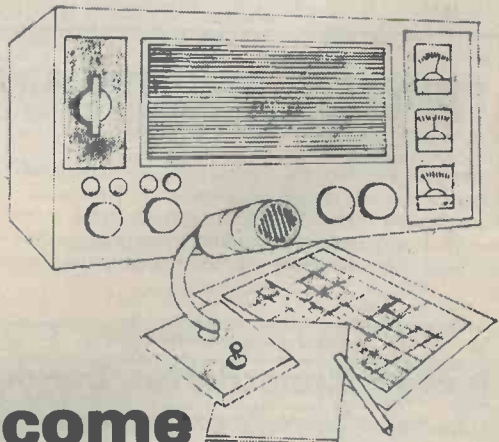

## Become a radio amateur.

Learn how to become a radio-amateur in contact with the whole world. We give skilled preparation for the G.P.O. licence.

WAA

REK 1/79

Brochure, without obligation to:  
**BRITISH NATIONAL RADIO & ELECTRONICS SCHOOL**

P.O. Box 156, Jersey, Channel Islands.

NAME \_\_\_\_\_

ADDRESS \_\_\_\_\_

(Block caps please)



## DISCOUNT BOXES, INSTRUMENT CASES AND COMPONENTS

Aluminium box with lid and screws			Professional black P.V.C. coated case with satin anodised front panel and trim			Black P.V.C. top with U-shaped aluminium chassis		
L	W	H	W	D	H	L	W	H
3 x 2 x 1		44p	9 x 6 x 3	443p	12 x 8 x 3	6 x 4 1/2 x 2	134p	
4 x 3 x 1 1/2		52p	9 x 6 x 4 1/2	479p	12 x 8 x 4 1/2	6 x 4 x 3 1/2	145p	
4 x 3 x 2		60p	9 x 6 x 6	512p	12 x 8 x 6	8 x 5 1/2 x 2 1/2	165p	
6 x 4 x 2		87p	12 x 8 x 3	544p		10 x 6 1/2 x 3 1/2	215p	
8 x 6 x 2		105p	12 x 8 x 4 1/2	618p				
8 x 6 x 3		118p	12 x 8 x 6	660p				
AD181/2 MP		83p	BC347A		14p	BF274		24p
OC36		60p	BD183		80p	BF394		30p
BC108A		9p	BD263A		42p	BF422		20p
BC148		8p	BF137		24p	LM741C		17p
BC149C		9p	BF194		10p	TBA120A		75p
BC154		9p	BF195		10p	SN78013N		120p
BC371B		9p	BF198		21p	SN78033N		120p
BC172B		9p	BF200		21p	SN78110N		75p
BC183A		10p	BF255		23p	SN78131N		150p
BC308		15p	BF256 FET		33p	SN78680N		75p
AXIAL ELECTROLYTIC			220/16v	11p	22/50v	8p		
10/25v	5p	330/10v	12p	33/63v	9p			
15/16v	6p	330/25v	10p	47/16v	7p			
22/10v	5p	330/63v	16p	100/18v	8p			
22/16v	6p	470/16v	15p	220/16v	11p			
22/25v	7p	100/25v	15p	220/40v	12p			
33/35v	8p	2000/30v	20p	220/63v	16p			
33/60v	9p			330/10v	12p			
47/40v	10p	P.C. MOUNTING			330/25v	12p		
100/10v	8p	10/25v	6p	470/25v	15p			
100/63v	10p	10/50v	7p	1000/35v	19p			

Ceramic Filters SEF 6.0MA 40p  
TV Colour Crystals 4.433619 MHz 1.50p  
MIXED PACK OF 100 AXIAL AND P.C. ELECTROLYTICS 300p  
**DISCOUNT ON ALL ORDERS OVER £5 — 5%  
OVER £10 — 10% OVER £20 — 15% OVER £30 20%**  
All prices include post and packing.  
All orders under £1. please add 20p for handling charge.

**HARRISON BROS.**  
P.O. BOX 55, WESTCLIFF-ON-SEA, ESSEX S60 7LQ  
PHONE: SOUTHEND 32338

## PRINTED CIRCUITS AND HARDWARE

Comprehensive range Constructors' hardware and accessories. Selected range of popular components. Printed circuit boards for individual designs. Drawing materials for printed circuits. Resist coated laminate, epoxy glass for the d.i.y. man. Full processing instructions, no unusual chemicals required.

Send 15p for catalogue

**Ramar Constructor Services**  
Masons Road · Stratford-on-Avon · Warwick CV37 9NF

SINCLAIR PRODUCTS Microvision tv £90 PDM35 £27.2B. Mains adaptor £3.24, Case £3.25. DM235 £48.30. Rechargeable battery units £8. Adaptor/charger £3.70. Case £8.80. Cambridge prog. calculator £13.16. Prog. library £3.45. Mains adaptor £3.20. Enterprise prog. calculator £20.95.  
COMPONENTS. Send s.a.e. for full list. 1 lb FaC1 £1.05. Delco pen 73p. 80 sq ins pcb 55p. Laminate cutter 75p. Small drill 20p. zn414 £1.05. pcb and exte parts for radio £3.85. Case £1. 1N4148 1.4p. 1N4002 3.6p. 741 15p. NE555 23p. bc182b, bc183b, bc184b, bc212b, bc213b, bc214c 4.5p. Plastic equivs. bc107, bc109, bcv71, bcv72 4.5p. 1W 8% E12 resistors 10R to 10M 1p 0.5p for 50+ of one value. 18v electrolytics 5/12/5/10/22mf 5p. 100mf 6p. 1000mf 10p. Polyesters 250v 018, .088, .1mf 11p. Ceramics 50v E6 22pf to 47n 2p. Polystyrenes 63v E12 10pf to 10n 3p. Zeners 400mW E24 2v7 to 33v 7p.

TV GAMES. Send s.a.e. for data. AY-3-8500 + kit £8.95. AY-3-8600 + kit £12.50. Tank battles chip £8.90. kit £7.05. Stunt cycle chip £8.90, kit £5.80. Rifle kit £4.95.

**SWANLEY ELECTRONICS**

(Dept. REC) 32 Goldscl Road,  
Swanley, Kent.  
Post 30p extra. Prices include VAT.

TRANSFORMERS. 6-0-6v 100ma 74p. 1 1/2 £2.35. 6.3v 1j £1.89. 9-0-9v 75ma 74p. 1a £2.2a £2.80. 12-0-12v 100ma 90p. 1a £2.49.  
IC AUDIO AMPS with pcb Jc12 6v £1.80. Jc20 10W £2.95. Jc40 20W £3.95.  
BATTERY ELIMINATORS 3-way type 8/7 1/2 300 ma £2.95. 100ma radio type with pre-studs 9v £3.35. 9+9v £4.50. Stabilized type 3/6 1/2 9v 400ma £6.40. 12v car converters 3/4 1/2 7 1/2 9v 800ma £2.50.  
BATTERY ELIMINATOR KITS. Send s.a.e. for data. 100ma radio types with pre-studs 4 1/2v £1.80. 6v £1.80. 9v £1.80. 4 1/2+4 1/2v £2.50. 6+6v £2.50. 9+9v £2.50. Stabilized 8-way types 3/4 1/2 9/12/15/18v 100ma £3.80. 2-30v 1A £8.95. 2-30v 2a £10.95. 12v car converter 8/7 1/2 1a £1.88.  
T-DEC AND CBC BREADBOARDS. s-dec £3.17. t-dec £4.02. u-deca £4.40. u-decb £7.08. 18 dll adaptor £2.14. exp300 £8.21. exp 350 £3.40. exp650 £3.89. exp4b £2.48.  
81-PAK AUDIO MODULES. +450 £23.51. AL60 £4.86. pa100 £18.71. spm80 £4.47. bml80 £8.95. Stereo 30 £20.12.

## SMALL ADVERTISEMENTS

(Continued from page 325)

**FOR SALE:** Volumes 10, 11 and 13 *Radio Constructor*, £3.00 per volume. Telephone: 06755-2342.

**NOT THE CHEAPEST — THE BEST!** Quality, low noise, high output Cassette Tapes, with free library case, index. C60, 5 for £2.87, 10 for £4.95. Sample tape 62p. C90, 5 for £3.46. 10 for £5.95. Sample tape 72p. VAT paid. Add 15% for postage. Money back guarantee. Sigtronic Electronics, 27 Malvern Street, Stapenhill, Burton-on-Trent, Staffs.

**FOR SALE:** Phillips VCR1700 £700.00 Sinclair microvision pocket television £200.00. Box No. G369.

**FOR SALE:** Integrex "Texan" tuner-amp. £50. Transcription turntable McDonald 810, £20. Goldring G800, £4. 10 watt chassis speakers, 3-way, £25. Mullard 10 watt amp. £3. F.M. Tuners £8 and £12. Metal detector parts £1. Collaro tape deck £5. Mullard 5-10 valve amp. £3. Alphaphone £3. Goodmans Axiom-10, £3. Dolby PCB £5. DNL £1. Active crossover £2. Car cassette, faulty, £3. Postage extra. — 75 Central Avenue, Northfield, Birmingham B31 4JA.

**SOLDERING IRONS.** 240V, 40W, £2.10 plus 25p post. Transistors 100 for 98p, postage 15p. W. Higgins Electrical, 35 Cattle Market Street, Norwich, Norfolk.

**CLEARING BOOKSHELF.** Bound Volumes *Radio Constructor* and recent books on electronics. S.A.E. for list. Box No. G370.

**ELECTRIC SHOCK MACHINES.** Battery operated, harmless. £1.95 inclusive. P. Faherty, 4 Angus Drive, South Ruislip, Middlesex.

**POSTAL ADVERTISING?** This is the Holborn Service. Mailing lists, addressing, enclosing, wrapping, facsimile letters, automatic typing, copy service, campaign planning, design and artwork, printing and stationery. Please ask for price list. — The Holborn Direct Mail Company Capacity House, 2-6 Rothsay Street, Tower Bridge Road, London, S.E.1. Telephone: 01-407 6444.

**FOR SALE:** Approx. 10 lbs mixed capacitors £5.00. 10 lbs mixed components, etc. £5.00. Tins switch cleaner 50p. Postage 25p. 12in steel rules 50p. Level meter 50p. Box No. G371.

**FOR SALE:** 1000 mixed resistors £1.00. 100 high wattage resistors 50p. 25 2W zeners 50p. Stereo cassette mechanisms £10 and £15. J. Fulton, Derrynaseer, Dromore, Co. Tyrone, N. Ireland.

**FOR SALE:** *Radio Constructor* 1954 to 1966. 12 Bound Volumes. V.G.C. £35. Telephone: Beaconsfield 3118 (evenings).

**WANTED:** FAX equipment, manuals, service sheets, etc. G2UK, 21 Romany Road, Oulton Broad, Lowestoft, Suffolk. NR32 3PJ.

**LEARN CODE THE EASY WAY.** No. 1 Cassette fundamentals. No. 2 Practice 10-16 wpm. No. 3 Practice 18-20 wpm. C.90 cassettes. £3.75 each. P&P 30p. R. Eastland, 50 Heath Road East, Petersfield, Hants., GU3 14HN.

**110 INTEGRATED CIRCUIT PROJECTS** for the home constructor. 128 pages. By R. M. Marston. £3.70. From Bacca Electronics, Box No. G372.

**RECITALS OF RECORDED MUSIC.** The second Saturday evening of each winter month. Next recital: December 9th, 1978, 8 p.m. at Woodford Green United Free Church, Woodford Green, Essex. Bus routes 20, 20A, 179 & 275 — alight at "The Castle" stop. Programme includes works by Ravel, Langlais and Gelineau.

(Continued on page 327)



## SMALL ADVERTISEMENTS

(Continued from page 326)

**COMPONENTS:** Bargains for Radio & Mechanical Engineers. Clearance lines, regular lists, from: **SOUND SYSTEMS**, 676 Foxhall Road, Ipswich, Suffolk.

**HOME REPAIR MEN.** Send now for your bumper box of electrical spares and interesting items. New, but slightly shop soiled. They are valued at £12+. Just £5 plus £1 P. & P. **ELECTRONIC CONSTRUCTORS.** Send now for your bumper box of electronic spares, full of everything you will need to boost your stock. £5 plus £1 P. & P. Mail order only to: **Bacca Electronics**, 34 Keats Close, Wootton Bassett, Wiltshire. Terms C.W.O. please.

**CASSETTE TAPES**, C60, six for £1.60. C90, four for £1.60. Case and index included. VAT Paid. Please add 10% postage. West, (A1), 56 Frankwell Drive, Coventry, CV2 2FB.

**FOR SALE:** *Radio Constructor* from No. 1 (1947) to 1977. 30 volumes. Mostly bound. £90. Wilson, 54 Chepstow Villas, London W.11.

## PERSONAL

**JANE SCOTT FOR GENUINE FRIENDS.** Introductions to opposite sex with sincerity and thoughtfulness. Details free. Stamp to: **Jane Scott**, 3/Con North St. Quadrant, Brighton, Sussex, BN1 3GJ.

**BROADLANDS RESIDENTIAL CLUB** for elderly people. Are you recently retired and looking for a home? We have a delightful top floor room overlooking Oulton Broad, facing south. Write to: **The Warden**, Broadlands Residential Club, Borrow Road, Oulton Broad, Lowestoft, Suffolk.

**SPONSORS** required for exciting scientific project **Norwich Astronomical Society** are building a 30" telescope to be housed in a 20' dome of novel design. All labour being given by volunteers. Already supported by Industry and Commerce in Norfolk. Recreational. Educational. You can be involved. Write to: **NAS**, Secretary, 195 White Woman Lane, Old Catton, Norwich, Norfolk.

**IF YOU HAVE ENJOYED A HOLIDAY** on the Norfolk Broads, why not help to preserve these beautiful waterways. Join the **Broads Society** and play your part in determining Broadlands future. Further details from: — **The Hon. Membership Secretary**, **The Broads Society**, "Icknield," Hilly Plantation, Thorpe St. Andrew, Norwich, NOR 85S.

## CHESTER ELECTRONICS

CONVERGENCE POTS: 20n, 22n, 30n, 33n, 60n, 120n, 250n. All at 5p each or 100 mixed for £3.

AC128	16p	BC125	10p	BRY39	26p	1S44	4p
AC187K	25p	BC147B	7p	BU208	£2.00	1N914	2p
AD161	35p	BC184C	7p	BFY50	15p	1N4148	3p
AD162	35p	BD131	34p	BFY52	15p	0A47	10p
AD149	50p	BD132	34p	BFY53	15p	0A200	8p
AU110	£1.00	M/Pair	82p	TIP32C	50p	1N4001	4p
BC107	8p	BD238	45p	2N3055	35p	1N4004	5p
BC108	8p	8F262	30p	OC45	25p	1N4006	8p
BC109	8p	8FX89	20p	OC72	30p	1N4007	7p

Belling Lee Flush mounted 2-Gang Coaxial Outlets (Complete with screws) (Type L1481/R) **SPECIAL CLEARANCE PRICE**, 50p each

Belling Lee Flush Mounting Diplexer (UHF & VHF) (Complete with screws) (Type L1893) **SPECIAL CLEARANCE PRICE**, 75p each

Belling Lee Flush Mounting Twin Coaxial Outputs, Type L1704 (complete with screws) **SPECIAL CLEARANCE PRICE** 75p each

Zener Diodes 400mW: 4V7, 5V1, 11V, 13V5, 24V, 30V  
8p each, 50 for £3.50, 100 for £5.00

Axial 25µ 24V	4p	Axial 200µ 6V	5p	Tantalum Beas Capacitors	
Axial 1.0µ 63V	5p	Axial 220µ 80V	15p	1+	100+
Axial 15µ 450V	20p	Axial 640µ 25V	20p	0.1µ 35V	10p 8p
Axial 47µ 160V	10p	Tag 4700µ 18V	30p	0.22µ 35V	10p 8p
Axial 100µ 80V	10p	Tag 3500µ 30V	25p	0.47µ 35V	10p 8p
Radial 100µ 10V	5p	Tag 10000µ 25V	40p	68µ 3V	10p 8p

**SMITH** small clock motors. Mains 50V 2W (Brand new and unused) £1.00 each  
**Metal Rotary Pots** 10 for £1.00 (Advise us of value preferred and we will send it or the nearest available)

**SPECIAL OFFER:** BFY50, BFY51, BFY52. (All new, full spec. marked etc) 10 for £1.45, 50 for £7.00, 100 for £12.50

**WHITE IN LINE, CAR RADIO TYPE, FUSEHOLDERS.** 5p each, 100 for £4.00  
4 core Curly leads (unscreened) stretch from 3' to 8'. 30p each

**SPECIAL OFFER:** 741 8 pin DIL, Brand New, marked, full spec, etc) 1-18p, 50 for £8.00, 100 for £15.00

Hunts Capacitor, Axial 0.0015µ 400V only 5p each

Tubular Ceramic Capacitors, 100 for £1.00 (Our mix but all low of values)

*Do not add any VAT to the above prices. Only add 15p P&P for your total order. No callers please as we have no retail facilities.*

Send your orders to:

**DEPT. DP9 CHESTER ELECTRONICS**  
6 HUNTER STREET, CHESTER. CH1 2AU

## BUILD YOUR OWN

### P.A. GROUP & DISCO SPEAKERS by R. F. C. Stephens

Save money with this practical guide. Plans for 17 different designs, Line source, I.B., Horn and Reflex types, for 8"-18" drive units. £3.95 post free (\$8 overseas).

### THE DALESFORD SPEAKER BOOK by R. F. C. Stephens

This book is a must for the keen home constructor. Latest technology DIY designs. Plans for I.B., and Reflex designs for 10-100 watts. Also unusual centre-bass system. £2.20 post free (\$5 overseas).

**VAN KAREN PUBLISHING**  
5 Swan Street, Wilmslow, Cheshire

# CELEBRATE XMAS WITH US

## FREE

THIS MONTH, "PACK X1" — Containing £1's worth of electronic goodies — with the first 25 orders worth £5 or more ...

\* **Sticky problems solved fast: — with AVDEL the Wonder Bond Cynocrylate Adhesive** (Bonds: Ceramics, plastics, rubber, wood, etc). **Our Price Only 75p (inc. VAT) P & P this item 7p**

\* **Full Spec/ Tested Transistors** BC107 / BC108 / BC109 / BC170 / BC172 / 2N2926G / 2G371B Only 7p each, inc. VAT. BF199/BF240/ BF241 Only 10p each, inc. VAT. **Special Offer BFY51 15p each, inc. VAT. While Stocks Last.**

\* **Metal Foil Capacitors** Similar to C280 — Series in values ... .47µf/.068µf/.22µf/.015µf/ 0.1µf/0.01µf 160 volts wkg. Only 6p each inc. VAT.

\* **Big Value Electrolytic Capacitors** In values 47Mfd to 10Mfd and from 10Mfd to 100Mfd and 100Mfd to 680Mfd 10 to 250 volts wkg. Only 7p each inc. VAT.

\* **The Best Quality** Low noise — high output C60:— (Ferric Oxide) Cassette Tapes. All only 58p inc. VAT P & P 10p. 5 for £2.42 P & P 45p inc. VAT.

\* **Academy C90** High quality cassette tapes (Ferric Oxide). Low Noise — High Output. All only 66p each; VAT inc. P&P 10p. 5 for £2.90 P&P 45p VAT inc.

\* **Ceramic Capacitors** 22pf / 27pf / 33pf / 39pf / 47pf / 68pf / 82pf / 100pf / 120pf / 150pf / 180pf / 270pf / 330pf / 390pf / 470pf / 560pf / 820pf / 1000pf. (Printed circuit types). Big saving at 4p each, inc. VAT.

**SIGTRONIC ELECTRONICS,**

27 Malvern Street, Stapenhill, Burton-on-Trent, Staffs. DE15 9DV. (Tel: 0283 46868) 6pm for Special Orders. Prices inc. VAT add 30p. To order for P & P — Cheques/Giro Cheques/P.O.'s accepted.

# RADIO & ELECTRONICS CONSTRUCTOR

## Single Copies

Price 50p each, p&p 13p

Issue(s) required .....

## Annual Subscription

Price **£7.00 inland, £8.00 overseas**

post free, commence with..... issue

## Bound Volumes:

Vol. 27. August 1973 to July 1974	Price <b>£2.80</b> , post & pkg 90p
Vol. 28. August 1974 to July 1975	Price <b>£3.20</b> , post & pkg 90p
Vol. 29. August 1975 to July 1976	Price <b>£3.50</b> , post & pkg 90p
Vol. 30. August 1976 to July 1977	Price <b>£3.70</b> , post & pkg 90p
Vol. 31. August 1977 to July 1978 (Available shortly)	Price <b>£5.20</b> , post & pkg 90p

## CORDEX SELF-BINDERS *NEW FORMAT*

With title, 'RADIO & ELECTRONICS CONSTRUCTOR' on spine,  
maroon only

Price **£1.80**, post & pkg 40p

With no title on spine, maroon

Price **£1.70**, post & pkg 40p

With no title on spine, green

Price **£1.70**, post & pkg 40p

*Prices include V.A.T.*

## DATA BOOK SERIES

DB5 TV Fault Finding, 132 pages Price **£1.20**, P. & P. 20p

DB6 Radio Amateur Operator's Handbook,  
New edition in course of preparation

DB17 Understanding Television, 504 pages Price **£3.95**, P. & P. 70p

DB19 Simple Short Wave Receivers Price **80p**, P. & P. 20p  
140 pages

## STRIP-FIX PLASTIC PANEL SIGNS

Set 3: Wording — White — 6 sheets Price **£1.00**, P. & P. 8p

Set 4: Wording — Black — 6 sheets Price **£1.00**, P. & P. 8p

Set 5: Dials — 6 sheets Price **£1.00**, P. & P. 8p

**Prices include V.A.T. on Panel Signs**

I enclose Postal Order/Cheque for.....in payment for.....

NAME .....

ADDRESS .....

..... (BLOCK LETTERS PLEASE)

*Postal Orders should be crossed and made payable to Data Publications Ltd.*

*Overseas customers please pay by International Money Order.*

*All publications are obtainable through your local bookseller*

**Data Publications Ltd., 57 Maida Vale, London W9 1SN**

**PLEASE MENTION THIS MAGAZINE WHEN WRITING TO ADVERTISERS**