

THE **Radio Constructor**

RADIO
TELEVISION
AUDIO
ÉLECTRONICS

VOLUME 19 NUMBER 5
A DATA PUBLICATION
TWO SHILLINGS & THREEPENCE

December 1965

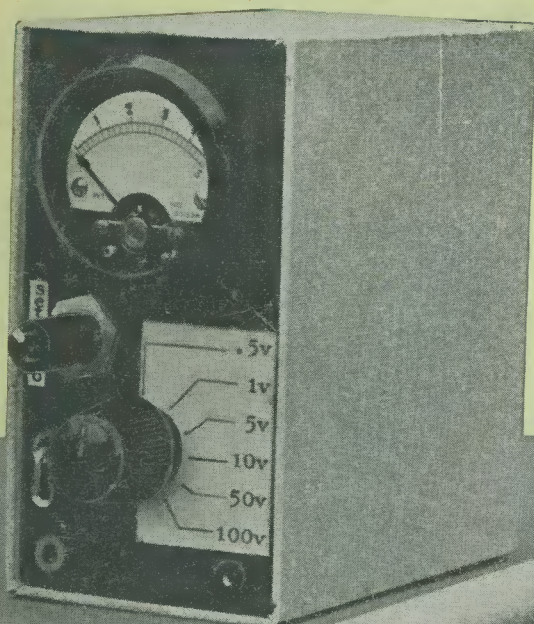

***Pocket
Valve
Voltmeter***

Versatile Power
Pack



Simple Square
Wave Generator



Electronic Shooting
Range



Improvised Variable
Resistors

370 VOLTS

$$\frac{3}{750}$$

$$I = \frac{E}{R}$$

$$I = \frac{250}{50,000 \Omega}$$

$$\frac{50,000 \times 250,000}{0.003}$$



Eddystone

TWO FINE RECEIVERS

3421 AMP
30A

840c

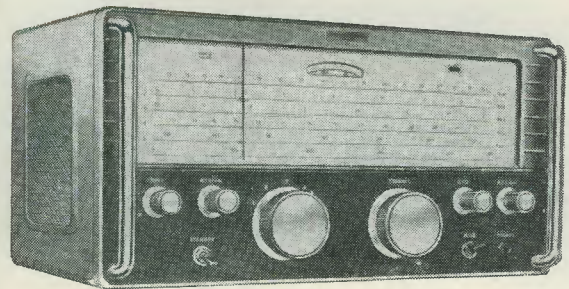

The Eddystone '840c' is an inexpensive, soundly engineered communications receiver giving full coverage from 480 kc/s to 30 Mc/s. It possesses a good performance and is built to give years of reliable service. The precision slow motion drive—an outstanding feature of all Eddystone receivers—renders tuning easy right up to the highest frequency, and the long horizontal scales aid frequency resolution. Modern styling and a pleasing two-tone grey finish lead to a most attractive receiver.

List price £66 0s. 0d

940

The Eddystone '940' is a larger and more elaborate communications receiver, with a correspondingly better performance. It has two fully tuned radio frequency stages and two intermediate frequency stages; variable selectivity with a crystal filter; built-in carrier level meter and push-pull output stage. Sensitivity is very high and outstanding results can be expected. Workmanship, construction, and finish are all to the usual high Eddystone standards. Styling is modern with two-tone grey finish.

List price £133 0s. 0d

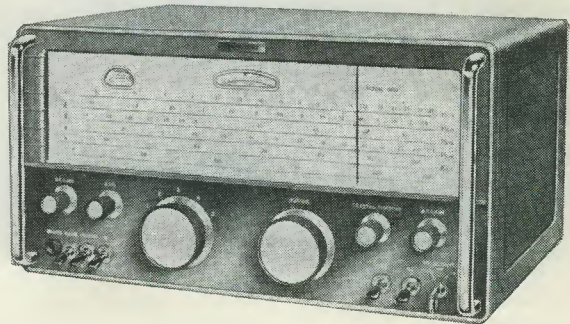

There's an Eddystone communications receiver for any frequency between 10kc/s and 1,000 Mc/s

Eddystone Radio Limited

Eddystone Works, Alvechurch Road, Birmingham 31
Telephone: Priory 2231 Cables: Eddystone Birmingham Telex: 33708

LTD/ED7

6 VALVE AM/FM TUNER UNIT

Med. and VHF 190m-550m, 86 Mc/s-103 Mc/s, 6 valves and metal rectifier. Self-contained power unit, A.C. 200/250V operation. Magic-eye indicator, 3 push-button controls, on/off, Med., VHF. Diodes and high output sockets with gain control. Illuminated 2-colour perspex dial 1 1/2" x 4", chassis size 1 1/2" x 4" x 5 1/2". A recommended Fidelity Unit for use with Mullard "3-3" or "5-10" Amplifiers.

Bargain Price: Complete kit of parts, inc. Power Pack, £10.19.6, carriage and insurance, as illustrated. Ditto less Power Pack, £9.19.6. Carr. 7/6. Circuit and constr's details, 4/6 Free with kit.

7 VALVE AM/FM RADIOGRAM CHASSIS

New 1965 Model Now Available.

Three Waveband & Switched Gram positions. Med. 200-550m. Long 1,000-2,000m. VHF/FM 88-95 Mc/s. Phillips Continental Tuning insert with permeability tuning on FM & combined AM/FM IF transformers. 460 kc/s and 10.7 Mc/s. Dust core tuning all coils. Latest circuitry including AVC & Neg. Feedback. 3 watt output. Sensitivity and reproduction of a very high standard. Chassis size 13 1/2" x 6 1/2" x 4 1/2". Edge illuminated glass dial 1 1/2" x 3 1/2". Vert. pointer Horiz. station names. Gold on brown background. A.C. 200/250V operation. Magic-eye tuning. Circuit diag. now available.

Valves ECC85, ECH81, EF89, EABC80, EL28, EM81, EZ80



Aligned and tested ready for use. Carr. & Ins. 7/6. **£13.19.6**

Comp. with Tape, O/P socket, ext. spkr & P/U sockets and indoor F.M. aerial, and 4 knobs—walnut or ivory to choice. 3P.M. Speaker only required. Recommended Quality Speakers 10" Rola, 27/6. 13 1/2" x 8" E.M.I. Fidelity, 37/6. 12" R.A. with conc. Tweeter, 42/6. Carr. 2/6.

Jack Plugs. Standard 2 1/2" Igranite Type, 2/6. Screened Ditto, 3/3. Miniature scr. 1 1/2", 2/3. Sub-min. 1/3. **Jack Sockets.** Open Igranite Moulded Type, 3/6. Closed Ditto, 4/-. Miniature Closed Type, 1/6. Sub-min. (deaf aid) ditto, 1/6. Stereo Jack Sockets, 3/6. Stereo Jack Plugs, 3/6. **Phono Plugs, 9d.** Phono Sockets (open), 9d. Ditto (closed), 1/-. Twin Phono Sockets (open), 1/3.

Grundig Continental. 3 p. or 5 p. plug, 3/6. Sockets, 1/6. **Soldering Irons.** Mains 200/220V or 230/250V, Solon 25W Inst., 24/6. Spare Elements, 5/6. Bits, 1/3. 65W, 29/6, etc. **Aluminum Chassis.** 18g. Plain Undrilled, folded 4 sides, 2" deep, 6" x 4", 4/6, 8" x 6", 5/9, 10" x 7", 6/9, 12" x 6", 7/6, 12" x 8", 8/-. etc. **Alumin. Sheet.** 18g. 6" x 6", 1/-. 6" x 9", 1/6, 6" x 12", 2/-. 12" x 12", 4/6, etc.

L.P. RECORDING TAPE

BARGAIN OFFER!

By leading British manufacturers—

PROFESSIONAL GRADE—DOUBLE-SIDED

(each side coated) 5 1/2" reels only

Special Price Offer 1,450 feet (2 reels) 20/- post free

Ideal for the experimenter who wants to record both sides, and a good L.P. Tape for the enthusiast who wishes to record single side only.

New Boxed	VALVES	Reduced Bargain Prices	Electrolytics All Types New Stock
174	3/6	EF80 7/6	PCF80 10/6
1R5	6/	EF86 8/6	PCLB83 8/6
1S5	6/	EL33 12/6	PCLB84 10/6
354	7/	EL34 12/6	PCLB85 11/6
3V4	7/	EL84 7/	PL36 10/6
ECC81	7/	EY51 9/	PL81 9/6
ECC82	7/	EY86 9/	PL83 8/
ECC83	7/	EZ80 7/	PY33 10/6
ECL80	9/	EY81 7/	PY82 7/
ECL82 10/		GZ32 9/6	U25 10/6
ECL86 10/6		PCC84 8/	UL84 9/6

DE LUXE R/PLAYER KIT

Incorporating 4 Speed Garrard Auto-Slim unit and Mullard latest 3 watt printed circuit amplifier (ECL 86 and EZ 80), volume, bass and treble controls, with 8" x 5" 10,000 line speaker. Superb quality reproduction.

Contemporary styled two-tone cabinet, charcoal grey and off-white with matching blue relief. Size: 17 1/2" x 16" x 8".

COMPLETE KIT £13.19.6 Carr. & ins. 12/6.

Ready wired, 30/- extra.

Illuminated Perspex escutcheon, 7/6 extra. 4 Contemp' legs 6" x 10/6, 9" x 11/6, 12" x 12/6, ex. Catalogue & construction details 2/6 (free with kit).

STANDARD RECORD PLAYER KIT

Using BSR UA14 Unit, complete kit £11.10.0, carr. 7/6. Ready wired Amplifier, 7" x 4" quality Speaker and O/P trans., £3.19.6, carr. 2/6. BSR UA14 Unit, £6.10.0, carr. & ins. 5/-. Revine covered cabinet in two-tone maroon and cream, size 15 1/2" x 14 1/2" x 8 1/2" with all accessories plus uncut record player mounting board 14" x 13", 59/6, carr. & ins. 5/-.
Speakers P.M.—2" Plessey 75 ohms, 15/6. 2 1/2" Continental 8 ohms, 13/6. 7" x 4" Plessey 35 ohm, 23/6.

Ear Plug Phones—Min. Continental type. 3ft. lead, jack plug and socket. High Imp. 8/-. Low Imp. 7/6. High sensitivity M/coil 8-10 ohms, 12/6.

ANOTHER TAPE RECORDER BARGAIN

New re-designed contemporary Cabinet. Famous Mrs. end of production Surplus Offer

A 24 gns. Tape Recorder offered at the fabulous bargain price of only 15 gns. + 10/- Carr. Supplied in 3 Units already wired and tested—only simple inter-Unit connections necessary. A modern Circuit for quality recording from Mike, Gram or Radio, incorporating the latest BSR Twin Track Monardeck Type TD2. Housed in attractive two-tone Cabinet of contemporary design, size 14" x 13 1/2" x 7 1/2" complete with Tape and Mike storage pockets. Valve line up—EF86, ECL82, EM84, EZ80 and Silicon Diode.

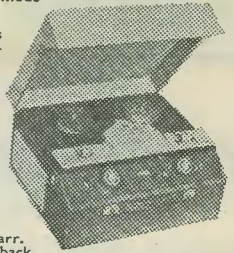

Complete Kit comprising items below.

BARGAIN PRICE 15 gns. + 10/- carr.

Cabinet and 7" x 4" Speaker, £3.5.0 + 5/- Carr. Wired Amplifier complete with Record/Playback Switching, 4 Valves, front Panel, Knobs, etc., £5.19.6 + 3/6 Carr. BSR Monardeck Type TD2, £7.7.0 + 4/6 Carr. Accessories—Mike, Tape, empty Reel, screened Lead & Plugs, Instructions, etc., £1.0.0 + 2/- Carr.

Volume Controls—5K-2 Meg-ohms. 3" Spindles Morganite Midget Type. 1 1/2" diam. Guar. 1 year. LOG or LIN ratios less Sw. 3/- + DP. Sw. 4/6. Twin Stereo less Sw. 7/6. D.P. Sw. 9/6 (100 k. to 2 Meg. only). 1/2" Meg. VOL Controls D.P. Sw. 1/2" flattened spindle. Famous Mrs. 4 for 10/- post free.

COAX 80 OHM CABLE

High grade low loss Cellular air spaced Polythene—3" diameter. Stranded cond. Famous mfrs. Now only 6d. per yard.
Bargain Prices—Special lengths: 20 yds. 9/-. P. & P. 1/6. 40 yds. 17/6. P. & P. 2/-. 60 yds. 25/-. P. & P. 3/-. Coax Plugs 1/-. Sockets 1/-. Couplers 1/3. Outlet Boxes 4/6

Close Tol. S/Micas—10% 5pF-500pF 8d. 600-5,000pF 1/-. 1% 2pF-100pF 9d. 100pF-500pF 11d. 575pF-5,000pF 1/6. Resistors—Full Range 10 ohms-10 megohms 20% 1/4 and 1/2W 3d., ditto 10% 4d. 1/2W 5d. (Midget type modern rating) 1W 6d., 2W 9d. Hi-Stab 5% 1/2W 10d. 1% 1/2W 1/6. W/W Resistors 25 ohms to 10K 5V 1/3, 10W 1/6, 15W 2/-. Pre-set T/V Pots. W/W 25 ohms-50K 3/-. 50K-2 Meg. (Carbon) 7/-. **Speaker Fret—Expanded gilt anodised metal 1/2" x 1/2" diamond mesh, 4/6 sq. ft., multiples of 6" cut. Max. size, 4ft. x 3ft. 47/6. Carr. extra.** Ditto, finer mesh, 4/6 sq. ft. Multiples 12" only, max size 3ft x 2ft. 27/6 Plus Carr.

TYGAN FRET (contemp. pat.) 12" x 12" 2/-, 12" x 18" 3/-. 12" x 24" 4/-. 18" x 18" 4/6, etc.
BONDACOUST Speaker Cabinet Acoustic Wadding, superior grade, 1" thick, 18" wide, any length cut 2/3 per ft., 6/- per yd.

ENAMELLED COPPER WIRE— 11b reels, 14g-20g, 3/-. 22g-28g, 3/6; 36g-38g, 4/9; 39-40g, 5/-. etc.

TINNED COPPER WIRE— 14-22g. 4/- 1/2 lb.

PVC CONNECTING WIRE— 10 colours (for chassis wiring, etc.)—Single or stranded conductor, per yd., 2d. Sleeving, 1mm. and 2mm., 2d. yd., etc.

KNOBBS—Modern Continental types: Brown or Ivory with Gold Centre, 1" dia., 9d. each; 1 1/2", 1/3 each; Conc. Knobs with gold centre 1 1/2" dia., 2/9 per pair. Matching ditto, 2/6 each. **LARGE SELECTION AVAILABLE.**

TRANSISTOR COMPONENTS

Midget I.F.'s—465 kc/s 1/4" diam., first, second or third 5/6
Osc. coil M. & L.W. 3/8" diam. 5/6
Midget Driver Trans. 9/1 6/0
Ditto O/Put Push-pull 3 ohms 6/0
Elect. Condensers—Midget Type 15V 1mfd-50mfd, ea. 1/9. 100mfd. 2/-. Ferrite Aerial—M. & L. W. with car aerial coupling coil, 9/3. Condensers—150V, wkg. .01 mfd. to .04 mfd., 9d. .05 mfd., .1 mfd., 1/-. .25 mfd., 1/3. .5 mfd., 1/6, etc. Tuning Condensers. J.B. "008" + 176pF, 8/6. Ditto with trimmers, 9/6. 365pF single, 7/6. Sub-min. 2" DILEMM 100pF, 300pF, 500pF, 7/-. Midget Vol. Control with edge control knob, 5kΩ with switch, 4/9, ditto less switch, 3/9.

JASON FM TUNER UNITS

Designer-approved kit of parts:
FMT1, 5 gns. 4 valves, 20/-.
FMT2, £7.10.0. 5 valves, 35/-.
JTV MERCURY 10 gns.
3 valves, 23/6.
JTV £13.19.6. 4 valves, 28/6.
NEW JASON FM HANDBOOK, 2/6. Prompt Alignment Service 7/6. P. & P. 2/6.

MULLARD "3-3" & "5-10" HI-FI AMPLIFIERS

3 OHM & 15 OHM OUTPUT

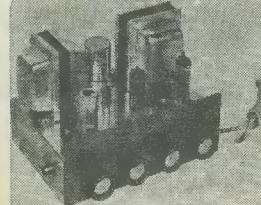

"3-3" Amp. 3-valve, 3 watt, Hi-Fi quality at reasonable cost. Bass Boost and Treble controls, quality sectional output transformer, 40 c/s-25 kc/s ± 1dB, 100mV for 3W, less than 1% distortion. Bronze escutcheon panel.

Complete Kit only 7 gns. Carr. 5/-. **Wired and tested £8.10.0**

MULLARD "5-10" AMPLIFIER— 5 valves 10W, 3 and 15 ohms output.

Mullard's famous circuit with heavy duty ultra-linear quality output tfr. **Basic amplifier kit price £9.19.6.** Carr. 7/6. **Ready built 11 1/2 gns.**

2-VALVE PRE-AMP. UNIT Based on Mullard's famous 2-valve (2 x EF86) circuit with full equalisation with volume, bass, treble, and 5-position selector switch. Size 9" x 6" x 2 1/2". **Ready built, wired and tested, £7.19.6.** Carr. 3/6.

Send for detailed bargain lists, 3d. stamp. We manufacture all types Radio Mains Transf. Chokes, Quality O/P Trans., etc. Enquiries invited for Specials, Prototypes for small production runs. Quotation by return.
RADIO COMPONENT SPECIALISTS
70 Brigstock Road, Thornton Heath, Surrey THO 2188. Hours: 9 a.m.-6 m., 1 p.m. Wed. Terms C.W.O. or C.O.D. Post and Packing up to 1lb. 11/-, 1 lb. 1/9, 3 lb. 3/-. 5 lb. 3/9, 8 lb. 4/6.





Choose Heathkit models for value and performance

Easy-to-follow instruction manuals tell you how to build any model

HI-FI AMPLIFIERS ~~~~~ TUNERS ~~~~~ RECORD PLAYERS

STEREO AMP. AA-22U



PLAYER AT-60



POWER AMP. MA-12

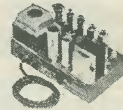

STEREO AMP. S-99

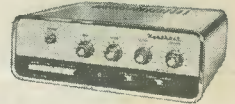

TRANSISTOR MIXER. Model TM-1. A must for the tape enthusiast. Four channels. Battery operated. Similar styling to Model AA-22U Amplifier. Kit **£11.16.6** Assembled **£16.17.6**

20+20W TRANSISTOR STEREO AMPLIFIER. Model AA-22U. Outstanding performance. Kit **£39.10.0** (less cabinet). Attractive walnut veneered cabinet **£2.5.0** extra.

GARRARD AUTO/RECORD PLAYER. Model AT-60. less cartridge **£13.1.7** With Decca Deram pick-up **£16.15.1** incl. P.T.

HI-FI MONO AMPLIFIER. Model MA-5. A general purpose 5W Amplifier, with inputs for Gram., Radio. Presentation similar to S-33. Kit **£10.19.6** Assembled **£15.10.0**

Many other Garrard models available.

HI-FI MONO AMPLIFIER. Model MA-12. 10W output, wide freq. range, low distortion. Kit **£11.18.0** Assembled **£15.18.0**

DE LUXE STEREO AMPLIFIER. Model S-33H. De luxe version of the S-33 with two-tone grey perspex panel, and higher sensitivity necessary to accept the Decca Deram pick-up. Kit **£15.17.6** Assembled **£21.7.6**

HI-FI STEREO AMPLIFIER. Model S-99. 9 + 9W output. Ganged controls. Stereo/Mono gram., radio and tape inputs. Push-button selection. Printed circuit construction. Kit **£28.9.6** Assembled **£38.9.6**

POWER SUPPLY UNIT. Model MGP-1. Input 100/120V, 200/250V, 40-60 c/s. Output 6.3V, 2.5A A.C. 200, 250, 270V, 120mA max. D.C. Kit **£5.2.6** Assembled **£6.12.6**

3 + 3W STEREO AMPLIFIER. Model S-33. An easy-to-build, low cost unit. 3 inputs per channel. Kit **£13.7.6** Assembled **£18.18.0**

FOR THE INSTRUMENTALIST

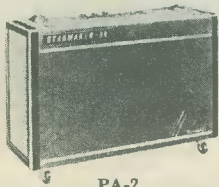

PA-2

NEW! STARMAKER-33

TRANSISTOR PA/GUITAR AMPLIFIER, PA-2. 20 Watt amplifier. Two heavy duty speakers. Four inputs. Two channels. Variable tremolo. Speed and depth controls. Weight 51lb.

18" high x 29" wide x 10" deep. Kit **£44.19.0** Assembled **£59.10.0** Castors or legs available as extras.

INSTRUMENTS

DE LUXE LARGE-SCALE VALVE VOLTMETER: Model IM-13U. Circuit and specification based on the well-known model V-7A but with many worth-while refinements. 6" Ernest Turner meter. Unique gimbal bracket allows operation of instrument in many positions. Modern styling. Kit **£18.18.0** Assembled **£26.18.0**



IM-13U

AUDIO SIGNAL GENERATOR. Model AG-9U. 10 c/s to 100 kc/s, switch selected. Distortion less than 0.1%, 10V sine wave output metered in volts and dB's. Kit **£22.10.0** Assembled **£30.10.0**



V-7A

VALVE VOLTMETER. Model V-7A. 7 voltage ranges d.c. volts to 1,500. A.c. to 1,500 r.m.s. and 4,000 peak to peak. Resistance 0.1Ω to 1,000MΩ with internal battery. D.c. input resistance 11MΩ. dB measurement, has centre-zero scale. Complete with test prods, leads and standardising battery. Kit **£13.18.6** Assembled **£19.18.6**



RF-1U

MULTIMETER. Model MM-1U. Ranges 0-1.5V to 1,500V a.c. and d.c.; 150μA to 15A d.c.; 0.2Ω to 20MΩ. 4½" 50μA meter. Kit **£12.18.0** Assembled **£18.11.6**

R.F. SIGNAL GENERATOR. Model RF-1U. Up to 100 Mc/s fundamental and 200 Mc/s on harmonics. Up to 100mV output. Kit **£13.8.0** Assembled **£19.18.0**

T.V. ALIGNMENT GENERATOR. Model HPW-1. Offers max performance at lowest cost. Covers 3.6 to 220 Mc/s fundamentals. Electronic sweep oscillators. Built in marker generators (5 Mc/s crystal). **£37.18.0** Kit **£47.10.0** Assembled

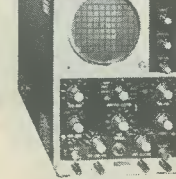
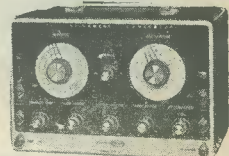

IO-12U

5" GENERAL-PURPOSE LABORATORY OSCILLOSCOPE. Model IO-12U. This outstanding oscilloscope, with its professional specification and styling, fulfils most laboratory and service requirements. Vertical frequency response 3 c/s to over 4.5 Mc/s, sensitivity 10mV r.m.s. per cm. at 1 kc/s. T/B covers 10 c/s-500 kc/s. Kit **£35.17.6** Assembled **£45.15.0**

2½" PORTABLE SERVICE 'SCOPE. Model OS-1. This is a light, compact oscilloscope, ideal for servicing, etc. Dimensions 5" x 8" x 14½" long. Wt. 10½lb. Fitted mu-metal CRT shield. Kit **£22.18.0** Assembled **£30.8.0**

ELECTRONIC SWITCH. Model S-3U. Converts a single beam 'scope to double beam operation at low cost. Kit **£12.18.0** Assembled **£18.10.0**

TRANSISTOR POWER SUPPLY. Model IP-20U. Up to 50V, 1.5A output. Ideal for Laboratory use. Compact size. Kit **£35.8.0** Assembled **£47.8.0**

TRANSISTOR RECEIVERS

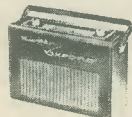

UXR-2

"OXFORD" LUXURY PORTABLE. Model UXR-2. Specially designed for use as a domestic, car or personal portable receiver. Many features, including solid leather case. Kit **£14.18.0** incl. P.T.



UXR-1

TRANSISTOR PORTABLE. Model UXR-1. Pre-aligned I.F. transformers, printed circuit. Covers L.W. and M.W. Has 7" x 4" loudspeaker. Real hide case. Kit **£12.11.0** incl. P.T.



UJR-1

JUNIOR EXPERIMENTAL WORKSHOP. Model EW-1. More than a toy! Will make over 20 exciting electronic devices, incl: Radios, Burglar Alarms, etc. 72 page Manual. The ideal present! Kit **£7.13.6** incl. P.T.

JUNIOR TRANSISTOR RADIO. Model UJR-1. Single transistor set. Excellent introduction to radio. Kit **£2.7.6** incl. P.T.

ARE YOU ON OUR MAILING LIST?

FREE CATALOGUE of full range INSTRUMENT BROCHURE AMATEUR RADIO BROCHURE or Full specification of any model gladly sent on request

Enjoy Yourself and Save Money with these Kits

No previous experience required to build any Heathkit model



TAPE AMPLIFIERS ~~~~~ TAPE DECKS ~~~~~ CONTROL UNITS



FM
TUNER
FM-4U

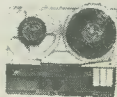

MAGNAVOX
NEW
DECK

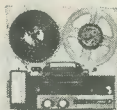

TRUVOX
DECK



AM/FM
TUNER

HI-FI FM TUNER. Model FM-4U. Also available in two units. R.F. tuning unit (£2.15.0 incl. P.T.) with I.F. output of 10.7 Mc/s, and I.F. amplifier unit, with power supply and valves (£13.13.0).

Total Kit **£16.8.0**

MAGNAVOX "363" TAPE DECK. The finest buy in its price range. Operating speeds: 1 1/2", 3 1/4" and 7 1/2" p.s. Two tracks, "wow" and "flutter" not greater than 0.15% at 7 1/2" p.s. **£14.19.6**

HI-FI AM/FM TUNER: Model AFM-1. Available in two units which, for your convenience, are sold separately. Tuning heart (AFM-T1—£4.13.6 incl. P.T.) and I.F. amplifier (AFM-A1—£22.11.6). Printed circuit board, 8 valves. Covers L.W., M.W., S.W., and F.M. Built-in power supply. **Total Kit £27.5.0**

TRUVOX D-93 TAPE DECKS. High quality stereo/mono tape decks. D93/2, 1/2 track, £36.15.0 D93/4, 1/4 track, £36.15.0

TAPE RECORDING/PLAYBACK AMPLIFIER. Thermometer type recording indicators, press-button speed compensation and input selection.

Mono Model TA-1M. Kit **£19.18.0** Assembled **£28.18.0**
Stereo Model TA-1S. Kit **£25.10.0** Assembled **£35.18.0**

MONO CONTROL UNIT. Model UMC-1. Designed to work with the MA-12 or similar amplifier requiring 0.25V or less for full output. 5 inputs. Baxandall type controls. Kit **£8.12.6** Assembled **£13.12.6**

STEREO CONTROL UNIT. Model USC-1. Push-button selection, accurately matched ganged controls to ±1dB. Rumble and variable low-pass filters. Printed circuit boards. Kit **£19.10.0** Assembled **£26.10.0**

SPEAKER SYSTEMS

HI-FI SPEAKER SYSTEM. Model SSU-1. Ducted-port bass reflex cabinet "in the white". Two speakers. Vertical or horizontal models with legs, Kit **£12.12.0**, without legs, Kit **£11.17.6** incl. P.T.

COTSWOLD "MFS" SYSTEM. Designed to give best possible results where floor space is at a premium. This minimum floor space model is based on standard Cotswold. Size: 36" high x 16 1/2" wide x 14 1/2" deep. Kit **£25.12.0** Assembled **£33.17.0**

THE "COTSWOLD". This is an acoustically designed enclosure 26" x 23" x 15 1/2" housing a 12" bass speaker with 2" speech coil, elliptical middle speaker together with a pressure unit to cover the full frequency range of 30-20,000 c/s. Capable of doing justice to the finest programme source, its polar distribution makes it ideal for really Hi-Fi Stereo.

Kit **£25.12.0** Assembled **£33.17.0**



SSU-1



MFS

"AMATEUR" EQUIPMENT

AMATEUR BANDS RECEIVER. Model RA-1. To cover all the Amateur Bands from 160-10 metres. Many special features, including: half-lattice crystal filter; 8 valves; signal strength "S" meter; tuned R.F. Amp. stage. Kit **£39.6.6** Assembled **£52.10.0**

THE "MOHICAN" GENERAL COVERAGE RECEIVER. Model GC-1U. With 4 piezo-electric transmitters, variable tuned B.F.O. and Zener diode stabiliser, this is an excellent fully transistorised general purpose receiver for Amateur and Short wave listeners. Printed circuits, telescopic aerial, tuning meter and large slide-rule dial. Kit **£37.17.6** Assembled **£45.17.6**

160-10M TRANSMITTER. Model DX-100U. Careful design has achieved high performance and stability. Completely self-contained. Kit **£79.10.0** Assembled **£104.15.0**

COMMUNICATIONS TYPE RECEIVER. Model RG-1. A high performance, low cost receiver for the discriminating listener. Frequency coverage: 600 kc/s-1.5 Mc/s and 1.7 Mc/s-32 Mc/s. Kit **£39.16.0** Assembled **£53.0.0**

REFLECTED POWER METER and SWR BRIDGE. Model HM-11U. Indicates reliably, but inexpensively, whether the RF power output of your TX is being transferred efficiently to radiating antenna. Kit **£8.5.0** Assembled **£10.10.0**

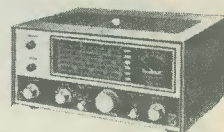

RA-1

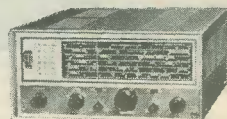

RG-1

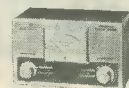

HM-11U

HI-FI CABINETS

A wide range available including:

PLAYBOX Table Player. Available in walnut, mahogany or teak finish. Assembled **£10.10.0**

GLOUCESTER. Kit £18.10.0 incl. P.T.

MALVERN. Kit £18.1.0 incl. P.T.

CHEPSTOW. Kit £11.12.6 incl. P.T.

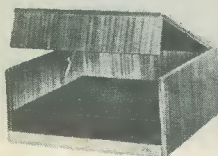

PLAYBOX
finished Cabinet

MANY OTHER BRITISH MODELS

Send for free Catalogue

Deferred terms available in U.K. over £10.
Extended terms over £75. Send for details.

DAYSTROM LTD

DEPT. RC.12
GLOUCESTER

AMERICAN HEATHKIT "AMATEUR" EQUIPMENT

A wide range of American Amateur SSB equipment is now available in the U.K. Why not send for full details of range, for example:

80-10M RECEIVER. Model SB-300E.

Of advanced design employing up-to-date construction techniques, its specification ensures unparalleled performance.

Kit **£147.0.0** (less speaker) price incl. carriage, duty, etc.

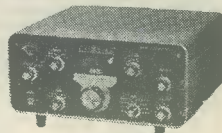

SB-300E

Without obligation please send me
FREE BRITISH HEATHKIT CATALOGUE.....

(Tick here)

FULL DETAILS OF MODEL(S).....

(Please write in BLOCK CAPITALS)

NAME

ADDRESS

DEPT. RC.12

A NEW SINCLAIR AMPLIFIER

SINCLAIR
Z.12 COMBINED
AMPLIFIER
AND
PRE-AMP

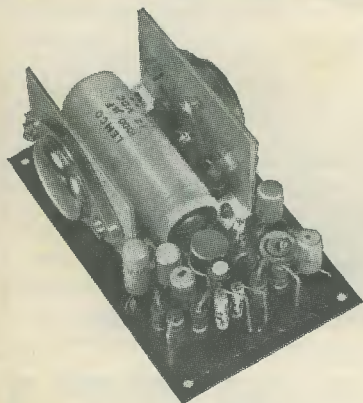
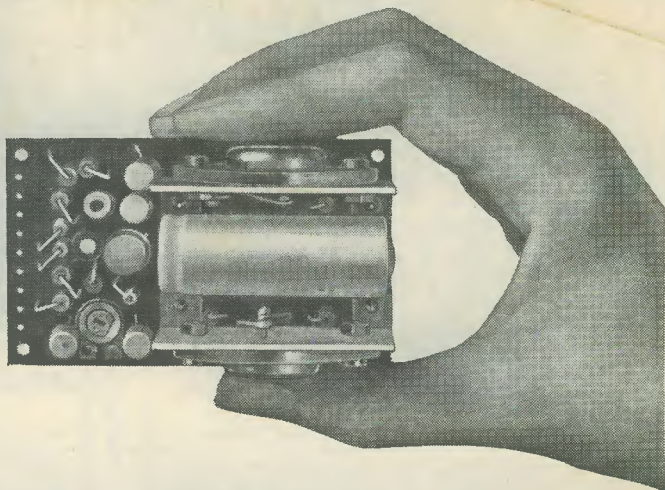

A TINY, VERSATILE AMPLIFIER GIVING 12 WATTS R.M.S. OUTPUT

The Sinclair Z.12 is a universally flexible amplifier in which great power and extreme smallness are the outstanding features. It comes to you ready built and can be incorporated to great advantage into any high quality hi-fi system. Its small size and high efficiency, however, make it equally useful for a guitar, for car radio, P.A. system or any other application where high quality is the first requirement. The Z.12 incorporates its own pre-amplifier to which you add the tone and volume control system of your choice as shown in the Z.12 manual supplied with the amplifier. The size, the performance, and the price of the Sinclair Z.12 all favour the constructor who wants the best in modern transistor equipment; in fact, the Z.12 is unbeatable in every way and is today's finest buy in top grade high fidelity.

Ready built,
tested and
guaranteed

89/6

SINCLAIR PX10 POWER PACK £2.14.0

- **SIZE—**
3" x 1½" x 1¼"
- **WEIGHT—**
3 oz.
- **TRUE HI-FI
PERFORMANCE**
- **OPERATES
FROM 6 TO 20
VOLT SUPPLY**

TECHNICAL DETAILS

High fidelity amplifier with pre-amp and ultra-linear class B output. Eight special H.F. transistors are used in original circuitry to achieve laboratory standards of performance. Generous negative feedback ensures extra good quality.

Frequency Response—15 to 50,000 c/s ±1dB

Output—12 watts RMS continuous sine wave (24 watts peak); 15 watts RMS music power (30 watts) peak

Output Impedance—suitable for 3, 7.5 and 15 ohms speakers. Two 3 ohm speakers may be used in parallel if required.

Input—2mV into 2K ohms

Signal to Noise Ratio—better than 60dB

Quiescent Current Consumption—15mA

Power Supply—6 to 20V d.c. from power unit available or batteries

SINCLAIR GUARANTEE

All purchases from Sinclair Radionics Ltd., Comberton, Cambridge, are covered by this simple, straightforward guarantee as follows: Should you not be completely satisfied with your purchase when you receive it from us, your money will be refunded in full and at once without question.

Should you prefer not to cut this page, please quote R.C.12 when writing your order.

sinclair

**SINCLAIR RADIONICS
LTD.**
COMBERTON, CAMBRIDGE
Tel: Comberton 682

ORDER FORM

To: **SINCLAIR RADIONICS LTD.,
COMBERTON, CAMBRIDGE**

Please send items detailed below:

.....
.....
.....

For which I enclose cash/cheque/money order

NAME

ADDRESS

RC12

Scottish Insurance Corporation Ltd

38 EASTCHEAP · LONDON · EC3



TELEVISION SETS, RECEIVERS AND TRANSMITTERS

Television Sets, Receivers and Short Wave Transmitters are expensive to acquire and you no doubt highly prize your installation. Apart from the value of your Set, you might be held responsible should injury be caused by a fault in the Set, or injury or damage by your Aerial collapsing.

A "Scottish" special policy for Television Sets, Receivers and Short Wave Transmitters provides the following cover:

- (a) Loss or damage to installation (including in the case of Television Sets the Cathode Ray Tube) by Fire, Explosion, Lightning, Theft or Accidental External Means at any private dwelling-house.
- (b) (i) Legal Liability for bodily injury to Third Parties or damage to their property arising out of the breakage or collapse of the Aerial Fittings or Mast, or through any defect in the Set. Indemnity £10,000 any one accident.
- (ii) Damage to your property or that of your landlord arising out of the breakage or collapse of the Aerial Fittings or Mast, but not exceeding £500.

The cost of Cover (a) is 5/- a year for Sets worth £50 or less, and for Sets valued at more than £50 the cost is in proportion. Cover (b) (i) and (ii) costs only 2/6 a year if taken with Cover (a), or 5/- if taken alone.

Why not BE PRUDENT AND INSURE your installation—it is well worth while AT THE VERY LOW COST INVOLVED. If you write to the Corporation's Office a proposal will be submitted for completion.

Write for full details, quoting reference J/B, to:—

THE MANAGER
SCOTTISH INSURANCE CORPORATION LTD.,
38 EASTCHEAP, LONDON E.C.3

J/B

TESTED TRANSISTORS

1/- each Red or White Spots. 10/- per doz.

2/- each XA101, XA102, XA111, XA112, XB103, NKT122, 2E1, OA70, OA90, OC430.

3/- each OC44, OC45, OC70, OC71, OC81, OC81D, OC82, OC82D, OC169, OC200.

4/- each AF114, AF115, AF116, AF117, XA103, XB102, XC121, XU611, OC170, OC171.

5/- each OC72, OC139, OC204, ORP60, XC141, BY100, ACY22, GET8, AFZ11, AFZ12.

10/- each OC22, OC26, OC28, OC35, ORP12, AFY19, GET571, BFY17, BSY26, BSY29.

ZENER DIODES 4.7 volt to 30 volt $\frac{1}{2}$ watt, $\frac{3}{6}$ each, 1.5 watt, 5/- each, 7 watt, 6/- each.

Plus lots not listed—i.e. S.C.R.'s, V.H.F. and N.P.N.'s.
Send 6d. stamp for Full Lists and Equivalent Chart.

B. W. CURSONS

78 BROAD STREET, CANTERBURY, KENT

“PLEASE GIVE ME A SOLON ELECTRIC SOLDERING IRON FOR CHRISTMAS”

Or perhaps you could gently lead the conversation round to it by saying how many more jobs round the house you could do. How Solon are the best soldering irons. They last for years and all parts are replaceable. But remember, do say Solon electric soldering iron—get her to repeat it after you—then you can be sure of getting the best. From your electrical supplier or hardware store.



The 25 watt Solon is a good standard iron for radio and electronic work, being light and easy to handle.

SOLON AEI

Cut out this advertisement and leave it where it will be noticed.



FIRST QUALITY PVC TAPE

5 $\frac{1}{2}$ " Std. 850ft	9/-	5" L.P. 850ft	10/6
7" Std. 1200ft	11/6	3" T.P. 600ft	10/6
3" L.P. 240ft	4/-	5" T.P. 1800ft	25/6
5 $\frac{1}{2}$ " L.P. 1200ft	11/6	5 $\frac{1}{2}$ " T.P. 2400ft	32/6
7" L.P. 1800ft	18/6	7" T.P. 3600ft	42/6

P. & P. on each 1/6, 4 or more post free.

3kW IMMERSION HEATER



Complete with McLaren Variable Thermostat 90° to 180°F. 20 amp. A.C. and GEC double pole 20 amp. mains switch. 11", 14", 27", 30" and 36". State length required. £2.0.0, plus 5/- P. & P.

“PREMIER” KETTLE ELEMENT

1000W, 8/6 plus 3/- P. & P. Retaining nut and flange 2/6, switch plug to suit 2/6.

G.E.C. FLAT HEATER ELEMENT 500W

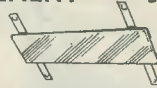

Can be used for wash boilers, washing machines, etc. Five or six elements can be used in parallel to give 2500/3000W. Size 5 $\frac{1}{2}$ " x 1 $\frac{1}{2}$ ", copper enclosed. 2/6 each, P. & P. 1/-, 4 or more post paid.

3 to 4 WATT AMPLIFIER KIT

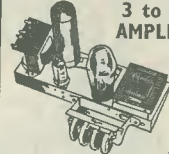

comprising chassis 8 $\frac{1}{2}$ " x 2 $\frac{1}{2}$ " x 1". Double wound mains transformer,

output transformer, volume and tone controls, resistors, condensers, etc. 6V6, ECC81 and metal rectifier. Circuit 1/6, free with kit. 29/6, plus 4/6 P. & P.

40W FLUORESCENT LIGHT KIT



incorporating GEC Choke size 8 $\frac{1}{2}$ " x 1 $\frac{1}{2}$ " x 1 $\frac{1}{2}$ ", 2 bi-pin holders, starter and starter holder, 11/6. P. & P. 4/6.

Similar to above: 80W Fluorescent Light Kit incorporating GEC choke size 11 $\frac{1}{2}$ " x 1 $\frac{1}{2}$ " x 1 $\frac{1}{2}$ ", 2 bi-pin holders, starter and starter holder, 17/6. P. & P. 5/6.

8-watt 5-valve PUSH-PULL AMPLIFIER & METAL RECTIFIER

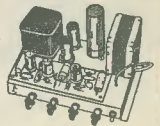

Size: 9" x 6" x 1 $\frac{1}{2}$ " A.C. Mains 200–250V 5 valves. For use with Std. or L.P. records, musical instruments, all makes of pick-ups and mikes. Output 8 watts at 5 per cent total distortion. Separate bass and treble lift controls. Two inputs, with controls, for gram. and mike. Output Transformer tapped for 3 and 15 ohms speech coils. Built and tested. £3.19 6. P. & P. 8/-.

SPECIAL OFFER: POWER SUPPLY KIT to purchasers of Elegant Seven parts, incorporating mains transformer, etc. A.C. mains 200–250V. Output 9V 100mA. 7/6.

“ELEGANT SEVEN” Mk. II

Combined Portable and Car Radio The Radio with the “Star” Features

- ★ 7-transistor superhet. Output 350mW.
- ★ Grey wooden cabinet, fitted handle with silver coloured fittings. Size 12 $\frac{1}{4}$ " x 8 $\frac{1}{2}$ " x 3 $\frac{1}{2}$ "
- ★ Horizontal tuning scale, size 11 $\frac{1}{4}$ " x 2 $\frac{3}{8}$ " in silver and black lettering.
- ★ All stations clearly marked.
- ★ Ferrite-rod internal aerial.
- ★ I.F. Neutralisation on each stage. 460 kc/s.
- ★ D.C. coupled output stage with separate A.C. negative feed back.
- ★ All components, ferrite rod and tuning assembly mounted on printed board. ★ Operated from PP9 battery. ★ Full comprehensive instructions and point-to-point wiring diagrams. ★ Printed circuit board, back printed with all component values. ★ Fully tunable over medium and long waveband. ★ Car aerial socket.
- ★ Full after-sale service. 4" SPEAKER.

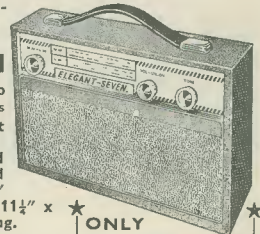

★ ONLY ★
£4.4.0

Plus 6/6 Post & Packing

Parts list and circuit diagram 2/6, FREE with parts.

Shop Hours 9 a.m.–6 p.m. Early Closing Wednesday

Goods not despatched outside U.K. Terms C.W.O.

All enquiries Stamped Addressed Envelope.

RADIO & TV COMPONENTS (ACTON) LTD.
21F High St., Acton, London, W.3



Dear Customers,

Perhaps your catalogue is being delivered by the venerable gentleman above; if not we'll try and squeeze one out for you, but send early if possible. Remember the post is a little slower near Christmas. Post the coupon today, enclosing your cheque or P.O. for 9/-.

A Happy Christmas to all our readers.

The Home Radio Components Catalogue has 210 pages, listing 5,800 items, 900 of them illustrated. This bumper Catalogue, plus a 21-page supplement and a Semi-Conductor Centre brochure, is yours for 9/- (7/6 plus 1/6 p. & p.). Every catalogue contains five coupons, each worth one shilling when used as directed.

Please write your Name and Address in block capitals

Name

Address

Home Radio Ltd., Dept. RC, 187 London Rd., Mitcham, Surrey

THE Radio Constructor



Incorporating THE RADIO AMATEUR

DECEMBER 1965

Vol. 19, No. 5
Published Monthly
(1st of month)

*Editorial and
Advertising Offices*
57 MAIDA VALE LONDON W9

Telephone
CUNningham 6141

Telegrams
Databux, London

First Published
1947

Versatile Power Pack, <i>by Peter Moran</i>	282
Home-Built High Quality Headphones, <i>by F. Howard</i>	284
Electronic "Telepathy" (Suggested Circuit No. 181), <i>by G. A. French</i>	287
Can Anyone Help?	290
News and Comment	291
Transistorised Tape "Tailer", <i>by Wallace Studley</i>	292
High-Brightness Cathode Ray Tubes, <i>by M. Harding</i>	295
Simple Square Wave Generator, <i>by C. May</i>	296
In Your Workshop	301
Using a Slide Rule, <i>by P. J. LeRiche</i>	308
Club Events	309
Pocket Valve Voltmeter, <i>by D. Bollen</i> (Cover Feature)	310
The Story of the Valve, Part 4, <i>by C. H. Gardner</i>	315
Electronic Shooting Range, <i>by J. Daich</i>	318
TV Topic, <i>by Recorder</i>	319
Improvised Variable Resistors, <i>by T. R. Balbirnie, B.Sc.</i>	320
Transistor for Exceedingly High Frequencies, <i>by J. B. Dance, M.Sc.</i>	322
Understanding Radio, <i>by W. G. Morley</i> (Amplification Factor and Dynamic Voltage Gain)	323
Quality and Sensitivity with Two Pentodes, <i>by Sir Douglas Hall, K.C.M.G., B.A.(Oxon)</i>	326

© Data Publications Ltd., 1965. Contents may only be reproduced after obtaining prior permission from the Editor. Short abstracts or references are allowable provided acknowledgement of source is given.

Annual Subscription 33s. (U.S.A. and Canada \$5) including postage. Remittances should be made payable to "Data Publications Ltd". Overseas readers please pay by cheque or International Money Order.

Published in Great Britain by the Proprietors and Publishers Data Publications Ltd. 57 Maida Vale London W9
Printed by A. Quick & Co. (Printers) Ltd. Oxford Road Clacton-on-Sea England

Versatile Power Pack

By Peter Moran

A power unit which automatically switches off its h.t. supply when current consumption exceeds a pre-set figure

RECENTLY THE AUTHOR WANTED TO BUILD HIMSELF some test equipment as he was becoming increasingly more interested in experimental radio work. Since he only possessed one mains transformer offering suitable voltages and was unable to buy separate ones for each piece of equipment as well as for experimental items, he decided to squeeze as much as possible out of the single transformer and run all the apparatus from it. Because the cost had to be as small as possible, many ex-equipment components were used in the power pack which resulted. The remainder were purchased for under £1.

In view of the fact that the power pack was to be used for experimenting as well as for running test equipment, the following outputs were provided.

1. 250 volts d.c. (to trip at 75mA)
2. 0-250 volts d.c. (to trip at 15mA)
3. 6.3 volts a.c. (fused at 2 amps)
4. 6 volts d.c. (fused at 1 amp)
5. 0-6 volts d.c. (fused at 0.5 amp)

All the d.c. outputs were to be smoothed.

The Circuit

The circuit is quite simple and straightforward except, perhaps, for the trip arrangements. It was considered dangerous to have a common line or to earth any parts of the circuit to chassis, owing to the fact that if any equipment run from the power pack was used with other equipment having a live chassis, the power unit chassis could also become live. Thus, no parts of the mains transformer secondary circuit are at chassis potential.

The transformer, rectifier and smoothing components in the prototype were ex-equipment, but are easily obtainable. The transformer should have a separate heater winding for the rectifier. This winding should not be used for any other function as it is possible for it to have a potential up to 400 volts above the h.t. negative line. A 5Z4 is shown in the diagram, but any other full-wave rectifier capable of offering 80mA or more could be employed in its place provided that the transformer has a separate winding to suit its heater.

The relay is a P.O. type 3000 unit with a coil resistance of 2k Ω . This will trip at 6 to 8mA. If a

Components List

Resistors

- R₁ 1k Ω potentiometer wirewound
- R₂ 5k Ω potentiometer wirewound
- R₃ 1k Ω $\frac{1}{2}$ watt 20%
- R₄ 27k Ω 5 watt 10%
- R₅ Series neon resistor (see text)
- R₆ 50k Ω 6 watt potentiometer wirewound
- R₇ 100 Ω 4 watt potentiometer wirewound
- R₈ 2.7 Ω 4 watt 10%

Capacitors

- C_{1, 2, 3} 8 μ F electrolytic 400V wkg.
- C_{4, 5} 0.1 μ F paper 400V wkg.
- C_{6, 7} 1,000 μ F electrolytic 12V wkg.

Inductors

- T₁ Mains transformer. Secondaries (with minimum currents): 250-0-250V at 80 mA, 5V at 2A, 6.3V at 2A
- L₁ Smoothing choke, 10-20H, 80mA

Rectifiers

- V₁ 5Z4 (or alternative—see text)
- MR₁ Bridge rectifier, 6-12V 1A

Switches

- S₁ d.p.s.t. toggle
- S_{2, 3} s.p.s.t. toggle
- S_{4(a), (b)} d.p.d.t. toggle

Fuses

- F₁ 500mA cartridge fuse
- F₂ 2A cartridge fuse
- F₃ 500mA cartridge fuse
- F₄ 1A cartridge fuse

Relay

- A/2 P.O. type 3000 with 2k Ω coil and 1 change-over and 1 break contact set

Miscellaneous

- Neon bulb and holder
- Fuseholders
- Octal valveholder (for V₁)
- Knobs, etc.

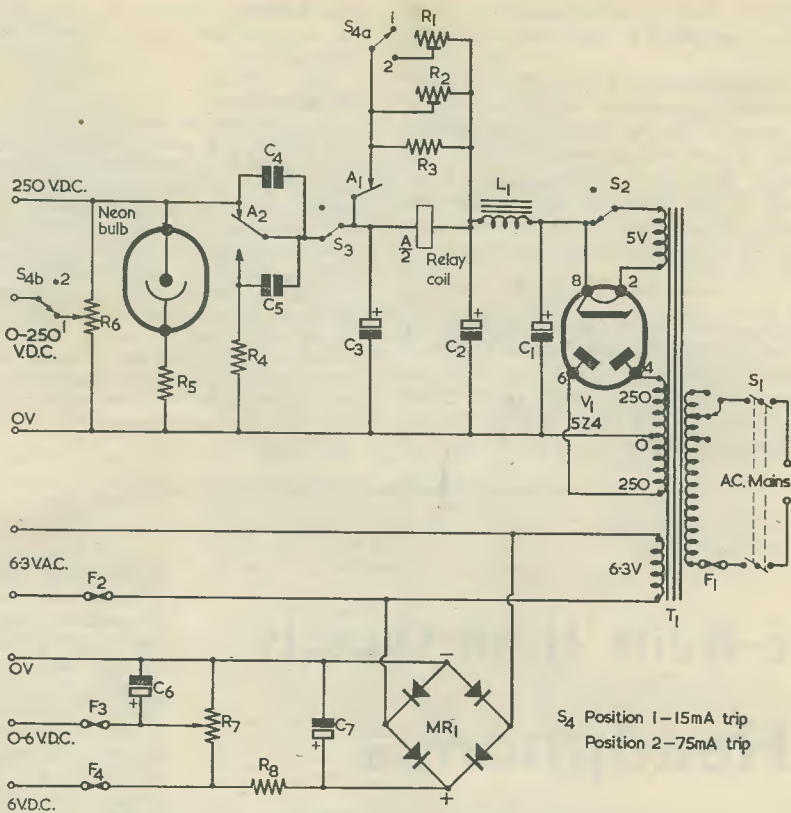

The circuit of the versatile power supply. The relay contacts, A₁ and A₂, are shown "detached" from the relay coil, and are depicted in the de-energised position. If too high a current is drawn from the h.t. section of the supply, the relay energises. Contacts A₂ disconnect the external equipment and connect the relay coil to R₄, thereby causing it to remain energised. At the same time, contacts A₁ disconnect the resistance across the relay coil, reducing the current in R₄ which is needed to hold on the relay

500Ω resistor is placed in parallel with the coil, the tripping current is around 20mA. The current at which the relay trips is increased as the parallel resistance is decreased. The power unit gives two tripping currents, 75mA and 15mA, but these may be altered at will by adjusting R₁ and R₂. As the power pack is required to deliver 75mA before the 75mA trip functions, the resistance needed to hold the relay locked on in the tripped position (R₄) would require to have an absurdly high wattage rating. Therefore, the resistance across the coil is switched out of circuit, by contacts A₁, when the relay trips.

An indication that the trip has functioned is given by the extinguishing of the neon. When lit, this neon indicates that h.t. is available. The neon should be a panel-mounting type that takes a low current, such as those that are available cheaply for mains testing. The value of R₅ depends on the type of neon employed.

R₁ and R₂ are the variable resistors which adjust

the tripping current. They should preferably have screwdriver slots for adjustment, and must be insulated from chassis.

S₃ is the trip re-set switch, and may be used also for temporarily switching off the h.t. supply. S₄(a), (b) select the tripping current. S₄ is a 2-pole, 2-way switch so wired that no current can be drawn from potentiometer R₆ when the trip is set for 75mA. S₂ switches off the h.t. supply when only the low voltage circuits are required. It should not be repeatedly switched on and off as damage to the valve's cathode may result.

C₄ and C₅ prevent sparking across the relay contacts.

The value of R₄ is fairly critical, and this resistor should be rated at 5 watts.

The low voltage supply is straightforward. No relay trip circuit can be fitted here as it would cause an excessive voltage drop, so fuses are employed instead. Any type of fuse-holder may be used but panel-mounting types will be found most convenient.

If a hum-free output in excess of 0.5 amp output is required, the 6 volt terminal is used and R_7 set to maximum.

The make contacts at A_2 lock the relay on after energising. However, the current which energises the relay passes through the A_2 break contacts and, to prevent chatter, it may be necessary to adjust the contacts here such that the hold-on occurs very shortly after the break contacts disconnect the external equipment. Alternatively, the contacts may be adjusted to give a make-before-break action.

Setting Up

After the unit has been wired up and checked, it is necessary to set up the relay trip circuit. This is done by applying appropriate loads across each output and adjusting first R_2 at 15mA and then R_1 at 75mA load current. It will prove helpful during setting up to draw the 15mA current from the 250

volt terminal and not via R_6 . S_4 should, of course, be in the 15mA trip position when R_2 is being adjusted.

Editor's Note

It is possible for either C_4 or C_5 to be charged when the appropriate relay contacts are open and the small discharge current which flows at the instant of contact closing may cause increased contact wear. However, there appears to be little trouble in this respect with the prototype, and both C_4 and C_5 can, in any event, be omitted without affecting the basic operation of the tripping circuit or the power unit as a whole.

If the equipment connected to the zero and 250 volt terminals has an electrolytic bypass capacitor connected across its h.t. rails, a limiting resistor of several hundred ohms should be inserted in series with the h.t. positive connection. Otherwise, very heavy charge currents could flow at the instant of closing S_3 if C_3 were charged and the electrolytic capacitor in the external circuit discharged.

Home-Built High Quality Headphones

By F. HOWARD

Fantastic as it may appear, a headphone capable of offering what one well-known loudspeaker manufacturer describes as "excellent reproduction" and "splendid performance" may be constructed at home using several yards of 32 to 36 s.w.g. enamelled wire, a small magnet and a tin of Sellotape!

THE USE OF HEADPHONES FOR high fidelity listening is becoming increasingly common. Good quality headphones can offer a reproduction and "presence" which is difficult to obtain with the less expensive type of loudspeaker, and they also enable sound to be reproduced at a relatively high level without annoyance to other members of the family or to neighbours. For stereophonic reproduction, high quality headphones can offer an illusion of spatial presentation which has to be heard to be believed.

However, headphones capable of doing full justice to high fidelity equipment are costly items of equipment. In the headphone design

described in this article it is possible to obtain a very high quality of reproduction with exceptionally cheap component parts, since the only major items needed for each headphone are a tin of Sellotape, a magnet and a length of 32 to 36 s.w.g. enamelled wire. Assembly is almost ridiculously easy and could be carried out by anybody who is keen on construction. The basic method of operation is extremely simple and the design offers a very wide field for experiment. On the debit side is the fact that sensitivity may be lower than with the more conventional (and very much more expensive) type of headphone, but this does not stop the

writer from using his own headphones with complete success in conjunction with such equipment as a home-built transistor t.r.f. receiver and a tape recorder.

Method Of Operation

The headphone consists basically of an air-cored coil consisting of some 60 to 80 turns of 32 to 36 s.w.g. enamelled wire which is fastened to a diaphragm and positioned in the field of a permanent magnet. One version of the headphone employs the field around one pole of a permanent bar magnet, as shown in Fig. 1. The audio signal is applied to the coil, which then moves the diaphragm in sympathy.

The construction of a practical version of this assembly is illustrated in Fig. 2. In Fig. 2 (a) a small bar magnet is secured by glue or any other convenient means to the inside centre of a round Sellotape tin having a diameter of $2\frac{1}{8}$ in. The tin is of the type which holds $\frac{1}{8}$ in Sellotape, and its depth is, in consequence, slightly greater than this figure. The length of the magnet is such that its upper end is just below the upper edge of the tin.

Fig. 2 (b) shows the coil after winding. The coil is random wound separately on a suitable former and has an internal diameter which is about $\frac{1}{8}$ in greater than the longest dimension of the magnet face. (In the later diagrams in Fig. 2 it is assumed that the magnet has a rectangular cross-section, whereupon the longest dimension would be given by either diagonal.) The

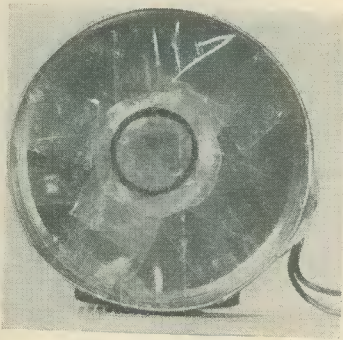

A partly constructed headphone

coil is self-supporting and may be doped to impart stiffness, but this is not essential if it is wound tightly. Holding one side of the coil between the thumb and finger, and turning it through 60° or so (Fig. 2 (c)) imparts a twist to it which causes it to be sufficiently rigid for the present application.

The coil is next secured to a 6in length of 1/8in Sellotape by means of a second short piece of the same tape (sticky surfaces together, with the coil sandwiched in between) as shown in Fig. 2 (d). The 6in. length of Sellotape is next slightly stretched and its ends passed over the edges of the tin and secured in this position. Since the sticky surface of the tape is downwards, this surface is presented to the edge and sides of the tin, to which it adheres. See Fig. 2 (e). The Sellotape strip is now held taut across the tin, the coil being underneath it and over the magnet pole. The final process consists of applying further strips of Sellotape, sticky side downwards, across the tin as illustrated in Fig. 2 (f), these all being secured to the edge and sides of the tin and all held taut. Each new strip of Sellotape passes over the coil at the centre and sticks to the previous ones, and just sufficient strips are added to ensure that an unbroken surface results, with no gaps. All the strips of Sellotape are taut, and their combined surface forms the diaphragm of the headphone.

During this operation it is necessary to secure the two lead-outs from the coil. These are held, at the edge, under one of the strips of Sellotape, a piece of Sellotape having been previously applied to the edge of the tin at this point to provide added insulation. There should be adequate slack between the coil and the point where the

lead-outs are secured at the edge of the tin. The lead-outs consist of the coil wire itself and they may be connected to terminals or more robust wire in any convenient manner. In the writer's units the enamel of the wire is stripped off and the lead-outs soldered to two thin flexible p.v.c. covered wires. The soldered joints are taped and secured to the side of the tin with more Sellotape.

The working section of the headphone is now complete. Some form of protective housing is required and this may be readily provided by completing the assembly in the manner shown in Fig. 3. A small piece of cambric or similar material, together with a piece of light expanded metal, is fitted over the front of the diaphragm to protect it, spacing off being provided by a ring of thin plastic foam around the tin edge. A further ring of plastic foam on the outside finishes the assembly and offers a comfortable

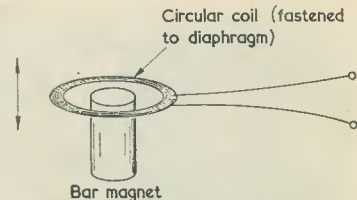

Fig. 1. The basic method of operation of one version of the headphone. An air-cored coil fastened to a diaphragm is positioned close to one pole of a bar magnet

surface for contact with the ear. The side and back of the tin may be covered, if desired, a suitable material being Fablon. All these materials may be glued to the original assembly.

Dimensions And Impedance

The description just given applies to a tin of 1/2in. Sellotape and a bar

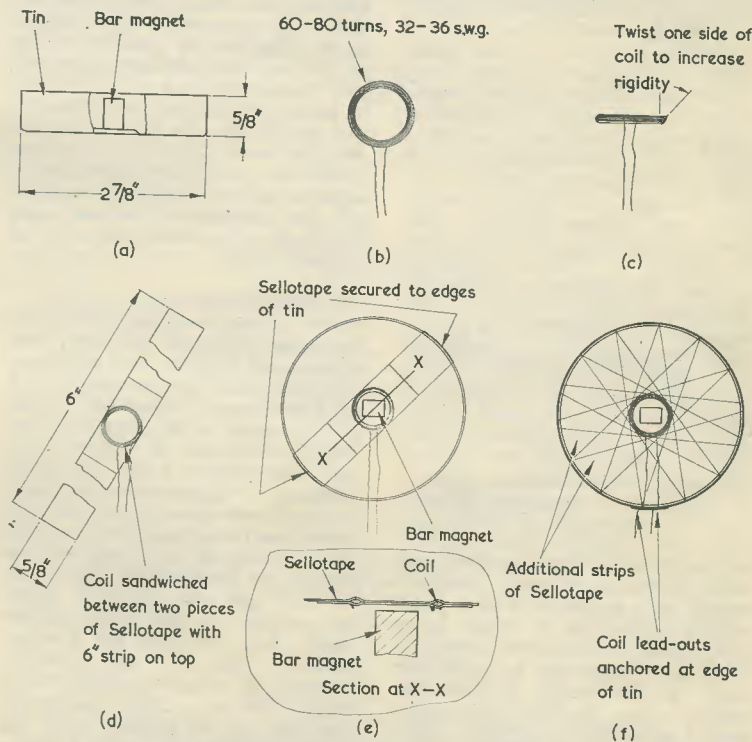

Fig. 2 (a). The bar magnet is secured at the inside centre of the tin such that its upper surface is just below the upper edge of the tin
 (b). The self-supporting coil is random-wound on a suitable former
 (c). The rigidity of the coil may be increased by twisting one side
 (d). Securing the coil to the 6in strip of Sellotape
 (e). Fixing the 6in strip to the tin. In the inset, the thickness of the Sellotape is exaggerated for purposes of illustration
 (f). Adding further strips of Sellotape, sticky side down, until an unbroken surface is presented. This provides the diaphragm



Two complete headphones

magnet which is slightly shorter in length than this figure. As may be readily gathered, the same principle of construction can be applied to round tins of slightly differing depth or diameter and to magnets of different dimensions. The length of the magnet obtained

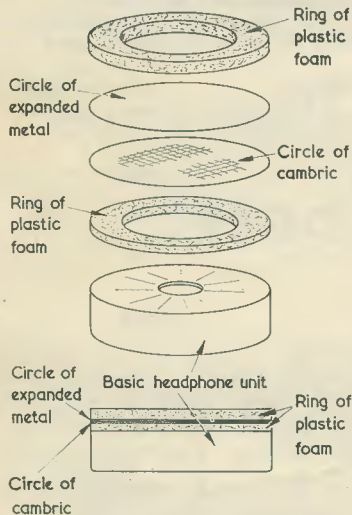

Fig. 3. The construction may be completed by adding the parts shown here

will, in general, determine the depth of tin which can be used. Adequate results will be given if the lower surface of the coil is about $\frac{1}{8}$ to $\frac{1}{16}$ in above the face of the magnet. It is most important to remember that all the strips of Sellotape which make up the diaphragm should be *taut*.

The d.c. resistance offered by the coil will depend upon the turns and gauge of the wire and should, in general, be some 10 to 20Ω. An adequate match should be obtained if it is assumed that the impedance is about 1.5 times the d.c. resistance.

As is to be expected, sensitivity depends largely upon the strength

of the bar magnet and it is desirable to obtain as powerful a magnet as possible. Small bar magnets are available from some of the component stores, as well as from old TV line linearity and width controls, gramophone pick-ups, and similar sources.

The most important point about the headphone is the excellent quality it provides, despite the extreme simplicity of its construction. With respect to the latter, it is possible to obtain results at the very first attempt, and there is a fascinating field of experiment in the way of different coil impedances and so on. So far as the diaphragm itself is concerned, the writer has found, after considerable experiment, that Sellotape applied in the criss-cross manner just described is an essential part of the construction.

An Alternative Design

An alternative design based on the same principle has also been constructed. This uses a round television focus magnet ring instead of a bar magnet, the focus magnet having poles at its ends and an outside diameter of about $2\frac{1}{4}$ in. See Fig. 4 (a). Using the same method of construction as with the Sellotape tin, a coil is then suspended beneath criss-cross strips of Sellotape at one end of the magnet, as indicated in Fig. 4 (b). In this case the Sellotape strips are secured to the focus magnet itself. Also, the coil has a wider diameter than in the previous instance, its outside diameter being about $\frac{1}{2}$ in less than the inside diameter of the magnet, with the result that the clearance between the outside of the coil and the inside of the magnet is $\frac{1}{4}$ in all round. This assembly offers the same quality of reproduction as do the headphones using the bar magnet, but the use of the focus magnet makes it heavier. It may be completed in the manner shown in Fig. 3.

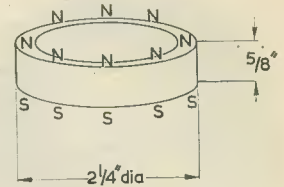

(a)

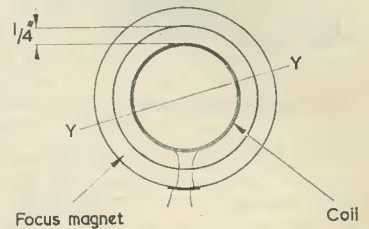

(b)

Fig. 4 (a). The focus magnet ring employed for the second version of the headphone. This has poles at its ends, as indicated by the letters N and S. It is, of course, immaterial which pole is uppermost in the final assembly

(b). Fitting the coil and Sellotape to the magnet

A sample of the focus magnet type of headphone was sent to Messrs. Wharfedale Wireless Works Ltd. for their comments. Their subsequent letter, which, of course, deals with the headphone as an amateur and not as a professional design, states "... we feel we must congratulate you on the quality of the earphones you have produced. These give excellent reproduction, particularly over the lower part of the frequency spectrum, and we have also been able to test them on stereophonic reproduction, the performance again being splendid. It would no doubt be possible to improve the sensitivity with larger magnets, and with a slight modification to the design, but for domestic listening there seems to be very little point in doing this."

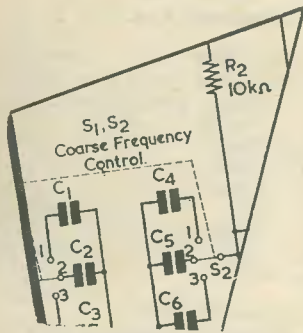

Electronic "Telepathy"

SUGGESTED CIRCUIT No. 181

By G. A. FRENCH

TELEPATHY IS EASY. PROVIDED, that is, you don't mind cheating!

To give an example of how "telepathy" may be demonstrated, let us imagine that, when your Christmas party is at its peak, you suddenly introduce a surprise visitor to your guests. This gentleman, or lady, is dressed in garments which obviously befit the true exponent of the art of telepathy, these consisting, say, of rich Eastern clothes including a turban or, for the lady, of an impressive gypsy costume complete with appropriate headgear. Some of the guests then retire to another room whilst the visitor stays in full view of the remainder. The guests who have departed next read passages from books, pick cards at random from a pack or give verbal messages for telepathic "reception" by the visitor. Despite the fact that he cannot possibly see or hear what is going on in the other room, the mysterious visitor then exercises his occult powers and tells the guests around him exactly what passages are being read, what cards are being picked, and what messages are being passed to him via the astral plane!

If correctly staged, and with the proper atmosphere, a demonstration of this type can be exceedingly impressive. Even the most distrustful of guests can have difficulty in finding how the "messages" are received, since there are no obvious means of communication whatsoever between the visitor and the room from which they originate. To emphasise the lack of physical means of communication the visitor may, indeed, walk around the room, engage in conversation and sit in any chair at will.

The simple basic ideas just given can, of course, be enlarged upon by the more imaginative to give really

striking demonstrations of what purports to be non-physical communication.

However, the writer does not need to emphasise the possibilities offered, since inventive readers will be able to present their own versions of this manifestation of unworldly and supernatural communication.

Inductive Coupling

How does the scheme work? The answer is that the method of communication is electronic and that it employs the same principles of inductive coupling as are used in offices, factories and hospitals to call individual members of the staff when required.

Fig. 1 shows the basic set-up. A microphone at the room in which the "telepathic messages" originate is coupled to a valve a.f. amplifier in or near the room in which the mystic visitor performs. The output of the amplifier is connected to a two-turn wire loop laid around the wainscot of the room or under the periphery of the carpet. The visitor is provided with a small iron-cored coil which picks up the signals on the loop, a

transistor a.f. amplifier, and an earpiece over which he hears the messages from the microphone. As will have been guessed, the turban and gypsy headgear mentioned earlier are needed to mask the earpiece. If, incidentally, the transistor amplifier is made sufficiently small, it could be secreted, with the pick-up coil, in the headgear itself. Otherwise, it may be kept in a pocket.

The equipment needed to set up this system is surprisingly simple and well within the capabilities and pocket of most constructors. The main requirement of the valve amplifier is that it should be capable of offering about 1 to 2 watts of reasonably undistorted a.f. output. The inductive loop laid down in the room is coupled, quite simply, to the 3Ω secondary of the valve amplifier output transformer in place of a loudspeaker. In some instances it will be possible to use an existing mains operated valve receiver to provide the output stage of the amplifier, a simple microphone pre-amplifier then being added to it.

A transistor a.f. amplifier could also be used to drive the loop,

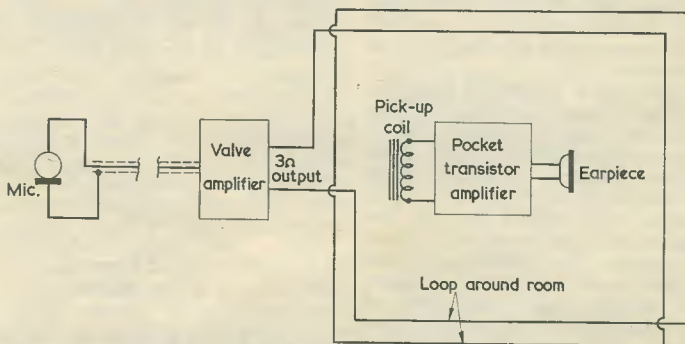

Fig. 1. The system by means of which messages are transmitted without interconnecting wires

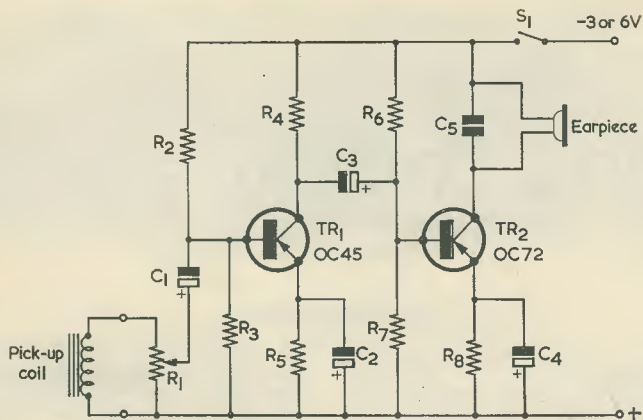

Fig. 2. The pocket transistor amplifier. Most coils with iron or ferrite cores will function satisfactorily as pick-up coils

provided it has sufficient output power. However, the Class-B output stages associated with the smaller type of transistor receiver would not be suitable, owing to the risk of excessive distortion.

The pocket transistor amplifier employs two transistors, five capacitors (four of which are electrolytic) and eight resistors (one of which is a gain control). Power is given by a miniature 3 or 6 volt battery, which has to provide a low current only. Even if the resistors are $\frac{1}{2}$ watt types and the capacitors are components of normal size, the whole amplifier may still be made small enough to fit unobtrusively into a pocket. The transistor amplifier output feeds into a "personal" earpiece.

Constructing the System

To make up the system it is necessary to proceed in two steps. The first step consists of constructing the pocket transistor amplifier and ensuring that it functions satisfactorily. After this, the valve amplifier is made and similarly brought into working order. It will be convenient, now, to discuss the circuits involved in the same order as they will be constructed.

The circuit of the pocket transistor amplifier is shown in Fig. 2. This comprises two transistors in a conventional circuit, the input being obtained, via gain control R_1 , from the pick-up coil. It is desirable to have a gain control because the operator will not be able to touch or remove the earpiece without destroying the "telepathy" illusion, and he may need some form of protection against excessively loud signals. The control may be an edge-operated component, since this can be readily adjusted by touch.

It will be preferable to mount all components, with the exception of the pick-up coil and, perhaps, the battery, on a small insulated board. The earpiece could couple into circuit via a miniature jack plug and socket. The earpiece specified has an impedance of $1k\Omega$, but magnetic earpieces of slightly lower or higher impedance should also function satisfactorily. The writer also checked the prototype amplifier with a single $2,000\Omega$ earphone as an alternative to the earpiece and obtained satisfactory results. Next tried were two $2,000\Omega$ earphones in series (making up a conventional pair of headphones) but the additional resistance introduced in the collector circuit of TR_2 resulted in considerable distortion. This was cleared by connecting a low resistance iron-cored inductor (actually the primary of a valve loudspeaker transformer) across the phones, and the writer mentions this last point in case constructors encounter similar distortion when using earpieces or earphones having higher resistance than the type specified.

In the prototype an OC45 was employed in the TR_1 position, but

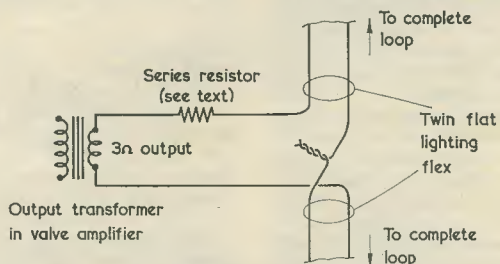

Fig. 3. The two-turn loop may be made up with twin flat lighting flex. The series resistor ensures that the overall resistance presented to the secondary of the output transformer is of the order of 3Ω .

Components List (Fig. 2)

Resistors

- (All fixed values $\frac{1}{4}$ or $\frac{1}{2}$ watt 10%)
- R_1 $25k\Omega$, potentiometer, log track
 - R_2 $47k\Omega$
 - R_3 $10k\Omega$
 - R_4 $4.7k\Omega$
 - R_5 $1k\Omega$
 - R_6 $33k\Omega$
 - R_7 $10k\Omega$
 - R_8 $1k\Omega$

Capacitors

- (All electrolytic capacitors may be 6V wkg.)
- C_1 $10\mu F$ electrolytic
 - C_2 $25\mu F$ electrolytic
 - C_3 $10\mu F$ electrolytic
 - C_4 $25\mu F$ electrolytic
 - C_5 $0.02\mu F$

Transistors

- TR_1 OC45 (see text)
- TR_2 OC72

Earpiece

- Personal earphone Type A, $1,000\Omega$ impedance (Henry's Radio Ltd.)

Switch

- S_1 s.p.s.t. on-off switch

Pick-up Coil

- Suitable ferrite or iron cored coil (see text)

the type used here is not critical. An OC71 should function just as well.

It will be noted that the amplifier incorporates full stabilising circuits, even though these require two electrolytic capacitors (in the emitter circuits) which would not be needed if stabilising were omitted. However, it was felt that the advantage of reliability of performance given by the use of full stabilising considerably outweighed the disadvantage of slight extra bulk.

To check the amplifier it is necessary to set up an inductive loop. This can consist of a temporary two-turn loop laid on the floor in the form of a square having a side

Components List (Fig. 4)

Resistors

(All fixed values $\frac{1}{4}$ watt 10% unless otherwise specified)

R ₉	220k Ω
R ₁₀	1.5k Ω
R ₁₁	220k Ω
R ₁₂	250k Ω , potentiometer, log track
R ₁₃	470k Ω
R ₁₄	270 Ω 1 watt
R ₁₅	3k Ω 2 watts

Capacitors

C ₆	10 μ F electrolytic, 6V wkg.
C ₇	500pF
C ₈	200pF
C ₉	1,000pF
C ₁₀	25 μ F electrolytic, 25V wkg.
C ₁₁	0.005 μ F, 350V wkg.
C ₁₂	4 μ F electrolytic, 250V wkg.

Valves

V ₁	12AX7
V ₂	6BW6

Transformers

T ₁	Microphone transformer. Approx. ratio 1:100
T ₂	Speaker transformer. Approx. ratio 40:1

Microphone

Small 3 Ω moving-coil loudspeaker

of about 12ft. It is desirable for the loop to present a resistance to the valve amplifier of some 2 to 4 Ω to enable a reasonable match to be made to the output transformer 3 Ω secondary. This resistance can, if desired, be provided by using thin wire in the loop, and it may be helpful here to remember that 26 s.w.g. copper wire has a resistance of 96 Ω per 1,000yds. The 32yds of wire in the loop would then have a resistance of 3 Ω if 26 s.w.g. wire were used. However, the same current will flow in the loop if heavier wire is employed and series resistance is inserted in one lead to bring the total up to around 3 Ω . A convenient method of forming the two-turn loop could consist of using a length of twin flat lighting flex with one lead at the entry point into the loop joined over as shown in Fig. 3 and the two remaining ends connected, via the series resistor, to the 3 Ω secondary of the valve amplifier output transformer.

Any mains-operated valve radio receiver having a 3 Ω speaker may be used for testing the transistor amplifier. All that has to be done is to tune the receiver to a station, adjust volume to a level slightly higher than that needed for domestic listening, switch it off, disconnect the internal loudspeaker, and connect

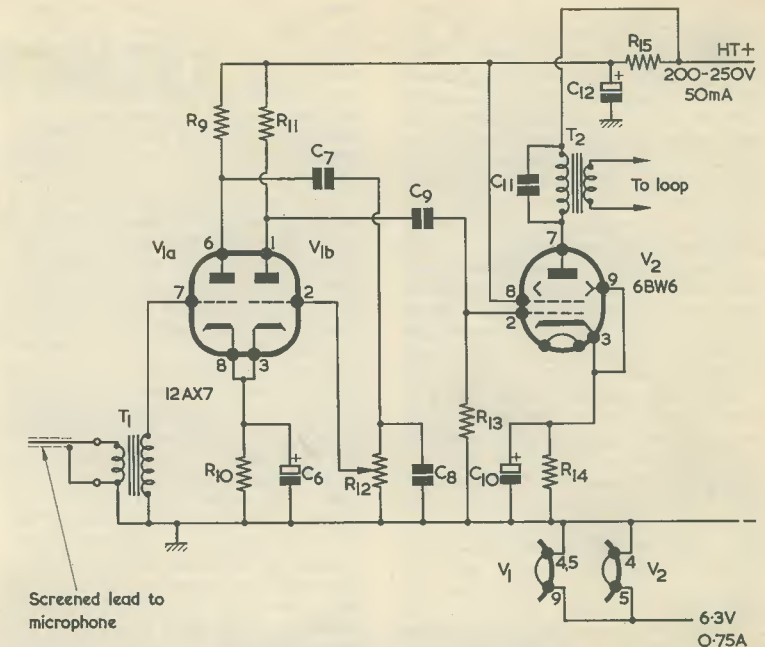

Fig. 4. A suitable valve amplifier for feeding the microphone signal into the loop. The screened lead to the microphone may consist of TV coaxial cable

the loop (with its series resistor, if fitted) to the 3 Ω secondary of the speaker transformer. If the receiver is then switched on again, the broadcast signal fed into the loop may be used for checking the transistor amplifier. *It must be remembered that if the receiver has a live chassis the loop wiring will also be live.*

Almost any coil having a straight iron core will function as a pick-up coil for the transistor amplifier. The writer obtained best results with an iron-cored relay coil about 2 $\frac{1}{2}$ in long, but quite satisfactory signals were given using a medium wave ferrite rod aerial and, slightly better, a long wave ferrite rod aerial. Any coils having a fairly large number of turns may be tried out, fitting these with some form of iron core if such a core is not already provided. With the prototype set-up the writer found that the tightness of coupling between the two-turn loop and the pick-up coil was surprisingly high. When a pair of 2,000 Ω headphones was connected directly to the relay coil just mentioned, it was possible to hear the signal from the radio receiver faintly without the transistor amplifier in circuit at all!

Summing up on the subject of the pick-up coil it may be said that *some* results should be obtained with almost any coil having an iron or ferrite core, and that the constructor

should check through his stock of suitable coils to find one that gives best results. The choice of coil is not, in the writer's experience, particularly critical, and there would appear to be little point in winding one especially for the application if an existing component can be adopted for the job. The pick-up coil finally used should be small enough to be hidden on the person and its axis should be vertical for maximum coupling to the loop.

If all is well, the transistor amplifier should reproduce the signal fed into the loop at adequate level and with good quality. It will be found that there is no significant change in signal strength with the pick-up coil at any point within the loop and at any height up to some 6ft or so from the floor. Signal strength drops rapidly as the pick-up coil is taken outside the loop. Due to the low input impedance of the amplifier, there should be little risk of capacitive pick-up of hum from the mains, and the pick-up coil may be connected to the amplifier via unscreened twisted flex.

Either a 3 volt or a 6 volt battery may be used to drive the transistor amplifier, the 6 volt battery giving somewhat increased gain and power output. With the prototype, current consumption was 0.7mA at 3 volts, and 1.5mA at 6 volts.

It is worth mentioning, incidentally, that the installation, as described up to the present stage, offers a very satisfactory method of obtaining headphone reception of a receiver or a.f. amplifier without any connecting wires between the receiver or amplifier output and the headphones. This could be useful for applications where a person has to listen to headphones whilst having freedom to move around.

When the tests just described have been completed, a more permanent loop may be installed in the room in which the "telepathy" demonstrations are to be given. The loop may either be laid under a carpet or around the wainscot. If the loop is considerably larger than the square with 12ft side which was used for testing, there may be a loss in sensitivity and a third turn may be called for. The new loop can be tested out with a radio receiver in the same manner as occurred previously.

The Valve Amplifier

A suitable valve amplifier for the final installation is shown in Fig. 4. This is basically the same as an amplifier described some years ago by the author,* with the exception that the output valve is a 6BW6

instead of the 6AM5 used previously. The 12AX7 employed in the V_1 position provides a very high gain, and C_7 and C_9 are given values which purposely offer attenuation of the lower audio frequencies and, in consequence, hum level. The gain control, R_{12} , is inserted in the grid circuit of $V_{1(b)}$ rather than that of $V_{1(a)}$ to simplify wiring. At the $V_{1(b)}$ stage the effect of hum pick-up is lower and there is less need to pay attention to this point when wiring up the gain control. The connection from T_1 secondary to $V_{1(a)}$ grid should be short and, if necessary, screened.

T_1 is a microphone transformer having a step-up ratio of around 1:100. The remote microphone may be any small 3Ω loudspeaker, and it can be coupled to the primary of T_1 by TV coaxial cable. The amplifier, itself, is mounted fairly close to the loop to prevent loss of power in the coupling leads. The power supply requirements are as shown, and *must* be provided by a power pack having a double-wound mains transformer in order to provide isolation from the mains.

If the radio receiver used for the

* "A Very High Gain Low-Cost A.F. Amplifier", Suggested Circuit No. 71, *The Radio Constructor*, October 1956.

previous tests has a chassis which is isolated from the mains, its output stage may be pressed into service for the present application. In this case V_2 , R_{13} , R_{14} , C_{10} , C_{11} and T_2 of Fig. 4 are not required, and C_9 can couple direct to the grid of the output valve in the receiver. The V_1 circuit then functions as a pre-amplifier, obtaining heater and h.t. supplies (the latter via R_{15}) from the receiver.

Final Setting Up

To finally set up the system it is desirable to carry out several rehearsals to find the optimum volume level settings in both amplifiers. The loudspeaker which functions as a microphone may be placed fairly near the point at which "messages" are to be read out or discussed. A good point is *above* head level, as there is then less risk of unexpectedly high outputs due to people approaching it too closely. For other versions of the demonstration a confederate could, of course, speak into the microphone directly.

The festive season is now very nearly upon us, and the writer would like, in consequence, to conclude this particular article by wishing happy telepathy transmissions to all his readers!

CAN ANYONE HELP?

Requests for information are inserted in this feature free of charge, subject to space being available. Users of this service undertake to acknowledge all letters, etc., received and to reimburse all reasonable expenses incurred by correspondents. Circuits, manuals, service sheets, etc., lent by readers must be returned in good condition within a reasonable period of time

R1392 VHF Receiver.—A. G. Coker, 48 Charlock Way, Burpham, Guildford, Surrey—handbook or servicing information on this unit (also known as type 62H, P104 or AP61357). Also associated power unit type 234A.
* * *

Cossor Oscilloscope Model 339.—J. Hines, 85 Bechlow Road, London, W.12—purchase service manual.
* * *

No. 76 Transmitter.—D. O'Sullivan, EI9AX, 17 Shanliss Road, Whitehall, Dublin, 9—purchase circuit or any other information.
* * *

Premier 5V5 Receiver.—A. R. Preston, 46 Longleigh House, Peckham Road, London, S.E.5—circuit, alignment data or any other information.
* * *

Indicator CTR Type 103.—R. Banks, 48 Connaught Road, Mays Lane, Barnet, Herts.—Ref. No. 10Q/16208, part of unit Monitor type 101; any information or circuits.
* * *

Indicator Unit Type 247.—R. Thorogood, 10 Kent House Lane, Beckenham, Kent—Ref. No. 10QB/6323, loan or

purchase manual or any information on this peak power meter.
* * *

Korting Tape Recorder Model 112.—M. J. Attwood, 18 Danesmoor House, Hobmoor Road, Yardley, Birmingham—service sheet and/or manufacturer's address.
* * *

Indicator Unit CRT Type 1A.—E. L. Schofield, 255 Moor Lane, Birkenshaw, Bradford, Yorks.—part of Indicator CRT 7301; any information.
* * *

Bendix Transmitter Type TA12.—M. C. Donnelly, GI3NSV, Tullykevan, Dungannon, Co. Tyrone, N. Ireland—circuit or any other information.
* * *

VHF Tuner.—A. R. Froud, 12 Remus Avenue, Heddon-on-the-Wall, Northumberland—has obtained a kit of parts for the Mullard designed tuner but the circuit and instructions are missing—can any reader help?
* * *

CR150/4 Receiver.—W. A. Hutchings, 74 Sandy Lane, Caldicot, Newport, Mon.—any modification details, loan of handbook would be appreciated.

NEWS AND COMMENT . . .

1965 Mullard Award

We have referred from time to time to the excellent work done by The Radio Amateur Invalid and Bedfast Club. We were therefore delighted that Mr. and Mrs. J. Woolley, G3ESR and G3LWR, were jointly presented with the Mullard Award at the recently held R.S.G.B. International Radio Communication Exhibition.

This annual award, which takes the form of books or equipment to the value of £25, plus a commemorative plaque, is offered by Mullard Ltd., the well-known electronics firm.

It goes to the Society member who, in the opinion of a special committee, has, through the medium of amateur radio, "rendered outstanding service to the community during the preceding year by his own endeavours or by his example of fortitude and courage."

Mr. and Mrs. Woolley are honorary treasurer and honorary secretary respectively of the Radio Amateur Invalid and Bedfast Club, and it is for their work in this connection that they jointly received the Award.

Founded eleven years ago, the club has blind and disabled members all over the world. It publishes a monthly news-letter and there are twice-weekly hook-ups on the amateur wavelengths for exchanges of news and views.

The club also helps members, studying for their transmitting licences, with text books, recorded lessons and information in Braille. Although the club has a large number of active voluntary supporters, members are encouraged to help themselves as much as possible.

Former signals officers with the R.A.F. and W.R.A.F., Mr. and Mrs. Woolley have long been keen amateur radio operators and first became interested in the R.A.I.B.C. while living at Saxilby, Lincs.

The presentation of the Mullard Award was made at the opening ceremony of this year's Exhibition, by Mr. D. A. Barron, C.B.E., M.Sc., M.I.E.E., Engineer-in-Chief of the G.P.O. Mr. and Mrs. Woolley were afterwards interviewed on film for the B.B.C. news feature *Town and Around*.

Computer Humour

As computers are not human perhaps we can be forgiven for having another "go" at them.

Consequent upon our remarks

under the above heading last month, we are indebted to two readers who have sent in a newspaper cutting and a further story respectively.

The cutting is from *The Times*, and is a report by their New York correspondent on a claim for damages against the police following an arrest for a traffic offence, based on information sorted out by a computer. Apparently 200 newsmen were invited to observe the new computer method of tracing traffic offenders. A lady driver caught by the use of the computer, on this publicity occasion, claims that she suffered from mental anguish due to the ridicule that the enormous publicity to her offence brought down upon her.

The case was adjourned to a date too late for us to include the result in these notes. We have a certain sympathy for the lady, perhaps heightened by the fact that the writer was recently fined for speeding in a "catchy" trap area.

The story concerned a ship's captain piloting his vessel through a difficult channel during a thick mist. Suddenly through the mist a large wreck was seen drifting right across his path. Quickly the relevant information was fed into a computer to decide whether to pass the wreck on the port or starboard side.

Quick as a flash came back the reply "Yes". "Yes what!" the computer was asked. "Yes sir" came back the reply.

Licences Ruling

An interesting ruling has just been given by the G.P.O. to the University of Sheffield Amateur Radio Society. The latter required enlightenment on the following points:

Can Sound "B" licences operate on any amateur frequency providing that they use a Sound "A" call sign, the holder of which is present?

Can Sound "B" licences operate a club (Sound "A") station as authorised operators, unsupervised on frequencies higher than 420 Mc/s?

It is appreciated that the use of Morse is not allowed when a Sound "B" licence is transmitting.

The G.P.O. Radio Services Branch replied as follows:

The holder of an Amateur (Sound) licence "B" is permitted to operate an "A" station under the direct supervision of the licensee on all amateur frequencies. Operation, however, is restricted to telephony only.

The holder of an Amateur (Sound) licence "B" cannot be authorised to act as an additional operator of an "A" club station.

Readers will recall that the Amateur (Sound) licence "A" permits operation in any amateur band by any of the authorised modes of transmission, whereas the Amateur (Sound) licence "B" authorises the use of telephony only on frequencies above 420 Mc/s only.

We are indebted to the Honorary Secretary of the University of Sheffield Amateur Radio Society, Mr. J. P. Billingham, G8AAC, for the foregoing information.

B.B.C.-2 Service from Rowridge

The B.B.C. have announced their regret that due to cumulative delays caused by bad weather at other sites and to technical difficulties that have been encountered in meeting the exacting requirements for the UHF transmitting aerial at the Rowridge, Isle of Wight, station, it was not possible to start B.B.C.-2 transmissions from this station in November as was hoped.

The Rowridge transmitter will make B.B.C.-2 available to about one million people living in South Hampshire and the Isle of Wight, the eastern parts of Dorset and parts of West Sussex.

The B.B.C.-2 transmitting aerial has been designed to radiate maximum power to these areas but the power radiated towards the continent must be limited in order to protect French UHF television services under international agreement. This requires very precise technical adjustment of the aerial.

Every effort is being made by the B.B.C. to complete the aerial and to start test transmissions of B.B.C.-2 programmes before the end of the year but this will depend on the progress made on the development of the aerial and on the weather conditions at the time it is being erected at the top of the 500ft Rowridge mast.

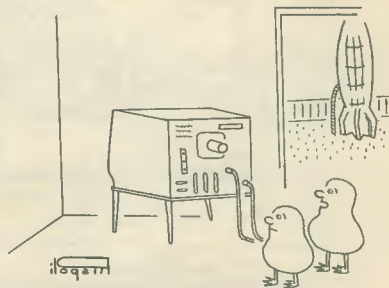

"I don't understand why they make so much fuss about TV!"

TRANSISTORISED TAPE "TAILER"

By WALLACE STUDLEY

Add this tiny transistor oscillator to your tape recording accessories. It offers a professional touch by providing electronic marking of tape ends

AUTOMATIC CUT-OUT DEVICES ARE NOT USUALLY fitted to low or moderately priced tape recorders and, because of this omission, annoyance is often felt when surveying the results of a run-out tape. Tedious re-threading of the tape on to the spool to find that it is back to front gives rise to further exasperation! Such aggravations can, however, be eliminated by constructing the Tape "Tailer" described in this article.

This unique self-contained device generates an audio signal of approximately 400 c/s and may be used at the time of recording to insert a high level signal on the last few inches of tape. In practice it is best to arrange for a newly made recording to fade out gently into a short silent period after which the audio tone due to the Tape "Tailer" is heard, this being in no way offensive to the ear.

Physically the unit is small indeed, and it is housed in a round aluminium container only 2in long and 1 3/8in in diameter. This container and every item used in the construction may be obtained quite easily, considerable thought having been given to

this point. The unit can be constructed by anyone reasonably adept at fine work, but the latter does necessitate a small pencil-bit soldering iron to make the twenty joints entailed.

The Circuit and Some Mechanical Notes

The circuit of the device is shown in Fig. 1. In this diagram a single p-n-p transistor is made to oscillate due to feedback via transformer T_1 . The oscillations are at audio frequency, and are passed from the transistor collector via C_1 to a socket, into which a tape recorder input lead may be plugged. On-off switching of the device is effected by screwing,

Components List

Resistors

(All $\frac{1}{10}$ watt, 10%)

- R_1 18k Ω
- R_2 4.7k Ω
- R_3 2.2k Ω
- R_4 1.2k Ω

Capacitor

C_1 2,000pF, miniature ceramic

Transformer

Transformer type D.1001 (T1079), with clamp (Ardente)

Transistor

TR_1 OC45

Battery

3-volt, type V.0038 (Vidor)

Miscellaneous

- 1 piece Veroboard, 0.2in pitch, 6 strips by 8 holes (see Fig. 2)
- 1 screening can, Ref. 11 (Denco)
- 1 surface mounting TV coaxial socket
- 2 solder tags
- 2 6BA nuts and bolts ($\frac{3}{8}$ in)
- 1 8BA nut and bolt
- Short lengths, yellow and red p.v.c. insulated wire

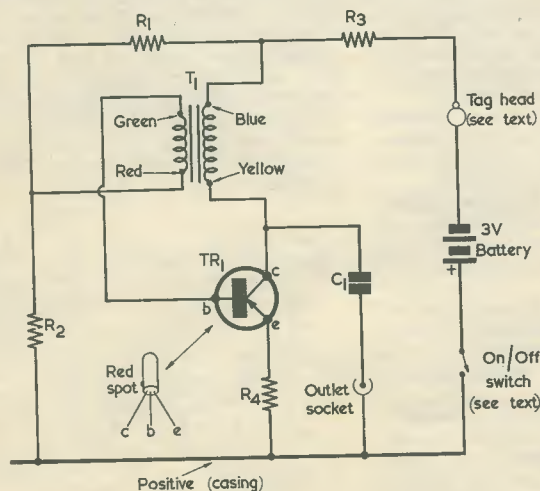

Fig. 1. The circuit of the Tape "Tailer"

or unscrewing, the screening container lid, and this feature will be described more fully later.

The battery used will rarely need replacing since the measured circuit current drain is only $280\mu\text{A}$, or 0.00028A from a 3 volt battery, and when it is remembered that a small torch bulb might consume 0.15A or more, the economy of the circuit will be appreciated! The oscillator will also function from a 1.5 volt Penlight cell; the larger physical size of such a cell cannot, however, be accommodated within the container specified.

A form of printed-circuit construction is given by mounting the components on a piece of "Veroboard". This is Paxolin, plain on one side but carrying, on the other, parallel strips of copper, each 0.1in wide and spaced by a like distance. Small holes are pierced in the copper strips at 0.2in intervals.*

Construction

To simplify constructional work each operation will be detailed in turn. Also, the section of Veroboard used is given letter and numerical designations for the holes—see Fig. 2.

(1) Take a piece of Veroboard and cut it with a hacksaw or fretsaw to agree with the plan depicted in Fig. 2 (a) so that six strips of copper exist (A-F) each having eight holes (1-8), and the overall dimensions are as shown.

(2) Using a hacksaw or knife cut a channel as indicated at point "Y", just deep enough to sever the copper strips. Also sever the copper at point "Z".

(3) Slightly enlarge holes D3 and D6, working from the conductor side, and drill a $\frac{1}{16}\text{in}$ hole at point "X". Write (e), (b), (c) in pencil on the strips as shown at the left of Fig. 2.

(4) Take T_1 , fit its clamp and, referring to Fig. 2 (b), pass the two mounting lugs through holes D3 and D6 so that the transformer body stands on the plain side of the board. Bend both lugs inwards on the underside to secure but do not apply solder yet.

(5) Take resistors R_1 , R_2 and R_4 and bend their lead-outs to agree with the inset diagram at Fig. 2 (b).

(6) Insert one end of a 3in length of thin red p.v.c. insulated wire (ends bared) in hole D3 from plain side, together with one lead-out of R_4 (coded Brown-Red-Red). Twist these around the transformer mounting lug on the conductor side and solder the whole to the board.

(7) Take R_2 (Yellow-Violet-Red) and insert one end at hole D6 from the plain side. Solder this and the transformer lug to the copper strip.

(8) Connect the free ends of R_2 and R_4 to holes C7 and C2 respectively and solder, snipping off any unwanted lengths of wire.

(9) Bare the ends of T_1 transformer lead-outs then solder red lead at hole C5, green at hole D2, yellow at hole E2 and blue at hole B7.

(10) Connect and solder R_1 (Brown-Grey-Orange)

* It should be noted that Veroboard is also available with closer hole spacing. However, the present design requires Veroboard having an 0.2in matrix, as described here.

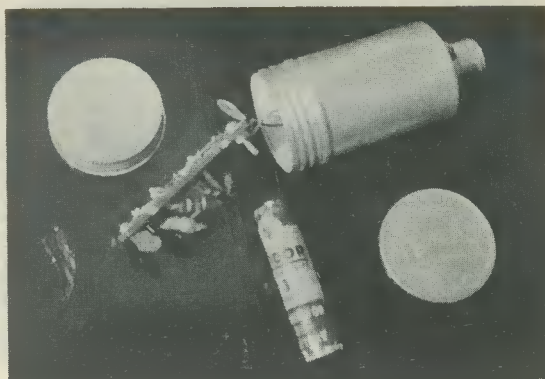

Screening can, lid, Veroboard and battery shown alongside half-a-crown piece for size comparison

to holes B6 and C6. Likewise connect and solder R_3 (Red-Red-Red) to holes B8 and D8. R_3 is mounted flat, as shown in Fig. 2 (b).

(11) Insert one end of a 3-in length of thin yellow p.v.c. insulated wire (ends bared) in hole F1 and solder. This wire leaves the board from the copper side; see Fig. 2 (a).

(12) Connect and solder a short length of thin insulated wire between holes B2 and D7 on the copper side, as shown in Fig. 2 (a).

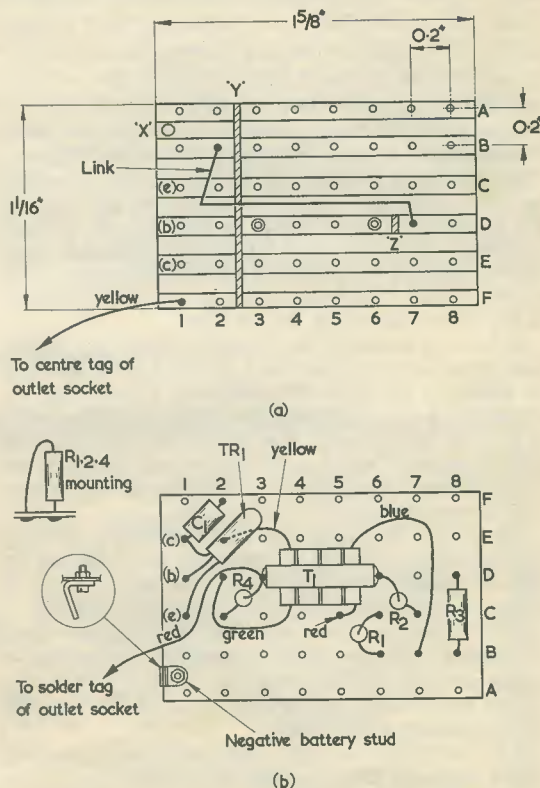

Fig. 2. The board dimensions, together with wiring details

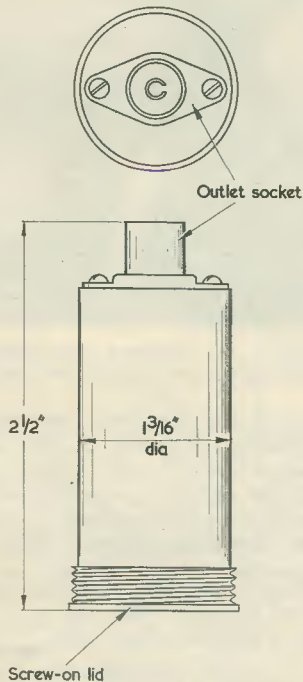

Fig. 3. The case assembly

(13) Fit and solder one end of C_1 to hole F2.

(14) Take the transistor and carefully cut each lead-out back to $\frac{1}{2}$ in. Sleeve the centre lead-out and insert the three wires as shown at Fig. 2 (b), making sure that the lead-out adjacent to the red spot on the transistor shell connects to hole E1. Hold each transistor wire with tweezers to shunt off iron heat when soldering to the board. Solder the three wires at the points indicated, inserting also the free end of C_1 before soldering the (c) wire.

(15) Take a solder tag, bend it to an "L" shape, then wrap it around the end of the board, fixing it by means of the 8BA nut and bolt. Check that the screw head short circuits the strips at A1 and B1. If it does not, remove and fit a washer. (The tag should project on the plain side of the board at an angle of approximately 60° . The base of the battery will engage this tag.)

(16) Take the container and, removing the lid, fix the coaxial socket in position as indicated in Fig. 3, using 6BA nuts and bolts and placing a solder tag beneath one of the nuts on the inside.

(17) Take the free end of the yellow lead emanating from the board assembly and solder it to the coaxial socket centre lug.

(18) Solder the free end of the red lead to the coaxial socket solder tag.

(19) Cut a strip of thin card $1\frac{1}{8}$ in long to exactly fit the inside of the container as a lining.

(20) Take the assembled board and carefully coax it into the container after wrapping a piece of Sellotape around the transistor end to prevent

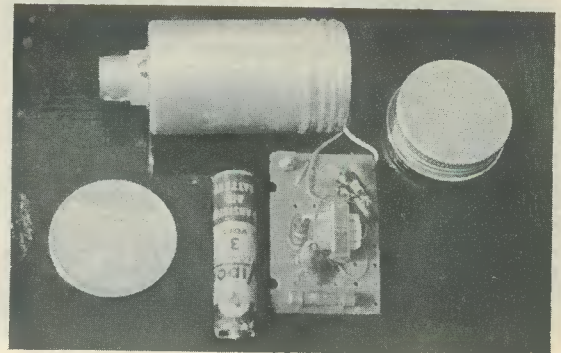

Plan view of the Veroboard assembly

unwanted short-circuits—to the output socket centre lug, for example. Refer to Fig. 4 when attempting this operation.

(21) Insert the battery with its brass connector towards the open end of the container and in such a way that the flat end contacts the "L" shaped tag. The brass battery stud connector should now project very slightly above the container rim as is shown in Fig. 4 (a) and in such a way that it will only be connected when the lid is screwed almost fully home. Should it not do so, remove the board and adjust the tag angle.

Conclusion

The Tape "Tailer" is now complete except that, after testing, the existing air spaces may be filled with thin tissue paper, gently pressed in, to afford rigidity.

If the tape recorder is now set to "Record" and an appropriate screened input lead connected to the

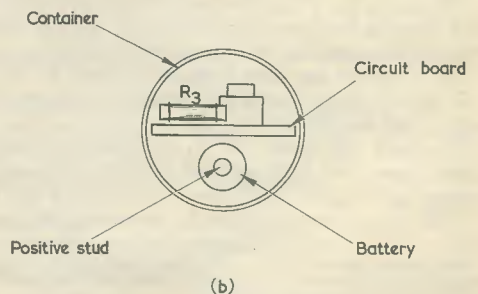
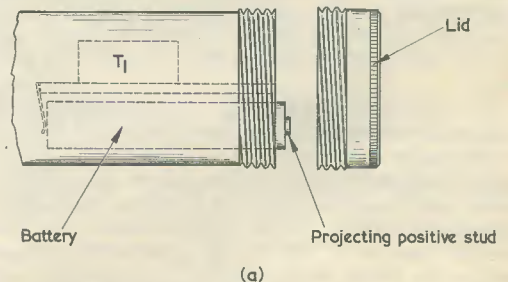

Fig. 4. Final steps in construction

output socket of the Tape "Tailer", operation can be checked visually via the level indicator and, later, aurally on "Playback". The simple, but effective, on-off switching effected by manipulating the lid can also be checked at the same time. It will be found that the output afforded by this simple device is surprisingly high and will in most cases have to

be suitably attenuated by means of the appropriate control on the tape recorder. The device can also be checked without using a tape recorder merely by connecting a pair of high impedance headphones to the output socket, and this immediately suggests other uses for the device. We will, however, leave the reader to think these out for himself!

HIGH-BRIGHTNESS CATHODE RAY TUBES

By M. HARDING

CATHODE RAY TUBES WITH A DISPLAY BRIGHTNESS approximately 100 times that of the more conventional c.r.t. are now in current use in radar monitors. Most radar systems employ a c.r.t. with a long persistence phosphor and, as a result, suffer from the disadvantages of low brightness and a rather short tube life.

However, a type of c.r.t., known as a "Direct View Storage Tube", has been developed, and this differs from an ordinary c.r.t. in that a short persistence phosphor is used together with a storage mesh to form an adjustable long persistence combination. The screen is composed of a short persistence phosphor with a thin metal mesh placed immediately behind it, which together with a thin layer of dielectric forms the storage mesh.

There are two electron gun assemblies, known as the "writing gun" and the "flood gun". The flood gun produces a uniform diffuse beam of low velocity electrons, which impinge on the total surface of the storage mesh. These electrons liberate less secondary electrons, from the surface of the

storage mesh, than the number arriving. The result is an overall negative charge on the mesh preventing penetration of the flood electrons through the mesh on to the phosphor.

The writing gun produces a high velocity stream of electrons which pass through the usual modulation, focus and deflection systems. Owing to their velocity, these electrons liberate more secondary electrons from the surface of the storage mesh than the number arriving. The result this time is a positive charge pattern traced out on the mesh in the shape of the required picture information. The positive charge pattern now accelerates the flood electrons, which are of course arriving at the mesh continuously, allowing their penetration through to the screen. This results in the excitation of the phosphor by the flood electrons in the form of the original positive charge pattern. It is this continuous excitation, as opposed to scanning, which is responsible for the high tube brightness, enabling it to be used in bright sunlight or where the room lighting has to be bright, and without the usual cumbersome viewing hood.

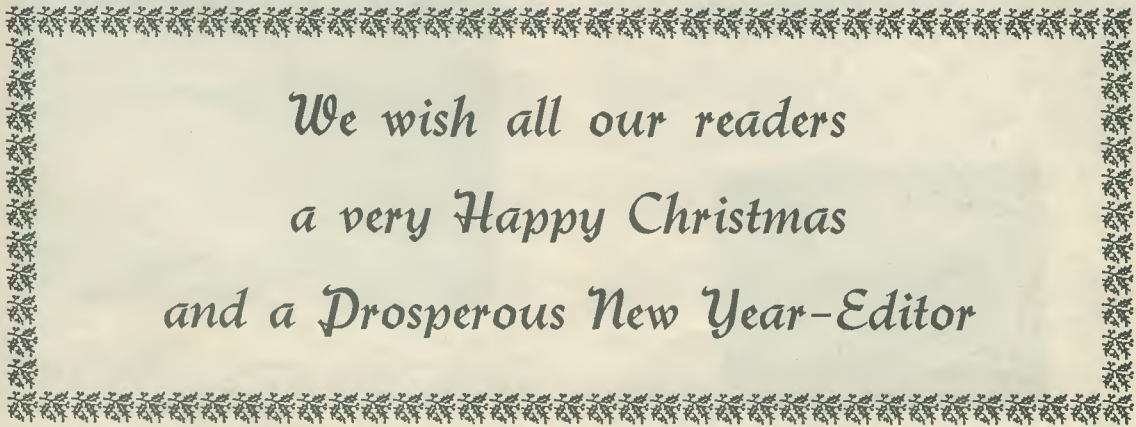

*We wish all our readers
a very Happy Christmas
and a Prosperous New Year—Editor*

SIMPLE SQUARE WAVE GENERATOR

By C. MAY

THE SUBJECT OF THIS ARTICLE IS A SIMPLE, BUT very useful, square wave generator that is capable of giving a waveform of rise-time 0.1 microseconds which is continuously variable from less than 10 c/s to about 500 kc/s. It is also continuously variable in amplitude from 10 volts peak-to-peak to 10 millivolts; and all this is done with only two valves and a stabiliser tube.

Square Waves

However, it might be as well to first of all consider a few theoretical aspects of square waves. As is well known, the square waveform can be considered as a series, consisting of the fundamental, plus 1/3 of the 3rd harmonic, 1/5 of the 5th harmonic, and so on to infinity. This means that, say, a 1 kc/s signal has an appreciable quantity of 3, 5 and 7 kc/s components and so, by using square waves, one can test circuits with several signals all at once. Any deficiency in high frequency response, as in low-pass interstage circuits, immediately shows up as a distortion of the waveform. Also, using the higher harmonics, it is by no means impossible to check the response of circuits in the megacycle region.

But the most common uses of square waves derive from an alternative way of looking at them. Instead of thinking of them as a sum of harmonics, they can be considered as a periodic switching on and off of the circuit. The sudden switching effect may then cause shock excitation or "ringing" of badly designed or constructed circuits. Location of this annoying fault is very valuable in hi-fi amplifiers. Furthermore, during the flat top of the square wave the circuit under test is being subjected to d.c. excitation. With conventional circuits, d.c. is prevented from being passed from an anode to the following grid by a coupling capacitor. The capacitor, in conjunction with the grid leak, forms a closed circuit that will discharge during the duration

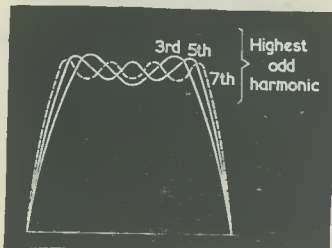

Fig. 1. Illustrating the synthesis of a square wave

of the flat top, so that the emerging signal shows a sag. There are various ways of estimating the value of the grid RC product from the frequency of the signal and the amount of sag. In the converse case, the increase in rise time due to stray capacitances to earth, things are simpler. In this case, the stray capacitances, mainly from the anode to earth, have to be charged each time the wave "switches", and since these capacitances take a certain time to charge or discharge, the leading and trailing edges of the wave are lengthened. If the time for the wave to rise from 10% to 90% of its full value is taken, then calling this "t" gives $t=2.2RC$, and the value of the stray capacitances in the circuit may be estimated. Of course, the cleaner and faster the original signal is the easier it is to perform these estimates.

Other uses of square waves will suggest themselves, and those just given are merely a few ideas. To help those new to them, Fig. 2 shows several

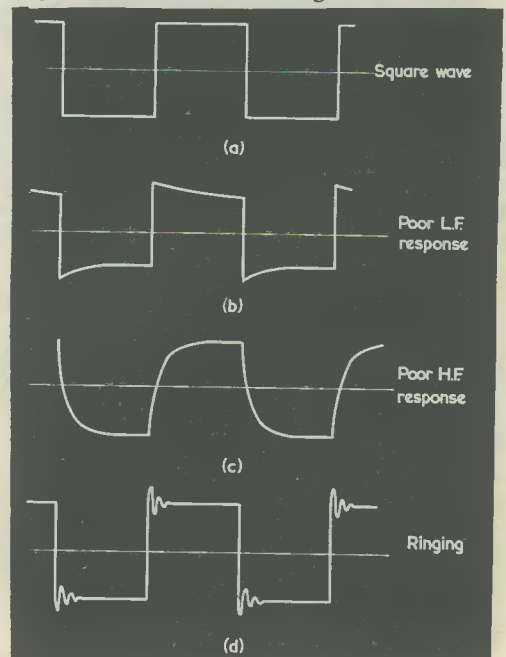

Fig. 2. Square wave testing. If the square wave of (a) is fed to an amplifier having poor low frequency response, the output resembles the waveform of (b). Poor high frequency response gives the output shown in (c). The waveform of (d) illustrates a ringing condition

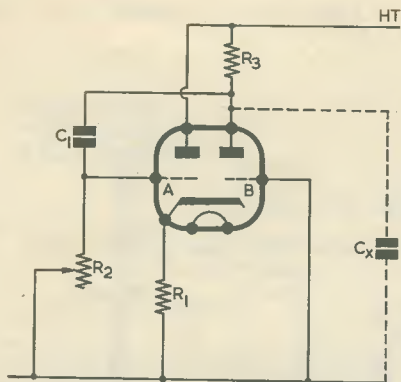

Fig. 3. The basic cathode coupled multivibrator circuit used by the author

examples of the typical waveforms mentioned above. It must be remembered that the results are surprisingly dependent on the oscilloscope used. Very often cheap instruments suffer from insufficient bandwidth, i.e. a long rise-time, together perhaps with overshoots in the peaking circuits. So it is often better to use the "Y DIRECT" terminal if possible.

Generation of Square Waves

There are two ways of producing a square wave. These consist of chopping a sine wave and amplifying the result, or of using a self-running switch circuit such as a multivibrator.

The first method can easily be adjusted to give sine waves as well, or else an add-on squaring unit can be made for existing sine-wave generators. This method has several advantages: it is automatically balanced to a 50-50 waveform and, provided the sine wave oscillator is properly designed, its frequency stability is good. However, it is very uneconomical on components; a pair of matched diodes is needed for the chopper, and then at least one stage of amplification for the resulting low-level signal is needed before the output circuit. Also, its rise-time is dependent on the fundamental frequency, as is readily seen in Fig. 4.

A symmetric multivibrator, on the other hand, only uses one valve, but it suffers from overshoots, is not self-balancing, and needs a ganged potentiometer and matched capacitors on the two range switches to change the frequency! All these imposing drawbacks can be solved by resorting to a cathode coupled multivibrator. This is simplicity itself. (See Fig. 3.) The two halves of the double triode are connected as a cathode follower and a grounded-grid amplifier. Since it is free-running, to follow its working we can break into the circuit when, say, valve A is cut off, and B is on. C_1 then discharges through R_2 (why this happens will become clear in a little while) so that the grid potential of A rises with a time constant R_2C_1 until the grid-base is reached, when A just begins to conduct again. The anode current flowing through R_1 rises,

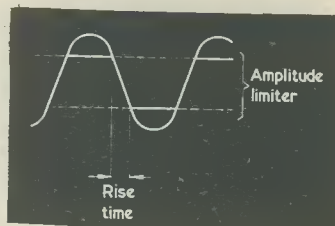

Fig. 4. Showing, in exaggerated form, the difficulties given when obtaining a square wave from a sine wave

and so produces a drop in voltage across this resistor. Since B has its grid earthed, its grid potential is the negative voltage across R_1 ; so the slight anode current just starting in A causes the grid of B to be driven negative. However, this negative pulse reduces the anode current of B, thus increasing the anode potential; and this increase is fed back to the grid of A, further raising its anode current. The switching action proceeds rapidly until A is fully on and B is off. C_1 now charges through R_2 and R_3 in series but, since R_3 is very much smaller than R_2 , it can safely be neglected. As C_1 charges, the anode current of A falls, and so the bias on B is reduced and eventually its grid-base is reached when the circuit switches over again.

To summarise, the square wave from B is fed back to A where it is differentiated by the grid circuit. The timing is by C_1 and R_2 and, provided the loss due to cathode follower action is small, the circuit is self-balancing. In the circuit to be described, no unbalance could be detected. By using a stabilised h.t. supply, the frequency stability is very good. The rise time of the circuit is almost entirely dependent on the stray capacitances C_x (see Fig. 3) which include anode-to-earth capacitance and also the capacitance of the following circuit to earth. As explained above, the time constant is $R_3 C_x$. This may be reduced by either lowering R_3 , or by decreasing C_x . C_x can be reduced by using a cathode follower to prevent the circuit under test and the connecting cable increasing the capacitance to earth, and by avoiding a metal cased coupling capacitor. The complete circuit diagram of the square wave generator is given in Fig. 5. In this diagram, the coupling capacitor just referred to is C_2 . Low-loss valve bases, an insulated chassis and careful layout also help in reducing C_x . A limit exists for R_3 where the voltage developed across it is insufficient to cause the switch-over. But if the anode current can be increased, then R_3 may be decreased and an adequate voltage is still developed. An ECC88 is pre-eminently suitable for this function as it allows a very small value of R_3 to be used.

The 12AT7 cathode-follower provides a smooth gain-control and isolates the square-wave generator from the circuit under test. Its action is entirely conventional.

Construction

The layout of the generator is not critical. As a guide, the prototype was constructed on a chassis

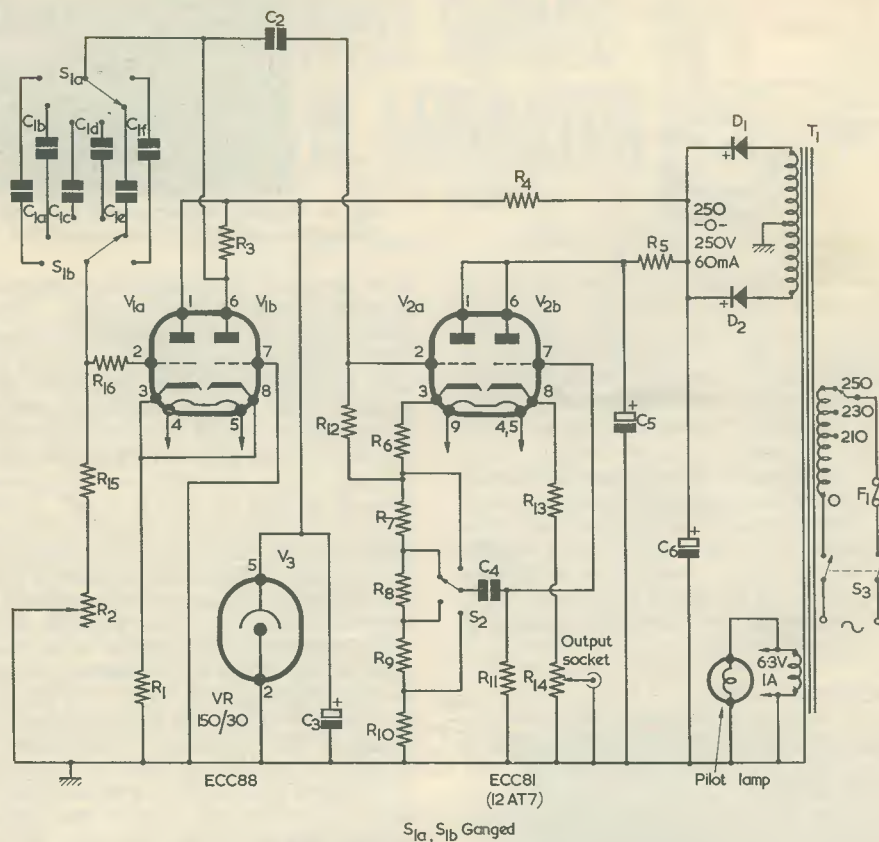

Fig. 5. The complete circuit of the square wave generator

Components List (Fig. 5)

Resistors

(All fixed resistors 10% $\frac{1}{2}$ watt unless otherwise stated)

R ₁	330 Ω 1 watt
R ₂	1M Ω linear potentiometer or 500k Ω log potentiometer (to suit type of scale required)
R ₃	1.8k Ω 3 watts
R ₄	3.9 k Ω 5 watts
R ₅	1.8k Ω 5 watts
R ₆	180 Ω
R ₇	2.7k Ω 1 watt
R ₈	270 Ω
R ₉	27 Ω
R ₁₀	3 Ω
R ₁₁	1M Ω
R ₁₂	1M Ω
R ₁₃	180 Ω
R ₁₄	5k Ω linear potentiometer wirewound
R ₁₅	Adjust to suit maximum frequency change needed
R ₁₆	1k Ω

Capacitors

C _{1(a)}	1 μ F
C _{1(b)}	0.1 μ F
C _{1(c)}	0.01 μ F
C _{1(d)}	0.001 μ F
C _{1(e)}	100pF
C _{1(f)}	10pF (adjust as needed)
C ₂	1 μ F (must not be metal-cased)
C ₃	32 μ F 250V wkg, electrolytic
C ₄	1 μ F
C ₅	50 μ F 350V wkg, electrolytic
C ₆	50 μ F 350V wkg, electrolytic

Transformer

T ₁	Mains transformer. Secondaries: 250-0-250 volt 60mA; 6.3 volt 1A
----------------	--

Valves

V ₁	ECC88
V ₂	ECC81 (12AT7)
V ₃	VR150/30

Rectifiers

D₁, D₂ Metal rectifiers, 250 volt 60mA

Switches

S₁ 2-pole, 6-way
S₂ 1-pole, 4-way
S₃ d.p.s.t. toggle

Fuse

F₁ 250mA cartridge fuse with holder

Miscellaneous

6.3 volt pilot lamp and holder
2 low-loss B9A valveholders (V₁, V₂)
1 octal valveholder (V₃)
Slow motion drive and knobs
Insulated panel
Chassis, etc.

measuring 6 x 10 x 2in with an 11 x 8in front panel.
The location of the larger components is shown in Fig. 6. Turret board was used for its ease of mounting small components and its reduced earth capaci-

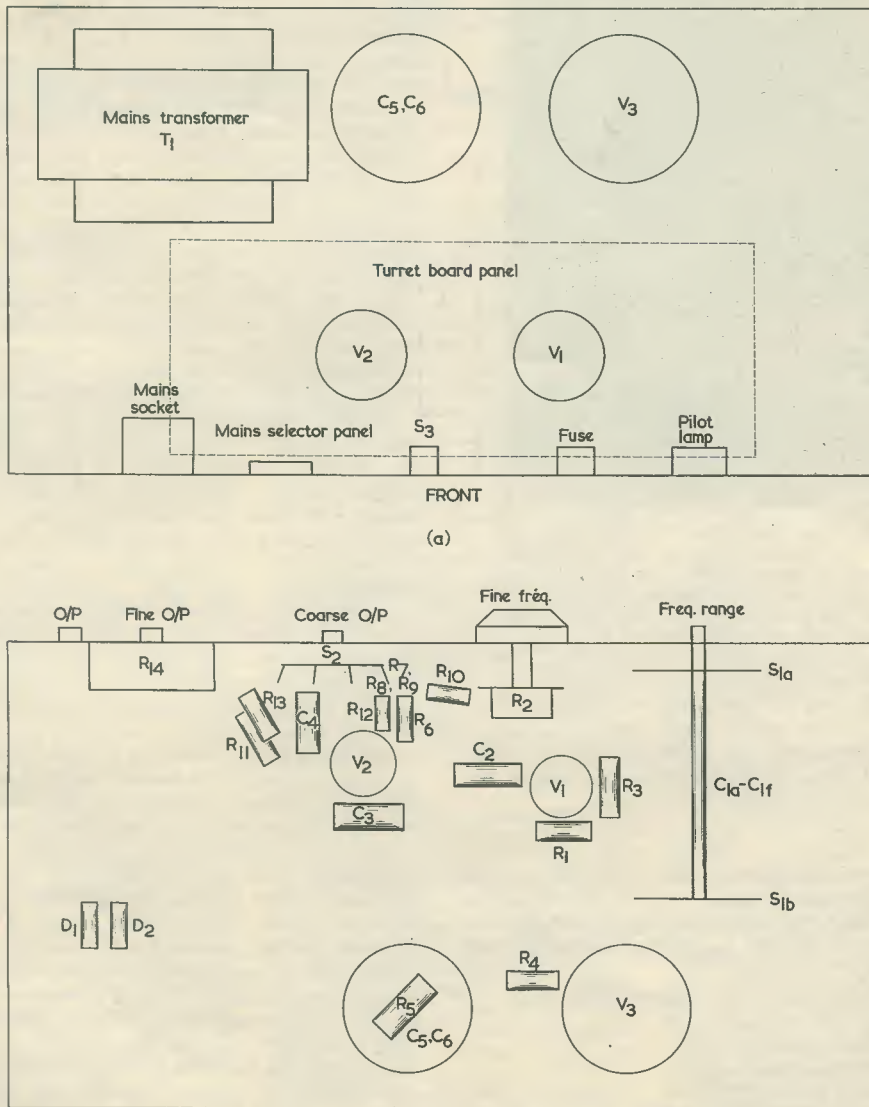

Fig. 6 (a). The layout above the chassis
(b). Below-chassis layout

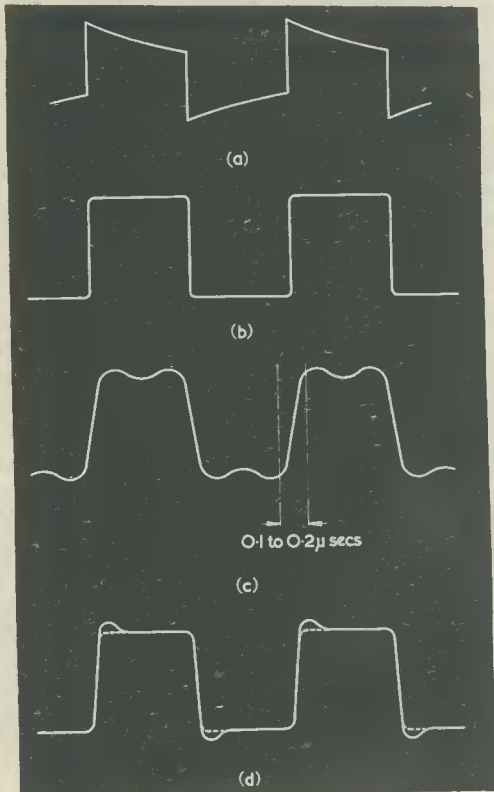

Fig. 7. The output waveforms obtained from the generator. The output given at low frequencies (around 20 c/s) is shown in (a). The mid-frequency waveform (100 c/s to 100 kc/s) appears in (b), whilst (c) shows the top frequency (about 660 kc/s). High frequency output (at about 300 kc/s) is illustrated in (d), the fine output control being at maximum. The dotted line shows the output waveform when the fine output control is at 70% or less of maximum setting

tance. The rest of the chassis employed 16 s.w.g. aluminium. A slow-motion dial is very useful for the fine frequency control.

Testing

After completing construction, it is worthwhile making a few voltage and current checks. The following are those measured on the prototype, and individual results should be within about 10% of these values.

- ECC81 (V_2) total anode current—19mA
- V_2 anode voltage—220V
- $V_2(a)$ cathode voltage—38V
- $V_2(b)$ cathode voltage—40V
- Unregulated h.t.—250V

The range capacitors work in decades from about 1 c/s on the low frequency end of the $1\mu\text{F}$ range to 600 kc/s at the top of the 10pF range. The first five ranges can be set up by using accurate decades, 1% mica capacitors being very good for the 1,000pF and 100pF ranges. But the highest range needs

special attention and in the prototype, 8.5pF was required. The choice between a linear or log law potentiometer for R_2 is entirely arbitrary; the linear potentiometer gives a good, nearly linear, sweep over most of its range, with a cramping at the upper end of the scale. If the capacitors are mounted between the wafers of a rotary switch, it may be advantageous to use all twelve contacts and further subdivide the ranges.

A certain amount of sag will be found on the lower ranges, starting at about 50 c/s. This looks like Fig. 2 (b) and can be improved by raising the value of R_1 , since the effect is due to imperfect cathode follower action in $V_1(a)$. 470Ω is probably the safe maximum before $V_1(b)$ is biased back too far for satisfactory operation. R_{15} decides the overlap of the ranges, and can be left out if desired. A value of 10kΩ is approximately that required for a small overlap. Similarly, R_{16} may not be required. R_{14} is specified as wirewound, its small inductance helping to sharpen the waveform, although, as shown in Fig. 7 (d), it does produce a certain amount of overshoot over the last 30% of its travel. But this is only a few per cent and so is not a serious drawback. It might also be wise to insert a capacitor of about $1\mu\text{F}$ or so between the slider of R_{14} and the output socket.

Typical waveforms are given in Fig. 7, these showing how the unit performs at various frequencies.

Finally, it should be pointed out that, when connecting the unit to other apparatus, coaxial cable of the minimum capacitance must be used or even two separate wires. This is because even a few picfarads will result in the rise-time of the waveform being increased three or four times.

Addendum

Since designing the generator, it has been pointed out to the author that television engineers may be surprised to see this form of circuit giving a 50:50 waveform. The author has consequently consulted a few TV timebase circuits using a cathode coupled multivibrator, and they all seem to suffer from either gross loss of cathode follower action, or grid current—or both! Of course “suffer” refers to their use as square wave generators, and is no reflection on their suitability as TV timebases.

The circuit described in this article will only act properly if both grid current and loss of cathode follower action in the multivibrator are avoided. By making R_1 fairly large, the loss of cathode follower action can be kept to a very low value. Little will be gained by any great increase in the value given. Indeed, if it is increased too far, the anode currents may be so reduced that other forms of trouble arise. If it is decreased by about 50% or more, then the cathode no longer accurately follows the excursions of the grid on the positive-going signal (which is where the loss of cathode follower action occurs) and the output is no longer 50:50.

This fairly large value of R_1 also keeps the cathode at quite a few volts negative of the grid, so that there is less chance of the positive signal driving grid current.

It might also be added that a small resistor, up to about the same value as R_3 , could be included in the anode circuit of $V_{1(a)}$ and the output taken from

it. This would eliminate the capacitance of the wiring to the output stage given by C_x , but this is so low that no significant improvement results.

IN YOUR WORKSHOP



IT WAS CHRISTMAS EVE IN THE Workshop, and the snow was falling fast.

This opening line, unashamedly lifted—with slight amendment—from a well-known festive verse, could well be used to usher in a scene in which Smithy the Serviceman is cast as the Workshop Master, and his faithful assistant Dick as the indignant recipient of the Workshop Christmas Pud. But we cannot, unfortunately, continue in this light-hearted vein because, on this particular Christmas Eve, Dick and Smithy were gravely preoccupied with matters electronic. The "For Repair" racks at the end of the Workshop groaned under the weight of receivers which had, inevitably, developed faults over the last few days, and Dick and Smithy laboured sternly and incessantly in order to clear them up in time for Christmas Day itself.

If we were to join them at their technical endeavours (regretfully passing up the chance to learn the ultimate fate of that Christmas Pudding) we would enter a world of feverish activity in which grunts of satisfaction at a fault successfully traced were interspersed with such sounds as the intermittent moan of the signal generator, the rattling of turret tuners as they were quickly adjusted from one local v.h.f. channel to the next, and the clatter of cabinets triumphantly transferred to the "Repaired" rack.

Despite its rush and bustle, the Workshop still gave evidence that the festive season was by no means forgotten. On the shelf above Dick's bench stood an imposing array of Christmas Cards from all his many aunts, plus one from his uncle who

(to Smithy's intense vexation) was also the steward at Smithy's club. Smithy's cards were much fewer in number, and had all come from trade representatives. Nevertheless, they still passed on their own individual Christmas messages. The first card depicted Santa Claus gaily descending a chimney with a transistor radio, the second showed Santa Claus merrily driving a sleigh on which reposed a stereo radiogram, the third had Santa Claus happily bursting his way through the screen of a television receiver, and the fourth showed Santa Claus joyfully gazing through the hole in the centre of a deflection yoke. The somewhat disturbing consistency in Smithy's Christmas Cards had once again made itself evident. The previous Christmas his cards had all been robins and, in the year before that, candles. This year they were all Santa Clauses.

The Last Set

Diligence and application can surmount almost any obstacle and, as Christmas Eve wore on, the number of sets awaiting repair in the Workshop slowly diminished. When the afternoon was half-way through, Dick and Smithy found themselves carrying two now-serviceable sets to the "Repaired" racks, after which they turned in unison to the "For Repair" shelves. Simultaneously, their mouths dropped open in amazement.

It was Smithy who recovered himself first.

"Blow me," he exclaimed, wiping his brow. "There's only one left!"

"Have we," asked Dick incredulously, "cleared up all the rest of them?"

"We must have done," replied Smithy. "I've been bashing away at them so much I haven't even bothered to see how many we've done."

"Same here," concurred Dick. "I've just been picking wildly at the first set I bumped into."

"Well," said Smithy, "the sooner we get this last receiver out of the way the sooner we can pack in for the day."

Dick needed no further bidding. He picked up the set, a dual-standard TV receiver, and carried it back to his bench.

"Since this is the last one," he said, "shall we have a stab at it together?"

"If you like," replied Smithy.

Whilst Dick busied himself with connecting the receiver to the mains and applying an aerial, the Serviceman walked to his bench, returned with his stool, and settled himself comfortably at Dick's side.

Dick switched on.

After some moments, the sound of one of the local v.h.f. channels became evident from the speaker. Shortly afterwards the line output stage and e.h.t. rectifier came to life and the screen displayed a picture having excellent brightness and contrast. Dick switched to the other v.h.f. channel, to be rewarded by similarly encouraging results. Leaning over the receiver, he connected a second coaxial cable to the u.h.f. socket. He next carefully adjusted the u.h.f. tuning, to find that B.B.C.2 was reproduced just as well as were the two v.h.f. channels.

"Not much to worry about here," he called out happily.

"Things certainly seem to be O.K.," agreed Smithy warily.

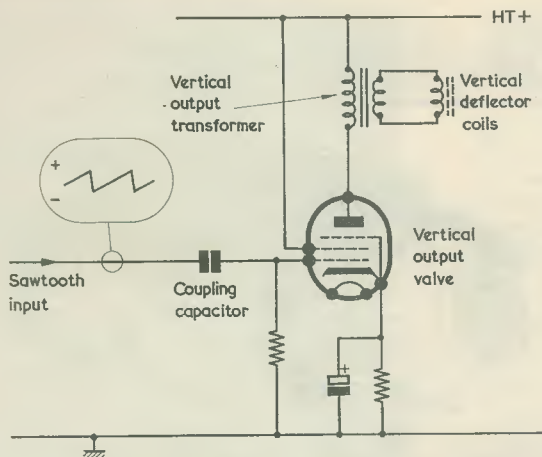

Fig. 1. The basic vertical output stage, without linearising components. As is common practice, a double-wound vertical output transformer is used

He examined the picture carefully. "One thing," he remarked, "is that we have what the customers refer to as a 'black bar' at the top and bottom of the picture. In other words, there isn't sufficient height!"

Dick noted that the top and bottom of the picture were about half an inch short of the screen edges, then peered round the back of the receiver to locate the picture height control. He adjusted this experimentally. The picture height reduced, then returned to its original condition, still just failing to fill the screen.

"Can't get any more out of it," he remarked. "The height control is hard over."

"Fair enough," said Smithy promptly. "Then we've got a nice simple fault to clear. Pop in a new vertical output valve!"

"Just like that?"

"Just like that," confirmed Smithy. "The vertical output valve is the most likely culprit because, if it has low emission, it can't provide enough anode current to give adequate vertical deflection."

"But in that case," protested Dick, "you'd get the lack of deflection at the bottom of the picture only, because that's where the vertical output valve has to pass most current."

Smithy raised his eyes.

"Here we are," he addressed the ceiling, "with one last job to do before we pack up for Christmas, and he has to raise objections!"

"What I said was perfectly reasonable," replied Dick, stung at Smithy's remark. "At the start of the vertical scan the vertical output valve draws a low anode current.

And, at the end of the scan, it draws a high anode current. If it's low emission it won't be able to draw the high anode current and so you should lose deflection at the bottom of the picture only. With this set you've lost deflection both at the bottom *and* the top."

Smithy lowered his eyes to gaze at his assistant.

"I suppose," he conceded, "that you have got a point there. Don't forget, though, that someone may have waggled the picture shift control around to get this picture centralised despite its lack of vertical scan. But even without that happening, a low emission vertical output valve can still cause you to lose deflection at the top of the picture as well as the bottom. What you have to remember is that, in most sets, there is a double-wound vertical output transformer between the anode of the vertical output valve and the vertical deflector coils. (Fig. 1.) During the scan period the current in the primary of this transformer is the anode current of the vertical output valve, and it flows in the same direction throughout the period, starting at a low value and ending at a high value. After which it goes back to a low value again during flyback, ready for the next scan period. In other words, the primary current consists of a sawtooth superimposed on a direct current. All that's induced in the turns of the secondary, however, is the sawtooth waveform. This is just an alternating current on its own, and it has what can be called a central average value equal to the sum of all the currents in a cycle, and at which current direction

changes. The resulting vertical deflection then tends to centralise at this average value. If, due to low emission in the vertical output valve, the maximum current in the primary at the end of the scan period is reduced, what you get in the secondary is a sawtooth waveform having a lower peak-to-peak amplitude. It's still an alternating current with an average central value, and the result is that deflection in both the upward and downward directions is reduced. I would agree, incidentally, that the sawtooth given by the low emission vertical output valve may not be all that linear, but this still doesn't prevent it from being an alternating current which behaves in the manner I've just described."

"I think I see what you mean now," said Dick thoughtfully. "It's rather like a carbon microphone transformer circuit, where you have a battery in series with the carbon mike and the primary of a microphone transformer. In the primary you have a current which always flows in the same direction, but which varies when you speak into the microphone. But in the secondary you have a straightforward alternating current whose peak-to-peak amplitude varies according to the difference between maximum and minimum current in the primary."

"That," said Smithy, pleased, "is the idea, and it similarly applies to the vertical output transformer. You've got d.c. and a.c. in the primary, but only a.c. appears in the secondary, whereupon the vertical scan tends to centralise near the centre of the screen. In practical vertical output circuits, by the way, the reduction in top and bottom deflection limits due to a low emission vertical output valve won't be exactly equal because of non-linearity in the sawtooth currents involved. But the basic effect will still occur."

"Just a minute," said Dick, as a thought occurred to him. "I've seen lots of sets in which the vertical output transformer is not double-wound. It is, instead, an autotransformer."

Smithy reached over for Dick's notepad and pulled a ball pen from his top pocket.

"What you normally see," he remarked, sketching out a circuit on the pad, "is what *appears* to be an autotransformer. A typical double-wound vertical output transformer circuit looks like this. (Fig. 2 (a).) The secondary circuit has to be earthed at some point, and the most convenient method consists of connecting one end of the secondary to the h.t. positive line."

"Why not," asked Dick, "earth it to chassis?"

"Because," replied Smithy, "the vertical deflector coils in the deflector yoke are very close to the line deflector coils, and the latter will be at boosted h.t. potential. Having the vertical deflector coils at h.t. positive potential reduces the voltage between the two sets of coils and thus diminishes the risk of breakdown between them. It also helps to simplify vertical output transformer design as, with no other aid but my pen and this notepad of yours which nowadays seems to be always so conveniently at hand, I shall next proceed to demonstrate."

Smithy drew a further circuit on the convenient notepad. (Fig. 2 (b).)

"This," he continued, "is what you frequently bump into in service manuals. But it's exactly the same as the circuit I drew previously."

"Come off it, Smithy," said Dick. "It can't be. This one's an auto-transformer!"

"No it isn't. If you look at it carefully, you'll see that the tap in the winding connects to h.t. positive. In my previous circuit the upper end of the primary went to h.t. positive, and so did the lower end of the secondary. All I've now done is to draw the secondary on top of the primary, so that they look like one winding. Which in a practical transformer they can be, although it would be necessary to use thicker wire for the secondary bit because, since the vertical output transformer is a step-down component, the secondary has to pass more current. You still have a double-wound transformer, though. The fact that one end of each winding connects to the same point makes it possible to assemble it and connect it into circuit as though it were a three-terminal component."

"So it isn't," said Dick, "an autotransformer after all."

"Of course it isn't," replied Smithy. "With an autotransformer you have to have part of the winding common to both the primary and the secondary circuits. I must point out, though, that I wouldn't be giving you a complete picture of what goes on in commercial TV design if I didn't tell you that you will occasionally encounter a vertical output transformer which is a *true* autotransformer. (Fig. 2 (c).) In this case the winding between h.t. positive and the deflector coil tap is common to both windings. What happens here is that the d.c. component of the anode current flows in the deflector coil circuit and modifies the automatic tendency of the vertical scan to centralise on the

screen. But, due to the action of the transformer, the secondary current is quite a lot higher than the primary current, and so the de-centralising effect of the primary current will not be too great. Added to which is the fact that it's Christmas Day tomorrow!"

Presentations

"Blimey," said Dick, startled, "so it is! We'd better get weaving on this set if we're ever going to get away tonight."

"I did suggest," remarked Smithy mildly, "that we could pop in a new vertical output valve."

"I don't know what type we need for this set."

"Then find out," said Smithy sweetly, "from the service manual."

Dick stood up and walked over to the cupboard which held the service

sheets. Smithy rose also, and proceeded to take the back from the receiver on Dick's bench. When he had completed this task, and had re-applied the mains connection and aerial plugs he gazed idly through the window above Dick's bench.

A setting wintry sun was breaking through a sky of ragged grey clouds. It was almost dusk already.

And it had started to snow.

Outside, in the nearby brightly lit streets, people would be bustling cheerfully past the glittering shop windows, intent on last-minute purchases before the Day itself arrived. Outside, families would be gathering together, plans would be being made, food prepared, parties organised, Christmas trees dressed, and all manner of presents hidden away in all manner of unlikely hiding places. Outside . . .

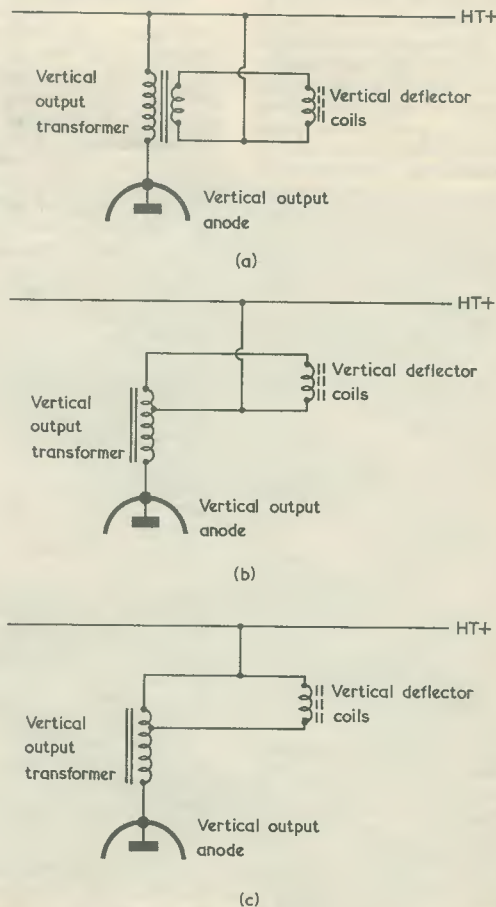

Fig. 2 (a). Usually, one side of the vertical output transformer secondary is earthed to the h.t. positive rail
 (b). The double-wound transformer of (a) can be redrawn in the manner shown here
 (c). Occasionally, the vertical output transformer is an autotransformer

Smithy's eye fell on the television receiver which probably needed a new vertical output valve. Dick seemed to be a long time finding it.

A thought occurred to the Serviceman and he walked over to his bench, opened a drawer and extracted a flat brown paper parcel. He had just returned to Dick's bench when that latter worthy returned from the valve cupboard. Smithy was mildly interested to note that his assistant proceeded to open a drawer in *his* bench and to similarly extract a flat brown paper parcel.

"Here," said Dick, offering his parcel to the Serviceman, "here's a little Christmas present I got for you."

"Well, that *is* nice," said Smithy, pleased, as he took the package and examined it carefully. "And here's one from me to you!"

Smithy handed his parcel to Dick, and then proceeded to remove the paper from his own present whilst his assistant looked on expectantly. Eventually, the last of the coverings were removed, to reveal a hard-cover book of about the size of an average novel. On the dust-cover was a brightly reproduced picture of a boot.

Smithy stiffened at the sight.

"Do you like it?" asked Dick anxiously.

"Yes, of course I do," said Smithy doubtfully.

"It's called *How to Repair a Boot*."

"So I see."

"It's not," continued Dick, eager to dispel any ideas of excessive munificence, "entirely *new*, of course. Actually, it's one of the very first do-it-yourself books which was ever written, and it came out just after the war. And there's been no real change in boots since those days, has there?"

"No, of course not."

It occurred to Dick that he had, perhaps, overdone the denigration of his present.

"What I meant," he rushed on, "by not being new is that this particular edition has been in the wholesaler's store for some time. But it's not second-hand or anything like that. And it can, of course, be jolly useful if you ever have a boot that needs repairing."

"I'm certain it can be," replied Smithy uncomfotably. "And thank you very much indeed."

"Good," said Dick, gratified. "And now, let's see what you've given me."

"Shouldn't we," asked Smithy hurriedly, "be getting down to this set of ours? We'll be stuck here over

Christmas Day itself if we don't get it fixed soon."

"I won't be a minute," replied Dick, cheerfully tearing away the paper from his parcel.

"Why not," suggested Smithy desperately, "leave it till tomorrow? After all, presents aren't supposed to be opened until Christmas Day."

"I'm nearly finished," replied Dick excitedly. "Here we are, I'm getting the last bit of paper off now. Why, it's just what I . . ."

Dick's voice died away as he stared at Smithy's Christmas present. It was a hard-cover book of about the same size as an average novel. And on the dust-cover was a brightly reproduced picture of a boot.

New Valve

"I think," said Dick icily, "we'd better try out that new valve now."

"Don't be like that," pleaded Smithy. "Coincidences like this can happen at the best of times."

"It was *you*," retorted Dick shortly, "who wanted to get this set fixed up as soon as possible. So, let's just do that little thing!"

"As you like, then," grunted Smithy, opening out the service manual Dick had brought over to the bench. "I see from the circuit that the vertical output valve is a PCL85."

"I know," replied Dick stonily, "I've picked one up from the valve cupboard."

"And here," said Smithy, pointing to the layout diagram in the manual, "is where it's supposed to go."

Dick condensed to glance at the point indicated by Smithy's finger, then turned the set round so that he could remove the corresponding valve from its socket. He inserted the new valve, returned the set to its original position and switched it on. After a short while, the speaker once again gave voice, to be followed by the picture. This time, however, the picture rolled rapidly downwards. Dick put his hand on the vertical hold control and adjusted it. At the extreme end of its range he found that it was just possible to obtain vertical synchronisation, but even here the picture tended to go out of lock at intervals of several seconds or so. It was noticeable, however, that picture height was now considerably greater than the confines of the screen. At least three or four inches of the picture at top and bottom were outside the screen.

"Just our luck," grumbled Dick. "We cure one snag and we get lumbered with another!"

"We've certainly proved," com-

mented Smithy, "that the previous PCL85 wasn't giving us enough picture height."

"But we've now," wailed Dick, "lost vertical sync. Previously, it was the picture height control that was hard over. Now it's the vertical sync control that's hard over!"

"Try another PCL85."

"Another one?"

"Another one," confirmed Smithy. "Dig around and see if you can find another PCL85 of a different make to the last one. Or one which was delivered to us in a different batch."

Rebelliously, Dick went back to the valve cupboard, whilst Smithy switched off the set and removed the replacement PCL85.

"Here you are," grunted Dick, returning with another valve. "This one's a different make to the other one."

Quickly, Smithy fitted the valve Dick handed him into the set and switched on again. The sound and picture re-appeared, the latter rolling, this time, upwards.

"Try that vertical sync control now," ordered Smithy.

Distrustfully, Dick adjusted the control once more, to find that it gave perfect lock at the centre of its travel. As with the previous PCL85, the picture height was still too great. Dick next adjusted the height control then gazed unbelievably at the now correctly sized and solidly synchronised picture.

"I just don't get it," he said.

"You change one vertical output valve and you get correct height but loss of sync. You put in *another* vertical output valve and you get correct height *and* good sync!"

"It wasn't the vertical output valve that did the sync business," said Smithy. "It was the triode section of the PCL85 that was the culprit there."

"I'd forgotten about the triode," confessed Dick. "I'd been thinking so much about the pentode vertical output section that I didn't remember that the PCL85 has a triode as well. I suppose the first PCL85 we picked out has a duffy triode, then."

"Not necessarily," said Smithy. "It's probable that the triode grid cut-off voltage doesn't quite fit in with the vertical timebase in this particular set."

"Come again?"

"That triode," Smithy explained further, "forms one half of the vertical multivibrator which drives the pentode output section of the PCL85. What is more important is that the PCL85 triode is the half of the multivibrator which is non-conductive during the scan period."

"I'm glad you told me that,"

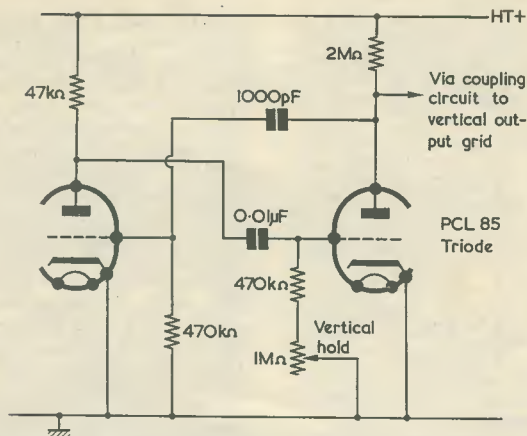

Fig. 3. A basic vertical timebase multivibrator, with representative component values. As is explained later, the anode load of the PCL85 triode (shown here, for reasons of clarity, as a fixed $2M\Omega$ resistor) consists, in practice, of a fixed resistor in series with the picture height control

commented Dick sarcastically. "Without that bit of information I'd have been *completely* in the dark!"

"Don't you," asked Smithy, surprised, "understand what I'm getting at?"

"I haven't," replied Dick, "the vaguest clue!"

"It seems," said Smithy, "that a little further education is needed, then. To start off with, take a look at the circuit diagram for this set. If you examine the vertical timebase section you'll see that the triode of the PCL85 forms a multivibrator in company with a triode section of another valve. The other triode could be part of a PCF80 or an ECC82, or any similar valve, and the particular type doesn't concern us here. If we take away the trimmings in the circuit, we can draw the basic multivibrator in that manual like this. (Fig. 3.) Now, the coupling components between the triodes have values which cause the PCL85 triode to be off, or non-conductive, during the scan period, and the other triode to be off during the flyback period."

Once more, Smithy pulled Dick's notebook towards him.

"Let's have a shufti," he continued, "at the waveform which appears on the grid of the PCL85 triode. I'll draw it out for you. (Fig. 4 (a).) Let's start at the instant when flyback starts. At this instant, the PCL85 triode becomes conductive, which means that its anode goes suddenly negative and cuts off the other triode by way of the $1,000pF$ capacitor to the other triode's grid. At the same time, the anode of the

other triode goes positive, and the $0.01\mu F$ capacitor from this anode to the PCL85 triode grid causes the latter to go positive also. The grid and cathode of the PCL85 triode

form a diode which prevents the PCL85 triode grid going positive of its cathode by any significant amount but, even so, you still get a little initial positive pip on the grid waveform at the start of the flyback period. So, we are now in the flyback period with the PCL85 triode on—that is, conducting—and with the other triode off."

"Fair enough," said Dick, "I'm with you up to now."

"Good," replied Smithy. "The flyback period comes to an end when the $1,000pF$ capacitor from the PCL85 triode anode to the grid of the other triode discharges sufficiently for the other triode to pass anode current. This marks the end of the flyback period and starts us off on the scan period. Multivibrator action causes the PCL85 triode to go off and the other triode to come on. The important point I now want you to concentrate on is that, at the instant of changeover, the anode of the other triode goes negative, whereupon the $0.01\mu F$ capacitor from this anode to the PCL85 triode grid causes this grid to go negative also, cutting off the PCL85 triode. The length of time that the PCL85 triode

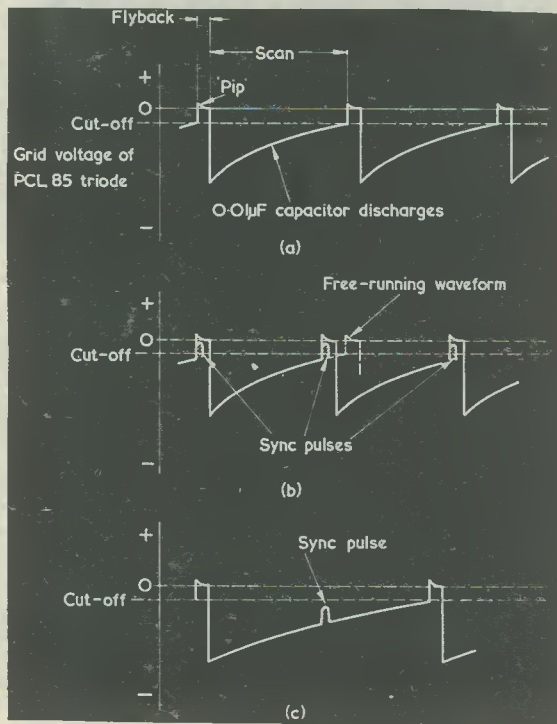

Fig. 4 (a). The voltage at the grid of the PCL85 triode in Fig. 3
 (b). Synchronising pulses initiate flyback before this would occur in the free-running condition
 (c). Synchronisation will not occur if the sync pulse cannot raise the grid voltage above cut-off potential. This occurs when the timebase frequency is considerably lower than sync pulse frequency

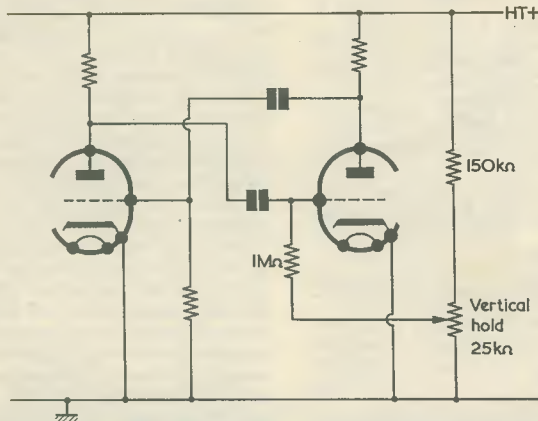

Fig. 5. An alternative method of varying vertical timebase frequency, based on the circuit of Fig. 3. In this case the grid leak of the PCL85 triode is fixed, and is returned to a variable positive potential

is cut-off depends upon the time needed for the $0.01\mu\text{F}$ capacitor to discharge sufficiently for the PCL85 to pass current. As I've shown in the waveform I've drawn, the grid of the PCL85 triode is, at the start of the scan period, well beyond cut-off. As the capacitor discharges, the grid of the PCL85 triode approaches cut-off potential. When it reaches cut-off potential, the PCL85 triode commences to draw anode current. Multivibrator action occurs once more, and we go from the scan period to the flyback period. Note well that the moment of changeover is at the cut-off potential for the PCL85 triode."

Smithy paused for a moment.

"The next point," he continued, "is how to control the frequency of the multivibrator. All we ask of the flyback period is that, when the timebase is synchronised to the transmitted signal, this period should end before the end of the transmitted vertical blanking period. So we give the timing components for the flyback period suitable fixed values which will ensure that this occurs, and then forget about them. Let's next turn our attention to the scan period. The length of this period is controlled by the time needed for the $0.01\mu\text{F}$ capacitor connected to the PCL85 triode grid to discharge, and the discharge path for this capacitor includes the grid leak of the PCL85. If we make part of this grid leak variable, as is done in the circuit we are considering, we can then control the length of the scan period. It follows from this that, since the length of the flyback period is fixed, we're also controlling the frequency of the multivibrator."

"That's all very well," objected

Dick. "And I can understand how the variable grid leak resistor controls frequency. But in your circuit diagram you've marked it as the 'vertical hold' control."

Vertical Sync Pulses

"I know I have," chuckled Smithy. "But don't forget that I haven't started putting sync pulses in yet! What we next do is to apply vertical sync pulses, which are derived from the transmitted signal via the sync separator section of the receiver, to the multivibrator. These have a polarity such that they cause the grid of the PCL85 triode to go positive. Let's draw a new waveform, with the sync pulses included."

Smithy quickly drew out the waveform. (Fig. 4 (b).)

"Let's assume," he said, "that the setting of our vertical hold control is such that, in the absence of sync pulses, the multivibrator scan period is a wee bit longer than the scan period in the transmitted signal. In consequence, the positive-going sync pulse arrives just before the PCL85 triode grid reaches cut-off. The transmitted sync pulse then takes the grid positive of cut-off, whereupon the PCL85 triode commences to draw current and the multivibrator action takes over, causing the circuit to go into the flyback period. In other words, the sync pulses cause the initiation of flyback a short time before the circuit would go into flyback on its own. So the sync pulses then keep the multivibrator in step with the transmitted signal."

Smithy stopped for a few seconds, before embarking on the next part of his explanation.

"There are," he went on, "two

limits outside which synchronisation will not occur. Synchronisation will not take place if the multivibrator runs at a higher frequency than the transmitted sync pulse frequency. This is because the flyback period will start *before* the sync pulse arrives, and the latter then has no effect. And synchronisation will not occur if multivibrator frequency is considerably lower than transmitted field frequency. When the sync pulses arrive the grid voltage will, in this case, nearly always be too negative for the pulses to take it above cut-off level. The effect is like this. (Fig. 4 (c).) What you have to do, therefore, is to adjust the vertical hold control so that the natural running frequency of the multivibrator is lower than transmitted sync pulse frequency, but not so low that the sync pulses can't raise the valve grid above cut-off. And that's why it's called the 'vertical hold' control."

"I see," said Dick. "But I'm still not clear why we couldn't get correct sync with the first replacement PCL85 we tried."

"We couldn't get proper sync," said Smithy, "because the triode in that PCL85 had a cut-off voltage which was too far removed from the range of voltages which the particular circuit used in this set could cater for. Don't forget that the natural running frequency of the multivibrator is dictated by the time taken for the PCL85 triode grid to reach its cut-off potential. Cut-off potential is not an easy factor to control in a valve, and the particular specimen we encountered had a cut-off voltage which was quite some way removed from the average valve. Because of this, the natural running frequency of the multivibrator could not be brought within the two synchronisation limits I've just described, and so we couldn't get the vertical timebase to lock. That valve might, however, be quite O.K. in another set of different design."

"Does this sort of thing happen very often?" asked Dick.

"You bump into it occasionally," replied Smithy. "Sometimes the set designer gives the vertical hold components values which give rather a small range of natural running frequencies. Such a set will be more 'fussy' with regard to suitable valves than another whose vertical hold control offers a wider range of natural running frequencies. To complete the picture, I think I should just mention that there is another type of hold control which doesn't offer a variable grid leak resistance. Instead, the grid leak is fixed, and a potentiometer and series resistor

applies a variable positive potential to the grid. (Fig. 5.) This still controls the time needed for the grid capacitor to discharge to cut-off potential, and the overall effect is the same."

Controlled Valve

"Well," said Dick enthusiastically, "I've certainly learned something new today. Including, especially, this business of valve cut-off voltage affecting multivibrator frequency."

"There's another little point you should have picked up," said Smithy. "Since the hold control varies the length of the scan period, it's always connected in the grid circuit of the valve which is non-conductive during that period. This little bit of information can be very useful if you're sorting out valve functions in an unfamiliar circuit. I've used a multivibrator circuit based on the one in that service manual as an example, but the same remarks will apply for any other multivibrator timebase, regardless of the types of triode which are used. You'll find that the hold control is in the grid circuit of the valve which is cut off during the scan period with a cathode coupled multivibrator as well. You don't see so many vertical blocking oscillators these days but the same is true with these, too. The blocking oscillator only requires one valve, and this is cut off during the scan period. So the vertical hold control goes, once more, into its grid circuit. I ought to add that what I've been saying about vertical oscillators applies, basically, to line timebase oscillators also, provided that direct sync, and not flywheel sync, is employed."

"I've just thought of something," said Dick. "The multivibrators we've been talking about give a square wave, whereas the vertical output grid requires a sawtooth."

"That's easily catered for," said Smithy, busy once more with Dick's notepad. "All that's needed to get a sawtooth is a shaping capacitor after the triode that's cut-off during the scan period. This shaping capacitor can be connected between the triode anode and chassis. (Fig. 6.) It discharges during the flyback period because the triode is then conductive. When the triode becomes non-conductive at the start of the scan period the shaping capacitor commences to charge via the anode load resistor of the triode, until the next flyback period comes along and causes the triode to discharge it again. The result is that you get a sawtooth across the capacitor which has the right polarity for application to the grid

of the vertical output valve, because it goes more positive as the scan period proceeds. We can also make the amplitude of the sawtooth variable by using a variable resistor as part of the triode anode load resistor. This variable resistor then becomes the picture height control, because it varies the amplitude of the sawtooth."

"Blimey," exclaimed Dick, "so it does! But there's still one difficulty which comes to my mind."

"What's that?"

"Many of the vertical timebase and output circuits you see in service manuals look so complicated," replied Dick. "They seem to have capacitors and resistors bristling out all over the place."

"Those extra components," said Smithy, "are needed to give good vertical linearity, and they often do add quite a bit of complexity. The thing to do is to look upon them as a rather complicated superstructure built upon the basic circuits we've been discussing. There is, unfortunately, a great deal of variance between the vertical linearity circuits of different sets, and it's not possible to talk about common points which may be generally encountered."

Clearing-up

Smithy stopped, and pushed Dick's notepad away from him.

"Talking of vertical linearity circuits," he said, "reminds me that we may need to touch up the linearity controls on the set on your bench which started all this. Perhaps, Dick, you could oblige?"

Obediently, Dick tackled the adjustments until Smithy pronounced

that both vertical linearity and height were finally satisfactory. All that then remained to do was to put the back on the set and carry it over to the "Repaired" rack.

"It's about time," remarked Dick, returning to his bench, "that our van driver came along to collect all these sets we've fixed."

"It is indeed," confirmed Smithy. "Still, I don't expect he'll be long, now."

He picked up *How To Repair a Boot* and idly turned the pages.

"There seem," he remarked thoughtfully, "to be some rather interesting things in this book."

Dick picked up his copy.

"There's a good bit here," he said, "on fitting hob-nails."

"Whereabouts?"

"Page 75."

Smithy turned to the page and carefully studied the text.

"Tell me," he said suddenly.

"Did you get this book from that uncle of yours?"

"Funnily enough," replied Dick in a surprised tone, "I did. He called round one evening and said he had a pile of them to clear cheap. He said they'd make excellent Christmas presents."

"That's what he told me, too," said Smithy, thoughtfully. "Down at the club."

The pair looked at each other, and chuckled.

"Sorry I was a bit off, just now," said Dick. "About your present, I mean."

"Not to worry, boy," replied Smithy, benevolently. "It would be a tame old world if we didn't have our moods from time to time."

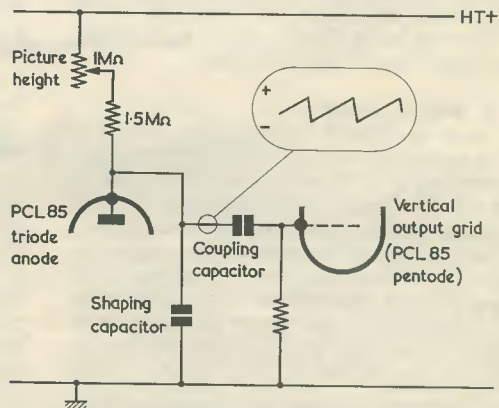

Fig. 6. The $2M\Omega$ anode load for the PCL85 triode in Fig. 3 is here replaced by the picture height components required in a practical circuit. The value of the shaping capacitor (which is frequently returned to vertical output cathode instead of to chassis) is, typically, of the order of $0.02\mu F$. In the receiver serviced by Dick and Smithy, the vertical output valve was the pentode section of the PCL85

"I think," said Dick, loyally, "you've given me a jolly good present."

"Same here, too."

"Even if," went on Dick, "both our presents turned out to be the same."

Smithy laughed, then rose from his stool.

"Where," asked Dick, "have you hidden it this year?"

"On the bookshelf" replied Smithy.

The Serviceman removed Volumes 1 and 2 of the *Mullard Technical Handbook* and the Workshop copy

of J. R. Davies' *Understanding Television* from the bookshelf, to reveal a small bottle and two glasses. He took these out and returned the books to the shelf. As an afterthought he added *How To Repair a Boot*.

"Here we are," said Smithy, handing a charged glass to his assistant, "and the very best of British luck!"

Dick sipped appreciatively.

"Thanks, Smithy," replied Dick warmly, "and a very Merry Christmas to you."

"A Merry Christmas," replied Smithy gravely, as he held up his glass, "to you as well, my boy."

The pair rose.

"We mustn't forget," continued Smithy, "to wish a Merry Christmas also to the readers who've put up with our adventures over the last twelve months. A very Happy and Merry Christmas to you all!"

"And we must end," added Dick quickly, "as we have done at all the previous Christmasses, by saying 'God Bless Us, Every One!'"

Using a Slide Rule

By P. J. Le Riche

Once one has become accustomed to its use, the slide rule can save considerable time in electronics calculations. Some simple examples of the use of the slide rule are described in this article

THE SLIDE RULE IS AN EXTREMELY USEFUL DEVICE which enables the user to multiply, divide and evaluate a number of functions, including squares and square roots, very simply and quickly with reasonable accuracy. The most basic form of the instrument consists of two logarithmic scales which can be moved alongside each other, as shown in Fig. 1. The top scale (the C scale) is movable, and the lower one (the D scale) is fixed.

Use of the C and D Scales

If the C scale is moved to the right until the figure 1 on it coincides with the figure 2 on the D scale, as shown in Fig. 1, it will be found that below any number on the C scale, twice that number will appear on the D scale. Thus we have multiplied any number up to 5 by 2. Numbers larger than this come off the end of the scale.

The reason for the multiplication by 2 is quite simple. The distance of any point on each scale from the figure 1 on that scale is proportional to the logarithm of the number at that point. In the

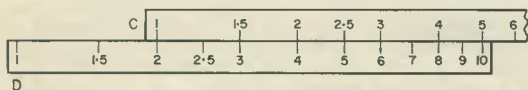

Fig. 1. Using the C and D scales of a slide rule to multiply a number by 2

operation just described, we added the distance between the 1 and 2 on the D scale to the distance represented by any number selected on the C scale; in other words, we added the logarithms of the two numbers, so the result was their product.

To divide two numbers we must subtract the distances along the scales; for instance, to divide 6 by 2 we find the 6 on the D scale and place the 2 on the C scale against it. The number below the 1 on the C scale is the result, 3. This is shown in Fig. 2.

These methods for multiplying and dividing with the C and D scales will not cover every calculation. For example, if we try to use them to multiply 2 by 6 or divide 2 by 6 the result comes off the end of the scale. There are two methods of overcoming this.

The first of these methods depends on the fact that the distance from the 10 on the scale is proportional to the logarithm of the reciprocal of the number. If we multiply by the reciprocal of the number it is the same as dividing by that number, and similarly if we divide by the reciprocal of a

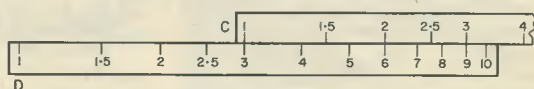

Fig. 2. Dividing 6 by 2

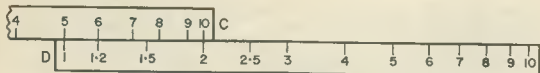

Fig. 3. Multiplying 2 by 6 on the C and D scales

number, it is the same as multiplying. Hence, to multiply 2 by 6, we set the 10 on the C scale against the 2 on the D scale and look along the C scale until we find the 6—it will be found directly over the 1.2 on the D scale, as shown in Fig. 3. (A slide rule cannot tell us where to put the decimal point, this has to be found and adjusted by means of a rough calculation.)

If we want to divide 2 by 6, we set the 6 on the C scale against the 2 on the D scale and read off the answer below the 10 on the C scale, which is 0.33 after adjusting the decimal point.

The second method of making calculations whose answers otherwise come off the end of the scale can only be used with slide rules having a reciprocal scale. This is normally labelled C₁, and is engraved on the slider above the C scale. It is just the same as the C scale except that it is backwards, having the 1 at the right hand end and the 10 at the left. It works and is used in much the same way as the previous method. Thus, if we add the distance given on the C₁ scale to the distance on the D scale, it is equivalent to dividing, and vice versa for multiplying. To employ this scale it is necessary to bring the cursor into use. This is a glass or Perspex attachment with a hairline drawn across it, and it slides over the scales, enabling the user to read one scale against another which is not adjacent.

The A and B Scales

Slide rules have several scales other than the C₁, C and D, the most important being the A and B scales. These are similar in appearance to the C and D scales and can be used in the same way,

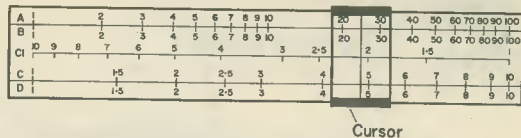

Fig. 4. The elements of a simple slide rule. The centre scale slides freely between the outside A and B scales. The cursor also moves freely along the slide rule

but they are marked from 1 to 100 as shown in Fig. 4. The numbers on these scales are the squares of the numbers found directly below on the C and D scales.

Accuracy

A 10in. slide rule can be read with an accuracy of around $\frac{1}{4}$ to $\frac{1}{2}$ % on the C and D scales and around $\frac{1}{2}$ to 1% on the A and B scales. As every multiplication or division involves reading the scale up to three times, the possible error will rise to several per cent on a long calculation, although the probable error will be somewhat smaller as the inaccuracies will tend to cancel out. This accuracy is quite good enough for many electronics calculations, where the answer is seldom required to better than 5% accuracy and rarely to better than 1%.

A 6in. slide rule would be somewhat cheaper than a 10in one, but only about half as accurate. If the slide rule is to be used entirely for electronics this is probably good enough, but for other purposes, such as school work, the larger type is highly desirable.

Conclusion

After a little practice, the slide rule is a very simple device to use and it can save quite a lot of time, being considerably quicker than logs. The cost is moderate, making it a worthwhile investment for the engineer, the experimenter and the student.

Club Events

The Slade Radio Society

Hon. Sec.: D. Wilson, 177 Dower Road, Sutton Coldfield.

December 10th—Fun and Games. Usual seasonal get-together and some new innovations.

Derby and District Amateur Radio Society

Hon. Sec.: F. C. Ward, 5 Uplands Avenue, Littleover, Derby.

December 22nd—Annual Christmas Party.

"Northern Heights" Amateur Radio Society

December 8th—Annual Dinner.

December 22nd—Ragchew.

Radio New York Worldwide SWL Club

Radio New York Worldwide, N.Y.C.19, N.Y., U.S.A.

Radio New York Worldwide announce the formation of another special service for short wave listeners and DX'ers—the formation of the Radio New York Worldwide SWL Club. Run by, and for SWL's, the following services are now available—Translation Bureau, offering QSL Report Forms in Spanish, German, French, Arabic and English; Identification Bureau, which through the use of multilingual personnel will identify stations; Address Service, providing addresses of short wave, point-to-point, military and medium wave stations, and a monthly Club Bulletin containing DX tips from the world's leading DX-ers and special news from the RNYW programme for DX'ers.

A certificate of membership is supplied and the Club may be joined by forwarding, to the above address, IRC's to value of \$1.00 (7s. sterling).



Cover Feature

Pocket Valve Voltmeter

By D. BOLLEN

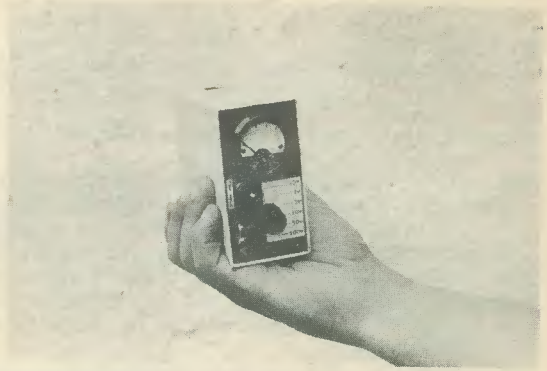

The small size of the valve voltmeter is readily apparent from this illustration

This article describes a comprehensive valve voltmeter which can be slipped into a jacket pocket. An ingenious hybrid design is incorporated, and the instrument offers an input resistance of $10M\Omega$, six ranges from 0.5 to 100 volts, a linear scale and freedom from drift. The transistor employed should have a current gain of 100 or more, and this may necessitate selection with some types

THE VALVE VOLTMETER RANKS HIGH ON ANY LIST of instruments to be begged, borrowed, or bought. With an input resistance of $10M\Omega$ or more it normally imposes no significant load on the circuit to which it is connected. It can measure alternating voltages accurately over a very wide bandwidth. In fact, coupled with suitable accessories, almost anything can be measured, even the static created by stroking a cat, to use an unconventional illustration!

Because of its versatility, the valve voltmeter has tended to replace the universal testmeter in professional circles. Expensive versions combine many functions, often including current, resistance, and decibel scales. Unfortunately, unlike the testmeter, valve voltmeters normally require a mains supply and have a warm-up period sometimes extending to 15 minutes before the zero setting and calibration become stable. A truly portable voltmeter, using a valve, invariably needs some fairly stable source of high tension. A high voltage battery can supply this but with an unavoidable increase in bulk and operating expense. A valve run at an anode potential of less than 15 volts can be made to pass only a limited current, typically $100\mu A$ or less, unless a special valve type is used. Though attractive from the point of view of compactness and economical battery operation, solid-state voltmeters cannot always be easily designed to offer input

resistances much above $1M\Omega$ on their lower ranges.

The subject of the present article is a hybrid instrument, combining the high input sensitivity of a valve with the low operating voltage of a transistor. It provides a linear scale, a quick warm-up time, stable operation, and is just small enough to fit into a jacket pocket.

The Circuit

It can be seen, from Fig. 1, that the base-emitter junction of a high gain p.n.p. transistor, TR_1 , shown upside down for convenience, forms the anode load of V_1 . V_1 is a B7G based battery pentode strapped as a triode to improve its transfer characteristic and to make the most of the limited current available at an anode potential of only 8 volts. A small negative voltage applied to the grid of V_1 causes a reduction of anode current which, in turn, reduces the bias on the base of TR_1 . This is indicated by the meter in a resistive bridge circuit composed of R_9 , R_{10} , and zero adjust control VR_1 . 150mV on the grid is sufficient to give full-scale deflection of the $500\mu A$ meter.

Only one half of the DL96's filament is connected, and this is underrun at approximately 1 volt by inclusion of the dropper resistor R_{11} . This serves to limit grid current, and reduces the gain product to provide a suitable compromise between sensitivity and reliability. Much greater sensitivity is possible,

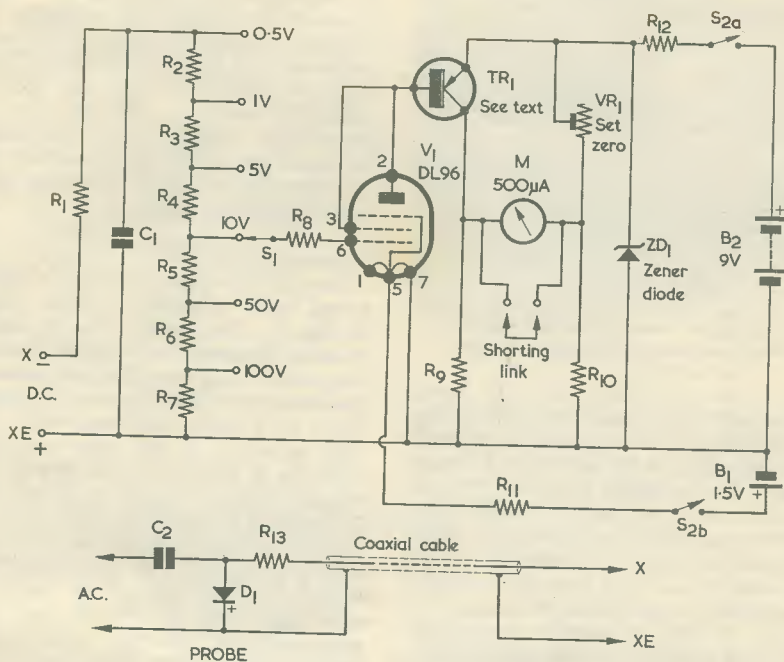

Fig. 1. The circuit of the valve voltmeter. Only half of the DL96 filament is used

Components List

Resistors

(All fixed values $\frac{1}{2}$ W)

R ₁	7M Ω (see text)
R ₂	1.5M Ω 1%
R ₃	1.2M Ω 1%
R ₄	150k Ω 1%
R ₅	120k Ω 1%
R ₆	15k Ω 1%
R ₇	15k Ω 1%
R ₈	1M Ω 10%
R ₉	510 Ω 10%
R ₁₀	510 Ω 10%
R ₁₁	16 Ω 10%
R ₁₂	62 Ω 10%
R ₁₃	1M Ω 10%
VR ₁	2k Ω pre-set potentiometer, panel mounting

Capacitors

C ₁	0.1 μ F 100 V wkg.
C ₂	0.01 μ F 100V wkg.

Valve

V ₁	DL96
----------------	------

at the expense of linearity and long term drift, if R₁₁, R₁₂, and the zener diode are omitted from the circuit.

The filament supply, B₁ in the diagram, consists in practice of three pen-cells in parallel, these guarding against large excursions of voltage due to

Semiconductors

TR ₁	See text
D ₁	OA95
ZD ₁	ZB 8.2 (S.T.C.) or OAZ206

Switches

S ₁	1-pole 6-way miniature
S ₂	d.p.s.t. on-off

Meter

Moving coil, 500 μ A, 1 $\frac{1}{2}$ in diameter

Batteries

One PP6 9-volt battery
Three D14 1.5-volt cells

Miscellaneous

Four sockets (two for input, two for Shorting Link)
1 knob
Materials for case, etc.

a rapidly declining battery and being more than sufficient to supply the 18mA required. B₂ is a small transistor radio battery, its voltage being dropped by R₁₂ and maintained constant by the zener diode at 8.2 volts. The current demand here is around 12mA.

The input voltage divider R₁-R₇ is straightforward, but R₁ should be individually selected to

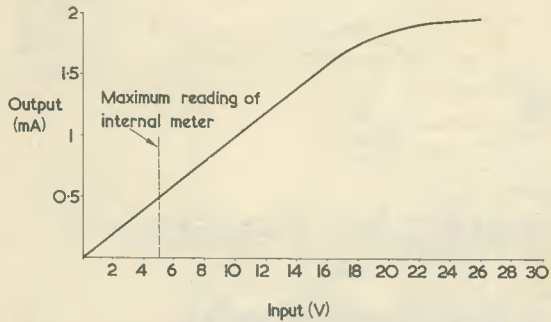
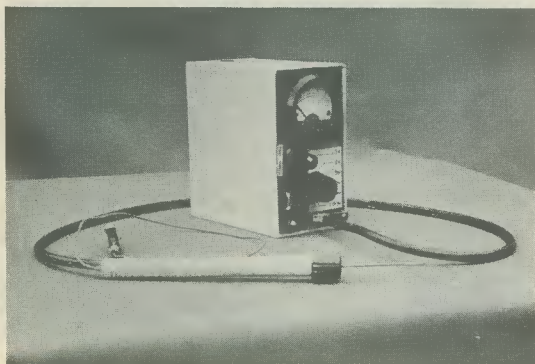

Fig. 2. Input voltage/output current curve given on the 5 volt range. Output is measured at the shorting link terminals

allow for spreads in transistor gain and variations, if any, between DL96's. R_1 has a nominal value of $7M\Omega$. No particular type is specified for TR_1 in the Components List because any low power transistor with an α' of more than 100 will serve, provided its leakage current is not excessive. The writer used a specially selected "Red Spot" transistor in the original unit. Also tried successfully was a MAT121, again selected for gain.

Careful selection of the a.c. probe diode will ensure the maximum possible input impedance. The OA95 has a satisfactory reverse characteristic for this role, but surplus diodes may be usable if they do not pass more than about $2.5\mu A$ when a reverse voltage of 10 is applied, and if they can also withstand the maximum voltage to be encountered.

The shorting link serves a multiple purpose. For instance, it gives a ready solution to the problem of the meter pointer striking against the full-scale stop when the instrument is switched on, and before the valve filament has reached full emission. Also, it allows the meter movement to be damped against mechanical shock when the valve voltmeter is transported from place to place. The shorting link sockets enable a large-scale external meter to be used in conjunction with the internal miniature meter for greater accuracy or to cover alternative scales as, for example, a decibel scale. The curve of Fig. 2 shows that up to 1.5mA are available as



The valve voltmeter complete with probe

an output before the transfer characteristic becomes non-linear. The internal meter may therefore be shunted by appropriate resistors to multiply the existing ranges by a factor of up to three. Another point is that several interesting combinations are possible with the shorting link sockets, these including driving a chart recorder, a d.c. amplifier, or a relay. Finally, differential measurements may be made by injecting a low d.c. current into the shorting link sockets while also using the normal high impedance input.

Construction

Paxolin of $\frac{1}{8}$ in thickness is ideal for the front panel, which measures $2 \times 3\frac{3}{4}$ in. The layout is given in Fig. 3. The meter, VR_1 , S_1 , input sockets, and shorting link sockets are positioned as shown in this diagram. V_1 , TR_1 , ZD and resistors R_8 - R_{12} are mounted on a sub-assembly, measuring $2\frac{3}{4} \times 1\frac{1}{2}$ in, made of Paxolin pegboard with $\frac{1}{4}$ in hole spacing. This is bolted to the meter terminals on brackets of 14 s.w.g. wire, as shown in Fig. 4. Plain Paxolin, suitably drilled, could also, of course, be used. Positioning of the components is not critical but care should be taken with the insulation of the grid lead and grid resistor. R_1 to R_7 and C_1 are soldered directly to the tags of S_1 , and it should be remembered that too much heat applied to these resistors might adversely effect their tolerance and the accuracy of the instrument.

The case for the original was constructed of stout cardboard, afterwards covered with self-adhesive p.v.c. This seemingly flimsy method of fabrication was, in fact, surprisingly durable and rigid, probably because the box is small, and it saved time and expense. More conventional materials could also be employed, if desired. The batteries, together with

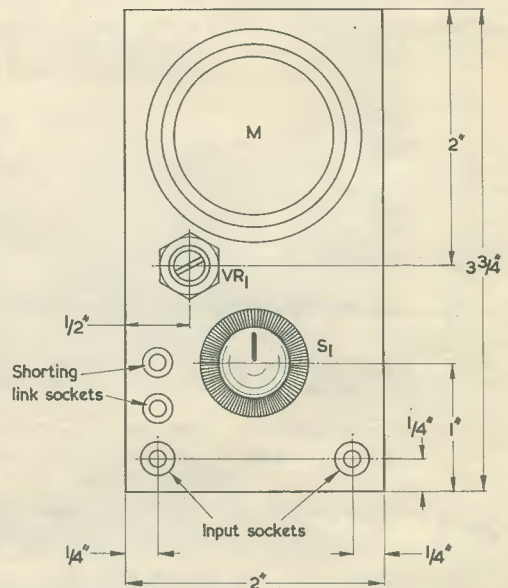

Fig. 3. Dimensions and layout of the front panel

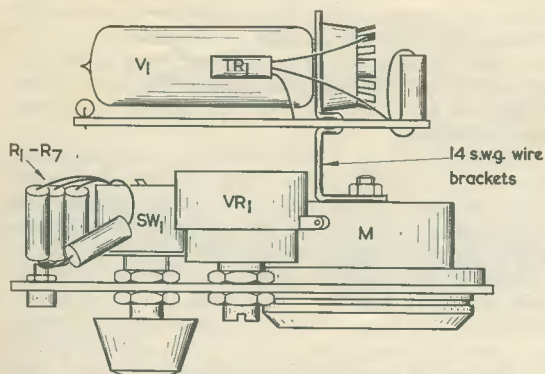

Fig. 4. Side view showing the internal layout. The small Paxolin panel on which V_1 and TR_1 are fitted is secured to the meter terminals by brackets made of 14 s.w.g. wire

the on-off switch, are located at the rear of the box as shown in Fig. 5, and a small door can be cut, hinged with the same plastic used for covering and fitted with a fastener, to allow for easy battery replacement. The front panel is slightly recessed and may be lightly glued to thin strips of wood previously fixed just inside the front of the box. For servicing the panel can be pressed out from behind and re-glued afterwards. Bostik No. 1 is a suitable adhesive here, as well as for the probe (to be mentioned later) since it does not become brittle when dry. Again, a more conventional method of panel securing may be used, if desired.

If C_2 is small enough, the probe components may be contained within a tube of gummed paper, wound on a former of $\frac{1}{4}$ in diameter and 4 in long, this being not much thicker than the coaxial lead. (See Fig. 6.) C_2 , D_1 , and R_{13} are first soldered together and then to the coaxial lead, as shown, after which they are slid into the tube. A thermal shunt should be clipped on to the diode leads during soldering as excessive heat may increase the reverse leakage current. Before sealing the ends of the tube with glue, the probe should be tested, as outlined in the next section.

Setting Up

To set up the valve voltmeter, first shunt the meter with a resistor, placed across the shorting link sockets, of approximately $\frac{1}{3}$ the internal resistance of the meter. This will prevent the movement being overloaded by a mis-setting of VR_1 . It is always advisable to monitor the battery consumption of a newly constructed unit as this is a sure guide to serious faults. A millimeter in the 9V battery lead should indicate not more than 15 and not less than 9mA. Switch on and zero the valve voltmeter. If no zero can be obtained, check that the filament of the valve is running near 1V. Assuming it is, and that there are no wiring errors, the transistor will be suspect and should be checked for gain and leakage. When the meter is zeroed, remove the shunt resistor and switch to the 5V setting of S_1 .

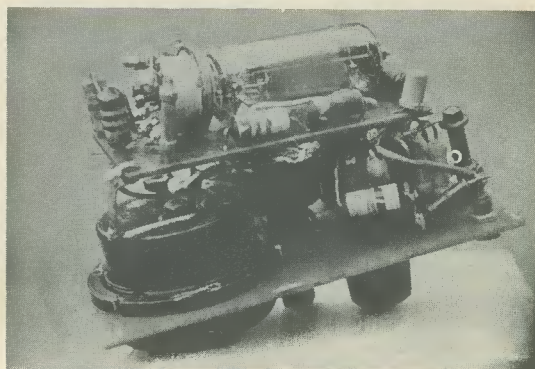

Internal view of the prototype

Check calibration with a dry cell or some other d.c. source of known accuracy. If there is an error, R_1 may be reduced or increased appropriately. When this operation has been carried out, the instrument should be equally precise on the other ranges.

To test the probe, a known sinusoidal alternating voltage at 50 c/s can be applied. A square wave or a seriously distorted sine wave will give misleading results. The probe is most liable to error on the 0.5V and 1V ranges, and special attention should be given to its performance at those settings. As previously stated, a great deal depends on the diode used.

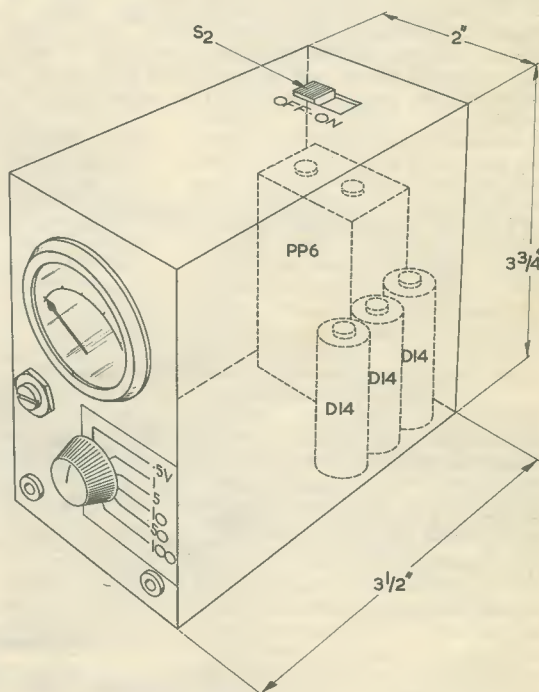

Fig. 5. The manner in which the batteries and on-off switch are fitted. Internal dimensions are shown

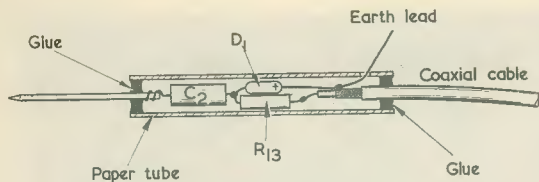

Fig. 6. Details of the a.c. probe

The Valve Voltmeter in Use

Following switch on, the zero setting becomes stable after five minutes has elapsed and thereafter remains constant until either of the batteries approaches the end of its useful life. Slight adjustment of VR_1 is necessary when switching between the lower ranges, as occurs with most valve voltmeters. The shorting link should be left in position for a few seconds after switching on, to protect the meter.

With the type of construction suggested, the probe has an input capacitance of less than 3pF. The importance of this will be realised when calculation shows that even this small value of capacitance has a reactance of only about 1k Ω at 50 Mc/s, which should be borne in mind when measurements are made at high frequencies. On the 5 volt range, at low audio frequencies, the probe impedance is better than $\frac{1}{2}M\Omega$, which is reasonable for a semiconductor "rectification before amplification" system. The a.c. accuracy achieved with the prototype is 5% of full scale on the 0.5V and 1V ranges and 1.5% on the other ranges. The probe will not withstand peak voltages higher than 40 and, when making audio measurements at this level, a 10k Ω resistor should be placed in series with the

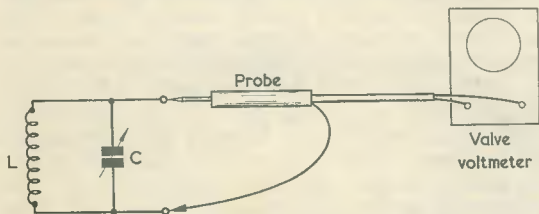

Fig. 7. Employing the valve voltmeter for frequency measurement

probe earth lead to limit diode current. Although insignificant below 100 kc/s, this resistor must be omitted for r.f. measurements where it would certainly cause the valve voltmeter to read low, and care should be exercised when, say, the probe is being used to investigate a transmitter where high level r.f. might be encountered. If a higher working voltage on a.c. is required, matched diodes could

be cascaded in series, each diode being shunted by a 1M Ω resistor. In addition, a capacitor of a suitable voltage rating should be used in the place of C_2 .

A high voltage d.c. probe, containing simply a series resistor, will extend the range of the instrument so that h.t. and e.h.t. supplies and resistive networks may be checked.

The simple circuit of Fig. 7 suffices for the accurate measurement of frequency. The coil and capacitor are chosen to cover the desired band of frequencies. In contrast, the usual absorption wavemeter, employing a crystal diode and a moving coil meter, is prone to give false indications when fed with too great an input, but the valve voltmeter's negligible loading of the tuned circuit preserves its efficiency, and the selectivity remains virtually unimpaired. The absence of any coil tap or coupling winding also simplifies construction.

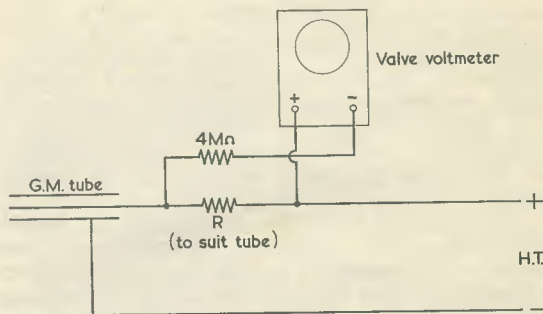

Fig. 8. Using the valve voltmeter as a ratemeter in conjunction with a Geiger Muller tube. If desired, the background count may be suppressed by adjustment of the set zero control, whereupon any increase in radiation gives a positive reading

When used with a Geiger Muller tube, the valve voltmeter can function as a highly sensitive wide range ratemeter. If the capacitor C_1 , in Fig. 1, is increased in value, time constants of the order of many seconds are possible, providing a steady indication of the random pulses from the GM tube. The ratemeter circuit is shown in Fig. 8. A useful feature here is that the background count may be completely suppressed by adjustment of the set zero control, whereupon any increase of radiation gives a positive reading. On test, the background count from a G10H tube gave more than half scale deflection on the instrument's 5V range.

Obviously, there is not enough space here to give a full list of possible accessories but the above should serve to demonstrate the valve voltmeter's adaptability and general usefulness.

ELECTRONIC CAR IGNITION ANALYSER

In "Electronic Car Ignition Analyser" (published in the November 1965 issue) Fig. 2 shows the lead from the junction of VR_6 and the collector of TR_2 connecting, incorrectly, to the "live" primary terminal of T_2 . As is evident from the accompanying text, this lead should, of course, connect to the "210V" primary tap.

The Story of the Valve

Part 4

C. H. Gardner

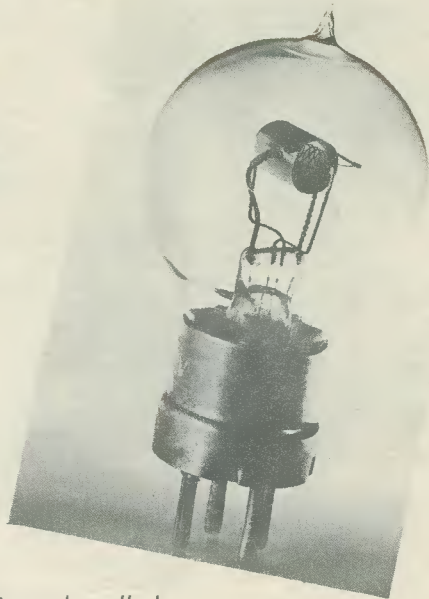

In this concluding article C. H. Gardner examines the all-glass construction, carrying on to reliability and quality control. He concludes by demonstrating the importance of close collaboration between valve manufacturer and equipment designer when new applications appear

IN THE PREVIOUS ARTICLE THE "heart" of the valve, its cathode, was dealt with at some length. The development of this and of the all-glass technique were fundamentals of progress. The all-glass technique is sometimes confused with miniaturisation but this was far from being its main object. As the use of higher and still higher frequencies became a requirement, it was necessary to ensure that the self-capacitance, the inductance, and the dielectric losses in the valve were all reduced to a minimum. In order to increase the efficiency of the valve and reduce the spread of characteristics in production it also became necessary to devise a more rigid form of construction.

Glass Base Construction

Although a form of all-glass construction had been used in the very early days, examples being the "peanut" valve and the Marconi "V" series, these forms of assembly were unsuitable for mains valves and did not lend themselves to mass production methods. It was in 1938 that the pressed glass base came into use and this did away with the pinch type of construction with its many disadvantages.

The basic idea behind the glass base construction was to seal the connecting pins into a glass disc. The top ends of the pins were connected to the electrodes, the lower ends being intended for insertion in a valveholder of advanced design. These valves had either eight or nine pins as standard. Various ideas were used in order to ease the location of the valve in its holder. In some receivers, and especially in TV sets, some of the valves were located in positions which required the use of such accessories as dental mirrors to locate the eight or nine pins in their respective sockets. Some of the early valves were fitted round the base with a metal rim having a projection on the side, the associated valveholder being surmounted with a metal skirt having a vertical groove to take the projection. When the projection on the valve was slid down the groove the pins were in the right position to enter the holes in the socket.

Later, the metal rim and projection were replaced by a pip formed on the glass valve base itself and, finally, both of these locating devices were dispensed with, correct insertion in the valveholder being governed by the spacing of the pins.

This final construction was not too popular with the service engineer as valves still continued to be placed in TV receivers in positions where it was almost impossible to see the holes in the valve socket. This difficulty also caused another headache for the valve manufacturer. Owing to the difficulty of getting at some of these valves they were apt to be withdrawn from their holders at an angle. This put a strain on the pins and, consequently, a strain on the glass base. Minute cracks in the glass then became possible, causing loss of vacuum and failure of the valve. The use of a softer metal for the pins was apt to result in their being bent during valve withdrawal, but straightening jigs became available for the service engineer.

As the valve pins were moulded directly into the glass base it was essential that the pins and glass should have similar coefficients of expansion. The necessary type of glass was unsuitable for the envelope and, to avoid undesirable strains being set up as the valve heated and cooled, the base had to be built up in the form of sandwich of different types of glass. This allowed low temperature sealing of the bulb to the base and avoided any oxidation of the electrodes or poisoning of the cathode due to the heat of sealing. These are very important matters now that the electrode system has been brought as close as possible to the base in order to reduce the self-

inductance of the pins at the ultra-high frequencies currently in use.

Much could be written about the glass techniques used in valve manufacture, and the research work carried out in order to obtain the various types of glass required. For instance, although certain types of glass are entirely suitable for the various processes, they are subject to electrolysis when the valve is in use and can result in the appearance of conductive deposits between the electrodes. But sufficient may have been said to show that glass techniques, vacuum techniques, and the construction of the cathode have been basic matters in valve development. Without success in these developments the work done on electrode geometry would have been of no avail.

Reliability and Quality Control

With the rapid development of electronics the number of applications for valves extended well beyond the confines of communication and entertainment. Some of these applications called for a very high degree of reliability, often under very arduous conditions where valve failure might not only be costly but very dangerous.

In almost every manufactured article there is a "built-in" reliability and "lasting power" which is reflected in the price. One might almost state that "perfection" is unattainable. "Near perfection" is possible but can be very costly. "Reasonable perfection" at reasonable cost is the aim of the manu-

facturer of the good class product and, to attain and maintain this, an efficient quality control organisation is essential. Particularly is this the case with a product such as the valve, in which complicated chemical, electrical and mechanical matters in manufacture and use will effect its reliability and endurance.

When an application demands maximum reliability regardless of cost, the investigations and experience incurred in achieving this will usually allow many of the features involved being adopted in later manufacture of the "standard" product; and this factor has been very true in the case of the valve. Manufacturers' quality control departments soon realised that a certain proportion of the production failed factory tests. Of those that passed these exacting tests, another proportion failed during early life in the field. A high proportion still remained and the failure rate over a long period was very low until an "end of life" time was reached at which all the remainder had arrived at a stage where they were "worn out".

It was therefore necessary to carry out investigations to discover the reason for the failure of a small proportion of valves which had satisfactorily passed the rigid factory tests but which still failed at an early period in use. In some cases certain applications accentuated the early failures. In others no such relationship was traceable and the faults were of a more random nature.

Failure of a valve in entertainment

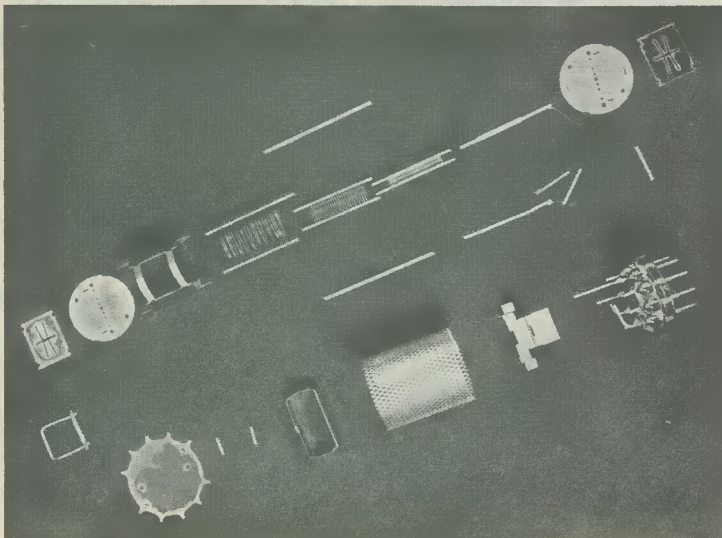

(Mullard Ltd.)

The make-up of a modern valve. This photograph shows the component parts of the EF86 low-noise a.f. pentode



(Mullard Ltd.)

An example of present day construction. This valve, the PC88, operates as a grounded-grid triode amplifier at frequencies of the order of 850 Mc/s in u.h.f. tuner units for 625 line television receivers. It offers a fitting contrast to the ORA valve (circa 1920) which forms the heading illustration

equipment has a nuisance value only, but failure of a valve used, for instance, in aircraft communication or control might present disastrous possibilities. Failure of valves used in repeaters in cables buried under the ocean or valves used in the automatic control of intricate machinery might entail enormously expensive results, but if such early random failures could be overcome and the "end of life" time of the remainder were known, a position could be arrived at which would allow replacement before failure occurred.

One hundred per cent reliability is virtually unattainable although it can be very nearly reached. In modern installations where an extremely high degree of safety is required it is usual to duplicate or triplicate equipment, with automatic switch-over arrangements if failure takes place. As there

are many components other than valves which are equally, if not more, subject to random failure, an arrangement of this nature guards against the failure of such components as well.

The causes of early random failures are somewhat complex, but two of the more obvious ones may be quoted as examples. Equipment used for certain applications, such as in military vehicles or aircraft, or for the control of vibrating machinery, can be subject to intense vibration. In some cases this has been found to be severe enough to cause serious displacement of the valve electrodes, vibration of the electrode supports having caused gradual elongation of the holes in the supporting micas. The "cure" came about by the shortening of the electrode system and the use of materials providing greater rigidity.

Other random failures proved to be due to microscopic impurities getting into the valve during assembly or during the manufacture of the grids. Such impurities might lie dormant in a position in the assembly where they cause no harm, only to later find their way into a position which might cause inter-electrode short-circuits or leakages. This resulted in the modern method of "dust free" manufacture in which the valves are assembled by operatives in special clothing and in sections of the factory where precautions are taken to exclude any form of dust. Grids are now manufactured without ever being touched by the human hand and, as a further precaution, the long lengths of grid assemblies are contained in protective tubes.

Changing Applications

From time to time particular applications have resulted in the appearance of conditions which were not apparent in the valve when employed for its original design application. In many cases these conditions become apparent only after the valves have been in service for some

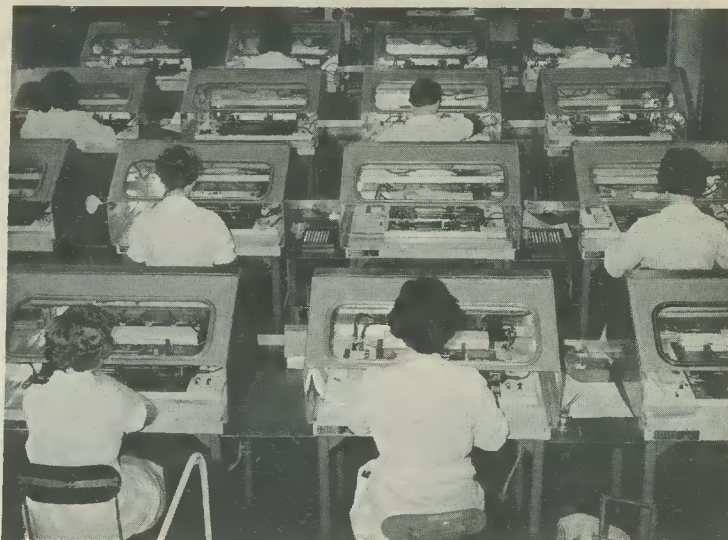

(Mullard Ltd.)
Automatic grid winding machines installed at the Mullard Blackburn factory. As explained in the text, it is essential to avoid any possible contamination of the grids during manufacture and subsequent handling. It is common practice to wind grids (on their support wires) for lengths much greater than is needed for a single valve. Suitable lengths are then cut off for each valve

time. Technical collaboration between equipment designers and the valve manufacturer is close and constant but, nevertheless, difficulties of this nature still appear on occasions. When they do, speed in correcting the matter is of prime importance. Usually the trouble can be overcome by minor valve or circuit modifications, but what might appear to be a minor modification of a valve might present unusual difficulties. As we have already seen, the use of a different material for the control grid might materially alter the characteristics of the valve, because of the change in contact potential.

The development of the valve from the early battery triode to its present high state of efficiency and reliability is a fascinating story of endeavour, ingenuity in research work, and the practical application

of many sciences. In the early stages of development it was often possible to attribute progress to individuals, but the situation soon arose in which advances were the result of team work amongst scientists, chemists, and engineers.

Today, one thinks of production in terms approaching the hundreds of millions. In a rapidly expanding industry such as we have in electronics, new applications, new requirements and new facets of knowledge are almost hourly occurrences. Sometimes there is a tendency to think of the valve as "outdated" and replaced by the semiconductor. It is perhaps as well to realise that the two are complementary and that further research and development of the valve continues, and is likely so to do for many more years to come.

(Concluded)

Mullard Ferroxcube Toroids Now Available With Nylon Coatings

Three sizes of Mullard Ferroxcube toroids, 12.7, 25.4, and 38.1mm diameter, are now available with a nylon coating. Unlike other insulating materials employed to coat toroids, nylon will not chip, flake, or crack. Thus the insulation between the toroid and its winding remains permanently intact.

The toroids are primarily intended for use as transformer cores in pulse and wideband applications. Their nylon coating can withstand a voltage of 1,000V d.c. so eliminating the need for the user to insulate the Ferroxcube before winding. It also prevents abrasion by the toroid of the insulation around the winding wire.

The colour of the coating is dependent on which of the eight grades of material is used in making the toroid. The grades cover tuned circuit applications up to 50 Mc/s, wideband transformers up to 100 Mc/s and low-power pulse applications.

ELECTRONIC SHOOTING RANGE

By J. DAICH

Hit the bull's-eye at your Christmas Party with this ingenious design!

MANY OF THE COMPONENTS REQUIRED FOR THIS electronic shooting range may be found in the spares box, and it provides an inexpensive unit which can offer plenty of entertainment, particularly at party-time.

The Circuit

The circuit is shown in Fig. 1. The sensing device at the target is a photoconductive cell type ORP12, this exhibiting low resistance when a flash of light from the "gun" falls on it. The ORP12 is coupled to a monostable circuit, and its reduced resistance when illuminated causes the base of TR₁ to go more negative. This triggers the monostable circuit, causing TR₁ to conduct, the relay to energise, and TR₂ to cut off. TR₂ remains cut off until C₁ has discharged sufficiently for the circuit to revert to its previous stable condition.

With the component values shown, the relay is energised for 1 to 2 seconds, which is long enough to give evidence of a "hit" by flashing a lamp or ringing a bell. More ambitious schemes could incorporate a solenoid to move the target, or a counter to indicate the number of direct "hits".

The relay employed in the prototype had a coil resistance of 170Ω and energised at around 5 volts. Relays with coil resistances between 150 and 200Ω

Fig. 1. In the electronic shooting range, the ORP12 is mounted behind a lens at the bull's-eye of the target. When illuminated by a flash from the gun, it triggers the monostable circuit given by TR₁ and TR₂, thus energising the relay. A bell or lamp then indicates that a "hit" has been scored

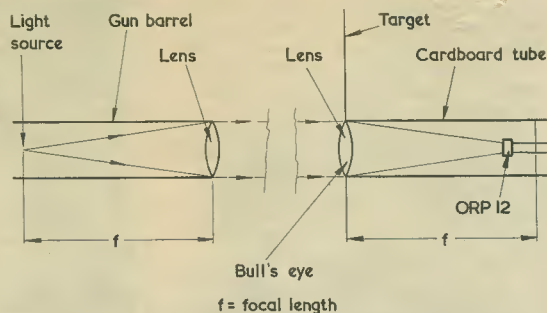
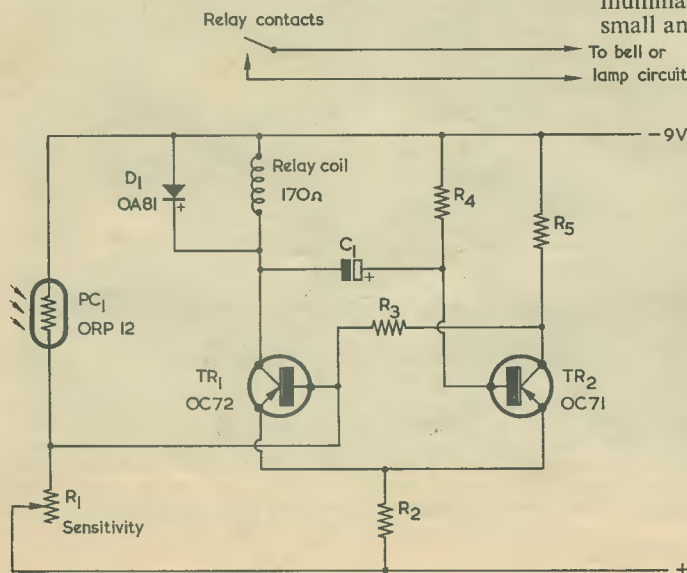

Fig. 2. It is important to have the lenses at the gun and target carefully aligned

should be satisfactory in the circuit, provided they have the requisite energising voltage.

The Gun

The gun was made from a small plastic pistol obtained from a toy shop. In the barrel was mounted a 1.5 volt torch bulb at the focus of a small lens, two small cells being housed in the handle. A pair of contacts were fixed to the trigger so that, on pressing it, they made contact momentarily and caused the bulb to flash. It is also possible to use the Pifco No. 1640 "Zetaray" for this purpose. The "Zetaray" is a streamlined "space pistol" that "shoots" a beam of white light when the trigger is pressed, giving a narrow beam of approximately 2in diameter at a distance of 5ft. The No. 1640 "Zetaray" is available from retailers in the normal way.

The ORP12 is mounted behind a lens fitted at the bull's-eye of the target, as illustrated in Fig. 2. It is important that it be mounted slightly forward of the focus of the lens so that the light will fall over all its photosensitive surface, rather than at a single point. It will be necessary for the gun to be directly in front of the lens, although having the ORP12 slightly forward of the focus will permit it to be illuminated when the light strikes the lens from a small angle.

Components List

Resistors

(All fixed values ¼ watt 10%)

R ₁ 250kΩ potentiometer, linear	R ₄ 33kΩ
R ₂ 47Ω	R ₅ 1.8kΩ
R ₃ 4.7kΩ	

Capacitor

C₁ 50μF electrolytic, 12V wkg.

Semiconductors

D ₁ OA81	TR ₂ OC71
TR ₁ OC72	

Photoconductive Cell

PC₁ ORP12

Relay

170Ω coil, see text

Miscellaneous

- 9 volt battery
- Components for bell or lamp circuit
- Components for gun
- 2 convex lenses

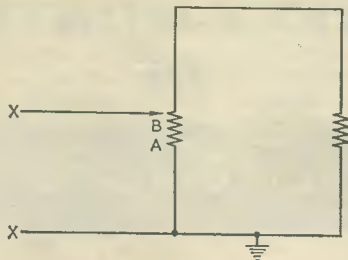

Fig. 3. Maximum rotation of the slider

resistor and a variable on its own.

There is a difference, however, and this effects the "law" of the arrangement. If a linear variable is paralleled with a fixed resistor the arrangement is no longer linear. That is, equal amounts of spindle rotation will not give equal changes in resistance. This is rarely a cause for concern except, perhaps, for high quality audio equipment. The deviation from linearity (assuming the variable is linear to start with) depends on how far the combined resistance is removed from that of the variable on its own. In practice it is found that if a variable is paralleled with a fixed resistor equal to its own value to produce a combined resistance of half its value there is no great change in law, as the graph of Fig. 4 shows.

Under certain circumstances the law change could be useful for designing specialised equipment. Selected values of components could then be combined to produce the desired law. Another possible advantage of the system is to relieve the variable resistor of excess power over its rated value. The relative spread of power between the two components depends on the degree of spindle rotation.

Normally there is little point in replacing such a system by a new component of the correct value since, although an improvisation, the arrangement is very sound.

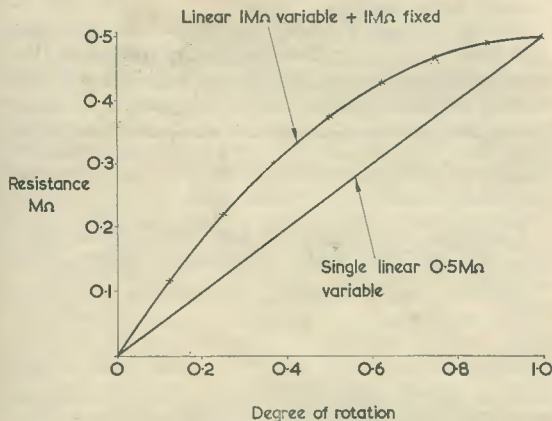

Fig. 4. Graphs showing the resistance offered by a 1MΩ linear variable resistor shunted by a 1MΩ fixed resistor, as compared with a single 0.5MΩ linear variable

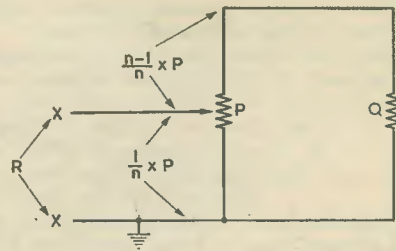

Fig. 5. Analysing the resistances in the combination

A General Mathematical Analysis

In the system of fixed and variable resistors described, consider a variable resistor value P with a fixed resistor across its outer contacts of value Q. (See Fig. 5.) Let the resistance between the slider and earth be R at any point. If the variable resistor is adjusted to $\frac{1}{n}$ of its total rotation from earth it can be seen that the circuit is equivalent to one containing a resistor of value $\frac{1}{n} \times P$ in parallel with one of value $\frac{n-1}{n} \times P + Q$, as in Fig. 6. Thus, Fig. 5 is equivalent to Fig. 6.

$$\text{Using } \frac{1}{R} = \frac{1}{r_1} + \frac{1}{r_2},$$

$$\begin{aligned} \frac{1}{R} &= \frac{1}{P/n} + \frac{1}{Q + \frac{(n-1)P}{n}} \\ &= \frac{n}{P} + \frac{n}{nQ + P(n-1)} \\ &= \frac{n(nQ + nP - P) + nP}{P(nQ + nP - P)} \end{aligned}$$

From which

$$\begin{aligned} R &= \frac{nPQ + nP^2 - P^2}{n^2Q + n^2P} \\ &= \frac{n(PQ + P^2) - P^2}{n^2(P + Q)} \quad (1) \end{aligned}$$

This expression gives the value of the resistance of the combination for any values of the fixed

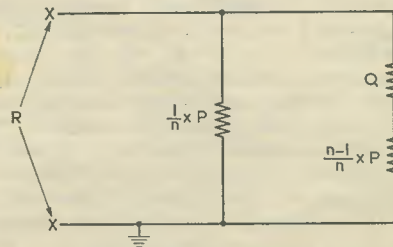

Fig. 6. An equivalent to Fig. 5

resistor and variable resistor, together with any degree of rotation of the variable spindle.

Consider a particular case where the value of the variable is equal to the value of the fixed resistor, and to, say, 1MΩ.

$$\text{Put: } P=Q=1 \text{ in (1)}$$

$$R = \frac{n(1+1)-1}{n^2(1+1)} = \frac{n-1}{n^2}$$

Or, if x is the fraction through which the spindle is turned set: $x=1/n$

$$R = \frac{1-1}{x^2} = x^2 \left(\frac{1}{x} - \frac{1}{2} \right)$$

Drawing a Graph

A graph, such as that of Fig. 4, can be drawn showing the law of the arrangement described by compiling a table for various values of x, the fraction of spindle rotation. The straight line of Fig. 4 shows the law followed by a single variable resistor having the same resistance as the combination. As can be seen the deviation is not great as long as the value of the fixed resistor is not too small compared with the value of the variable.

Transistor for Exceedingly High Frequencies

J. B. DANCE, M.Sc.

A FEW YEARS AGO ONE OF THE MAIN DISADVANTAGES of transistors was thought to be their limited maximum operating frequency. This results from the time taken for minority carriers to diffuse through the field-free base region from the emitter to the base-collector junction. The thinner the base region, the smaller this diffusion time and the greater the maximum operating frequency. In some types of transistor the carriers are accelerated through the base region by an electric field.

Recent research has extended the maximum theoretical frequency at which transistors can function by a factor of about ten to 20 Gc/s (20,000 Mc/s). The basic idea for this new type of transistor was suggested by D. V. Geppert of the Stanford Research Institute and involves the use of an extremely thin base layer consisting of metal in the silicon transistor. The thickness of the base is about 100 Å (1/100,000mm), whilst that of a conventional u.h.f. transistor is not normally less than about 2,000 Å.

The new device, which is being developed by the Sprague Company of North Adams, Massachusetts, U.S.A., will provide a moderate gain. It is much more resistant to nuclear radiation than a normal transistor and this could be vital for space research work. Some people believe that the design of this transistor is the most important breakthrough in semiconductor technology during the past five years, but time alone will tell.

NEXT MONTH IN

THE Radio Constructor

The Use of Zener Diodes with Voltmeters

Zener diodes can expand or compress part of the scale of a voltmeter. They may also provide overload protection which is quicker-acting than any mechanical device. Suitable circuits for these applications are discussed in this article.

Transistorised Capacitance Relay

For those readers interested in the "gadgets" side of electronics, one of the most interesting is the capacitance relay. This is a circuit which operates a relay when a hand approaches a metal plate and it may also be used for automatic ringing of doorbells and many other applications. (OC171, OC71—3 off, germanium diode).

Sine and Square Wave Audio Oscillator

This simple circuit will provide low-distortion sine or square waves at the touch of a switch and has proved useful when testing various types of audio amplifiers. When used in conjunction with an oscilloscope, it is possible to trace different types of distortion quickly and easily. (6C4, 12AX7.)

Also

Our cover feature—"Two-Plus-Two" Receiver—an ideal project for the beginner, together with the usual supporting features.

January issue out 1st January. From your local newsagent (2s. 3d.).

Annual Subscription

For an Annual Subscription (33/- p.a.) complete and send in the coupon below or, if you do not wish to cut your copy, supply the required information by letter. Single copies 2s. 3d. plus 5d. postage.

To Data Publications Ltd.,
57 Maida Vale, London, W.9.

I enclose remittance of 33/- for Annual Subscription to *The Radio Constructor* commencing with the..... issue.

Name.....

Address.....
(Block Capitals)

IN LAST MONTH'S ISSUE WE INTRODUCED THE subject of valve characteristics and constants. We discussed two of the three important valve constants, these being mutual conductance and anode a.c. resistance. These constants were considered with respect to the triode valve, it being pointed out that they apply also to amplifying valves having more complicated electrode structures than has the triode.

We shall now proceed to the third important valve constant.

Amplification Factor

As we have already seen, a change in grid voltage, with anode voltage constant, causes a change in anode current. It can also be shown that, if anode current is kept constant, a change in grid voltage causes a change in anode voltage. This fact may be readily observed with the aid of the circuit of Fig. 325 (published in last month's issue) in which the anode voltage of the valve under consideration can be varied by means of a potentiometer connected across the h.t. supply, the anode voltage and anode current being indicated by appropriate meters.

to change in grid voltage) has to be expressed in terms of milliamps per volt. Similarly, anode a.c. resistance (the ratio of change in anode voltage to change in anode current) has to be expressed in ohms. However, amplification factor is the ratio of change in one voltage to change in another voltage. Both changes are in the same units, and so amplification factor is expressed as a figure on its own, and without any units.

The abbreviation employed for amplification factor is μ (Greek letter "mu"), and it may be expressed as:

$$\mu = \frac{dV_a}{dV_g} (I_a \text{ constant}).$$

The denominator of the fraction (dV_g) represents "change in V_g ", and the numerator (dV_a) represents "corresponding change in V_a ". It will be noted that this fraction has the same form as those we saw last month for mutual conductance and anode a.c. resistance.

As is to be anticipated, the amplification factor of a triode under normal conditions is always greater than 1. Typical figures for triodes encountered in practice range from around 10 to 100.

understanding

AMPLIFICATION FACTOR AND DYNAMIC VOLTAGE GAIN

By W. G. Morley

If, without any other adjustments, the grid voltage of the valve being investigated is made more negative, anode current will fall. But the anode current can be brought back to its previous value by increasing the anode voltage. Similarly, if grid voltage is made more positive, anode current will increase. Again, the anode current can be returned to its previous value, this time by reducing anode voltage. Thus, in a circuit in which anode current is maintained constant, a change in grid voltage results in a corresponding change in anode voltage.

This relationship is defined by the third important constant of the valve, *amplification factor*. The amplification factor of a valve is the ratio of change in anode voltage to corresponding change in grid voltage, anode current remaining constant. The two constants previously discussed define ratios between unlike units, and have, themselves, to be expressed in appropriate units. Thus, mutual conductance (the ratio of change in anode current

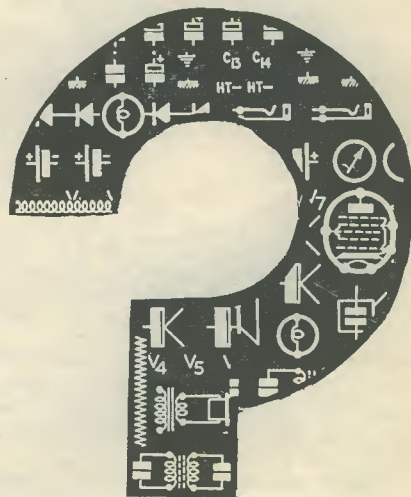

radio

Occasionally, a triode may be classified as a "low- μ " type or a "high- μ " type to give an indication of the performance which may be expected of it. As an example, the double-triode type 12AU7 consists of two similar triodes in a single envelope and these, with an amplification factor of 19 at an anode voltage of 100, are sometimes referred to as "low- μ " triodes. Another double-triode, the 12AX7, also has two similar triodes in a single envelope, these having an amplification factor of 100 at an anode voltage of 100. The 12AX7 triodes are, in consequence, sometimes

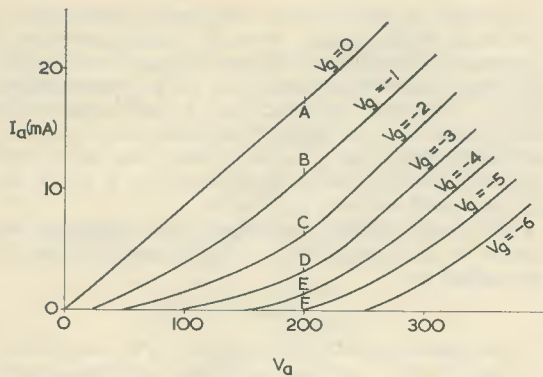

(a)

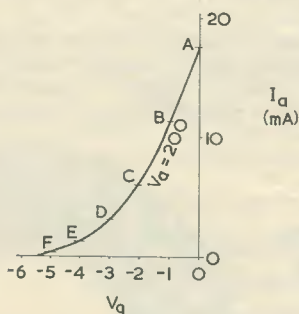

(b)

Fig. 329 (a). A set of $I_a V_a$ curves for a typical triode (b). The information in the $I_a V_a$ curves may be employed to draw a set of $I_a V_g$ curves. In this diagram an $I_a V_g$ curve for $V_a = 200$ is shown, the plotting points (A to F) being taken from the $I_a V_a$ curves in (a)

referred to as "high- μ " triodes. Occasionally, the term "medium- μ " may also be met. These three terms are approximate only, and should be looked upon as offering only a rough idea of the capabilities of a triode.

When we discussed mutual conductance and anode a.c. resistance, we also examined the characteristic curves which correspond to these quantities. With mutual conductance we had $I_a V_g$ curves with anode voltage as parameter, and with anode a.c. resistance we had $I_a V_a$ curves with grid voltage as parameter. There is no reason why, with amplification factor, we could not similarly have a set of $V_a V_g$ curves with anode current as parameter but, in practice, such curves are very rarely drawn or encountered. This is because adequate information on valve performance may be obtained from the $I_a V_g$ and $I_a V_a$ curves. Also, these provide the most convenient means of obtaining any further information which may be required on the valve.

It is interesting to note that it is possible to draw any of the three sets of curves from the information offered by one set only, provided that sufficient parameter values are given. Fig. 329 (a) shows, for

instance, a family of $I_a V_a$ curves with grid voltage as parameter. These can be used to plot a set of $I_a V_g$ curves with anode voltage as parameter. Fig. 329 (a) tells us that, at a V_a of 200, a V_g of zero corresponds to an I_a of 17mA, a V_g of -1 corresponds to an I_a of 11mA, a V_g of -2 to an I_a of 6mA, a V_g of -3 to an I_a of 3mA and so on. These are the points where the appropriate V_g curves pass the 200 volt V_a co-ordinate, and are indicated in Fig. 329 (a) by the letters A to F. If these points are plotted on an $I_a V_g$ graph we may then draw an $I_a V_g$ curve corresponding to a V_a of 200. Such a curve is shown in Fig. 329 (b). $I_a V_g$ curves corresponding to other values of V_a may similarly be drawn. The process is laborious, yet it emphasises that $I_a V_a$ and $I_a V_g$ curves present the same basic information, but on different axes. Readers who have access to manufacturers' valve data may find it of interest to check the points of correlation between $I_a V_a$ and $I_a V_g$ curves when both sets of curves are given for a specific valve.

A set of $V_a V_g$ curves could also be obtained by the same process. In this instance I_a would be the parameter. The values of V_a for different values of V_g at any fixed I_a may be obtained from the $I_a V_a$ or the $I_a V_g$ curves, and a new set of $V_a V_g$ curves drawn up.

Relationship Between Constants

We have now found that, for mutual conductance,

$$gm = \frac{dI_a}{dV_g} \quad (V_a \text{ constant}),$$

for anode a.c. resistance,

$$r_a = \frac{dV_a}{dI_a} \quad (V_g \text{ constant}),$$

and, for amplification factor,

$$\mu = \frac{dV_a}{dV_g} \quad (I_a \text{ constant}).$$

It is possible, from these equations, to find a relationship between gm , r_a and μ . A simple approach consists of first multiplying gm and r_a , a process which gives us:

$$\frac{dI_a}{dV_g} \times \frac{dV_a}{dI_a}$$

The two dI_a terms cancel out, and the expression then becomes

$$\frac{dV_a}{dV_g},$$

which is that for μ .

Thus,¹

$$\mu = gm \cdot r_a.$$

Similar manipulations can also show that:

$$gm = \frac{\mu}{r_a}$$

and that

$$r_a = \frac{\mu}{gm}$$

¹ This exercise does not take into account the fact that we are cancelling out two dI_a terms when the definition for μ assumes that I_a is constant. However, the definition for μ will still hold good if dI_a is almost infinitesimally small, and so the relationship is accurate.

It should be added that these three relationships are only completely accurate when μ , g_m and r_a are evaluated for changes around the same anode voltage, anode current and grid voltage.

Dynamic Conditions

The three valve constants we have discussed do not enable us to directly evaluate performance in a practical valve amplifier circuit. We could, for instance, try to determine the performance of a valve amplifier by using the mutual conductance figure. But if we are to use a valve as a practical amplifier we have to provide it with an anode load, such as is given by the anode load resistor for the triode in Fig. 330 (a). The sole function of the anode load is to provide a large *varying* voltage on the anode. If we want to determine the performance of the valve in this circuit, what use is the mutual conductance figure which is dependent upon a *fixed* anode voltage?

Fortunately, a valve's performance under working, or *dynamic*, conditions may be readily found from its constants, all that is required being one or more simple arithmetical or graphical steps which allow the valve's load to be taken into account.

As a start, let us find the voltage amplification, or voltage *gain*, offered by the triode of Fig. 330 (a). This voltage amplification will be given by the alternating voltage across the anode load resistor R_L divided by the alternating voltage applied to the grid.²

Our first step consists of replacing the valve by an equivalent alternating voltage generator offering the same alternating voltage as is given at the anode of the valve. This alternating voltage will be equal to the alternating voltage at the grid multiplied by the valve's amplification factor, μ . We saw last month that the anode a.c. resistance of the valve, r_a , can be looked upon in the same manner as the internal resistance of a generator. This resistance must, therefore, be added in series with the generator if our new circuit is to be exactly equivalent to that given with the valve. The result is shown in Fig. 330 (b), in which diagram the valve is replaced by the a.c. generator in series with r_a , the combination being then applied to the anode load resistor R_L .

We next move r_a over to the right hand side of the diagram, as in Fig. 330 (c), since this new position helps to demonstrate that r_a and R_L form a potentiometer. The output alternating voltage

across R_L is then $\frac{R_L}{R_L+r_a}$ of the alternating voltage given by the generator. Since the latter is the grid alternating voltage multiplied by μ , it follows that:

$$\text{Alternating Voltage across } R_L = \frac{R_L}{R_L+r_a} \times \mu \times \text{Alternating Voltage at grid.}$$

² In choosing the symbol R_L for the anode resistor we are working to the generally accepted convention concerning valve quantities. If any quantity is *inside* a valve it is represented by a small letter, and if it is *outside* the valve it is represented by a capital letter. The anode load of the triode of Fig. 330 (a) is a resistance *outside* the triode and we refer to it as R_L , with a capital "R". Shortly, we shall be introducing the anode a.c. resistance which, as we already know, is referred to as r_a . A small letter "r" is used here because the anode a.c. resistance is *inside* the valve.

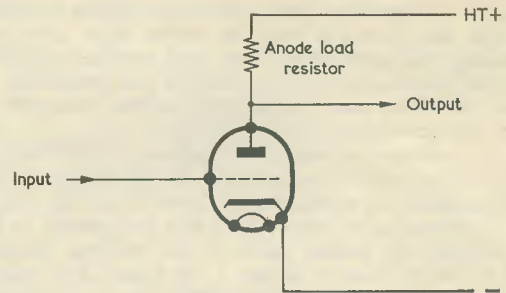

(a)

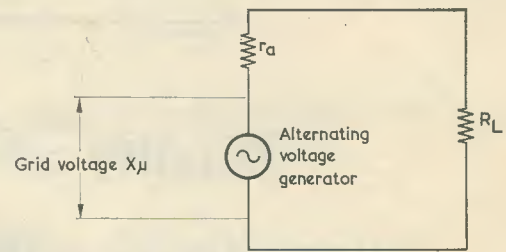

(b)

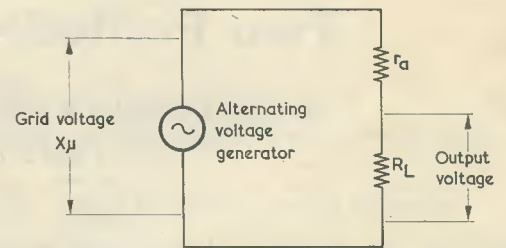

(c)

Fig. 330 (a). If a valve is to function as an amplifier it requires an anode load across which the output voltage may appear. (Bias components are omitted here for simplicity)

(b). The valve may be replaced by an alternating voltage generator in series with the r_a of the valve, as shown here

(c). Moving r_a to the right demonstrates that the output voltage is that dropped across R_L in the potentiometer R_L+r_a

This may be changed to:

$$\frac{\text{Alternating Voltage across } R_L}{\text{Alternating Voltage at grid}} = \frac{\mu R_L}{R_L+r_a},$$

or:

$$\text{Voltage Amplification} = \frac{\mu R_L}{R_L+r_a}.$$

This formula is commonly used to evaluate voltage amplification in a circuit of the type shown in Fig. 330 (a), and it enables the modifying effect of the load resistor to be taken into account. It should be pointed out that it is only completely accurate in the cases where the valve is worked over the linear (i.e. straight line) parts of its characteris-

tics.³ In practice, the accuracy of results obtained with this formula will be more than adequate enough for most radio work, and particularly when small alternating voltages (which are less likely to run the valve over excessively non-linear sections of its characteristics) are concerned.

In some radio circuits, a very low anode resistance (or impedance) is employed. If this resistance (or impedance) is considerably lower than the anode a.c. resistance of the valve it can be ignored in the denominator (lower part) of the fraction, because it is much lower than the r_a to which it is added. Voltage amplification then becomes approximately

³ Because, otherwise, μ and r_a may vary.

Quality and Sensitivity with Two Pentodes

By SIR DOUGLAS HALL
K.C.M.G., B.A.(Oxon).

Although the ex-R.A.F. intercom amplifier type A1134A is not nowadays generally available on the surplus market, large quantities of these amplifiers have been purchased by amateur constructors for experimental projects. This article describes an ingenious two-pentode medium wave receiver circuit which takes advantage of the high-inductance transformers employed in the A1134A to obtain efficient inter-valve coupling with a very wide audio frequency response. Another neat feature is the reflexing of the first valve and the use of a single control for reaction and audio volume

MANY DESIGNERS OF SIMPLE TWO-PENTODE circuits use transformer coupling between the valves, presumably because they have found that amplification with resistance coupling is too small.

On page 335 of the issue of this magazine for December 1962¹ it was shown that the maximum

¹ V. T. Rolfe, "Modernise That Valve Portable", *The Radio Constructor*, December 1962.

equal to $\frac{\mu R_L}{r_a}$. We saw, earlier on in this article,

that mutual conductance is equal to $\frac{\mu}{r_a}$, so we may then say that voltage amplification under these conditions is approximately equal to $gm.R_L$. It must be emphasised that this approximate relationship is only true when R_L is considerably lower than r_a .

Next Month

In next month's article we shall discuss an alternative method of evaluating dynamic performance, this time with the aid of the load line.

gain from a DAF96 valve with resistance coupling was 65 times. This involved the use of an output load of about $700k\Omega$ ($1M\Omega$ anode load shunted by a following grid resistor of $2.2M\Omega$) and the passage of an anode current which, through $1M\Omega$, would drop most of the 85 volts direct current available from the battery. The amplification given by the valve in these conditions indicates that the gm has dropped to a relatively low figure at the low direct voltage available for it, and in these circumstances the designer would find that it would refuse to oscillate at radio frequencies. Since some form of radio frequency amplification, either straight or by the use of reaction, is essential in a two-valve receiver used without an external aerial, it would be necessary to increase the battery voltage available by dropping the value of the anode resistance. But this would reduce still further the amplification at audio frequencies. To overcome this difficulty a transformer is frequently used which, with its low d.c. resistance, allows most of the 85 volts from the battery to be used. But the use of a transformer after a pentode produces most unpleasant frequency distortion—all the bass disappears—and this is intolerable for anyone who is not tone deaf; or so the author believes!

Anode Load Inductance

The point of course, is that the primary winding of an average intervalve transformer is not likely to have an inductance of more than about 40 henrys. 40 henrys offers an impedance of about $12k\Omega$ at 50 c/s—and roughly $1.2M\Omega$ at 5,000 c/s. As the output impedance of a small voltage amplifying pentode is at least $1M\Omega$ the gain is approximately proportional to the output load, and there is consequently an increase of nearly 100 times in the amplification of extreme treble as compared with extreme bass.

If a load is used consisting of a very large inductance it is possible to obtain high amplification with good quality. It is true that the impedance to alternating current will still rise with frequency, but amplification varies less as the impedance becomes very high, and the effect is in any case cancelled out at high audio frequencies where the

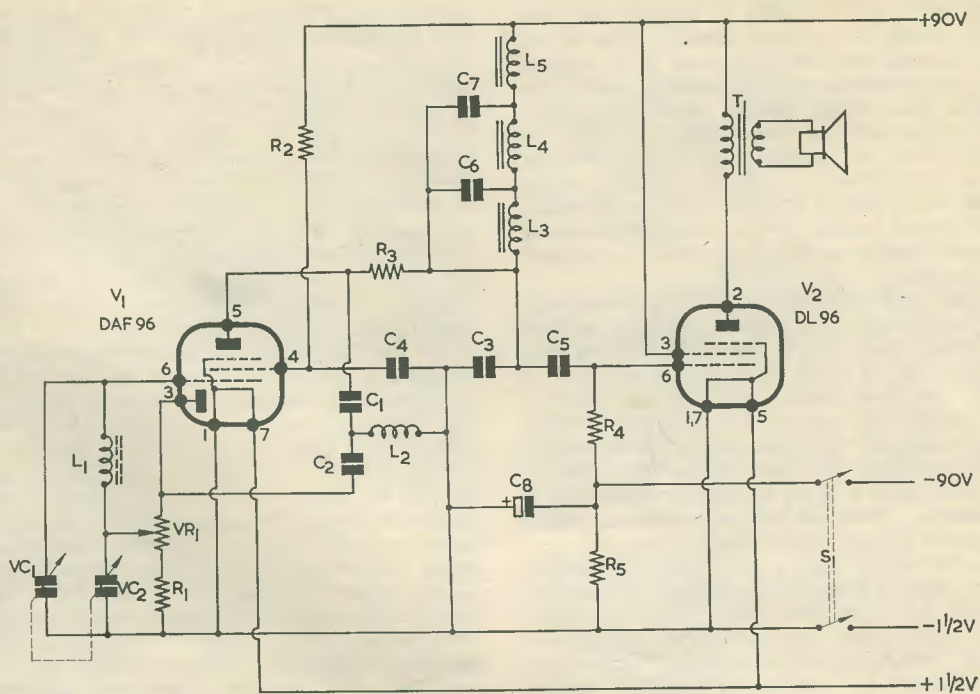

Fig. 1. The circuit of the receiver

Components List

Resistors

(All fixed resistors $\frac{1}{4}$ watt, 10%)

- R₁ 10k Ω
- R₂ 100k Ω
- R₃ 10k Ω
- R₄ 470k Ω
- R₅ 750 Ω
- VR₁ 500k Ω potentiometer, log track

Capacitors

- C₁ 100pF silver-mica or ceramic
- C₂ 100pF silver-mica or ceramic
- C₃ 100pF silver-mica or ceramic
- C₄ 1 μ F paper
- C₅ 0.05 μ F paper
- C₆ 3,000pF ceramic
- C₇ 500pF silver-mica or ceramic
- C₈ 50 μ F electrolytic 12V wkg.
- VC₁ 176pF } Type "00" Twin Gang Capacitor,
- VC₂ 208pF } Cat No. 5265 (Jackson Bros.)

Inductors

(L₃, L₄, L₅ and T₁ are taken from the A1134A

amplifier, and the numbers specified are R.A.F. Stores Ref. numbers)

- L₁ See text
- L₂ 2.5mH r.f. choke type CH1 (Repanco)
- L₃ 10K/10280
- L₄ 10K/1571
- L₅ 10K/574
- T₁ 10K/575

Valves

- V₁ DAF96
- V₂ DL96

Loudspeaker

3 Ω , 8in speaker

Switch

S₁ d.p.s.t. on-off switch, rotary or toggle

Miscellaneous

- Ferrite rod 8 \times $\frac{3}{8}$ in
- Battery type B103 (Ever Ready)
- Cabinet, etc.

impedance offered by stray and circuit capacitances begins to take over. In fact, with a very high inductance of the order of thousands of henrys, the load will become capacitive for most of the audio range. In addition there is a damping effect

brought about by the grid resistor necessary for the output valve. If this is of the order of half a megohm it is possible to arrive at a load which does not vary much from 300k Ω throughout, except at the extreme high frequency end of the

spectrum. It is also possible to arrange for bass boost by means of a tuned circuit. This circuit will be damped by the following grid resistor but can, nevertheless, still produce a useful rise at extreme bass which the ear does not register so easily as the middle frequencies. It might be mentioned that at comparatively low volume levels, as are normally used in a sitting room, the writer feels that a straight line amplification does not sound nearly as good as amplification which rises at both ends of the spectrum to compensate for the ear.

One source of very high inductance is the secondary of a q.p.p. intervalve transformer. To take an example the author has, in his possession, a pre-war transformer with a primary inductance of 40 henrys with 4mA passing through the winding, and an overall step up of 1:9 between primary and the whole of the centre-tapped secondary. The inductance of the secondary, with 400 μ A passing through it is thus 40×81 , which equals 3,240 henrys. (This is an approximate figure which ignores leakage inductance.)

Another winding with a very high inductance is the secondary of a good microphone transformer.

The ex-R.A.F. amplifier type A1134A contains a q.p.p. transformer, and a good microphone transformer. Each has a high inductance secondary. It also contains an excellent multi-ratio output transformer with two primary windings and two secondary windings, one of each being centre-tapped. Yet a fourth transformer is included which can be used for boost of extreme treble in relation to middle frequencies.

The Circuit

If the circuit shown in Fig. 1 is examined it will be seen that the low frequency load for V_1 consists of three chokes in series. L_3 is the q.p.p. transformer from the A1134A with its two windings connected in phase. L_4 is the secondary of the microphone transformer, and L_5 is the secondary of a transformer designed for matching high impedance phones to low impedance output. The secondary is the large winding. The inductance of L_3 is of the order of 1,000 henrys. It is shunted by a 3,000pF capacitor, C_6 , in order to reduce impedance at middle frequencies. Because of C_6 these become restricted for their load to little more than L_4 and L_5 . The highest audio frequencies are also deprived of L_3 as a load and, because of C_7 , L_4 is, in addition, largely bypassed. But these very high audio frequencies still appear across L_5 which, although of comparatively low inductance, offers a high impedance to high audio frequencies. C_7 , a capacitor of 500pF, shunts both L_3 and L_4 and, together with C_6 , produces a tuned circuit with a resonant frequency of between 50 and 100 c/s. This circuit is heavily damped by R_4 and therefore offers a spread over the lowest audio frequencies. The result of this rather complicated load is a very high impedance for the lowest frequencies; considerably lower impedance for middle frequencies and something between the two at the

highest audio frequencies. These highest frequencies are further looked after by the fact that the output pentode has no capacitor from anode to earth and therefore produces its customary increase in amplification of the top notes. The capacitors C_1 , C_3 , C_5 and C_7 all play an important part in producing the desired response curve in conjunction with the chokes L_3 , L_4 and L_5 , and the values shown for these capacitors should be carefully adhered to. The same applies to the resistor R_4 . Should R_4 be increased in value in an attempt to improve amplification there will probably be threshold howling as reaction is advanced, quite apart from frequency distortion.

As the low frequency arrangements have been designed to give a very carefully balanced frequency response it is important to arrange for as much high frequency amplification as possible in order not to throw away the high notes with the sideband cutting which takes place when critical reaction is used to boost a very weak signal. For this reason a Colpitts reaction circuit is used, since such a circuit tends to put stray capacitances in series with each other. This reduces minimum tuning capacitance and allows the use of a large tuning inductance. In practice a ganged capacitor is employed, of the type in common use with transistor superhets. The two sections are in series and give a total capacitance of only about 90pF.² This capacitor will be found to tune the whole of the medium waveband and with an inductance of about 800 μ H. Such an inductance is about 5 times the value of that used with a normal 500pF tuning capacitor so that a gain of 25 times over normal may be expected due to the tuned circuit. But, owing to the capacitance tap arrangement, only about half the voltage across the tuned circuit is available between grid and cathode of V_1 , so that the overall figure is reduced to about 12.5 times. L_1 is made by winding 110 turns of 32 s.w.g. enamelled wire, close wound, on a $\frac{3}{8}$ in ferrite rod 8in long.

The amplified signal appears across R_3 . A gain of not more than about 4 times can be expected owing to the small load, which cannot usefully be increased because of the effect of stray capacitances. But this, multiplied by the 12.5 figure already mentioned, provides an increased gain of 50 times as compared with normal arrangements, and helps to compensate for the lack of an external aerial and earth, or a tuned r.f. stage.

The filter formed by C_1 , C_2 and L_2 is to prevent unwanted negative feedback of audio frequencies which would otherwise be serious with the very large low frequency load. Through this network the high frequency signal is applied to the diode in V_1 and rectified. The rectified signal appears across the volume control VR_1 and is fed to V_1 . VR_1 also acts as a reaction control, some of the amplified radio frequency signal appearing at the bottom of L_1 . The capacitance tap formed by

² The twin-gang capacitor specified is normally supplied with trimmers. These should be set to give minimum capacitance.—EDITOR.

VC₁ and VC₂ produces a correct phase relationship for regeneration. VR₁ should be connected so that volume increases in an anti-clockwise direction. With a log control this will mean that a fair proportion of the movement will be available for the smallish resistance change needed to control reaction, and smooth operation will result. R₁ is included to prevent mistuning at very low volume levels which might otherwise be troublesome if the local station gave a very powerful signal.

It will be noted that the screen-grid capacitor for V₁ has the rather large value of 1μF. This large value was purposely chosen, as V₁ is amplifying at audio as well as radio frequencies, and even as large a value as 1μF has an impedance of about 3kΩ at 50 c/s.

Using the Transformers

It is an easy matter to remove the lid from the case of the A1134A and take out the four transformers, each of which is held in position by two screws. Fig. 2 shows, in detail, the way these transformers are connected including the output transformer which, when wired as shown, offers a good match from the DL96 to a 3Ω speaker.

In designing the layout of the receiver it should be remembered that there is a great deal of low frequency amplification and that wiring must be kept short. The metal cover of VR₁ must be connected to chassis and the ferrite rod kept well away from the transformers. The output transformer should be as far as possible from L₃, L₄ and L₅. These last three transformers need not be widely separated.

The circuit is strictly for powerful local stations which it will receive without an aerial (which can not, in any case, be used without the risk of introducing instability). It will receive more distant stations after dark, but the exceptionally high amplification of bass will produce woolly results when critical reaction is used with a weak signal. For local station reception the quality of the output is quite unusual. The author has not heard, on any other portable receiver, anything approaching the bass response, which is comparable to that heard from a good radiogram adjusted to give 200mW output. A good feature is that the bass is still there even when volume is turned down to a low level.

The loudspeaker should not be less than 8in in diameter and should be a good, though not necessarily very expensive, unit. The cabinet

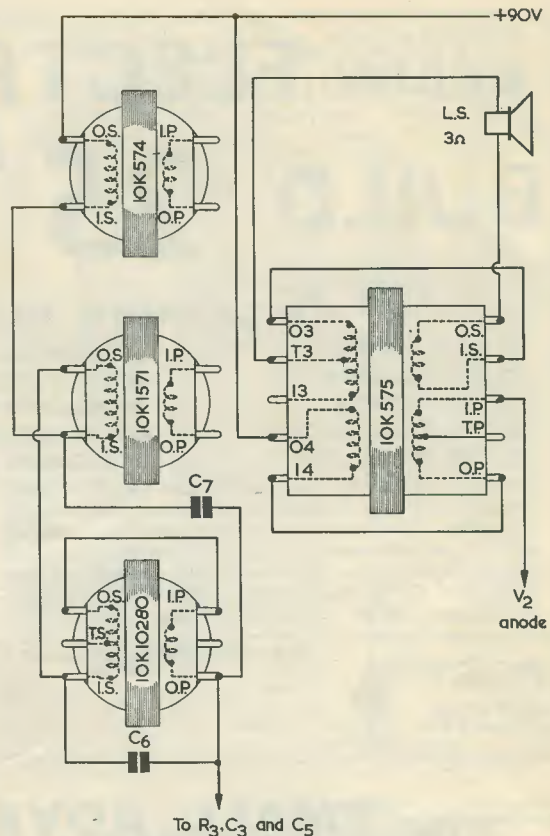

Fig. 2. The manner in which the A1134A transformers are connected into circuit

should be of reasonably thick wood and not too small. The prototype uses a cabinet which originally housed a commercially built all-dry battery superhet. It is about 11in high, 10in wide and 7in deep.

Current consumption is 75mA at 1.4 volts and 6 to 7mA at 90 volts. A B103 type battery will give very long service.

Editor's Note

As was mentioned in the introduction to this article, the ex-R.A.F. A1134A amplifier is not nowadays generally available from suppliers. Interested readers may, however, find it possible to purchase one of these amplifiers from Lyons Radio Ltd., 3 Goldhawk Road, London. W.12, whilst stocks last.

Lasky's Radio Ltd.

Lasky's Radio Ltd. announce that they will shortly be moving their Head Office and Mail Order Department to new premises at 3-15 Cavell Street, Tower Hamlets, London, E.1. (Tel.: Stepney Green 4821-2.)

The new building has an interior specifically designed by the company to greatly facilitate the handling of mail orders and to accord more warehouse space to accommodate the stocking of a greater range of goods.

The new premises are expected to be fully operational by 22nd November.

LEARN ELECTRONICS AS YOU BUILD 25 CIRCUITS ... EXPERIMENTS ... TEST GEAR ...

including

● CATHODE RAY OSCILLOSCOPE

- VALVE EXPERIMENTS
- SQUARE WAVE GENERATOR
- SIGNAL TRACER
- BASIC AMPLIFIER
- SIMPLE TRANSMITTER
- BASIC COMPUTER CIRCUIT
- BASIC RECTIFIER
- TRANSISTOR EXPERIMENTS
- BASIC RADIO RECEIVER
- PHOTO ELECTRIC CIRCUIT
- BASIC OSCILLATOR
- MORSE CODE OSCILLATOR
- TIME DELAY CIRCUIT
- ELECTRONIC SWITCH
- ETC. ETC.

This complete practical course will teach you all the basic facts of electronics by making experiments and building apparatus. You learn how to recognise and handle all types of components—their symbols and how to read a circuit diagram. You see how circuits are built and how they work **BY USING THE OSCILLOSCOPE PROVIDED.** Applications of all the main electronic circuits are

demonstrated—radio reception and transmission; photo-electrics; computer basics; timers; control circuits; etc.; including servicing techniques. **NO MATHS USED OR NEEDED. NO THEORY NEEDED. NO PREVIOUS KNOWLEDGE OR EXPERIENCE NEEDED.** Tutor service available. No extras needed—tools provided. Send now, for *Free Details* without obligation, to address below

To **RADIOSTRUCTOR**, Dept. K3, READING, BERKS. Please send free details of your electronics kit set to:

POST NOW



NAME _____
ADDRESS _____

SMALL ADVERTISEMENTS

Use this form for your small advertisement

To: **The Advertisement Manager, Data Publications Ltd., 57 Maida Vale, London, W.9**
Please insert the following advertisement in the issue of **THE RADIO CONSTRUCTOR**

16 words at 9d.
= 12/-

**ALL WORDING
IN
BLOCK LETTERS
PLEASE**

I enclose remittance of being payment at 9d. a word. **MINIMUM 12/-.**
Box Number, if required, 2/- extra.

NAME _____
ADDRESS _____

Copy to be received four weeks prior to publication. Published on the 1st of every month

SMALL ADVERTISEMENTS

Rate: 9d. per word. Minimum charge 12/-.
Box No. 2/- extra.

Advertisements must be prepaid and all copy must be received by the 4th of the month for insertion in the following month's issue. The Publishers cannot be held liable in any way for printing errors or omissions, nor can they accept responsibility for the *bona fides* of advertisers. (Replies to Box numbers should be addressed to: Box No. —, The Radio Constructor, 57 Maida Vale, London, W.9.)

THE INCORPORATED PRACTITIONERS IN RADIO AND ELECTRONICS (I.P.R.E.) LTD.
Membership conditions booklet 1s. Sample copy of I.P.R.E. Official Journal 2s. post free.—Secretary, Dept. D, 32 Kidmore Road, Caversham, Reading, Berkshire.

SERVICE SHEETS, 1925-1965. From 1s. Catalogue 6,000 models, 1s. 6d. S.A.E. enquiries.—Hamilton Radio, 13 Western Road, St. Leonards, Sussex.

HAMMERITE hammer pattern brush paint, for panels and boxes, gives a perfect pattern in only 10 sec. Just brush it on!

Colours: Blue, silver or metallic black.
2½ oz. tins 3s. 6d. ½ gallon 35s.*
½ pint 7s. 6d. 1 gallon 58s.*
1 pint 15s. (* sent by road).

Carriage: Orders up to 5s., 9d.; up to 10s., 1s. 9d.; over 10s., 2s. 9d.

Return of post service Monday to Friday.
From your component shop, or direct from the manufacturer: **FINNIGAN SPECIALITY PAINTS, (RC)**, Mickley Square, Stocksfield, Northumberland. Telephone: Stocksfield 2280.

GOVERNMENT SURPLUS electrical and radio equipment. Our new catalogue No. 16 ready now, 2s. 6d. post free, cost refunded on purchase of goods over £2.—Arthur Sallis Radio Control Ltd., 93 North Road, Brighton, Sussex.

FOR SALE. Oscilloscopes—Galvanometers—Evershed & Vignolles Meggers. Also other items and components. Free list. Stamp please.—R. & E. Mart, Box 9 G.P.O., Tunbridge Wells, Kent.

FOR SALE. Genuine Mullard BY100 and resistor 6s. Also BVA, EF80, ECC81, EBF89, etc., 5s. Lists free—Messrs. E. A. Johnson, 12 Park Avenue, New Barnet, Herts. Mail only.

FOR SALE—VALVES. DL92, EB91, EF92, IT4 at 1s. 6d. ECC82, EL91 at 3s. CV1075, U14, VR91, VT136, 955, 6AT6 at 5s. EF40, 801, 830B, T20 at 7s. 6d.—Box No. F241.

SPEED SERVICING with a stage substitution analyser made from surplus 2 band T.V. receiver. Descriptive leaflet. Diagrams 5s. 6d. inc. postage.—Moore, 40 Carleton Road, Higher Poynton, Cheshire.

continued on page 333

BENTLEY ACOUSTIC CORPORATION LTD

38 CHALCOT ROAD CHALK FARM LONDON NW1
THE VALVE SPECIALISTS Telephone PRIMROSE 9090

1L4	2/3	6/30L2	8/9	DAF96	6/-	EF37A	7/-	HABC80	9/3	U25	8/6
1R5	4/-	10C1	9/9	DF96	6/-	EF41	6/6	KT66	12/3	U26	7/6
1S4	5/-	10C2	12/-	DK92	8/-	EF80	4/3	N339	25/-	U31	6/6
1S5	3/3	10F1	10/-	DK96	6/6	EF83	9/9	PABC80	6/9	U191	9/6
1T4	2/3	10F18	9/9	DL96	6/-	EF85	4/6	PC86	9/9	U282	12/3
2D21	5/-	10LD11	9/6	DM70	5/-	EF86	6/6	PC88	9/-	U301	11/-
3D6	3/9	10P13	12/-	DY86	6/6	EF89	4/3	PC95	6/9	U329	9/-
3Q4	5/3	10P14	11/6	DY87	7/6	EF91	3/-	PC97	6/9	U404	6/6
3Q5	6/9	12AH8	10/9	EBC8C	13/6	EF92	2/6	PCC84	5/6	U801	15/-
354	4/9	12AT6	4/6	EABC80	5/9	EF97	10/-	PCC85	6/9	UABC80	5/6
3V4	5/-	12AU6	5/9	EAF42	7/9	EF98	9/9	PCC88	10/6	UAF42	6/9
5Y3GT	4/9	12AV6	5/9	EB91	2/3	EF183	7/3	PCC89	11/6	UBC41	6/3
5Z4	7/6	12BA6	5/3	EBC33	6/-	EF184	6/6	PCC189	10/-	UBC81	6/3
6AQ5	5/9	12BE6	4/9	EBC41	6/6	EL33	6/6	PCF80	6/6	UBF80	5/6
6AT6	3/6	12BH7	6/6	EBF81	6/3	EL36	8/9	PCF82	6/-	UBF89	6/3
6AU6	5/9	19AQ5	7/3	EBF80	5/9	EL41	7/-	PCF84	8/6	UBL21	10/9
6AV6	5/6	20D1	10/-	EBF83	7/3	EL42	7/9	PCF86	8/3	UC92	6/3
6BA6	4/6	20F2	11/6	EBF89	5/9	EL83	6/9	PCF801	9/9	UCC84	8/6
6BE6	4/3	20L1	12/-	EBL21	10/3	EL84	4/6	PCF802	10/-	UCC85	6/-
6BH6	5/3	20P1	12/6	ECC92	6/6	EL85	7/6	PCL82	6/6	UCF80	8/3
6BJ6	7/6	20P3	13/-	ECC81	3/6	EL86	7/3	PCL83	9/6	UCH21	8/-
6BQ7A	7/6	20P4	13/6	ECC82	4/6	EL95	5/-	PCL84	7/6	UCH42	8/-
6BR7	12/-	20P5	11/6	ECC83	4/6	EL80	13/6	PCL85	8/6	UCH81	6/6
6BV6	7/6	30C15	10/-	ECC84	5/6	EM34	11/6	PCL86	8/6	UCL82	7/3
6CD6G	18/-	30C17	11/9	ECC85	5/9	EM71	15/6	PEN45	7/-	UCL83	9/3
6CH6	6/6	30C18	9/3	ECC88	8/9	EM80	6/3	PL36	9/-	UF41	6/9
6F1	9/6	30F5	7/3	ECC189	11/6	EM81	7/-	PL38	16/-	UF42	4/9
6F7G	4/6	30F1	9/3	ECF80	7/3	EM84	6/-	PL81	6/9	UF80	6/3
6K7G	1/3	30L15	10/3	ECF82	6/3	EM85	8/9	PL82	5/3	UF85	6/9
6K8G	3/3	30L17	11/6	ECF86	10/-	EM87	7/6	PL83	6/-	UF86	9/-
6L1	10/-	30P12	7/6	ECH21	10/-	EY51	5/6	PL84	6/3	UF89	5/6
6L6GT	7/3	30P19	12/-	ECH35	6/-	EY81	7/3	PMB84	9/3	UL41	7/-
6L18	10/-	30P11	9/6	ECH42	8/-	EY83	9/3	PY33	8/9	UL84	5/6
6LD20	6/6	30P13	10/6	ECH81	5/9	EY84	9/6	PY80	4/9	UM80	8/3
6Q7G	4/3	30PL14	11/3	ECH83	6/6	EY86	6/6	PY81	5/-	UY21	9/-
6SL7	4/9	30PL15	9/6	ECH84	9/6	EY88	5/9	PY82	4/9	UY41	5/-
6SN7	4/6	35W4	4/6	ECL80	5/9	EZ40	5/6	PY83	5/6	UY85	4/9
6V6G	3/6	85A2	6/6	ECL82	6/6	EZ41	6/3	PY88	7/3	VP4B	12/-
6X4	3/9	5763	7/6	ECL83	8/9	EZ80	3/9	PY801	5/9	X41	10/-
6X5	5/3	AZ31	9/6	ECL86	8/9	EZ81	4/3	PY801	7/6	X78	26/2

Terms of business: Cash with order only. No C.O.D. Post/packing 6d. per item. Orders over £5 post free. All orders despatched same day. Complete catalogue including transistor section and components with terms of business 6d. Any parcel insured against damage in transit for 6d. extra. We are open for personal shoppers 9 a.m.—5 p.m. Saturdays 9 a.m.—1 p.m.

“EXPERIMENTAL” PRINTED CIRCUIT KIT

Contents

(1) 2 copper laminate boards 4¼" x 2½"; (2) Resist; (3) Etchant; (4) Resist Solvent; (5) Cleanser/Degreaser; (6) 16-page illustrated booklet "PRINTED CIRCUITS FOR AMATEURS" containing full etching instructions;

also free with every kit (7)

"24 SUGGESTED PROJECTS" which you can build on a P.C. chassis made from this kit using your own components. Circuit Diagrams. P.C. chassis plans. Assembly drawings. Photographs. Many recently developed very efficient transistorised designs you probably haven't heard of yet including . . .

Four Crystal Sets. Carrier Power Conversion Receiver. Matchbox Photocell Radio. Solar Battery L/S Radio. Pocket L/S Double Reflex. Triple Reflex with self-adjusting regeneration. Bacteria-powered Radio. 3 micro-miniature radios just released

Postage-Stamp Radio; 1.62" x .95" x .25". Wrist-watch Radio; 1.15" x .80" x .55". Ring Radio; .70" x .70" x .55". Amplifiers. Photoelectric Alarms. Light-Controlled Robot. Human Body Radiation Detector. "Perpetual Motion" Machine. Transistor Tester and many more. (8) Attractive case 4½" x 2½" to suit. (9) Miniature Radio Dial MW/LW. (10) Full-size P.C. chassis template for any one design of your choice. (State which).

Price 7/6, Post and Packing 1/-

"YORK ELECTRICS" 181A York Road, S.W.11

Send S.A.E. for full details

THE MODERN BOOK CO

Servicing Electronic Organs. By C. R. Pittman and E. J. Oliver. 30s. Postage 1s.

Transistor Transmitters for the Amateur. By D. L. Stoner. 21s. Postage 1s.

Troubleshooting With The Oscilloscope. By R. G. Middleton. 20s. Postage 1s.

A Guide to Amateur Radio. An R.S.G.B. Pub. 5s. Postage 6d.

The Radio Amateurs' Examination Manual. An R.S.G.B. Pub. 5s. Postage 6d.

Pick Ups the Key to Hi Fi. By J. Walton 10s. Postage 6d.

Electrical Installation Work. By T. G. Francis. 20s. Postage 1s.

Worked Examples in Electrotechnology. By A. C. Shotton. 12s. 6d. Postage 1s.

Radio Valve Data. 7th Ed. Compiled by "WW". 7s. 6d. Postage 1s.

Radio and Television Servicing Electronics Servicing. Specimen Answers to Inter. Papers, 1961/64. By Bennewitz. 8s. 6d. Postage 6d.

Ham Antenna. By J. A. Stanley. 24s. Postage 1s.

Elementary Telecommunications Examination Guide. By W. T. Perkins. 17s. 6d. Postage 1s.

101 Ways to Use Your Ham Test Equipment. By R. G. Middleton. 21s. Postage 1s.

Know Your Test Meters (VOM-VTVM). By J. A. Risse. 21s. Postage 1s.

Basic Theory and Application of Transistors. Compiled by U.S. Army. 10s. Postage 1s.

101 Ways To Use Your Audio Test Equipment. By R. G. Middleton. 18s. Postage 1s.

Short Wave Amateur Radio. By J. Schaap. 22s. 6d. Postage 1s.

Handbook of Line Communication: Vol. 1, Royal Signals. H.M.S.O. 30s. Postage 2s. 6d.

Complete Catalogue 1s.

We have the Finest Selection of English and American Radio Books in the Country

19-21 PRAED STREET (Dept RC) LONDON W2

Telephone PADdington 4185

THE WORD

D
MAXI-Q

IS THE REGISTERED
TRADE MARK

OF DENCO (CLACTON) LIMITED

IT IS ALSO A GUARANTEE OF
WORKMANSHIP AND
TECHNICAL PERFORMANCE

OUR RANGE OF PRODUCTS IS SO GREAT THAT WE NOW HAVE TO REQUEST THE AMOUNT OF 2s. 0d. FOR OUR GENERAL CATALOGUE AND TO SAVE YOU POSTAL ORDER POUNDAGE CHARGE WE REQUEST SEND 2s. 0d. IN STAMPS.

IN RESPONSE TO CONTINUOUS DEMAND we have commenced production of Self-Contained Multiplex Decoder Unit, aligned ready for immediate use, that will convert your two receivers—tuner and two amplifiers—tuner and stereo amplifier or stereo receiver without Multiplex provision to a complete B.B.C. Stereo Broadcast Reception Unit. Price £8.0.0, post paid. Technical Publication MDI, 4s. 0d., post paid.

IFT.11/465 kc/s centre tapped transformer for use in crystal filter circuits, $1\frac{7}{8}'' \times \frac{13}{16}''$ square. 10s. 6d. plus 8d. post.

IFT.18/465 kc/s and 1.6 Mc/s Double Tuned transistor transformer $1\frac{1}{2}'' \times \frac{1}{2}''$ square. 10s. 6d., plus 8d. post.

Please send S.A.E. with all enquiries. General Catalogue 2s. 0d.

DENCO (CLACTON) LTD.

(DEPT. R.C.)

357/9 OLD ROAD, CLACTON-ON-SEA, ESSEX

SMALL ADVERTISEMENTS

continued from page 331

STEREO RECORDS FOR SALE. *Marches from Operas*, AF.FCS 50008; *Stainer's Crucifixion*, HMV ASD 454; *Bob Sharples and His Music*, Decca SKL 4110; *Tchaikovsky in Phase Four*, Decca PFS 4044. All unblemished at 15s. each.—Box No. F246.

FOR SALE. Woden 350-0-350, 120mA; 6.3V 2A; 6.3V 4A; at £2. Woden 3.75-0-3.75 at 5 amps fil. trans at £1. Woden Swinging choke 5/25H, at 250mA at £1. 500-0-500 at 500mA surplus trans at £2. 10H 250mA smoothing choke, surplus, at £1. 5V at 5A, three times, C.T. surplus fil. trans. at £1. All above transformers for 250V a.c. Postage extra. 4in speaker in small metal case, suitable communications receiver £1. .5µF 3,000V d.c. capacitors, unused at 5s. plus postage—Box No. F248.

FOR SALE. Minimitter transmitter, 100W, Phone/CW, V.F.O. 28, 21, 14, 7, 3.5 Mc/s, aerial matching unit, T.V.I. Filter. £30.—Box No. F249.

"MEDIUM WAVE NEWS" Monthly during DX season—Details from: B. J. C. Brown, 60 White Street, Derby.

TECHNICAL DRAWINGS, Artwork, etc. Electronic and Radio Circuits a speciality. Moderate charges.—B. P. Meaney, 43 Forest Road, Worthing, Sussex.

ARE YOU A MOTORING ENTHUSIAST? The Seven Fifty Motor Club caters for all types of motor sport—racing, rallies, hill climbs, etc. Monthly Bulletin free to members. For full details write to: The General Secretary, Colin Peck, "Dancer's End", St. Winifred's Road, Biggin Hill, Kent.

POSTAL ADVERTISING? This is the Holborn Service. Mailing lists, addressing, enclosing, wrapping, facsimile letters, automatic typing, copy service, campaign planning, design and artwork, printing and stationery. Please ask for price list.—The Holborn Direct Mail Company, Telephone: TERminus 0588.

FREE! YOUR NAME EMBOSSED ON VINYL TAPE. Give your equipment that professional look with colourful embossed self-adhesive labels. Write for details and your free label to—Capitol Advertising Service, 15 Newman Street, London, W.1.

RECITALS OF RECORDED MUSIC. The second Saturday evening of each winter month. Next recital: 11th December, 1965, 8 p.m. at Woodford Green United Free Church, Woodford Green, Essex. Bus routes—20, 20a, 38a & 179. Programme will include works by Pergolesi, Marcello, Handel and Ravel.

WANTED. Circuit for ultra-sensitive transistor L.W. tuner. Offers to—Mr. Pescud, Greystones, Glanton, Alnwick, Northumberland.

INTERESTED IN AMATEUR RADIO TELEPRINTING? Then join the British Amateur Radio Teletypewriter Group. Details from Hon. Sec., G3LLV, 15 Havelock Square, Broomhill, Sheffield 10.

continued on page 335

EXTRA!

IN

PRACTICAL WIRELESS

16-PAGE PULL-OUT BOOKLET

SHORT WAVE DATA

Another vital booklet packed with at-a-glance information—When and Where to Listen—Amateur and Broadcasting Bands—Codes and Abbreviations—International Prefixes—Frequency and Time Signal Transmissions — How to Become a Radio Amateur.

OTHER OUTSTANDING FEATURES

ELL80 Push-Pull Amplifier
Inexpensive Multimeter
Aerial Tuners—Understanding FM

SHORT WAVE DATA

PRACTICAL WIRELESS

JANUARY ISSUE OUT DEC. 9th-2/-

Increased Demand—Make sure of your copy!

AN IDEAL CHRISTMAS PRESENT . . .

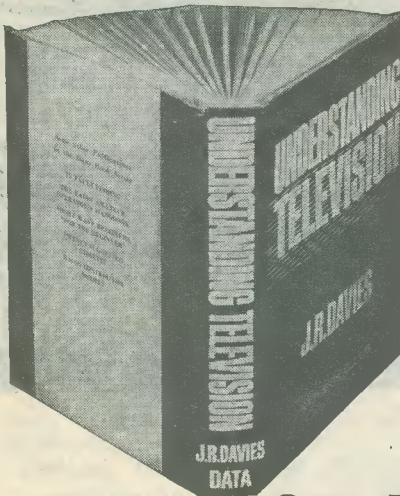

UNDERSTANDING TELEVISION

by

J. R. Davies

Over 500 pages 300 diagrams 37/6

UNDERSTANDING TELEVISION deals with the principles of 625 line reception as fully as 405 line reception, and explains in detail: the nature of the television signal; the cathode ray tube; receiver tuner units; receiver i.f. amplifiers; a.f. and video amplifiers; vertical and horizontal timebases; deflector coil assemblies; synchronising; automatic gain and contrast control; power supplies and receiver aerials. There is also a very comprehensive section dealing with present-day colour television.

The reader is required to have only a basic knowledge of elementary radio principles. The treatment is non-mathematical throughout, and there is no necessity for any previous experience in television whatsoever. At the same time, UNDERSTANDING TELEVISION is of equal value to the established engineer because of the very extensive range it covers and the factual information it provides.

Some Recent Reviews

"An extremely well written book which will be useful to anybody who wishes to gain or consolidate knowledge on the practical aspects of television . . ."—*British Communications & Electronics*.

"The text is well written, the diagrams well drawn and to the point, and the printing is good. Apprentices and all service engineers who wish to obtain a greater grasp of this subject will find this book very useful. . . ."—*Radio & Electrical Retailing*.

"The treatment is entirely non-mathematical and should be well suited to anyone who has a reasonable knowledge of radio theory. The text is profusely illustrated with diagrams and explanatory captions succinctly hammer home the relevant points—a valuable supplementary to the main text. . . ."

—*Practical Television*.

To Data Publications Ltd., 57 Maida Vale, London, W9

Please supply.....copy(ies) of your latest publication "Understanding Television", Data Book No. 17. Price 37/6. Postage 2/6.

NAME

ADDRESS

SMALL ADVERTISEMENTS

continued from page 333

PRINTED CIRCUIT BOARDS supplied for any circuit. Simply send full size drawing of board. Prices include drilling. 6d. per square inch, plus 2s. 6d. processing. Post free. Also boards designed, kits built, etc.—Temple, 12 Beech House Road, Croydon, Surrey.

JOIN THE INTERNATIONAL S.W. LEAGUE. Free Services to members including Q.S.L. Bureau. Amateur and Broadcast Translation. Technical and Identification Dept.—both Broadcast and Fixed Stations, DX Certificates, contests and activities for the SWL and transmitting members. Monthly magazine, *Monitor*, containing articles of general interest to Broadcast and Amateur SWLs, Transmitter Section and League affairs, etc. League supplies such as badges, headed notepaper and envelopes. QSL cards, etc., are available at reasonable cost. Send for League particulars. Membership including monthly magazine, etc., 35s. per annum.—Secretary, ISWL, 12 Gladwell Road, London, N.8.

EDUCATIONAL

TV AND RADIO. A.M.I.E.R.E., City & Guilds, R.T.E.B. Cert., etc., on "Satisfaction or Refund of Fee" terms. Thousands of passes. For details of Exams. and home training courses (including practical apparatus) in all branches of radio, TV and electronics, write for 156 page Handbook—FREE.—B.I.E.T. (Dept. 303), 29 Wright's Lane, London, W.8.

MORSE MADE !! EASY

The famous RHYTHM RECORDED COURSE cuts practice time down to an absolute minimum !
One student, aged 20, took only 13 DAYS and another, aged 71, took 6 WEEKS to obtain a G.P.O. pass certificate. If you wish to read Morse easily and naturally, please enclose 8d. in stamps for full explanatory booklet to:—
G3CHS/D, 45 Green Lane, Purley, Surrey.

DRY REED SWITCHES

from **Cockrobin Controls**:—
Miniature type, 10 Watt rating (½ Amp. max.), 3/6 each. Operating magnets 1/-, 1/6 and 2/-.
Cast switch covers 1/-. Encapsulated units, 6/3.
Please add 1/- post and packing on orders under £2. 3d. stamp for lists.
36 Villiers Avenue · Surbiton · Surrey

TRANSISTORS AND COMPONENTS

OC44, OC45, OC71, OC72, 3/- each.
OC171, AF117, AF116, 3/6 each.
ORP12 7/9 each. BY100, 5/- each.
BYZ13 200 P.I.V. 6 amps, 5/4 each.
WALKIE TALKIES, £8.10.0 pair.
OC82×2, OC82D×1 3 Transistors, 10/6 set.
OC44 + 2 OC45 Matched, 9/6 set.

J. ROBINSON

4 Highcliffe Road, Blackley, Manchester 9



ESTABLISHED

1865

Savings in this old established Building Society combine sound investment with an attractive return

THE DUCHESS OF KENT PERMANENT BUILDING SOCIETY

Member of the Building Societies Association

Shares are in units of £25 each (maximum investment £5,000) . . . BUT, for the smaller saver, Subscription Share accounts may be opened with any sum from 1/- upwards. Interest is payable half-yearly on Fully Paid Shares—credited annually on Subscription Shares—all interest accrues monthly

Withdrawals at short notice

INTEREST IS AT 4% PER ANNUM

(There is NO DEDUCTION FOR INCOME TAX, as this is paid by the Society)

For further information apply to

**DUCHESS OF KENT
PERMANENT BUILDING SOCIETY**
103 Cannon Street London EC4
Telephone MANSion House 8011

Please send to me, without obligation, free brochure and a copy of the audited statement of accounts. (I understand that I shall not be troubled with calls by representatives)

Name

(If lady, please state Mrs. or Miss)

Address

R.C.

(Please use Block Capitals for both name and address)

CHASSIS and CASES by



287/9 Edgware Road
London W2
TELEPHONE
PADDINGTON 5891/7595

BLANK CHASSIS—Same Day Service

Of over 20 different forms made up to YOUR SIZE.
(Maximum length 35", depth 4".)

SEND FOR ILLUSTRATED LEAFLETS

or order straight away, working out total area of material required and referring to table below which is for four-sided chassis in 16 s.w.g. aluminium.

48 sq. in.	4/3	176 sq. in.	9/-	304 sq. in.	13/6
80 sq. in.	5/6	208 sq. in.	10/-	336 sq. in.	14/9
112 sq. in.	6/6	240 sq. in.	11/3	368 sq. in.	15/9
144 sq. in.	7/9	272 sq. in.	12/6	and pro rata	
P. & P. 3/-		P. & P. 3/6		P. & P. 4/-	

Discounts for quantities. More than 20 different sizes kept in stock for callers.

FLANGES (1/2" or 3/8"), 6d. per bend.
STRENGTHENED CORNERS, 1/- each corner.
PANELS

Any size up to 3ft at 5/3 sq. ft. 16 s.w.g. (18 s.w.g. 4/6).
Plus postage and packing

CASES

ALUMINIUM, SILVER HAMMERED FINISH

Type	Size	Price	Type	Size	Price
U	4 x 4 x 4"	10/-	Y	8 x 6 x 6"	26/6
U	5 1/2 x 4 1/2 x 4 1/2"	15/-	Y	12 x 7 x 7"	41/-
U	8 x 6 x 6"	21/-	Y	13 x 7 x 9"	46/-
U	15 x 9 x 9"	44/6	Y	15 x 9 x 7"	48/6
W	8 x 6 x 6"	21/-	Z	17 x 10 x 9"	66/-
W	12 x 7 x 7"	34/-	Z	19 x 10 x 8 1/2"	71/-
W	15 x 9 x 8"	44/-		* Height	

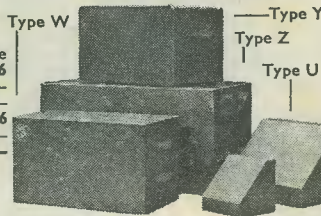

Type Z has removable back and front panels.
Type Y all-screwed construction.

BRASS · COPPER · LIGHT ALLOYS · ALUMINIUM BRONZE · STAINLESS STEEL

ROD, BAR, SHEET, TUBE, STRIP, WIRE. 3,000 STANDARD STOCK SIZES
No Quantity too small List on application

H. ROLLET & CO LTD
HOWIE ST. LONDON SW11 BATtersea 7872
Also at Liverpool, Birmingham, Manchester, Leeds, Glasgow

the unique **PANL** black crackle paint

4/-d. per 1/8 pt. Can
(We regret we can only supply on cash with order basis)

BRUCE MILLER LTD.,
219 Coastal Chambers,
Buckingham Palace Road, S.W.1.

V.H.F. RECEIVER: Pya PTC114, 65-100 Mc/s, 12 volts D.C. supply. This is an 11 Valve Double Superhet Receiver, operating on one fixed frequency between 65-100 Mc/s, crystal controlled, speaker output using midjet valves throughout. Supplied in first-class condition with tuning data, circuit diagram, and complete crystal formula. Ideal for the 4 metre band (70.2 Mc/s) offered at only 70/-, post 5/-.

Aerial Matching Tuning Units. These well made tuning units, made for the American I9 Tx-Rx, are housed in a metal case, colour green or brown, using a large precision calibrated scale, are an essential piece of equipment for the serious Tx or Rx operator. This unit will match an untuned wire or Whip Aerial to almost any Short Wave Receiver or Transmitter, exceptionally good for Mobile Top Band use. This American version being well noted as far superior to any other. **GUARANTEED BRAND NEW**, only 20/-, Post 7/6. Instructions supplied.

Mk. III 18 Set Receivers employing 4 valves in a superhet circuit. Range 6-9 Mc/s. C.W. or phone. Supplied in good, used condition. Only 30/-, post 5/-, Sender unit available with 500 micro-amp meter, only 20/-, post 5/-, Both circuits supplied.

JOHN'S RADIO (Dept. D.),
OLD CO-OP, WHITEHALL ROAD,
DRIGLINGTON, BRADFORD, YORKS.

YOUR CAREER IN RADIO?

Big opportunities and big money await the qualified man in every field of Electronics today—both in the U.K. and throughout the world. We offer the finest home study training for all subjects in radio, television, etc., especially for the **CITY & GUILDS EXAMS.** (Technicians' Certificates); the **Grad. Brit. I.R.E. Exam.**; the **RADIO AMATEUR'S LICENCE;** P.M.G. Certificates; the **R.T.E.B. Servicing Certificates;** etc. Also courses in Television; Transistors; Radar; Computers; Servo-mechanisms; Mathematics and Practical Transistor Radio course with equipment. We have **OVER 20 YEARS'** experience in teaching radio subjects and an unbroken record of exam. successes. We are the only privately run British home study Institute specialising in electronic subjects only. Full details will be gladly sent without any obligation.

SEND FOR FREE BROCHURE TO:

BRITISH NATIONAL RADIO SCHOOL
DEPT 4, RADIO HOUSE · READING · BERKSHIRE

(500/6)

SEMICON-INF SERVICE

Suppliers of INDUSTRIAL and ENTERTAINMENT types of semiconductor devices, AMERICAN and CONTINENTAL devices are our speciality. Send 9d. in stamps for price lists of more than 650 types.

TRANSISTORS: AF 139, 19/-; AUY 10, 47/-; BFY 17, 19/-; 2G 302, 5/8; 2G 381, 4/-; 2G 4035, 7/9; 2G 414, 7/3; 2G 415, 7/-; 2G 416, 6/6; 2G 417, 6/2; 2N 395, 3/9; 2N 404, 4/8; 2N 697, 13/6; 2N 699, 23/2; 2N 706, 9/9; 2N 1302/3, 5/8; 2N 1304/5, 6/9; 2N 1306/7, 8/8; 2N 2712, 7/7; 2N 3053, 13/6; HT 401, 11/3. 2N 2926 at 4/- each.

DIODES: OA 91, 2/3; OA 95, 2/7; OAZ 207, 10/6; BYZ 13/19, 11/6; IN 536, 4/8; IN 2858, 4/-; IN 3068, 12/-; IN 4009, 5/6; DD 006, 5/6; BA 110 (VARICAP), 6/3.

Field Effect Transistors from 37/6 each. Silicon Controlled Rectifiers from 21/- each (1.6A/25V). (Ideal for voltage regulators, etc.)

TRANSISTOR HEAT SINKS (THERMALLOY) TO-5 and TO-18 types at 5/6 each.

Please add 9d. P. & P. on all orders of less than £2.

MAIL ORDER ONLY PLEASE.

TERMS: C.W.O.

M. R. CLIFFORD & CO. (R)

66 OLD OSCOTT LANE, BIRMINGHAM, 22A

THE RADIO CONSTRUCTOR — BOUND VOLUMES

NOW AVAILABLE

Volume 18, August 1964 to July 1965. Price £1 10s. 0d. Postage 3s. 6d.

Where all issues are returned: Price £1. Postage 3s. 6d.

We regret earlier volumes now sold out.

Send for list containing details of our other publications

DATA PUBLICATIONS LTD 57 MAIDA VALE LONDON W9

Please mention **THE RADIO CONSTRUCTOR** when writing to advertisers

ORDER FORM

TITLE	No.	£	s.	d.
<p>THE RADIO CONSTRUCTOR Price 2/3 each, postage 6d. Issue(s) required</p> <p>.....</p> <p>Annual subscription commencing with..... issue Price 33/-, post free</p> <p><i>Bound volumes:</i> Vol. 18. August 1964 to July 1965 Price 30/-, postage 3/6</p>				
<p>DATA BOOKS SERIES</p> <p>DB5 TV Fault Finding 96 pages. Price 6/-, postage 6d.</p> <p>DB6 The Radio Amateur Operator's Handbook 64 pages. Price 5/-, postage 5d.</p> <p>DB14 Short Wave Receivers for the Beginner 72 pages. Price 6/-, postage 6d.</p> <p>DB15 Twenty Suggested Circuits 48 pages. Price 3/6, postage 5d.</p> <p>DB16 Radio Control for Models 192 pages. Price 15/-, postage 9d.</p> <p>DB17 Understanding Television 512 pages. Price 37/6, postage 2/6</p>				
<p>PANEL-SIGNS TRANSFERS Six sheets in each set</p> <p>Set 3: Wording — White</p> <p>Set 4: Wording — Black</p> <p>Set 5: Dials — Control Panels have a clear background</p> <p>Set 6: Dials — Control Panels have a black background Price per set 4/6, postage 4d.</p>				

£ : :

*Please send cash with order, regret no C.O.D.
 Overseas customers please pay by International Money Order*

NAME

ADDRESS

(Please use Block Capitals for both name and address)

*All publications are obtainable from your local bookseller or direct from
 Data Publications Ltd., 57 Maida Vale, London W.9*

FULLY DETAILED AND ILLUSTRATED

CATALOGUE

96 big pages. The largest range available in the country. All types of components and equipment at competitive prices.

PRICE 2/6 (post paid)

PROVED & TESTED DESIGNS FULL AFTER SALES SERVICE AND GUARANTEE

★ CALL IN FOR DEMONSTRATIONS ★
DETAILED LEAFLETS FREE ON REQUEST

FREE New 12 page catalogue 500 transistors, rectifiers, screws, light devices, heat sinks, 1,000 crystals, 800 valves, etc. Ask for your FREE copy NOW

MW/LW POCKET SUPERHET

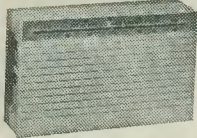

RADIO
TOTAL COST TO BUILD
85/- P.P. 2/-
(Battery 2/6 Phone 5/-)

★ All parts sold separately.

- ★ 6-Transistor design. Push-pull output.
- ★ 2 1/2" Clearstone speaker. Printed circuit.
- ★ Attractive moulded cabinet.
- ★ Slow motion tuning.
- ★ Full medium and long waves.
- ★ Size: 5" x 3" x 1 1/4".

● AMAZING SENSITIVITY AND SELECTIVITY ●

- ★ 6-Transistor push-pull design.
- ★ Uses factory built panels.
- ★ Permeability geared tuning.
- ★ Full med./long wave tuning with push-button wave change.
- ★ Double tuned IFT's.
- ★ Chromed front panel plate.
- ★ Size: 7" x 4" x 2". Fits any car.
- ★ Pre-built units sold separately.

TOTAL COST TO BUILD

£8.19.6
P.P. 3/6

(7" x 4" speaker with car fixing kit and baffle board 20/- extra.)

TWO WAVEBAND ALL-TRANSISTOR CAR RADIO TO ASSEMBLE
● HIGH PERFORMANCE SUPERHET ●



2- AND 4- TRACK TAPE RECORDERS TO ASSEMBLE

Pre-built Equipment—6 Valves—Collaro Studio Decks—Portable Cabinets with Speakers. Complete record and playback.



★ 2-track deck 10 gns. P.P. 5/- Amplifier 11 gns. Cabinet with speaker 5 gns.

OR SPECIAL PRICE **£26** P.P. TWO TRACK 8/6

★ 4-track deck £13.19.6. P.P. 5/- Amplifier 12 gns. Cabinet with speaker 5 gns.

OR SPECIAL PRICE **£30** P.P. FOUR TRACK 8/6

Prebuilt and tested units. Low distortion, low noise.

10W & 20W HI-FI AMPLIFIERS

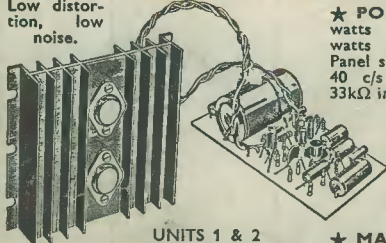

UNITS 1 & 2

★ POWER AMPLIFIERS. 10 watts R.M.S. music power. 20 watts peak. 6-Transistor design. Panel size 4" x 2 1/2" x 2". Response 40 c/s to 20 kc/s. 100mV into 33kΩ input.

UNIT 1. For 12/15 ohm speakers. 40 volt supply.

PRICE BUILT **£5.19.6** P.P. 2/6

UNIT 2. For 3 to 5 ohm speakers. 24/28 volt supply.

PRICE BUILT **£5.10.0** P.P. 2/6

★ MAINS UNITS. 59/6. To power one amplifier or 69/6 to power two amplifiers. (State 24 or 40 volt version.)

PREAMPLIFIERS. Mono and stereo versions, 8 inputs, 1 1/2 to 300mV at 1k to 500k. Response 30 c/s to 20 kc/s. Complete range of controls. Mains unit or battery operated. For pickups, tuners, tape, microphones, etc.

UNIT 3. Mono full-function pre-amplifier. Size 9 1/2" x 2 1/2" x 2".

PRICE BUILT **£5.10.0** P.P. 2/-

(Brown/Gold front panel plate 8/6)

UNIT 4. Simplified version of Unit 3. Price 65/-, P.P. 1/6. Panel plate 6/6.

UNIT 5. Stereo preamplifier for use with two units 1 or 2. Size 9" x 3 1/2" x 1 3/4".

PRICE BUILT **£10.19.6** P.P. 3/6

(Front panel plate 12/6)



UNIT 5

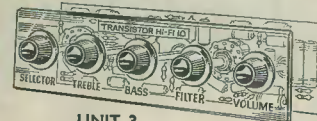

UNIT 3

THE FINEST QUALITY HI-FI AT UNBEATABLE PRICES

TRANSISTOR TRANSMITTER RECEIVERS



★ 1/2 mile range, price per pair **£7.19.6**

★ 5 mile range, price per pair **£22.10.0**

4-CHANNEL MICROPHONE MIXER



Transistorised, 4 inputs up to 100kΩ. Full mixing. 49/6
Stereo 79/6

SINCLAIR DESIGNS

- ★ Micro-6 MW radio 59/6
- ★ TR750 "Add-on" power amp. 39/6
- ★ Micro injector 27/6
- ★ Micro amp. 28/6
- ★ X10 Amp. kit **£5.19.6**
- BUILT **£6.19.6**

NEW FM RADIO POCKET VHF KIT £5-19-6

X20 AMPLIFIER Kit **£7-19-6**
Built **£9-19-6**
Mains unit **99/6**

5 WATT AND 1 1/2 WATT PACKAGED AMPLIFIERS

- ★ 6-Transistor push-pull printed circuit designs
- ★ Size only 2 1/2" x 2" x 1 1/2"
- ★ 5 watt 18 volt, 1 1/2 watt 12 volt
- ★ For 3 to 5 ohm speakers
- ★ 7mV into 1kΩ 30 c/s to 16 kc/s
- PRICES BUILT **1 1/2w 65/- P.P. 1/6 5w 79/6 P.P. 1/6**



● Mono PREAMPLIFIER
Full range of controls, inputs for mics, p.-u., tuner, etc. Output 6-10mV. Suitable for any sensitive transistor amplifiers as above. 7 1/2/12/18V operated. Price built/tested incl. panel **79/6 P.P. 2/6**. Stereo version **79/6**.

HI-FI ALL MAKES AVAILABLE—New Hi-Fi Demonstration Room Opening Shortly

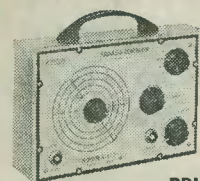

TRANSISTOR PORTABLE TEST EQUIPMENT. All units size 6 1/2" x 4 1/2" x 2 1/2".
★ RF generator, 150 kc/s to 350 mc/s in 8 ranges. RF, Mod. RF, AF outputs.

PRICE **£9.10.0** P.P. 2/6

★ Resistance/capacitance bridge. **£8.5.0** P.P. 2/6.

★ Audio generator 10 c/s-100 kc/s. 4 ranges. **£16.15.0**. P.P. 2/6.



VHF/FM TUNER TO ASSEMBLE
★ Two pre-built plus metal work and front panel.
Total Cost **£12.17.6**
P.P. 2/6

- ★ Size: 9 1/2" x 3 1/2" x 4"
- ★ 88 to 108 mc/s tuning.
- ★ 100mV to 100kΩ output
- ★ 6-Transistor printed cct. superhet design

NEW SW/MW/LW PUSH BUTTON PORTABLE TO BUILD. 3 wavebands

TOTAL COST **£8.19.6**
P.P. 3/6

The only fully Tunable 3-waveband radio for home construction.

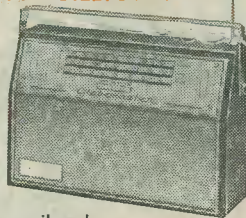

- ★ Push-button coil pack.
- ★ 1 watt push-pull output
- ★ Ferrite aerial/Telex. aerial/special car coils
- ★ Printed circuit 6-transistor design
- ★ SW 17/50m. LW 1100/1900m. MW 195/550m.
- ★ Car aerial and tape sockets
- ★ Attractive sturdy cabinet with handle. Size 11" x 7 1/2" x 3 1/4". Black fabric with chrome fittings.

LET US QUOTE PARTS FOR YOUR CIRCUIT, SEND LIST FOR QUICK REPLY

VHF/FM TRANSISTOR TUNER TO BUILD

TOTAL COST **£6.19.6**

P.P. 2/6 (complete with frontplate) (Gold sprayed cabinet 20/- extra).

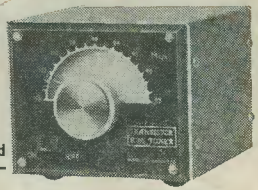

- ★ 5-Transistor 4 diodes.
- ★ Printed circuit superhet.
- ★ Geared tuning 87 to 105 Mc/s FM
- ★ RF stage and double tuned IFT's.
- ★ Output up to 1 volt peak up to 100kΩ.
- ★ 9 volt 9mA supply.
- ★ Size in cabinet 4" x 3 1/2" x 2 1/4".
- ★ All parts sold separately.

HENRY'S RADIO LTD.

303 EDGWARE ROAD, LONDON, W2 PADDINGTON 1008/9

Open Mon. to Sat. 9-6. Thurs. 1 p.m.
Open all day Saturday