

THE Radio Constructor

RADIO
TELEVISION
AUDIO
ELECTRONICS

VOLUME 16 NUMBER 11
A DATA PUBLICATION
PRICE TWO SHILLINGS

June 1963

An Introduction to Colour Television

Also featured

Simple Low-Cost Fidelity
Amplifier

Transmitter Design for
4-metres

An F.M. Tuner

Simple Crystal Marker

Converting Battery Portables
to Mains Operation

Inexpensive 3-Transistor
Radio

etc., etc., etc.

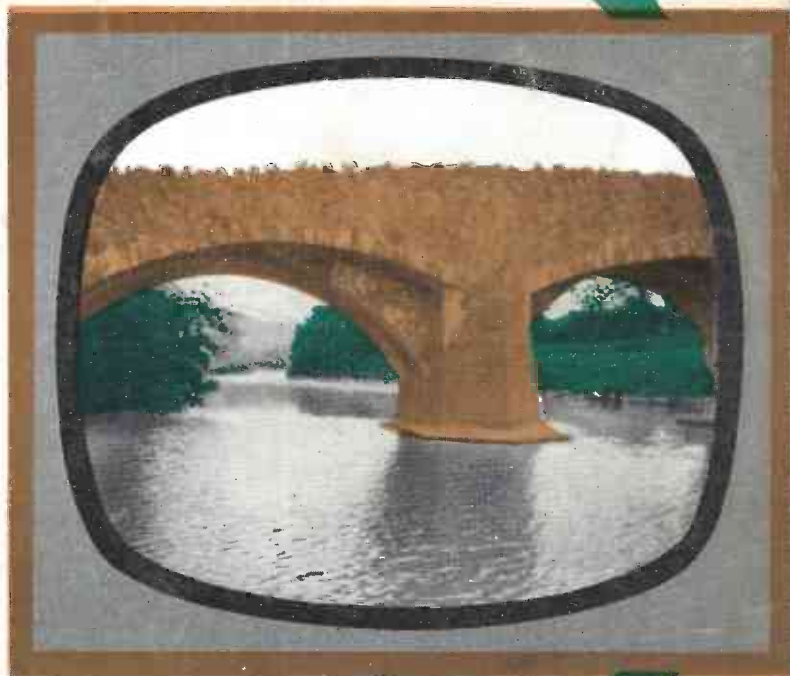

USE THE

EDDYSTONE

General Purpose Communications Receiver

840c

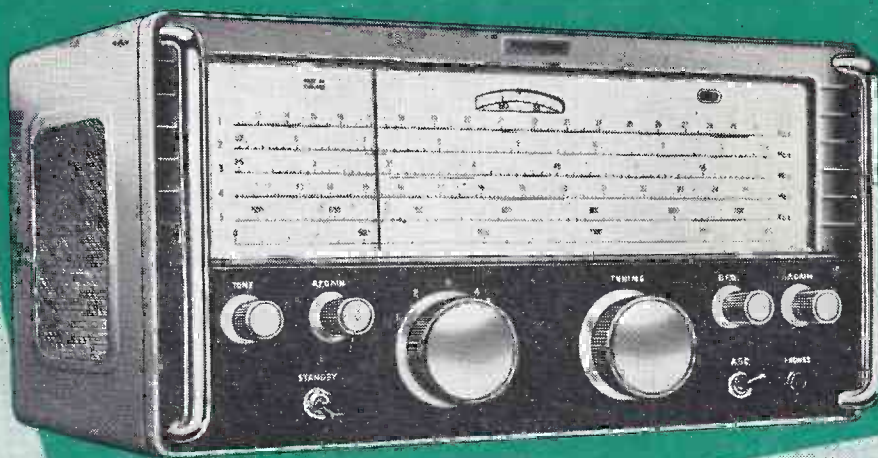

With continuous coverage from

480 kc/s

to

30 Mc/s

LIST PRICE

£58.0.0



**MODERN STYLING
AND PRESENTATION**



**GREATER EASE OF TUNING AND
FREQUENCY RESOLUTION**



**LINEAR SCALES AND
BETTER BANDSPREAD**



IMPROVED ELECTRICAL PERFORMANCE



**HIGH QUALITY WORKMANSHIP
AND CONSTRUCTION**



ILLUSTRATED BROCHURE GIVES SPECIFICATION AND FULL DETAILS.

STRATTON & CO. LTD · BIRMINGHAM · 31.

FREE TO AMBITIOUS ENGINEERS

— THE LATEST EDITION OF ENGINEERING OPPORTUNITIES

Have you sent for your copy?

ENGINEERING OPPORTUNITIES is a highly informative 156-page guide to the best paid engineering posts. It tells you how you can quickly prepare at home for a recognised engineering qualification and outlines a wonderful range of modern Home Study Courses in all branches of Engineering. This unique book also gives full details of the Practical Radio & Electronics Courses, administered by our Specialist Electronics Training Division—the *B.I.E.T. School of Electronics*, explains the benefits of our Employment Dept. and shows you how to qualify for five years promotion in one year.

We definitely Guarantee

"NO PASS — NO FEE"

Whatever your age and experience you cannot afford to miss reading this famous book. If you are earning less than £25 a week send for your copy of "ENGINEERING OPPORTUNITIES" today—FREE.

BRITISH INSTITUTE OF ENGINEERING TECHNOLOGY (Incorporating *E.M.I. Institutes*)
(Dept. SE/23), 29 Wright's Lane, London, W.8

WHICH IS YOUR PET SUBJECT?

Mechanical Eng.,
Electrical Eng.,
Civil Engineering,
Radio Engineering,
Automobile Eng.,
Aeronautical Eng.,
Production Eng.,
Building, Plastics,
Draftsmanship,
Television, etc.

GET SOME LETTERS AFTER YOUR NAME!

A.M.I. Mech. E.
A.M.I.C.E.
A.M.I. Prod. E.
A.M.I.M.I.
L.I.O.B.
A.F.R. Ass. B.
B.Sc.
A.M. Brit. I.R.E.
City & Guilds
Gen. Cert. of Education
Etc., etc.

PRACTICAL EQUIPMENT

Basic Practical and Theoretic Courses for beginners in Radio, T.V., Electronics, Etc., A.M. Brit. I.R.E. City & Guilds Radio Amateurs' Exam. R.T.E.B. Certificate P.M.G. Certificate Practical Radio Radio & Television Servicing Practical Electronics Electronics Engineering Automation

INCLUDING TOOLS!

The specialist Electronics Division of *B.I.E.T.* (Incorporating *E.M.I. Institutes*) NOW offers you a real laboratory training at home with practical equipment. Ask for details.

B.I.E.T. SCHOOL OF ELECTRONICS

POST COUPON NOW!

- Please send me your FREE 156-page "ENGINEERING OPPORTUNITIES"
- (Write if you prefer not to cut page)
- NAME
- ADDRESS
-
-
- SUBJECT OR EXAM THAT INTERESTS ME



THE B.I.E.T. IS THE LEADING ORGANISATION OF ITS KIND IN THE WORLD

TEST METERS

2,000 O.P.V. Model TP-19 £3.19.6. 30,000 O.P.V. Model 500 £8.19.6. SAE for illustrated leaflet.



20,000 O.P.V. MODEL TP-55. Reads Voltage up to 1,000; D.C. at 20,000 ohms per volt and A.C. at 10,000 o.p.v.; D.C. Current to 500mA; Resistance to 10 Meg.; Capacitance to 0.1µF; Decibels from -20 to +36. Size 3½" x 5½" x 1½". £5.19.6.

COMBINED VIBRATOR/MAINS UNIT. The Power Pack section of the Army R.107 Receiver. Has Vibrator for 12 volts D.C. operation, and Mains Transformer for 100/250 volts A.C. Output 12.6 volts 3 Amps LT, and 250 volts 100mA HT. Complete with Vibrator, 6X5G Rectifier, and connecting data. Ideal for driving TCS or Type 52 Receivers, etc., or Mobile Equipment. BRAND NEW IN MAKER'S CARTONS, ONLY 45/- (carr. 5/6).

LAVOIE UHF WAVEMETER MODEL 105. Coverage 375/725 Mc/s. Complete with correct Calibration Chart. First-class condition. Battery operated and portable, size 11" x 8" x 7½" ONLY £3.19.6 (carriage 7/6).

AVOMETERS MODEL 7. Reconditioned and in perfect order, with leads, internal batteries, and instructions. ONLY £11.0.0. (Regd. post 5/-). **AVOMETER MODEL 7 LEATHER CASES,** fitted with carrying handle and long strap. BRAND NEW. ONLY 52/6 (post 2/6).

PCR COMMUNICATION RECEIVERS

Manufactured by *Pye and Philips*. One of the Army's most versatile and sensitive sets. RF stage and 2 of IF, using 6 British I.O. type valves Large 180 degrees. Illuminated and Calibrated Dial. Flywheel tuning with locking device. Aerial trimmer. Tone and volume controls. Band switch from panel jacks for speaker or phones. In black metal case, size 17" x 8" H x 10" D. Model PCR covers 6-18 Mc/s, 200-550 metres and 850-2,000 metres and has internal 5" speaker. £6.19.6. Model PCR2 has similar L & M wave-band coverage. Short wave 6-22 Mc/s, but no speaker. Used but excellent condition. £5.19.6. Model PCR3. As PCR2 but has 2 Short Wave Bands, 2.0-7.0 Mc/s and 7.0-23.0 Mc/s, and Medium Wave Band 190-550 metres. ONLY £8.8.0. Every receiver aerial tested before despatch. Add 10/6 carr. all models. Designed to operate from bulky EXTERNAL power supply, but any set can be fitted with BRAND NEW COMPONENTS INTERNAL PACK for 200/250V a.c. at extra cost of £2. S.A.E. for illustrated leaflet.

THE "GOOD COMPANION" Mk. II

Using transistors, the latest manufacturing technique to save alignment difficulty.

As described in "THE RADIO CONSTRUCTOR", August issue THE FINEST COMBINED PORTABLE and CAR RADIO YET DESIGNED FOR THE HOME CONSTRUCTOR

★ 750mVW output.

★ 6 transistors and 1 diode.

★ Full Medium and Long Wave coverage.

★ Quality speaker.

★ Brilliantly styled 2-tone cabinet, size 11" x 8" x 3".

★ Very fine tuning with calibrated dial.

★ Latest printed circuit. ★ Internal high gain aerial with car aerial socket. Easy to follow construction data (available separately 3/6).

All parts sold separately and full illustrated details will be sent on request.

With alternative luxury cabinet using 7" x 4" speaker, £10.19.6. Either type, plus 5/- post and ins. (Battery 3/6 extra.)

"Practical Wireless" 6 TRANSISTOR PERSONAL RECEIVER. 2 band, printed circuit, etc. Building cost £7.19.6. "Pocket 4" TRANSISTOR PERSONAL. Ideal for beginner. Building cost 42/6.

All components sold separately, price lists for either of above, SAE.

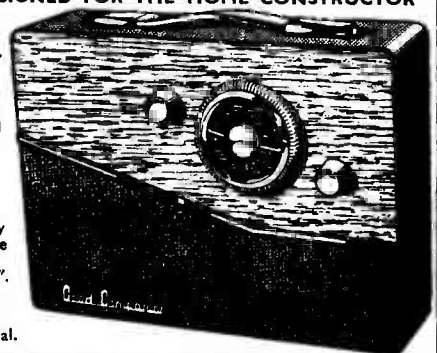

£9.19.6

Total Cost

HARRIS ELECTRONICS (LONDON) LTD (DEPT. M)

138 GRAY'S INN ROAD LONDON WC1 Telephone TERMINUS 7937

Please include carriage costs on ALL items. (Open until 1 p.m. Saturdays.)
We are 2 mins. from High Holborn (Chancery Lane Station) and 5 mins. by bus from Kings Cross.

THE MODERN BOOK CO

Hi-Fi Year Book 1963. 10s. 6d.
Postage 1s.

The Oscilloscope. 2nd ed. by G. Zwick. 27s. Postage 1s.

Television Engineers' Pocket Book. By J. P. Hawker. 12s. 6d. Postage 6d.

Radio Upkeep and Repairs. By A. T. Witts. 18s. Postage 6d.

Amateur Radio Call Book 1963. By R.S.G.B. 4s. 6d. Postage 6d.

Radio and Line Transmission. 1. By G. L. Danielson and R. S. Walker. 21s. Postage 1s.

Telecommunications Principles (In M.K.S. Units). By R. N. Renton. 45s. Postage 2s. 6d.

Radio Valve Data. 7th Ed. Compiled by "WW". 6s. Postage 10d.

Electronic Musical Instrument Handbook. By N. H. Crowhurst. 20s. Postage 6d.

Basic Transistor Course. By P. R. Kenian. 30s. Postage 1s.

The Radio Amateur's Handbook 1963. By A.R.R.L. 36s. Postage 2s. 6d.

Radio & Television Test Instruments. By G. J. King. 25s. Postage 1s. 3d.

Radio Servicing Pocket Book. By J. P. Hawker. 12s. 6d. Postage 6d.

Servicing Transistor Radios & Printed Circuits. By L. Lane. 42s. Postage 1s.

World Radio TV Handbook 1963. 22s. Postage 1s.

Service Valve Equivalents. An R.S.G.B. Publication. 3s. Postage 6d.

We have the Finest Selection of British and American Radio Books in the Country

Complete Catalogue 1s.

19-21 PRAED STREET (Dept RC) LONDON W2

Telephone PADdington 4185

THE DUCHESS OF KENT PERMANENT BUILDING SOCIETY

Member of the Building Societies Association



ESTABLISHED

1865

Savings in this old established Building Society combine sound investment with an attractive return

Shares are in units of £25 each (maximum investment £5,000) . . . BUT, for the smaller saver, Subscription Share accounts may be opened with any sum from 1/- upwards. Interest is payable half-yearly on Fully Paid Shares—credited annually on Subscription Shares—all interest accrues monthly

WITHDRAWALS AT SHORT NOTICE

INTEREST IS AT 3 $\frac{3}{4}$ % PER ANNUM

(There is NO DEDUCTION FOR INCOME TAX, as this is paid by the Society)

FOR FURTHER INFORMATION APPLY TO

**DUCHESS OF KENT
PERMANENT BUILDING SOCIETY
103 Cannon Street London EC4**

Telephone MANsion House 8011

Please send to me, without obligation, free brochure and a copy of the audited statement of accounts. (I understand that I shall not be troubled with circulars or calls by representatives)

Name

(If lady, please state Mrs. or Miss)

Address

R.C.

(Please use Block Capitals for both name and address)

COLLARO STUDIO TAPE RECORDER KIT

Special Bargain Offer

Regret all complete kits of this popular unit now sold out. Only a few cabinets and Collaro Tape Decks remain—NO AMPLIFIERS LEFT.

SPECIAL CLEARANCE OFFER

Cabinets 18" x 6 1/2" x 6" £13-10-0 with cut-out mounting board and Collaro Tape Deck as Plus 10/- illustrated. Carr.

STOP PRESS!

ANOTHER TAPE RECORDER KIT—BARGAIN OFFER!

Manufacturers end of production run. Latest B.S.R. Tape Deck, Valve line-up: EF86, ECL82, EM84, EZ80 and Silicon Diode. Quality recorder kit in three wired and tested units. Simple assembly only required. Housed in contemporary two-tone cabinet 14" x 13 1/2" x 7 1/2" complete with 8" x 5" speaker. Complete with microphone, tape, spare reel, lead, plugs, etc. Prov. price approx. 15 1/2 gns. Carr. 5/-.

RECOMMENDED BARGAIN—Send For Full Details Now

New Boxed	VALVES	Guaranteed	All Types	Electrolytics	All Types	New Stk. TUBULAR CAN TYPES
1T4	6/-	ECC83 8/-	PCC84 9/6	25/25V	1/9	8+8/450V 4/6
1R5	7/6	ECL82 10/6	PCF80 9/6	50/12V	1/9	16+16/450V 5/6
1S5	7/6	ECL80 10/6	PCL83 12/6	50/50V	2/-	32+32/275V 4/6
3S4	7/6	EF80 8/-	PCL84 12/6	100/25V	2/-	50+50/350V 6/6
3V4	7/6	EF86 12/6	FL81 12/6	8/450V	2/3	60+250/ 275V 12/6
DAF96	9/-	EL84 8/6	FL82 9/6	16+16/450V	5/6	100+300/ 275V 12/6
DF96	9/-	EY31 9/6	FL83 10/6	32+32/450V	6/6	2000+4000/ 6V 3/6
DK96	9/-	EY86 10/6	PY32 12/6	1000/25V	3/9	2000+4000/ 6V 3/6
DL96	9/-	EZ81 9/6	PY81 9/6			6V 3/6
ECC81	8/-	GZ32 12/6	PY82 7/6	Ersin Multicore Solder	60/40	3d. 3/6
ECC82	8/-	EM84 9/6	U25 12/6	per yard.	1/2lb.	2/6, etc.

RECORDING TAPE—REDUCED BARGAIN PRICES
Famous American Columbia (CBS) Premier Quality Tape at **NEW REDUCED PRICES**. A genuine recommended Quality Tape—TRY IT! Brand new, boxed and fully guaranteed. Fitted with leader and stop foils.

Standard	Long Play	Double Play
5" 600ft. 13/-	900ft. 17/6	1,200ft. 31/6
5 1/2" 900ft. 16/-	1,200ft. 19/6	1,800ft. 37/6
7" 1,200ft. 21/-	1,800ft. 28/6	2,400ft. 47/6

Post and Packing, per reel, 1/-, plus 6d. each for additional reels.
SPECIAL OFFER—3" mfrs. surplus tape, Std. 150 ft. 3/9, L.P. 225 ft. 4/9, D.P. 300 ft. 6/6. P. & P. per reel 6d. Plastic Tape Reels 3" 1/3, 5" 2/-, 5 1/2" 2/-, 7" 2/3. Plastic Spool Containers 5" 1/6, 5 1/2" 2/-, 7" 2/3

Jack Plugs. Standard 2 1/2" Igranite Type, 2/6. Screened Ditto, 3/3. Miniature 1 1/2", 2/3. Screened Ditto, 2/6.

Jack Sockets. Open Igranite Moulded Type, 3/3. Closed Ditto, 3/9. Miniature Closed Type, 1/9. Sub-min (deaf aid) ditto, 1/3.

Phono Plugs 1/-. Phono Sockets (open), 1/- Ditto Closed, 1/6. Twin Phono Sockets (open), 1/6.

Soldering Irons. Mains 200/220V or 230/250V, Solon 25 watt Inst., 22/6. Spare Elements, 4/6. Bits, 1/- 65 watt, 27/6 etc.

Alumin. Chassis. 18g. Plain Undrilled, folded 4 sides, 2" deep. 6" x 4", 4/6, 8" x 6", 5/9, 10" x 7", 6/9, 12" x 6", 7/6, 12" x 8", 8/- etc.

Alumin. Sheet. 18g. 6" x 6", 1/- 6" x 9", 1/6, 6" x 12", 2/-, 12" x 12", 4/6 etc.

MULLARD "3-3" HI-FI AMPLIFIER

3 VALVES 3 WATT

3 ohm and 15 ohm Output
A really first-class Amplifier giving Hi-Fi quality at a reasonable cost. Mullard's latest circuit. Valve line-up: EF86, EL84, EZ81. Extra H.T. and L.T. available for Tuner Unit addition. This is the ideal companion Amplifier for FM tuner units.

TECHNICAL SPECIFICATION—Freq. Response: ± 1dB. 10 kc/s. Max. Bass Boost 14dB at 80 c/s sensitivity; 100MV for 3W output. Output Power (at 400 c/s): 3W at 1% total harmonic distortion. Hum and Noise Level: At least 70dB below 3W.

COMPLETE KIT (incl. valves, all components, wiring diagram and special quality sectional Output Trans.) **ONLY £6.19.6** carr. 4/6.
Complete wired and tested, 8 gns. Wired power O/P socket and additional smoothing for Tuner Unit, 10/6 extra.

Bronze Escutcheon Panel, Printed Vol., Treble, Bass, On-Off, supplied with each Kit.
Recommended Speakers—R. & A. 12" with tweeter 52/6. WBFH10-12 £4.7.6. Goodmans Axiette £5.5.0. Axiom 10 £6.5.0. Carr. extra

Volume Controls—5K-2 Meg. ohms. 3" Spindles Morganite Midget Type. 1 1/2" diam. Guar. 1 year. LOG or LIN ratios less Sw. 3/- DP. Sw. 4/6. Twin Stereo less Sw. 6/6. D.P. Sw. 8/-.

COAX 80 OHM CABLE
High grade low loss Cellular air spaced Polythene 1/4" diameter. Stranded cond. Famous mfrs. Now only 6d. per yard.
Bargain Prices—Special lengths 20 yds. 9/- P. & P. 1/6. 40 yds. 17/6. P. & P. 2/- 60 yds. 25/- P. & P. 3/-
Coax Plugs 1/- Sockets 1/- Couplers 1/3. Outlet Boxes 4/6.

Close Tol. S/Micas—10% 5pF-500pF 8d. 600-5,000pF 1/- 1% 2pF-100pF 9d. 100pF-500pF 11/- 575pF-5,000pF 1/6. **Resistors** Full Range 10 ohms-10 megohms 20% ± and 1W 3d., 1/2W 5d. (Midget type modern rating) 1W 6d., 2W 9d. Hi-Stub 5% 1-1/2W 100 ohms 1 1/6. W/W Resistors 25 ohms to 10K 5V 1/3, 10W 1/6, 15W 2/- Pre-set T/V Pots. W/W 25 ohms-50 K 3/- 50 K-2 Meg. (Carbon) 3/-.

JASON FM TUNER UNITS
Designer-approved kits of parts: **FMT1**, 5 gns. 4 valves, 20/- **FMT2**, £7. 5 valves, 37/6. **JTM MERCURY 10 gns.** **JTY2** £13.19.6. 4 valves, 32/6. **NEW JASON FM HANDBOOK**, 2/6. 48 hr. Alignment Service 7/6. P. & P. 2/6.

Speakers P.M.—3 ohms 2 1/2" E.M.I. 17/6. Goodmans 3 1/2" 18/6. 5" Rola 17/6. 6" Elac 18/6. 7" x 4" Goodmans 18/6. 8" Rola 20/- 10" R. x A. 25/- 9" x 6" Goodmans 25/- E.M.I. Tweeter 29/6.

Speaker Fret—Expanded bronze anodised metal 1/4" x 1/4" diamond mesh, 4/6 sq. ft., multiples of 6" cut. Max. width 4 ft.

TYGAN FRET (contemp. pat.) 12" x 12" 2/-, 12" x 18" 3/-, 12" x 24" 4/-, 18" x 18" 4/6

BARGAINS 4-SPEED SINGLE PLAYER UNITS
Single Players carr. 3/6
Garrard SRB10 £5.5.0
B.S.R. Latest Model TU12 72/6
E.M.I. Junior '985' 67/6
Collaro Jr. 65/-
Auto-Changeers carr. 5/-
Garrard AT6 Mono 9 gns.
Garrard 'Auto-Slim' £6.15.0
B.S.R. (UA14) £6.10.0

ENAMELLED COPPER WIRE—1/2lb reels, 14g-20g, 2/6; 22g-28g, 3/-; 30g-40g, 3/9. Other gauges quoted tvc.

PVC CONNECTING WIRE—10 colours (for chassis wiring, etc.)—Single or stranded conductor, per yd., 2d. Sleeving 2d. yd.

TRANSISTOR COMPONENTS

Midget I.F.'s—465 Kc/s 1/2" diam. 5/6
Osc. Coil—1/2" diam. M/W. 5/3
Osc. coil M. & L.W. 5/9
Midget Driver Trans. 3.5:1 6/9
Ditto O/P/Tr Push-pull 3 ohms 6/9
Elect. Condensers—Midget Type 12V 1mf-50mf, ea. 1/9. 100mf, 2/-
Ferrite Aerial—M. & L. W. with car aerial coupling coil, 9/3.

Condensers—150V. wkg. .01 mfd., to .04 mfd., .9d. .05 mfd., 1 mfd., 1/- .25 mfd., 1/3. .5 mfd., 1/6, etc.

Tuning Condensers. J.B. '00' 208+176pF, 8/6. Ditto with trimmers, 9/6. 365pF single, 7/6. Sub-min. 1/2" DILEMIN 100pF, 300pF, 500pF, 7/- .25 mfd., 1/3. .5 mfd., 1/6, etc.

Midget Vol. Control with edge control knob, 5kΩ with switch, 4/9, ditto less switch, 3/9.
Condensers P.M.—2" Plessey 75 ohms, 15/6. 2 1/2" Continental 8 ohms, 13/6. 7" x 4" Plessey 35 ohm, 23/6.

Ear Plug Phones—Min. Continental type, 3ft. lead, jack plug and socket, High Imp. 8/- Low Imp., 7/6.

TRANSISTOR BARGAINS

Brand New—BVA 1st Grade

OC44	8/6	OC70	5/6
OC45	8/-	OC71	6/-
OC81	7/6	GEX34	2/9
2/OC81	15/6	OA70	2/9
GET114	6/6	OA81	2/9
OC72	7/6		

SPECIAL OFFER
OC44 } 21/6
2/OC45 }
OC81D }
2/OC81 } 19/6

TRIMMERS, Ceramic (Compression Type)—30pF, 70pF, 9d.; 100pF, 150pF, 1/3; 250pF, 1/6; 600pF, 1/9.

PHILIPS, Bee Hive Type (conc. air spaced)—2-8pF, 1/-; 3-30pF, 1/-.

KNOB—Modern Continental types: Brown or Ivory with Gold Ring, 1" dia., 9d. each; 1 1/2", 1/- each; Brown or Ivory with Gold Centre, 1" dia., 10d. each; 1 1/2", 1/3 each. **LARGE SELECTION AVAILABLE.**

METAL RECTIFIERS, STC Types—RM1, 4/9; RM2, 5/6; RM3, 7/6; RM4, 16/-; RMS, 21/-; RM4B, 17/6.

RECORD PLAYER CABINETS

Contemporary style, rexine covered cabinet in outlaid red and white polka dot. Size 18 1/2" x 13 1/2" x h. 8 1/2", fitted with all accessories including baffle board and anodised metal fret. Space available for all modern amplifiers and auto-changeers, etc. Uncut record player mounting board 14" x 13" supplied.
Cabinet Price £3.3.0 Carr. and Ins. 5/-

2-VALVE 2 WATT AMPLIFIER
Twin stage ECL82 with vol. and neg. feedback tone control. A.C. 200/250V with knobs, etc., ready wired to fit above cabinet. £2.17.6. P. & P. 1/6. 6" Speaker and trans, 22/- P.P. 2/-

COMPLETE R/PLAYER KIT. Ditto RECORD PLAYER KIT As ill. inc. BSR UA14 Unit with BSR UA20 Unit. New Reduced Price £12.10.0. Carr. 7/6.



Send for detailed bargain lists, 3d. stamp. We manufacture all types Radio Mains Transf. Chokes, Quality O/P Trans, etc. Enquiries invited for Specials, Prototypes for small production runs. Quotation by return.
RADIO COMPONENT SPECIALISTS
70 Brigstock Rd., Thornton Heath, Surrey
THO 2188 Hours: 9 a.m. — 6 p.m., 1 p.m. Wed. Terms C.W.O. or C.O.D. Post and Packing up to 1/2 lb 9d., 1 lb., 1/3, 2/3, 5 lb., 2/9 8 lb., 3/6



Even if you are an absolute beginner

SINGLE SIDEBAND ADAPTOR. Model SB-10U. May be used with most A.M. transmitters. Less than 3W R.F. input power required for 10W output. Operation on 80, 40, 20, 15 and 10m bands on U.S.B., L.S.B. or D.S.B. **£39.5.0**

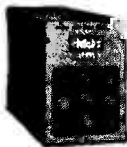

SB-10U

AMATEUR TRANSMITTER. Model DX-40U. Covers all amateur bands from 80 to 10 metres; crystal controlled. Power input 75W C.W., 60W peak controlled carrier phone. Output 40W to aerial. Provision for V.F.O. Filters minimise TV interference. **£33.19.0**



DX-40U

GRID-DIP METER. Model GD-1U. Functions as oscillator or absorption wave meter. With plug-in coils for continuous frequency coverage from 1.8 Mc/s to 250 Mc/s. **£10.19.6**



GD-1U

Q MULTIPLIER KIT. Model QPM-1. May be used with receivers having 450-470 kc/s I.F.; provides either additional selectivity or signal rejection; self powered. **£7.12.6**

2½" SERVICE 'SCOPE. Model OS-1. Light, compact portable for service engineers. Dim. 5" x 8" x 14½" long. Wt. 10½lb. **£19.19.0**



"GLOUCESTER"



GL-58



AM/FM TUNER

HI-FI AM/FM TUNER, Model AFM-1. Available in two units which, for your convenience, are sold separately. Tuning heart (AFM-T1—£4.13.6 incl. P.T.) and I.F. amplifier (AFM-A1—£20.13.0). Printed circuit board, 8 valves. Covers L.W., M.W., S.W., and F.M. Built-in power supply. Total **£25.6.6**

HI-FI EQUIPMENT CABINETS. Our four cabinets meet a wide variety of tastes and requirements: the "CHEPSTOW" designed for those who have little floor space, the contemporary "MALVERN" for the Tape and Gram, enthusiast, and the "GLOUCESTER" Mk. I and II for those with traditional tastes. Supplied "in the white". Prices from **£11.12.6 to £18.10.0**

An additional range of assembled and finished cabinets is now available from us, details on request.

GOLDRING Lenco TRANSCRIPTION RECORD PLAYER. Model GL-58 with G-60 pick-up arm and Ronette 105 cartridge. **£18.19.2**

GARRARD AUTO/RECORD PLAYER, Model AT-6. With Ronette 105 cartridge. **£13.12.1** With Decca Deram pick-up **£14.6.1**

Prices include free delivery in U.K.

★ Construction is so simple from start to finish

5" OSCILLOSCOPE. Model O-12U. Has wide-band amplifiers, essential for TV servicing, FM alignment, etc. Vertical frequency response 3 c/s to over 5 Mc/s, without extra switching T/B covers 10 c/s to 500 kc/s in 5 ranges. **£38.10.0**



O-12U

ELECTRONIC SWITCH. Model S-3U (Oscilloscope Trace Doubler.) Enables a single beam oscilloscope to give simultaneous traces of two separate and independent signals. Switching rates approx. 150, 500, 1,500, 5,000 and 15,000 c/s. Sig. freq. response 0-100 kc/s, ±1dB. Separate gain controls and sync. output. Sig. input range 0.1-1.8V r.m.s. **£11.15.6**



S-3U

RESISTANCE CAPACITANCE BRIDGE. Model C-3U. Measures capacity 10pF to 1,000µF, resistance 100Ω to 5MΩ and power factor. 5-450V test voltages. With safety switch. **£9.5.0**



C-3U

AUDIO SIGNAL GENERATOR. Model AG-9U. 10 c/s to 100 kc/s, switch selected. Distortion less than 0.1%, 10V sine wave output metered in volts and dB's. **£21.9.6**



AG-9U

TRANSISTOR INTERCOM. Models XI-1U & XIR-1U. The master unit uses a 4-transistor amplifier, constructed on a printed circuit board, and an internal 9V battery. Remote stations use a similar battery for call only. Up to five remote units can be ordered for each master. **£4.7.6**

XIR-1U (remote) £4.7.6
XI-1U (master) £10.19.6
SUGDEN MOTOR UNIT "CONNOISSEUR CRAFTSMAN". Heavy duty motor operating at 33½ and 45 r.p.m. Very heavy 12" turntable. Virtually no rumble. **£16.6.6**



S-33

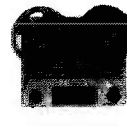

COLLARO



TA-1S

NEW DE LUXE STEREO AMPLIFIER. Model S-33H. De luxe version of the S-33 with two-tone grey perspex panel, and higher sensitivity necessary to accept the Decca Deram pick-up. **£15.17.6**

HI-FI 6W STEREO AMPLIFIER. Model S-33. 3 watts per channel 0.3% distortion at 2.5W/chnl., 20dB N.F.B. Inputs for Radio (or Tape) and Gram, Stereo or Monaural, ganged controls. Sensitivity 200mV. **£13.7.6**

COLLARO "STUDIO" TAPE DECK. The finest buy in its price range. Operating speeds: 1½", 3¼" and 7½" p.s. Two tracks "wow" and "flutter" not greater than 0.15% at 7½" p.s. Long Term Speed stability better than 0.5%. **£17.10.0**

TAPE RECORDING/PLAYBACK AMPLIFIER. Thermometer type recording indicators, press-button speed compensation and input selection. Printed Circuit Board. Mono Model TA-1M **£19.2.6** Stereo Model TA-1S **£24.10.0**

HI-FI MONO AMPLIFIER. Model MA-5. A general purpose 5W Amplifier, with inputs for Gram., Radio. Presentation similar to S-33. **£10.19.6**

4 W-B TRANSISTOR PORTABLE RECEIVER. Model RSW-1. In a handsome leather case it has retractable whip aerial and socket for car radio use. Covers Med., Trawler and two S wave bands. **£19.17.6**



MA-12



RSW-1

HI-FI SINGLE CHANNEL AMPLIFIER. Model MA-12. 12W output, wide freq. range, low distortion. **£11.9.6**

POWER SUPPLY UNIT. Model MGP-1. Input 100/120V, 200/250V, 40-60 c/s. Output 6.3V, 2.5A A.C. 200, 250, 270V, 120mA max. D.C. **£5.2.6**

ANNOUNCING OUR NEW INTERNATIONAL MAIL ORDER SCHEME COVERING

AMERICAN HEATHKIT RANGE OF 250 MODELS.

For direct delivery from U.S. Plant to your U.K. address. Latest available American Heathkit catalogue and full details of the scheme can be obtained from us at the nominal charge of 1/-, post paid.

SEND FOR FREE ILLUSTRATED BRITISH CATALOGUE TO

You can build any of these Models



RA-1



VF-1U



GC-1U



V-7A



MM-1U



RF-1U

NEW MODEL! BASIC AMATEUR BANDS RECEIVER. Model RA-1. To cover all the Amateur Bands from 160-10 metres. Many special features, including: half-lattice crystal filter; 8 valves; signal strength "S" meter; tuned R.F. Amplifier Stage. Full specification sheet available on request. **£39.6.6**

THE "MOHICAN" GENERAL COVERAGE RECEIVER. Model GC-1U. With 4 piezo-electric transistors, variable tuned B.F.O. and Zener diode stabiliser, this is an excellent fully transistorised general purpose receiver for Amateur and Short wave listeners. Printed circuit boards, telescopic whip antenna, tuning meter and large slide-rule dial, 10 transistors. **£39.17.6**

AMATEUR TRANSMITTER. Model DX-100U. The world's most popular, compact and completely self-contained Amateur Transmitter. Covers all amateur bands: 160-10 m. 150W d.c. input. Careful design has achieved the stability and high performance for which the DX-100U is noted and no less than 35 disc ceramic capacitors reduce TVI to a minimum. **£74.19.0**

VARIABLE FREQUENCY OSCILLATOR. Model VF-1U. Calibrated, 160-10 m. Fundamentals on 160 and 40 m. Ideal for our DX-40U and similar transmitters. **£11.17.6**

Deferred terms available over £10

VALVE VOLTMETER. Model V-7A. 7 voltage ranges d.c. volts to 1,500. A.C. to 1,500 r.m.s. and 4,000 peak to peak. Resistance 0.1Ω to 1,000MΩ with internal battery. D.C. input impedance 11MΩ. dB measurement, has cent-zero scale. Complete with test prods, lead and standardising battery. **£13.18.6**

MULTIMETER. Model MM-1U. Ranges 0-1.5V to 1,500V A.C. and D.C.; 150μA to 15A D.C.; 0.2Ω to 20MΩ. 4½" 50μA meter. **£12.10.0**

R.F. SIGNAL GENERATOR. Model RF-1U. Up to 100 Mc/s fundamental and 200 Mc/s on harmonics and up to 100mV output on all bands. **£12.15.6**

AUDIO WATTMETER. Model AW-1U. Up to 25W continuous, 50W intermittent. **£15.15.0**

AUDIO VALVE MILLIVOLTMETER. Model AV-3U. 1mV-300V A.C. 10 c/s to 400 kc/s. **£14.17.6**

AUDIO SINE-SQUARE WAVE GENERATOR. Model AO-1U. Covers 20 c/s to 150 kc/s and square waves to 50 kc/s in four ranges. Maximum output 10V, distortion less than 1%. **£13.15.0**

The instruction manual guides you step-by-step☆



USC-1



Truvox D83



FM TUNER



SSU-1

NEW MODEL! "OXFORD" LUXURY TRANSISTOR PORTABLE. Model UXR-2. Specially designed for use as a domestic, car or personal portable receiver. Many features, including solid leather case. Send for full details! **£14.18.0**

HI-FI FM TUNER. Model FM-4U. Also available in two units. R.F. tuning unit (£2.15.0 incl. P.T.) with I.F. output of 10.7 Mc/s, and amplifier unit, with power supply and valves (£12.6.0). Total **£15.1.0**

TRUVOX D83 & D84 TAPE DECKS. High quality mono/stereo tape decks. D83, 2 track, for highest fidelity. D84 (identical presentation), 4-track. **£31.10.0**
£29.8.0

STEREO CONTROL UNIT. Model USC-1. Push-button selection, accurately matched ganged controls to ±1dB. Negative feedback, rumble and variable low-pass filters. Printed circuit boards. **£19.10.0**

MAINS POWER SUPPLY—BATTERY ELIMINATOR KIT. Model UBE-1. Designed to supply 9V or 12V d.c. to transistor receivers. Many other uses. Sizes: 3½" x 2¼" x 1¼". **£2.17.6**

TRANSISTOR PORTABLE. Model UXR-1. Pre-aligned I.F. transformers, printed circuit. Covers L.W. and M.W. Has 7" x 4" loudspeaker. Real hide case. **£12.11.0**

TELEPHONE AMPLIFIER. Model TTA-1. Easy-to-assemble. Transistorised, enables hand-free conversation. Ivory toned cabinet. **£7.9.6**



UXR-1



TTA-1

Assembled models also available — prices on request.



S-99



THE "COTSWOLD"

HI-FI SPEAKER SYSTEM. Model SSU-1. Ducted-port bass reflex cabinet "in the white". Two speakers. Vertical or horizontal models with legs **£11.12.0** without legs **£10.17.6**

CAPACITANCE METER. Model CM-1U. Direct-reading 4½" scale. Full-scale ranges 0-100μF, 0-1,000μF, 0-0.01μF and 0-0.1μF **£15.15.0**

HEATHKIT ELECTRONIC WORKSHOP. Model EW-1. This educational kit will teach and amuse your children. It can make 21 exciting experiments including transistor radios, burglar alarm, radio or TV silencer, intercom, etc. **£7.13.6**

JUNIOR TRANSISTOR RADIO. Model UJR-1. Single transistor set. Excellent introduction to radio. An instructive present. **£2.7.6**

HI-FI STEREO AMPLIFIER. Model S-99. 18W output. Ganged controls. Stereo/mono gram, radio and tape recorder inputs. Push-button selection. Printed circuit construction. **£27.19.6**

THE "COTSWOLD". This is an acoustically designed enclosure 26" x 23" x 15½" housing a 12" bass speaker with 2" speech coil, elliptical middle speaker together with a pressure unit to cover the full frequency range of 32-20,000 c/s. Capable of doing justice to the finest programme source, its polar distribution makes it ideal for really Hi-Fi Stereo.

COTSWOLD "MFS" SYSTEM. Specially developed to give best possible results in small rooms. This minimum floor space model is based on standard Cotswold. Size: 36" high x 16½" wide x 14½" deep. Either Model, **£23.4.0**

Without obligation please send me

FREE BRITISH HEATHKIT CATALOGUE

(Tick here)

FULL DETAILS OF MODEL(S)

(Please write in BLOCK CAPITALS)

NAME

ADDRESS

DEPT. RC6

DAYSTROM LTD DEPT. RC6 GLOUCESTER

LASKY'S RADIO

LASKY'S LEAD WITH THE LOWEST PRICES ★ ★ ★

The SPRITE

A 6-TRANSISTOR SUPERHET MINIATURE PERSONAL POCKET RADIO



- ★ Fully tuneable over Long and Medium wavebands.
- ★ Uses single PP3 battery.
- ★ Ferrite Rod aerial.
- ★ High sensitivity circuit.
- ★ I.F. Frequency 470 kc/s.
- ★ Transistors used: 3 x Philco 2067's, 2 x Mullard OC81 M, OC81 DM and OA90 diode.
- ★ 3" speaker.
- ★ Printed circuit 2½" x 2".
- ★ Slow Motion Drive.
- ★ In very attractive plastic case, size 4" x 2½" x ½".

FOR YOUR CONVENIENCE and in order to ensure perfect results, **The Sprite** is supplied to you with R.F. and I.F. stages. Driver and Output stages, ready built with all components ready mounted on the printed circuit. In order to complete assembly you only have to fit the wave-change switch, tuning condenser and drive, volume control, earphone socket and aerial rod; the remaining components all having been pre-fitted at the factory for you. **The Sprite** is offered as above, pre-assembled, plus cabinet, speaker and all components for final construction at the inclusive price of **79/6** Data and Instructions separately 2/6. Refunded if parcel is purchased. Real calf leather case, wriststrap, personal earphone and case for earphone and battery 12/6 the lot extra. Make no mistake this is a SUPERHET receiver of genuine commercial quality. It is not a regenerative circuit.

Postage and Packing 3/6 extra

BUILD IT YOURSELF REALISTIC "7"

The finest receiver at present available for home construction. Fully tuneable long and medium wavebands. Uses 7 Mullard Transistors: OC44, 2 OC45s, OC71, OC81D and 2 OC81s, plus Crystal Diode OA70.

£5.19.6

Post and Packing 4/6.

7 Transistor Superhet. 350 milliwatt output into 4" high flux speaker. All

components mounted on a single printed circuit board, size 5½" x 5½", in one complete assembly. Plastic cabinet with carrying handle, size 7" x 10" x 3½", in choice of colours: red/grey, blue/grey, all grey. Easy to read dial. External socket for car aerial. I.F. frequency 470 kc/s. Ferrite Rod internal aerial. Operates from PP9, or similar battery. Full comprehensive data supplied with each Receiver. All coils and I.F.s, etc., fully wound ready for immediate assembly.

CAN BE BUILT FOR £5.19.6

PP9 Battery 3/9 extra. P. & P. 4/6 extra.

Data and instructions separately, 2/6, refunded if you purchase the parcel.

BETA TWO

A 2-Transistor plus 2 diode personal receiver for home construction. Uses printed circuit and ferrite rod aerial. Personal earphone gives clear reception for private listening. Tunes over full medium waveband. Size 5½" x 3½" x 1½" overall. All components available separately.

Can be built for 21/-

Postage 2/6 extra

including personal earphone, cabinet, etc. Circuit diagram and step-by-step instructions 1/6. (Free with parcel.)

THE Corover "6"

as featured on page 603 of the March issue of **RADIO CONSTRUCTOR**
A SUPERHET 6-TRANSISTOR PLUS TWO DIODE RECEIVER USING THE LATEST CIRCUITRY.

★ Three Mullard AF117 alloy diffused transistors are used with OA79 and OA91 diodes, followed by OC81D and two OC81s in push-pull. I.F. Frequency 470 kc/s.

★ Covers the full medium and long wavebands.

★ Sockets are provided for a personal earpiece or tape recorder, and car radio aerial. Large internal ferrite rod aerial gives high sensitivity. Operates from four 1.5 volt pen torch batteries.

★ All components mounted on a single printed circuit. Easy to build from simple stage-by-stage instructions.

★ Cabinet size 6½" x 4" x 1½". With carrying handle. All coils and if's ready wound.

P. & P. 4/- extra. Data and instructions separately 2/6. Refunded if you purchase the parcel.

£5.7.6

All components available separately

GET THIS SUPERB 100-PAGE CATALOGUE

Read all about hi-fi equipment of every kind in our superb Catalogue. Over 100 large pages (11¼" x 8½"), in photogravure and colour.

Price 3/6, post free (returnable in full on making your first hi-fi purchase from the Catalogue). Call or send for it right away!

Also send for our latest Components Catalogue. Complete new edition of over 100 pages. 8½" x 5½". Invaluable for the "ham" or serviceman. Price 2/-, post 6d.

CAR-PORTABLE RADIO



SCOOP!!

Last few left—as advertised in "RADIO CONSTRUCTOR"—MAY

LASKY'S PRICE £10.19.6

complete with tray, all car fittings, 8" x 5" car speaker and baffle. Carr. and Pack 7/6 extra. PP9 Battery 3/9 extra, supplied with full fitting and installation instructions.

BRAUN MODEL PC4L 4-Speed Stereo Record Player Unit

Incorporates a number of refinements including hydraulic pick-up lift; heavy die-cast metal turntable with rubber mat, and retractable adaptor for large hole 45 r.p.m. records; multi-mains voltage, etc.

Light-weight pick-up arm fitted with an Elac type KST102 stereo cartridge, also suitable for L.F. and 78 r.p.m. mono records. Auto-stop mechanism fitted. Unit plate size only 12" x 8". Depth below unit plate, 3". Height above top of unit plate, 12".

Motor has voltage tappings for use on 110, 160 and 200-250V 50 c.p.s. A.C. mains. Hydraulic pick-up lift incorporated, of a foolproof design, together with a set down position indicator. Speeds: 16, 33½, 45 and 78 r.p.m. 6ft of mains lead and 3ft of multi-way cable for pick-up connection fitted.

Brand new and unused. Fully guaranteed.

LASKY'S PRICE £12.9.6

Postage and Packing 5/- extra

33 TOTTENHAM COURT ROAD • W1

2 mins. Oxford St. Nearest Station: Goudge St.

MUSEum 2605

Tottenham Ct. Rd. & Edgware Rd. addresses open all day Sat. Close 1 Thur.

207 EDGWARE ROAD • W2

Few yards from Praed St.

PADDINGTON 3271/2

Please address all Mail Orders to Dept. W at above Edgware Road address

152/3 FLEET STREET • EC4

FLEet 2833

Open all day Thurs. Closed 1 p.m. Sat.

Stern's

MULLARD DESIGNS

COMPLETE KITS OF PARTS

MULLARD 3-VALVE PRE-AMPLIFIER CONTROL UNIT

Designed mainly for Mullard Range of Amplifiers, also suitable for any Amplifier requiring input up to 250 mV. Incorporates 5 input channels, including for Tape and Magnetic Pick-ups, Separate Bass and Treble controls. High pass filter 20 to 160 c/s. low pass filter 5-9 Kc/s. Totally enclosed in case, size 11 1/4" x 4 1/2" x 4". (Carr. & Ins. 5/-)



KIT OF PARTS **£10.00** ASSEMBLED AND TESTED **£13.13.0**

MULLARD "5-10" MAIN AMPLIFIER

For use with MULLARD 2 or 3 Valve Pre-amplifiers with which an undistorted power output of up to 10 watts is obtained. SPECIFIED COMPONENTS AND MULLARD VALVES including PARMEKO MAINS TRANSFORMER and choice of PARMEKO or PARTRIDGE Output Transformer. Complete Kit (Parmeko Output Trans) **£10.00** (Carr. & Ins. 6/6)

ASSEMBLED AND TESTED **£13.10.0**

ABOVE INCORPORATING PARTRIDGE OUTPUT TRANSFORMER **£1.6.0** extra.

THE MULLARD 510/RC AMPLIFIER

The popular complete "5-10" incorporating Passive Control Unit, and providing up to 10 watt output with an input of 600mV. Specified components and new MULLARD VALVES. Includes PARMEKO MAINS TRANSFORMERS and choice of the latest PARMEKO or PARTRIDGE output Transformers. Surplus Power available for Tuner. Price : COMPLETE KIT **£12.00**

ASSEMBLED AND TESTED **£16.00**

(Carr. & Ins. 7/6) with PARTRIDGE OUTPUT TRANSFORMER **£1.6.0** extra.



MULLARD'S 2-VALVE PRE-AMPLIFIER TONE CONTROL UNIT

Employing two EF86 valves and designed to operate with the Mullard MAIN AMPLIFIERS but also perfectly suitable for other makes. ★ Equalisation for the latest R.I.A.A. characteristic. ★ Input for Crystal Pick-ups and variable reluctance magnetic types. ★ Input (a) Direct from High Imp. Tape Head. (b) from a Tape Amplifier or Pre-Amplifier. ★ Sensitive Microphone Channel. ★ Wide range BASS and TREBLE Controls.



KIT OF PARTS **£6.6.0** ASSEMBLED AND TESTED **£9.10.0** (Carr. & Ins. 5/-)

COMBINED PRICE REDUCTIONS

- (a) The KIT OF PARTS to build both the "5-10" Main Amplifier and the 2-Stage Pre-Amplifier **£15.15.0**
- (a) The "5-10" and the 2-Stage Pre-Amplifier both Assembled and Tested **£21.10.0** (Carr. & Ins. 8/6)
- With PARTRIDGE OUTPUT TRANSFORMER **£1.6.0** extra.
- (b) The KIT OF PARTS to build the "5-10" Main Amplifier and 3 Valve Pre-Amplifier **£19.10.0**
- (b) The "5-10" and 3 Valve Pre-Amplifier both Assembled and Tested **£25.10.0** (Carr. & Ins. 10/6)

THE MULLARD 33/RC

HIGH QUALITY AMPLIFIER DEVELOPED FROM THE VERY POPULAR 3-WATT MULLARD "3-3" DESIGN. KIT OF PARTS **£8.8.0**
ASSEMBLED AND TESTED **£11.10.0**
Complete to the MULLARD specification including PARMEKO OUTPUT TRANSFORMER. Switched inputs for 78 and L.P. records plus a Radio position. Extra power to drive a Radio Tuning Unit is also available. (Carr. & Ins. 6/6)

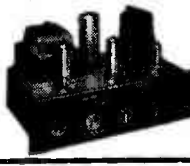

RECORD PLAYERS

- THE COLLARO "JUNIOR" 4-speed single player with separate crystal pick-up **£3.10.0**
- GARRARD Model SRP10. Single Record Player fitted with high output crystal pick-up. **£5. 9.1**
- THE NEW GARRARD "AUTOSLIM" 4-speed Autochanger with crystal pick-up **£6.10.0**
- GARRARD "AUTOSLIM DE LUXE" 4-speed Autochanger, incorporates transcription Pick-up Arm **£11. 8.0**
- THE COLLARO "C60" 4-speed autochanger unit with Studio "C" pick-up **£6.19.6**
- B.S.R. Model UA14, a 4-speed Mixer Autochanger with crystal pick-up. **£5.19.6**
- The new GARRARD Model 4HF High Quality Single Record Player fitted with the latest T.P.A. 12 pick-up arm and G.C.B crystal Cartridge PHILIPS Model AG1016. A 4-speed Player which can be operated both manually and automatically. Suitable for Mono or Stereo operation **£16.17.6**
- Carrage and insurance on each above, 5/6 extra. **£12.12.0**

THE MONO-GRAM

A small Amplifier of genuine high quality performance. Incorporates new MULLARD ECL86 Valve, separate BASS and TREBLE controls and produces up to 3 watts undistorted output. KIT OF PARTS **£4.10.0** ASSEMBLED AND TESTED **£6.0.0** (Carr. & Ins. 3/6)

Perfectly suited for Portable Installations for which purpose we offer... PORTABLE CASE **£3.10.0**, the AMPLIFIER (Kit) and 8 x 5 in. SPEAKER (**£1**). All for **£9.0.0**. Alternatively with ASSEMBLED AMPLIFIER **£10.0.0**. (Carr. & Ins. 5/-)
The case quoted above will accommodate some 4 speed Single Record Units. A larger model for auto-changer is available for extra 10/-. With this Equipment a COMPLETE PORTABLE RECORD PLAYER CAN be built for from **£14.0.0**.



THE "TUDOR" STEREO AMPLIFIER

PRICE ONLY **£15.0.0** (Carr. & Ins. 7/6)
A self-contained Shelf Mounting Amplifier designed to provide high quality stereo-phonics and monophonic reproduction. Each channel provides a rated output of 6 watts and for monophonic operation approx. 12 watts is produced. Separate BASS and TREBLE CONTROLS. Cabinet in Black Crackle. Size 14" x 8" x 4".



Stereo Amplifiers

Mullard's "10+10" Stereo Amplifier with Passive Control Unit
A HIGH FIDELITY DESIGN PROVIDING UP TO 10 WATTS (per channel). SUPERB REPRODUCTION FREQUENCY RESPONSE FLAT TO WITHIN 3db from 3 c/s to 60 kc/s at 50mW. TOTAL HARMONIC DISTORTION AT 10 WATTS, 0.1%. PRICE : (a) ASSEMBLED AMPLIFIER **£24.0.0** (As illustrated). (b) KIT OF PARTS **£20.0.0**
Built to the highest technical standards and presented strictly to MULLARD'S specification. Two specially designed GILSON OUTPUT TRANSFORMERS with 20% taps are used. We can also supply the assembled MAIN AMPLIFIER only for operation with our DUAL CHANNEL PRE-AMPLIFIER; this provides for more versatile installation and is essential if a low output Pick-up is to be used. When ordering, specify loudspeaker impedance.
(a) THE ASSEMBLED MAIN AMPLIFIER and ASSEMBLED DUAL CHANNEL PRE-AMP **£34.0.0**
(b) KIT OF PARTS for both Units **£27.0.0** (Carr. & Ins. 10/6)



MULLARD DUAL CHANNEL PRE-AMPLIFIER

A four Valve design for both STEREOPHONIC and MONOPHONIC operation. Operates equally well with any make of Amplifier requiring input of up to 250 mV. KIT OF PARTS **£12.10.0**
ASSEMBLED AND TESTED **£15.0.0** (Carr. & Ins. 5/-)



THE "TWIN THREE" STEREO AMPLIFIER

ASSEMBLED AND TESTED for **£9.0.0** (Carr. & Ins. 5/- extra)
Based on a recent design by MULLARD LTD., is ideally suited for use in PORTABLE RECORD PLAYERS for which purpose we offer a specially designed case : It incorporates MULLARD ECL 86 Valves, separate BASS and TREBLE CONTROLS and produces up to 3 watts per channel. Frequency response 40 c/s to 30 Kc/s, size 11 1/4 in. x 3 in. x 5 in. To construct a STEREO PORTABLE RECORD PLAYER we offer : ASSEMBLED AMPLIFIER with two ROLA 8 in. x 5 in. LOUDSPEAKERS and PORTABLE CASE for **£16.10.0** (Carr. and Ins. 10/- extra).



POSTAL ENQUIRIES and MAIL ORDERS TO... STERN RADIO LTD.

6-12, TUDOR PLACE, TOTTENHAM COURT RD. LONDON, W1. TEL. MUSEUM 6128/9

DEMONSTRATION and SHOWROOMS AT... STERN RADIO LTD. PREMIER RADIO

109, FLEET ST. LONDON, EC4
TEL. FLEET ST. 5812/3
OPEN 9 a.m. to 6 p.m. SAT. close 1 p.m.

23, TOTTENHAM COURT RD. LONDON, W1. TEL. MUSEUM 6128/9
OPEN 9 a.m. to 8 p.m. THURS. close 1 p.m.

Scottish Insurance Corporation Ltd

38 EASTCHEAP * LONDON * EC3



TELEVISION SETS, RECEIVERS AND TRANSMITTERS

Television Sets, Receivers and Short Wave Transmitters are expensive to acquire and you no doubt highly prize your installation. Apart from the value of your Set, you might be held responsible should injury be caused by a fault in the Set, or injury or damage by your Aerial collapsing.

A "Scottish" special policy for Television Sets, Receivers and Short Wave Transmitters provides the following cover:

- (a) Loss or damage to installation (including in the case of Television Sets the Cathode Ray Tube) by Fire, Explosion, Lightning, Theft or Accidental External Means at any private dwelling-house.
- (b) (i) Legal Liability for bodily injury to Third Parties or damage to their property arising out of the breakage or collapse of the Aerial Fittings or Mast, or through any defect in the Set. Indemnity £10,000 any one accident.
- (ii) Damage to your property or that of your landlord arising out of the breakage or collapse of the Aerial Fittings or Mast, but not exceeding £500.

The cost of Cover (a) is 5/- a year for Sets worth £50 or less, and for Sets valued at more than £50 the cost is in proportion. Cover (b) (i) and (ii) costs only 2/6 a year if taken with Cover (a), or 5/- if taken alone.

Why not BE PRUDENT AND INSURE your installation—it is well worth while AT THE VERY LOW COST INVOLVED. If you will complete and return this form to the Corporation's Office at the above address, a proposal will be submitted for completion.

NAME (Block letters).....
(If lady, state Mrs. or Miss)

ADDRESS (Block letters).....

SUCCESS!

The **SINCLAIR SLIMLINE** has proved itself. Over a thousand constructors have already built this wonderful little receiver and dozens have written to let us know how pleased they are. The reasons for this enormous success are simple:

1. The **Sinclair Slimline** is the smallest receiver of them all, only $2\frac{1}{4} \times 1\frac{1}{2} \times \frac{1}{2}$ in. Yet in performance and design it far surpasses sets many times as large.
2. Using only its internal ferrite rod aerial it will receive all stations on the medium wave band including **Home, Light, Third, Luxembourg** and dozens of continental transmissions.
3. Elegant deep royal blue case with gold lettering and calibrated dial in gold on white. Both designed by a professional artist.
4. The earpiece provided gives superb reproduction free from noise or distortion and sufficient volume even for use in a car.
5. All the components are brand new and **MICRO-ALLOY TRANSISTORS** are employed throughout.
6. The completely new reflex circuit developed by Sinclair Radionics engineers results in a radio with the sensitivity and selectivity of a good superhet but with no alignment problems.
7. Well illustrated, superbly clear instructions are provided.
8. A carefully designed printed circuit board, on which all the components are mounted, is supplied.
9. Assembly is perfectly straightforward and simple even for a complete beginner yet the brilliant performance will more than satisfy the expert.



TOTAL COST
49'6 P.P. 1/6

JUST TWO OF THE MANY LETTERS WE HAVE RECEIVED. THE ORIGINALS MAY BE SEEN AT OUR CAMBRIDGE OFFICE.

Dear Sirs,

I have just built your Transistor Micro-Radio the "Slimline" and I'm amazed at the results. So far I've got about 10 stations including AFN, Stuttgart and Munich. I've built many sets but this leaves them all standing!

Thanking you,
H.S., Watford.

Dear Sirs,

I have received delivery of the "Sinclair Slimline" and have completed assembly. The quality of reproduction for both voice and music obtained with your circuit is so delightful that I do not overstate when I say that I have lost interest in the other more conventional transistor sets that I have built. I have one good quality sound reproducer, which I described some years ago in the technical press, but have found that I can obtain an equal effect for personal listening with the "Sinclair Slimline".

I should be favoured to receive a further kit when more are available (I assume the demand will be high and shall be glad to take my turn). I enclose a cheque in payment for this further order.

Yours faithfully,
J.F., Glasgow.

We would like to thank all those constructors who have written us such pleasant letters and to apologise for slight delays in delivery which have occurred owing to the overwhelming demand. However we have now increased our staff to cope with this and can give a very prompt service.

A complete book on MAT's entitled "22 TESTED CIRCUITS USING MICRO-ALLOY TRANSISTORS" is available from us at 5/9 including postage.

Prices of MAT's remain

MAT 100 and MAT 120 7/9 } POST FREE
MAT 101 and MAT 121 8/6 }

SEND FOR YOUR SLIMLINE TODAY TO:—

SINCLAIR radionics LTD

69 HISTON ROAD
CAMBRIDGE

HOME RADIO OF MITCHAM

DEPT. AC 187 London Road Mitcham Surrey MIT 3282

Shop hours 9 a.m. to 6 p.m. (Wed. 1 p.m.)

STOCKISTS FOR THE INCOMPARABLE



LEAK HI-FI EQUIPMENT

This superb equipment is still the standard by which all other Hi-Fi is judged. Full range of pre-amplifiers, amplifiers, mono and stereo, and also tuners normally in stock.

TL12PLUS 12W amp. (Mono) 18 gns.	POINT ONE STEREO pre-amp. 20 gns.
POINT ONE PLUS pre-amp. 12 gns.	VARILOPE STEREO pre-amp. £25
VARILOPE 111 pre-amp. 15 gns.	TL25. 25W amp. 24 gns.
STEREO 20.20W stereo amp. 29 gns.	TL50. 50W amp. 32 gns.

TROUGH LINE FM/VHF TUNER £29.7.6.

Still the best Short Waver GLOBE KING 100A



Explore the world from your armchair. Build this truly amazing one valve battery set which gives really world-wide reception at minimum cost. Learn Morse and listen in to shipping and amateurs, etc. Extra stage can be added later. Kit of parts with three coils covering 10 to 100 metres £3.19.6, post 1/6.

HAVE YOU HAD OUR SUPER CATALOGUE?

- ★ 172 PAGES
 - ★ 600 PICTURES
 - ★ OVER 5,000 ITEMS
- PRICE 2/6 Post 9d.



HOLIDAYS AHEAD

The UNIC Dry Shaver operates from a single U2 cell and will give you a quick clean shave anywhere. Ideal for holidays, camping, car rallies, etc. Swiss precision engineered. PRICE £2.18.10, complete, post paid.

EDDYSTONE 898 DIAL

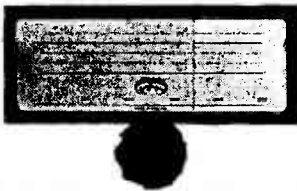

The finest slow motion dial drive assembly available, and essential for all high grade tuners, transmitters, and test gear. 110 to 1 gear driven reduction drive with special vernier logging device. Size 9 1/2" x 5 1/2". PRICE £3.11.4, post 1/6. (Overseas Post 7/6).

MULLARD AMPLIFIERS ON PRINTED CIRCUITS

We can supply printed circuit boards ready drilled and clearly marked for the following Mullard Amplifier circuits:

Mullard "3-3" 3 valve 3 watt	7/6
Mullard "5-10" 5 valve 10 watt	12/6
Mullard 3 watt ECL86 amplifier	7/6
Mullard 10 watt ECL86 amplifier	12/6

Can be used in pairs for stereo

PLEASE ADD 1/- POSTAGE TO ORDER

F.M. TUNER



A really first class immaculately engineered FM/VHF tuner designed to bring crystal clear interference free Hi-Fi reception to all the B.B.C. programmes. Coverage 86 to 104 Mc/s. Complete in neat case for shelf or cabinet mounting. Size 11" x 6 1/2" x 3". PRICE without power pack £13.19.6, post 1/6. With self-contained power pack £15.14.6, post 1/6.

SPECIAL OFFER JACK PLUGS

BRAND NEW GRUNDIG TYPE J2 JACK PLUGS. WILL FIT STANDARD IGRANIC JACK SOCKETS AS WELL. Normal price 5/- each. OUR SPECIAL PRICE 1/6 EACH. Plus 6d. post to order.

LEKTROKIT

We carry the full range of the LEKTROKIT chassis construction system and components and we can offer a by-return service to schools, laboratories, research depts, etc. Write in on official heading for full details and prices.

TRANSISTORS

Every one brand new and individually boxed and fully guaranteed. Why chance spoiling results with "surplus" when the best can be obtained at these low prices. AF114 11/-, AF115 10/6, AF116 10/-, AF117 9/6, OC26 25/-, OC44 11/-, OC45 10/-, OC70 6/6, OC71 6/6, OC72 8/-, OC75 8/-, OC76 8/-, OC78 8/-, OC139 12/-, OC140 19/-, OCP71 26/-, MAT101 8/6, MAT121 8/6, also most diodes and the latest Zener diodes in stock.

EDDYSTONE RECEIVERS



MODEL 870A Compact size, light weight, attractive styling, make this the ideal dual purpose domestic and Short Wave Receiver. Full Long and Medium Wave plus three Short Wave bands covering 12 to 2,000 metres. Gear-driven full width dial with special vernier logging scale. Built-in speaker. Operates on any voltage AC or DC 110 to 250 volts. PRICE £30.17.6, carriage paid U.K. EXPORT PRICE £26.0.0, carriage 30/-.

MODEL 840C 8 valve 5 waveband full Communications Receiver. Full specification on request. PRICE £58.0.0, carriage paid U.K. Overseas shipping on request.

MODEL 940 12 valve 5 waveband de luxe Communications Receiver. Full specification on request. PRICE £125, carriage paid U.K. Overseas shipping quoted on request.

MODEL 960 Fully transistorised Communications Receiver using 12 transistors and 7 diodes. Covering 500 kc/s to 30 Mc/s. Operates from 12 volt dry battery or car accumulator. PRICE £135, carriage paid U.K. Overseas shipping on request.

WE ARE MAIN STOCKISTS FOR HEATHKITS

Build your own Tape Recorder with a RECORDAKIT

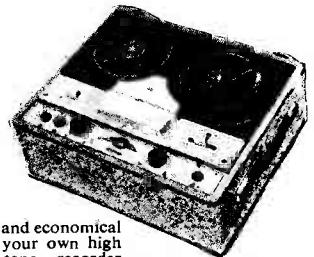

It is easy and economical to build your own high quality tape recorder with a Martin Recordakit. The amplifier is already wired up, and tested and a few simple tools are all that are required to assemble, thus saving pounds. Send 3d. stamp for details of all models.

MODEL "C" Twin track 3 speed Collaro Studio deck complete with amplifier Hi-Fi 9" x 5" speaker, modern two-tone carrying case, and full instructions. PRICE £29.18.0.

HEADPHONES



Brand new lightweight high-resistance (4000ohms) headphones, fully adjustable and very sensitive. Ideal for short wave and crystal sets, etc. PRICE 15/-, post 1/6. Brown's Type "F" 37/6. Ericssons professional type £4.2.6. Brown's Super K low impedance Mono or Stereo £6.10.0 high impedance version £8.3.0.

THE Radio Constructor

Incorporating THE RADIO AMATEUR

Vol. 16, No. 11

Published Monthly

Annual Subscription 29/-
(including postage)

Editorial and
Advertising Offices

57 MAIDA VALE LONDON W9

Telephone
CUNningham 6141
(2 lines)

Telegrams
Databux, London

JUNE 1963

Simple Low-Cost Fidelity Amplifier, by R. Hindle	788
Suggested Circuits No. 151: Obtaining Varying Impedances by Step-Up Transformer, by G. A. French	795
Improved Sub-Miniature 1mW Amplifier, by S. Smith	798
Can Anyone Help ?	799
Transmitter Design for 4 Metres, by D. Noble, G3MAW, and D. M. Pratt, G3KEP	800
News and Comment	804
A Versatile Humdinger, by B. G. Gaydon	805
An FM Tuner, by V. E. Holley	806
Trade Review, Stamp Type Shack Photographs	813
Understanding Radio, Part 22, by W. G. Morley	814
Book Reviews	821
Simple Crystal Marker, by J. A. Roberts	822
Converting Battery Portables to Mains Operation, by Michael J. Dunn	823
Voltmeter Measures Resistance, by R. F. Thorpe	826
In Your Workshop	827
A Neon Stroboscope, by C. Morgan	832
An Introduction to Colour Television, Part 1, by J. R. Davies	833
Radio Topics, by Recorder	837
The Magneto-resistor, by J. B. Dance, M.Sc.	839
An Inexpensive 3-Transistor Radio, by G. Phillimore	840
Checking Superhet Oscillators by Substitution, by Niall O'Riordan	841

© Data Publications Ltd, 1963

CONTENTS may only be reproduced after obtaining prior permission from the Editor. Short abstracts or references are allowable provided acknowledgment of source is given.

TECHNICAL QUERIES must be submitted in writing. We regret that we are unable to answer queries, other than those arising from articles appearing in this magazine; nor can we advise on modifications to the equipment described in these articles.

CONTRIBUTIONS on constructional matters are invited, especially when they describe the construction of particular items of equipment. Articles should be written on one side of the sheet only and should preferably be typewritten, diagrams being on separate sheets. Whether hand-written or typewritten, lines should be double spaced. Diagrams need not be large or perfectly drawn, as our draughtsmen will redraw in most cases, but all relevant information should be included. Photographs should be clear and accompanied by negatives. Details of topical ideas and techniques are also welcomed and, if the contributor so wishes, will be re-written by our staff into article form. All contributions must be accompanied by a stamped addressed envelope for reply or return, and should bear the sender's name and address. Payment is made for all material published.

OPINIONS expressed by contributors are not necessarily those of the Editor or the proprietors.

CORRESPONDENCE should be addressed to the Editor, Advertising Manager, Subscription Manager or the Publishers, as appropriate.

REMITTANCES should be made payable to "DATA PUBLICATIONS LTD."

Simple Low-Cost Fidelity Amplifier

By R. HINDLE

High fidelity amplifying equipment tends to be expensive. In this article our contributor had paid especial attention to cost, and has produced a design which employs a bare minimum of readily obtainable components whilst still providing an adequate performance

MANY READERS WILL HAVE STUDIED DESIGNS for high fidelity amplifiers and may have seen in their construction a formidable task requiring more experience than they possess; others may find the cost of a complete high fidelity outfit built to the best specification too high for their finances.

Those faced with this situation often turn to designs using a single-ended circuit. It is doubtful if such equipment should ever be classed as high fidelity, though it does satisfy some needs for a very simple and cheap, as well as compact, amplifier. Doubtless, however, the ambition of the constructor is to produce a unit which can be classed in the high fidelity bracket. A single-ended design has inherent distortion at a high level, though this can be reduced to around 1% by means of negative feedback so long as output is kept down to a reasonable level. Perhaps 3 watts is the maximum that can be taken from such a circuit with reasonable economy. Above such a level, with the usual valve and h.t. supply, distortion rises sharply in spite of negative feedback.

Advantages of Push-Pull

There are some fundamental advantages in push-pull amplification which make circuits using this technique very attractive. Higher outputs are obtained using reasonable h.t. voltages, distortion levels are reduced quite apart from improvements that result from the use of negative feedback, the risk of d.c. saturation of the output transformer is less and the degree of h.t. smoothing required is more modest. The present design has the aim of showing that a push-pull circuit capable of good results does not necessarily call for expensive or complicated construction. As a matter of fact, construction is comparatively easy and the number of components used has been reduced to a minimum. Both these interests are served by using the larger octal valves which are in good and cheap supply, as may be seen from advertisements in this issue. These valves are much easier to wire than the more modern miniature types, and comparatively inexperienced constructors should have no difficulty in getting good results. This does not mean that

the resulting chassis is necessarily big. In practice the size of a chassis for an amplifier is determined by the sizes of the transformers and chokes rather than by the valves. The present design is easily accommodated on a chassis 10 x 7 x 2½ in, a standard size which is readily available.

Circuit Design—The Output Stage

Design starts with the output stage and, in the present design, 6V6's are used. There are various methods of connecting these valves. If, for the purpose of comparison and assuming an h.t. supply of 250 volts, one 6V6 is used in a single-ended circuit, an output of 4.5 watts can be obtained, though distortion is up to 8%. As mentioned previously, distortion can be reduced by means of negative feedback.

Using a pair of 6V6's in push-pull the lowest distortion is obtained if they are connected as triodes, but power rating is very low at 2 watts for 0.5% distortion—not much return for 100mA of h.t. at 250 volts (25 watts). Tetrode connection gives much more power for the same signal input and power supply, the actual figure depending on the conditions of operation. It is customary in these days to operate output valves in AB1

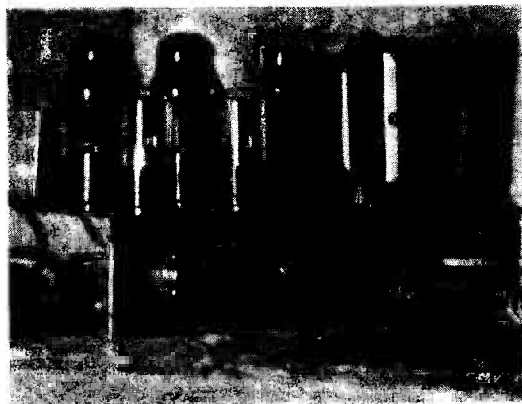

Above-chassis view of the completed amplifier

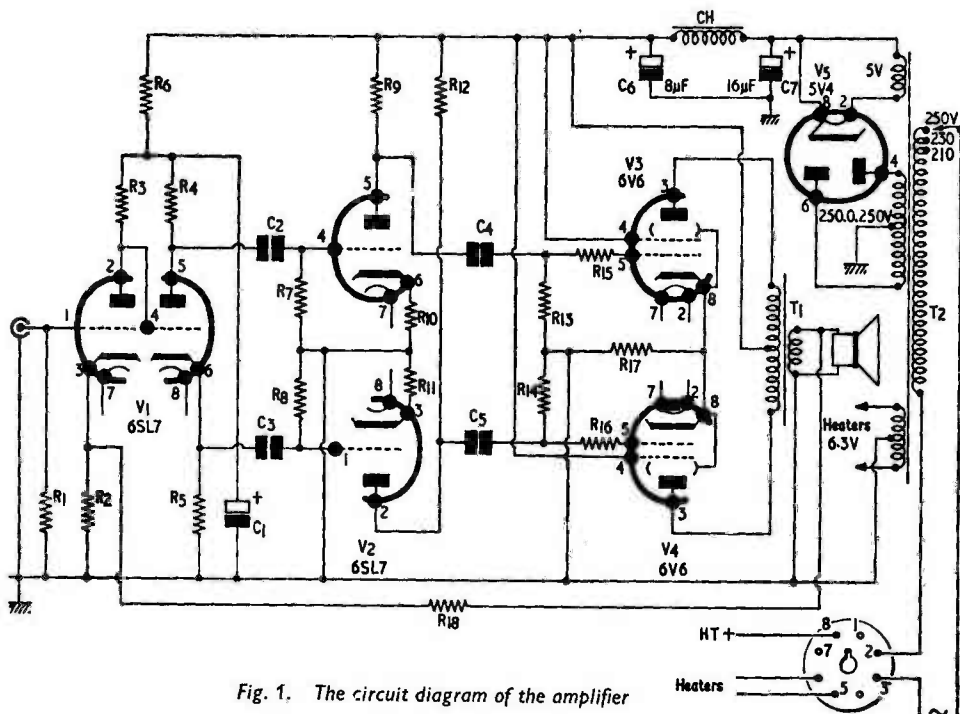

Fig. 1. The circuit diagram of the amplifier

Components List

Resistors (all $\frac{1}{2}$ W 20% unless otherwise stated)

- R₁ 1MΩ
- R₂ 4.7kΩ
- R₃ 220kΩ high stab.
- R_{4, 5} 100kΩ high stab., close tolerance.*
- R₆ 22kΩ
- R_{7, 8} 1.5MΩ
- R_{9, 12} 100kΩ, close tolerance.*
- R_{10, 11} 3.3kΩ, close tolerance.*
- R_{13, 14} 220kΩ, close tolerance.†
- R_{15, 16} 3.3kΩ
- R₁₇ 120Ω 3 watts
- R₁₈ 15kΩ for 15Ω output impedance (see text)

* Preferably matched within 5% or better.

† Preferably matched within 10% or better.

Valves

- V_{1, 2} 6SL7
- V_{3, 4} 6V6
- V₅ 5V4 (5Z4 will be satisfactory if no power is to be fed to another chassis)

Capacitors

- C₁ 64µF (32+32) electrolytic, 350V wkg., wire-ended
- C_{2, 3, 4, 5} 0.1µF, 250V wkg.
- C_{6, 7} 8+16µF electrolytic, 350V wkg., chassis mounting

Inductors (see text for sources of supply)

- T₁ To match push-pull 6V6 output to speaker impedance. (Primary impedance=8000Ω anode to anode)
- T₂ Secondaries 250-0-250V 150mA, 6.3V 4A, 5V 3A. (Amplifier heater requirements are 6.3V 1.5A, and 5V 2A)
- Ch 10H. 150mA

Miscellaneous

- Chassis (see text)
- Valveholders
- Tagstrips
- Coaxial input socket
- Wire, grommets, etc.

condition; that is, they are slightly overbiased and, as a consequence, current fluctuates somewhat with signal strength. Class A operation is slightly less efficient but nevertheless it is rather more

tolerant of component values and is easier on biasing circuitry, giving a power output only slightly lower than with the AB1 condition (9 watts against 10 watts) with only 2.5% distortion. Once

more the distortion figures are without feedback and are reduced very considerably by feedback. The class A condition calls for less signal drive of course (26 volts grid to grid) than the class AB1 condition (34 volts) to load fully. This follows from the fact that the grid bias is higher for AB1, the fully loaded peak input signal being twice the applied bias.

There is a further alternative method of connection known as the "distributed load" circuit. This is the method whereby the screen grid of the two output valves are returned to taps on the primary of the output transformer. Technically this is probably the best compromise of all, but it does not fit in with the purposes of the present design—cheapness with good quality—as it requires a more expensive output transformer.

A glance at the circuit of Fig. 1 will indicate that the number of components has been reduced to a minimum, and the output stage is no exception to this rule. A single resistor, R₁₇, is common to the cathodes of both valves. Because this resistor carries the current for both valves its value is only half that quoted in valve lists for a single valve. In simple theory, the signal currents for both valves cancel out in this resistor leaving only the d.c. current to produce a voltage, and so no bypass capacitor is needed. Actually, valves are unlikely

to be sufficiently well balanced to satisfy this simple theory. However, the differences are not serious in practice, and it is found that the bypass capacitor does not contribute significantly to results; hence its elimination. Using the more usual AB1 condition it is advisable to use separate cathode resistors and bypass capacitors—another dividend is thus received from the use of the class A condition. Two resistors that have not been eliminated are those in the grid leads (R₁₅, R₁₆). Their purpose is to prevent spurious oscillation in the output stages.

The Phase Splitter

The next decision to take is whether to put the phase splitter immediately before the output valves or to have a push-pull driver stage. The advantage of push-pull drive is that each half of the driver stage has to provide only half of the signal needed by the push-pull pair, and therefore will introduce less distortion into the total output. Push-pull drive is easily achieved with a single valve—a double triode. A 6SL7 is used, this giving adequate drive and a remarkably high gain, actually 50 times. Each half of the driver stage must provide 13 volts peak signal and so about 0.25 volt would be expected at each grid. However, cathode bypass capacitors have been

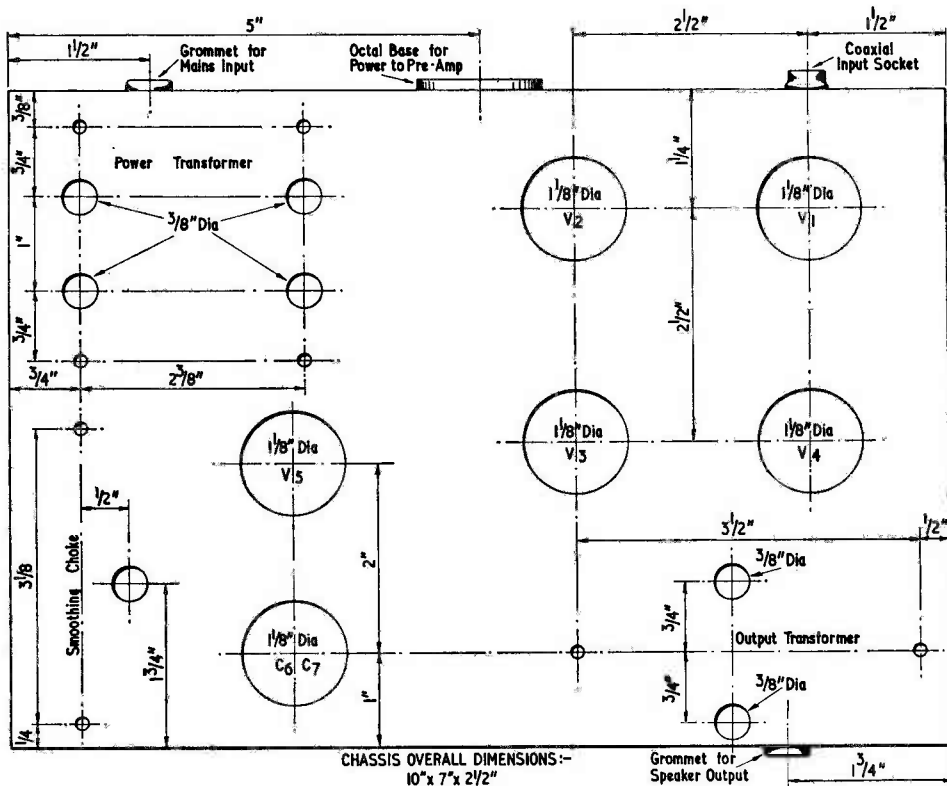

Fig. 2. Top view of chassis, showing drilling dimensions for the prototype. The grommets, power socket and input socket are mounted on the side walls 1 1/4 in from the top.

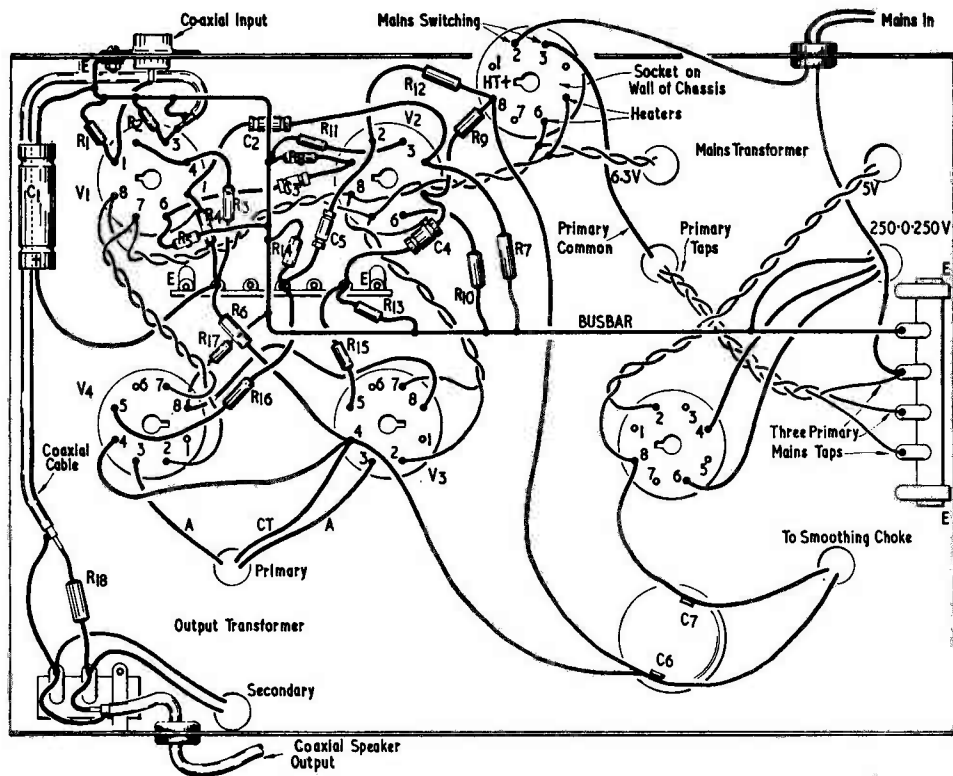

Fig. 3. Wiring layout

eliminated in this stage also, and a degree of negative feedback is present. The input signal has therefore to be 0.25 volt plus the feedback voltage in the cathode resistor.

A further 6SL7 provides the first stage and phase splitter. The second half of this valve is a split load phase inverter, half of the load being in the anode and the other half in the cathode. In this case a cathode bypass capacitor could not be used, economy or no economy, because a signal is needed across this resistor to feed to the next stage. Negative feedback takes place, and this is of quite a high order because of the high value of the cathode resistor. The stage is, in fact, almost akin to a cathode follower, the cathode signal being slightly less than the input. Since the anode resistor is of the same value, the signal at this electrode will also be somewhat less than the input and will be equal to the cathode signal; but it will be of opposite polarity, as is required for a push-pull circuit. The d.c. effect is that the cathode is at quite a high voltage—of the order of 100 volts. By designing the first half of the valve so that its anode is at a similar d.c. potential a direct coupling can be used between the two triodes, thus avoiding more components and incidentally reducing phase shift. The cathode resistor of the first stage is also without bypass. The main feedback loop is taken from the output transformer secondary

to this cathode resistor via a series resistor R_{18} .¹ The main feedback loop, aided by the incidental feedback in the other stages as a result of eliminating bypass capacitors, very considerably cleans up the reproduction and also eliminates all audible sign of hum.

All in all, it will be seen that quite a number of components normally seen in an amplifier have been eliminated.

The Transformers

The most expensive components in a high fidelity amplifier are the output and power transformers. The size of the latter is determined in general by the demands of the output valves, and as the two 6V6's only require 250 volts at about 100mA, quite a modest component can be used. A good (and therefore expensive) output transformer always pays off by improved results, and it is normally wise to pay as much as one can afford for this component. At the same time, however, one pays quite a lot for a marginal improvement, and if funds are limited it would be wrong, for instance, to economise when buying a speaker so that an expensive output transformer could be purchased. The important consideration is to

¹ The value given for R_{18} in the Components List (15k Ω) applies for a 15 Ω output impedance from the speaker transformer. An 8.2k Ω resistor would be advisable if a 3 Ω output impedance were used.—EDITOR.

balance one's expenditure so that the component parts work well together. With regard to the output transformer, class A working does permit economy. Under these conditions, the d.c. currents in the two halves of the primary are practically constant and equal, though of course, their flow is in opposite directions. Consequently saturation of the core is less likely (in simple theory it is impossible) and the actual core can be smaller. This means that a cheaper and smaller component can be used for equivalent results. The third bulky and comparatively expensive component which also comes from the transformer-maker is the smoothing choke. The current requirements of an amplifier such as this are well within the specification of standard components easily and cheaply available, and the smoothing needs for this circuit are not very exacting.

When choosing the power transformer and choke it has to be remembered that an outlet for power to feed a pre-amplifier is provided in this design and so the rating must allow for likely demands of this nature. In the present case a possibility of taking about 20mA from this outlet was foreseen and therefore components with a rating of 150mA were chosen. Also, the make of components will have a bearing on the chassis size and shape. It may help the reader to know, therefore, that the components used were as advertised by R.S.C. (M/c) Ltd.² and the layout and drilling diagram are based on these components. Nevertheless, the construction will be described in such a way that other components, which may already be to hand, can be used.

The valves used were surplus types, also obtainable from a number of advertisers at quite low prices. The moulded type of valveholder is used in preference to the thin wafer type which is prone to trouble after being in use for some time.

One position where economy is not recommended, and where the best components cost only coppers more, is at the load resistor position of the two first stages (i.e. the two halves of V_1). There are three resistors in all in this category, i.e. R_3 , R_4 and R_5 , and all these should be high stability types, the latter two preferably of close tolerance.

Construction

If the components employed in the prototype are used, there will be no difficulty in fitting them comfortably on the specified size of chassis. Fig. 2 gives the drilling diagram for the prototype. However, components tend to vary in size and even those from the same maker may alter somewhat in the actual position of mounting holes. The first thing to do therefore is to get together the components to be used. They can then be placed on a piece of paper with the chassis outside dimensions drawn on it, keeping to the relative positions indicated in Fig. 2. If the components can be fitted within the chassis outline, then check the positions of the mounting holes to see if they

differ from those shown in Fig. 2 before marking out the chassis. If the components are found to be appreciably larger than those used in the prototype they can be spread out on the paper to see how much bigger the chassis will need to be than that shown in Fig. 2. The relative positions and distances between the four valveholders for V_1 and V_4 must be retained but there is a reasonable amount of freedom in placing the other components. The positions of the holes for the leads from components mounted on top of the chassis may also vary somewhat. Having sorted out these matters the chassis can be drilled and the components mounted. The drilling diagram does not give the positions of the securing bolts for valveholders and electrolytic capacitors. The best procedure is to drill the major holes, drop in the components, turn the valveholders until the pins are in the relative positions indicated on the wiring diagram of Fig. 3, and then mark the positions of the holes for the bolts. Tagstrips are mounted in the relative positions shown on the wiring diagram. No holes for these strips are shown on the drilling diagram because they vary so much in sizes and positions. The one on the side nearest the power transformer takes the taps from the primary for adjusting to mains voltage. Only three of the tags on the strip between the valveholders are used; a 7-way tagstrip was used in the prototype to spread the connections out, but obviously a 4 or 5-way tagstrip could be substituted. A 3-way tagstrip is also used under the output transformer to anchor the speaker and feedback components. A 4-way tagstrip here would provide a more satisfactory mounting for R_{17} which, in the prototype, was supported at one end only. C_1 is supported by its lead-out wires. Actually, this component is $32+32\mu\text{F}$, with the two sections connected in parallel to make $64\mu\text{F}$ in all.

Wiring

It should be noted that the chassis is not used for earth returns. Such a practice is undesirable because it results in loops which include the chassis and, as the chassis is very efficient in picking up

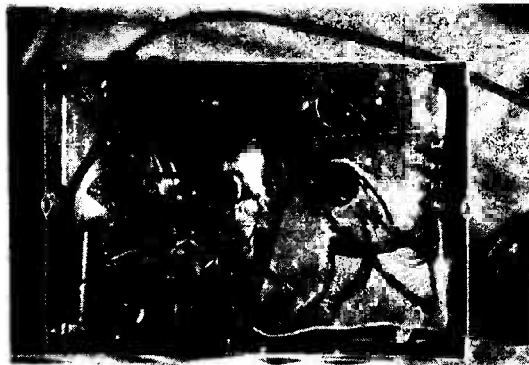

Under-chassis view of the amplifier constructed by the author

² R.S.C. (M/C) Ltd., 29-31 Moorfield Road, Leeds 12.

hum, this method is well calculated to induce hum into the circuits. The method employed here is to use an earth busbar which runs across the chassis above the components (looking at the chassis upside down). This busbar is connected to the chassis at only one point, this being a solder tag under one of the holding-down nuts of the coaxial input socket. The busbar is shaped to run between the valveholders as indicated in the wiring diagram and is anchored at the other end to one of the free tags of the 4-way tagstrip. The busbar is *not* connected at this end to one of the tags in contact with the chassis. Earth returns all go to a convenient position on the busbar and, where

or other piece of equipment to the power output socket, that the 6.3V supply is centre-tapped to earth and that the heater wiring of the other chassis must be floating, (that is, neither side must be connected to earth). Another piece of mains flex carries the 6.3 volt supply to this socket.

The various other leads from the mains transformer can now be wired up. Having connected the primary taps to the tagstrip the appropriate tag is selected according to the supply on which the amplifier is to be used, and one side of the mains lead is soldered to this. The connection to the other side of the mains lead depends on the way the chassis is to be used. It is convenient to group all controls on the pre-amplifier, and this includes the mains switch. In order to permit this the common transformer primary lead is taken to one pin of the output power socket and the second mains lead (the live side) to another pin. The cable carrying the supplies to the pre-amplifier must be five-core and insulated up to mains standard. Fig. 4 (a) illustrates this method of connection, which corresponds to that given in the full wiring diagram. An alternative is to feed the mains supply to the separate chassis, the latter carrying the switch. The switched mains is then fed to the amplifier. A five-core connection is still needed and Fig. 4 (b) will make this second method clear. When testing the amplifier by itself and assuring the first method of connection, it will be necessary to place a temporary shorting link across the appropriate pin of the power output socket so that the mains is fed direct to the transformer. The link is removed when the pre-amplifier is brought into use.³

The remaining wiring can now be proceeded with, working methodically from V₁ to V₄, remembering that signal leads should always follow the most direct route, and that coupling capacitors should preferably not be against the chassis. Two anchoring points for h.t. connections are the appropriate pin on the power output socket, and pin 4 of V₄.

Coaxial cable developed for television purposes is extremely useful in audio applications and can be used where a long run for a signal lead cannot be avoided. In the present design this need arises in the case of the feedback lead from the output transformer to the first stage cathode which must obviously run across the chassis, for this lead a length of coaxial cable is used. Such cable is also used for the speaker output lead and also for the connection from the feeder (pre-amplifier or other unit) to the amplifier. The principle of avoiding loops into which hum currents can be induced apply also in the cases where screened or coaxial cable is used for audio connections. The feedback lead outer braid is not connected to the chassis but to the earth busbar at the valve end. At the trans-

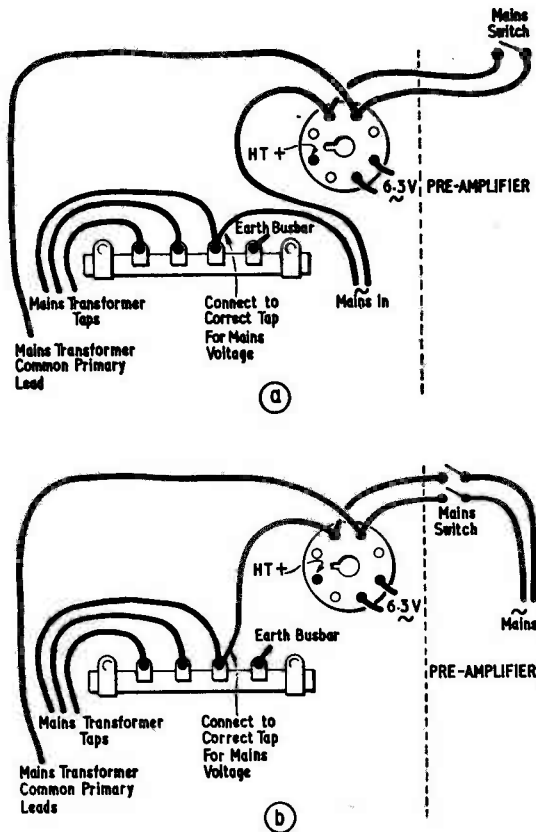

Fig. 4. Alternative methods of connecting the mains switching circuits

practicable, the earth returns of each circuit are grouped together.

The first connections to make are those to the heaters of V₁, 2, 3 and 4. Twin twisted p.v.c. covered mains flex may be used for this purpose, all the leads being run along the surface of the chassis. The mains transformer in the prototype provides a centre-tap for the 6.3 heater winding, and this connects to the busbar. It must be remembered, however, when connecting a pre-amplifier

³ The power output socket connections shown in Figs. 1, 3 and 4 do not include an h.t. negative connection. Such a connection could be carried by the outer conductor of the screened cable coupling the ancillary equipment to the amplifier, whereupon it has to be pointed out that a shock may result if the two chassis are touched when this screened cable is disconnected.—EDITOR.

former end the braid connects to one of the free tags of the tagboard, *not* the earthed tag. The tag taking the braid is used to earth the braid of the coaxial cable to the speaker and also to anchor the earthy lead from the secondary of the output transformer. The earth returns are thus carried back to the busbar near the valve and no hum loops are introduced.

Using the Amplifier

When constructional work is completed, carefully check all wiring against the circuit diagram before plugging in the valves. Temporarily short circuit the appropriate pins of the power output socket if the method of connection shown in Fig. 4 (a) is used. Also temporarily disconnect the feedback lead from R_{18} , leaving the earth connections untouched. Now connect a speaker to the coaxial output lead. If the output transformer has different taps for various output loads see that, in wiring up, the correct connections have been selected. For instance the component in the prototype had two alternative connections, one for 3Ω speaker and the other for 15Ω speaker.

Power can now be switched on without connecting anything to the input socket. Some hum should be present, which may diminish slightly when the inner connector of the input coaxial socket is short circuited to the metal body. Hum should certainly increase considerably if a screwdriver metal blade touches the inner connector without the short-circuit to earth. This is, in fact, a useful test that all is well, and the degree of increase of hum gives some indication of the sensitivity of the amplifier, which will be quite considerable without the main feedback loop.

Now switch off power, reconnect the feedback loop and switch the power back on again. If the amplifier is found to be unstable and bursts into oscillation, positive feedback is taking place and power must be switched off immediately. The two leads from the secondary of the output transformer are then reversed to make the feedback negative. The amplifier should now be quite stable. Also hum should have been reduced to negligible proportions and should entirely disappear, so far as the speaker is concerned, when the input socket is shorted across.

The sensitivity of the amplifier is such that no pre-amplifier is needed when working from the usual crystal pick-up, 0.1 volt being an adequate input signal. The amplifier can be quickly brought into

use by providing a volume control and pick-up connected as in Fig. 5. If tone controls are needed, a pre-amplifier incorporating such controls and the volume control (plus also the mains switch for convenience) will have to be constructed. With a pick-up of the type just mentioned, the gain in the pre-amplifier need be no more than is necessary to recover losses in the tone controls themselves; in other words, the overall pre-amplifier gain need be only unity.

In order to use the amplifier for stereo two similar chassis could be constructed, together with a suitable pre-amplifier to feed them. A simple design for this purpose is being currently developed by the writer. Thus, one amplifier could be made now and used for mono, a second being provided when it is decided to extend the system to stereo.

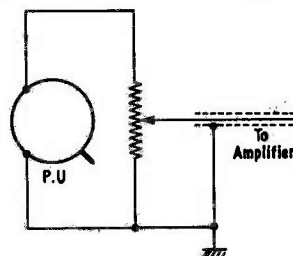

Fig. 5. A simple method of coupling a pick-up direct to the amplifier

Alternatively the two amplifiers could be mounted on a single chassis. In this case no doubt the constructor will consider using power components capable of giving twice the power of those specified for the present design to feed both audio chains. However such components are less easy to come by in the reasonable price range, and there is a lot to be said for using separate power components for each channel. A pre-amplifier could be fed from the power outlet from one chassis and perhaps a radio tuner from the other chassis. Two small chassis can be stowed away more easily in a modern cabinet than can one large one.

The amplifier described has been in use for some months now, feeding sometimes a G.E.C. metal cone speaker and at other times a W.B. 12in high fidelity speaker, both mounted in reflex cabinets of appropriate dimensions. Quality of reproduction has surpassed all expectations. It can be fully recommended as an exceptionally good, low cost, high fidelity amplifier.

SIMPLE RATEMETER

With respect to "Simple Ratemeter for Radioactivity Measurements", published in our April issue, Mullard Educational Service inform us that there is a possibility of a potential difference appearing between the chassis of the power unit and the metal case of the ratemeter if the 4.5 volt battery is not adequately insulated from the case. This occurred with the Mullard prototype, in which the battery corroded after lengthy use and developed a wet patch. Under these conditions there is a risk of shock if both units are touched at the same time, and this possibility may be eradicated by ensuring that the battery is well insulated from the metal case of the ratemeter. The other components should similarly be well insulated from the case. The two chassis can also, of course, be bonded together by way of the h.t. negative lead.

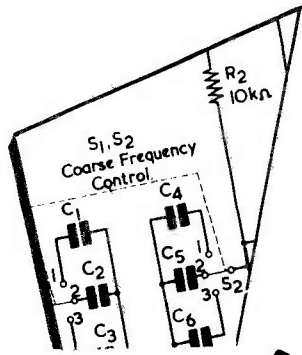

The circuits presented in this series have been designed by G. A. FRENCH, specially for the enthusiast who needs only the circuit and essential data

suggested circuits

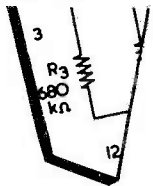

No. 151 Obtaining Varying Impedances by Step-Up Transformer

AS WAS DISCUSSED LAST MONTH by W. G. Morley in the "Understanding Radio" series, the primary of an ideal transformer presents a resistive impedance when the secondary is loaded by a resistor. Also, the resistive impedance reduces when the value of the resistor across the secondary reduces.

This is a fact which most of us take for granted, but the writer, reminded of it on seeing W. G. Morley's article, decided to carry out an investigation to see whether this particular characteristic of a transformer could be put to practical use. What was envisaged was that one winding of a transformer would present a resistive impedance to an a.c. circuit, and that the magnitude of this impedance would be varied by altering the value of a resistance connected across a second winding.

This technique would then allow alternating voltages at high impedance to be controlled by variable resistors operating at low impedance, and vice versa.

Remote Volume Control

An application along these lines which immediately presents itself is the remote volume control of an audio amplifier. It is frequently desirable to be able to control volume from a remote point, the controlled circuit in the amplifier being incorporated in one of the early stages. The wiring to the remote point in such an arrangement is, however, always liable to give rise to difficulties due to hum pick-up and the loss of high frequencies caused by self-capacitance in the cable.

The writer decided to investigate the possibilities of a circuit similar to that shown in Fig. 1. In this diagram an a.f. voltage from the input to the amplifier, or from the preceding anode, is passed to the grid by way of a fixed resistor. Connected between grid and chassis is the secondary of a step-up transformer. The primary of the transformer couples to the remote volume control, which consists of a variable low-value resistor. The principle of the circuit is that the fixed resistor and the resistive impedance offered by the transformer secondary constitute a potentiometer. When the remote variable resistor inserts maximum resistance so also, as resistive impedance, does the transformer secondary; whereupon maximum a.f. is passed to the grid of the amplifying valve. When the remote variable resistor inserts minimum resistance, the transformer secondary offers minimum resistive impedance, and minimum a.f. is passed to the grid. Intermediate settings of the variable resistor will cause intermediate resistive impedances in the secondary, with the result that the remote variable resistor functions, effectively, as a volume control.

The advantage of the circuit is that, due to the presence of the transformer, the wiring to the remote point is at low impedance and is, in consequence, less liable to cause hum pick-up or loss of high frequencies due to self-capacitance in the cable.

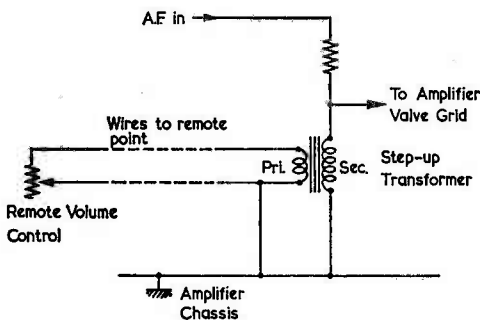

Fig. 1. An experimental method of obtaining remote volume control

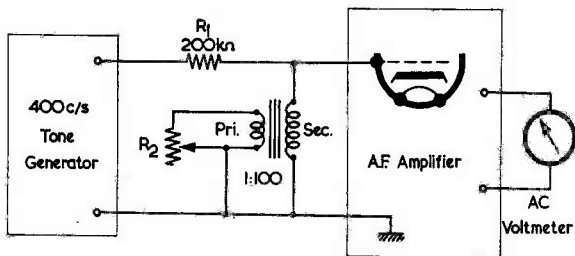

Fig. 2. The set-up employed for checking the result of variations in the variable resistor

A Test Circuit

In order to check the practical possibilities of the idea, the test circuit shown in Fig. 2 was set up. A 400 c/s tone generator of negligible output impedance was coupled via a 200kΩ resistor, R_1 , to the secondary of a step-up transformer. This secondary was connected, also, between grid and chassis of an early valve in an a.f. amplifier. The primary of the transformer was loaded by the variable resistor R_2 . An a.c. voltmeter, connected across the output of the amplifier, monitored the a.f. voltage applied to the valve grid. The amplitude of the maximum a.f. signal handled by the amplifier was considerably below its maximum rated figure, and it was assumed, in consequence, that it offered linear amplification of all signals passed to the grid during the experiment.

The step-up transformer employed was an inexpensive 1:100 microphone transformer. As events proved, a more expensive component with a lower ratio may have been preferable. Nevertheless, the results obtained amply illustrate both the usefulness and shortcomings of the circuit.

The curve of Fig. 3 gives the attenuations resulting from varying values in R_2 . There was little increase in gain for values above 200Ω, and this was taken as the zero dB point. As may be noted, dB loss decreases fairly smoothly as the log of R_2 resistance. A maximum

loss of 23dB is given by 0.1Ω. This last reading was, in practice, given by short-circuiting the transformer primary terminals, the 0.1Ω being given by the resistance of the primary winding itself.

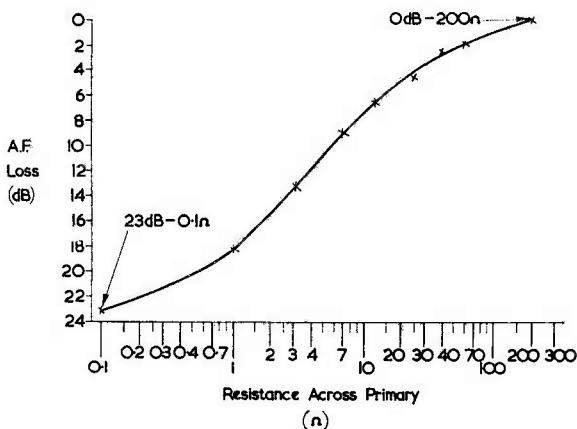

Fig. 3. Output voltage plotted against resistance in R_2

The results obtained correspond roughly with what would be expected from a theoretical consideration of the circuit. Since the turns ratio of the transformer was 1:100, the impedance transformation from primary to secondary would be $1:100^2$, or 1:10,000. Thus, the effective value of the resistive impedance presented by the secondary would

be 10,000 times the value of R_2 . The fact that the primary winding resistance is 0.1Ω infers that the secondary resistive impedance could never be less than 10,000 times this figure, i.e. 1,000Ω. The maximum loss given was 23dB ($=0.07$) which infers a secondary resistive impedance, Z_s , of 0.07 ($Z_s+200,000$), or 15,000Ω. The secondary winding resistance of the transformer was 4,000Ω, and it would seem, in consequence, that much of the 15,000Ω figure was contributed by leakage reactances. Another factor which is made evident by the curve of Fig. 3 is that, to obtain high loss figures, a low resistance is required in the connecting leads to the remote variable resistor. It would appear, in consequence,

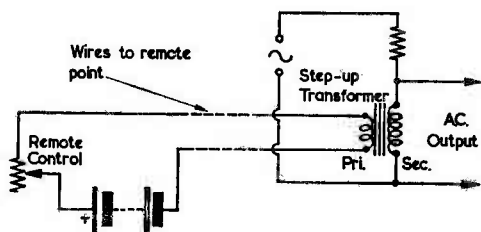

Fig. 4. An alternative method of varying secondary impedance

An Alternative Approach

An alternative approach to obtaining varying secondary impedances is shown in Fig. 4. In this instance, secondary inductance is reduced, this being done by passing varying currents through the primary. The

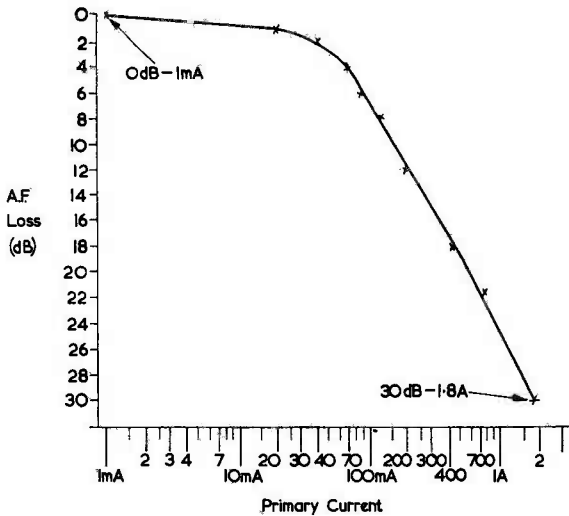

Fig. 5. The curve given by a practical version of Fig. 4

remote volume control now varies the incremental inductance of the secondary winding according to the magnetic flux in the core. At minimum resistance level, the current passing through the primary will be sufficient to fully saturate the core.

Apart from passing an increasing current through the primary, reducing the value of the remote variable resistor in Fig. 4 has another effect, this being given by the reduced resistance (offered by the variable resistor in series with the internal resistance of the battery, or other source of supply) which is applied to the primary. This effect may partly contribute to the reduction of secondary impedance as the value of the variable resistor is reduced.

The curve shown in Fig. 5 was obtained by connecting a 3 volt battery and a variable resistor to the primary of the 1:100 microphone transformer, as shown in Fig. 6. As

may be seen, it is, in this instance, possible to obtain an a.f. loss of 30dB (=0.03).

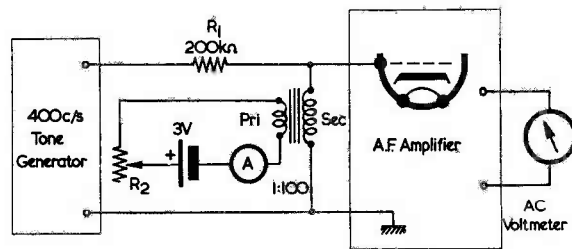

Fig. 6. The circuit used for obtaining the curve of Fig. 5

The circuit of Fig. 4 has the advantage that the resistance of the remote leads is unimportant, as they merely have to carry the current applied to the primary. With the 1:100 microphone transformer, a

high current (1.8 amps) was needed to obtain maximum a.f. loss, but this situation would be eased if a transformer with a lower ratio (giving more primary turns) were employed. Also, some of the laminations could be removed to allow for earlier saturation.

A major disadvantage with the Fig. 4 circuit is that, since the varying secondary impedance is largely inductive, it is not really suitable for a.f. applications. Nevertheless, the technique is of interest and readily illustrates the possibility of varying high impedance a.c. voltages from a remote point over low impedance wiring.

Results with A.F.

Both the circuits of Fig. 2 and Fig. 4 were checked to see the effect of replacing the 400 c/s tone by a normal broadcast programme. Over most of the range of control, the Fig. 2 circuit offered a slight cut of bass, this increasing as volume was reduced. It is probable that this effect (which was not excessive) was largely due to the high leakage

reactances of the transformer employed, and would be less pronounced in a more expensive component. As was to be expected, the circuit of Fig. 4 gave more obvious bass cut.

Science Museum to have Closed-Circuit TV System

There is good news for the 30,000 people a year who attend lectures at the Science Museum, South Kensington. The museum authorities have ordered a closed-circuit television system from EMI Electronics Ltd. for use in the museum's lecture theatre. One of the latest type cameras will transmit close-up pictures from the lecturer's bench to two 23in receivers placed towards the rear of the theatre.

"We present several lectures a day and there is hardly a lecture in which we shall not be able to use this equipment," said Mr. Walter Winton, curator of the lecture theatre.

"One of our biggest problems is to show small specimens to those sitting at the back of this 180-seat theatre. People can, of course, come down to the bench afterwards to inspect the specimens. Sometimes we make large models for all to see, but this is not always possible. That is why we are going to have this television camera, to give everyone a front-row view throughout the lecture."

Improved Sub-Miniature 1mW Amplifier

By S. SMITH

Due to the availability of silicon transistors on the home-constructor market, our contributor has carried out some improvements on an amplifier he described several years ago in these pages. The improved amplifier retains the original stabilising arrangement, offers a very wide response with low noise, and requires very few components

A SUB-MINIATURE AMPLIFIER WAS DESCRIBED IN this journal in 1961.* The pair of transistors specified were OC71's, but the circuit (including component values, setting-up instructions, etc.) will accept any low-power transistors. The first improvement that can be made is to use r.f. or even v.h.f. transistors, whereupon the circuit comes into the "Hi-Fi" category. Indeed, if the 0.003 μ F capacitor bypassing the output be removed, it will amplify r.f. very satisfactorily with OC44's instead of the OC71's.

The Improved Circuit

A second improvement concerns the input arrangements. In the original circuit the input capacitor was duplicated, and two resistors and a further capacitor were added to protect against reversed polarity. (See Fig. 1.) In Fig. 2, it will be seen that these additional components have been dispensed with by the simple expedient of taking the earthy side of the input to the emitter of the output transistors instead of to the battery positive.

This latter arrangement, besides economising in components, introduces a further advantage. In the original circuit (Fig. 1) very low frequencies, for

which the decoupling provided by C₆ was inadequate, were fed back to the input via R₅ as negative feedback, and so were lost. Thus the frequency response of the whole circuit was limited at the high frequency end by the choice of transistor, and at the low frequency end by negative feedback. With the arrangements shown in Fig. 2, the emitter of the output transistor is the "virtual earth", so

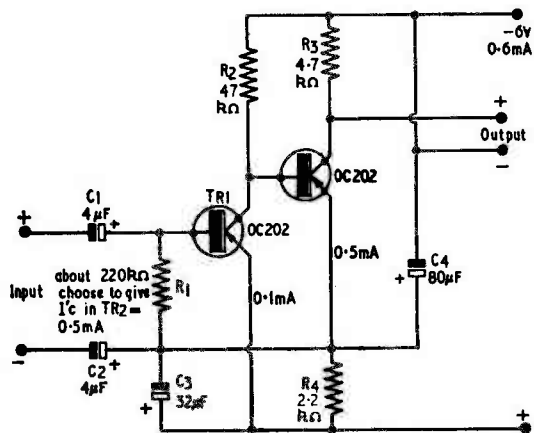

Fig. 2. The improved amplifier circuit. For sub-miniature construction, a printed circuit is recommended

Components List (Fig. 2)

Resistors

- R₁ See Fig. 2 (220k Ω approx.)
- R₂ 47k Ω
- R₃ 4.7k Ω
- R₄ 2.2k Ω

Capacitors

- C₁ 4 μ F electrolytic 12V wkg.
- C₂ 4 μ F electrolytic 12V wkg.
- C₃ 32 μ F electrolytic 2.5V wkg.
- C₄ 80 μ F electrolytic 6V wkg.

Transistors

- TR₁ OC202
 - TR₂ OC202
- } Or other silicon r.f. transistors

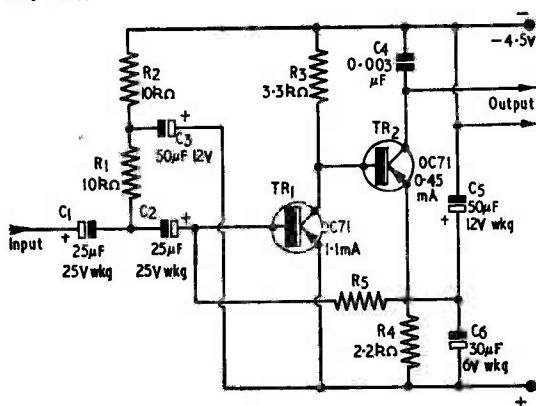

Fig. 1. The original circuit employing OC71 transistors. The value of R₅ was discussed in the previous article and, in the prototype, was 33k Ω . The previous article also described the optimum output load, this being 3.3k Ω resistive or high impedance phones (4k Ω a.c.; 3k Ω d.c.)

that there is no (spurious) signal on it to be fed back.

Low Noise

Yet another advantage can result from choice of a low noise transistor. For example, the GET880 has a noise factor of 4dB under the conditions in Fig. 1 at audio frequencies. However, low noise can be achieved with any transistor by working at a sufficiently low collector current. Fig. 1 implies 1mA in the first transistor, and one cannot properly reduce this to any great extent with germanium transistors because of stability considerations. However, silicon transistors have a low I'_{co} and a low

$\frac{dI'_{co}}{dT}$ (i.e. low rate of change of I'_{co} with tempera-

ture), so they are much easier to stabilise and a lower I'_c can be allowed for in the design. The OC202 silicon transistor has an f_1 of 3 Mc/s, high gain at low collector currents ($h_{fe}=40$ at $I'_c=100\mu A$), and a fairly low noise factor. Fig. 2 is based on the OC202, but any silicon r.f. transistor with reasonable gain at 0.1mA could be used instead. If germanium transistors must be used, Fig. 1 is the appropriate design for stability, though it should be modified at the input as shown in Fig. 2.

The circuit of Fig. 2 is designed to be cascaded if desired. Its output impedance of $4.7k\Omega$ is significantly higher than the input impedance of the following identical circuit (for low distortion), but not to high as to cause marked loss of gain by the mismatch.

CAN ANYONE HELP?

Requests for information are inserted in this feature free of charge, subject to space being available. Users of this service undertake to acknowledge all letters, etc., received and to reimburse all reasonable expenses incurred by correspondents. Circuits, manuals, service sheets, etc., lent by readers must be returned in good condition within a reasonable period of time.

21in Masteradio TV Model TG21T.—R. A. Salami, 91 Marlboro Road, Wood Green, London, N.22, requires the circuit diagram and service sheet for this televisor. Would also like to obtain the address of the manufacturer.

* * *

Transistor Oscillator for Tape Erase Head.—R. S. Finlayson, 64 Downlands Road, Purley, Surrey, wishes to obtain a suitable circuit diagram for use with a Garrard Magazine deck.

* * *

CR100.—A. R. Brackenborough, 41 Poets Corner, Margate, Kent, requires the loan (or would purchase) a drawing of the component layout, both above and below the chassis, of this receiver.

* * *

Pye Transistor Radio.—G. Woodcock, 19 Fairview, Barnstaple, Devon, requires the i.f. and circuit diagram of this table model radio, serial No. PE777T.

* * *

TV/Oscilloscope Conversion.—J. Anderson, 19 Elmsway, Bramhall, Cheshire, would like to know if any reader has any data on converting a TV into an oscilloscope, or has specific knowledge relating to the conversion of a Ferranti 20T4 projector—in which case their experiences would be appreciated.

Guitar Pre-amplifier and Main Amplifier.—B. Bowden, 23 Victoria Street, Warwick, wishes to obtain circuit diagrams and details of the above units having about 5 to 10 watts audio output.

* * *

Marconi Receiver Model No. 858.—D. Watts, 52 Edgell Road, Staines, Middlesex, would like to buy or borrow the circuit diagram and any other information in respect of this receiver.

* * *

National NC46 Communications Receiver.—A. Meadows, "High Birch", Tunbury Avenue, Walderslade, Kent, urgently requires to purchase or borrow the circuit diagram of this receiver.

* * *

3FP7 C.R.T.—John H. Wood, 19 Ventnor Avenue, West Hartlepool, Co. Durham, would like to know where he can obtain a mu-metal screen and holder for this tube.

* * *

Ferrograph Model 4A.—G. Smallwood, 5 Bede Avenue, Burton Stone Lane, York, would appreciate the loan of a manual—or would purchase.

* * *

Ekco TV Model No. TC165N.—W. J. Robbins, 7 Cedar Avenue, Birstall, Leicester, requires the circuit, loan or purchase.

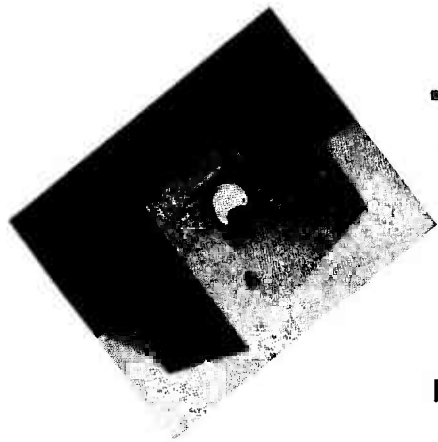

Transmitter Design for 4 Metres

By D. Noble, G3MAW and D. M. Pratt, G3KEP

THE TRANSMITTER DESCRIBED IN THIS ARTICLE WAS designed specifically to investigate the prospects of using the four metre band for local working.

In hilly country the four metre band is found to be preferable to the higher v.h.f. bands. Furthermore, four metres has advantages over, say, 10 metres as a band for local working due to smaller aerials being required. Also, the interference with Dx stations is much less likely to cause trouble. For these reasons a simple transmitter was designed and constructed to enable experiments to be carried out.

Circuit

A conventional design is employed using a modified Colpitts crystal oscillator on 11.717 Mc/s, the anode circuit of which is tuned to the crystal frequency. This is followed by an EF91 operating as a doubler, and a 5763 tripler. The anode circuit of the 5763 is link-coupled to the Power Amplifier grids. The P.A. uses a TT15 as a push-pull amplifier.

In the anode circuit a split-stator capacitor is used to tune the centre-tapped coil. As the centre-tap is grounded as regards r.f. by the capacitor C19, the rotor of the P.A. tuning capacitor must be isolated from chassis.

An anode current meter (150mA full-scale deflection) is provided for tuning-up purposes.

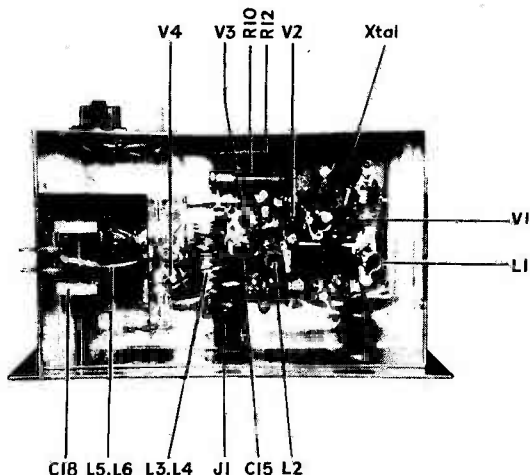

A view of the underside of the transmitter, showing the major components and below-chassis screen

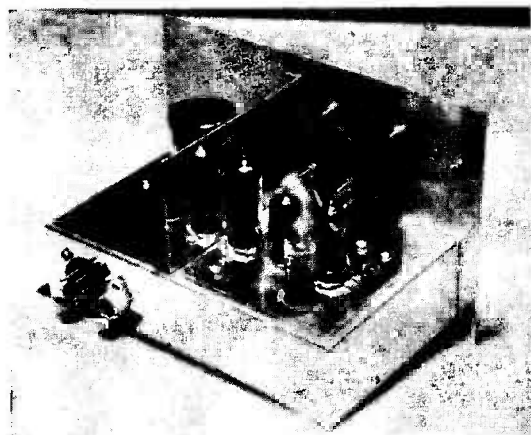

Three-quarter rear view of the transmitter showing the B7G based crystal mounted in the foreground.

It is not anticipated that the transmitter will be used much for c.w. operation, but a key jack is provided in the P.A. cathode "just in case". This avoids the necessity of providing protective devices which would be required if an earlier stage were keyed. The key jack may also be used for metering purposes.

T.V.I. Precautions

As 35 Mc/s falls in the vision i.f. passband of most modern television receivers, it is undesirable to have one stage tuned to 35 Mc/s. For this

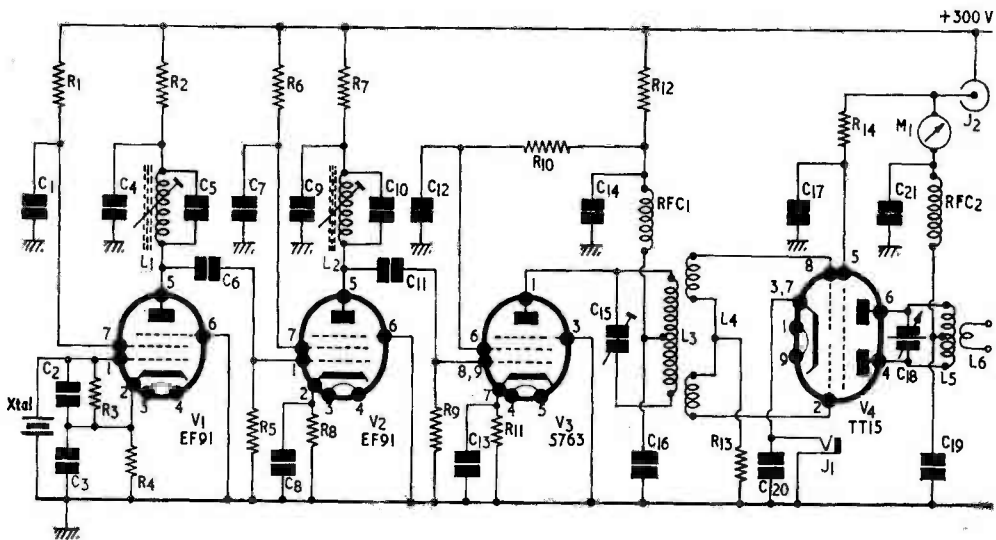

Fig. 1. The circuit of the 70 Mc/s transmitter

Components List

Resistors. (All $\frac{1}{4}$ watt unless otherwise specified)

- R₁ 47k Ω
- R₂ 22k Ω
- R₃ 100k Ω
- R₄ 2.2k Ω
- R₅ 68k Ω
- R₆ 47k Ω
- R₇ 22k Ω
- R₈ 1k Ω
- R₉ 100k Ω
- R₁₀ 12k Ω 1 watt
- R₁₁ 390 Ω 1 watt
- R₁₂ 1k Ω 2 watts
- R₁₃ 22k Ω
- R₁₄ 15k Ω 2 watts

Capacitors

- C₁ 1,000pF disc ceramic
- C₂ 50pF silvered mica
- C₃ 180pF silvered mica
- C₄ 1,000pF disc ceramic
- C₅ 4.7pF tubular ceramic
- C₆ 50pF silvered mica
- C₇ 1,000pF disc ceramic
- C₈ 1,000pF disc ceramic
- C₉ 1,000pF disc ceramic
- C₁₀ 4.7pF tubular ceramic
- C₁₁ 50pF silvered mica
- C₁₂ 1,000pF disc ceramic
- C₁₃ 1,000pF disc ceramic
- C₁₄ 1,000pF disc ceramic
- C₁₅ 2-8pF concentric trimmer
- C₁₆ 1,000pF disc ceramic
- C₁₇ 1,000pF disc ceramic
- C₁₈ 25+25pF split-stator
- C₁₉ 1,000pF disc ceramic
- C₂₀ 1,000pF disc ceramic
- C₂₁ 1,000pF disc ceramic

Inductors

- RFC_{1, 2} 50 turns, 28 s.w.g. enam. close-wound on $\frac{1}{4}$ in wooden dowel
- L₁ 30 turns, 28 s.w.g. enam. close-wound on $\frac{3}{8}$ in Aladdin former with iron dust core
- L₂ 18 turns, 22 s.w.g. enam. close-wound on $\frac{3}{8}$ in Aladdin former with iron dust core
- L₃ 6 turns, 18 s.w.g. tinned copper, spaced $\frac{1}{4}$ in, self-supporting, $\frac{3}{8}$ in inside dia. Centre tapped. (See Fig. 2)
- L₄ 6 turns, 18 s.w.g. tinned copper, split winding, $\frac{1}{2}$ in inside dia. (See Fig. 2.)
- L₅ 6 turns, 16 s.w.g. enam. spaced $\frac{1}{4}$ in, self-supporting, $\frac{3}{8}$ in inside dia. Centre tapped
- L₆ 1 turn link, p.v.c. insulated 22 s.w.g. tinned copper, $\frac{3}{8}$ in inside dia.

Valves

- V_{1, V2} EF91
- V₃ 5763
- V₄ TT15

Jacks

- Close-circuit jack socket
- J₂ Insulated coaxial socket (Belling-Lee type L.603A)

Crystal

- 11.700 to 11.733 Mc/s

Meter

- M₁ 0-150mA d.c. milliammeter

Miscellaneous

- 3 B7G valveholders
- 1 B9A valveholder
- 1 B9G valveholder
- 3 Nylon lead-through connectors

Cabinet

- Type W
- (H. L. Smith & Co., Ltd.)

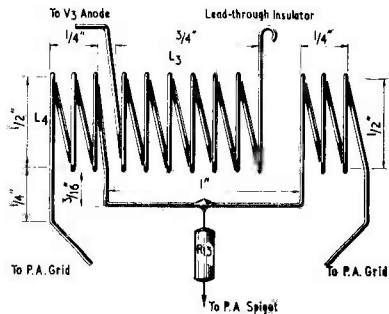

Fig. 2. Dimensions of the tripler anode and P.A. grid coils. The wire used is 18 s.w.g. tinned copper

reason the sequence of double-tripler rather than vice versa is chosen. V_2 is tuned to 23 Mc/s, which is then tripled to 70 Mc/s.

Construction

The unit is built on a 16 s.w.g. aluminium chassis 8 x 5 x 2in with a front panel 6 x 9in. The layout employed may be seen from the illustrations. Fig. 3 gives chassis drilling details, and it is recommended that all holes are drilled before the assembly is commenced. Details of the above and below-chassis screens are given in Figs. 4 (a) and (b). The

Hole	Dimension	Hole	Dimension
A	$\frac{1}{8}$ in diam.	G	$\frac{3}{4}$ in diam.
B	$\frac{3}{32}$ in diam.	H	1 $\frac{1}{8}$ in diam.
C	$\frac{3}{8}$ in diam.	J	1 $\frac{1}{2}$ in diam.
D	$\frac{1}{2}$ in diam.	K	$\frac{1}{4}$ in diam.
E	$\frac{1}{2}$ in diam.	L	No. 22 drill
F	$\frac{5}{8}$ in diam.		

below-chassis screen is made of brass in order that the valveholder spigot of the P.A. can be soldered to it. This screen is designed to be positioned between pins 3 and 4 and pins 6 and 7 of the valveholder, which should be inserted from the top of the chassis. The holes for the screen fixing screws are not given on the chassis and front panel drawings.

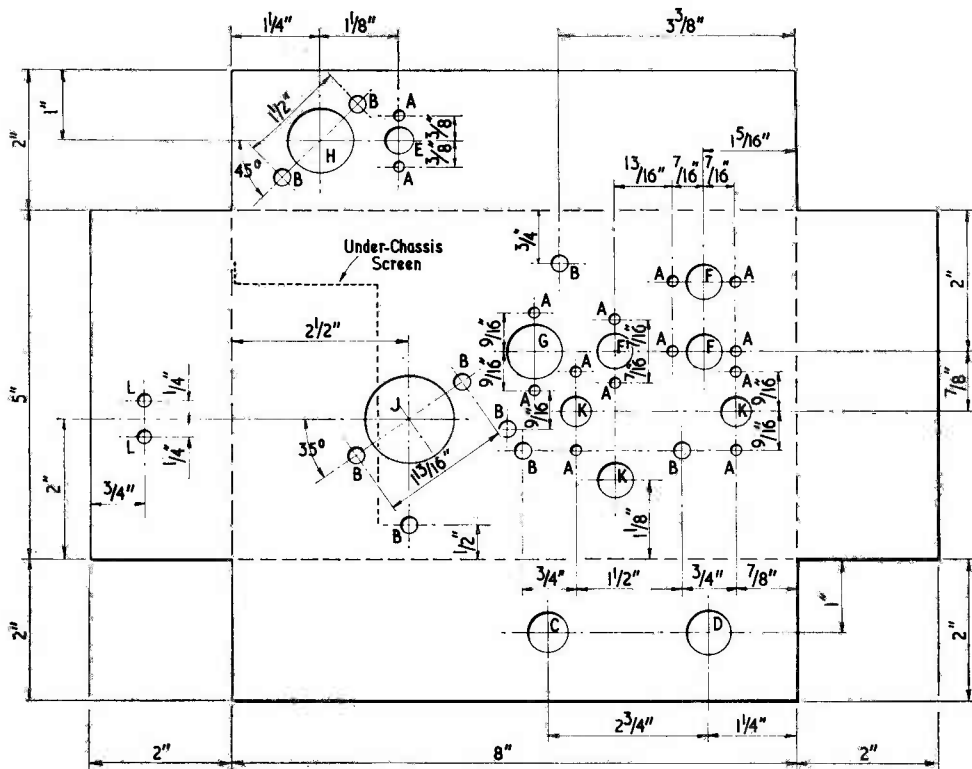

Fig. 3. Chassis drilling details

These holes are best marked out with the screens correctly positioned on the chassis. Due to the many different types of split-stator capacitors which may be used for the P.A. tuning, the positions of the fixing and spindle holes for this have also been omitted from the drawings. Hole diameters for the chassis drawings are given in the Table.

The arrangement of the coils, L_3 and L_4 is given in Fig. 2. It should be noted that these details should be followed closely in order to obtain optimum drive conditions. One end of L_3 is connected to the anode tag of V_3 valveholder while the other is supported by a nylon lead-through insulator. As L_3 and L_4 are wound with non-insulated wire it is essential to ensure that they do not touch each other, since the positive voltage which would result at the P.A. grids would cause damage to the valve.

The P.A. anode coil is soldered across the anode pins of the TT15 valveholder. The leads to the stators of the tuning capacitor should be of thick wire and kept as short as practicable. A link coupling coil of p.v.c. insulated wire is positioned near the centre of the winding, and its twisted leads connected to a pair of nylon lead-through insulators which are used as aerial terminals.

The P.A. stage is designed for anode and screen modulation. To this end a Belling-Lee insulated coaxial socket is provided on the rear of the chassis. This type of connector is recommended as it will withstand the high peak voltages associated with anode and screen modulation.

Power Requirements

The transmitter requires a heater supply of 6.3 volts at 3A. For the high tension supply capable of delivering 300 volts at approximately 150mA is needed. Of this, the power amplifier draws about 70mA anode current when tuned up. The d.c. power input is, thus, just over 20 watts. In order to fully modulate the transmitter a modulator with

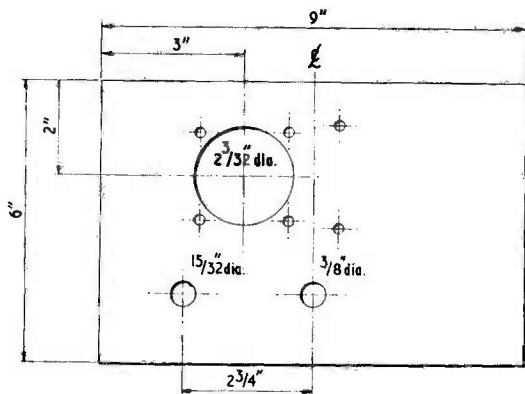

Fig. 5. Drilling details for the front panel of the 70 Mc/s transmitter. The exact positions of the meter fixing holes and above-chassis screen fixing holes are not given here, these best being marked out after assembly

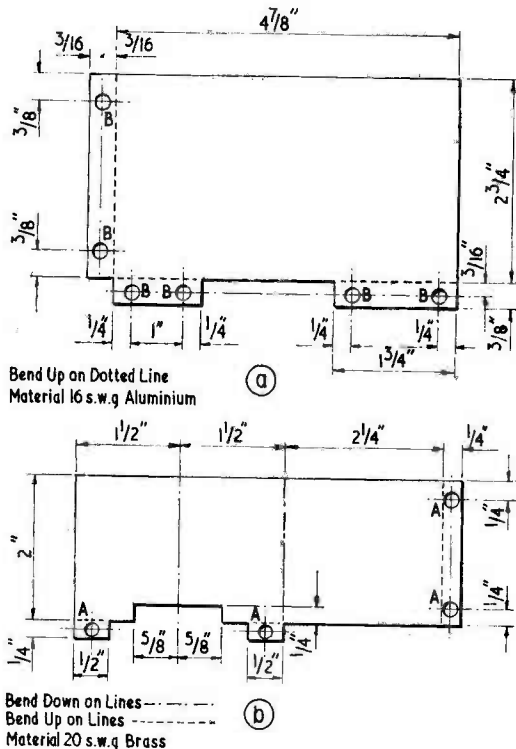

Fig. 4 (a). Above-chassis screen for the 70 Mc/s transmitter and (b) the below-chassis screen

an output impedance of $3,000\Omega$ and a power output of at least 10 watts would be required.

Alignment

The transmitter was built stage by stage, in order, commencing with the crystal oscillator. Thus, it is possible to align each stage as it is completed. Final adjustment must be made, however, when the unit is completed.

Before alignment is commenced the P.A. valve should be removed from its holder. H.T. power may then be applied and each stage tuned to its correct frequency. When optimum output from the 5763 is achieved, the P.A. valve may be inserted and tuned to resonance, a lamp being used as a load. The anode circuit of the 5763 will require slight readjustment in order to obtain optimum drive conditions. This slight readjustment is necessary due to the additional capacitance of the TT15.

The r.f. circuits will be slightly detuned when the unit is inserted into a cabinet. Suitably aligned holes should, therefore, be provided in the underside of the cabinet in order to facilitate final adjustment of the circuits.

Results

Encouraging reports were received from many stations when a simple indoor dipole aerial was used. With a good aerial system for the four metre band, stations can be worked all over the country.

News and Comment . . .

Teaching by Radio and TV

Many readers will be aware of the arguments about school education programmes on TV and no doubt the new adult education series to be given by the B.B.C. in the Autumn will arouse further discussions and suggestions for co-operation between the B.B.C. and the programme companies.

In the Bishop Bell memorial lecture given at Chichester, the Director General of the B.B.C. gave details of these programmes. Eight programmes a week are to be televised, mostly on Saturday and Sunday mornings. Three series have been planned—Italian, human biology, and modern scientific ideas being the subjects of each series. In due time subjects as diverse as dressmaking, the development of young children, everyday economics, and European art will be dealt with.

The suggestion that there should be a "television truce" at or near peak viewing times to enable the B.B.C. and commercial television to put out educational programmes at the same time, was considered by Mr. Carlton Greene to be a non-starter, as it would be tantamount to "ramming adult education down people's throats".

On sound radio, adult education programmes are to be extended by an hour a day and cover a wider range of subjects. We hope next month to refer briefly to the manner in which some other countries are tackling these problems.

Computers as Composers and Scholars?

One of the lecturers at a course on computers and the arts held at the Bristol College of Science and Technology described how characteristics of great composers were being analysed in the hope that computers would be able to produce original melodies in the composer's style. The lecturer, Mr. E. V. Hope, described how stylistic devices used by composers can be put into mathematical terms and fed into a computer. It was hoped to produce all possible permutations of these stylistic devices, more probably than the composer would have time to think of in his lifetime.

Another lecturer, the Rev. A. Q.

Morton, wrote an article which appeared in *The Times*, describing how information regarding the use of phrases, grammatical terms, etc. of New Testament writers could be put into a computer and it could clearly be shown which books, or parts of them, followed certain usages. It could then be deduced with certainty that certain writers did, or did not, write specific passages. This method has apparently proved to his satisfaction that Bacon did not write the works of Shakespeare.

In principle, the lecturer likened a computer to a library. The section where information is stored as patterns of electrical impulses corresponding to the books on the library shelves, and the section which carries out instructions to arrange the information stored in the way desired, is like asking the library assistant for a book from the shelves.

New Admiralty Scheme for Electrical Officers

The growing complexity of new warships coming into service and planned for the Royal Navy in the future means that more Electrical Officers are needed. As a result, new entry regulations for electrical and electronic specialists are being introduced for qualified men between 21 and 39 years of age. Officer entrants will be given seniority "credits" on entry based on their previous experience in outside industry and additional seniority for their academic qualifications.

As an example, a man who qualifies for no "credits" will enter as a Sub-Lieutenant and will remain so for 18 months. An officer who qualifies on entry for the maximum 8-years "credits" will come into the Navy as a Lieutenant with 6½ years seniority.

In many new ships now coming into service, electrical and electronic equipment installed may well account for up to 50% of the total cost of the warship, and this increasing proportion of complex equipment is reflected in the numbers of Electrical Officers carried. Older ships like the *Daring* and *Battle* Class destroyers (carrying one or two Electrical Officers) are being replaced by the Guided Missile Destroyers with anything between

six and eight Electrical Officers embarked.

Under the new entry scheme for the Electrical Specialisation, candidates will be accepted into the Navy between 21 and 39 years of age providing they have one of three basic qualifications: (1) A degree or degree equivalent in electrical engineering—or in science with suitable engineering subjects; (2) Graduate membership of the Institution of Electrical Engineers or of the British Institution of Radio Engineers, or (3) Possession of a Higher National Diploma or equivalent in electrical subjects.

There will be a great flexibility of career offered. For example, successful candidates will be able to choose between a short service (five year) commission or a 16-year pensionable commission, those who enter initially for five years will be given the opportunity of extending their service to 10 years or of converting to the 16-year pensionable scheme, etc. Tax-free gratuities at the rate of £155 for each year served on a Short Service commission, and for those qualifying for the minimum pensionable service a yearly pension (at current rates) of £545 with a terminal grant of three times that amount are other attractions.

Vitamin Injections for Publishers?

We hope that our readers will never need to consider that we need revitalising—the constantly rising circulation of this magazine, and the sales of books published by us, would seem to show that we are still "with it". There are books, however, which are given injections of vitamin PP to restore crumbling fibres. They are books in a special category, of course, namely ancient books which have been badly damaged. We were very intrigued with this information which was published in *The Daily Telegraph*. Apparently these injections form part of a process used by Benedictine monks at the Institute of Scientific Book Restoration in Rome.

The foregoing information could give us ideas—we already occasionally come across scented envelopes, and postcards impregnated with the scent of the flowers illustrated. Perhaps one day *The Radio Constructor* will be injected with the smell of wild roses when we have a pink colour on the cover, oranges when an orange colour hmm . . . perhaps we had better stop!

A VERSATILE HUMDINGER

By B. G. GAYDON

The humdinger, a frequently encountered component in tape recorder amplifiers and the like, has been familiar in electronic circuits since the inception of a.c. heated valves. In this article our contributor describes how a standard humdinger, combined with a hum cancellation circuit at the input terminals, completely eradicated hum in a high-gain oscilloscope Y amplifier. It should be noted that the hum cancellation circuit may require different settings for varying impedances presented to the input terminals

THIS ARTICLE DESCRIBES A SIMPLE DEVICE WHICH is suitable for addition to almost any piece of electronic equipment that is powered by alternating current. In the writer's case an oscilloscope had just been designed and constructed, but 50 c/s mains hum almost filled the screen when the Y amplifier was adjusted to full gain.

The first step which was taken to reduce the hum is shown in Fig. 1. This consisted of adding a 100Ω variable resistor across the heater supply, with its movable contact connected to chassis. When this control was carefully adjusted, hum was reduced by about a third of its original value.

A second variable resistor was then wired across the heater supply, but this time the movable contact was coupled through a 1MΩ resistor to the input to the amplifier, as shown in Fig. 2. As a result, the hum was now reduced to about 1in on the 6in screen.

The remaining hum was then analysed (by connecting the timebase) and was found to have a fundamental frequency of 50 c/s, but it was a few degrees out of phase with the hum that had been suppressed. A phase changing network was therefore added. (See Fig. 3.)

The values of the components in this network are not at all critical. In the prototype wirewound variable resistors were used since these are generally more reliable than their carbon counterparts.

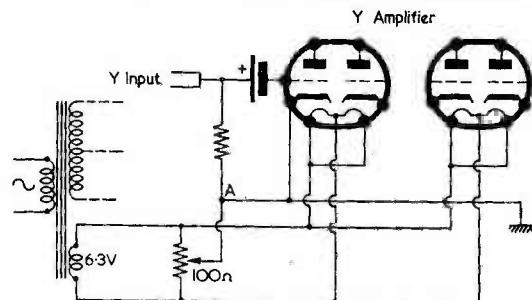

Fig. 1. The initial humdinger circuit. The slider of the humdinger is returned to chassis, at A, at the same point as the input load resistor. Heater wiring may be twisted and screened but, for reasons of clarity, this is not shown here

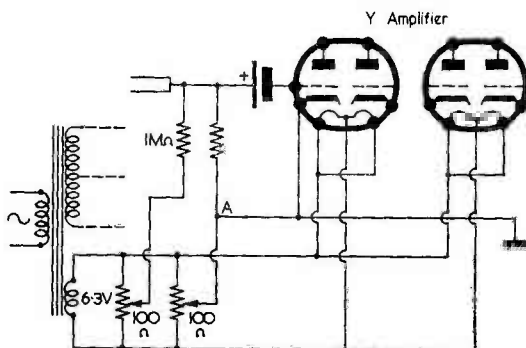

Fig. 2. Adding a hum cancellation circuit to the Y amplifier input terminals

Nevertheless, the latter would undoubtedly work quite satisfactorily.

As well as removing all the hum present inside the oscilloscope, this humdinger also neutralised

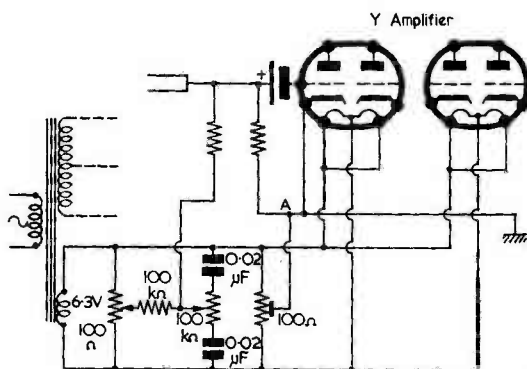
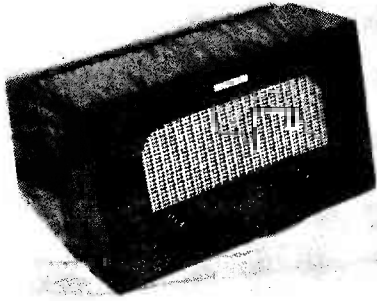

Fig. 3. The final arrangement, in which variable phase shift is added to the hum cancellation circuit. The original humdinger is now shown as a pre-set component

any hum from the wires connecting the instrument to the equipment under test. In order to do this it was found necessary to have the two variable resistors readily accessible. The original humdinger was pre-set, and mounted inside the case.



An F.M. TUNER

By V. E. HOLLEY

THIS TUNER IS DESIGNED TO GET THE BEST RESULTS from the B.B.C. v.h.f./f.m. transmissions and with a suitable aerial it will do this in practically any part of the country. Each of the valves performs only one function thereby enabling optimum design to be achieved in each stage and overall sensitivity to be high. Though not economical in the use of valves, the types specified are available at very modest prices and the cost of construction is not high.

R.F. Stage

As will be seen from Fig. 1, the signal from the dipole aerial is applied to the grid of the first valve, an r.f. pentode, via the coil L_1 , which is tuned very broadly by means of its dust core to the centre of the band of frequencies to be received. No separate tuning capacitance is necessary as the stray capacitances plus the input capacitance of the valve are sufficient. V_1 is provided with cathode bias in the usual way. Inductance L_2 in its anode circuit causes the amplified signal to be transferred via C_6 to the next stage. L_2 , also, is broadly tuned to the centre of the reception band. The anode and screen-grid of V_1 are decoupled to their own cathode and also to the cathode of V_3 in order to preserve stability.

Oscillator

A single triode, 6C4, is employed as the local oscillator in a shunt fed circuit. The oscillator coil, L_3 , which is the tuned coil, has only a single winding which serves both as tuned circuit and feedback path from the anode via C_{12} . It is tuned by the variable capacitor C_{10} and its associated trimmer, C_{11} , and it will be seen that these two are effectively in series with the parallel combination C_{13} , C_{14} . The result of this arrangement is that, by suitable adjustment of the variables, the three B.B.C. stations to be received in a particular area can be spread over the whole range of C_{10} and tuning becomes remarkably easy. The signal generated by the oscillator is introduced to the grid of V_3 via the small capacitance C_8 , of 2.2pF.

Oscillator Drift

High frequency oscillators are liable to drift from two causes. The cold input capacitance of a valve is different from its capacitance when hot and there is consequently a fairly large short term drift after switching on from cold. After about five minutes

this effect is negligible but there is a further long term drift which lasts up to an hour or more and, if not corrected, necessitates frequent adjustments to the tuning. The adjustments are always towards the high frequency end of the band and correspond to an increase of tuned circuit capacitances with rising temperature within the cabinet. The effect of the initial drift in this tuner is minimised by good ventilation and by using a rectifier valve with a longer warming up time than that of the oscillator. It will be found that, when switching on from cold, the programme is received clear of distortion as soon as the h.t. comes on, provided of course, that the tuning has not been altered since last switching off. Long term drift is balanced out by the negative co-efficient capacitor C_{13} (N75OK); balancing is not difficult and can be done with a high degree of accuracy, so that correct tuning is maintained indefinitely.

Mixer

A second r.f. pentode, EF91, is employed as an additive mixer. Signal and oscillator frequencies are fed to grid 1 and combined in the valve to produce in the anode circuit the intermediate frequency of 10.7 Mc/s. This is extracted by the transformer IFT_1 and passed on for further amplification. The conversion conductance is high and contributes very considerably to the overall sensitivity of the tuner. Anode and screen-grid are decoupled to cathode and bias is provided by the resistor R_9 , bypassed by the 2,000pF capacitor C_{17} .

I.F. Stage

The valve V_4 is another EF91 arranged in similar mode as an i.f. amplifier. The cathode bypass capacitor is here given a value of 0.01 μ F and it must be a good quality ceramic, completely non-inductive, if instability is to be avoided.

Limiter

The signal taken from the anode circuit of V_4 by the transformer IFT_2 is passed to the grid of V_5 , which is arranged as a limiter. Anode and screen-grid voltages are low and the current through the valve is still further reduced by the combination R_{12} , C_{20} , in the grid circuit, which generates bias. The result is that signals applied to the grid are reproduced in amplified form at the anode to a limited and predetermined level only, and noise

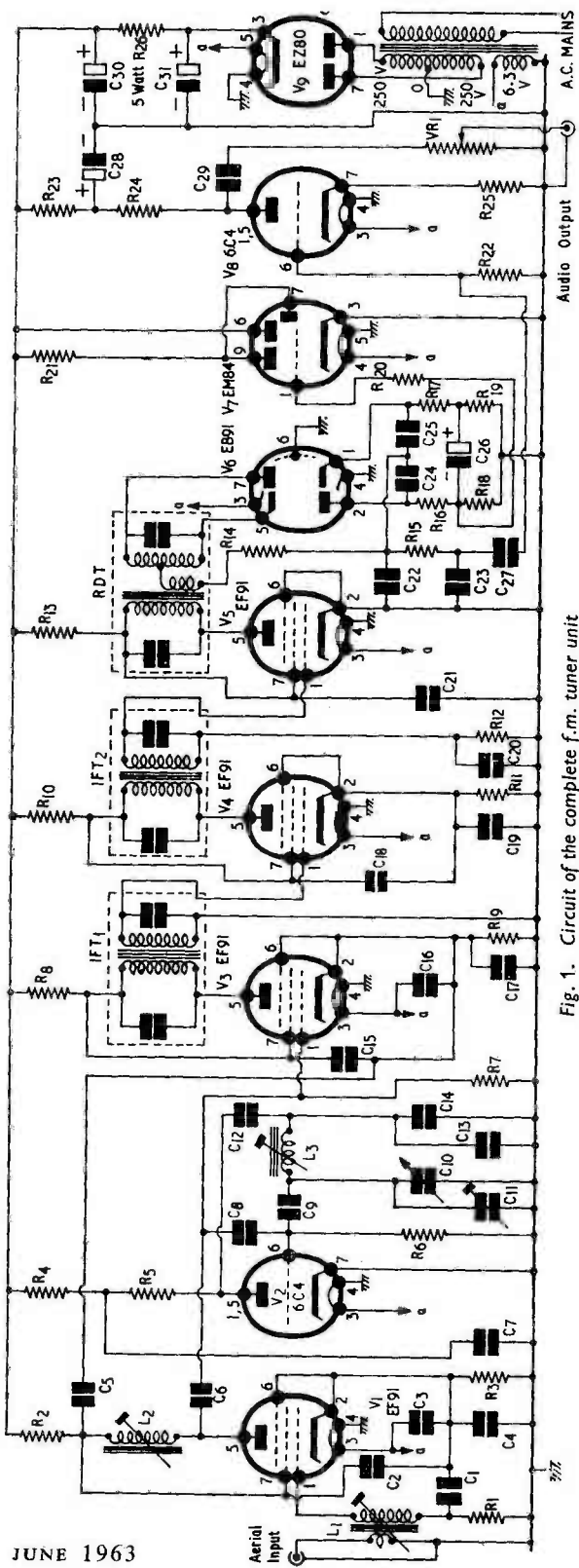

Fig. 1. Circuit of the complete f.m. tuner unit

Components List (Fig. 1)

Resistors (all resistors preferably 10% unless otherwise stated)

- R₁ 47kΩ ½W
- R₂ 4.7kΩ ½W
- R₃ 150Ω ½W
- R₄ 4.7kΩ ½W
- R₅ 10kΩ ½W
- R₆ 22kΩ ½W
- R₇ 47kΩ ½W
- R₈ 4.7kΩ ½W
- R₉ 150Ω ½W
- R₁₀ 4.7kΩ ½W
- R₁₁ 150Ω ½W
- R₁₂ 47kΩ ½W
- R₁₃ 47kΩ 1W
- R₁₄ 68Ω ½W
- R₁₅ 27kΩ ½W
- R₁₆ 1.5kΩ ½W 5%*
- R₁₇ 1kΩ ½W 5%*
- R₁₈ 10kΩ ½W } Matched 5%
or better
- R₁₉ 10kΩ ½W
- R₂₀ 2MΩ ½W
- R₂₁ 1MΩ ½W
- R₂₂ 1MΩ ½W
- R₂₃ 18kΩ ½W
- R₂₄ 47kΩ ½W
- R₂₅ 1.2kΩ ½W
- R₂₆ 1.5kΩ 5W†
- VR₁ 1MΩ log.

* R₁₆ and R₁₇ may be omitted in strong signal areas.

† R₂₆ may require adjustment (see text)

Capacitors (350V wkg. unless otherwise stated)

- C₁ 0.002μF disc ceramic
- C₂ 0.002μF tubular ceramic
- C₃ 0.002μF disc ceramic
- C₄ 0.002μF disc ceramic
- C₅ 0.001μF tubular ceramic
- C₆ 100pF ceramic
- C₇ 0.002μF tubular ceramic
- C₈ 2.2pF ceramic
- C₉ 22pF ceramic
- C₁₀ 15pF panel mounting air-spaced variable
- C₁₁ 30pF air spaced concentric trimmer
- C₁₂ 330pF ceramic
- C₁₃ 6.8pF N750K ceramic
- C₁₄ 27pF silver mica
- C₁₅ 0.01μF paper or ceramic
- C₁₆ 0.002μF disc ceramic
- C₁₇ 0.002μF disc ceramic
- C₁₈ 0.01μF paper or ceramic
- C₁₉ 0.01μF ceramic
- C₂₀ 47pF silver mica
- C₂₁ 0.01μF paper or ceramic
- C₂₂ 300pF ceramic
- C₂₃ 0.002pF ceramic or paper
- C₂₄ 300pF ceramic
- C₂₅ 300pF ceramic
- C₂₆ 10μF electrolytic, 50V wkg. wire ended
- C₂₇ 0.05μF paper
- C₂₈ 8μF electrolytic
- C₂₉ 0.1μF paper
- C₃₀, C₃₁ 16+16μF electrolytic, wire ended

Valves (and Valveholders)

V ₁	EF91 (B7G ceramic or nylon loaded base and screen)
V ₂	6C4 (B7G ceramic base and screen)
V ₃	EF91 (B7G ceramic or nylon loaded base and screen)
V ₄	EF91 (B7G base)
V ₅	EF91 (B7G base)
V ₆	EB91 (B7G base)
V ₇	EM84 (B9A base)
V ₈	6C4 (B7G base)
V ₉	EZ80 (B9A base)

Transformers

Mains—250-0-250V 60mA; 6.3V 3A
I.F.—Denco IFT10/11, 2 required
Detector—Denco, type RDT

voltages are very much reduced if not entirely eliminated. If the tuner is used in a fringe or difficult reception area, the signal at the grid of V₅ will be small and the stage will make a useful contribution to the overall gain; limiting will be less efficient of course, but this is not a serious matter.

Demodulation and De-emphasis

The frequency modulated signal is taken from the anode of V₅ by the ratio detector transformer and the audio signal is extracted by the double diode valve V₆ and its associated network of resistors and capacitors. This is a conventional ratio detector circuit with the addition of the balancing resistors R₁₆ and R₁₇, which improve the inherent interference rejection properties. If the tuner is to be used in an area of good signal strength, these resistors can be omitted, but for fringe reception, where V₅ is less effective as a limiter, they should be included.

The audio signal appears at the junction of C₂₄ and C₂₅ and is then passed through the filter R₁₅

C₂₃ to remove the pre-emphasis of the higher frequencies before being taken to the output stage via C₂₇.

Tuning Indicator

In addition to extracting the audio signal, the ratio detector produces a d.c. voltage across the reservoir capacitor C₂₆, which is proportional to the strength of the received signal. This voltage is balanced about earth and the negative portion is applied through the isolating resistor R₂₀ to the control grid of the tuning indicator valve, V₇. The valve selected for this function in the prototype is the EM84, but any other indicator of about the same sensitivity would serve equally well. It is fitted, with its base, at the end of a length of four-core cable, connection to the chassis being made by way of a B7G plug and socket, and may thus be fitted in any desired position. If fitted in the cabinet to be described, the base should be of the moulded type and the metal surround should be removed.

A.F. Stage

A single triode, 6C4, is employed here as a resistance coupled amplifier with an anode load of 47k Ω and a bias resistor of 1.2k Ω which is not bypassed. The gain is 6 times and the output, controlled by VR₁ is, in the prototype, fed direct to the inverter of a push-pull output stage. If R₂₅ be bypassed by a 50 μ F electrolytic capacitor, the gain will be doubled but linearity will not be quite so good. Additional smoothing and decoupling are provided by R₂₃ and C₂₈.

More commonly, perhaps, the tuner will be required for use with a conventional high fidelity amplifier and in this case, V₈ may with advantage be used as a cathode follower in the circuit given in Fig. 2. This provides a low impedance output which allows the signal to be carried by a small diameter screened cable over a relatively long distance without attenuation of the higher audio frequencies.

Power Supply

The tuner requires about 40mA h.t. at around 230 volts and a heater supply of 2.7 amps at 6.3 volts. This is rather a large demand to make upon an existing amplifier, so a power supply is included in the design. A mains transformer of the semi-miniature type could be used but heat generation will be reduced if a component capable of, say, 60mA is employed. Smoothing is provided by the two capacitors C₃₀ and C₃₁ and the resistor R₂₆; the value of the resistor may need some adjustment to provide the correct h.t. line voltage according to the output of the transformer-rectifier combination employed. The rather long heating time of the EZ80 makes it a very suitable rectifier but any other indirectly heated type could be used provided the proper heater voltage is available from the transformer. A metal rectifier is not recommended. No mains switch is included, since the supply in the prototype installation is controlled elsewhere.

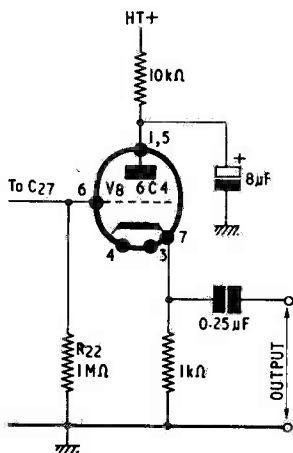

Fig. 2. Alternative output stage (low impedance)

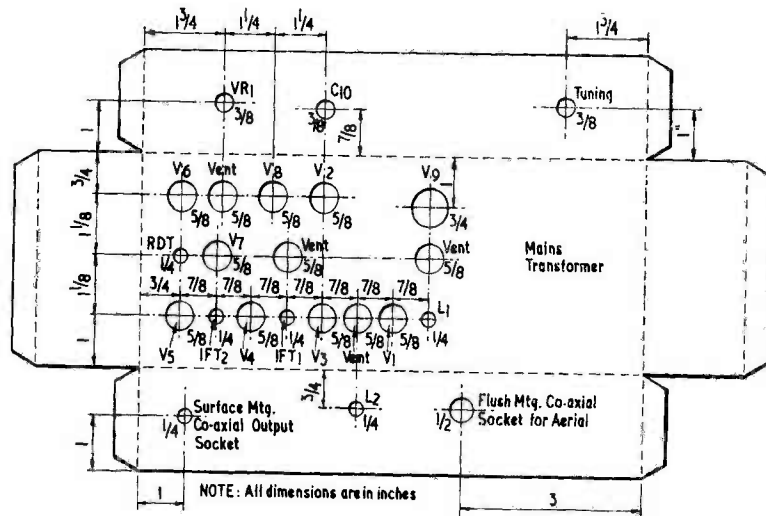

Fig. 3. Plan of chassis (top view)

Construction

A plan of the chassis, of 16 s.w.g. aluminium, measuring 10 x 4 x 2 in, on which the tuner and its power supply are constructed, is given in Fig. 3. Fixing holes for transformers, etc., are not shown, since they will vary somewhat according to the components used. There is plenty of room for all the components and construction is quite simple and straightforward. It is important to appreciate the considerable effect which the physical form of a circuit has upon its performance at very high frequencies, and the constructor who is not familiar with the liberties which may be taken with wide band v.h.f. amplifiers, should follow the recommended layout exactly. It is essential to avoid instability. Even a slight trace of this will impair the acceptance bandwidth of the tuner so that it may be unable to accept the frequency deviations of the transmissions, thus introducing distortion. A reduction of bandwidth also shows up minor random variations of oscillator frequency which would otherwise be of no account, so that the tuning may need frequent adjustment.

With the layout shown, the tuner is completely stable without the aid of any screening below the chassis; in fact, the only screening needed is around the valves, V_1 , V_2 and V_3 , where it is included to guard against possible radiation of the oscillator second harmonic in television Band III. No such radiation has been detected in the prototype.

Construction can proceed in any desired order. The author found it convenient to fit the valveholders and transformers, etc., first and wire up the power supply and heater circuits, proceeding then stage by stage from aerial to output.

Wiring

Flexible p.v.c. covered wire is recommended for the heaters and 22 s.w.g. tinned copper for the remainder of the wiring. V.H.F. technique must of course be observed, all connections being made as

short and direct as possible without regard to appearance, especially for decoupling components. A small soldering iron of the instrument type is necessary and care must be taken not to damage small components by overheating. The main smoothing resistor, R_{26} , must be fitted above the chassis where the heat which it produces is easily dissipated; in the prototype it is on a tagstrip bolted to the top of the mains transformer. Dropping and decoupling resistors should be fitted vertically so that, when all else is done, the h.t. line can be run round to each stage in turn in a position well away from other components, whereupon it will not be likely to conduct r.f. currents from one stage to another.

A complete wiring diagram is given in Fig. 4. It shows the correct connections and the approximate position in the chassis of each component. The wiring has been opened out for clarity and the connections consequently appear longer than is permissible in construction. In most cases it will

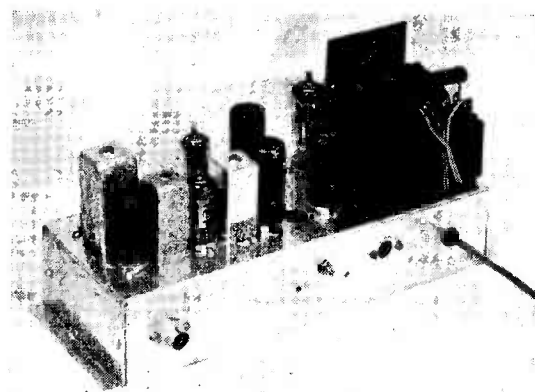

Above-chassis view of the tuner unit constructed by the author

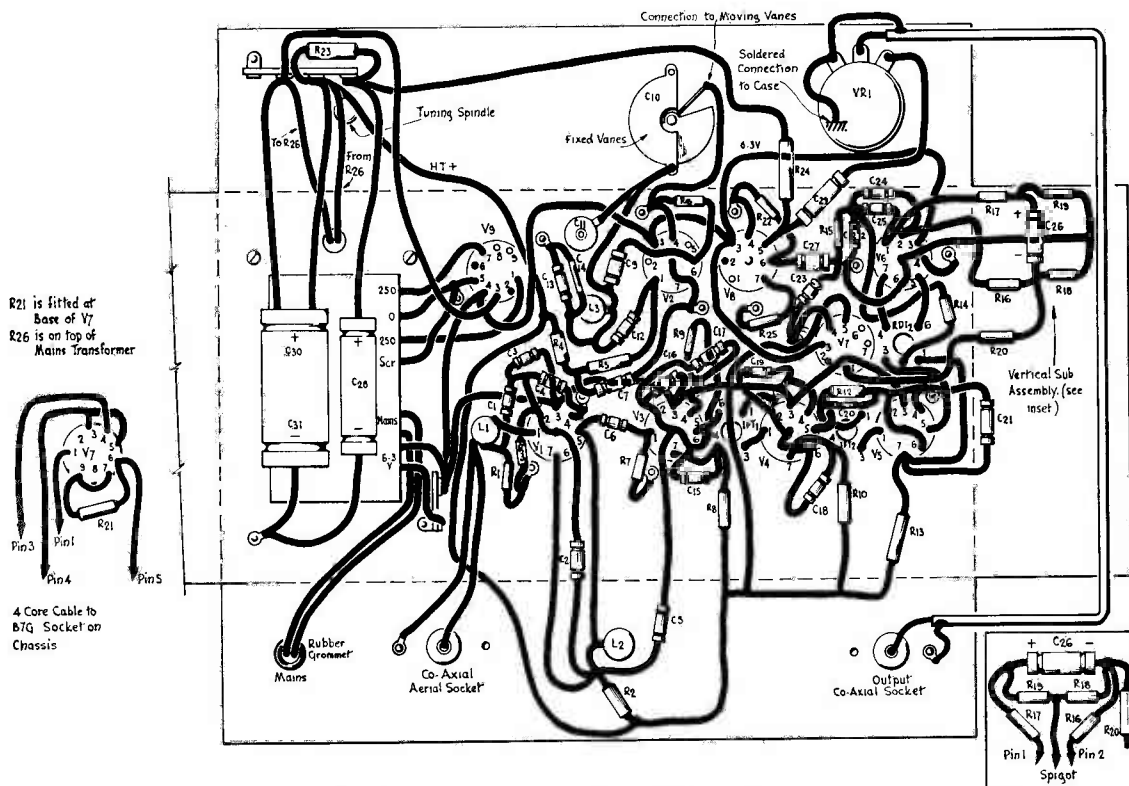

Fig. 4. Point-to-point wiring diagram of the tuner

be found that connections to bypass and decoupling components can be reduced to less than $\frac{3}{8}$ in without difficulty and this should be the aim.

Operation

As the three transmissions are spread over the whole range of the tuning capacitor, the usual slow motion drive and tuning scale are not required. It is in fact quite satisfactory to fit a large diameter control knob direct to the tuning capacitor spindle, the programmes being identified by indicators engraved on the periphery of the knob in such positions that each is received when its marker is brought to the 12 o'clock position. In the prototype, V_8 is used as an amplifier and a volume control is included in its output. The tuning drive is therefore transferred to the left, being taken from the capacitor by a $2\frac{1}{2}$ in drive drum, as in Fig. 5, to a $1\frac{1}{2}$ in drum mounted on the tuning spindle, giving an almost 2:1 reduction. A projecting lug soldered to the smaller drum and a 4BA bolt in the front of the chassis, limit its rotation to about 350° , corresponding to 180° rotation of the tuning capacitor.

Components

The resistors generally should be 10% tolerance but R_{16} and R_{17} should be 5%. R_{18} and R_{19} should be balanced as accurately as possible. The wattage

rating for each is given in the components list. The capacitors are not in general very critical but in some cases a particular kind is necessary and is specified without alternative in the components list. The electrolytic, C_{26} , must be a wire-ended type as neither side is at earth potential.

The aerial coil, L_1 , is wound with 20 s.w.g. tinned copper wire on a former of $\frac{3}{8}$ in in diameter, having a dust core of $\frac{1}{4}$ in; $3\frac{1}{2}$ turns are needed for the grid winding, spaced one wire diameter, while the aerial coupling coil is one complete turn of 22 s.w.g. enamelled wire located at the bottom of the grid winding as in Fig. 6. The inductance, L_2 , consists of 3 turns of 20 s.w.g. wire on a similar former with the same spacing. The oscillator coil, L_3 , is wound on a standard Neosid $\frac{3}{8}$ in former, with core coded black, and consists of four turns of 22 s.w.g. enamelled wire, spaced one diameter. L_1 and L_2 may also be wound on Neosid formers if preferred, in which case the turns will be 4 and $3\frac{1}{2}$ respectively. All the windings should be made a good spring fit by winding them first on a slightly smaller former, and should be secured in position with polystyrene cement or some similar adhesive.

Testing

It should be noted that although the tuner will not radiate when properly aligned, it is possible for

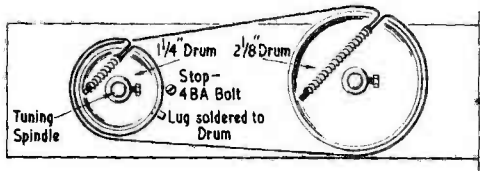

Fig. 5. The tuning drive arrangement

it to cause interference in television Band III when it is upside down on the bench for preliminary adjustment. It is best, therefore, to carry out this operation outside viewing hours.

When construction is complete and all the wiring has been checked, apply a meter between C_{31} and chassis to make sure there are no short-circuits in the h.t. If all is well, power can be connected and a check made with a meter that voltage is present at the anodes and screen-grids of the valves. The measured h.t. voltage should be within the range 220-240 volts at C_{30} ; if it is not, the value of R_{26} must be altered to make it so.

I.F. Alignment

This should be done, if possible, with the aid of an a.m. signal generator and a high resistance d.c. voltmeter (10,000 ohms per volt or better). Connect the meter on the 10V range across C_{26} , observing polarity, and inject an unmodulated signal of 10.7 Mc/s at the grid of V_4 . Adjust both cores of IFT_2 and the primary (top) core of RDT for maximum reading on the meter. The signal should be reduced in amplitude as the circuits come into line so that the meter reading does not exceed about 5 volts. Now connect the meter between chassis and the junction of R_{14} , R_{15} , and adjust the bottom core of RDT for zero on the meter. It will be found that movement of this core over the range of its travel will cause the meter reading to rise to a maximum, decline through zero to a reverse maximum and then return to zero after which further movement has no effect. The proper position for the core is at the zero between the two maxima. This adjustment will probably affect RDT primary, the core of which should accordingly be readjusted as described above.

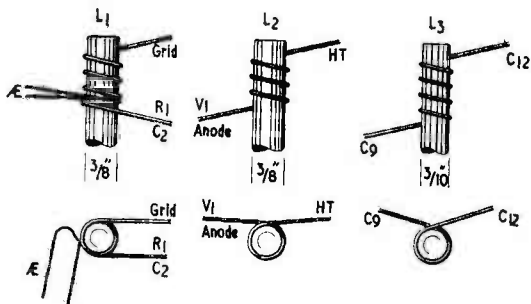

Fig. 6. Coil details

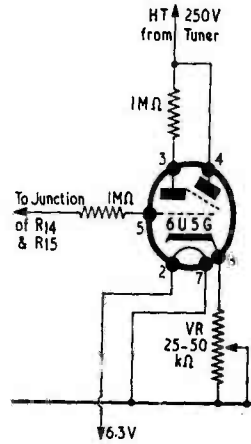

Fig. 7. Circuit of null point indicator for alignment

Reconnect the meter across C_{26} , inject a signal at the grid of V_3 and adjust both cores of IFT_1 for maximum meter reading. As the adjustments are to some extent interdependent, it is advisable now to repeat the whole process as a check.

Acceptance Bandwidth

The acceptance bandwidth of the i.f. amplifier should now be checked. With signal injection at V_3 grid and the meter connected between chassis and the junction of R_{14} , R_{15} , move the generator slowly over the range 10.5 to 11 Mc/s. If the alignment is symmetrical as it should be, a maximum reading will be observed on the meter at 10.6 Mc/s, zero at 10.7 and a maximum of inverse polarity at 10.8 Mc/s. The two maxima should be of equal magnitude and equidistant from the zero.

R.F. and Oscillator Circuits

These are perhaps best adjusted on actual transmissions. Connect the tuner to an aerial and an a.f. amplifier and set C_{10} at full capacitance and C_{11} at about half. Manipulate the core of L_3 till the lowest frequency transmission (normally the Light programme) is received, and then with C_{10} , tune in the centre frequency transmission (normally the Third programme). The signal must now be attenu-

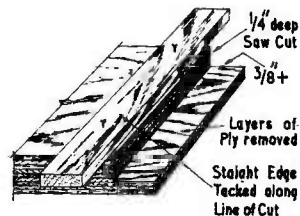

Fig. 8. Forming a rebate

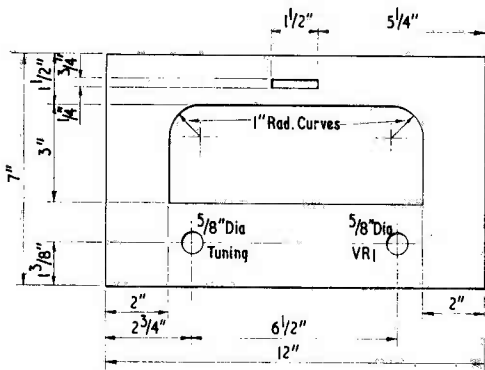

Fig. 9. Plan of the cabinet front panel

ated in some way as, for instance by connecting a less efficient aerial, so that the meter across C_{26} shows only a low reading. Adjust the cores of L_1 and L_2 for maximum reading and then stagger them a little so that equal meter readings are obtained from each of the three transmissions to be received. Finally, by adjustment of C_{11} and the core of L_3 , space the transmissions so that they occupy the whole range of C_{10} .

It may be found that stations are received at two different settings of L_3 core. The oscillation frequency should be below that of the received signal and the correct core setting is that which gives the greater inductance.

Alignment without Instruments

If a signal generator is not available, pre-tuned i.f. and detector transformers should be used. Connect the best available aerial and adjust C_{10} and C_{11} as described above. Search for a transmission by manipulating the core of L_3 and when one is received, adjust the cores of both i.f. transformers and the top core of RDT for maximum deflection on the tuning indicator. The adjustments required will be limited to those necessary to compensate for differences in circuit stray capacities and will be small; do not make any large alterations or the pre-alignment will be lost. It is well to have an amplifier connected for this operation so that the transmission can be identified definitely as one of the wanted programmes, but it is important that the adjustments should be made with the aid of the tuning indicator and not by ear, since the point of greatest sound output does not correspond with resonance in frequency modulation reception.

Accurate adjustment of the bottom core of RDT demands some sort of sensitive zero indicator for the potential at the junction of R_{14} and R_{15} . If a high resistance meter is not available, a Magic Eye tuning indicator of the 6U5 variety can be pressed into service. Set it up in the circuit of Fig. 7 and with the control grid connected to chassis, adjust the potentiometer in the cathode circuit so that the shadow angle on the display is exactly zero. Transfer

the grid connection to the junction of R_{14} and R_{15} and adjust the bottom core of RDT for zero shadow angle. The display will open out or overlap according to the polarity of the voltage applied to the grid. It will not be possible to carry out an acceptance bandwidth test but a fair idea of the symmetry of alignment can be obtained when the r.f. and oscillator circuits have been adjusted by tuning "through" a carrier and noting the deflection of the tuning indicator (V_7) each side of maximum.

The r.f. and oscillator circuits can now be dealt with as described, using V_7 as an indicator in lieu of the meter.

Drift Test

A test must now be carried out to see that the long term drift has been correctly balanced out. Place the tuner right side up on the bench, raised about half an inch from the surface so as to simulate service conditions. Allow ten minutes for warming up and then tune in a transmission accurately with the aid of the tuning indicator or a meter across C_{26} . Examine after one hour and note if the tuning has been maintained. If it has not, note whether the required correction is an increase or decrease in the capacity of C_{10} . If it is an increase, the value of the correction capacitor C_{13} must be reduced: if a reduction, C_{13} must be made larger. It is unlikely that any large alteration in value will be necessary but if it should exceed 5pF it will be advisable to make a corresponding alteration to C_{14} so that the value of the parallel combination is maintained at $33\text{pF} \pm 5\text{pF}$.

Housing the Tuner

The form of construction recommended makes the tuner suitable for fitting in a cabinet containing other equipment, the only panel space required being for the tuning knob and indicator. Adequate ventilation above and below chassis must be provided. Alternatively, a separate cabinet of professional appearance can be made quite easily from plywood having an oak, walnut, etc., facing. A good source of supply is an old television cabinet or some other item of plywood furniture, because, although all the old polish will have to be removed, the wood will need much less attention before final finishing than if it were new.

Mark out and cut the sides first, each 7 x 5in, from $\frac{3}{8}$ in ply and form rebates at the top and bottom on the unfaced surfaces $\frac{1}{4}$ in deep and very

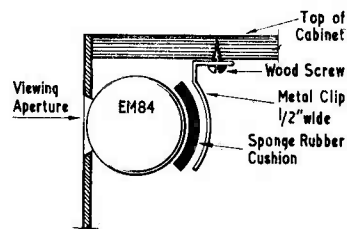

Fig. 10. Section through the tuning indicator showing the method of fitting

slightly more than $\frac{3}{8}$ in wide. This is quite a simple operation with plywood and if a rebating plane is not to hand, can be done very satisfactorily by making a cut with a tenon saw and removing the unwanted layers of ply with a chisel or even a penknife. Finish off with glasspaper. A light wooden straight-edge tacked along the line of cut as in Fig. 8 is a useful aid to accurate work with the saw. Cut next the top and bottom, $11\frac{1}{2}$ in x 5in, and fit the four pieces together using two or three $\frac{3}{8}$ in panel pins driven halfway home at each corner. Nail a diagonal across what will be the back of the cabinet to keep the assembly truly rectangular.

Faced plywood $\frac{3}{8}$ in thick is required for the front. Place the assembly front down on the "wrong" surface of the ply, mark out the front and cut it very slightly larger than the outline so as to leave a small margin for sanding off; then prepare it as in Fig. 9. The large aperture is not of course essential, but it is a suitable treatment and when covered with Tygan improves both the appearance and the ventilation. The rounded top corners are arcs of a circle whose radius is 1in and can be cut accurately with a 2in centre bit. When a satisfactory fit has been obtained, dismantle the temporary assembly and cut about eight $\frac{1}{8}$ in diameter holes in the bottom for under-chassis ventilation. All the mating surfaces can now be covered with a thin layer of glue and the cabinet finally assembled, driving the panel pins right home and punching the heads below the surface. Surplus glue should be wiped away while it is wet.

When the glue is hard, the indentations above the heads of the panel pins and any other blemishes should be filled with plastic wood of the colour in which the cabinet is to be finished.

Finishing

When the filler is hard, the cabinet should be well rubbed down with No. 2 glasspaper, removing old polish, projections at the corners, etc., and finishing

off with No. 0 paper. Whatever final finish is applied, the result depends very greatly on the preparation at this stage and care should be taken that no scratches or blemishes remain. Wood dye of the desired colour can now be rubbed in with a rag wad. For the final finish there is nothing better than french polish, the application of which, contrary to popular conception, is not at all difficult with one of the polishes sold for amateur use. The prototype cabinet was polished in two hours using "Furniglas", with a first class result. If the wood is new, some filler may have to be applied first, but the polish manufacturer's instructions should be followed here.

Fitting the Tuner

Glue a piece of Tygan over the front aperture and fit the tuning indicator behind the viewing slot, securing it with an aluminium bracket and sponge rubber cushion as shown in Fig. 10. Place the tuner in position and drill $\frac{1}{8}$ in holes up through the bottom of the cabinet and through the flanges at the ends of the chassis, two at the mains transformer end and one at the other. Enlarge and countersink the holes in the wood only, and secure the tuner with wood screws or self-tapping screws of suitable diameter inserted through the bottom and into the chassis flanges. It now remains to fit four small rubber buffers to the bottom of the cabinet so that it will not damage polished surfaces on which it may stand; this will also enhance the appearance and permit under-chassis ventilation.

Aerial

In favourable reception areas, a rudimentary indoor dipole will probably be found sufficient. Under difficult conditions, a loft-mounted or outside dipole with reflector is recommended. The down lead should be 75Ω coaxial cable and if the utmost is required, the low loss type as used for fringe television reception offers a worthwhile advantage.

TRADE REVIEW

STAMP TYPE SHACK PHOTOGRAPHS

Photo Stamps Ltd., 334-6 Goswell Road, London, E.C.1, provide a service of interest to all radio amateurs and others who would like to obtain small stamp type photographs of their shacks, workshops, etc. These are often required to affix to QSL cards and letters where the information imparted requires amplification by photographic means.

From an original photograph they will produce sheets of stamps, perforated and gummed, in sizes of $1 \times 1\frac{1}{2}$ in, $1\frac{1}{2} \times 1\frac{1}{4}$ in, $1\frac{1}{2} \times 2$ in and $2\frac{1}{4} \times 3$ in according to preference. Each sheet of stamps consists of 90, 50, 40 and 27 stamps respectively and costs 18s. 6d. per sheet.

The sample sheet we had prepared was of the $1\frac{1}{2} \times 2$ in size (40 stamps) and this appeared to be just the right size for attaching to QSL cards.



The twenty-second in a series of articles which, starting from first principles, discusses the basic theory and practice of radio

part 22

understanding radio

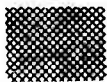

By W. G. MORLEY

IN LAST MONTH'S CONTRIBUTION TO THIS SERIES WE introduced the transformer, and carried on to consider the iron-cored version of this component. We concluded by showing that, although the current in the secondary of a transformer flows in the opposite direction to that in the primary, the two windings give the appearance, in practice, of being "in phase".

We shall now carry on to discuss the autotransformer.

The Autotransformer

Up to now we have considered transformers with separate primaries and secondaries. It is possible, however, to employ a common winding for both the primary and the secondary, and this technique is used in a special type of component known as the *autotransformer*.

Fig. 129 (a) illustrates an autotransformer in which the secondary consists of a section of the primary winding. As in Fig. 128¹, the windings are assumed, for ease of explanation, to be wound on a cylindrical iron core. When an alternating voltage is applied to the primary a changing magnetic field is produced, this inducing a back e.m.f. which is, for all practical purposes, equal to the applied voltage. The back e.m.f. appears in the secondary because, in this case, it is part of the primary winding.

As occurred with the case of Fig. 128, the secondary voltage has all the appearance of being "in phase" with the applied voltage. In consequence when, as in Fig. 129 (b), we examine circuit conditions at an instant during the cycle when the upper primary terminal is positive, we find that the upper terminal of the secondary is positive also. Since, because

they are all in the same changing magnetic field, each turn of the winding has the same voltage induced in it, we have the same voltage relationship as occurred with the transformer with separate primary and secondary windings; viz.,

$$\frac{\text{Voltage across secondary}}{\text{Voltage applied to primary}} = \frac{\text{Turns in secondary}}{\text{Turns in primary}}$$

However, an important point which now arises is that the secondary current flows in the *opposite* direction to the primary current. In the section of winding which is common to both primary and secondary we have, therefore, two currents flowing in opposing direction; whereupon the total current becomes equal to the difference between the two. When the turns ratio is close to 1:1, the difference between the primary and secondary currents will be considerably smaller than either of the two currents on their own and it is possible, in consequence, to employ thinner wire in the common section than would be needed to carry either the primary or the secondary current.

Fig. 129 (c) illustrates an autotransformer in which the secondary has more turns than the primary. In this instance the secondary voltage will be higher than the primary voltage. Once again, assuming a turns ratio which is close to 1:1, the common winding could have thinner wire than that which would be needed for the primary or secondary currents on their own.

Further alternatives are shown in Figs. 129 (d) and (e). In Fig. 129 (d), the secondary winding is common to the centre section of the primary, whilst the reverse state of affairs is shown in Fig. 129 (e). Again, when the turns ratio is close to 1:1, the common winding may employ thinner wire.

It should be noted that, if the turns ratio is not

¹ Published last month.

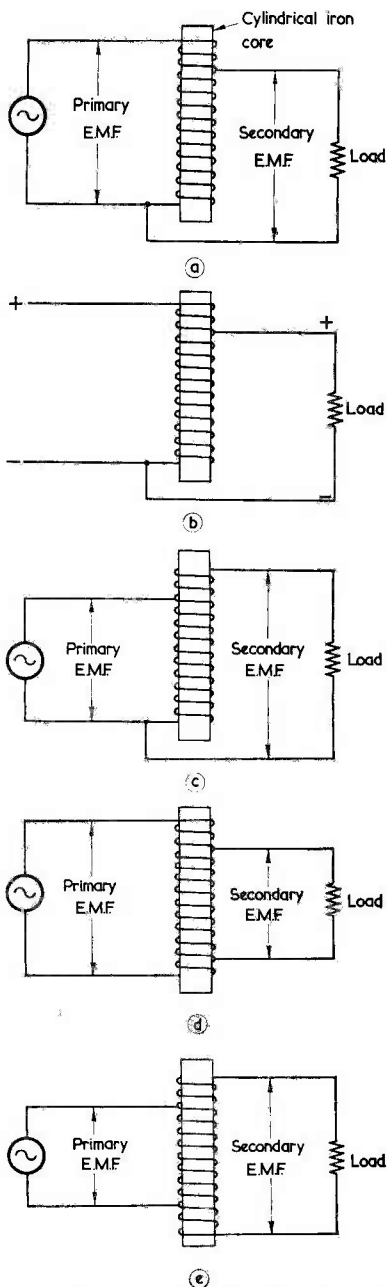

Fig. 129 (a). Demonstrating the action of an autotransformer. A cylindrical iron core is assumed.
 (b). The polarities at one instant during the a.c. cycle
 (c). A step-up autotransformer
 (d). A step-down autotransformer in which the shared winding appears between the ends of the primary
 (e). A step-up autotransformer in which the shared winding is between the ends of the secondary

close to 1:1, the primary and secondary currents vary by proportionate amounts, and the difference between them tends to become only slightly smaller than the larger of the two. Thus, the advantage of being able to use thinner wire for the common winding only applies to autotransformers with turns ratios close to 1:1.

Fig. 130 illustrates the circuit symbols corresponding to the different autotransformer types we have just discussed. As may be seen, these are virtually self-explanatory.

In practice, iron-cored autotransformers employ cores which completely encircle the winding, as occurs with the core constructions we saw for power and a.f. transformers in Fig. 122.² Because one winding is common to both primary and secondary, the saving in winding wire causes autotransformers to be cheaper than transformers with separate primaries and secondaries. On the other hand, autotransformers have the disadvantage that the primary and secondary windings are not isolated from each other.

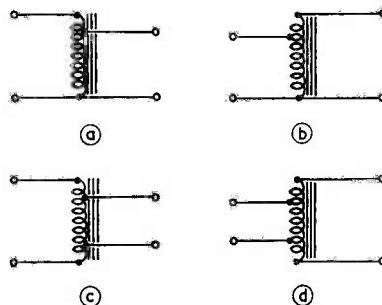

Fig. 130. Circuit symbols for the autotransformers of Fig. 129; (a) depicts the autotransformer of Fig. 129 (a), (b) that of Fig. 129 (c), (c) that of Fig. 129 (d), and (d) that of Fig. 129 (e)

Eddy Currents and Laminations

In a transformer employing an iron core, the magnetic field resulting from the primary current causes currents to be induced not only in the turns of the secondary but in the iron core itself. Fig. 131 (a) illustrates this effect by showing a cross-section through a transformer having a solid iron core, and illustrating a typical current in the core. The currents induced in the core follow circular routes which tend to be coaxial (i.e. share a common axis) with the coil which produces them. The solid iron core offers little resistance to the flow of the induced currents, and a considerable amount of power may be wasted in consequence. As we have already noted when considering iron dust cores,³ the currents induced in the iron core are known as *eddy currents*. In an iron-cored transformer, the eddy currents not only cause a waste of power but they also result in an undesirable rise in core temperature due to the heat dissipated.

² Published last month.

³ In "Understanding Radio" part 19, March 1963 issue.

Eddy currents may be considerably reduced by *laminating* the core, as in Fig. 131 (b). In this diagram the core is made up of a number of thin sheets, or *laminations*, of magnetic material, each of which is insulated from its neighbours. In consequence, the circulating current illustrated in Fig. 131 (a) cannot flow, because its path is broken by the insulating surfaces between laminations.

The use of a laminated core does not entirely eradicate eddy currents since these may still flow in individual laminations, as shown in the magnified view of Fig. 131 (c). However, the total currents which flow in individual laminations is very much smaller than the total currents which could flow in a solid iron core.

Eddy current losses increase with frequency. As a result it is, in general, desirable to employ thinner laminations in transformers operating at audio frequencies than at mains power frequencies. The use of thinner laminations reduces the small eddy

currents which flow in each lamination. In this country, many mains power transformers (for radio applications) and large audio frequency transformers employ laminations which have been standardised at one of two thicknesses, viz. 0.020 and 0.014 in. Usually, 0.020in laminations are employed in mains power transformers and 0.014in laminations in large audio frequency transformers.⁴ It must be pointed out that the total range of lamination materials and thicknesses for iron-cored transformers intended for radio applications is very much wider than the two types just mentioned, and we shall discuss this subject in greater detail at a later date.

If it were possible for a circulating eddy current of the type depicted in Fig. 131 (a) to be interrupted at one point by inserting insulation, an e.m.f. would appear on either side of the insulating material. This e.m.f. could never be greater than the e.m.f. induced in a single turn of the transformer itself and it is, in consequence, low in value. In a practical mains transformer it would, for instance, be considerably less than 1 volt. Because of the low voltages associated with the eddy currents there is no necessity to employ thick, or high-grade, insulation between laminations, since rudimentary insulation will cope quite satisfactorily. In practice, laminations may be insulated from each other by coating one surface of the strip metal from which they are stamped out with varnish, thin paper, china clay or any other similarly inexpensive material. Often sufficient insulation is offered by the oxide surface which forms naturally on the laminations, or by the scale which forms on the strip material at the rolling mill. The insulating effect offered by the natural oxide surface may be increased, also, by allowing deliberate rusting to take place.

In order that a core made with laminations may provide a complete magnetic circuit around the primary and secondary, the laminations are manufactured in pairs. A typical U and T pair is shown in Fig. 132 (a), these being assembled together as in Fig. 132 (b). An alternative is the E and I pair shown in Fig. 132 (c). Frequently, "scrapless" or "no-waste" versions of the E and I pair are employed, and these derive their name from the fact that, when two E's are stamped out of the strip material, the two rectangular pieces punched from the centre form the complementary I's. See Fig. 132 (d). A number of other shapes likely to be encountered are illustrated in Figs. 132 (e), (f) and (g), those in (f) and (g) being employed for the two-limb core constructions which were shown in Figs. 122 (b) and (c). Other shapes may also be met. However, the most frequently employed lamination shapes are the U and T pair of Fig. 132 (a) and the E and I pair of Fig. 132 (c).

Laminations are inserted into a transformer either by *interleaving* them (Fig. 133 (a)) or by

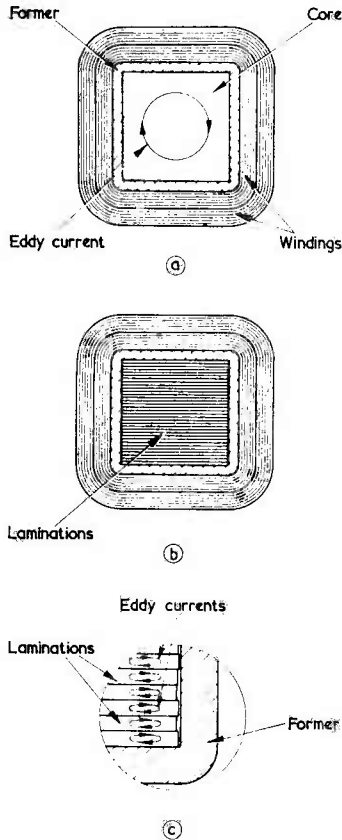

Fig. 131 (a). If a transformer has a solid iron core, eddy currents, similar to that shown here, may flow in the core

(b). The flow of eddy currents may be considerably reduced by employing laminations which are insulated from each other

(c). A magnified view which illustrates that, even with laminations, small eddy currents may still flow

⁴ This is by no means always true, however. It is cheaper to make a transformer with 0.020in laminations than with 0.014in laminations, because the core material per unit volume costs less and because transformer assembly time is reduced (since there are fewer laminations to be handled). Quite a few large audio frequency transformers are manufactured with the thicker laminations.

“butt-jointing” them (Fig. 133 (b)). The interleaved construction is the most efficient, because it most closely resembles a solid iron core. Whilst small gaps must inevitably appear at the points where one lamination meets its partner, the interleaved assembly allows the lines of magnetic force at such gaps to branch out and travel through the continuous material provided by the laminations on either side. Butt-jointed assemblies are employed where a complete magnetic circuit is *not* required, and the inevitable gap between one set of laminations and the other can be purposely made larger by inserting a thin piece of paper or card between the two. The interleaved assembly takes longer in production than does the butt-jointed assembly, because every lamination has to be handled individually. In consequence, a compromise is sometimes employed when a complete magnetic circuit is required, and this takes the form shown in Fig. 133 (c). In this diagram a number of lamination pairs are butt-jointed, to be succeeded by a similar number with the butt-joint at the other end. Such an assembly is somewhat less efficient than the fully interleaved version, but it is cheaper to produce. It is sometimes described as an “imbricated” assembly.

A full set of laminations in a transformer is known as a *stack* of laminations, and this term also defines the dimension at right angles to the lamination surfaces. See Fig. 134. Thus, we refer to a transformer as having, say, “a 1½ in stack of laminations”. The *core cross-section* of a transformer is another important dimension and is given by the product of the stack dimension and the dimension across the centre limb, or *tongue*, which passes through the primary and secondary windings, as shown in Fig. 134. The *window space* is also illustrated. The window dimensions limit the size of the windings which can be fitted on the centre limb.

Due to the presence of insulation material and surface irregularities, a stack of laminations does not contain as much magnetic material as would a similarly sized solid core. The ratio between the magnetic material in a stack and the solid equivalent is known as its *stacking factor*. With 0.014 or 0.020 in laminations, stacking factor is usually 90% or more.

A completely different type of laminated core for transformers may be briefly introduced at this stage. This is the *C-core*, or *ribbon core*. C-cores are manufactured by initially winding a strip of magnetic material into an oval form, a plastic binder being introduced to insulate adjacent surfaces from each other (if they are not already insulated) and to bond the coil of material into a solid whole. The oval coil is then cut, as indicated in Fig. 135 (a). The two adjoining ends are next ground to present flat surfaces to each other, and they are then butt-jointed inside a primary and secondary winding to form a complete magnetic circuit, as in Fig. 135 (b). The butt-jointed surfaces are ground with sufficient accuracy to ensure that the effective gap between them is very small. When a gap is purposely required, strips of thin paper or card may be introduced at the butting surfaces. If desired, two sets of

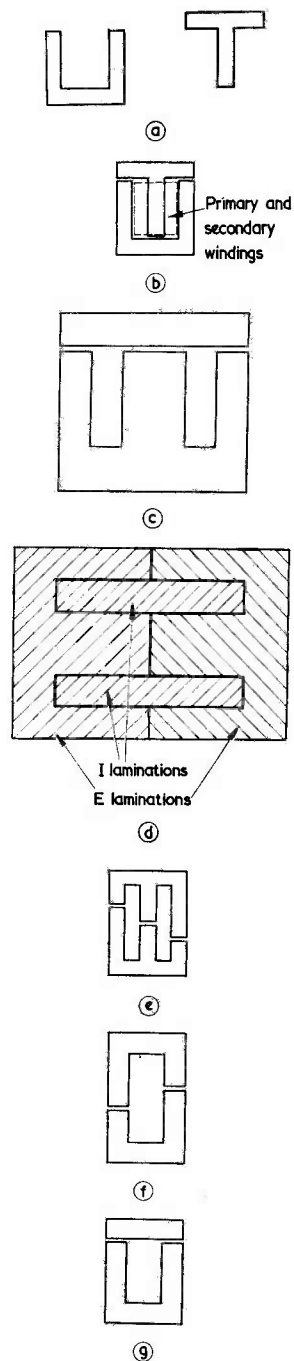

Fig. 132 (a). A U and T lamination pair (b). How the U and T laminations are assembled together (c). An E and I pair (d). The “scrapless” E and I pattern allows two E’s and two I’s to be punched out without waste (e). An alternative lamination shape (f) and (g). Laminations suitable for a two-limb core assembly

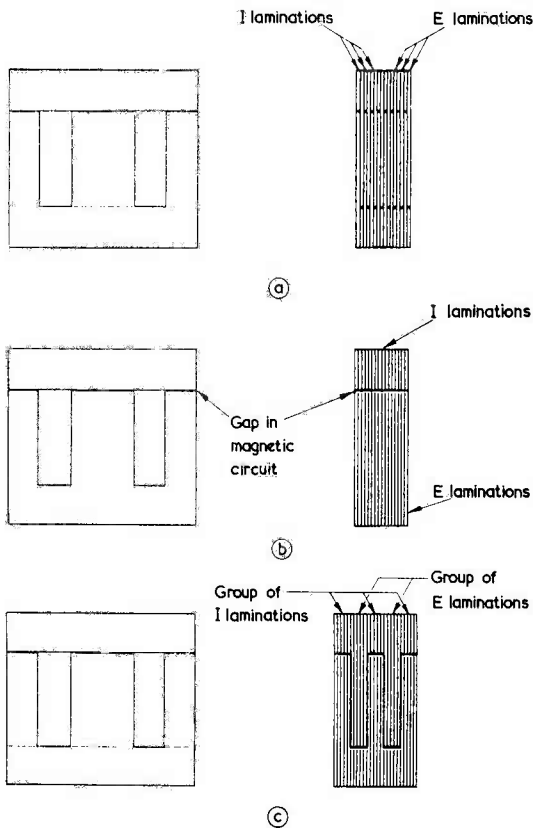

Fig. 133 (a). Interleaved laminations
 (b). "Butt-jointed" laminations
 (c). A cheaper method of interleaving laminations

C-cores may be combined to form two E's, as in Fig. 135 (c).

C-core transformers have a number of advantages (which will be discussed later) but, so far as ordinary radio applications are concerned, they tend to be more expensive than equivalent components employing conventional laminations.

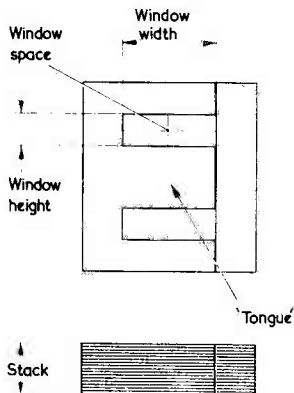

Fig. 134. The dimensions of a stack of laminations. The "tongue" is the centre limb

Hysteresis

We have noted that, when an iron core is inserted in a coil, the inductance of the coil increases. This is because the permeability of the core is greater than the permeability of the air it replaces. However, the permeability of an iron core is not a constant factor and it varies according to the magnetising force applied. This is a property which we must next examine.

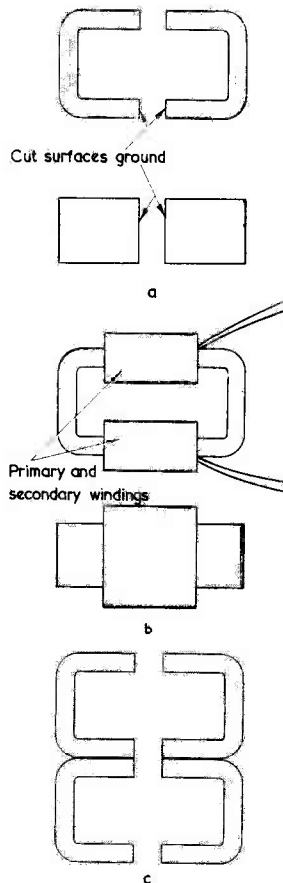

Fig. 135 (a). A pair of C-cores
 (b). The C-cores assembled in the primary and secondary windings of a transformer
 (c). Two sets of C-cores may be joined to form a pair of E's

Permeability in a magnetic circuit is similar to conductance in an electrical circuit. When, in the electrical case, conductance increases (which is the same as saying: when resistance decreases) more current appears in the circuit. When, in the magnetic case, permeability increases, more lines of magnetic force appear in the circuit. In the second instance, we may describe the increase in lines of force as an increase in *flux density*.⁵ In order to cause lines of

⁵ The term "flux", in this context, describes the flow of lines of force. An increase in flux density then corresponds to an increased number of lines of force per unit area of cross-sectional area.

magnetic force to appear, a magnetising force has to be applied; this being done, in the case of an electromagnet, by causing current to flow through the turns of the coil. We can, in consequence, continue with the electrical analogy, and say that the effect of magnetising force in a magnetic circuit is similar to that of e.m.f. in an electrical circuit.

$$\text{In the electrical instance conductance} = \frac{\text{current}}{\text{e.m.f.}}$$

because conductance is the reciprocal of resistance and we know, from the Ohm's Law equation, that

$$R = \frac{E}{I}$$

The analogous magnetic properties

follow the same rule, whereupon we can say that

$$\text{permeability} = \frac{\text{flux density}}{\text{magnetising force}}$$

Using standard abbreviations, this equation may

be written as $\mu = \frac{B}{H}$ where μ stands for permeability, B for flux density and H for magnetising force.⁶

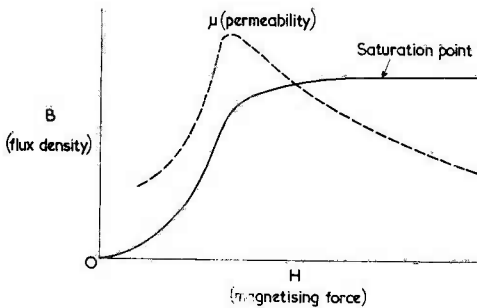

Fig. 136. A B/H curve for a magnetic material. (Normally, B/H curves are not drawn beyond the saturation point, as here)

If we were to take an iron core and attempt to find its permeability by measuring B for different values of H, we could obtain a graph similar to that illustrated by the solid line in Fig. 136. Starting at the zero point of the graph we find, as is to be expected, that B (the flux density) is zero when H (the magnetising force) is zero. As H increases, so also does B. But B does not increase in a linear manner. At first it increases at a low rate, then at a fast rate, after which the increase becomes low once more. If H is increased above a certain point (shown in the diagram as "saturation point") there is no further increase in B at all. What has happened here is that the iron core cannot support any further increase in flux density. In this condition it is described as being *saturated*.

⁶ Actual quantities do not enter the present discussion, but it should be added, for completeness, that $\mu = \frac{B}{H}$ where μ is permeability, B is flux density in gauss, and H is magnetising force in oersteds.

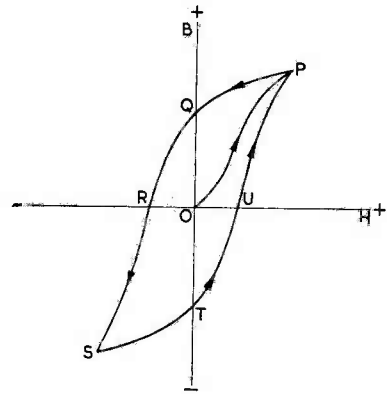

Fig. 137. The hysteresis loop of a transformer core

The solid line graph of Fig. 136 is known as B/H curve, and we may find the permeability for different values of magnetising force by the simple process of dividing B by H at a number of points along the curve. This we do in Fig. 136, and it will be noted that the resultant permeability curve (shown dashed) rises to its maximum over the range where the B/H curve has the greatest upward slope. Further along the graph the permeability falls, dropping to a low value after we pass the saturation point.

In a transformer, the magnetising force is provided by the alternating current flowing in the primary and, in the course of one cycle, this causes the magnetising force not only to increase, but to decrease and then increase and decrease again in the opposite direction. Let us next examine the shape that our B/H curve takes up under these conditions.

At point 0 in Fig. 137 we have the instance where we have just switched on an alternating current applied to the primary. This point corresponds also to the start of a cycle, with the result that current is at zero and so, in consequence, are magnetising force and flux density. The current now increases, as does magnetising force, taking the curve up to a peak at point P. So far our new curve is exactly

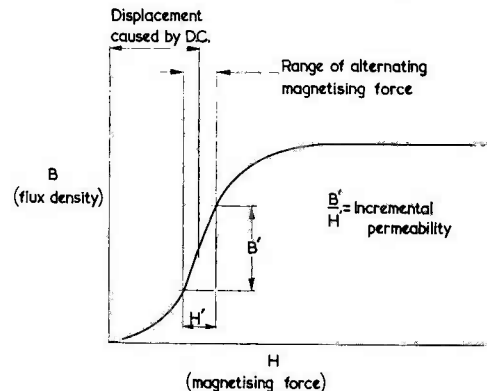

Fig. 138. Illustrating the effect given when a transformer primary handles an alternating current superimposed on a direct current

the same as the earlier part of the B/H curve in Fig. 136. Current now commences to decrease, as, in sympathy, does the magnetising force. However, the flux density decreases much less rapidly and, by the time magnetising force is at zero, flux density has dropped to point Q only. Despite the absence of a magnetising force, some of the flux density remains; this being the result of *residual magnetism* in the iron core.

After point Q the applied alternating current reverses in polarity as, also, does the magnetising force. The flux density continues to drop, but it does not reach zero (at point R) until quite a high negative magnetising force has been applied. Eventually, the alternating current and magnetising force reach their negative maxima at point S. This point corresponds also to maximum negative flux density.

The alternating current now commences to decrease, whereupon we have the same effect over the next half-cycle as occurred along the curve P Q R S. At T, the alternating current and magnetising force are at zero, but residual magnetism in the core enables it to retain the flux density indicated. The flux density comes down to zero, at point U, only after the magnetising force has considerably increased in the positive direction. Alternating current, magnetising force and flux density then reach their positive maxima at point P, whereupon the whole process repeats itself once more.

We may now sum up by stating that, for each cycle of alternating current applied to the transformer primary, the flux density follows the curve indicated by P Q R S T U P.⁷ This represents a waste of power, because extra primary current is needed to overcome the effect of the residual magnetism present in the core. The power loss is proportional to the area enclosed by the curve P Q R S T U P, and it follows that it may be reduced by employing a core material which exhibits residual magnetism to a lesser degree. Such a core would exhibit reduced *remanence*.⁸ The curve P Q R S T U P is known as the *hysteresis loop* of the magnetic material, and the power loss resulting is described as the *hysteresis loss*.

If we examine Fig. 137 in conjunction with Fig. 136 we may learn another point of importance. As we have already stated, the initial section, O P, of Fig. 137 corresponds to an early section of the B/H curve of Fig. 136. What is more to the point here is that, in Fig. 137, we have not brought our iron core anywhere near the saturation point. Had we done so, we would have encountered further

losses in addition to those given by hysteresis. These further losses would have been given by the fact that, above saturation point, increases and decreases in primary current have no effect on flux density at all. It follows that a transformer should always be designed such that, at no time during the primary current cycle, does the core approach saturation.

In many radio applications, a transformer is called upon to handle an alternating current which is superimposed upon a direct current. Frequently, the direct current is greater than the peak value of the alternating current, with the result that magnetising force is always in one direction, and changes only in intensity. These combined currents, if applied to the B/H curve of Fig. 136, could cause the magnetising force to pass saturation point either over the whole a.c. cycle or, at least, during the half-cycle peaks when the a.c. and d.c. are additive. This effect is obviously undesirable, and it may be alleviated by inserting an air gap into the magnetic circuit of the core. This gap will then reduce the lines of force (and, hence, flux density) which appear in the core, and there will be a consequent drop in permeability. The reduced flux density ensures that the core does not approach saturation point, and this is an advantage which completely outweighs the loss in permeability.

We referred earlier to the fact that some transformer laminations are butt-jointed, frequently with gaps given by thin pieces of paper or card. We may now see that transformers of this type are employed when their primaries are required to handle alternating currents which are superimposed upon direct currents. It may also be stated that the interleaved transformer construction is then employed when an alternating current only (without a direct current) is applied to the primary.

Another term has to be introduced to cover the case where an a.c. is superimposed on a direct current. Fig. 138 illustrates the B/H curve for the associated transformer core (with gap), and it will be noted that the alternating magnetising force resulting from the applied a.c. is shifted (because of the continual magnetising force resulting from the

d.c.) to the right. The ratio $\frac{B'}{H'}$, over the range

occupied by the alternating magnetic force, represents the *incremental permeability* for these conditions. It is interesting to note that, when the range occupied by the alternating quantity is wholly past the saturation point, incremental permeability is zero.

Next Month

In next month's issue, we shall continue our discussion on transformers.

STATIC INVERTER TRANSFORMER

Repanco Ltd., 203-269 Foleshill Road, Coventry, announce a new transformer for d.c./a.c. inverter circuit. In a suitable transistor circuit supplied by 12V d.c. the output is 230/250V 50 c/s with a conservative power rating of 15 watts. Using this d.c./a.c. inverter enables mains driven instruments of suitable low power rating to be operated from a 12V car battery. This makes many small instruments more portable by enabling them to be installed and operated in a vehicle. Also ideally suitable for making use of mains electric razor while travelling. This transformer is designated TT51 in the Repanco range of transformers and coils.

BOOK REVIEWS . . .

RADIO AND TELEVISION (4 Volumes). By C. A. Quarrington, A.M.Brit.I.R.E. $7\frac{1}{4} \times 9\frac{1}{2}$ in. Published by The Caxton Publishing Co. Ltd., Caxton House, 44 Hill Street, Mayfair, London, W.1. Price £10.

This is a new work comprising 4 volumes which deal very comprehensively with the principles, design considerations, applications, component parts, maintenance, adjustment and repair of both radio and television equipments. All of the volumes have been specifically designed to meet the needs of all connected with this branch of engineering; the fourth volume being a data book which presents a carefully chosen series of circuits, data and formulae available in a manner permitting immediate use. Each of the circuits is accompanied by a complete components list and is reproduced on a fold-out double page format.

The mathematics used are extremely simple and an Appendix is included as a reminder to those who have not had occasion to deal with formulae since schooldays. This Appendix also contains useful notes on the interpretation of graphs and a summary of the many wiring conventions used in Britain and overseas.

There are over 1,260 pages with 24 full-page plates, 15 folding circuit diagrams and over 1,100 illustrations. If required, the work may be obtained on instalments at a total price of £10 10s. 0d. A further feature is that any purchaser is entitled to use the free information service, the questions being answered by a panel of radio and television experts.

WORLD RADIO TELEVISION HANDBOOK in a new (17th) and greatly enlarged edition.

For radio listeners all over the world it is an annual event when *World Radio Television Handbook* appears. The 1963 edition has been completely revised and brought up to date, containing a quantity of practical information about all radio and television stations. An enormous development is taking place within television, the linking of European television with Eurovision and Intervision has been an accomplished fact for some considerable time now, and transatlantic TV is a reality as described in an interesting article by the Chief Engineers Edgar T. Martin and George Jacobs of the Voice of America.

World Radio Television Handbook is a must for listeners—they not only find the addresses, interval signals, programme particulars giving times, etc., of all broadcasting stations in the world, but also many interesting and topical articles, masses of illustrations, and informative articles on how to obtain the best possible utilisation of radio reception, etc.

The United Nations, UNESCO, the European and American radio organisations give, in a preface to this edition, their warmest recommendations of *World Radio Television Handbook* as a valuable contribution towards the promotion of understanding between the peoples of the world, and on its title page the radio organisations of the world commend *World Radio Television Handbook*. Available from the Modern Book Company, 19 Praed Street, London, W.2, at 22s., plus 1s. post and packing.

B.B.C. TO COVER NATION WITH 625 LINE SERVICE

In order to implement the conditions of the recent Government White Paper on Broadcasting, the British Broadcasting Corporation is inaugurating an extensive technical scheme for the provision of Bands IV and V (ultra-high-frequency) television transmitting stations which will ultimately cover the entire country.

The Marconi Company has been awarded the major contract so far placed (approximate value £650,000) and is entrusted with the responsibility for supplying and installing the transmitting equipment for six main high-power stations.

Each of these stations will have a peak vision transmitter power of 50kW and a sound output power of 10kW. The effective radiated powers will depend upon the types of aerial the B.B.C. elect to use, but will probably be of the order of 500kW in some cases and 1,000kW in others.

The Marconi transmitters used will be the new type BD378, which combine the vision and sound elements in one equipment. The BD378 is rated at 25kW vision and 5kW sound, and two will be connected in parallel at each station to provide the requisite power. There are thus 12 transmitters on order, together with a considerable quantity of ancillary equipments.

The stations will be capable of radiating either black-and-white or compatible colour transmissions to 625-line standards. The contract specifies that the equipment for the six stations will be delivered by February 1965.

SIMPLE CRYSTAL MARKER

By J. A. ROBERTS

This crystal marker unit employs ingenious circuitry to reduce cost to a minimum. It must be emphasised that the circuit operates at mains supply potential, and that it is essential that all points are adequately insulated from the metal case, that a reliable earth connection is employed, and that full precautions against shock are observed. The 50pF isolating capacitor in the output circuit must be capable of withstanding the full supply voltage

MOST EXPENSIVE SHORT WAVE COMMUNICATIONS receivers employ a crystal marker as an accurate frequency check. If this is not fitted it is possible to incorporate such a unit in some receivers, although such an addition is not always desirable because of lack of space or because it entails extensive alterations to a complete receiver. An alternative solution consists of constructing an external unit with its own power supply, together with a modulator if the receiver has no b.f.o. Since a unit of this type may require a number of expensive components, an attempt has been made here to simplify the usual circuit without limiting its usefulness.

The Circuit

It will be apparent from the accompanying circuit that no rectifier, smoothing components or heater dropper has been used. The a.c. mains supply is

taken directly to the anode and cathode of the oscillator valve, and the heater supply is obtained by means of a small and inexpensive heater transformer. The valve conducts, therefore, when positive half-cycles appear at the anode, and this makes the note of the oscillator easily recognisable amid the many others encountered on the short wavebands. The oscillator employs the well-known Pierce circuit, which will oscillate with almost any crystal. Most valves are suitable, and the circuit shows a 6C4, which functioned reliably in the prototype.

The layout of the components is not critical, but a very careful check on the wiring should be made before switching on. The metal case must be correctly earthed.*

Crystals

Surplus crystals will be found to oscillate quite readily with this circuit, and perhaps the most useful would be a 3.5 Mc/s crystal. This will mark the beginning of the 80, 40, 20, 15 and 10 metre amateur bands. The note from the oscillator was easily identifiable on the 10 metre band even when a 160 metre crystal was in use, and despite the fact that there was no direct connection to the receiver.

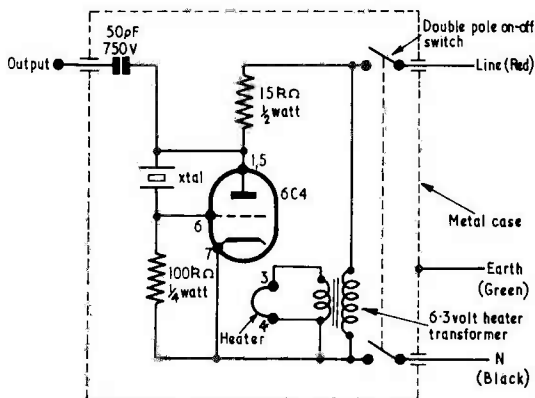

* The prototype employed a series heater dropper capacitor instead of the heater transformer shown in the diagram (which we consider safer and more reliable). The capacitor was connected, after the on-off switch, between "Line" and heater, the other side of the heater, also after the on-off switch, connecting to "Neutral". Dropper capacitors used should be capable of withstanding the mains voltage and the author recommends values of 2.5, 2 and 1.5μF for heater currents of 0.2, 0.15 and 0.1 amp respectively. Small value capacitors may be wired in parallel with the dropper capacitor if the resultant heater voltage is too low. A 100kΩ 1W resistor was connected across the supply after the on-off switch to discharge the capacitor after switching off, and prevent shocks from the mains plug pins. Whilst constructors may wish to experiment with the capacitor drooping system, we must point out that we only consider the heater transformer shown in the circuit as offering a reliable heater supply.—EDITOR.

CONVERTING BATTERY PORTABLES TO MAINS OPERATION

By MICHAEL J. DUNN

If you have an old battery portable superhet with octal valves and conventional wiring, it may be given a new lease of life by being converted to mains operation. Our contributor describes the necessary steps for typical receivers of this class

THERE ARE A GREAT NUMBER OF OUTDATED superhet battery portables about, using the now obsolete range of valves with octal bases (DK32, DF33, DAC32 and DL35 or their equivalents). Many readers, their relatives or their friends, may have such a set stored away or discarded; alternatively, they frequently sell at very low prices in the salerooms and elsewhere. These sets are eminently suitable for conversion to mains operation because the valve base connections are materially the same as those in the mains superhet series 6K8, 6K7, 6Q7 and 6G6—all of which, if not already possessed by most constructors, are otherwise freely and cheaply obtainable from advertisers. The basic circuitry of the set itself requires little or no alterations or additions and, furthermore, the final process of alignment is simplified by the fact that, at most, only a small amount of trimming is required in the aerial and oscillator circuits to offset the small change of inter-electrode capacitances given by the new valves. For these reasons not only can one make a good and very compact mains superhet transportable very economically, but the process also offers an excellent opportunity for the comparative beginner to identify the salient features of a simple superhet circuit and to get it going without complicated alignment procedure.

Although it is not absolutely essential for the battery set to be in working order this is most desirable, and it is a very good plan to try and get it going as such before embarking on the conversion, so as to eliminate any faults outside the actual parts undergoing modification.

The class of receiver to be converted will almost certainly have a frame aerial; some constructors may prefer to substitute a ferrite rod and this can easily be done but will put up the costs. Alternatively a dual-range aerial coil may be fitted, and this will require some sort of external aerial. On the whole the best plan is to use the existing frame aerial as this not only means that no extra expenditure is involved but it also satisfies the existing conditions of the set's input circuit. The oscillator coils and i.f. transformers will be left *in situ* and require no alterations.

The Conversion—General Considerations

(1) The fundamental addition to the set is the provision of a cathode circuit for each valve in place of the directly heated filament circuit which served for the battery valves.

(2) In the battery circuit, negative bias for the grid of the output valve is almost certainly derived

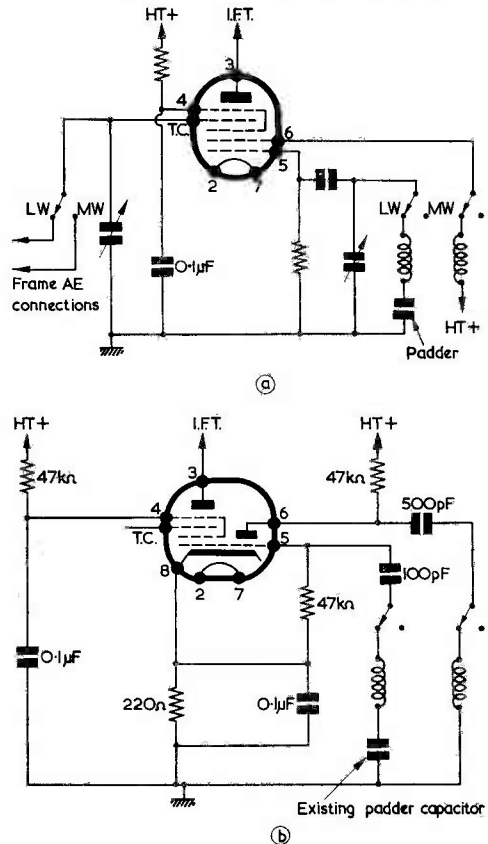

Fig. 1 (a). Stage 1. Original battery circuit using a DK32 valve and (b) circuit after conversion for use with 6K8

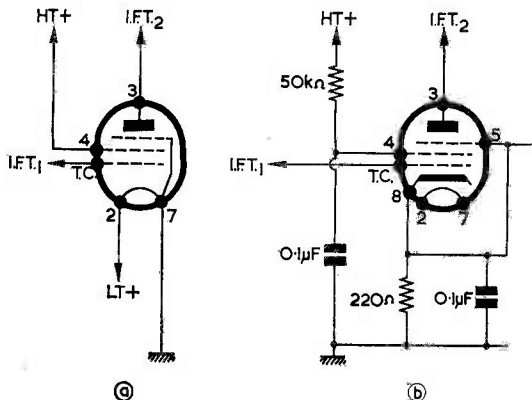

Fig. 2 (a). Stage 2. Original battery circuit using a DF33 and (b) circuit after conversion for 6K7

from a dropper resistor in the h.t. negative lead, this being shunted by a capacitor. These two components can be removed and the h.t. negative lead connected direct to chassis; the new indirectly heated valves will then get their bias from their cathode resistors.

(3) Some alterations will be required in the h.t. positive circuit to allow for the increase in potential required by the mains valves. Most of these modifications will be discussed in the stage-by-stage description which follows, but one important factor applies to the set as a whole and is best dealt with at the outset. All capacitors connecting to the h.t. positive circuit should be checked to ascertain their working d.c. voltage, as in some sets this will be too low at, say, 150V working. This mainly applies to such capacitors as screen grid decouplers. These should be replaced, if necessary, with components rated at 350V working. The question of working voltage particularly applies to the coupling capacitor between V₃ (diode triode) anode and V₄ (output pentode) grid. As this must be a really reliable component it is probably best to renew it in any case. Any 0.1μF capacitors which are removed for low working voltage can be tested, and if found satisfactory, can be re-used as cathode bypass capacitors for V₁ (frequency-changer) and V₂ (i.f. amplifier).

(4) The valve base connections correspond closely between the two series of valves, but the following points should be noted.

- (a) Pin No. 1 of all mains valves connects with any external metal shell fitted, and should be connected to chassis.
- (b) Pins 2 and 7 originally connect with the filament of the battery valves and require no alteration for the 6.3V heater supply. If one side is connected to chassis, this may remain so.
- (c) Except for V₁, the mains frequency changer, pin 6 has no internal connection and with the mains valves, may be used as an anchor tag.
- (d) The new cathode connection, pin 8 on all-mains valves, has no function in the battery

valves and in some sets may be found to have been used as a tag for other connections. If so, the wires should be disconnected and anchored to a single insulated tag which may be conveniently secured by one of the bolts holding the valve base, or by any other adjacent bolt.

We are now in a position to discuss the modifications stage by stage.

The Frequency Changer (V₁ 6K8 Fig. 1(b)).

Pin 8, Cathode. Requires 220Ω ¼W resistor to chassis bypassed by 0.1μF capacitor.

Pin 6, Oscillator anode. Originally connected through coil direct to h.t. positive. The modification requires the insertion of a 47kΩ ½W resistor in the anode circuit to drop the h.t. potential and this is best achieved by (a) connecting the resistor from h.t. positive to pin 6, (b) inserting a 500pF capacitor between pin 6 and the upper end of the coil, and (c) connecting the lower end of the coil to chassis (i.e. the end originally connected to h.t. positive). This alteration is suggested because

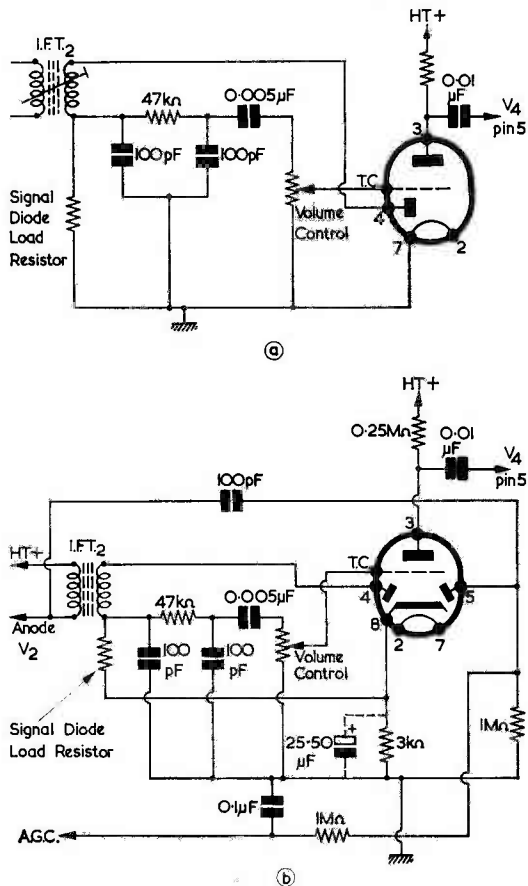

Fig. 3 (a). Stage 3. Original battery circuit with DAC32 (a.g.c. components not shown) and (b) modifications required for 6Q7

in at least one set the writer failed to get consistent oscillation by leaving the coil in the h.t. circuit, but found that it worked perfectly after the above modification had been carried out.

Pin 4, Screen-grid. If the existing resistor is not in the region of $47k\Omega \frac{1}{2}W$, it should be changed to this value and a $0.1\mu F$ capacitor, 350V working connected between this pin and chassis.

No other changes to this valve base are required.

The I.F. Amplifier (V_2 6K7 Fig. 2).

Pin 8, Cathode. Requires $220\Omega \frac{1}{4}W$ resistor, bypassed by $0.1\mu F$ capacitor.

Pin 4, Screen-grid. $47k\Omega \frac{1}{2}W$ resistor to h.t. positive and $0.1\mu F$ capacitor to chassis. One word of caution is needed here. In some sets the DF33 will be found to have its screen-grid connected direct to h.t. positive and in these cases pin 4 may be used as a general h.t. distribution point. The leads so connected will then have to be removed, whereupon they can conveniently be transferred to pin 6, which is vacant, and the $47k\Omega$ resistor connected between pins 4 and 6.

Pin 5, Suppressor grid. Connect to pin 8.

No other modifications are required for this valve base.

Detector and First A.F. Stage. (V_3 6Q7 Fig. 3).

This probably calls for more detailed attention than any other stage because of the complication of the a.g.c. circuit, but the beginner need suffer no undue anxiety and the modification will be found to be quite instructive. The problem to be solved is the fact that, with the battery DAC32, a single diode does duty for both signal detection and provision of an a.g.c. potential. The indirectly heated valve type 6Q7 requires cathode bias and, as the original diode load is returned to chassis, this modification could impose a delay

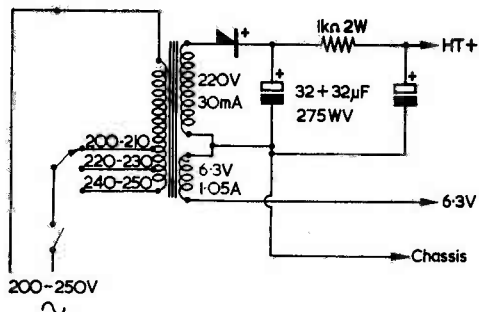

Fig. 5. Circuit of a suitable power supply

bias on the diode so that it would rectify weak signals either improperly or not at all, giving rise to poor sensitivity and distortion. Such a delaying potential is, however, useful in the a.g.c. circuit and, as the 6Q7 has two diodes, the two functions may be conveniently separated. The original a.g.c. line should be identified, traced to its source and temporarily disconnected. The subsequent modification of this stage may then be carried out in the following manner:

- (1) Locate the chassis end of the signal diode load resistor and transfer this connection from chassis to pin 8 of the valveholder—the cathode. (Detector diode is pin 4.)
- (2) Insert a $1M\Omega \frac{1}{4}W$ resistor between d_2 (pin 5) and chassis and reconnect the a.g.c. line to this pin via a $1M\Omega$ resistor, if the latter is not already present.
- (3) Either join the two diodes (pins 4 and 5) via a $100pF$ capacitor or place this capacitor between V_2 anode and d_2 (pin 5). The latter is probably the better course and is that shown in Fig. 2 (a).
- (4) Insert R_k , $3k\Omega$, between pin 8 and chassis together with a bypass capacitor of $25-50\mu F$, 12V working. (This capacitor is optional.)
- (5) Make sure that the anode load resistor is of the correct value. This should be around $0.25M\Omega \frac{1}{2}W$ and the original may be found to be too high. The coupling capacitor between the anode of V_3 (pin 3) and the grid of V_4 (pin 5) should be rated at at least 350V working and be leak-free.

Output Stage (V_4 6G6 or other suitable valve. Fig. 4)

The writer chose a 6G6 valve because it has very modest power requirements and is obtainable very cheaply. For a small set of this kind it is found to be completely adequate and it is important to avoid the dissipation of too much heat inside the small cabinet. Furthermore, the relatively low I_k of this valve makes the design of the power pack very simple and minimises the current passing through the primary winding of the output transformer. The alterations to this stage are quite straightforward and present no difficulties. See Fig. 4. A bias resistor of 560Ω is suitable for the 6G6, but if another valve is chosen the correct

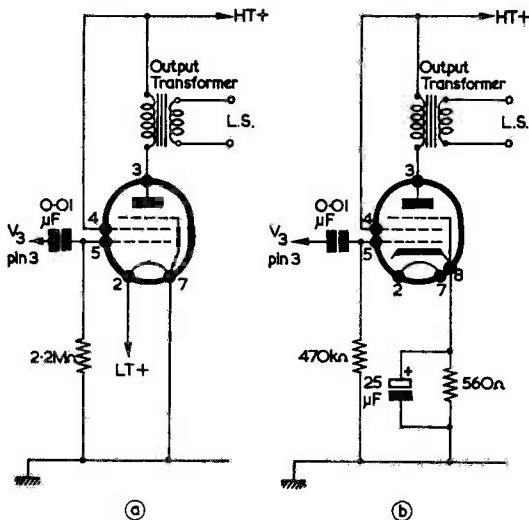

Fig. 4 (a). Stage 4. Original battery circuit with DL35 and (b) circuit after conversion from 6G6

value of R_k should be obtained from the relevant valve data. The inclusion of a 25 or 50 μ F cathode bypass capacitor will make the set noticeably more lively. The grid leak, between pins and chassis, should be reduced, if necessary, to 470k Ω $\frac{1}{4}$ W.*

Power Supplies

The power supply requirements for the mains circuit using the 6G6 output valve are 200 volts h.t. at approximately 30mA, and 6.3 volts heater at 1.05A. Under these conditions, h.t. smoothing can be carried out quite satisfactorily with a suitable resistor, a choke being unnecessary. It is preferable to use a mains transformer having a separate h.t. secondary winding in order to give isolation from

* It may be necessary to add a capacitor having a value around 0.002 μ F in parallel with the output transformer primary to reduce shrillness. Also, if the existing output transformer is to be retained, it would be preferable not to employ output valves having anode currents greatly in excess of that of the 6G6 as such valves would increase the risk of primary winding burn-out.—EDITOR.

the mains supply. A suitable circuit is shown in Fig. 5, in which the rectifier may be a "metal" or contact-cooled component.

Many battery portable superhets have no provision for isolating the chassis (and speaker frame) from contact by the user and, in consequence, it is normally undesirable to employ power supply circuits which would cause the chassis to have the same potential as one side of the mains supply.

In a number of portable receivers, the on-off switch is ganged with the volume control, and a switch of this type may be employed for switching the mains input after conversion. Other receivers have the on-off switching incorporated with the wavechange circuit. In such instances a separate toggle switch will need to be fitted to the receiver cabinet to provide on-off switching. Alternatively, and provided there is sufficient space on the receiver chassis, the existing volume control may be replaced by a component incorporating an on-off switch.

Voltmeter Measures Resistance

By R. F. Thorpe

IT IS NOT GENERALLY KNOWN THAT A VOLTMETER may be used to measure resistance in quite a simple manner. This is done by employing the formula:

$$R_x = \frac{R(E - E')}{E'}$$

where R_x is the unknown resistance, R is the meter resistance, E is the applied voltage and E' is the meter reading.

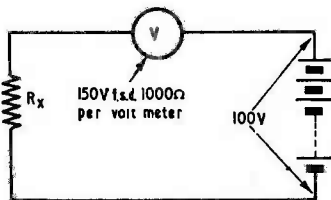

If, for example, we connect a 1,000 Ω per volt, 150 volt f.s.d., meter as shown in the accompanying diagram, we have $R = 150,000\Omega$ and $E = 100$ volts.

Should we obtain a meter reading of 10 volts then,

$$R_x = \frac{150,000(100 - 10)}{10} = 1,350,000\Omega$$

The process of reasoning used to arrive at the formula is as follows:

$$\frac{E}{E'} = \frac{R + R_x}{R}$$

$$\therefore ER = E'R + E'R_x$$

$$\therefore -E'R_x = -ER + E'R$$

$$\therefore E'R_x = ER - E'R$$

$$\therefore R_x = \frac{R(E - E')}{E'}$$

"FOLIAC" CONDUCTIVE CEMENT—NO.L719

This new product from the Dispersions Division of Graphite Products Ltd., Point Pleasant, Wandsworth, London, S.W.18 (Telephone Vandyke 6422), is a ceramic cement containing a dispersed metal filler.

As a cement it will make strong joints between most metals and other materials such as silicon carbide, graphite and ceramics. Joints are substantially unaffected by temperatures up to 600°C and can in fact withstand 1,000°C for short periods. What is unusual about it is that, by virtue of the metal in its composition, it is a good thermal and electrical conductor. The electrical resistivity of a bar of the cement is 6.56 x 10⁻⁴ ohms cms.

Many applications can be foreseen for this new cement in the electric, electronic and engineering industries.

IN YOUR WORKSHOP

This month Smithy the Serviceman, aided by his able assistant Dick, returns to the field of simple electrical computing devices

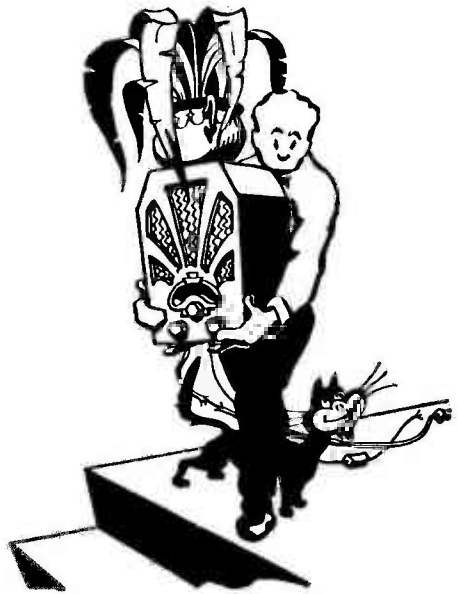

DICK LEANED HIS CHAIR BACK against the wall of the Workshop.

"I've been thinking," he announced.

"That," remarked Smithy encouragingly, "is always a good sign."

"I've been thinking," repeated Dick, ignoring Smithy's comment, "of those simple analogue computers we were talking about last March.¹ Do you remember?"

Smithy adjusted the large coloured handkerchief, knotted at each corner, which rested on his head.

"Yes, of course I do," he replied. "They enabled simple multiplication and division problems to be solved with the aid of a few pots and a null indicator. Drat that fly!"

Wrathfully, Smithy attempted to catch the insect which had been hovering around his nose; but it escaped and flew safely away in the warm June sunshine to seek more profitable avenues of exploration elsewhere.

The Serviceman and his assistant, attracted by the weather, had chosen to take their lunch outside the Workshop. Smithy had unbent sufficiently to remove his jacket and tie, and was now comfortably arrayed in open-neck shirt, sober grey trousers, black shoes, and braces. Dick, on the other hand, was dressed resplendently in a bright yellow sweat shirt, blue jeans and his "bowling alley creepers", the latter being a pair of

unnatural plimsolls which had violent puce uppers and enormous rubber soles projecting a full half-inch all round at the bottom, in the manner of the guards around a dodg'em car. The pair had consumed their lunch and were now taking their ease whilst their digestive juices worked respectively on salmon sandwiches (Dick) and brawn-and-black-pudding sandwiches followed by Lyon's Individual Fruit Pie (Smithy).

Simple Counters

"I've been wondering," continued Dick, still following his train of thought, "whether it wouldn't be possible to make up some other simple calculating gadgets which, like those computers, could be knocked up just as easily out of odds and ends."

"It's funny you should say that," remarked Smithy, "because it so happens that I've been playing around, just recently, with one or two circuits along those lines myself. A friend of mine is a school teacher, and he asked me if I could make a simple low-cost adding machine which would bring a bit of variety into the process of stuffing mathematics into his pupils' heads."

"Did you have any success?"
"I made a gadget," replied Smithy, "which met his requirements quite well. It consists, in fact, of an electro-magnetic counter, a telephone dial and a simple power unit. You dial any number from 1 to 10 and the counter adds it on to the existing number it's showing. Even

a hardened type like myself found the effect rather fascinating."

"Where did you get the counter and the dial?"

"They're available on the surplus market," replied Smithy, "and the ones I got were used and ex-equipment. Don't forget that Post Office gear is manufactured to much tighter specifications than the stuff we handle in radio and television sets and so, even if it is used or soiled, it can still give plenty of service for simple devices like the adding machine I made for my friend."

Smithy stood up and wandered into the Workshop.

"By a stroke of luck I've got a spare counter and dial knocking around," he announced as he returned. "If you have a look at these you'll understand more readily how they can be made to work. To start off with, here's the counter."

Smithy handed the counter over to Dick, who examined it eagerly. (Fig. 1).

"As you can see," continued Smithy, "the counter presents a four-digit number at the window. The right hand digit represents units, the next one tens, the next one hundreds, and the next one thousands. If you pull off the cover you'll see that there's a coil and armature inside. These actuate the right hand wheel, that showing the units, by way of a simple pawl and ratchet. When the coil is energised the armature pulls down (Fig. 2 (a)), whereupon the operating

¹ "In Your Workshop", March 1963.

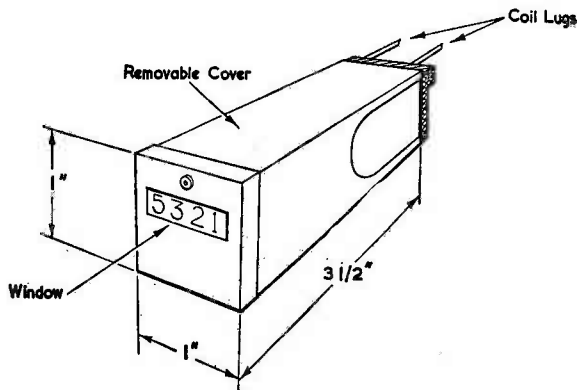

Fig. 1. Illustrating, with approximate dimensions, an electro-magnetic counter of the type currently available on the surplus market

pawl engages with the next tooth on the ratchet. When the coil is de-energised the armature releases, whereupon the pawl moves the ratchet round one tooth. (Fig. 2 (b)). The right hand wheel similarly moves round to the next position and indicates the next higher digit in the window. On every tenth operation, the right hand wheel moves the neighbouring wheel—which presents tens—to the next number by way of a mechanical coupling. The second wheel is coupled in the same way to the wheel presenting hundreds, and so on. In other words, it's a conventional 0 to 9999 counter, the unit digit going up by 1 each time the armature releases."

Dick pressed and released the armature on the counter that Smithy had passed to him and observed the effect the Serviceman had described.

"It's a neat little gadget, isn't it?" remarked Dick. "How do you re-set it to zero?"

"I'm afraid you can't," replied Smithy. "You just have to carry on from the last number it's set to. That isn't a great disadvantage, though, because you can soon bring it up to the nearest 100 before you start an adding operation."

Operating Voltages

"What would counters like these be used for originally?" asked Dick.

"For monitoring telephone subscribers' calls," replied Smithy, "and they would operate once for each call. Indeed, the Post Office boys call them 'meters'. In the Post Office application a high counting speed is not required, and counters such as this have a top speed around 10 to 15 counts per second only."

"What voltage do you need for energising the coil?"

"So far as I know," said Smithy, "most of the counters on the surplus market have a nominal energising voltage of 50. However, it's best to experiment in practice with the particular counter you have, before trying it in a working circuit. The counter I used myself had a 2,300Ω coil, and I found that it worked most happily with 60 volts applied."

"Blimey," said Dick, "that's a pretty high voltage, isn't it?"

"Not really," replied Smithy. "Don't forget that these counters aren't as sensitive as ordinary relays. The coil has to pull in the armature over quite a large distance, and it also has to work against an armature restoring spring which

needs to be strong enough to operate the counting mechanism reliably."

"Is it possible," asked Dick, "to reduce the energising voltage by easing off the restoring spring tension?"

"It can be done," replied Smithy. "If you look at that counter, you'll see that the restoring spring is hooked over a small tongue, or anchorage, at the heel of the assembly (Fig. 3 (a)). A little judicious bending of that anchorage (Fig. 3 (b)) will ease the armature restoring tension and the energising voltage required. But you don't want to reduce it so much that the armature pawl doesn't operate the counting mechanism properly, and you must remember that the latter presents the greatest load when all four digit wheels move together."

"As would occur," queried Dick, "if you go from, say, 1999 to 2000?"

"That's the idea," confirmed Smithy. "Another point is that, if you look at energising from the point of view of current, the number of milliamps you need is quite low. In my case I had 60 volts across a 2,300Ω coil. That's only 26mA, you know."

"I see your point," said Dick. "If you wanted to use a mains power unit you could get 26mA quite easily from many 'converter' mains transformers, together with, say, a 30mA contact-cooled rectifier."

"Exactly," agreed Smithy. "But I think I'll leave the question of power supplies until a little later. I think I should add, before con-

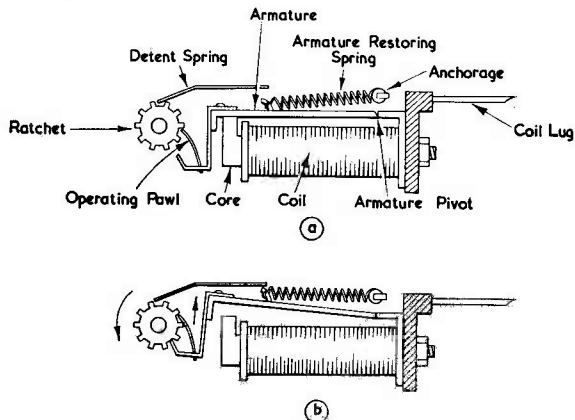

Fig. 2 (a). Side view of the electro-magnetic counter (with side panel cut away) showing the main operating parts. The ratchet wheel is coupled to the unit digit indicator wheel. In this diagram the coil is energised and the armature is pulled down to the core
(b). When the coil is de-energised the armature releases, whereupon the ratchet wheel is rotated through one tooth. The unit digit wheel then indicates the next number

cluding on counters, that there's another adjustment which you may find helpful occasionally. The armature back stop (Fig. 3 (a)) is also capable of being bent, provided you're careful about it, whereupon it varies the position of the armature when it's released. I don't think you would need to take advantage of this adjustment normally, though."

Telephone Dial

As he spoke, Smithy pulled a telephone dial assembly from his pocket and turned the dial abstractedly.

"Here, take it easy," said Dick. "Do you realise that you've just dialled 999?"

"Have I?" replied Smithy absent-mindedly.

"I'll say you have," chuckled Dick. "It wouldn't half shake you if the local law came swinging round the corner right now!"

"You've been seeing too much of 'Z Cars'," accused Smithy.

"Perhaps I have," said Dick. "I must have acquired a conditioned reflex after seeing so many people dial 999 on the telly."

"Your statement," pronounced Smithy, "is one which I can only dismiss as a load of irrelevant old rubbish!"

Dick chuckled again.

"After that," he said, "I don't need three guesses as to which has been *your* favourite TV programme recently!"

"Probably not," grinned Smithy.

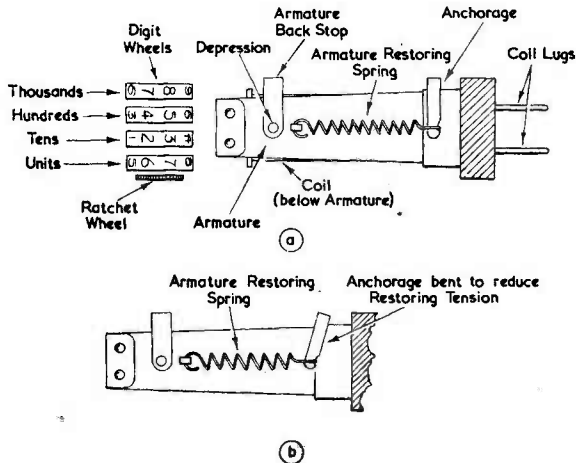

Fig. 3 (a). Top view of the counter, showing the armature restoring spring and the armature back stop. The depression in the latter corresponds to a "pip" on the surface facing the armature (b). Armature restoring spring tension may be reduced by bending the anchorage as shown (exaggeratedly) here. Care must be taken to avoid breaking the anchorage

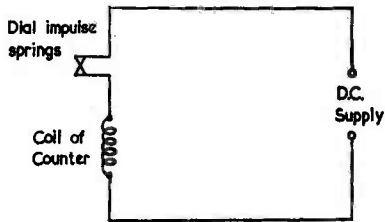

Fig. 4. A simple counting circuit employing an electro-magnetic counter and the impulse springs of a telephone dial

"Anyway, let's get on to this phone dial."

"Fair enough," said Dick equably.

"And I must add that, seriously though, you're doing a grand job."

"I won't argue," replied Smithy.

"Now, if you look at the phone dial mechanism you'll find a pair of contacts which are normally closed. They stay closed whilst you bring the dial round to the finger stop but, when you release it, they open and close repeatedly according to the number you select. Thus, if you dial 5, the contacts open 5 times whilst the dial returns after being released. If you dial 2 they open 2 times. If you dial 0, they open 10 times. These are the impulse springs for the dial, and they are the contacts which you employ for the simple adding machine application."

Smithy handed the assembly to Dick, who turned the dial experimentally.

"It's quiet easy to locate those contacts," he announced.

"Piece of cake," agreed Smithy.

"The contact actuating principle may vary for different dial assemblies, but you should still have a pair of contacts which open according to the number you dial."

Dick looked thoughtful.

"There's a snag here," he remarked.

"What's that?"

"It's these contacts," replied Dick. "They're normally closed. What you want is a pair of contacts which are normally open."

"That's true enough," agreed Smithy, "and it is a bit of a nuisance. Fortunately, it doesn't cause much trouble in the present instance, even though it does result in the electro-magnetic counter having to work wrong way round, as it were."

"How come?"

"Well," said Smithy. "What you do to couple the counter and the dial contacts together is to connect them in series with a suitable source of voltage. (Fig. 4). As soon as you apply the supply voltage, the coil in the counter energises and the armature pulls down. O.K.?"

"O.K."

"Right," said Smithy. "Now, the armature remains pulled down whilst you turn the dial to the finger stop. When you release the dial you get one or more cessations of current in the coil, these cessations of current being given by the dial contacts opening. At each cessation the armature in the counter releases and its pawl moves the ratchet wheel over one tooth, giving a count of 1. Immediately after the cessation of current the armature pulls down again, whereupon its operating pawl engages with the next tooth. The next cessation of current causes the armature to release once more, and a further count of 1 is made. So you get the same number of counts as you have cessations of current. Whereupon you can say that the circuit

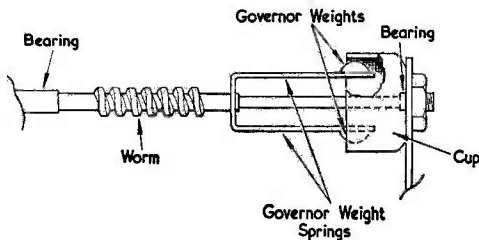

Fig. 5. Detail showing a telephone dial speed regulator assembly. The worm is coupled to the dial via a gear train which causes the governor weights to revolve at a relatively high speed as the dial returns

is carrying out its intended function, even though the counter *is* working back-to-front."

"I see," said Dick thoughtfully. "The circuit operates in the manner you want despite the fact that the counter armature is normally pulled down instead of being normally released."

"Exactly," confirmed Smithy. "There's one minor snag, though." "Oh yes," said Dick, "what's that?"

"Every time you switch off the supply," explained Smithy, "you get an additional count of 1. You see, when you turn off the supply, the counter armature releases, and it moves the unit digit wheel to the next number. When you switch on again, the armature becomes pulled down once more, and its pawl engages with the *next* tooth. However, this is only a minor disadvantage in a simple sort of gadget like this."

Dial Speed

"Are there any other points to watch out for?"

"The only one I can think of at the moment," said Smithy, "is dial speed. As I said earlier, these electro-magnetic counters have a top speed of 10 to 15 counts a second only. As a result, they won't follow the cessations of current from the dial contacts correctly if the dial revolves too quickly after it's released. Because of this, you want a dial which takes about

1½ secs. to return from zero after being released."

"How do you check that?"

"It's easy enough," said Smithy, "if you have a watch with a second sweep hand. All you do is dial 0 and see how long the dial takes to return after release."

"Can you adjust the speed?"

"Fairly readily," replied Smithy. "Although it's a process which has to be carried out very carefully if you're not going to do any damage. If you look inside the dial assembly you'll find that, on return, the dial is coupled through a gear train to a pair of governor weights, and these regulate the speed at which the dial revolves. (Fig. 5). If, whilst the dial is at rest, you adjust the governor weight springs so that the weights more closely approach the inside surface of the cup in which they revolve, the dial will return more slowly. I must repeat, however, that the process has to be carried out very carefully, or you may do more harm than good. This is not a job for the ham-handed!"

"I suppose," said Dick, "that the reverse holds true, also. That is, if you adjust the governor weight springs in the opposite direction the dial returns more quickly."

"That's correct," confirmed Smithy.

Alternative Switching Circuits

There was silence for a moment,

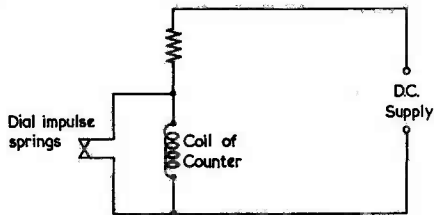

Fig. 6. An alternative counting circuit suggested by Dick. For reasons explained by Smithy, this is not successful in practice

and Dick appeared to be deep in thought.

"I've just had an idea," he remarked suddenly. "It's one which should overcome the business of the normally closed dial contacts."

"Fire away," said Smithy, encouragingly.

"Well," said Dick, "why don't you feed the coil in the counter via a resistor, and connect the dial contacts across it? (Fig. 6). Then, when the contacts are closed, the coil becomes short-circuited and the armature releases. When the contacts are open the short-circuit is taken off the coil, whereupon it becomes energised and pulls down the armature. With this method, the coil is normally de-energised and you don't have the snag whereby you get a count of 1 each time the power is switched off."

"It's a good idea," said Smithy, "but it doesn't work. I've tried it! The trouble is that the armature doesn't release quickly enough when you short-circuit the coil after it's been energised. Short-circuiting the coil has the same effect as putting a slug on it. The field in the coil takes longer to collapse and so armature release is delayed. With the present application the counter is operating pretty well at its top speed, and the additional delay given by the short-circuit slows it up too much to follow the dial contacts."

"Couldn't you put a diode in series with the coil?"

"I've tried that too!" said Smithy. "Since the initial back e.m.f. from the coil is of opposite potential to the energising e.m.f., I checked the effect of a series diode which conducted for energising current only. I'm afraid it didn't do the trick in practice."

"The only other thing I can think of," said Dick, "is to modify the dial contacts themselves, so that they're normally open."

"You could, I suppose, *attempt* that," replied Smithy, reluctantly. "But I would certainly not recommend it myself. It would be extremely difficult to obtain a really good contact assembly with proper pressure *or* with contact points meeting correctly. Far better to leave things in that department as they are!"

"Okeydoke," said Dick. "What about power supplies?"

"There's nothing much out of the ordinary there," commented Smithy. "Since the counter coil is energised almost all the time, and since it requires a high voltage, it would seem very desirable to employ a mains power unit. The

thing to do is to find out initially what voltage and current the counter relay requires for energising, and to work on from there. When the required current is less than 30mA, many mains transformers with half-wave h.t. secondaries can be brought into service, and all you'll need is a simple half-wave rectifier, a reservoir capacitor, and a dropper resistor. (Fig. 7). The value of the dropper resistor depends on counter requirements, and it might need a little adjustment when you are getting things finally set up. If possible, it would be preferable to use a mains transformer whose secondary doesn't give too high a voltage, as this could result in rather hefty voltages appearing across the dial contacts. If you can get hold of a transformer with a secondary voltage between, say, 80 and 120, this would be preferable. Although the dial contacts may stand up to fairly high voltages, it is unwise to make these any larger than can reasonably be avoided. And, of course, the dial and counter circuit *must* be isolated from the mains by way of a transformer."

Other Applications

"Are there any other applications for these electro-magnetic counters?" asked Dick.

"There are quite a few," replied Smythy. "They can be used for pretty well any counting job where

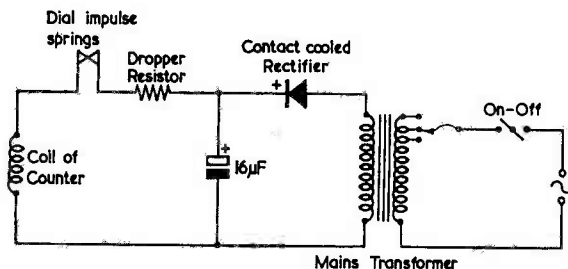

Fig. 7. A simple power supply would be adequate for the counter circuit, and a representative example is shown here

electrical contacts can be operated. They can, for instance, be used for counting the number of times a shop door is opened, and give you an idea of the number of customers thereby. A particularly interesting application is to couple them to a light operated relay circuit, whereupon you can count the number of times a beam of light is broken. Our old friend, G. A. French, gave some gen on this last year,² and he showed how an ORP12 light dependent resistor could operate a relay directly. It would be a very simple matter to couple an electro-

magnetic counter to the contacts of such a relay; whereupon the whole set-up would comprise the ORP12, the relay, the counter, and the necessary power supply components."

Lunch Over

Smythy looked at his watch.

"Well," he said, getting up. "Lunch time's over. Back to the grind!"

"Righty-ho," said Dick, rising also. "Just for the fun of it, I'm now going to find out what voltage and current this particular counter I've got here needs for energising."

Smythy frowned disapprovingly.

"I'm afraid," he remarked, "that that doesn't come under the heading of official Workshop activities."

"I know it doesn't," replied Dick. "It comes under the heading of counter-measures!"

² Suggested Circuits No. 139. "Light Dependent Resistor Control Circuits," June 1962 issue.

Editor's Note: Ex-equipment electro-magnetic counters and telephone dial assemblies of the type discussed by Smythy are available from Samson's (Electronics) Ltd., 9 & 10 Chapel Street, London, N.W.1.

Weather Forecasting by Unattended Telemetry System

BRITAIN TO HAVE WORLD'S MOST ADVANCED EQUIPMENT

Britain's weather forecasts will be based on more complete data and should therefore become more accurate, if an experiment soon to be undertaken by the Meteorological Office proves successful.

It is proposed to develop a system of automatic weather stations to fill gaps in the observing network throughout the British Isles. Initially, the Meteorological Office has placed a contract with EMI Electronics Ltd. to supply one experimental unattended telemetry system, to transmit data between two points over the G.P.O. telephone system.

This will be the first automatic weather monitoring system to be installed in this country, and the most advanced of its type in the world. It samples more information channels more accurately than comparable systems in France and the United States.

This first set of equipment, which will be delivered in August, will be used by the Meteorological Office to determine how best to apply the technique of telemetry to the automatic monitoring of weather information at a range of widely dispersed locations.

Data concerning pressure, temperature, humidity, total rainfall, sunshine, wind speed, wind direction and rate of rainfall at any given moment can be sensed by transducers and transmitted from the remote station to a central forecasting office, many miles away.

Entirely unattended, the telemetry transmitter will be silent and will not consume any power until interrogated from the central location. It will then transmit the meteorological data in analogue form to the receiver, where the information will be shown on meters or digital display devices. These will retain the readings until manually erased. Provision will also be made for attaching a paper tape punch or tabulating machine, to preserve the data for subsequent reference. Overall accuracy of the EMI system will be better than $\pm 1\%$.

A NEON STROBOSCOPE

By CLIFF MORGAN

THE ADDITION TO THE WORKSHOP EQUIPMENT OF a cheap and economical stroboscope was brought about by the requirements of the author's work in connection with electric motors and commutators. It was necessary to make a close study of any part of the segments without stopping the motor.

Since the construction of this simple but useful item of equipment, many other uses have been discovered for it. These include the strobing of record players, motor spindles for eccentricity, and the examination of fast revolving cog wheels.

Operation

The principle of the neon, in conjunction with the strobe unit, is as follows. In the accompanying circuit R_1 is the safety resistor and R_2 is the variable potentiometer. R_2 controls the flow of current into capacitor C_1 and the discharge rate of the neon.

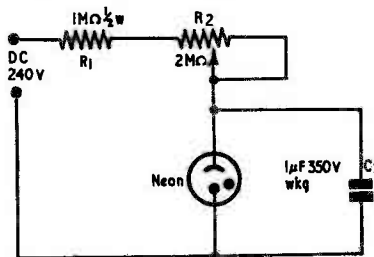

C_1 receives a charging voltage via the two resistors in series with it. When the capacitor is sufficiently charged, it discharges through the neon lamp, the latter remaining illuminated for a short

period as the capacitor discharges. The capacitor then recharges from the a.c. source and the whole process is repeated.

By varying the flow of charging current by means of R_2 , the neon can be made to flash at any frequency within the range of the circuit.

Almost any d.c. supply will be satisfactory, since the circuit draws very little current.

The neon should be mounted on a length of Paxolin tubing, the rest of the components being fitted in a small case, which is preferably insulated.

The possibility of different values of resistance for different neons arises, but a little experimenting with the resistor-capacitor configuration should enable the correct results to be quickly obtained.

Remember to include the safety resistor. This is essential, because without it, both the potentiometer and the neon can suffer damage.

Prototype

No socket was used for the neon in the prototype. Instead, two leads were soldered to the bulb and the latter fitted into a Paxolin tube five inches long and having a diameter suitable for the neon chosen. Insulating tape was wound around the end of the tube and the neck of the neon, thereby obviating the risk of shock to the user. This assembly was capable of being applied to small spaces and was particularly useful for inspecting commutators.

Neons which were successfully used in the prototype are as follows:

- (1) M.E.S. base, with length 26mm and diameter 6.75mm approx. Rating 80V.
 - (2) S.E.S. base, with length 28mm and diameter 12mm approx. Rating 200–260V at 0.2W.
- Larger neons have also been used.

New General Purpose Photomultiplier Tube

A recent addition to EMI Electronics Ltd.'s range of photomultiplier tubes, the type 9660, is a 9-stage "squirrel cage" design having an opaque caesium antimony photocathode with an S5 spectral response.

In contrast to other types of EMI photomultiplier tubes, the 9660 is sensitive to radiation through its side wall, which is made of U.V. transmitting glass. This gives a spectral coverage from approximately 2,000 AU to 6,700 AU with a peak at approximately 3,500 AU.

The high gain and low dark current which characterise this versatile tube make it particularly suitable for low level U.V. and visible radiation spectrometers and many other applications. It has a B14B pressed glass base, for which a p.t.f.e. socket can be supplied by EMI.

A quartz envelope version—type 9662—can be supplied to extend the short wavelength coverage to approximately 1,700 AU. The type 9661, an overcapped version of the type 9660, has a small shell sub-magnal 11-pin base and will operate as a direct equivalent of the RCA 1P28.

Cover Feature

An introduction to . . . COLOUR TELEVISION

By J. R. DAVIES

PART 1

With 625 line transmissions commencing early in 1964, the gateway is now open for the introduction of domestic colour television in the United Kingdom. This article is the first of a short series which has been specifically written to introduce readers to the principles involved in colour television. Major emphasis will be placed on the American N.T.S.C. system, which is now firmly established in the U.S.A. and in Japan, and the articles will end with a description of the French SECAM system

THIS SHORT SERIES OF ARTICLES IS INTENDED to introduce the principles involved in the transmission and reception of colour television. The articles will deal with the basic theory which enables a colour presentation of a scene to be reproduced at a remote point, and they will describe the main processes employed. Most of the material will be devoted to the American N.T.S.C. system, which is now fully operational both in the United States and in Japan, and we shall consider this system in terms of the American 525 line standard. At the time of writing, final details for adapting the N.T.S.C. system to 625 lines are not generally available, but any difference with those employed with the 525 line standard should be of a minor nature only, and should in no way affect the basic principles involved. The articles will also deal, more briefly, with the French SECAM system.

We shall commence by considering the three primary colours, dealing also with additive mixing and colour analysis.

The Colours Of The Spectrum

When a beam of what we normally describe as "white" light is passed through a glass prism, as in Fig. 1(a), we obtain a display of colours which range from red to violet. The reason for this display is that the surfaces of the prism offer different amounts of refraction (i.e. bending) to the wavelengths which constitute the "white" light. The display is shown laid out horizontally, in Fig. 1(b), and the various colours are indicated at the approximate points at which they appear. The colours do not have finite boundaries, and they blend, instead, from one colour to the next. Also indicated in Fig. 1(b) are the wavelengths in millimicrons ($=10^{-9}$ metres) of the colours along the

display. The human eye cannot perceive radiations having wavelengths below about 400 millimicrons (ultra-violet) nor radiations above about 750 millimicrons (infra-red). The radiations in between provide the *colours of the spectrum*.

In a colour television system it is desirable to reproduce all the colours which appear in everyday life. It would be impossible to have an inter-connecting medium in which an individual channel

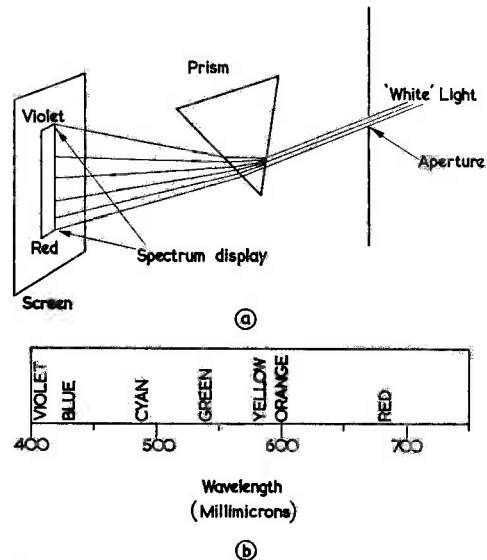

Fig. 1 (a). Obtaining the colours of the spectrum by means of a glass prism
(b). The approximate positions of some of the spectrum colours with respect to wavelength

was ascribed to each colour, because the number of different colours which exist is virtually infinite. We employ, instead, a technique known as *additive colour mixing*. It can be readily demonstrated that if two light beams of dissimilar colour are projected on to a screen, their combination assumes a different colour to either of the two original colours. Thus, if, as in Fig. 2, we throw a red and a green light on to the screen, we obtain a yellow colour as a result. If we similarly mix red and blue we obtain magenta, and if we mix green and blue we obtain cyan. If further, we mix red, green and blue together (in the right proportions) we obtain a "white" resultant.

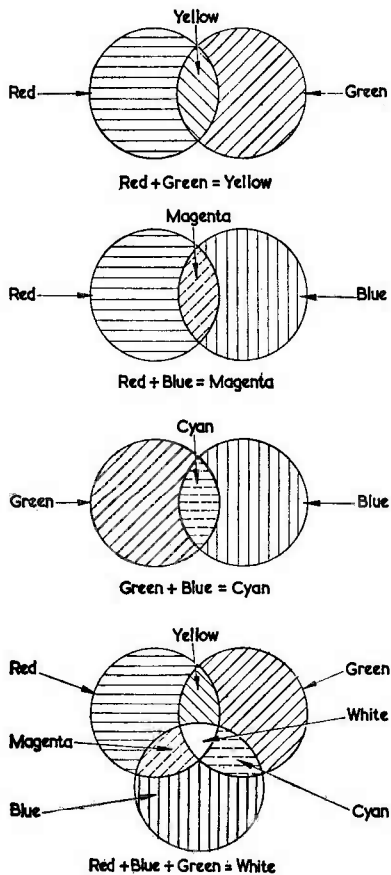

Fig. 2. The results given by additive colour mixing. Red, green and blue are primary colours; and yellow, magenta and cyan are complementary colours

Because of the ability to create new colours by additive mixing, it would seem that, to obtain a satisfactory colour television system, we require only a small number of information-carrying channels between the transmitter and the receiver. Each channel could then carry information concerning a particular colour; and the channel signals, if additively mixed, would then reproduce the

original scene at the receiver. In practice, this state of affairs is closely approached and it is possible, by using three colours only, to obtain reproduction which ranges over a very wide range of colours by using additive mixing at the receiver. The three colours best suited for this process are red, green and blue, since these, in combination, provide a wider range of colours than any other three colours. Red, green and blue are described as *primary colours*, and they are those which are employed in colour television.

We have just noted that additive mixing of two of the three primary colours produces yellow, magenta or cyan. Yellow, magenta and cyan are described as *complementary colours*.

Up to now, we have put the term "white" in inverted commas. The reason for this is that different versions of what we describe loosely as "white" light in everyday life vary quite considerably according to the sources from which they are radiated. White light is, actually, the result of additive mixing of all the colours in the spectrum. All these colours appear in sunlight and they all appear in the light from an incandescent electric lamp. However, whilst we might normally describe both lights as being "white", they are obviously quite different. The reason for the difference is that the various colours which make up sunlight differ in proportion to those emitted by the electric lamp. All the spectrum colours are roughly equal in strength in sunlight, whilst those radiated by the lamp are more pronounced at the red end of the spectrum than at the violet end. In colour television it is undesirable to refer to "white" without defining with reasonable precision the proportions of colour of which it is composed, and it has been internationally agreed to adopt a standard "white" which is known as *Illuminant C*.¹

Evaluating Colour

In colour television we have to evaluate the colours we transmit and reproduce in terms which make them readily capable of being distinguished. In consequence, we now pass on to a consideration of the manner in which colours may be analysed.

The first term to be introduced is *hue*. Hue describes the basic colour which is under consideration. If we have a red object, then its hue is, also, red. However, "hue" differs from "colour" in that the hue remains unaltered if we add white light to the colour. If we add white light to red we obtain a pink colour but, in colour television, we still describe the result as having a red hue.

The *brightness* of a colour defines the light energy it radiates. We can have a bright red lamp and a dim red lamp; both will have the same colour but, obviously, the first will have a higher brightness level than the second. Since the quantity of light emitted in a given unit of time is measured in *lumens*, the brightness of a colour may also be described as its *luminance* (or, occasionally,

¹ There are two other standard "whites", Illuminant A and Illuminant B, but these do not concern us in the present context.

luminosity). In these articles we shall use the term luminance rather than brightness, because the latter term tends to carry a number of associations from black and white television.

Another term which is used for defining a colour is *saturation*, and this defines its "depth", or its freedom from dilution by white light. Any colour on the spectrum is stated to be *fully saturated*. If white light is added to it, it becomes *less saturated* or *more desaturated*. The term *purity* may also be employed to describe saturation.

We now have three terms with which we can define any colour which is presented to us. These are its hue, its luminance and its saturation. In the N.T.S.C. colour system, the hue and saturation information is transmitted as a separate signal on a sub-carrier, and this separate signal is known as the *chrominance* signal. Thus, chrominance is a blanket term which covers the combination of hue and saturation.

The Chromaticity Diagram

It is always desirable to show measurable quantities in a graphical manner, and this can be achieved, for hue and saturation, with the aid of an ingenious chart which is known as the C.I.E. Chromaticity Diagram.² This diagram is reproduced in Fig. 3(a), in which the approximate positions of various colours are indicated by printing their descriptions. When the diagram is produced in full colour the actual colours named merge into each other in a similar manner to the merging of the colours in the spectrum.

In Fig. 3(a), the curved outside line represents the colours of the spectrum, and it is graduated in divisions from 400 to 700. These figures are the wavelengths of the spectrum colours and correspond to those given in Fig. 1(b). The sloping straight outside line at the bottom (joining the 400 and 700 graduations) does not represent any colours of the spectrum. It will be noted that the centre of the chart is white and that it contains a point marked C. This point corresponds to Illuminant C.

The Chromaticity Diagram can indicate the result of additive mixing between any two colours, and this is done by drawing a straight line joining the two colours concerned. To take a simple example, let us see what effect is given by mixing red and Illuminant C white. This we do in Fig. 3(b), wherein we draw a straight line between point R and point C. At point R we have a fully saturated red but, as we travel along the line RC towards point C, it becomes less and less saturated, this corresponding to an increasing proportion of added white. When we reach point C the colour is completely desaturated. If we pick a position on the line which is midway between points C and R, this corresponds to 50% saturation. If we pick a point 75% of the length of the line away from C, we have 75% saturation. It will be noted

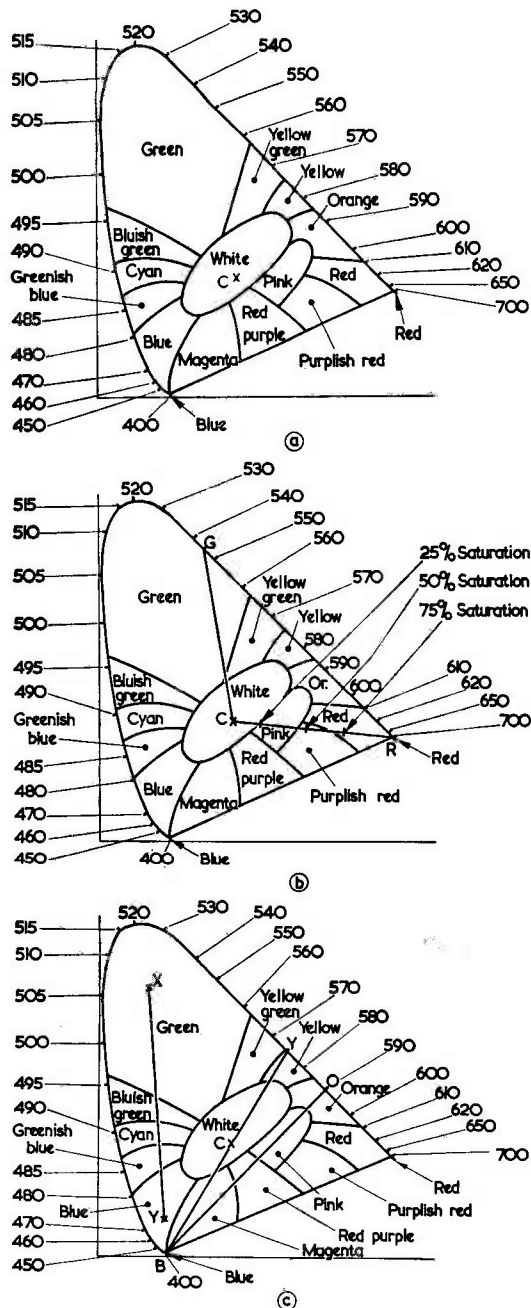

Fig. 3 (a). The C.I.E. Chromaticity Diagram
 (b). The effect on saturation given by mixing red and white (line RC) and green and white (line GC)
 (c). A line, BO, drawn from blue to orange passes through the colours given by different proportions of the two colours. The line BCY, from blue passing through C, meets the complementary colour at Y. The effect of mixing pastel shades is shown by line YX

² The Commission Internationale de l'Éclairage, or C.I.E., is an international body which introduced the Chromaticity Diagram shown in Fig. 3 and, also, Illuminants A, B and C.

that about 25 to 45% of saturation corresponds to the boundaries of the pink area in Fig. 3(b). So far as *hue* is concerned, all points along line RC have a *red* hue, even when they are very close to point C. We can repeat this process for any other spectrum colour. For instance, point G corresponds to the spectrum green, and line GC will trace out the colours given as more and more white is additively mixed with green.

If we mix two basic colours together, the result can also be shown by the Chromaticity Diagram. Thus, in Fig. 3(c), we see the effect of mixing together blue and orange by drawing line BO. As we proceed from B to O we see the result of adding more and more orange to blue, and we pass through magenta, red purple, and pink. Another valuable feature is that a line drawn from any spectrum colour through point C continues to its complementary colour. Thus, in Fig. 3(c), line BCY illustrates that yellow is the complementary colour for blue. It follows from this that, if we mix blue and yellow together in the correct proportions, we will get Illuminant C white. This can be readily imagined from what we have already discussed, because yellow is the result of additive mixing of red and green, and blue, red and green are our primary colours.

The colours we encounter in natural life are rarely as saturated as those which appear on the outside curve of the Chromaticity Diagram. They are, instead, the "pastel shades", such as light green, light blue, and pink. In Fig. 3(c) we have two such pastel shades, these being indicated by points X and Y. By adding the colour indicated by Y to the colour indicated by X we can read off along the line XY the range of colours which would appear for different proportions.

The Colour Response Of The Eye

Although the human eye can perceive very fine detail when this is presented in terms of varying luminance, it cannot identify colour with a similarly high degree of accuracy. This can be demonstrated by attempting to observe the colour of a thin thread, such as cotton, from varying distances. If the eye is a comparatively long distance away from the thread it can only detect its outline. The eye has to approach the thread more closely to be able to identify its colour.

The inability of the eye to discern colour in fine detail varies also with the colour itself, and in small areas some colours may be perceived more readily than others.

Again, the eye tends to associate luminance boundaries with colour boundaries. If a boundary having a sharp change in luminance is superimposed over another in which one hue blends into a second hue, the eye will ascribe a sharp change in hue to the boundary as well.

These shortcomings of the human eye are of considerable advantage in colour television because they allow an important saving in the bandwidth of the transmitted signal to take place. In the American 525 line system the video bandwidth is 4.2 Mc/s. However, because of the incapability of the eye to detect colour in fine detail, the colour information in the picture may be transmitted over a much lower bandwidth than this. As we shall see later, the colour information is, in fact, transmitted by way of two signals, one of these having a bandwidth of 1.5 Mc/s and the other having a bandwidth of 500 kc/s only.

(To be continued)

EMI Develops Miniature Telemetry Techniques for Industry

Telemetry has become an established technique for transmitting readings over long distances. Recent work by EMI Electronics Ltd. has changed the scale and put telemetry to work over a distance of inches.

The reason for going to the complexity of telemetry instead of bringing out some wires which connect to indicators, is that the latter technique is often impractical. Sometimes the presence of the wires would invalidate the whole exercise. Sometimes, as with EMI's engine telemetry, the conditions are such that the wires would not survive long enough for useful experiments to be undertaken.

To use telemetry in this way depends on modern techniques for making compact equipment, small enough not to affect the job being measured, of low consumption so that a small battery will run the equipment long enough to cover a useful experiment. In some cases, the equipment has to withstand really fierce environments, operating at high temperatures or under extremes of shock or vibration. Completely encapsulated transistor circuitry can be made to fit these needs quite well, and these circuits can cope with high-accuracy multi-channel telemetry applications, just as they can with the simple relatively low accuracy needs of the radio pill.

Up till now, most applications have been for carrying out experiments which cannot be tackled in any other way, but the system has been proved sufficiently for it to be built in as a routine method of observing an inaccessible instrument, such as the temperature of a bearing inside a machine.

EMI has used this technique for transmitting information regarding the oil film thickness inside a big end bearing, and stress in a connecting rod of the same engine.

The equipment uses one frequency-modulated oscillator for each channel of information. These oscillators function at about 100 kc/s. They are of a type which requires a very small signal input, so that for most transducers there is no need for preamplification. The output of the oscillators is fed into a loop, which induces into another "receiving" loop on a stationary part of the machine. The output of the loop feeds into selective amplifiers, one per channel, whose output operates the necessary indicators or meters.

All this is old technique. What is new is to have done it in so small a space and so reliably in such difficult environments.



RADIO

topics

By RECORDER

MOST OF MY READING SEEMS to be devoted to electronic journals these days, and so it is with considerable relief that, every now and again, I take up a book or magazine which covers a completely different subject. As in most houses, woman's magazines tend to accumulate, and I find myself with no other alternative but to flip through their pages.

Sometimes, I end up at the column which advises on readers' problems. These features seem to be run entirely by benevolent aunts who dispense all manner of kindly advice to "Bewildered" of Brighton, or "Harassed" of Hampstead Heath. What I find fascinating is that the female population of the British Isles is capable of supporting the vast quantity of writers-in who are needed to maintain all the advice columns which are published every week.

I thought that the mystery was solved when a young wife I know told me that, in her last year at school, she and her class-mates had dreamed up a quite appalling predicament, which they had then put to paper and posted off. But the woman's magazine concerned neither answered the letter nor replied to it in print. I have since heard of a journalist who, in his struggling days, was employed by a woman's magazine to compose the readers' queries for each issue. And that, perhaps, is the answer to the riddle. If it is true, I see no reason why another struggling writer (myself) shouldn't follow his example and similarly compose a column of *electronic* queries.

Auntie Recorder Replies

Dear Auntie Recorder,

Can you help me with my television

problem? Whenever I settle down to watch "Panorama" I am subjected to continual interference by the man next door, who insists on running his electric razor throughout the programme. If I complain he says that "amongst his pet aversions he includes Richard Dimbleby, to mention but a few". Isn't this an anti-social attitude on his part?

"Afflicted"—Aberystwith.

Dear "Afflicted",

Not only is your neighbour's attitude anti-social, my dear, but it is positively illegal. You must be firm and put a stop to all this at once. Go straight away to your nearest Post Office and tell them that he is contravening the Wireless Telegraphy Act, 1949. That will fix him!

Dear Auntie Recorder,

My problem has to do with my record-player. If I play an Elvis Presley 45 r.p.m. record I find that the stylus starts hopping around whenever he gets near the "quivery" bits. Sometimes it jumps two or three grooves. What shall I do?

"Bothered"—Basildon.

Dear "Bothered",

It is obvious that your stylus pressure is not adequate for Elvis Presley. I suggest that you fit an additional 2-lb weight to the cartridge when you play these records. Alternatively, have you ever thought of playing them at 78 r.p.m.? They'll sound much better.

Dear Auntie Recorder,

I always thought that transistor radios were low voltage instruments, but I had quite a nasty shock recently whilst playing my transistor set in our nearby woods.

"Mortified"—Minchinhampton.

Dear "Mortified",

I'm afraid you haven't given me enough information to answer your query completely. Can you send me a circuit diagram?

Dear Auntie Recorder,

After twenty years of married life, I must now confess to being bested by a computer. My husband started to build this computer in the spare room three years ago, but he now states that there is only enough room there for the memory store. Two years ago he commandeered the dining room for a battery of digital tape handlers, and he followed this by filling our sitting room with printing-out equipment. Even the kitchen is not inviolate, and the oven, washing machine and refrigerator have all gone to make way for tape-reading units. Our house is a honeycomb of wires and, whenever he thinks of a new application for the computer, he adds the equipment at the most convenient place. We have logic units on the stairs, ferrite core matrixes in the bathroom, punched card read-out gear in the bedroom, and a revolving magnetic drum memory system in the hall. Despite my protests the computer continues to grow, and it will soon be impossible to get into the house at all. Please, Auntie Recorder, what shall I do?

"Grieved"—Gresham.

Dear "Grieved",

You mustn't try to fight this thing, my dear. It's bigger than both of you.

Dear Auntie Recorder,

I have just built my first receiver, using unbranded Japanese transistors, and I find it has a most peculiar fault. When I switched on I found that I was getting the following day's programmes. Even as I write, the set is announcing the winners for tomorrow's races.

"Perplexed"—Peterborough.

Dear "Perplexed",

Don't you dare alter that set, my girl! I never did dig this query-answering lark anyway, and I'm catching the next train to Peterborough. After which, you and I will be backing all those gorgeous dead-cert gee-gees!

Transistor Output Stages

Turning (hastily!) to another subject, I must state how much I agree with the many people who complain about the excessive use of transistor radios in the countryside and on our beaches. The aspect that I find most distressing, however, is the heavy distortion which is evident with such a high proportion of these receivers.

Obviously, the tiny speaker and small cabinet of the average "personal" transistor set is quite incapable of offering reproduction approaching high fidelity standards. The main distortion likely to occur here is restricted and uneven frequency response but, provided that there are not any perceptible resonances, this is something which I could accept as being an inevitable adjunct in a very small radio. It is the heavy harmonic distortion on the signals fed to the speaker which annoys me, and I can only presume that this results from poorly matched transistors in the Class B push-pull output stage, or to the output transistors having to work under incorrect crossover conditions. In the latter case, distortion is liable to increase when volume is reduced. Crossover distortion is at its worst for low level signals, with the result that reduced volume causes a higher proportion of the a.f. fed to the output stage to be applied to the most non-linear part of its characteristic.

It is pleasing to note that one manufacturer, Ferguson Radio Corporation, Ltd., has introduced a "personal" receiver incorporating a complementary output stage. This set, the Model 3110, has a p.n.p. and an n.p.n. transistor in a single-ended output configuration, each of the two transistor bases receiving an in-phase signal. No driver or output transformer is needed. The transistor types are OC81M (p.n.p.) and AC127 (n.p.n.) and they are biased with the aid of a diode which automatically counterbalances battery and temperature variations. The great advantage of transistors in a complementary circuit is that they function as emitter-followers and do not need to be closely matched. In consequence, one of the main causes of transistor receiver distortion—incorrect matching—is eradicated. The other main cause, incorrect crossover conditions, would appear to be looked after by the diode biasing circuit.

I have, over the last few years, looked forward keenly to the demise of the Class B push-pull output circuit in commercially manufactured transistor receivers. I now

devoutly hope that the change-over to complementary output stages will gain greater favour with commercial manufacturers, and that these will eventually oust their push-pull counterpart.

Two Announcements

Mullard Limited inform us that the latest edition (March 1963) of the Mullard *Designers' Guide To Semiconductors* is now available. This provides a quick reference to semiconductor devices recommended by Mullard for new industrial and communication equipment designs.

Also, the Institution Of Electrical Engineers announce a Symposium on Automatic Production in Electrical and Electronic Engineering, to be held on 24th and 25th October in connection with National Productivity Year. The subjects proposed are: design of components for automatic assembly; automatic functional testing of electrical components and assemblies; automatic production processes; automatic assembly; automatic inspection and testing; automatic adjustment; automatic production scheduling; and automatic storage and distribution. The Symposium will be held at the Institution, Savoy Place, London W.C.2.

Impregnation and Q

A chap I know, who likes everything he builds to be really strong and sturdy, recently wound himself some coils which were intended to operate on the Medium and Long wave bands. He completed his windings, checked them out in the receiver for which they were intended, and pronounced himself satisfied with their inductance and performance. The next thing he did was to paint the windings very liberally with shellac varnish, allowing this to soak well into the body of the coils.

An hour later the varnish seemed fairly hard, whereupon he checked the coils in the receiver once more. To his dismay he found that, whilst the coils still covered the same frequency range as before, their Q had fallen so abysmally low that they were completely useless.

He had used the shellac varnish before and its insulating properties had seemed to be quite adequate, and he decided to look upon the peculiar results he had obtained as just another of life's little mysteries. At any event, he put the set on one side and decided to return to it the next day.

When he did so, he found that the coils were now working nearly as well as they had before he applied the shellac! Furthermore, their performance gradually improved until, on the following day, they gave exactly the same results, so far as Q was concerned, as they had initially.

This effect is, of course, an "oldie", but the story is worth recounting for the benefit of those who haven't encountered it yet. When shellac varnish is in its liquid state, it gives a very high dielectric loss, this being quite sufficient to bring the Q of any impregnated coil right down to basement level. The Q only reaches its final high value when the shellac varnish has finally set, and is rock-hard. In the case I've just mentioned, the shellac would, first of all, have formed a hard film on the outside surface of the coil, thereby delaying the evaporation of the remaining solvent in the body of the coil.

The same effect is liable to occur with many other impregnating materials, and it is one that should always be kept in mind when working with coils. For instance, if a wave-wound coil is impregnated in wax, its Q value immediately after it is withdrawn from the wax may, quite frequently, be lower than normal. It is only after the wax has cooled and finally "settled" that the coil offers its maximum Q.

I haven't bumped into this difficulty with coils impregnated with polystyrene dope, and this may possibly be due to the fact that most polystyrene dope solvents are very volatile. They evaporate extremely quickly, and the dope sets almost instantly. In consequence, the impregnated coil reaches its final state almost immediately, and there are no misleading effects.

These particular comments apply, incidentally, only to the Q of the impregnated coil. All impregnated coils have a higher self-capacitance than in the un-impregnated state, because the impregnant has a higher dielectric constant than that of the air it replaces. I might add that shellac varnish is not exactly the best choice these days for the impregnation of components operating at r.f., and that there are a number of synthetic impregnating varnishes which would be more satisfactory from the electrical point of view. But don't be surprised if these varnishes, whilst they are drying and setting, do not similarly reduce Q!

The Magnetoresistor

By J. B. Dance, M.Sc.

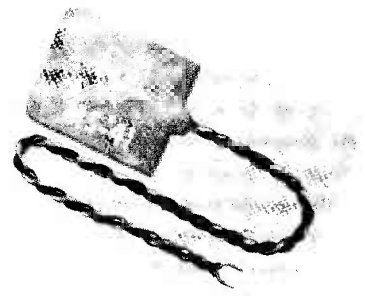

RESISTORS WHICH CHANGE IN VALUE AS SOME physical quantity around them changes are now well known in electronics. For example, the photoconductive cell is a resistor which changes in value as the amount of light falling on it changes, the voltage dependent resistor changes in value as the voltage across it changes and the thermistor changes in value as its temperature changes. A new addition to this range is the magnetoresistor, which changes in value as the magnetic intensity of the field in which it is placed changes.

The Magnetoresistive Effect

The resistance of any material increases when the material is placed in a magnetic field the direction of which is perpendicular to the direction of the current flow. This magnetoresistive effect is present in all substances, but is only large enough to be of practical importance in materials which have high charge carrier mobilities. The new semiconductor materials indium antimonide and indium arsenide have particularly high electron mobilities and are therefore very suitable for use in magnetoresistors.

The MS-41 magnetoresistor manufactured by Ohio Semiconductors employs indium antimonide—which, with indium arsenide, has the highest electron mobility of any material yet discovered. The MS-41 has a zero field resistance of 1Ω , this increasing with field strength to 25Ω at 22,000 gauss. Other magnetoresistors having zero field resistances of between 0.01 and 50Ω are being developed. The low resistance of these devices

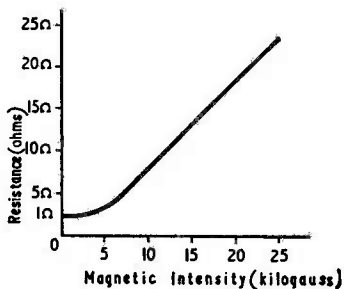

Fig. 1. The MS-41 characteristic curve

is a direct result of the high electron mobility of the semiconductor material used. A thin wafer of the material is employed so that the magnetic circuit requirements are simplified. Power magnetoresistors have been mounted on heat sinks which permit up to 20 watts dissipation and currents of up to several amperes.

Linearity

It can be seen from Fig. 1 that the characteristic of the MS-41 is non-linear below about 5,000 gauss. In this region the change of resistance is approximately proportional to the square of the magnetic induction. Above 5,000 gauss the characteristic is substantially linear. If a linear device is required, a magnetic biasing current may be passed through a separate winding on the magnet assembly so that a steady magnetic field is produced which is superimposed on any field produced by current flowing in the signal winding. The ability of the device to operate either linearly or nonlinearly according to the bias applied greatly increases its versatility.

Uses

The MS-41 may be used in the type of circuit shown in Fig. 2 as a voltage stabiliser. If the voltage across the load increases, the current through the magnetising coil increases also, thus producing an increase in the resistance of the magnetoresistor which tends to reduce the initial voltage increase.

Another simple use is as a transducer. The

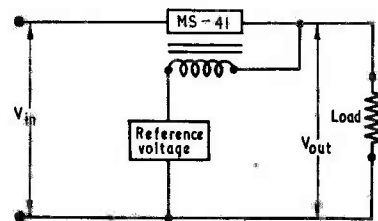

Fig. 2. The MS-41 as a voltage stabiliser

magnetoresistor could be connected to a microphone diaphragm, gramophone pick-up, barometer or air speed indicator so that, when movement occurs, the amount of the magnetoresistor which is inside the gap of a magnet changes. The output will be a function of the distance moved.

If the magnetoresistor is used as one arm of a bridge circuit, it can be used to detect small changes in magnetic field strength.

The MS-41 may also be employed as a power amplifier with complete electrical isolation between the input and output. The input is used to control

the magnetic field strength of the region in which the magnetoresistor is placed.

Other uses include contactless variable resistors, current regulators, squaring devices, modulators, choppers, control applications and computer applications. The low noise and fast response time of the magnetoresistor should present characteristics much better than those provided by electromechanical systems in many applications.

Further details can be obtained from Ohio Semiconductors, 1205 Chesapeake Avenue, Columbus 12, Ohio, U.S.A.

An Inexpensive . . .

3-TRANSISTOR RADIO

By G. Phillimore

An experimental circuit which gives good results whilst employing a minimum of components

THIS CIRCUIT REPRESENTS WHAT MAY ALMOST BE the cheapest and simplest type of 3-transistor radio which can be made. It will be seen from the accompanying diagram that a bare minimum of components is required. The total cost could well be less than 25s. in all.

Not being of a regenerative type, the receiver requires a small aerial and earth. Even with about 20ft of wire thrown out, good results are obtained.

Tuning is provided by a dual range coil and a single 500pF solid dielectric capacitor, C₂. If a

ferrite rod is preferred for a higher Q, C₂ could be deleted,¹ tuning being effected by sliding the rod in and out of the coil. Suggested coil winding details in this case are 70 turns of 30 s.w.g. wire for L₁ and 150 turns of the same wire for L₂, these being wound on a thin tube which is free to move along a ferrite rod 4in long by $\frac{1}{8}$ in in diameter. In the prototype a cheap dual range crystal coil was used.

As the circuit stands, the out-of-phase emitter

¹ Or replaced by a fixed capacitor around 50 to 100pF.—EDITOR.

Components List

Resistor

R₁ 50 to 100kΩ

Inductor

L₁, L₂ Dual-range coil

Switches

S₁ s.p.s.t. MW/LW switch

S₂ s.p.s.t. on/off

Battery

1.5 to 6 volts, as required

Capacitors

C₁ 50pF

C₂ 500pF solid dielectric variable

C₃ 1 to 6μF, 6 w.v. electrolytic

Semi-conductors

TR₁ OC44 or equivalent r.f. type

TR₂ Red spot

TR₃ OC71 or OC72

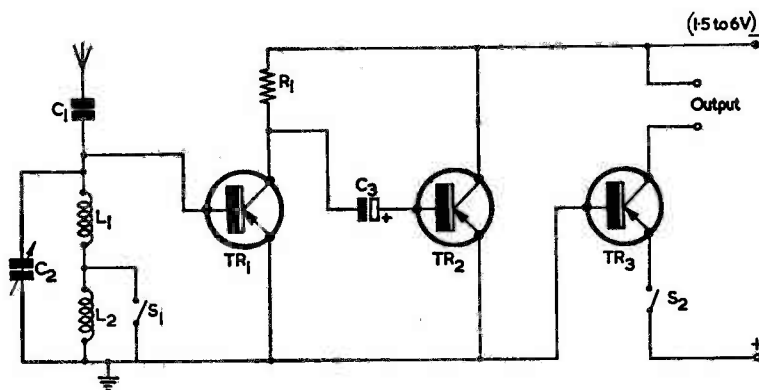

currents of TR₁ and TR₂ flow through the base-emitter junction of TR₃. To check whether this incurred a loss of output, the emitter of TR₁ was experimentally returned to the positive supply terminal. The result was that half the signal strength disappeared! In consequence the emitter connec-

tions shown in the accompanying diagram are those which are recommended.²

² It should be noted that TR₂ is not biased by any physical resistor and that its performance may depend upon leakage current in C₃.
—EDITOR.

The prototype is housed in a plastic case measuring 4 x 3 x lin. Any battery potential between 1.5 and 6 volts may be employed, the latter being used for loudspeaker reception.

CHECKING SUPERHET OSCILLATORS BY SUBSTITUTION

By Niall O'Riordan

THIS CAN HARDLY BE DESCRIBED AS A NEW HINT but the writer cannot recall having seen it recommended in any of the magazines catering for servicemen. It is always used in the writer's workshop, as it gives a really unmistakable indication whether the fault is in the aerial or oscillator section of the frequency changer in valve receivers.

It is quite simple and quick to carry out, and is done as follows:

When a set comes in and the usual checks indicate that it may have an oscillator fault, plug in the aerial and tune in to the local station. Now clip the output from the signal generator (unmodulated) to

the grid pin of the oscillator section of the frequency changer valve. Feed a signal whose frequency is 460 kc/s higher than that of the local signal and if the oscillator is the cause of the trouble the local station should now be heard normally. The writer always uses the Light Programme on 200 kc/s for this test, injecting a signal of 660 kc/s. If the receiver's i.f. is not known for certain, just "rock" the signal generator's tuning control about the likely settings.

Incidentally, this is a very effective way of showing apprentices how the frequency changer functions.

First Metal-Clad Transistor Batteries

The first British transistor batteries ever to be made with a metal—instead of a cardboard—casing are now being produced and marketed by Vidor Ltd. The casing is being used for the company's range of popular 6V and 9V transistor radio batteries.

This is one of the most important battery developments in recent years for it has provided a new solution to a long-standing performance problem common to all "layer"-type dry batteries—that of maintaining firm contact between the individual cells throughout their operating life.

The result is a range of power packs that are outstandingly efficient, and are virtually unbreakable. Nevertheless, these metal-clad batteries are being marketed at the same price as the cardboard clads that they are replacing.

Cardboard-clad "layer" dry batteries are produced with the cells strapped together, but this is not always capable of restraining the swelling of the cells, which takes place on discharge, and which may distort the cardboard and so the shape of the battery. With severe distortion contact between the cells may be completely lost.

Now, however, by inserting the cells, together with the terminals, into a metal casing and turning over the ends of the metal, Vidor have eliminated strapping. The metal holds the cells together in a strong unyielding grip that permits no loss of contact whatsoever and no distortion in the shape of the battery.

The new metal-clads are much more robust. All of them are of the press-stud-mounting type and, unlike the cardboard-clad batteries, they cannot buckle under the pressure exerted to push in the connecting studs.

It is not only the users of transistor radios that will benefit from the development. Elimination of the strapping leaves more space for the cells so that Vidor are able to produce batteries that offer more life for a given size. This is of special interest to the designer in the electronics industry, which is working constantly towards more miniaturisation. Moreover, the metal-clads are being manufactured with extremely close tolerances, and this, coupled with the fact that there can be no dimensional change in the batteries during discharge, will be of considerable assistance in the design of radio receivers' battery compartments.

Production of the batteries coincides with the introduction by Vidor of new simplified reference numbers for these transistor power packs as well as for many other types of batteries made by the company. The catalogue numbers of the metal-clad transistor batteries are VT1 (replacing T6001), VT3 (T6003), VT4 (T6004), VT5 (T6005), VT6 (T6006), VT7 (T6007), and VT9 (T6009).

The bulk of the specially lacquered open-ended tinplate canisters that constitute the metal casing are being manufactured for Vidor by John Dale Ltd., one of the Metal Closures group of companies. In various shapes and sizes with Mennen sides for neatness, the canisters are now in full production at Dale's North London works.

BRITISH AUTOMATIC CONTROL SYSTEM FOR EUROPEAN BISCUIT PLANT

The most up-to-date automatic control system for biscuit making, using computer techniques, is being installed by British companies at the factory of one of the leading biscuit manufacturers in Europe.

EMI Electronics Ltd is main contractor for the entire project which will control bulk handling of flour, sugar and liquid ingredients of biscuit doughs, and the automatic weighing and measuring of these materials during manufacture. Sub-contractor for the bulk handling and mixing equipment is Baker Perkins (Exports) Ltd.

When the installation is completed, the high quality standard of the biscuits can be consistently maintained and the factory output increased to cope with expanding demand. The automatic control problem has been made more complex by the policy of the company that the well-established recipes shall not be modified to simplify the use of modern techniques. Indeed, the fine control of the new system will ensure uniformity of the product to required recipes at all times.

Flour and sugar will be delivered to the factory in tankers and stored in specially constructed silos. These materials and the liquid ingredients will be conveyed to the weighers and mixers by special pipes. Equipment has also been supplied to handle the large quantities of butter that are used in these biscuits.

A number of high speed mixers and dough handling machines are also being installed, and these will be fed direct from the weighing apparatus. So at no time will there be any human contact with the ingredients.

Weighing of solid ingredients and measuring of liquid ingredients is to be carried out by an EMI automatic electronic control plant so that the various materials can be added and mixed in the exact sequence and quantities demanded by the special recipes. The control plant will deliver the right amount of materials to each mixer at the right time in accordance with the specification of the recipe and predetermined daily programme of dough requirements.

FREE THIS BOOK WILL INTEREST YOU!

LEARNING the PRACTICAL WAY

RADIOSTRUCTOR
EQUIPMENT-COURSES

FOR ... Your Career
... Your Own Business
... An Absorbing Hobby

A NEW-PRACTICAL WAY of UNDERSTANDING

RADIO • TELEVISION • ELECTRONICS

Including: Transistors; VHF/FM; Hi-Fi Equipment; Computers; Servo-Mechs. Test Instruments; Photo-electrics; Nucleonics; etc.

Radiostructor—an organisation specialising in electronic training systems—offers a new self-instructional method using specially designed equipment on a “do-it-yourself” basis. You learn by building actual equipment with the big kits of components which we send you. You advance by simple steps, performing a whole series of interesting and instructive experiments—with no complicated mathematics! Instructional manuals employ the latest techniques for showing the full story of electronics in a practical and interesting way—in fact, you really have fun whilst learning!

RADIOSTRUCTOR
LEADS THE WORLD
IN ELECTRONICS TRAINING

POST NOW

To RADIOSTRUCTOR (Dept. G149), READING, BERKS.
Please send brochure, without obligation, to:

*Name

*Address

(We do not employ representatives)

6.63
*Block Caps Please

SMALL ADVERTISEMENTS

Private: 3d. per word, including address.

Minimum charge 2/6.

Use of Box Number, 2/- extra.

Trade: 9d. per word. Minimum charge 12/-.

Terms: Cash with order.

All copy must be received by the 6th of the month for insertion in the following month's issue. The Publishers cannot be held liable in any way for printing errors or omissions, nor can they accept responsibility for the *bona fides* of advertisers.

PRIVATE.

FOR SALE. *The Radio Constructor* volumes 11, 12, 13 and 14. No Index. 24s. per volume. Collect or pay carriage.—George, 205 Avon Road, Chelmsford, Essex.

WANTED. Collector requires early wireless valves, pre-1925. Details and price to Box No. F170.

ANYONE INTERESTED in fighting for a novice band please contact E. Wiles, High Street, Wilden, Beds.

FOR SALE. 160 metre table-top transmitter, 10 watt, phone and c.w., in polished oak cabinet, 15 1/2 x 8 1/2 x 8 in high. Separate power supply, 250V 5c/s input. Aerial change-over relay included in Tx, as well as power relays in power supply. A very neat table-top unit. £20 o.n.o.—Box No. F171.

FOR SALE. Signal generator, type CG/6/1. Coverage 100 kc/s to 100 Mc/s on fundamentals and 100 Mc/s to 200 Mc/s on harmonics. Used once. £6.—Box No. F174.

FOR SALE. Linear L45 5 watt quality amplifier, for use with record player or microphone. Small size, 6 x 5 x 6 in. 200-250V a.c. mains power supply. £5.—Box No. F175.

FOR SALE. Ex-governor 2 1/2 in 1mA M.C. meters, new. Few only at 16s. VCR97 tube, mumetal screen, base, as new. 27s. 6d. Carriage free.—C. Forrest, 83 Leighton Avenue, Swindon, Wiltshire.

FOR SALE. *Radio and TV Servicing* 10 volumes up to 1962. Excellent condition. £10. Telephone BOW 3817, 6-6.30 p.m.—Easton, 40 Hereward Gardens, Palmers Green, London, N.13.

FOR SALE. EM1 985 4-speed record player deck, 9 volt operation, with stereo turnover cartridge, speaker and cabinet, £6. Almost completed version *Practical Television* Multimeter, £2. Pifco Radiometer, £1.—Secker, 65 Brim Hill, London, N.2, Telephone MEA 3158.

FOR SALE. Garrard TA Mk. 2 four-speed single record player. GC8 t/o cartridge (new sapphires). Also Garrard plug-in crystal stereo head (unused) for above. All perfect. £5 10s. the lot.—Dodd, 266 King's Drive, Eastbourne, Sussex.

FOR SALE. Quantity of electronic equipment for sale, valves, c.r.t.s, transformers, meters, etc. Mostly ex-W.D.—A. J. Drew, 19 Birchwood Avenue, Sidcup, Kent.

WANTED. Two light transistorised walkie-talkies. Please state details, condition and price.—Box No. F176.

FOR SALE. Audio signal generator 20-100,000 c/s, £4 10s. o.n.o. Transistor signal generator 100 kc/s-220 Mc/s, £5 o.n.o. Avonmorn meter, £3. Collaro studio tape deck, £7 10s. o.n.o. Magnavox tape amplifier, £4 o.n.o.—Lanworn, 3 Gainsborough Road, Finchley, London, N.12.

Continued on page 845

BENTLEY ACOUSTIC CORPORATION LTD

38 CHALCOT ROAD CHALK FARM LONDON NW1
THE VALVE SPECIALISTS Telephone **PRIMROSE 9090**
ALL GOODS LISTED BELOW IN STOCK

0A2	6/-	7H7	5/9	D15	13/6	EL95	6/6	SP41	2/3	MIDGET
0B2	17/6	7Y4	5/-	D43	17/9	EL360	27/-	SP61	2/-	SILICON
0Z4GT	4/3	8D2	2/6	DAF96	6/9	EL820	18/2	SU25	27/2	RECTI- FIERS
1A3	3/-	98W6	14/11	DD41	13/7	EL821	5/-	T41	9/-	Mullard
1A7	9/6	9D2	3/-	DF66	15/-	EL822	19/6	TDD4	8/6	BY100
1C5	7/-	10C1	10/-	DF96	6/9	EM4	17/9	TH41	17/6	
1G6	6/-	10C2	13/-	DH76	7/6	EM71	22/8	TY86F	13/-	Output 250
1H5GT	6/9	10D2	7/8	DH96	4/6	EM80	6/9	U12/14	7/6	volt at 3
1L4	3/-	10F1	10/-	DK40	18/8	EM81	8/-	U16	10/-	larger than
1LD5	4/3	10LD11	11/3	DK92	7/-	EM84	8/6	U18/20	6/6	a shirt but-
1LN5	4/6	10P13	8/6	DK96	6/9	EM85	9/6	U19	48/6	ton!
1N5GT	8/9	10P14	12/-	DL66	17/6	EN31	7/1-	U22	6/9	
1R5	5/3	12A6	6/3	DL68	15/-	EY51	6/9	U24	15/6	8/- each.
1S4	5/-	12AC6	13/5	D196	6/9	EY81	12/6	U25	10/-	TRANSIS-
1S5	4/3	12AD16	16/10	DS10	19/6	EY86	6/3	U26	8/6	IST-6
1T4	5/6	12AE6	12/3	DM70	5/-	EZ40	5/3	U31	7/-	DIODES
1U4	7/-	12AH8	9/-	DY86	7/-	EZ41	6/6	U33	29/11	GD3 5/6
1U5	5/3	12AT6	5/-	E80F	30/-	EZ80	5/3	U35	29/11	GD4 5/6
2D21	15/-	12BA6	7/-	E83F	30/-	EZ81	5/-	U37	25/11	GD5 5/6
2X2	3/-	12BE6	5/-	E180F	34/6	GU50	41/6	U45	15/6	GD6 5/6
3A4	4/-	12BH7	8/-	EABC80	6/6	GZ30	7/-	U50	5/3	GD12 4/6
3A5	5/6	12CF7	7/6	EC91	11/6	GZ31	7/6	U52	4/6	GD15 4/6
3B7	5/-	12K5	17/6	EAF42	8/3	GZ33	15/8	U76	5/6	GD16 4/6
3D6	4/-	12K7GT	4/3	EB41	5/-	GZ34	11/6	U107	17/6	GET106/17/6
3Q4	6/-	12K8	9/-	EB91	3/-	HL2	7/6	U91	11/6	GET114 6/6
3Q5	7/6	12Q7GT	4/6	EBCC41	7/6	HN309	26/2	U281	12/6	GET873 9/3
3S4	4/9	12SA7	7/-	EBCC81	7/-	HVR2	9/-	U282	14/9	GET874 9/6
3V4	6/-	12SC7	4/-	EBF80	7/3	HYR2A	9/-	U301	12/3	GEX36 10/6
3R4GY	5/-	12SK7	7/6	EC32	11/6	K22	9/6	U32	6/6	GEX37 8/6
5T4	8/-	12SQ7	8/-	EBF89	7/9	KT33C	9/-	U339	11/3	GEX64 11/6
5U4G	4/6	19AQ5	7/9	EC70	12/6	KT36	32/4	U404	6/-	GEX66 15/6
5Y4G	7/6	19H1	6/6	EC81	27/6	KT41	11/6	U801	18/6	AF102 27/6
5Y3GT	5/3	20D1	14/11	EC92	11/8	KT44	6/-	U4020	18/2	AF114 11/-
5Z3	19/3	20P2	12/3	ECC33	4/-	KT61	8/6	UABC80	6/-	AF115 10/6
5Z4G	7/-	20L1	15/-	ECC34	12/11	KT62	4/-	UAF42	8/6	AF116 10/6
6B8	7/-	20P1	12/6	ECC35	5/9	KT66	11/6	UB17	6/6	AF117 6/6
6AG5	2/9	20P3	12/6	ECC40	9/6	KT88	4/3	UBC41	7/-	AF118 20/-
6AK5	5/-	20P4	14/-	ECC81	4/6	KT101	32/4	UBC81	7/9	AF127 12/-
6AQ5	6/-	20P5	15/-	ECC82	4/9	KT241	6/-	UBF80	7/6	MAT100 7/6
6AU6	5/-	25A6G	8/-	ECC83	4/9	L63	3/-	UBF89	7/3	MAT101 8/6
6AU6	7/6	25L6GT	7/-	EC84	7/3	LP12	9/6	UCC85	9/9	MAT120 7/6
6BA6	5/6	25Z4	8/-	EC88	11/6	ML9	7/6	UC89	10/6	MAT121 8/6
6BE6	5/6	27S5	25/11	ECF80	8/3	MU14	5/6	UCH81	7/3	OA10 8/-

We require for prompt cash settlement all types of valves, loose or boxed, but must be new. Send list of types available for offer by return.

6BH6	6/-	28D7	7/-	ECF82	8/-	IN37	25/11	UCL82	9/-	OA70 3/-
6BJ6	5/9	30C1	7/-	ECF86	19/3	IN78	29/11	UCL83	11/-	OA73 3/-
6BQ7A	6/-	30C15	15/-	ECF85	7/-	JA18	6/6	UL42	7/6	OA79 3/-
6BR7	8/6	30F5	6/-	ECH42	8/6	N308	12/6	UL42	7/6	OA81 3/-
6BR8	9/3	30FL1	9/6	ECH81	7/-	N339	15/-	UFB0	7/6	OA85 3/-
6BW6	10/6	30FL12	12/6	ECH83	8/-	PC95	13/-	UF85	7/-	OA86 3/-
6BW7	5/-	30L1	6/3	ECH84	14/7	PC97	9/6	UF86	13/6	OA91 3/6
6C9	5/-	30L15	11/6	ECL80	6/6	PCC84	6/3	UF89	6/3	OA95 3/6
6C9	11/-	30P4	12/6	ECL82	8/-	PCC85	7/6	UL41	4/6	OA10 13/6
6CDEG	35/8	30P12	12/6	ECL83	16/11	PC88	11/9	UL44	25/11	OA21 13/6
6CH6	5/-	30P19	12/6	ECL86	9/6	PCC89	8/6	UL46	9/-	OC16V 35/-
6D6	3/-	30PL1	10/-	EF22	7/6	PC189	13/6	UL84	6/3	OC19 25/-
6E5	7/-	30PL13	9/6	EF36	3/3	PCF80	7/-	UM4	15/6	OC22 23/-
6E1	9/6	35A5	20/6	EF37A	6/9	PCF83	6/9	UM44	18/6	OC26 25/6
6F6G	4/-	35L6GT	7/9	EF39	4/-	PCF84	16/2	UM80	6/6	OC35 18/6
6F13	6/9	35W4	6/-	EF40	11/-	PCF86	8/6	UR1C	18/2	OC36 21/6
6F23	10/6	35Z3	16/4	EF41	7/6	PCL82	7/-	U06	11/9	OC41 9/-
6F24	11/6	35Z4GT	5/-	EF42	6/9	PCL83	8/9	U08	13/3	OC43 12/6
6F33	3/6	35Z5GT	7/-	EF50(A)	2/6	PCL84	5/6	U09	3/6	OC44 9/3
6F5G	3/-	50C5	6/3	EF50(E)	1/6	PCL85	9/-	UY1N	10/9	OC44PM 9/3
6I6	3/-	50L6GT	7/-	EF73	5/-	PC186	10/-	UY21	16/2	OC45 9/-
6I7G	4/9	52KU	14/4	EF80	4/6	PCL88	21/4	UY41	5/9	OC45PM 9/3
6K7G	1/9	53KU	23/3	EF85	5/-	PEN46	4/6	UY85	5/6	OC65 22/6
6K8G	4/6	72	6/6	EF86	6/9	PL33	18/9	VMS48	12/6	OC66 25/-
6K25	13/6	80	9/6	EF89	5/9	PL36	9/-	VP4	19/-	OC70 6/6
6L1	9/6	83	15/-	EF9	3/6	PL38	25/11	VP48	22/8	OC71 6/6
6L6G	7/6	85A2	12/-	EF92	3/-	PL81	8/-	VP13C	7/-	OC72 8/6
6L7GT	4/6	90AG	6/6	EF97	11/8	PL82	6/-	VP23	2/9	OC73 16/-
6L18	7/6	90AV	6/6	EF98	11/8	PL83	6/-	VR105	5/6	OC75 8/6
6N7	5/-	90CG	37/6	EF183	9/-	PL84	7/-	VR150	5/6	OC76 8/6
6P2B	11/6	90CV	42/-	EF184	9/-	PL820	18/2	W76	4/9	OC77 12/-
6CG	5/6	90C1	6/6	EF187	7/6	PB18	4/6	U34M	12/6	OC78 9/6
6R7G	6/-	150B2	16/6	EL32	3/6	PX4	10/-	X61	10/-	OC81 8/6
6S17	5/9	150C2	6/-	EL33	7/6	PX4	8/-	X65	11/-	OC82 10/6
6SNT	4/6	185BT	38/10	EL34	10/-	PY32	9/6	X66	7/9	OC83 6/6
6U4GT	9/6	807	6/-	EL37	21/7	PY33	10/6	X76M	11/-	OC84 8/6
6U5G	5/-	5763	7/6	EL38	12/6	PY80	6/-	X78	26/2	OC140 18/-
6V6G	4/-	AC6PEN	6/-	E141	6/6	PY81	6/-	X79	40/6	OC170 9/6
6V6GT	6/-	AZ31	7/-	EL42	9/-	PY82	5/6	XD(1.5)	6/6	OC171 10/6
6X4	4/3	AZ41	12/3	EL81	8/9	PY83	6/6	XFY23	6/6	OC771 17/6
6X5	4/6	B36	5/9	EL83	7/6	PY88	9/-	XFY51	2/8	T52 12/6
6/30L2	9/-	BL63	10/6	EL84	6/-	PZ30	17/6	XFY54	18/-	T53 13/6
7B7	7/6	GL3	7/6	EL85	13/6	PZ31	25/11	XH(1.5)	9/9	XA102 19/6
7C5	10/-	CY1	18/2	EL86	13/6	R18	14/-	Y63	8/-	XA103 19/6
7C6	7/6	CY31	7/6	EL91	3/-	R19	9/-	Z66	8/6	XA104 18/-

All goods new and first grade only. Please note that we do not sell second-hand goods, manufacturers' rejects or seconds (often described as "new and tested"), no items from disassembled equipments. Complete catalogue of over 1,000 valves, also resistors, condensers, metal rectifiers, microphones, loudspeakers, transformers of all types, etc., and other components 6d.

Terms of business: Cash with order or C.O.D. only. Post 6d. per item. Orders over £3 post free. C.O.D. 3/6 extra. All orders despatched same day. C.O.D. orders by telephone accepted for immediate despatch until 3.30 p.m. Any parcel insured against damage in transit for 6d. extra. We are open for personal shoppers 8.30-5.30. Sats. 8-1 p.m.

Eighth Revised Edition

NOW AVAILABLE



The Radio Amateur Operator's Handbook



COMPILED BY THE STAFF OF **THE RADIO CONSTRUCTOR**

IN COLLABORATION WITH **The International Short Wave League**

**56
pages**

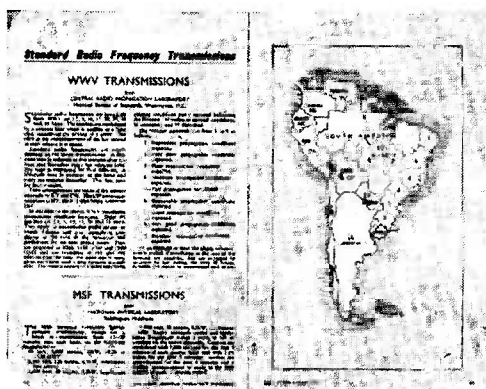

4/6

In the eighth edition of this well established handbook, several new features have been included in addition to the complete revision of the Amateur Prefix lists—these containing the latest issued information.

Essential to both the Transmitter and the Listener, it is full of such information as Radio Zone Boundaries—1/40, Call Areas, Amateur Band Frequency Allocations, Local Time Conversions, Mileage Table, Amateur Codes and Abbreviations, the Amateur Licence, International Morse Code, QSL Bureaux of the World, Standard Frequency Transmissions, Operating Technique, Charts on which countries, states, zones and counties worked or heard can be recorded, a QSL record, Prefix/Directional Bearing List, 2 Metre and 70 cm. Band Plan with map, Frequency/Wavelength Conversion Chart, Amateur Radio News Broadcasts, National Societies with addresses and Call Area Maps of Australia, U.S.S.R., South America, Canada, U.S.A. and Weather Forecast Areas, etc., etc.

To **Data Publications Ltd., 57 Maida Vale, London, W.9**

Please supply..... copy(ies) of your latest publication "THE RADIO AMATEUR OPERATOR'S HANDBOOK" DATA BOOK No. 6 at 4s. 6d. each, postage 4d.

NAME.....

ADDRESS.....

BLOCK LETTERS PLEASE

SMALL ADVERTISEMENTS

continued from page 843

TRADE

DIRECT TV REPLACEMENTS LTD. Largest stockists of TV components in the U.K. Line output transformers, Frame output transformers, Deflector coils for most makes. Official sole suppliers for many set makers. Same day despatch service. Terms C.O.D. or C.W.O. Send S.A.E. for quotes. Day & Night telephone: TIDeway 6666. 138 Lewisham Way, London, S.E.14.

METALWORK. All types cabinets, chassis, racks, etc., to your specifications.—Philpott's Metalworks Ltd., Chapman Street, Loughborough.

SERVICE SHEETS (1930-1962) from 1s. Catalogue 6,000 models, 1s. 6d. S.A.E. enquiries.—Hamilton Radio, 13 Western Road, St. Leonards, Sussex.

THE INCORPORATED PRACTITIONERS IN RADIO AND ELECTRONICS (I.P.R.E.) LTD. Membership conditions booklet 1s. Sample copy of I.P.R.E. Official Journal 2s. post free.—Secretary, 32 Kidmore Road, Caversham, Reading, Berks.

ALL TYPES OF LINE OUTPUT TRANSFORMERS SUPPLIED (RETAIL & TRADE). Finest service in the country. Send S.A.E. for return of post service. Terms C.W.O. or C.O.D. Trade enquiries invited.—D. & B. Television (Wimbledon) Ltd., 131 Kingston Road, Wimbledon, London, S.W.19. Telephone: CHerrywood 3955.

CATALOGUE No. 15. Government surplus electrical and radio equipment. Hundreds of items at bargain prices for the experimenter and research engineer, 2s. 6d. post free. Catalogue cost refunded on purchase of 50s.—Arthur Sallis' Radio Control Ltd., 93 North Road, Brighton.

FIND TV SET TROUBLES IN MINUTES from that great book *The Principles of TV Receiver Servicing*, 10s. 6d., all book houses and radio wholesalers. If not in stock, from Secretary, I.P.R.E., 32 Kidmore Road, Caversham, Reading, Berks.

JOIN THE INTERNATIONAL S.W. LEAGUE. Free Services to members including Q.S.L. Bureau, Amateur and Broadcast Translation. Technical and Identification Dept.—both Broadcast and Fixed Stations, DX Certificates, contests and activities for the SWL and transmitting members. Monthly magazine, *MONITOR*, containing articles of general interest to Broadcast and Amateur SWLs, Transmitter Section and League affairs, etc. League supplies such as badges, headed notepaper and envelopes. QSL cards, etc., are available at reasonable cost. Send for League particulars. Membership including monthly magazine, etc., 21s. per annum.—Secretary, ISWL, 12 Gladwell Road, London, N.8.

THE INTERNATIONAL HAM HOP CLUB is a non-profit-making organisation open to RADIO AMATEURS AND SHORT WAVE LISTENERS. OBJECT: To improve international relationships through an organised system of hospitality. MEMBERS offer overnight hospitality to visiting members, subscription 10s. per annum. ASSOCIATE MEMBERS invite radio amateurs to visit their stations. Associate membership 5s. per annum. FAMILY EXCHANGE holidays arranged, also FRIENDSHIP LINKS between radio clubs. The Club's official journal is free to both Full and Associate Members.—Hon. Gen. Secretary: G. A. Partridge, G3CED, 17 Ethel Road, Broadstairs, Kent.

CASES, CHASSIS, PANELS, CABINETS, Tubular Frames, etc. Quotations by return. Unpainted or stove enamelled, any finish. "One off" with pleasure. Engraved Traffolite labels. Quality assured.—Moss Watson, 40 Mount Pleasant Street, Oldham, Lancs.

HIGH STAB. RESISTORS. Preferred values, large range. 1% 3s. doz, 5% 2s. 3d. doz, stock list 1s. No order less than 10s.—F. Walker, 152 Gammons Lane, Watford, Herts.

Continued on page 847

JACKSON



the big name in PRECISION components

Precision built radio components are an important contribution to the radio and communications industry. Be sure of the best and buy Jackson Precision Built Components



"DILEMIN" CONDENSERS

These miniature solid dielectric condensers are only $\frac{7}{8}$ " square. The $\frac{1}{4}$ " dia. spindle projects $\frac{1}{2}$ " from the front plate. Low loss construction provides Power Factor better than .001.

JACKSON BROS. (LONDON) LTD.
Dept. R.C., KINGSWAY-WADDON, CROYDON, SURREY
Phone: Croydon 2754-5 Grams: Walfilco, Souphone, London

PRICE LISTS & INFORMATION ON

Various Designs in

Practical | Radio | Wireless | R.S.G.B.
Wireless | Constructor | World | Bulletin

SEND 6d. POSTAGE FOR



CIRCUITS

OSMOR LTD 418 BRIGHTON ROAD
S. CROYDON SURREY
Telephone CRO 5148

PANDORA * * *

the New Transistor 6

designed by MEL ELECTRONIC

Only **£4.15.0**

P. & P. 3/6

**TOTAL
BUILDING
COST**



- MEDIUM WAVE, LONG WAVE/LIGHT PROGRAMME
- 6 TRANSISTORS+DIODE
- SUPERHET CIRCUIT
- AUTOMATIC WAVECHANGE
- 500mW PUSH PULL OUTPUT
- PRE-TINNED PRINTED BOARD
- EXCELLENT RESULTS

All components obtained direct from
MEL ELECTRONIC CO.

SEND S.A.E. ONLY FOR
FREE DETAILS and in-
formation on other Tran-
sistor designs

USING NEW HIGH GRADE PARTS

FULL AFTER SALES SERVICE

MEL ELECTRONIC CO. Rear of 240 HIGH STREET BECKENHAM KENT

SCOTTISH INSURANCE CORPORATION, LTD

38 EASTCHEAP · LONDON · EC3

Established 1877

THE SHEDDING OF A LOAD

An ACCIDENT can cause serious financial embarrassment. Could you meet your commitments on the National Insurance Benefit?

A "SCOTTISH" Policy will carry the load for you if you are disabled by ANY ACCIDENT and will pay compensation for as long as two years for any one accident.

For a BENEFIT of £10 PER WEEK the premium varies between £2 10s. 0d. and £4 10s. 0d. per annum according to occupation, and the premium can be paid half-yearly or quarterly if desired.

If you will complete and return this form to the Corporation's office at the above address, a quotation will be sent with a proposal for completion, or write for details quoting reference /JB.

NAME (Block Letters)

OCCUPATION

ADDRESS (Block Letters)

/JB

SMALL ADVERTISEMENTS

continued from page 845

TRADE—continued

SURPLUS 3 OHM SPEAKERS. Performance guaranteed. 6½in 12s. 6d. each, 7 x 4in 8s. 6d. each, 6½ x 4½in, 7s. 6d. each. Post free.—J. W. Barker, 183 Lake Road, Portsmouth, Hants.

YOUR KIT—radio, amplifier, etc.—professionally assembled, wired, tested. Moderate charges. Prompt attention. Write to—M. Johnson, Ivy Cottage, Astwood Bank, Redditch, Worcs.

JACK PORTER LTD. Brand new components at keenest prices. All post paid. Genuine Mullard transistors, OC45 5s., OC71, OC81 5s. 6d., OC72, OC44 7s. 6d., OC139, OC140 10s., OC170, OC171 8s. 6d., OC26 17s. 6d. B.T.H. diodes 9d., S.T.C. GD5 3s. 6d. American 6S17 valves, boxed, 2s. 6d. 6C4 triodes 4s. 11d. Midget tuning condensers ¼in square, ¼in shaft, approx. 0.0005, 4s. 11d. Crystal lapel or hand mikes, chrome plated, 13s. 6d. 36ft plastic covered stranded wire, 1s. 3d. coil.—Jack Porter, A.M.Brit.I.R.E., 30/31 College Street, Worcester. (Est. 1929.)

SITUATIONS VACANT

PUBLIC SCHOOL LEAVER REQUIRED as an electronic and/or electro-mechanical trainee to assist in the design and construction of industrial controls for use in the manufacture of glass fibre products. Starting salary £624. Write giving details of education and interests to Fibrelite Industries, Trafford Hall, Chester.

WIRE VISION EQUIPMENT ENGINEER REQUIRED. Apply stating experience to Engineer in Charge, Rank Relay Services, 430 High Road, Chiswick, London, W.4.

FOR ELECTRONIC COMPONENTS PAD 4455

SAVE TIME — SAVE MONEY
TELE-RADIO (1943) LTD

- First for availability
- First for prices
- First for speedy delivery

Huge stocks of Belling-Lee, Bulgin, Painton, Welwyn, Erie and other famous component manufacturers. Switches to order—Mullard Switches—metal cases from 4" x 4" x 2½" to 19" x 11" x 10" and our famous READIPACKS.

WRITE TODAY FOR FREE LISTS

**TELE-RADIO
(1943) LTD**
189 EDGWARE ROAD
LONDON W2

E. R. NICHOLLS 46 LOWFIELD ROAD SHAW HEATH STOCKPORT BUMPER PARCEL

- | | |
|--------------------------|----------------------------|
| 100 Assorted Resistors | 1 Small Chassis containing |
| 50 Assorted Condensers | 60 components |
| 1 5in 3 ohm Elac Speaker | 2 Westectors |
| 1 Isolating Transformer | 2 Thermistors |
| 4 Terminal Blocks. | 100 Cartridge Fuses |
| 2 Rotary Toggle Switches | |

ALL FOR 20/-, Post free in U.K.

20ft Steel Telescopic Mast, 50/- High Stab Resistors 6d. ea.
List now ready for Paper Black Condensers, Valves, Oscillators, Test Sets. S.A.E. please.

Mail Order to

33/35 CARRINGTON FIELD STREET STOCKPORT CHESHIRE

TILLEY TV Radio Electronic Supplies

27 STOUGHTON STREET LEICESTER

TELEPHONE 58479

POST FREE!

POST FREE!

MULTI-RANGE METERS

AVO Model 8	£24. 0.0
AVO Multi Minor	£9.10.0
Taylor 88C	£23. 0.0
Taylor 127A	£10.10.0
Jemco MT955 50,000 O.P.V.	£10.19.6
Jemco L/C 20,000 O.P.V.	£6. 2.6
Jemco MT316 20,000 O.P.V.	£5.17.6
Jennen 500 30,000 O.P.V.	£8.19.6
Jennen 200H 20,000 O.P.V.	£5. 5.0
Jennen 200S 4,000 O.P.V.	£3.10.0
EP 10K 10,000 O.P.V.	£4.12.6
TK 20A 1,000 O.P.V.	£2. 2.0

All the above are new and complete with test leads.

RECORD CHANGER UNITS

FREE!!! Cut out motor board supplied to your dimensions.	
UA14 with Mono P.U.	£7.17.0
UA16 with Mono P.U.	£9.11.0
Garrard Auto Slim Mono	£7.17.6
Garrard Auto Slim De Luxe	£11. 9.0
Garrard Auto Slim De Luxe Stereo	£12. 5.0

F.M. UNITS

Jason FMT1 Kits	£6. 5.0
Jason FMT2 Kits	£10. 0.0

AMPLIFIERS

Linear Diatonic 5 valve 10 watt	£12.12.0
Linear Concord Ultra Lin.	£16.16.0
Linear L3/3 Stereo 3 watt	£7. 7.0
Linear L5/5 Stereo 5 watt	£12.12.0

Capacitors, Resistors, Transformers, etc.: Top quality components always in stock, send your list for return of post service at keenest prices.

ALIGNMENT AND REPAIR SERVICE for your home-built equipment, Radio, Hi-Fi, Radio Control, etc. Dispatch to us with circuit diagrams. Returned to you within 5 days. Keenest prices.

Terms of Business: Cash with order or C.O.D. only. Post and packing will be paid by us on all goods. All items advertised carry a full money-back guarantee and after sales service, and unless otherwise stated are new and unused. Mail order only. S.A.E. for list.

PANL BLACK CRACKLE PAINT

Give your metalwork a really professional finish.
Easily applied by brush. Air drying.

Available by post from

THE BRUCE MILLER CO. LTD
249 COASTAL CHAMBERS
BUCKINGHAM PALACE ROAD SW1

4/- per ½ pint can which includes application instructions, postage and packing

CHASSIS and CASES by



287/9 Edgware Road
London W2
TELEPHONE
PADDington 5891/7595

BLANK CHASSIS—Same Day Service

Of over 20 different forms made up to YOUR SIZE.
Order EXACT SIZE you require to nearest 1/16th.
(Maximum length 35", depth 4".)

Specials dealt with promptly.

SEND FOR ILLUSTRATED LEAFLET

or order straight away, working out total area of material required and referring to table below which is for four-sided chassis in 18 s.w.g. (for 16 s.w.g. add 1/16th).

48 sq. in.	4/-	176 sq. in.	8/-	304 sq. in.	12/-
80 sq. in.	5/-	208 sq. in.	9/-	336 sq. in.	13/-
112 sq. in.	6/-	240 sq. in.	10/-	368 sq. in.	14/-
144 sq. in.	7/-	272 sq. in.	11/-	and pro rata	

P. & P. 2/6 P. & P. 2/9 P. & P. 3/-
Discounts for quantities. Finishes arranged for quantities of 25 or over.

FLANGES (1" or 3/4"), 6d. per bend.
STRENGTHENED CORNERS, 1/- each corner.
PANELS

Any size up to 3ft at 4/6 sq. ft. 18 s.w.g. (16 s.w.g. 5/3).
P. & P. (sq. in.): 72 1/3, 108 2/-, 114 2/6, 432 2/9, 576 3/-.

CASES

ALUMINIUM, SILVER HAMMERED FINISH.		Type W			
Type	Size	Price	Type	Size	Price
U	4 x 4 x 4"	9/6	Y	8 x 6 x 6"	25/-
U	5 1/2 x 4 1/2 x 4 1/2"	14/6	Y	12 x 7 x 7"	39/-
U	8 x 6 x 6"	20/-	Y	13 x 7 x 9"	44/-
U	15 x 9 x 9"	42/6	Y	15 x 9 x 7"	46/-
W	8 x 6 x 6"	19/6	Z	17 x 10 x 9"	63/-
W	12 x 7 x 7"	32/6	Z	19 x 10 x 8 1/2"	67/6
W	15 x 9 x 8"	42/-			

Special sizes to order. Type Z has removable back and front panels. Type U all-screwed construction.

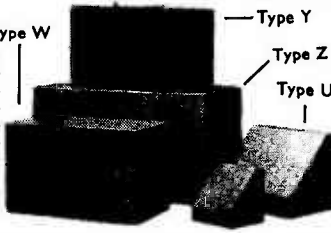

The thrills of VHF can now be yours for only 39/6d, complete kit! Tunable 150-100 Mc/s, simplified construction, write today for leaflet. Also, if a newcomer to Amateur Radio, ask for free copy of the world famous "Globe-King" kits and receivers, stamp please to cover postage:

Johnsons (Radio) St. Martin's Gate Worcester

BRASS · COPPER · DURAL · ALUMINIUM · BRONZE ROD, BAR, SHEET, TUBE, STRIP, WIRE. 3,000 STANDARD STOCK SIZES.

No Quantity too small List on application

H. ROLLET & CO LTD
6 CHESHAM PLACE SW1 BELgravia 4300

Also at Liverpool, Birmingham, Manchester, Leeds

G2ACC offers you . . .

- A 56 page illustrated catalogue No. 12
- Your buying guide for short wave, broadcast and transmitting components. 9d. post free (refundable on first order). U.K. and H.M. Forces anywhere.

SOUTHERN RADIO AND ELECTRICAL SUPPLIES

SORAD WORKS REDLYNCH SALISBURY WILTS Telephone Downton 207

Quality Components FOR CONSTRUCTORS

capacitors, resistors, coils, valves, transistors, controls, chassis, transformers, speakers, pick-ups, cartridges, stylii, and all types of components in stock.

CATALOGUE AVAILABLE ON REQUEST

J. T. FILMER 82 DARTFORD ROAD
DARTFORD KENT
Telephone Dartford 24057

SURPLUS RADIO SUPPLIES

2 LAING'S CORNER MITCHAM SURREY

SEND 2/6 FOR OUR CATALOGUE OF 400 BARGAINS

(2/- REFUNDED ON FIRST ORDER OVER 10/-)

BASIC COMPONENTS TO BUILD AN F.M. RECEIVER

12/6 and 1/6 packing and postage. Consisting of:—

- 2-gang 10.3pF each section with 3:1 reduction drive
- 2 I.F. Coils, 1 Ratio Detector Coil
- 2 Grade 1 Diodes

(GANG ALONE WORTH THE MONEY!)

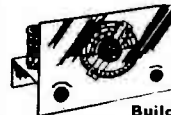

LISTEN TO THE WORLD ON TELSTAR

our 1-VALVE SHORT WAVE RADIO
Receives speech and music from all over the world. Price includes valve and one coil covering 40-100 metres. Can be extended to cover 10-100 metres. Can be converted to 2 or 3 valve and all-mains speaker use. Total

Building Costs 35/-, P. & P. 2/- Send 2/- for wiring diagram and parts list.
R.C.S. PRODUCTS (Radio) Ltd., 11 Oliver Road, London, E.17

140FT. AERIAL INSTALLATION

First Government release of these brand new Marconi Coil Aerial tuning systems, enabling operators to work their receivers or transmitters to their best efficiency. Containing a drum of 140ft copper aerial wire with insulators, etc., feeding into the matching unit, size 13" x 8 1/2" x 9 1/2", with slow motion tuning using Nos. 0-999. Originally intended for the 52 TX-RX, a must for any poor reception areas and serious operators. 300 only, 35/-, post 5/-; two post paid.

Dept. Q **J.T. SUPPLY** 309 Meanwood Road Leeds 7

THE RADIO CONSTRUCTOR BOUND VOLUMES

Volume 13, August '59 to July '60 £1.5.0 postage 2/3

Volume 14, August '60 to July '61 £1.5.0 postage 2/3

Volume 15, August '61 to July '62 £1.9.0 postage 2/9

Where all issues of a volume are returned for exchange

Vols. 13-14 12s. 6d. post 2/3

Vol. 15 14s. 6d. post 2/9

Attractively bound in blue cloth, with gold-blocked spine

DATA PUBLICATIONS LTD 57 MAIDA VALE LONDON W9

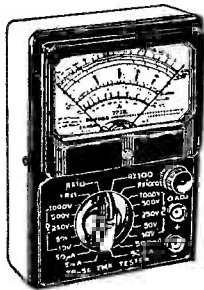

MODEL TP55
 A.C./D.C. voltage up to 1,000 in 5 ranges. D.C. current 4 ranges up to 500mA. 4 range resistance to 10 meg. Capacity dB scales, etc.
 20,000 ohms/volt
 Fully Guaranteed
£5.19.6

With Test Leads, Battery

and Instructions. Size 5½" x 3½" x 1½"

DETAILS ON REQUEST

- ★ **MODEL EP50K**
50,000 ohms per volt £9.19.6
- ★ **MODEL EP30K**
30,000 ohms per volt £6.19.6
- ★ **MODEL ITI-2** 20,000 ohms per volt. 5 gns.
- ★ **EP10K** 10,000 ohms per volt. 65/-
- ★ **CABY M1** 2,000 ohms per volt. 54/-

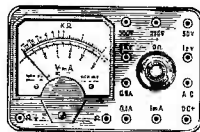

45/-
 1,000 ohms per volt
Model PT34

0/10/50/250/500/1,000 volts A.C./D.C. 0/1/100/500 mA D.C. Resistance 0/100kΩ
 Ideal pocket sizes multi-tester for all radio and domestic work.

Size 3½" x 2½" x 1½" with battery, leads and instructions.

All Meters Fully Guaranteed for 6 months. Full Service Facilities.

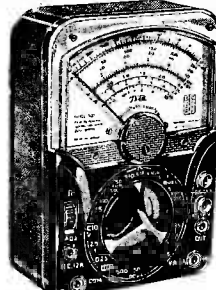

30,000 ohms per volt. Model 500 £8.19.6
 8 Ranges D.C. volts to 1kV. 7 Ranges A.C. volts to 1kV. 5 Ranges D.C. current to 12 amps.
 3 Range resistance to 60 meg. Short circuit buzz test. Output meter dB, etc., etc. Size 6½" x 4½" x 2½". With Leads, Batteries and Instructions.



75/-
 2,000 ohms per volt
Model THL33

0/10/50/250/500/1,000 volts D.C.
 0/10/50/250/500/1,000 volts A.C.
 0/500μA/10/250mA D.C. Resistance 0/10k/100k/1 Meg Capacity and dB ranges, etc. Size 5" x 3½" x 1½" with Batteries, Test Leads and Instructions.

A SELECTION FROM OUR STOCKS

Full Details in our Latest Illustrated Catalogue. 1/6 Post Free

1. 2,000 ohm Headphones ... 12/6
- 4,000 ohm Headphones ... 14/-
- Stereo Phones 2 x 8 ohm ... 27/6
2. Make your own printed circuits. Full details with 3 boards 6" x 3", etc. 19/6
3. Crystal Microphones (P.P. 1/6 any type)
 Acos 39-1 Stick Microphone ... 32/6
 Acos 40 Desk Microphone ... 15/-
 Acos 45 Hand Microphone ... 25/-
 Lapel/Hand Microphone ... 15/-
 MC24 Stick Microphone ... 25/-
 100C Stick with Stand ... 39/6
 BM3 Stick with Stand ... 52/6
4. Transistor Megaphone £12.10.0.
5. 250mV 4-Transistor Amplifier, built ready to use ... 47/6 P.P. 1/6
6. Complete Test Lead Kits ... 8/6
7. Miniature Vernier Dial 8:1, reduction marked 0/100 for ¼" spindles, 1½" diam., 12/6; 2" diam., 14/-; 3" diam., 16/-.
8. 931A Photomultiplier. Brand new with base ... 60/-

DEAC RECHARGEABLE BATTERIES

- (a) 18 volt 100mA/H 4" x 1" diameter. Brand new, sleeved, 30/-.
 - (b) As above but 150mA/H, 35/-.
- Both types easily split into any multiple of 1.2 volt. Brand new.

9. CV2886 (M2H) Liquid Sampling Geiger Tube, 370 volts., 22/6, P.P. 1/-.
10. Antex Miniature Mains Soldering Iron, ⅜" bit., 29/6, P.P. 1/-.
 Pocket Iron with Pouch, 30 watt, 220/250 volt, 18/6.
 Solon 15 watt, ⅜" bit, 22/6, P.P. 1/-.
11. Pocket Radio Booster Unit, for any radio. Improves output and quality. Size 9½" x 3½" diam., 27/6, P.P. 1/-.
 Size 8" x 2½" diam., 25/-, P.P. 1/-.
 Ideal for using pocket radios in car.
12. 125mV 9 volt Sub-min. 3-Transistor Amplifier, 2" x 1" x 1", 39/6.
13. Telephone Coil for any amplifier or Recorder, 12/6, or fitted Miniature Jack Plug, 14/-.
14. Crystal Contact Microphone for guitars, etc., 12/6.

15. Personal Earphones: 600 ohm, 10/6; 1,000 ohm, 12/6. Crystal, 8/6, 8/10 ohm, 9/6. Fitted leads, jack plugs and sockets.
16. Battery Record Players. Single speed 45 r.p.m. 6-7½ volt player 55/-.
 Two Speed, 33 and 45 r.p.m. 9 volt player 99/6. Four-speed 9 volt player £5.15.0.
17. Transistor Baby Alarm, as previously advertised, £5.10.0, P.P. 2/-.
 Also Telephone Amplifier, £5.10.0, P.P. 2/-.
18. 4-Transistor 2-way Intercom, £7.10.0.
 2-Transistor 2-way Intercom, 89/6.
19. SRP10 Mains 4-speed Garrard single player £5.7.6.
20. Miniature 3-Press Button Switches, 6-pole, 2-way and on/off, 5/-, P.P. 9d.
21. Transistor Signal Injector, 42/6. For circuit testing and checking.
22. 8" 15 ohm double cone Hi-Fi Speaker, 84/-.
 Complete range of speakers stocked.
23. 12-way Selector Tube, GS12C (CV 1740), 25/- each.
24. Quartz Fibre Pocket Dosimeters 0/150R and 0/500R, 12/6 each.
25. 6-Transistor speaker superhet Pocket Radio ready to use. Complete with leather case, phone, etc., 99/6 P.P. 2/-.
 Fully guaranteed.
 De Luxe version, 5 gns. P.P. 2/-.
26. 8 watt de luxe Stereo Amplifier. Mono/stereo inputs full controls. Gold hammer finish. £9.10.0 P.P. 3/6. Leaflet on request.
27. Sub-miniature Jack Plug and Socket, 2/6. Sub-miniature Screened Plug, 2/-.
28. Standard Jack Plug, 2/6. Standard Screened Jack Plug, 3/6.
29. New Telephone Amplifier in moulded cabinets, 79/6.
30. Tuning Indicator and Battery Level Meter. Miniature Meter (400mA) for Recorders, Transmitters, etc., 24/6.
31. Crystal Microphone Inserts: 2", 10/6. 1½", 7/6; 3", 3/6; Acos 39-1, 15/-.
32. Stereo Amplifier, 2 watts each channel. Brand new, 79/6, P.P. 2/-.
33. Transistor All Wave Signal Generator. 200 kc/s to 220 Mc/s in 7 Bands. Variable output: CW, RF, mod RF. £7.10.0. P.P. 2/6. Leaflet on request.
34. Type 38 Transmitter/Receiver. 5-valve, 7.4-9 Mc/s, 22/6, P.P. 2/6 (sold without guarantee).
35. Valve Voltmeter, AC/DC/Resistance, etc., £9.19.6, P.P. 5/-.
36. STC F15 Thermistors, 6/-; R53, 15/-.
37. ORP12 LDR Cell, 12/6; ORP60 Cell, 9/6; OCP71 Photo trans., 27/6.
38. Half Track Record/Playback Tape Heads. 2kΩ impedance, 15/-.
39. Personal Earphones with Jack Plug and Socket. 8/10 ohm, 6/6; 600 ohm, 9/6; 1,000 ohm, 10/6; Crystal, 6/6.
40. 6" x 7" Printed Circuit Panels for etching, 4/-, post free.
41. Recording Tape: 5" 600ft, 12/6; 5" 900ft, 15/-; 7" 1,200ft, 18/6; 7" 1,800ft, 25/-.
 Excellent quality.
42. DC to AC Converter. Converts 12 volts DC, i.e. car battery, to 230 volts AC up to 15 watts. Ideal for using electric razor, etc., in a car. All-Transistor complete kit, 57/6, P.P. 1/6.
43. Collaro Mains Twin Track Tape Decks. Brand new, 10 gns, P.P. 3/6.
44. Garrard Autoslim 4-speed auto-changers. Plug-in heads. £7.0.0. P.P. 3/6.

SUBSTITUTION BOXES

- ★ Capacitor Box. Provides 9 standard values from 0.001μF to 0.22μF at 600 volt working, 29/6.
- ★ Resistor Box. Provides 24 standard values at 1 watt. 15 ohms to 10 meg., 37/6.

Each box fully calibrated with insulated leads. Invaluable for service and design.

FIELD STRENGTH METER

Measures transmitter carrier waves from 1 Mc/s to 200 Mc/s in 5 switched fully adjustable ranges. Contains 200μA meter for carrier level and earphone for modulation. Requires no connection to transmitter. Self-contained, ready for use, 69/6, post free.

HENRY'S RADIO LTD

PADdington 1008/9

303 EDGWARE RD., LONDON W2

Open Monday to Sat. 9-6, Thurs. 1 o'clock

PLEASE TURN TO BACK PAGE

"CAPRI" POCKET-6

6-TRANSISTOR SUPERHET

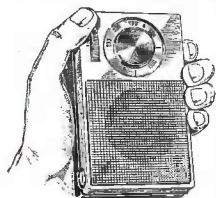

Size only
4½" x 2½" x 1½"

**REALLY
POCKET
SIZE!**

The most compact 6-transistor and diode radio with speaker available to the home constructor. Features the latest in miniature components and circuitry. Supplied with Mullard transistors and two-tone moulded cabinets in red/white or blue/white with gold fittings. All components are supplied in packets and clearly identified. A printed circuit is used with fully illustrated building instructions. Push-pull output coupled with a sensitive and selective circuit make the "CAPRI" hard to beat. Fitted Earphone/Record Socket. Full tuning on medium waves with long wave Light.

Illustrated leaflet on request.

TOTAL COST **£5.19.6** P.P. 2/-

★ Slip it into your Pocket ★

HENRY'S RADIO LTD

303 EDGWARE ROAD LONDON W2

PADDington 1008/9

Open Monday to Sat. 9-6. Thurs. 1 o'clock

LATEST SUMMER CATALOGUE

54 PAGES 10½" x 7½"

Fully detailed and illustrated 1/6 post free

THE "CONTESSA"

★ COMBINED PORTABLE AND CAR RADIO ★

AMAZING SENSITIVITY AND SELECTIVITY ON MEDIUM AND LONG WAVEBANDS

★ The easiest Superhet Radio to build on the market. Features clearly marked printed circuit and packaged components with full illustrated building instructions. Full tuning of medium and long wave bands with unbeatable sensitivity and selectivity. Excellent tone and volume with over 600mV push-pull output.

★ Clearly marked horizontal station dial with slow motion tuning. Two-colour blue or beige cabinets with gold handles, grilles and fittings. Size 10½" x 7½" x 3½". Include car aerial socket, recording sockets.

★ 6 Mullard Transistors and 2 Diodes. Guaranteed the Best Obtainable

★ Attractive Appearance—Reliable Design—Quality Performance ★
UNBEATABLE FOR QUALITY AND VALUE

Fully Detailed and Illustrated Leaflet on request

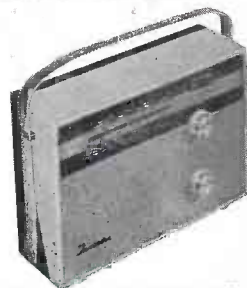

TOTAL COST
£9.19.6 P.P. 3/6
NO EXTRAS TO BUY

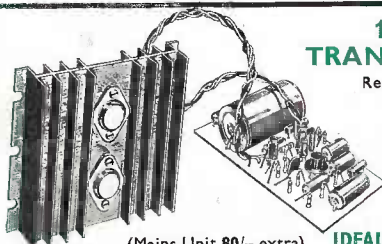

10 WATT HI-FI TRANSISTOR AMPLIFIER

Replace that Valve Amplifier with this High Fidelity Amplifier

- 40 C/S TO 20 KC/S ±1dB
- LESS THAN 0.3% DISTORTION
- 100mV INPUT FOR 10 WATTS OUTPUT
- 33K OHM INPUT IMPEDANCE

(Mains Unit 80/- extra)

IDEAL FOR ALL MONO AND STEREO

Supplied complete with booklet showing HI-FI EQUIPMENT including preamplifiers, mixers, stereo, public address, etc. Can be used with any commercially available valve or transistor preamps, tuners, etc.

Booklet available separately 1/6 post free

PERFORMANCE EQUIVALENT TO VALVE AMPLIFIERS OF FOUR TIMES THE PRICE AND MANY TIMES THE SIZE

Built ready to use
£5.19.6
P.P. 2/-

Call for demonstration—any time.

NEW!

7-TRANSISTOR RECORD PLAYER/RADIOGRAM

4 Watt (Peak) Amplifier

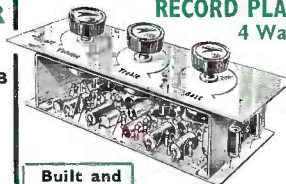

- Full Treble and Bass boost and cut
- 40 c/s to 20 kc/s ±3dB
- Inputs for Pick-ups, Radio Tuners, Microphones, mixers, etc.

Built and Ready to Use

£5.19.6
P.P. 2/-
(Complete with full descriptive Booklet)

- 15 ohm Speaker (8" x 5" 22/6 extra)
- 12 to 18 volts mains or battery
- Size only 6" x 2½" x 2"

Ideal for mains or battery, portable or domestic record players, grams, etc.

Mains Unit 80/-extra Call for demonstration

● BOOKLET FREE ON REQUEST ●

RUN YOUR RADIO OR AMPLIFIER FROM MAINS BATTERY ELIMINATORS AND CHARGERS

1. For PP3 or equivalent 9 volt Pocket Radio Battery 18/6, P.P. 1/-
2. For PP4, PP7, PP9, PP10, 9 volt Portable Radio and Equipment Supplies up to 300mA 49/6, P.P. 2/-
3. De Luxe version of No. 1, also charges PP3 type batteries. 29/6, P.P. 1/-
4. Rechargeable PP3 battery. Runs as long as 100 batteries. Completed with charger unit 25/-, P.P. 1/-

REMEMBER — WE CAN SUPPLY MOST OR ALL OF THE TRANSISTORS, RECTIFIERS, DIODES, VALVES, CRYSTALS, EQUIPMENT AND COMPONENTS SPECIFIED IN THIS AND OTHER MAGAZINES AND BOOKS. SEND A LIST OF ITEMS REQUIRED. WE WILL QUOTE COMPETITIVE PRICES BY RETURN OF POST.

3 4 Watt 4 Transistor Amplifier

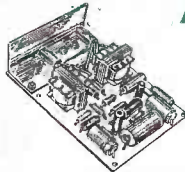

- Improved Version
 - 1½ watt peak output.
 - ±3dB 70 c/s to 12 kc/s.
 - Output to 3 ohm speaker
 - 9 volt operated
- Details on request

Built and Tested Kit of Parts
59/6 OR 52/6
P.P. 1/6 P.P. 1/6

METER BARGAINS

50 Microamp 2" square MC	... 36/-
1mA 2" square MC...	... 25/-
1mA 2½" Flush round	... 30/-
2½" Moving Coil double range Voltmeter centre zero. 30-0-30 and 3-0-3 volts. Ideal for transistor tester or voltage measurements, 12/6, post free.	
0/500 microamp, 2½" flush mounting DC	... 20/-
2½-0-2½mA, 2½" flush DC	... 12/6
0/40/120mA 2" DC	... 10/-
0/15 volt M.1, 2½" FR	... 8/6

Miniature Panel Meters

*0/50µA (DC) 39/6	*0/5mA (DC) 27/6
*0/500µA (DC) 32/6	*0/3004 (DC) 27/6
*0/1mA (DC) 27/6	Vu Meter 42/6

"S" Meter 35/-, All Brand New Boxed.
*Available Clear Plastic Front or Black Moulded. State which.

"MINIRANGER"

3-Transistor plus 2 Diodes. Smallest radio to build yourself. Printed circuit, full tuning. ONLY 3" x 2" x ¾". Over 20 stations.

TOTAL COST **49/6** P.P. 1/6

"QUINTEZ" POCKET RADIO

Size 5½" x 3" x 1½"
5-Transistor, plus Diode MW/LW to build.

79/6 P.P. 2/-

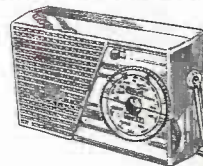

BOTH MODELS AS PREVIOUSLY ADVERTISED

★ ALL PARTS SOLD SEPARATELY. BOOKLETS FREE ON REQUEST ★