

THE Radio Constructor

RADIO
TELEVISION
AUDIO
ELECTRONICS

VOLUME 16 NUMBER 7
A DATA PUBLICATION
PRICE TWO SHILLINGS

February 1963

USEFUL PUSH-PULL AUDIO AMPLIFIER

Also featured

20-50 Metre Short Wave
Mains Two

•
"Crystella" Crystal-
Controlled F.M. Tuner

•
Top Band Converter
etc., etc., etc.

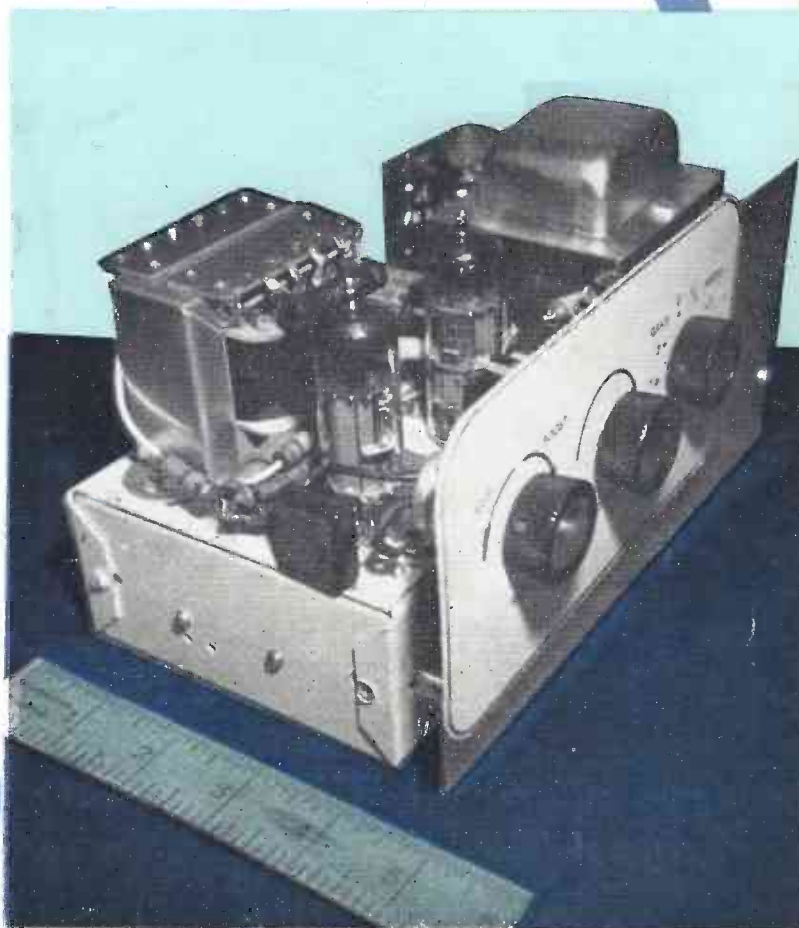

A SIMPLE EXPLANATION OF **TRANSISTOR RADIOS** FOR THE SERVICE ENGINEER

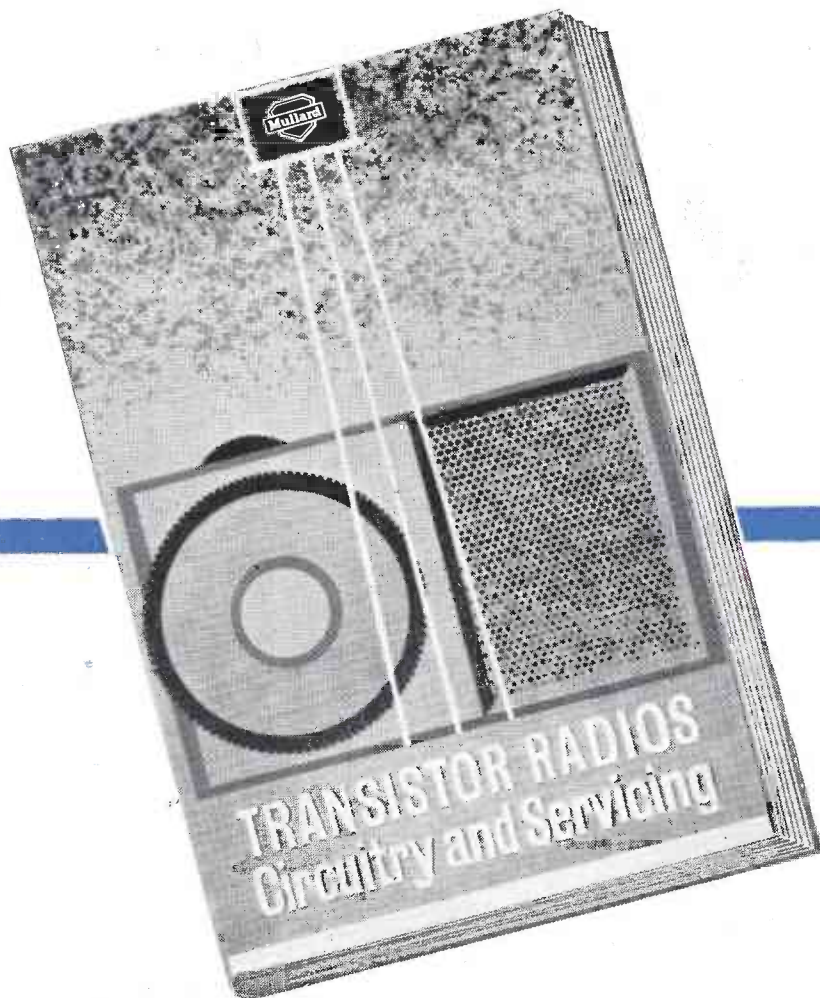

Starting with a description of the basic properties of semi-conductors, the book explains the action of a transistor in detail and without recourse to complex mathematics. The circuits used in transistor radios are described, and the techniques for servicing these sets are considered.

CONTENTS INCLUDE

Semiconductor materials; Transistor action; Transistor circuits; Servicing, etc. In all, seven chapters with the emphasis always on practical considerations.

U.K. PRICE 5/-

Published by Mullard Ltd. Get your copy from your radio dealer or send remittance with direct order (Postage and packing 6d. extra).



MULLARD LIMITED • MULLARD HOUSE • TORRINGTON PLACE • LONDON WC1

MVM/CA1020

PCR COMMUNICATION RECEIVERS

Manufactured by Pye and Philips. One of the Army's most versatile and sensitive sets. RF stage and 2 of IF, using 6 British I.O. type valves Large 180 degrees. Illuminated and Calibrated Dial. Flywheel tuning with locking device. Aerial trimmer. Tone and volume controls. Band switch from panel jacks for speaker or phones. In black metal case, size 17" L x 8" H x 10" D. Model PCR covers 6-18 Mc/s, 200-550 metres and 850-2,000 metres and has internal 5" speaker. £6.19.6. Model PCR2 has similar L & M waveband coverage. Short wave 6-22 Mc/s, but no speaker. Used but excellent condition, £5.19.6. Model PCR3. As PCR2 but has 2 Short Wave Bands, 2.0-7.0 Mc/s and 7.0-23.0 Mc/s, and Medium Wave Band 190-550 metres. ONLY £8.8.0. Every receiver aerial tested before despatch. Add 10/6 carr. all models. Designed to operate from bulky EXTERNAL power supply, but any set can be fitted with BRAND NEW COMPONENTS INTERNAL PACK for 200/250V a.c. at extra cost of £2. S.A.E. FOR ILLUSTRATED LEAFLET

TEST METERS FOR EVERY PURPOSE & POCKET

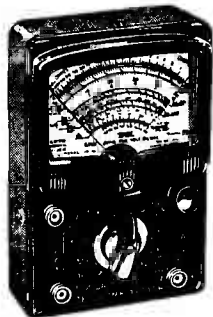

2,000 O.P.V. MODEL TP-10. Reads A.C. and D.C. volts up to 1,000; D.C. Current to 500mA; resistance to 1 Meg; Capacitance to 1µF; Decibels from -20 to +36; Output jack for Audio Measurements. Size 3½" x 5" x 1½". £3.19.6



20,000 O.P.V. MODEL TP-SS. Reads Voltage up to 1,000; D.C. at 20,000 ohms per volt and A.C. at 10,000 o.p.v.; D.C. Current to 500mA; Resistance to 10 Meg.; Capacitance to 0.1µF; Decibels from -20 to +36. Size 3½" x 5½" x 1½". £5.19.6



30,000 O.P.V. MODEL 500 Volts to 1,000; D.C. at 30,000 o.p.v.; A.C. at 20,000; 12 Amps D.C. Current; 60 Meg. Resistance; -20 to +56 Decibels; Internal buzzer short circuit warning. Size 3½" x 6½" x 2½". £8.19.6

All new stock, with leads, prods & internal batteries. 6 mths. guar. backed by full service facilities. Details S.A.E

HRO SENIOR TABLE MODEL RECEIVERS. Complete with 9 coil sets covering 50 kc/s to 30 Mc/s. Used, very good condition, aerial-tested. ONLY £7.10.0 (carriage, etc., 30/-). A few late MODEL 5T with I.O. valves, £22.10.0 plus carriage.

BC342 RECEIVERS. A few only of these famous American sets covering 1.15-8.0 Mc/s in six bands. Internal 115V A.C. Mains Pack. A super receiver in first-class condition and perfect working order. ONLY £20 (carriage 15/-).

BC221 FREQUENCY METERS. The famous American crystal controlled frequency measuring standard. Coverage 125 kc/s-20 Mc/s with original Calibration Book. Perfect order. ONLY £16.

12 VOLT AMERICAN DYNAMOTORS. Delivery 220 volts at 100mA. Size 5½" x 3½" diameter. Ideal for running electric shaver, etc, from car battery. ONLY 32/6 (post 2/6).

DOUBLE BEAM OSCILLOSCOPE TUBES TYPE CV1596. Equivalent to COSSOR O9D as used in Oscilloscopes by Cossor (339 series) and Hartley & Erskine (13 series). Listed £12. BRAND NEW IN MAKER'S CRATES. ONLY 25/- (carriage 5/-).

LAYOIE UHF WAVEMETER MODEL 105. Coverage 375/725 Mc/s. Complete with correct Calibration Chart. First-class condition. Battery operated and portable, size 11" x 8" x 7½". ONLY £3.19.6 (carriage 7/6).

AVOMETERS MODEL 7. Reconditioned and in perfect order, with leads, internal batteries, and instructions. ONLY £11.0.0 (Regd. post 5/-).

AVOMETER MODEL 7 LEATHER CASES, fitted with carrying handle and long strap. BRAND NEW. ONLY 32/6 (post 2/6).

MINIATURE MOTORS. Ideal for models. Operates on 3-6 volts D.C. Size 1½" x 1" x 1½" plus ¼in spindle. BRAND NEW 5/-.

SPRAGUE CONDENSERS. Metal cased wire ends. NEW. 0.01 mfd 1,000 volt and 0.1 mfd 500 volt. 7/6 per dozen.

RESISTORS. 100 assorted values. NEW 10/-.

CONDENSERS. 100 assorted Mica and Silver Mica. NEW 12/6.

THE "GOOD COMPANION" Mk. II
Using transfilters, the latest manufacturing technique to save alignment difficulty.

As described in "THE RADIO CONSTRUCTOR", August issue
THE FINEST COMBINED PORTABLE and CAR RADIO YET DESIGNED FOR THE HOME CONSTRUCTOR

★ 750mW output.

★ 6 transistors and 1 diode.

★ Full Medium and Long Wave coverage.

★ Quality speaker.

★ Brilliantly styled 2-tone cabinet, size 11" x 8" x 3".

★ Very fine tuning with calibrated dial.

★ Latest printed circuit. ★ Internal high gain aerial with car aerial socket. Easy to follow construction data (available separately 3/6)

All parts sold separately and full illustrated details will be sent on request.

Total Cost **£9.19.6**

With alternative luxury cabinet using 7" x 4" speaker, £10.19.6. Either type, plus 5/- post and ins. (Battery 3/6 extra.)

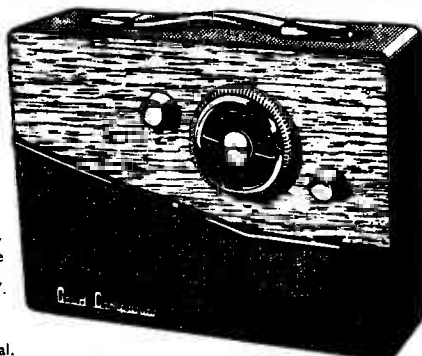

"POCKET 4" TRANSISTOR RECEIVER

Uses miniature speaker, proper tuning condenser, and volume control. Built-in aerial makes unit efficient and portable. Ideal for the beginner. Full medium wave coverage. All components and case for only 42/6 (p. & p. 2/6). Ten-page constructional book free with parts or separately 1/6. S.A.E. for parts price list.

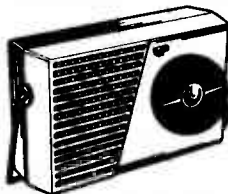

"P.W." 6 TRANSISTOR PERSONAL RECEIVER

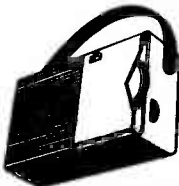

Designed by the technical staff of Practical Wireless: easy to build, using printed circuit and 1st grade Matched Transistors and Diode. Full Medium and Long Wave coverage to internal speakers. All parts sold separately (new components only) enabling you to buy as required, and full detailed price list will be sent on request. Constructional details 1/6. Newly designed OSMOR Cabinet and reduced price. TOTAL COST INCLUDING BATTERY AND CABINET NOW £7.19.6. S.A.E. for 7 transistor version.

BATTERY AND CABINET NOW £7.19.6. S.A.E. for 7 transistor version.

HARRIS ELECTRONICS (LONDON) LTD

(DEPT. M)
138 GRAY'S INN ROAD LONDON WC1

Telephone **TERminus 7937**

Please include carriage costs on ALL items.
(Open until 1 p.m. Saturdays.) We are 2 mins. from High Holborn (Chancery Lane Station) and 5 mins. by bus from King's Cross.

Model 8 Universal AVOMETER

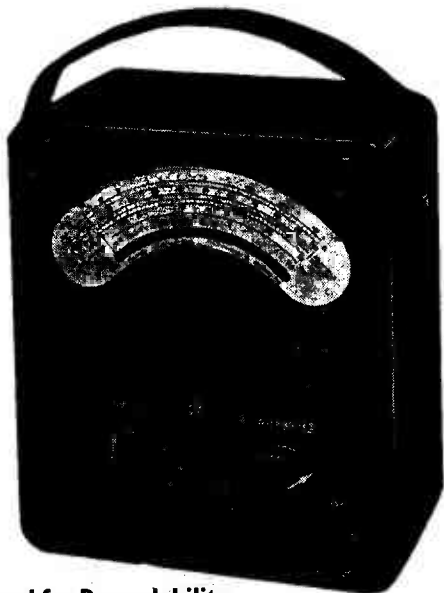

Designed for Dependability

The Model 8 Universal Avometer is a high sensitivity multi-range a.c./d.c. electrical testing instrument providing thirty ranges of readings on a 5-inch hand calibrated scale. Range selection is effected by two rotary switches for a.c. and d.c. respectively.

The instrument has a sensitivity of 20,000 ohms per volt on d.c. voltage ranges and 1,000 ohms per volt on a.c. from the 100-volt range upwards, and meets the accuracy requirements of B.S.S.89/1954 for 5-inch scale length portable industrial instruments. It is robust, compact, and simple to operate, and is protected by an automatic cut-out against damage through inadvertent electrical overload.

VOLTAGE		CURRENT		RESISTANCE
D.C.	A.C.	D.C.	A.C.	
2.5V	2.5V	50µA	100mA	First indication 0.5Ω
10V	10V	250µA	1A	Maximum indication 20MΩ
25V	25V	1mA	2.5A	0-2,000Ω
100V	100V	10mA	10A	0-200,000Ω
250V	250V	100mA	—	0-20mΩ
500V	—	1A	—	} using internal batteries using external batteries
1,000V	1,000V	10A	—	
2,500V	2,500V	—	—	
				DECIBELS
				-15 dB to +15 dB

Various external accessories are available for extending the above ranges of measurement. Leather carrying cases are also available if required.

Dimensions: 8½" x 7½" x 4½". Weight: 6½ lb.

Write for fully descriptive Folder or for complete Catalogue of AVO Instruments.



AVO LTD

AVOCET HOUSE, 92-96 VAUXHALL BRIDGE ROAD,
LONDON S.W.1



Tel: VICToria 3404 (12 lines)

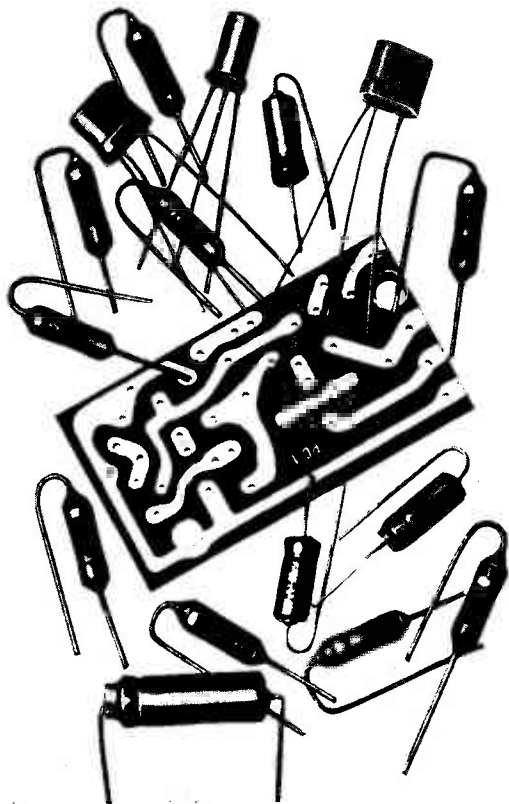

seventeen into one



will go

pre-assembled packaged circuits by Pye Industrial Electronics save space, time, and money

The P.C.1. first of a new range! This transformer-less 125mW-9V audio amplifier circuit provides a pre-assembled block for simplifying the design and assembly of laboratory equipment and intercomm sets etc. The unit uses Newmarket matched npn/pnp audio transistors in complementary symmetry circuits to achieve low distortion (typically 2% total) medium high sensitivity (50mV max out of 600 ohms for 50mW out) and low standby battery current (typically 4mA). Measuring only 2" x 1" x ¾" the P.C.1. is guaranteed for one year.

Write for full technical data to:

Pye Industrial Electronics Ltd, Exning Road,
Newmarket. Telephone: Newmarket 3381



INCREASE YOUR KNOWLEDGE

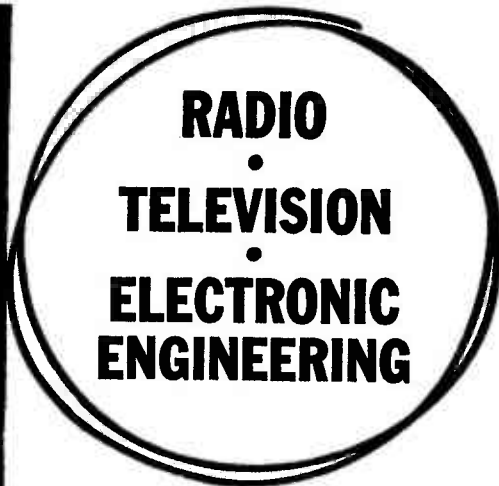

MEMBER OF THE ASSOCIATION OF BRITISH
CORRESPONDENCE COLLEGES

CHOOSE THE RIGHT COURSE FROM:

RADIO AND TELEVISION ENGINEERING, INDUSTRIAL TELEVISION, RADIO AND TELEVISION SERVICING, RADIO SERVICE AND SALES, VHF/FM ENGINEERING, ELECTRONICS, COMPUTERS AND PROGRAMMING, ELECTRONIC TECHNICIANS, SERVOMECHANISMS, TELEMETRY, COLOUR TV, INSTRUMENTATION, AND PRINCIPLES OF AUTOMATION.

ALSO EXAMINATION COURSES FOR:

A.M.Brit.I.R.E.; City and Guilds Telecoms. Technicians, C. & G. Radio and T.V. Servicing (R.T.E.B.), and P.M.G.'s Certificates. C. & G. Radio Amateurs' Certificates.

LEARN AS YOU BUILD

Practical Radio Courses: Gain a sound knowledge of Radio as you build YOUR OWN 5-valve superhet radio receiver, Signal Generator and High-quality Multimeter. At the end of the course you have three pieces of permanent and practical equipment and a fund of personal knowledge and skill. ICS Practical Radio Course opens a new world to the keen Radio amateur.

THERE IS AN ICS COURSE FOR YOU

Whether you need a basic grounding, tuition to complete your technical qualifications, or further specialised knowledge, ICS help you with a course individually adapted to your requirements.

There is a place for you among the fully-trained men. They are the highly paid men—the men of the future. If you want to get to the top, or to succeed in your own business, put your technical training in our experienced hands.

ICS Courses are written in clear, simple and direct language, fully illustrated and specially edited to facilitate individual home study. You will learn in the comfort of your own home—at your own speed. The unique ICS teaching method embodies the teacher in the text; it combines expert practical experience with clearly explained theoretical training. Let ICS help you to develop your ambitions and ensure a successful future. Invest in your own capabilities.

FILL IN AND POST THIS COUPON TODAY

You will receive the FREE ICS Prospectus listing the examinations and ICS technical course in radio, television and electronics, PLUS details of over 150 specialised subjects.

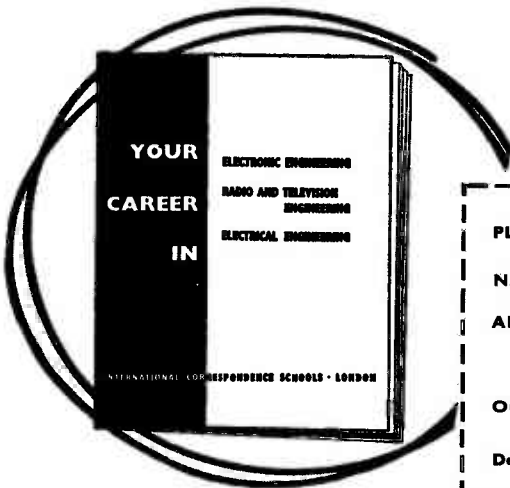

PLEASE SEND FREE BOOK ON _____

NAME _____

ADDRESS _____

OCCUPATION _____ AGE _____

INTERNATIONAL CORRESPONDENCE SCHOOLS
Dept. 248. INTERTEXT HOUSE, PARKGATE ROAD, London SW11
2.63



Enjoy Yourself & Save Money-

SINGLE SIDEBAND ADAPTOR. Model SB-10U. May be used with most A.M. transmitters. Less than 3W R.F. input power required for 10W output. Operation on 80, 40, 20, 15 and 10m bands on U.S.B., L.S.B. or D.S.B. **£39.50**

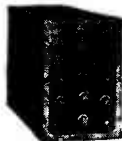

SB-10U

AMATEUR TRANSMITTER. Model DX-40U. Covers all amateur bands from 80 to 10 metres; crystal controlled. Power input 75W C.W., 60W peak controlled carrier phone. Output 40W to aerial. Provision for V.F.O. Filters minimise TV interference. **£33.19.0**



DX-40U

GRID-DIP METER. Model GD-1U. Functions as oscillator or absorption wave meter. With plug-in coils for continuous frequency coverage from 1.8 Mc/s to 250 Mc/s. **£10.19.6**

Three Additional Plug-in Coils Model 341-U extend coverage down to 350 kc/s. With dial correlation curves. **17/6**

TRANSISTORISED VERSION. Model XGD-1. Similar to GD-1U. Fully transistorised with a frequency range of 1.8 to 45 Mc/s. **£10.18.6**



GD-1U

2 1/2" SERVICE 'SCOPE. Model OS-1. Light, compact portable for service engineers. Dim. 5" x 8" x 1 1/4" long. Wt. 10 1/2 lb. **£19.19.0**



"GLOUCESTER"

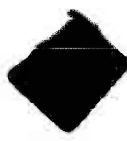

GL-58



AM/FM TUNER

HI-FI AM/FM TUNER, Model AFM-1. Available in two units which, for your convenience, are sold separately. Tuning heart (AFM-T1—£4.13.6 incl. P.T.) and I.F. amplifier (AFM-A)—£20.13.0). Printed circuit board, 8 valves. Covers L.W., M.W., S.W., and F.M. Built-in power supply. Total **£25.6.6**

HI-FI EQUIPMENT CABINETS. Our four cabinets meet a wide variety of tastes and requirements: the "CHEPSTOW" designed for those who have little floor space, the contemporary "MALVERN" for the Tape and Gram, enthusiast, and the "GLOUCESTER" Mk. I and II for those with traditional tastes. Supplied "in the white". Prices from **£11.12.6 to £18.10.0**

An additional range of assembled and finished cabinets is now available from us, details on request.

GOLDRING Lenco TRANSCRIPTION RECORD PLAYER. Model GL-58 with G-60 pick-up arm and Stereo/mono cartridge. **£17.12.10**

GARRARD AUTO/RECORD PLAYER, Model AT-6. With Ronette 105 cartridge. **£12.11.3** With Decca Deram pick-up **£14.18.6**

Prices include free delivery in U.K.

★ We guarantee that without any previous experience

5" OSCILLOSCOPE. Model O-12U. Has wide-band amplifiers, essential for TV servicing, FM alignment, etc. Vertical frequency response 3 c/s to over 5 Mc/s, without extra switching T/B covers 10 c/s to 500 kc/s in 5 ranges. **£38.10.0**



O-12U

ELECTRONIC SWITCH. Model S-3U (Oscilloscope Trace Doubler.) Enables a single beam oscilloscope to give simultaneous traces of two separate and independent signals. Switching rates approx. 150, 500, 1,500, 5,000 and 15,000 c/s. Sig. freq. response 0-100 kc/s. ± 1dB. Separate gain controls and sync. output. Sig. input range 0.1-1.8V r.m.s. **£11.15.6**



S-3U

RESISTANCE CAPACITANCE BRIDGE. Model C-3U. Measures capacity 10pF to 1,000µF, resistance 100Ω to 5MΩ and power factor. 5-450V test voltages. With safety switch. **£9.5.0**



C-3U

AUDIO SIGNAL GENERATOR. Model AG-9U. 10 c/s to 100 kc/s, switch selected. Distortion less than 0.1%. 10V sine wave output metered in volts and dB's. **£21.9.6**



AG-9U

TRANSISTOR INTERCOM. Models XI-1U & XIR-1U. The master unit uses a 4-transistor amplifier, constructed on a printed circuit board, and an internal 9V battery. Remote stations use a similar battery for call only. Up to five remote units can be ordered for each master. **£4.7.6**

XIR-1U (remote) £4.7.6

XI-1U (master) £10.19.6

SUGDEN MOTOR UNIT "CONNOISSEUR CRAFTSMAN". Heavy duty motor operating at 33 1/3 and 45 r.p.m. Very heavy 12" turntable. Virtually no rumble. **£16.6.5**



S-33



COLLARO



TA-1S

NEW DE LUXE STEREO AMPLIFIER. Model S-33H. De luxe version of the S-33 with two-tone grey perspex panel, and higher sensitivity necessary to accept the Decca Deram pick-up. **£15.17.6**

HI-FI 6W STEREO AMPLIFIER. Model S-33. 3 watts per channel 0.3% distortion at 2.5W/chnl., 20dB N.F.B. Inputs for Radio (or Tape) and Gram, Stereo or Monaural, ganged controls. Sensitivity 200mV. **£13.7.6**

COLLARO "STUDIO" TAPE DECK. The finest buy in its price range. Operating speeds: 1 1/2", 3 1/2" and 7 1/2" p.s. Two tracks "wow" and "flutter" not greater than 0.15% at 7 1/2" p.s. Long Term Speed stability better than 0.5%. **£17.10.0**

TAPE RECORDING/PLAYBACK AMPLIFIER. Thermometer type recording indicators, press-button speed compensation and input selection. Printed Circuit Board. Mono Model TA-1M **£19.2.6** Stereo Model TA-1S **£24.10.0**

HI-FI MONO AMPLIFIER. Model MA-5. A general purpose 5W Amplifier, with inputs for Gram., Radio. Presentation similar to S-33. **£10.19.6**

4 WB TRANSISTOR PORTABLE RECEIVER. Model RSW-1. In a handsome leather case it has retractable whip aerial and socket for car radio use. Covers Med., Trawler and two S wave bands. **£19.17.6**

HI-FI SINGLE CHANNEL AMPLIFIER. Model MA-12. 12W output, wide freq. range, low distortion. **£11.9.6**

POWER SUPPLY UNIT. Model MGP-1. Input 100/120V, 200/250V. 40-60 c/s. Output 6.3V, 2.5A A.C. 200, 250, 270V. 120mA max. D.C. **£5.2.6**



MA-12



RSW-1

MONEY-SAVING "PACKAGED DEALS"

For the benefit of customers wishing to purchase several units of their Hi-Fi equipment at the same time, useful price reductions are offered. Such "Packaged Deals" may include RECORD PLAYERS and TAPE DECKS of your preference, not necessarily featured in our catalogue.

★ SEND FOR FREE ILLUSTRATED CATALOGUE TO

Building Your Own Equipment!

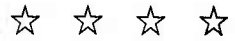

DX-100U



VF-1U



GC-1U



V-7A



MM-1U



RF-1U

THE "MOHICAN" GENERAL COVERAGE RECEIVER. Model GC-1U. With 4 piezo-electric transfilters, variable tuned B.F.O. and Zener diode stabiliser, this is an excellent fully transistorised general purpose receiver for Amateur and Short wave listeners. Printed circuit boards, telescopic whip antenna, tuning meter and large slide-rule dial, 10 transistors. **£39.17.6**

AMATEUR TRANSMITTER. Model DX-100U. The world's most popular, compact and completely self-contained Amateur Transmitter. Covers all amateur bands: 160-10 m. 150W d.c. input. Careful design has achieved the stability and high performance for which the DX-100U is noted and no less than 35 disc ceramic capacitors reduce TVI to a minimum. **£74.19.0**

VARIABLE FREQUENCY OSCILLATOR. Model VF-1U. Calibrated, 160-10 m. Fundamentals on 160 and 40 m. Ideal for our DX-40U and similar transmitters. **£11.17.6**

BALUN COIL UNIT. Model B-1U. Will match unbalanced co-axial lines to balanced lines of either 75 or 300Ω impedance. **£4.15.6**

Q MULTIPLIER KIT. Model QPM-1. May be used with receivers having 450-470 kc/s I.F. provides either additional selectivity or signal rejection. Self-powered. **£7.12.6**

VALVE VOLTMETER. Model V-7A. 7 voltage ranges d.c. volts to 1,500. A.C. to 1,500 r.m.s. and 4,000 peak to peak. Resistance 0.1Ω to 1,000MΩ with internal battery. D.C. input impedance 11MΩ. dB measurement, has centre-zero scale. Complete with test prods, lead and standardising battery. **£13.18.6**

MULTIMETER. Model MM-1U. Ranges 0-1.5V to 1,500V A.C. and D.C.; 150μA to 15A D.C.; 0.2Ω to 20MΩ. 4½" 50μA meter. **£12.10.0**

R.F. SIGNAL GENERATOR. Model RF-1U. Up to 100 Mc/s fundamental and 200 Mc/s on harmonics and up to 100mV output on all bands. **£12.15.6**

AUDIO WATTMETER. Model AW-1U. Up to 25W continuous, 50W intermittent. **£15.15.0**

AUDIO VALVE MILLIVOLTMETER. Model AV-3U. 1mV-300V A.C. 10 c/s to 400 kc/s. **£14.17.6**

AUDIO SINE-SQUARE WAVE GENERATOR. Model AO-1U. Covers 20 c/s to 150 kc/s and square waves to 50 kc/s in four ranges. Maximum output 10V, distortion less than 1%. **£13.15.0**

Deferred terms available over £10

you can build any of our Heathkit models



USC-1



Truvox D83



FM TUNER



SSU-1

HI-FI FM TUNER. Model FM-4U. Also available in two units. R.F. tuning unit (£2.15.0 incl. P.T.) with I.F. output of 10.7 Mc/s, and amplifier unit, with power supply and valves (£12.6.0). Total **£15.1.0**

TRUVOX D83 & D84 TAPE DECKS. High quality mono/stereo tape decks.

D83, 2 track, for highest fidelity.

D84 (identical presentation), 4-track.

£31.10.0

£29.8.0

STEREO CONTROL UNIT. Model USC-1. Push-button selection, accurately matched ganged controls to ±1dB. Negative feedback, rumble and variable low-pass filters. Printed circuit boards. **£19.10.0**

ELECTRICITY MAINS EXTENSION KIT. Model PUE-1. Completely safe, conforms fully to I.E.E. Regulations, ideal light and power source to out-buildings (or for soil heating). Complete with sockets, cables, switches, lampholder, junction box, etc. **£4.15.6**

MAINS POWER SUPPLY—BATTERY ELIMINATOR KIT. Model UBE-1. Designed to supply 9V or 12V d.c. to transistor receivers. Many other uses. Sizes: 3½" x 2½" x 1½". **£2.17.6**

TRANSISTOR PORTABLE. Model UXR-1. Pre-aligned I.F. transformers, printed circuit. Covers L.W. and M.W. Has 7" x 4" loudspeaker. Real hide case. **£12.11.0**

TELEPHONE AMPLIFIER. Model TTA-1. Easy-to-assemble. Transistorised, enables hand-free conversation. Ivory toned cabinet. **£7.9.6**



UXR-1



TTA-1

Assembled models also available — prices on request.

HI-FI SPEAKER SYSTEM. Model SSU-1. Ducted-port bass reflex cabinet "in the white". Twin speakers. With legs **£11.12.0.**

£10.17.6

CAPACITANCE METER. Model CM-1U. Direct-reading 4½" scale. Full-scale ranges 0-100μF, 0-1,000μF, 0-0.01μF and 0-0.1μF. **£15.15.0**

HEATHKIT ELECTRONIC WORKSHOP. Model EW-1. This educational kit will teach and amuse your children. It can make 21 exciting experiments including transistor radios, burglar alarm, radio or TV silencer, intercom, etc. **£7.13.6**

JUNIOR TRANSISTOR RADIO. Model UJR-1. Single transistor set. Excellent introduction to radio. An instructive present. **£2.7.6**

HI-FI STEREO AMPLIFIER. Model S-99. 18W output. Ganged controls. Stereo/mono gram., radio and tape recorder inputs. Push-button selection. Printed circuit construction. **£27.19.6**

THE "COTSWOLD". This is an acoustically designed enclosure 26" x 23" x 15½" housing a 12" bass speaker with 2" speech coil, elliptical middle speaker together with a pressure unit to cover the full frequency range of 32-20,000 c/s. Capable of doing justice to the finest programme source, its polar distribution makes it ideal for really Hi-Fi Stereo.

COTSWOLD "MFS" SYSTEM. Specially developed to give best possible results in small rooms. This minimum floor space model is based on standard Cotswold. Size: 36" high x 16½" wide x 14½" deep. Either Model, **£23.4.0**



S-99



THE "COTSWOLD"

Without obligation please send me

FREE BRITISH HEATHKIT CATALOGUE.....

(Tick here)

FULL DETAILS OF MODEL(S).....

(Please write in BLOCK CAPITALS)

NAME.....

ADDRESS.....

DAYSTROM LTD DEPT. RC2 GLOUCESTER

DEPT. RC2

Stern's

MULLARD DESIGNS

COMPLETE KITS OF PARTS

MULLARD 3-VALVE PRE-AMPLIFIER CONTROL UNIT

Designed mainly for Mullard Range of Amplifiers, also suitable for any Amplifier requiring input up to 250 mV. Incorporates 5 input channels, including for Tape and Magnetic Pick-ups. Separate Bass and Treble controls. High pass filter 20 to 160 c/s. low pass filter 5-9 Kc/s. Totally enclosed in case, size 11 1/4" x 4 1/4" x 4".



KIT OF PARTS £10.10.0 ASSEMBLED AND TESTED £13.13.0

Designed by MULLARD—presented by STERNS strictly to specification

MULLARD'S 2-VALVE PRE-AMPLIFIER TONE CONTROL UNIT

Employing two EF86 valves and designed to operate with the Mullard MAIN AMPLIFIER but also perfectly suitable for other makes.

- ★ Equalisation for the latest R.I.A.A. characteristic.
 - ★ Input for Crystal Pick-ups and variable reluctance magnetic types.
 - ★ Input (a) Direct from High Imp. Tape Head. (b) from a Tape Amplifier or Pre-Amplifier.
 - ★ Sensitive Microphone Channel. ★ Wide range BASS and TREBLE Controls.
- KIT OF PARTS £6.6.0 ASSEMBLED AND TESTED £9.10.0

MULLARD "5-10" MAIN AMPLIFIER

For use with MULLARD 2-stage pre-amplifier with which an undistorted power output of up to 10 watts is obtained. SPECIFIED COMPONENTS AND MULLARD VALVES including PARMEKO MAINS TRANSFORMER and choice of PARMEKO or PARTRIDGE Output Transformer. COMPLETE KIT £10.0.0

(Parmeko Output Trans.) ASSEMBLED AND TESTED £13.10.0

ABOVE INCORPORATING PARTRIDGE OUTPUT TRANSFORMER £1.6.0 extra.

THE MULLARD 510/RC AMPLIFIER

The popular complete "5-10" incorporating Control Unit providing up to 10 watts. Specified components and new MULLARD VALVES. Includes PARMEKO MAINS TRANSFORMERS and choice of the latest PARMEKO or PARTRIDGE output Transformers.

Price: COMPLETE KIT £12.0.0

ASSEMBLED AND TESTED £16.0.0

with PARTRIDGE OUTPUT TRANSFORMER £1.6.0 extra.



COMBINED PRICE REDUCTIONS

- (a) The KIT OF PARTS to build both the "5-10" Main Amplifier and the 2-Stage Pre-Amplifier £15.15.0
 - (a) The "5-10" and the 2-Stage Pre-Amplifier both Assembled and Tested £21.10.0
 - (b) The KIT OF PARTS to build the "5-10" Main Amplifier and 3 Valve Pre-Amplifier £19.10.0
 - (b) The "5-10" and 3 Valve Pre-Amplifier both Assembled and Tested £25.10.0
- With PARTRIDGE OUTPUT TRANSFORMER £1.6.0 extra.

THE MULLARD 33/RC

HIGH QUALITY AMPLIFIER DEVELOPED FROM THE VERY POPULAR 3-WATT MULLARD "3-3" DESIGN. KIT OF PARTS £8.8.0

ASSEMBLED AND TESTED £11.10.0

Complete to the MULLARD specification including PARMEKO OUTPUT TRANSFORMER. Switched inputs for 78 and L.P. records plus a Radio position. Extra power to drive a Radio Tuning Unit is also available.



THE MONO-GRAM

A small Amplifier of genuine high quality performance. Incorporates new MULLARD ECL86 Valve, separate BASS and TREBLE controls and produces up to 3 watts undistorted output.

KIT OF PARTS £4.10.0 ASSEMBLED AND TESTED £6.0.0



Perfectly suited for Portable Installations for which purpose we offer... PORTABLE CASE £3.10.0, the AMPLIFIER (Kit) and 8 x 5 in. SPEAKER (£1). All for £9.0.0. Alternatively with ASSEMBLED AMPLIFIER £10.0.0.

The case quoted above will accommodate some 4 speed Single Record Units. A larger model for auto-changer is available for extra 10/- . With this Equipment a COMPLETE PORTABLE RECORD PLAYER CAN be built for £14.0.0.



MULLARD FOUR CHANNEL MIXING UNIT

Self powered Cathode follower output. Incorporates two inputs for CRYSTAL MICROPHONES, one for CRYSTAL PICK-UPS and a fourth for Radio or Tape.

KIT OF PARTS £8.8.0 ASSEMBLED AND TESTED £11.10.0 Alternative Model I/L provides for one input matched for moving coil or ribbon mike £1.17.0.



!!! SENSATIONAL BARGAINS !!!
A BULK PURCHASE ENABLES US TO OFFER THESE TWO GRUNDIG MODELS AT APPROX. HALF PRICE... Each is fully GUARANTEED.

THE GRUNDIG "MINIBOY"

The "LITTLE" SET with "BIG" PERFORMANCE

Original Price is £26.5.0
OUR PRICE ONLY £10.10.0



A six Transistor (plus two Diodes) Portable covering the Medium Waveband. Small enough to slip into Handbag or Pocket (4 x 2 1/2 x 1 in.) but when at home "big set" performance is obtained simply by slipping the set into the companion Speaker Enclosure (size 9 1/2 x 3 1/2 x 1 1/2 in.).

GRUNDIG T.M.60 TAPE UNIT

FOR STEREOPHONIC or MONOPHONIC OPERATION, BEAUTIFULLY STYLED WITH FINGER TIP CONTROLS, CONSISTING OF TAPE DECK INCORPORATING HIGH QUALITY PREAMPLIFIER. LIST PRICE IS £94.10.0.

OUR PRICE ONLY... £49.10.0

A completely self-contained self-powered Unit designed to add full TAPE RECORDING facilities to existing sound reproducing equipment. Will operate with the majority of high quality audio installations and ideally suited for our MULLARD AMPLIFIERS. When ordering please state the make and type of Amplifier or Radiogram to be used with the Unit.



LOUDSPEAKERS

WE STOCK THE COMPLETE RANGE OF HIGH FIDELITY UNITS by... GOODMANS, WHARFDALE and W. B. STENTORIAN

A few recommended examples:

8 INCH TYPES	
GOODMANS "AXIETTE"	£5. 5.6
W.B. HF.816	£3.18.6
WHARFDALE "SUPER 8/RS/OD"	£6.14.0
10 INCH TYPES	
GOODMANS "AXIOM 10"	£6. 5.6
W.B. Model HF.1016	£7. 0.0
WHARFDALE "GOLDEN 10/RS/OD"	£7.17.0
12 INCH TYPES	
GOODMANS "AXIOM 20" 15 watts	£10. 7.0
GOODMANS "AXIOM 30" 20 watts	£14.10.0
W.B. Model HF.1214 15 watts	£10. 5.6
WHARFDALE "W12/RS"	£10.10.0
WHARFDALE "Super 12/RS/OD"	£17.10.0

LEAK AND QUAD AMPLIFIERS

LEAK "TL12 PLUS" POWER AMPLIFIER with the "POINT ONE PLUS" PRE-AMPLIFIER... 14 watts rated output	£31.10.0
LEAK "TL25 PLUS" with the "POINT ONE PLUS" PRE-AMPLIFIER... 28 watts rated output	£37.16.0
LEAK "STEREO 20" POWER AMPLIFIER with the "VARIABLE STEREO" PRE-AMPLIFIER... 22 watts (11 watts per channel)	£55.9.0
QUAD II. POWER AMPLIFIER with QUAD II CONTROL UNIT 15 watts output	£42.0.0

RECORD PLAYERS

THE COLLARO "JUNIOR" 4-speed single player with separate crystal pick-up	£3.10.0
GARRARD Model SRP10... Single Record Player fitted with high output crystal pick-up	£5. 0.0
THE NEW GARRARD "AUTOSLIM" 4-speed Autochanger with crystal pick-up	£7.10.0
GARRARD "AUTOSLIM DE LUXE" 4-speed Autochanger, incorporates transcription Pick-up Arm	£11. 8.0
THE COLLARO "C60" 4-speed autochanger unit with Studio "C" pick-up	£6.19.6
B.S.R. Model UA14, a 4-speed Mixer Autochanger with crystal pick-up	£6.10.0
The new GARRARD Model #11F High Quality Single Record Player fitted with the latest T.P.A. 12 pick-up arm and G.C.S. crystal Cartridge	£16.17.6
PHILIPS Model AG1016. A 4-speed Player which can be operated both manually and automatically. Suitable for Mono or Stereo operation	£12.12.0

Carriage and insurance on each above, 5/- extra.

HOME CONSTRUCTORS

A Range of "EASY TO ASSEMBLE" PREFABRICATED CABINETS designed by the W.B. "STENTORIAN" COMPANY for "Hi-Fi" Loudspeaker systems or to accommodate high quality equipment. FULL RANGE IN STOCK, please enclose S.A.E. for descriptive leaflets.

IF YOU ARE PLANNING TO INSTALL HI-FI AND UNCERTAIN OF THE TYPE OF EQUIPMENT TO USE—OUR WIDELY EXPERIENCED TECHNICAL STAFF WILL WITH PLEASURE PUT FORWARD RECOMMENDATIONS—STATE TYPE OF INSTALLATION CONTEMPLATED AND APPROX. PRICE LEVEL.

CREDIT SALE TERMS are available on all Equipment over £10. FULLY DESCRIPTIVE LEAFLETS are readily available... please enclose S.A.E.

Stern's

SPECIALISTS IN SOUND EQUIPMENT FOR OVER 50 YEARS

TAPE RECORDING EQUIPMENT

STEREO TAPE PRE-AMPLIFIER

Model STP-1. For use with current TRUVOX, BRENELL or COLLARO "STUDIO" 1/2 and 1/4 track Stereo Decks. Incorporates Ferroxcube Oscillator, 4-speed Equalisation Signal Level Meter and separate Gain Controls. Includes separate Power Unit.



KIT OF PARTS £22.0.0 ASSEMBLED AND TESTED £28.0.0

MULLARD'S TYPE "C" TAPE PRE-AMPLIFIER

Suitable for most 1/2-track Mono Tape Decks. Incorporates Ferroxcube Push Pull Oscillator and 3-Speed Treble Inductor. Includes separate Power Unit.



KIT OF PARTS £14.0.0 ASSEMBLED AND TESTED £19.10.0

MULLARD'S TAPE AMPLIFIER (Model HF/TR3)

Based on Mullard's Type "A" design and suitable for most 1/2 track Mono Tape Decks. Incorporates Ferroxcube 3 speed Treble Inductor and Gilson Output Transformer. Includes separate Power Unit.



KIT OF PARTS £13.13.0 ASSEMBLED AND TESTED £19.0.0

STERN'S "ADD-A-DECK"

A self-contained Unit consisting of Garrard Deck and matched Pre-amplifier on one chassis. Provides full tape recording facilities and replays through Pick-up Sockets of standard Radio receiver or Amplifier. PRICE: Includes Spool of Tape £18.18.0



TAPE DECKS AND COMPLETE RECORDERS

By Collaro, Brenell, Truvox, Wearite, Grundig, Ferrograph, Philips and others. Descriptive leaflets readily available.

THE "TUDOR" AM/FM TUNING UNIT

A SELF-POWERED HIGH FIDELITY TUNER OF OUTSTANDING DESIGN. PROVIDES FULL COVERAGE OF THE VHF/FM TRANSMISSIONS and also the LONG and MEDIUM WAVEBANDS. PRICE ONLY £19.19.0

Operates perfectly with the STERN-MULLARD AMPLIFIERS and contains matching FRONT PANEL in Black/Gold or White Black. Also operates equally well with any Amplifier requiring input of 100 to 350 m-Volts.

Mk. II "Fidelity" FM TUNING UNIT

An attractively presented Unit incorporating MULLARD PERMEABILITY TUNING HEART and corresponding Mullard valve line-up. Very suitable to operate with our Mullard Amplifiers.

KIT OF PARTS £10.10.0
ASSEMBLED AND TESTED £14.5.0

ARMSTRONG RADIOGRAM CHASSIS

We have the full range in stock. Prices Range from £20.10.0. Full details are readily available.



THE "TUDOR" STEREO AMPLIFIER

PRICE ONLY £18.18.0. A self-contained Amplifier designed to provide high quality stereophonic and monophonic reproduction. Each channel provides a rated output of 6 watts and for monophonic operation approx. 12 watts is produced. Separate BASS and TREBLE CONTROLS.



!! COMBINED PRICE OFFERS !!
Includes small charge for special testing and PRECISE MATCHING of the ASSEMBLED PRE-AMPLIFIER (or amplifier) to TAPE DECK

STP-1 (Kit) and "STUDIO" Deck	£39.0.0
STP-1 (Assembled) "STUDIO" Deck	£46.0.0
STP-1 (Kit) and Brenell Deck	£66.0.0
STP-1 (Assembled) Brenell Deck	£75.0.0
STP-1 (Kit) and Truvox Deck	£51.0.0
STP-1 (Assembled) Truvox Deck	£59.0.0
TYPE "C" (Kit) and "STUDIO" Deck	£26.10.0
TYPE "C" (Kit) and BRENELL Deck	£43. 0.0
TYPE "C" (Assembled) and WEARITE Deck	£70. 0.0
HF/TR3 (Kit) and "STUDIO" Deck	£26. 0.0
HF/TR3 (Kit) and BRENELL Deck	£42. 0.0
HF/TR3 (Assembled) and WEARITE Deck	£70. 0.0

Assembled £33. 0.0, Assembled £50. 0.0, Includes Head Lift Transf. £33. 0.0, Assembled £30. 0.0, Includes Head Lift Transf. £30. 0.0

Full Range of Lustraphone Microphones, Stands, and Accessories are in Stock.

Stereo Amplifiers

MULLARD'S "10+10" STEREO AMPLIFIER

A HIGH FIDELITY DESIGN PROVIDING UP TO 10 WATTS (per channel), SUPERB REPRODUCTION FREQUENCY RESPONSE FLAT TO WITHIN: 3dB from 3 c/s to 60 kc/s at 50mW.

TOTAL HARMONIC DISTORTION AT 10 WATTS, 0.1%. PRICE: (a) ASSEMBLED AMPLIFIER £24.0.0 (As illustrated).



(b) KIT OF PARTS £20.0.0. Built to the highest technical standards and presented strictly to MULLARD'S specification. Two specially designed GILSON OUTPUT TRANSFORMERS with 20% taps are used.

We can also supply the assembled MAIN AMPLIFIER only for operation with our DUAL CHANNEL PRE-AMPLIFIER; this provides for a more versatile installation and is essential if a low output Magnetic Pick-up is to be used. When ordering, specify loudspeaker impedance.

(a) THE ASSEMBLED MAIN AMPLIFIER and ASSEMBLED DUAL CHANNEL PRE-AMP £34.0.0

(b) KIT OF PARTS for both Units £27.0.0

THE "TWIN THREE" STEREO AMPLIFIER

ASSEMBLED AND TESTED for (Carr. & Ins. 7/6 extra) £9.0.0

Based on a recent design by MULLARD LTD. is ideally suited for use in PORTABLE RECORD PLAYERS for which purpose we offer a specially designed case:

It incorporates: MULLARD ECL 86 Valves, separate BASS and TREBLE CONTROLS and produces up to 3 watts per channel. Frequency response 40 c/s to 30 Kc/s, size 11 1/2 in. x 3 in. x 5 in. To construct a STEREO PORTABLE RECORD PLAYER we offer: Assembled AMPLIFIER with two ROLA 8 in. x 5 in. LOUDSPEAKERS and PORTABLE CASE for £16.10.0 (Carr. and Ins. 10/- extra).



MULLARD DUAL CHANNEL PRE-AMPLIFIER

A four Valve design for both STEREOPHONIC and MONOPHONIC operation. Operate equally well with any make of Amplifier requiring input of up to 250 m.v.

KIT OF PARTS £12.10.0
ASSEMBLED AND TESTED £15.0.0



POSTAL ENQUIRIES and MAIL ORDERS TO...
STERN RADIO LTD.
6-12, TUDOR PLACE, TOTTENHAM COURT RD.
LONDON, W1. TEL. MUSEUM 6128/9

DEMONSTRATION and SHOWROOMS AT...
STERN RADIO LTD.
109, FLEET ST. LONDON, EC4
TEL. FLEET ST. 5812/3
OPEN...9 a.m. to 6 p.m. SAT. close 1 p.m.

PREMIER RADIO
23, TOTTENHAM COURT RD.
LONDON, W1. TEL. MUSEUM 6128/9
OPEN...9 a.m. to 6 p.m. THURS. close 1 p.m.

BREAKTHROUGH

- ★ **IN SIZE**
- ★ **DESIGN**
- ★ **PERFORMANCE**
- ★ **QUALITY**
- ★ **VALUE**



THE

SINCLAIR SLIMLINE

The **Sinclair Slimline** is the smallest receiver of them all, only $2\frac{3}{4}$ " x $1\frac{5}{8}$ " x $\frac{5}{8}$ ". Yet, in performance and design it far surpasses every other set on the market. Using only its internal ferrite rod aerial it will receive all stations on the medium wave band including **Home, Light, Third, Luxembourg**, and dozens of continental transmissions.

The case is in deep royal blue with gold lettering and the calibrated dial is in gold on white. Both were designed by a professional artist.

The earpiece provided gives superb reproduction free from noise or distortion and the volume is sufficient even for use in a car. The receiver uses a completely new reflex circuit developed by engineers at Sinclair

Radionics Ltd. All the components used are brand new and **MICRO-ALLOY TRANSISTORS** are employed throughout. The result is a radio with the sensitivity and selectivity of a good superhet but with no alignment problems.

The components are mounted on a printed circuit board and clear detailed instructions are provided. Assembly is perfectly straightforward and simple even for a beginner yet the brilliant performance will more than satisfy the expert.

TOTAL COST
49/6 P.P.
1/6

SINCLAIR RADIONICS LTD
69 HISTON ROAD CAMBRIDGE
TRADE INQUIRIES INVITED

RETURN-OF-POST SERVICE

We offer a really efficient Mail Order Service on all items stocked. All cash orders are dealt with on the day of receipt.
★ Hire purchase orders are subject to slight delay but this is kept to the absolute minimum.

● MARTIN STEREO AMPLIFIER KITS

Printed circuit, already wired and tested. Only requires wiring to mains and output transformers. Complete kit with plastic escutcheon and full instructions £6.6.0.

● TRANSISTORISE YOUR CRYSTAL SET

We have two new designs for Transistor amplifiers which can be used to greatly improve the signal from any crystal set. RLD4 Kit, one stage, 12/-; RLD5 Kit, two stage, 21/-; both post free. The kits are easy to build and very detailed instructions are supplied. Leaflet available.

● NEW MULLARD CONDENSERS

We now stock the following range of the new Mullard Miniature Foil and Polyester condensers as used in the latest TV and Transistor sets. Fully detailed list available giving full technical information and dimensions
Miniature Foil. 30 volt working for Transistor sets. .01mfd, 7½d; .022mfd, 9d.; .047mfd, 9d.; 1mfd, 11d.

Polyester Tubular Capacitors. Moulded outer case designed to withstand accidental contact with the soldering iron. Tolerance 10%. 125V range: .01mfd, .022mfd, .047mfd, all 9d. each. .1mfd, 1/2; .22mfd, 1/3; .47mfd, 1/6; 1mfd, 3/-.
400V range: .001mfd, .0022mfd, .0047mfd, .01mfd, .022mfd, all 9d. each. .047mfd, 1/2; .1mfd, 1/3; .22mfd, 1/6; .47mfd, 2/5. Postage extra.

● TAPE RECORDING EQUIPMENT

TAPE DECKS	Cash Price	Deposit	Hire Purchase Mthly/Pmts.
ALL CARRIAGE FREE			
B.S.R. TD2	£8.19.6	£1.16.6	12 of 13/7
Latest COLLARO Studio	£10.19.6	£2.3.6	12 of 16/4

TAPE AMPLIFIERS

We now stock the Martin Recorder Kits. These are partly assembled kits for complete tape recorders. The Amplifier Printed Circuit panels are completely wired, but the assembly of this and external components is left to the constructor. Very complete instructions are supplied. Send for leaflet.

MODEL C for Collaro Studio Deck, £11.11.0.
MODEL B for BRS TD2 Deck, £8.8.0.

CARRYING CASES. Smart carrying cases are available to take the above amplifiers and decks. Fitted with speaker.
For Model C Amplifier and Collaro Deck, £5.5.0.
For Model B Amplifier and BSR Deck, £4.4.0.
H.P. Terms available for amplifiers, cases and decks.

TAPE PRE-AMPLIFIERS

MULLARD TAPE C PRE-AMPLIFIER. We stock complete kits and all components. Send for list.

MARTIN. Pre-amp kit for Collaro Studio Deck, £8.8.0.

● "BRAND FIVE" RECORDING TAPE

Long Play: 900' (5"), 18/6; 1,200' (5½"), 23/6; 1,800' (7"), 35/-, post free

● JASON F.M. TUNER KITS

Kits supplied complete with every item needed including instruction manuals. Fully detailed list available. Separate items supplied, ask for price list. H.P. Terms available on any kit.
FMT1, £6.12.6; FMT2 (less power), £7.15.0.
FMT2 (with power), £9.12.6; FMT3 (less power), £9.9.6.
FMT3 (with power), £11.7.6. Mercury 2, £10.14.6. JTV/2, £14.12.6.

● ILLUSTRATED LISTS

Illustrated lists are available on LOUDSPEAKERS, TAPE DECKS, TEST GEAR, GRAMOPHONE EQUIPMENT, AMPLIFIERS. Any will be sent free upon request.

● STEREO COMPONENTS

Morganite ganged potentiometers as specified for the Mullard circuits.
★ Log/Anti-Log, 500k, 1 meg., 2 meg. ★ Log/Log, 50k, 250k, 1 meg., 2 meg. ★ Lin/Lin 250k, 500k, 1 meg. All 10/6 each.

● TRANSISTORS

MULLARD. Reduced prices. Current production types, not rejects. All in makers' boxes. Postage 3d. on each. OC44, 9/3; OC45, 9/-; OC70 and OC71, 6/6; OC72, 8/-; OC72 Matched Pairs, 16/-; OC78, 8/-; OC81, 8/-; OC170, 9/6; OC171, 10/6.

● AMPLIFIER KITS

We have full stocks of all components for the Mullard 510. Mullard 3-3, Mullard 2 and 3 Valve Pre-amp. Mullard Stereo. Mullard Mixer, GEC 912 Plus. Fully detailed list on any of these sent upon request.
Instructional Manuals: All Mullard Audio Circuits in "Circuits for Audio Amplifiers", 9/5. GEC912, 4/6. All post free.

● TERMS OF BUSINESS

Cash with order or C.O.D. We charge C.G.D. orders as follows: Up to £3, minimum of 3/2. Over £3 and under £5, 1/6. Over £5 and under £10, 1/8. Over £10, no charge. Postage extra on CASH orders under £3 except where stated. Postage extra on overseas orders irrespective of price.

● GRAMOPHONE EQUIPMENT

ALL LATEST MODELS
ALL POST FREE

RECORD CHANGERS

	Cash Price	Deposit	Hire Purchase Mthly/Pmts.
GARRARD AUTOSLIM ...	£7.2.6	£1.8.6	12 of 11/2
GARRARD AUTOSLIM De-luxe (Mono PU) ...	£11.9.0	£2.6.0	12 of 16/11
GARRARD AUTOSLIM De-luxe (Stereo/Mono PU) ...	£12.5.4	£2.9.4	12 of 18/-
B.S.R. UA14 (TC8 Mono PU) ...	£6.19.6	£1.7.6	12 of 11/-
B.S.R. UA 14 Monarch (TC8S Stereo/LP/78) ...	£7.19.6	£1.11.6	12 of 12/4

SINGLE RECORD PLAYERS

B.S.R. TU12 (TC8 Mono PU) ...	£3.17.6	£1.4.6	3 of 21/-
B.S.R. GU7 (TC8 Mono PU) ...	£4.18.8	£1.8.8	3 of 11.6.8

TRANSCRIPTION UNITS

GARRARD 4HF (GC8 PU) ...	£16.12.6	£3.6.6	12 of 11.4.5
PHILIPS AG1016 ...	£12.12.0	£2.10.0	12 of 18/6

Many of the above can be supplied for stereo working. See our Gramophone Equipment List for details.

● LOUDSPEAKERS

GOODMANS: Axiette 8", £5.5.7; Axiom 10", £6.5.11; 12", Axiom 201, £10.7.0; 12", Axiom 301, £14.10.0; 12", Audiom 51 Bass, £8.14.0; 12" Audiom 61 Bass, £13.14.0; Trebax Tweeter, £6.4.0; X05000 Crossover unit, £1.19.0.

WHITELEY: HF1016 10", £7.0.0; HF1012 10", £4.7.6; HF816 8", £6.0.0; T816 8", £5.13.6; T10 Tweeter, £4.8.3; T359 Tweeter, £1.10.6; CX3000 Crossover unit, £1.11.6; CX1500 Crossover unit, £2. H.P. Terms available on all speakers.

● P.W. STRAND, MAYFAIR & SAVOY UNITS

We stock parts for the P.W. Strand Amplifier, Mayfair Pre-amplifier and Savoy F.M. Tuner. Detailed price lists are available.

● P.W. MERCURY

P.W. Mercury (Osmor printed circuit version) including Mullard first grade transistors and instruction manual. Complete set of parts, £9.19.6. Instruction manual available separately at 2/6 post free. Separate components supplied. Send for list.

● LATEST TEST METERS

	Cash Price	Deposit	Hire Purchase Mthly/Pmts.
AVO Model 8 Mark II	£24. 0.0	£4.16.0	12 of £1.15. 2
AVO Model 8 with leather carrying case	£27.18.0	£5.12.0	12 of £2. 0.11
AVO Model 7 Mark II	£21. 0.0	£4. 4.0	12 of £1.10.0
AVO Multiminor	£9.10.0	£1.19.0	12 of 14/4
AVO Multiminor with leather carrying case	£11. 9.0	£2. 5.0	12 of 17/-
TAYLOR MODEL 127A	£10.10.0	£2. 0.0	12 of 15/8
CABY A-10	£4.17.6	£1. 7.6	3 of £1. 6.8
CABY B-20	£6.10.0	£2. 0.0	3 of £1.13.4
CABY M-1	£2.14.0	—	—

Full details of any of the above supplied free on request
The AVO Models 7 and 8 are both latest models from current production—not to be confused with Government Surplus.

● OUTPUT TRANSFORMERS

GILSON: W0696A, W0696B, 50/6, post 2/6. W0710, 55/6, post 2/6. W0892, 62/3, post free; W0767, 27/-, post 1/6. W01796A, 57/6, post 2/6. W01932, 84/-, post free.

PARTRIDGE: P3667, 75/-; P4131, 65/-; P5202, P5203, £5.18.6. All post free.

PARMEKO: P2629, 45/6; P2642, 43/3; P2643, 45/6. All plus post 2/9. P2641, 28/3, post 2/-; P2928, 15/3, post 2/-; P2932, 39/3, post 2/6.

ELSTONE: OT/ML, 45/-, post 2/9; OT/3, 25/-, post 2/6.

● MAINS TRANSFORMERS

GILSON: W0741AB, 63/-, post free; W0839, 48/9, post 2/9; W01328 58/6, post 3/6; W01288, 58/-, post 3/6; W01566, 80/-, post free; W01341 (Choke), 36/-, post and packing 2/-.

PARMEKO: P2631, 33/9, post 2/9; P2630, 52/6, post 3/3; P2644, 73/6, post free; P2930, 39/3, post 3/-; P2931, 54/6, post 3/3.

ELSTONE: MT/MU, 45/-, post 3/3; MT3/M, 35/-, post 3/-; MT/510, 42/-, post 3/3.

WATTS RADIO

(MAIL ORDER) LTD.
54 CHURCH STREET WEYBRIDGE SURREY
Telephone Weybridge 47556
Please note: Postal business only from this address
(Callers welcome by appointment)

● HIRE PURCHASE TERMS

are available on any item. Repayments may be spread over 3, 6 or 12 months. Details as follows: Three months; Deposit 6/- in the £. Service charge 5 per cent but minimum charge of 10/-; Six and Twelve months; Deposit 4/- in the £. Service charge 10 per cent, but minimum charge 20/-.

THE MODERN BOOK CO

World Radio TV Handbook, 1963 Ed.
22s. Postage 1s.

Electronic Musical Instruments Handbook. By N. H. Crowhurst. 20s. Postage 1s.

Principles of Colour Television. By G. N. Patchett. 16s. Postage 6d.

Electronic Music and Musique Concrete. By F. C. Judd. 16s. Postage 1s.

Radio Data Reference Book. An R.S.G.B. Publication. 12s. 6d. Postage 1s.

Extra Equipment For Your Tape Recorder. By A. H. Rasheed. 6s. Postage 6d.

TV Fault Finding. A Data Publication. 5s. Postage 6d.

Principles of Semiconductors. By M. G. Scroggie. 21s. Postage 1s.

Radio Control for Models. By F. C. Judd and R. F. Stock. 15s. Postage 9d.

Mullard Transistor Radios. Circuitry and Servicing. 5s. Postage 6d.

Tape Recording Year Book 1962-3. 7s. 6d. Postage 9d.

Servicing Transistor Radios and Printed Circuits. By L. Lane. 42s. Postage 1s.

Principles of Transistor Circuits. By S. W. Amos. 21s. Postage 1s.

R.S.G.B. Amateur Radio Call Book, 1963 Ed. 4s. 6d. Postage 6d.

Sound and Cine For Beginners. By R. Golding. 7s. 6d. Postage 6d.

Radio Data Charts. By R. T. Beatty, revised by J. McG. Sowerby. 10s. 6d. Postage 1s.

We have the Finest Selection of British and American Radio Books in the Country
Complete catalogue 1s.

19-21 PRAED STREET (Dept RC) LONDON W2

Telephone PADdington 4185

Premier RADIO

23 Tottenham Court Road London W1 Telephone MUSEum 3451/2 and 309 Edgware Road London W2 Telephone PADdington 6963



THE "MID-F1" A NEW DESIGN 4W AMPLIFIER KIT
MAY BE BUILT FOR 95/- plus 3/- P & P.
A new circuit for the home constructor requiring a good quality med. powered amplifier for reproduction of records or f.m. broadcasts.

Technical spec.: sep. bass and treble controls. Valves: EF86, EL84, EZ80. Voltage adjustment for a.c. mains from 200/250V, 3 or 15Ω imp. Neg. feedback. Size 7" x 5" x 2", overall ht. 5". Silver hammered finished chassis.



WHY NOT DO IT YOURSELF!

Long & Medium Waveband
T.R.F. Receiver

May be built for **£5.10.0** Plus 5/- P. & P.

This receiver uses the very latest circuitry and when constructed is housed in a Bakelite cabinet size 12" x 6 1/4" x 5 1/4", available in either walnut or ivory. Individual instruction books 1/- each, post free.

WE HAVE BEEN APPOINTED STOCKISTS FOR FULL RANGE OF STERN'S RADIO (Fleet Street)

Famous Mullard Designs such as Type 'C' Tape Pre-amplifier and Erase Unit, including separate Power Supply. Complete Kit of Parts £14. 0. 0 or Completely assembled and tested

Also available Less Power Supply at £11.15.0 and £14.10.0 respectively.

Stern's Model HF/TR3 Mk.2. Tape Amplifier Complete Kit of Parts £13.14. 0 or Completely assembled and tested

Complete Mullard 5-10 Amplifier with Pre-amplifier on same Chassis Complete Kit with Parmeko O/P and Mains Transformers £11.10. 0

Completely assembled and tested £13.10. 0
Complete Mullard 3-3 Amplifier Kit £7.10. 0
Completely assembled and tested

..... £8.19. 6 P. & P. 6/6
Mullard 10-10 Stereo Power Amplifier based on the famous Mullard 5-10 Complete Kit of Parts £18.10. 0
Completely assembled and tested

..... £21. 0. 0
(Control Unit on Main Chassis) Also available with separate dual-channel Pre-amp.

Complete Kit for Power Amp. & Pre-amp £26. 0. 0
Completely assembled and tested £30. 0. 0

All components used in these kits are of the highest possible standard and strictly to circuit specifications.

Full descriptive literature available on these products and Circuit Diagrams may be purchased separately.

The "Handyphone" Intercom



Fully Transistorised Battery Operated

89/6 P. & P. 4/-

Including PP3-Battery and 25 yds. lead with plugs. At last a completely Portable Intercom with 101 uses being ideally suitable for the office or even as a Baby Alarm, since being battery operated, it is completely safe. Two-way calling system and volume on/off switch, the units are housed in attractive plastic cabinets (black/white) with chrome stands. It is extremely economical operating on one 9-volt battery, replacement price being 2/6.

The "Petite" PORTABLE

MAY BE BUILT FOR **£7.0.0** plus 5/- P. & P.
Batteries extra
HT 10/- (Type B126) or equiv.
LT 1/6 (Type AD35) or equiv.



★ Size only 8" x 8" x 4 1/2"

★ Instruction book 1/6

Battery Eliminator, available in component form price 37/6 plus 2/- P. & P.

COLLARO STUDIO TAPE RECORDER KIT

SPECIAL BARGAIN OFFER. Comp. Kit only **£25** Carr. 12/6

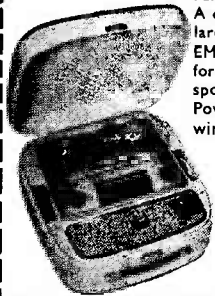

Famous mfr.'s surplus offer—listed 42 gns. A quality Tape Recorder Kit based on Mullard's famous design—EF86, ECC83, EL84, EM81 and Rectifier. Specially designed Kit for Collaro latest Studio Deck, freq. response ± 3 dB, 60 c/s-10 kc/s. Amp. and Power Pack already wired, inter. unit wiring only required. Cabinet size: 18" x 16½" x 6" finished in contemp. 2-tone blue Rexine with gilt Speaker Escutcheon. Magic Eye indicator. Circuit and Tech. H/Book, supplied free with kit. Send 3d. stamp now for full details of today's outstanding Tape Recorder Bargain.

COLLARO TAPE DECK
£12.10.0 Carr. 7/6

CABINET **£3.15.0** P. & P. 6/6
AMPLIFIER KIT **£8.19.6** P. & P. 5/-
SPEAKER 7" x 4" **16/6** P. & P. 2/-
If above items are purchased together **£12.19.6** P. & P. 10/-

New Boxed VALVES

Guaranteed	All	Electrolytics	All Types	New	Stk.
1T4 6/-	ECC83 8/-	PCC84 9/6	25/25V 1/9	8+8/450V	4/6
1R5 7/6	ECL82 10/6	PCF80 9/6	50/12V 1/9	16+16/450V	5/6
1S5 7/6	ECL80 10/6	PCL83 12/6	50/50V 2/-	32+32/275V	4/6
3S4 7/6	EF80 8/-	PCL84 12/6	100/25V 2/-	50+50/350V	6/6
3V4 7/6	EF86 12/6	PL81 12/6	8/450V 2/3	60+250/	
DAF96 9/-	EL84 8/6	PL82 9/6	4/350V 2/3	275V	12/6
DF96 9/-	EY51 9/6	PL83 10/6	16+16/450V	5/6	100+200/
DK96 9/-	EY86 10/-	PY32 12/6	32+32/450V	6/6	275V
DL96 9/-	EZ81 7/6	PY81 9/6			
ECC81 8/-	GZ32 12/6	PY82 7/6			
ECC82 8/-	EM84 9/6	U25 12/6			

RECORDING TAPE—REDUCED BARGAIN PRICES

Famous American Columbia (CBS) Premier Quality Tape at NEW REDUCED PRICES. A genuine recommended Quality Tape—TRY IT! Brand new, boxed and fully guaranteed. Fitted with leader and stop foils.

Standard	Long Play	Double Play
5" 600ft. 13/-	900ft. 17/6	1,200ft. 31/6
5½" 900ft. 16/-	1,200ft. 19/6	1,800ft. 37/6
7" 1,200ft. 21/-	1,800ft. 28/6	2,400ft. 47/6

Post and Packing, per reel, 1/-, plus 6d. each for additional reels.
SPECIAL OFFER—3" mfrs. surplus spec. Std. 150 ft. 3/9, L.P. 225 ft. 4/9, D.P. 300 ft. 6/6. P. & P. per reel 6d. Plastic Tape Reels 3" 1/3, 5" 2/-, 5½" 2/-, 7" 2/3. Plastic Spool Containers 5" 1/6, 5½" 2/-, 7" 2/3

Jack Plugs. Standard 2¼" Igranite or 230/250V. Mains 200/220V Type, 2/6. Screened Ditto, 3/3. Miniature 1¼", 2/3. Screened Ditto, 2/6.

Jack Sockets. Open Igranite Moulded Type, 3/3. Closed Ditto, 3/9. Miniature Closed Type, 1/9. Sub-min (deaf aid) ditto, 1/3.

Phono Plugs (incl. aid). Phono Sockets (open), 1/-, Ditto Closed, 1/6. Twin Phono Sockets (open), 1/6.

Soldering Irons. Mains 200/220V or 230/250V. Solon 25 watt Inst., 22/6. Spare Elements, 4/6. Bits, 1/- 65 watt, 27/6 etc.

Alumin. Chassis. 18g. Plain Undrilled, folded 4 sides, 2" deep. 6" x 4", 4/6, 8" x 6", 5/9, 10" x 7", 6/9, 12" x 6", 7/6, 12" x 8", 8/- etc.

Alumin. Sheet. 18g. 6" x 6", 1/-, 6" x 9", 1/6, 6" x 12", 2/-, 12" x 12", 4/6 etc.

MULLARD "3—3" HI-FI AMPLIFIER 3 VALVES 3 WATT

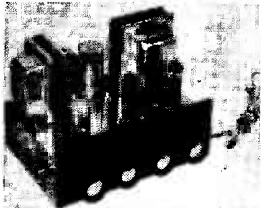

3 ohm and 15 ohm Output
A really first-class Amplifier giving Hi-Fi quality at a reasonable cost. Mullard's latest circuit. Valve line-up: EF86, EL84, EZ81. Extra H.T. and L.T. available for Tuner Unit addition. This is the ideal companion Amplifier for FM tuner units.

TECHNICAL SPECIFICATION—Freq. Response: 4-1dB, 10 Kc/s. Max. Bass Boost 14 dB, at 80 c/s. sensitivity: 100 MV for 3W output. Output Power (at 400 c/s): 3W, at 1% total harmonic distortion. Hum and Noise Level: At least 70 dB, below 3W.

COMPLETE KIT (incl. valves, all components, wiring diagram and special quality sectional Output Trans.)

ONLY £6.19.6 carr. 4/6d. Complete wired and tested 8 gns. Wired power O/P socket and additional smoothing for Tuner Unit, 10/6 extra.

Bronze Escutcheon Panel, Printed Vol., Treble, Bass, On-Off, supplied with each Kit.

Recommended Speakers—WBHF 10 12 £5, Goodmans Axiom 10 £5/15/8, Axiote £6/10, or Axiom 112 £8/10.

Volume Controls—5K-2 Meg-ohms, 3" Spindles Morganite Midget Type. 1¼" diam. Guar. 1 year. LOG or LIN ratios less Sw. 3/-, DP. Sw. 4/6. Twin Stereo less Sw. 6/6. D.P. Sw. 8/-.

COAX 80 OHM CABLE

High grade low loss Cellular air spaced Polythene—¼" diameter. Stranded cond. Famous mfrs. Now only 6d. per yard.
Bargain Prices—Special lengths 20 yds. 9/-, P. & P. 1/6. 40 yds. 17/6. P. & P. 2/-, 60 yds. 25/-, P. & P. 3/-.
Coax Plugs 1/-, Sockets 1/-, Couplers 1/3. Outlet Boxes 4/6.

Close Tol. S/Micas—10%, 5pF-500pF 8d. 600-5,000pF 1/-, 1% 2pF-100pF 9d. 100pF-500pF 11d. 575pF-5,000pF 1/6
Resistors—Full Range 10 ohms-10 megohms 20% \pm and $\frac{1}{2}$ W 3d., $\frac{1}{2}$ W 5d. (Midget type modern rating) 1W 6d., 2W 9d. Hi-Stub 10% $\frac{1}{2}$ W 5d., $\frac{1}{2}$ W 7d. 5% $\frac{1}{2}$ W 9d., 1% $\frac{1}{2}$ W 1/6. W/W Resistors 25 ohms to 10K 5W 1/3, 10W 1/6, 15W 2/-, Preset 1/3 Pots. W/W 25 ohms-50 K 3/-, 50 K-2 Meg. (Carbon) 3/-.

JASON FM TUNER UNITS

Designer-approved kits of parts:
FMT1, 5 gns. 4 valves, 20/-
FMT2, £7. 5 valves, 37/6.
JTV MERCURY 10 gns.
JTV2 £13.19.6. 4 valves, 32/6.
NEW JASON FM HANDBOOK, 2/6. 48 hr. Alignment Service 7/6. P. & P. 2/6.

Speakers P.M.—3 ohms 2½" E.M.I. 17/6. Goodmans 3½" 18/6. 5" Rola 17/6. 6" Elac 18/6. 7" x 4" Goodmans 18/6. 8" Rola 20/-, 10" R. x A. 25/-, 9" x 6" Goodmans 25/-, E.M.I. Tweeter 29/6.

Speaker Fret—Expanded bronze anodised metal ¼" x ¼" diamond mesh, 4/6 sq. ft., multiples of 6" cut. Max. width 4 ft.

TYGAN FRET (contemp. pat.) 12" x 12" 2/-, 12" x 18" 3/-, 12" x 24" 4/-, 18" x 18" 4/6

BARGAINS 4-SPEED

SINGLE PLAYERS carr. 3/6
Garrard TA Mk. 2 **£6.19.6**
B.S.R. Latest Model TU12 **70/-**
E.M.I. Junior "985" **79/6**
AUTO-CHANGERS carr. 5/6
Garrard RC209 **8½ gns.**
Garrard "Auto-Slim" **£7.10.0**
Collaro C60 **£7.7.0**
B.S.R. (UA14) **£6.19.6**

RECORD PLAYER CABINETS

Contemporary style, rexine covered cabinet in mottled red and white polka dot. Size 18½" x 13½" x ht. 8½", fitted with all accessories including baffle board and anodised metal fret. Space available for all modern amplifiers and auto-changers, etc. Uncut record player mounting board 14" x 13" supplied.

Cabinet Price £3.3.0 Carr. and Ins. 5/-

2-VALVE 2 WATT AMPLIFIER

Twin stage ECL82 with vol. and neg. feedback tone control. A.C. 200/250V with knobs, etc., ready wired to fit above cabinet. **£2.17.6** P. & P. 1/6. 6" Speaker and trans, 22/-, P.P. 2/-

COMPLETE R/PLAYER KIT

As ill. inc. BSR UA14 Unit with BSR UA20 Unit. **New Reduced Price £12.10.0** Carr. 7/6.



Ditto RECORD PLAYER KIT

As ill. inc. BSR UA14 Unit with BSR UA20 Unit. **New Reduced Price £11.19.6** Carr. 7/6.

ENAMELLED COPPER WIRE—¼lb reels, 14g-20g, 2/6; 22g-28g, 3/-; 30g-40g, 3/9. Other gauges quoted for.

PVC CONNECTING WIRE—10 colours (for chassis wiring, etc.)—Single or stranded conductor, per yd., 2d. Sleeving 2d. yd.

TRANSISTOR COMPONENTS

Midget I.F.'s—465 Kc/s $\frac{1}{2}$ " diam. 5/6
Osc. Coil— $\frac{1}{2}$ " diam. M/W. 5/3
Osc. coil M. & L.W. 5/9
Midget Driver Trans. 3.5:1 6/9
Ditto O/Put Push-pull 3 ohms 6/9
Elect. Condensers—Midget Type 12V 1mfd-50mfd, ea. 1/9. 100mfd, 2/-.

Ferrite Aerial—M. & L.W. with car aerial coupling coil, 9/3.

Condensers—150V. wkg. .01 mfd., to .04 mfd., 9d. .05 mfd., .1 mfd., 1/-, .25 mfd., 1/3. .5 mfd., 1/6, etc.

Tuning Condensers, J.B. "00" 208+175pF, 8/6. Ditto with trimmers, 9/6. 365pF single, 7/6. Sub-min. 2½" DILEMIN 100pF, 300pF, 500pF, 7/-.

Midget Vol. Control with edge control knob, 5kΩ with switch, 4/9, ditto less switch, 3/9.

Speakers P.M.—2" Plessey 75 ohms, 15/6. 2½" Continental 8 ohms, 13/6. 7" x 4" Plessey 35 ohm, 23/6.

Ear Plug Phones—Min. Continental type, 3ft. lead, jack plug and socket, High. Imp. 8/-, Low Imp., 7/6.

TRANSISTOR BARGAINS

Brand New—BVA 1st Grade

OC44	8/6	OC70	5/6
OC45	8/-	OC71	6/-
OC81	7/6	GEX34	2/9
2/OC81	15/6	OA70	2/9
GET114	6/6	OA81	2/9
OC72	7/6		

SPECIAL OFFER

OC44 } 21/6 OC81D } 19/6
2/OC45 } 2/OC81 }

TRIMMERS, Ceramic (Compression Type)—30pF, 70pF, 9d.; 100pF, 150pF, 1/3; 250pF, 1/3; 600pF, 1/9.

PHILIPS, Bee Hive Type (conc. air spaced)—2-8pF, 1/-; 3-30pF, 1/-.

KNOB—Modern Continental types: Brown or Ivory with Gold Ring, 1" dia., 9d. each; 1½", 1/- each; Brown or Ivory with Gold Centre, 1" dia., 10d. each; 1½", 1/3 each.

LARGE SELECTION AVAILABLE.
METAL RECTIFIERS, STC Types—RM1, 4/9; RM2, 5/6; RM3, 7/6; RM4, 16/-; RM5, 21/-; RM4B, 17/6.



Send for detailed bargain lists, 3d. stamp. We manufacture all types Radio Mains Transf. Chokes, Quality O/P Trans., etc. Enquiries invited for Specials. Prototypes for small production runs. Quotation by return.

RADIO COMPONENT SPECIALISTS

70 Brigstock Rd., Thornton Heath, Surrey
THO 2188 Hours: 9 a.m., —6 p.m., 1 p.m. Wed. Terms C.W.O. or C.O.D. Post and Packing up to ¼ lb 9d., 1 lb., 1/3 3 lb., 2/3 5 lb., 2/9 8 lb. 3/6

HOME RADIO OF MITCHAM

DEPT. AC, 187 London Road, Mitcham, Surrey. MIT 3282

Shop hours 9.0 a.m. to 6 p.m. (Wed. 1 p.m.)



GOODMAN HI-FI SPEAKERS

We are main stockists for Goodman Hi-Fi Speakers. Enclosures and Accessories.

"AXIETTE 8". 6 watts, 15 ohms, 8" die-cast chassis with Feroba 11 high flux magnet. PRICE £5.5.6, post 1/6.

"AXIETTE 10". 10 watts, 15 ohms, 10" die-cast chassis with Feroba 11 high flux magnet. PRICE £6.6.0, post 1/6.

"AXIOM 201". 15 watts, 15 ohms, twin diaphragm, giving powerful smooth response 30 to 16,000 cycles. High flux magnet and aluminium voice coil. Ideal for mono or stereo. PRICE £10.7.0, post 2/6.

"AXIOM 301". The most advanced 12" twin diaphragm Hi-Fi speaker ever produced. Similar appearance and specification to "AXIOM 201" but will handle up to 20 watts. PRICE £14.10.0, post 2/6.

ARMSTRONG CHASSIS

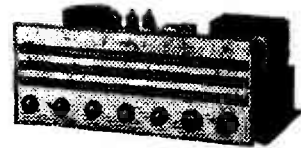

We carry the full range of ARMSTRONG radio chassis, tuners, amplifiers and tape pre-amplifier chassis including:

AF208. An economical chassis of traditional Armstrong quality giving 5 watts output, full FM/VHF plus Medium waveband. Separate Bass and Treble controls. PRICE £21.4.0, carriage 3/6.

JUBILEE Mk. 2. A high fidelity chassis with 8 watts push-pull output and covering full FM/VHF plus Medium and Long wave bands. Automatic tuning on VHF, separate Bass and Treble controls. PRICE £28.5.0, carriage 3/6.

STEREO 55. Provides 5 watts each channel. Full FM/VHF plus Medium wave-band. Separate Bass and Treble controls and inputs for mono and stereo pick-ups. PRICE £29.18.0, carriage 3/6.

STEREO 12 Mk. 2. The last word in compact Stereo High Fidelity combined radio, pre-amplifier, and amplifier. 8 watts push-pull output on each channel. Full FM/VHF plus Medium and Long wavebands. Automatic tuning on VHF, full range Bass and Treble controls, ferrite rod aerial for AM bands, and a host of other features. PP £40.5.0, carriage 3/6.

MULLARD TRANSISTORS, ETC.

Every one brand new individually boxed and fully guaranteed. Why chance spoiling results with "surplus" when the best can be obtained at these new low prices?

AF114 11/-, AF115 10/6, AF116 10/-, AF117 9/6, OC26 25/-, OC44 11/-, OC45 10/-, OC70 6/6, OC71 6/6, OC72 8/-, OC75 8/-, OC76 8/-, OC78 8/-, OC81 8/-, OC139 13/6, OC140 22/-, OC170 13/6, OCP71 26/-, DIODES. OA70, OA71, OA79, OA81, OA85, 3/- each; ORP12 12/6. ZENER DIODES. AOZ200 to AOZ207 in stock also AOZ213. Prices on request.

**WE ARE
MAIN STOCKISTS
FOR THE FAMOUS
HEATHKITS**

**APPOINTED AGENTS FOR
EDDYSTONE
RECEIVERS & COMPONENTS**

ACKNOWLEDGED TO BE THE BEST COMPONENT CATALOGUE

**A
MUST
for every
radio
enthusiast**

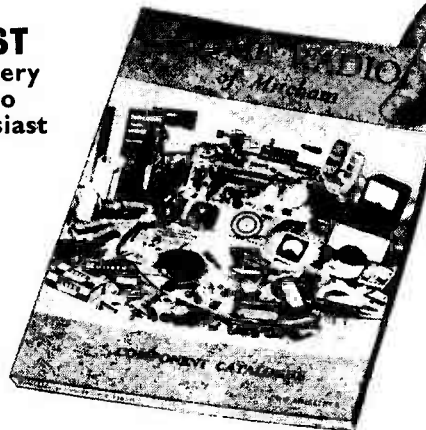
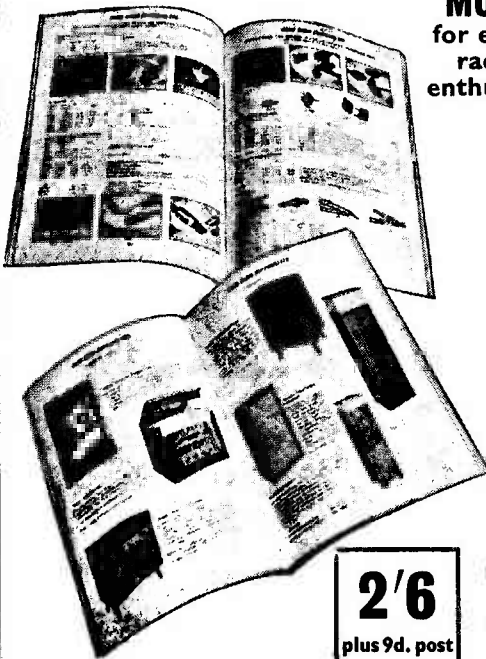

**NOW
172 pages
Over 600
illustrations
Over 5000
components listed**

This is today's most up-to-date and most comprehensive component catalogue for the radio constructor, experimenter, electronic engineer and hi-fi enthusiast.

**2/6
plus 9d. post**

**POST
COUPON
TODAY**
Write
CATALOGUE
on top left of
envelope.
Enclose P.O. 3/3

Name

Address

Home Radio Ltd., (AC), 187 London Road, Mitcham, Surrey

THE Radio Constructor

Incorporating THE RADIO AMATEUR

FEBRUARY 1963

Vol. 16, No. 7 Published Monthly	Suggested Circuits No. 147: Pocket Valve Voltmeter, <i>by G. A. French</i>	486
Annual Subscription 29/- (including postage)	20-50 Metre Short Wave Mains Two, <i>by R. Morgan</i>	488
<i>Editorial and Advertising Offices</i> 57 MAIDA VALE LONDON W9	Can Anyone Help?	491
Telephone CUNningham 6141 (2 lines)	News and Comment	492
Telegrams Databux, London	Understanding Radio. Part 18, <i>by W. G. Morley</i>	493
	Simple Extending Aerial for the Short Wave Bands, <i>by B. W. Hollinshead</i>	500
	In Your Workshop	502
	Useful Push-Pull Audio Amplifier, <i>by Wallace Studley</i>	509
	The "Crystella" Crystal-Controlled F.M. Tuner, Part 1, <i>by Sir John Holder, Bart.</i>	516
	Simple High-Low Resistance Continuity Tester, <i>by I. M. Rees</i>	521
	Door Chime Repeater, <i>by K. V. R. Bowerman</i>	522
	Comprehensive Valve Tester. Part 2, <i>by P. Cairns</i>	526
	Turns-Time Relationship for Magnetic Tape, <i>by R. S. Childs, B.Sc. (Eng.)</i>	528
	Radio Topics, <i>by Recorder</i>	529
	A Transistorised Electronic Organ- Further Notes, <i>by S. Astley</i>	531
	Top Band Converter, <i>by K. Laycock</i>	535
	Radio Astronomy, Part 3: The Aerial System, <i>by Frank W. Hyde, F.R.S.A., F.R.A.S., M.S.E.</i>	537
	Book Review	544
	Two Safety Switch Circuits, <i>by C. Morgan</i>	545

© Data Publications Ltd, 1963

CONTENTS may only be reproduced after obtaining prior permission from the Editor. Short abstracts or references are allowable provided acknowledgment of source is given.

CONTRIBUTIONS on constructional matters are invited, especially when they describe the construction of particular items of equipment. Articles should be written on one side of the sheet only and should preferably be typewritten, diagrams being on separate sheets. Whether hand-written or typewritten, lines should be double spaced. Diagrams need not be large or perfectly drawn, as our draughtsmen will redraw in most cases, but all relevant information should be included. Photographs should be clear and accompanied by negatives. Details of topical ideas and techniques are also welcomed and, if the contributor so wishes, will be re-written by our staff into article form. All contributions must be accompanied by a stamped addressed envelope for reply or return, and should bear the sender's name and address. Payment is made for all material published.

OPINIONS expressed by contributors are not necessarily those of the Editor or the proprietors.

TRADE NEWS. Manufacturers, publishers, etc., are invited to submit samples or information of new products for review in this section.

TECHNICAL QUERIES must be submitted in writing. We regret that we are unable to answer queries, other than those arising from articles appearing in this magazine; nor can we advise on modifications to the equipment described in these articles.

CORRESPONDENCE should be addressed to the Editor, Advertising Manager, Subscription Manager or the Publishers, as appropriate.

REMITTANCES should be made payable to "DATA PUBLICATIONS LTD."

The circuits presented in this series have been designed by G. A. FRENCH, specially for the enthusiast who needs only the circuit and essential data

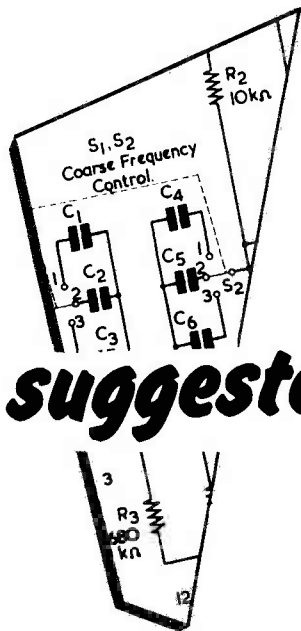

suggested circuits

No. 147 Pocket "Valve Voltmeter"

FOR QUITE SOME TIME, THE articles published in the "Suggested Circuit" series have been devoted to applications which require the use of light dependent resistors or semiconductors. In consequence, it makes rather a pleasant change, this month, to turn our attention to a circuit employing a thermionic device which was introduced some ten years or so ago. Despite a number of unusual and attractive features, this device has not appeared in home-constructor and experimental designs as frequently as might have been expected. The device is the subminiature tuning indicator type DM70, and it was initially intended for use in battery or mains operated receivers. In the present article, the DM70 is employed in an extremely simple arrangement wherein it can indicate changes in voltage whilst drawing negligible current. In this last respect it resembles a valve voltmeter of the type which presents a negatively biased grid to the circuit under test. The simple unit described here is not capable, however, of indicating voltage amplitude with the same degree of resolution as would be given by a valve voltmeter incorporating a meter.

The DM70

The DM70 has the general appearance illustrated in Fig. 1.

It consists of a tubular glass envelope in which the grid takes the form of a plate having a tapered aperture, as shown. The anode, behind the grid, is coated with a fluorescent material, whilst the filament is in front of the grid aperture, and extends over its length. When anode and filament supplies are connected, the fluorescent anode gives a bright green image in the form of an exclamation mark having a length of some 14mm. If the grid is made negative of the filament, the repulsion offered by the tapered aperture causes the length of the column in the display to shorten. Thus, the length of the column gives an indication of the negative potential on the grid.

In its intended application, the DM70 grid couples to the a.g.c. line of a valve a.m. receiver, whereupon an increasing negative a.g.c. bias causes the length of the column to reduce. In consequence, the device functions as a tuning indicator, the shortest column length corresponding to the position of correct tuning.

The power consumption of the DM70 is very low. The filament draws 25mA at 1.4 volts, whilst anode current, at 90 volts, is of the order of 170 μ A only.

Fig. 2 shows the base connections to the DM70. Four lead-out wires, corresponding to the filament, grid and anode, appear at the

base, these being intended for direct soldering into circuit. Solder connections must be at least 5mm from the glass seal, and no lead should be bent closer than 1.5mm from this seal. The display on the anode is viewed through the grid aperture, the requisite viewing direction being indicated by the arrow in Fig. 2.

The Circuit

The circuit of the pocket "valve voltmeter" unit appears in Fig. 3. As may be seen, this is extremely simple and comprises only the DM70, a switch, a series 6.8M Ω resistor, the h.t. battery, and the filament cell. The h.t. battery may be a miniature radio type, or several hearing aid batteries connected in series. Because of the very low anode current drawn by

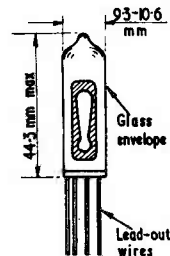

£261

Fig. 1. The general appearance of the DM70

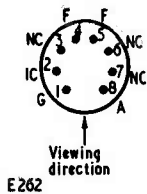

Fig. 2. The positions of the lead-out wires. (IC=Internal Connection. NC=No Connection)

the DM70, the h.t. battery should have a considerably long life. The l.t. supply can be given by any single dry cell of suitable size and, here again, the low current demand of the DM70 should ensure an extensive life. It should be noted, incidentally, that the anode supply must not exceed 90 volts, as this is the limiting value quoted for the indicator. The filament leads should be wired up as shown in the diagram, lead 4 connecting to the negative side of the cell.

In use, the terminals of the unit are connected to the circuit under test, whereupon the length of the column displayed will vary according to the voltage appearing in the circuit. The range available with the arrangement of Fig. 3 is from zero to 10 volts negative, the latter causing complete extinction of the column. This range may be extended, if desired, by inserting a resistor between the positive terminal of the h.t. battery and the anode, and a value of 470kΩ here should give a range extending up to some 15 volts.

It is possible to obtain an approximate idea of the potential applied to the unit by observing the length of the column displayed by the DM70. A simple voltage scale could, indeed, be fitted alongside the indicator, but the smallness of the display and the inevitable parallax error preclude any serious attempts in this direction. On the other hand, the unit is extremely useful for comparative measure-

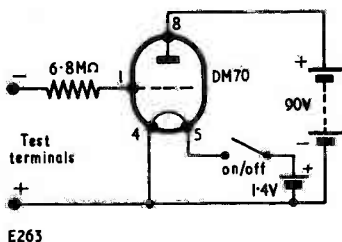

Fig. 3. The circuit of the pocket "valve voltmeter"

ments. It may, for instance, be connected between chassis and the a.g.c. line of a valve sound or television receiver whereupon, without upsetting receiver operating conditions, it can give immediate indications of any voltage changes which may occur. It can, therefore, frequently be used as an alignment aid. In transistor receivers, the a.g.c. voltage immediately after the detector is normally positive of chassis, in which case the unit could indicate changes in a.g.c. potential by connecting its negative terminal to chassis and its positive terminal to the a.g.c. line. Alternatively, the positive terminal may be connected to chassis and the negative terminal to the emitter of any a.g.c. controlled transistor, in which case the unit would indicate varying voltages across the emitter stabilising resistor. Yet another application would be given by connecting the unit across the grid leak of a suspect valve oscillator. The negative voltage on the grid due to the presence of oscillations would at once be shown by the indicator. It should be noted that, in all these instances, the unit offers virtually no loading at all on the circuit to which it is connected.

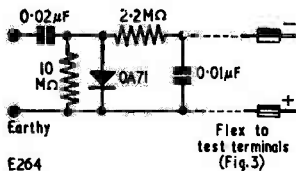

Fig. 4. An a.c. probe for the unit of Fig. 3

Adding a Probe

An add-on probe is shown in Fig. 4, and this may be used to provide indications of r.f. and a.f. voltages. A simple shunt detector is used, this being followed by the low-pass filter given by the 2.2MΩ resistor and 0.01μF capacitor. The latter two components are needed to prevent flicker in the indicator if a low frequency alternating

voltage is being checked. The probe connects to the input terminals of the DM70 unit by means of two-core flex, no screening being required.

With the probe, the DM70 can give comparative indications of r.f., i.f., and a.f. voltages and may, once more, be employed for alignment and similar processes.

Construction and Use

Few problems are involved in constructing the unit of Fig. 3, as the number of components required is very small. As was mentioned above, a miniature h.t. battery may be employed, and this will have a long life at the extremely low currents involved. The 6.8MΩ resistor may be an ½ watt component. The writer has experienced the subjective impression that column length is more readily ascertained if the DM70 is mounted horizontally rather than vertically. If this effect is similarly experienced by the constructor, it would be preferable to position the DM70 accordingly.

The probe unit of Fig. 4 also requires very few components, and it can be made small in consequence. Again, ½ watt resistors may be employed. It is desirable that the probe terminals should be capable of closely approaching the circuit to which it connects and it should, preferably, be built in an insulated housing. Such a housing may then rest in a chassis without risk of short-circuits. There is no necessity to screen the probe if its components are close to the circuit under test.

Care should be taken to prevent voltages of incorrect polarity being applied to the input terminals of the unit of Fig. 3 as, despite the presence of the series 6.8MΩ limiting resistor, these can cause damage to the indicator if they are sufficiently high. Similarly, excessively high voltages of correct polarity should also be avoided.

"CLOWN, when I asked you to get me a small pot I meant potentiometer!"

20-----Metre-----50

Short Wave Mains Two

By R. MORGAN

THIS IS A SMALL SELF-CONTAINED MAINS RECEIVER, tuning from approximately 20 to 50 metres, and using a 12AT7 or ECC81 double-triode as detector and a.f. amplifier. A speaker is incorporated, and can provide good volume with quite a number of stations. For weak transmissions and greater range phones may be employed, and these are plugged into a jack at the rear of the receiver. The phones are isolated from the h.t. circuit by C_8 .

The complete circuit is shown in Fig. 1 and is very straightforward. The receiver is isolated from the mains by T_1 , which has a centre-tapped h.t. secondary. H.T. for the audio amplifier, $V_{1(b)}$, is obtained directly from C_7 , while R_5 and C_9 provide additional smoothing for the detector $V_{1(a)}$. As a result, the hum level is low. With the coil and component values listed reaction is very satisfactory, and sensitivity to weak signals is good.

A panel indicator lamp is fitted, but no mains switch has been incorporated. If a switch is to be added, this can be of the lead-through type inserted in the flexible cord as indicated at X in Fig. 1. It

will be seen that it is inserted in the lead which terminates in the "L" pin of the mains plug. Also, it is good practice to connect all metal parts of mains equipment to the earth pin of the mains plug.

Chassis and Panel

The chassis measures 6 x 4 x 2in, and the panel 7 x 5in. The above-chassis layout is shown in Fig. 2. In this diagram the valveholder is placed centrally, about 1in from the rear, and is of the skirted type to take a screening can. The tags are positioned as illustrated in Fig. 3.

Two bolts secure the mains transformer, and a hole is positioned as in Fig. 2 so that the appropriate leads can pass through. Output transformer T_2 has mounting lugs which are passed through slots in the chassis and bent over. These slots can be made by drilling two or three small holes close together. Holes should also be drilled to allow the coil and r.f. choke to be mounted, and for the primary leads from T_2 .

Fig. 3 shows the underside of the chassis, and an insulated terminal or socket (or a co-axial socket)

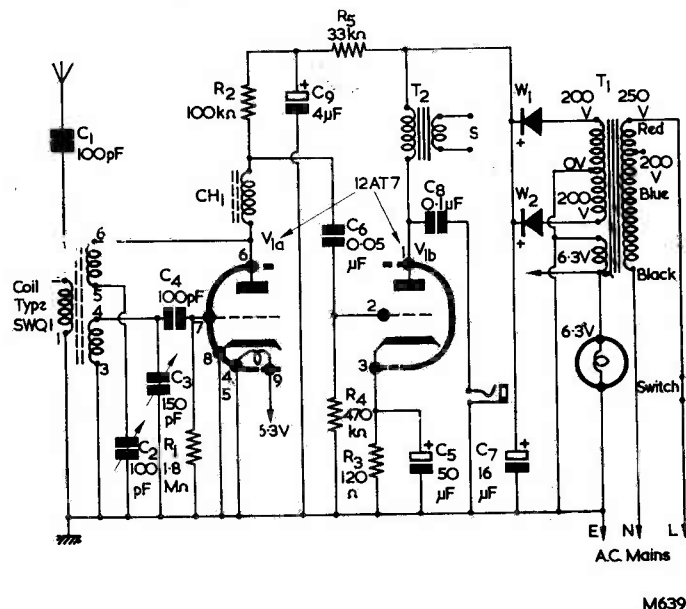
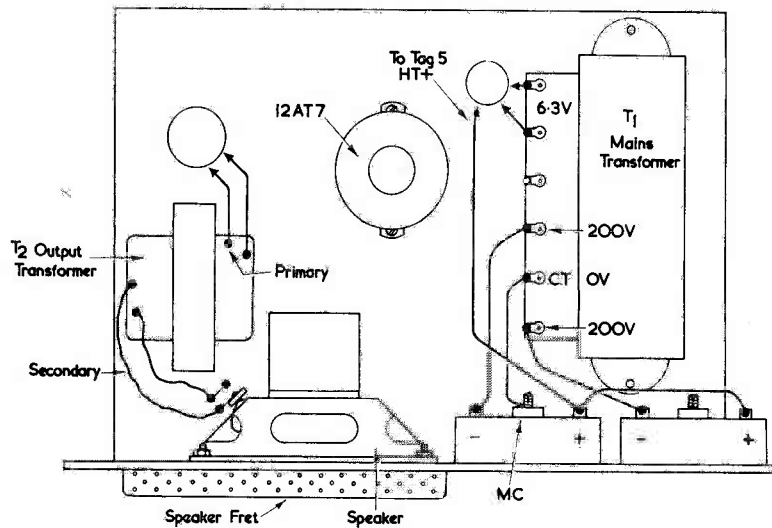

Fig. 1. Circuit of the 20-50 Metre Short Wave Mains Two

Fig. 2. Above-chassis component layout



M640

is fitted centrally at the rear, for the aerial. The phone jack is fixed as indicated, and is in contact with the chassis to complete the phone circuit. A further hole, fitted with a grommet, is required for the mains lead.

The panel can be marked out for the speaker by placing the unit in position, and pencilling through the four holes. A large hole, about 2 to 2½ in in diameter, is then cut out, this being centrally located

from the four mounting bolt holes. This large aperture can be made with a washer cutter or similar device, or by drilling a ring of small holes. The aperture and securing bolts are hidden by the speaker fret. This has four lugs which are inserted through slots in the panel, and these can be made with a small drill, as described previously.

Both metal rectifiers are positioned as shown in Fig. 2 illustrating the above-chassis layout, these

Components List

Capacitors

- C₁ 100pF
- C₂ 100pF variable (Jackson Brothers, Type C804)
- C₃ 150pF variable (Jackson Brothers, Type C804)
- C₄ 100pF
- C₅ 50μF 12 w.v. electrolytic
- C₆ 0.05μF 250 w.v.
- C₇ 16μF 350 w.v. electrolytic
- C₈ 0.1μF 350 w.v.
- C₉ 4μF 350 w.v. electrolytic

Resistors

- R₁ 1.8MΩ ¼W
- R₂ 100kΩ ¼W
- R₃ 120Ω ¼W
- R₄ 470kΩ ¼W
- R₅ 33kΩ ¼W

Inductors

- Coil type SWQ1 (Osmor Radio)
- CH₁ Choke type QC1 (Osmor Radio)
- T₁ Mains transformer, 200/0/200V 30mA, 6.3V 1A (Osmor Radio)
- T₂ Output transformer type QXO8 (Osmor Radio)

Valve

12AT7 or ECC81

Rectifiers

W₁, W₂ Type FC116 metal (Westinghouse)

Other Components

- B9A holder and screening can
- Phone jack and plug
- Aerial socket
- Speaker, 2½ in E.M.I. (or similar p.m. unit)
- Ball drive
- Bracket for C₃
- 10-way tagstrip (end tags earthed)
- 3-way tagstrip (centre tag earthed)
- Chassis 6 x 4 x 2 in
- Panel 7 x 5 in
- Two knobs 1 in dia.
- 1 Dial and glass type FM (Osmor Radio)
- Speaker fret type PW (Osmor Radio)
- 3-core mains lead
- Panel indicator lampholder (Bulgin) and 6.3V bulb
- Connecting wire, sleeving, etc.

being held to the panel with countersunk bolts. The heads of these bolts are concealed by the tuning scale.

A small ball-drive is fitted to facilitate tuning and C_3 must, therefore, be supported on a bracket. Drive and capacitor must be correctly in line, and an anchor bolt for the drive is fitted to the panel.

Wiring

A ten-way tagstrip is fitted near the rear of the chassis, as in Fig. 3. The outer tags, 1 and 10, are in contact with the chassis, being secured by short bolts. Tag 1 is used for the mains earth lead, and the negative lead-out wire of C_7 . Tag 2 is for mains neutral (black) and the black lead from T_1 primary. Tag 3 anchors the blue lead (200V) whilst the red lead from T_1 (250V) goes to tag 4. The red (L) mains conductor then connects to tag 3 or 4 according to the mains voltage available. Normally, it will connect to tag 4.

Tag 5 of the tagstrip takes the positive lead from C_7 , and one end of R_5 . A lead also travels from this tag through the chassis to the positive tags of both rectifiers, as in Fig. 2. A further lead connects from tag 5 to the tag marked "HT+" in the diagram. Tag 7 anchors the positive end of C_9 , and also R_5 and R_2 , as shown. Tag 10 acts as a chassis return for C_9 , R_3 , R_4 and C_5 .

Both C_7 and C_9 lie above the tagstrip, but they are shown removed from this position in Fig. 3 so that the wiring may be followed more clearly. C_7 and C_9 should have insulated sleeves, or should be bound with insulating tape, and they are best fitted after the other components.

The remaining tagstrip has two tags insulated from the chassis, and these are marked "HT+" and

"A" (for Anode) in Fig. 3. They serve as connecting points for the primary of the speaker transformer T_2 .

To avoid hum, the leads from C_4 and R_1 to tag 7 of the valveholder should be very short, and heater wiring should be clear of these components and tag 7.

Coil tags are identified by the notch in the former. Tags 1, 2, 3 and 4 are at the top of the coil, but tags 5 and 6 (reaction winding) are on a ring near the other end of the former. Leads must be kept reasonably short in the tuned circuit and detector stage.

Referring to Figs. 2 and 3 the 6.3V winding is connected to chassis and tag 9 of the valveholder. The h.t. winding centre-tap is taken to a tag held by one of the bolts securing the rectifiers as a convenient chassis return point. Each 200V tag goes to a negative tag on a rectifier as indicated.

The primary of T_2 is connected to the "HT+" and "A" tags as described previously. The secondary is taken direct to the loudspeaker tags. T_2 primary has a large number of turns of fine wire, whilst its secondary has few turns of stout wire, and this fact will assist in identifying the lead-outs.

All wiring should be checked before inserting the valve or connecting the receiver to the mains. Assure there are no bare leads which may touch each other, the chassis, or other components. Note that C_5 , C_7 and C_9 are wired up with negative to chassis in each case. Also check that the mains circuit and primary of T_1 are completely isolated from the chassis and receiver.

Operating

If an earth is available, this can be connected to the receiver chassis. Results should be satisfactory

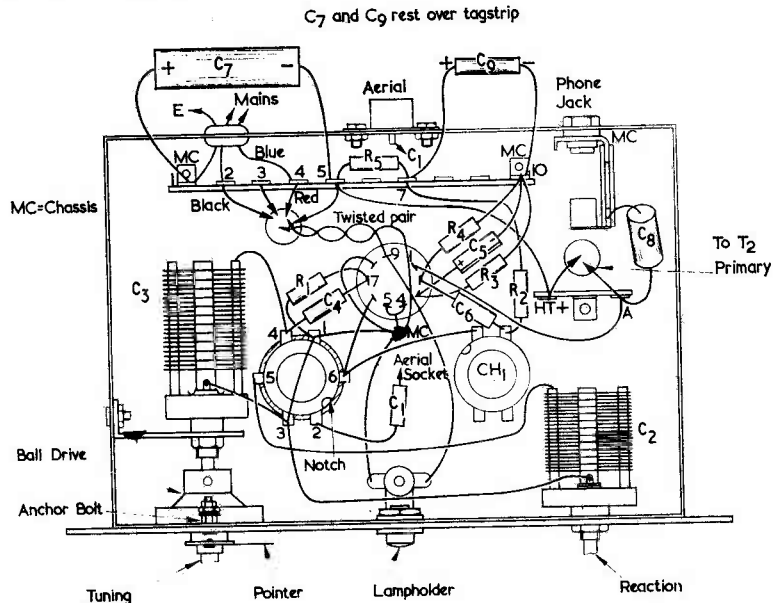

Fig. 3. Below-chassis point-to-point wiring diagram

M641

without such an earth connection, but it can improve results, especially when the mains earth circuit is not very effective from the radio point of view. Any aerial can be connected to the aerial socket. Indoor aerials, or short outdoor aerials, can give quite good results. However, the signal strength of distant stations will naturally be improved if the aerial is reasonably high and in the clear. One end of the aerial (the down lead) is merely taken to the receiver, and this type of aerial will work on all bands. It is also possible to use a dipole, with a 75Ω coaxial feeder. This type of aerial is intended for a single band only, however, and is therefore not suitable for general listening on all frequencies.

When the receiver is connected to the mains supply, the pilot lamp should light at once, at which time the valve heater should soon reach operating temperature. If not, the heater circuit wiring should be examined. The h.t. line voltage will be roughly 210V when measured with a high resistance meter. The cathode voltage at pin 3 of the valveholder should be about 2V.

The reaction capacitor is closed slowly to build up the volume of weak transmissions, and is operated in this way in conjunction with the tuning control. With powerful transmissions, reaction is less important. To receive weak signals, however,

operation is a two-handed affair, with careful adjustment of reaction to maintain full sensitivity. This is, of course, usual with "straight" circuits. The reaction control should not merely be turned so as to close C_2 completely, as this will *not* give best sensitivity.

Band coverage is modified to some extent by the position of the coil core, the change in coverage being most at the high wavelength, or low frequency, end of the band. The core should be situated near that end of the coil occupied by the reaction winding, or reaction may not be obtained.

C_1 is of suitable value for average aerials. If an extremely short, poor aerial is used, C_1 may be increased in value, or even removed. With a very long, efficient aerial, C_1 could be of smaller value. This is most easily arranged by simply adding a further small capacitor in series with the aerial lead at the receiver, and a 3–30pF trimmer is convenient for this purpose.

Quite a lot of stations should be heard at reasonable volume with the speaker. For phone reception, the phones are simply plugged into the phone jack. The usual type of medium impedance headsets will work satisfactorily, and no direct current passes through the phone windings. If it is wished to listen with phones and silence the speaker, one secondary lead of T_2 may be disconnected.

CAN ANYONE HELP?

Requests for information are inserted in this feature free of charge, subject to space being available. Users of this service undertake to acknowledge all letters, etc., received and to reimburse all reasonable expenses incurred by correspondents. Circuits, manuals, service sheets, etc., lent by readers must be returned in good condition within a reasonable period of time.

Canadian 52 Set.—W. J. Lewis, 5 Galon Uchaf Road, Merthyr, Glam., would like to obtain the circuit of this receiver also any information on modifications carried out.

* * *

W.S.62, W.S.88 and A.M. Transmitter Unit 54A.—M. S. Dixon, "Westover", Boundary Road, Farnborough, Hants, has obtained these units and would be grateful if any reader would sell the circuit diagrams and/or supply any information.

* * *

Taylor Valve Tester Model 45B, CT53 VHF Signal Generator.—R. S. Preston, 4 The Circle, Colenso, Natal, Republic of S. Africa, would like to obtain circuit diagrams for these units, also method used to set up the valve tester for dealing with valves not in the manual. The latter unit is surplus equipment.

Monitor Type 61.—C. J. Evans, 24 Northville Drive, Southend, Essex, wishes to obtain the circuit or any information and/or conversion data.

* * *

H.M.V. 5300 Radiogram.—W. H. Rees, 57 Belmont Road, Bushey, Herts, would like to obtain the service sheet or any details of the receiver—loan or purchase.

* * *

3FP7 Tube.—S. J. Coak, "Sunnycroft", 26 Mount Harry Road, Sevenoaks, Kent, requires information on this tube and details of a suitable timebase circuit (push-pull) for 350V h.t. and 900V e.h.t.

* * *

BC342-N and AM/FM Receiver R44/ARR5.—A. Redman, 46 Tukes Avenue, Bridgemary, Gosport, Hants, would like to purchase or obtain on loan the manuals or circuit diagrams of these receivers.

News and Comment . . .

Early Warning Systems

Aircraft and missiles can now be pinpointed by sophisticated multi-beam radar equipment, using high power klystron amplifiers manufactured by E.M.I. Electronics Ltd. The Ministry of Aviation has already ordered a large quantity of these klystrons.

This type of radar equipment is used for instant altitude plus azimuth early warning systems. Tubes used are E.M.I. high power klystron amplifiers with a high gain of 50dB.

Other applications of this klystron are found in air traffic control, to improve the resolution of the radar system and extend the range of control of civil aircraft over wide areas. It can also be fitted in linear accelerators or injectors for synchrotrons and other particle accelerators as used in modern nuclear research establishments.

This tube has the E.M.I. cone-type output window, which has been tested up to 20mW peak and 50kW mean power and so makes it possible to handle the high output of the tube—even under considerable mismatch from the load—with a single window.

The tube is designed as a plug-in device which makes for quick and easy exchange in sockets, to facilitate frequency changes and general maintenance.

Titles

We have, of course, no copyright in words such as "Data", "Radio", "Publications" or "Constructor", and therefore such words, or initials representing them, quite often appear, perfectly properly, in the titles of firms advertising in this and similar magazines. On occasion this has led readers, and others, to suppose that we have a financial interest in some business or other, advertising in the radio press.

We therefore think it advisable to state that we do not have an interest in any other business trading in the radio world, nor have we ever done so. Such an interest could lead to partiality in advice to readers and could result in advertisers being treated unfairly in our columns, and we therefore think it undesirable to ever acquire one.

Exhibitions

It is very pleasant to report that the Symposia and Exhibition held at the Bristol Technical College on 11th, 12th, and 13th December, as mentioned in our December issue, was a great success.

More than 1,200 people visited the exhibition and the lecture theatre was frequently filled to capacity, indeed, such was the demand for seats, that provision had to be made for over-spill with closed circuit television kindly provided by Pye Ltd.

The lecture on the "Basic principles of Nor-Logic" was acclaimed as the highlight, although all the talks were popular. West-country professional readers will be interested to learn that it is hoped to arrange this exhibition each year in future.

Our industrial readers who are employed using ultrasonics and were not able to attend the Physical Society's 1963 exhibition at the Royal Horticultural Society's Halls at Westminster would, no doubt, have been interested in the Visiguage 14, type 1109, displayed at the Dawe Instruments stand.

The Visiguage 14 employs an ultrasonic resonance method to measure the thickness of a wide range of materials from one side of the material. The resonance method is particularly suitable for thin materials in the range 0.005in to 2in. and an accuracy of thickness measurement to 0.1% can be achieved. The particular feature of this new design is the immersion testing facility which permits thickness measurements to be taken without physical contact between the transducer and the material under test. Coupling for the ultrasonic waves can be provided either by a water column or by immersion of transducer and test piece in a tank of water.

The obvious advantages are that there is no transducer wear, continuous measurement can be made on flow line production and consistently uniform coupling permits very high accuracy of both visual and recorded measurements.

The English Electric Valve Co. Ltd., at the same exhibition, are going to demonstrate a new 3in Image Orthicon Television camera tube.

This tube is a development of the earlier and very successful tubes which E.E.V. produced some years ago. Continuing research has now evolved an improved internal construction which, coupled with advanced processing techniques, makes it possible now to obtain better resolution from scenes having only a very low level of illumination. One of these new experimental Image Orthicons will be fitted into a standard Marconi television camera,

and using normal control units and display monitors, will show pictures derived from the Exhibition Hall without any additional illumination, and with lens stops as low as f/32.

Although tubes of this highly sensitive type are not yet commercially available, E.E.V. development engineers have progressed sufficiently to stage this demonstration and confidently expect to be able to offer to television companies in the near future new production tubes which will not only give good monochrome pictures in very poor light, but also allow full colour working without any increase above present normal studio illumination.

The Institution of Electrical Engineers will be holding a Symposium on Automatic Production in Electrical and Electronic Engineering, at the Institution, on 24th and 25th October, in connection with the National Productivity Year. The Institute will also be holding a conference on Dielectric and Insulating Materials from 8th-10th April, 1964. The object of this conference is to discuss and record advances in the theory and practice of the subject since the last similar conference held in 1953.

Papers are invited for submission at both the foregoing events. It is not possible in the space available to give details of length of papers, scope of subjects, etc., anyone interested should write for details to the Secretary of the Institution at Savoy Place, London, W.C.2, as soon as possible.

Radio Operators Royal Navy

A new rating structure for the Royal Navy's Communication Branch is being introduced into the Fleet to bring training and employment into line with future trends in techniques and provide greater flexibility within the branch, and to conform with the common entry and initial training in the structure, new titles and badges are being introduced.

Aim of the new structure will be to develop a single Communication Branch with sub-specialisation kept to a minimum for junior ratings. Only as ratings qualify for higher rates will their specialisation be confined to specific duties. As an example of this policy, as from today (1st January, 1963) all Communication ratings in the Navy will be entered as Junior Radio Operators or as Radio Operators 3rd Class (according to age) and given a common basic training in the New Entry Training Establishments and in *H.M.S. Mercury*—the Royal Navy's Signal School.



The eighteenth in a series of articles which, starting from first principles, discusses the basic theory and practice of radio

part 18

understanding radio

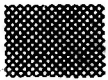

By W. G. MORLEY

IN LAST MONTH'S ISSUE WE EXAMINED THE EFFECT of connecting resistance, inductance and capacitance in series and showed that, when the inductive reactance was equal to the capacitive reactance, the total opposition to current flow offered by the series combination was due to the resistance on its own. Under these conditions, the combination became a *series resonant circuit*, the resonant

frequency being given by the equation $f_r = \frac{1}{2\pi\sqrt{LC}}$.

We also discussed response curves for the series resonant circuit and showed that these became sharper as the quality factor, or *Q*, of the circuit increased. We shall now carry on to the case where inductance and capacitance are connected in parallel.

Inductance and Capacitance in Parallel

In Fig. 105 (a) we have an a.c. generator connected to an inductor and a capacitor in parallel. We will assume for the time being that both the inductor and the capacitor are perfect components, in that they have no resistance and no "losses".

As with the series circuits we have considered up to now, it is possible to draw vector diagrams illustrating the effects given by the individual components in the parallel circuit. In the case of series circuits we were able to state that the same current must obviously flow through all the components in series. This current then gave us a reference vector. In the parallel circuit of Fig. 105 (a), we start by saying that the same *voltage* obviously appears *across* the two components, and so we use the voltage as a reference vector.

In Fig. 105 (b), vector OP represents voltage. Also shown in this diagram is vector OQ, which represents the current in the capacitor. This current

leads by 90° on the voltage and its vector is, by convention, shown as being anticlockwise of the voltage vector. A third vector, OR, represents the current flowing in the inductor and, since this lags by 90° on the voltage, it is shown as being clockwise of the voltage vector.

As we know,¹ the current flowing through a reactance is given by the equation:

$$I = \frac{E}{X}$$

where *I* is the current in amps, *E* is the e.m.f. in volts, and *X* is the reactance in ohms. We may,

therefore, give vector OQ the dimension $I_C \left(= \frac{E}{X_C} \right)$

and vector OR the dimension $I_L \left(= \frac{E}{X_L} \right)$.

Since the same voltage is applied to both the capacitor and the inductor, we can divide *I_C* and *I_L* by this common quantity, giving us the vector diagram shown in Fig. 105 (c). In this, vectors OQ and OR have the same dimensions as in Fig. 105 (b)

and their lengths are $\frac{1}{X_C}$ and $\frac{1}{X_L}$ respectively.

Examination of Fig. 105 (b) tells us that more current flows through the capacitor than through the inductor, because vector OQ is longer than vector OR. The resultant vector is equal to the difference between OQ and OR, and it points in the same direction as OQ, which is the longer. The resultant is shown in Fig. 105 (b) as vector OS. If we look at Fig. 105 (c) we see that *X_C* is smaller

¹ From "Understanding Radio" part 16, December 1962 issue.

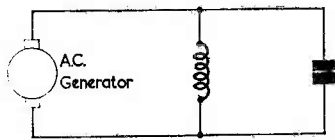

(a)

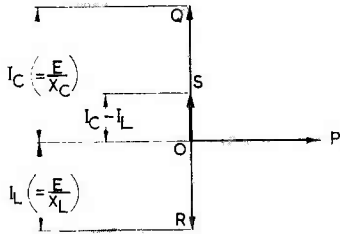

(b)

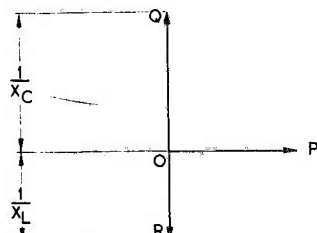

(c)

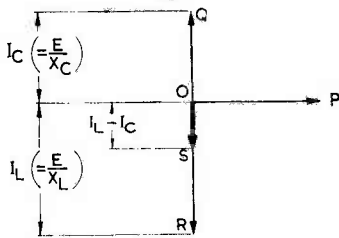

(d)

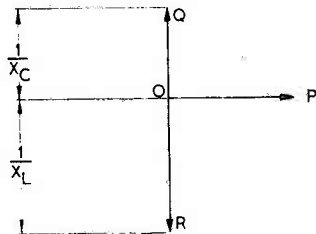

(e)

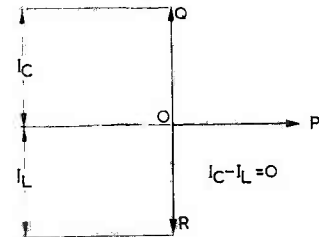

(f)

M653

than X_L , since it appears in a reciprocal expression.² Our two vector diagrams tell us, therefore, that if the reactance of the capacitor of Fig. 105 (a) is lower than the reactance of the inductor, more current flows through the capacitor (as is to be expected). Also, the current which flows through the parallel circuit is that which would occur with a capacitive reactance.

In Fig. 105 (d) we have the case where more current flows through the inductor than the capacitor. Fig. 105 (e) shows the same vectors dimensioned in terms of reactance, and we may now see that the reactance of the inductor is smaller than that of the capacitor. Because of this, the resultant vector in Fig. 105 (d), shown as OS, corresponds to the current which would flow in an inductive reactance.

Let us now turn to the important case where the reactance of the capacitor is equal to the reactance of the inductor. Since these reactances are equal, the same current must flow through both components, and the corresponding vector diagram is given in Fig. 105 (f). In this diagram we now have two opposing vectors of the same length, with the result that the resultant vector has a length of zero. In other words, *no current flows from the generator.*

From what we have just discussed we may now see that, when a perfect capacitor and a perfect inductor are connected in parallel, the current which flows through their combination decreases as the capacitive reactance approaches the inductive reactance. When the two reactances are equal, no current flows at all. If we refer to the opposition to current flow offered by the parallel combination, we can also say that, as the two reactances approach each other, the total impedance increases. When the two reactances are equal, the total impedance is infinite.

When we dealt with the series resonant circuit last month we saw that we could cause opposing changes in capacitive and inductive reactances by varying the frequency of the a.c. generator, and that it was possible to find a frequency which caused both the inductive and reactive reactances to be

² If $\frac{1}{X_C}$ is larger than $\frac{1}{X_L}$, it will follow that X_C , itself, is smaller

than X_L . If X_C were equal to 2 and X_L to 3, then $\frac{1}{X_C}$ (= $\frac{1}{2}$) is larger than X_L (= $\frac{1}{3}$).

Fig. 105 (a). An a.c. generator connected to an inductor and capacitor in parallel. It is assumed that there is no resistance in the circuit

(b). Vector diagram for the instance where more current flows through the capacitor than the inductor
(c). If the diagram of (b) is re-dimensioned in terms of reactance, it is found that the capacitive reactance is smaller than the inductive reactance

(d). In this case, the greater current flows through the inductor

(e). In (d) the inductive reactance is smaller than the capacitive reactance

(f). When inductive and capacitive reactances are equal, the circuit is at resonance and no current flows from the generator

equal. This frequency was the resonant frequency of the series circuit. Exactly the same process may be carried out with the parallel circuit of Fig. 105 (a), and the frequency which causes the two reactances to be equal (and zero current to flow) is the *resonant frequency* of the parallel combination. If we refer to the resonant frequency as f_r , then

$\frac{1}{2\pi f_r C}$ (the reactance of the capacitor) must be equal to $2\pi f_r L$ (the reactance of the inductor). This relationship enables us to obtain an equation for the resonant frequency in terms of L and C.

$$\text{Since } 2\pi f_r L = \frac{1}{2\pi f_r C}$$

$$f_r^2 = \frac{1}{2\pi L \times 2\pi C}$$

$$= \frac{1}{(2\pi)^2 \times LC}$$

$$\text{therefore } f_r = \frac{1}{2\pi \sqrt{LC}}$$

This gives the resonant frequency of a parallel resonant circuit (assuming a perfect capacitor and inductor) where f_r is the resonant frequency in cycles per second, L is the inductance in henrys, and C is the capacitance in farads.

The expression for resonant frequency with the parallel resonant circuit of Fig. 105 (a) is exactly the same as that for the series resonant circuit we discussed last month, and is derived from the fact that resonance occurs when the inductive and capacitive reactances are equal. It must be remembered, however, that the *effect* of the parallel circuit at resonance is exactly opposite to that of the series circuit. The impedance offered by the series circuit reduces as the resonant frequency is approached, and is at a minimum at the resonant frequency itself. With the parallel circuit, impedance *increases* as the resonant frequency is approached, and is at a *maximum* at the resonant frequency.

Practical Parallel Resonant Circuits

We have introduced the parallel resonant circuit by discussing the action of a circuit containing capacitance and inductance only, since this allows a basic understanding of parallel resonance to be easily obtained. In any *practical* parallel resonant circuit there must, however, be resistance in addition to the capacitive and inductive reactances. Such resistance is given by the inevitable resistance of the conductors employed in the inductor and capacitor, together with any "losses" which may appear in these components.

It is easy to understand the effect of resistance in the series resonant circuit because, at resonance, the

inductive and capacitive reactances cancel out and the only opposition to current flow is that offered by the resistance itself. With the parallel resonant circuit the effect of resistance is very much more complex, and anything approaching a full treatment of the effect would be quite out of place in the present context. To give an idea of what takes place we shall, therefore, content ourselves with briefly examining a single instance in which resistance is introduced, and we shall not undertake any mathematical analysis of the circuit operation which results. The purpose of this exercise is merely to show *why* the introduction of resistance produces complications.

As occurs with the series resonant circuit, most of the resistance and "losses" associated with the parallel resonant circuit appear in the inductor, and may be represented as a physical resistor in series with the inductor. Such a resistor is shown in Fig. 106 (a), and we give it the designation R. Whereas, in Fig. 105 (a), the same voltage (from the a.c. generator) was applied across the capacitor and inductor, we now have the same voltage applied across the capacitor and the inductor *in series with a resistor*. To produce a final vector diagram for the resonant condition of the same type as that shown in Fig. 105 (f), this resistor must first of all be taken into account.

We start off by finding the impedance given by the series combination of inductor and resistor. Obviously, the same current flows through the two, and we draw, in Fig. 106 (b), the current reference vector OP. The voltage across the resistor is in phase with the current, giving us vector OQ with a length of $E_R (=IR)$. The voltage on the inductor leads by 90° on the current, giving us vector OR, whose length is $S_L (=IX_L)$. The resultant vector is OS and its length is E_{TOTAL} , or $I Z_{LR}$, where Z_{LR} is the impedance of the combination of inductor and resistor. Fig. 106 (b) tells us that the voltage across the inductor leads on the current by an angle that is less than 90° , which is the same as saying that the current lags on the voltage by a similar angle.

We next transfer these results to a second vector diagram which is based on that of Fig. 105 (f). In Fig. 106 (c) we have the vector OQ, which represents the current flowing in the capacitor of Fig. 106 (a). This current leads on the voltage by 90° , and it is shown in the diagram as being anticlockwise of the reference voltage vector, OP. The current flowing in the series combination of inductor and resistor lags on the applied voltage, but it does so by an angle which is *less* than 90° . The corresponding vector is given by OR.

In Fig. 105 (f) the capacitive and inductive current vectors were directly opposed to each other, and they completely cancelled each other out. In Fig. 106 (c), however, they are not directly opposed, and we obtain the resultant vector, OS. The length of OS is proportional to the current which flows, and it may be seen from inspection that it has its shortest length when (as occurs in Fig. 106 (c)) the

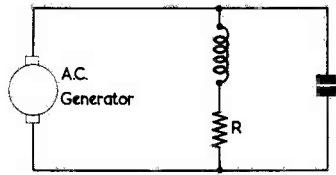

(a)

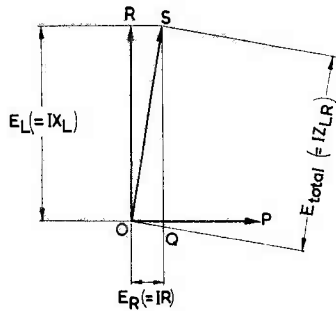

(b)

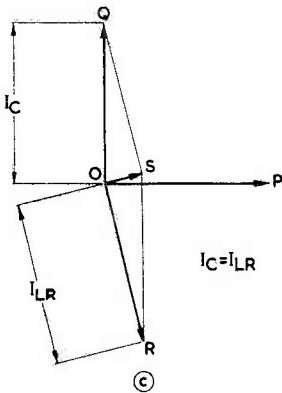

(c)

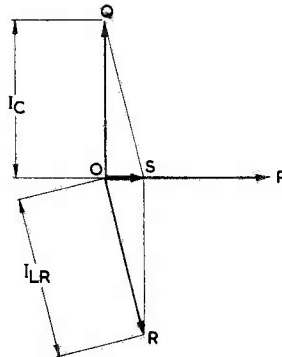

(d)

M654

reactance of the capacitor is equal to the impedance of the inductor and resistor in series. It will be seen that the current indicated by vector OS is not in phase with the applied voltage. By adjusting the

reactance of the inductor³ it is possible to obtain the vector diagram illustrated in Fig. 106 (d). In this instance, the resultant current, OS, is in phase with the applied voltage, but it is longer than that represented by the resultant vector in Fig. 106 (c).

The conditions shown in Fig. 106 (c) are those in which the circuit of Fig. 106 (a) causes minimum current flow, or *maximum impedance*. The conditions illustrated in Fig. 106 (d) are those which result in current flow that is *in phase with the voltage*. If the values of the inductor, capacitor and resistor remain constant, the diagrams of Fig. 106 (c) and Fig. 106 (d) will correspond to different frequencies from the a.c. generator of Fig. 106 (a). *Either of these frequencies could be called the resonant frequency of the circuit*. The frequency which causes the Fig. 106 (c) condition would then be defined as the "maximum impedance resonant frequency", and the frequency which causes the Fig. 106 (d) condition would be defined as the "resistive impedance resonant frequency".⁴

It will be apparent that the reason for the complexity resulting from introducing resistance in series with the inductor is due to the fact that the current in the series combination of inductor and resistor lags on the applied voltage by less than 90°. If more resistances were introduced, the current lag in the inductor and resistor would be less than that shown in Figs. 106 (c) and 106 (d), and the complicating effect on circuit operation would be even more pronounced. At the same time, if less resistance were introduced, the current lag in the inductor and resistor would be nearer to 90°, and the vector diagrams of Figs. 106 (c) and 106 (d) would more closely approach the "ideal" state of affairs shown in Fig. 105 (f).

In the case of Fig. 105 (f), we were able to state that resonance occurred when the capacitive reactance was equal to the inductive reactance. As soon as we introduce resistance this relationship no longer holds true. Fortunately, however, almost all practical parallel resonant circuits of the type likely to be encountered in radio work contain relatively low values of resistance. It then becomes possible, without introducing excessive errors, to ignore this resistance and make the assumption that resonance occurs when the capacitive and inductive reactances are equal. In consequence it can be assumed, for practical work, that the equation for resonant frequency in a parallel resonant circuit is the same

³ Or the reactance of the capacitor, or the applied frequency.

⁴ "Resistive impedance" applies to the instance where voltage and current are in phase, as in a resistor.

Fig. 106 (a). A practical parallel resonant circuit has resistance, and this may be shown, as R, in series with the inductor

(b). Finding the impedance and angle of voltage lead of the combination of inductor and resistor

(c). A vector diagram showing the effect of R on the parallel resonant circuit. Under the conditions shown here, the circuit offers maximum impedance

(d). By adjusting the reactances the circuit can be made to offer a resistive impedance

as occurs in the "ideal" case without resistance,⁵ viz.:

$$f_r = \frac{1}{2\pi\sqrt{LC}}$$

Dynamic Resistance and Q

If we have an inductor in series with a resistor, R, as in Fig. 107 (a), it is possible to show that this combination will perform in the same manner as the same inductor having a resistor, R_D, in parallel. See Fig. 107 (b). Provided that the value of R is low compared with the reactance of the inductor,

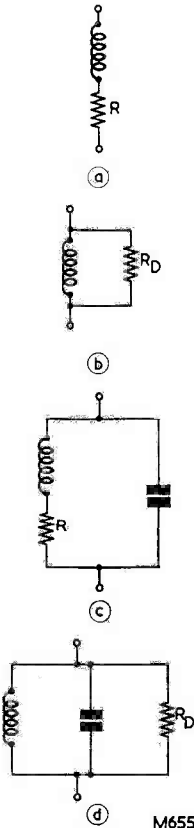

Fig. 107 (a). An inductor having its resistance and "losses" represented by a series resistor, R
 (b). The same effect is given if a parallel resistor, R_D, replaces the series resistor
 (c). The inductor and its series resistor in a parallel tuned circuit
 (d). Again, the series resistor may be replaced by a parallel resistor. The latter is the dynamic resistance of the resonant circuit

⁵ This assumption holds true for certain values of Q which are discussed later in this month's article. Also, when the assumption is made, it is possible to refer to the "resonant frequency" only. The maximum impedance resonant frequency and resistive impedance resonant frequency only assume practical importance as separate entities in circuits having a high level of resistance (or low Q).

the value of R_D is given by the following equation:

$$R_D = \frac{X_L^2}{R}$$

We may now take a further step by adding a capacitor to form a parallel resonant circuit, as in Fig. 107 (c). Once again, the series resistor R may be replaced by the parallel resistor R_D, as shown in Fig. 107 (d).

Because of the presence of resistance, practical parallel circuits cannot give infinite impedance at resonance (as occurs in the "ideal" case of Fig. 105 (f).) The impedance which they present at resonance depends upon the resistance in the circuit, which can be assumed to be wholly in the inductor; whereupon this impedance becomes equal to R_D of Fig. 107 (d). R_D, which is of course imaginary, is known as the *dynamic resistance* of the parallel resonant circuit. We have just seen that R_D is

equal to $\frac{X_L^2}{R}$, and it follows that dynamic resist-

ance increases as the resistance (and "losses") introduced by the inductor decreases.

By a little manipulation, it is possible to express R_D in terms of L, C and R. To do this we must remember that:

$$X_L = 2\pi fL,$$

$$X_C = \frac{1}{2\pi fC},$$

and that, at resonance,

$$X_L = X_C.$$

We proceed as follows:

$$\begin{aligned} R_D &= \frac{X_L^2}{R} \\ &= \frac{2\pi fL \times 2\pi fL}{R} \\ &= \frac{2\pi fL}{2\pi fC \times R} \\ &= \frac{L}{CR}. \end{aligned}$$

When we considered series resonant circuits we saw that the voltage across the inductor or the capacitor was greater than the applied voltage. The ratio between the voltage across the inductor or capacitor and the applied voltage was then described as the magnification factor of the resonant circuit, and it was equal to its Q, or quality factor. In the

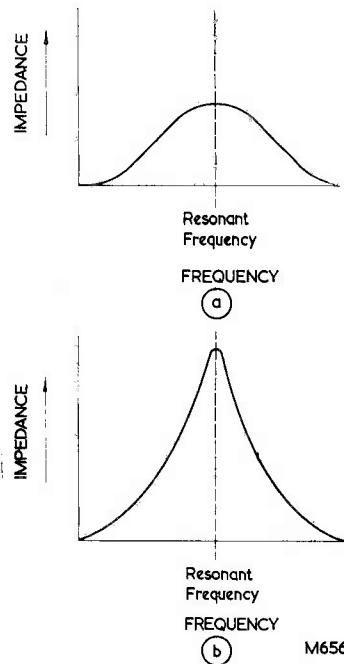

Fig. 108 (a). A broad response curve, as would be given by a parallel resonant circuit having a relatively high value of R
 (b). A sharper response curve, which would result from reducing R

M656

case of the parallel resonant circuit there is no voltage magnification. There is, instead, a *current* magnification effect, and the ratio between the current which circulates between the capacitor and inductor and that obtained from the a.c. generator can be described as the current *magnification factor* of the circuit. This magnification factor is, once more, equal to *quality factor* or Q. As with the

series resonant circuit, Q is equal to $\frac{X_L}{R}$ or $\frac{X_C}{R}$

(where R is assumed to be in series with the inductor, as in Fig. 107 (c)).

It is possible, by combining the equations

$R_D = \frac{L}{CR}$ and $Q = \frac{X_L}{R}$, to express R_D in terms of

Q, C and the resonant frequency.

$$R_D = \frac{L}{CR}$$

therefore $CR_D = \frac{L}{R}$

$$Q = \frac{X_L}{R}$$

$$= \frac{2\pi fL}{R}$$

therefore $\frac{Q}{2\pi f} = \frac{L}{R}$

From 1 and 2,

$$CR_D = \frac{Q}{2\pi f}$$

therefore $R_D = \frac{Q}{2\pi fC}$.

From this last equation, we may see that R_D is directly proportional to Q. When Q increases, so does R_D .

Before concluding on this particular subject, it should be pointed out that we normally assume that the capacitor in the parallel resonant circuit offers very small resistance or "losses".⁶ In consequence, the Q of the resonant circuit depends almost entirely upon the design of the inductor. This is, of course, the same state of affairs as occurs with the series resonant circuit.

Another point which should be mentioned at this stage is concerned with the fact, mentioned earlier in this article, that the resonant frequency of a

parallel circuit is approximately equal to $\frac{1}{2\pi\sqrt{LC}}$

when circuit resistance is low. It may now be added that the errors involved in this approximation are too low to be significant in most practical work provided that the Q of the resonant circuit is equal to 10 or more.

Response Curves

In Fig. 103⁷ we saw two response curves for a series resonant circuit. When the circuit had low resistance, the response curve became sharper.

The same effect is given with a parallel resonant circuit. Fig. 108 (a) illustrates a broad response curve, as would be given by a circuit having a relatively large value of resistance (R in Fig. 107 (c)); whilst Fig. 108 (b) illustrates a sharper response curve, as would result if the resistance in the resonant circuit were reduced. Reducing resistance is equivalent to increasing Q (or increasing dynamic resistance), with the result that the resonant circuit giving the curve of Fig. 108 (b) can be assumed to have a higher Q than that giving the curve of Fig. 108 (a).

It will be noted that the vertical axes of the

⁶ Provided that a capacitor type suitable for the resonant frequency is employed.

⁷ Published in last month's issue.

graphs of Fig. 108 are calibrated in terms of impedance, and that the resonant circuit with the higher Q offers a higher relative impedance at the resonant frequency. This is to be expected, since this impedance will be equal to the dynamic resistance of the circuit.

L/C Ratio in Parallel Circuits

When we discussed the series resonant circuit last month we saw that, in general, a circuit having a high L/C ratio can be assumed to have a sharper response curve than a similar circuit having a low L/C ratio. The same effect is true with parallel

resonant circuits. It is obvious, from $R_D = \frac{L}{CR}$,

that dynamic resistance (and hence Q) increases with L/C ratio.

Terminology and Applications

We have covered rather a large amount of detailed ground with respect to resonant circuits. Some readers may have found the basic theory fairly difficult to follow, since quantities and effects are described which are quite some way removed from those encountered in normal practical work. We have now, however, completed our examination of this aspect of radio and will, next month, revert to matters which are perhaps more easy to understand.

It would be helpful at this stage to briefly sum up the more important points we have found out about resonant circuits, and to introduce a few facts concerning terminology and applications.

When a capacitor and inductor are connected in series, they form a series resonant circuit in which

$$f_r = \frac{1}{2\pi\sqrt{LC}}$$

At resonance the circuit offers minimum impedance, and this is equal to the unavoidable resistance in the series combination of components.

When a capacitor and inductor are connected in parallel, they form a parallel resonant circuit in which it can be assumed, with a low margin of error, that

$$f_r = \frac{1}{2\pi\sqrt{LC}}$$

This equation is sufficiently accurate for practical purposes when the Q of the resonant circuit is greater than 10 (as is normally the case in radio applications). At resonance the circuit offers maximum impedance, and this is equal to its dynamic resistance. The dynamic resistance is an imaginary quantity, and is related to the circuit

resistance by $R_D = \frac{L}{CR}$.

The sharpness of the response curve given by

either series or parallel resonant circuits increases with Q. It can be assumed that "losses" in the capacitor are very low, whereupon the Q of the tuned circuit is only very slightly lower than the Q of the inductor on its own. In both types of

resonant circuit, Q is equal to $\frac{X_L}{R}$ or $\frac{X_C}{R}$.

We may now turn to some details of terminology. Resonant circuits, whether series or parallel, are also called *tuned circuits*. Tuned circuits are described as being resonant at a certain frequency, or as being *tuned* to that frequency.

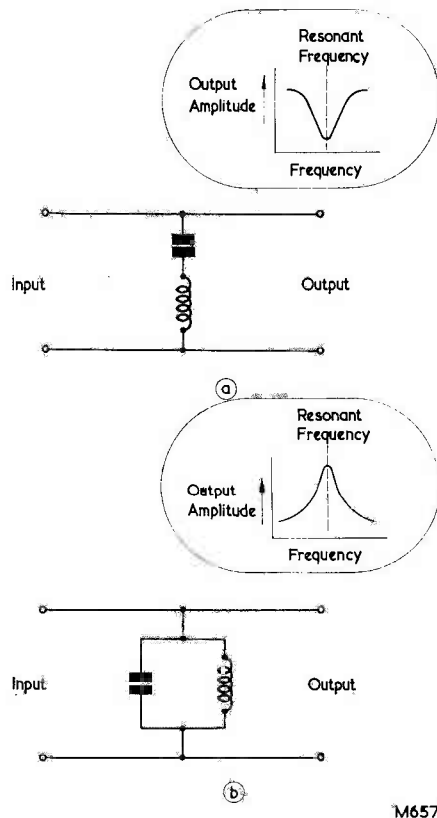

Fig. 109. (a) Illustrating the effect of a series resonant circuit
(b). The result given with a parallel resonant circuit

Because a series resonant circuit offers lowest impedance at the resonant frequency, it may also be called an *acceptor circuit*. This is because it "accepts" the resonant frequency in preference to others. The parallel resonant circuit offers highest impedance at resonance, and is, in consequence, also referred to as a *rejector circuit*. This is because it "rejects" the resonant frequency to a greater extent than other frequencies.

A term which is frequently used to qualify the sharpness of the response curve given by a resonant circuit is *selectivity*. A resonant circuit having a sharp response curve has greater selectivity, or is more *selective*, than a circuit having a broader response curve. Selectivity may be expressed in terms of the frequency spacing on either side of the resonant frequency at which the response curve falls to a certain fraction of its maximum amplitude.

Resonant circuits have very many applications in radio work, and two simplified examples may help to introduce these. In Fig. 109 (a) we have a series resonant circuit connected between two wires coupling one circuit to another. If a large number

of frequencies are present at the input terminals, the series resonant circuit will offer minimum impedance to that at its resonant frequency. In consequence, the resonant frequency will be that which is most heavily attenuated (that is, made smaller) at the output terminals. In Fig. 109 (b), the series circuit is replaced by a parallel resonant circuit. This offers maximum impedance at resonant frequency, whereupon the latter will have maximum amplitude at the output terminals.

Next Month

In next month's article we shall deal with the practical design of resonant circuits intended for use at the frequencies encountered in radio work.

SIMPLE EXTENDING AERIAL FOR THE SHORT WAVE BANDS

By B. W. HOLLINSHEAD

REQUIRING A SIMPLE EXTENDING AERIAL FOR USE in conjunction with a portable short wave receiver, and finding the cost of a commercial aerial of the telescopic variety prohibitive, the writer set about making one from materials available. This aerial is described in the following paragraphs for the benefit of constructors who would like to make a similar item for themselves.

Although, obviously, performance cannot be expected to be comparable with that given by an aerial designed for a particular waveband or receiver, surprisingly good results are nevertheless obtained. Also, there are several commercial receivers designed for use with similar aeri-als. In spite of being constructed for short wave operation, the aerial should prove suitable for long or medium wave receivers as well. The cost of the finished aerial should not exceed three shillings and this makes it a worthwhile proposition.

Main Parts

The basis of the aerial is the top section of an ex-Government whip aerial of the type used on tanks. These are generally available from shops dealing in surplus equipment, that purchased by the writer, at a cost of threepence, being approximately four feet in length. This tapered from approximately $\frac{1}{4}$ in at the top to $\frac{3}{16}$ in at the lower end.

On purchase, the writer's aerial was somewhat rusty although it had originally been painted.

Before commencing work, all paint and rust were removed with emery cloth. This will leave the rod ready for the necessary soldering operations which have to be carried out, and will also leave a suitable surface for finishing to the constructor's individual taste.

Three feet six inches was decided upon as a suitable length for the finished aerial, and this was measured from the thin end of the rod and cut with a hacksaw. As it was necessary that the aerial should be collapsible, it was cut into three pieces, each being 14 in in length. (See Fig. 1.) The ends of these pieces were cleaned up with a file and all burrs removed.

Some tinplate was next obtained from a suitable source. Only a small amount is required and a strip $1\frac{1}{4}$ in wide and about $2\frac{1}{2}$ in in length will be sufficient. From this tinplate, two ferrules are made as shown in Fig. 2, in order that the aerial may be assembled in a manner similar to a fishing rod. These two ferrules are formed by bending the strip tightly around the end of the wider section, care being taken to ensure a tight fit. Before soldering, the ends of the sections which take the ferrules must be thoroughly cleaned and tinned for

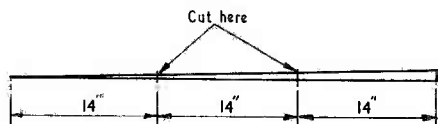

E258

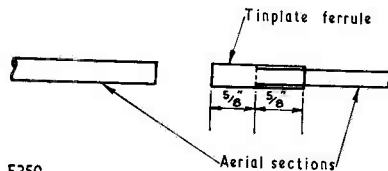

E259

approximately $\frac{3}{4}$ in. Tinning may be achieved either with a fairly large soldering iron or over a gas flame. The ferrules are then placed in their positions on the two sections concerned and carefully sweated on. If necessary they may be temporarily bound during soldering by using thin iron wire, this being removed when soldering is completed. The writer used resin cored solder for all joints and this proved perfectly satisfactory.

Aerial Plug

It is necessary that the receiver be fitted with a coaxial socket in order to take the aerial. Many short wave sets are fitted with such a socket but, if not, it is quite easy to fit one in a suitable position. As only the centre contact is used the socket need not necessarily be bolted to a metal part of the receiver.

A coaxial plug is obtained and taken apart. The centre pin is removed by gently heating with a soldering iron until the pin can be eased out of its polythene insert with a pair of pliers. Care should be taken over this operation to avoid undue damage to the insert, which has to be used again.¹

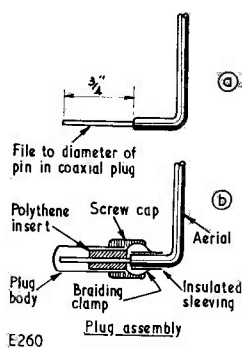

¹ As may be gathered, the procedure needed for securing the aerial to the coaxial plug may vary if a plug having a different construction to that employed by the writer is used. It should, however, be possible to adapt most available types so that the centre pin can be replaced by the end of the aerial in a manner generally similar to that described here.—*Editor.*



The bottom section of the aerial is clamped in a vice and, with a file, a length of $\frac{3}{4}$ in is reduced to the diameter of the centre pin of the coaxial plug. (See Fig. 3 (a).) This must be done accurately in order to ensure a good fit with the centre contact in the socket. If the socket is fitted to the side or rear of the receiver chassis or cabinet, the bottom of the rod will have to be heated and bent at right angles to ensure that the rod is in a vertical position when in place. If the socket is fitted to the top of the chassis or cabinet this operation will not be necessary. The end of the aerial is next heated as required, passed through the polythene insert of the plug, and allowed to cool. After this the plug can be re-assembled. It will be necessary to fit a short length of insulated sleeving over that part of the aerial which will be beneath the braiding clamp of the plug. When the whole assembly is screwed up tight a rigid fixture will result, as shown in Fig. 3 (b).

Finally, two small Terry clips can be fitted to a convenient part of the receiver case to hold the aerial section when not in use. The whole assembly can be given a coat of aluminium paint and the result will be a neat and efficient aerial at a fraction of the cost of a commercially made equivalent.

G.E.C. Travelling Wave Tubes for Satellite Communication

With the successful launching of the communication satellite "Relay", G.E.C. travelling wave tubes, manufactured by the M-O Valve Co. Ltd., are again providing a vital link to the high power transmitter at Goonhilly Downs.

"Relay", a project of the National Aeronautics and Space Administration, is designed to develop and test a wide-band communications satellite capable of relaying signals of television bandwidth on an inter-continental basis.

The G.E.C. TWS10 travelling wave tube is employed as a single stage amplifier supplying the 10kW multi-cavity klystron amplifier at 1,725 Mc/s.

In the recent "Telstar" experiments, the G.E.C. TWC5 travelling wave tube was used to drive the 5kW travelling wave tube, developed by the Services Electronics Research Laboratory, at 6,390 Mc/s.

IN YOUR WORKSHOP

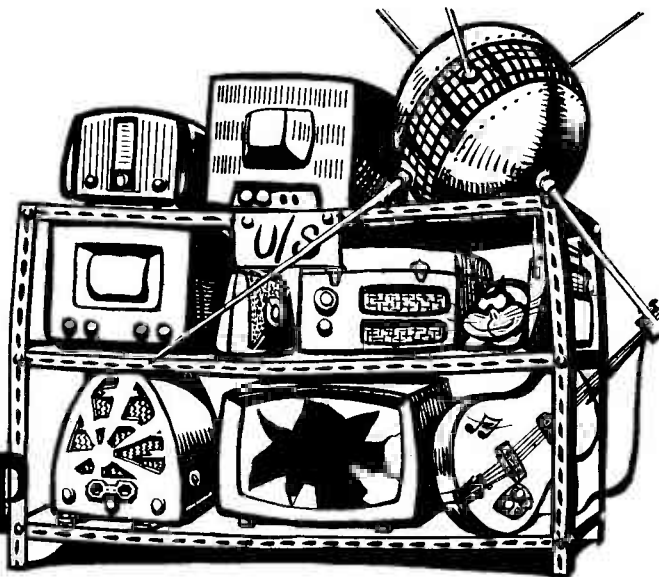

This month Smithy the Serviceman, aided as always by his able assistant Dick, makes a detailed examination of switchable 405/625 line television receivers

"ANOTHER THING I CAN'T UNDERSTAND," said Dick aggressively, "is how the District Attorney in 'Perry Mason' holds his job down. He's never won a case yet!"

Smithy the Serviceman sighed.

"I can only repeat," he remarked resignedly, "that when I asked you what it was that you didn't understand, I meant in the *technical* sense."

But Dick ignored the Serviceman's protest.

"There's another thing," he continued aggrievedly. "Why was Bill Bailey put out with nothing but a fine tooth comb? Why, of all things, a fine tooth comb? Do you know, Smithy, trustful lads such as myself could develop psychoses over unexplained things like that."

"I must admit," confessed Smithy, "that that fine tooth comb business has worried me quite a bit, too. Perhaps," he added helpfully, "Bill Bailey was combing the dog just before he was put out."

"If that's the case," replied Dick indignantly, "they should *say* so. I think it's shocking, leaving things up in the air like that!"

Switchable Receivers

"Anyway," said Smithy, abruptly dismissing Bill Bailey from the

conversation. "I'm quite certain you didn't call me over just to complain about things like that. What *did* you want?"

With an effort, Dick brought himself back to his immediate surroundings.

"It's this telly I've got on the bench," he grumbled. "It gives a perfectly good picture but the sound is rather weak. I got the service manual out to have a shufti at the sound i.f. amplifier circuit, but it seemed so complicated that I thought I'd call you over and ask you to explain it to me."

"Fair enough," said Smithy, examining with interest the chassis on Dick's bench. "For once, too, I shan't grumble at being dragged away from my work. We've got a switchable 405/625 line receiver here, and I'm very keen on getting in a bit of practical experience on sets of this nature."

Smithy drew up a stool and sat alongside Dick. He opened the service manual for the receiver at the circuit diagram and laid it out flat on the bench.

"We will probably find," he remarked to Dick, "that, as the months and years go by, switchable 405/625 line receivers will vary quite a bit in basic design. Also, different

manufacturers will tackle the switching problem in different manners. However, what I'm going to concern myself with now is receivers similar to that we have in front of us. We will then deal with the points which are typical of other receivers employing the same basic ideas for 405/625 line switching. Got the idea?"

"Yes, certainly."

"Right," said Smithy. "Having said that, let's take a butcher's at the way in which the sound i.f. problem is handled in switchable receivers of the general class we have here. Now, with a normal 405 line receiver the sound i.f. appears as an amplitude modulated signal at 38.15 Mc/s, and we can tap it off immediately after the tuner unit or after a common vision and sound i.f. amplifier stage. When we come to consider 625 lines, however, the situation is quite different. Tost art off with, the sound i.f. is frequency modulated. This frequency modulated signal *could* be tapped off immediately after the tuner or after a common vision and sound i.f. amplifier, but this isn't done in practical 625 line sets such as you have on the Continent or in Australia. Instead, the sound is taken off as an inter-carrier frequency at some point after the vision detector."

"I know all about that," broke in Dick. "The intercarrier frequency is given by the beat between the vision and sound i.f.'s, and it is both amplitude modulated by the video signal and frequency modulated by the sound signal. You limit out the amplitude modulation in an amplifier tuned to the intercarrier frequency, after which you apply it to an f.m. discriminator which gives you audio in the normal way."

"Excellent," commented Smyth approvingly. "You're right on the ball! We must next remember that, in the British 625 line system, the spacing between unmodulated sound and vision carriers in any channel is 6 Mc/s. So the intercarrier signal appearing at the vision detector has a frequency of 6 Mc/s, and this is the frequency to which the intercarrier amplifier must be tuned."

"I follow," commented Dick. "I suppose that 6 Mc/s is going to be a frequency which will stick in our minds just as indelibly as other frequencies have in the past. Like, for instance, 465 kc/s or thereabouts as the i.f. for a.m. sets, 10.7 Mc/s for f.m. sets, and 38.15 Mc/s for 405 line TV sound i.f. strips."

"You're right there," chuckled Smyth. "This time next year we'll be talking about 'six meg amplifiers' as though they'd been in existence all our lives!"

Vision Detector Switching

The Serviceman paused for a moment and examined more closely the circuit laid out on the bench.

"This particular type of set," he continued, "will, I think, be typical of many switchable receivers, and it employs intercarrier amplification at 6 Mc/s. Furthermore, the same valves which amplify at 38.15 Mc/s for 405 line sound also amplify at 6 Mc/s for 625 line sound."

"I told you," said Dick triumphantly, "that the sound circuit was complicated!"

"Not at all," protested Smyth. "When you take things stage by stage, the sound circuit is quite straightforward. However, before we start on the sound amplifier itself, let's first look at the intercarrier sound take-off point. Where will that be?"

"After the vision detector," replied Dick promptly. "As you said just now."

"And what else, peculiar to 405/625 line sets," queried Smyth, "will the vision detector have to do?"

"It will have to reverse the polarity of the detected signal for the different systems," said Dick with

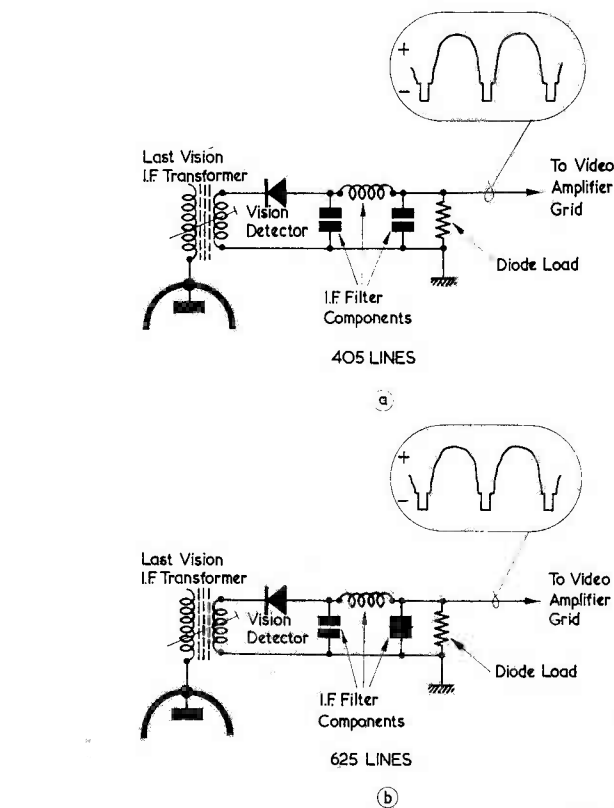

Fig. 1. Detection of 405 and 625 line signals in a single receiver could be catered for by reversing the vision detector diode, as shown here

equal promptness. "Because the 405 line vision i.f. is positive modulated and the 625 line vision i.f. is negative modulated."

Smyth looked impressed. "You are bright today," he commented.

"I'm always like this," replied Dick. "I'm a real gone kiddy, you know!"

"Then I must take advantage of the situation," said Smyth, "and ask you yet another question. What's the simplest way of reversing the polarity of the detected vision i.f.?"

"That's easy," said Dick, drawing a notebook towards him, "all you have to do is to arrange the 405/625 switching so that, for 405 lines, the detector diode is connected one way round (Fig. 1 (a)) and, for 625 lines, it is connected the other way round." (Fig. 1 (b).)

"At first sight you're perfectly right," said Smyth, looking at Dick's scribbled circuits, "but there is one big snag to reversing the diode like that."

"What's that?" asked Dick, suspiciously.

"The snag," said Smyth, "is that the vision detector rectifies a signal which has a proportionately high amplitude, with the result that a lot of the detected signal is of the nature of a quite large square wave. In consequence, the video detector circuit can radiate a lot of harmonics back into the early stages of the receiver unless it is fully screened. It is due to this fact that the video detector circuit is usually bottled up tightly in the same can as the last vision i.f. transformer. Because of the screening, you couldn't add switching to reverse the diode, because the switch leads would then have to leave the can and you'd be back with the radiation problem again."

"What's the solution?" "There are several solutions," replied Smyth, "of which one of the most obvious consists of reversing the detected signal after it leaves the can. As is done with sets like that we're examining here. (Fig. 2.) As

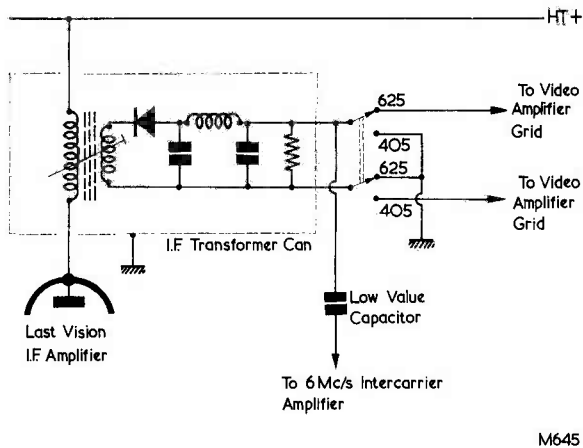

Fig. 2. This simplified circuit shows how the polarity of the detected vision i.f. may be reversed in a practical receiver. The low value capacitor provides 6 Mc/s intercarrier take-off when 625 lines is selected. The two-pole two-way switch is part of the main 405/625 switch

you can see from the circuit, the vision detector, together with its i.f. bypass components, are all kept safely inside the can, and it is only pure and unadulterated video which eventually finds its way into the outside world. It is *then* that we do the switching. A two-pole two-way switch, which is part of the main 405/625 switch, is quite adequate for the job. When it's in the 405 lines position the upper end of the detected video connects to chassis, and the lower end connects to the grid of the video amplifier. With the diode connected as shown, this means that positive-going 405 line video is applied to the grid of the video amplifier. If we put the switch in the 625 lines position, the lower end of the detected video connects to chassis and the upper end goes to the video amplifier grid, which now receives 625 line video that is positive-going as before."

"That's neat," commented Dick approvingly. "With this arrangement, you can have all the switching outside the can."

Smithy nodded.

"A further point," he continued, "is that there's a low-value capacitor hung on the upper detected video terminal. On 405 lines the upper plate of this capacitor is earthed to chassis, but on 625 lines it receives the full video signal. This capacitor is used to couple the 6 Mc/s intercarrier signal to the sound amplifier section; and it is important to note that it can only carry this signal, or any other signal for that matter, when the set is switched to 625 lines.

On 405 lines it is well and truly earthed."

Tuner Output Switching

"Blow me!" exclaimed Dick. "I hadn't realised that the circuit worked as simply as that. It's really amazing what you can do with a few simple switches!"

Smithy made a gesture reminiscent of one who draws his cloak about him.

"Now that I have awakened a sense of wonder in your mind," he said in a sepulchral tone, "I shall carry on to reveal even greater mysteries. Let us next, therefore, turn our

attention to what happens immediately after the tuner units."

"Units?"

"Units," confirmed Smithy gravely. "Sets of this nature require a v.h.f. tuner, which covers Bands I and III, and a u.h.f. tuner, which covers Bands IV and V. Even if the u.h.f. tuner isn't fitted, the receiver chassis will still have terminal points available to allow it to be connected in at a later date. Both the tuner units give an output at i.f., and so the switching required at these outputs can be fairly simple. (Fig. 3.) If you look at the circuit you'll see that, on 405 lines, the output of the v.h.f. tuner connects to a coupling coil and, thence, to a filter. After passing through the filter it is applied to the first vision i.f. transformer in the receiver. Enough i.f. current passes through the coupling coil to enable a tuned circuit, resonant at 38.15 Mc/s, to pick off the 405 line sound i.f. and pass it on to a 38.15 Mc/s amplifier. O.K.?"

"O.K."

"Let's next," said Smithy, "move on to what happens when we switch over to 625 lines. The first thing that we then see is that the h.t. supply to the v.h.f. tuner is broken, and that h.t. is now fed to the u.h.f. tuner. At the same time, the i.f. output from the u.h.f. tuner passes through another filter and then arrives at the first vision i.f. transformer. I don't think we want to go any further into the switching circuit at this point of the proceedings other than to recap on what we have seen up to date. When we're on 405 lines, the v.h.f. tuner receives h.t., and its output couples to a tuned circuit resonant at 38.15 Mc/s. It then passes

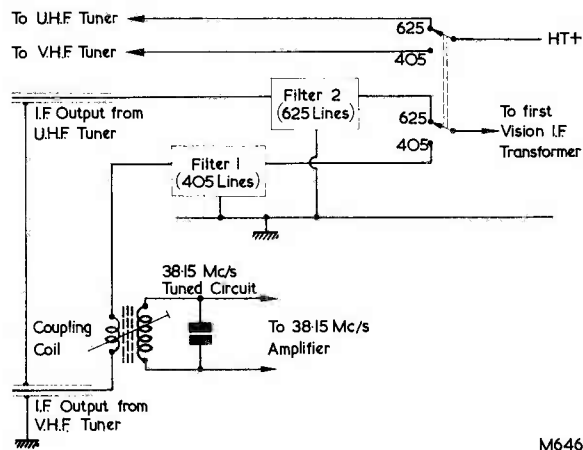

Fig. 3. Typical 405/625 switching at the outputs of the v.h.f. and u.h.f. tuners

through a filter before reaching the first vision i.f. transformer. When we're on 625 lines, the v.h.f. tuner loses its h.t. supply, and the output of the u.h.f. tuner passes through a second filter before reaching the first vision i.f. transformer. I should add that the switches employed are, once again, part of the main 405/625 switch."

"I am with you," said Dick, "all the way!"

"Right," said Smithy. "Now, there's one incidental little point in our circuit which is worth bringing to attention before we proceed further. As we've just mentioned, the 405 line intermediate frequency passes through one filter and the 625 line intermediate frequency passes through another. These filters contain one or more tuned circuits and they can, in consequence, change the overall response of the whole vision i.f. amplifier so that it meets either 405 line requirements."

"Blimey," ejaculated Dick, impressed. "That's a neat way of doing things, isn't it?"

The Sound Amplifier Section

"It is, indeed," agreed Smithy. "But we must now press on to the section of the receiver which started our present discussion. This is the sound amplifier section which handles both the 6 Mc/s intercarrier signal from the vision detector on 625 lines, and the 38.15 Mc/s signal given immediately after the tuner unit on 405 lines."

"There must be some very complicated switching in that amplifier section," declared Dick. "It's got to handle one signal which is a.m. and another which is f.m.!"

"I know it has," said Smithy. "In practice, though, the switching required is very simple. If you look at the circuit you will, in fact, find that only two switches are needed."

Smithy paused for a moment, and smoothed out the circuit diagram around the intercarrier and sound i.f. amplifier. (Fig. 4.)

"The first thing to remember," he continued, "is that, when we're on 405 lines, the 6 Mc/s intercarrier coupling from the vision detector is shorted down to chassis. The second thing is that, on 625 lines, the 38.15 Mc/s i.f. output disappears, because the v.h.f. tuner has no h.t. In consequence, the sound amplifier section can have two sets of tuned circuits in series in each grid or anode stage, one tuned to 38.15 Mc/s and the other tuned to 6 Mc/s. This is the same technique as you have with a.m./f.m. sound receivers, in which an i.f. transformer tuned to 465 kc/s

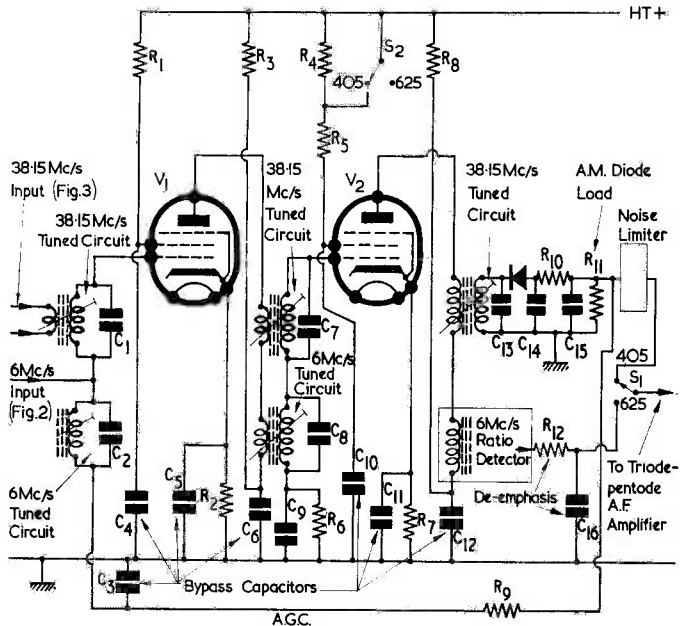

M647

Fig. 4. A simplified circuit illustrating the more important points of a sound amplifier capable of handling 38.15 Mc/s i.f. signals and 6 Mc/s intercarrier signals. Component values are those commonly encountered around r.f. pentodes. When S_2 is set to 625 lines, the total resistance in series with the screen-grid of V_2 increases by a large amount, allowing this valve to function as a limiter. S_1 and S_2 are sections of the main 405/625 switch

is connected in series with another tuned to 10.7 Mc/s. You'll find the same idea also in television receivers which tune the f.m. band, only in that instance you have 10.7 Mc/s tuned circuits in series with 38.15 Mc/s circuits. In the present case, both the 6 Mc/s and the 38.15 Mc/s tuned circuits are permanently connected without switching, because the amplifier only gets the 6 Mc/s signal when the set is switched to 625 lines, and it only gets the 38.15 Mc/s when the set is switched to 405 lines."

"Well, that's a turn-up for the book," said Dick, impressed once more. "I suppose you could say that the few turns of wire you need for a 38.15 Mc/s coil look like a dead short so far as the 6 Mc/s tuned circuit is concerned. And that the fairly large parallel capacitor across the 6 Mc/s coil is pretty well a dead short at 38.15 Mc/s."

"I think," said Smithy judiciously, "that that is rather an over-simplification, although looking upon the tuned circuits in that manner may help you to more easily visualise their operation at first sight. In

practice, one tuned circuit is bound to have an effect upon the other in series with it, and they would both have to be very carefully designed to ensure that the desired response curve was obtained."

Smithy scribbled on Dick's notebook. (Fig. 5.)

"This response curve would," he added, "look something like that I've sketched here."

"This is all very interesting," said Dick. "You can practically look upon the amplifier as having two 'gateways', one at 6 Mc/s and one at 38.15 Mc/s. A signal can go in at either 'gateway' and it will come out amplified at the end."

"You've got it," said Smithy. "Now, at the end of the amplifier you have to separate the signals again. This is done very simply by connecting a 38.15 Mc/s a.m. detector tuned circuit coupling winding in series with the primary of a 6 Mc/s f.m. ratio transformer. The a.m. detector circuit demodulates the 38.15 Mc/s i.f. in conventional manner, and the detected a.f. appears across the a.m. diode load. The a.m. detector coupling winding

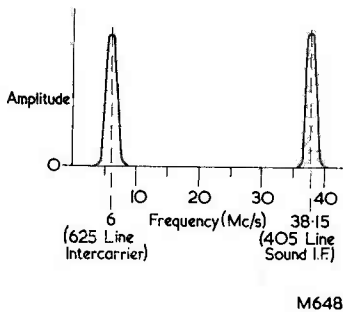

Fig. 5. Typical frequency response for the amplifier of Fig. 4

is in series with the primary of the 6 Mc/s f.m. ratio detector transformer and, at this frequency, f.m. demodulation occurs in the normal fashion. The a.f. from the ratio detector then passes through a conventional de-emphasis circuit."

"Ah," said Dick, stabbing his finger at the circuit, "that's where one of your switches comes in!"

"That's right," said Smithy. "This is the switch (S₁) immediately preceding the triode-pentode a.f. amplifier—which is quite conventional, by the way—and, on 405 lines, it switches the amplifier to the a.m. detector output whilst, on 625 lines, it switches the amplifier to the ratio detector output."

"There are," said Dick, frowning, "a few other gubbins between the a.m. detector and the switch."

"Nothing out of the way," replied Smithy, off-handedly. "First of all, an a.g.c. voltage is taken from the a.m. detector diode load and is passed back to the first amplifier valve in the section. Which is quite a conventional thing to do. And there is also a common-or-garden noise limiter diode circuit as well."

Limiting

Dick scratched his head and looked puzzled.

"Why is the noise limiter only put in," he asked, "in the a.m. detector circuit?"

"Because," explained Smithy, "you don't need it with the intercarrier f.m. signal. All a.m. in the latter is limited out, partly by the ratio detector, and partly by the pentode amplifier (V₂) which immediately precedes it."

"But," protested Dick, "that pentode *can't* be a limiter, or it would mess up the a.m. signal as well!"

"Yes it can," grinned Smithy. "If you look a little more closely, you will see that a second switch (S₂)

inserts a crafty bit of high resistance (R₄) in series with the screen-grid when you turn over to 625 lines. This extra resistance causes the screen-grid voltage to drop to a very small value, with the result that the valve cuts off at a low negative grid bias and works, therefore, as a limiter. Neat, isn't it?"

"I'll say," agreed Dick. "Incidentally, a limiter needs a grid capacitor and leak. Would those be given by the resistor and capacitor at the bottom of the two tuned circuits?"

Dick indicated the components (R₆, C₉) on the diagram.

"That's right," said Smithy. "These don't have any effect on the a.m. signal because, on 405 lines, the pentode has a higher cathode bias, so that positive signal tips don't get rectified."

Dick examined the circuit again. "There is," he remarked after a moment, "no a.g.c. voltage offered by the ratio detector."

"You don't need it," pronounced Smithy. "The intercarrier signal will be at fairly constant amplitude for different signal strengths at the aerial, because of the a.g.c. in the vision i.f. strip. So there's no need for a.g.c. in the sound amplifier at 6 Mc/s. In any case, the process of limiting out a.m. will also limit out any small changes in intercarrier signal level which may occur in practice."

"Provided," interposed Dick, "that the intercarrier signal is always at least equal to, if not greater than, limiting amplitude."

"That goes without saying," replied Smithy. "But, then, the receiver design will automatically ensure adequate intercarrier signal level for all signals which are strong enough to resolve a decent picture. However, you've raised rather an interesting point there."

"Oh, yes," said Dick. "What's that?"

"It's the importance," said Smithy, "of ensuring that the receiver fine tuner is correctly positioned when you're receiving a 625 line programme. With 405 lines, the correct position is often indicated by maximum volume from the relatively sharply tuned 38.15 Mc/s sound i.f. amplifier, and this effect is very helpful when non-technical people attempt to set up the fine tuning control. With 625 lines, though, the intercarrier frequency is *always* 6 Mc/s whatever the setting of the fine tuner, and there is no audible aid to setting up this control. There is, however, the fact that, if the fine tuner is badly adjusted, the sound i.f. from the tuner may be applied

very low down the vision amplifier response curve. (Fig. 6.) The result will be a very weak intercarrier signal which is too low in amplitude to be limited. This will then cause the sound from the speaker to be modulated by a heavy field buzz."

"That's an interesting effect," commented Dick. "It's something we'll get used to in time, I suppose."

"I should think so," agreed Smithy. "I can't predict how serious the effect will be in British receivers, as it depends upon how much gain the manufacturers apply to the intercarrier signal before it's limited. If there is enough gain, the effect may be outside the range of the fine tuner."

A Repair

Smithy paused for a moment. "I think," he said, "that that's enough nattering for now. Let's get down to the snag which you called me over for."

"As you like," said Dick equably. He switched on the chassis, which soon displayed an acceptable picture. He then demonstrated the fact that the sound level from the speaker was noticeably weaker than would normally be expected. Smithy listened critically.

"There's no noticeable distortion on the sound," he remarked, after a moment, "and it is, in consequence, quite possible that we're losing some gain before the detector. Have you tried the bottles?"

"First thing I did," replied Dick. "I've checked the two r.f. pentodes

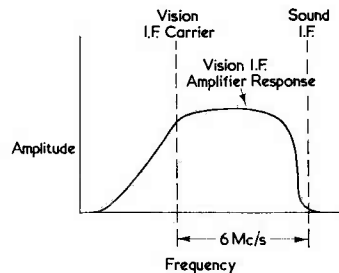

Fig. 6. An incorrect setting of the fine tuner on a 625 line receiver can cause the sound i.f. to appear very low down the vision i.f. amplifier response curve. In this diagram, the vision i.f. carrier and sound i.f. are shown displaced to the right because of the incorrect setting. The resulting low-level intercarrier signal may be too small in amplitude for effective limiting

in the sound amplifier and the triode-pentode a.f. amplifier. They're all O.K."

"Fair enough," said Smithy, picking up Dick's test prods. "As you've got the chassis out, a few voltage measurements would not be out of place. Let's start off with the second pentode, the one which doubles as a limiter on 625 lines."

Smithy applied his prods to the chassis.

"I'm on the cathode now," he announced. "What's the meter say, Dick?"

"Less than a volt," replied Dick, looking closely at the scale.

"That seems low," grunted Smithy, setting the testmeter to a higher voltage range and re-applying the test prods. "What am I getting now?"

"The meter's reading 20 volts," said Dick.

"That *is* low," stated Smithy. "I'm checking screen-grid voltage this time, and it sounds to me as though this pentode is trying to act as a limiter before its time!"

He switched off the receiver and took a few resistance measurements.

"Here we are," he pronounced, after a minute, "it's the 405/625 switch contacts. The pair that should short out the extra screen-grid resistor (R₄ in Fig. 4) just ain't doing so!"

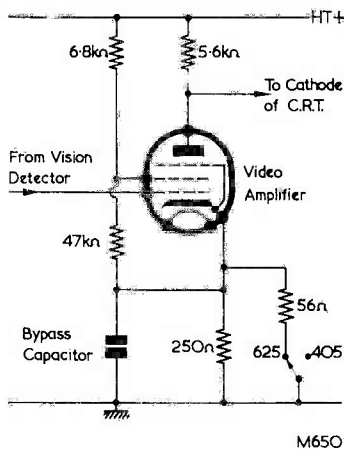

Fig. 7. For 625 line reception it is necessary to reduce the cathode bias for the video amplifier, and this may be effected with the simple switching circuit illustrated here. 3.5 and 6 Mc/s filters, and peaking chokes, may also appear in the video amplifier stage, but these are omitted here for clarity. The resistor values given are representative of current practice

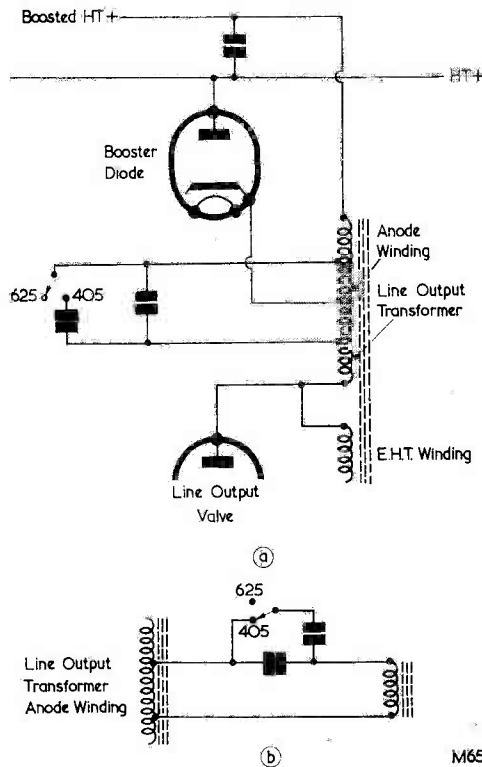

Fig. 8 (a). In some receivers, a single line output transformer may cater for both 405 and 625 line systems by incorporating a switch which reduces capacitance across part of the anode winding when 625 lines is selected (b). Similarly, capacitance in series with the line deflector coils may be reduced when switching over to 625 lines

"That snag shouldn't take a moment to fix," said Dick. "I'll clean those contacts up in a jiffy."

"As you like," commented Smithy. "If the contacts have got the requisite amount of springiness, they will probably work O.K. if you operate the whole switch once or twice. They've probably just got a bit of oxide on them which the self-cleaning action of the switch will automatically clear."

It did not take Dick long to carry out Smithy's instructions, and the fault cleared after he had operated the 405/625 switch several times. Dick's face took on an expression of disgust as he switched the receiver on again and listened to the sound, which was now restored to its full level.

"What are you looking so cheered off about?" asked Smithy.

"I'm annoyed with myself," announced Dick. "If I'd had enough savvy to waggle that switch in the first place I'd have cleared the fault and wouldn't have to call you over!"

"Not to worry," soothed Smithy. "I must admit that whilst I normally hate spending a lot of time in chasing a simple fault, the present case is an exception. Indeed, I've had quite an interesting time gaining a bit of practical experience with one of these new sets. Don't forget that, in a few years' time, a very high proportion of the receivers we handle will be of the 405/625 line type!"

Other Changes

Dick grinned confidently. "I'm not too worried," he pronounced. "After we've got ourselves fully experienced with 405/625 sets, things will be a piece of cake when the 625-only receivers start coming through!"

"Don't you believe it," chuckled Smithy. "By that time we'll have graduated to colour sets."

Dick's expression of confidence departed immediately.

"I do wish," he grumbled, "you wouldn't keep on about colour sets."

I can cope with 625 lines, but this colour business scares me!"

"Nonsense," snorted Smithy. "Colour television is just the same as anything else. You've just got to tackle the theory first of all, and then get in a bit of practice. It's the same with any equipment that's new and unfamiliar. Once you've got over the initial hurdle of getting acquainted with it, you're in the straight from then on."

"I hope you're right," said Dick, lugubriously. "Anyway, let's forget about the awful future and concentrate on the present. What other circuits are altered in switchable 405/625 line sets?"

Smithy pondered for a moment. "The main circuits," he replied eventually, "are the video amplifier and the line time-base. As I told you some months ago,* the video amplifier needs a lower cathode bias for 625 lines than it does on 405 lines. You may, therefore, find that a section of the main 405/625 switch reduces the value of the cathode bias resistor when you go over to 625 lines. (Fig. 7.) On 405 lines it may be necessary to insert a 3.5 Mc/s filter in the video amplifier circuit to keep the sound i.f. beat out of the video applied to the c.r.t. A similar sort of filter tuned to 6 Mc/s will be needed for 625 lines. These filter circuits may also be controlled by the 405/625 switch contacts.

"What is probably," continued Smithy, "the most complicated switching occurs in the line timebase. I wouldn't like to generalise about the line oscillator at this stage, apart from saying that some sort of switching circuit will be used to

increase its speed when going over to 625 lines. A common line output transformer is required in sets of this type, and this may be made to change from 405 to 625 lines by reducing capacitance across part of its anode winding. (Fig. 8 (a).) To give the same line scan on both systems, capacitance in series with the line deflector coils may similarly be reduced when you go on to 625 lines. (Fig. 8 (b).) I think I should add, incidentally, that I'm speaking here in very general terms."

"What about the vertical time-base?"

"There's no need for any circuit changes there," said Smithy shortly. "It runs at 50 fields per second on either system."

"I've heard that some sets," persisted Dick, "make a change to the vertical timebase as well as the line timebase."

Smithy pondered.

"My apologies," he remarked, after a moment. "You *are* right there. You may bump into instances in which the vertical timebase oscillator runs from the boosted h.t. line. This line increases in voltage when you turn over to 625 lines, whereupon a section of the 405/625 switch connected in the h.t. feed to the oscillator will bring the latter back to the same condition again."

With an air of finality, Smithy rose.

"And now," he said, "I must get back to my own work again. Before I finish though, I think I should repeat what I said at the beginning, this being that I have been dealing in general terms with 405/625 line switchable receivers of one particular design. It's very possible that you'll meet quite a few switchable sets

which employ, for instance, quite different sound amplifying techniques from those we've been discussing. Nevertheless, what I've told you should give you a good idea of the problems set manufacturers face, and how some of them, at any rate, are tackling them."

"Righty-ho," said Dick, "and many thanks for the gen. I presume," he added artlessly, "that if we switch a set from 405 to 625 we can say that it's been re-lined!"

"All right, all right," said Smithy hastily, "I'll get back to my own bench now."

But Dick was just warming up.

"And if we switch the set back again," he continued relentlessly, "would it then become underlined? Also, if it used a germanium vision detector would we get 625 crystal-lines?"

An expression of horror spread over Smithy's face as he realised that his assistant was only just beginning to enter the full flush of creation.

"Just listen to this, Smithy," Dick carried on exultantly, breaking out into limerick form:

*"When you fix super-heterodynes
With switches for 625 lines,
The first thing that you
Should remember to do
Is make sure you are on the right
lines!"*

However, that was the last example of Dick's inventiveness for the day. For, as we all know, a budding punster and poet requires an appreciative audience if his skill is to flourish. And not, as occurred with Dick, an audience which gives vent to its Philistine coarseness by cruelly striking the composer behind the ear with a well-aimed 0.1 μ F capacitor. And 750V working at that!

* "In Your Workshop", October 1962.

Community TV Lays Malvern "Ghosts"

Ghost images in the Malverns caused by signal delays in the hilly terrain are only one of the factors contributing to bad television reception for viewers in the area. This outer-fringe location, situated midway between the transmitters at Cardiff and St. Hilary on the one side and Birmingham on the other, has always been too far away from all three to receive strong television signals.

This problem of poor reception has now been solved for the residents of Ledbury by the introduction of a wired television system operated by Ledbury Wired Services Ltd., using wide-band equipment supplied by E.M.I. Electronics Ltd. The system eliminates the ugly maze of individual roof-top aerials by the introduction of E.M.I. community aerial arrays, mounted on a 100ft tower, and E.M.I. head-end and distribution equipment. The aerial arrays are sited a mile outside the town, and amplified signals are relayed along co-axial cable to television receivers in subscribers' homes.

Greatly improved television reception is now available for residents of Ledbury who will be able to receive Welsh and Midland I.T.V. and B.B.C. TV Midland programmes at good strength.

Some wired television systems necessitate the installation of special receivers in subscribers' homes, but with those using E.M.I. equipment ordinary domestic receivers may be used. Extra channels, colour television, pay TV and the 625-line standard can all be received by the system as they are introduced.

E.M.I. were the pioneers of the distribution of television signals by co-axial cable, and the E.M.I. Community Television System has greatly improved reception in many fringe areas, including nearby Ross-on-Wye.

Towns where E.M.I. installations are in use include The Hague, Bedford, Boston, Spalding, Bognor, Wantage, Wellingborough, Luton, Cwmbran, Grimsby, Rothbury, Seaford, Seaton Valley, Bridlington and Newcastle. In many cases, viewers in these areas now enjoy a better picture quality than those considered to be in good reception areas.

Cover Feature

USEFUL PUSH-PULL AUDIO AMPLIFIER

By WALLACE STUDLEY

**A compact and easily built design using
modern triode-pentodes**

THE AVAILABILITY OF THE ECL86 VALVE SIMPLIFIES the construction of a push-pull amplifier capable of delivering some 8W of good quality audio when fed from a crystal pick-up or a superhet tuner.

The benefits derived from the push-pull circuit are well known, and results surpass those obtainable from simpler single-ended stages. Although some 3-4W output is often considered adequate for home use it is generally better to design for considerably more than this so that the amplifier is not, amongst other things, worked too hard into a region of high distortion. This frequently occurs when a single-ended Class A stage is in use and it is not unusual to find the volume control associated with such an amplifier well advanced. This is undesirable.

The amplifier to be described here was built originally for record reproduction purposes and is an economical proposition. Facilities for connecting a tuner are also provided.

It is not considered a "hi-fi" amplifier—using the term in the undebased sense—but it is, nevertheless, surprisingly efficient and very compact, since only two actual valves are required in addition to the rectifier. The chassis dimensions are only 8 x 4 x 2in.

An output socket is provided from which power supplies may be taken to a valve tuner if required. Some 20mA h.t. current is available, this usually being adequate, together with 6.3V at 1A. If this facility is not required—as would occur where the use of a transistorised tuner is envisaged—the socket may be deleted and minor economies effected by selecting a mains transformer of lower h.t. current rating together with a less generous rectifier valve, such as the EZ80.

The Amplifier Circuit

The amplifier circuit is shown in Fig. 1, where it will be seen that of the two triodes available one is used as a pre-amplifier feeding into the second triode, which functions as a phase splitter. Signals opposite in polarity appear at C_{10} and C_{11} , and these are fed to the output pair operated here in true pentode mode as opposed to the ultra-linear form. The latter is frequently encountered nowadays but would demand the use of a specially designed output transformer.

A moderate degree of feedback is applied degeneratively to the input triode at its cathode via R_{21} ; too large an amount is not desirable here.

Above-chassis view of the amplifier

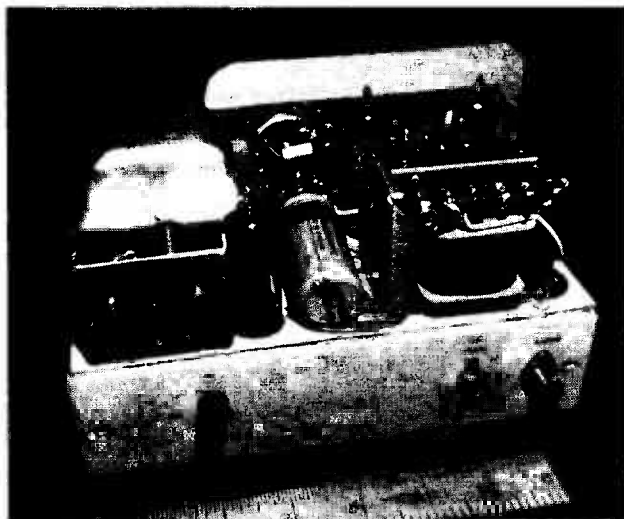

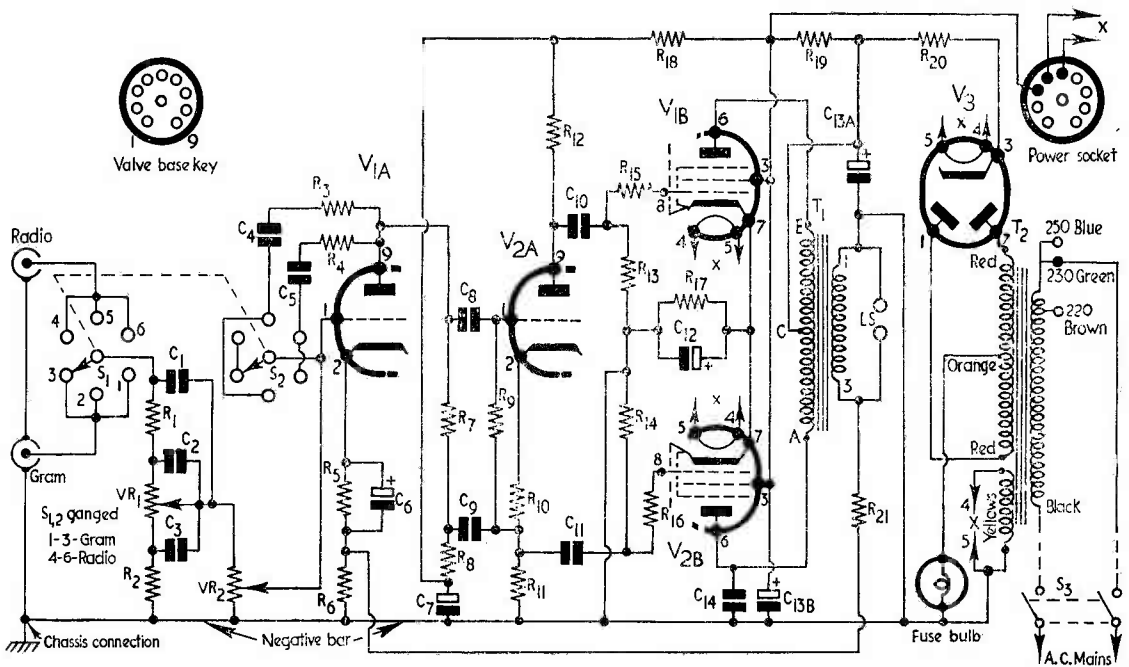

C22

Fig. 1. Circuit of the Useful Push-pull Amplifier

The use of a common cathode bias resistor for the output pair provides a degree of automatic current self-balancing but the pentode sections should not be widely dissimilar in their characteristics; ideally they should be matched despite the fact the parallel ageing may not take place.

The Power Supply

Full-wave rectification is adopted and it may be noted that the pentode anodes are effectively supplied direct from the rectifier cathode, R_{20} merely being a surge limiter. The screen-grids of the pentodes are not fed from this point, however, but via R_{19} and $C_{13}(b)$. This method obviates the need for a smoothing choke and permits the use of a low wattage resistor for R_{19} . The triode stages are further decoupled and there is no mains hum despite the fact that the heater supply is at chassis potential on one side.

The Output Transformer

This is a comparatively inexpensive item rated at 7–10W, and is a multi-ratio type enabling 22 single-ended and 17 push-pull ratios to be obtained. The d.c. rating is 75mA maximum. The particular specimen used in the prototype tended to “buzz” during sustained notes around 100 c/s and less although an improvement resulted when the

laminations were wedged tightly externally. The addition of C_{14} was also found beneficial, but if the amplifier is to be much used at high volume settings with full bass boost a 250V. a.c.w. component is recommended. The value of C_{14} in the prototype was $0.005\mu\text{F}$, but this may be increased to $0.01\mu\text{F}$ if desired. The connections shown for the output transformer assume the use of a 3Ω speaker, but if a 15Ω unit is to be used R_{21} must be changed to $6.8\text{k}\Omega$ and tags 1 and 5 of the transformer used for the speaker connections.

Tone Control

Experience shows that in any unit designed for general home use the inclusion of a complex array of control knobs is undesirable, for it is not unusual to find the “Treble” and “Bass” controls being turned unwittingly by unskilled users to alter volume—even when clearly labelled. Here only three controls are fitted, VR_1 being used for “Bass” and VR_2 for “Volume”. The third control performs a dual purpose in that it not only changes over the two inputs but also acts as a “Treble” switch.

Of the six positions available on the switch two are probably the most likely to be used, viz., positions 3 and 4. In position 3 the “Gram” input socket is connected, whilst moving the switch one point to the right connects the “Radio” socket. If

Components List

Resistors ($\frac{1}{2}$ W, 10% or as stated)

R ₁	270k Ω
R ₂	47k Ω
R ₃	680k Ω
R ₄	1M Ω
R ₅	3.9k Ω
R ₆	100 Ω
R ₇	220k Ω 5% H.S.
R ₈	39k Ω 5% H.S.
R ₉	470k Ω 5% H.S.
R ₁₀	2.2k Ω 5% H.S.
R ₁₁	39k Ω 5% H.S.
R ₁₂	20k Ω 5% H.S.
R ₁₃	270k Ω
R ₁₄	270k Ω
R ₁₅	2.2k Ω
R ₁₆	2.2k Ω
R ₁₇	180 Ω 2W
R ₁₈	22k Ω
R ₁₉	1.2k Ω 1W
R ₂₀	100 Ω , 1W
R ₂₁	3.3k Ω (see text)
VR ₁	1M Ω log.
VR ₂	1M Ω log.

Transformers

T ₁	Osmabet type MRT/10 multi-ratio
T ₂	Tapped mains input. Secondaries: 250-0-250V, 100mA. 6.3V, 3.5A. Drop-through type (R.S.C. Ltd.)

Capacitors

C ₁	470pF mica
C ₂	330pF mica
C ₃	3,000pF mica
C ₄	10pF mica
C ₅	35pF mica
C ₆	25 μ F 12 w.v. electrolytic, wire ended
C ₇	8 μ F 350 w.v. electrolytic, wire ended

C ₈	0.01 μ F mica or ceramic
C ₉	0.25 μ F paper 250 w.v.
C ₁₀	0.01 μ F mica (see text)
C ₁₁	0.01 μ F mica (see text)
C ₁₂	50 μ F 50 w.v. electrolytic, wire ended
C ₁₃	32 x 32 μ F 350 w.v. electrolytic, tag ended
C ₁₄	0.05 μ F 350 w.v. (see text)

Valves

V ₁	ECL86 (Mullard)
V ₂	ECL86 (Mullard)
V ₃	EZ81 (see text) (Mullard)

Valveholders

Noval (4)

Chassis

4-sided aluminium 8 x 4 x 2in.

Panel

8 x 4in ditto

Switch

2-pole, 6-way rotary type

Input Sockets

Belling-Lee, type L604/S (2)

Output Sockets (2)

$\frac{1}{4}$ in (Radiospares) with banana plugs

Miscellaneous

Fuse bulb 0.2A MES and holder
Control knobs (3)
Spacers $\frac{1}{2}$ in (2)
Grommets
Tagstrips (2)
Screened cable, etc., etc.

the switch is so set, i.e. to position 4, and "top" is considered excessive, a further turn to the right will bring R₃ C₄ into the circuit and top-cut will occur. Similarly on "Gram" (position 3) excessive "top" can be reduced by moving the switch one point to the left—to position 2. Still greater top-cut is possible for either function at positions 1 and 6, but as the amount provided is not likely to be required very often the most inaccessible positions of the switch are chosen for these. Top-cut occurs due to frequency selective feedback from the output to the input of V_{1A}. Individual constructors might like to experiment with different values in the C₄ and C₅ positions to suit their own tastes.

To sum up, the three positions of the switch to left of centre operate on "Gram" whilst the other three positions operate on "Radio". Of the six positions, 3 and 4 are those most likely to be required.

A disadvantage of the arrangement is that the

"Radio" input is not completely muted when "Gram" is in use, but it is usually possible to slightly detune the tuner to remove any remaining traces of signal present.

"Bass" control is obtained by VR₁. As the slider is moved towards the lower end of the track of VR₁ C₂ becomes added progressively in series with the signal, and low frequencies are attenuated. At the other end of the track, C₃ increases the impedance presented to R₁ as the frequency is lowered, and greater output results in this region. Bass cut and boost (approximately 5 and 12dB respectively) are thus available by means of a single control.

The tone and other controls have been so positioned that, if required, the panel to which they are affixed can be removed completely from the amplifier chassis, and in some cases this facility might be beneficial—to suit a particular cabinet for example. Inclusion of an On/Off switch is undesirable with either of the controls since these are

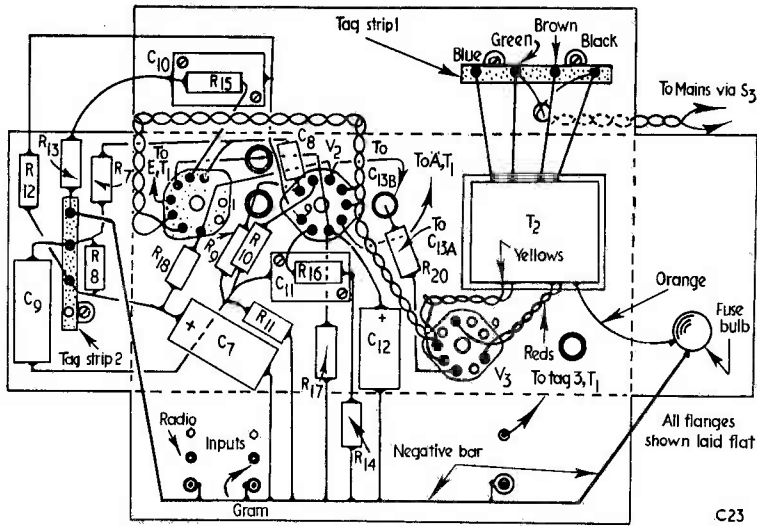

Fig. 2. Below-chassis wiring diagram

at a point in the circuit which is very susceptible to mains hum. In the prototype a switch is inserted in the flexible mains lead. Plenty of space exists on the panel, however, for the fitting of a rotary or toggle switch, if preferred, and/or for the inclusion of a warning lens and lamp.

The Phase Splitter

The phase-splitter circuit is of interest in that the resistors in the anode and cathode circuits of $V_{2(a)}$ are not equal in value, R_{12} being approximately only one-half the value of R_{11} (the grid resistor, R_9 , and the cathode resistor, R_{10} , are merely bias fixing

Fig. 3. Above-chassis wiring diagram

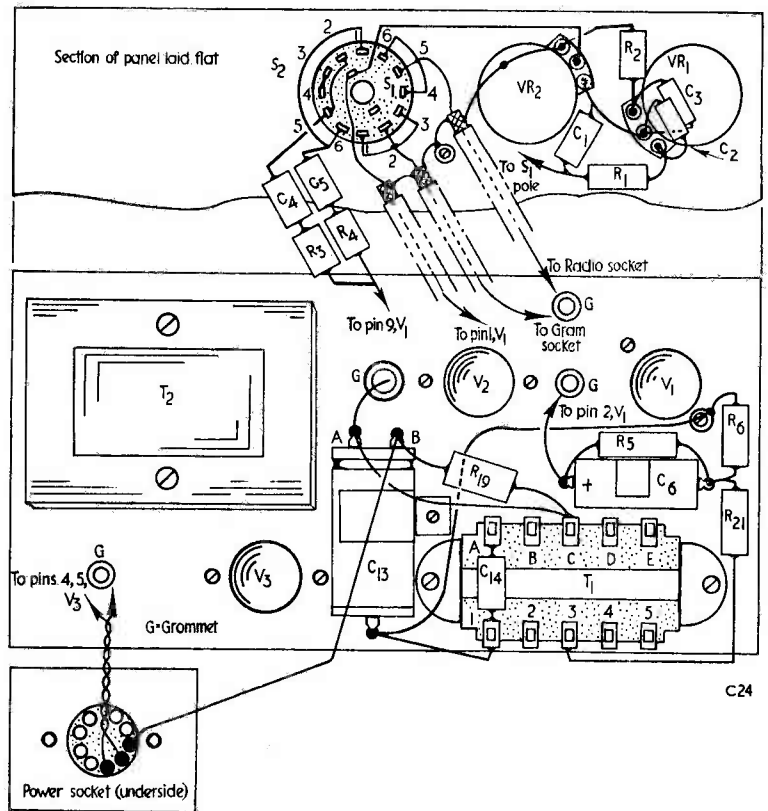
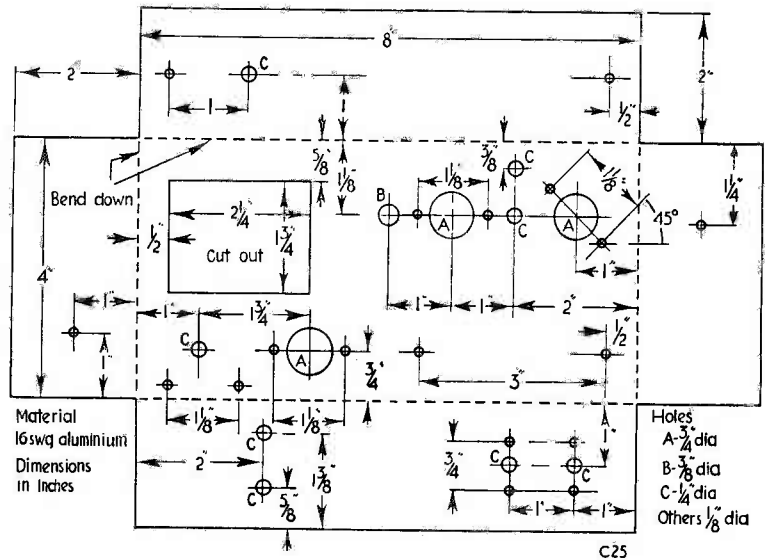

Fig. 4. Chassis drilling details



components for the stage). It would seem that use of the values specified would result in unequal signal outputs to the pentode grids. To a.c., however, R_8 is effectively in parallel with R_{11} due to C_7 and C_9 , and the loads are thus fairly equal over a wide range of frequencies. The high input impedance of the $V_{2(a)}$ stage enhances the gain of the previous stage, hence the use of this particular circuit.

Layout

Since only two valveholders are required to carry the amplifier circuitry, minor problems arise in eliminating congestion and preventing unwanted feedback from occurring. The underside layout of the chassis is shown in Fig. 2 and it is unlikely that this can be much improved upon. Actually it is more compact than it appears here since, in the diagram, the chassis flanges are shown laid out flat for clarity. Note that the amplifier proper is at one end of the chassis and that the power supply is at the other. The photographs accompanying this article further illustrate the layout.

Precautions against mains hum consist of keeping the input and output circuits separated, by tightly twisting together the heater and other leads carrying

a.c. and by using only a single chassis connecting point for the under-chassis components (via a negative bar consisting of heavy copper wire) at the input sockets, thereby helping to eliminate unwanted chassis currents. All wiring associated with $V_{1(a)}$ grid circuit must be screened.

No space exists for groupboard techniques, so anchor points are provided by two simple tagstrips, C_{10} and C_{11} also assisting here since they are chassis-mounting mica types. Tubular components may be used instead provided Spire clips are fitted to retain them.

Spire clips also retain C_6 , C_9 and C_{13} . Note the location of the fuse bulb, which is fitted to prevent a destructive flow of current if a fault such as a heater-cathode short-circuit developed in V_3 .

The above-chassis layout (see Fig. 3) is also compact and here, too, the power supply socket and a section of the panel are shown laid flat. Note the space available for a panel-mounted lamp or switch and observe that screened cable is used for the input leads. This screening must be connected to the panel as shown in Fig. 3, the other ends of the screened wires being earthed to the negative bar of Fig. 2. (It should be noted that this method of connection enables the panel to be removed entirely.)

Mechanical Details

Although a 5-piece sectional chassis was used in the original, a standard type may also be employed, and all essential cutting and drilling details (applicable to both types) are shown in Fig. 4.

The panel dimensions, etc., are indicated in Fig. 5 whilst in Fig. 6 details of the bracket needed for the power socket are shown. These items are made from 16 s.w.g. aluminium. Although the panel control holes may be more widely separated, if desired, extra care will need to be taken to avoid mains hum. The panel is held clear of the chassis by $\frac{1}{2}$ inch spacers.

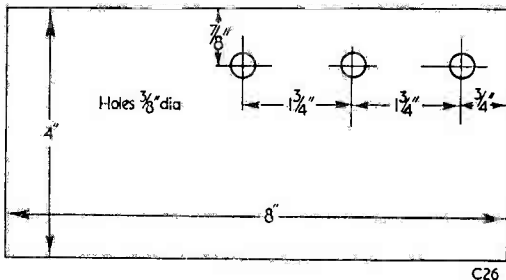

Fig. 5. Panel details

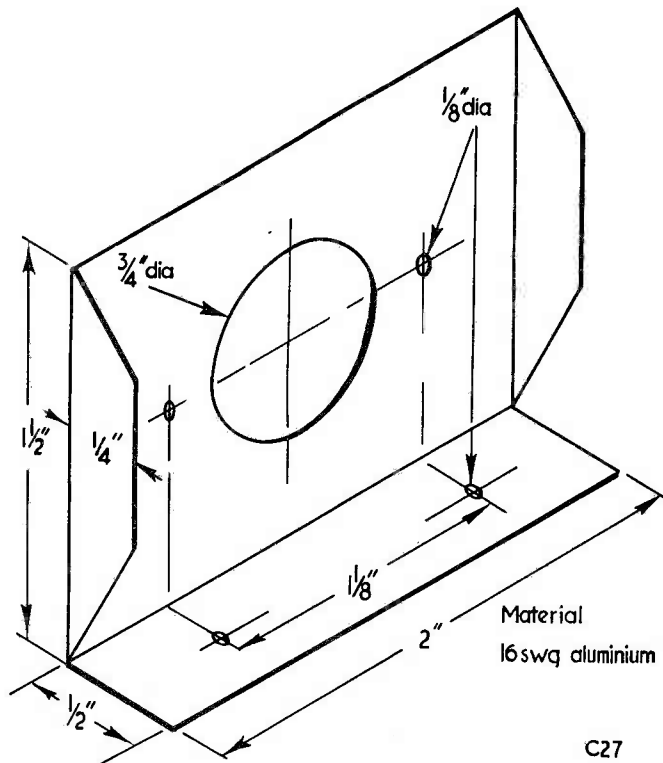

Fig. 6. Dimensions of a suitable power socket bracket

Constructional Notes

After chassis preparation all major components are mounted, including the panel, the valveholders being oriented as shown in Fig. 2. Preliminary work consists of bringing up the flying leads of T_2 , soldering the negative bar in position and wiring the heaters as shown. Grommets must be located at the holes marked "G" in Fig. 3.

General chassis wiring can then be proceeded with as shown in the diagrams, leaving the panel mounted components and the power socket wiring towards the end. Resistor R_{21} should also be left temporarily disconnected at the end associated with T_1 secondary winding.

Checking

Upon completion, a thorough check of all wiring should be made and if all is well the valves and fuse bulb may be inserted as appropriate. With the mains supply plug *not* inserted in its socket an ohmmeter should be brought into use to ensure that no direct circuit exists between any tag on tagstrip 1 (Fig. 2) and chassis, and that a low resistance reading is obtainable between any two of the tags.

The ohmmeter negative test lead should then be clipped to the chassis and readings taken from pins 1 and 8 of V_1 and V_2 ; these should be high due to the grid resistors. Fairly low readings should be obtained from pins 2 and 7 of V_1 and V_2 , and from pins 1 and 7 of V_3 . The positive test prod should next be applied to pin 3 of V_3 , whereupon the pointer should swing over towards zero then move steadily towards a higher reading as C_{13} charges. If the pointer continues to read zero a fault exists on the h.t. rail and the unit should on no account be connected to the mains until clearance has been effected.

If all is well the test meter should be set to read volts, d.c. and the positive prod disconnected. Control knobs may next be fitted and a speaker connected. The amplifier may now be switched on remembering that tags A-E of T_1 are "hot" spots!

The valve heaters should commence to glow fairly quickly and a series of meter readings should then be taken; these should bear some resemblance to those given in the accompanying Table, which was compiled using a Weston Analyzer with a sensitivity of 1,000 ohms per volt. If no heater glow

Below-chassis view of the completed unit

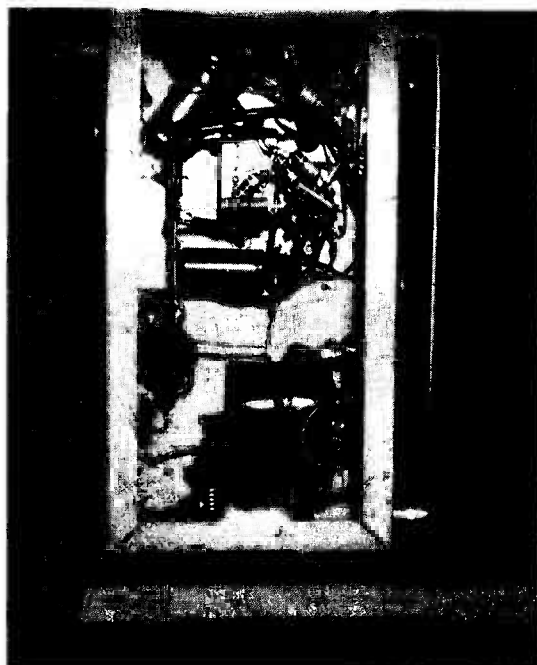

is observable switch off immediately and check the wiring after discharging the h.t. electrolytic capacitors via a resistor of 10–20k Ω .

TABLE
Voltage readings with respect to chassis

Location	Volts d.c.	Meter set to
Pin 3, V ₃ ..	300	1,000V range
Pins 3, V ₁ , V ₂ ..	285	1,000V range
C ₇ , tagstrip 2 ..	240	250V range
Pins 7, V ₁ , V ₂ ..	9.8	10V range
Pin 2, V ₁ ..	1.2	10V range

A Trial Run

If all is well VR₁ and VR₂ should be set to approximately 25% of full travel and the rotary switch set to position 3. If the output from a crystal

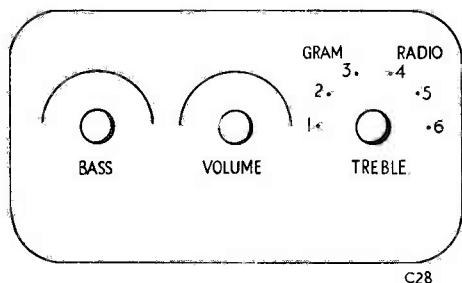

Fig. 7. Suitable escutcheon layout

pick-up is now applied to the appropriate input socket on the amplifier via screened cable and plug, the results should be heard in the speaker. The quality should be crisp and clear and the various controls may then be experimented with to become familiar with their functioning.

R₂₁ has yet to be connected and when this is done the volume level should be lower than before for the same setting of VR₂; the response should also be improved. Should fierce oscillation occur when R₂₁ is connected, the amplifier should be switched off at once. The oscillation will be due to incorrect feedback phasing, and this may be remedied by changing over the leads to the secondary tags on T₁. Changes should not be made whilst the amplifier is switched on.

Conclusion

For normal home use it is not likely that VR₂ will need to be turned to more than about half travel when records are being played. The positions used on the switch will depend largely upon the user's needs, and older listeners are more likely to prefer full "top" than their younger relations. Switch positions 1 and 6 are most useful when old 78 r.p.m. discs with noisy surfaces are played.

The amplifier runs at a fairly high temperature and should not be made available for general use until contained in a suitable cabinet, the design of which should permit a flow of cooling air from below. The amplifier should never be run without a speaker being connected.

An escutcheon may be drawn up (black lettering on a gilt background is effective if faced with clear Perspex) and a suitable outline is shown in Fig. 7, this agreeing with that used with the prototype.

The "Crystella" Crystal-Controlled F. M. Tuner

By SIR JOHN HOLDER, Bart.

A PREVIOUS ARTICLE¹ DESCRIBED A CRYSTAL-controlled oscillator for F.M. use. The "Crystella" is a complete tuner, which employs the same crystals, but in a different manner.

In the former article, the crystal was used to ensure that the oscillator valves could only provide regeneration at the correct frequency and, being of a restrictive nature, control was therefore limited. In the present article, the crystal is inserted in the LC circuit of the oscillator, where, being excited by the circulatory current, it dominates the whole arrangement.

The result is a profound difference in behaviour. Whereas the oscillator previous described has shown itself to be remarkably adaptable to different tuner designs, but requires adjustment to within fairly precise limits for each of the three B.B.C programmes, the one to be described here is intolerant of changes in layout, but works extremely well in a *specified design* of the right kind. Moreover, it is self-adjusting to the extent that one crude adjustment suffices for all three programmes.

The previous circuit, then, is the obvious choice for the experimenter, and the present one for the reader who likes to follow a proved design. In this connection, the author wishes to state that the "Crystella" is the result of much careful thought and experiment. It has demonstrated that there are many reasons for success if the prototype is copied carefully, but that alterations or innovations may lead to unexpected and undesirable results.

It has been found that the "front-end" described in the previous article will combine well with the "rear-end" of the present tuner; but, starting *ab initio*, it is more logical to use the "front-end"

¹ "A Crystal Controlled Oscillator for F.M." by Sir John Holder, Bt. *The Radio Constructor*, August and September, 1961.

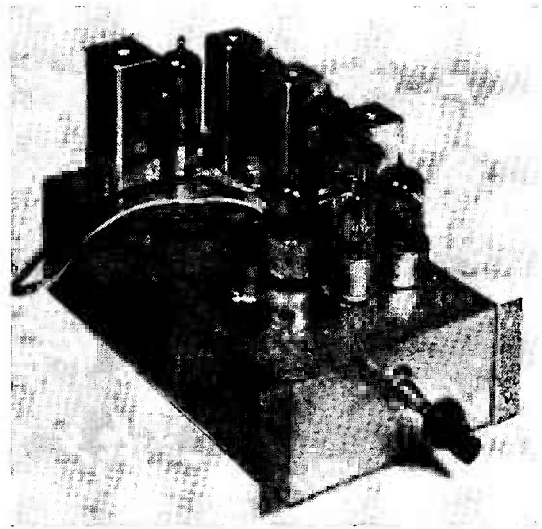

described herewith because it is cheaper, less complicated and, if properly constructed, easier to adjust.

The starting point of both oscillators was leaflet MQ/104 issued by Standard Telephones and Cables Ltd., the manufacturers of the crystals. Considerable modifications have been made to the circuits contained in this leaflet, some of these modifications having been originated by the author and others suggested by S.T.C. Ltd., to whom grateful acknowledgements are made. In its final form, the "Crystella" employs the optimum arrangement developed by the writer, who can confidently recommend it as a tuner which will give an enduring performance of the highest order.

The Advantages of Crystal Control

Crystal control confers two great advantages. Firstly it prevents the crackling and frying noises which develop in normal tuners with age and, secondly, it eliminates one of two interdependent variables which normally render receiver adjustment difficult for the home constructor.

The first fault is caused by worn or oxidised switch or variable capacitor contacts. These cause intermittent alterations in oscillator working conditions, so that the oscillator frequency varies, with consequent changes in the intermediate frequency. Whilst this would have little effect in an a.m. receiver, in an f.m. receiver these frequency variations are rendered audible as noise. A crystal locks the oscillator to a certain frequency so that, for all but gross variations of operating conditions, it will continue to function at the correct frequency and no noise will be generated.

Adjustment of a receiver consists in correctly setting two groups of circuits: the "front end" group which is dominated by the oscillator, and

the i.f. group which follows. The two are interdependent and alteration of the one affects the appropriate setting of the other. The professional feeds a standard signal into the i.f. and adjusts this. He then goes back to the oscillator. The home constructor seldom has a signal-generator and has to purchase a complete ready-adjusted front end. If, at any time, adjustment if either end is disturbed in trying to locate a faulty circuit, the constructor will be lucky if he does not lose the adjustment of the whole unit. Crystal control does away with all these difficulties because, if the crystal functions at all it will, with a B.B.C f.m. programme, afford the correct i.f. frequency to which the circuits are to be set.

The S.T.C. Crystals

The making of a crystal which is small enough to oscillate at f.m. receiver frequencies presents great difficulties, and hitherto the receiver constructor has had to use crystals which operate at lower frequencies and employ frequency-multiplying circuits with their attendant disadvantages. Now, Standard Telephones and Cables Ltd. have produced a series of overtone crystals in groups of three, these mounted in one envelope to cover the B.B.C. frequencies in different areas.² The appropriate group is plugged into the receiver exactly like a valve. The crystals oscillate on their 5th overtone so that, when combined with the appropriate B.B.C. signal, an intermediate frequency of exactly 10.7 Mc/s is produced without any frequency-multiplying circuits.

An oscillator consists of a regenerative loop, regeneration being afforded by valve amplification which is necessary in order to overcome losses in the oscillating circuit. The overtone crystal is interposed in the loop and allows only regeneration at the correct frequency to take place round the loop. At another point in the loop is a broadly tuned circuit which limits regeneration to frequencies within a band bracketing the required frequency, thereby preventing the crystal from oscillating on any other harmonic or the fundamental.

The Circuit

Fig. 1. shows the circuit of the complete tuner. It would function very well with the aerial transformer connected direct to the grid of the pentode portion of V₂, and with V₁ omitted, but this would cause energy to be radiated into the aerial and the primary function of V₁ is to prevent TV interference. A grounded-grid triode or a cascode circuit could be used but the EF80 pentode makes up for the use of three broadly-tuned circuits, and it contributes negligible noise when used with f.m. as opposed to a.m. Experiment showed it to be the best valve for the job.

V₁ is coupled to V₂b by a broadly tuned anode circuit formed by the inductance of L₂ in parallel with the anode capacitance of V₁ and stray

capacitances. The tuning is broadened by the damping provided by V₁ anode.

The oscillator circuit shown in Fig. 1 can be rearranged in the form of a bridge (see Fig. 2) balanced about a central earthy point. The corners of the bridge have been lettered A, B, X and Y. C represents the combined effect of the coupling capacitor C₇ in series with the grid-cathode capacitance of the mixer V₂b, and strays. R₃ is merely to broaden the tuning and, for theoretical consideration, can be ignored.

The crystal behaves as if it were a combination of a very high inductance (in fact, the mechanical mass of the crystal) in series with a very small capacitance, as shown in Fig. 3.

The whole is shunted by C¹ (in Fig. 3) which represents the capacitance of the crystal-holder, switch and other strays. Such a circuit, provided that C¹ is kept small, offers a high impedance to currents of alien frequencies, but acts as practically a short-circuit to current at resonant frequency, so that for theoretical purposes, it can be omitted from Fig. 2. The whole of L₃ must be tuned to broad resonance in conjunction with the various capacitances grouped between A and B.

For the crystal to exert the maximum selective feedback to the grid of V₂a, not only must C¹ be kept as small as possible, but all capacitances at oscillator frequency potential must be at the irreducible minimum. For this reason, the use of p.t.f.e. holders for V₂ and the crystals is essential. Also, we cannot afford to add an adjustable tuning capacitor to L₃, but must rely on design and adjustment of the coil. If unwanted capacitances, particularly C¹, are too large, there may be sufficient regeneration for the valve to oscillate at the wrong frequency.

For stable operation, the bridge must also be approximately balanced. This occurs when:

$$\frac{L_{3a}}{L_{3b}} = \frac{\text{grid-cathode capacity of } V_{2a}}{\text{Combined effect of } C \text{ and anode-cathode capacity of } V_{2a}}$$

Both terms of the right-hand half are affected by strays.

For convenience, we make L_{3a}=L_{3b} and it is then found that a value of between 5 and 8pF for C₇ will effect a balance.

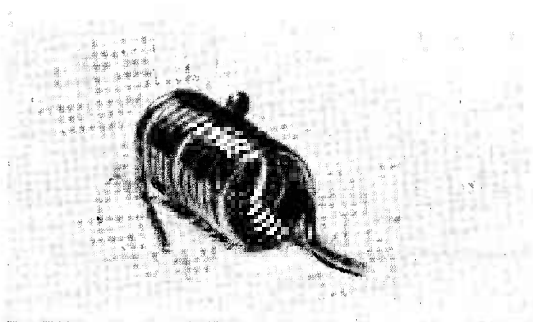

A view of the oscillator coil, L₃

² These are the Standard Telephones & Cables Ltd, crystal unit type 4434. A suffix letter corresponds to the B.B.C. transmitter with which the particular unit employed should be used.—EDITOR

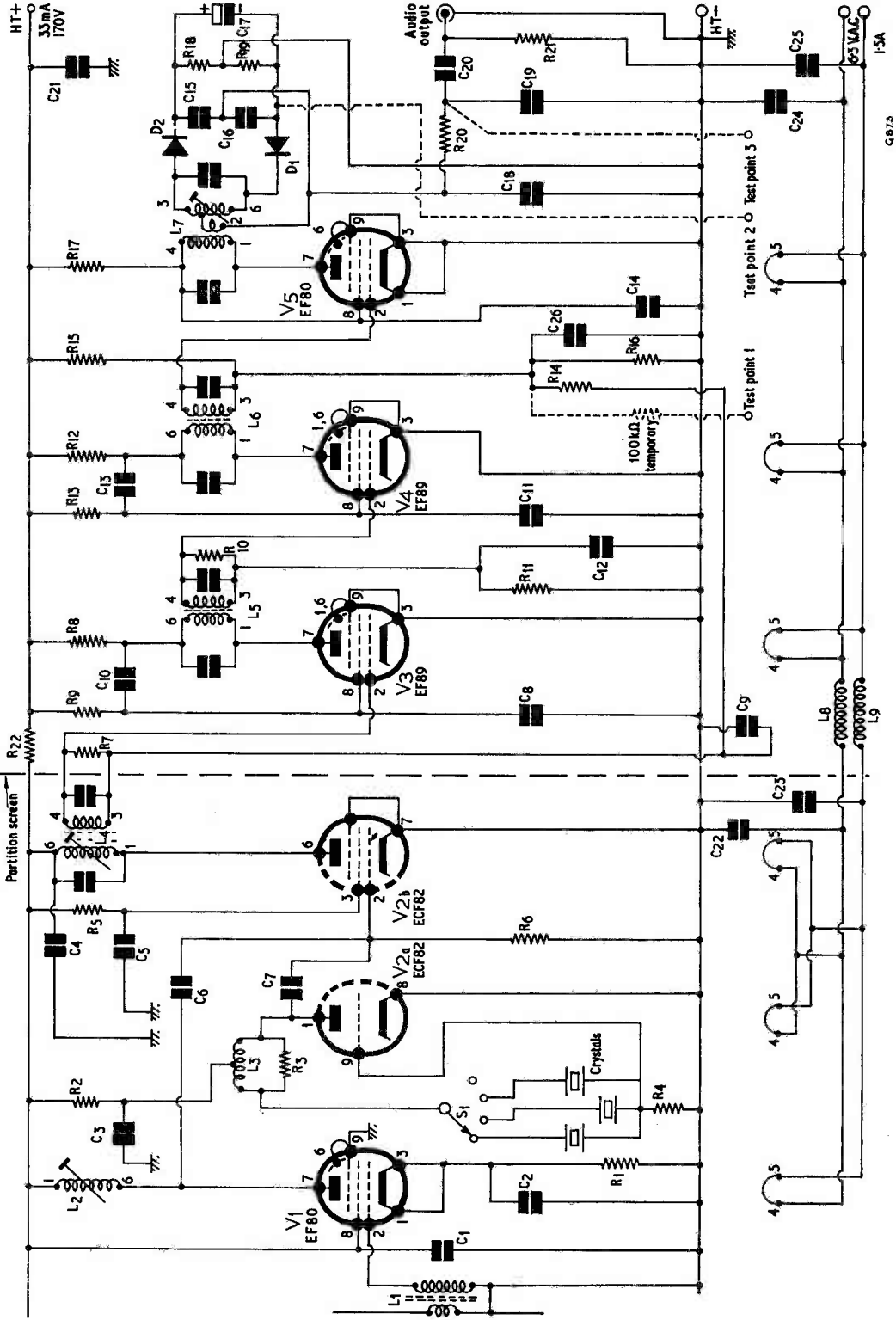

G 87.3

Fig. 1. The circuit of the Crystella Tuner Unit. It should be noted that pins 6 and 9 of V₁ connect to centre spigot, pins 7 and 8 of V₂ and pins 1, 3, 6 and 9 of V₃, V₄ and V₅ all connect to the centre spigot of their respective valveholders. All pins 9 then connect to chassis except that of V₂, in which latter case, the spigot itself is connected to the chassis

Components List

Capacitors All 20% unless otherwise stated

- C1 5,000pF Ceramic
- C2 2,200pF Ceramic
- C3 5,000pF Ceramic
- C4 2,200pF Ceramic
- C5 2,200pF Ceramic
- C6 15pF Silver Mica
- C7 6.8pF Silver Mica
- C8 5,000pF Ceramic
- C9 10,000pF Ceramic
- C10 5,000pF Ceramic
- C11 5,000pF Ceramic
- C12 150pF Silver Mica
- C13 5,000pF Ceramic
- C14 5,000pF Silver Mica
- C15 200pF Ceramic 10%
- C16 200pF Ceramic 10%
- C17 5μF Electrolytic (50 w.v.)
- C18 200pF Ceramic
- C19 1,000pF Ceramic 10%
- C20 0.05μF Paper
- C21 5,000pF Ceramic
- C22 5,000pF Ceramic
- C23 5,000pF Ceramic
- C24 1,000pF Ceramic
- C25 1,000pF Ceramic
- C26 47pF Silver Mica

Note: Instead of Silver Mica or Ceramic, the new T.M.C. Yellow-Label "S" series can be used for values up to 220pF.

Valves, Etc.

- V1 EF80
 - V2 ECF82
 - V3 EF89
 - V4 EF89
 - V5 EF80
- Crystals—S.T.C. Type 4434/ to suit locality.
 D1 & D2 Diodes GEX34

Valveholders

- V1 B9A Nylon Loaded.
 - V2 B9A p.T.F.E.
 - V3, V4 & V5 B9A Nylon Loaded.
- Crystal B7G p.t.f.e.
 All valveholders preferably skirted.

Resistors All 20% 1/4w unless otherwise stated

- R1 270Ω
- R2 10kΩ
- R3 22kΩ
- R4 27kΩ
- R5 33kΩ
- R6 270kΩ
- R7 100kΩ
- R8 1kΩ
- R9 33kΩ
- R10 100kΩ
- R11 1MΩ
- R12 1kΩ
- R13 33kΩ
- R14 100kΩ
- R15 2.2MΩ
- R16 47kΩ
- R17 47kΩ 1W
- R18 10kΩ 10%
- R19 10kΩ 10%
- R20 47Ω 10%
- R21 1MΩ
- R22 270Ω

Coils

- L1 Jason Type L1
- L2 7 turns of 18 s.w.g. tinned copper wire extended to 1/2in long on 7 m/m bakelite former with VHF slug. (See text)
- L3 10 1/2 turns of 81 s.w.g. tinned copper wire, centre tapped, 1/2in outside diameter, self supporting, extended to 7/8in long. (See text)
- L4 } Jason Type L4
- L5 } Jason Type L4
- L6 } Jason Type L4
- L7 Jason Type L32
- L8 } F.M. heater chokes, Jason Type L7
- L9 } F.M. heater chokes, Jason Type L7

Note: The L32 coil may be supplied with a resistor additional to the circuit given in Fig. 1. This resistor may be retained in circuit.

SUNDRIES

- S1 Chassis (see drawings)
Switch—Radio Spares "Midget" 4-pole, 3-way.
Screening Can—To suit L2 (Height 1 3/8in)
- TS Tagstrips

Table

Voltages to Chassis

- "Live" side of C21 170V
 - Tap of oscillator coil 100-110V
 - V2 pin 3 (g2) 80V
 - L5 pin 6 (anode V3) 160V
 - V4 pin 8 (g2) 80V
 - L6 pin 6 (anode V4) 160V
 - V5 pin 8 (anode supply) 20V
- (under no signal conditions)

We could use a variable trimmer for C7, but it would only complicate the adjustment because, in addition to controlling the balance of the bridge, it would affect the tuning of L3. Fortunately, the oscillator will still function with the circuit slightly out of balance. It merely means that points X and Y will oscillate slightly above and below neutral potential and a small out-of-balance current will flow through C3. A value of 6.8pF for C7 seems to be about average.

Brimar Ltd. publish two alternative sets of typical operating conditions for the pentode portion of the ECF82 as a mixer. One uses a g2 potential of 110 volts with no cathode bias resistor and the other uses a Vg2 of 170 volts and a cathode bias resistor of 680Ω. Although, for a given r.f.

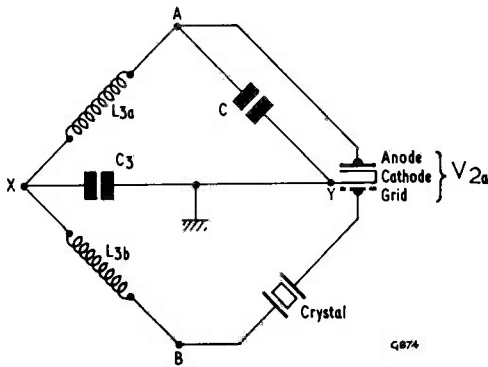

Fig. 2. The oscillator circuit rearranged in bridge form

input, the second alternative gives a slightly higher i.f. output, the first has been chosen in this instance because there is less chance of noise when the cathode is grounded.³

The remainder of the tuner is conventional, one extra pentode being used to ensure good reception in difficult localities. In fact the tuner has ample reserve both of gain and limiting.

The Coils

L₁ can be purchased, ready-made. L₂ is housed in a standard 1 3/8 in square coil-can and is wound on a standard Bakelite former 7 mm. diameter with square base and v.h.f. type slug. The coil may be made in the following manner. Wind 7 turns of 18 s.w.g. tinned copper wire tightly round the former. Pull out to 1/2 in long, bend the ends down, insert them in holes 1 and 6 of the former and slide the coil on to the former until it is centrally positioned. The top end of the coil goes through No. 6 hole and the bottom end through No. 1 hole. Fix the coil in place with a suitable adhesive, such as polystyrene dope, and cut off the ends to about 3/8 in long.

Fig. 4. The oscillator coil L₃. When correctly constructed and viewed from above, there will appear to be 11 turns with tap at the centre; although there are, in fact, 10 complete turns and 2 quarter turns

Constructing the Oscillator Coil

L₃, shown in Fig. 4, is air-cored and self-supporting.

To construct, obtain a 1/8 in diameter rod of some kind, say, a bolt with a portion of plain shank. If the wire is wound on to this it will be found that it will spring out so that the outside diameter is exactly that required, namely 1/2 in. To make the centre-tap, take a two-foot length of 18 S.W.G. tinned copper wire. Fold it in the centre and continue round with the ends until it is straightened out

³ The second alternative requires an oscillator voltage at the grid of 5 volts peak as against 3 volts peak for the first.—EDITOR

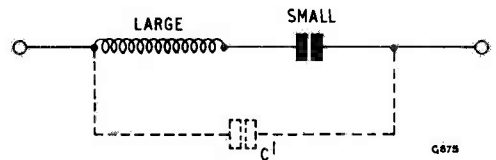
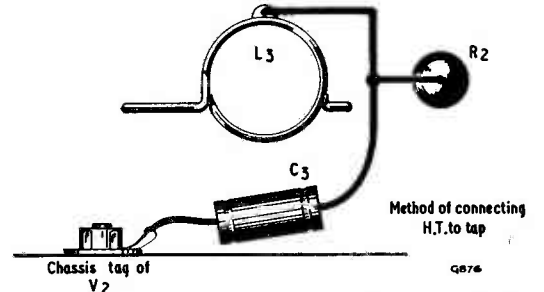
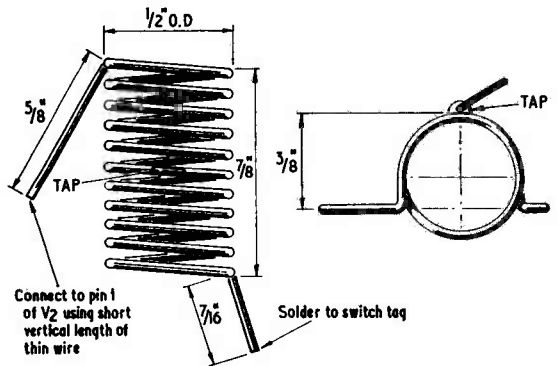

Fig. 3. Showing how a crystal behaves as a series-resonant acceptor circuit

again, leaving a tight looped kink in the centre. Flatten the kink, using pliers, and fill the loop with solder. Now wind the wire on the 1/8 in former.

Wind on 10 1/2 turns in such a manner that when the coil is held so that the axis points towards you, the far end of the coil will hang down to the left of the former and the near end to the right, the tap being at the top. (The tap is the kink or curl at the centre). Pull out the coil until it is approximately 7/8 in long, the turns being evenly spaced, and remove it from the former. Shorten the ends as required, and bend them at right angles so that when the coil is in position the front end will be in position for soldering to the switch tag. At the same time the rear end is bent diagonally forwards towards the front, the tip of the wire being directly above pin 1 of V₂.



When mounting, the coil should be attached to pin 1 by a short vertical length of thin wire (say 22 s.w.g. or a little thinner), so as to allow some "come-and-go" when the separation of the turns is finally adjusted. (To be continued)

It is important that the wire connecting the tap to C₃ should lead round the right-hand side of the coil. If it travels round the other side it will, in

effect, cancel half a turn of the "anode" section of the coil.

(To be continued)

Simple High-Low Resistance Continuity Tester

By I. M. REES

USING A BUZZER AND BATTERY TO INDICATE continuity in wiring and components is a useful technique. By the addition of a suitable transformer and switch the arrangement can be extended to check high resistances up to around 20kΩ or, with a neon, up to several megohms.

Circuit

If, in the accompanying circuit diagram, the switch is set to position 1 the buzzer can be used via the output sockets for normal low resistance checks (0-10Ω approx.).

In switch position 2 the buzzer acts in rather the same way as a vibrator in a battery h.t. power supply, the voltage being stepped up by the transformer. The secondary of the transformer is applied to the same output sockets and can be used for high resistance checks (0-20kΩ). Continuity is indicated in this case by a rise in note of the buzzer due to the reflected impedance drop in the transformer primary.

By inserting a neon in the circuit as shown, resistances of a very high order may be indicated (0-6MΩ).

Constructional Notes

Obviously any suitable layout can be adopted but a wise choice of components is necessary to produce really good results. The buzzer should be of the G.P.O. type with a clean high pitch. Any type of transformer can be used provided the ratio is high and the primary winding suits the supply voltage

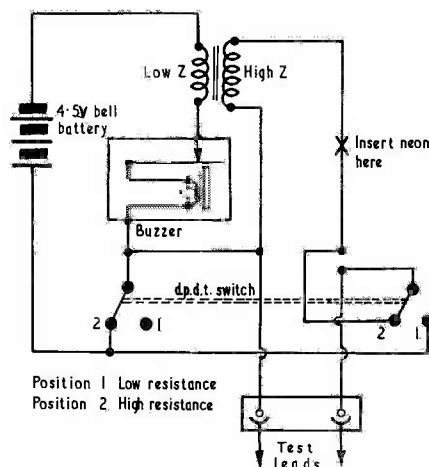

E 254

and the buzzer. In the prototype an old speaker transformer was employed.

The neon may need to be chosen experimentally. Most types with a low striking voltage should cope, as may the higher voltage working types with the series resistor removed.

One final word of warning. Quite an unpleasant shock can be received from this unit so care is required when testing. The writer's model gave a voltage of just under 100 across the transformer secondary.

Purchase Tax Cuts—Valves Affected

With the recently announced reductions in purchase tax on radio and TV sets, etc., little mention was made in the national press that such reductions also applied to the retail prices of valves.

Mullard Ltd. have kindly supplied us with a few examples of these reductions.

Type	Old Price	New Price	Type	Old Price	New Price
EF86	17/6	15/9	EL84	12/4	11/1
ECL86	16/2	14/7	EZ81	9/1	8/2
ECC83	14/3	12/10	PY80	9/9	8/9

Door Chime Repeater

By K. V. R. BOWERMAN

WE HAVE ONE OF THOSE DEVICES WHICH GOES “ding-pause-dong” as the bell-push on the front door is pressed and released. And very melodious it is, too. But if the sitting-room door is closed and our favourite programme is on the TV, we don’t always hear it. The same thing applies when the XYL is in the garden hanging out the washing.

The Solution

The obvious solution would be to have a supplementary warning device (either a lamp or audible signal) at the points where a single “ding-dong” might go unheard. This idea was discarded on the grounds that it involved laborious extra wiring. In any case, the scheme described here is equally effective and much more fun to do. It consists in making the “ding-dong” repeat automatically about six times for each operation of the bell-push.

There are two possible ways of achieving this. One method consists of having a motor which drives a drum with six contacts on it, and which is arranged to start, complete one revolution, and then cut out. The other way is to do the thing with the aid of relays. We did the latter.

The Repeating Relay

A repeating relay (RY₃) is the heart of the circuit, which is shown in Fig. 2. Regular readers may

recognise this as being based on one of the “Suggested Circuits” by G. A. French¹ See Fig. 1. Briefly, it comprises a relay, the coil of which is fed from a source of d.c. via a resistor and one pair of contacts which are normally closed. A large value capacitor is connected in parallel with the coil. When the h.t. is applied the voltage across the relay coil starts to rise but, because of the high charging current of the capacitor and the limiting effect of the resistance, this rise is slow. When the voltage across the coil is sufficiently high the relay operates, whereupon the contacts open and the supply voltage is cut off. Owing to the charge on the capacitor, however, the relay remains energised. It stays that way until the charge on the capacitor has dissipated sufficiently to allow the voltage across the coil to fall to the “release” value. On release, the contacts re-make and the cycle starts all over again. If the relay has one pair of “make” contacts and one pair of “break” contacts, then the spare pair can be made to do the switching of an external circuit—in this case, the “ding-dong” unit.

How the Repeater Works

When the bell-push in Fig. 2 is pressed, low voltage a.c. is fed from the bell transformer to the “ding-dong” unit via the primary of T₁. Now, T₁ is a loudspeaker transformer connected in reverse (i.e. the 3Ω secondary is used as a “primary”). The only function of T₁ is to step up the 8-volt bell current to provide enough volts to operate the rectifier MR₁ efficiently.

The high voltage induced across the secondary of T₁ is rectified by MR₁, smoothed by C₁, and fed via the pre-set potentiometer R₃ to the coil of RY₁. This relay has a pair of normally-open heavy-duty contacts (RY_{1A}), and it is carefully adjusted (by weakening the contact spring pressure and narrowing the contact gap—see under “Adjusting”) so that it will operate at a low current around 4 to 5mA.

Mains voltage is fed via contacts RY_{1A} and RY_{2A} to rectifier MR₂. D.C. from MR₂ quickly charges the large-value capacitor C₂. MR₂ also partially charges C₃. After a brief delay due to the presence of R₁, RY₂ operates. During this delay C₃ charges sufficiently to initiate the repeating action. As soon as RY₂ operates (about a quarter of a second later than RY₃), contacts RY_{2A} open, and this isolates MR₂

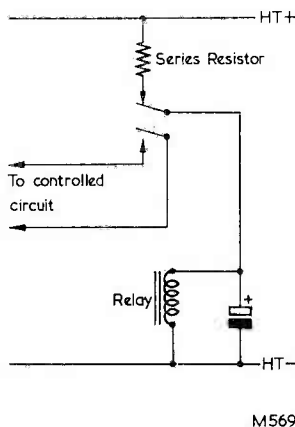

Fig. 1. The basic repeating circuit

¹ Suggested Circuits No. 88, “A Periodic Switching Device”, by G. A. French. *The Radio Constructor*, March 1958.

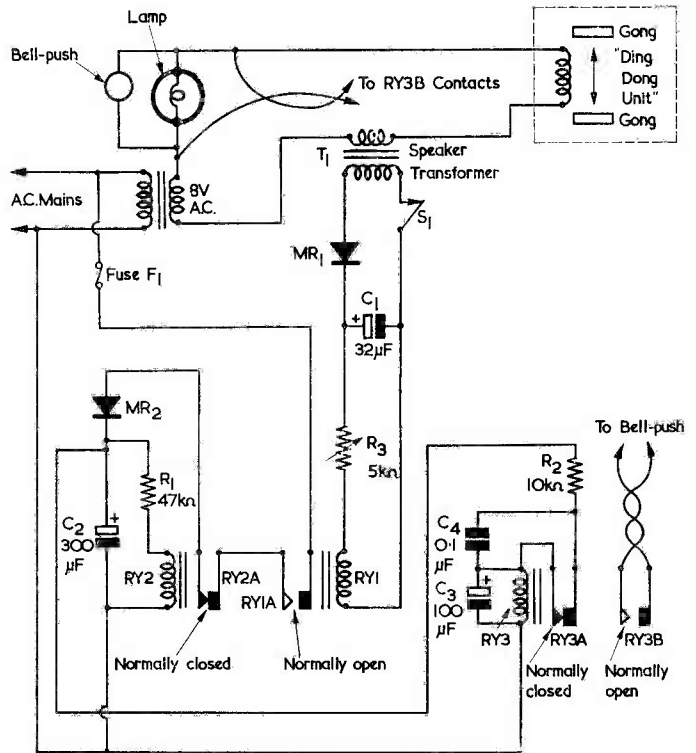

Fig. 2. The complete circuit of the chime repeater unit

Components List (Fig. 2)

M570

Resistors

- R₁ 47kΩ, ½W
- R₂ 10kΩ, ½W
- R₃ 5kΩ, variable, wirewound

Capacitors

All capacitors are 275 v.v.

- C₁ 32μF
- C₂ 300μF (100+200μF used in prototype)
- C₃ 100μF
- C₄ 0.1μF

Relays

3 Type 3,000 relays, 10,000Ω coils, with contacts as detailed in Fig. 2 and text.

Rectifiers

MR₁, MR₂ Metal rectifiers, 250 volts, 30mA or more.

Transformer

Any pentode speaker transformer with 3Ω secondary.

Switch

S₁ Toggle, s.p.s.t.

Fuse

Cartridge fuse, 2 amp.

from the mains voltage for the rest of the cycle. Meanwhile, the repeating relay is now well into its stride and continues to operate entirely from the charge on C₂. A second pair of contacts RY_{3B} are in parallel with the bell-push, so the "ding-dong" unit operates in unison with the repeating relay. C₄ eliminates arcing across contacts RY_{3A}.

The repeating action will continue about eight times until C₂ can no longer supply the operating current. Because relay RY₂ has been adjusted in the same way as RY₁, it operates at much lower current than RY₃. It therefore remains energised for approximately one second after the repeater stops, due to the residual charge on C₂. When RY₂ finally releases, all circuits are restored to the stand-by condition, waiting for the next caller to press the bell-push.

RY₂ must be included in the design, otherwise one press on the bell-push would cause the "ding-dong" unit to go on repeating *ad infinitum*.

The function of S₁ is to select "Single" or "Automatic" operation. Obviously, when S₁ is open, T₁ is inoperative and cannot initiate the repeating cycle. The presence of the 3Ω impedance of T₁ "primary" in the original bell circuit is of no consequence.

Timing

It may help here to summarise the preceding paragraphs.

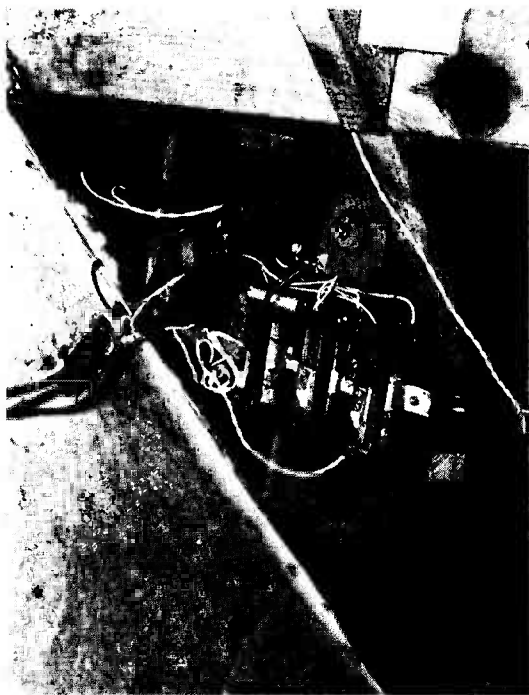

The unit in position without its protective cover

1. Bell-push pressed — current flows through T_1 primary — bell goes “ding” — RY_1 operates — bell-push released — bell goes “dong”
 2. MR_2 (fed via RY_1^A , RY_2^A) charges C_2 and C_3 — RY_3 starts operating
- } 1 second
- $\frac{1}{4}$ second elapses
3. RY_2 operates, isolating MR_2
 4. C_2 continues to feed RY_3 and RY_2 — RY_3 repeats 7 to 8 times in 12 seconds then ceases to function
- } 12 seconds
- 1 or 2 seconds elapse
5. RY_2 releases, after having been energised for a total time of about 13 seconds.

Circuit Values

The relays are all P.O. Type 3,000 with 10,000 Ω coils. These were chosen because they happened to be on hand in the junk box. The values of C and R throughout the circuit were determined entirely empirically and the constructor is advised to use the values shown as a basis for experiment only. There are so many variable factors involved that it would be impossible to make firm recommendations. With the prototype, the procedure was to employ wirewound potentiometers for R_2 and R_3 and adjust these, together with the values of C, until

the device worked satisfactorily. VR_1 was left variable because the operation of RY_1 is rather critical (see under “Adjusting”).

Some juggling is required with the circuitry of RY_3 to get an even operate/release ratio. About half a second in either condition is required. If this is not achieved, there is a “ding . . . DONG-ding . . . DONG-ding . . .” effect which doesn’t sound quite right.

Construction

The prototype, shown in the accompanying photographs, was made up on a piece of hardboard fitted with 2in by $\frac{1}{2}$ in battens. The large-value capacitors were mounted on the opposite side of the hardboard to the relays. The relays were secured with thin aluminium brackets, care being taken not to screw these down too tightly, whilst MR_1 and MR_2 are old metal rectifiers salvaged from early TV receivers. The completed unit was mounted in the meter cupboard under the stairs.

It is essential that a protective cover made of insulating material be fitted over the unit after it has been installed. There are many points at mains potential and care must be taken to ensure that under no conditions can these be accidentally touched. Also, the insulation between the coil and contacts of RY_3 must be adequate to ensure that no mains voltages appear in the bell circuit or wiring.

Adjusting

A word is needed about adjusting spring tensions on relay contacts. Both RY_1 and RY_2 are adjusted so that there is only light spring tension and, consequently, these relays operate at quite low currents. RY_3 , on the other hand, has two pairs of contacts which are quite heavily sprung. These conditions are achieved, as indicated earlier, by judicious bending of the relay contact springs.

RY_1 is so sensitively adjusted that its operation is influenced by the angle at which it is mounted. It may work quite well when it is flat on the bench, but not when it is mounted upright. Therefore, it is necessary to mount and connect the unit in its final position, after which VR_1 is adjusted with the bell-push pressed until the relay operates correctly. Once adjusted, nothing else is required.² Our own unit has been in daily operation without trouble since March 1960.

Final comments

Some readers may regard the whole scheme as a “sledgehammer to crack a nut”. In some ways it may be, but it did provide a use for some old relays and rectifiers which happened to be lying around, and an hour or two of good clean fun was spent in devising the unit.

One of the lesser rewards for our labours is the look on the faces of visitors unacquainted with the device. Our bell-push is illuminated and it flashes in time with the “ding-dong” unit. When we

² To avoid the adjustments to RY_1 and RY_2 just detailed it would be possible, of course, to fit more sensitive relays in these two positions. — Editor.

Top view of the prototype

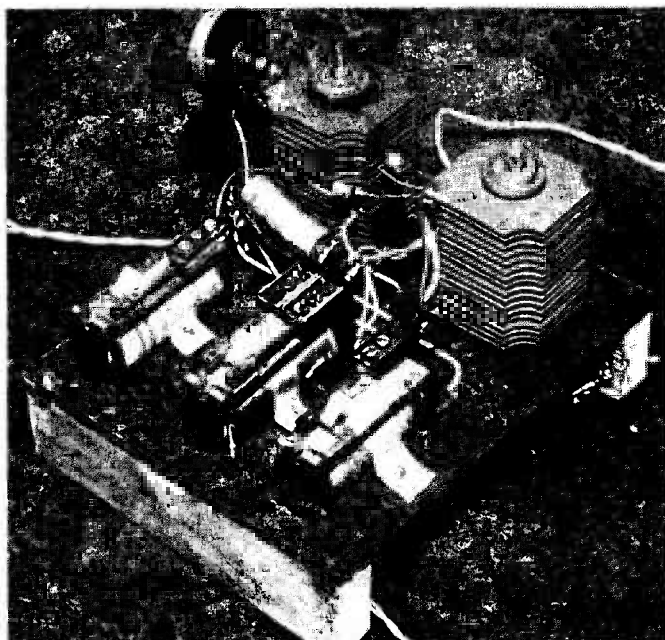

open the door, the bemused visitor smiles a wanly apologetic smile and confesses that he or she must have “broken the bell”. We reassure them

and say the whole thing is deliberate. They look at us as if we were slightly crazy. Perhaps we are!

British TV Protects American Tyre Inspectors

Engineers at B. F. Goodrich Company's new indoor tyre testing laboratory at Brecksville, Ohio, are now able to watch close-up views of car and lorry tyres undergoing high-speed endurance tests, without exposing themselves to injury—thanks to British television.

Constant observation of test operations is made possible by four E.M.I. Electronics cameras, installed in two Fairbanks-Morse closed-circuit television systems.

The high-definition television equipment forms part of two comprehensive road test simulators designed to measure the response of new tyre designs to the most severe operating conditions.

Work at the test centre is directed towards improving the durability of tyres. New designs are run to destruction to obtain information on new materials and new constructions.

To accelerate testing, the tyres are subjected to stresses greatly in excess of those likely to be met in normal operating conditions. Test engineers are shielded from the severe explosion hazard that can result from failure of a tyre or test assembly at high speed, as four remotely-controlled cameras, with automatic light control, keep constant watch on the laboratory's powerful dynamometer wheels.

Remotely controlled zoom camera lenses give operators in the laboratory's main control room close-up views on large-screen receivers.

An operator can adjust the test machines and automatically select viewing angles of the TV cameras without leaving the main control panel. During testing he can watch visible phenomena, such as standing waves that form in the tyre tread at excessive speeds, and vibrations that indicate when a tyre is about to fail.

Comprehensive

VALVE TESTER

By P. CAIRNS, A.M.I.P.R.E.

Examples of Test Procedure

Example 1. It is required to check the emission and slope of a 6K7G valve. From the valve data book the following information is obtained: 6K7G, vari- μ pentode. I.O. base. Pin connections, 1-NC, 2-H, 3-A, 4-G₂, 5-G₃, 6-NC, 7-H, 8-K, Top cap G1. Vh-6.3. V_a-250. VG₂-100. VG₁-minus 3. I_a-8mA, slope, or g_m-1.5 mA per V.¹

The valve tester is set up as follows: Plug 1 not used. Plug 2 to socket H. Plug 3 to socket A. Plug 4 to socket G₂. Plug 5 to socket G₃. Plug 6 not used. Plug 7 to socket H. Plug 8 to socket K. Top cap plug to G₁ socket. Set S₃ to 6.3 volts and VR₃ to minus 3 volts. The valve is now plugged into the I.O. valveholder and the top cap clip connected. S₄ is switched to position 2. The bulb should light indicating heater continuity. Next turn S₄ to position 3, allow the valve to warm up, and put S₄ to position 4, first connecting a voltmeter into the appropriate sockets if no internal meter is used. Put shorting link across milliammeter sockets. With S₁ in the "G₂" position, press S₅ and set the voltage to 100 by means of VR₁. With S₁ in "A" position, press S₅ and set anode volts to 250 by means of S₂ and VR₂. Connect milliammeter in place of shorting link and press S₅, the anode current reading obtained is a measure of the valves emission. A new valve should read the I_a quoted in the data book. As a guide for emission values the percentage of I_a read against that quoted indicates the approximate fall off in emission, i.e. if I_a reads 80% of the quoted value, emission will be about 80%, or 20% down; 60% of I_a indicates 60% emission, or 40% down, etc.

Let us assume that the actual valve checked in the example read just over 7mA, showing it was less than 10% down and therefore good. As a general rule any valve more than about 40% down should be replaced and any between 20 and 40% down should be regarded as suspect. Better than 20% usually indicates a good valve. No hard and fast rule can be laid down however as much depends upon the circuit in which the valve is working. Valves as low as 50% may work satisfactorily in some circuits, while in others a valve only 20% down may cause trouble.

¹ Slightly different figures for 6K7 I_a and g_m are given in some references.—Editor

The next step is to check the slope or g_m. Leaving the milliammeter connected, and all other controls as set, readjust VR₃ to minus 1 volt, this making G₁ 2 volts more positive. Press S₅ and note the increase in anode current from the previous reading. Let us assume that, in the present example, this change was 3.5mA, the I_a going up to just over 10.5mA. The g_m in mA per volt can now be found by dividing the change in anode current by the change in grid volts. In this case the g_m

$$= \frac{3.5\text{mA}}{2\text{V}} = 1.75\text{mA per volt.}^2$$

This figure compares very well with the specified figure of 1.5mA per V, thus reaffirming the fact that the emission is well up. A low g_m is usually synonymous with low emission and indicates a fall-off in the valve's conductivity and gain and, therefore, in its efficiency.

Example 2. It is required to check the emission, g_m, μ , and r_a, of a 12AT7 (ECC81) valve. This is a miniature all glass double triode and may be regarded and tested as two separate valves or sections. From the valve data book the specified data and pin connections are obtained. B9A Base. Pin connections, 1-A", 2-G", 3-K", 4-H, 5-H, 6-A', 7-G', 8-K', 9-H tap. Vh-12.6. V_a-250. V_g-minus 2. I_a-10mA, g_m-5.5mA per V. μ -60. r_a-11k Ω .³

Set up the valve tester for the first triode section as follows: Plug 4 to socket H. Plug 5 to socket H. Plug 6 to socket A. Plug 7 to socket G₁. Plug 8 to socket K. Other plugs are not used. Set S₃ to 12.6 volts and VR₃ to minus 2 volts. Plug the valve into the B9A valveholder, switch S₄ to position 2, and check heater continuity. Now switch S₄ to position 3 and let the valve warm up. Put S₁ to A, connect the voltmeter across the voltmeter sockets, and connect the shorting link across milliammeter sockets. (If internal meters are used these last operations will be unnecessary.) Next switch S₄ to position 4, press S₅ and set anode voltage to 250 by means of S₂ and VR₂. Now disconnect the voltmeter and connect the milliammeter in place of the

² The increased anode current for V_g=1 volt will, of course, cause a drop in anode voltage. This drop should be sufficiently low for the g_m reading obtained to be accurate enough for practical purposes.—Editor

³ Slightly different figures for 12AT7 μ and r_a are given in some references.—Editor

shorting link. Press S_5 and check anode current which should be 10mA or very near if the valve is good. The fall off in emission can be found as in the previous example, if the I_a is low. Next reset VR_3 to 0 volts and read change in anode current, whereupon g_m can be calculated as previously. Let us assume that, for the valve under test, the g_m was found to be 5mA per V. To find r_a set VR_3 back to minus 2 volts, press S_5 and note anode current. Next reduce the anode voltage to 225, leaving the grid volts constant. Press S_5 again and note change in anode current. The r_a can now be found by dividing the change in anode voltage by the change in anode current. Let us assume that the change in current was 2mA, whereupon r_a

$$\text{becomes } \frac{25V}{2mA} = \frac{25}{.002} = 11.5k\Omega.$$

The amplification factor μ can now be calculated as $\mu = g_m r_a$. Therefore $\mu = 5 \times 10^{-3} \times 11500 = 57.5$.

The second triode section can next be tested in similar fashion.

A set or family of curves may also be taken if required. These are normally composed of two types of curve, grid voltage plotted against anode current for various fixed values of anode voltage, and anode voltage plotted against anode current for various fixed values of grid voltage. In case of tetrodes or pentodes, the G_2 voltage is normally maintained at a constant value throughout the test.

To sum up, the writer has regularly used this valve tester over a period of months and found it extremely useful and reliable both for quick valve checks and more detailed curve analysis. After checking a number of valves and becoming familiar with the controls and test procedure, one finds that not only can valves be checked quickly and accurately, but that a good working knowledge of their function and characteristics is soon assimilated.

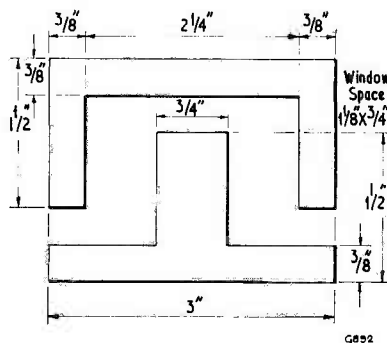

Fig. 7. Laminations employed in the prototype for T_2 and T_3

Transformers T_2 and T_3 —Winding Details

Both transformers T_2 and T_3 have similar primaries and are wound on similar laminations. They are wound on a $\frac{3}{4}$ in square core, the laminations being type 60A Stalloy. The dimensions of the laminations are given in Fig. 7.

The primary winding in either T_2 or T_3 consists of 2,120 turns for 230V mains, 2,270 turns for 240V mains, and 2,400 turns for 250V mains. This is wound with 38 s.w.g. enamelled wire, using one layer of thin paper tissue insulation about every 500 turns.

The secondary winding of T_2 consists of 400 turns of 36 s.w.g. enamelled wire.

The secondary winding of T_3 comprises 680 turns (50V) of 22 s.w.g. enamelled wire tapped at 55, 68, 86, 172, 205, 272, 354, 422, 475, 530 and 612 turns. These taps correspond to heater voltages of 4, 5, 6.3, 12.6, 15, 20, 26, 31, 35, 39 and 45 respectively.

(Conclusion)

A.E.I. Equipment for new British Railways Testing Station

British Railways Eastern Region has placed a contract with Associated Electrical Industries Ltd. covering electrical loading equipment and a communication system for the new diesel-electric locomotive testing station now being built at Doncaster. When completed this station will be capable of testing a range of twenty-one different locomotives, from small shunters to 3,300-h.p. "Deltics".

Testing will be carried out from two A.E.I. control desks mounted in a control room overlooking the interior of the station. The desks will control the contactors on the fan-cooled loading resistance banks and will also carry test instrumentation. They will be equipped with an A.E.I. Clearcall system enabling two-way speech communication between either control desk and its associated testing position; or when necessary each control desk can communicate with both testing positions.

An A.E.I. type RP loading resistor, in which the resistance strip is edgewise wound and ceramic insulated from the central steel mounting strips, will be mounted on two banks, each with a dissipating capacity of 2,000 h.p. Tappings can be varied on-load by means of contactors mounted on the resistor banks which, in conjunction with the changeover switches and links in the termination cubicles, will enable either one Deltic locomotive to be tested alone, or two locomotives of 2,000 h.p. maximum, by using both resistor banks separately.

Turns-Time Relationship for Magnetic Tape

By **R. S. CHILDS** B.Sc. (Eng.)

MOST MODERN TAPE-RECORDERS ARE FITTED WITH a revolutions counter on the feed spool which is used as a "place" indicator, but it is often required to know how much recording time remains. One way of finding this is to calibrate the counter against time, but it was thought more accurate and interesting to find a theoretical expression and hence complete a table relating counter reading to time.

Theory

- Let N be number of turns on full spool
- a be internal radius of spool (inches)
- R be external radius of tape on full spool (inches)
- S be tape speed (inches per second)
- t be recording time remaining on spool (minutes)

- n be number of turns remaining on spool
 - l be length of tape remaining on spool (inches)
 - r be external radius of tape remaining on spool (inches)
 - d be thickness of tape (inches)
- Then $l = 2\pi n \times \text{average radius of tape}$
- $$= 2\pi n \left(\frac{a+r}{2} \right)$$
- $$= \pi n (a+r) \dots \dots \dots (1)$$

now $d = \frac{R-a}{N} = \frac{r-a}{n}$

$\therefore r = \frac{n}{N} (R-a) + a$

Substituting in (1), $l = \pi n \left[2a + \frac{n}{N} (R-a) \right]$

TABLE I
7in spool, 1,200ft tape

Counter Reading	Time (min.) × 2 for 3½ in/sec × 4 for 1½ in/sec
0	31.4
50	29.0
100	26.8
150	24.6
200	22.6
250	20.6
300	18.7
350	16.8
400	15.1
450	13.4
500	11.8
550	10.2
600	8.8
650	7.4
700	6.1
750	4.9
800	3.8
850	2.7
900	1.7
950	0.8
1,000	0

TABLE II
7in spool, 1,800ft tape

Counter Reading	Time (min) × 2 for 3½ in/sec × 4 for 1½ in/sec
0	47.1
75	43.5
150	40.2
225	36.9
300	33.9
375	30.9
450	28.1
525	25.2
600	22.7
675	20.1
750	17.7
825	15.3
900	13.2
975	11.1
1,050	9.2
1,125	7.4
1,200	5.7
1,275	4.1
1,350	2.6
1,425	1.2
1,500	0

TABLE III
7in spool, 2,400ft tape

Counter Reading	Time (min) × 2 for 3½in/sec × 4 for 1½in/sec
0	62.8
100	58.0
200	53.6
300	49.2
400	45.2
500	41.2
600	37.4
700	33.6
800	30.2
900	26.8
1,000	23.6
1,100	20.4
1,200	17.6
1,300	14.8
1,400	12.2
1,500	9.8
1,600	7.6
1,700	5.4
1,800	3.4
1,900	1.6
2,000	0

$$\text{now } t = \frac{1}{60S}$$

$$\therefore t = \frac{\pi n}{60S} \left[2a + \frac{n}{N} (R - a) \right] \dots\dots\dots(2)$$

Taking $a = 1\frac{1}{8}$ in, $R = 3\frac{3}{8}$ in (for a 7in spool), $S = 7\frac{1}{2}$ in/sec., $N = 1,000$ (typical value for 1,200ft tape) the equation simplifies to

$$t = \frac{\pi n}{200} \left(1 + \frac{n}{1,000} \right)$$

This is used to calculate Table I.

Note that the counter reading is $(N - n)$ if the counter is set to zero at the beginning of the tape.

Tables II and III for 1,800ft and 2,400ft tapes on 7in spools have been derived by multiplying both columns of Table I by 1.5 and 2 respectively. The value of N for a particular recorder depends on the method of coupling the counter to the feed spool. A 7in reel of 1,200ft tape should be run through the recorder to determine N . If N is not 1,000, simply multiply both columns of each table by the ratio, e.g. if $N = 1,050$, multiply by 1.05.

For any other size of spool, the tables would have to be recalculated using equation (?) since the values of "a" and "R" are different.

If preferred, the results can be given in graphical form. It is suggested that the tables or graphs be mounted in the recorder lid for easy reference.

Radio Topics . . .

By RECORDER

PERHAPS I'VE BEEN UNLUCKY BUT, whenever I tackle the repair of a radio or television receiver these days, there occurs one moment which I have learned to dread more than anything else. This is the time when, during disassembly, I have to remove the knobs!

In the old days receivers were fitted in solid wooden cabinets with chassis built like battleships, and the process of taking off the knobs was a very minor episode in the general procedure of lugging out the works. At that time, knobs were secured with grub-screws which were easily loosened, and they could be removed in a jiffy.

Nowadays, we live in the age of the Spring-Loaded Knob. Modern commercial receiver knobs employ nothing so convenient as a grub-screw, and they are fixed, instead, by leaf springs inserted into the hole of the knob. The plastic material of the knob bears on the round section of

the control spindle, whilst the spring presses against the spindle flat. In *really* horrible cases the knob has several axial slots along its length, whereupon the plastic itself is sprung against the surface of the spindle by means of an outside C-spring.

Almost all modern commercial valve receivers have "live" chassis, and their knobs must be sufficiently secure on the spindle to prevent their being accidentally pulled off. This point is covered by British Standard 415 (Safety Requirements for Radio or other Electronic Apparatus) which states that all knobs on "live" equipment should be capable of withstanding an axial pull of 10Kg (=22.05lb) for one minute.

What Happens in Practice?

All this is very well in theory and I, for one, would be quite happy if all I had to do, when removing

spring-loaded knobs in present-day receivers, was to apply an axial pull somewhat in excess of 10Kg. In practice, though, the pull required to remove *some* knobs is almost fantastically greater than this figure. Also, many knobs have a very flimsy construction and are liable to break if excessive tension is applied to their periphery. A further fact is that the spindle bush inside the receiver is frequently secured to a particularly unsubstantial mounting, whereupon the latter becomes distorted out of shape whilst pulling a really tight knob. There is the final point that, in many instances, the only purchase one can obtain opposing the direction of pull is against the front surface of a plastic cabinet.

However, I don't want to break into an impassioned diatribe against the designers of spring-loaded knobs (although I must confess I feel like it sometimes). I shall, instead,

recount an almost unbelievable instance I encountered recently with a receiver of well-known make. This set had not had its knobs removed since it was purchased some three or four years earlier.

The receiver had four knobs of sensible design and, although they were quite stiff, the first three came off without an excessive amount of trouble. Then I came to knob No. 4, to find that this was quite immovable, either with the fingers or with a piece of stout cord passed under the boss. It quite simply refused to shift. Worse, it was fitted to a potentiometer inside the cabinet which was mounted on a flimsy strip of metal, the latter being secured to a printed circuit board. I had not shifted the knob on the spindle by my efforts up to date, but I *had* bent the potentiometer mounting through an eighth of an inch or so. I next tried to hold the potentiometer on the inside whilst I once more tugged at the knob. The idea was to prevent the mounting bracket from becoming further bent, but my efforts were completely unsuccessful. That knob was *fixed!*

If I was ever to get the chassis out of its cabinet at all there were now two courses open to me. I could either break the knob off, or I could be very wicked and try the effect of leverage against the front of the cabinet. I chose the latter and, employing a piece of wood to spread the pressure across the cabinet face, I very carefully applied a pair of angled pliers to the boss of the knob. This resulted in ominous creaking noises but, after applying very firm pressure, I found that the knob was finally beginning to move. What next puzzled me was that, although I had got the knob started, it was still as stiff as ever. I had to continue with the leverage idea, working very slowly and very, very carefully, for at least several minutes before that knob finally came away from its spindle. Fortunately, there was no noticeable damage to the cabinet front despite the maltreatment I had subjected it to, and in this respect I had been lucky.

I repaired the set and, before putting the chassis back into the cabinet, decided to give the offending potentiometer spindle a touch with

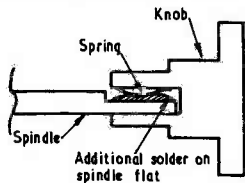

E265

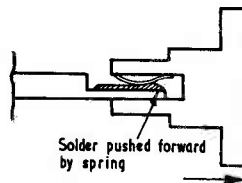

E266

a file so that the knob could be refitted under normal pressure. Whereupon I found—believe it or not—that *the flat had been built up with soft solder*. Furthermore, the spindle was still a very tight fit even after I had removed the solder! I append two diagrams showing the effect. Fig. 1 shows the solder as it probably was before I started removing the knob. In the process of removal I must have pushed some of the surface solder along with the spring, as in Fig. 2. This would account for the continuing stiffness.

Due to the history of the set, that solder *must* have been put on at the factory where the receiver was made. Presumably, a number of potentiometers with undersize spindles had been received when supplies were short, and the Production Department must have obtained the O.K. from Inspection to carry out this incredible bodge. I can visualise a girl setting to work on the spindles with a whacking great iron and unlimited solder, the soldered potentiometers then being rushed to the lines to keep production going. Of course, the fact that this treatment would cause some of the spindles to become practically fixed for ever in their knobs probably never occurred to anyone.

Silicon Rectifiers

Unusual applications for silicon rectifiers seem to be popular these days. For instance, in the last September issue we had Smithy the Serviceman recommending that a BY100 rectifier be inserted in series with a soldering iron to enable the latter to run at half power during periods when it was not wanted. And, in last month's issue, G. A. French (who can always be relied on to provide us with a really ingenious application) showed how silicon rectifiers could be inserted in a.c. series heater circuits.

Silicon h.t. rectifiers of the BY100 type have been entering the domestic equipment scene at the rate of one per television receiver for some time now, and this class of rectifier has become that which is most commonly encountered, particularly in servicing circles. There are, however, quite a few silicon rectifiers available to the home-constructor which have a maximum peak inverse voltage

rating of 400 only (as compared with the 800 volt figure for the BY100) together with a maximum average forward current of 500mA, and these would be quite suitable for connecting in series with a soldering iron or a heater chain of the type described in last month's "Suggested Circuit". A typical rectifier having a maximum p.i.v. of 400 and a maximum forward current of 500mA is the OA210, which has the same dimensions as the earlier BY100 (whose threaded stud has been removed in the current version). I note that several silicon rectifiers having the 400 p.i.v. rating are listed at quite low cost in, for instance, the component catalogue issued by Henry's Radio Ltd.

As I stated just now, the BY100 has a maximum p.i.v. rating of 800. This high rating is not needed, however, if the diode is employed as a half-wave rectifier feeding a resistive load. In this instance, the p.i.v. applied to the rectifier is the peak value of the applied a.c. which, for 250 volt mains, is 353 volts; a figure sufficiently below the maximum 400 volt rating to allow the use of an OA210 or equivalent for the soldering iron and heater chain applications. I should point out, though, that when a 400 p.i.v. diode is employed, the load must be *purely* resistive. The addition of any reservoir capacitance after the rectifier could cause the p.i.v. given by the circuit to rise above 400, with the result that the rectifier could break down immediately.

Points From The Post

Smithy's half power soldering iron circuits last September have also caused a response from L. H. Brown of Abingdon. He writes to state that, in the past, he has used an old desk telephone stand (metal, of course) as an iron rest. The cradle contacts then carried out the half power switching.

Another letter, from G. R. Pendrill of Edinburgh, also has to do with "In Your Workshop", and it has given us all quite a chuckle in the office. Mr. Pendrill asks:

"Is Dick's face made of 'Pan-lume' or hasn't he checked the insulation on his test prods recently?"

The reason for this query appears in column 2, page 352, of the December issue.

"... So' [said Smithy] 'slap your testmeter across the bulb and the resistor and see what happens.'

"Dick did as he was bid, and his face lit up."

And that, I think, caps all comment for this month very nicely!

A TRANSISTORISED ELECTRONIC

ORGAN

(Further Notes)

By S. ASTLEY

Since the series of four articles describing a transistorised electronic organ (which ended in the November 1962 issue) was written, our contributor has carried out further investigations and experiments. These are now detailed here, and will bring readers fully up to date with current developments

ONE OF THE FASCINATING ASPECTS OF ELECTRONIC organ construction and design is the wide and unexplored field which is available to the experimenter. The organ which was described in the August, September, October and November 1962 issues of *The Radio Constructor* has proved to be no exception, and the writer has carried out a number of experiments and modifications which, together with suggestions for the future, are detailed in the notes given here.

The Crescendo Pedal

In "Suggested Circuits" No. 142¹ G. A. French describes a volume control incorporating an ORP12 light dependent resistor. This is illuminated by a low voltage lamp and offers varying resistance in a volume control circuit according to the brightness of the lamp. The circuit shown in Fig. 2 of G. A. French's article would provide an excellent crescendo pedal control, since not only could the l.d.r. be placed in the stop tray, and thereby obviate long leads and hum trouble, but also because the control would be completely noiseless. An 8 volt 0.04A lamp may be used, and should be supplied from the d.c. unbalanced side of the power supply (i.e. from C₁ of Fig. 7 in Part 2 of the series, September issue). The lamp potentiometer would be coupled to the pedal by rack and pinion.

The Master Oscillators—Additional Octave

The writer is in process of extending the 4ft stops upwards by a further octave in order to overcome the existing octave repetition above C⁶. (See Table 1, Part 1, August issue.) After C⁶ the 4ft stop carries on from 72 up to 84. So far as the 2½ft stop is concerned this now carries on, after F⁵, from 72 up to 84 at F⁶. There is no need to run back an octave after F⁶ on the 2½ft stop, and the manual

keys from 55 to 61 are left blank for this stop. This is because their effect at these higher frequencies is not warranted. Readers will appreciate the added brilliance given by taking this step, since the fundamental is now transferred up to some 4 kc/s.

This change will necessitate the construction of 12 new master oscillators, whereupon the 12 previous master oscillators will function as dividers. These revert to the circuit given in Fig. 11 (Part 2, September 1962 issue); and that for C⁷ requires the following values: C₁ approximately 0.05µF, C₂ 500µF, and R₂ 4.7kΩ.

The Master Oscillators—Stability

Although the stability of the master oscillators described in the preceding articles is excellent, it was decided to take advantage of the modern ferrite pot cores which are now available for the new oscillators. The ideal cores would be Mullard "Vinkor" types in the lower-frequency Yellow Range, such as the LA2002 with a 2-section former. The cores are adjustable and may be used for tuning.

However, the writer is employing some Ferro-cube pot cores which are readily obtainable on the surplus market. These are 1½in in diameter and the retaining case is marked "Type 35". (It has been ascertained that they are type LA7.²) When using these pot cores for the new oscillator transformers, the primary consists of 200 turns of 40 s.w.g. silk or rayon covered wire, the rest of the former then being wound with 500 turns of the same wire to provide the secondary. The circuit in which the pot core transformers are employed is given in Fig. 42, which is similar to that for the previous master oscillators in Fig. 8 (Part 2, September issue). A 0.01µF mica capacitor in the C₁ position should allow the tuning range to cover C⁸, but if this does not happen the number of turns on the secondary

¹ G. A. French, "Suggested Circuits No. 142—Remote Volume Control Employing an L.D.R." *The Radio Constructor*, September 1962.

² These pot cores are available from G. W. Smith and Co. (Radio) Ltd., 33-4 Lisle Street, London, W.C.2, or Crystals and Components Ltd., 2-4 Earlsam Street, London, W.C.2.

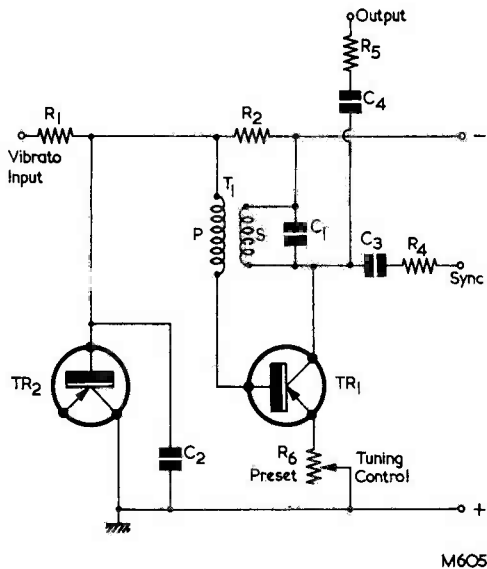

Fig. 42. The new master oscillator circuit for C8, employing pot core transformers. This is similar to that for the previous master oscillators given in Fig. 8 (Part 2, September 1962 issue) but it should be noted that TR₂ now replaces R₃

should be reduced accordingly. Some adjustment can also be given by inserting packing between the two halves of the pot core, but the final assembly should always be clamped up tightly and securely to prevent drift. The use of ferrite pot cores ensures a higher Q, together with better stability at the higher frequencies involved.

The surplus pot cores employed by the writer have no adjustable slugs and it is necessary to retain the tuning control given by R₆ in Fig. 42. If the Mullard "Vinkor" pot cores are employed, tuning may be effected by their adjustable cores, in which case R₆ may be replaced by a 2kΩ high-stability resistor shunted by a 2μF electrolytic capacitor. The same number of turns are employed in transformers using the "Vinkor" pot cores as in transformers using the surplus pot cores.

It should be noted that pot cores are only employed in the master oscillators, since these affect the frequency stability of the total instrument.

Fig. 42 differs from the previous master oscillator circuit given in Fig. 8 in that R₃ is replaced by the base-collector junction of transistor TR₂. The emitter is not connected into circuit, and the base-collector junction functions as a diode. This arrangement provides temperature stability. When temperature rises the resistance offered by TR₂ falls, thus opposing the rise in current in TR₁ by reducing its base bias. The reverse effect occurs during low ambient temperatures. Ideally, TR₁ and TR₂ should have the same characteristics, whereupon they will balance each other more precisely.

Percussion Keying

For entertainment purposes, such as when playing

Components List (Fig. 42)

Resistors

- R₁ 47kΩ ¼W
- R₂ 33kΩ ¼W
- R₄ 270kΩ ¼W
- R₅ 270kΩ ¼W
- R₆ 3kΩ w.w. pre-set. (See text for alternative when using "Vinkor" pot cores.)

Capacitors

- C₁ 0.01μF mica
- C₂ 0.05μF miniature 150 w.v.
- C₃ 0.005μF miniature 150 w.v.
- C₄ 500pF

Transistors

- TR₁ XB101 or XB102
- TR₂ XB102 (diode connected)

Transformer

- T₁ See text

dance music, it is desirable to have a sharp attack or percussive effect applied to the note, as shown in Fig. 43 (a). Alternatively, a reverse effect is possible, as in Fig. 43 (b), in which the note builds up relatively slowly after the key contact has been made. This second effect would be very authentic if applied to the pedal board since, when blowing large pipes in practice, the sound does not appear immediately.

The sharp attack shown in Fig. 43 (a) can be used to give a variety of effects including plucked string, banjo, mandoline, amplitude tremulant and, in conjunction with the crescendo pedal, chimes. A somewhat detached method of fingering the keys is necessary (for both fast and slow attacks) but this applies to other systems offering similar facilities. Most methods of obtaining percussion require an entirely separate set of contacts under the keys but this is not necessary with the writer's system, which is extremely versatile and simple. The secret in the

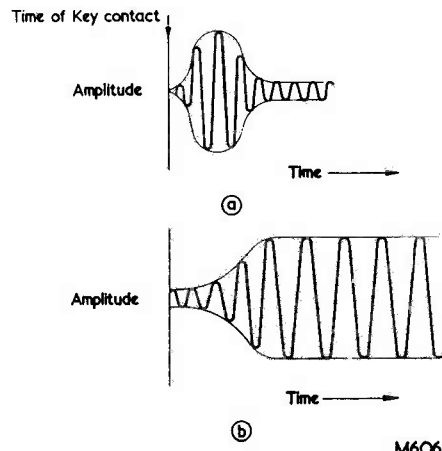
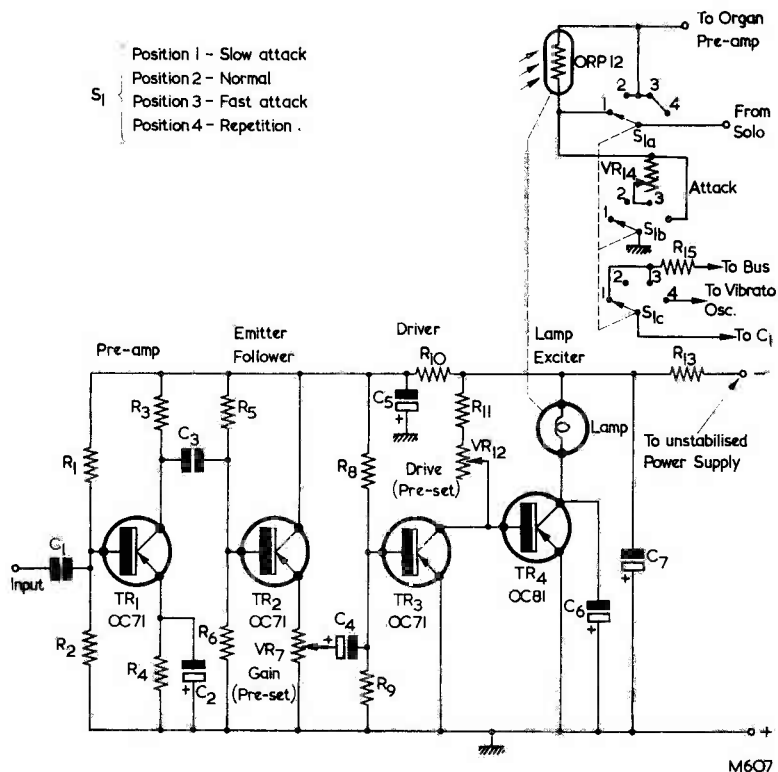

Fig. 43 (a). The waveform given by sharp attack keying. (b). A reverse effect, with which the attack is slow

Fig. 44. A circuit which provides Slow Attack, Fast Attack, and Repetition



Components List (Fig. 44)

Resistors

(All fixed resistors $\frac{1}{4}$ W unless otherwise stated)

R ₁	56k Ω
R ₂	10k Ω
R ₃	4.7k Ω
R ₄	2.2k Ω
R ₅	47k Ω
R ₆	10k Ω
VR ₇	5k Ω pre-set
R ₈	56k Ω
R ₉	10k Ω
R ₁₀	1k Ω
R ₁₁	4.7k Ω
VR ₁₂	5k Ω pre-set
R ₁₃	150 Ω $\frac{1}{4}$ W
VR ₁₄	50k Ω log track
R ₁₅	33k Ω

Capacitors

C ₁	0.25 μ F
C ₂	8 μ F 12 w.v.
C ₃	2 μ F 12 w.v.
C ₄	2 μ F 12 w.v.
C ₅	100 μ F 12 w.v.
C ₆	8 μ F 12 w.v.
C ₇	100 μ F 12 w.v.

Transistors

TR_{1, 2, 3} OC71 (or XB102, XB103)
TR₄ OC81

Light Dependent Resistor

L.D.R. ORP12

Lamp

M.E.S. 6.3V 0.04A

Switch

S_{1(a),(b),(c)} 3-pole 4-way

writer's system is the use of a light dependent resistor.³

The circuit of the unit providing the effects of Figs. 43 (a) and (b) is given in Fig. 44. In this diagram the signal from the 8ft or 4ft main bus (the writer used the 4ft bus) is applied, via R₁₅ and S_{1(c)} (in positions 1 and 3), to C₁. The signal is amplified by TR₁ and fed to the emitter follower TR₂. It is then passed, via the gain control VR₇, to driver TR₃, and thence to TR₄. A 6.3 volt 0.04A

lamp is connected in the collector circuit of TR₄. When a note is played a signal is present on the bus whether stops are selected or not, and the amplified version fed to TR₄ causes this transistor to bottom, whereupon most of the supply voltage appears across the lamp. The lamp illuminates the ORP12 l.d.r., whose resistance then falls.⁴ The circuit takes advantage of the fact that the bulb

⁴ Owing to the non-linear characteristic of the lamp filament, there may be somewhat heavy dissipation in TR₄ under half-drive conditions. It is advisable, therefore, to fit this transistor with a heat sink.

³ This is the subject of a provisional patent by the writer.

takes a small time to light fully. Also, the l.d.r. is sluggish, with the result that it exhibits its reduced resistance after a slight delay.

When S_1 is set to position 1 the l.d.r. appears in series between the output from the Solo manual and the input to the associated pre-amplifier. This gives the slow attack effect of Fig. 43 (b), the l.d.r. giving a high level of attenuation until it becomes fully illuminated.

If S_1 is set to position 3 the fast attack of Fig. 43 (a) is given. In this instance the l.d.r. is connected, in series with VR_{14} , across the output from the Solo manual, whereupon an increased level of attenuation is provided when the l.d.r. has achieved its low resistance. VR_{14} controls the amount of attenuation provided. The value chosen for VR_{14} is suitable for the writer's organ, but it may need variation if the circuit is used in other instruments having different impedances. If VR_{14} requires a critical setting to obtain the desired result, a second pre-set variable resistor may be connected across it (or in series with it) to function as a "fine control".

If the vibrato oscillator is fed into the input of the amplifier of Fig. 44 instead of to the master oscillators, the lamp will flash in sympathy with the vibrato frequency. For high resistance settings of the Attack control, RV_{14} , the effect will be that of an additional amplitude modulated vibrato. (The master oscillators are frequency modulated by the vibrato oscillator.) At low resistance settings of VR_{14} a repetition effect, similar to that of a mandoline, is given at vibrato frequency. This is provided by position 4 of switch S_1 .

When S_1 is set to position 2 the output of the Solo manual is fed directly to the pre-amplifier, and no input is fed to the amplifier of Fig. 44. In consequence, organ operation is normal.

It will be noted that an $8\mu F$ capacitor, C_6 , connects between the collector of TR_4 and the positive supply line. This capacitor was necessary as, otherwise, the l.d.r. became modulated by the particular frequency being played. The bulb was actually conveying the tone to the l.d.r., but the resultant sound was distorted.

It should be appreciated that the system functions admirably in providing the effects selected by S_1 . Control is simple and noiseless, because there are no contacts. The output of the Accompaniment manual should be applied to its own pre-amplifier, so that this manual is unaffected by the percussion effect.

Another advantage given by the circuit is that it can be of considerable help during tuning up. When tuning in fifths it is possible to count the beats, sharp or flat, by carefully observing the lamp. This facility can be particularly useful to those who are not gifted with a good sense of pitch.

Amplifiers

The advantages of a second amplifier and set of speakers are obvious. A single amplifier could, for instance, be used for each manual. Alternatively, a special amplifier could be made for the pedal notes, this employing large coupling capacitors up to $0.5\mu F$



or so, and similarly large screen-grid decoupling capacitors. A 15in speaker with such an amplifier and the slow attack facility of Fig. 44 would make an excellent pedal department.

On the other hand, a single manual organ could be made up using one of the many excellent transistorised power amplifiers described in this journal, with provision for headphones for "silent" practice. Such an organ should be capable of fitting into a suitcase.

Leakage Current

The leakage current for the master oscillator transistors should not exceed $10\mu A$.⁵ A very simple method of checking leakage current employs the circuit given in Fig. 45.

The $12k\Omega$ limiting resistor in this circuit ensures that a faulty transistor will not damage the meter when the battery is initially connected. The $12k\Omega$ resistor is short-circuited for the final leakage reading.

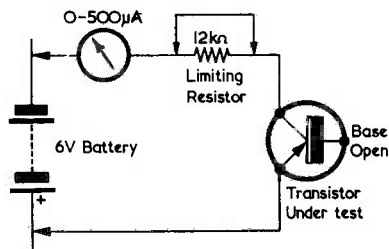

Fig. 45. Checking transistor leakage current

Power Supply

In response to enquiries from readers, the writer would like to make it clear that the only sections which should be run from the stabilised supply are

⁵ This was given, incorrectly, as 10mA in Part 2, September 1962 issue.—Editor.

the master oscillators and dividers. This is to keep the load as light as possible. All other pre-amplifiers, etc., are run from the unstabilised supply (i.e. from C_1 in Fig. 7). Each of these may be individually decoupled by a 100Ω resistor and a $100\mu\text{F}$ capacitor.

Errata

In Fig. 7 (September 1962 issue) C_2 is listed in the components list as $100\mu\text{F}$ instead of $1,000\mu\text{F}$.

Figs. 25 and 26 (October 1962 issue) are transposed.

TOP BAND CONVERTER

By K. LAYCOCK

A simple and inexpensive converter which, in combination with an R1155 receiver tuned to 465 kc/s, can offer a high degree of sensitivity on the 160 metre band

DUE TO THE FACT THAT MOST OF THE R1155 communications receivers which are available do not cover the 160 metre amateur band, a converter was designed to enable these otherwise good receivers to do so. Although the R1155 was originally designed for installation in aircraft, a number of short wave enthusiasts have converted them for use with mains power units. As the converter described here does not require a great amount of power, it will be possible, in most cases, to run it from the power pack employed for the R1155.

The converter has been in operation at the author's station for a few months and has proved to be a most useful piece of equipment. It was originally intended to enable the author to listen to the R.S.G.B. slow Morse transmissions which are only radiated on this particular band. A number of short wave listeners will be in the same position and, even if the converter is only used once a week for these transmissions, it will prove to be an invaluable unit.

Components List

Resistors

- R_1 470 Ω
- R_2 220k Ω
- R_3 47k Ω
- R_4 22k Ω

Capacitors

- C_1 500pF variable (ganged with C_7)
- C_2 60pF trimmer
- C_3 0.01 μF
- C_4 100pF
- C_5 0.01 μF
- C_6 60pF trimmer
- C_7 500pF variable (ganged with C_1)
- C_8 2,500pF silver mica
- C_9 0.1 μF

Coils

- IFT 465 kc/s
- L_1, L_2 Osmor QA4
- L_3, L_4 Osmor QO4

Valve

- V_1 VR57 (CV1057, EK32)

Circuit

The circuit, given in the accompanying diagram, has been designed around the VR57 valve.¹ This valve is readily available on the surplus market and there should be no difficulty in obtaining one very cheaply. The coils used will produce an output around 465 kc/s. When the receiver is tuned to this

¹ The VR57, or CV1057, has an International Octal base. The commercial equivalent is the EK32.—Editor.

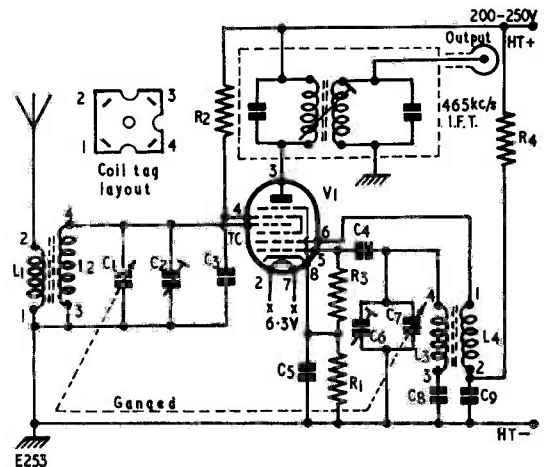

frequency (Range 4 on the R1155), signals from the 160 metre band will be heard. In fact, the receiver and converter function as a double superhet with the first i.f. on 465 kc/s and the second (that of the receiver) on 560 kc/s. Many coils were tried but the prototype seemed to work best with Osborn QA4 and QO4 coils, which give a coverage from 1.3 to 4.3 Mc/s. The 465 kc/s i.f. transformer may be of any type, although it should preferably have iron dust cores.

Construction

A ready-built chassis was used. This may be of any dimensions, its size being determined by the size of the i.f. transformer used. It is an advantage if the chassis is housed in a metal box to reduce possible i.f. breakthrough. Coaxial cable is used to connect the converter to the mains receiver. This cable should be as short as possible and should be connected to the aerial and earth terminals of the receiver in the usual way.

Power Supplies

The VR57 only requires 6.3 volts at 0.2 amps and 250 volts at 4.3mA and, as stated earlier, adequate power may be obtained from the receiver power pack. Failing this, a simple power pack, built on a separate chassis or accommodated on the converter chassis, can be employed. It must be remembered that, when using the receiver power pack the h.t. negative line in the R1155 is not connected to its chassis. No direct connection should, therefore, be made between the chassis of the converter and the chassis of the receiver. A 0.1 μ F capacitor may be connected between the two chassis, and the

co-axial i.f. output of the converter should have its outer braid connected to chassis at the receiver end only.²

Adjustment and Operation

After allowing a little warming up time, the dust cores of the coils should be set, using a non-metallic tool, so that they are level with the tops of the coil formers. The receiver should be tuned to a quiet spot around 465 kc/s, whereupon the main tuning may be carried out by means of the converter tuning capacitor. To align the i.f. transformer, the converter should be tuned until a steady signal, preferably from a signal generator, is picked up. The transformer cores should then be adjusted, using a non-metallic tool, for maximum signal strength.³ Trimming (at the high frequency end of the tuning range) may next be carried out by adjusting C₂ and C₆; and padding (at the low frequency end of the tuning range) by adjusting the cores in L₁, L₂ and L₃, L₄.

Although the converter was originally designed for use with the R1155, there is no reason why it should not be used with any other receiver which covers 465 kc/s. If the converter is set up and used correctly, reception of Top Band should leave nothing to be desired and may be better than is given by a number of commercial receivers at these frequencies.

² It might be preferable, at the converter end, to connect the outer braid to the converter chassis via the 0.1 μ F capacitor just mentioned.—*Editor*.

³ Because of the additional capacitance connected across the secondary of the i.f. transformer, it may be necessary to reduce any fixed capacitance across this winding before satisfactory tuning can be achieved.—*Editor*.

VIDICON TELECINE EQUIPMENT FOR B.B.C.

Following a recent order for a considerable quantity of television studio caption equipment, the British Broadcasting Corporation has placed a contract with Marconi's for the supply of four simplex 35mm vidicon telecine systems.

In essentials, the telecine equipment consists of a BD896 Mk. IV vidicon camera mounted on the front of a 35mm projector mechanism. Both are mounted on a common table, with a single lens projecting the film image on to the vidicon tube face. The operator's position is formed by two standard studio rack cabinets type 4785.

The BD896 vidicon camera channel has been designed primarily for telecine work, and the high quality of its output has been assured by using a vidicon tube with (1,000 volt) wall voltage. (English Electric Valve Co. P820 vidicons have been used in the development of this camera.) Particular attention has been paid to the problems associated with the use of either positive or negative film stock; there are separate pre-set gamma controls for each, with instant changeover.

For B.B.C. requirements the equipments are switchable to either 405 or 625-line operation, but similar units are available for 525-line standards also. Facilities are provided for the use of COMOPT (optical sound-on-film), COMAG (magnetic sound-on-film) or SEPMAG (separate magnetic sound track) operation.

Should colour operation be required, the BD896 camera is removed and replaced with a Marconi 3-vidicon colour camera.

A Radio Astronomy Receiver

for the Advanced Constructor

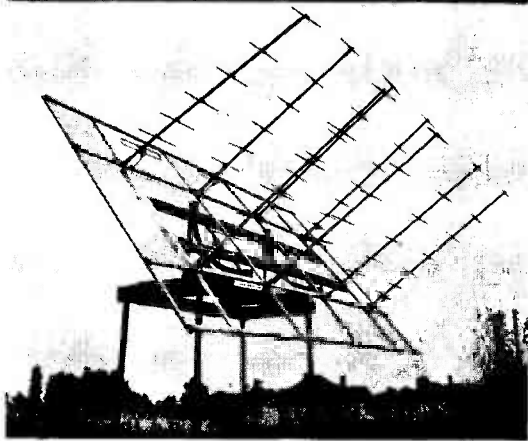

The Aerial

THE AERIAL SELECTED FOR THIS TELESCOPE IS THE corner V, this choice being made for the reasons that its mechanical construction is relatively simple and that it can be built quite economically. Electrically it has several advantages over the flat sheet reflector, or even the Kooman array. It is possible to predict the polar diagram of this aerial with very considerable accuracy, and this is an important point when it is used for radio astronomy.

The corner reflector has been investigated by a number of workers, notable among these being Kraus in America. Kraus showed that, provided the sides of the reflector were at least one wavelength long, satisfactory agreement was possible between the experimental polar diagram and those that were calculated using the simple image theory which regarded the sides as having infinite extent. The departure of the polar diagram from the ideal is very slight, although it may be a little wider or a little narrower than the calculation made on the final design. It is however an easy aerial to test empirically and the slight difference between the theoretical and final empirically derived polar diagram is very small.

Reference to the diagram in Fig. 14 shows a half-wave dipole which is placed parallel to the

Part 3. The Aerial System

By Frank W. Hyde

F.R.S.A., F.R.A.S., M.S.E.

This is the third of a series of four articles written by the foremost amateur authority on radio astronomy in this country. These articles cover the construction and assembly of a complete radio telescope installation.

intersection of the two sides of the reflector. The angle between the planes of the two sides of the reflector is 90° in this instance. The dipole must lie in the semi-angle and there will then be two main parameters to be considered: these are the angle between the planes and the distance of the dipole from the apex. If the planes are regarded as perfect reflectors and infinite in extent, the operation of the aerial can be explained very well by image theory.

Taking the basis of the design of this aerial as having two reflecting sheets set at an angle of 90° , with half-wavelength spacing from the apex to the dipole, Fig. 15 shows reflection conditions according to image theory. There will be negative images at B and C, which correspond to the single reflections produced by the rays a and b. In addition, there will be a positive image at D owing to the double reflection represented by the ray c. If four dipoles were spaced and phased as shown, but without the reflectors being present, the group would behave as if it were in fact a corner V. The images B and C would be in phase and the image at D, being one wavelength behind the point of the dipole at A, would reinforce it. Thus, all the images will reinforce the direct signal from the dipole. One dipole, therefore, with corner reflecting screens, becomes equal to four suitably phased dipoles without the conducting screens. The gain of this type of aerial is found to be of the order of 9-10dB along the main axis.

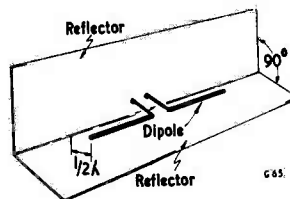

Fig. 14. Corner reflector of 90° , with dipole at intersecting plane and $\frac{1}{2}$ wavelength from apex

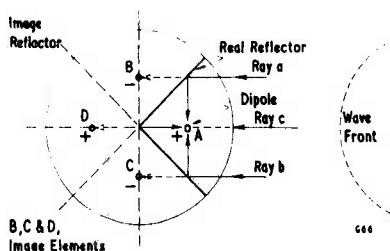

Fig. 15. Showing the image conditions of the corner reflector

Dipole Spacing

Optimum spacing of the dipole from the apex of the corner V is important, although the gain, from quite small spacings out to half a wavelength, is reasonably constant around 10dB. There is, however, a considerable change of impedance over such a range of positions. Over an octave of frequency at the point for which the aerial is designed, change of spacing would produce a change in the resistive component of the dipole from 27 to 123Ω. It will be realised, therefore, that the corner V is a comparatively narrow band aerial.

If the spacing is increased from one half-wavelength to one wavelength the beam splits into two halves and there is a null along the central axis. If the spacing is still further increased to 1.5 wavelengths the gain rises to a value of about 13dB, but there are difficulties arising in that two quite considerable side lobes are produced and, in any case, the size of the reflectors would become unduly large. The optimum spacing is usually a little less

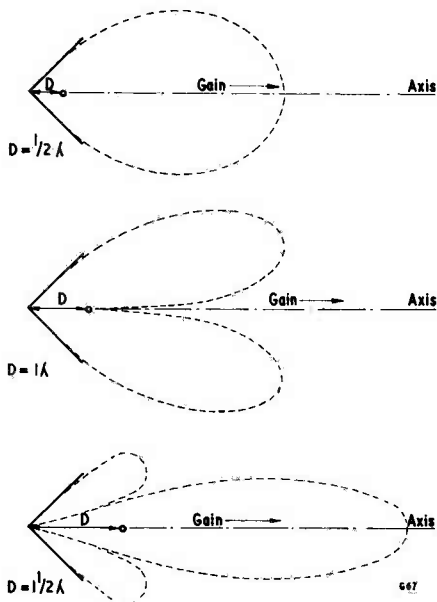

Fig. 16. Polar diagrams resulting from differing spacings

than half wavelength and at a spacing of 0.35 wavelengths the dipole resistive component is about 72Ω. The polar diagrams showing the effect of various spacings are given in Fig. 16.

Charts I and II show respectively the gain and radiation resistance of the dipole and corner reflector for different spacings.

The optimum distance from the dipole to the apex having been decided it is necessary to set the optimum for the other parameter, that is the length of the side of the reflector. It has been shown by Kraus and Moulin that the minimum length of the side should be of the order of 0.7 of a wavelength. In the design of the corner V for this telescope therefore, the lower limit of the operating frequency will be that determined by the length of the side equalling 0.7 of a wavelength. As the units from which the aerial is made have been standardised at 10 x 6ft the lower limiting frequency of the aerial system would be of the order of 135 Mc/s. This figure is mentioned specifically because this is near one of the frequencies for satellite tracking.

The upper limit of use for the aerial will be

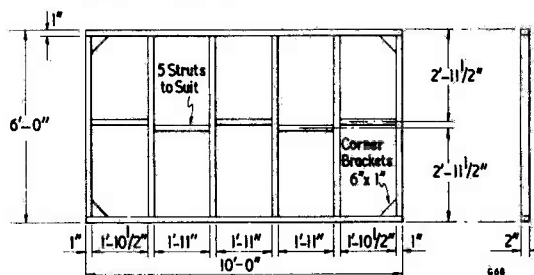

Fig. 17. The standard frame referred to in the text. The material is 2 x 1 in rough sawn wood. The reflecting screen can be single wires spaced 2 in apart or 1 1/2 in galvanised wire mesh

determined by the reflector screen itself. This may be of wire mesh or parallel wires. In the case of parallel wires the distance between the wires will be determined by the upper frequency limit, and the spacing between them should not exceed 1/16th of a wavelength. For the limiting frequency of this aerial it will be of the order of 2in.

If wire mesh is being used a 1 1/2 in mesh would be suitable, since this could then be stretched into position and at no place would the spacing between the links of the mesh exceed 2in. At the high frequency end more than one dipole could be used, of course, whilst at the low frequency end one dipole only would be accommodated. The particular frequency for which the receiver is designed lies at about 216 Mc/s. Details for the aerials and spacing, therefore, will be given for this frequency, and any variation from this figure for use with other receivers can be arranged to suit the user's own requirements.

Aerial Construction

Turning to the construction of the aerials themselves it has already been stated that these consist

of standard units 10ft long x 6ft wide. These are made from 2 x 1in rough sawn timber. Reference to Fig. 17 shows dimensions for a firm and rigid structure; the long sides are constructed from two pieces of timber 10ft in length, and the ends and intermediate members are 5ft 10in in length. Six of these members are used to form each standard frame.

A number of short struts are arranged as shown in Fig. 17, and these are necessary to take the strain when the reflector wires (or mesh) are pulled tight. The actual method of jointing is left to the individual constructor, but here there appears to be two choices, glueing and nailing or glueing and screwing. Corner gussets are used and these are made from 6 x 1in floorboard material.

The assembly can either be finished with wood preservative or given two coats of a good aluminium paint. Aluminium paint is to be preferred for, in

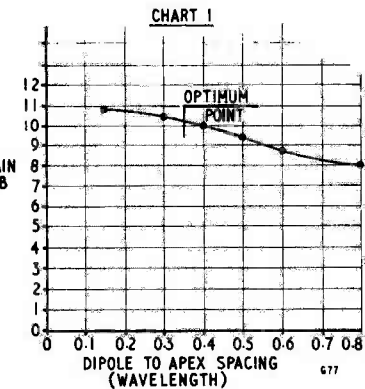
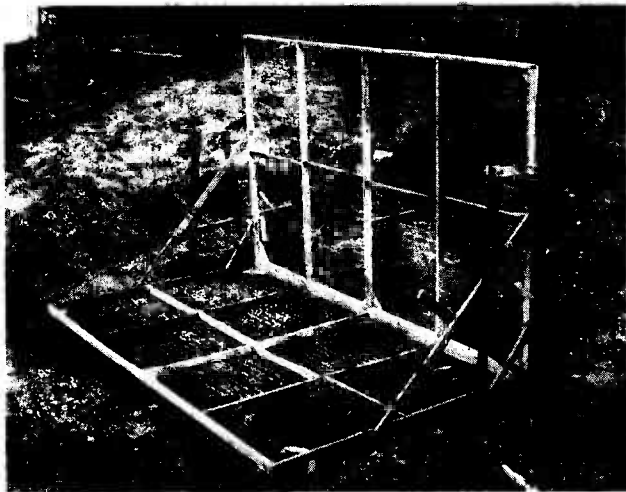

Chart I. Gain of corner reflector over half-wave dipole in free space

The two standard frames fixed together and forming a corner reflector, prior to being mounted to the pivot

the author's opinion, it weathers better than any other preservative treatment.

It should perhaps be noted that although the timber is nominally 2 x 1in there is often considerable variation, and this fact must be taken into account during assembly. The simplest method is to make one face agree over the whole area.

After the paint has dried the reflecting wire (or mesh) may be fitted. It has been recommended that if wire is used the spacing should be approximately 2in.

The type of wire used is entirely optional; galvanised semi-soft steel, about 14 s.w.g., or any one of the many ex-Government wires, such as telephone wire—which is usually steel with some copper or a type of stranded p.v.c. covered wire consisting of several strands of copper and one of steel, can be utilised. This latter appears to be very plentiful on the surplus market at £1 per mile; approximately 400ft will be required for each frame

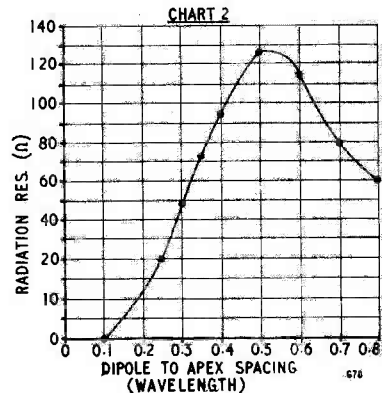

Chart II. Radiation resistance of $\frac{1}{2}$ wavelength dipole in 90° corner reflector

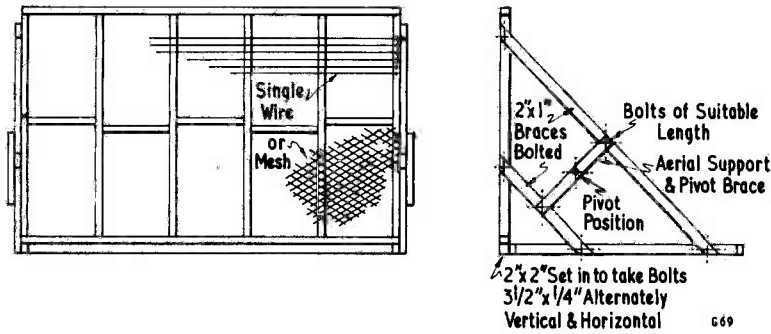

Fig. 18. Two standard frames fixed together to form a corner reflector. The pivot position depends upon the centre of gravity which must be found empirically

of the aerial. The wires are anchored with ordinary wire staples.

It will be found that the most practical way of fixing the wires will be to start from the centre and work out to the outside edges taking care to pull each wire to approximately the same degree of tension.

If galvanised mesh is used for the reflecting screen it will be found to be quite a tricky business fixing this to the frame, and two people will be required to perform the task. The mesh should be 3ft wide and, in this case also, the two centre edges should be fitted first. The mesh must be strained so as to provide a guide for the remainder of the area to be fitted. Care is needed to ensure that the mesh is spread evenly over the whole frame as it

may otherwise buckle after a short period, thereby impairing the efficiency of the aerial at high frequencies.

Two of these frames will be required for each corner V, and one illustration shows a finished unit before being raised to a fixed stand. Fig. 18 shows the arrangement of the end supports and the position of the pivot.

Two alternative methods are suggested for the base of the aerial; Fig. 19 illustrates the first of these, a frame 5ft square and built of 2 x 2in timber with half-lapped joints at the corners which are glued and bolted. On the underside at each corner two diagonal bearers are provided, also 2 x 2in timber, for the support of a wheel and spindle. Four of these wheels are fitted and this enables the

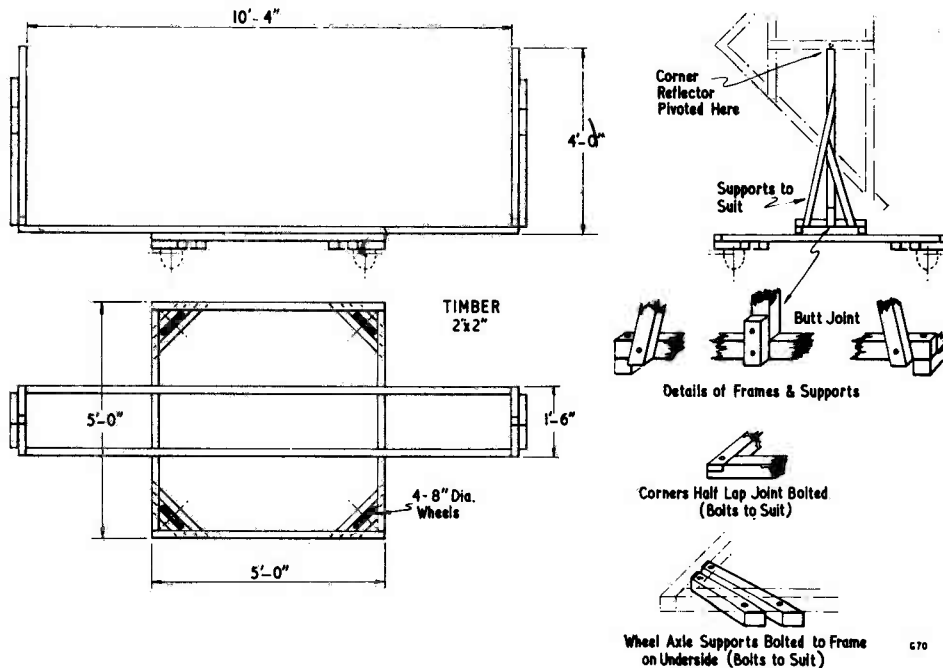

Fig. 19. Base and supports (type 1)

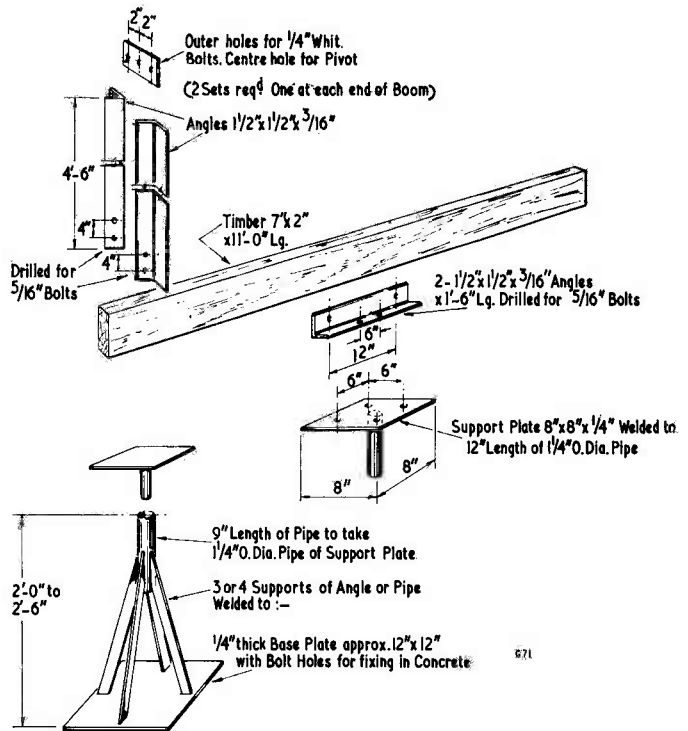

Fig. 20. Corner reflector supports (type 2)

assembly to be rotated in azimuth. On the frame is built a skeleton platform, again of 2 x 2in timber, 18in wide and with a spacing of 10ft 4in between the two uprights, which are 4ft high and carry the pivot for the corner V. The upright is butt-jointed to a cross piece with clamping supports on either side and, again, these are glued and bolted. Two supports to reinforce the vertical pivot support are provided for rigidity; the whole assembly is then bolted to the base.

The aerial proper can be adjusted in altitude and it is suggested that a plastic protractor be fitted

with a plumb bob so that the angle of elevation may be known. The whole of this assembly provides an aerial which can be rotated through 360° in azimuth and 90° in altitude. It can therefore be pointed to any part of the sky.

An Alternative Base

An alternative type of base is shown in Fig. 20. This base consists of a support from 2ft to 2ft 6in in height, with a 9in length of pipe a little over 1½in inside diameter being supported by three or four struts. These struts can be 1in piping, or angle,

The completed aerial mounted on the type 2 base, thus enabling the whole assembly to be aimed at any point of the sky

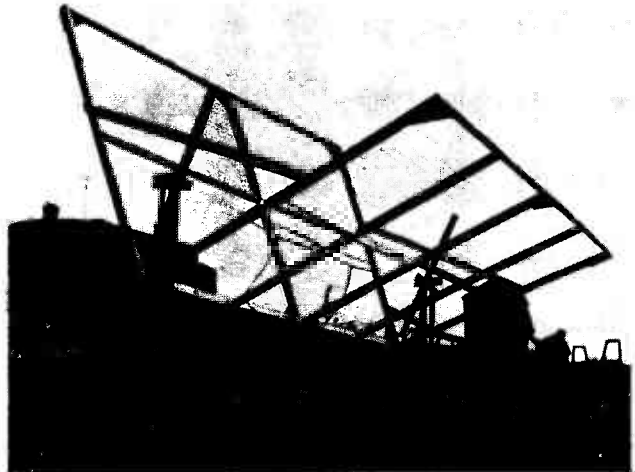

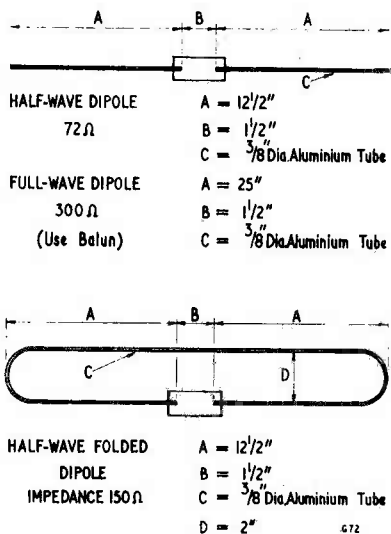

Fig. 21. Alternative dipoles for use with the corner reflector. The centre frequency is 216 Mc/s

attached to a 1/4 in thick plate base about 12 in square, and should be drilled to take fixing bolts set in a concrete foundation.

The rotating part of the unit consists of a boom and supports attached to a support plate, which is free to revolve, with another piece of pipe of a size suitable to fit inside that of the base. This second pipe should be long enough to protrude through the base pipe, thereby enabling a bolt to be passed through it at the bottom to prevent the whole assembly lifting out. This is very important for during a gale, the author had two aerials lifted clean out of their supports and carried some distance away; this bolt will effectively prevent such an occurrence.

Details of the support plate, which is 8 x 8 in and 1/4 in thick, are shown in Fig. 20, together with two angles which are fixed to it. Between these is fixed the main boom. This boom is of timber 11 ft long and 7 in x 2 in in cross-section.

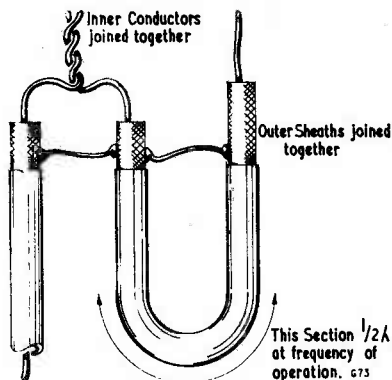

Fig. 22. A balun made from coaxial cable

At each end of this unit is an assembly for the support of the aerial. These assemblies consist of angle irons 4 ft 6 in long, one at each end of the boom and secured with bolts. At the top a piece of quarter inch plate 1 1/2 in wide, or alternatively angle with the web facing outward, is used for the bearing of the aerial pivot.

A further illustration shows a complete assembly and it will be clear from an examination of this how the assembly can be made to point to any part of the sky.

Choice of Dipole

Now that the reflector and its base have been completed the next task is to decide on the type of dipole. In Fig. 21 a number of alternative dipoles are shown with dimensions to suit a centre frequency of 216 Mc/s. At this frequency there are three choices: a simple half-wave dipole suspended in the semi-axis plane and having the dimensions shown in Fig. 21. This can be fed directly with 72 Ω coaxial cable, and it should be emphasised that this coaxial cable must be the best obtainable. The alternative to this is to use a full-wave dipole which will have an impedance of 300 Ω, and in this case a balun will be required. (See Fig. 22.)

Examination of the illustration for the aerial wiring the base of Fig. 20 will show another alternative method of mounting two half-wave folded dipoles; and it is this method which is favoured by the author. The impedance of each aerial is about 150 Ω; the two can be joined in parallel with two equal lengths of low loss coaxial cable, and connected to a quarter-wavelength of 72 Ω coaxial cable.

The linear spacing between the dipoles will vary between 1/3 and 1/2 of a wavelength, and this must be derived by trial and error.

Aerial Pre-amplifier

When the type of dipole to be used has been decided upon, and assembled, the aerial is ready for testing. In order to get the best possible results from the aerial an aerial amplifier is required. At the frequency for which the receiver has been designed, it is important that the best noise figure should be achieved. The amplifier should be sited at the aerial and could be the aerial-head amplifier, transistorised version, manufactured by Belling and Lee Limited, for Band III, channel 11. This requires only a battery and no mains supply in the vicinity of the aerial. The noise figure of these amplifiers is extremely good.

As an alternative, two single valve amplifiers are suggested and these are shown in Figs. 23 and 25. Fig. 23 shows a grounded grid arrangement using a G.E.C. valve, type A2521. The basic circuit was developed by the makers¹ and has been put into practice in the form shown in Fig. 23. The mechanical layout is rather important and this is shown in Fig. 24.

A further alternative to this amplifier is the type shown in Fig. 25 making use of the Mullard type

¹ The General Electric Company, *Application Notes—A2521 U.H.F. Grounded Grid Triode.*

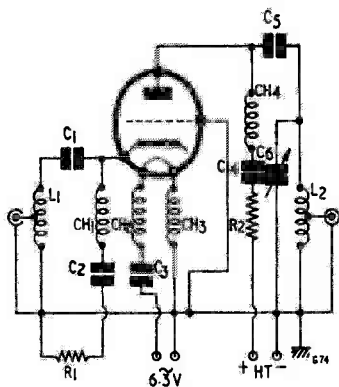

Fig. 23. Circuit of pre-amplifier to be sited at the aerial. Note that C_2 , C_3 and C_4 are feedthrough type capacitors and therefore the positive l.t. and h.t. supplies, together with the grid earth return, via CH_1 and R_1 , will not be broken as shown here

7895, the so-called Nuvistor, which is a counterpart of the American 6CW4. There are a number of arrangements in which this valve can be used, but the circuit and components given in Fig. 25 will be found to operate very satisfactorily.

Both these amplifiers will give an improvement in noise figures of the order of 3dB.

It is important when using these special valves to see that the earthing is good for both d.c. and r.f. conditions. All soldered joints between pins and chassis and contacts between screens and wiring should be exceptionally well made. Neglect of these precautions can lead to r.f. instability which is exceedingly difficult to eliminate.

The amplifiers, together with their power supplies, should be housed in waterproof boxes of not too large a size in order that the heat radiated by the components and valves shall serve to keep the whole at a stable temperature level and prevent the ingress of dampness.

The feed cable into the shack or the house should be laid flat on the ground, or if convenient, below the surface.

The amplifier should be well earthed at the site of the aerial as also should the receiver at the remote end, in order to minimise the effects of current due to interference in the outer sheath of the coaxial cable.

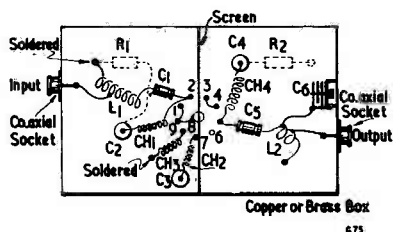

Fig. 24. Component layout for the pre-amplifier of Fig. 23

Components List

(Fig. 23)

Resistors

- R_1 68 Ω $\frac{1}{4}$ W
- R_2 3.7k Ω 1W

Capacitors

- C_1 47pF ceramic
- C_2 1,000pF (feedthrough type)
- C_3 1,000pF (feedthrough type)
- C_4 1,000pF (feedthrough type)
- C_5 1,000pF ceramic
- C_6 10pF air spaced trimmer

Valve

- A2521 (G.E.C.)

Inductors

- L_1 8 turns 18 s.w.g., $\frac{3}{8}$ in internal dia., air spaced, tapped at $5\frac{1}{2}$ turns
- L_2 2 $\frac{1}{2}$ turns, 10 s.w.g., $\frac{7}{8}$ in internal dia., tap to suit gain and bandwidth
- $CH_1, 2, 3, 4$ 27 turns, 24 s.w.g., enamelled, $\frac{1}{8}$ in internal dia., air spaced

Checking the Polar Diagram

At this point the polar diagram of the aerial should be checked. If there is a local Band III station transmitting on channel 11 this will serve as an ideal method of plotting the polar diagram. The aerial should be steered into the position of maximum signal and this point noted either by a mark on the ground or a stick stuck into the ground. The aerial should then be turned slowly to one side of this centre point and the level of the signal observed on the meter of the receiver until the output falls to half the maximum value. Mark this point also. Continue in the same direction until the end of the aerial points in the direction of the transmitter; observe whether there is a rise in the output level. Should this be so it will indicate the presence of secondary lobes and an adjustment of the position of the aerals within the V will be necessary to eliminate these side lobes.

Return the aerial to the centre position and adjust the distance from the aerial to the apex of the V and again repeat the previous tests. If the first test showed no side lobes this adjustment will not, of course, be necessary. One half of the polar diagram having been checked, it is now necessary to plot the other half, starting again by checking the output with the aerial pointed directly at the transmitter. Proceed now in the opposite direction to the previous test and again mark the point where the signal falls to half the value. Continue checking to see if side lobes are present. If the previous aerial adjustment has been made correctly no side lobes will show.

With this preliminary check now completed a more careful test can be undertaken and the results plotted on graph paper. Draw a series of concentric

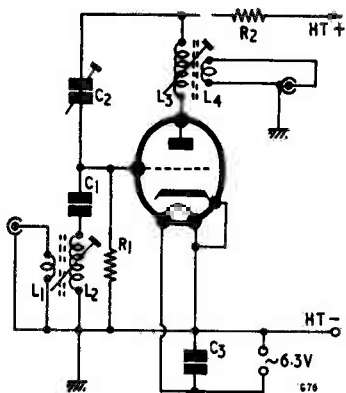

Fig. 25. Circuit of an alternative pre-amplifier using the Mullard Nuvistor 7895

semi-circles spaced at some optimum division of the meter scale. For example, if the output meter is 0-1mA, then use one-tenth mA change as the plotting point. Ten concentric semi-circles will therefore be required. Set the aerial directly towards the transmitter and adjust the meter suitably. Move the aerial 10° at a time noting the reading at each point and entering it on the graph. Repeat the measurements until the aerial is at right angles to the station. Re-check each point by moving 10° at a time back to the central position; then repeat the whole sequence on the opposite side. The shape of the azimuth polar diagram will now appear on the graph paper. The point at which the reading on the meter fell to half the maximum should be noted on each side. The angle between those points is the standard beam width of the whole aerial, and it is this beamwidth that will be recognised when making the assessment of the duration or extent of the radio sources.

Now that the azimuth polar diagram has been determined it is necessary to form some opinion as to the extent of the polar diagram in altitude. This is slightly more difficult since ground reflections play a part. The best method of approach, therefore, is to set the aerial at the point of maximum signal and then tilt it 10° at a time until it is facing vertically upwards. It may be that the signal will have disappeared or fallen to a very low value before this point is reached. The same technique should be

Components List (Fig. 25)

Resistors

- R₁ 47kΩ ¼W
- R₂ 3.3kΩ 1W

Capacitors

- C₁ 27pF ceramic
- C₂ 10pF pre-set trimmer
- C₃ 1,000pF ceramic

Valve

- 7895 (Mullard)

Inductors

- L₁ 2 turns, 22 s.w.g., p.v.c.
- L₂ 4 turns, 22 s.w.g., p.v.c.
- L₃ 4½ turns, 22 s.w.g., p.v.c.
- L₄ 2 turns, 22 s.w.g., p.v.c.

(Coils are close-wound on standard Aladdin formers. L₁ is inter-wound at earthy end of L₂. L₄ is inter-wound at centre of L₃.)

used for this measurement as for the measurement in azimuth, except that only one half will be measured and it will be assumed that the other half is similar. Practice has shown that this is perfectly satisfactory. The graph of this vertical beamwidth should be completed and again the angle between the points at which the output fell to half the maximum value measured. Both parameters of the polar diagram are now complete and the area of the aerial can be computed in square degrees.

The measurements made at the test frequency will apply also to those lying within 20 Mc/s on either side. Aerials arranged for frequencies outside these limits will require the test routine to be followed at the particular frequency to be used. Where no signal is available from a television transmitter or other source, it may be necessary to make up a small oscillator for the purpose. In this case the distance from the aerial to be tested and the oscillator with its aerial should not be less than 100 feet. If this procedure is not possible then it will be necessary to use the sun as the test source. This will be dealt with, among other things, in the next article, which will also describe some specific tests that can be made with the complete radio telescope.

(To be continued)

HI-FI YEAR BOOK

The seventh edition of the *Hi-Fi Year Book* has two major changes from its preceding editions. First of all, all reference to cine photography has been dropped, this subject now being dealt with in a companion volume, *Cine Year Book*, which those of our readers who are interested in this subject might well peruse.

The second change is the inclusion of a number of articles, contributed by experts, on various aspects of Hi-Fi. The Dynamic Decibel, The Disc Stereo Picture 1962, Radio Tuners, Time on Tape, are some of the headings in this section of the book, and good reading they make too. The usual Directory feature of this publication is, if anything, more detailed than ever. In it, the reader will find information on most of the commercially available pick-ups and their accessories, motor units, microphones, tape recorders and constructional kits.

This is a most useful source of information which should be on every Hi-Fi enthusiast's book shelf. Published by Miles Henslow Publications Ltd. at 10s. 6d. per copy.

TWO SAFETY SWITCH CIRCUITS

By C. MORGAN

In many high voltage power supply circuits it is necessary for heaters to be switched on before h.t. is applied. This article describes a simple but ingenious method of ensuring that this switching sequence is correctly followed.

IN AN EFFORT TO STOP THE RAPID DETERIORATION of rectifiers used in high voltage equipment because of misuse by inexperienced radio enthusiasts, the development of a safety circuit was a "must".

A slight modification of the input supply switching was all that was required to achieve this end.

Circuits

A glance at the two circuits shown, Figs. 1 and 2, will reveal two switches in the place of the normal one which is usual in most circuits. It will also be seen that, no matter which switch is made first, only the heaters come on. The h.t. supply remains off until the second switch is made.

This is very essential in the case of mercury

vapour rectifiers, and can effect a saving, both in valves and money.

One other novel point is that when the circuit is switched off the h.t. supply is always broken first, no matter in what order the switches are operated.

The circuit of Fig. 1 is used for medium voltage equipment such as communication receivers, and that of Fig. 2 for higher voltages.

As a matter of interest, heaters should not be left on any longer than is required without an h.t. supply, as they may become subject to "cathode poisoning", another factor which leads to valve deterioration. If it is desirable that the heaters should be left in this condition for long periods, a short application of h.t. will cause any poisoning of the cathodes to be dispersed.

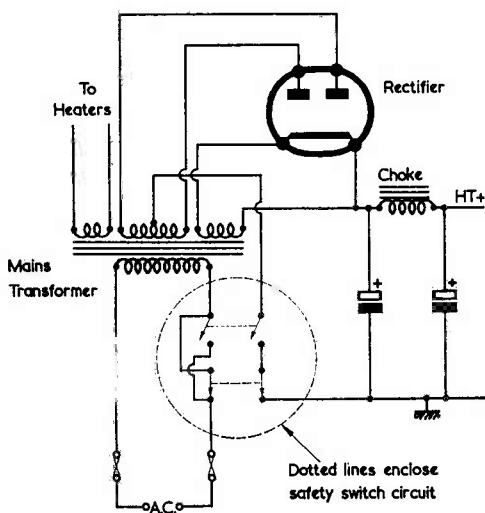

M573

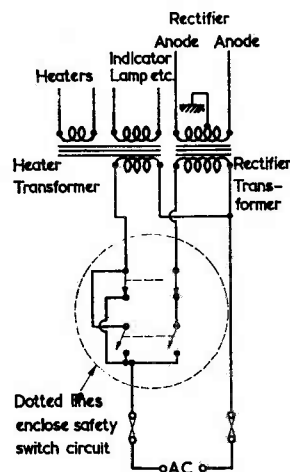

M574

NOW YOU can MASTER ELECTRONICS!

**BRITAIN'S MOST COMPREHENSIVE PRACTICAL
COURSE IN RADIO
ELECTRONICS • TELEVISION!**

**THESE SPECIAL TRAINING
KITS — YOURS TO KEEP**



**Multi - Range
TEST METER**



**CATHODE RAY
OSCILLOSCOPE**

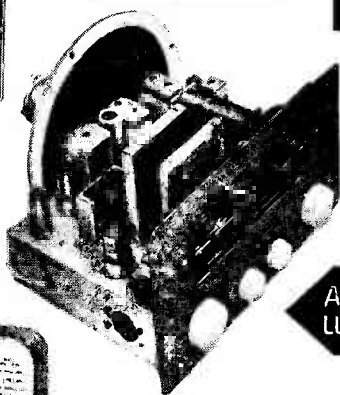

**AM and VHF/FM
LUXURY RECEIVER**

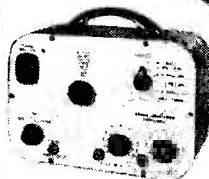

SIGNAL GENERATOR



**Complete set of
Picture Way books and
Experimental Manuals**

**LEARN BY BUILDING
NOW for your
CAREER • HOBBY
OWN BUSINESS**

YOU RECEIVE

- Complete kits of equipment as illustrated.
- Complete set of experimental manuals.
- Complete set of "picture-way" theory books.
- Modern test-yourself examination sheets.
- Study programme.
- Unlimited consultation with Tutors.

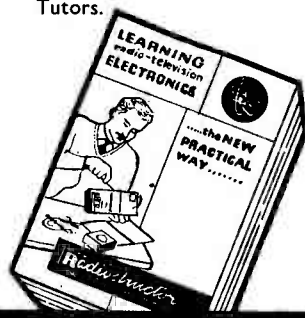

**FREE
BROCHURE**

POST NOW

RADIOSTRUCTOR

TO RADIOSTRUCTOR (DEPT. M.31)
READING, BERKS.

Name

Address

**BLOCK
CAPS
PLEASE**

(We do not employ representatives)

1.63

SMALL ADVERTISEMENTS

Private: 3d. per word, including address.
Minimum charge 2/6.
Use of Box Number, 2/- extra.

Trade: 9d. per word. Minimum charge 12/-.
Terms: Cash with order.

All copy must be received by the 6th of the month for insertion in the following month's issue. The Publishers cannot be held liable in any way for printing errors or omissions, nor can they accept responsibility for the *bona fides* of advertisers.

PRIVATE

WANTED. Murphy TPG11, Cossor Telecheck.—Addinson, 43 Brompton Road, Northhallerton, Yorks.

FOR SALE. Five volumes *The Radio Constructor*, one unbound, to 1962. Also R1155B, not working, with power pack, speaker, manual.—Foster, 16 Weston Avenue, Leighton Buzzard, Beds.

FOR SALE. Taylor valve tester with adaptors and manuals, £9 10s. Carriage paid.—Ward, "Blue Waters", Worsley Road, Gurnard, Cowes, I.O.W.

FOR SALE. 34in model launch for R/C work, £3. Heathkit G.D.O., £7. Large stock of xtals and components. List available. Several receivers also available. State requirements.—Cain, 18 Oaky Balks, Alnwick, Northumberland.

FOR SALE. 14 watt stereo amplifier. Please write for full details Box. No. F167.

FOR SALE. Reflectograph 500 tape recorder. Two track, separate record and replay heads and amplifiers, level meter, 8 1/2 in spools, continuously variable speed 3 1/2-8in/sec. Ideal Morse training, Goon-type recordings, etc. Manual and servicing data. £45.—Ellis, 53 Prestbury Road, Cheltenham, Glos.

TRADE

METALWORK. All types cabinets, chassis, racks, etc., to your specifications.—Philpott's Metalworks Ltd., Chapman Street, Loughborough.

PANL, recognised for many years as the unique one-coat black crackle finish. Brush applied, no baking. Available by post in eighth-pint cans at 3s. 9d. from G. A. Miller, 255 Nether Street, London, N.3.

SERVICE SHEETS (1930-1962) from 1s. Catalogue 6,000 models, 1s. 6d. S.A.E. enquiries.—Hamilton Radio, 13 Western Road, St. Leonards, Sussex.

THE INCORPORATED PRACTITIONERS IN RADIO AND ELECTRONICS (I.P.R.E.) LTD. Membership conditions booklet 1s. Sample copy of I.P.R.E. Official Journal 2s. post free.—Secretary, 20 Fairfield Road, London, N.8.

ALL TYPES OF LINE OUTPUT TRANSFORMERS SUPPLIED (RETAIL & TRADE). Finest service in the country. Send S.A.E. for return of post service. Terms C.W.O. or C.O.D. Trade enquiries invited.—D. & B. Television (Wimbledon) Ltd., 131 Kingston Road, Wimbledon, London, S.W.19. Telephone: CHerrywood 3955.

CATALOGUE NO. 15. Government surplus electrical and radio equipment. Hundreds of items at bargain prices for the experimenter and research engineer, 2s. 6d. post free. Catalogue cost refunded on purchase of 50s.—Arthur Sallis Radio Control Ltd., 93 North Road, Brighton.

CATALOGUE, VOL. 1, NO. 1, RADIO COMPONENTS (1963). For the *RADIO CONSTRUCTOR* and *MODEL RADIO CONTROL CONSTRUCTOR*. Price 1s, including postage from—Harrogate Radio Co. (Mail Order), 16 Regent Parade, Harrogate, Yorks.

continued on page 549

BENTLEY ACOUSTIC CORPORATION LTD

38 CHALCOT ROAD CHALK FARM LONDON NW1
THE VALVE SPECIALISTS Telephone PRIMROSE 9090
ALL GOODS LISTED BELOW IN STOCK

*indicates valves with new type chemical cathode for extra life & reliability

OA2	17 6	757	9 6	DAF96	7 6	EL360	27	SP61	3 6	MIDGET	
OB2	17 6	7Y4	7 6	DD41	13 7	EL820	18 2	SU25	27 2	SILICONE	
OZ4GT	5	8D2	3 6	DF66	15	EL821	25 11	T41	9	RECTI-	
IA5	6	9BW6	14 11	DF96	7 6	EL822	19 6	TDD4	12 6	FIER	
IA7	12	9D2	4	DF97	9	EM4	17 9	TP22	15		
IC5	12 6	10C1	12 6	DH76	5	EM34	9 6	TY86F	13	Mullard	
IG6	17 6	10C2	25 11	DK40	21 10	EM71	23 10	UI2 14	8 6	BY100	
IHSGT	10 6	10D2	11 8	DK92	10 6	EM80	9	UI6	10	Output 250	
IL4	3	10F1	25 11	DK96	8 6	EM81	9 6	UI8 20	8 6	No. larger	
ILD5	5	10P13	15	DL66	17 6	EM84	10 6	UI9	48 6	than a shirt	
ILN5	5	10P14	18 9	DL68	15	EM85	16 10	U22	8	button!	
INSGT	10 6	12A6	5	DL96	7 6	EN31	53	U24	29 1	8 - each.	
IR5	6	12AC6	14 11	DLS10	10 6	EY51*	8 6	U25*	17 6		
IS4	9	12AD6	16 10	DM70	7 6	EY83	16 2	U26*	9		
IS5	5	12AE6	13 7	EB07	30	EY96*	7 6	U31	11 6	TRANSIS-	
IT4	3	12AH8	12 6	EB3F	30	EZ40	6 6	U32	25 2	TORS &	
IU4	12 6	12AT6	7 6	E180F	34 6	EZ41	7	U35	29 1	DIODS	
IU5	5 6	12BA6	8	EABC80	9	EZ80	6	U37	32 4	GD3	5 6
D2D1	15	12BE6	9	EAC91	4	EZ81	6	U45	13 6	GD4	5 6
2X2	4 6	12BH7	20 9	EAF42	9	GU50	41 6	U50	5 6	GD5	5 6
3A4	6	12J7GT	8 6	EB41	8 6	GZ30	9	U52	4 6	GD6	5 6
3A5	10 6	12K5	17 6	EB9	4	EZ32	10	U76	6	GD12	4 6
3B7	12 6	12K7GT	5	EC33	5	EZ33	19 1	U107	19 5	GD15	8
3D6	5	12K8	14	EBCA1	8	EZ34	14	U191	16 2	GD16	8 6
3Q4	7 6	12Q7GT	5	EC81	8	HL2	7 6	U201	16 2	GET106	17 6
3Q5	9 6	12SA7	8 6	EB80	8	HN309	29 1	U281	19 5	GET114	6 6
354	6	12SC7	8 6	EBF83	13 7	HV92	10	U282	22	GET873	9 3
3V4	7 6	12SK7	6	EBF89	9 6	HVR2A	6	U301	22 8	GET874	9 6
5R4GY	17 6	12SQ7	11 6	EBL31	22 8	KT2	5	U329	14	GET36	10 6
SU4G	4 6	19AQ5	10 6	EC70	12 6	KT33C	8	U339	16 2	GET45	16 6
SU4G	10	19H1	10 6	EC81	20 6	KT36	32	U404	27 6	GET55	17 6
5Y3	5	620D1	14 11	EC92	13	KT41	29	U801	29 1	F17	9 6
5Z3	19 5	20F2*	25 11	ECC32	5 6	KT44	12 6	U4020	18 2	GET64	11 6
5Z4G	9	20L1*	25 11	ECC32	11 11	KT61	12 6	UABC80	9	GET66	15 6
6A8	9	20P1*	25 11	ECC35	8 6	KT63	7	UAF42	9 6	AF102	27 6
6AG5	5 6	20P3*	22 8	ECC40	7 6	KT66	15	UB41	12	AF114	11 6
6AK5	9	20P5*	25 11	ECC81*	5	KT88	43 6	UBC41	8 6	AF115	10 6
6A5	7 6	20P5*	22 8	ECC82*	5	KT101	32 4	UBC81	11	AF116	16 6
6AT6	6	25A6G	10 6	ECC83*	7	KT66	6	UBF80	9 6	AF117	9 6
6AU6	10	25L6GT	11 6	ECC84*	9	KTW62	7 6	UBF89	9 6	MAT100	7 9
6B8	3	25Z4G	11 6	ECC85	7 6	KTW63	6 6	UCC85	7 6	MAT101	8 6
6B8A	6	25Z5	10 6	ECC88	18	MHL4	7 6	UCF80	16 2	MAT120	7 9
6B8E	6	27SU	25 11	ECF80*	10 6	M54B	22 8	UCH42	9 6	MAT121	8 6
6BH6	8	28D7	7	ECF82	10 6	MU14	8	UCH81	9 6	OA5	6 6

We have large stocks of obsolete and hard to get valves. Quotation by return of receipt of stamped addressed envelope.

6B16	6	30C1*	7 6	ECF86	19 5	N37	25 11	UCL82	9 6	OA10	8
6BQ7A	15	30C15	16 2	ECH35	6 6	N78	29 1	UCL83	18 9	OA70	3
6BR7*	9	30F5*	6	ECH42	9 6	N108	29 1	UF41	9	OA73	3
6BR8	18 2	30FL1*	9 6	ECH81	7 6	N308	20 1	UF42	12 6	OA79	3
6BW6*	10 6	30L1*	7 6	ECH83	13 7	N339	15	UF80	10 6	OA81	3
6BW7*	5	30L15*	9 6	ECL80*	9	PC95	13	UF85*	9 6	OA85	3
6C5	6 6	30P4*	15	ECL82	9 6	PCC84*	7 6	UF86*	13 6	OA86	6
6C9	13 6	30P12	7 6	ECL83	18 9	PCC85	9 6	UF89	8	OA91	3
6CDD6G	35 8	30PL1	9 6	ECL86	16 2	PCC88	18	UL41	10 6	OA95	3 6
6CH6	7 6	30PL13	10 6	EF9	22 8	PCC89*	8 6	UL44	25 11	OA210	9 6
6D6	6 6	35A5	20 9	EF22	14	PCF80*	7 6	UL46	14 6	OA211	13 6
6E5	12 6	35L6GT	9 6	EF36	4	PCF82	10 6	UL84*	8 6	OC16W35	3
6F5	25 11	35W4	7 6	EF37A	8	PCF83	4	UM80	16 10	OC19	6 6
6F6G	7	35Z3	18 2	EF39	4 6	PCF86	9 6	UM34	16 10	OC22	23
6F13	10	35Z4GT	6	EF40	15	PCL82*	9 6	UM80	14 11	OC26	25
6F23	10 6	35Z5GT	9	EF41	8	PCL83*	9 6	URIC	18 2	OC35	18
6F24	9 6	50C5	10	EF42	10	PCL84*	7 6	UJ6	19 5	OC36	21 6
6F33	7 6	50L6GT	10	EF50(A)	7	PCL85	10	UJ8	25 11	OC41	9
6J5	3	52K	14 6	EF50(E)	5	PCL86	16 2	UJ9	8 6	OC44	9 3
6J6	3	53KU	19 5	EF73	10 6	PEN25	4 6	UY1N	18 2	OC44PM	9 3
6J7G	4 6	72	4 6	EF80*	5	PEN45	19 6	UY21	16 2	OC45	9 6
6K7G	2	78	6 6	EF85*	6	PEN46	4 6	UY4	6 6	OC45PM	9 6
6K8G	5	80	9	EF86*	9	PL33	18 9	UY85	6	OC65	22 6
6K25	15 8	83	15	EF89	9	PL36*	15	VM54B	15	OC66	25
6L1	22 8	85A2	16	EF91	3 6	PL38	25 11	VP4	15	OC70	6 6
6L6G	7 6	90AG	6 6	EF92	4 6	PL81*	10 6	VP4B	22 8	OC71	6 6
6L7GT	7 6	90AV	6 6	EF97	13	PL82	7 6	VP13C	7 6	OC72	8 6
6L18	13	90CV	37 6	EF98	13	PL83	9	VP23	6 6	OC73	16 6
6N7	8	90CV	37 6	EF183	18 2	PL84*	12 4	VR105	7	OC75	8 6
6P2B	25 11	90C1	16	EF184	9 6	PL820	18 2	VR150	7	OC76	7 6
6Q7G	6	150B2	18	EK32	8 6	PM84	16 10	V76	5 6	OC77	12
6R7G	10	150C2	17 6	EL32	5	PK4	10 6	VM81	6	OC78	8 6
6S17	6 6	185BT	32 4	EL33	12 6	PY31	16 2	X61	12 6	OC81	8 6
6S7	5 6	807	6	EL34	15	PY32*	13 6	X65	12 6	OC82	10 6
6U4GT	12 6	5763	7 6	EL37	23 11	PY33*	13 6	X66	12 6	OC83	6 6
6U5G	7 6	AC6PEN7	6	EL38	25 11	PY80	7 6	X76M	14	OC84	8 6
6V6G	4 6	AZ31	10	EL41	5	PY81	7 6	X78	29 1	OC140	29 6
6V6GT	8 6	AZ41	13 7	EL42	10	PY82	7 6	X79	45 3	OC170	9 6
6X4	4 6	B36	9	EL81	16 2	PY83	7 6	XD(1)	6 6	OC171	10 6
6X5	5	BL63	7 6	EL83	19 5	PY88	13	XFG1	18	OCPT71	6 6
630L2	10	CL33	18 9	EL84*	7 6	PZ30	19 5	XFY34	17 6	PXC1101	6 6
7B7	8 6	CY1	18 2	EL85	13 7	R16	25 11	XFY54	18	PXC1101A	
7C5	8	CY31	11	EL86	16 10	R18	14	XH(1.5)	6 6		
7C6	8	D15	10	EL91	9	R19	19 5	XJ3	7 6	XA103	15 6
7H7	8	D43	17 9	EL95	10 6	SP41	3 6	Z66	9 6	XA104	18

All goods new and first grade only. Please note that we do not sell secondhand goods. Complete list of valves, resistors, condensers, metal rectifiers, loudspeakers, transformers of all types, and other components 6d. Terms of business:—Cash with order or C.O.D. only. Post 6d. per item. Orders over £3 post free. C.O.D. 2 6 extra. All orders despatched same day. C.O.D. orders by telephone accepted for immediate despatch until 3.30 p.m. Any parcel insured against damage in transit for 6d. extra. We are open for personal shoppers 8.30-5.30. Sats 8-1 p.m.

FREE TO AMBITIOUS ENGINEERS

— THE LATEST EDITION OF ENGINEERING OPPORTUNITIES

Have you sent for your copy?

ENGINEERING OPPORTUNITIES is a highly informative 156-page guide to the best paid engineering posts. It tells you how you can quickly prepare at home for a recognised engineering qualification and outlines a wonderful range of modern Home Study Courses in all branches of Engineering. This unique book also gives full details of the Practical Radio & Electronics Courses, administered by our Specialist Electronics Training Division—the B.I.E.T. School of Electronics, explains the benefits of our Employment Dept. and shows you how to qualify for five years promotion in one year.

We definitely Guarantee

“NO PASS—NO FEE”

Whatever your age and experience you cannot afford to miss reading this famous book. If you are earning less than £25 a week send for your copy of “ENGINEERING OPPORTUNITIES” today—FREE.

BRITISH INSTITUTE OF ENGINEERING

TECHNOLOGY (Incorporating E.M.I. Institutes)

(Dept. SE/23), 29 Wright's Lane, London, W.8

WHICH IS YOUR PET SUBJECT?

Mechanical Eng.,
Electrical Eng.,
Civil Engineering,
Radio Engineering,
Automobile Eng.,
Aeronautical Eng.,
Production Eng.,
Building, Plastics,
Draughtsmanship,
Television, etc.

GET SOME LETTERS AFTER YOUR NAME!

A.M.I. Mech. E.
A.M.I.C.E.
A.M.I. Prod. E.
A.M.I.M.I.
L.I.O.B.
A.F.R. Ae. S.
B.Sc.
A.M. Brit. I.R.E.
City & Guilds
Gen. Cert. of Education
Etc., etc.

PRACTICAL EQUIPMENT

Basic Practical and Theoretic Courses for beginners in Radio, T.V. Electronics, Etc., A.M. Brit. I.R.E. City & Guilds Radio Amateurs' Exam. R.T.E.B. Certificate P.M.G. Certificate. Practical Radio Radio & Television Servicing Practical Electronics Electronics Engineering Automation

INCLUDING TOOLS!

The specialist Electronics Division of B.I.E.T. (Incorporating E.M.I. Institutes) NOW offers you a real laboratory training at home with practical equipment. Ask for details.

B.I.E.T. SCHOOL OF ELECTRONICS



POST COUPON NOW!

Please send me your FREE 156-page “ENGINEERING OPPORTUNITIES” (Write if you prefer not to cut page)

NAME

ADDRESS

SUBJECT OR EXAM THAT INTERESTS ME

THE B.I.E.T. IS THE LEADING ORGANISATION OF ITS KIND IN THE WORLD

Here's the way to

BUILD A BETTER RECORDER

and save too!



ALL PARTS AVAILABLE SEPARATELY

MODEL “D”—4 TRACK
Amplifier 8311-4-V 12 gns
Speaker & Case assembly 5 gns
Complete with Collaro Deck 34 gns

MODEL “B”—2 TRACK
Amplifier 8312 8 gns
Speaker & Case assembly 4 gns
Complete with BSR Deck 21 gns

It's the excellence of the design and layout of the printed circuit amplifier sections of Martin Recordakits which ensure such exceptionally good standards of reproduction. It's the thoughtful way in which these Kits are presented for building that makes success assured. Everything is provided for and the finished product is one you will be proud of having built.

● Send coupon for details of all Recordakits

MARTIN RECORDAKITS

MARTIN ELECTRONICS LTD.
155 High St., Brentford, Middx.
Recordakits leaflet please!

NAME

ADDRESS

From Radio Stockists or direct in cases of difficulty Tel. Isl. 5885

A 6-WATT HIGH FIDELITY AMPLIFIER

THE COOPER-SMITH “PRODIGY”



This booklet, No. 10 in our Radio Reprint Series, contains full constructional details, including a circuit for a microphone pre-amplifier, signal sources, and choosing a loudspeaker.

Price 2/6 postage 4d.

DATA PUBLICATIONS LTD

57 MAIDA VALE . LONDON W9

SMALL ADVERTISEMENTS

continued from page 547

TRADE - continued

ELECTRONIC ORGAN SUPPLIES. Keys, Pedals, Contacts, Wire Blocks, Silver, Gold Clad Wire, Springs, Stop Keys. - Ernest Holt, Organ Part Maker, 101/2/3 Wolverhampton Street, Walsall, Staffs.

FIND TV SET TROUBLES IN MINUTES from that great book *The Principles of TV Receiver Servicing*, 10s. 6d., all book houses and radio wholesalers. If not in stock, from Secretary, I.P.R.E., 20 Fairfield Road, London, N.8.

JOIN THE INTERNATIONAL S.W. LEAGUE. Free Services to members including Q.S.L. Bureau, Amateur and Broadcast Translation, Technical and Identification Dept.—both Broadcast and Fixed Stations, DX Certificates, contests and activities for the SWL and transmitting members. Monthly magazine, *MONITOR*, containing articles of general interest to Broadcast and Amateur SWLs, Transmitter Section and League affairs, etc. League supplies such as badges, headed notepaper and envelopes. QSL cards, etc., are available at reasonable cost. Send for League particulars. Membership including monthly magazine, etc., 2/1s. per annum.—Secretary, ISWL, 12 Gladwell Road, London, N.8.

THE INTERNATIONAL HAM HOP CLUB is a non-profit-making organisation open to RADIO AMATEURS AND SHORT WAVE LISTENERS. OBJECT: To improve international relationships through an organised system of hospitality. MEMBERS offer overnight hospitality to visiting members, subscription 10s. per annum. ASSOCIATE MEMBERS invite radio amateurs to visit their stations. Associate membership 5s. per annum. FAMILY EXCHANGE holidays arranged, also FRIENDSHIP LINKS between radio clubs. The Club's official journal is free to both Full and Associate Members.—Hon. Gen. Secretary: G. A. Partridge, G3CED, 17 Ethel Road, Broadstairs, Kent.

AT LAST A REALLY EFFICIENT and inexpensive two transistor Baby Alarm and Intercom Kit. Easy and cheap to make from our Simple as ABC Plans. Build one yourself and then earn extra money by making for your friends. Constructional data with point-to-point diagrams, 2s. 6d., post paid.—Autronic Designs, BCM/Autronics, London, W.C.1.

continued on page 551

SITUATIONS VACANT

Central Electricity Generating Board

SOUTH EASTERN REGION
NORTH THAMES DIVISION

West Thurrock Generating Station

Applications are invited for the following vacancies:

INSTRUMENT MECHANICS

Applicants will be required to carry out electronic bench servicing. Modern plant and the latest test equipment are provided. Rented housing accommodation may be available to the successful applicants.

The rate of pay is 6s. 0½d. per hour for a 42 hour, 5 day week. Applications giving details of age, qualifications, present position and past experience should be addressed to the Station Superintendent, West Thurrock Generating Station, Stoneness Road, Grays, Essex.

TECHNICAL FILING CLERK

Suitable for man who has retired early, with radio as a hobby, maximum age 60 years. Write Personnel Officer, Mullard Limited, Torrington Place, London, W.C.1.

AMAZING RESULTS FROM OUR LATEST 5-STAGE TRANSISTOR RECEIVER.

A highly sensitive receiver using top grade transistors and components. Fully tunable over medium waves.

- ★ Can be built in 1 hour.
- ★ High flux moving coil speaker.
- ★ Built-in ferrite rod aerial.
- ★ Specially designed coils for maximum signal strength.
- ★ Volume on/off control.
- ★ Eyeleted circuit board.
- ★ Easy to follow building plans.

Total Building Costs **59/6** P. & P. 2/6

Send S.A.E. for **FREE** Layout plans and parts lists



LISTEN TO THE WORLD no "TELSTAR" our easy to construct 1-VALVE SHORT WAVE RADIO

Total Building Costs only **35/-** P. & P. 2/-

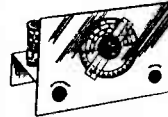

- ★ Receives speech and music from all over the world.
 - ★ Construction price includes valve and one coil covering 40-100 metres.
 - ★ Can be extended to cover 10-100 metres.
 - ★ Can be converted to 2 or 3 valve.
- Send 2/- for wiring diagram and components price list.

5-STAGE SUPER-SENSITIVE TRANSISTOR PORTABLE EASY TO BUILD ★ FIRST GRADE PARTS

A truly portable transistor radio giving full medium wave reception. Incorporates 5" High Flux Speaker, push pull output, first grade transistors, High-Q ferrite aerial, socket for car aerial, pre-tagged circuit board for easy construction. Attractive two-tone case. All parts sold separately.

Total Building Costs **95/-** P. & P. 2/6

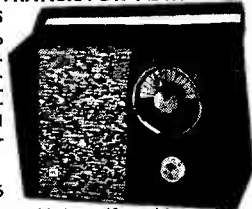

Send 1/6 for itemised price list & full assembly instr. (free with order)

R.C.S. PRODUCTS (Radio) LTD
11 Oliver Road · London · E17 (Mail Order Only)

R. COOPER G8BX RADIO CROYDON

32 South End Croydon Surrey CRO 9186

★ VALVES New Tested and Guaranteed

1R5	5/6	6K8GT	8/6	DAF96	7/-	1ECC85	8/6	PL82	10/6
1S5	7/-	6Q7G	5/9	DC90	10/6	ECF82	8/-	PY81	7/-
1T4	3/-	6S17GT	8/-	DF91	3/-	ECY81	8/-	PY82	7/-
3S4	5/9	6V6G	7/6	DF96	7/-	ECH42	8/6	PCC84	7/-
3V4	6/6	6X4	7/6	DH76	5/-	ECL80	7/6	PCF80	7/-
5U4G	6/-	12AT7	6/-	DH77	5/6	EF41	8/-	PCF82	7/-
5Y3GT	7/6	12AU7	6/-	DK91	5/6	EF80	8/-	PCL82	7/-
5Z4G	9/-	12AX7	7/6	DK92	7/6	EF86	9/-	PCL83	10/-
6AK6	6/6	12BH7	10/6	DK96	7/-	EF91	4/-	PCL84	7/6
6AL5	4/6	12K7GT	8/6	DL92	5/9	EL41	9/-	U76	8/6
6AM6	4/-	12K8GT	11/-	DL94	6/6	EL84	7/-	UBC41	7/6
6AT6	7/6	12Q7GT	6/6	DL96	7/-	EY51	7/6	UCH42	7/6
6BA6	5/-	25A6G	10/6	EB91	3/-	EZ40	6/-	UF41	7/6
6BE6	7/-	25L6GT	7/6	EBC41	8/-	EZ80	6/-	UL41	7/6
6BR7	8/9	35Z4GT	5/6	ECC81	6/-	EZ81	6/-	UY41	6/-
6BW6	6/6	35L6GT	7/6	ECC82	6/6	GZ32	10/6	W76	8/6
6J7GT	8/6	5763	7/6	ECC83	6/6	KT66	15/-	Z77	4/-
6K7G	7/6	DAF91	7/-	ECC84	7/9	PL81	12/6	ZD17	7/6

MATCHED PAIRS. EL34, 27/6; EL84, 15/-; EL85, 25/-; 6V6G, 15/-; 6BW6, 14/-; KT33C, 19/6; 807, 18/- pair; KT66, 37/6.

SETS OF VALVES

DK96, DF96, DAF96, DL96 " REGENT "	27/6 per set
DK91, DF91, DAF91, DL92, or DL94	19/6 per set
1R5, 1T4, 1S5, 3S4, or 3V4	19/6 per set
6K8, 6K7, 6Q7, 6V6, 5Z, " G " Types	37/6 per set
ECH42, EF41, EBC41, EL41, EZ40	35/- per set
UCH42, UF41, UBC41, UL41, UY41	35/- per set

Rotary Switches. 1P, 3W., 1P, 4W., 1P, 8W., 2P, 2W., 2P, 3W., 2P, 4W., 3P, 2W., 3P, 3W., 4P, 2W., 4P, 3W., 3/-, 2P, 5W., 2 Bank, 2P, 6W., 2 Bank 5/6.

Instrument Switches Push to Test. 3/6. Toggle Switches, S.P.S.T. 2/-; S.P.D.T., 2/6; D.P.S.T., 3/6; D.P.D.T., 4/-.

Volume Controls. Midset Long Spindle 1/2, 5K to 2M, Non-Switch 3/-; D.P. Switch 4/6; Min. Edge Type 3/6; D.P.S. 5/6.

Pre-Set Controls. 3W w.w. to 30K 1/2W Carbon 50K to 2M 3/-; Wire Wound Long Spindle 1/2 4W, 50Ω to 100K 6/-.

Block Capacitors. .004 2kV 2/9; .05 4kV 2/6; .5 2.5 kV Nitrolog 4/3; 1 MFD 350V, T.C.C. 1/6; 2 MFD 350V, Nitrolog 3/-; 4 MFD, 350V, Nitrolog 4/3; 4 MFD, 1,000V, T.C.C. 4/6; 4 MFD, 100V, T.C.C. 2/-; 4 MFD, 500V, Dubilier 4/9; 4 MFD, 600V, Nitrolog 5/6; 4 MFD, 750V, Nitrolog 6/6; 8 M.F.D. 600V, Dubilier 6/-.

P. & P. 6d. C.O.D. 3/- S.A.E. FOR ALL ENQUIRIES.

MINISETS LTD Hatherley Mews London E17

THE IMPERIA

An easy-to-build 6-Transistor Portable Superhet which can be built by the constructor. Pre-assembled circuit board for easy construction. All components are new. 5" speaker giving good tone and output. Attractive case of exclusive design 8½" x 5½" x 2½" with gold-plated grille. Specially designed matching coil for use in car. Only first grade fully guaranteed matched transistors and diodes are used. Anyone can build this set for

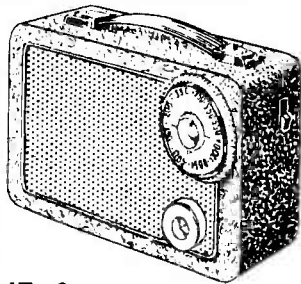

£7.17.0

Everything supplied except soldering iron. P. & P. 3/-. Full instructions 1/6 (free with order).

3-Transistor Radio (plus 2 diodes)

Total building **70/-** P.P. 2/6

- ★ Pre-assembled circuit board, ensuring easy construction
- ★ Full medium-wave coverage
- ★ Attractive case 5½" x 3" x 1½"
- ★ All components including transistors are brand new and direct from manufacturers
- ★ Ferrite Rod aerial coil, no external aerial or earth required
- ★ 2½" high flux speaker direct from manufacturer
- ★ After-sales service

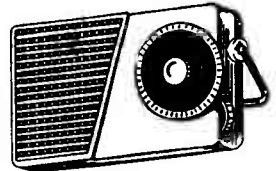

Send 1/6 for instructions, circuit and price list

6-Stage Transistor Pocket Portable

- Can be built for **£4.19.6** P.P. 2/6
- ★ Completely self contained, no aerial or earth required.
 - ★ Push-pull output, 250 milliwatts.
 - ★ 3" high flux speaker
 - ★ Pre-assembled circuit board with simple instructions ensuring easy construction
 - ★ High Q Ferrite Rod Aerial
 - ★ After-sales service
- Can be supplied with long-wave 6/- extra



Full instructions, price list 1/6 (Free with order)

THE RIETI

6-Stage super sensitive Transistor Portable. Easy to build. All components first grade. A real portable transistor radio, covering Medium wave reception. 5" speaker, high Q ferrite aerial especially designed. Pre-assembled circuit board enables the complete set to be assembled and tested before placing in case.

Attractive case 8½" x 5½" x 2½" with gold-plated grille. Total build costs **£5.2.6** P. & P. 3/-

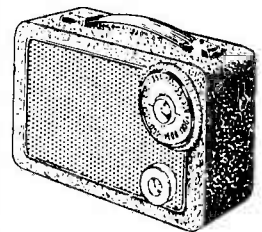

Medium and Long wave 8/- extra. Full instructions 1/6 (free with order).

PANDORA

THE NEW

TRANSISTOR 6

Designed By

Mel Electronic
ONLY £6.19.6.

USING NEW HIGH GRADE PARTS

FULL AFTER SALES SERVICE



TOTAL BUILDING COST

SEND S.A.E. ONLY FOR FREE DETAILS and Information on other Transistor designs

● MEDIUM WAVE, LONG WAVE/LIGHT PROGRAMME

Obtainable from your local stockist or in case of difficulty DIRECT FROM

- 6 TRANSISTORS + DIODE
- SUPERHET CIRCUIT
- AUTOMATIC WAVECHANGE
- 500mW PUSH PULL OUTPUT
- PRE-TINNED PRINTED BOARD
- EXCELLENT RESULTS

½ WATT 3-TRANSISTOR AMPLIFIER

- ½ Watt Peak Output
- Output to 3Ω Speaker
- 9 Volts Operated
- Push-pull Output Stage



A PRINTED CIRCUIT HIGH GAIN AMPLIFIER

Size 3½ x 2 x ¾in.

Price **45/-** P. & P. 1/6

Using two Newmarket transistors (NKT251 and NKT252). Ideal for intercomm. or as record player amplifier.

2 WATT 4-TRANSISTOR AMPLIFIER

with Two Drivers and Push-Pull Stage

Size 4 x 2¾ x ¾in.

Ready Built **62/6** P. & P. 1/6

MEL ELECTRONIC CO. R/O 240 HIGH STREET BECKENHAM KENT

SMALL ADVERTISEMENTS

continued from page 549

TRADE—continued

BUILDING YOUR OWN ORGAN. We have for disposal a few obsolete hire organs. Wealth of parts, including keyboards, consoles, pedal boards, transformers, condensers, and other valuable electronic components. Write for details and prices.—Box No. F.166.

MIXING UNITS. Transistorised, two to four inputs. Unique features. Full details.—Morgan Laboratories, 9 Parker Road, Croydon, Surrey.

ALUMINIUM, BRASS, COPPER AND BRONZE. In sheet, rod, strip, tube, also Stainless Steel sheet. Any size cut. Complete price list, 1s.—Slater Metals (N.F.) Ltd., 17 Slater Street, Liverpool 1.

A LAB IN YOUR POCKET!

Controlled Electronics now have two invaluable pocket, pen-sized instruments to save you time and make servicing pay.

664

Signal Injector injects A.F., I.F. and R.F. signals into circuits; a simple procedure locates faults in radio and audio circuits. £2.15.6

670

Signal Tracer with R.F. and A.F. probes traces signals from aerial to loudspeaker, will locate circuit breaks and sources of hum, noise and distortion. Priced at £6.19.6 complete with high quality magnetic earpiece, or £5.19.6 if supplied with lower sensitivity crystal earpiece.

Batteries for either instrument 1/10 each. P. & P. 1/-

CONTROLLED ELECTRONICS

62 HIGH STREET CROYDON SURREY

LISTEN TO YOUR FAVOURITE PROGRAMME, "200", ETC., YOURSELF ON THE V.E.I.



Personal Transistor Radio

45/6 (inc. P.T.). P. & P. 1/6

Battery 2/3 extra. Not a Toy, but a ready built radio for personal listening, to give you hours of delight. No aerial or earth required, tunable over the Medium Wave Band, complete with earpiece.

Self-contained battery, plastic case with gold dial. The ideal gift. (For those who wish to build, we can supply the components separately for 26/6 plus 1/6 P. & P.)

SUPER CRYSTAL DIODE RECEIVER

This crystal receiver will delight many a boy, and even a grown up. Completely built, ready to go (or for those who wish to build themselves, we can supply all the parts separately for a total cost of 9/6, (plus P. & P. 1/-).

Parts for either receiver are obtainable from us separately.

"SUCCESS ASSURED BY SUPER AFTER SALES SERVICE"

Send S.A.E. for Free Layout Plans

REDISERVICE LTD (Dept. RC) 44 BROADWAY MARKET, LONDON E.8.
PERSONAL CALLERS WELCOME

12/6

(inc. P.T.)

P. & P. 1/-.

Headphones 12/6 pair.



OSMOR

P.W. BEST SETS

P.W. POCKET SHEET

Case $5\frac{1}{2} \times 3\frac{1}{2} \times 2$ 12/6

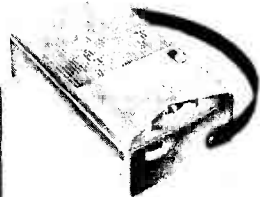
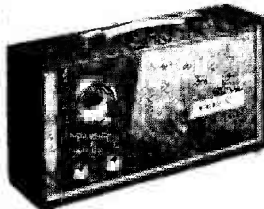

Case $14\frac{1}{2} \times 7\frac{1}{4} \times 3\frac{1}{4}$ 48/-

P.W. MERCURY SIX

3 IFS and Osc. 22/-
Driver and Output 16/3

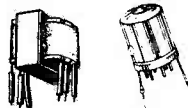

For above and all similar transistor circuits

CONSTRUCTIONAL BOOKLETS 2/6 each

COMPONENT LISTS ON REQUEST

OSMOR LTD 418 BRIGHTON ROAD
S. CROYDON SURREY

MINIATURISATION? No problem with the new MULLARD Capacitors.

ELECTROLYTICS. Physical size, working volts, etc., of some of the more popular values as below.

0.8 mfd. (1) 25V	1/9	40 mfd. (3) 16V	1/3
2.0 mfd. (1) 10V	1/9	64 mfd. (3) 10V	1/3
4.0 mfd. (1) 4V	1/9	64 mfd. (5) 40V	1/9
5.0 mfd. (1) 2.5V	1/9	100 mfd. (3) 4V	1/3
10.0 mfd. (2) 16V	1/8	100 mfd. (4) 16V	1/8
16.0 mfd. (2) 10V	1/8	200 mfd. (4) 6.4V	1/8
16.0 mfd. (4) 6.4V	1/8	250 mfd. (4) 4V	1/8
20.0 mfd. (2) 6.4V	1/8	400 mfd. (5) 6.4V	1/9
25.0 mfd. (3) 25V	1/3	500 mfd. (5) 4V	1/9
32.0 mfd. (4) 40V	1/8	640 mfd. (5) 2.5V	1/9

Bracketed numbers indicate approx. size as follows: (1) L. 4", dia. 13"; (2) L. 4", dia. .15"; (3) L. 7", dia. .25"; (4) L. 7", dia. .36"; (5) L. 1.1", dia. .36".

MINIATURE FOIL CAPACITORS. 30V D.C. Wkg. Colour coded. Average approx. size: L. .5"; H. 5"; B. .2".

.01 mfd. 7½d.; .022 mfd. 9d.; .047 mfd. 9d.; 1 mfd. 11d.

Also available polyester tubular capacitors. 125V range from 0.01 mfd. to 1.0 mfd., and in the 400V range from 0.001 mfd. to 0.47 mfd. Prices from 9d.

May we suggest you keep this list for future reference.

Terms of business: Cash with order; C.O.D. 3/- extra; postage extra under £3 total value. General list stamp please.

Glasgow Electronic Services

21 OLD DUMBARTON ROAD GLASGOW C3

Telephone WEST 2642

CHASSIS and CASES by



287/9 Edgware Road
London W2
TELEPHONE
PADdington 5891/7595

BLANK CHASSIS—Same Day Service

Of over 20 different forms made up to YOUR SIZE. Order EXACT SIZE you require to nearest 1/16th. (Maximum length 35", depth 4").
Specials dealt with promptly.

SEND FOR ILLUSTRATED LEAFLET

or order straight away, working out total area of material required and referring to table below which is for four-sided chassis in 18 s.w.g. (for 16 s.w.g. add 1/6th).

48 sq. in.	4/-	176 sq. in.	8/-	304 sq. in.	12/-
80 sq. in.	5/-	208 sq. in.	9/-	336 sq. in.	13/-
112 sq. in.	6/-	240 sq. in.	10/-	368 sq. in.	14/-
144 sq. in.	7/-	272 sq. in.	11/-	and pro rata	
	P. & P. 2/6		P. & P. 2/9		P. & P. 3/-

Discounts for quantities. Finishes arranged for quantities of 25 or over.

FLANGES (1/2" or 3/4"), 6d. per bend.
STRENGTHENED CORNERS, 1/- each corner.
PANELS

Any size up to 3ft at 4/6 sq. ft. 18 s.w.g. (16 s.w.g. 5/3).
P. & P. (sq. in.): 72 1/3, 108 2/-, 114 2/6, 432 2/9, 576 3/-.

CASES

ALUMINIUM, SILVER HAMMERED FINISH

Type	Size	Price	Type	Size	Price
U	4 x 4 x 4"	9/6	Y	8 x 6 x 6"	25/-
U	5 1/2 x 4 1/2 x 4 1/2"	14/6	Y	12 x 7 x 7"	39/-
U	8 x 6 x 6"	20/-	Y	13 x 7 x 9"	44/-
U	15 x 9 x 9"	42/6	Y	15 x 9 x 7"	46/-
W	8 x 6 x 6"	19/6	Z	17 x 10 x 9"	63/-
W	12 x 7 x 7"	32/6	Z	19 x 10 x 8 1/2"	67/6
W	15 x 9 x 8"	42/-			

Special sizes to order. Type Z has removable back and front panels. Type U all-screwed construction.

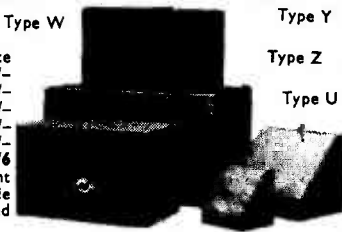

The thrills of VHF can now be yours for only 39/6d, complete kit! Tunable 150-100 Mc/s, simplified construction, write today for leaflet. Also, if a newcomer to Amateur Radio, ask for free copy of the world famous "Globe-King" kits and receivers, stamp please to cover postage:

Johnsons (Radio) St. Martin's Gate Worcester

BRASS · COPPER · DURAL · ALUMINIUM · BRONZE

ROD, BAR, SHEET, TUBE, STRIP, WIRE.

3,000 STANDARD STOCK SIZES.

No Quantity too small

List on application

H. ROLLET & CO LTD

6 CHESHAM PLACE SW1 BELgravia 4300

Also at Liverpool, Birmingham, Manchester, Leeds

G2ACC offers you . . .

- A 56 page illustrated catalogue No. 12 Your buying guide for short wave, broadcast and transmitting components. 9d. post free (refundable on first order). U.K. and H.M. Forces anywhere.

SOUTHERN RADIO AND ELECTRICAL SUPPLIES

SORAD WORKS REDLYNCH SALISBURY WILTS Telephone Downton 207

Quality Components FOR CONSTRUCTORS

capacitors, resistors, coils, valves, transistors, controls, chassis, transformers, speakers, pick-ups, cartridges, stylii, and all types of components in stock.

PRICE LISTS AVAILABLE ON REQUEST

J. T. FILMER

82 DARTFORD ROAD
DARTFORD KENT
Telephone Dartford 24057

SURPLUS RADIO SUPPLIES

2 LAING'S CORNER MITCHAM SURREY

SEND 2/6 FOR OUR CATALOGUE OF
400 BARGAINS

(2/- REFUNDED ON FIRST ORDER OVER 10/-)

S.A.E. for list of meters

New Boxed Meters by Sangamo Weston

50 microamps full scale deflection. Limited quantity

19/6. P. & P. 2/6

SPARES, VALVES, TUBES 1930-1960

Guaranteed perfect, set tested, ex-working equipment

SU4	4/-	7S7	6/-	20P1	4/-	KT81	6/-	PY80	4/-
5R4	6/-	10P13	4/-	20P3	6/-	N37	6/-	PY81	4/-
6AQ5	4/-	10P14	4/-	20P4	12/6	PCC84	4/-	PY82	4/-
6AU6	4/-	12A7	2/6	1858T	10/-	PCF80	4/-	PZ30	4/-
6BG6	12/6	12AU7	4/-	ECC85	5/-	PCL82	4/-	U191	7/6
6BQ7A	5/-	12AX7	4/-	ECC88	5/-	PCL83	4/-	U403	6/-
6CH6	6/-	12BH7	4/-	ECF80	5/-	PenA4	5/-	U801	15/-
6U4	6/-	12E1	6/-	ECF82	5/-	PenA5	4/-	UCH42	6/-
6SN7	2/6	12SN7	4/-	ECL80	4/-	PL81	4/-	UL41	4/-
6SJ7	4/-	20D1	2/6	EL38	4/-	PL82	4/-	OC44	8/6
7B7	5/-	20F2	4/-	EL81	6/-	PL83	4/-	OC45	7/6
7C5	5/-	20L1	4/-	EL90	6/-	PY31	4/-	OC201	15/-

Most pre-war 4, 5, 7, 9-pin valves 5/- each. P. & P. 6d. per valve
VALVE PARCEL. 12 assorted, all different, 8/6. Postage 1/6.
CONSTRUCTOR'S PARCEL. 2 lb mixed resistors, condensers pots, valveholders, electrolytics, etc. 7/6, postage 2/6.
Send S.A.E. with enquiries or for list of 1,000 valves

ST. JOHN'S RADIO 3 Jews Row, SW18 Tel. VAN 8822

THE RADIO CONSTRUCTOR BOUND VOLUMES

Volume 12, August '58 to July '59 £1.5.0 postage 2/3

Volume 13, August '59 to July '60 £1.5.0 postage 2/3

Volume 14, August '60 to July '61 £1.5.0 postage 2/3

Volume 15, August '61 to July '62 £1.9.0 postage 2/9

Where all issues of a volume
are returned for exchange

Vols. 12-14 12s. 6d. post 2/3

Vol. 15 14s. 6d. post 2/9

Attractively bound in blue cloth, with gold-blocked spine

DATA PUBLICATIONS LTD 57 MAIDA VALE LONDON W9

BRAND NEW TEST METERS - BEST VALUE - FOR ALL PURPOSES



£8.19.6

30,000 ohms per Volt Model 500

8 Ranges D.C. volts to 1 kV.
7 Ranges A.C. volts to 1 kV.
5 Ranges D.C. current to 12 amps.
3 Range resistance to 60 meg.
Short circuit buzz test. Output meter dB, etc., etc. Size 6½" x 4½" x 2½". With Leads, Batteries and Instructions.

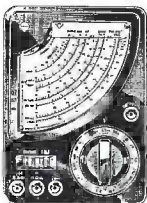

5 GNS.

20,000 ohms per Volt Model ITI-2

6 Ranges D.C. voltage to 2½ kV.
5 Ranges A.C. voltage to 1 kV.
3 Ranges D.C. current to 250mA.
Resistance to 6 meg.
Capacity and dB ranges.
Size 4½" x 3½" x 1½" with leads, batteries and instructions.



75/-

2,000 ohms per Volt Model THL33

0/10/50/250/500/1,000 volts D.C.
0/10/50/250/500/1,000 volts A.C.
0/500µA/10/250mA., D.C.
Resistance 0/10K/100K/1 meg.
Capacity and dB ranges, etc.
Size 5" x 3½" x 1½" with batteries, test leads and instructions.

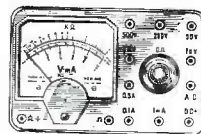

49/6

1,000 ohms per volt Model PT34

0/10/50/250/500/1,000 volts A.C./D.C. 0/1/100/500mA D.C. Resistance 0/100k ohm.
Ideal pocket sized multi-tester for all radio and domestic work. Size 3½" x 2½" x 1½" with battery, leads and instructions.

All Meters Fully Guaranteed for 6 months. Full Service Facilities.

MINIATURE CLEAR FACED Brand New PANEL METERS

0-50 microamp D.C.	39/6
0-500 " D.C.	32/6
0-1 milliamp D.C.	27/6
0-5 " D.C.	27/6
0-300 volts D.C.	27/6
"S" meter 1mA	35/-
"VU" meter	42/6

CRYSTAL MICROPHONES

ACOS 39-1. Stick Microphone with screened cable and stand (list 5 gns.), 32/6. P.P. 1/6.
ACOS 40. Desk Microphone with screened cable and built-in stand (list 50/-), 15/-, P.P. 1/6
ACOS 45. Hand Microphone with screened lead, very sensitive, 25/-, P.P. 1/6.
100 C. Stick Microphone with muting switch and screened cable, detachable desk stand and neck cord, 39/6. P.P. 1/6.
MC 24. Stick Microphone with muting switch and cable, 25/-, P.P. 1/6.
LAPEL. Miniature Microphone with clip. Ideal for recording, 15/-, P.P. 1/6.
BM 3. De Luxe Stick Microphone with muting switch cable, neckcord and detachable stand. Complete 52/6. P.P. 2/-.

(Illustrations of all types in our New Catalogue. 1/- post free.) **FULLY GUARANTEED.**

4-TRANSISTOR PUSH-PULL AUDIO MODEL PK-5 3 AMPLIFIER

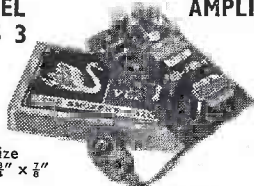

Size
3" x 1½" x ¾"

A ready-built miniature 250mW push-pull amplifier incorporating input and output transformers, 4 transistors, 9 volt battery snap cord, speaker and column connection leads. Ideal for use with record players, intercoms, hearing aids, tape recorders, etc. Complete with full instructions and circuit diagram.

PRICE 52/6 P.P. 1/6.

SUITABLE 2½ in. SPEAKER 16/6

NEW 44-PAGE CATALOGUE, 1/-



LIGHTWEIGHT HEADPHONES

- 2,000 OHMS 12/6
 - 4,000 OHMS 14/6
- HIGH EFFICIENCY

RUN YOUR RADIO OR AMPLIFIER FROM MAINS. BATTERY ELIMINATORS AND CHARGERS.

1. For PP3 or equivalent 9 volt Pocket Radio Battery. 18/6. P.P. 1/-.
2. For PP4, PP7, PP9, PP10, 9 volt Portable Radio Batteries up to 300mA. 49/6. P.P. 2/-.
3. De Luxe version of No. 1, also charges PP3 type batteries. 29/6. P.P. 1/-.
4. Rechargeable PP3 battery. Runs as long as 100 batteries. Complete with charger unit. 25/- P.P. 1/-.

STEREO AMPLIFIER

4-Valve Amplifier with 2 watts output per channel to 3 ohms. Ready built, complete with Dials, Sockets and Knobs. Full tone, volume and balance controls. Crystal input. 270/250 volt mains input.

Fully Guaranteed **79/6** P.P. 2/-
Suitable 8" x 5" Speakers 49/6 Pair.

TYPE 38, TRANSMITTER RECEIVER

Complete with 5 valves. In new condition. These sets are sold without guarantee but are serviceable. **22/6** P.P. 2/6
7.4 to 9 Mc/s. Headphones 7/6 pair. Junction Box 2/6.
Throat Mike 4/6. Aerial Rod 2/6.

POCKET RADIO BOOSTER

Tubular unit which plugs into earphone socket of any transistor radio. Performance increase is fantastic. Ideal for home or car. 8" x 2½" diameter, 22/6. P.P. 1/-.
9½" x 3½" diameter, 27/6. P.P. 1/-.

STEREO PHONES

New stethoscope type stereo earphones with adjustable tubes. Fitted miniature jack plugs and leads. 2 x 8 ohms impedance. 27/6.

TRANSISTORS, VALVES, QUARTZ CRYSTALS
Hundreds of types listed in our new catalogue, 1/- post free.

OFFICE, WORKS OR HOME USE COMPLETE INTERCOMM. SYSTEMS

- 2-transistor transformer coupled, two speakers in moulded cabinets. Features 2-way Buzzer system and talking. Supplied complete with cable **89/6** P.P. 1/6
- 4-transistor de luxe version, with 2-way calling and talking. Moulded cabinets, long battery life—very sensitive. With cable and batteries. **£7.10.0** P.P. 2/-

TRANSISTOR ALL WAVE SIGNAL GENERATOR

200 kc/s to 220 Mc/s in 7 switched fully tunable bands. Variable outputs on C.W. Mod. to 2% A.F. output, **£7.10.0** P.P. 2/6.

TRANSISTOR BABY ALARM

As previously advertised. **£5.10.0**

TELEPHONE AMPLIFIER

Speaker output from G.P.O. phone **£5.10.0**

TRANSISTOR SIGNAL INJECTOR

A new design pocket size tester for fault finding on valve or transistor radios, TV amplifiers, etc. Built-in indicator and batteries with detachable probe. 42/6.

METERS—BRAND NEW

0/50µA 2" square, d.c.	35/-
0/1mA 2" square, d.c.	27/6
0/1mA 2½" f. round, d.c.	30/-
0/500µA 2½" f. round, d.c.	20/-
2½-0-2½mA 2½" f. round, d.c.	12/6
0/40/120mA 2½", d.c.	10/-
0/15 volts 2½" M.I., a.c.	8/6

BATTERY RECORD PLAYERS

- 6-7½ volt Garrard turntable with crystal pick-up. Plays 45 r.p.m. Ideal for above amplifier. **55/-** P.P. 1/6.
- Suitable cabinet for amplifier and player, 17/6 P.P. 2/-.



HENRY'S RADIO LTD

PADdington 1008/9
5 HARROW ROAD, LONDON W2
Open Monday to Sat. 9-6, Thurs. 1 o'clock

PLEASE TURN TO BACK PAGE

Published in Great Britain by the Proprietors and Publishers Data Publications Ltd. 57 Maida Vale London W9

Printed by A. Quick & Co. (Printers) Ltd. Oxford Road Clacton-on-Sea England

Obtainable abroad through the following Collects Subscription Service Continental Publishers & Distributors Ltd. William Dawson & Sons Ltd. Australia and New Zealand Gordon & Gotch Ltd. Electronics Publications (Australia) South Africa Central News Agency Holland "Radio Electronica" Registered for transmission by Magazine Post to Canada (including Newfoundland)

COMPARE THE PRICES—COMPARE THE QUALITY AND PERFORMANCE!

● FULL DETAILS OF ANY MODEL ON REQUEST—WRITE NOW ●

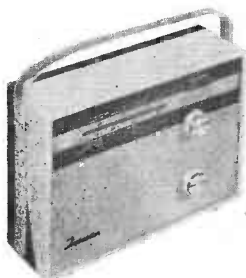

The fabulous 'Contessa' Mk. III

★ combined portable and car radio ★

- NOW** WITH 600mW MELLOWTONE OUTPUT ON MEDIUM AND LONG WAVES
- NOW** FITTED HORIZONTAL TUNING SCALE WITH ALL STATIONS CLEARLY MARKED
- NOW** SUPPLIED WITH SIX MULLARD TRANSISTORS AND TWO DIODES
- NOW** FITTED RECORDING SOCKET AND CAR AERIAL SOCKET
- NOW** SUPPLIED WITH TWO-TONE BEIGE OR TWO-TONE BLUE CABINET WITH GOLD FITTINGS

OVERALL SIZE
10½" x 7½" x 3½"

● Detailed Leaflet on Request ●

The New "CONTESSA" 6-Transistor Portable Superhet Radio. Features simple printed circuit construction and fully illustrated building instructions, with all parts clearly marked and identified. Fitted with 8" Ferrite aerial. Double IFTs and the latest in components and design. Full tuning of both Medium and Long Wave bands with unbeatable selectivity and sensitivity. Clearly marked station dial and room-filling "MELLOWTONE" push-pull output are standard features.

TOTAL COST

£10.19.6 P.P. 3/6

GUARANTEED THE VERY BEST OBTAINABLE

● All parts sold separately ●

★ ALL THESE EXTRA FEATURES AT NO EXTRA COST ★

★ NEW HUGE PURCHASE REDUCES TOTAL COST ★ "CAPRI" POCKET-6 6-TRANSISTOR SUPERHET

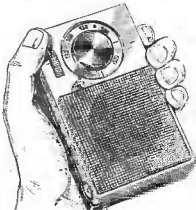

Size only
4½" x 2½" x 1¼"
REALLY POCKET SIZE!

The most compact 6-transistor and diode radio with speaker available to the home constructor. Features the latest in miniature components and circuitry. Supplied with Mullard transistors and two-tone moulded cabinets in red/white or blue/white with gold fittings. All components are supplied in packets and clearly identified. A printed circuit is used with fully illustrated building instructions. Push-pull output coupled with a sensitive and selective circuit make the "CAPRI" hard to beat. Fitted Earphone/Record socket. Full tuning on medium waves with long wave Light.

TOTAL COST £5.19.6 P.P. 2/-

★ Detailed Leaflet on Request ★
After Sales Service and Guarantee

POCKET TRANSISTOR RADIO

Special offer of brand new 6-transistor pocket radio. With leather case and phone. Tested and ready to use. £5.10.0
Ideal Christmas Gift. P. & P. 2/6

NEW 44 PAGE 10½" x 7½" ILLUSTRATED CATALOGUE FULL OF COMPONENTS AND UNITS. 1/- POST FREE

"QUINTET" MEDIUM AND LONG WAVE POCKET RADIO

PUSH-PULL SPEAKER OUTPUT

Size
5½" x 3" x 1½"

Red or Blue with Gold trim

Total Cost
99/6 P.P. 2/-

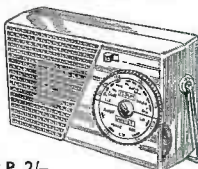

New Improved 5-Transistor and Diode Medium and Long Wave Printed Circuit Loudspeaker Radio. Features Ediswan transistors and plainly marked printed circuit with carded components. Now with better quality and greater sensitivity. Excellent results with full station separation guaranteed. Including Radio Luxembourg. Push-pull output up to 200mW. Fitted phone/record socket and car aerial socket.

Leaflet on request.

Full after-sales service and guarantee.

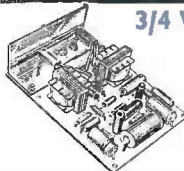

3/4 WATT TRANSISTOR AMPLIFIER

★ 1½ watt peak output.

± 3dB 70 c/s to 12 kc/s.

Output to 3 ohm speaker. 9 volt operated.

Details on request.

Built and Kit of Tested Parts

59/6 OR 52/6
P.P. 1/6 P.P. 1/6

A printed circuit high gain amplifier size 4" x 2½" x ½" using Ediswan XB112, XB113 and XC171 Transistors. Ideal for Intercomm., Record Player, Tuner Amplifier or any application requiring a quality and reliable amplifier. New Improved Design.

We can supply most of the components specified on circuits published in this and other magazines and books. Let us quote for your circuit. Competitive prices.

IT'S TINY BUT POWERFUL "MINIRANGER"

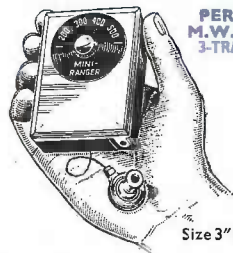

PERSONAL M.W. RADIO 3-TRANSISTOR, 2-DIODE

Size 3" x 2" x ½"

The smallest printed circuit transistor radio available for home construction. Full coverage of Medium waves and top band without any aerial or earth. Fitted calibrated dial, volume control and 9 volt battery. All stations including Radio Luxembourg are received with amazing clarity. Pre-tinned printed circuit clearly marked with component details.

● Simple to Build ●
Guaranteed Amazing Results

TOTAL COST OF ALL PARTS 59/6 P.P. 1/6

● Designed for your top jacket pocket ●
Circuit Diagram Free on Request

Medium and Long Wave Superhet Radio

Size
5¾" x 3¾" x 2"

£7.19.6 P.P. 2/-

Modified version of previously advertised "PW" Superhet. Now with new style Two Tone Cabinet. First grade components and transistors. Printed circuit. Features matched set of 6 Transistors. New 2½" quality speaker and new illustrated building instructions.

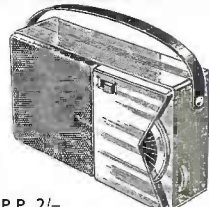

← PLEASE TURN PAGE

Henry's Radio Ltd

PADDINGTON 1008/9

5 HARROW ROAD LONDON W2

Open Monday to Sat. 9-6. Thurs. 1 o'clock