

Introducing the Jason "Jupiter" Stereo Pre-Amp & Amplifier

VOLUME 11
NUMBER 11
JUNE
1958

The RADIO Constructor



RADIO · TELEVISION · AUDIO · ELECTRONICS

FREQUENCY/WAVELENGTH **CONVERSION** **CHART**

THE MINI-METER

A Frequency Meter for
the Beginner

by JAMES S. KENT

Included in this issue

- "MINI-7" TRANSISTOR POCKET SUPERHET, Part 2
- SELF-CALIBRATING TRANSISTOR TESTER, Part 2
- 3-VALVE MAINS T.R.F. RECEIVER
USING SURPLUS METERS
- SIMPLE TRANSISTRON OSCILLATOR
- UNDERSTANDING TELEVISION, Part 6

DATA
Publications 19

THE MODERN BOOK CO

The Radio Amateur's Handbook.
1958 ed. 32s. 6d. Postage 1s. 9d.

TV and Radio Tube Troubles. By
S. Heller. 23s. Postage 1s.

TV Fault Finding. A Data Publication.
5s. Postage 6d.

Low-Cost High-Quality Amplifier.
By P. J. Baxandall. 3s. 6d. Postage 6d.

Television Servicing. By G. N.
Patchett. Vol. 1. 5s. Postage 6d.

Quality Amplifiers for A.C. Mains.
A Data Publication. 4s. 6d. Postage
6d.

**An Introduction to the Cathode Ray
Oscilloscope.** By H. Carter. 12s. 6d.
Postage 9d.

MK Electronic Tube Handbook.
5s. Postage 1s.

The Gramophone Handbook. By
P. Wilson. 15s. Postage 1s.

Television Explained. By W. E.
Miller. 12s. 6d. Postage 1s.

Television Engineers' Pocket Book.
By E. Molloy and J. P. Hawker.
10s. 6d. Postage 9d.

Magnetic Tape Recording. By
H. G. M. Spratt. 55s. Postage 1s. 3d.

Fun with Radio. By G. Davey. 10s. 6d.
Postage 1s.

**Telecommunications Principles (In
M.K.S. Units).** By R. N. Renton.
45s. Postage 1/6

We have the Finest Selection of British and American Radio Books in the country

Complete catalogue 6d.

19-23 PRAED STREET (Dept RC) LONDON W2

Telephone PADddington 4185

MAXI-Q

COIL PACKS

CP.3/370pF and **CP.3/500pF.** These 3-waveband Coil Packs are available for use with either 370pF or 500pF tuning condensers. The coverages are: Long Wave 800-2,000 metres; Medium Wave 200-550 metres; Short Wave 16-50 metres. Designed for use with "MAXI-Q" glass scale type S2. Retail price of each unit: 32/- plus 12/9 P.T.—total 44/9.

CP.3/G. As above but with Gram position, suitable for use with 500pF tuning condenser: 39/- plus 15/7 P.T.—total 54/7.

CP.3/F. This Coil Pack is for use with a 500pF tuning condenser and covers the standard Long, Medium and Short wavebands with the addition of the band 50/160 metres. This covers the Trawler band, Aeronautical and the 80 and 160 metre Amateur bands: 49/- plus 19/7 P.T.—total 68/7.

CF.3F/G. As CP.3/F but with Gram position: 57/- plus 22/9 P.T.—total 79/9.

CP.4/L and **CP.4/M.** These compact 4-station Coil Packs are available for either 1 Long Wave and 3 Medium Wave stations (CP.4/L) or 4 Medium Wave stations (CP.4/M). They are fully wired and require only four connections for use with any standard frequency changer valve: 25/- plus 10/- P.T.—total 35/-.

CP.4/L/G and **CP.4/M/G.** As CP.4/L and CP.4/M but with provision for Gram position: 31/- plus 12/5 P.T.—total 43/5.

See Technical Bulletin DTB.9 for details of all Coil Packs, 1/6

GENERAL CATALOGUE covering technical information on full range of components 1/- post free

DENCO (CLACTON) LTD (Dept. RC) 357 9 OLD ROAD CLACTON-ON-SEA ESSEX

STOP PRESS.—TREBLE LIFT INDUCTOR FOR THE MULLARD TYPE "C" TAPE AMPLIFIER. Wound in ferro-cube pot core assembly. Price: 22/6 each.

Trading Terms for direct postal orders, C.W.O. plus appropriate postal charges. Please send S.A.E. with all enquiries

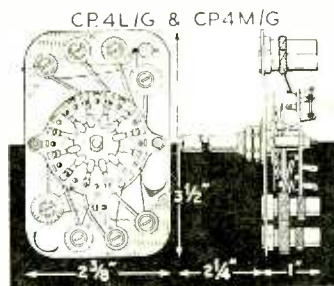

data for **AUDIOPHILES** *

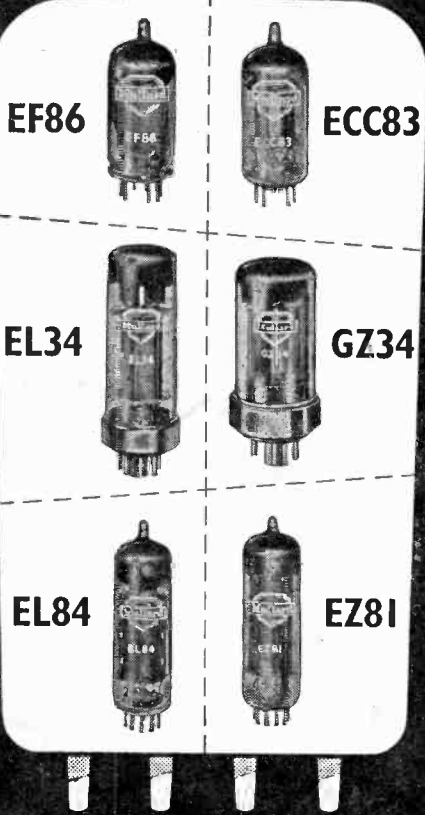

Audiophiles all over the world are demanding Mullard audio valves for their high quality sound equipment. And who can blame them when they know that the Mullard World Series of Audio Valves is the finest in the world.

Fill in the coupon below for free data on Mullard World Series Audio Valves.

* *Audiophile—Enthusiast for high quality sound reproduction who is satisfied with nothing but the best.*



This popular book is available now from most dealers, price 3/6d. It contains designs and full constructional details of the new Mullard EL34 High Quality 20 Watt Amplifier, a Mullard Band II F.M. Tuner, pre-amplifiers for the Mullard EL34 Amplifier and for the popular Mullard 5 Valve 10 Watt Amplifier, together with other useful technical information.

COUPON

TO: MULLARD LTD., PUBLICITY DIVN.

Please send me, free of charge, leaflets on the Mullard World Series of Audio Valves, and details of "High Quality Sound Reproduction".

NAME

ADDRESS

Mullard

WORLD SERIES
AUDIO VALVES



Mullard Ltd · Publicity Division
Mullard House Torrington Place
London WC1

MVM 349A

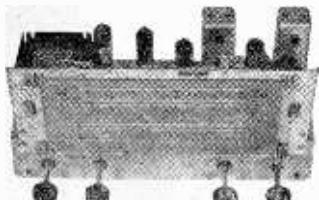

1958 RADIOGRAM CHASSIS

THREE WAVEBANDS FIVE VALVES
S.W. 16 m.-50 m. LATEST MULLARD
M.W. 200 m.-550 m. ECH42, EF41, EBC41,
L.W. 800 m.-2,000 m. EL41, EZ40
12 month Guarantee. A.C. 200/250V, 4-way switch.
Short-Medium-Long-Gram. A.V.C. and negative feed-
back. 4.2 watts. Chassis 13 1/2" x 5 1/2" x 2 1/2". Glass dial
10" x 4 1/2" horizontal or vertical available. 2 pilot lamps.
Four knobs, walnut or ivory, aligned and calibrated.
Chassis isolated from mains. Immediate delivery

BRAND NEW £10.10 Carr. 4/6

TERMS: Deposit £5.5.0 and 6 monthly payments of £1
MATCHED SPEAKERS: 8" 17/6, 10" 25/-, 12" 30/-

**COLLARO
HIGH FIDELITY AUTOCHANGER
MODEL RC456**

For 7", 10", 12" Records, 16, 33, 45, 78 r.p.m.

**4 SPEEDS — 10 RECORDS
WITH STUDIO "O" PICK-UP XTAL
BRAND NEW IN MAKER'S BOXES**

OUR PRICE £9.15.0 Post free

Terms: Deposit £5.5.0 and 6 monthly payments of £1

AUTOCHANGER ACCESSORIES

Suitable player cabinets	49/6
Amplifier player cabinets	63/-
2 valve 2-stage amplifier and 6 1/2" speaker ...	72/6
3 valve 3-stage amplifier and 6 1/2" speaker ...	95/-

Tested ready for use

**B.S.R. MONARCH 4-SPEED
AUTOMATIC RECORD CHANGERS**

1958 MODELS

Brand new and fully guaranteed 12 months

Designed to play 16, 33, 45, 78 r.p.m. Records 7", 10",
12". Lightweight Xtal pick-up, turnover head, two
separate sapphire styli, for standard and L.P.

OUR PRICE £8.15.0 each. Post free

Terms: Deposit £5 and 5 monthly payments of £1

BUILD THIS REPRODUCER BARGAIN

SPECIAL SINGLE PLAYER KIT

COLLARO 4-speed Gram-Pick-up Unit £4. 12. 6
Handsome portable case with 1 1/2" x 1 1/2" x 7" £2. 5. 0
Ready-built 3 watt amplifier with two valves
and 7" elip. speaker, printed circuit £3. 12. 6

All available separately, post 2/6 each, or

£9.15.0 complete kit post free

£3.5.0 extra with Garrard 4 SP

I.F. TRANSFORMERS 7/6 pair

465 kc/s slug tuning miniature can 2 1/2" x 1" x 1".
High Q and good band width. By Pye Radio. Data
sheet supplied.
Wearite M800 Midget I.F.S. 465 kc/s, 12/6 pair
Wearite 550 Standard I.F.S. 465 kc/s, 12/6 pair

C.R.T. ISOLATION TRANSFORMERS

For Cathode Ray Tubes having heater-cathode short circuit and for C.R. Tubes with falling emission.
Type A. Low leakage windings. Ratio 1:1.25 giving a 25% boost on secondary: 2V, 4V, 6.3V, 10.3V, 13.3V, 10/6 each; ditto with mains primaries, 12/6
Type B. Mains input 220/240V. Low capacity. Multi-output 2, 4, 6.3, 7.3, 10 and 13V. Input has two taps which increase output volts by 25% and 50% respectively. This transformer is suitable for all cathode ray tubes. With tag panel, 21/- each
Ditto for 6 volt tubes, only 17/6 each
Type C. Low capacity wound transformer for use with 2V tubes with falling emission. Input 220/240V. Output 2, 2 1/2, 2 3/4, 3V at 2A, 17/6 each
All isolation transformers are individually boxed, labelled and clearly marked with relevant data.
NOTE.—It is essential to use mains primary types with TV receivers having series connected heaters.

RESISTORS. Preferred values. 20% 10 ohms to 10 meg, 1W 4d., 1/2W 4d., 1W 6d., 1 1/2W 8d.
HIGH STABILITY. 1/2W 1%, 2/- All preferred values 100Ω—10MΩ. Ditto 5% 100Ω—5MΩ 9d. each.
WIRE-WOUND RESISTORS { 1/3
5 watt }
10 watt } 1/6
15 watt } 2/-
25 ohms-10,000 ohms

15,000 ohms-50,000 ohms, 5W, 1/9; 10W, 2/3
WIRE-WOUND POTS 3W Lab. Colvern, etc.
Pre-set min. TV type. Standard size Pots, 2 1/2"
Knurled slotted knob. Spindle, high grade. All
All values 25 ohms to 30k, 5/6; 100k, 6/6
3/- each. 50k, 4/-
Ditto Carbon Track 50k W/W EXT. SPEAKER
to 2 Meg, 3/- CONTROL 10Ω, 3/-

O/P TRANSFORMERS. Heavy duty 50mA, 4/6.
Multi-ratio push-pull, 7/6. Miniature 3V4, etc., 4/6.
Small pentode, 4/6. Hygrade push-pull 7 watts, 15/6
Mullard "510" 6k or 8 kΩ, 30/-
L.F. CHOKES 15/10H 60/65mA, 5/-; 10H, 85mA,
10/6; 20/15H, 120/150mA, 12/6; 5H, 250mA, 15/-
MAINS TRANS. 350-0-350, 80mA, 6.3V tapped 4V
4A 5V tapped 4V 2A, ditto 250-0-250 80mA, etc., 22/6

CRYSTAL MIKE INSERT by Acos

Precision engineered. Size only 1 3/8" x 1 1/8". Bargain price 6/6 No transformer required

HEATER TRANS. Tapped 200/250V 6.3V 1 1/4, 7/6
ALADDIN FORMERS and cores. 1/2" 8d., 3/4" 10d.,
0.3" FORMERS 5937/8 and cans TV1/2. 2 1/2" sq. x 2 3/8"
and 3" sq. x 1 1/2", 2/- complete with cores
SLOW MOTION DRIVES. Epicyclic ratio 6-1, 2/3
TYANA. Midget Soldering Iron. 200/250V or 230/
250V, 16/9. **SOLON MIDGET IRON,** 25W, 24/-
MAINS DROPPERS. 3" x 1 1/4". Three adj. sliders,
0.3A 750 ohms, 4/3; 0.2A 1,000 ohms, 4/3

LINE CORD. 0.3A 60 ohms per foot, 0.2A 100 ohms
per foot, 2-way, 6d. per foot; 3-way, 7d. per foot
MIKE TRANSF. 50-1, 3/9; 100:1, potted, 10/6
LOUDSPEAKERS. P.M. 3 ohm. 2 1/2" and 5", 17/6;
7" x 4" Goodmans, 21/-; 4" Hi-Fi Tweeter, 25/-; 8"
Plessey, 19/6; 6 1/2" Goodmans, 18/6; 10" R.A., 30/-; 12"
Plessey, 30/-; 8" M.E. 2.5k field tapped, o.p. transformer,
24/6; 15 ohm Plessey 10W 12", with tweeter, 97/6;
Stentorian HF1012 10" 3 to 15 ohms 10W, 99/6

CRYSTAL DIODES. G.E.C., 2/-; GEX34, 4/-
**40 CIRCUITS FOR GERMANIUM DIODES, 3/-
TUNING AND REACTION CONDENSERS**
100pF, 300pF, 500pF, 3/6 each, solid dielectric
H.R. HEADPHONES 4,000 ohms, brand new, 16/6 pr.
SWITCH CLEANER FLUID, squirt spout, 4/3 tin
TWIN GANG CONDENSERS. 365pF, miniature,
1 1/2" x 1 1/2" x 1 1/2", 10/-, 0.0005 standard with trimmers,
9/-; less trimmers, 8/-; Midget 7/6; 50pF single, 2/6

**GARRARD 4-speed Single Record Player with GC2
Hi-Fi Xtal Turnover Head for 78 r.p.m. and L.P.
Space required 14" x 12 1/2", 2 1/2" above, 2 1/2" below.
Model 4 SP—BARGAIN £8 post free**

Written guarantee with every purchase

RADIO COMPONE

Buses 133 or 68 pass door S.R. Stn. Selhurst

48-HOUR
POSTAL SERVICE

Aluminium Chassis. 18 s.w.g. Plain, undrilled, with 4 sides, riveted corners and lattice fixing holes, with 2 1/2" sides. 7" x 4", 4/6; 9" x 7", 5/9; 11" x 7", 6/9; 13" x 9", 8/6; 14" x 11", 10/6; 15" x 14", 12/6; 18" x 16" x 3", 16/6

Volume Controls

Midget size
Long spindles. Guaranteed 1 year. All values 10,000 ohms to 2 Meg.
No. Sw. D.P.Sw.
3/- 4/9
Linear or Log Tracks

80 Ω Coaxial Cable

Semi-air spaced Polythene insulated 1/4" dia. stranded core. Ideal Band III 9d. yd Losses cut 50%

FRINGE QUALITY
Air-spaced Coaxial 1/6 yd

Coaxial Plugs 1/- **Double Socket** 1/3
Sockets 1/- **Outlet Boxes** 4/6

Balanced Twin Feeder, per yd 6d., 80Ω, 300Ω
Twin Screened Balanced Feeder, 1/6 yd, 80 ohms

Trimmers. Ceramic, 30, 50, 70P, 9d.; 100P, 150P
1/3; 250P, 1/6; 600P, 750P, 1/9 Philips 1/- each

BLACK CRACKLE PAINT. Air drying, 3/- tin
P.V.C. CONN. WIRE, 10 colours, single or stranded,

2d. yd. Sleeving, 1, 2mm, 2d., 2, 3mm, 3d., 6mm. 5d. yd
5" **RADIO SCREWDRIVERS**, 6d. each

NEON MAINS TESTER SCREWDRIVERS, 5/3
SOLDER RADIOGRADE, 3 yds 9d., 1/6 2/6

Sentinel Rectifiers. E.H.T. Type Flyback. Voltages: K3/25 2kV, 5/-; K3/40 3.2kV, 7/-; K3/45 3.6kV, 7/6; K3/50 4kV, 8/-; K3/100 8kV, 14/6

50 cps voltage 30% of above ratings
Mains Type RM1, 125V 60mA, 5/- RM2 100mA, 6/-; RM3 120mA, 8/-; RM4 250V 275mA, 16/-; RM5, 20/-

Miniature Contact Coated Rectifiers. 250V 50mA, 8/6; 250V, 85mA, 9/6. **Selenium Rect.** 300V 85mA, 7/6
Coils. Wearite "P" type, 3/- each. Osom "Hidger

"Q" type, adj. dust core, from 4/- each. All ranges
Teletron. L & Med. T.R.F. with reaction, 3/6

Ferrite Rod Aerials. M.W., 8/9; M. & L., 12/6
T.R.F. Coils A/HF, 7/- pair. **H.F. Chokes**, 2/6

Speaker Fret. Gold cloth, 17" x 25", 5/-; 25" x 35"
10/-; Expanded metal, silver, 15 1/2" x 9", 2/- each;
Tygan. 4' 6" wide, 10/- ft; 2' 3" wide, 5/- ft

HANDY VOLTMETERS. 2" Twin Range 0-25V, 1
0-250V d.c. with leads and leather case, 12/6 each

Condensers. New stock, 0.001μF 7kV T.C.C., 5/6 ditto 20kV, 9/6; 100pF to 500pF Micaflex, 6d.; Tubular 500V 0.001 to 0.01μF, 9d.; 0.05, 0.1, 1/-; 0.25, 1/6; 0.5, 1/9; 0.1/350V, 9d.; 0.01/2,000V, 1/9; 0.1/2,000V, 3/6

Ceramic Condensers. 500V 0.3pF to 0.01μF, 10d.
Silver mica. 10% 5pF to 500pF, 1/-; 600pF to 3,000pF, 1/3; Close tolerance (plus or minus 1pF); 1.5pF to 47pF, 1/6; ditto 1% 50pF to 815pF, 1/9; 1,000pF to 5,000pF, 2/-

NEW ELECTROLYTICS. **FAMOUS MAKES**

TUBULAR TUBULAR CAN TYPES

1/350V 2/- 100/25V 2/- 8+16/450V 5/-
2/450V 2/3 8+8/500V 6/- 16+16/450V 5/6

4/450V 2/3 16+16/500V 6/- 6,000μF 6V 6/6
8/450V 2/3 CAN TYPES 32+32/350V 4/6

8/500V 2/9 Clips 3d. 32+32/450V 6/6
16/450V 3/6 16/500V 4/- 64+120/275V 7/6

16/500V 4/- 32/350V 4/- 60+100/350V 11/6
32/450V 5/6 100/275V 5/6 100+200/275V

25/25V 1/9 50+50/350V 7/- 10/-
50/25V 2/- 500/12V 3/- 1,000+1,000/6V

50/50V 2/- 2,500/3V 4/- 6/6
Full Wave Bridge Selenium Rectifiers. 2, 6 or 12V 1 1/2A, 8/9; 2A, 11/3; 4A, 17/6. Free charger circuit

Charger Transformers. Tapped input 200/250V for charging at 2, 6 or 12V 1 1/2A, 15/6; 2A, 17/6; 4A, 22/6

12/6 PURETONE RECORDING TAPE

1,200ft on standard fitting 7" metal reels. Spare reels 7" metal, 2/3; 5 1/2" plastic, 3/-; 7" plastic, 4/-

SUPERIOR 1,200ft plastic tape, 21/-, on 7" plastic reels

Please address all Mail Orders correctly as below

IT SPECIALISTS

& P. 1/-, over £2 post free. C.O.D. 1/6 (Export C.W.O. post extra, no H.P.)

THE HIGH GAIN BAND III TV PRE-AMP Tunable Channels 8, 9 and 10, Gain 17dB, Cascade Circuit. Complete kit with ECC84 valve, plans and instructions, 29/6 less power, or 49/6 with power pack. Plans only, 1/6

TRANSISTORS. Audio, 10/-; R.F. 2.6 Mc/s, 21/-; Mullard OC71, 20/-; Sub-miniature Electrolytics, 5μF 12V, 8μF 6V, 16μF 12V, 25μF 6V, 3/- each

JASON FM TUNER COIL SET, 26/-. H.F. coil, aerial coil, oscillator coil, two i.f. transformers 10.7 Mc/s, detector transformer and heater choke. Circuit and component book using four 6AM6, 2/-; **Complete Jason FM Kit**, with valves and Jason superior calibrated dial, £6.15.0, post free

Wavechange Switches. 2 p 2-way, 3 p 2-way, short spindle, 2/6; 5 p 4-way 2 wafer, long spindle, 6/6; 2 p 6-way, 4 p 2-way, 4 p 3-way, long spindle, 3/6; 3 p 4-way, 1 p 12-way, long spindle, 3/6; wave change "MAKITS," 1 wafer, 8/6; 2 wafer, 12/6; 3 wafer, 16/-; 4 wafer, 19/6; 5 wafer, 23/-; 6 wafer, 26/6
Toggle Switches, s.p. 2/-, d.p. 3/6, d.p.d.t. 4/-
Morse Keys, good quality, 2/6. **Buzzers** 3/6

TELETRON 'COMPANION' PRINTED CIRCUIT TRANSISTOR THREE

Pocket receiver kit, 4 1/2" x 3" x 1 1/2" complete with cabinet, all parts and transistors. Super-regenerative circuit, price 99/6.

Valveholders. Pax. int. oct., 4d. EF50, EA50, 6d B12A, CRT, 1/3. Eng. and Amer. 4, 5, 6, 7 and 9 pin, 1/-
MOULDED Mazda and int. oct., 6d.; BTG, 8BA, B8G, B9A, 9d. BTG with can, 1/6. VCR57, 2/6. B9A with can, 2/6. Ceramic, EF50, BTG, B9A, int. oct., 1/-; BTG with can, 1/9; B9A with can, 2/9

SUPERHET COIL PACK 27/6

Miniature size high Q dust cored coils. Short, Med., Long. Gram. switching with connection diagram. 465 kc/s i.f.

TV Fault Finding. Data Publications, 5/- each
Radio Valve Guide. Books 1, 2 or 3, 5/- each

TELETRON "AJAX" CRYSTAL SET

Complete kit with cabinet 4 1/2" x 3" x 1 1/2". All components and instructions. 15/-, or with pair of H.R. headphones to match, 30/-

New boxed		VALVES		90-day Guarantee	
1R5	8/6	6K8	8/6	EA50	1/6
1S5	8/6	6L6	10/6	EABC8016	6/6
1T4	8/6	6Q7	10/6	EB91	6/6
2X2	2/6	6SA7	10/6	ECB33	8/6
3S4	8/6	6SJM	10/6	EBF40	10/6
3V4	8/6	6SN7	8/6	EBF80	10/6
5U4	8/6	6V6G	7/6	ECC84	12/6
5Y3	8/6	6V6GT	8/6	ECF80	11/6
5Z4	10/6	6X4	7/6	ECF82	11/6
6AM6	8/6	6X5	7/6	ECH42	10/6
6B8	5/6	757	10/6	ECL82	6/6
6BE6	7/6	12AH8	10/6	EF39	7/6
6BH6	10/6	12AT7	10/6	EF41	10/6
6BV6	10/6	12AU7	9/6	EF50	5/6
6CH6	10/6	12AX7	9/6	Equip.	10/6
6D6	7/6	12BE6	9/6	EF50	8/6
6F6	7/6	12BH7	10/6	Sylv.	10/6
6H6	3/6	12K7	8/6	EF80	10/6
6J5	6/6	12Q7	8/6	EF92	5/6
6J6	7/6	35Z4	9/6	EL32	5/6
6J7	8/6	80	10/6	EL84	10/6
6K6	6/6	807	6/6	EY51	12/6
6K7	5/6	954	1/6	EZ40	10/6
				U281	11/6
				E1148	1/6
				HABC80	12/6
				HVR2A	7/6
				MU14	10/6
				P61	6/6
				PCC84	12/6
				PCF80	11/6
				PCF82	11/6
				PCL82	11/6
				PEN25	6/6
				PL82	10/6
				PY80	10/6
				PY81	10/6
				PY82	10/6
				SP61	5/6
				UBC41	10/6
				UCH42	10/6
				UF41	10/6
				UL41	10/6
				UY41	10/6
				U22	10/6
				X79	10/6

337 WHITEHORSE ROAD WEST CROYDON

Telephone THO 1665

Catalogue 6d.

OPEN ALL DAY (Wed. 1 p.m.)

CLYNE RADIO LTD



"The Component Specialists"

ALL POST ORDERS AND CORRESPONDENCE TO
162 HOLLOWAY ROAD . LONDON N7
NOR 6295/6/7
18 TOTTENHAM COURT RD. LONDON W1
MUS 5929/0095

Callers welcome at both branches



ALL NECESSARY COMPONENTS AT SPECIAL INCLUSIVE PRICE OF

£10.10.0

P. and P. 2/6
Medium Wave only

£9.19.6

P. and P. 2/6

"R.E.P. MINI-7"

(As described in this issue)

POCKET TRANSISTOR PORTABLE

AT LAST! A pocket-sized SUPERHET Transistor Portable for medium and long wave reception THAT REALLY WORKS, and at a price YOU can afford.

- Utilises 2 White Spot, 4 Red Spot and 1 R.F. Transistor specially selected to our specification by leading manufacturer
- Push-pull output
- Powered by two 3V miniature transistor batteries
- Attractive plastic case, finished in dove grey with scarlet knobs. Size only 5½" x 3¼" x 1¼"
- Hi-Grade 2½" p.m. loudspeaker
- Ferrite Slab Aerial
- Drilled and eyeleted Paxolin Chassis

Easy to follow practical and theoretical diagrams and itemised price list available separately at 1/6, post free

NOTE.—For those who purchase the complete set of components from us we shall be pleased to carry out alignment of completed receiver for 15/- plus p. and p.—provided there are no faults in assembly.

JASON!

We have long been noted as London's Leading Stockists. The combination of CLYNE/JASON is your key to satisfaction. All components stocked for the Jason Standard FM Tuner, Fringe Area FM Tuner, "Mercury Switch Tuned FM Feeder, "Argonaut" AM/FM Chassis, J.4-4 and J.2-2 Stereophonic Pre-amplifiers, etc. Your enquiries invited.

The "New Look RAMBLER"

(as described in
May issue 1957)



Your summer holiday will not be complete without our most popular All-dry Battery Portable Superhet, now available with a new cabinet of even more attractive appearance. Finished in two-tone RED/GREY "Lionide," it is washable and unscratchable. The standard cream plastic top panel, engraved in red and green, completes the overall "air of quality." This receiver has everything: quality, sensitivity, economy and ample volume. Employs a high quality 5" loudspeaker and the following popular readily obtainable miniature valves: 3V4, 1R5, 1S5, 1T4. All necessary components, including cabinet, can be supplied, ex-stock, at the original Special Inclusive Price of £7.7.0 plus 2/6 p. and p. (less batteries). Uses all-dry 1.5V l.t. (1/6), 90V h.t. (10/-). Easy-to-follow instruction booklet containing practical and theoretical diagrams and itemised price list available separately at 1/6 post free.

RAMBLER MAINS UNIT

Enabling the above receiver to be used on a.c. mains, fits snugly into battery compartment. Completely self-contained in metal case measuring only 7" x 2½" x 1¼". All necessary components ex-stock at only 47/6 plus 1/6 p. and p. or assembled and tested at £3.5.0. Instruction booklet and itemised price list available separately at 9d. post free.

ALL "TELETRON" COMPONENTS IN STOCK

R.E.P.—I-VALVE BATTERY RECEIVER

All components, as specified, available ex-stock, including headphones, at a Special Inclusive Price of 42/- (less battery) plus 2/- p. and p. B114 battery 8/- extra. Instruction envelope and itemised price list available separately at 9d. post free.

AM, FM, AM/FM, CHASSIS, TUNERS, AMPLIFIERS, LOUDSPEAKERS, CABINETS, TAPE RECORDERS, RECORD PLAYERS, VALVES, COMPONENTS, Etc., Etc.

● 109-page Illustrated Catalogue

2/-
POST FREE

BRIDGE COMPONENTS

If you require a stockist of High Grade Components, we are the people for the job.

ALL BOOKS BY

Kendall & Mousley Ltd.
Bernards (Publishers) Ltd.
Norman Price (Publishers) Ltd.
Data Publications Ltd.

STOCKED—SEND FOR LIST

Components by *McMurdo, Colvern, Lab., Hunts, Elstone, T.S.L.*, available from stock.
Send for Catalogue

The High Fidelity Co

18 MELVILLE ROAD EDGBASTON
BIRMINGHAM 16

(Proprietors Kendall & Mousley Ltd)

EXCLUSIVE

Low voltage, halogen quenched

**GEIGER—MUELLER
TUBES at 55/- each**

A large contract purchase from famous manufacturer enables us to make an exclusive offer of these highly sensitive gamma counters. Straight from production, individually tested and fully guaranteed.

Specification

- Effective length: 11.8cm. Standard British 4-pin base
- Background count: 90/min.
- Plateau: Minimum length 80V. Slope 5% per 100V
- Working potential: 400-450V
- Current: 0.001 μ A to 1 μ A at 100 to 6,000 c/min.
- Response: exceeds 30,000 c/m
- Dead time: 100 μ sec. at 6,000 c/m. Rise time: 5 to 10 μ sec. at 6,000 c/m
- Temperature range: -55°C to $+60^{\circ}\text{C}$
- Gamma efficiency: 1%
- Stainless iron electrode

... at the Walk-Around Shop

**PROOPS
BROS. LTD**

DEPT. R
52 Tottenham Court Rd
London W1

LANgham 0141

Hours 9-6, Thurs. 9-1
Open all day Saturday



JUST PUBLISHED

The Cooper-Smith, type B.P.I. **HIGH FIDELITY AMPLIFIER** and **Mk. 2 CONTROL UNIT** by Jack Cooper

A new addition to our Radio Reprint series (RR6), this book of 24pp., plus laminated plastic board cover, is a worth while addition to the Hi-Fi enthusiast's bookcase.

In addition to the material reprinted from our December 1957, January and February 1958 issues, two new chapters have been included, these giving much useful information on Signal Sources for use with the amplifier and on Choosing a Loudspeaker.

Complete circuit and constructional details of the balanced phase inversion amplifier are given, including point-to-point diagrams.

PRICE 2/6 Postage 2d.

Published by

DATA PUBLICATIONS LTD 57 Maida Vale · London W9

SUB-MINIATURE SPEAKERS

(By W.B.)

1 $\frac{1}{2}$ " round. Depth 1". Impedance 3 Ω 27/- tax paid
2" x 3" elliptical. Depth 1 $\frac{1}{2}$ ". Impedance 3 Ω 33/- tax paid
Sub-miniature Output Transformers for above:

Type A single ended, ratio 18.2/1
Type B push-pull, ratio 10.3/1
Type C push-pull, ratio 8/1
All $\frac{1}{2}$ " x $\frac{1}{4}$ " x $\frac{1}{8}$ " 12/6 each

TRANSISTORS

White Spot (r.f.) ... 20/-
Yellow/Red (2.8 Mc/s) ... 21/-
Blue Spot (1.6 Mc/s) ... 15/-
Yellow/Green (audio) ... 10/-
Red Spot ... 9/6

We have a large range of Ardenite Sub-miniature components

Special Catalogue available 6d. post free

SUB-MINIATURE VOLUME CONTROLS

Spindle Type, $\frac{3}{8}$ " diam., $\frac{1}{8}$ " deep, 2" spindle. $\frac{1}{2}$, 1 or 2 M Ω . Log track ... 4/3

Peripheral Ring Type. Totally enclosed, $\frac{3}{8}$ " x $\frac{1}{2}$ " deep. 47k Ω and 1M Ω only ... 2/6

Preset Type. Skeleton assembly. $\frac{3}{8}$ " diam., $\frac{1}{8}$ " below panel, $\frac{1}{4}$ " above panel (including knob). Suitable for manual or screwdriver operation. 5k Ω only ... 2/6

(See page 705 May issue)

THE "COMPANION" 3 TRANSISTOR RECEIVER

(By Teletron)

Now available with

PRINTED CIRCUIT

Complete kit ... £5.15.6

Details and Price List 6d.

PRICES REDUCED! SUB-MINIATURE CAPACITORS

(By Mullard)

8 μ F 6V, 25 μ F 6V, 16 μ F 125V, 32 μ F 3V, 5 μ F 125V, 5 μ F 40V, 2.5 μ F 40V, 1.6 μ F 6V. All at 3/3 each. Also 100 μ F 6V at 3/- (T.C.C.)

PAPER SUB-MINIATURES

0.01, 0.001, 0.002 μ F, $\frac{1}{4}$ " x $\frac{1}{8}$ " diam., 8d. each; and 0.005 μ F ($\frac{1}{4}$ " x $\frac{1}{8}$ " diam.), 7d. each

• Send for Catalogue, price 5d. • QUOTATION gladly given. (Please send S.A.E.) • Please add postage to above prices

THE "MINI-7"

(Page 798)



All parts as specified now in stock
All parts for Stage I ... £5.15.6
All parts for Stage II ... £1.15.6
All parts for Stage III ... 14/3
All parts for Stage IV ... £4.12.6
Set of nuts, bolts, wire, etc. 2/9
Send S.A.E. for detailed price list or 1/6 for detailed constructor's envelope and price list

MINIATURE MAINS NEON INDICATORS

With built-in resistor. Domed front with chrome bezel. Only $\frac{1}{4}$ " length and $\frac{1}{8}$ " diam.
Opal, red or amber 3/10, green 4/7

REPANCO I-VALVER

(Page 653 April)

Constructor's Envelope 9d.
Complete kit (less 'phones) £2.8.0

All parts sold separately
'Phones available at 14/-

AJAX CRYSTAL RECEIVER

Complete kit 14/6. Long wave version 15/-. 'Phones 14/- pair
Superior type 16/- (see R.C. March).

CRYSTAL HEADPHONES (by Rothermel) bargain at 21/- pair

HIGAIN BAND 3 PRE-AMPLIFIER

(See page 568 March)

Resistor Set ... 1/6
Capacitor Set (with clip) 8/9
Valve ECC84 ... 17/-
Rectifier (50mA) ... 7/6
Transformer ... 13/-
Coil Set (L-L $\frac{1}{2}$) ... 9/-
Chassis (punched for coils, space for Power Pack) ... 3/9
Coax Sockets, V/holder, Tag Strip, Nuts, Bolts ... 5/6

COMPLETE KIT AS ABOVE
£3.3.0

SPECIAL OFFER

Further Reduction

Recording Tape by famous manufacturer, 1,200ft on 7" standard spool.

Limited Stock at 21/- each
(Normal price 35/-)

LITESOLD SOLDERING IRONS

Are specially suitable for those small assemblies. With $\frac{1}{4}$ " non-wearing bit. Total weight $\frac{1}{2}$ oz. Mains or battery (state voltage required), 21/6
SOLDER (Multicore) 4d. yard.
20ft reel 2/6, 11b reel 14/9. PRINTED CIRCUIT CORED SOLDER, 40ft fine gauge 2/6

"THE MERCURY" FM SWITCHED TUNER

(All parts as specified)

Complete front end (ready built, with 2 valves) ... £6.5.0
Coils, chokes and transformers ... £1.4.6
Condenser set ... 9/8
Resistor set ... 5/-

All other components (including valveholders, diodes, knob, wire, etc.) 16/7

Complete kit with 2 front end valves but less EF80's ... £9.0.0

Complete Power Pack kit £2.1.9

All other Jason components stocked

KNOBBS. All types from 10d. Send sketch and sizes for quotation.
TYGAN. Assorted offsets (none less than 3" x 3"). Parcels of 3 sq ft 10/-, 5 sq ft, 15/-.

CAPACITORS. Paper from 10d. Silver Mica from 7d. Assorted mixed s/m and small paper 16/- for 25.

RESISTORS. All types and ratings from 3d. Wirewound from 1/3. Mixed carbon resistors $\frac{1}{2}$ to 1 watt, 20% to 5%, 50 for 7/-, Hi Stabs. 10% $\frac{1}{2}$ W 6d.; 10% 1W 9d.; 1% $\frac{1}{2}$ W 2/-.

Most usual values available. (A few values in 5%, 2% and 1% available at 1/-).

P.V.C. WIRING. Assd. colours, 2d. yd. FILES. 6 in plastic wallet, 12/6.

SCREWDRIVERS. 2 blades, file and bradawl in hollow handle, 3/6. Mains-tester type, 4/-.

Flexible blade, 7/9. Wallet containing 3 blades, 2 Philips blades, 2 bradawls and handle, 12/-.

INSULATING TAPE $\frac{1}{4}$ " wide, 25 yds in tin, 1/6.

SWITCHES. Toggle On/OFF, s.p. 2/3, d.p. 3/6; rotary from 2/-.

COIL FORMERS with CANS. Having easily removable coil, $\frac{3}{8}$ " x $\frac{3}{8}$ " x $\frac{1}{2}$ " or 2 $\frac{1}{2}$ " x 1 $\frac{1}{2}$ ". SLEEVING, p.v.c. from 1d. yd.

FERRITE RODS, 8" x $\frac{1}{4}$ " diam, 2/6. TRANSISTOR HOLDERS, 1/- each, 5/9 for six, 11/- per dozen.

R. Fagelston

(MAIL ORDER)

46 HARDWICKE ROAD • LONDON N13

Wanted!

QUALIFIED MEN AND WOMEN

Industry and Commerce offer their best posts to those with the qualifications — appointments that will bring personal satisfaction, good money, status and security. As part of a modern industrial organisation, we have skilled knowledge of what is required and the best means of training personnel for its present day and future requirements. We specialise also in teaching for hobbies, new interests or part-time occupations in any of the subjects listed below. Write to us to-day for further information. There is no obligation of any kind.

PERSONAL & INDIVIDUAL TRAINING IN—

Accountancy	Electronics	Production
Advertising	Electronic	Planning
Aeronautical Eng.	Draughtsmanship	Radar
A.R.B. Licences	Eng. Drawing	Radio
Art (Fashion, Illustrating, Humorous)	Export	Radio Amateur's (C&G) Licence
Automobile Eng.	General Certificate of Education	Radio & Television Servicing
Banking	Heating & Ventilating Eng.	Refrigeration
Book-keeping	High Speed Oil Engines	Sales Management
Building	Industrial Admin.	Sanitary Eng.
Business Management	Jig & Tool Design	Salesmanship
Carpentry	Journalism	Secretaryship
Chemistry	Languages	Shorthand & Typing
City & Guilds Exams	Management	Short Story Writing
Civil Service	Maintenance Eng.	Short Wave Radio
Commercial Subjects	Mathematics	Sound Recording & Reproduction
Commercial Art & Drawing	M.C.A. Licences	Telecommunications
Customs Officer	Mechanical Eng.	Television
Draughtsmanship	Metallurgy	Time & Motion Study
Economics	Motor Eng.	Tracing
Electrical Eng.	Painting & Decorating	Welding
Electrical Installations	Photography	Workshop Practice
	P.M.S. Cert.	Works M'gement and many others
	Police	
	Production Eng.	

OUR BACKGROUND!



The E.M.I. Factories at Hayes, England.

NEW! Courses with PRACTICAL EQUIPMENT

IN RADIO · TELEVISION · MECHANICS · CHEMISTRY
ELECTRICITY · DRAUGHTSMANSHIP
PHOTOGRAPHY, ETC., ETC.

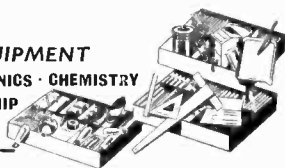

The only Home Study College
operated by a world-wide
manufacturing organisation

EMI

INSTITUTES

POST THIS TODAY

E.M.I. INSTITUTES, Dept. 179K, London, W.4

NAME _____ AGE _____
(if under 21)

ADDRESS _____
I am interested in the following subject(s) with/without equipment

June/58

(We shall not worry you with personal visits).

FREE

BLOCK
CAPS
PLEASE

IC 92

The only Home Study College run by a World-wide industrial organisation

New stereophonic kits

from



J.4-4

All parts include prepared chassis, but less 8 valves

£16.10.0

J.2-2

All parts as above but less 4 valves

£12.18.0

Two designs are offered. The first, Model J.4-4 (8 valves) is intended for the more experienced constructor to build, and has sufficient gain to play off a tape head. This is the model as designed by Mr. H. Lewis Yorke, of Cape Electrophonics, and described in Hi-Fi News. Model J.2-2 (4 valves) is a somewhat simpler version of the original design, and less complicated to build.

A special amplifier is also to be made available, the Jason J.2-10. This is virtually the original J.10 converted to stereo, and like the J.10 is intended for shelf mounting. All Jason Stereophonic equipment can be used also for single channel reproduction.

FULL DETAILS GLADLY SENT ON APPLICATION

THE JASON MOTOR & ELECTRONIC CO 3-4 (E) GREAT CHAPEL STREET
 OXFORD STREET LONDON W1
 GER 0273/4

Yours the easiest way!

How would you like to have one of the famous M.I.P. Series 100 Multi-Range Test Sets on your bench almost by return of post? It's easy, you just send 47/6 as deposit and pay the rest in six monthly instalments of £1.16.0. The cash price is £12.7.6. Post the coupon for full details.

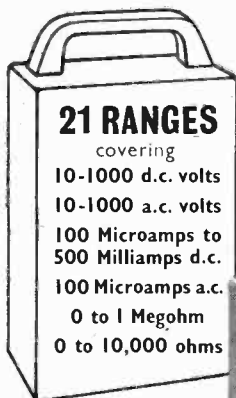

MULTI-RANGE TEST SET - SERIES 100

To **MEASURING INSTRUMENTS (Pullin) Ltd**
 Electrin Works, Winchester Street,
 Acton, London, W.3

Please send illustrated leaflet of the Series 100 Test Set with details of new easy payment scheme...
 Ditto Series 90

*Please indicate instrument required

NAME _____
 ADDRESS _____

F658

*There is also the **SERIES 90**
 Terms for the Series 90 Test Set (19 self-contained ranges a.c./d.c., 200 micro-amps, 5,000 ohms per volt): Deposit 35/- and six monthly payments of 28/10 (Cash price £9.15.0)

GD14



BRIMAR 6BQ7A

The Brimar 6BQ7A is a double triode consisting of two independent high slope sections with similar characteristics. It contains an internal screen which is brought out of a separate base pin to ensure low interaction between the two independent sections. The valve is particularly useful in all functions where high slope triodes are required and can also be used as a cascode RF amplifier or a combined oscillator and mixer.

TYPICAL CHARACTERISTICS

Heater voltage	6.3 volts
Heater current	0.4 amp
Anode voltage	150 volts
Cathode bias resistor	220 ohms
Anode current	9mA
Mutual conductance	6.4mA/V
Amplification factor	39
Anode resistance	6,100 ohms
Grid cut-off voltage ($I_a=10\mu A$)	-10 volts approx.



Cut this out for further reference or write to the Publicity Department at Footscray for a data sheet.

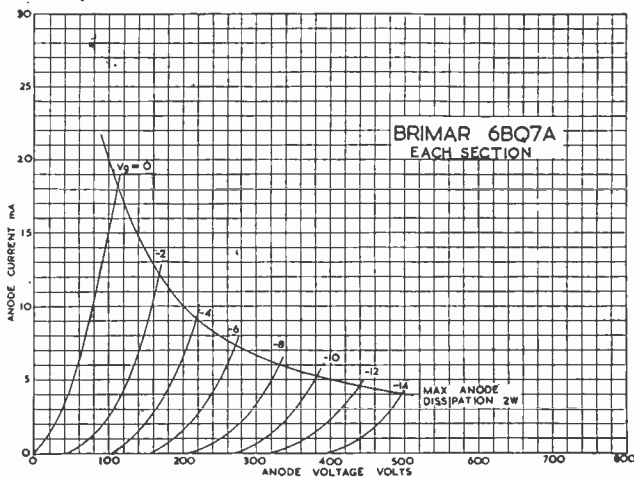

Standard Telephones and Cables Limited

(Reg. Office 63 Aldwych London WC2)

FOOTSCRAY SIDCUP KENT

Telephone 3333

◆ ◆ ◆ ◆ REPANCO ◆ ◆ ◆ ◆

HIGH GAIN COILS and QUALITY COMPONENTS for the constructor

TRANSISTOR COMPONENTS

FERRITE SLAB AERIAL TYPE FS2. A new super-sensitive aerial, Long and Medium Wave, specially designed for transistor portable receivers. Complete with fixing brackets. Length $5\frac{1}{2}$ "	13/6
COMBINED OSCILLATOR AND 1st I.F. TRANSFORMER TYPE OT1 (315 kc/s), fully screened, $\frac{1}{2}$ " x $\frac{1}{2}$ " x $1\frac{1}{2}$ "	11/6
2nd I.F. TRANSFORMER TYPE TT2 (315 kc/s), $1"$ x $\frac{3}{8}"$ dia.	5/-
3rd I.F. TRANSFORMER TYPE TT3 (315 kc/s), $1"$ x $\frac{3}{8}"$ dia.	5/-
PUSH-PULL INTER-STAGE TRANSFORMER TYPE TT4. Ratio 1:1 ct. Stack $1\frac{3}{8}"$ x $1\frac{1}{16}"$ x $\frac{1}{16}"$	8/6
PUSH-PULL OUTPUT TRANSFORMER TYPE TT5. Ratio 15:1 ct. Stack $1\frac{3}{8}"$ x $1\frac{1}{16}"$ x $\frac{1}{16}"$	8/-

MINIATURE RANGE—For pocket receivers

FERRITE SLAB AERIAL TYPE FS3. Medium Wave only. With fixing grommets. Size $3"$ x $\frac{1}{2}"$ x $\frac{3}{16}"$	7/6
OSCILLATOR COIL TYPE XO8. Medium Wave only. Overall size $\frac{1}{2}"$ dia. x $1"$. Enclosed in Ferrite pots	5/-
I.F. TRANSFORMER TYPE XT6. Suitable for 1st and 2nd I.F. 455 kc/s. Size $\frac{1}{2}"$ sq. x $\frac{1}{16}"$	10/-
I.F. TRANSFORMER TYPE XT7. Designed for 3rd I.F.T. or detector I.F.T. 455 kc/s. Size as XT6	10/-
PUSH-PULL INTERSTAGE TRANSFORMER TYPE TT9. Ratio 1:1 ct. Radiometal Core. Size $\frac{3}{8}"$ x $\frac{3}{8}"$ x $\frac{1}{16}"$	12/6
PUSH-PULL OUTPUT TRANSFORMER TYPE TT10. Ratio 8-1 ct. Matched to 3 ohm speaker. Size as TT9	12/6

Practical and Theoretical circuits enclosed with each Repanco Transistor Component

HIGH GAIN COILS

Dual-range Miniature Crystal Set Coil with circuit, type DRX1	2/6	Matched pair TRF Dual-range Coils with Reaction. With mains, battery and feeder unit circuits, type DRM3	8/-
Dual-range Coil with Reaction. With 2 mains, 2 battery and Transistor Circuit type DRR2	4/-	Pair—Dual-range Superhet Coils. With mains and battery circuits, type SH4	8/-
Ferrite Rod Aerial, Long and Medium Wave. With fixing brackets, type FR1	12/6	Miniature I.F. Transformers, pre-aligned, 465 kc/s $\frac{1}{2}"$ x $\frac{1}{2}"$ x $1\frac{1}{2}"$, type MSE	12/6

REPANCO EASY-TO-BUILD RECEIVERS

Constructors' Envelopes of easy wiring plans, instructions and detailed price lists of components

THE HIWAYMAN Four-valve superhet Dual-range Portable using Ferrite Rod Aerial	Envelope 1/6 (post 3d.)
REPANCO ONE-VALVE Beginner's Dual-range Radio Set for use with headphones	Envelope 9d. (post 3d.)
REPANCO FM TUNER UNIT Using 4 EF91, 1 EB91, 1 EM80 Valves, Ratio Detector	Envelope 1/6 (post 3d.)
REPANCO "THREE DEE" Dual-range Transistor Radio using 3 Transistors and Crystal Diode. Amazing loudspeaker reception from $7\frac{1}{2}$ volt battery supply	Envelope 9d. (post 3d.)
REPANCO "TRANSEVEN" A new 7 Transistor superhet Portable with preset station tuning using Repanco transistor components	Envelope 1/6 (post 3d.)
JUST RELEASED	
REPANCO "MINI-7" The amazing new transistor pocket portable radio with all the technical features of a standard receiver. Seven transistors, superhet circuit, fully tunable over medium wave. Size $5\frac{1}{4}"$ x $3\frac{1}{4}"$ x $1\frac{1}{2}"$	Envelope 1/6 (post 3d.)

MAIL ORDER and TRADE—

RADIO EXPERIMENTAL PRODUCTS

LIMITED

33 MUCH PARK STREET COVENTRY

Telephone 62572

WHOLESALE and EXPORT—

REPANCO LTD

O'BRIENS BUILDINGS

203-269 FOLESHILL ROAD COVENTRY

Telephone 40594

EMI

"HIS MASTER'S VOICE"

MARCONIPHONE · COLUMBIA

Announce

NEW PRACTICAL WAY OF LEARNING AT HOME

NEW—completely up-to-date methods of giving instruction in a wide range of technical subjects specially designed and arranged for self-study at home under the skilled guidance of our teaching staff.

NEW—experimental outfits and lesson manuals are despatched on enrolment and remain the student's property. A tutor is allotted to each student for personal and individual tuition throughout the course.

Radio and television courses, with which specially prepared components are supplied, teach the basic electronic circuits (amplifiers, oscillators, detectors, etc.) and lead, by easy stages, to the complete design and servicing of modern Radio and T.V. equipments.

If you are studying for an examination, wanting a new hobby or interest, commencing a career in industry or running your own full-time or part-time business, these practical courses are ideal and may be yours for moderate cost. Send off the coupon to-day for a free Brochure giving full details. There is no obligation whatsoever.

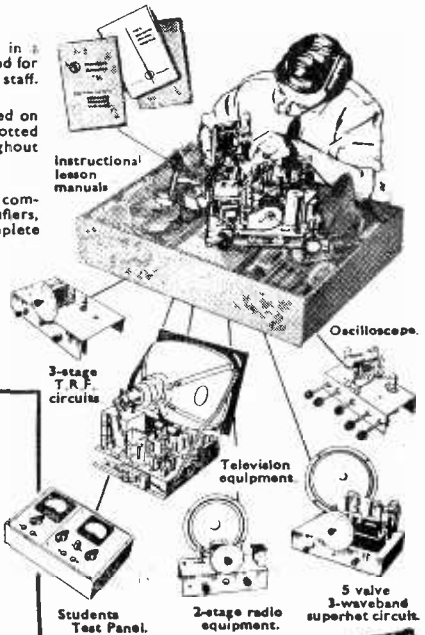

Courses with Equipment

- RADIO · SHORT WAVE RADIO
- TELEVISION · MECHANICS
- CHEMISTRY · PHOTOGRAPHY
- ELECTRICITY · CARPENTRY
- ELECTRICAL WIRING · 'HI-FI'
- DRAUGHTSMANSHIP · ART, etc.

E.M.I. Factories
at Hayes,
England.



EMI INSTITUTES

Fill in for **FREE BROCHURE**
E.M.I. INSTITUTES, Dept. 179X, London, W.4.

Name Age

(If under 21)

Address

I am interested in the following subject(s) with/

without equipment.

(We shall not worry you with personal visits)



BLOCK CAPS PLEASE

IC107
JUNE/53

The only Home Study College run by a World-wide industrial organization

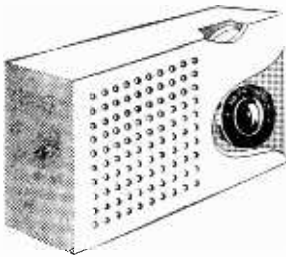

HOME RADIO OF MITCHAM

have all the parts for the
AMAZING NEW "MINI-7"

This 7-transistor superhet pocket portable, with a 2½" speaker, gives guaranteed results on its internal ferrite rod aerial.

It can be assembled in four stages, from standard components which are available from our stock, with the aid of point-to-point diagrams and wiring instructions (1/9 post paid)

STAGE ONE	
Repanco 17/S group board	5/-
Repanco XT6 i.f. trans. (2)	£1
Repanco XT7 i.f. trans.	10/-
Repanco XO8 Jackson "00" twin gang (208 x 176)	5/-
10k volume control with s.p. switch	9/6
Resistors, miniature, 4d. each	5/-
R.F. transistors, White spot (3)	1/4
Complete Stage 1	£2.15.6
	£5.0.0.

STAGE TWO	
Repanco TT9	12/6
Repanco TT10	12/6
2 x 60pF trimmer	1/9
Crystal diode	1/3
Resistors, miniature, 4d. each	8d.
0.01µF 150V	9d.
100µF 6V	2/9
8µF 6V or 15V	3/-
300pF 5% miniature condenser	9d.
Complete Stage 2	£1.12.6

STAGE THREE	
Resistors, miniature, 4d. each.	
2 56 ohms, 1 4.7k, 2 47k, 2 10k, 2 1k, 1 3.3k, 1 6.8k	3/8
0.01µF 150V type W99 or similar size (2)	1/6
0.1µF 150V	9d.
8µF 15V TCC CE67B, Mullard AO5705-8 (3 required, 3/6 each)	10/6
Complete Stage 3	13/6

STAGE FOUR	
Repanco ferrite slab aerial type FS3	7/6
Rola/Celestion 2½" speaker C.25	£1.9.0
L.F. transistors, Red spot (4 required at 8/- ea.)	£1.12.0
Vidor V.0038 3V batteries (2 required at 10d. ea.)	1/8
Grey plastic case with scarlet control knobs	16/-
Complete Stage 4	£4.0.0.

Complete set of additional sundries 3/-

All parts are available separately.

Please add sufficient postage

HOME RADIO

(MITCHAM) LTD

187 LONDON ROAD, MITCHAM, SURREY

Tel: MITcham 3282



BUILD THE
COOPER-SMITH B.P.I.
HIGH FIDELITY
10-12 Watt AMPLIFIER
and CONTROL UNIT

(as described in this Magazine)

For the highest possible enjoyment of FM radio and Hi-Fi disc and tape recordings

- SIMPLE LAYOUT
- ULTRA-LINEAR OUTPUT
- BALANCED PHASE INVERSION
- UNCONDITIONAL STABILITY
- NEW, EXCLUSIVE CIRCUIT

Any part sold separately

Hundreds of delighted users

See December, January and February numbers or send 2/10 for Radio Reprint which gives full instructions, additional material and price list of parts

Complete kit of parts for Amplifier (including valves) £12.12.0
Complete kit of parts for Control Unit (including valves) £8.3.0

Carriage free in U.K.

H. L. SMITH & CO LTD

287/9 EDGWARE ROAD . LONDON W2 . Telephone Paddington 5891

The

Radio Constructor

incorporating THE RADIO AMATEUR



CONTENTS FOR JUNE

VOL. 11 NO. 11
 JUNE 1958
 ANNUAL SUBSCRIPTION 25/-
 including postage

*Editorial and
 Advertising Offices*
 57 MAIDA VALE LONDON W9

Telephone
 CUNNINGHAM 6141
 (2 lines)

Telegrams
 DATABUX, LONDON

Editor
 C. W. C. OVERLAND, G2ATV

Advertising Manager
 F. A. BALDWIN A M I P R E

- 782 Suggested Circuits: A Simple Line Output Stage Protection Circuit, *by G. A. French*
- 786 In Your Workshop
- 791 A Miniature Test Clip
by D. F. Marshall
- 792 Understanding Television, Part 6
by W. G. Morley
- 798 The "Mini-7" Transistor Superhet Pocket Portable, Part 2, *described by D. Peters*
- 805 A Simple Transistor Oscillator
by J. Dalton, A.M.I.E.E.
- 808 The "Mini-Meter"—a Frequency Meter for the Beginner, Part 1, *by James S. Kent*
- 811 A Self-Calibrating Transistor Tester, Part 2
by John K. Owen
- 816 Introduction to the "Jupiter" Stereo Pre-Amplifier and Main Amplifier—A Jason design, *by G. Blundell*
- 820 Radio Miscellany, *by Centre Tap*
- 822 Technical Forum
- 824 Can Anyone Help?
- 825 The London Audio Fair, 1958
- 826 A 3-Valve Mains T.R.F. Receiver
by W. Harris
- 830 Using Surplus Meters
by R. H. Wright, G3IBX

THE CONTENTS of this magazine are strictly copyright and may not be reproduced without obtaining prior permission from the Editor.

ARTICLES appearing in this magazine which describe kits are inserted only on condition that such kits, or special components thereof, are freely available at a trade discount to all retail advertisers.

OPINIONS expressed by contributors are not necessarily those of the Editor or proprietors.

NOTICES

THE EDITOR invites original contributions on construction of radio subjects. All material used will be paid for. Articles should preferably be typewritten, and photographs should be clear and sharp. Diagrams need not be large or perfectly drawn, as our draughtsmen will redraw in most cases, but all relevant information should be included.

ALL MSS must be accompanied by a stamped addressed envelope for reply or return. Each item must bear the sender's name and address.

TRADE NEWS. Manufacturers, publishers, etc., are invited to submit samples or information of new products for review in this section.

QUERIES. We regret that we are unable to answer queries other than those arising from articles appearing in this magazine; nor can we advise on modifications to the equipment described in these articles.

ALL CORRESPONDENCE should be addressed to THE RADIO CONSTRUCTOR 57 Maida Vale London W9

REMITTANCES should be made payable to "DATA PUBLICATIONS LTD."

Suggested Circuits

No. 91 A Simple Line Output Stage Protection Circuit

OVER THE LAST FIVE YEARS OR SO, LINE output stages in directly viewed television receivers have settled into a constant basic design form. This design form employs two valves, one of these being the line output valve and the other the booster, or efficiency, diode. The line output valve normally functions in the manner of a switch connected in series with the combined inductance provided by the line output transformer and deflector coils, whilst the booster diode rectifies, and causes to be stored in a reservoir condenser, energy which would otherwise be dissipated during the line cycle.

It is common practice for the line output valve to be biased by means of a grid leak returned to cathode and a series grid condenser. The drive waveform from the line timebase then causes grid current to flow at its positive peak, with the result that the grid condenser becomes charged and the average bias voltage appearing at the line output grid becomes equal to the average voltage, below the positive peak, of the drive waveform.

This set of conditions can only exist, however, during the time when the drive waveform is applied to the line output grid. If, due to a fault in the line timebase, the drive waveform stops, the line output grid at once assumes zero potential with respect to its cathode. At the same time the boosted h.t. voltage disappears, and the normal h.t. voltage is applied, via the booster diode and the line output transformer windings, to the line output anode. Despite the reduced h.t. voltage at its anode the line output valve, under conditions of zero bias, may now commence to pass a current well in excess of

The circuits presented in this series have been designed by G. A. FRENCH, specially for the enthusiast who needs only the circuit and essential relevant data

that normally maintained. This excess current can easily cause damage to the windings of the line output transformer and to the line output valve itself. Also, the booster diode, h.t. rectifier, and smoothing choke of the receiver may be similarly over-run, and may similarly suffer damage.

The risks which are undertaken by the use of a grid leak biased line output stage are not, of course, unknown; and attempts have been made, in various designs, to provide safety devices, or circuits, for the line output stage. The most obvious safety device is a fuse in series with the h.t. supply to the line output anode. Fuses of conventional type are not always successful here, unfortunately, this being possibly due to the fact that in some cases the overload current may only be of the order of two to three times the running current, with the result that long-term deterioration of the fuse may occur. What may be a more probable reason for the unsuitability of a fuse is the fact that some line output valves, especially when new, are liable to pass occasional heavy surges of current. These surges, being of an intermittent nature, can cause fuses to blow but may not damage the components or valves through which they flow. Slow-acting fuses would appear to offer an answer to the surge problem, provided that they can differentiate between overload and running conditions over very long periods of time.

The points just discussed can be amplified considerably but, whatever arguments are made for or against fuses, the fact remains that whereas it was commercial practice to insert fuses in series with the h.t. feed to the

line output stage some years ago, such fuses are not now employed; and the main reason for their deletion is that they were liable to fail from time to time under what appeared to be quite normal conditions of operation.

It would appear from the above that some simple protection device for television line output stages is very desirable, and that it might be worth while attempting an approach which did not rely upon fuses. This month's circuit suggests a relatively simple method of applying protection, and it employs a technique for obtaining a negative voltage from a conventional television chassis which might be unfamiliar to some experimenters and which may help them to resolve design problems involving negative voltages in

simple check must first of all be carried out to see whether the modification can be fitted to any specific model, and this is also described. The safety modification cannot be used with receivers where the line output stage is of the self-running type.

Due to the fact that a number of steps are involved which require a reasonably good working knowledge of television circuitry, the writer would not really advise that the modification be attempted by the beginner who has had no television experience.

Checking for Suitability

The line output protection circuit operates basically on the very simple principle of disconnecting the earthy end of the line output

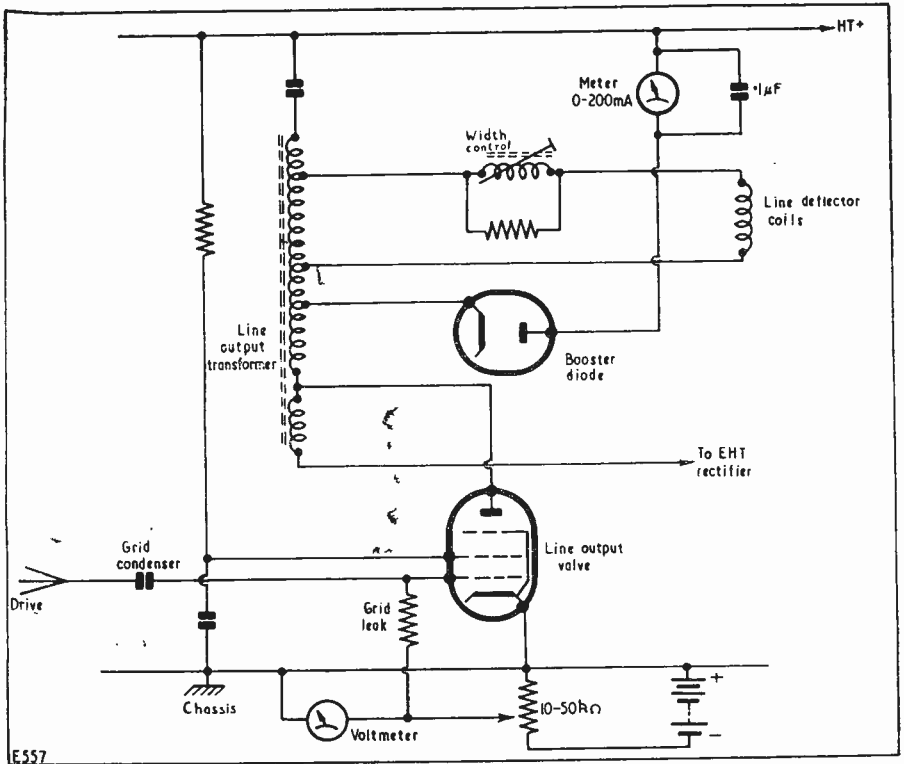

Fig. 1. A typical line output stage, illustrating how a check may be made to ensure that a protection circuit can be employed

different applications. The circuit discussed this month is presented in the form of a possible modification to existing televisions, but it must be stressed that it may not function satisfactorily with all receivers. A

grid leak from chassis and connecting it to a point which has a negative potential with respect to chassis. Provided that this negative potential is not greater than the average potential of the drive waveform

below its positive peak, grid current will still flow at that positive peak and the grid should still receive the same input. In practice this supposition may not hold entirely true because the shape of the drive waveform may be qualified by the point, relative to the bias potential, at which grid current commences to flow. As a result the introduction of negative bias may cause a slight change in drive waveform shape, and this point has to be checked before the modification is fully carried out.*

Fig. 1 illustrates a simple test circuit which may be employed for checking the suitability of a line output stage for the safety modification. The earthy end of the line output valve grid leak is disconnected from chassis and is coupled to the slider of a potentiometer connected across a source of d.c., thereby enabling a continuously variable potential to be applied to the grid leak. The potentiometer should be positioned close to the line output grid leak, and should have a value of some 10 to 50k Ω . The source of d.c. voltage can consist of a suitable dry battery, and its potential should lie between 20 and 50 volts.

In order to maintain a check on operating conditions it is advisable to insert a meter in series with the h.t. supply to the line output anode before commencing the check for suitability. This meter would, preferably, be inserted in series with the connection to the booster diode anode, as shown in Fig. 1. The 0.1 μ F condenser connected across the meter provides a safety measure, insofar that it prevents pulse voltages at line frequency being built up across this instrument. (In the event that the experimenter may feel it more convenient to insert the meter in series with the line output cathode, it should be pointed out that this is rather bad practice. Even though the meter may insert a low amount of resistance, this will still almost certainly be large enough to upset the line output stage operating conditions.)

It is recommended in Fig. 1 that a voltmeter be connected between the slider of the potentiometer and chassis. The provision of a voltmeter at this position is not entirely necessary, provided that voltage readings may be taken after the potentiometer has been set to its final position. If only a single testmeter is available this could then be employed for checking anode current and, afterwards, for reading the voltage tapped off by the potentiometer. A sufficiently accurate idea of the voltage provided by the potentiometer during the check should be given

* The fact that the protection circuit applies a negative fixed bias to the line output valve is the reason for stating that the circuit cannot be employed with self-running line output stages. It would be difficult to make such stages start without a preliminary condition of zero bias.

by judging the amount of rotation given to its slider.

To commence the check of the line output stage it is first of all necessary to choose a period when a test pattern, such as Test Card C, is being transmitted. The slider of the potentiometer should be initially set to the earthy end of its track; this causing the line output grid leak to be at chassis potential, as would occur normally. The television should next be switched on and allowed to warm up for some ten minutes or so. (Line output stages usually take a little time to "settle down" to running conditions.) Carefully observing the screen, the slider of the potentiometer should then be slowly advanced until the negative voltage required by the line output valve for safe working conditions is reached.† This voltage will vary for different line output valves but will normally lie between 12 and 20 volts. If there is no variation in line linearity, width, brilliance, and anode current when this voltage is reached, then it may be assumed that the line output stage is capable of being modified. The reason for checking for changes in line linearity is that these would help in indicating changes in drive waveform shape. At the same time, changes in width would point to changes in waveform, and in e.h.t. voltage. It is doubtful if there would be any variations in brilliance which would not be accompanied by marked changes in any of the other parameters, but the point has of course to be observed.

The above check would be made more comprehensive if it were possible to measure the e.h.t. voltage and examine the drive waveform at the line output grid with an oscilloscope whilst the bias voltage was being adjusted. However, the writer has assumed that an e.h.t. meter and an oscilloscope may not be readily available to the experimenter.

If minor changes in any of the parameters just mentioned occur, the experimenter must decide whether these are sufficiently large to merit a decision against employing the safety modification. It should be borne in mind that if the application of negative bias causes a reduction in line output efficiency which does not seriously prejudice the entertainment value of the reproduced picture, there is still a slight risk of under-running the e.h.t. rectifier filament, with consequently shortened life.

It may be thought that the grid bias voltages mentioned above (12 to 20 volts) are rather high, especially when it is assumed that they would not upset line output stage operation. In practice these figures are not excessive, as the peak-to-peak value of the

† For valves of the PL81 class this will be of the order of 16 volts or more. The valve manufacturers' literature should be checked for other valve types

drive waveform in many televisions is frequently of the order of 100 volts or more.

After the check just described has been completed, it is advisable to switch off the receiver and allow the line output valve and efficiency diode cathodes to cool. The receiver may then be switched on again to ensure that the application of negative bias does not adversely affect operating conditions immediately after warm-up.

The Negative Bias

If the receiver has shown itself capable of being modified, it next becomes necessary to provide a negative voltage equivalent to that given by the battery and potentiometer. Fig. 2 illustrates how this may be done.

In Fig. 2 an 0A71 diode (now superseded by the 0A81—Ed.) is connected to the a.c. developed across the bottom three heaters in the receiver chain. It is assumed that an r.m.s. a.c. voltage of approximately 18.9 (3×6.3 volts) is provided at this point. The diode functions as a rectifier, causing a d.c. voltage to be built up across the reservoir condenser C_1 and the load resistor R_2 . Under these conditions a d.c. voltage of 20 to 25 should appear across R_2 , these figures corresponding to a current flow through R_2 of 2 to 2.5mA. The peak inverse voltage given by the circuit (the d.c. voltage across the reservoir condenser plus the peak value of the applied a.c.) is of the order of 64 volts (assuming 25 volts across C_1) and this falls within the maximum inverse rating of 75 volts for the 0A71 at 60°C. ambient temperature. The 300Ω series resistor R_1 is included as a limiting component, and it limits the forward current to 100mA (the maximum specified for the 0A71 is 150mA) even under conditions of short-circuit in C_1 . In practice, the value specified for R_1 is more than adequate, as the crystal diode does not, in the average receiver, even have to withstand switching-on surges (which could cause high peak currents to flow). This is due to the fact that the a.c. voltage appearing across the heaters normally rises slowly after the receiver has been switched on.

In order to apply the requisite proportion of the negative voltage developed across R_2 to the line output grid leak, it is first of all

necessary to carry out the initial check mentioned above. R_2 may then be replaced by two resistors in series whose total value is 10kΩ, and at whose junction the required voltage appears.

As was mentioned above, the a.c. voltage assumed in Fig. 2 is 18.9 r.m.s. It is possible that some receivers may not have three 6.3 volt heaters at the earthy end of the chain, in which case it becomes necessary to tap off from the chain a suitable a.c. voltage for the rectifier circuit. In most instances it should be possible to obtain an a.c. voltage lying between 12 and 20 volts, and this should give sufficient negative voltage for the purposes required here. Due to the necessity of keeping within maximum inverse voltage ratings it would be unwise to employ a.c. voltages

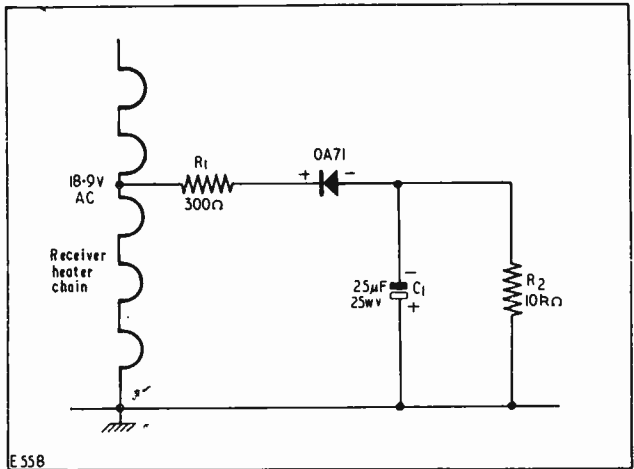
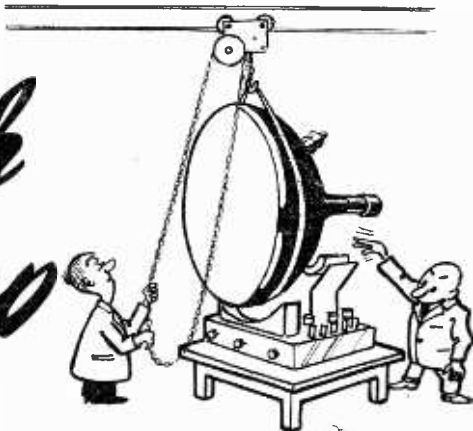

Fig. 2. Obtaining a negative bias voltage from the heater chain

above 20 volts when an 0A71 is employed, unless the ambient temperature around the crystal diode is known to be low, a condition which does not always exist in television chassis. As a guide it is worth pointing out that at an ambient temperature of 25°C. the maximum inverse voltage rating of an 0A71 increases from 75 to 90 volts. If it is quite impossible to obtain a sufficiently low a.c. voltage, an 0A91 could be employed instead of the more commonly encountered 0A71. The 0A91 has a maximum inverse voltage rating of 100 at 75°C. ambient temperature. The use of an 0A91 involves no circuit changes.

In Your Workshop



In response to many requests from readers, Smithy the Serviceman, together with his able assistant Dick, continues to run the Workshop.

SSMITHY," CALLED OUT DICK DEJECTEDLY, as he entered the Workshop one sunny Monday morning, "you're looking at the world's original mug!"

The Serviceman, who had opened up the Workshop some minutes before and was holding a soldering iron close to his cheek preparatory to applying it to a chassis, started in surprise.

"Drat it," he complained vexedly. "Dick, you must never startle me like that again. You nearly made me burn myself with this iron. Thinking about it, though, I suppose I should say in all fairness that if you're a mug, so am I for not breaking myself of the habit of checking soldering iron temperatures against my cheek. I'll be branding myself for life one of these days."

This prospect did little either to increase or to relieve Dick's gloom. He merely nodded, as though the idea of elderly service engineers scorching their features with soldering irons every now and again was just an accepted part of existence.

"I'll never learn," Dick stated, after a period of moody silence. "I wouldn't mind so much," he added, "if my aunt hadn't warned me against doing precisely what I did."

"Just one moment," protested Smithy. "Whilst I am only too ready to offer sympathy, my present reaction to your statements is entirely one of curiosity. Also, I must remind you that, during the firm's time

—which commenced precisely ninety seconds ago—we're supposed to be thinking of things connected with radio only. I don't quite know what it was that your aunt told you not to do, but the possibilities, where a young man like yourself is concerned, appal me."

"But it *is* to do with radio," lamented Dick. "The clanger I dropped was a technical clanger. And on, of all things, a simple four-plus-one medium and long wave set which had just gone weak on one of the bands."

Aunty's Advice

Smithy looked interested.

"We could do with some help around here," he commented, "and it's not everyone who has electronic aunts capable of dishing out good sound technical advice. D'you think she might be interested in working here?"

Despite himself, Dick grinned.

"This particular aunt of mine," he remarked, "is like the James Thurber woman who thought that, if you don't have bulbs in each light socket, all the electricity leaks out and gets around the house. However, there's one thing she's really good at, and that's making blackcurrant wine."

Dick paused reflectively for a moment.

"You're veering," Smithy remarked.

"Yes, I am rather," admitted Dick. "But I feel that it is entirely due to the stress of

events. What happened is that I was at my aunt's place yesterday and I noticed that the little radio she uses was very weak on medium waves. With the result that I offered to have a look at it there and then."

"And what did your aunt say?"

"She was very pleased with my offer, but she asked me wouldn't it be better if I took it in to work, so that I could get what she described rather vaguely as 'meters' to assist me."

"She sounds a very sensible aunt to me," Smithy commented gravely.

"Well, the only meter she's ever seen," said Dick, "is the one she puts shillings in for the gas. But, as you say, she is very sensible. What is more, she turned out to be dead right. I, being big-headed and armed only with my trusty Woolworth's screwdriver, decided to tackle the set right on the spot, with the result that I made what can only be described as a complete and utter mess of it."

"I think I'll take over from here," commented Smithy, assuming a brisk, professional manner. "First of all, let me get an idea of the situation. What sort of set was it?"

"As I said just now," replied Dick, "it was a very simple little five-valve set. Four valves in the radio section proper, and one valve as rectifier. It was an a.c./d.c. medium and long wave model."

"Fair enough," said Smithy. "And the symptoms?"

"Well, the set worked O.K. on long waves, but on medium waves it was pretty weak and most of the stations had a whistle of some sort behind them."

"I presume that the whistles changed in frequency as you tuned through the stations?"

"That's right," said Dick. "You could go right-through zero beat, but this didn't necessarily agree with the best tuning position. About the only local station which didn't have a whistle was the Light Programme on 247 metres, together with some of the stations between it and the high frequency end of the dial. Funnily enough, the Light Programme on 247 metres came up quite loudly, too."

"That's interesting," commented Smithy. "Did the stations come up on the correct parts of the dial?"

"I didn't bother to check," replied Dick. "In any case, is it important? After all, you know as well as I do that the tuning dials on some of the cheaper sets aren't all that accurate."

Smithy sighed a little but made no comment. "Anyway," continued Dick, after a moment, "I decided that the best thing I could do was to whip the chassis out of the cabinet and give it a quick look through. I gave the

grid of the double diode triode a touch and there seemed to be plenty of life in the a.f. section. And so I next had a go at the i.f.s."

Smithy raised an eyebrow.

"What happened then?"

Dick looked a little shamefaced.

"Well," he explained, "I was working in a dark corner of the room and, when I popped my screwdriver into the first i.f. can I tackled, I must have done so at the wrong angle. Anyway, there was suddenly a hefty spark, which could only point to my having shorted out h.t. The spark was so unexpected that my hand jumped a little, whereupon I dug my screwdriver further into the can and, so far as I know, into the i.f. coil itself. Anyway, the set at once expired and that was that."

"What did you do next?"

"There wasn't much I *could* do," said Dick lamely. "With only a screwdriver to help me I felt that the best thing I could do in the circumstances was to leave the set at my aunt's house and go back tonight with a new i.f. transformer."

"Well, all I can say," commented Smithy, "is that it was a good thing that this happened at your aunt's place. Because she will, at least, keep quiet about your abortive attempts to fix her set. And to think that, only last month, I was commending you on your abilities, and telling you that I was prepared to let you loose in customers' houses."

"I suppose I did make a pickle of it," confessed Dick, "but, after all, I needn't have told you about it!"

"That's true enough," Smithy remarked, unbending a little. "And I suppose that we all have our off-days now and again. Anyway, I don't like the thought of that set lying around in your aunt's place so perhaps you could pop round at lunch time and bring it in. We'll get some 'meters' on it in here this afternoon."

"O.K. Smithy," said Dick gratefully, "and thanks a lot. Don't forget that, after we've fixed the damage I did to the i.f. transformer, we still have to find the original fault. Let's hope it doesn't take too long."

"I already have a fairly good idea where it is," remarked Smithy, grinning at Dick's surprised expression, "but I'm not entirely certain, and so I won't say any more until we've got the set on the bench."

With which remark Smithy left the somewhat mystified Dick to his own devices, and proceeded to start on the day's work.

Basic Analysis

During the midday break Smithy's assistant picked up his aunt's receiver and brought it back to the Workshop. Smithy was engaged in his lunch time crossword puzzle when Dick re-entered.

"As this set is going to be repaired 'on the house'," the Serviceman remarked, looking up from his newspaper, "it mightn't be too bad an idea if you devoted the last ten minutes of your lunch time to at least fixing up the mischief you did last night."

Now that Dick had the offending receiver in front of him his spirits had risen considerably. Like many people engaged in servicing work, one of the things which occasionally plagued him was the thought of an annoying fault which could not be tackled, merely because the chassis was not immediately available. The bedtime beverage advertisements which refer to such events as bus conductresses punching tickets in the small hours of the morning could well depict a service engineer tossing in his bed whilst mentally analysing faults on a tantalising chassis many miles away at work.

of wire left on the condenser and I'm resoldering it up now."

"Fair enough," said Smithy. "And let that experience be a warning against poking metal screwdrivers into the i.f. transformers of sound receivers unless you're certain you're locating with the core or trimmer screw. In most sound receivers the i.f. primaries run straight from the h.t. line, which means that if you short them to chassis you get a spark which is as big-and fat as the electrolytic across h.t. can make it. Shorting out the h.t. supply rarely puts new life into a receiver; and the firework display can often make you jump and damage something else as, indeed, happened last night. I think I should add that the risk of shorting h.t. used to be far worse with some of the older i.f. transformers, even when your screwdriver was located with their trimmers in perfectly legitimate fashion.

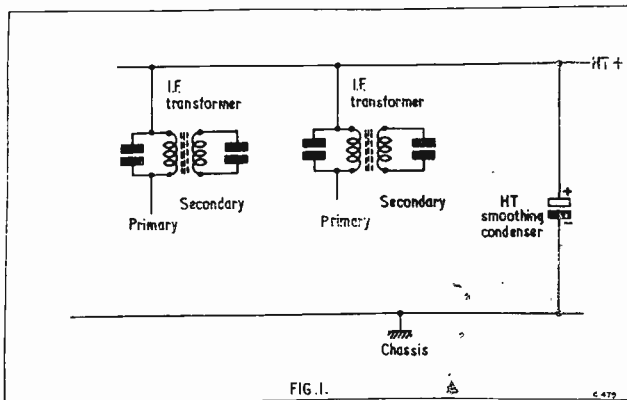

Fig. 1. In a conventional sound receiver the i.f. transformer primaries are connected directly to the h.t. positive line. Accidental short-circuits to chassis during alignment are, in consequence, liable to cause heavy sparks

Dick made a comment about "heartless gov'nors grinding the faces of their juniors" and proceeded to work on the receiver. Behind the cover of his newspaper, Smithy grinned to himself.

Shortly afterwards, the Serviceman made the last entry in his crossword, gazed at the completed puzzle triumphantly, and put his paper away. He then rose from his chair, lit a cigarette, and wandered over to Dick.

"Well, how's it going, lad?" he asked.

"Not too bad, Smithy," replied Dick. "I hadn't done too much damage with my screwdriver after all. The fat spark I got last night must have been caused by my touching h.t. positive inside the can (Fig. 1), but the only harm I did was to break one lead of the condenser across the primary away from its tag. Fortunately, there's plenty

The adjusting screws of these trimmers often had h.t. on them and you had to guard quite carefully against causing damage because of this. Whenever I lined up transformers of this type I always tried to use an insulated trimming tool. If an insulated tool wasn't available I would follow a second-best course of fitting a little sleeving over a metal screwdriver (Fig. 2). This gave a fair degree of safety. There aren't so many i.f. transformers of that type knocking about these days, but it's a point you want to watch."

Whilst Smithy had been talking Dick had repaired the i.f. transformer and had re-fitted it to the chassis. He was about to reach over for the output lead from the bench signal generator when Smithy stopped him.

"Did you touch any of the i.f. cores last night?" he asked.

"No," replied Dick, "they're all in the same position as they were when I started."

"I see," said Smithy, thoughtfully. "In that case, I'm going to take the risk that the i.f. transformer you've just repaired is now O.K., and I'm going to start off from exactly the same point that you did last night."

With this comment Smithy plugged the receiver into the mains supply and connected a short aerial to it. (Apart from final check purposes, Smithy rarely used the large outside aerial for repairing sound receivers. On the assumption that most of his customers employed a few yards of wire around the picture rail as an aerial, he did nearly all his work on sound receivers with aerials of similar type inside the Workshop.)

Smithy switched on the receiver and set the wavechange switch to the long wave position. After a few moments the set commenced to function.

"Ah, there we are," commented Smithy, adjusting the controls. "Now, let's first of all tune in a station. The Light Programme on 1,500 metres will do very nicely. As you can see, this is appearing almost exactly at the correct point of the tuning scale. Your comment this morning about not relying on the accuracy of tuning scale calibration may be true enough for small deviations. If you have large deviations, however, you should begin to suspect things. That is a point we shall check in a moment when we try out this set on medium waves.

"In the meantime I would like to show you that you can often get a rough idea of what the i.f. alignment of a sound receiver is like by swinging the tuning condenser across a station. This is especially true on the long wave band where a relatively large movement of the tuning condenser causes only a small change in oscillator frequency. Now, in this receiver the i.f. alignment seems to be quite reasonable. The signal appears to weaken symmetrically on either side of the correct tuning position, and even my own ageing ears can detect some slight top-cut when we're spot on tune. I would say that the i.f. transformers here are as well aligned as are those of any other low to middle-fi receiver of this class. I'm not saying that a little run through with the signal genny wouldn't raise an added dB or so; but we shan't bother about that yet, as we have a little more important business in hand."

Smithy switched to medium waves and experimented with the tuning condenser.

"Ah," he said, with some satisfaction, "my hunch appears to be correct. You said this morning that the Light Programme on 247 metres was clear of whistles and that it wasn't as weak as other stations on the band. As a matter of fact it's coming up here at about

280 metres. Now our local Home Service is on 285 metres* and here it is now."

Dick looked at the tuning scale interestedly.

"Why, it's appearing at 350 odd metres."

"Exactly," Smithy replied. "Now why do you think that should be?"

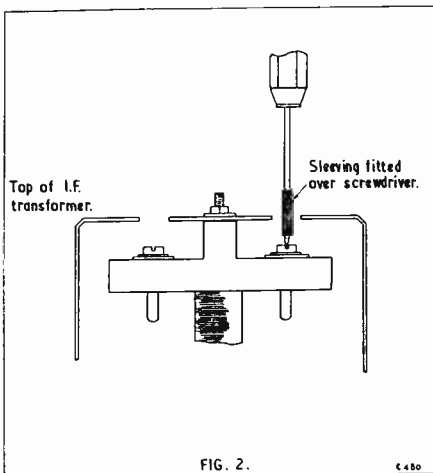

Fig. 2. I.F. transformers of older types had trimmers whose adjusting screws frequently connected to h.t. positive (sometimes via the primary coil). A safety precaution whilst aligning such transformers consists of fitting sleeving over the screwdriver used for trimming

"Just a moment," said Dick. "Let me think. Now, if the stations are coming up at the wrong parts of the dial it means that the oscillator is tuning at the wrong frequency; because it is the oscillator which, by converting it to the intermediate frequency, really selects the signal you receive. The tuning condenser needs a little extra rotation past the correct scale position for a station at the high frequency end of the band, and a lot of extra rotation past the correct scale position for a station lower down. This means that the tuning condenser has to provide more and more capacity, as you go lower in frequency, to bring in the stations you want."

"Well?" prompted Smithy.

Dick pondered.

"Why, of course!" he exclaimed. "The oscillator tuned circuit has a padding con-

* Readers wishing to trace the locality of the Workshop by this information are reminded that Smithy is liable, at times, to prevaricate a little if this assists his argument!

denser in series with it (Fig. 3), and if this has gone low in value the tuning condenser has to make up the loss itself. The effect is bound to get worse as you go down the band in frequency, because it's at the bottom of the band that the padding condenser has greatest effect. Now, why in heaven's name didn't I tumble to that before?"

falling out of the coil, the first would argue a really ham-handed tinkerer getting at the set, and there's no history of that here." Dick looked a little uncomfortable. "The second eventuality, that of shorted turns, is credible but is one of those things that only happens once in a blue moon.

"I'm a little puzzled, though, at the fact

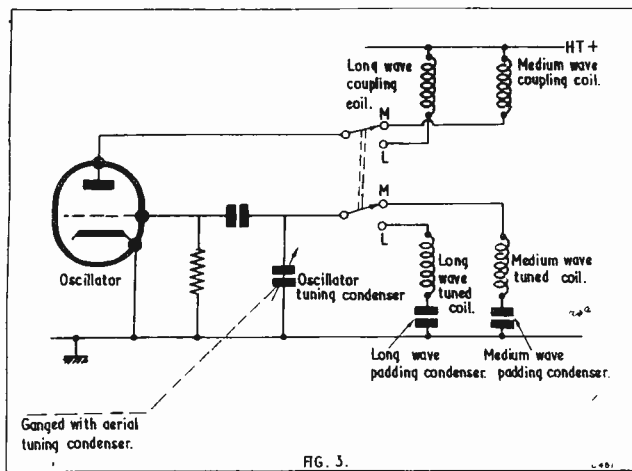

Fig. 3. In order that it may cover the requisite tuning range, the oscillator coils of sound receivers normally have padding condensers connected in series. Shifts in padding capacity cause bad tracking and result in incorrect tuning scale calibration

Lining Up

"Why, indeed?" answered Smithy, drily. "Anyway, as I said before, we all have our off-days, and so I don't suppose I should criticise. It just happens that your off-days spread over greater periods than other people's!

"However, to return to your diagnosis, you're almost certainly correct. If I had been in the position you were in last night I would have proceeded in the same manner as we have done up to now. I would first of all have given the set a quick run over the bands and, whilst on long waves, I would have made a rough check of i.f. alignment in the manner I've just described. A check of this type doesn't take a second and can be particularly useful if you're working without instruments.

"The incorrect positioning of the stations on the medium wave scale would have stuck out a mile to my mind, whereupon I would immediately have suspected a low capacity padding condenser. With the qualification, however, that the oscillator dust core could be madly out of alignment or that the oscillator coil might have lost inductance due to shorted turns. Both of these possibilities are remote. Apart from the core actually

that you didn't notice that sensitivity and background hiss dropped progressively as you went down the medium wave band. At this time of the year Continental stations don't come up at full strength until quite late in the evening, so I suppose you may not have heard enough stations to make comparisons at different parts of the band. Also, so far as background hiss is concerned," Smithy added, gently, "this *can* be masked if the tone control is adjusted for maximum top-cut."

"I seem to have broken every rule in the book," wailed Dick. "I shall have to take a lot more care in the future. Anyway, let's have a look at that padding condenser."

Whilst Dick located and checked the padding condenser, Smithy remarked that he would almost certainly find it to be a fixed component. "You don't often find variable padders these days," remarked the Serviceman.

Cause and Effect

After a further ten minutes or so Dick had checked the offending condenser, found it to be, in fact, low in value and had replaced it. On switching on again the receiver reverted to its correct performance. Dick quickly

touched up the alignment and finally pronounced the set as being repaired.

"Excellent," said Smithy, "and, as you can now hear, all the heterodynes have disappeared from the band. This being due, of course, to the fact that the set is tracking properly and the aerial coil is able to let the right signals in and keep the wrong signals out."

"My aunt will be very pleased about this," said Dick. "So don't be surprised if you find a bottle of blackcurrant wine on your bench tomorrow morning!"

A light of understanding suddenly shone in Smithy's eyes.

"Am I correct in assuming," he said, slowly, "that your aunt makes *lots* of wine?"

"Oh, yes," said Dick innocently, "she's

always at it. Every now and again one of her bottles of wine blows a cork, but she just takes it in her stride!"

"And could I also be right," continued Smithy, "in assuming that you might have had a glass of it last night before you started work on the set?"

"Oh, I had quite a few glasses," replied Dick readily. "I think it's very nice wine."

Smithy chuckled.

"Young man," he laughed, laying a hand on Dick's shoulder, "I have decided that your mistakes of last night are to be forgiven and forgotten!"

Dick looked up at the Serviceman with a surprised expression on his face. But all the queries he put to Smithy only elicited mocking laughter, with no attempt at a serious reply whatsoever.

TEST EQUIPMENT

A *miniature* TEST CLIP

By D. F. MARSHALL

With the advent of transistors and other miniature components, the conventional crocodile clip becomes far too large and clumsy for experimental use. A simple type of miniature clip which is both suited to current circuit requirements as well as being capable of easy manufacture by the home constructor, is outlined in Fig. 1.

The body of the clip is made from the polythene inner of standard coaxial cable, the inner conductor being removed. A groove is cut in the body to a suitable depth to accommodate the terminating wire of the components in use. This groove is most easily cut by running the tip of a hot soldering iron around the co-ax. Any proud portions thrown up by the use of the iron may be removed by gentle sandpapering.

The clip itself is made of some material such as piano wire. (A suitable source is the B or G string of a guitar—this also has the merit of temporarily suspending unwanted

skiffle interference.) The clip is bent into shape at the "working" end with a small pair of wiring pliers and then inserted into the polythene body. The lead-out is then made by bending the central conductor at right-angles to the body, twisting the lead-out wire around the conductor, finally bending the central conductor back on itself along the

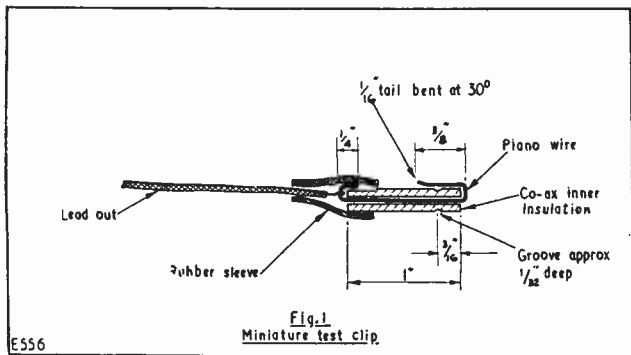

body of the clip. To finish the whole assembly a rubber sleeve is slipped over the end of the clip.

UNDERSTANDING TELEVISION

PART 6

By W. G. MORLEY

The sixth in a series of articles which, starting from first principles, describes the basic theory and practice of television.

IN LAST MONTH'S ISSUE WE INTRODUCED the subject of cathode ray tubes and described the basic operation of electron gun assemblies. We also devoted some time to the development history of the cathode ray tube up to its present form. This month we shall proceed to some of the essential factors of cathode ray tube design.

Beam Deflection

Up to the present we have discussed the beam of electrons which is emitted by the cathode of the electron gun, and which is accelerated towards the screen of the cathode ray tube by its anode or anodes. We have not as yet described how the beam is deflected nor how it can be made to focus at the screen. These points we shall now commence to examine.

It is possible to focus or deflect a beam of electrons in a cathode ray tube either by electrostatic means or by magnetic means. In television receivers either electrostatic means or a combination of electrostatic and magnetic means may be employed for focusing, whilst deflection is almost always carried out by magnetic means. This is a different technique from the method of deflection employed in cathode ray tubes intended for use in oscilloscopes and similar instruments, wherein both focusing and deflection are carried out electrostatically.

Although electrostatic deflection is hardly ever employed in cathode ray tubes intended

for television purposes, it would be of assistance if we were to quickly examine the techniques it employs, as these principles help in the understanding of electrostatic focusing.

Fig. 27 illustrates the basic requirements of an electrostatic deflection system. In this diagram the beam of electrons travelling towards the final anode is made to pass between two pairs of parallel plates mounted consecutively at right angles to each other. The purpose of the pair of plates marked "X" is that of deflecting the beam in the horizontal direction, whilst the purpose of the plates marked "Y" is that of deflecting the beam in the vertical direction. Control of the degree of deflection is then obtained by the simple process of applying certain potentials to the plates.

The functioning of either of the two pairs of plates may be understood with the aid of Fig. 28, wherein we have a beam of electrons passing through one pair of plates. In Fig. 28 (a) it is assumed that the top plate has a potential which is more positive than that of the lower plate. In consequence, the electrons of the beam become attracted towards the more positive top plate and are repelled by the more negative lower plate, and the beam is deflected upwards. In Fig. 28 (b) the reverse holds true. In this case the lower plate is made more positive than the top plate, with the result that the beam is attracted towards it and is repelled from the

top plate, and the beam becomes deflected downwards. The amount of deflection suffered by the beam varies according to the potential difference existing between the two plates and, because of this, it becomes possible to apply any desired amount of deflection to the beam by varying this potential difference.

the first instance the fixed deflection would cause a stationary spot to appear on the screen of the cathode ray tube whilst, in the second instance, a line would be traced out. If the deflection plates were employed in a television cathode ray tube, a continually changing potential would be applied, and this would take up the form illustrated in

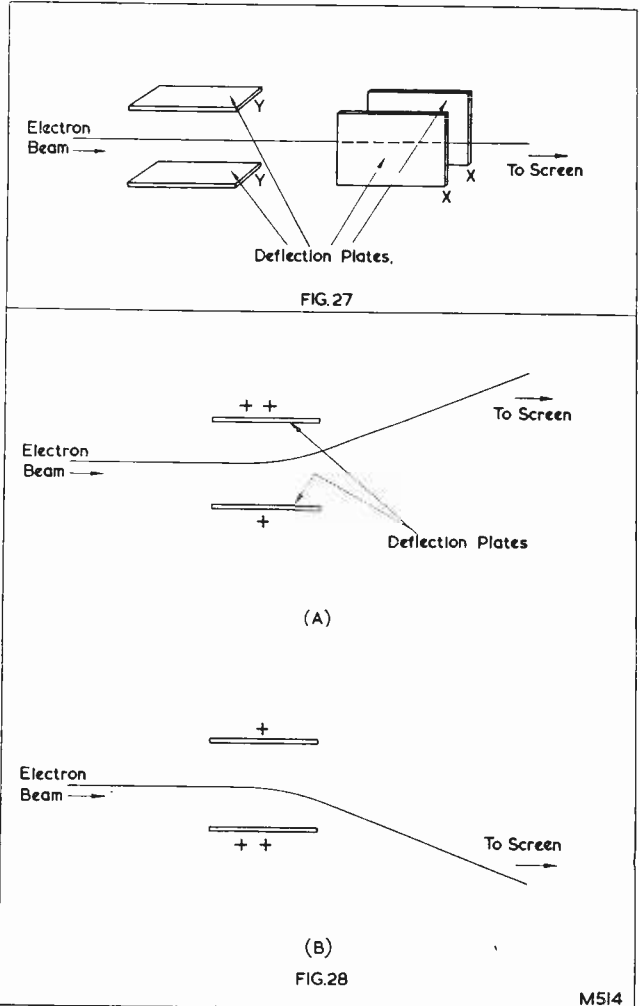

Fig. 27. How horizontal and vertical deflection of an electron beam may be obtained by electrostatic means. Fig. 28 (a). Simplified diagram illustrating the action of a pair of deflection plates. The symbols “+” and “++” indicate lower and higher positive potentials respectively. Fig. 28 (b). If the lower deflection plate has the higher positive potential, the beam is deflected downwards.

If desired, the potential difference between the two plates may be fixed, whereupon a constant deflection of the beam results; or it may be continually changing, whereupon the beam becomes deflected accordingly. In

Fig. 29. Due to its shape the waveform shown in this diagram is known as a *sawtooth waveform*, and it is interesting to note the manner in which it deflects the electron beam. Let us assume that point A in Fig. 29 corre-

sponds to the case where the top deflection plate of Fig. 28 is most positive with respect to the lower plate. The beam will in consequence be deflected upwards by the greatest amount. As we proceed along the waveform the positive potential decreases until we reach point B, at which point both plates hold the same potential. Between points A and B the beam will have suffered less and less deflection until, at point B, there will be no deflecting force acting upon it at all and it will pass straight between the plates. After point B the top plate becomes more and more negative with respect to the lower plate, and the beam now becomes deflected downwards, the amount of deflection still being proportional to the potential difference between the plates. At point C the beam undergoes the greatest amount of downward deflection. We next proceed to point D, and in so doing, quickly revert to greatest deflection in the upward direction again.

forms at the transmitter, we then become able to reproduce the required picture.

This description of electrostatic deflection has been of value to us here not only because it helps in an understanding of electrostatic focusing but also because it introduces, in a very simple manner, the sawtooth waveform which is employed in television for purposes of deflection. We do not want to spend much more time on electrostatic deflection but, before carrying on, it must be mentioned that the potential held by the deflection plates relative to the cathode of the tube is normally of an order which does not cause interference with the accelerating action of the anode or anodes in the cathode ray tube. Thus, in a typical practical tube, the deflection plates may have a potential approaching, or equal to, that of the final anode. This could result in the deflection plates having an average potential of, say, 1kV positive of cathode, whilst the sawtooth applied to them causes

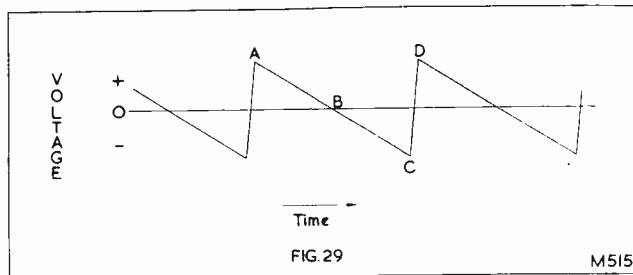

Fig. 29. A sawtooth waveform. This could be illustrative of the potential difference applied to a pair of deflection plates in a television cathode ray tube.

The cycle of events just carried out is exactly what is required for the deflection of the beam for television purposes. The relatively slow deflection of the beam which occurs between points A and C provides the movement required for scanning, whilst the relatively quick movement between points C and D provides the retrace.

Returning to Fig. 27, in which we have the two sets of deflection plates at right angles to each other, we now become able to deflect the beam over the scanning pattern required by the television system. The two "X" plates of Fig. 27 will provide our horizontal deflection, and so we may apply to these plates a sawtooth whose frequency is the same as that employed for horizontal deflection at the transmitting camera. The two "Y" plates will provide vertical deflection, and we may therefore apply to these plates a sawtooth waveform whose frequency is equal to the frame frequency at the transmitting camera. Provided that we keep our sawtooth waveforms synchronised with the deflection wave-

forms at the transmitter, we then become able to reproduce the required picture.

As was stated above, electrostatic deflection is not employed in modern television cathode ray tubes. This is due to the fact that the wide deflection angles dictated by the economics of receiver production necessitate very high sawtooth voltages. These are not easy to generate and raise difficulties due to the attendant risks of flashover and breakdown. Also, electrostatic deflection is liable to introduce a basic form of distortion at the edges of the scan, this being caused by the fact that, for wide deflection angles, the amount of deflection provided at the edges is not directly proportional to the applied deflecting voltage.

Electrostatic Focus

Whilst electrostatic deflection is not of much help in modern television receivers, electrostatic focusing provides a considerable advantage. This is because it obviates the

necessity of employing bulky and relatively expensive magnetic focusing units.* Television cathode ray tubes employing electrostatic focusing have been in use in this country for several years and, so far as commercial manufacture is concerned, may eventually completely oust tubes which require magnetic focusing.

(It should be pointed out that all television cathode ray tubes, whether "electrostatic" or "magnetic"—the term qualifies the type of focusing required—employ an elementary form of electrostatic focusing by reason of the action of the grid-cathode assembly. However, this only provides preliminary focusing of the beam inside the electrode structure, and not on the surface of the screen.)

Electron optics† is not an easy subject, and it would be best, at this stage, to content ourselves with fairly elementary examples of "electron lenses." It first of all becomes necessary to consider, in simple terms, the action of an electrostatic field on an electron in motion.

In Figs. 28 (a) and (b) we saw that, if we have two deflection plates on either side of the electron beam, the electrons in that beam are attracted towards the plate which has the higher positive potential, and are repelled by the plate which has the lower positive potential.

An alternative method of showing this effect consists of drawing lines of electrostatic force between the two plates, as shown in Fig. 30 (a). In the diagram arrows are given to the lines of force, these indicating their direction, which is always towards the higher positive potential. These lines of force, incidentally, constitute an electrostatic field. If an electron enters this electrostatic field, as it does in Fig. 30 (b), the lines of force act on the electron and cause it to be deflected in the direction of the arrows. In Fig. 30 (b) the electron is only partially deflected by the electrostatic field through which it travels. If the electrostatic field had been greater (i.e. if the upper plate had been made more positive) the electron would have been deflected through a greater angle; this culminating in the case where, with a sufficiently strong field (i.e. with the upper plate made more positive again) the electron would actually be forced to move in the same direction as the lines of force and would end up by striking the upper plate itself. Also, the electron would be deflected through a greater angle than it is in Fig. 30 (b) had it

stayed in the electrostatic field for a longer time. This longer time would occur if either: (a) its velocity were reduced or, (b) the plates were made longer, causing a consequent lengthening of the field.

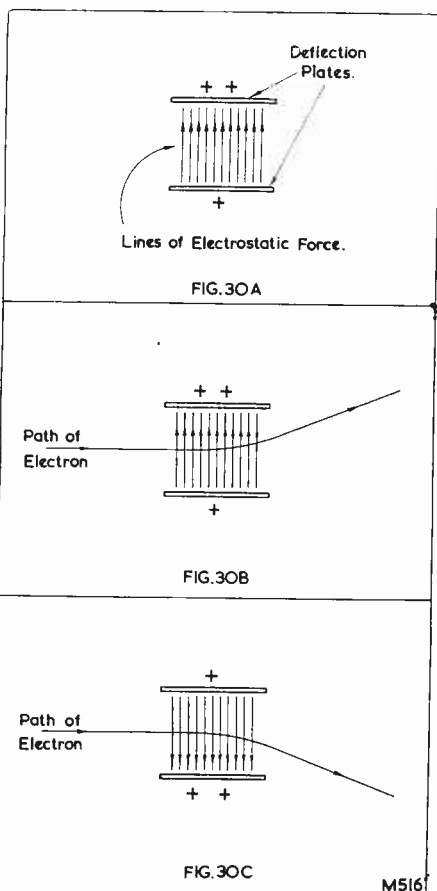

Fig. 30 (a). An electrostatic field exists between two electrodes when a potential difference exists between them. Fig. 30 (b) and (c). The electrostatic field causes electrons to be deflected in the same direction as the lines of force.

If the electrostatic field shown in Fig. 30 (b) is reversed by making the lower plate more positive than the upper plate (see Fig. 30 (c)), then the direction of the lines of electrostatic force would be in the downward direction, and the electron would consequently become deflected downwards.

*Magnetic focusing is dealt with in next month's issue.

†The process of treating electron beams as rays of light and of controlling their direction of movement by means of electrostatic fields.

It will be noticed that Figs. 28 (a) and (b) and Figs. 30 (b) and (c) are almost identical, with the exception that Figs. 30 (b) and (c) show lines of electrostatic force whilst Figs. 28 (a) and (b) do not. In Figs. 28 (a) and (b) we contented ourselves with saying, in effect, that an "electron is attracted towards the more positive plate, and is repelled from the more negative plate."

In Figs. 30 (b) and (c) we, somewhat more "correctly," considered the deflection of the electron in terms of the force exerted upon it by the electrostatic field through which it passes. The important point to remember is that the field always attempts to make the electron travel in the same direction as its lines of force.

and commences to accelerate towards it. Should the electron leave the cathode in a direction which would cause it to travel through the exact centre of the grid aperture, then the lines of force between grid and cathode are symmetrical about it and it would travel unimpeded along the straight line ABC. If, however, the electron leaves the cathode at an angle it becomes acted upon by the lines of force through which it passes. An electron travelling along the path AD would, for instance, find itself meeting a field whose direction is such that it tends to force it back to the cathode again. The acceleration provided by the positive anode causes the electron to continue forwards, however, with the final result that it traces

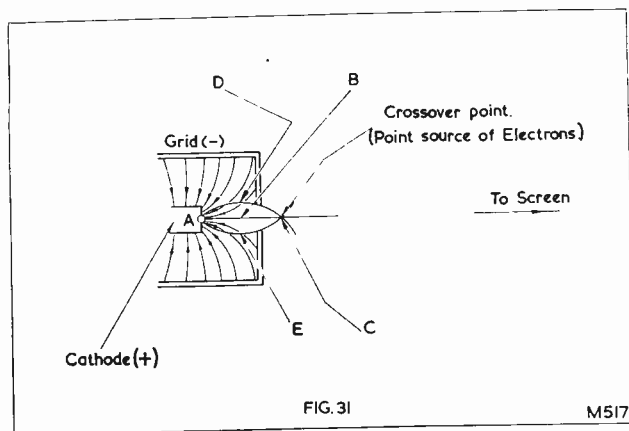

Fig. 31. The elementary focusing action provided by the grid and cathode of a cathode ray tube.

First Focusing Action

The first focusing action which is given by a cathode ray tube occurs in the cathode and grid assembly. This is the elementary process referred to previously in parentheses which is common to both "electrostatic" and "magnetic" tubes. The electrostatic forces present here are illustrated in Fig. 31, wherein we see the lines of force which exist between the grid and cathode. The direction of these lines of force is from grid to cathode, this being due to the fact that the grid is, conventionally enough, negative of the cathode. A further electrostatic field is provided by the positive anode (or anodes) following the grid. This anode is not shown in the diagram nor is the field it provides; and it will be adequate enough here to consider it as applying an accelerating force to electrons as soon as they leave the cathode.

When an electron leaves the cathode it at once falls under the influence of the anode

out the path ADC. Another electron can, in the same fashion, be caused to travel along the path AEC, and so on.

The result of the forces acting upon the electrons leaving the cathode is that all these are made to pass through point C, whereupon it could be said that they become focused at this point. Point C, the crossover point, is only slightly forward of the grid, and, at first sight, may seem to serve no obviously useful purpose. Nevertheless, point C offers the advantage of functioning as a *point source* of electrons, thereby enabling a second lens to cause a second focusing action to occur with the crossover point at the cathode ray tube screen itself. We know that this second lens may be either electrostatic or magnetic, but we shall concern ourselves this month with the electrostatic lens only.

The Electrostatic Lens

A typical electrostatic lens is shown in

Fig. 32. In this diagram we see the electron point source given by the cathode and grid assembly, this being followed by the lens itself. The lens consists basically of two consecutive electrodes having large apertures, each being connected to a positive source of supply. In the diagram the two electrodes are shown as having similar shapes, but, as will shortly be seen, this is not entirely essential. The second electrode may be part of the final anode or a separate final anode could follow the lens.

positive potential. Directly between the inside surfaces of the two electrodes the lines of force are largely straight, but at the aperture edges they curve out in the manner illustrated. It is these curved lines of force which perform the focusing action.

Electrons leaving the point source immediately after the grid start to spread out again before they enter the electrostatic field of the lens. Thus, an electron following the path AB soon comes under the influence of the curved lines of force around electrode P.

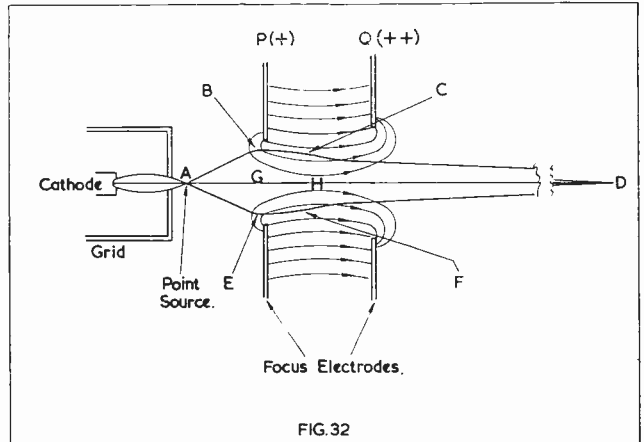

FIG. 32

Fig. 32. A simple electrostatic lens.
Fig. 33. An alternative type of electrostatic lens.

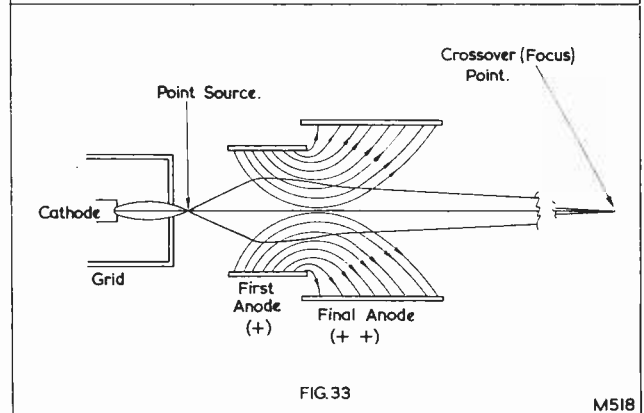

FIG. 33

MS18

The two electrodes of Fig. 32 are connected to positive potentials, electrode Q having a higher positive potential than electrode P. In consequence, an electrostatic field is set up between the two plates, the direction of the lines of force being, as in our previous cases, towards the electrode having the higher

potential. These lines of force cause the electron to be deflected in the same direction that they themselves have, whereupon the electron follows the inward-going path BC. At point C the electron starts to fall under the influence of the field around electrode Q, the

continued on page 815

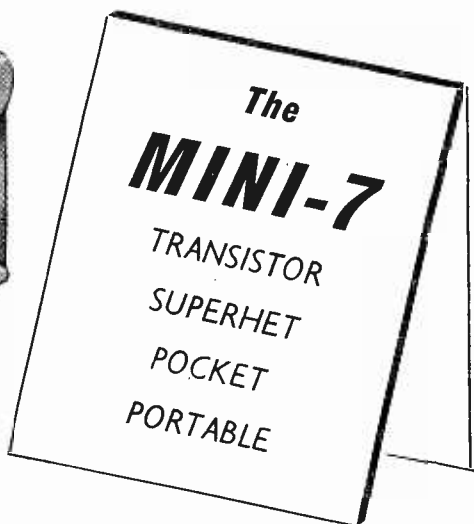
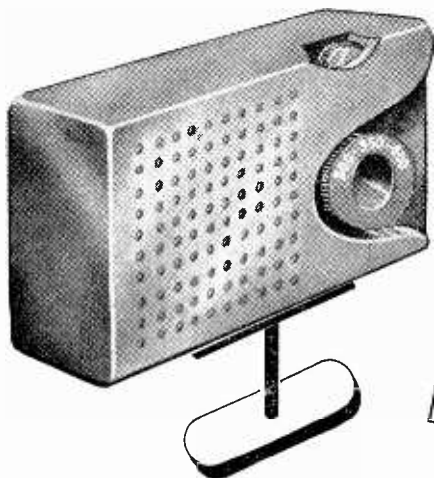

This article covers the major steps in the construction of a 7-transistor portable—which is truly capable of being carried in a pocket or in a handbag. The Mini-7 offers an excellent performance with its own slab ferrite aerial, providing a volume level which is more than ample. It is housed in an attractive plastic cabinet of contemporary design

Part 2

Described by D. PETERS

IN LAST MONTH'S ISSUE WE DISCUSSED THE circuit of the Mini-7 and embarked on the preliminary stages of its construction. In this, the concluding article, we shall complete construction, giving also details of alignment. The modification required for reception on long waves will be described as well.

Further Steps

Readers may recall that it was necessary, in the previous issue, to publish an assembly diagram (Fig. 3) which was not dealt with completely in the instructions then printed, but to which occasional reference had to be made. In the instructions which cover the next stage of construction it will be necessary to refer to Fig. 3 much more frequently, after which we shall proceed to the diagrams which accompany this month's article.

The ultimate step carried out last month was the fitting of the three transistors TR₁, TR₂ and TR₃. The next process consists of preparing the two-way trimmer block C₂, C₆, for mounting to the insulated circuit board.

First of all cut off one end of the metal mounting strip on the block flush to its ceramic body such that, when the trimmer block is mounted as shown in Fig. 3, the figures "60" (indicating the capacity) will be nearer the speaker cut-out. (The tags projecting on the figure "60" side of the block are those connected to the top vanes, immediately under the adjusting screws.) It will be recalled that the 4BA $\frac{1}{4}$ in countersunk screw at hole G was not finally tightened up in the last article. This screw is removed from the loudspeaker mounting pillar, and refitted such that it now secures the trimmer block. It is necessary to fit a 4BA solder tag under the 4BA screw head, as shown in Fig. 3. Fig. 3, in addition, illustrates clearly the position of the trimmer block. Also needed are two 4BA washers below the metal mounting strip of the trimmer block and the circuit board, these functioning as spacers. The $\frac{1}{4}$ in 4BA screw is now finally tightened up.

With a piece of bare tinned copper wire connect together the solder tag, just fitted at hole G, and the two inside trimmer tags

(those nearer the speaker cut-out). Next connect one end of C_7 (300pF) to the outer tag of C_6 (see Fig. 3), pass the other end through hole J, and solder to tag 4 of L_3 , L_4 . See Fig. 2. Identify the red p.v.c. covered lead which was, last month, soldered to the two-gang tuning condenser and, causing it to follow the route shown in Fig. 3, solder this to the outside tag of C_6 , shortening as necessary. Similarly shortening as necessary, connect the green lead from the tuning condenser to the outside tag of C_2 . For purposes of illustration Fig. 3 shows the red and green leads side by side, but in practice the green lead lays on top of the red lead. Neither lead should project excessively outside the area of the circuit board or it may foul the cabinet when the latter is, later, fitted.

The following wiring steps should closely follow the layout given in Fig. 3. Connect a p.v.c. covered lead from the solder tag at hole B to tag W of the on-off switch on the volume control assembly. Connect a p.v.c. covered lead from tag W of the switch to tag Z of R_9 (the volume control proper). Connect R_8 (3.3k Ω) between eyelet 14 and tag Y of R_9 , ensuring that this resistor is clear of the tuning condenser moving vanes

marked by a coloured band around the body or by a coloured body end).

Next connect C_{10} (0.01 μ F) between tags Y and Z of R_9 . The electrolytic condenser C_{11} (8 μ F) is then fitted. This condenser is positioned vertically with respect to the board in the position shown in Fig. 3, and its leads should be bent accordingly. The negative lead of C_{11} is that nearer the board and this connects to eyelet 10. The positive end of C_{11} connects to tag X of R_9 . No part of C_{11} should project higher above the board than the tags of the on-off switch. It is advisable to check, once more, that none of the components just fitted are liable to foul the moving vanes of the tuning condenser.

Transformer T_1 is next mounted on the circuit board. The tags of this component are identified by colour coding, and the transformer should be orientated such that these tags take up the positioning illustrated in Fig. 3. The transformer is secured by bending its bottom mounting lugs inwards, these straddling the width of that part of the circuit board at which it is fitted. Next, identify the black fly-lead of T_1 . Cutting back as necessary, this fly-lead should be soldered to eyelet 2. Employing p.v.c.

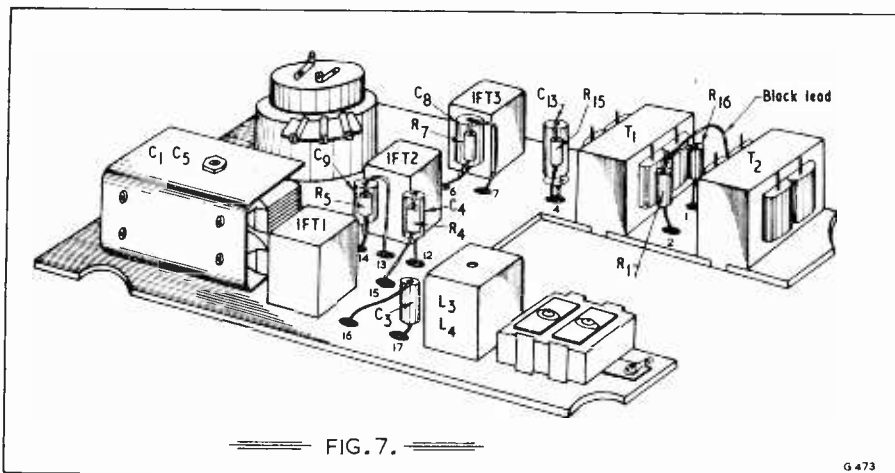

Fig. 7. This diagram illustrates the manner in which some of the smaller components are fitted to the circuit board

and that sleeving is fitted over that lead which connects to eyelet 14. Connect the crystal diode D_1 between eyelet 7 and tag Y of R_9 , fitting sleeving over the lead which connects to the eyelet and ensuring that it is the positive end which connects to tag Y. (The positive terminal of an OA70 diode is is

covered wire, next connect the red tag of T_1 to eyelet 1.

Also connected to eyelet 1 is one end of R_{16} (56 Ω). This resistor is fitted such that it is perpendicular to the board and is directly over eyelet 1. The body of R_{16} should not project higher above the board than the

laminations of T₁, and its position is shown clearly in Fig. 7. In a similar fashion R₁₇ (6.8kΩ) is mounted perpendicular to the board, and is directly over eyelet 2, to which its bottom lead is soldered. Fig. 7 shows this resistor also. The two top leads of R₁₆ and R₁₇ are next brought over, twisted together, and their junction soldered, cutting off excess wire as necessary.

Fitting sleeving over one of its leads, R₁₈ (150Ω) is next soldered in. The sleeved lead from this resistor connects to eyelet 2 and should follow the route illustrated in Fig. 3. The unsleeved lead of R₁₈ is connected later. C₁₄ (100μF) is connected up in somewhat similar fashion. First fit sleeving over its negative lead-out wire, and then solder this wire to eyelet 1. The positive lead of C₁₄ is connected later. In Fig. 3, C₁₄ is shown as laying alongside R₁₈ but it should, in practice, lay *above* this resistor, taking up the same level, approximately, as the tops of the i.f. transformer cans.

The second transformer, T₂, is next fitted, taking care again to ensure that the colour coded tags assume the orientation shown in Fig. 3. Transformer T₂ is secured by bending its mounting lugs inwards in the same manner as were those of T₁.

Battery clip "A" (the smallest of the three clips) is next secured to the circuit board. This clip should be mounted by a single 8BA nut and screw, a solder tag being fitted under the screw head. Both the clip and the screw head are on the underside of the board and care should be taken to ensure correct orientation of the solder tag and clip, as shown in Fig. 3. The upright section of the clip is adjacent to eyelet 12 and it should be parallel to the long edge of the board. With the aid of a length of p.v.c. covered wire, connect the solder tag just fitted to tag V of the on-off switch.

Further Steps

We now proceed to a further stage in the wiring. In the instructions which follow, reference will be made mainly to Fig. 7.

First, connect the black fly-lead from transformer T₂ to the junction of R₁₆ and R₁₇, cutting back to length as required. Two components are next soldered to eyelet 4, these being perpendicular to the circuit board in the same manner as were R₁₆ and R₁₇. The first of these components is C₁₃ (8μF) and it is its positive lead which connects to eyelet 4. Condenser C₁₃ should be positioned directly over eyelet 4. The second component is R₁₅ (1kΩ) and its bottom lead (that soldered to eyelet 4) is bent such that it stands alongside C₁₃, as shown in Fig. 7. Ensure that the bottom lead of R₁₅ does not touch the metal case of C₁₃. Twist together and solder the free ends of C₁₃ and R₁₅,

cutting off excess wire as necessary. This junction should not project higher above the board than do the tags of the on-off switch.

In a similar manner, C₈ (0.1μF) and R₇ (47kΩ) are fitted perpendicular to the board, one end of both these components being soldered to eyelet 6. Their free ends are twisted together and soldered, excess wire being cut off as necessary; and a p.v.c. covered wire is taken from their junction to eyelet 5*, where it is soldered. The junction of C₈ and R₇ should not project above the board higher than the on-off switch tags, and the two components should lie between IFT₂ and IFT₃. (*Not 7 as in Fig. 7)

Observing the same requirement for maximum height above the board, next solder the negative wire of C₉ (8μF), and one end of R₅ (4.7kΩ), to eyelet 14, ensuring that the bottom lead of R₅ does not touch the metal case of C₉. The free ends of R₅ and C₉ are twisted together and soldered, cutting away excess wire as required. Their junction connects with p.v.c. covered wire to eyelet 13. C₉ and R₅ are perpendicular to the board and should lie between IFT₁ and IFT₂.

The next component, which is, again perpendicular to the board, is C₄ (0.01μF), one lead of which is soldered to eyelet 12. R₄ (see note in last month's issue concerning value) is next fitted perpendicular to the board, one lead being soldered to eyelet 15. Twist together and solder the free ends of R₄ and C₄, cutting away excess wire and ensuring that the junction does not protrude above the level of the on-off switch tags. Condenser C₃ (0.01μF) is next similarly fitted, one wire soldering to eyelet 17. The free end of C₃ is bent over and soldered to eyelet 16 as shown in Fig. 7.

We now proceed to the components illustrated in Fig. 8. All these are fitted perpendicular to the board as shown, and the requirements for maximum height over the board mentioned above have, once more, to be met. The layout shown in Fig. 8 should be adhered to carefully.

First connect one wire of R₁₀ (10kΩ), R₁₂ (1kΩ) and C₁₂ (8μF) to eyelet 11, as illustrated in Fig. 8. It is the positive wire of C₁₂ which connects to eyelet 11, and a check should be made after soldering to ensure that this component will not foul the moving vanes of the tuning condenser. The free leads of R₁₂ and C₁₂ are brought together, twisted and soldered, cutting away excess wire as required. The free end of R₁₀ is bent over and soldered to eyelet 10. Also soldered to eyelet 10 is R₁₁ (47kΩ), the free end of this resistor being bent over for soldering to eyelet 9. In its turn, eyelet 9 takes, also, one end of R₁₄ (3.3kΩ). The free end of R₁₄ is brought over to eyelet 8,

to which eyelet it is soldered in company with one end of R_{13} ($10k\Omega$). The free end of R_{13} is soldered to tag W of the on-off switch (refer to Fig. 3, if necessary) sleeving being fitted over the lead. The final operation at this stage consists of soldering a one-inch length of p.v.c. wire to the outside solder tag of tuning condenser C_1 . The other end of this wire is connected later.

The loudspeaker follows, this being secured to the four speaker-mounting pillars which were fitted last month. The speaker is secured to the pillars with four $\frac{1}{4}$ in 4BA countersunk screws, and its tags should be on the outside, as shown in Fig. 9.

Next, connect tag T of the loudspeaker to the solder tag at hole G, using bare tinned copper wire. Connect the free ends of C_{14}

Fig. 8. Detail showing layout around the volume control and tuning condenser

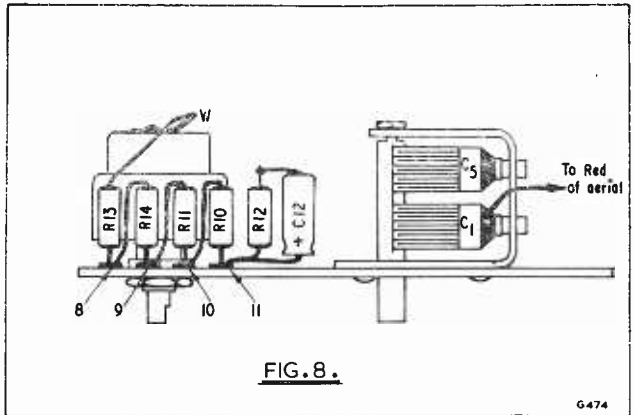

Final Steps

The construction of the Mini-7 now approaches completion and we are ready to embark on the final steps in assembly. In the instructions which follow, reference will be made mainly to the layout illustrated in Fig. 9.

The two large battery clips have next to be fitted. These are mounted on holes B2 and B3 (see Fig. 3) with the aid of $\frac{1}{8}$ in 8BA screws and nuts. An 8BA solder tag is fitted under the screw head at hole B2, and this tag should have the orientation illustrated in Fig. 9. The positions taken up by the battery clips are shown in Fig. 9, and it is important to ensure that their edges are parallel with the short edge of the board. The positive connection from the batteries is taken from battery clip "A" which was fitted earlier; and the positive terminal of the lower battery, when it is later fitted, is intended to pass through the hole in the large battery clip in order to make contact with clip "A." Mounting the large battery clip in the correct manner will ensure that this contact can be made reliably. The batteries must not be fitted yet. The 8BA solder tag at hole B2 is connected by p.v.c. covered wire to the junction of R_{16} and R_{17} .

and R_{18} to tag T of the loudspeaker, ensuring that neither component projects over the edge of the circuit board. For purposes of clarity, C_{14} is not shown in Fig. 9 and it should be remembered, as was mentioned above when it was initially fitted, that it should lay directly over R_{18} . Also connected to tag T of the speaker is the brown tag of the transformer T_2 . P.V.C. covered wire should be used for this connection. Similarly using p.v.c. covered wire, connect the mauve tag of T_2 to tag U of the speaker.

The remaining transistors are now fitted. In all cases transistor lead-out wires should be covered with sleeving. It is advisable to read all the comments concerning each transistor before commencing its connection into circuit. Transistor TR_6 comes first. Connect the emitter of TR_6 to the brown tag of T_2 , the collector of TR_6 to the red tag of T_2 , and the base of TR_6 to the yellow tag of T_1 . The positioning of TR_6 is discussed below. Follow with transistor TR_7 . Connect the emitter of TR_7 to the brown tag of T_2 , the collector of TR_7 to the blue tag of T_2 , and the base of TR_7 to the green tag of T_1 . In Fig. 9, TR_6 and TR_7 are shown projecting sideways from that area of the chassis into which they connect, but in practice they may

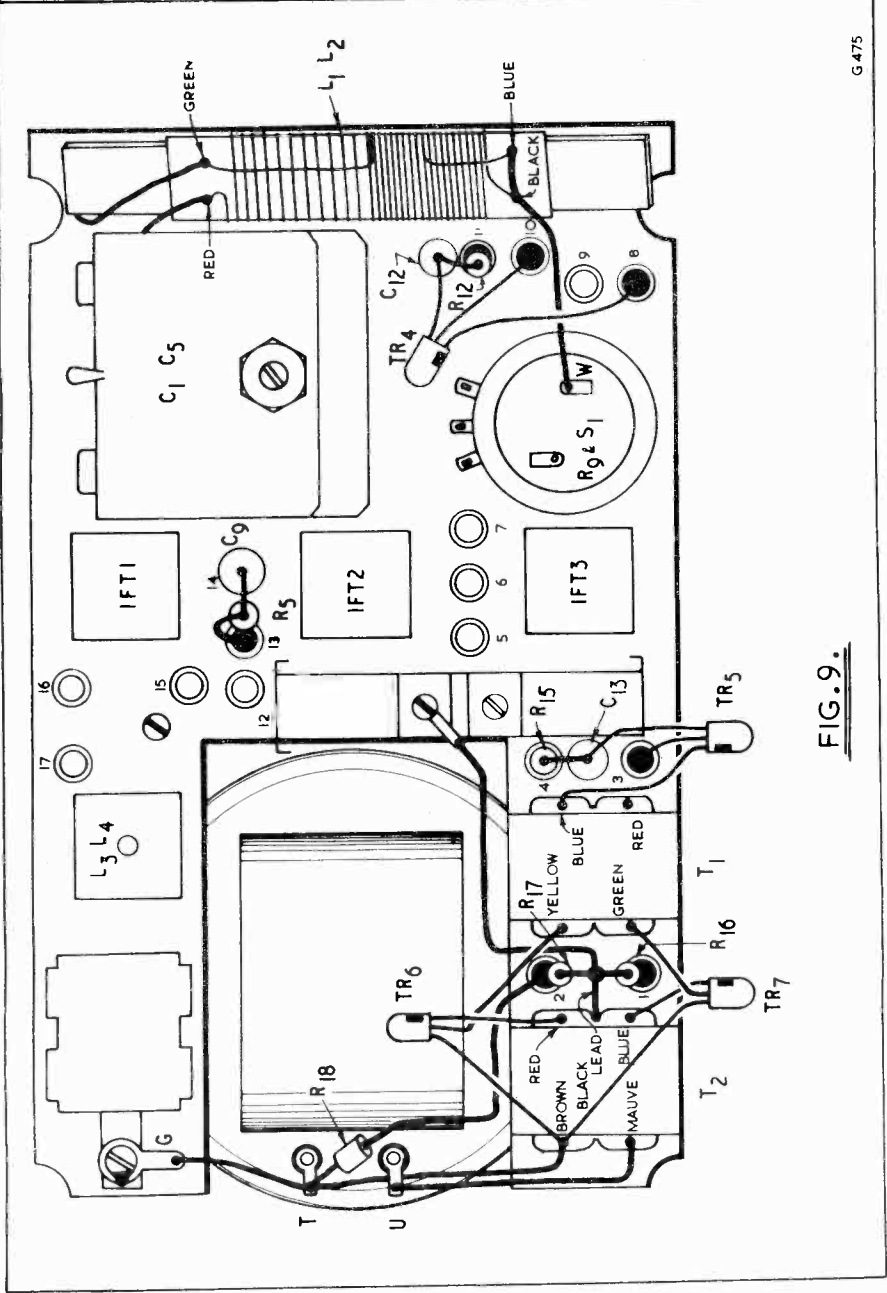

FIG. 9.

Fig. 9. Final steps in assembly

be made to lie over T_1 and T_2 without protruding over the edges of the board or, upwards, above the level of the battery clips. There is no necessity to cut the leads of TR_6 and TR_7 shorter than an inch or so as these may, if necessary, be folded back on themselves.

Transistor TR_5 is the next to be soldered in. Connect the emitter of TR_5 to the junction of R_{15} and C_{13} , the collector of TR_5 to the blue tag of T_1 , and the base of TR_5 to eyelet 3. Although TR_5 is shown projecting sideways in Fig. 9 it should, in practice, be kept within the confines of the circuit board assembly. A convenient layout consists of having the transistor body positioned approximately between eyelet 3 and T_1 . Again, there is no necessity to cut lead-out wires shorter than one inch or so.

The final transistor to be fitted is TR_4 , and this takes up the position shown in Fig. 9, its body being at approximately the same level as the tags of the volume control switch. Once more there is no necessity to cut the lead-out wires shorter than one inch. (In fact, layout requirements may dictate one or more leads being markedly longer.) Connect the collector of TR_4 to eyelet 8, the base of TR_4 to eyelet 10, and the emitter of TR_4 to the junction of R_{12} and C_{12} .

The ferrite slab aerial L_1, L_2 , may now be connected into circuit. This aerial is held in position by the wires which connect to its eyelets, its light weight enabling a reliable and sturdy fitting to be provided in consequence. For purposes of illustration the ferrite slab aerial is shown in Fig. 9 at an angle to the surface of the circuit board but, in practice, its width is perpendicular to the board and it should fit snugly inside its boundaries. The photograph of the underside of the chassis demonstrates the position of the aerial. The two rubber grommets should be removed before the aerial is connected up.

The aerial is soldered into the receiver circuit in the following manner. Connect the p.v.c. covered wire from tuning condenser C_1 (see Fig. 8) to the red eyelet of the aerial. Connect the wire which was passed through hole R (Figs. 2 and 3) to the green eyelet of the aerial, shortening as necessary. Finally, connect together the blue and black eyelets of the aerial and join these with a length of p.v.c. covered wire to tag W of the on-off switch.

All that now remains is to fit the batteries. The receiver should primarily be switched off (volume control spindle fully anti-clockwise). The first battery is inserted such that its positive terminal is towards eyelet 12. The brass cap then makes contact to battery clip A in the manner mentioned above. The second battery is then fitted the other way

round, the positive terminal being at the TR_5 end.

The receiver is now completed and is ready to be switched on and aligned.

Alignment

The process of alignment is quite simple and straightforward. The constructor is strongly advised to employ a signal generator, if only to make certain that coil cores and trimmers are set up at the correct frequency. In all cases the signal generator output should be attenuated as necessary in order to allow alignment to proceed at a low signal level.

The signal generator should first of all be set up to 465 kc/s and its output connected across the earth line of the receiver and tag 1 of IFT_2 . The core of IFT_3 is then adjusted for maximum output. The signal generator is next connected across pin 1 of IFT_1 and the earth line, whereupon the core of IFT_2 is similarly adjusted for maximum output.

The signal generator output is next connected via a series 0.1 μ F condenser to eyelet 12 (TR_1 emitter) and the earth line, and the core of IFT_1 adjusted for maximum output. With the signal generator in this position, all three i.f. transformers should be re-checked for correct alignment and any small final adjustments carried out. After this the i.f. transformers require no further attention.

The frequency of the signal generator is next adjusted to 750 kc/s and the tuning dial to 400 metres. Under these conditions the core of L_3, L_4 should be adjusted for maximum output. The signal generator is then set to 1.2 Mc/s and the tuning dial to 250 metres, whereupon trimmer C_6 is adjusted for maximum output.

Next, return the signal generator to 750 kc/s and the tuning dial to 400 metres, and readjust the core of L_3, L_4 for maximum output. Also, at this stage adjust the inductance of L_1, L_2 for maximum output, this process being carried out by sliding the coil along the ferrite slab. Return the signal generator to 1.2 Mc/s and the tuning dial to 250 metres, and readjust C_6 for maximum output. Also adjust C_2 for maximum output.

Since inductance adjustments (padding) and capacity adjustments (trimming) are slightly interdependent it is advisable to repeat the procedure given in the last paragraph until no further improvement is necessary. Unless cores and trimmers were initially considerably out of alignment, a single repetition should normally cover this requirement.

Long Wave Reception

As was mentioned in the first article, it is possible to modify the Mini-7 for reception of a long wave station, should this be desired.

It is assumed that the long wave station required will normally be the Light Programme transmission on 1,500 metres. The circuit modification required is illustrated in Fig. 10, and the extra components needed were listed in the parts list accompanying the previous article.

To make the modification it is necessary to carry out the following steps. The long wave loading coil, L_5 , should be fitted to hole S (see Fig. 3) of the component board such that it projects on the underside; i.e. on the same side as the ferrite slab aerial. The wire adjoining the blue and black eyelets of the ferrite slab aerial is next cut and

wavechange switch. The long wave contact of the wavechange switch is coupled, via the additional 250pF condenser, to tag 4 of L_3 , L_4 ; and its arm is connected to the earth line of the receiver at tag W of the on-off switch, or at any other convenient point.

When the receiver is modified in this manner, throwing the wavechange switch to long waves results in the additional 250pF condenser being connected across the oscillator tuned circuit, causing the resonant frequency of this circuit to be lowered to the requisite range. At the same time, the short circuit across L_5 is removed, allowing additional inductance to be inserted into the

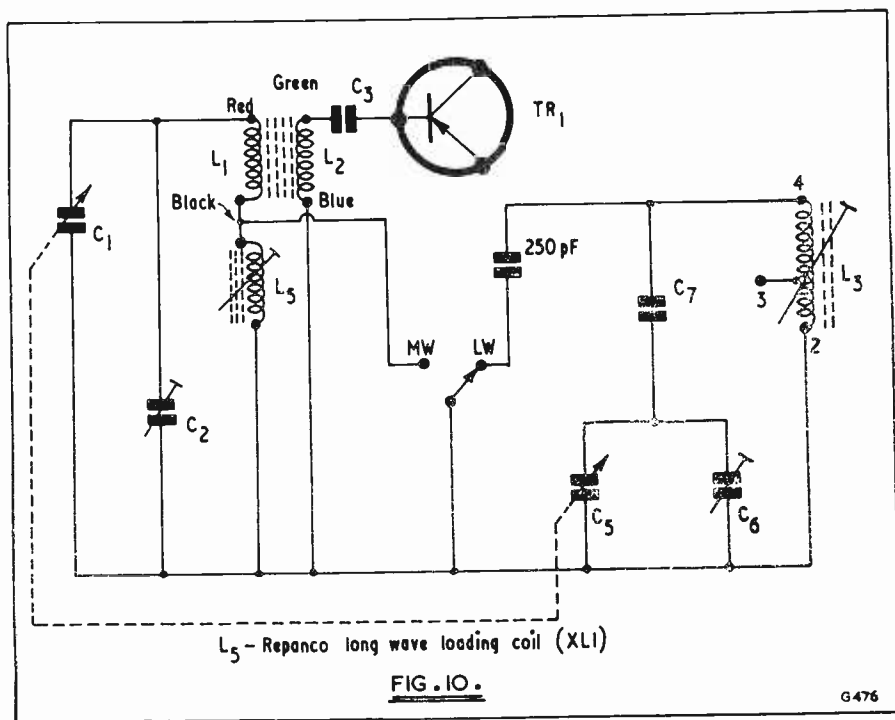

Fig. 10. The circuit employed for the optional modification for two waveband reception

removed. P.V.C. covered wire should be employed for the connections which follow. The blue tag of the slab aerial should be connected to tag W of the on-off switch. Connected also to tag W of the on-off switch (or any other convenient earth point) is one tag of L_5 , whilst the other tag of L_5 connects to the black tag of the slab aerial. The black tag of the slab aerial connects, in addition, to the medium wave contact of the

aerial circuit. When the wavechange switch is in the medium wave position the receiver circuit reverts to its original state.

The position taken up by the wavechange switch should not be excessively critical, provided that it is reasonably close to the aerial and oscillator circuits.

After the modification has been completed, it becomes necessary to adjust L_5 for optimum results. This may be done without a

signal generator, alignment being carried out with received signals. The tuning condenser is first of all adjusted until the Light Programme transmitter on 1,500 metres is heard at maximum strength. This process ensures that the receiver oscillator is functioning at the frequency required to convert the transmitted signal to the intermediate frequency of 465 kc/s. The core of the loading coil, L_5 is then adjusted for maximum output, whereupon alignment is complete. In areas of high signal strength it might be advisable to rotate the receiver chassis for minimum aerial pick-up in order to ensure that an accurate

adjustment of L_5 is finally obtained.

Note: Since Part 1 was published, it has been found that better control of volume is obtained by connecting R_9 with the top end of the track to D_1 , C_{10} and R_8 , and with the slider to C_{11} —bottom of track to h.t.+ as before. A log law potentiometer, better in this position than a linear type, is not easily obtainable in the value specified—but since low value components R_8 in series with R_5 are already in parallel with R_9 , a 250k Ω potentiometer may be used satisfactorily for the latter control, and is available in the miniature range.

TEST EQUIPMENT

A Simple TRANSITRON OSCILLATOR

By J. DALTON, A.M.I.E.E.

THE TRANSITRON OSCILLATOR IS A USEFUL piece of equipment for experimental work. It is easily constructed, and has the ability to set up oscillations in a simple two-terminal circuit which may even be screened and inaccessible. In addition, it will oscillate over a wide range of frequencies and with low values of anode load impedance. As it operates over a portion of the valve characteristic which has only a slight curvature, the output is relatively free from harmonics, and an amplitude of ten to twenty volts is readily obtainable.

The simplicity of the transitron arises from the fact that no external phase shift is required for oscillation. In a triode valve the grid voltage and the voltage of the anode may be said to be 180 degrees out of phase, for as the control grid voltage goes more negative, the anode current decreases and the voltage of the anode goes more positive. In order, then, to feed back an a.c. voltage which will be in phase with the a.c. voltage at the control grid and so provide oscillations, a further phase shift has to be introduced by mutual inductance between the anode and grid circuits.

In the transitron the screen and suppressor grids take the place of the control grid and anode used in the triode, these latter now acting as auxiliary electrodes only. Conditions for correct feedback are automatically

fulfilled by the choice of operating voltages, leading to a simple and easily controllable circuit.

Experimental Data

The valve chosen was the SP61 pentode as it is cheap, easily obtainable and, most important of all, the suppressor grid is not internally connected to the cathode. In order to assess its capabilities, a test circuit was set up as in Fig. 1. With fixed anode and screen voltages R was varied in suitable steps and a table of screen current against suppressor grid voltage constructed. The results are plotted in Fig. 2, where it will be seen that the screen current increases when the suppressor voltage goes more negative. This is because the suppressor voltage controls the division of current between anode and screen. A high negative suppressor voltage prevents electrons from reaching the anode, and they are therefore attracted to the screen because of the positive field existing between suppressor grid and screen grid. The mutual inductance, a.c. resistance and amplification factor between these two electrodes are obtained as indicated on the graph.

The valve is operated as a transitron oscillator by placing a parallel tuned circuit of dynamic resistance L ohms between the

\overline{CR}
screen grid and h.t., the a.c. voltage across

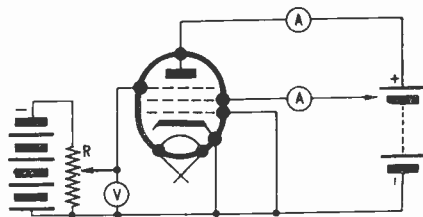
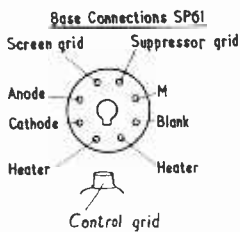

FIG. 1. TEST CIRCUIT.

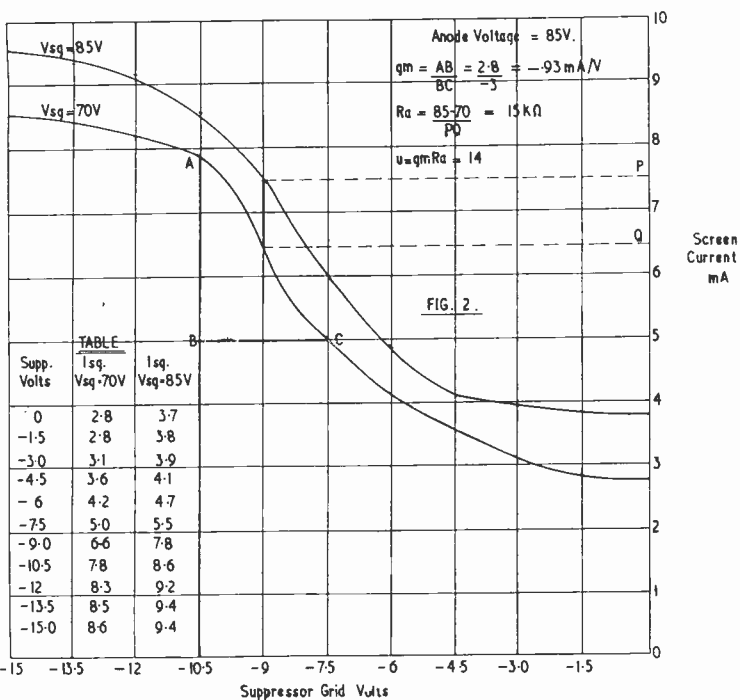

FIG. 2.

Components.

- $R_1 = 47 \text{ k}\Omega$ 1/2w
- $R_2 = 50 \text{ k}\Omega$ V.C.
- $R_3 = 5000 \Omega$ 1/2w
- $C_1 = 0.1 \mu\text{F}$
- Bias = -7.5V
- $V_a = 85 \text{ V}$
- $V_{sq} = 85 \text{ V}$

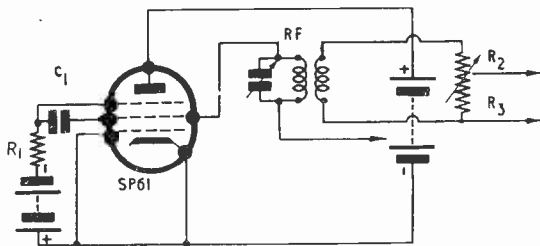

FIG. 3.

the load being coupled back to the suppressor grid by a condenser whose reactance is low at the oscillating frequency.

In an amplifier with a parallel tuned circuit as load, the voltage across the load

is given by $\frac{\mu \cdot V_g \cdot R_1}{R_1 + R_a}$ where R_1 is the dynamic

resistance of the tuned circuit. In a transitron oscillator this voltage across the load is also the a.c. voltage at the suppressor grid.

$$\text{Therefore } \frac{\text{Voltage across load}}{V_g} = 1 = \frac{\mu \cdot R_1}{R_a + R_1}$$

$$\text{That is: } R_a + R_1 = \mu \cdot R_1$$

$$R_a = R_1 (\mu - 1)$$

$$\text{and } R_1 = \frac{R_a}{\mu - 1}$$

This is the condition for oscillation to take place.

The values of R_a and μ from the graph are approximately $15k\Omega$ and 14 respectively, and substituting these values in the equation shows that R_1 is about 1200Ω . This leads to the conclusion that the SP61 when used as a transitron oscillator will operate down to a much lower value of dynamic resistance than is normally obtained, even with poor tuned circuit components.

Practical Details

The circuit used by the author is shown in

Fig. 3 together with component values. Coupling to the output was provided by about ten turns wound at the bottom end of the tuned circuit inductance. When measured on a cathode ray oscilloscope, the output was approximately five volts. No noticeable effect on amplitude or frequency was noted with a resistance of 5000Ω as the secondary load.

It was then decided to check whether the oscillator was satisfactory at audio frequencies, and for this purpose the primary of a mains transformer was connected in the anode circuit with a condenser of $0.1\mu F$ across it. No difficulty was experienced in obtaining oscillations down to 200 c/s at an output of 10 volts, but harmonic distortion was very high. However, by reducing the suppressor grid resistance to 4000Ω , the waveform was very much improved and would be quite satisfactory for the output of an a.f. oscillator. In practice, a l.f. choke with suitable fixed condensers could provide a number of fixed frequencies.

In conclusion, if a different type of valve than the one used by the author is available, its characteristics should be plotted using the test circuit shown in Fig. 1. This will prevent time being wasted on trial and error methods, avoidance of possible damage to the valve and, perhaps most important of all, a better insight into the operation of a useful type of oscillator.

TRADE NEWS

Tape Position Indicator

The purpose of the indicator, manufactured by Smiths Industrial Instrument Division, Chronos Works, North Circular Road, London, N.W.2, is to give an indication to length of recording or to the position of any particular passage on a wire or tape recording. It has been introduced to give a more efficient and more ready means of determining a recorded item on a tape.

The indicator is a comparator and has a dial based on the universal clock presentation of two-hand movement. This facilitates easy reading, and when a tape is run at speed the moving hands afford an exact check on position. A pulley is in contact with the spool shaft and operates the hands or pointers through a train of gearing; this mechanism has been designed to ensure that only the minimum of load and friction is

imparted to the tape. It is also constant, and thus will not affect the clarity of reproduction. Adjustment of the measuring pointers can be readily accomplished from the front of the indicator dial by a reset knob connected to the centre spindle. The dial, if required, can be illuminated by means of a light source from the back of the plastic bezel.

The complete indicator is encased in a light die-cast alloy body to which is attached the aluminium drive pulley. The unit is safeguarded against ingress of dust, etc., and weighing only sixty-two grammes can be easily fitted to a tape deck. All standard lengths of tape can be accommodated by the tape position indicator, and dial presentation colour of hands and bezel are considered according to individual requirements.

The Mini-Meter

A Frequency Meter for the Beginner

By JAMES S. KENT

Part I

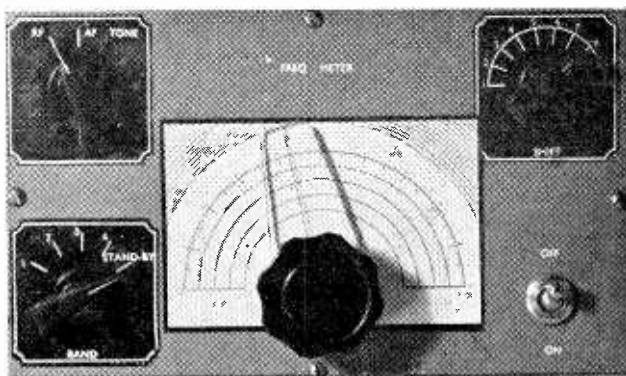

IT WOULD APPEAR, FROM LETTERS RECEIVED, that many of our beginner readers built the "Meteor" receiver described in earlier issues (Sept., Oct. and Nov., 1955), and that many more own receivers constructed from one or other of the designs published in *The Radio Constructor*. From this correspondence emerges the fact that many would like to build a frequency meter by the aid of which they may be able to ascertain the frequency of a particular transmission. It is to this class of reader that the present series is directed.

Design Considerations

For the beginner, the corner stones of design are obvious enough. The instrument must be simple to construct, relatively cheap, stable and efficient in operation. Coupled with this, in order to both match the "Meteor" and be contemporary in design, it should be small physically and include the same range of valves. The more experienced reader will at once ascertain that some of the above considerations are apt to be contradictory—for instance "simple, cheap, stable and efficient" are strange bedfellows in one and the same specification. Nevertheless, the design offered in this series is an attempt to meet, at least in most respects, all of the aspects so far discussed.

A frequency meter is of little use unless an audio modulating stage is incorporated, and this usually entails the addition of a second valve, thus partially destroying the "cheap and simple" proviso at one blow. This has been avoided by using one of the double triodes—virtually two valves for the price of one. The consequent saving of space thus achieved, not to mention the added simplicity

of wiring, etc., make this type of valve an obvious choice.

The availability of components from well-known advertisers, where these parts are not obtainable locally, is also a prime factor to be considered. It is of little help to specify items of equipment that have long since been out of production and are therefore not only obsolete but also completely unobtainable.

A self-contained power unit, in the writer's opinion, is another factor to be favourably considered. By its inclusion within the physical limits of the cabinet itself, it not only reduces the cost by excluding a further chassis and cabinet, but also results in the unit as a whole becoming semi-portable, i.e. being capable of transportation as a single entity, between places where a.c. mains are available.

As few components as possible, compatible with efficiency in general, should be included. To ignore this factor would only result in added confusion when wiring the circuit—and, in addition, result in increased cost, thus destroying the "simple and cheap" consideration.

All in all, in the design about to be discussed, the foregoing merits have been incorporated. Furthermore, a symmetrical layout of the front panel, together with "eye appeal" and ease of operation, have also been achieved.

Circuit Description

A study of Fig. 1 will show that one-half of the double triode valve, a Mullard ECC40 and one of the B8A range, is used as the r.f. oscillator, the remaining portion being utilised as the audio modulator. This valve, as may be seen, consists of two entirely separate triodes. The heaters of each are

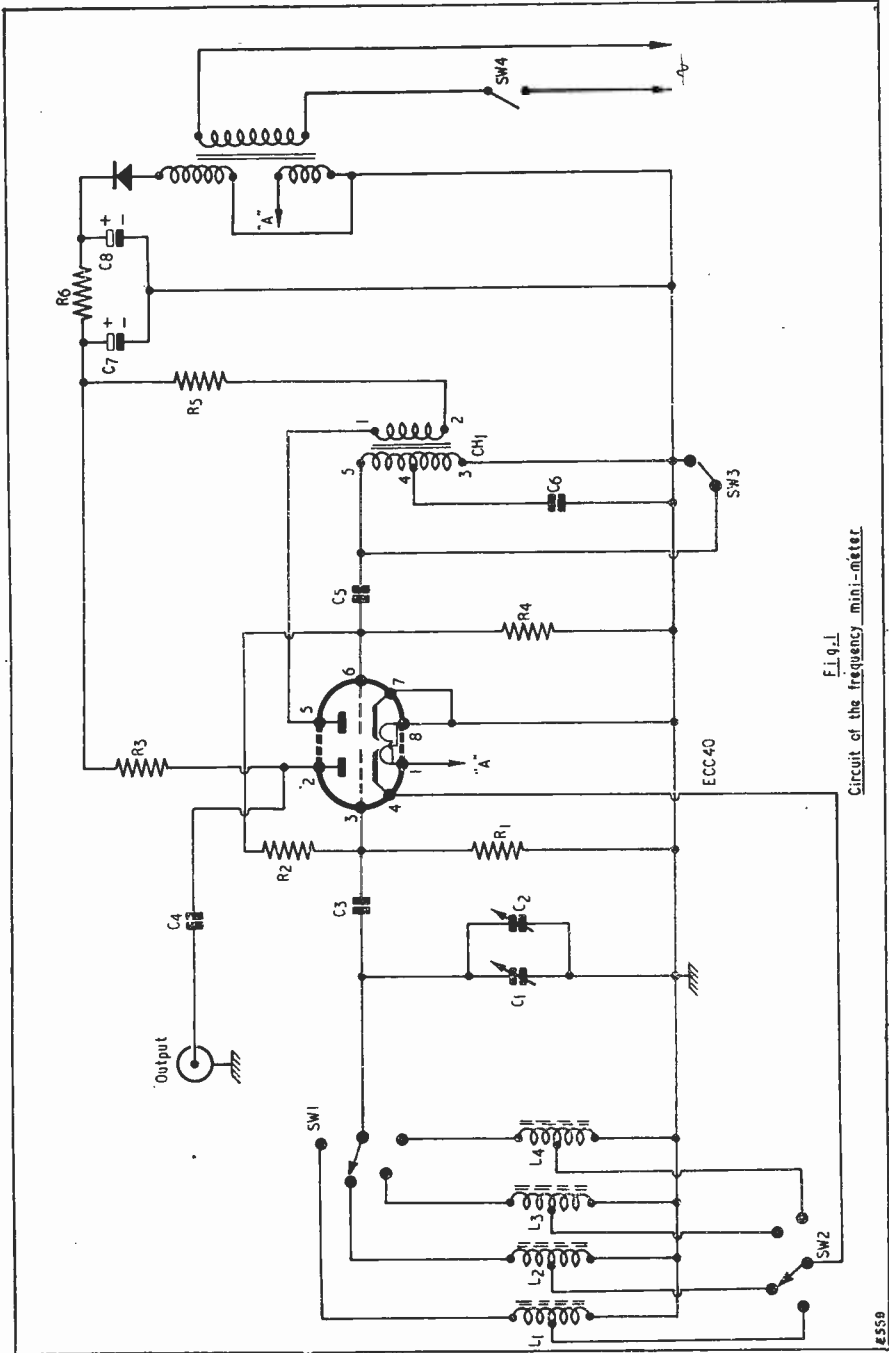

Fig. 1
Circuit of the frequency mini-meter

connected in parallel and, as each heater current is 0.3A, the total is 0.6A. Each section of the ECC40 has a gain factor of 32 and it is normally used as a cascade audio amplifier preceding an output valve. Nevertheless, it will provide reasonable gain and, at the same time, function efficiently as an r.f. oscillator. It is for this reason, among others, that it has been selected for this design.

The oscillator itself is of the E.C.O. (electron coupled oscillator) type. It is so termed by reason of the fact that the output (anode) is coupled to the oscillator (grid and cathode), only through the electron stream. Electron coupled oscillators are very widely used as frequency converter stages in super-heterodyne receivers and as oscillators of transmitters operating over a wide frequency range.

Four ranges are provided, SW₁ and SW₂ being ganged and used as the wavechange and standby control. These ranges are: (1) 15 to 63 metres (20-4.762 Mc/s); (2) 60 to 230 metres (5-1.3 Mc/s); (3) 200 to 750 metres (1,500-400 kc/s); (4) 750 to 3,000 metres (400-100 kc/s). The coils are types EO1, 2, 3 and 4, these being tapped and made specially for this design by the Teletron Co. Ltd. (see advert.). The selected coil is tuned by the variable condenser combination C₁/C₂, the latter being used either as the zero set or as a bandspread control. R₁ and C₃ are the grid condenser and leak respectively. The cathode of the valve is connected, via SW₂, to the centre tap of the coil.

The resistor R₃ forms the anode load of the oscillator and C₄ is the output condenser. So much for the r.f. oscillator.

The other half of the valve is wired as an audio modulator. The primary winding of a small inter-valve transformer is used as a feedback winding for the audio oscillator. The audio tone of the oscillator may be varied by experimenting with the values of C₆, the normal choice of tone being 400 c/s. Individual tastes, however, vary with respect to the audio tone, but those wishing to obtain an approximation to the 400 c/s note may gain a rough idea of this audio frequency by listening to either MSF or WWV. These frequency standard transmissions are radiated on 2,500, 5,000 and 10,000 kc/s from both stations, MSF being situated at Rugby and WWV at Washington D.C., U.S.A. The latter station also transmits on the additional frequencies of 15,000, 20,000, 25,000, 30,000 and 35,000 kc/s.

Injection of the resultant audio tone into the r.f. oscillator is effected via R₂ connected between the two grids. The degree of injection may, of course, be varied by changing the value of this resistor. Switch SW₃ is the a.f. tone on/off control. When in the earthed position, it causes the oscillations to cease

Valve Component List

ECC40 Mullard

Resistors

R₁ 33kΩ ½ watt ±10%
 R₂ 100kΩ ½ watt ±10%
 R₃ 5kΩ ½ watt ±10%
 R₄ 100kΩ ½ watt ±10%
 R₅ 33kΩ ½ watt ±10%
 R₆ 1kΩ ½ watt ±10%

Inter-Valve Transformer

Elstone type LF36

Switches

SW₁, SW₂ 2-pole, 6-way Yaxley
 SW₃ 1-pole, 2-way Yaxley
 SW₄ 1-pole 1-way toggle switch

Other Items

B8A valveholder; nuts and screws; p.v.c. wire; short length of coax (6in); output socket and connector (t.v. type); length of mains flex; rubber grommet, small; small piece of Perspex sheet to cover tuning scale

Coils

Type EO1, 2, 3 and 4, The Teletron Co.

Condensers

C₁ 500pF variable, midget, Polar or J.B.*
 C₂ 15pF variable
 C₃ 100pF ceramic
 C₄ 0.05μF tubular, T.C.C., type CP35N
 C₅ 0.005μF mica
 C₆ 0.01μF tubular
 C₇ 16μF electrolytic, 150V wkg
 C₈ 16μF electrolytic, 150V wkg

*C₁ is a two-ganged type, only one-half of which is used. C₂, C₇ and C₈, if not obtainable locally, are available from cabinet supplier (see under).

Cabinet, etc.

Cabinet, panel and chassis, mains transformer, metal rectifier, C₂, C₇ and C₈. R.C.S. Products (Radio) Ltd.

Panel Signs

Sets Nos. 1 and 2

by grounding the grid, via C₅, to chassis. In the open position, the oscillator is allowed to function and inject the note into the grid of the r.f. oscillator. Both oscillations are mixed and appear at the anode where they are taken, via C₄, to the output socket. This method of switching the audio modulator is much to be preferred to the more usual method of switching the h.t.+ to the anode. With the system adopted, no sudden drain is imposed upon the h.t.+ output which would cause the r.f. oscillator to violently shift frequency.

The power unit is a simple half-wave rectifier consisting of the mains transformer and a metal rectifier, the Brimar RMO. The resultant output is smoothed by the combination of R₆, C₇ and C₈. A 6.3V heater winding is provided on the transformer.

to be continued

A Self-Calibrating TRANSISTOR TESTER

Part 2

By JOHN K. OWEN

Construction

The general construction can be seen from the photograph, Fig. 5. There is no chassis—all the components are mounted on the underside of the aluminium panel, which is finished in black crackle paint. There are four holes in the corners—clearance for the No. 6 round-head black japanned wood-screws which hold the instrument in the case.

The prototype model was housed in a wooden case because a suitable one was to hand. If carpentry presents a problem, an alternative is an aluminium case: a ready-made version of this is to be had in the shape of a standard chassis, which is readily obtainable with corner reinforcing brackets. This can be used inverted, with the panel secured to the corner brackets by self-tapping screws.

The panel measures 9in. by 6in., so that if the inverted chassis arrangement is used, a standard 9in. by 6in. by 2½in. deep model is just the right size.

The general layout of the panel can be seen from the photograph shown on the title page. The meter is a 2½in. dia. flush mounting type, though there is sufficient room for a larger one, if necessary.

The transistor being tested is connected by one of two alternative methods. On the right of the panel can be seen a miniature socket into which the specimen can be plugged, while on the left are three "crocodile" clips. This apparent duplication may seem an unnecessary complication: those who have tried to hold the thin, straight connecting wire of an unused transistor in a crocodile clip will agree it is not. It is far more difficult that it would seem to make reliable contact with even one wire—when it comes to three the operation can be irritating in the extreme.

On the other hand, when the transistor has been in use, the wires are usually formed into loops at the ends, where they have been

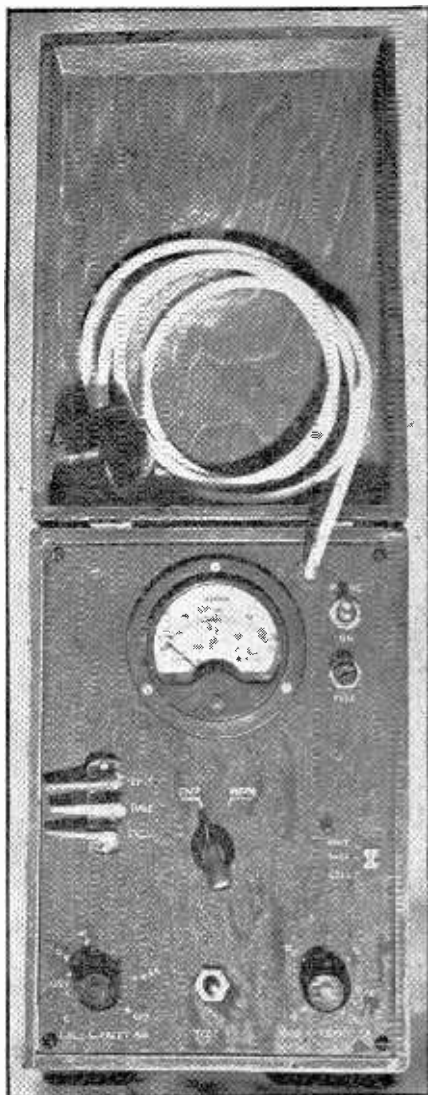

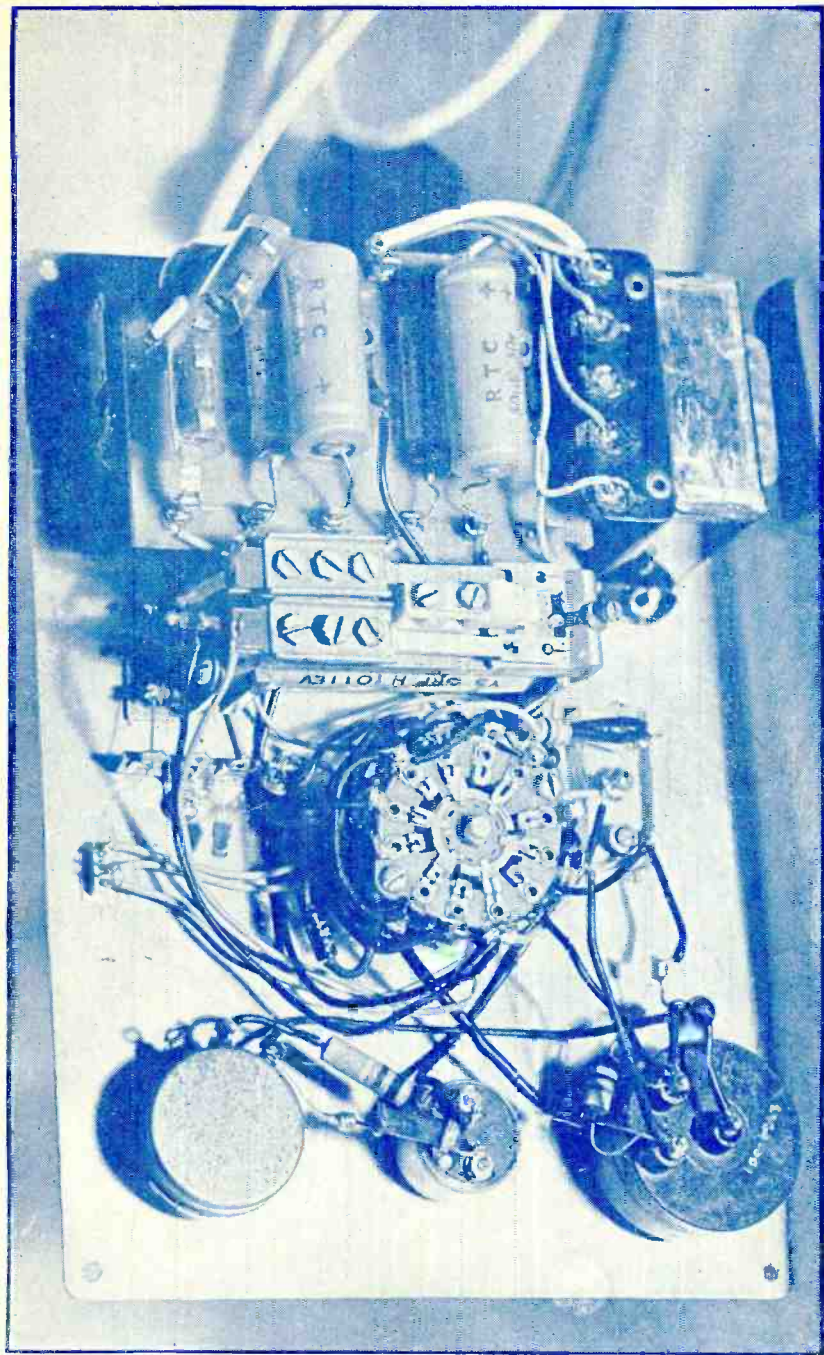

Fig. 5. Underside (back of panel) view of the self-calibrating transistor tester, showing the general arrangement of components

connected into the circuit. While they will not then plug into the socket, the formed ends make for easy gripping by the crocodile clips.

To prevent the clips shorting together, they are mounted on a saddle made of perspex, details of which are shown in Fig. 6.

Transformer

The mains transformer, as mentioned earlier, is a 6.3 volt 1.0 or 2.0 amp heater transformer, with the secondary re-wound. A transformer of this rating will usually be found to have a "turns-per-volt" figure of around 12, so that the 11 volt and 8 volt secondaries will then require 132 turns and 96 turns respectively. The "turns-per-volt" of the particular transformer being used should, of course, be checked, by counting the number of turns on the secondary during stripping, and dividing by the rated voltage. Both the new secondaries can be wound with 32 s.w.g. enamelled wire, care being taken to ensure that they are well insulated from each other and from the primary. If the voltage across R_1 and R_2 is not exactly 12, it is an advantage for it to be higher, rather than lower, as it can then be adjusted by the insertion of a suitable resistor at X (Fig. 4), bearing in mind that approximately 20Ω is required for each volt to be dropped.

Rectifiers

The rectifiers MR_1 and MR_2 have to handle some 50mA, so that, as explained previously, the small germanium point contact types are unsuitable.

There is a Westinghouse instrument rectifier, type M-3, which with a very small modification, is eminently suitable. Its current rating is 50mA, and its small size ($\frac{1}{2}$ in. dia. by $\frac{27}{32}$ in. long) fits in well with the general layout. As supplied, the M-3 is bridge connected. There are four connecting leads, as indicated in Fig. 7. The two outside lugs are joined together, and a lead joined to one of them. This is the positive lead. The lead connected to the centre lug is the negative one, while the two intermediate leads form the "a.c." connections. The modification consists simply of joining these two "a.c." leads together, thus forming the centre tap of the rectifiers MR_1 and MR_2 .

Should the M-3 prove difficult to obtain, the alternative of stripping and re-building a selenium rectifier can be adopted. Almost any dealer handling "surplus" or ex-service equipment can supply a suitable unit. The one used in the prototype was rated at 150 volts, 60mA. Since the a.c. input is only 11 volts, a single plate is sufficient for each rectifier and, provided a little care is exercised, there should be no difficulty in re-assembling them.

Fig. 8 shows an "exploded" section of two plates, as stripped from the complete unit. The rectifier is formed by the junction of the copper and selenium, with the copper disc serving as cathode and also as a heat dissipating fin. The lead washer which is fused to the reverse side of the copper disc is to make contact with the selenium on the adjacent plate, and *only* with the selenium. If the lead washer was omitted, the full area of the copper disc would contact the selenium and, as this is only a very thin layer, there would be the possibility, if there was any distortion in either disc, of the copper of one disc contacting the copper of the next, so shorting the rectifying element. This is the point which has to be watched in assembly.

Fig. 9 shows the complete assembly. A connection has to be made to the junction of the two plates, to provide the necessary centre-tap. This connection is made by interposing a lug, as shown, between the two elements. However, to prevent this lug shorting to the copper, where it should be contacting only the selenium, a further washer must be inserted; the outside diameter must be slightly less than the diameter of the selenium layer, while the central insulating tube must be slightly larger than the "hole" in the selenium. Since this washer will "float" on the central insulating tube, it must be carefully centralised just prior to finally tightening the complete assembly. A suitable washer can usually be found in the rectifier assembly itself. The lug, however, will probably have to be made, since there will only be two in the original unit. This should not present undue difficulty; using one of the existing lugs, a duplicate can be cut from a piece of tin-plate (such as a cocoa tin, for instance, if no better material is available).

MR_3 and MR_4 are straightforward. Since the current is only of the order of 5.0mA, almost any type of germanium diode is suitable. The only point to watch here is the polarity—if this is reversed, the control transistor is likely to be damaged. Most germanium diodes are colour-coded—the majority red—the colour invariably being adjacent to the cathode, or "positive" wire.

A feature of the circuit which was not mentioned earlier is the "range multiplier," consisting of R_8 and S_3 . With S_3 "open", R_8 is introduced into the bias circuit in series with R_7 , reducing the bias current from 10 to 5 μ A, and thereby doubling the full scale reading of the meter. After the prototype had been completed, a number of transistors came to hand with gains considerably in excess of 100, so it was felt to be a desirable feature to be able to increase the range to 200. The switch can be fitted in any convenient place on the panel, and is marked

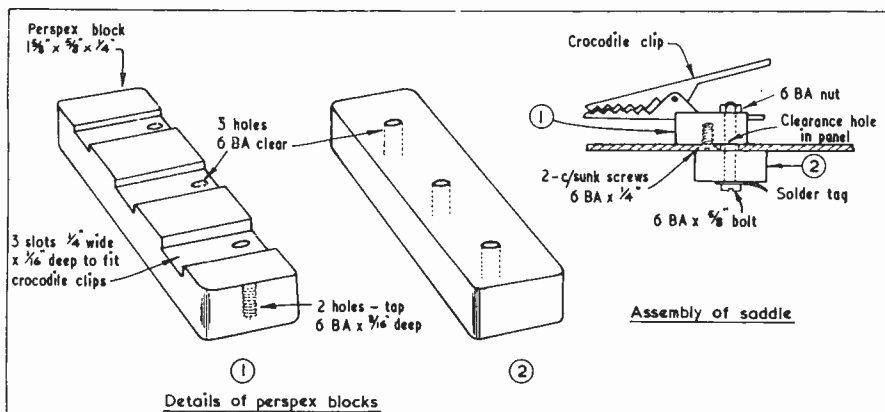

FIG. 6. PARTICULARS OF MOUNTING SADDLE FOR CROCODILE CLIPS

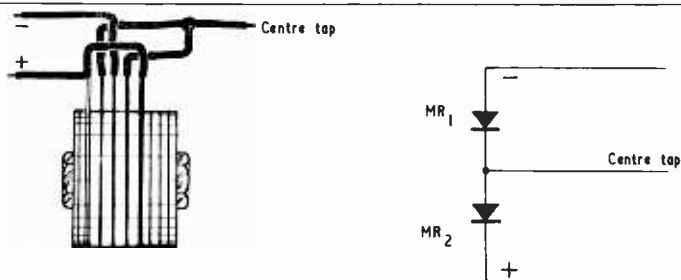
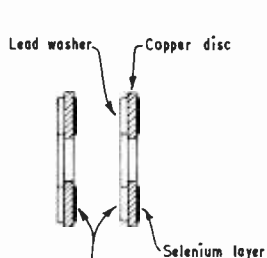
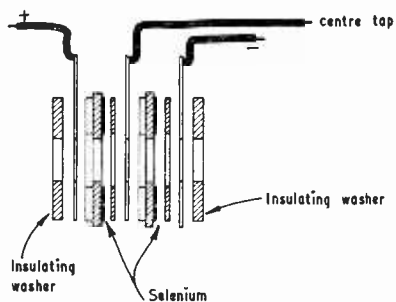

FIG. 7. METHOD OF CONNECTING WESTINGHOUSE M-3 RECTIFIER



Lead washer must contact selenium only
and not copper of adjacent disc

FIG. 8.



Central insulating tube must be cut approx 1/32"
shorter than the complete assembly above to ensure proper "nip"

FIG. 9.

G454

"X1" in the "closed" position, and "X2" in the "open" position.

To calibrate the "backing-off" control R_3 , connect a 5.0mA meter, in series with a fixed resistor of $2k\Omega$ and a variable of about $50k\Omega$ to the collector and emitter clips. Start with the variable at maximum resistance, and adjust it to give a current of 0.2mA. Back this current off to zero in the 1mA meter by means of R_3 and put an appropriate mark on the dial. Increase the current in steps of 0.2mA, backing off each increase to zero until the limit of R_3 is reached, around 1.5mA.

If a suitable micro-ammeter is available, the bias control can be similarly calibrated. The micro-ammeter is connected in this case to the base and emitter clips, whereupon

adjustment of R_5 will vary the current between about $4\mu A$ and $20\mu A$.

To use the tester, a transistor is connected to either the holder or the clips, S_2 is set to the correct position—either p.n.p. or n.p.n.—and initially S_3 is set to the "X2" range. The backing-off and bias controls are both set to zero, and the tester switched on. The resulting collector current is backed-off to zero, and the gain read by pressing the push-button.

If the reading is half-scale or less, the range switch can be set to "X1" when a more accurate reading can be taken.

The effect of increasing the bias current can then be observed, remembering to back-off the increased collector current by suitable re-adjustment of R_3 .

UNDERSTANDING TELEVISION

continued from page 797

direction of the lines of force here being such as to cause it to be deflected to an outward-going path. However, due to the acceleration provided by the final anode, the electron passes through the field around electrode Q in a shorter space of time than it did through the field around electrode P. In consequence, and although electrode Q causes the electron to be deflected in an outward-going manner, the degree of deflection here is less than that around electrode P. The result is that the electron follows the path CD.

An electron leaving the point source in the direction AE suffers a similar type of deflection, this causing it to follow the path AEFD. Other electrons leaving the point source are similarly deflected, the degree of deflection becoming less as the electron travels closer to the centres of the apertures. An electron leaving the cathode along the line AGHD and passing through the exact centres of both electrodes would travel in a perfectly straight line.

All the electrons shown in Fig. 32 begin to converge after leaving the electrostatic lens and they meet at point D. If this point is on the surface of the cathode ray tube screen the electrons will cause a small spot to appear at this point. In other words the electrons will be focused on to the screen. The size of the spot given at the screen will, of course, depend upon the accuracy with which the electrons converge at the crossover point D, and this is a function of the efficiency of the design and manufacture of the electrostatic lens. A control of focus is possible by adjusting the positive potential on one of the two electrodes in the lens, this varying

the strength of the curved field and, in consequence, the point at which crossover occurs.

The two basic factors of the electrostatic lens of Fig. 32 are as follows. Firstly, electrons leaving the point source travel through curved lines of force which result in their being deflected first inwards and then outwards. Secondly, by causing electrons to become accelerated whilst passing through the field, the time they spend in its second part is less and they suffer less outward deflection thereby.

The two cylindrical electrodes of Fig. 32 are meant to be typical only of the make-up of an electrostatic lens, and practical electrode shapes may vary widely from those shown. A frequently met variant is shown in Fig. 33. In this diagram we once more have the point source of electrons, this being followed by the first anode and the final anode of a "tetrode" cathode ray tube. The first anode has a lower positive potential than the final anode, with the consequence that we once again have curved lines of force between these two electrodes. These curved lines of force act in just the same manner as did those of Fig. 32, and electrons are similarly focused at a crossover point which should occur at the surface of the cathode ray tube screen. Control of focus is obtained by varying the potential of the first anode.

Next Month

In this article we have confined ourselves to the manner in which the electron stream inside a cathode ray tube may be deflected and focused by electrostatic means. In next month's issue we shall carry on to magnetic deflection and focusing.

Introduction to

The JUPITER

**Stereo Pre-Amplifier
and Main Amplifier**

A Jason Design, by G. Blundell

IN THIS SERIES OF ARTICLES THE DESIGN OF a stereo pre-amplifier and a main amplifier will be described. The two units will be shown as cabinet mounting models, but cases are available so that both may be free-standing. The two units may both be built as single-channel amplifiers—thus saving some initial cost—and the second channel may be added later.

First, what is "stereo"? True stereophonic reproduction is only possible by reproducing at each ear exactly what a person would have heard if standing in the same position as the microphone. This involves wearing headphones. This perfect reproduction is lost immediately the listener moves his head, and to see the reason for this an explanation of how direction is normally judged is required. Firstly, there is simply the volume difference between the sounds heard in each ear; secondly, the phase difference of the sounds heard in each ear.

The Difference in Level

Difference in level is very much more difficult to judge if one keeps one's head still. Try listening to sounds and see how difficult it is to judge the direction if one does this. A small head movement causes a louder signal in one ear and a lesser one in the other ear, and the source of the sound is quickly located.

The Difference in Phase

Less is known about how we judge direction by difference in phase; certainly direction of low notes can be estimated, though less accurately than high notes, and as measurements show that at low frequencies the sound levels arriving in each ear are approximately the same, it seems unlikely that the direction can be judged by difference in level. It is also likely that turning the head again gives a difference signal which allows more accurate judgment of direction. Under this heading of difference in phase (or time) may be included the fact that a sharp noise produces high frequency sound which arrives at the nearer ear first, and this also helps to give an immediate indication of direction.

Stereophony with Headphones

From the explanations in the previous paragraphs about how one judges direction

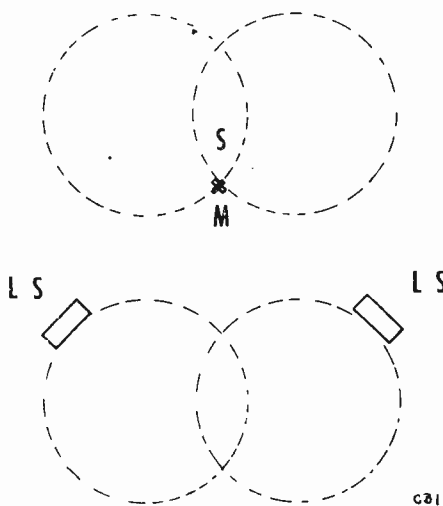

Fig. 1. The fields of the microphone M and the speaker LS. Why stereo works best when the listener is roughly midway between, although the stereo effect is not completely lost when the listener is right over on one side. A soloist near the microphone at point S would cause large changes in the relative output of the channels and thus apparent position just by turning his head.

by moving one's head, it can be seen that perfect stereophonic reproduction cannot be reproduced with headphones, contrary to many claims. The effect of turning one's head when listening via phones is to imagine that the whole sound source is moving around one rapidly. It is the aural equivalent to the room spinning round, which one knows is a very unpleasant effect. A sensitive person might have equally bad effects listening to stereo via headphones. At least a bad headache would probably result, due to the effort of the brain to interpret sounds which are not following the usual course of events which have been learned.

effect of a sound in the middle, and the illusion of stereophonic reproduction is complete.

This picture is quite adequate when applied to a large signal source spaced some distance from the microphone as shown in Fig. 1, and remarkably good effects can be obtained. It is possible, for example, by listening to a good recording, to make a complete drawing of the orchestra seating arrangements, and to throw in for good measure the positions of the microphones as well!

Unfortunately, the system does not work nearly so well for solo voices or instruments

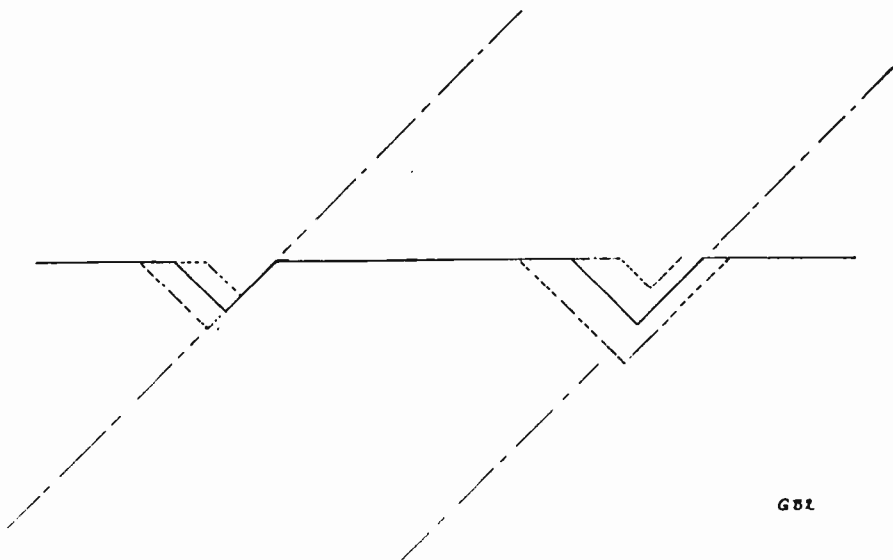

Fig. 2. The left-hand wall of the groove is being modulated. If the dotted line was the surface of the record, this would be equivalent to normal lateral modulation.

Fig. 3. The left-hand wall is being modulated with a signal and the right-hand wall with a smaller one. If the dotted line was the surface of the record, there would be both lateral and hill-and-dale modulation.

Stereo by means of Two Separate Channels

Many listeners may have noticed that if two speakers are connected to an amplifier and are arranged a few feet apart, the sound appears to come from the middle point between them. This fact shows how stereophonic reproduction is possible with two channels. Two microphones reproduce two signals through two amplifiers and loudspeakers. A sound on one side comes obviously from one channel, while equal sound from each loudspeaker produces an

near to the microphone. It can be seen from Fig. 1 that a small movement of the soloist near the microphone or change of direction of the soloist's head would cause a considerable change of level in each channel. The effect on the listener would be of the soloist appearing to be moving about rapidly in the middle of the stage. One solution to this problem would be to have the soloist on one side of the stage, but this is contrary to normal practice. The better way, probably, is to record the accompaniment stereophonically, but to record the soloist

using present-day close microphone techniques, monaurally, and to record this monaural signal equally on each channel. The effect then would be that the soloist would appear to come from the middle of the stage, and the unnatural positioning effects would not be present.

Some discussion on these problems is important because for most purposes two-channel reproduction is the only one possible. However, present results show that with improvement of microphone technique all present problems of stereophonic reproduction can be solved. What appears to be happening between the speakers shows up the weaknesses of the system. Another fault of microphone technique makes it appear that sounds are coming from either right or left of the stage but nothing from the middle. These, however, appear to be minor faults easily cured by good microphone techniques.

The "hole-in-the-middle" effect can be solved with another channel, but this of course increases the cost of the system considerably. However, recent American "spectacular" films are using as many as six separate channels!

The controlling factors for the reproduction in the home are cost and the gramophone disc itself, which means that two channels are the maximum which will be used. The point about the disc being limited to two channels will be explained later, but meanwhile it is an interesting possibility that three-track tape recordings can easily be made, and it is possible in a year or two that three-track recordings will be available.

Listening Sources

The three important possibilities are tape, disc, and radio. Stereo tape recordings have been available for a year or two in both England and America. Disc recordings are now being released, and the B.B.C. are making experiments with stereo broadcasts.

Stereo on Tape

This consists of two separate recordings on standard $\frac{1}{4}$ in wide tape. The two tracks are quite independent and are reproduced separately by two heads mounted directly one above the other. These two reproducing heads must be exactly in alignment or the stereophonic effect will be lost. An older American system uses heads following one after the other, one recording of course being delayed by an equal amount. To achieve good results the head spacing and tape speed have to be very accurate. No tapes have been released in England using this system.

Stereo on Disc

Contrary to many recent statements, recording of two channels in one groove is

a British invention first patented by A. D. Blumlein of H.M.V. before the war. There are two possible variations in the method of doing this, and it is to the credit of the gramophone record industry that complete agreement has been reached to standardise on one of them. Briefly, one method uses the normal lateral method of modulating the groove for one channel whilst the other channel is modulated in depth on the same groove using the hill and dale system. One needle of course reproduces both channels, vertical movement generating one voltage and lateral movements another voltage which are fed to the two amplifiers. This system was demonstrated in England by A. R. Sugden (Connoisseur) and Decca, and very good results were demonstrated. In America development took place by Westrex of the 45/45 system. A short explanation of this will be given, although briefly it is the same as the above system except that the plane of the record has been tilted through 45°. The advantages are considerable. Both channels are now identical, carrying the same amount and type of distortion, the same recording response curves may be used, external defects such as motor rumble affect each channel identically. This balance between the systems is important if good stereophony is to be obtained. Fig. 2a shows the way in which the groove is modulated, the dotted line showing one channel varying. In Fig. 2b the dotted line shows the depth of the groove in the presence of signal, while the full line shows the unmodulated groove. On each drawing is shown a further dotted line representing the plane in which the record surface would be if the drawings referred to hill and dale/lateral systems instead of 45/45. Basically, the systems are the same and the present standard 45/45 system was referred to by Blumlein. It may safely be claimed that though we have adopted an American development, the original system and variants were British inventions.

Stereo on Radio

As stereo radio is in its infancy here, it will be more helpful to describe American developments. American radio stations on the whole serve small areas of population and operate independently. They may take network programmes of major interest, but there is spare radio time available for unusual broadcasts. A number of stations operate both a.m. and f.m. transmitters, and these are sometimes used for stereo broadcasts—one channel being broadcast on each wavelength. This, of course, reduces the quality of the broadcast to that obtainable from the a.m. station; but as, usually, smaller areas are served, good quality is obtainable by the majority who live near the station.

Another possibility also being explored in America is a method known as multiplexing or sending out two programmes on the same f.m. wavelength. The bandwidth required prevents this being done on a.m. The f.m. carrier is modulated both with one channel and also an inaudible carrier frequency of 40 kc/s. This second carrier is modulated with the second channel, and complete separation between the channels is easily obtained. A normal tuner receives the first channel, to which a second unit must be connected to demodulate the 40 kc/s carrier.

priate disc, and it is not necessary for this to work with normal pick-ups and single channel equipment. The opposite is not true of radio. One channel of the radio must be "compatible," must carry all the information. One channel of stereo usually sounds rather weak and indistinct due to some of the sounds originating farther from the microphone being blurred with echoes. The balance of an orchestra is completely lost. Therefore, a new system has been proposed which works algebraically. The main programme carries both channels added to-

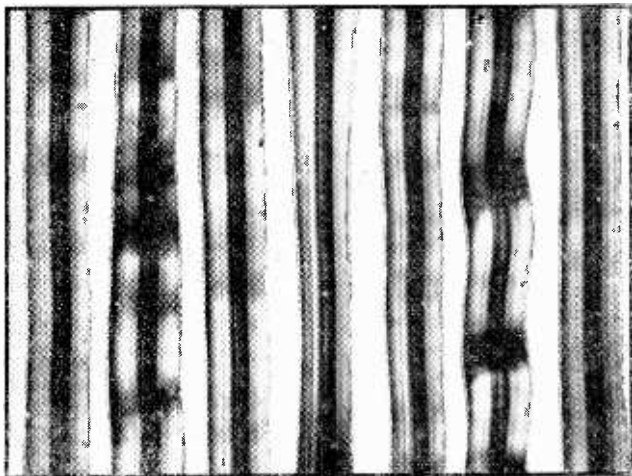

*Actual photograph
of a stereo groove*

*Photograph by courtesy
of E.M.I. International
Ltd.*

This unit must be connected before the de-emphasis circuit which would otherwise attenuate the second carrier completely. Slightly worse signal-to-noise ratio results since only the same bandwidth can be used, but this is more than balanced by the improvement in realism. The same remark is, of course, true of disc.

A difficulty arises, though, with radio which does not arise with discs. Anyone wanting to listen to stereo buys the appro-

gether $(A+B)$; the second channel or sub-carrier carries a difference signal $(A-B)$. Appropriate electrical circuits add these signals or subtract them by reversing the phase on one, giving the following results: $(A+B) + (A-B) = 2A$, secondly $(A+B) - (A-B) = 2B$ and—hey presto—our two original channels are recovered for feeding to our two amplifiers, and yet our first programme is compatible, carrying both signals A and B .

To CHASSIS BASHERS!

The Osmor people announce a FREE LOAN SERVICE for any of their chassis-cutters and "Jiffy" punches. These tools will be sent on application to Osmor Radio Products Ltd., 418 Brighton Road, South Croydon, Surrey, enclosing the retail price

of the tools required. The total cost (less postage) will be refunded in full when the tools are returned undamaged. The loan period is for a full 14 days, and the tools must be returned within 17 days.

Radio Miscellany

FREQUENTLY DURING THE LAST FEW months I have felt it only courteous to apologise to readers, where it has not been possible to deal with their points in print, for my apparent tardiness in replying to letters. Yet in doing so I have been rather uneasy for fear of irritating those readers who never write, with seemingly weak excuses—although as fellow enthusiasts they no doubt feel they haven't got enough spare time either! However, I really do try. As one who has for so long emphasised to newcomers our hobby's strongly established tradition of good fellowship, I should be ashamed to do otherwise. Imagine my surprise, therefore, to have a request for the address of a regular contributor to another periodical. Apparently two letters addressed to him failed to evince a reply. Could I supply his private address?

It jolted me into a desperate effort to get up to date with my correspondence and also to give over much of this month's space to "sequels" of points raised by readers. Please don't take this to mean a reply will be forthcoming by return of post. Unfortunately, I am still in hospital where my only pursuit of the hobby is to read and think about it and where, incidentally, I have just nearly injured myself through laughing. It happened this way. The chap in the next bed is nearly better and the Ward Sister thought he could well attend some sort of non-denominational thanksgiving service to be held in the chapel. He pleaded an improbable sort of excuse, intending to remain in bed and listen to his favourite funny man on the Light Programme. Thus he was lying with the earphones on while I was writing. Suddenly, he tore them off and they fell to the floor with a startling clatter. I thought he must have had a shock. In the early days before output transformers were in general use, headphones used to be wired direct in the anode circuit. Old boys with bald heads often used to get a mild shock when listening on their one-and-two-valvers. However, it wasn't that sort of shock he received. They cut off the Light Programme and began to relay the chapel

service instead, for the especial benefit of the bedridden! I don't know which made me laugh most. The poetic justice of it or the look on his face. If it amuses you, too, it must be the former.

I-Spy

A few weeks ago I heard from a Scottish reader who had never been to London before. At last the occasion was to arise and he would be spending a few days in the Big City. Would I suggest a comprehensive tour of the radio (and junk) shops?

I sent him a brief itinerary of places of interest in the Central London area. Not a very imaginative tour, I'm afraid, but it included the Lisle Street, Tottenham Court Road, Fleet Street, Edgware Road and Praed Street areas. Now he has written to thank me and says he enjoyed it. No special bargains mentioned! On his own initiative he added Broadcasting House, and while he stood admiring that magnificent edifice he noticed a parked car bearing simply the word "Radio." On closer inspection to see whose radio it was, he found it was the registration number RAD 10. Whilst contemplating this remarkable coincidence, a delivery van drove by. This bore the registration number 1 AMP. When he tells folks back home they allege he had either (a) been drinking, or (b) showing early symptoms of radio-mania. The only thing I can suggest is that the next time he comes to London he brings his camera with him—in an ever-ready case.

Test Record

Those who have followed the discussion on test records will be interested to know that a new hi-fi test disc was introduced last month at the Audio Fair. Its release to the record shops was held back until after this event. It was originally released under the U.S.A. "Popular Science" label in a 12in. double-sided 33½ r.p.m. disc, and is said to have sold over 50,000 copies there. While it doesn't quite meet the requirements of our original Aberdonian enquirer (who asked for

a 45 r.p.m. record), it will find a very wide welcome among hi-fi fans. Such a record makes for easy tuning of reflex speaker enclosures, detection of resonance points and vibration occurring in certain frequency ranges, checking turntable speed steadiness, testing amplifier equalisation, and in matching tweeters to existing speaker systems.

This record, by the way, also contains a sound effects quiz game, suitable for parties. If everybody gets them *all* right you can feel very satisfied with your equipment! Also included is a recording of five music-box selections.

Such a disc has an obvious appeal to the constructor experimenting in search of perfection in reproduction, but equally important is what it will reveal to the non-technical. The term hi-fi has only too often been exploited as a sales booster of equipment ill-deserving such a description. It should prove an effective means of protection against inferior amplifiers and accessories.

Still Coming

Last month I mentioned the availability of 16 r.p.m. records in the United States.

a coated paper. Three grades are available, unwaxed neutral kraft, waxed neutral kraft and pure union kraft (bitumen centre). A vapour is slowly given off by the coating, which it is claimed will render water non-corrosive to steel.

Samples have come to hand from the manufacturers who kindly offer to advise readers on their particular problems. I have had no opportunity to try out the samples they have sent me—obviously delayed until I am again on the active list—but I am told it is becoming widely used throughout the electrical trade. Uses which readily come to mind are for lining tool boxes, drawers, and shrouding small lathes and other tools.

Rustfoe paper should be used as an inner lining to prolong its protective life by retaining the non-corrosive vapour. When stored it should be kept in an envelope until required for use. It is supplied in either rolls or sheets to order and a popular handyman pack is available containing eight sheets 15in × 20in at a cost of 5s. The coated side of the paper (the white side) must, of course, face towards the metal to be protected. Readers unable to obtain supplies through

Centre Tap talks about Items of General Interest

I now hear that 16 r.p.m. records are on general sale in France in both 7 and 10in sizes. They play for 15 and 30 minutes per side respectively and a normal 33½ r.p.m. stylus can be used without difficulty.

I have had no opportunity of hearing any of the few specimens imported for test purposes, but a hard-to-please friend assures me they are "quite acceptable," although he said there was a very slight trace of wow on the outer circumference of the larger size. They are not normally available in the U.K. and as far as I can trace (from the remoteness of a hospital bed) nor are any other 16 r.p.m. discs—yet.

Rust Inhibition

As a result of my request for suggestions (on behalf of readers handicapped by garden shed, outhouse, or other damp workshops), details of a modern vapour phase inhibitor have come to hand. It is marketed under the name Rustfoe and comes in the form of

their usual retailers should write to Williams-Cook Ltd., 43-45 Brunel Road, W.3.

More of Yore

Several more letters from Old Timers this month, for which many thanks. They still outnumber correspondents on other matters. Perhaps they remember the stuff I wrote "way back" and look on me as an old friend. At least, it is nice to think so, especially as I am still numbered among the Bedfast. By the way, thanks fellow invalids for the regular copies of *Radial* and for the good wishes for my recovery. I found your current Newsletter cheerfully chatty and it made me less impatient with my infirmity.

Old Timer W.H.S., of Swindon, relates how he deserted our ranks for a spell, but like a great many others recently made a come-back. He celebrated his reunion with the hobby by building a battery portable. I gather it was the Petite, recently described in

continued on page 825

Technical Forum

The Remote Control of TV Sets

WHEN VISITING EXHIBITIONS ONE IS OFTEN surprised at the number of sales gimmicks which are added to standard pieces of equipment in an effort to enhance their sales value. Frequently it would seem that the addition has little more than a sales or novelty value, and may prove of little use to the final owner. Whether or not a gimmick is found to have a value to the user can often be assessed by noting whether it is retained for more than one season. Many will appear on one model only and will have been discarded by the time the next design is introduced. Others will survive much longer, in which case they will move out of the gimmick category into one of usefulness. We feel that the provision of a remote control system for a television receiver falls into the latter class, particularly if the receiver is used by an invalid where the need for readjustment can be a serious inconvenience.

particularly with this in mind that the following recommendations have been worked out.

The receiver controls which are most usefully and easily extended for remote operation are:

Contrast, brightness, volume, and the on/off switch.

There will be some cases where it would be considered an advantage to be able to remotely control the station selector. This is largely a mechanical problem which will vary in its complexity according to the type of station tuner which is employed, and it is therefore considered to be outside the scope of the present article. A general impression of the remote control unit will be obtained from Fig. 1, and it will be seen that the multi-way cable is terminated by a 12-way duodecal type plug. This plug fits a 12-way socket which is added on the back panel of the receiver, and enables the set to be used either with or without the extension unit.

When the unit is in use its controls are in circuit and those on the receiver are inoperative. When not required, the unit is unplugged from the receiver and a dummy plug inserted in the socket; the set then functions normally. The dummy plug is necessary to complete the circuit of the main controls. With the exception of the volume control the leads to the extension unit carry no r.f. or a.f. signal, so there is no serious chance of interaction causing instability. The volume control has been included in a low impedance part of the circuit, so that here again there is no possibility of interaction, thus it is permissible to employ any reasonable length of cable between control unit and receiver. The various receiver manufacturers use circuits which vary quite widely in their method of achieving similar results, so that it is impossible to give full details of how the remote

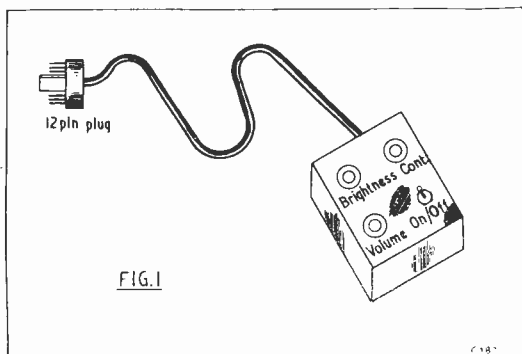

Most readers who are interested in adding a refinement of this type to a receiver will no doubt wish to do so with the very minimum of modification to the set itself, and it is

control unit is added to every class of set. The ensuing description, however, covers a unit which will be satisfactory for use with three-quarters of all receivers at present in use, and the reader should have no difficulty in adapting the system to cover the others.

The Circuit

When the unit is plugged into the receiver, the set controls are cut out of circuit and only those on the unit itself are operative. This is achieved by the use of shorting con-

replaced by R_2 . In some receivers an additional resistor may be found between R_1 and chassis, and in such cases a similar resistor must be employed between R_2 and pin 5 so that the two control circuits are identical. Should the extension unit not be required, it is unplugged from the back of the receiver and the dummy plug replaced in the socket. Shorting links in the plug bridge pins 1 and 2 and also pins 3 and 4, thereby enabling the brightness control in the receiver to function normally.

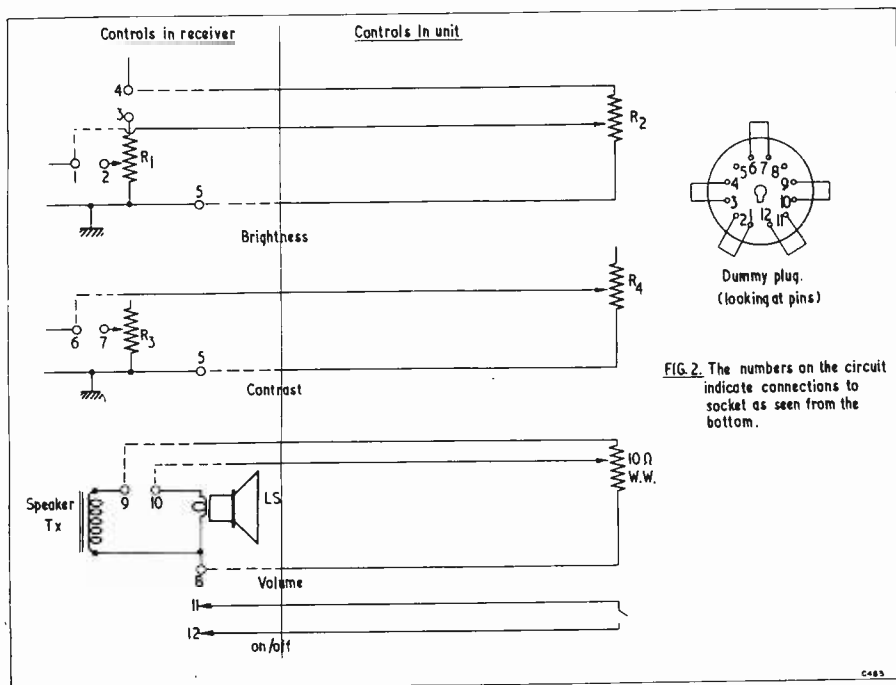

FIG. 2. The numbers on the circuit indicate connections to socket as seen from the bottom.

tacts on the 12-way socket at the receiver end. The circuit diagram (Fig. 2) indicates the way in which these shorting links are made to function. The brightness control in the set is R_1 and on the unit R_2 . R_2 is a linear potentiometer, and it is essential that it should have the same value as R_1 . In order that R_1 can be cut out of circuit, the leads to its slider and most positive end are broken and connected up to the 12-way socket added on the back panel of the set. When the remote unit is in use, leads to it are simply taken from contacts 1 and 4 together with the common earth line 5. This leaves R_1 out of circuit and completely

The contrast is normally varied by means of the cathode bias on valves in the r.f. and i.f. stages, and this is often achieved by a common adjustable resistor in the cathode circuits; such a resistor is shown as R_3 . With such an arrangement it is only necessary to break the lead to the slider and connect up to pins 6 and 7 on the socket. The remote control is then R_4 , having the same value as R_3 and joined between leads 6 and 5.

To eliminate the need for screened cable to the volume control, it has been joined in the secondary circuit of the speaker transformer. The impedance here is in the region of a few ohms only so there is no possibility

of hum occurring due to stray pick-up. One lead to the speech coil is broken and connected up to pins 9 and 10 on the socket, whilst pin 8 is taken to the other side of the speech coil. Volume is adjusted by means of a 10 ohm wire-wound potentiometer as shown on the diagram.

This leaves two spare positions on the 12-way socket for the single pole on/off switch, which is joined in the positive mains lead, and is in series with the switch in the receiver. Thus the receiver switch has to be closed before the remote unit is put into service.

Construction

These recommendations are equally applicable to both a.c.-only and the live chassis type of a.c./d.c. receiver, but it is essential to make sure that the user cannot make contact with any of the live parts. This includes the chassis lead to pin 5 in the case of the universal type of set. The best form of housing for the remote controls is a box made in either paxolin, Perspex, or one of the other plastic materials. The lead may be a multi-way type having at least nine cores each of which can be identical, as none has to be screened.

Can Anyone Help?

Requests for information are inserted in this section free of charge, subject to space being available

P. H. BYLES, 57 Devonshire Road, London, S.E.23, wishes to obtain a circuit of the MCR.1 Receiver, and would also like suggestions as to where he could obtain an output transformer for this set.

* * *

P. JACKSON, 60 Southwold Road, London, E.5, would like to buy or borrow a service sheet, manual, etc., for the Eddystone 358X Receiver.

* * *

E. M. E. DECOTTIGNIES, 58 Leighcliff Road, Leigh-on-Sea, Essex, wonders if any reader can help identify a valve. This is all-glass, IO based, with top cap, and is marked †EF—CV1501—KB/K. It appears to be a pentode, with anode connected to top cap. Heaters are as normal in IO valves.

* * *

P. L. GRIEVESON, 40 Clarence Crescent, Sidcup, Kent, has been trying, without success, to get a copy of the service sheet for the Ferguson 9in 841T televisor. Can anyone help?

* * *

J. P. HUPFIELD, 51 Wotton Road, Cricklewood, London, N.W.2, wishes to purchase, borrow or otherwise obtain a circuit diagram or manual for the New Zealand Transceiver Z.C.1 or Z.C.2.

* * *

P. G. MARTIN, 4 Beech Road, Princes Risborough, Aylesbury, Bucks, asks if anyone has a copy of *Wireless and Electrical Trader* which he can spare.

G. WORRALL, 2 Cecil Avenue, Dronfield, Derbyshire, would like to hear from anyone who has successfully built the Premier "Mayfair" televisor.

* * *

H. LANE, 21 Barrack Hill, Newport, Monmouth, wishes to buy or borrow the circuit of the Test Set 74 (VCR139A tube, SP61 valves, internal power pack) and would like to hear from anyone who has modified this unit for use as a 'scope. Any expenses involved will be covered.

* * *

F. W. HATTEMORE, 20 Baroness Place, Penarth, Glamorgan, would welcome information leading to a source of supply of a cabinet and baseplate for the CR.100 receiver. He offers any information required by any reader on the following equipments, providing an S.A.E. is enclosed: 358X Receiver, HRO, CR.100 or R.1155 Receivers.

* * *

W. WREN, 36 Curzon Street, Gateshead 8, Co. Durham, wishes to buy or borrow the handbook or any data on the ex-Admiralty Tuner-Amplifier, Marconi B.21.B.

* * *

T. G. WHITEHEAD, 86 Seymour Road, Trowbridge, Wilts, would like to buy or borrow the service manual or any data on the Collins TCS.13 Receiver.

* * *

J. LONGLEY, 7 Chapelfields, Marple, Cheshire, would like to buy or borrow any information or service manual on the American Du Mont Oscilloscope type 208.

The London Audio Fair 1958

It was heard suggested that if all the power dissipated at the Audio Fair as sound output were released as one gigantic signal, it would probably be no more than a tiny fraction of a peal of thunder.

If one adopts a less cynical view, however, there can be no doubt that the third London Audio Fair, held once again at the Waldorf Hotel from the 18th to the 21st April inclusive, was an outstanding success. The visitor's first reaction was to notice the increase in the size and scale of the Fair—a second exhibition hall has had to be brought into service to accommodate the total number of exhibitors, given in the programme as sixty-five. This did, in fact, result in a layout that lent itself to an easier flow through the exhibition halls. The organisers are to be congratulated, not for the first time, on the way in which their arrangements stood up to the severe test of the large number of visitors. As in previous years, the majority of the firms exhibiting were demonstrating their equipment in rooms on either the first, second or third floors of the hotel.

Strictly speaking, one of the objects of a report of this nature should be to highlight

the new equipment that was presented. This is always possible when two or three items only are noticed, but in view of the fact that this year marked the first real onslaught on the public of stereophonic reproduction, it will be appreciated that no space is available for individual mention, in fairness to those that would have to be omitted. A short while ago it would have been assumed that the natural sphere for stereophonic recording and reproduction was tape. Quite obviously the record manufacturers are determined that this shall not be the case, and several convincing demonstrations of stereophonic reproduction from disc were given. The method employed now seems to be universally according to the 45/45 standard, and pick-up cartridges for this type of record are now becoming available from several manufacturers.

Your correspondent was informed by the organisers that some 50,000 people attended the Audio Fair during the four days that it was open. Conversation with a number of manufacturers showed that amongst these visitors were a useful number of overseas buyers who showed considerable interest in the products available.

Radio Miscellany *continued from page 821*

our pages. He is tremendously enthusiastic and says in past years he has built dozens of designs, most of which were highly successful, but never before has he built a set so completely perfect!

He doesn't mention the date when he built his last portable. I suspect it must have been a few years back when it took a couple of able-bodied men to carry a portable equipped with batteries. The half a dozen full-sized valves, numerous large components and frame aerial-cum-tuning coil needed a fair-sized suitcase for a start! Even so the output level was little more than a good crystal set, with the most alarming instability. One had to tread gently whenever within six feet of it. I hope he is not judging the Petite by comparison with one of these. True it is a very well designed little set, but such lavish praise might give beginners (who would judge it by 1958 standards) a wrong impression.

Lt.-Col. F. C. Booty (Secretary of the Norfolk Broads Yacht Club) also writes of the good old days, *circa* 1925, in India. He recalls the early wireless periodicals, especially

the advice solemnly given to constructors: "When wiring up to terminal posts, never make a complete loop of the wire. Always leave a small gap and so avoid capacity." About 1929 he started on short waves, and although sited at 3,000 ft A.S.L. he was weeks before getting a signal. Then one day he heard a voice speaking in Urdu. When it said: "Ajaib Singh isn't here. He's gone to the latrines," he realised it was a harmonic from the regimental signallers in the next tent. At last he did resolve a signal and heard the strains of the Soldiers' Chorus—their regimental march! The signal came in and out for hours, but he was never able to confirm the call-sign. By all the rules it should have been KDKA—and what memories that revives!

By the way, he discovered something which would have been of vital interest to readers of those days. Dry wood was found to make much better panels than much of the expensive ebonite. Most old timers still harbour bitter thoughts of much of the ebonite of those days. Like the Greeks, they had a word for it. They called it muckite!

A 3-Valve MAINS

T • R • F RECEIVER

By W. HARRIS*

THE RECEIVER ABOUT TO BE DESCRIBED offers an opportunity to constructors who have so far limited their efforts to battery driven sets. The advantages are many, including cheaper running costs and better overall reception.

The receiver is built around modern slug-tuned coils, thus providing increased sensitivity and selectivity. Lining-up of the tuned circuits entails only the setting of the cores—once set, they can be forgotten.

For the original receiver an Eddystone cabinet fitted with a chassis measuring 9in × 6in × 2½in deep was used. Any alternative cabinet and chassis of suitable size may be used, provided that the front panel is a rigid structure—it may be stiffened, if necessary, by fitting an angle bracket at each end above the chassis top. The power pack, being a separate unit, can be employed for other experimental work, within the limits of its output, when not being used to drive the receiver.

The anode feedback condenser C_9 is a variable instead of the more usual fixed type, this enabling a setting to be determined for each detector coil to ensure stability and smooth regeneration control on all bands. The actual regeneration control is, of course, R_9 .

Electrical bandsread is incorporated which is effective on all bands; however, on MW and Top Band its effect is relatively small, but it is still useful for the purpose of setting the tuning to the dial calibration.

For the reception of c.w., or telegraphy, R_9 should be adjusted so that the receiver is just in oscillation. No radiation occurs via the aerial as the detector stage is isolated by the r.f. stage.

Construction

This does not entail any great difficulty. If the components are arranged as shown in the layout diagrams no inter-stage screens will be found necessary.

The Denco coil bases require a hole ⅝in diam., the bases being 9-pin noval. The octal based valves need the usual ⅞in diam. hole and i.o. holders. Before drilling the holes used for the fixing screws make sure

that the holders are oriented correctly for the obtaining of short wiring.

A 4-pin valveholder and plug will be needed for connecting the power supplies, and the hole for this is cut on the rear wall of the chassis.

The 375pF 2-gang bandset tuning condenser is placed so that the spindle is on the centre line of the chassis, and set back so that a flexible coupler and short extension spindle may be employed. The same applies to the 15pF 2-gang bandsread tuning condenser, which is fitted under the chassis.

If a metal cabinet is used, the holes cut for the spindles of the various controls must be positioned to correspond exactly with those controls which are mounted on the chassis. An extra nut on the r.f. gain and reaction

Condensers Component List

C_a	50pF variable
C_1-C_3	375pF 2-gang J.B.
C_2-C_4	15pF 2-gang
$C_5, C_6, C_7, C_{12}, C_{14}$	0.01μF
C_8	0.005μF
C_9	100pF variable
C_{10}	100pF mica
C_{11}, C_{15}	2μF electrolytic
C_{13}	0.5μF paper
C_{16}	25μF 25V electrolytic
C_{17}	0.1μF paper
C_{11}	3-30pF concentric trimmer

Resistors

R_1	330Ω ¼W
R_2	10kΩ potentiometer
R_3	56kΩ ½W
R_4	10kΩ ½W
R_5	2MΩ ¼W
R_6, R_7	100kΩ ½W
R_8, R_{11}	22kΩ ½W
R_9	50kΩ potentiometer
R_{10}	1MΩ ¼W
R_{12}, R_{14}	47kΩ ½W
R_{13}	600Ω ½W

Valves

V_1, V_2	EF39 or equivalent
V_3	L63 or equivalent

Coils

L_1, L_2, L_3, L_4, L_5	Denco miniature Noval based "Maxi-Q" to suit ranges required
---------------------------	--

RFC ₁	All-wave choke
------------------	----------------

* Radio Amateur Bedfast Club

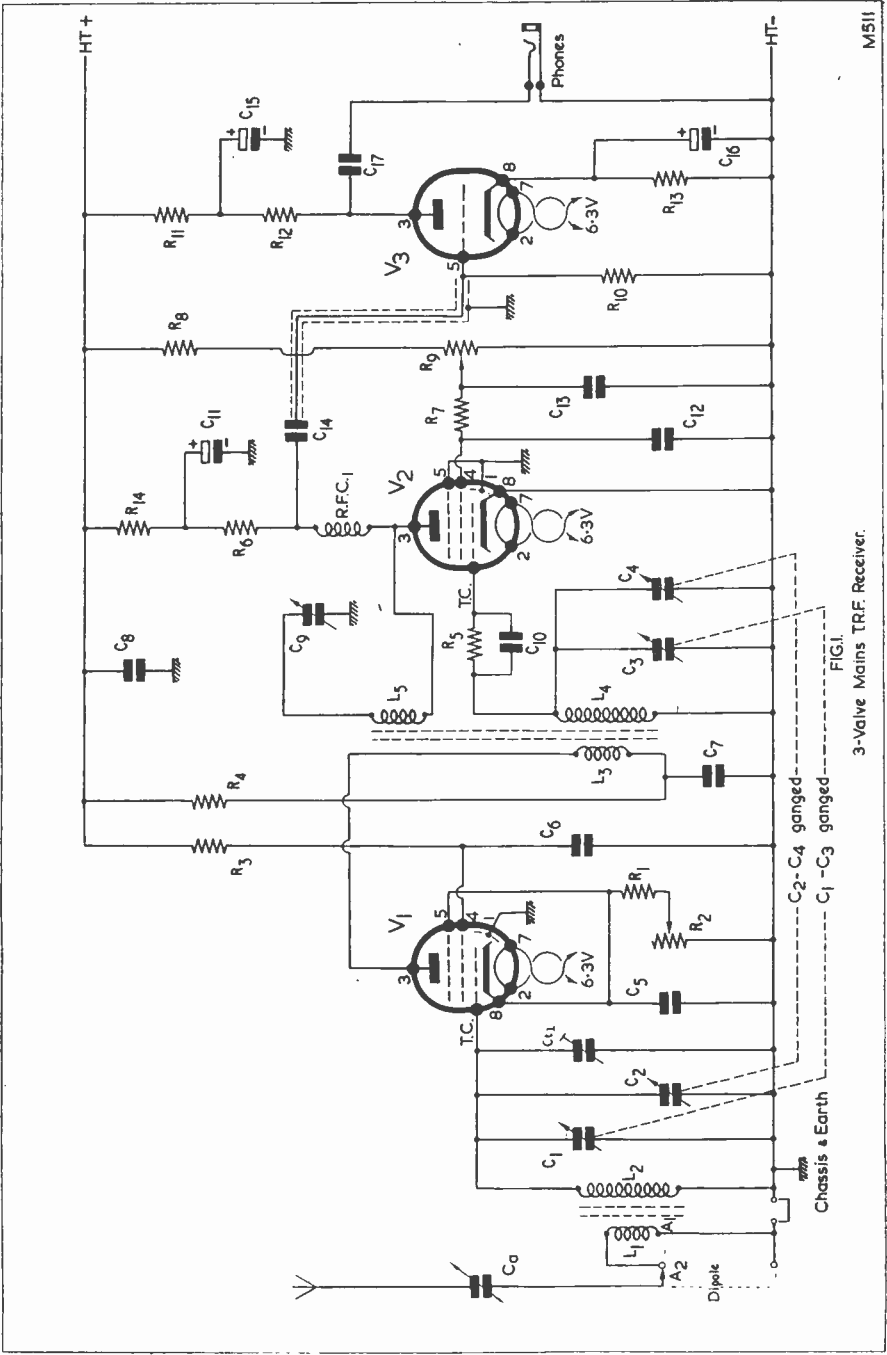
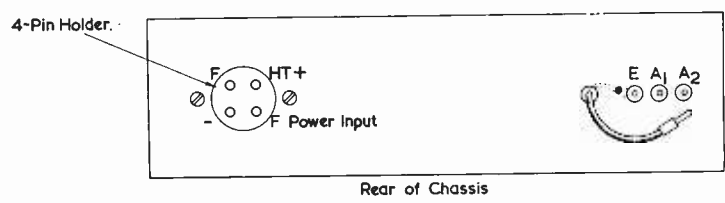
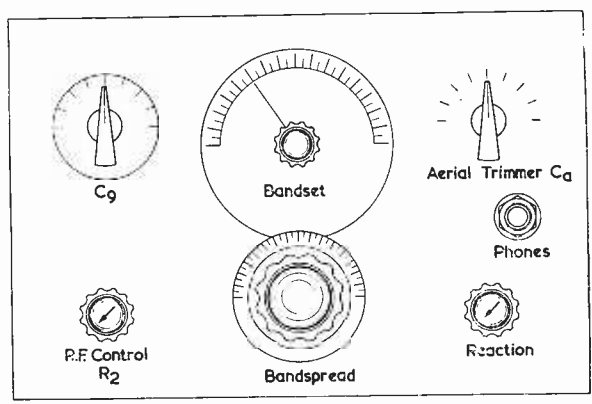
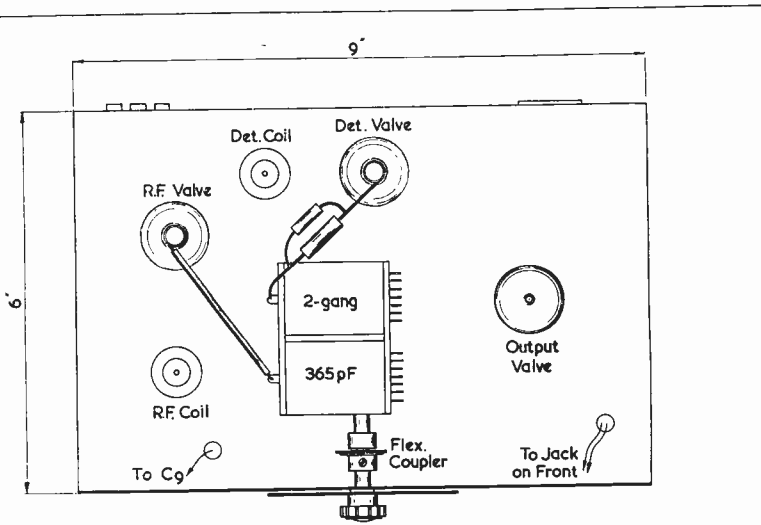

FIG. 1.

3-Valve Mains TRF Receiver.



Chassis
9x6x2 1/2"

Rear of Chassis

FIG.2
Suggested Layout.

M512

controls will lock the chassis to the front panel. A panel bush will be required for both the extension spindles of the tuning controls. These short extension spindles are cut to a length suited to the knobs and slow-motion drives employed. Any minor inaccuracy of these spindles with the bushes is taken care of by the flexible couplers.

Wiring

Covered wiring of 22 s.w.g. is recommended. Work should commence with the heater wiring, this being twisted together between connections and allowed to run along the bottom (that is, the underneath of the top) of the chassis. Start from the power supply socket at the rear of the chassis, using the two filament or heater pins. (The "grid" pin is used for h.t.— and is connected to a tag nearby on the chassis. The "anode" pin is used for h.t.+ wiring.) Solder tags under the valve and coil holders should be used to obtain short, direct earth connections. 2 or 3-way tag-strips should be employed where necessary to prevent undue movement of small components.

Having finished the heater wiring, a start can be made on the coil and valveholders, beginning with the r.f. stage. All wiring should be kept as short and direct as is possible. When using cored solder bring the iron point and solder together and make the connection with a minimum of solder—large blobs are liable to cause shorting where pins are close together.

Wiring above the chassis can be left until the under-chassis work is completed. Make certain that each joint is a sound one—"dry" joints cause much trouble and are often difficult to locate after the receiver is completed.

Power Pack

The power pack is fairly straightforward and should present no difficulties. The mains transformer, smoothing choke and electrolytic condensers are all standard items. The 4-pin plug should be connected to the end of the output cable taking care that the connections correspond with those on the socket at the receiver end. A chassis size 8in x 6in x 2½in is suitable.

Operating the Receiver

After connecting the aerial, earth, power pack and 'phones, set the r.f. gain control halfway, anode feedback condenser vanes about one-third "in," and switch on.

Assuming the 80m coils are being used, set the bandset tuning condenser at about one-quarter "in," tune in a signal and bring it

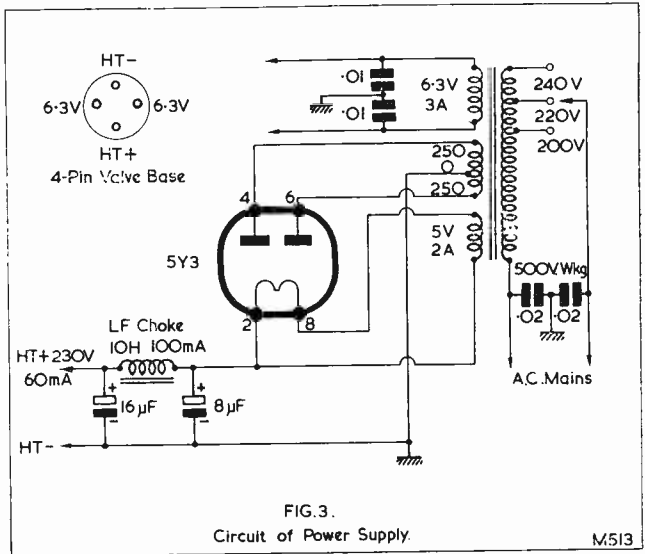

"up" with the regeneration or reaction control, then adjust the coil cores until the circuits are in line.

Adjustment of the aerial trimmer C_a will often be found beneficial in improving selectivity or, alternatively, in increasing the strength of a weak signal. In cases where a dipole aerial is to be used, provision has been made for isolating the bottom end of the primary winding from chassis for this purpose, and for omitting C_a likewise. A switch could be arranged to do both functions where different types of aerial are to be tried.

Tuning is normally carried out by first setting the bandset condenser to any required frequency, such as the l.f. end of an amateur band, with the bandspread condenser vanes fully engaged. Rotation of the bandspread condenser in the direction of minimum capacity will then tune a range on the high frequency side of that frequency to which the bandset condenser was tuned. Although it may seem to the beginner that there is a complexity of controls, he will, after a little practice in the handling of the receiver, realise the benefits of the flexibility which these controls confer.

Using Surplus Meters

By R. H. WRIGHT, G3IBX

PERIODICALLY, SUPPLIES OF METERS, VOLT-meters, milliammeters and ammeters appear to be released on to the surplus market and are advertised at reasonable prices in the magazine. Some of them have ranges which are extremely useful to the experimenter; but others have ranges which, except in odd cases, have little apparent practical use.

One of the more useful types is the meter having a full scale deflection current of 1mA with a meter resistance of 100 ohms. Such a movement may be used in conjunction with suitable shunt and multiplier resistors to build up a useful multi-range meter which, in addition to resistance measurements, has the following d.c. ranges:

Volts	Current (mA)
0-1	0-1
0-10	0-10
0-100	0-100
0-500	0-500

Suitable values of shunt and multipliers may be easily made up. Fig. 1 shows a suggested layout for such a meter.

The scale of the meter will, of course, be marked 0-1mA; therefore the scale reading will have to be multiplied by the appropriate factor when using the meter for higher current and voltage readings.

Range	Multiply scale reading by
0-1	—
0-10	10
0-100	100
0-500	500

For resistance measurements first connect the test terminals together and adjust R₂ for full scale deflection on the meter. In calibrating the meter for resistance measurement, the actual pointer position on the scale for different values of resistance may be calculated or, alternatively, a number of known value resistors may be measured and the scale calibrated accordingly.

Components Required

- M 0-1mA, 100 ohm moving coil meter
- R₁ 3.3kΩ ½ watt, 20% tolerance
- R₂ 2kΩ wire-wound variable resistor

Shunts

- R₃, R₄, R₅ 11.11Ω, tapped at 1.01 and 0.2004Ω

Multipliers

- R₆ 400kΩ
- R₇ 100kΩ
- R₈ 9.9kΩ
- R₉ 900Ω
- SW₁ 2-pole, 9-way switch (Bulgin, type S.206)
- B 4.5 volt battery

} Close tolerance resistors

The Planet Instrument Co., 25 Dominion Avenue, Leeds, can supply a made-up shunt resistor and also the close tolerance multiplier resistors. The arrangement shown in Fig. 1 will permit the shunt connections and the multiplier resistors to be wired directly on to the tags of the switch.

Previous reference was made to those meters which would appear to have little practical use to the experimenter. However, many of the more "awkward" range meters can be adapted for other uses by the simple application of Ohm's Law. In general terms this law states that the current in a circuit is directly proportional to the applied voltage and inversely proportional to the resistance of the circuit. Symbolically, this may be

shown as $I = \frac{E}{R}$, where I is the current,

measured in amperes, E is the applied voltage and R is the resistance, measured in ohms. Mathematically, this formula may be altered

to $R = \frac{E}{I}$, and $E = I \times R$, and it is from here

that one may set about altering the ranges of both voltmeters and ammeters.

With the exception of electrostatic, moving-iron and hot-wire type meters, those advertised are moving coil instruments having a basic full scale deflection current of, perhaps, one or two milliamps and a coil resistance varying between a few ohms and a hundred or so. If this basic movement is being used to measure a higher value of current, the current in excess of that required to give full scale deflection on the meter is shunted through a parallel resistor, as in Fig. 2 (a). Thus with a suitable shunt value, a meter may be adapted to read any value of current. The same type of meter may also be used to read voltages if a suitable current limiting

resistor is connected in series with it, as in Fig. 2 (b).

The correct values of shunt and/or multiplier resistors necessary to extend the range of any meter may easily be determined if

is now required to measure up to 10 volts. The f.s.d. of the meter is 1mA and so, when measuring 10 volts, the current through the meter must not exceed this value. The total value of the resistance required to limit the

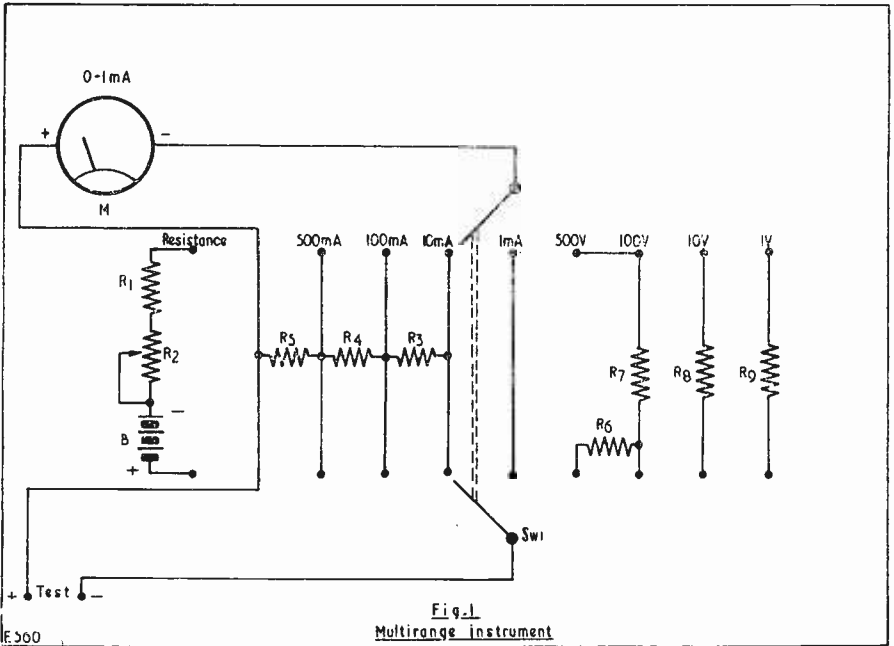

Fig. 1
Multirange instrument

the full scale deflection current and coil resistance of the meter are known.

To Calculate Shunt/Multiplier Values
Shunt Resistors

Since the meter and shunt are to be connected in parallel, the product of the current through the meter (I_m) and the resistance of the meter (R_m) must equal the product of the current through the shunt (I_s) and the resistance of the shunt (R_s) . . . $I_s \times R_s = I_m \times R_m$

$$\text{hence, } R_s = \frac{I_m \times R_m}{I_s}$$

Example: What value of shunt will be required to enable a meter having a full scale deflection (f.s.d.) of 1mA and resistance of 100Ω to read 0-10mA?

Since the meter required only 1mA for f.s.d., 9mA must pass through the shunt,

$$\begin{aligned} \text{Shunt resistance } (R_s) &= \frac{(1 \times 10^{-3}) \times 100}{9 \times 10^{-3}} \\ &= 11.11 \text{ ohms} \end{aligned}$$

Multiplier resistors

Suppose the meter of the previous example

current to the required value can be found by application of Ohm's Law—($R = \frac{E}{I}$)

$$\text{therefore, } R = \frac{10}{1 \times 10^{-3}} = 10,000\Omega$$

But the meter has a resistance of 100Ω, therefore an additional series resistor of 10,000—100=9,900Ω will be required.

In both examples, the actual meter reading will, of course, have to be multiplied by 10.

A multi-range meter, similar to that described previously can be made up quite easily with a basic moving coil movement and a suitable selection of shunts and multipliers.

The meter may also be used to measure resistance in addition to current and voltage by the inclusion—in series—of a battery of, say, 4½ volts and a current limiting resistor. For example, suppose we connect such a battery in series with the meter used in the above example, together with a fixed resistance of 3.3kΩ and a variable resistor of 2kΩ, as in Fig. 2 (c). If T_1 and T_2 are

joined, R_2 should be adjusted so that the meter shows f.s.d. If now a resistor of unknown value is connected in series between T_1 and T_2 , a reduced current will flow through the meter. A number of known value resistors may be used and the scale calibrated accordingly.

resistor of about $50k\Omega$ set to full resistance, and a small cell of about $1\frac{1}{2}$ volts—as in Fig. 3 (a)—and gradually reduce the resistor value until the unknown meter is reading f.s.d. The value of current flowing may now be read off the calibrated meter. To measure the resistance of the unknown coil, disconnect

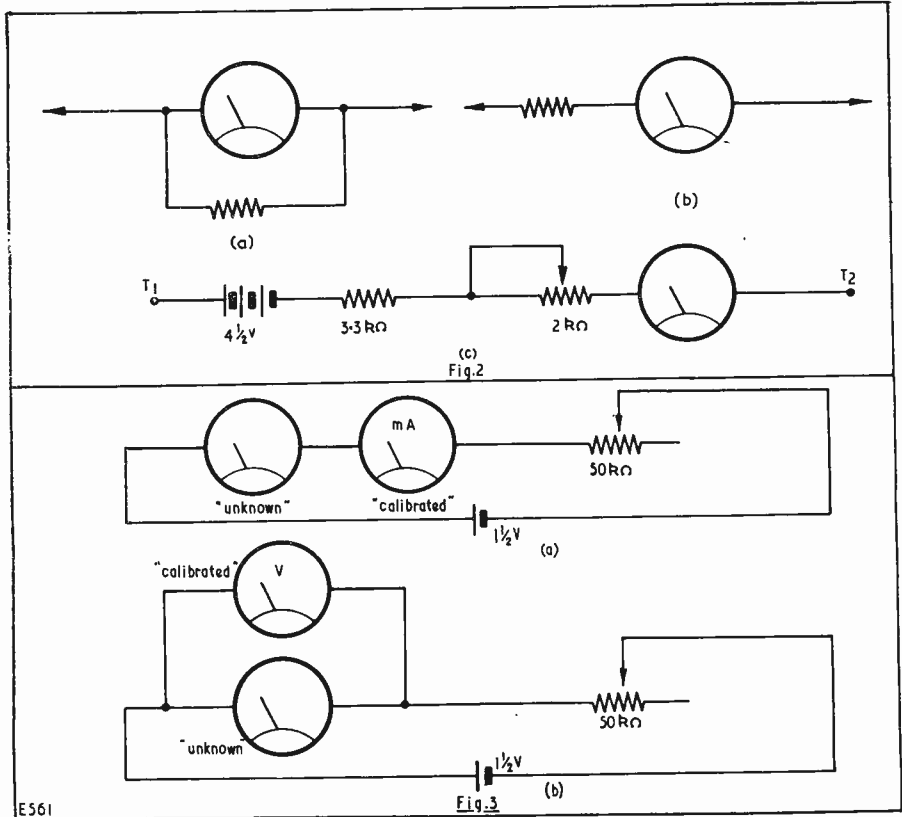

E561

Fig. 3

Meters previously used for measuring high voltage or current values may be used in multi-range instruments provided that they are dismantled and the internal shunt or multiplier resistance removed. Great care should be exercised when carrying out this operation since the coil, bearings and pointer are very easily damaged. In many cases the meter full scale deflection current and resistance are marked on the scale towards the bottom. If this information is not given, however, both values may be calculated if an accurately calibrated milliammeter and voltmeter can be borrowed. First connect the unknown meter together with the borrowed milliammeter in series with a variable

the calibrated meter, reconnect the unknown meter in the circuit without altering the resistor setting, and measure the voltage drop across the coil (Fig. 3 (b)). If this voltage drop is divided by the current, the resistance of the coil will be known.

Thermo-coupled ammeters may be used for multi-range meters or other purposes if the thermo-couple is carefully removed from inside the meter. Access may be obtained to the meter movement by removing—usually—three small screws located at the front or rear of the meter casing. Very often these thermo-coupled meters have a basic f.s.d. of about 2.5mA and a coil resistance of 6 to 10 ohms.



Our specialised buying knowledge and reputation ensure a square deal and enables us to

offer the best for your money!

BAND III TV CONVERTER
180 Mc/s—205 Mc/s

Suitable London, Birmingham, Northern, Scottish and Welsh ITA transmissions

Mk. 2 Model. Latest Cascade circuit using ECC84 and EF80 valves giving improved sensitivity (12 db) over standard circuits, built-in power supply a.c. 200-250V. Dimensions only 6½" x 3", ht. 4". Simple and easy to fit—only external plug-in connections. Wired, aligned and tested ready for use. State channel required. Guaranteed. Bargain offer—good results or full refund, only

£3.19.6 Carr. and pkg. 2/6

Band I/Band III changeover switch and B.B.C. aerial socket can now be fitted and wired to the above converter for 8/- extra

R.E.P. MINI-7. Kit of parts for this popular pocket transistor portable, 9½ gns., p. and p. 2/6

CONDENSERS. Mica or S. Mica. All pref. values. 3pF to 680pF, 6d. each. Ceramic types, 2.2pF to 5,000pF, 9d. each. Tubulars, 450V, Hunts and T.C.C. 0.0005, 0.001, 0.005, 0.01 and 0.1, 350V, 9d.; 0.02, 0.05, 0.1, 500V Hunts, T.C.C., 1/-; 0.25 Hunts, 1/6; 0.5 Hunts, 1/9; 0.001 6kV T.C.C., 5/6; 0.001 20kV T.C.C., 9/6

RESISTORS. Pref. values 10 ohms 10 megohms, 20% tol., ½W, 3d.; ¼W, 5d.; 1W, 6d.; 2W, 9d.; 10% tol., ½W, 9d.; 5% tol., ½W, 1/-; 1% h-stab., ½W, 2/-

PRE-SET W/W POTS. TV knurled slotted knob type. 25 ohms to 30,000 ohms, 3/-; 50,000 ohms, 4/-; 50,000 ohms to 2 Megohms (carbon), 3/-

S.T.C. RECTIFIERS. E.H.T. types, K3/25 2kV, 5/-; K3/40 3.2kV, 6/9; K3/45 3.6kV, 7/3; K3/50 4kV, 7/9; K3/100 8kV, 13/6, etc. Mains types: RM1 125V 60mA, 4/9; RM2 125V 100mA, 5/6; RM3 125V 120mA, 7/6; RM4 250V 250mA, 16/-; RM4B type 250V 275mA, 17/6, etc.

LOUDSPEAKERS. P.M. 3 ohm, 2½" Elac, 16/6; 3½" Goodmans, 18/6; 5" R. & A., 17/6; 6" Celes., 18/6; 7" x 4" Goodmans, 18/6; 8" Rola, 20/-; 10" R. & A., 25/-

SPEAKER FRET. Expanded bronze anodised metal: 8" x 8", 2/3; 12" x 8", 3/-; 12" x 12", 4/3; 12" x 16", 6/-; 24" x 12", 8/6, etc. **TYGAN FRET** (Murphy pattern): 12" x 12", 2/-; 12" x 18", 3/-; 12" x 24", 4/-, etc.

RECORD PLAYER CABINETS

Contemporary style rexine covered cabinet in two-tone grey and green. Size 18½" x 13½" x ht. 8½", fitted with all accessories, including speaker baffle board and plastic fret. Space available for all modern amplifiers and auto-changers, etc. Uncut record player mounting board 14" x 13". Cut mounting boards available.

Cabinet Price £3.3.0 Carr. and ins. 3/6

2-VALVE AMPLIFIER Mk. 1. 200/250V a.c. modern circuit with high gain EL84 output and double wound mains transformer, variable tone and volume controls, wired and tested with 6" speaker and o/p trans., complete with knobs and drilled ready to fit baffle-board in above cabinet. Only £3.12.6. Carr. and pack. 2/6

2-VALVE AMPLIFIER Mk. 2. 200/250V a.c. Specification as above but a higher fidelity and greater output (approx. 3 watts) is obtained by using latest twin stage triode-pentode valve ECL82 and negative feedback tone control. Complete, wired and tested as above, £3.19.6, carr. and pack, 2/6

We can only show a small selection from our vast stocks in this advert. Write now for full Bargain Lists, 3d.



RADIO COMPONENT SPECIALISTS

70 Brigstock Road Thornton Heath Surrey

Telephone THO 2188

Terms: C.W.O. or C.O.D. Post and packing up to ½lb 7d., 1lb 1/1, 3lb 1/6, 5lb 2/-, 10lb 2/9

RECORD PLAYER BARGAINS

SINGLE PLAYERS. 4-speed BSR (latest model, TU9), 92/6; 4-speed COLLARO JUNIOR, £4.10.0 4-speed GARRARD (4 S.P.), £7.15.0, carr & ins. 3/6

AUTO CHANGERS. 4-speed BSR (UA8), £8.10.0; 4-speed COLLARO, £8.15.0; 4-speed GARRARD /RC120/4H/2, £10.5.0, carr. and ins., 4/6. All above models brand new and guaranteed. Fitted latest style lightweight Xtal P.U. with turnover head and twin sapphire styl

VOLUME CONTROLS

Log. ratios, 10,000 ohms—2 Megohms. Long spindles, 1 year guarantee. Midget Ediswan type.

No Sw. D.P.Sw.
3/- 4/9

Linear Ratio, 10,000 ohms —2 Megohms. Less switch, 3/- each. Coax Plugs, 1/2. Coax Couplers, 1/-. Couplers, 1/3. Outlet Boxes, 4/6

80 ohm cable COAX

STANDARD ¼" diam. Polythene insulated. Grade 'A' only. 8d. yd.

Special. Semi-air spaced polythene. 80 ohm. Coax ¼" diam. Stranded core. Losses cut 50%. Ideal Band III, 9d. yd

C.R.T. HEATER ISOLATION TRANSFORMERS. New improved types—mains prim. 200/250V tapped. All isolation transformers now supplied with alternative no boost, plus 25%, and plus 50% boost taps at no extra cost. 2V 2A type, 12/6; 6.3V 0.6A type, 12/6; 10.5V 0.3A type, 12/6; 13V 0.3A type, 12/6 P. and p. 1/6 Other voltages in course of production. Small size and tag terminated for easy fitting

L.F. CHOKES—10H 65mA, 5/-; 15H 100mA, 10/6; 10H, 120mA, 10/6; 20H 150mA, 15/6

OUTPUT TRANSF.—Standard pentode, 4/6; push-pull 12 watt, 13/6. Small pentode, 3/9. Midget battery pentode (15A, etc.), 4/6

ELECTROLYTICS—ALL TYPES—NEW STOCK

Tubular—Wire Ends	Can Types, Clips 3D each
25/25V, 50/12V	1/9 8+8/450V T.C.C. 4/6
50/50V, 4/500V	2/- 8+16/450V Hunts 5/6
100/25V, 2/450V	2/- 16+16/450V T.C.C. 5/6
8/450V B.E.C.	2/3 32/350V 4/-
8/500V Dub.	2/9 32+32/275V Hunts 4/6
8+8/500V DUB.	4/6 32+32/450V T.C.C. 6/6
8+16/450V T.C.C.	5/- 250/350V B.E.C. 8/6
16/450V B.E.C.	3/6 100+200/275V 12/6

MIDGET TRANSISTOR TYPES. 2½F, 4½F, 8½F 6V, 3/6; 6½F, 10½F, 16½F 3V, 3/6; 32½F 1½V, 3/6

8" P.M. SPEAKER (3 ohms)
Ex. Mfrs.' Units: Rola, W.B., Celestion, etc. All reconditioned and guaranteed. Ideal ext. unit. Bargain, 7/6, carr. 1/6

VALVES—NEW BOXED—ALL GUARANTEED

1R5, 1T4, 7/6; 155, 154, 7/6; 354, 3V4, 8/-; 5Z4, 9/6; 6AT6, 8/6; 6K7, 6/6; 6K8, 8/6; 6Q7, 8/6; 6SN7, 8/6; 6V6, 7/6; 6X4, 7/6; 6X5, 7/6; 7C5, 9/-; 7Y4, 8/6; DAF96, 9/-; DPF96, 9/-; DK96, 9/-; DL96, 9/-; 35L6 10/6; EABC80, 9/6; EB91, 6/6; EBC41, 10/6; EVC33, 8/6; ECC84, 12/6; ECH42, 10/6; ECH81, 10/6; ECL80, 10/6; EF41, 10/6; EF80, 10/6; EF86, 12/6; EF91, 8/6; EY51 12/6; E240, 8/6; E280, 8/6; MU14, 9/6; PCC84, 10/6; PCF80, 10/6; PCF82, 10/6; PCL83, 12/6; PL81, 12/6; PL82, 10/6; PL83, 11/6; PY80, 9/6; PY81, 9/6; PY82, 8/6; U22, 8/6; U25, 12/6; UY41, 8/6

SPECIAL—1R5, 1T4, 155, 154 or 354 or 3V4 per set 27/6

Hours 9 a.m.—6 p.m., 1 p.m. Wed.

1T4	8/9	12K7	8/9	EF42	8/9	RL37	1/9
4D1	6/9	12Y4	8/9	EF50	2/9	SP41	4/9
5Y3	8/9	35Z4	8/9	EF50 red	5/9	SP61	6/9
6AM5	3/9	35L6	8/9	EF80	8/9	T41	10/9
6AM6	7/9	63SPT	2/9	EF85	8/9	UJ2	10/9
6B7	1/9	77	3/9	EF91	1	UF41	8/9
6B8G	3/9	21OVPT	5/9	EF92	3/9	UU6	7/9
6F12	7/9	7193	3/9	EL84	10/9	UJ2	8/9
6F14	8/9	AR6(2V)	1/9	EL91	3/9	YR65	6/9
6H6M	1/9	ARP35	3/9	EZ40	8/9	VT52	6/9
6J5M	2/9	CV1083	3/9	EZ80	8/9	VT501	6/9
6K7M	3/9	CV188	3/9	FW4/500		VW48	9d.
6SJ7M	8/9	D1	1/9		10/9	TT11	6/9
6V6M	8/9	DH76	8/9	KTW61	5/9	W76	8/9
6P28	12/6	DK96	8/9	L410	1/9	W81	3/9
6SA7M	3/9	DF66	5/9	NR41	3/9	Z77	7/9
6SG7	3/9	EAS0	1/9	PEN45	6/9		
6SG7M	2/9	EABC80	9/6	PEN46	6/9	UX Types	
8D2	3/9	EAF42	8/9	PEN220	3/9	18	3/9
8D3	7/9	EB34	1/9	PEN220A3/9		42	3/9
8D7	8/9	EBC33	6/9	PL82	8/9	78	3/9
9D2	6/9	ECC81	8/9	PL83	8/9	25RE	3/9
12A6	8/9	ECH42	8/9	PP225	3/9		
12AT7	8/9	EF37	4/9	PY81	8/9	Barrettor	
12BE6	6/9	EF39	3/9	P61	6/9	301	3/9

TV Aerials, 25/6. For all I.T.A. channels. Outdoor or loft. 3 elements. Half normal cost. P. & p. 2/6

Aerials, 3d. each. Copper plated steel. Interlock to any length (12" long each). P. & p. on 1 doz. 1/6

Gang Condensers, 1/9. 2 and 3-gang, salvage guar. 0.0005 μ F. Tested and guar. P. & p. 1/3

I.F. Transformers, 1/- pair. 465 kc/s. Tested and guar. P. & p. 1/-

Phillips Conical Trimmers, 6d. each. 5/- doz. 5-50pF. The world's finest trimmer. Unused. Post 4d. 1/- on 1 doz.

TV Slider Controls, 9d. 10k Ω , 2k Ω , only wirewound. Post 6d. 4 for 2/6. Post 6d

8" P.M. Speakers, 8/9. Ideal gift. If fitted in small cabinet. "Treat the lady at home." Fit one in kitchen or cupboard door. Post 2/9 with o/p trans. fitted, 10/-.

Rectifiers, 2/9. 250 volt, 100mA. Full or half-wave. Salvage guar. P. & p. 1/3

Ion Traps, 5/-. For all and any type of tube requiring a trap. Post FREE

Resistors, 6d. doz. 270 ohms, $\frac{1}{2}$ W ceramic. Post on 1 doz. 6d., on 4 doz. 1/-, on 10 doz. 2/6

Insulating Tape, 1/6. 75ft x $\frac{1}{2}$ " wide. Post on 1 tin 9d. Post on 6 tins, only 2/-

Solder Reels, 1/6. On plastic spools. 60-40 3-core Ersin. 20ft. List price 5/-, Post 6d.

O/P Transformers, 1/3. Salvage guar. 2-5 ohms, matching pentode or tetrode. O/P valve. Post 1/9. 20 for £1, post on 20. 5/6

Headphones, 1/9. Single earphone and band. C-LR type. Grand bargain. Ideal crystal sets. Ext. on radio or t.v. Post 1/6

Coax Cable, 6d. yd. Cut to any length. Good quality. Post on 20 yds 1/6. 45/- per 100 yds, post 3/6

Droppers, 9d. each. 750 ohms, 2 amp. Post 9d. 5/- per doz. post 2/6

Chassis, 1/- each. 6 or 8-valve latest type midgeat valve design for a.m. or f.m. New. Cadmium plated on s.w.g. steel 12 $\frac{1}{2}$ " x 7 $\frac{1}{2}$ " x 2 $\frac{1}{2}$ ". Post 1/9. 4 for 4/-, post 3/-, 12 for 10/-, carr. 5/-

Allen Scanning Coils, 7/6. Low imp. For 14" or 17" wide angle tubes. Post 1/-

FM Tuner Unit, 7/6. With 2-gang condenser. Takes ECC85 valve (not included). P. & p. 1/-

Volume Controls, 1/9. $\frac{1}{2}$ M Ω . Long spindle. New and boxed. Post 1/6

Relays, 9d. 105F/1479 150 ohms. Break one make two. G.P.O. pattern. Used. All tested. P. & p. 1/-

Condensers, 9d. 32 μ F 450V wkg. Cardboard, new and unused. Post 1/-, 12 for 7/-, post 3/6

R.F. Filter Units, 1/9. G.P.O. specifications. Beautifully made in solid brass case. Fitted with in-out switch. Simply fitted in the aerial. Has two-stage tuning. HURRY! Limited stock. P. & p. 1/3

P. P. COMPONENTS LTD

219 ILFORD LANE ILFORD ESSEX ILF 0295
Send 3d. stamp for FREE catalogue Closed Thursdays

834

The Teletron "COMPANION"

Portable 3-Transistor Receiver
now available with printed
circuit

Circuit diagram with
instructions available
from most advertisers
in this magazine, 9d.
post free

SAM MOZER LTD

283 Hedge Lane London N13

Telephone PALmers Green 1748

Sole Distributor to the Trade

OSMOR

Quality Components

are frequently recommended by "Radio Constructor" for use in their published circuits—a sure tribute to the reputation this company has built up for efficiency.

On page 642 of the April issue is described the "One-for-One" superhet receiver in which circuit Osmor Coils type QAB, QAS, QA9, QO8 and the All-Wave R.F. Cho are specially chosen.

OSMOR RADIO PRODUCTS LIMITED

418 Brighton Road South Croydon Surrey
Telephone Croydon 5148



A Versatile 2-Valve Audio Pre-Amplifier

The very latest in our Radio Reprint series (RR7). This 8-page booklet contains complete constructional details of a Mullard designed audio pre-amplifier. Complete with circuit and main component layout, together with photographic illustrations. The latest Mullard modification data is included.

Price 1/- · Postage 2d.

Published by

DATA PUBLICATIONS LTD 57 Maida Vale · London W9

ARTHURS HAVE IT !

Large Stocks of Valves and C.R.Ts
Full Range of Meters available
Avo, Taylor, Cosmor, Advance, etc.
Particulars on Request

FM Kit of Parts £5, less valves
(Ref. Radio Constructor July 1954)

Amplifier Tape Recorders and
Loudspeakers

Jason FM Tuner Unit £15 17 0

Jason Power Pack £3 10 0

Radios and Television always in stock

VALVE MANUALS

Mullard, 10/6; Brimar No. 6, Osram, Part 1, 5/-;
Osram, Part 2, 10/-

Publications "Lodestar" Tape Recorder 3/6

Goods offered subject to price alteration and being
unsold

Arthurs first
Est. 1919

Proprietors ARTHUR GRAY LTD

NOTE NEW ADDRESS **Gray House**
125 Tottenham Court Road
London WCI

Telephone EUSton 5802/3

The Teletron "COMPANION"

COMPLETE KIT

(as spec.) £4.16.0



(Circuit Diagram
9d post free)

Printed circuit
12/- extra

ELEC-RADIO

172a BLACKSTOCK ROAD HIGHBURY
LONDON N5 Telephone CANonbury 1672
Callers Welcome

5

NEW EDITION

"Basic Mathematics for Radio and Electronics"

by F.M. Colebrook, B.Sc., D.I.C., A.
C.G.I., revised and enlarged by J. W.
Head, M.A. (Cantab), 18/4 by post
available from **MODERN BOOK CO.**,
19 Praed Street, London, W.2.
Immediate delivery.

EDDY'S (NOTTINGHAM) LTD

(DEPT. RC) • 172 ALFRETON ROAD • NOTTINGHAM
Telephone Nottingham 74015

B.S.R. 4-SPEED AUTO-CHANGE UNITS.
Turnover crystal cartridges. 200/250 volts a.c.
Special Price £7.19.6, postage and packing 5/- extra.
SINGLE PIECE THROAT MIKES 1/- each, post,
etc. 6d. Could be used for electrifying musical
instruments.

MIDGET BATTERY ELIMINATORS. To convert
all types Battery Portables to Mains Operation.
57/6 each, plus post and packing, etc. 2/6 extra.
Please state make and model number. Smaller than
h.t. battery alone.

ALL ABOVE ARE NEW AND GUARANTEED

1C5GT	10/6	6BJ6	7/6	10F9	11/6	AZ31	12/11	EF41	9/6	PL33	9/11
1D5	10/6	6F1	13/11	12AH7	7/6	CY31	12/11	EF42	12/6	PL81	16/6
1H5GT	10/6	6F6M	9/6	12K7G	7/6	DAF96	9/6	EF80	8/6	PL82	9/6
1N5GT	10/6	6F13	13/11	12Q7G	7/6	DF96	9/6	EF86	12/6	PL83	9/11
1R5	7/11	6F15	13/11	12SK7	7/6	DK96	9/6	EF89	9/11	PY80	8/3
1S5	7/3	6J5G	2/11	14S7	14/6	DL96	9/6	EF91	6/11	PY81	8/6
1T4	7/3	6K7G	2/11	19AQ5	9/-	DM70	7/11	EL84	9/-	PY82	8/6
3Q5GT	9/6	6K7M	7/6	20P1	17/6	EABC80	8/6	EY86	15/-	TDD4	12/6
3V4	8/6	6K8G	7/11	25A6G	12/11	EB91	5/11	EZ80	8/3	UBF80	9/6
5Z4M	10/11	6L6G	5/11	25Z4G	9/-	EBF80	9/6	GZ32	12/6	UCH42	8/11
6AG5	7/6	6P28	17/6	35A5	10/6	ECC81	8/11	HY90	7/6	UF41	8/-
6AQ5	7/6	6Q7G	8/11	35L6GT	9/11	ECC82	8/11	KT33C	8/6	UL41	9/6
6AL5	5/11	6SK7GT	5/11	35W4	7/6	ECC84	8/11	KT66	13/6	UY41	7/6
6AM6	6/11	6SN7GT	5/11	35Z4	7/6	ECC85	8/11	MU14	8/6		
6AT6	7/6	6U4GT	13/11	954	1/6	ECH35	10/11	PCC84	9/-		
6B8G	2/11	6V6G	5/11	955	3/11	ECH42	9/11	PCF80	12/6		
6BA6	6/6	6X5GT	7/11	AZ1	12/11	EF40	13/11	PEN36C	17/6		

ANY PARCEL insured
against damage in transit for
only 6d. All uninsured
parcels at customer's risk.

**SURPLUS, NEW and
GUARANTEED VALVES**
All tested before despatch

Cash with Order or C.O.D. only

Postage and packing 6d. per
valve extra. Over £3 Free.

S.A.E. with all enquiries

THE MINI-7 Pocket Superhet Radio

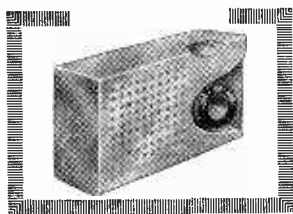

Another winning design from
REPANCO

*Manufacturers of Quality Components
for the Radio Constructor*

REPANCO LIMITED

O'Briens Buildings • 203-269 Foleshill Road
COVENTRY

Price list of specified components for the MINI-7

	£	s.	d.
Repanco group board 17/s and clips	...	5	0
Repanco i.f.t. type XT6—2 off at 10/-	...	1	0
Repanco i.f.t. type XT7	...	10	0
Repanco oscillator coil type XO8	...	5	0
Repanco transformer TT9	...	12	6
Repanco transformer TT10	...	12	6
Repanco ferrite slab aerial F53	...	7	6
Repanco plastic case and knobs	...	16	0
Sundries kit	...	2	0
J.B. gang type 00	...	9	6
10kΩ miniature pot with s.p. switch	...	5	0
Resistor kit	...	8	6
Condenser kit	...	1	2
Trimmer block	...	2	0
Crystal diode	...	1	6
Three White Spot transistors at 20/- each	...	3	0
Four Red Spot transistors at 10/- each	...	2	0
Rola 2½" speaker	...	1	8
Two Vidor batteries at 10d. each	...	1	8

All components available from

RADIO EXPERIMENTAL PRODUCTS LTD
33 MUCH PARK STREET • COVENTRY

Radio Control Mechanisms

by
RAYMOND F. STOCK

A new publication—and the first devoted entirely to the subject of radio control linkage mechanisms. Complementary to *Radio Control for Model Ships, Boats and Aircraft* and to other books on radio control.

64 PAGES ART BOARD COVER
170 ILLUSTRATIONS

First Edition . . . 4/6 plus 4d. postage

DATA PUBLICATIONS LTD
57 MAIDA VALE LONDON W9



PRECISION - BUILT COMPONENTS

JACKSON

'O' GANG CONDENSER

Miniature model in 1 or 2 gang, capacities up to 365pF swing, front area $1\frac{1}{4}'' \times 1\frac{1}{4}''$ including sweep of vanes, length 1 gang $1''$, 2 gang $1\frac{1}{4}''$, spindle $\frac{1}{4}''$ dia. x $\frac{3}{8}''$ long. Aluminium vanes, cadmium plated steel chassis
1 gang 7/6
2 gang 11/6

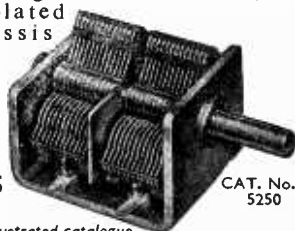

CAT. No. 5250

It's Reliable
if It's Made
By JACKSONS

Please write for illustrated catalogue

JACKSON BROS. (London) Ltd
Kingsway · Waddon · Surrey Phone CR0ydon 2754/5

RADIO AMATEURS . . .

get your Licence in Half The Usual Time!

You must be a good Morse operator!

A "slap-dash" 12 w.p.m. neither satisfies the authorities, yourself nor your operator friends. Morse operating is an exacting art unless your training is made simple and is based on sound fundamentals. For this reason, the Candler System was invented to take the "grind" out of Code tuition, turning a tricky subject into a pleasurable pursuit.

★ Send 3d. stamp for the "Book of Facts"

CANDLER SYSTEM CO.
(Dept. 55 RC) 52b Abingdon Rd., London, W8
Candler System Company, Denver, Colorado, U.S.A.

All Components Available for these Kits

Constructional Details and Price List

R.E.P. 1-Valve	9d.	Hiwayman	1/6
3 Dee	9d.	Transeven	1/6
Mini-7	1/6	FM Tuner	1/6

Add 3d. postage

Red Spot Transistors	9/-
Ajax Crystal Set Kit. Cabinet, Chassis, etc.	14/6
Headphones for above (post paid)	17/6

Let us have your enquiries for all other components

FAIRDEAL RADIO

73 WEST DERBY ROAD LIVERPOOL 6
Telephone ANField 5235

from one source

Denco, Repanco, J.B., T.C.C., Woden, Elac, McMurdo, Radiospares, Eddystone, Elstone, Bulgin, Belling & Lee, Hunts, Sorad, Acos, Brown, Mullard, Igranic, Cossor, Taylor, Avo, Henley, E.M.I., etc.

Orders dealt with day received

56 page illustrated catalogue No. 11, with 108 photographic illustrations, and over 2,000 new guaranteed lines by leading makers. 9d. post free.

SOUTHERN RADIO and ELECTRICAL SUPPLIES

SORAD WORKS · REDLYNCH · SALISBURY · WILTS

the EAVESDROPPER

PRICE 1/6 postage 2d.

A reprint of this MINIATURE TRANSISTOR LOCAL STATION RECEIVER is available, from your local supplier or

Data Publications Ltd
57 MAIDA VALE · LONDON W9

TELETRON Type FX.25

Self-tuned, dual wave
Ferrite rod aerial. 15/- each



Specified for the "Companion" 3 Transistor regenerative pocket receiver.
Type 24 Inductor 3/6 each



TRANSISTOR I.F. TRANSFORMERS

High Q "potted" construction, with Ferrite screw cores. Mounted in screening cans 1" x 3/4" dia., 6/6 each. Oscillator coil, 6/6. Transistor type Ferrite rod aerial for MW band, 10/- . Selective crystal diode coil type HAX, 3/- each. Type HAX.L (for LW band), 3/6. Dual wave TRF coils, type A/HF, matched pair, 7/-, with adjustable Iron dust cores.

FERRITE ROD AERIALS

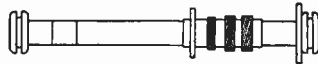

Wound on high permeability Ferroxcube rod. No external aerial required. Full sensitivity. Ideal for battery portable receivers. Medium wave, type FRM 4" x 5/16", 8/9. Dual wave type FRD, 8" x 5/16", 12/9. Miniature R.F. Chokes, wound on iron dust cores, with wire end terminations. 2.5 and 5mH, 3/- each; 10mH, 3/6.

TAPE OSCILLATOR COILS

Type TO.10, TO.10/1, TO.10/2 8/6 each
(as illustrated)
Top Lift Inductor, 200mH,
type TL.2 6/6 each
Bias Rejector Coil, type
BR.10 4/6 each

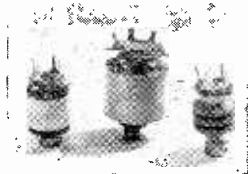

BAND III PRE-AMP COIL SET

(as featured in March issue)
Types 20T, 21T and 22T 9/- per set

Send 5d. in stamps for complete data and circuits. All types available from advertisers in this Magazine and local component stockists

THE TELETRON COMPANY LIMITED

266 Nightingale Road . London N9

Telephone HOW 2527

Trade enquiries to sole distributor

S. Mozer Ltd 288 Hedge Lane N13 Telephone PAL 1748 or EDM 7707

PREMIER RADIO COMPANY

B. H. MORRIS & CO. (RADIO) LTD

(Dept. R.C.I) 207 EDGWARE ROAD LONDON W2

Telephone
AMB 4033
PAD 3271

Open till
6 p.m. Saturday

Build the New "MAYFAIR" Televisor

which gives complete SAFETY to the constructor!

These Televisors use a double wound mains transformer which gives you complete safety from contact with the mains supply when handling the chassis or controls.

★ **B.B.C. & I.T.A. DESIGN** ★
WITH NEW TURRET TUNER

MAY BE BUILT FOR **£33.7.11** PLUS COST OF C.R.T.

Build in 5 easy stages. Full construction details available. Instruction Book 3/6 post free

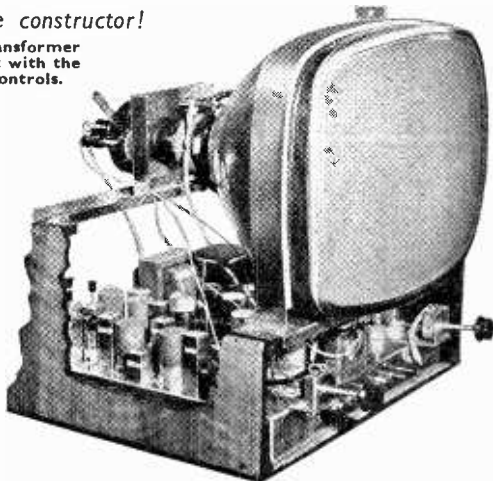

VISIT our New
Hi-Fi Showroom at
23 TOTTENHAM COURT RD

The best Hi-Fi Showroom in the district

Telephone MUSEum 3451

CONSTRUCTORS CORNER

PERSONAL PORTABLE RADIO

Ideal for the holiday, hiking, fishing, camping, cycling, etc. Use it at home, at the office, in bed, or just anywhere.



30/-

TRANSISTOR COMPONENTS

Miniature A.F. Transformers, specially designed for coupling transistor output stages, fully coded, 7/6 each.
Transistors, Red spot, 100% tested, 10/- each
Crystal Diodes, 100% tested, 2/6 each
Miniature Condenser, variable, single-hole fixing, 0.0004μF, 4/- each

ALL-WAVE RADIO



30/-

This 1 valve S.W. receiver can be built for 30/- from our list of components, which can be purchased separately. It includes valve and 1 coil covering 24-40 metres. Provision is made to increase to 2 or 3 valves if required, and all components are colour-coded so that the beginner can build this set quite easily.

Headphones, 1,000 ohms impedance, specially designed for above receivers, 14/- Per Pair

Power Unit type PU1. Input 250V a.c.; output 120V at 20mA, 6.3V at 1.5A. Ideal for small receivers, test equipment, etc. Kit of Parts 32/6
Built and tested £2 each

All components for the receivers advertised are sold separately. Full construction data, point-to-point wiring diagrams, parts lists, etc., are available at 2/- for each receiver.

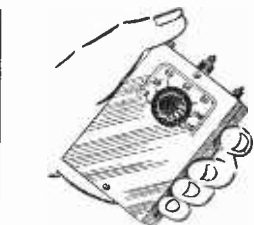

Transistor Pocket Radio, low cost and ideal for the beginner. Using the Varilooptstick aerial (see below) and miniature condenser, the whole Medium Wave is covered. Fits the palm of the hand. 30/-

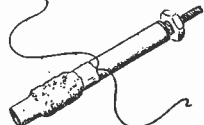

Varilooptstick, specially designed for maximum transistor receiver performance, high 'Q' 4/6

Postage: Under 10/-, 9d. Under 40/-, 1/6. Over 40/-, post free

R.C.S. PRODUCTS (RADIO) LTD

11 OLIVER ROAD (Mail order only) LONDON E17

Build your own 5 Transistor POCKET RADIO (Size 5½ x 3½ x 1½)

using a PRINTED CIRCUIT

for as little as **£9.18.0** Medium wave
or **£10.6.6** Medium and Long wave

Send for **FREE** price list (all parts sold separately) and/or **3/-** for instruction booklet with suggested circuits and assembly details.

OUR CIRCUITS OFFER

**HIGH SENSITIVITY
HIGH SELECTIVITY**

using:—

- 3 RF Transistors **1 gn.** each
- 2 LF Transistors **10/-** each

all specially selected to give
HIGH OVERALL GAIN with AVC

- Miniature Loudspeakers only **27/6**
1½" deep x 2½" diam.
- Miniature oscillator and I.F. coils **8/-**
1½" high ½" diam.
- Jackson 00 twin gang tuning condenser with intersection screen **10/6**
- Attractive High Impact Polystyrene Cabinet with fittings for tuner, trimmers, speaker and circuit board **8/6**

MANY OTHER SUB-MINIATURE COMPONENTS AVAILABLE

SPECIALISED ELECTRONIC COMPONENTS 9-11 MONMOUTH ST · LONDON · WC2





Mail Orders only

'Q' - Fidelity FM

Reliable FM Tuners of High Performance for Hi-Fi amplifiers or as add-on units for existing radios or radiograms. Fullest information supplied

Model 1. The "Mini-Magic." Economy is the watchword of this clever unit which is achieved without sacrifice of performance or reliability. Complete Kit **£4.10.0**

Model 2. Simple switch-tuning with automatic frequency control. A high-quality, stable and completely drift-free unit. Kit (less valves) **£7.5.0**. Size 4½" x 4½" x 5½"

<p>High "Q" Coils</p>  <p>4/- EACH Iron dust cores. Clip in fixing. EXTREMELY SMALL AMAZING EFFICIENCY For Superhet T.R.F. or Transistor operation.</p>	<p>All coils for Collaro Tape Transistor pre-amp.</p>  <p>BIAS OSC. Type QT9 Coil 7/6</p>	<p>STATION SEPARATOR HOME - LIGHT - THIRD - ETC.</p>  <p>10/6 Not a guaranteed cure but — A positive answer to selectivity problem.</p>	<p>Self-adjusting tunable BAND I/III TV Equaliser</p>  <p>10/- easily fitted</p>	<p>I.T.A. Converter To fit inside T.V. complete</p>  <p>£4.65/- KIT Very efficient. Can be built in an evening. State Channels</p>
--	--	--	---	---

OSMOR COILS FREE!
ARE BEST FOR
Selectivity & Performance



Send 1/- (stamps) for fully descriptive literature including OSMOR DESIGNS— 5-valve Superhet, Miniature ditto, Battery and Battery/Mains Receiver, Mains T.R.F. Superhet and T.R.F. Feeders. Band III Converters, Wiring Diagrams, Chassis Templates, Coils and Coilpack information, Transistor Circuit and price lists and information on circuits in *Wireless World*, *Practical Wireless*, *The Radio Constructor*. Please state your particular interest.

(Dept. RC23) 418 BRIGHTON ROAD Telephone CROYdon 5148/9
SOUTH CROYDON · SURREY

TERMS AVAILABLE

17" TV CHASSIS, TUBE & SPEAKER — £19.19.6

Latest improved circuits. Higher E.H.T. (brilliant picture), improved sensitivity (for greater range). Chassis easily fitted into any cabinet. 17" rectangular tube on adapted chassis. Less valves. 12 months guarantee on tube, 3 months guarantee on valves and chassis. With valves £25.19.6. Valve line-up: 6SN7G, 6V6, EY51, 6D2's, EL38, EL41 and 7-6F1's. Turret tuner 50/- extra. State B.B.C. and I.T.A. channel required. Extra channel supplied at 7/6 each. Ins. carr. (inc. tube) 25/-

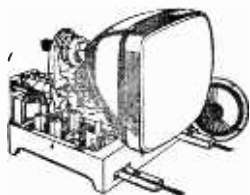

14" TV CHASSIS, TUBE AND SPEAKER — £13.19.6

As above with 14" round tube. Less valves. 3 months guarantee. With valves £19.19.6. Turret tuner 50/- extra. Ins. carr. 25/-

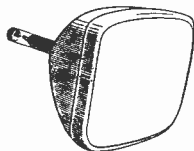

RECTANGULAR TV TUBES

17" £7.10.0

12 Months Guarantee

14" £5.10.0

6 months full replacement, 6 months progressive. Made possible by the high quality of our tubes. Ins. carr. 15/6. Convert your 9", 10", 12" tubes to 14", 15", 16" (round tubes). Our special offer of these sizes £5. Full instructions in our FREE CATALOGUE. 12" TV Tubes £6. 3 months guarantee on round tubes. Ins. carr. 15/6 on all tubes

End of Season SALE

(REDUCED TO CLEAR)

BOXED VALVES 3 MONTHS GUARANTEE

4D1	2/9	15D2	6/9	ECC81	8/9	EF92	3/9
6B8	3/9	45-1U	10/9	ECH42	8/9	EL91	3/9
6F12	5/9	77	1/9	EF37	4/9	KTW61	5/9
6H6M	1/9	2C22	2/9	EF39	3/9	PEN45	6/9
6P28	10/9	CV188	1/9	EF36	5/9	RL37	1/9
6SG7	3/9	6J5	2/9	EF50	2/9	SP61	2/9
8D2	3/9	DF66	5/9	EF91	7/9	T41	8/9
12BE6	6/9	EB34	1/9	Z77	7/9	TT11	4/9

American types UX. All at 1/9 each
18, 42, 75, 78

TRANSFORMERS

MAINS POWER TRANS. 350-0-350V, 9/9. 250mA, 6V heater at 5A, 4V at 5A, 4V centre tapped. Drop through type. Primary 200-250V (4½" x 5" x 5"). Post 3/9

MAINS TRANS. 3/9. 350-0-350V, 80mA, 4V. 4V heaters. 200-250V prim. Post 2/3

HEATER TRANS. 3/9. 1-2 ratio Auto-trans, 2V at 1.4A prim., 4V secondary. Post 1/9

MAINS TRANS. 5/9. 280-0-280V 80mA, 6V, 4V heaters. 200-250V prim. Post 2/3

O.P. TRANS. 1/3. Std. size. 2.5 ohms. Post 1/- 20 for £1. Post 5/6



POPULAR RADIO OR RADIOGRAM CHASSIS — 39/9

A.C. or a.c./d.c. 3 w/and and gram. 5 valve superhet. International octal. Ideal table gram, but still giving high quality output. 4 knob control. 8" p.m. speaker 7/9 extra. Set of knobs 2/- extra. Chassis size 15½" x 7½" x 8½". Less valves. Ins. carr. 4/6

SUPER CHASSIS — 99/6

5 valve superhet chassis, including 8" p.m. speaker and valves. Four control knobs (tone, volume, tuning, w/change switch). Four w/and with position for gram. p.u. and extension speaker. A.C. Ins. carr. 5/6

8" P.M. SPEAKER — 8/9

Ideal for kitchen and bedroom extension. Let the lady of the house enjoy that radio or TV programme. Complete with o/p trans. 10/- P. & p 2/9

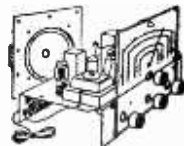

SOUND AND VISION STRIP 10/6. Superhet. Complete vision strip. Less valves. Drawings free. Post and packing 2/6 (not tested)

TIMEBASE 4/9. Complete including scanning coil, focus unit, etc. Less valves. Post and packing 2/6

POWER PACK AND AMPLIFIER 19/6. Output stage 6V6 with o.p. trans. Smoothed h.t. 350V 250mA, 6.3V at 5A, 22V at 3A, 6.3V at 4A centre tapped. Less valves. Free drawings. Carriage 5/6

SOLO SOLDERING TOOL 19/6



110V or 6V (special adaptor for 200/240V 10/- extra). Automatic solder feed. Includes a 20ft reel of ERSIN 60/40 solder and spare parts. It is a tool for electronic soldering or car wiring.

Revolutionary in design. Instantly ready for use and cannot burn. In light metal case with full instructions for use. Post 2/9

CHASSIS 1/- each. 6 or 8 valve. Latest type midget valve design for a.m. or f.m. Brand new cadmium plated. Size: 12½" x 7½" x 2¾". Post-1/9; 4 for 4/-, post 3/-; 12 for 10/-, carr. 5/-

HEADPHONES 1/9. Single earphone and band, C.L.R. type. Ideal for crystal sets, extension on radio, etc. Post 1/3

POWER PACK AND AMPLIFIER 19/6. Output stage PEN45, o.p. trans. choke. Smoothed h.t. 325V at 250mA, 4V at 5A, 6.3V at 5A, 4V at 5A centre tapped. Less valves. Carr. ins. 5/6

TV MASKS

TV MASKS 3/9. 12" new, white rubber. Postage 1/9

TV MASKS 14/9. 17" new, grey, white and halo plastic. Post 2/-

GANGED CONDENSERS 1/9. 2 and 3-gang. Salvaged, tested. P. & p. 1/3

COAX CABLE 6d. yd. Good quality. Cut to any length, 1/6 post on 20 yds. 45/- per 100 yds, post 3/6

Send for FREE 1958 Catalogue

Liverpool St. to Manor Park Stn. 10 min.

OPEN SATURDAY ALL DAY
THURSDAY CLOSED 1 p.m.

DUKE & CO (Dept. 1) 621/3 ROMFORD ROAD MANOR PARK E12 Telephone 1LF 6001/3

HENRY'S

(RADIO) LTD

5 Harrow Road Edgware Road
Paddington London W2

Opposite Edgware Road Station

PADddington 1008/9

OPEN MONDAY to SAT. 9-6 THURS. 1 o'clock

HUNDREDS OF BARGAINS AVAILABLE IN
TRANSISTOR COMPONENTS, VALVES, ETC.
TELETRON and REPANCO Products in Stock
SEND 6d. for 28-PAGE CATALOGUE

TRANSISTORS

JUNCTION TYPE P-N-P

RED-SPOT 800 kc/s Audio Frequency	... 7/6
WHITE-SPOT 2.5 Mc/s R.F. and I.F. Amp.	15/-
RED/YELLOW 1.5-8 Mc/s, R.F. and I.F.	... 21/-
XC101 matched pairs 60/- pr., XB102 audio. amp. 21/-, XA102 8 Mc/s osc/mixer	... 40/-

TRANSISTOR BASES 9d. each

TRIPLETT AC/DC POCKET TEST-METER
Type 666H—15 ranges, 1000 ohm p. volt, a.c./d.c.
10/50/250/1000/5000V, Milliamps 0-10/100/500, Ohms
0-300/250,000, £5.10.0 in new condition with prods
and internal battery



U.S.A. TESTMETER
Type "834-S"

AC/DC 15 Ranges
AC/DC Volts 12/60/
300/600/1200/6000
Milliamps 1.2/12/60/
600
Ohms 0-5,000/5 meg.
F.S.D. 1,000 o.p.v.
£6.19.6
Including Batteries

TRANSISTOR SQUARE WAVE GENERATOR
Complete Kit with 2 Transistors, components, circuit
and plastic case 20/-



MINI-TWO

2-TRANSISTOR MINIATURE POCKET RADIO
The smallest transistor set offered on the market.
Variable tuning. Drilled chassis, plastic case size 3" x
2" x 3/4", miniature hearing aid, 2 transistors and all
components including 1 1/2 volt battery, circuits and full
practical layout diagrams.

Total cost 47/6 complete

SPUTNIK-SPECIAL

SHORT-WAVE RECEIVER 10-60 MC/S (5-30
Metres) RECEPTION SET TYPE 208



Complete with 6 valves, 2 6K8G, 2 EF39, 6Q7G and
6V6G. Internal mains power pack and 6V vibrator
pack. Built-in 6 1/2" speaker. Muirhead slow-motion
drive. B.F.O. and R.F. stage. I.F. freq. 2 Mc/s.
Provision for phones and muting and 600 ohms.
Input 110/250V a.c. 6V vibra pack included for
battery operation. All sets in new condition and
air tested.

£6.19.6. Carr. 15/6

"EAVESDROPPER"

THREE-TRANSISTOR POCKET RADIO

(No Aerial or Earth required)

Medium wave, Variable
tuning. Total cost, as
specified, including
Transistors, Transform-
ers, Coils, Conden-
sers and Battery, etc.,
with circuit and plastic
case. All items sold
separately 70/- POST
FREE. With single
phone 73/6. With Acos
Mike, 82/6. With Min.
Hearing Aid, 86/-



Min. High Impedance Hearing Aid with ear pip 12/6
Standard Cord for above 3/6
2 1/2 ft Cord fitted with min. Jack Plug and including
Socket 12/6
The above may be used with any of our miniature
transistor portables

TRANSISTOR SIGNAL TRACER

Complete Kit with 2 Transistors, components, phones,
with circuit and plastic case 37/6

"HOMELIGHT" TWO TRANSISTOR PERSONAL PORTABLE

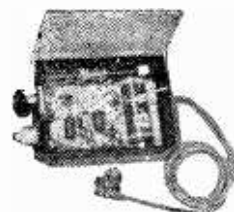

Variable tuning. We can
supply all components,
including two transistors,
diode, resistors, conden-
sers and miniature hear-
ing aid and plastic case,
size 4 1/2" x 2 3/4" x 1 3/8" and
3V battery for 50/-
Practical layout

All items sold separately

"HOMELIGHT III"

As above, but with extra transistor stage, increasing
output, complete with 3 transistors, etc. 58/6

The "TRANSISTOR - 8"

Push-Pull Portable Superhet

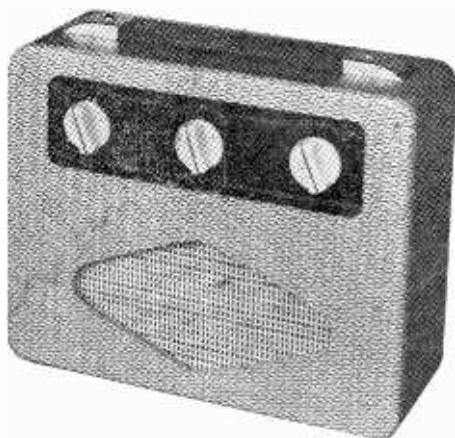

COMBINED CAR RADIO & PORTABLE

TWO SETS FOR PRICE OF ONE

TEN STAR FEATURES

- ★ 8 specially selected Transistors
- ★ 250 Milliwatts output push-pull
- ★ Medium and Long Waves
- ★ Internal Ferrite Rod Aerial
- ★ Highly sensitive
- ★ Drilled Chassis $8\frac{1}{2}'' \times 2\frac{1}{2}''$
- ★ Point to point wiring and practical layout
- ★ Economical. Powered by $7\frac{1}{2}V$ battery
- ★ Ideal as a car radio
- ★ Attractive lightweight contemporary case

Send stamps for Instruction Booklet

All components as specified can be supplied at an inclusive price of

£11.10.0 p.p. 2/6

Car radio conversion components 8/- extra

This Portable 8-Transistor Superhet is tunable for both Medium and Long Waves and is comparable in performance to any equivalent Commercial Transistor Set. Simplified construction enables this set to be built easily and quickly into an attractive lightweight cabinet supplied.

N.B.—Pair of XC101's for larger output supplied at additional cost of 40/- Call and hear demonstration model

MINI-7 POCKET TRANSISTOR PORTABLE

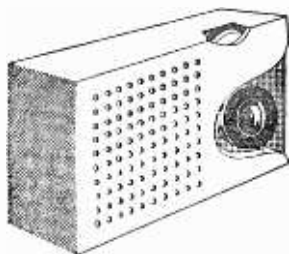

Size $5\frac{1}{8}'' \times 3\frac{1}{8}'' \times 1\frac{1}{8}''$

SPECIAL FEATURES

- ★ 7 selected transistors
- ★ Internal ferrite aerial
- ★ Operates from 6V battery
- ★ Practical layout
- ★ Drilled chassis
- ★ Long wave 10/6 extra
- ★ Attractive plastic case

ULTRA SENSITIVE!
ECONOMICAL!
HIGHLY SELECTIVE!

May be Built for **£9.19.6**

THIS SUPERHET IS SUPERIOR IN PERFORMANCE TO MOST COMMERCIAL TRANSISTOR SETS AND COSTS LESS THAN HALF THE PRICE

All components as specified can be supplied at an inclusive cost of **£9.19.6** p.p. 2/6

Send 1/6 for Instruction Booklet and Prices

• WELL RECOMMENDED •

HENRY'S RADIO LTD • 5 HARROW ROAD • LONDON W2

Telephone PADdington 1008/9

FULL DISCOUNTS ON TRANSISTORS AND COMPONENTS TO THE TRADE

CLEARANCE SALE

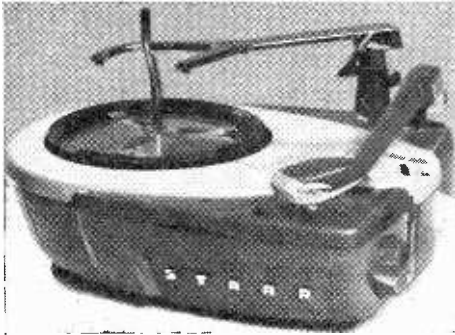

4 SPEED STEAR GALAXY

RECORD PLAYERS as illustrated. Acos GP65 sapphire turnover pick-ups Plays 10 records of any size or speed through your radio. 200/250 volts a.c. **£5.15.0** (Post 4/-)

THE BARGAIN OF THE YEAR!

AUTOCHANGERS as above player but less case (Post 4/-) (Listed £12.16.0) **£3.19.6**

SIGNAL GENERATORS. B.S.R. LO50A L.F., 30c/s-18 kc/s, £12.10.0. Marconi TF390G in transit cases, £12.10.0. Marconi TF517F, 150-300 Mc/s, £9. All mains 200/250V.

AMPLIFIERS. Parmeko 200/250V a.c. mains, 10/20W complete EF36, ECC31, 2 EL35, 524, untested, £3.15.0. Quality 5 watt amplifiers 6J5, 6J7, 6V6, 5Z4, Parmeko mains and output trans., £2.19.0. Ardenite 12V street broadcast 10/20W compact, 2 ECC31, 2 6L6, rotary converter, £4.10.0. Ditto 24 volt £3.15.0.

TRANSMITTER/RECEIVERS. U.S.A. Collins TCS12. Transmitters 1625's modulating 1625's, Xtal or manual 1½-14 Mc/s, store soiled, £6.10.0. Receivers to match £4.10.0 or £10 per pair. U.S.A. TBS-9 Transmitters, 808's modulating 808's (about 10 valves), 100-150 Mc/s, £7.10.0. Receivers to match (about 10 valves), £4.10.0

POWER PACKS. 230V a.c. in., 2 separate double smoothed outputs of 375, 550 or 620V at 200/250mA, also 6.3V 5A. Sealed transit cases, 4 5U4G valves, £7.10.0. Less valves, £6.10.0

MAINS TRANSFORMERS. 230V in., 525-0-525V 150mA, 6.3V 5A, 5V 3A, 25/-, Chokes to match, 150mA 6/-.

L.F. CHOKES. 10H, 80mA, 5/-; 5H 250mA, 4/6; 7H 250mA, 6/-

RECTIFIERS. Iron selenium 3½A 12V bridge 9/-, £5 doz. 250V 80mA 5/-; 250V 250mA, 12/6

ION TRAPS, standard type, 4/-

VALVE VOLT METERS. Marconi, standard type. Measures from 0.1 to 150 volts, transit cases, £9

TV CABINETS. 14" table with mask glass, front 7" x 4" speaker fret, attractive, 25/- carr. 4/-

FOCUS MAGNETS, wide angle, with centreing and mounting, 9/6. Ditto double magnet 12/6

CONDENSERS. U.S.A. 0.1µF 350V metal tub., 6/- doz. 16+16, 350V, small Dubilier, 3/-; 100µF 6V, 1/3; 100+200µF, 275V wkg, can, 5/6; 0.001µF, 18kV Visconal, 4/6

FLUTED KNOBS. 2½" instrument, large type for ¼" spindle, 1/- each

COMPLETE PLAYER

Consisting of Galaxy 4-speed changer in quality two-tone case excellent 3 valve amplifier, 7" spkr., beautiful reproduction (worth £20)

13 GUINEAS



COSSOR WOBBLATORS, all wave, £9.10.0

13 CHANNEL CONVERTERS. For T.R.F. or superhet receivers. Famous make. 3-position switch, fine tuner and 9 quick-set trimmers. Give any 3 channels, T.R.F. Band I, superhet Band III. Output direct to aerial socket. Beautiful bakelite case with PCC84, PCF80, £3.15.0

12 VOLT 3-4 AMP RECTIFIERS, 9/6 to £5 doz. **GUARANTEED TV TUBES (Ex Equipment)** 12" (MW31-74, 3/31, etc.), £5.5.0; 14" (MvV36-24, 4/14, etc.), £4.10.0; 17" (MW43-64, 4/15, etc.), £6.10.0; 17" (CRM171 only), £6. (All guaranteed 6 months) (carr. and ins. 12/6)

GERMANIUM CRYSTAL DIODES, famous make. tested, 9d., p. and p. 3d., 8/- doz.

TRANSISTORS. Red Spot (up to 800 kc/s), guaranteed, 7/-; White Spot (up to 2.5 Mc/s) guaranteed, 14/-

GUARANTEED RADIO VALVES, BOXED, 24 HOUR SERVICE

5U4G	6/6	6SN7GT	5/9	EBC33	7/-	EZ40	8/-
5Z4	9/-	6U4GT	12/6	EC52	5/-	EZ80	7/6
6AC7	5/-	6V6G	6/-	ECC31	9/6	HVR2A	5/-
6A8	9/-	6V6GT	6/6	ECC32	9/-	KTRW63	6/-
6AL5	5/6	6V6M	7/-	ECC81	8/-	MU14	9/-
6AM6	7/6	6X4	6/-	ECC82	6/6	P61	2/6
6BA6	6/6	6X5GT	5/6	ECC83	8/6	PCC84	9/-
6BE6	6/6	7B7	7/6	ECC84	10/6	PCC85	11/6
6C4	4/9	7C6	7/6	ECC85	9/-	PCF80	12/6
6C6	4/6	12A7M	8/6	ECC86	12/-	PCF82	11/-
6D6	4/6	12A7	8/-	ECF82	11/-	PEN25	5/-
6H6	2/-	12A07	6/6	ECH42	9/6	PL81	13/6
6J5M	5/-	12AX7	8/6	ECL80	13/6	PL82	9/-
6J5GT	4/6	12K7GT	6/6	EF36	4/-	PL83	10/-
6J5S	3/-	12Q7GT	7/6	EF37	7/-	PY80	8/6
6J7G	5/-	25L6GT	8/6	EF37A	8/-	PY81	8/6
6K7G	4/6	35Z4GT	7/6	EF39	5/-	PY82	8/6
6K7GT	5/6	80	7/6	EF50(B)	3/6	PY83	9/6
6K7M	6/-	83	7/6	EF50(A)	4/9	SP48	9/6
6K8G	7/6	807(BR)	3/9	EF80	8/9	SP41	2/6
6L6G	8/-	807(AM)	5/6	EF85	7/-	SP61	2/6
6L7	6/-	C1	9/6	EF89	9/6	U22	7/6
6SA7M	7/6	C1C	9/6	EF91	7/6	U52	6/6
6SG7M	5/6	EA50	1/3	EF95	8/6	UYH42	9/6
6SJ7M	7/-	EB34	1/6	EL32	4/-	UY41	8/-
6SK7GT	5/-	EB91	5/6	EL91	5/-	VR150/30	6/-

SEND S.A.E. FOR SPECIAL LIST 500 ITEMS

All items less 5% and post free for a dozen or more
Postage 1/- in £1 (1/9 in £1.5 speakers/trans.). Min. 6d.
No C.O.D.

100 TELEVISION SET BARGAINS TO CALLERS AT—

TECHNICAL TRADING CO (M.O.)

350/352 FRATTON ROAD
PORTSMOUTH

SMALL ADVERTISEMENTS

Readers' small advertisements will be accepted at 3d. per word, including address, minimum charge 2/- . Trade advertisements will be accepted at 9d. per word, minimum charge 6/- . If a Box Number is required, an additional charge of 2/- will be made. Terms: Cash with order. All copy must be in hand by the 8th of the month for insertion in the following month's issue. The Publishers cannot be held liable in any way for printing errors or omissions, nor can they accept responsibility for the bona fides of advertisers.

PRIVATE

HI-FI INSTALLATION complete, comprising all-wave radiogram chassis, new four-speed mixer autochanger and loudspeaker cabinet with three speakers and crossover system. £29 the lot, carriage paid.—28 Jewel Road, London, E.17.

FOR SALE 60 valves, including 1.O.'s, B7G, CRT. Most brand new, £5.—Box No. E168.

GOOD GEAR FOR DISPOSAL. ZCI (Mk. 1) outfit complete with special aerial and accessories, £15; Minimitter transmitter complete in cabinet, £50; Webb's VFO in cabinet, internal power supply, covers 80 metre band, £6; G5RV pattern transmitter, 807 PA, CW only on 40 and 80 metres, separate power unit, £25; standard rack holding (a) 20 metre transmitter, (b) 80 metre transmitter (both 2 x KT88 final, crystal controlled), (c) power unit, (d) EL37 modulator to match, complete with power supply, £40. All in good working order, spares and information included. Birmingham area. Collection or delivery by arrangement.—Box No. E166.

MCR1 COMMUNICATIONS RECEIVER, with mains power pack and all coils, complete with headphones. Condition and performance, as new. Money returned if not satisfied, £8.—39 Tonge Park Avenue, Bolton, Lancs.

FOR SALE Allen scanning components, LO30S with fitted EY51, DC300/C, also 6CD6 and 6U4G valves, £3 the lot. All in perfect working order.—Rankin, 4 Arden Grove, Harpenden, Herts.

FOR SALE converted R1155, separate power pack and speaker, £10. Also 9in TV spares.—Hobden, Windymead, Potmans Lane, Bexhill, Sussex.

FOR SALE Mullard type A tape amplifier and power pack, £15 o.n.o. Brenel Mk. II cabinet, £3. Acos microphone, type 33, £2. All as new.—Young, 15 Henry Street, Wisbech, Cambs.

ASPDEN TAPE DECK model 721 with oscillator coil, Lustraphone microphone and transformer, £9 or offers.—Henderson, 8 Piersfield Place, Edinburgh.

FOR SALE, 110 Practical Wireless, 45s.; 25 Practical Television, 10s.; 14 radio books, 20s.; Caxton's Radio and TV Servicing, 40s.; valves, 2s. to 7s. 6d.—J. Orr, 919 Argyle Street, Glasgow C.3.

WANTED first 9 volumes, bound or unbound, of *The Radio Constructor*—must be perfect.—Jerry Twching, Allied Radio, Middle Square, Macroom, Co. Cork.

NEW SURPLUS . . .

1A3	2/6	6L6M	10/6	803	20/-	EL84	9/-
1L4	5/-	6L7M	7/6	808	17/6	EL91	7/-
2A3	8/6	6Q7GT	9/6	830B	15/-	EM80	10/-
2X2	3/6	6SA7M	7/6	866A	12/6	EZ40	8/6
3A4	5/6	6SG7M	7/6	959	5/-	EZ80	8/6
3Q4	8/6	6SH7M	5/-	1616	5/-	HK24G	25/-
3S4	8/6	6SJ7M	7/6	1629	4/-	KT33C	9/6
5763	12/6	6SK7M	6/6	EASO	1/6	PCC84	10/6
5B/254M		6SL7GT	7/6	EABC8010		PCF82	10/6
	21/-	6SN7GT	6/6	EAC91	4/6	PL82	9/6
5Y4G	6/6	6SQ7M	7/6	EAF42	10/6	PL83	10/6
6AC7M	5/-	6X4	6/6	EB34	2/6	PCL83	12/6
6AG5	3/6	6X5GT	7/6	EB91	6/6	PY80	8/-
6AK5	5/-	7B7	9/-	EBC33	7/6	PY81	9/6
6AL5	6/6	7C5	9/-	EBC41	10/6	PY82	9/6
6AM6	7/6	7C6	9/-	EBF80	10/-	PY83	11/6
6AQ5	8/6	7S7	10/-	EBF89	10/-	R19	12/6
6AT6	8/-	7Y4	8/6	ECC82	9/6	SP61	3/-
6AU6	8/6	12A6M	7/6	ECC83	9/6	TT11	4/-
6B8G	4/6	12AT6	8/-	ECC84	11/-	UAF42	10/6
6BA6	8/6	12AT7	9/-	ECC85	10/6	UBC41	10/6
6BE6	7/6	12AU6	9/-	ECC80	12/6	UBF89	10/6
6BH6	7/6	12AU7	8/6	EFC82	11/6	UCC85	10/-
6BJ6	7/6	12BE6	8/6	ECH42	10/6	UCH42	10/6
6BR7	11/6	12CB8M	7/6	ECH81	10/-	UF41	10/6
6C4	5/-	12Q7GT	9/-	ECL82	12/6	UF89	10/6
6C5M	5/6	12K7GT	9/-	EF36	4/-	UL41	10/6
6F6M	5/6	12SC7M	2/6	EF39	5/-	UY41	8/6
6F8G	4/6	12SK7M	7/6	EF41	10/6	UY85	10/6
6G6G	4/6	12SQ7M	8/6	EF50	3/6	UAB80	
6J5GT	5/6	35L6GT	9/6	EF50(S)	5/-		10/6
6J5M	6/-	35Z4GT	8/6	EF55	7/6	VU39	9/6
6J6	4/-	35Z5GT	8/6	EF80	9/-	VR150/30	
6K7G	5/6	42	7/6	EF85	10/-		7/6
6K8G	8/6	50L6GT	9/6	EF89	10/-	VR116	4/-
6K8M	10/6	80	8/6	EF91	7/6	XP70	3/-
6H6M	3/6	446A	10/6	EL32	4/-	V51.5	3/-
6L6G	9/-	801A	7/6	EL41	10/-	Z77	7/6

SPECIAL OFFER

Units of the Famous R107

- Complete Front End**, r.f. mix, osc., 3 bands 1.2-18 Mc/s with large half-moon calibrated dial and slow-motion drive.
- Power Pack** for either 12V d.c. or 100-250V a.c. input. You only need an i.f. strip and output stage to make a first-class Short Wave Receiver. We offer both units brand new and boxed (less valves and vibrator) for only 52/6 the pair, plus 7/6 carriage

Indicator Units BC929. Ideal for 'scope modification. Fitted 3" tube. 3 BP1, 2 6SN7, 2 6H6, 1 6G6, 1 2X2. Dozens of pots, resistors, condensers, etc. Bargain price in good used condition, only 45/- each

Modulator 67. Contains a.c. power pack, input 230V 50 c.p.s., output 350V 120mA (transformer rated 200mA), 6.3V 5A with heavy duty choke. 5Z4, 11 other valves, switches, pots, etc. Brand new, boxed, 39/6 each carr. paid

M.C. Meters. 3½" rd. fl. (2½" dial), 0-30mA, 0-200mA, 0-500mA, 0-2A, 13/6 each; 0-150V a.c. (1mA Basic with Rect.), 22/6; 2½" rd. fl. (2" dial), 0-500µA, 17/6 each; 0-1mA, 21/-, post paid

Midget Mains Transformers (same size as std. spkr. o/p). Input 230/250V, o/p 220V 20mA, 6.3V 0.6A. Ditto but 175V 25mA, both types 11/9 each, post paid

Transmitter/Receivers. Army Type 17 Mk. 2. Complete with h.r. phones, hand mike and valves. 44-61 Mc/s. In good used condition, 29/6 each. Carr. paid. Few only

SPECIAL OFFER

Performance Meters No. 2. Comprising 230V 50 c/s mains trans. 250.0-250V 30mA 6.3V 1½A 5V 2A (60mA h.t. may safely be drawn), 20H choke, 5Z4, Y65 magic eye, 2 EF50, 1 EC52, 1 EASO, dozens of components, all in smart grey louvered case 10" x 9" x 9". Made by Parmeko. Brand new and boxed. Unrepeatable component value at only 27/6 each plus 5/- carriage (U.K. only)

Post 9d. Free over £2.

S.A.E. Enquiries

JOHN ANGLIN

385 CLEETHORPE ROAD GRIMSBY Lincs
Telephone 56315

continued on page 847

HOME RADIO OF MITCHAM

PULLIN MULTI-RANGE

TEST SET Series 100—completely restyled

This is the famous Pullin Series 100, completely restyled with clear-view Diakon plastic wide-angle cover, and a stand permitting use in horizontal, vertical or inclined positions. New printed circuit and rugged construction ensures an exceedingly robust instrument. 21 ranges a.c./d.c., from 100 μ A to 100V. Sensitivity 10,000 Ω /V. Sent by return for 50/- deposit; balance to be paid in 9 monthly instalments of 24/6. Cash price **£12.7.6**. Fully illustrated literature available on request.

REPANCO 1 VALVE ALL-DRY BATTERY SET

Full data and price list of all parts, 1/-. Complete kit for set including valve, 33/6.

W.B. STENTORIAN CABINETS

for speakers and equipment

The range comprises eleven different models, each beautifully made and finished, which can easily be assembled with only a screwdriver. Packed flat in cartons, they are ready for despatch to anywhere in the U.K. Send 3d. stamp for illustrated leaflet

Here's W.B.'s new

HF1016

No other speaker has all these fine features!

- ★ 10" die-cast chassis
- ★ 10 watts handling capacity
- ★ Universal impedance
- ★ 35 c/s bass resonance
- ★ 16,000 gauss magnet
- ★ Patented cambric cone
- ★ 30-15,000 c/s response

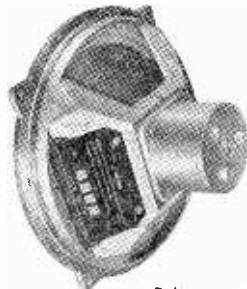

£8. 0. 0.

Delivery now from stock. Details sent on request.

IMPROVE YOUR ITV with the *Radio Constructor* Band III Pre-amplifier. Amazing results. All parts in stock—price list on request.

HOME RADIO

(MITCHAM) LTD

Telephone: Mitcham 3282

187 LONDON ROAD • MITCHAM • SURREY

★ VALVES NEW TESTED AND GUARANTEED ★

1R5	8/-	6SL7GT	8/-	DK91	8/-	EF91	7/-
1S5	7/6	6SN7GT	8/6	DK92	9/-	EF92	5/6
1T4	7/6	6V6G	7/6	DK96	9/-	EK32	8/6
354	7/6	6V6GT	7/6	DL92	7/6	EL41	10/-
3V4	8/-	6X4	7/6	DL94	8/-	EL84	10/6
5U4G	8/6	6X5GT	7/6	DL96	9/-	EL91	7/6
5Z4G	9/6	12A7T	9/-	EA50	1/6	EY51	11/6
6AM6	7/-	12AU7	9/-	EB91	6/6	EZ35	8/-
6AL5	6/6	12AX7	9/-	EBC41	8/-	EZ40	8/-
6AT6	8/-	12K8GT	13/6	EBF80	10/-	KT33C	9/6
6B8G	7/6	12K7GT	8/6	ECC81	10/6	KT66	11/6
6BA6	8/6	12Q7GT	8/6	ECC84	11/6	PCF82	11/-
6BE6	7/6	35Z4GT	8/6	ECC82	11/-	PL82	10/6
6BR7	10/6	35L6GT	9/6	ECH81	10/6	PY81	9/-
6BV6	8/6	53KU	11/6	ECH42	10/-	PCC84	10/6
6J5G	5/6	807	6/6	ECL80	13/6	U76	8/6
6J5GT	6/6	5763	10/6	EF36	7/6	UBC41	10/-
6J7GT	8/6	DAF91	7/6	EF37A	14/6	UCH42	10/-
6K7G	5/6	DAF96	9/-	EF39	5/6	UF41	10/-
6K8G	9/6	DF91	7/6	EF41	10/-	UL41	10/-
6L6G	9/6	DF96	9/-	EF80	9/6	UY41	8/-
6Q7GT	8/6	DH76	8/6	EF85	10/6	W76	8/6

Matched Pairs. EL84, 23/-; 6V6G & GT, 17/-; 6BV6, 18/-; KT33C, 19/6; KT66, 27/6; 807 14/6 pair

1R5, 1T4, 1S5, 354, 3V4, DK91, DK92, DF91, DAF91, DL92, DL94, any 4 27/6 per set

P.P. Op. Transformers. Mr 3-15 ohms for EL84, 6V6, 6BV6, etc., 18/6; Op. Pen. 50mA, 5/6; 30mA, 4/6

Volume Controls. All values, long spindle. L/S 3/-, s.p. 4/-, d.p. 4/9, ext. spkr. control 3/-

W.W. Pots. Pre-set 3/-; 3W long spindle 5/6, s.p. 6/6

P.M. Speakers. 3 ohm. 5" 16/6, 6 1/2" 17/6, 8" 21/-, 10" 25/-, 12" 30/-

Coaxial Cable. 75 ohm 1/2" stranded, 8d. yd; semi-air spaced, 9d. yd; screen cable single and twin, 9d. yd

Coaxial Plugs 1/- each; Sockets 1/- each

★ P. and p. 9d. to £1; 1/6 to £2; over £2 post free. C.O.D. 2/6

R. COOPER P 8BX

32 SOUTH END CROYDON SURREY

CROYDON 9186

C.R.T. Isolation Transformers with 25% boost. Low capacity, a.c. mains 200-240V. For 2V, 4V, 6.3V and 13V tubes. All 12/6 each; 1-1 for H.C. shorts 10/6

Valveholders. 4, 5, 7 pin English and U.S.A. B7G, B9A, 1.0 Mc. B8G, 9d. each; B7G, B9A with screening can, 1/6; B12A, 1/3. Aladdin formers 1/2" with core, 8d. each

Scotch Boy Recording Tape, 1,200ft reels, 27/-
Jack Plugs, miniature standard, 3/-; Sockets 3/-
2-Gang Condensers, .0005 small size, 7/6

I.F. Transformers, 465 kc/s, small size, 7/6 pair
Capacitors, small mica, 5% 1pF to 100pF, 8d.; 120pF to 1,000pF, 9d.; 1,000V wkg. .01, .0015, .0025, .004, .005, 1/- each

Crystal Diodes, G.E.C., 1/6 each

Headphones, lightweight, 4,000 ohm, 16/6 pair

Ceramic Capacitors, close tol. 500V for V.H.F., 9d.

Paper Capacitors, tubular, .01, 1,000V, 1/-; 0.1 to 0.5 500V, 10d.

Paper Blocks, 4 mfd, 1,000V wkg., 3/6

Rectifiers, contact cooled, 250V 50mA, 7/6; 85mA, 9/6

Reaction Condensers, .0001, .0003, .0005, 4/6 each

Heater Trans. 200/240V, 6.3V, 1.5A, 7/6

Resistors, 1/2 and 1/4W, insulated, 4d. and 6d.; 1W, 8d.

6W W.V.V., 1/-; 10W, 2/-

Electrolytics. Wire ends. 25/25V, 1/6; 50/50V, 2/-;

12/50V, 9d.; 8/450V, 2/9; 16/500V, 3/6;

32/450V, 4/-; 8+8/450V, 4/6; 8+16/450V, 4/6; can

types: 16/450V, 3/6; 16+16/500V, 6/-; 32/500V, 6/6;

32/450V, 6/6; 20+20/450V, 4/6; 64+120/275V, 7/6

Wavechange Switches, midget: 1p 12W, 2p 6W,

3p 4W, 4p 3W, 4p 2W, long spindles, 4/6

Toggle Switches. QMB, s.p.s.t., 2/-; s.p.d.t., 3/3;

d.p.s.t., 3/6; d.p.d.t., 4/-

Chokes, 80mA, 15H, 8/6; 100mA 10H, 10/6; 150mA

10H, 14/6

★ **Solder,** Multicore, 4d. yd; Sleeving 2mm, 3d. yd

SMALL ADVERTISEMENTS

continued from page 845

PRIVATE—continued

TRANSISTORS. Pye, B.T.H., 12s. 6d. each. One B.T.H. 9 Mc/s. 30s. Complete 'scope transformer, 20s.—O'Reilly, Abbey School, Fort Augustus, Inverness-shire.

LEAK PICK-UP with LP head and transformer; Quad II pre-amp; Partridge Williamson output transformer; Voigt cone; crossover parts; resistors, condensers and components. Newcastle area.—Box No. E169.

FOR SALE valves, mostly used but guaranteed tested OK, average price 2s. 6d. or assorted 6 for 10s., add postage. Also periodicals, components, meters. Send s.a.e. for list.—Box No. E170.

SHORT WAVE receiver, 2 valves, 95s. Teletron "Companion," 47s. 6d.—6A White Horse Avenue, Halstead, Essex.

METERS 4½in 100-0-100µA, calibrated in micro-amps, round flush mounting, extremely useful meter, 30s. Bailey, 44 Munster Avenue, Hounslow, Middx.

RADIO EQUIPMENT including part completed oscilloscope, valves, £4. Experimenter discontinuing hobby.—30 Ashwood Avenue, Coventry.

FOR SALE *Practical Wireless* 1947 (one missing), 1948, 1953, 1955, 1956 and 1957, all unbound. 1949, 1950, 1951, 1952, bound. *Practical Television* Vols. 1, 2 and 3, bound; 4, 5, 6 and 7, unbound, 7s. per volume or offers. Wanted: Index Vol. 2 *The Radio Constructor*.—T. Woods, 49 Oak Street, Southport, Lancs.

FOR SALE German naval battery receiver, medium/long waves, 1,525-72 kc/s; 5 wavebands, 9 valves, 8 positions selectivity, BFO, xtal, coil turret. Massive job, weighs 50lb approx. Selective and sensitive, OK for MW Dx enthusiast. Bargain at £10. S.E.E. battery-operated xtal calibrator (multi-vibrator) giving 1,000 kc/s, 100 kc/s, 10 kc/s and 1 kc points, £4. S.E.E. frequency meter, 0.97-20 Mc/s, requires slight attention, weighs approx. 50lb, bargain, £6. Complete Baird projection television chassis, good condition, 3 years old, ITV/BBC, £20. Cabinet available.—Box No. E171.

SERVICE SHEETS. Enthusiast disposing of complete range of new radio/t.v. service sheets. State model No. required. 2s. 9d. each, c.w.o.—H. Kates, 23 Meadway Close, Barnet Herts.

TRADE

SERVICE SHEETS. radio and television, for sale and hire, s.a.e. enquiries. Valves and components cheap, list, s.a.e.—J. Palmer (RC), 32 Neasden Lane, London, N.W.10.

DISAPPOINTED WITH TRANSISTOR CIRCUITS? Try Morco reflex circuit (2 transistors)—the best of its kind—loudspeaker results from indoor aerial (some districts no aerial). All parts available for Teletron "Companion" and Repanco "Mini-7" receivers. Send 8d. stamps for notes on transistors.—Morco Experimental Supplies, 8/10 Granville Street, Sheffield 2.

continued on page 848

DALY MINIATURE ELECTROLYTICS



Actual
size H5

Send for descriptive leaflet
giving full details of com-
plete new range

DALY (CONDENSERS) LTD

West Lodge Works, The Green,
Ealing, London, W5.

Telephone: EALing 3127/8/9

REVACUUMED TV TUBES

SIX MONTHS STRAIGHT GUARANTEE

Mullard		Mazda	
14" MW 36-22	£5.10.0	14" CRM 141	£5.10.0
14" MW 36-24	£5.10.0	14" CRM 142	£5.10.0
14" MW 36-44	£5.10.0	14" CRM 143	£5.10.0
14" AW 36-21	£5.10.0	15" CRM 153	£6.10.0
16" MW 41-1	£7. 0.0	17" CRM 171	£7.10.0
17" MW 43-43	£7.10.0	17" CRM 172	£7.10.0
17" MW 43-64	£7.10.0	21" CRM 211	£10.10.0
17" MW 43-69	£7.10.0	21" CRM 212	£10.10.0
21" MW 53-20	£10.10.0		
21" MW 53-80	£10.10.0	Brimar	
		14" C14BM	£5.10.0
		14" C14FM	£5.10.0
Cossor		17" C17BM	£7.10.0
14" 141K	£5.10.0	17" C17FM	£7.10.0
17" 171K	£7.10.0	17" C17JM	£7.10.0
17" 172K	£7.10.0		

14" Marconi, Emitron, Ferranti, G.E.C. £5.10.0
17" Marconi, Emitron, Ferranti, G.E.C. £7.10.0

Carriage and Insurance 12/6 (U.K.) Cash with order
Personal Callers Welcome

VIDIO REPLACEMENT CO

HALES STREET DEPTFORD HIGH STREET
LONDON SE8

Telephone TIDeway 4506

No connection with any firms of a similar name

Forrest

Transistor Transformers
for Quality Equipment

H. W. FORREST (TRANSFORMERS) LTD.
349 Haslucks Green Road Shirley Solihull
Warwickshire Telephone SHirley 2483

GUARANTEED VALVES — Over 3,000 in stock

EF92, EAC91, 616, 6C4, 4/6; 6K7, EC91, 5/6; 6AL5,
6SK7, R10, 3A4, 807, 6/-; 6AM6, EL91, 6X4, 6/6; 6BE6,
6CH6, 6F17, 6F33, 7/6; 12A7, 12AX7, 12AU7, 6BA6,
6BV6, 6E11, 6BR7, 12E1, 85A2, 2D21, 10/-; EF86, 6L6M,
5B/225M, 5B/251M, 11/6

A. A. W. SKILLMAN

79A FRANCHISE STREET WEYMOUTH

BRASS, COPPER, DURAL ALUMINIUM, BRONZE

ROD, BAR, SHEET, TUBE, STRIP, WIRE
3,000 STANDARD STOCK SIZES

No Quantity too Small List on application

H. ROLLET & CO. LTD

6 Chesham Place SW1 Telephone SLOane 3463

Also at Liverpool Birmingham Manchester Leeds

H.A.C. THE ORIGINAL SUPPLIERS OF SHORT-WAVE KITS

One-valve Kit, price 25/-. Two-valve Kit, price 50/-,
improved designs with Denco coils. All kits complete
with all components, accessories and full instructions but
less valves. Before ordering, call and inspect a demonstra-
tion receiver, or send stamped envelope for catalogue.

H.A.C. SHORT-WAVE PRODUCTS (DEPT. R)
11 OLD BOND STREET LONDON W1

HIGH FIDELITY

Quality components of all types always in stock for the
MULLARD 2-VALVE PRE-AMPLIFIER and
MULLARD 3-VALVE 3-WATT AMPLIFIER

Circuits free on request

510 AMPLIFIER FM TUNER	circuits 3/6
912 PLUS AMPLIFIER	" 4/-
912 PLUS FM TUNER	" 2/6
RADIO CONSTRUCTOR FM	" 2/-
MERCURY SWITCHED FM	" 2/-
DENCO FM TUNER	" 1/-

Price list available on request

J. T. FILMER 82 DARTFORD ROAD DARTFORD KENT
Telephone Dartford 4057

BOUND VOLUMES

Vol. 10, August '56 to July '57
inclusive, attractively bound in
blue cloth, with gold blocked
price £1.5.0. post 1/9

PUBLICATIONS LTD
LONDON W9

SMALL ADVERTISEMENTS

continued from page 847

TRADE—continued

MORSE CODE TRAINING. Special course for
Beginners. Full details from (Dept. RC), Candler
System Company, 52 Abingdon Road, London,
W.8.

A.M.I.P.R.E. For details of suitable study courses
(only a limited number of students accepted), send
for free Syllabus of Instructional Text. I.P.R.E.
Conditions of Membership booklet, 1s. *The Prac-
tical Radio Engineer* journal, sample copy, 2s. 3d.
6,000 Alignment Peaks for Superhets, 6s. All post
free from Secretary, I.P.R.E., 20 Fairfield Road,
London, N.8.

ILLUSTRATED CATALOGUE No. 13 containing
over 450 items of Government Surplus and Model
Radio Control Equipment, 2s. 2d. Refunded on
purchase of goods, 2s. 6d. overseas seamount.—Arthur
Sallis Radio Control Ltd., Department R.C., 93
North Road, Brighton. Telephone 25806.

PANL, recognised for many years as the unique one-
coat black crackle finish. Brush applied, no baking.
Available by post in 1/4th pint cans at 3s. 9d. from
G. A. Miller, 255 Nether Street, London, N.3.

LEARN as you do it—we provide practical equipment
combined with instructions in Radio, Television,
Electricity, Mechanics, Chemistry, Photography, etc.
Write for full details to E.M.I. Institutes, Dept.
RC47, London, W.4.

JOIN THE INTERNATIONAL S.W. LEAGUE.
Free Services to members including Q.S.L. Bureau
Translation. Technical and Identification Dept.—
both Broadcast and Fixed Stations, DX Certificates,
contests and activities for the SWL and transmitting
members. Monthly magazine, "MONITOR," con-
taining articles of general interest to Broadcast and
Amateur SWL's, Transmitter page and League
affairs, etc. League supplies such as badges, headed
notepaper and envelopes. QSL cards, etc., are
available at reasonable cost. Send for League
particulars. Membership, including monthly maga-
zine, etc., 15s. per annum.—Secretary, ISWL, 86
Barringer Road, London, N.10.

FREE. Brochure giving details in Home Study Training
in Radio, Television and all branches of Electronics.
Courses for the hobby enthusiast or for those
aiming at the A.M.Brit.I.R.E., City and Guilds,
R.T.E.B., with other Professional examinations.
Train with the college operated by Britain's largest
Electronics organisation. Moderate fees.—Write
to E.M.I. Institutes, Dept. RC28, London, W.4.

SITUATION VACANT

INSTITUTE OF CANCER RESEARCH, Royal
Cancer Hospital, Fulham Road, S.W.3. Senior
Technician or Technician required in Physics
Department. Applicants should be capable of main-
taining and servicing existing electronic equipment
and assisting with design and construction of new
apparatus. Work is on variety of research projects,
initially mainly with 30 MeV synchrotron. Ample
scope to person of enthusiasm and ability seeking
work of non-routine nature in interesting scientific
field. Salary scales—Senior Technician £620 x £20
—£660 x £25—£750. Technician £515 x £20—
£555 x 25—£630, plus London Weighting. Applica-
tions giving names and addresses of three referees
to be sent as soon as possible to the Secretary.

SCOTTISH INSURANCE
CORPORATION LTD



62-63 Cheapside
London EC2

TELEVISION SETS, RECEIVERS AND TRANSMITTERS

Television Sets, Receivers and Short Wave Transmitters are expensive to acquire and you no doubt highly prize your installation. Apart from the value of your Set, you might be held responsible should injury be caused by a fault in the Set, or injury or damage by your Aerial collapsing.

A "Scottish" special policy for Television Sets, Receivers and Short Wave Transmitters provides the following cover:

- (a) Loss or damage to installation (including in the case of Television Sets the Cathode Ray Tube) by Fire, Explosion, Lightning, Theft or Accidental External Means at any private dwelling-house.
- (b) (i) Legal Liability for bodily injury to Third Parties or damage to their property arising out of the breakage or collapse of the Aerial Fittings or Mast, or through any defect in the Set. Indemnity £10,000 any one accident.
- (ii) Damage to your property or that of your landlord arising out of the breakage or collapse of the Aerial Fittings or Mast, but not exceeding £500.

The cost of Cover (a) is 5/- a year for Sets worth £50 or less, and for Sets valued at more than £50 the cost is in proportion. Cover (b) and (ii) costs only 2/6 a year if taken with Cover (a), or 5/- if taken alone.

Why not BE PRUDENT AND INSURE your installation—it is well worth while AT THE VERY LOW COST INVOLVED. If you will complete and return this form to the Corporation's Office at the above address, a proposal will be submitted for completion.

NAME (Block Letters)

If Lady, state Mrs. or Miss

ADDRESS (Block Letters)

JB

YOU CAN RELY ON US



The New AVO MULTIMINOR

A first quality pocket instrument

Sensitivity 10,000Ω/V 0 to 1A in five ranges, 0 to 1,000V in 7 ranges. A.C. volts 0-1,000 in 5 ranges. Resistance 0-2 Meg in two ranges.

PRICE £9.10.0 Leather Case 32/6

or 63/4 Deposit and 6 Payments of 22/2 or 9 monthly payments of 23/3

ALL AVO INSTRUMENTS IN STOCK

COSSOR HI-FI AMPLIFIER KIT

3 valve 3W, Printed Circuit, twin speaker. Beautifully kitted by Cossor Radio and Television Ltd to the last nut and bolt.

COMPLETE KIT
£9.15.0

or 65/- Deposit and 6 monthly Payments of 23/4
or 23/10 Deposit and 8 monthly Payments of 23/10

82 SOUTH EALING ROAD
LONDON W5 Telephone EAL 5737

RADIO SERVICING CO

RADIO



BOOKS

Tape and Wire Recording. A selection of articles reprinted from the pages of *The Radio Constructor*, covering both the theory and practical applications. A really useful book on this latest development of the hobby.

4th Edition, 3/-. Postage 4d

TV Fault Finding. Profusely illustrated with photographs taken from a television screen depicting the faults under discussion, and containing a wealth of technical information, with circuits, enabling those faults to be eradicated.

5/-. Postage 5d

FM Tuner Units for Fringe and Local Area Reception. Including optional Tuning Indicator and circuit of Osram 912 Amplifier.

2/-. Postage 4d

The Argonaut AM/FM MW/VHF Tuner Receivers. Describing the construction, alignment, and other details of a high quality tuner (or complete receiver), together with map of present and projected coverage areas.

2/-. Postage 4d

Radio Amateur Operator's Handbook. An indispensable aid to the amateur transmitter and listener, containing all details of information which are constantly required. Prefix Lists, Zone Boundaries, Call Areas, Codes, and Mileage Tables, together with Maps and much other useful operating data.

1957/8 edition, 3/-. Postage 4d

Mercury Switched Tuned FM Tuner Unit. A stable unit employing automatic frequency control and a *ready built* front end.

2/-. Postage 2d

Radio Control for Model Ships, Boats and Aircraft, by F. C. Judd, G2BCX. A comprehensive work on this fascinating subject.

Standard edition 8/6. Postage 7d

Cloth bound edition 11/6. Postage 8d

The "Eavesdropper." A miniature transistor local station receiver. Complete constructional details of this pocket portable.

1/6. Postage 2d

Radio Control Mechanisms, by RAYMOND F. STOCK. The only book dealing solely with this important part of radio control.

4/6. Postage 4d

All available from your local bookseller, or from

DATA PUBLICATIONS LTD

57 MAIDA VALE LONDON W9

Telegrams Databux London

Telephone CUNningham 6141 (2 lines)

Published in Great Britain by the Proprietors and Publishers

Data Publications Ltd 57 Maida Vale London W9

Printed by A. Quick & Co. (Printers) Ltd. 125 High Holborn London WC1 England also at Clacton-on-Sea
Obtainable abroad through the following Collets Subscription Service Continental Publishers & Distributors Ltd
William Dawson & Sons Ltd Australia and New Zealand Gordon & Gotch Ltd South Africa Central News Agency
Holland "Radio Electronica"
Registered for transmission by Magnetic Post to Canada (including Newfoundland)

www.americanradiohistory.com