

The RADIO CONSTRUCTOR

incorporating The Radio Amateur
for the Radio and Television Enthusiast

The "SIMPLEX TWO" TRANSMITTER

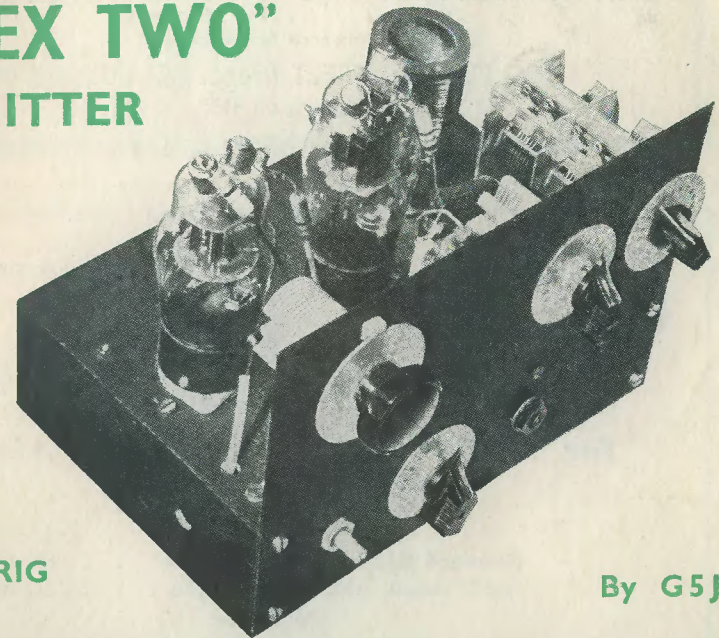

A USEFUL TOP-BAND RIG

By G5JU

ALSO IN THIS ISSUE

- ECONOMY FOUR 8W AMPLIFIER
- THE ORPHEUS TAPE RECORDER, Part 4.
- FRINGE AREA TELEVISION, Part 3.
- THERMISTORS: PROPERTIES & APPLICATIONS.
- BATTERY VALVE "MAINS" SETS.
- Aligning Homebuilt Signal Generators
- Suggested Circuits
- Query Corner
- Let's Get Started
- Useful Storage Rack
- Radio Miscellany, etc.

16

CLYNE RADIO LTD.



18 TOTTENHAM COURT ROAD, LONDON, W.1.

All goods specially selected for quality and value. Prompt service—Money-back guarantee—it will pay you to visit our retail shop premises. Situated 50 yds. only from Tottenham Court Road Tube! (Genuine).

RING MUSEUM 5929/0095
FOR IMMEDIATE ATTENTION
Staff Call Sign:
LIONEL E. HOWES, G3AYA

THE "ECONOMY FOUR" T.R.F. KIT. A three valve plus metal rectifier receiver. A.C. mains 200/250v. Medium and Long waves. We can supply all required components right down to the last nut and bolt. Valve line-up, 6K7, 6J7 and 6V6. Chassis ready drilled—Cabinet size 12in. long, by 6in. high by 5in. deep—Choice of ivory or brown bakelite, or wooden, walnut finish cabinet.

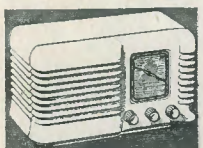

Complete instruction booklet with practical and theoretical diagrams. Each component brand new and tested prior to packing. Our price £5/15/- complete—Remember this set is being demonstrated at our shop premises! We proudly claim that our fully illustrated instruction booklet is the most comprehensive available for this type of receiver—Booklet available at 1/6 post free—This is allowed if kit is purchased later—Please, 2/6 packing and carriage for complete kit. **VALVES.** We have a very comprehensive stock of special purpose surplus valves at competitive prices. A stamp will bring Valve Price List.

BRANDENBURG E.H.T. UNITS. 6-9 kV., 6 gns.; 13-16 kV. 9 gns.; 6-9 kV. Coil, 39/-; 10-15 kV. Coil, 55/-; Wiring diagram supplied.

R.F. UNITS. All new condition and complete. Case size 9 1/2 in. x 7 1/2 in. x 5 in.
Type 24.—20-30 Mc/s, 15/-, Switched Tuning. Type 25.—40-50 Mc/s, 19/6. Switched tuning. Type 27.—65-85 Mc/s, 45/-, Variable Tuning.

We have a limited supply of RF27 new condition and complete, but tuning dial damaged. Price 30/- each only. ALL these units Post Free!

G.E.C. RECORDING TAPE. 1,200ft. on metal spool, at bargain price of 17/6 per spool.

WHIP AERIALS. All copper, 3 sections each of 4ft. Screw-in, 7/6 complete.

THE "SUPERIOR FOUR" KIT
Our new four-valve receiver. A.C. mains. 200/250 v. M. Long Waves. As with our very successful "Economy Four" all required components are supplied. Valve line-up, 6X5GT and 6V6GT. Chassis ready drilled: Cabinet size 10 1/2 in. high x 10 in. wide. Maximum depth at top, tapering to 3 1/2 in. at top of front. Very attractively finished in light walnut and peach. All component brand new and tested prior to packing. Complete instruction booklet with practical and theoretical diagrams is provided. Booklet available at 1/6—post free. Our price for complete kit—£6/9/6!!! Please add 2/6 packing and carriage if preferred, we can supply cabinet and back, Drilled chassis and bracket, pointer drum, drive spindle, drive spring and knobs—plus 2/6 packing and carriage. Our Kits are even supplied with sufficient solder for the job!

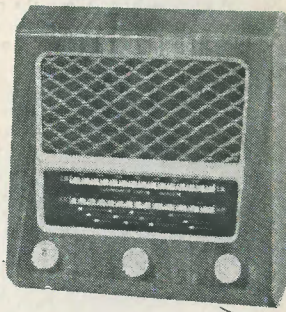

H.T. RECTIFIERS. Type RM1 at 4/6, RM3 at 6/-, RM4 at 9/6, DRM2B at 8/6. Rectifiers Type K3, K3/40 at 7/6, K3/45 at 8/8, K3/100 at 14/6, K3/21/6, and K3/200 at 26/-, New Surplus 300 v. 80 mA, 8/6.

TAPE RECORDER CABS. We can offer a well-constructed cabinet, finished in grey or brown rexine, made specifically to take Truvox or Wearite Tape Decks. Measures 22" x 14" x 9 1/2" deep. Completely portable, shows attractive grille at end, and made to take up to 8" Speaker. Will guarantee satisfaction and will be pleased to refund cash if dissatisfied. Ample room for suitable amplifier. Price 79/6, plus 2/6 packing and carriage. N.B.—We can supply from stock the latest Truvox and Wearite Tape Decks at 22 guineas and £35 respectively. Reduction of 2/- on cabinet if purchased at the same time as either of these tape decks!!

INTRODUCING RECTIFIERS TYPE R.K.T. Newly manufactured range, fully guaranteed for 12 months.
6 or 12v 1AFW. bridge type 7/6
6 or 12v 2AFW. bridge type 11/3
6 or 12v 3AFW. bridge type 12/6
6 or 12v 4AFW. bridge type 15/-
6 or 12v 6AFW. bridge type 23/6
6 or 12v 10AFW. bridge type 37/6

The New R.C. 'UNIVERSAL' AMPLIFIER — A small 3 watt gramophone amplifier for 110-250v. AC/DC operation. Negative feed-back, low hum-level, chassis isolated. Suitable for either crystal or magnetic pick-up, and carbon or moving coil microphone. Two controls: Volume/on/off and variable tone control. Chassis size 8" x 6" x 2 1/2". Only £4/19/6., absolutely complete, plus 5/- packing and carriage.

I.F. TRANSFORMERS. SPECIAL OFFER. All iron-cored 465 Kc/s. By Weymouth. Size 3 1/2 in. x 1 1/2 in. x 1 1/2 in., 8/6, or Philips, size 2 1/2 in. x 1 1/2 in. diameter (cylindrical), 7/6 pair. By Invicta—Cylindrical, 2 1/2 in. x 1 1/2 in. diameter 8/6 pr. Also, our own special ultra-midget, size 1 1/2 in. x 13/16 in. x 13/16 in. Only 9/9 per pair.

RADIO-GRAM CHASSIS 3 Wave-band Superhet. Med., long and short, 5 Latest Type MULLARD Valves. 4 Position Switching Gram., med., long and short. Provision for Extension Speaker. A.C. Mains 110/250 volts. Chassis 11" x 7" x 2 1/2". Scale 8" Square. Or Chassis 13 1/2" x 6 1/2" x 2 1/2". Dial 10" x 5 1/2". PRICE £10/5/- BRAND NEW AND GUARANTEED. CARR. PACKING AND INS. 10/-.

We can also supply and demonstrate any of the "Dulci" well-known Radio-Gram Chassis.
METER RECTIFIERS. 1 mA by G.E.C. at 11/6, also 5 mA. by Westinghouse at 8/6.

Please add postage under £1. C.O.D. or Cash with Order. C.O.D. charge extra. Open 9 a.m.—6 p.m.—Monday to Friday. Sorry, but we close at 1 p.m. on Saturday.



THE MODERN BOOK CO.

BRITAIN'S LARGEST STOCKISTS OF BRITISH & AMERICAN TECHNICAL BOOKS

Basic Electronic Test Instruments.
By R. P. Turner. 32/- Postage 9d.

Electronic Gadgets for the Constructor. By E. N. Bradley. 3s. 6d. Postage 3d.

Tape and Wire Recording, compiled by Radio Constructor & Radio Amateur. 2s. 6d. Postage 2d.

T.V. Fault Finding, compiled by Radio Constructor. 5s. 0d. Postage 4d.

Television Test Equipment. By E. N. Bradley. 5s. 0d. Postage 3d.

Art and Science in Sound Reproduction. By F. H. Brittain. 2s. 6d. Postage 3d.

The Williamson Amplifier. By D. T. N. Williamson. 3s. 6d. Postage 3d.

The Radio Amateur's Handbook, 1954 edn. Compiled by A.R.R.L. 30s. Postage 1s. 3d.

Receivers, Pre-Selectors & Convertors. Compiled by Radio Constructor & Radio Amateur. 2s. 6d. Postage 2d.

UHF Antennas, Convertors and Tuners—UHF I. By M. S. Kiver. 12s. Postage 6d.

A First Course in Wireless. By 'Decibel.' 12s. 6d. Postage 6d.

Elementary Telecommunications Examination Guide. By W. T. Perkins. 17s. 6d. Postage 6d.

R.S.G.B. Amateur Radio Call Book—Winter 1953. 2s. 6d. Postage 3d.

Radio Data Charts. By R. T. Beatty, revised by J. McG. Sowerby. 7s. 6d. Postage 6d.

Write or call for new catalogue

19-23 PRAED STREET (Dept. RC) LONDON W2
PADDington 4185



DATA BOOK SERIES, NO. 9.

RADIO CONTROL

for Model Ships, Boats and Aircraft

BY F. C. JUDD, G2BCX

Standard Edition, art board cover . . . 8s. 6d.

Cloth bound, with gold lettering . . . 11s. 6d.

Postage 3d.

A really comprehensive work on this fascinating subject
144 pages . . . 135 diagrams and illustrations

DATA PUBLICATIONS LTD 57 MAIDA VALE W9

Telephone CUNningham 6518

PUBLICATIONS LIST AND ORDER FORM SENT ON REQUEST



Produced in response to a demand for a high sensitivity version of the world-famous Universal AvoMeter, this model incorporates the traditional design features of its predecessors, so highly valued for simplicity of operation and compact portability. It has a sensitivity of 20,000 ohms per volt on all D.C. voltage ranges and 1,000 ohms per volt on A.C. ranges from 100 V. upwards. A decibel scale is provided for audio frequency tests. In addition, a press button has been incorporated which reverses the direction of current through the moving coil, and thus obviates the inconvenience of changing over test leads when the current direction reverses. It also simplifies the testing of potentials both positive and negative about a common reference point. A wide range of resistance measurements can be made using internal batteries, separate zero adjustment being provided for each range.

It is of importance to note that this model incorporates the "AVO" automatic cut-out for protection against inadvertent overloads.

D.C. VOLTAGE	D.C. CURRENT	A.C. VOLTAGE	A.C. CURRENT	RESISTANCE
2.5 V	50 uA	2.5 V	100 mA	First indication 0.5 Ω Maximum indication 20M Ω 0-2,000 Ω } using internal batteries 0-200,000 Ω } 0-20 M Ω } using external batteries
10 V	250 uA	10 V	1 A	
25 V	1 mA	25 V	2.5 A	
100 V	10 mA	100 V	10 A	
250 V	100 mA	250 V		
1,000 V	1 A	1,000 V		
2,500 V	10 A	2,500 V		

Sizes: 8½ in. x 7½ in. x 4½ in.
Weight: 6½ lbs. (including leads).

£23 : 10s.

THE AUTOMATIC COIL WINDER & ELECTRICAL EQUIPMENT CO. LTD.
WINDER HOUSE · DOUGLAS STREET · LONDON S.W.1 Telephone VICToria 3404-9



Polystyrene Insulation

Polystyrene is a glass clear, transparent, thermoplastic material and should not be confused with such material as celluloid, cellulose acetate, perspex, etc., which are comparatively poor radio insulators.

POLYSTYRENE is stocked in the following forms and sizes:

SHEET: $\frac{1}{8}$ " thick, $1\frac{1}{2}$ d per sq. inch;

$\frac{1}{16}$ " $1\frac{1}{2}$ d; $\frac{1}{8}$ " $2d$; $\frac{3}{16}$ " $3d$;

ROD: $\frac{3}{16}$ " dia., $1/-$ per foot; $\frac{1}{4}$ " dia. $1\frac{1}{2}d$;

$\frac{5}{16}$ " dia. $1/9$; $\frac{3}{8}$ " dia. $2/1$; $\frac{1}{2}$ " dia. $3/9$;

$\frac{5}{8}$ " dia. $4/8$; $\frac{3}{4}$ " dia. $5/11$; $1"$ dia. $15/-$;

TUBE: $\frac{3}{8}$ " O/D x $\frac{1}{4}$ " I/D, $1/5$ per foot.

Denfix Polystyrene Cement

This useful solution consists of clear polystyrene thermoplastic material dissolved in a quick drying solvent. When dry this varnish contains all the properties of pure polystyrene. It is, therefore, very low loss at radio frequencies and can be used for cementing or impregnating coils, etc. BOTTLES: $\frac{1}{2}$ oz, $1/-$; $2oz$, $1/10$; $4oz$, $3/6$; $6oz$, $5/-$; $8oz$, $6/6$.

Send 9d. for General Catalogue giving details of our other components.

DENCO (CLACTON) LTD., 357/9 OLD ROAD, CLACTON-ON-SEA

Blank Chassis in Aluminium or Steel

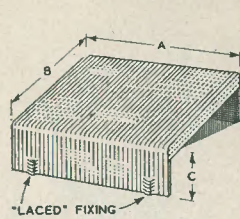

REF.	DIMENSIONS			PRICE	
	A'	B'	C'	ALI	STL.
CH8	7"	4"	2"	6/-	5/-
9	9"	5"	2 1/2"	7/3	6/3
10	10"	6"	2 1/2"	8/-	7/-
11	10"	8"	2 1/2"	8/9	7/9
12	12"	9"	2 1/2"	10/-	9/-
13	14"	9"	2 1/2"	10/6	9/6
14	16"	8"	2 1/2"	11/-	9/6
15	16"	8"	3 1/2"	12/6	10/9
16	20"	9"	2 1/2"	13/-	11/3
17	17"	9"	2 1/2"	12/-	10/3
18	17"	10"	2"	12/-	10/3

This extensive range of Steel Chassis is manufactured from 19 swg Steel and finished in Black Matt Cellulose. The Aluminium Chassis are made from 16 swg material. A feature of both ranges of chassis is the lattice fixing holes which enables the mounting to the cabinet with self tapping or wood screws only, thus saving the constructor a lot of time making brackets and holes, etc., and presenting a much firmer method of fixing.

Good News for Home Constructors and Small Manufacturers

Chassis made to your requirements with a scale of charges that enables you to work out the cost of your prototype. Material is in either 16 swg bright Aluminium or Matt Black 19 swg Steel at 1d per square inch—plus 3d per bend—plus 2d per round hole—plus 2/- per shaped hole—plus 1/- postage.

NEW!

EXPERIMENTAL OUTFITS

LEARN THE PRACTICAL WAY

Specially prepared sets of radio parts (which you receive upon enrolment) with which we teach you, in your own home, the working of fundamental electronic circuits and bring you easily to the point when you can construct and service radio sets. Whether you are a student for an examination; starting a new hobby; intent upon a career in industry; or running your own business—these Practical Courses are intended for YOU—and may be yours at very moderate cost.

EASY TERMS FROM £1 A MONTH

A tutor is available to give individual help and guidance throughout the Course.

POST THIS COUPON TODAY

Please send me your FREE book on Practical Courses :

To : E.M.I. INSTITUTES, Dept. 179X, 43, Grove Park Road, Chiswick, London, W.4.

NAME _____

ADDRESS _____

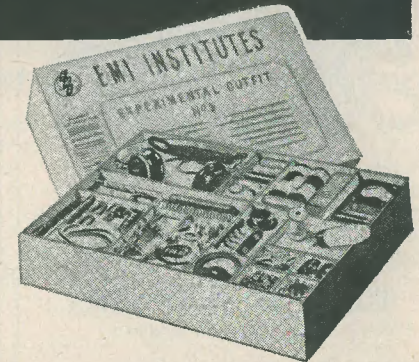

COURSES WITH PRACTICAL EQUIPMENT INCLUDE:—

Radio (Elementary and Advanced), Television, Mechanics, Electricity, Chemistry, Photography, Carpentry. Also Draughtsmanship, Commercial Art, Amateur S.W. Radio, Languages, Etc.

E.M.I. INSTITUTES

The only Postal College which is part of a world-wide Industrial organisation

IC23

IKOPATENTS

LTD.

Managing Director
E. G. O. ANDERSON

Consultants

- RADIO
- TELEVISION
- ELECTRONICS

17 CRISP ROAD W6
RIVERSIDE 2678

TELEVISION CABINETS

All Sizes up to 16" Tube

Specially Designed for 'The Radio Constructor' 'MAGNAVUE' TV Receiver.

Price **£18:10** Carriage £1

SEND FOR ILLUSTRATED LEAFLET

H. ASHDOWN

98 HERTFORD ROAD
TOTTENHAM 2621 EDMONTON N9

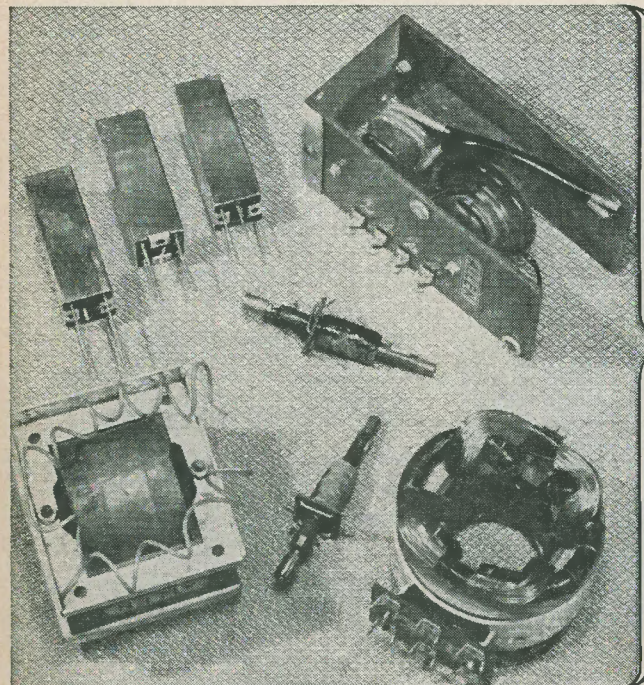

THESE STANDARD WIDE ANGLE COMPONENTS ARE USED IN THE "TELEKING" AND "SUPERVISOR"

Also for the conversion to 14" or 17" C/R Tube of all popular home-built televisions.



From all leading stockists.

ALLEN COMPONENTS LIMITED

Crown Works
Lower Richmond Road
Richmond Surrey

Telephone Prospect 9013

Send 9d. and stamped addressed envelope for Circuit Diagram.

Smith's
of
EDGWARE ROAD

Component Specialists Since Broadcasting Started

Invite all those interested in

ELECTRONIC COMPONENTS

(both Regular and Surplus)

to send for particulars of their

New Mailing List Scheme

H. L. SMITH & CO. LTD

287/9 Edgware Road London W2

Telephone Paddington 5891

Hours 9 till 6 (Thursday 1 o'clock)

Nr. Edgware Road Stations, Metropolitan & Bakerloo

ARTHURS HAVE IT!

LONDON'S OLDEST RADIO DEALERS

LARGE VALVE STOCKS

AVOMETERS IN STOCK

Avo Test Meters and Signal Generators
and Taylor Meters

Leak Point One Amplifiers and Tuning
Units.

Chapman Tuning Units.

Crystal and Moving Coil Mics.

Decca Replacement Heads and Pickups.

Goodman's Axiom 150 Speakers.

Partridge Output Transformers for
Williamson Amplifier.

All Components for the Radio Constructor's 16" Televisor.

Weare & Wright Tape Deck £35.

LATEST VALVE MANUALS

Mullard, Osram & Brimar No. 4 5/- each

Mazda 2/- each Postage 6d extra

TELEVISION SETS, WIRE AND TAPE

RECORDERS ALWAYS IN STOCK

Goods offered subject to price alterations
and being unsold.

EDDYSTONE FINE COMMUNICATION RECEIVERS

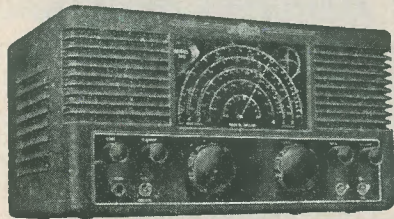

MODEL '740'

- Sound design
- Eight valves
- High performance
- Geared Drive
- Mechanical bandspread

£42 : 15 : 0 (exempt from Purchase Tax)



MODEL '750'

- Double superheterodyne
- Eleven valves
- Variable selectivity
- Long linear scales
- Chrome handles

£68 : 0 : 0 (exempt from Purchase Tax)

For full specifications, please apply to your local Eddystone Distributor or to:—
STRATTON & CO. LTD., EDDYSTONE WORKS, BIRMINGHAM, 31

COMPONENTS

for the

"ORPHEUS" TAPE RECORDER

Two speed Tape Desk assembled on correctly drilled top plate as shown.
PRICE £20

Cabinet in rexine covered wood, as shown £3 17 6

Pre-wired colour coded master selector switch. — 18/6d.

Oscillator coil with selected condenser 7/6.

All carriage paid. Cash with order

TRUSOUND LTD.
196 KINGSLEY ROAD, HOUNSLOW
MIDDLESEX

Build this Amazing Radio

- ★ Selective tuning
- ★ Acorn low drain valve
- ★ Loud clear tone
- ★ Long range
- ★ No earth
- ★ Short aerial, 2ft
- ★ Welded steel case
- ★ Easy to assemble
- ★ All parts for this set are sold separately

MAIL ORDER ONLY

This little set was designed to give you a real personal portable radio that you can enjoy anywhere without disturbing others. Use it on camping trips, in bed, in your office, or just anywhere. Send 2/- for layout, Wiring diagram and Components Price List.

R.C.S. PRODUCTS
(RADIO) LTD.
11 OLIVER ROAD LONDON E.17



FOR
30/-
Post Free

The Radio Constructor

INCORPORATING *The Radio Amateur*

CONTENTS FOR MARCH

- 436 Suggested Circuits: A Source of Bias for AC/DC Equipment, *by G. A. French*
- 438 Trade News
- 439 In Your Workshop, *by J.R.D.*
- 442 Thermistors — Their Properties and Applications, *by N. J. Wadsworth, B.Sc.*
- 446 Can Anyone Help ?
- 447 Radio Snapshots — Competition Result
- 448 The "Simplex Two" Transmitter — A Useful Rig for Top Band and Eighty, *by J. N. Walker, G5JU*
- 454 Book Reviews
- 455 A Storage Rack for Radio Components, *by K. Parkes, G3EHM*
- 456 Radio Miscellany, *by Centre Tap*
- 458 The "Orpheus" Tape Recorder, Part 4, *described by A. S. Torrance*
- 461 The "Economy Four" — An Eight Watts Amplifier, *by A. C. V. Seymour*
- 465 Query Corner — A Service for Readers
- 467 Fringe Area Television: Part 3, Sync and Timebase Circuits, *by J. Glazer*
- 472 Aligning the Homebuilt Signal Generator, *by T. W. Dresser*
- 474 Let's Get Started — On The Air, *by A. Blackburn*
- 476 Club News
- 479 Battery Valve "Mains" Sets, *by F. G. Rayer*

VOL. 7 NO. 8

ANNUAL SUBSCRIPTION 18/-

MARCH 1954

*Editorial and
Advertising Offices*

57 MAIDA VALE LONDON W9

Telephone
CUNNINGHAM 6518

Editor
C. W. C. OVERLAND, G2ATV

Advertising Manager
F. A. BALDWIN, A.M.I.P.R.E.

THE CONTENTS of this magazine are strictly copyright and may not be reproduced without obtaining prior permission from the Editor. Opinions expressed by contributors are not necessarily those of the Editor or proprietors

NOTICES

THE EDITOR invites original contributions on construction of radio subjects. All material used will be paid for. Articles should preferably be typewritten, and photographs should be clear and sharp. Diagrams need not be large or perfectly drawn, as our draughtsmen will redraw in most cases, but all relevant information should be included.

All Mss must be accompanied by a stamped addressed envelope for reply or return. Each item must bear the sender's name and address.

TRADE NEWS. Manufacturers, publishers, etc., are invited to submit samples or information of new products for review in this section.

ALL CORRESPONDENCE should be addressed to THE RADIO CONSTRUCTOR, 57 Maida Vale, London W.9 Telephone CUN. 6518.

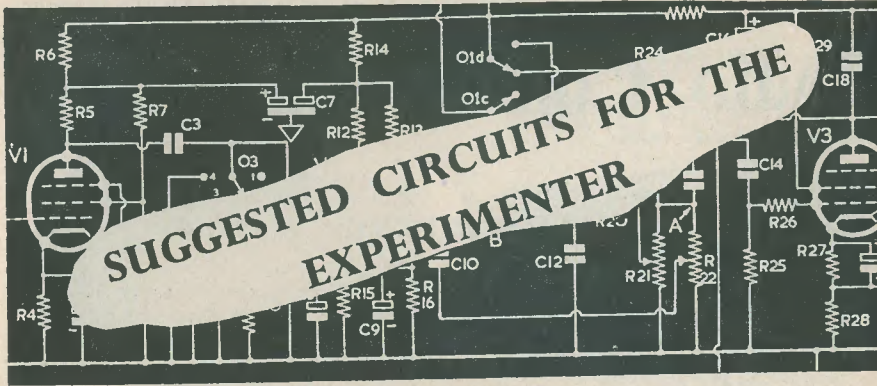

The circuits presented in this series have been designed by G. A. FRENCH specially for the enthusiast who needs only the circuit and essential relevant data.

No. 40: A Source of Bias for AC/DC Equipment

IN SUGGESTED CIRCUITS No. 32, published in the August 1953 issue of *Radio Constructor*, the writer introduced a system of obtaining negative bias for a receiver from the oscillator grid of the frequency-changer. Although this was not an original scheme, (it has been used in the past in one or two commercial American receivers), the idea created quite an interest among readers. It is probable that a miniature receiver using this system will be described in future issues of this magazine.

This month's *Suggested Circuit* illustrates another very simple method of obtaining bias for AC/DC equipment. So far as the writer is aware, the particular circuit used here is original. It is especially applicable to amplifiers, since it does not require an RF oscillator.

The Circuit

The basic arrangement is shown in Fig. 1. In this diagram, the mains supply is applied across the heater chain and dropper resistor in the normal fashion, with the exception that an additional resistor of small value (R_2) is introduced between one side of the mains and chassis.

When equipment is connected to DC mains of correct polarity, a negative voltage, with respect to chassis, appears at the lower end of R_2 . This voltage is applied to the potential divider given by R_3 and R_4 in series, individual bias voltages for the

various stages being tapped finally from R_4 . These voltages are smoothed by R_5 - C_2 , and R_6 - C_3 respectively. The diode V_1 does not conduct when DC mains are applied to the equipment, since its anode is then negative with respect to its cathode.

When the equipment is connected to AC mains a different process takes place. In this case an AC voltage, whose RMS value is equivalent to the previous DC voltage, is built up across R_2 . This voltage is applied via C_1 to the diode, which functions as a shunt rectifier. The rectifier load is given by R_4 , whilst R_3 serves to limit the rectified voltage. The rectified voltage built up across R_4 is such that the lower end of this resistor is negative with respect to chassis. If the value of C_1 is chosen with reasonable care, the rectified voltage appearing across R_4 will be equivalent to that obtained when the equipment was previously connected to DC mains. The bias tappings taken from R_4 via R_5 - C_2 and R_6 - C_3 will then have the same value as before.

Although there will obviously be no HT current when the equipment is connected to DC mains of incorrect polarity, it is worth mentioning that the diode V_1 serves the incidental purpose of keeping the bias voltage obtained with such a supply at zero level.

Practical Points

The arrangement shown in Fig. 1 is

intended only as an illustration of the capabilities of the circuit. It is obvious, for instance, that the number of bias voltages which can be taken from R_4 can be increased or decreased quite easily; or, if something more

that the correct voltage is obtained with the AC mains connection consists of primarily calculating the bias voltage which would be obtained with DC mains, and then adjusting C_1 empirically until the same voltage is

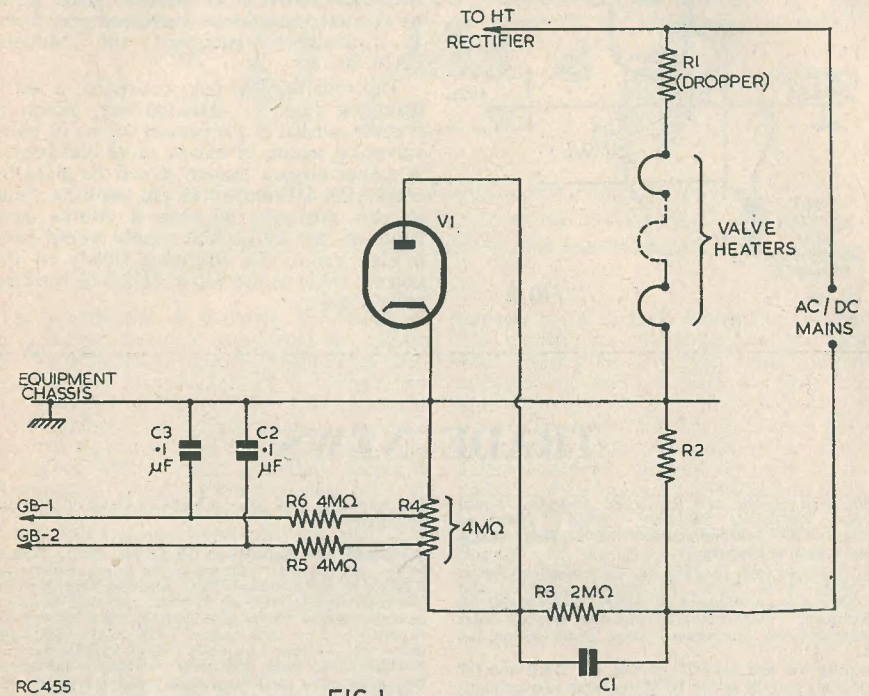

FIG. 1

simple is desired and only one bias voltage is needed, that such a voltage can be taken direct from the junction of R_3 and R_4 . In the diagram, the values of R_3 and R_4 are so chosen that, with the DC application, a voltage equal to two-thirds of that dropped across R_2 appears across R_4 . It is possible, however, to make the circuit function with any values of R_3 and R_4 , so long as the voltage built up across R_4 (when the equipment is connected to DC mains), is greater than half or less than five-sixths of the voltage dropped across R_2 . It is advisable to ensure that the values of R_3 and R_4 add up to a figure lying between 2 and 10 megohms.

The value of the voltage appearing across R_4 when the equipment is connected to AC mains depends mainly upon the diode used, the voltage dropped across R_2 , and the value of C_1 . The best method of ensuring

obtained from AC mains. The value of C_1 should not be very critical and will, in most cases, lie between 0.01 and 0.25μF. The bias voltage across R_4 can be measured with the aid of a valve voltmeter. If such an instrument is not available the circuit shown in Fig. 2 may be used, in which the bias voltage is compared against that obtained from a grid bias battery. When this arrangement is employed, it is merely necessary to connect the appropriate battery voltage across R_4 for comparative readings in the milliammeter, the AC supply being left connected all the time.

The Diode

Although at first sight it may appear that an extra diode is required, this is not, in practice, the case. If, for instance, the circuit is fitted to an amplifier, any suitable triode or pentode stage may be replaced

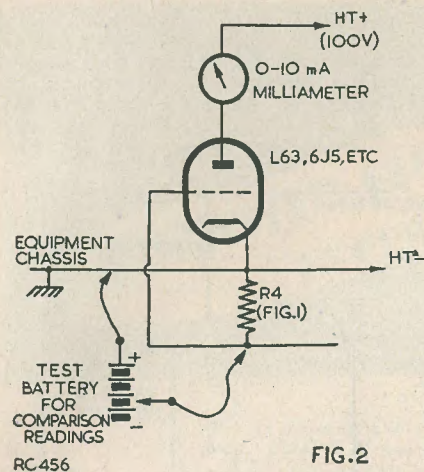

FIG. 2

TRADE NEWS

Southern Radio and Electrical Supplies, Sorad Works, Redlynch, Salisbury, Wilts. Telephone Downton 207. Manufacturers of So-Rad Transmitters and equipment.

First established in 1934 at 85 Fisherton Street, Salisbury, Wilts. by C. A. Harley, G2ACC, who has been actively engaged in radio for 29 years. In addition to a normal retail business a mail order department was commenced some years before the war.

During the war G2ACC was in the RAF and for some years was the senior NCO in charge of a technical maintenance department at HQ 60 Group, the RAF Radar Headquarters. During this time the firm was carried on by the proprietor's wife with the help of female staff only, when many thousands of British and American troops patronised the retail premises.

Since the war, in addition to the normal retail and mail order business the manufacture of radio transmitters was commenced, and for some years these were shown with other components and communications receivers at the annual RSGB Amateur Radio Exhibitions in London. Owing to recent shortages in raw materials and preparations for change of address, the manufacture was temporarily ceased.

A few months ago the firm moved to new factory premises of approx. 4,000 square feet of floor area a few miles outside the city of Salisbury, and present activities include retail local business, mail order, radio and television service and the manufacture of specialised electronic equipment, coils, VHF chokes, chassis, switches and under development at present is a new range of "TVI-proof" transmitters for amateur use. A useful service to the constructor is the manufacture to individual requirements of paxolin rotary switches in single or multi-bank up to eleven-way, also the cutting of aluminium panels in 16 swg to any size and the individual making of chassis in the same material.

A free comprehensive 60 page catalogue No. 8 covers a wide selection of radio, television and transmitting components and enables the constructor to obtain all his supplies of the best makes from one source with a "by-return" service. An illustrated

by an equivalent diode-triode or diode-pentode. Similarly, with a receiver, one diode of the double-diode-triode may be employed for detection and AVC, the remaining diode being used for bias rectification. The chassis connection for the cathode of the valve is, of course, already ensured. On the other hand, a crystal diode or Westector could be employed; or, even, a triple-diode, such as the Mullard EABC80.

The resistor, R2, may consist of a small dropping resistor. Alternatively, however, it could consist of the heaters of one or more valves or, again, of one or more dial lamps. A rather elegant system would be given by employing a Brimistor of the requisite value in this position. If such a course were followed, the initial bias supply would have a high value, this dropping slowly to the correct value as the valves achieved working temperature.

brochure *The New Approach* shows views of premise and activities.

Kendall and Mousley of 99 Dudley Port, Tipton, Staffs., are currently offering to the home constructor a parcel of useful components. Each package contains the following items:—24 various half watt resistors at useful values, 4 each of 0.05, 0.01 and 0.001 tubular capacitors, 2 potentiometers (50K and 250K, the latter with switch), 1 pentode output transformer and 1 electrolytic, 8uF, 450 volts working. Altogether very good value for £1 including packing and postage.

Radio Experimental Products Ltd., of 33 Much Park Street, Coventry, have favoured us with a sample of their Matched Pair Dual Range TRF Coils. These, together with two circuits, one a battery design using an IT4 as RF and Detector Stage with a 3V4 as output, and the other a mains version utilising the Mullard EF41 as RF stage, EF42 as Detector with an EL41 as Output, represent extremely good value for 8/- plus 3d postage. We used these coils in the mains version and found that the circuit worked very well with only a foot of wire for the aerial. We even managed to dispense with the Detector reaction circuit. An excellent buy for those requiring coils for that Medium/Long Wave job.

Messrs Stratton and Co. have recently made several additions to their well known "Eddystone" range of quality components. Among these is the small low loss polystyrene ribbed former having numerous applications in both HF and VHF equipment. The actual former is at an angle of 90 degrees to the mounting flange—a most useful feature where space is at a premium. It is complete with an iron core, diameter is 19/32", winding length 3/4". Catalogue No. 847.

A vernier slow motion dial catalogue No. 843, is of anodised satin finished aluminium, 4" in diameter and having a scale of 100 divisions marked over 180 degrees. The markings are in black and a vernier strip to match is provided. The driving head, of an improved ball-bearing epicyclic type, is totally enclosed and gives a reduction ratio of 10 to 1. This dial is the best of its type that we have seen and is an obvious choice where close tolerance readings are required.

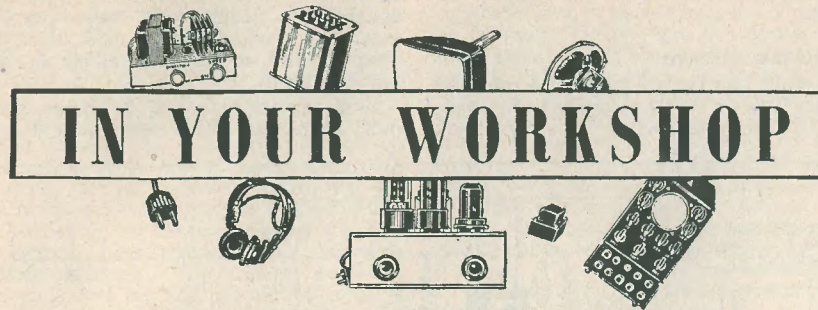

In which J. R. D. discusses Problems and Points of Interest connected with the workshop side of our Hobby based on Letters from Readers and his own experience.

AT THE TIME OF WRITING, the House of Lords has just completed its debate on the Government's White Paper concerning the introduction of a competitive TV service. If the debate has produced nothing else, it has at least given prominence to one or two personal animosities, the airing of which, whilst providing excellent newspaper "copy", achieve a sum total of nothing. We have also learnt that several noble Lords, who apparently do not care much for television themselves and look in only at infrequent intervals, are not prepared to credit the British public with enough elementary savvy to switch off a programme they do not like.

The need for a second TV programme is, by now, so long overdue that it is beyond demonstrating. If the money for such a programme cannot be obtained from sources available to the BBC, then it must come from advertising revenue. The compilers of the White Paper were certainly appreciative of this point, and have introduced controls to prevent advertisers from cheapening the quality of the transmitted material. It is a wise and sensible compromise.

The present situation is rather similar to that prevailing before the war, when the BBC broadcast such ghastly programmes on Sundays that the public were well-nigh forced to tune to Radio Luxembourg or switch off completely. The BBC has since, of course, changed its policy; and the Sunday programmes now transmitted present a nice balance between light and serious subjects.

Commercial TV

What will the second TV service offer to the radio engineer and the home constructor? To the radio engineer it should offer

enough work to keep him going for years. The demand for converters and new aerials will certainly be very high indeed, and the engineer will be kept extremely busy fitting and maintaining these. The reaction of the man-in-the-street will be that, after having spent some seventy pounds or so for his original receiver, he will certainly be prepared to spend another five to fifteen pounds for the converter needed to bring in the alternative programme. Although the "snob-appeal" of the television aerial has been done to death by cartoonists, the idea of an aerial mast sprouting a Band 3 Yagi in addition to the conventional "H" may even appeal to one or two people on these lines alone!

The Home Constructor

As always, the TV home constructor is better placed than anyone else to reap the benefits of new developments. As soon as concrete details of frequencies become available, *The Radio Constructor* staff will commence work on the design of converters which will enable domestic TV sets to receive the alternative programme.

One body has already taken the bull by the horns, so far as alternative TV is concerned. I refer, of course, to the Television Society, whose transmitter, on 427 Mc/s, will shortly be on the air, (if this has not already occurred by the time these notes appear in print). *The Radio Constructor* is already working on a converter suitable for reception of the Society's transmissions. I strongly advise any interested constructor to build this converter when it appears. TV is, even now, in its infancy; and, by gaining experience of equipment operating at these higher frequencies, the constructor will be "in on the ground floor" for future

developments well before the rest of the public.

Wide-Angle Scanning

I wonder how many TV receivers using the *Magna-View* or *Universal* circuits have been built by home constructors? I should think

of the two receivers mentioned have been designed by people with many years of experience behind them, and they are designed also to be as infallible as they possibly can be.

Wide-angle scanning is, of course, something which was "very new" several years

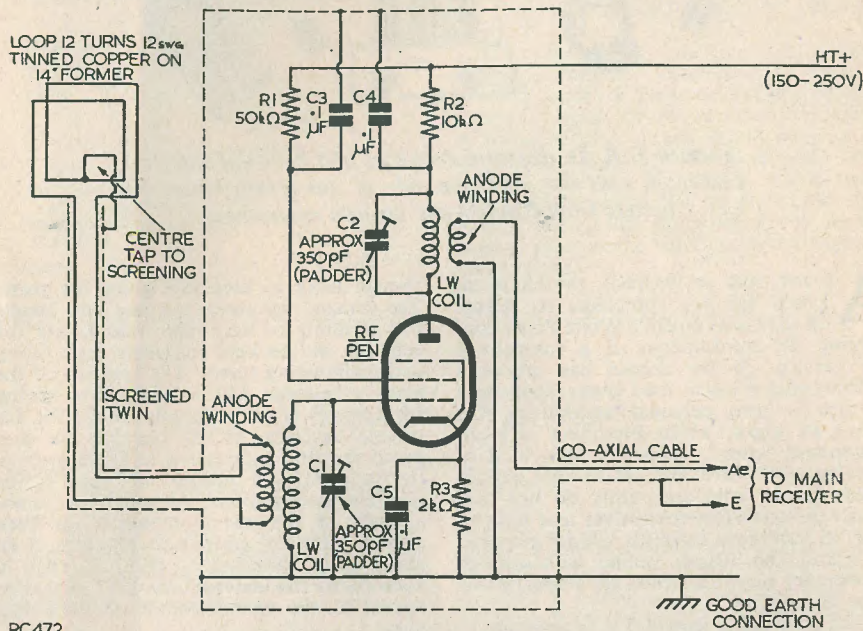

Using a loop aerial to reduce man-made interference on the long-wave band. The former for the loop windings may be either round or square; and turns should be spaced by approximately twice the wire diameter

that the number is, by now, well into the thousands at least; and I am trying to take a conservative view. And yet, I still hear from readers who doubt their ability to build a television receiver.

Let me assure those readers that there is absolutely nothing to it. A TV receiver differs from a sound receiver only because it has a few more "bottles" in it, and because some of these "bottles" perform the unfamiliar (to the beginner) functions of sawtooth generation and sync separation.

The receiver part of a TV set is simplicity itself. Indeed, the layouts of the *Magna-View* and the *Universal* are so designed that construction is made very easy indeed.

So far as the timebase circuits are concerned, these are easier to build than the beginner may think. The circuits used in these sections

ago, although it is now accepted as a standard thing. And I do honestly advise the reader who feels uncertain about his ability in this particular field to cast away his doubts and commence construction. The results will please him immensely, and he will also save himself money.

My own experience with these two receivers may perhaps be of help. I have built both the *Magna-View* and the *Universal*, using the specified English Electric Tube and the specified Allen components. And neither circuit gave me any trouble at all.

Money For Old Rope

Struggling as I do each day to earn my mite, I cannot sometimes repress a feeling of envy when I see some amongst us who

earn a considerable amount of money for doing very little.

For instance, I recently saw a very well-dressed gentleman in a street in Westminster selling "portable aeriels" from a suitcase. He was obviously an engineer of the highest repute because he frequently referred to "high frequency waves" and even, on occasion, to "heterodynes." With the aid of a vibrator-powered receiver and accumulator hitched up on the pavement he was able to illustrate how excellently his "portable aeriels" worked. They were doubtless assisted by the fact that he always kept his finger on one of the "aerial" terminals.

The "aeriels" themselves were Government surplus 2μF paper capacitors, each with a smart label pasted on its side. He sold them at 3/6 each-and, in half an hour, had got rid of at least thirty. Work it out for yourself!

Another gentleman I met recently was an inspector from one of the Ministries. It was his job to visit a certain firm and inspect the output of a radio production line before it was accepted by his Ministry. After arriving at half-past nine, he carried on till quarter to twelve. He then disappeared for lunch, returning just after two. During the afternoon, however, it appeared that he had become rather bored with inspecting radio equipment. Instead, he produced an exercise book and proceeded to do his night-school "homework" until about half-past four. Tired out, he then departed home.

Nice work if you can get it!

The Light Programme

It is surprising to learn that many people have difficulty in receiving the Light Programme on 200 kc/s free of interference. I know that this is definitely true in certain parts of South Wales as I have heard the results myself. The signal is so weak that it just cannot override the interference level given in a normal street of houses (electric light switches, hair dryers, etc., etc.), or the noise generated in the line-scan circuits of nearby TV receivers.

Of course, the Light Programme frequency is not nowadays a very good choice for nation-wide broadcast coverage. Random man-made interference almost always gets stronger as the received frequency becomes lower; and 200 kc/s is unfortunate insofar as it sits just a few kc/s from one of the line-scan harmonics.

Whilst the line-scan interference can often be reduced by getting the TV set-owner to re-position his set (or, merely, to re-orientate it through 90 degrees in some instances), the reduction of random interference in areas of low signal strength still remains a difficult problem.

Interference, in such cases, can sometimes be considerably reduced by employing a loop aerial of the type which is used for aircraft D/F. This type of aerial is quite simple to make (so far as this particular application is concerned) and is not at all critical in dimensions or number of turns. It needs, however, an additional RF amplifier to bring up the signal strength to that given by the more normal type of aerial.

The accompanying diagram shows a typical circuit in which the loop aerial may be used. It is coupled to the RF amplifier by means of the anode winding fitted to any long-wave coil designed for RF coupling. A coil intended specifically for aerial coupling should not be used, as the coupling winding may not match into the loop.

It will be noted that the lead to the loop, and the RF amplifier itself, are both completely screened. This is most important, as the circuit will not otherwise be able to prevent interference. In the diagram, the RF amplifier coils are shown as being pre-trimmed to the Light Programme at 200 kc/s, but the trimmers may be replaced by a two-gang capacitor to enable other long-wave transmissions to be received, if this should be desired.

The screened twin lead to the loop aerial may consist of any wire whose internal capacitance is not excessive. As an instance of what is required, screened twin-microphone wire would cope quite well. The connection to the main receiver may be taken via co-axial cable. If the main receiver is an AC/DC model, capacitors of .01μF must be connected in series with both aerial and earth coupling leads, and the receiver mains plug inserted such that the receiver chassis is connected to the neutral side of the mains.

Additionally, the receiver with which the loop and loop amplifier are used should be reasonably well screened. If the receiver still picks up heavy interference when its aerial is removed, it will have to be modified. This can usually be done by screening the lead which travels from the aerial socket to the wave-change switch or coils inside the set; and, in severe cases, by screening the coils themselves. However, in many instances, the signal from the loop amplifier will be sufficiently strong to prevent noises picked up in the receiver circuits themselves from being troublesome. Care should be taken to ensure that the interference is not mains-borne.

When the loop and its amplifier have been built and lined up, it should be found that the interference disappears almost completely. It may even be possible, by suitable orientation of the loop, to reduce interference from TV sets as well.

THERMISTORS— THEIR PROPERTIES AND APPLICATIONS

By N. J. WADSWORTH, B.SC.

MANY PEOPLE WHO ARE comparatively well read in most radio techniques seem to lack much knowledge of thermistors and of the many uses to which they may be put.

A "Thermistor" is used here to describe components whose resistance varies with temperature, although the term is often used exclusively for those with a negative temperature coefficient. They may be broadly divided into two groups. The first, "semi-conductors" whose resistance drops rapidly with increasing temperature, will be dealt

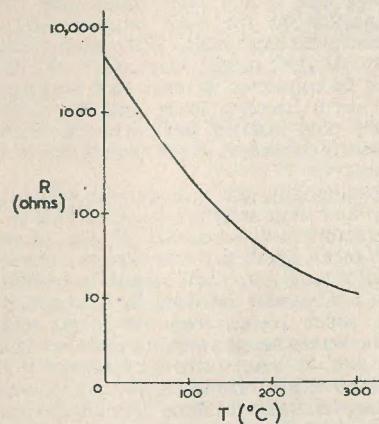

FIG. 1.

with first, followed by the second group, metal filament lamps, whose resistance increases with increasing temperature. Both groups may be used with great success in stabilising circuits of all types.

The First Group — Semi-conductors

These thermistors consist of blocks of semi-conductor with two electrodes attached, often in the form of wires embedded in the block. Their resistance at any temperature $T^{\circ}\text{C}$ may be written:

$$R = ac \frac{b}{(T+273)}$$

where c is 2.718, and a and b are constants (1). From this we see that as the temperature of the block increases the resistance R decreases and the temperature coefficient of resistance, or the proportional change in resistance for 1°C rise in temperature, being $-b/(T+273)^2$, gets smaller as the temperature is raised.

When equation (1) is plotted to show the variation of resistance with temperature, putting in normal values of a and b , the graph in Fig. 1 is obtained. This shows that an increase in temperature of a few hundred degrees is sufficient to reduce the resistance to one hundredth of its original value. It is possible to produce a bead less than 1mm in diameter with a cold resistance of 500,000 ohms.

The Second Group — Metallic Filament

Many pure metals have a resistance approximately proportional to the absolute temperature and thus double their resistance on being heated to about 300°C , and again on being heated to about 900°C . This rate of change of resistance with temperature is much slower than that of the first type, but quite large changes are possible if very high temperatures are allowed. Also the fact that metallic resistance increases with increasing temperature, instead of decreasing as that of semi-conductors does, is an advantage in some circumstances. The most common and cheaply available type of metallic thermistor is a normal tungsten filament lamp, and these may be run at up to 2800° .

In order to get a high resistance with this type, a great length of wire is needed which tends to make the thermistor bulky.

Fig. 2 shows a typical voltage current characteristic for a small mains lamp.

Thermistors may be used as a sensitive temperature measuring device, and in this application both types have their uses. The metallic type is represented by the platinum thermometer which is used for the accurate measurement of temperature up to 1100°C . Its advantages are its large operating range and its high stability. Semi-conductor thermistors, on the other hand, combine very high sensitivity with very small physical size, and are thus able to respond quickly to rapid changes in temperature and are able to measure accurately, for instance, the air temperature at the under-surface of a leaf, whereas any other thermometer would be too big. Owing to their high sensitivity, this type of thermistor is also to be preferred for larger work where the extreme stability of the metallic type is not required. The material can be made in the form of a block about $\frac{1}{8}$ " in diameter, mounted on a plate enabling it to be fixed to a metal surface whose temperature is being investigated.

We now pass from the direct use of thermistors to measure temperature to the less direct use of their properties in electrical circuits. Perhaps the most obvious method of using thermistors, say to control the gain of a valve, is to wind a heater coil round it and pass a current through this to heat it. In view of the high temperature and large size involved this is not usually done with metallic thermistors, but may be done with the semi-conductor type. In this case, a very small bead of the material with wire contacts is taken and some very fine wire wound round and insulated from it. The whole is then enclosed in a glass envelope which may be evacuated or gas filled. The former increases the heat insulation of the thermistor and so allows a smaller heater power to be used for the same temperature rise. In this case the power necessary to reduce the resistance to one five-hundredth of its cold value is only about 60mW, whereas if the glass envelope is gas-filled double this power is needed, but the response is quicker. When used in this manner, care must be taken that any current flowing through the thermistor does not produce much heat itself, or the thermistor will be kept hot all the time and may be overheated when full heater power is turned on. This brings us to the most common use of thermistors, in which no auxiliary heater is employed but all the heat is generated by the current flowing through the thermistor itself.

When we consider the effect of slowly increasing the current through a thermistor of the semi-conductor type, we notice a very

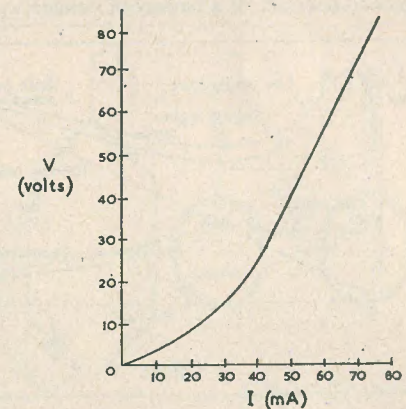

FIG. 2.

surprising effect. At very low values of current the heating effect is small and the thermistor resistance only changes slightly, but as the current is increased we get to a stage where a small increase in the current produces such a large drop in the resistance as the thermistor warms up that the voltage across it actually decreases. Thus we find that the voltage varies with current in the

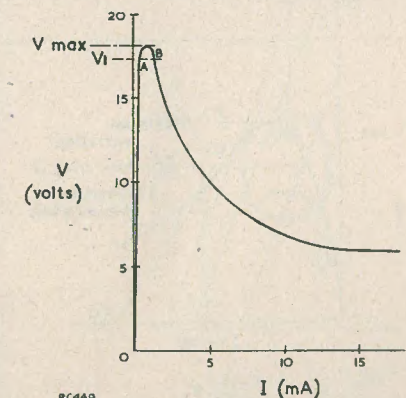

FIG. 3.

way shown in Fig. 3. It must be emphasised, of course, that this curve refers to static conditions in which the thermistor has time

to heat up. If AC is used, the RMS voltage may be read off from the curve using the RMS current, but in any one cycle the voltage will vary linearly with the current, as the thermistor will not have time to heat up or to cool off. If a battery of voltage V_1 ,

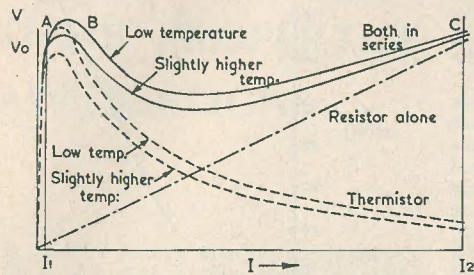

FIG. 4.

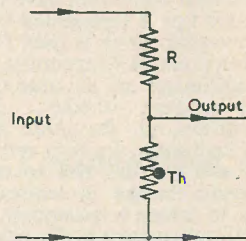

FIG. 5.

less than V_{max} (Fig. 3), is connected across the thermistor, the current flowing will be that given by point A but if the voltage is increased temporarily to move the operating point over the "hump", the system can also be in equilibrium in position B with a larger

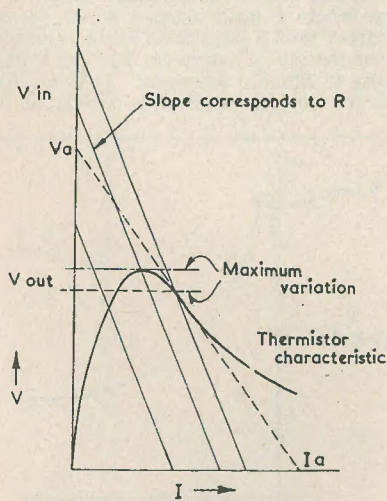

FIG. 6.

current flowing. This equilibrium is unstable, since if the thermistor cools very slightly its resistance increases so much that not enough power is available to make

up for the heat lost and it cools further until it reaches position A. If, however, the thermistor gets slightly hotter, the decrease in resistance causes more heating which makes it hotter still and this process continues until the thermistor burns out. If a series

resistor is used to prevent burning out, a sensitive temperature switch may be made. This is because as the outside temperature increases E_{max} is reduced. The effect is shown in Fig. 4, in which the voltage across a resistor and a thermistor is shown at two slightly different temperatures. If a voltage V_o is applied the current will increase to I_1 , corresponding to the point A. However, if the outside temperature increases slightly this is no longer a position of equilibrium, and the current increases to I_2 , corresponding to C. The heating need only last for a short time, and once the operating point passes B it will never return until the voltage is switched off. The increase in temperature may be produced by a momentary current in a small heater wound as described above. The ratio of I_2 to I_1 can easily be made 60 or more, and thus, for instance, if the resistor consisted of the coil of a relay there would be no difficulty in setting it to close at I_2 but not at I_1 .

Another use of this hump curve, a very important one, is to produce an output of constant amplitude irrespective of small variations of input voltage. To do this the circuit shown in Fig. 5 is used. It is arranged that, at the mean value of the input voltage, the voltage across the thermistor is V_{max} . As the input varies the current through the thermistor changes, but from Fig. 3 it is seen that for small changes this produces no change in output voltage. To ensure this, the right value of input voltage and of R must be used. To determine these the following graphical method is the most simple. Draw the thermistor characteristic as shown in Fig. 6, and put in the dotted

line corresponding to the maximum slope. Calculate the resistance of the thermistor at this point, let the axes and dividing the product of V_a by the current I_a . For best operation with no distortion, R should be somewhat larger than this. Having fixed on a value of R, draw a line through the top of the hump corresponding to the value of R just described. This new line will be slightly steeper than the dotted one. The point where it intersects the thermistor characteristic is the mean value of input voltage. To determine the variation in output voltage is permissible for a given change in input, draw lines parallel to this line intersecting the thermistor characteristic at the limit of tolerable variation of V_{in} . The points where these lines meet the voltage axis correspond to the limits of regulation. It will be found that the regulation is very good for small changes in V_{in} , and becomes worse for larger changes.

If a good waveform is to be maintained by an audio oscillator, it is essential that all circuit elements have linear voltage-current characteristics at the operating frequency. As explained above, thermistors satisfy this condition at audio frequencies. On the other hand, if oscillation is to be maintained there must be some method of ensuring that the "loop gain" is exactly unity, as if it is less there will be no oscillation, and if it is more the amplitude of oscillation will increase until the gain is reduced to one. In simple oscillators this reduction is achieved when the valves come on to curved parts of their characteristics, thus producing distortion of the output waveform. However, if a thermistor is used as described above the ratio of input to output voltages decreases rapidly as the oscillation builds up, and so stabilizes the oscillation without causing any distortion. Small changes in V_{in} can be dealt with without altering V_{out} at all. If a Wien bridge type of oscillator is used, the thermistor may be made one of the bridge arms in such a way that the bridge output drops as the oscillation amplitude increases. The essential part of the circuit using a semiconductor type thermistor is shown in Fig. 7. Metallic, positive temperature coefficient thermistors may be used if the bridge is rearranged; however, they are not recommended as they need a greater power input.

In a situation where it is desired to vary the gain of a valve by biasing its grid, it is the normal to use a "variable-mu" valve. These, however, by their very nature have non-linear characteristics, and so produce distortion unless the signal amplitude is kept very low. This situation may be improved by using a thermistor as its un-bypassed

cathode resistor, as shown in Fig. 8. In this case biasing the valve varies the cathode current, and hence the thermistor temperature which alters the gain, since the effective

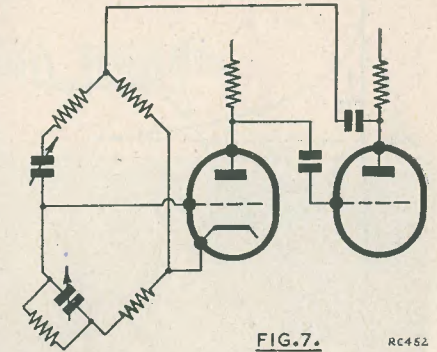

mutual conductance, G, of such a valve is given by $G=g/(1+gr)$ where g is the normal mutual conductance of the valve and r the cathode resistance. In this application small mains tungsten filament lamps are often used, and hence the gain reduced by making the grid more positive. It is necessary to take great care if one uses negative temperature coefficient thermistors in this circuit as there are many possible sources of instability. For instance, an increase in the signal amplitude will heat

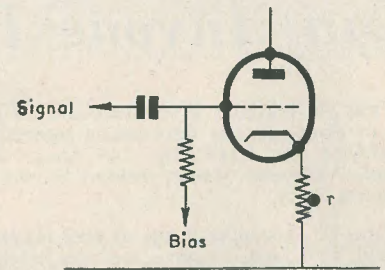

FIG. 9.

RC453

the thermistor and, if its resistance decreases with increasing temperature, this will give rise to a further increase in output. If the temperature coefficient is positive the

reverse effect takes place, and so improves the stabilisation. The performance of the circuit for small signal amplitude may be found graphically as shown in Fig. 9. The thermistor V-I curve is plotted and the normal V_g - I_a curve of the valve is superimposed as

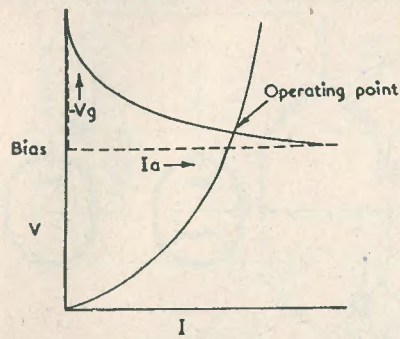

FIG. 9.

RC454

shown, with the origin at a voltage corresponding to the applied bias voltage. The operating point is the intersection of the two curves, and the resistance of the thermistor may be found from the slope of the line drawn dotted joining this point to the origin of the thermistor characteristic.

It will be seen that for certain bias values there will be more than one possible operating point if the normal semi-conductor thermistor is used. Unless great care is taken this can lead to instability. If the bias voltage is more than a small fraction of the anode voltage, allowance must be made, but in most cases the effect is small.

A very popular use of semi-conductor thermistors is for suppressing the switch-on surge in the heater circuit of series heater sets. A thermistor is connected in series with the heaters, and when power is switched on its large cold resistance compensates for the small cold resistance of the valve heaters, which would otherwise take a large current. The valves, in fact, are metallic thermistors. As the valves warm up, and their resistance increases, that of the extra thermistor decreases, and finally when its operating temperature is reached it is negligible. In this way, the normal large current surge at switch-on may be avoided, consequently increasing the lives of the valves at the expense of an increase in the warming-up period.

From the above description of a few of the many uses to which thermistors may be put, and of their characteristics, it should be obvious that there are many instances in which a thermistor will solve an awkward problem.

Can Anyone Help?

Dear Sir, I wonder if anyone could oblige me by giving me any information regarding modifying the R1147 for 144 Mc/s.—J. Allen, 7 Chaucer House, Tabard Gardens, London, S.E.1.

Dear Sir, I wonder if any of your readers would lend, sell, or give me the circuit details of the No. 19 sets made by Zenith. I wish to build a receiver embodying the "A" receiver and I do not know anything about the circuit of this section.—I. A. Beachell, Aldenham School, Elstree, Herts.

Dear Sir, Could you please spare a small space to ask any of your readers if they can supply me with a circuit for a G.E.R.9, manufactured by the General Electric Radio

Co. who are now out of business.—A. Lynch 108 Stockwell Park Road, London, S.W.9.

Dear Sir, Have any of your readers any information (data or circuit) on the Admiralty Test Set SE2?—C. Reeve, Newbury, Main Road, Holland-on-Sea, Essex.

Dear Sir, I am taking this opportunity of thanking you for publishing my request for information on the R1116 receiver. You will be glad to know that I have had several replies to my query and I have now got all the information I require. So I therefore wish to thank you again for your excellent services.—R. E. Bowgen, 36 Gibert Shelden House, Church Street, London, W.2.

RADIO SNAPSHOTS

Competition Results



"Where does this go?"

WE were most gratified by the encouraging number of entries received in this competition — so much so, in fact, that although the closing date was last November, we are only now able to publish the results.

As was stated at the time, we were not interested so much in "artistic" efforts as in those which put across the idea of our hobby. Naturally, points would be scored by good photography, but composition and, above all, the idea, would be the deciding

factor, so that those readers who possessed only elementary photographic apparatus would stand as much chance as the "expert."

We are happy to announce that the first prize of three guineas has been awarded to a joint effort by readers A. Cooper (seen in the photograph) and R. A. Yaxley (what an apt name!) of Dereham, Norfolk.

We would like to thank the senders of the many other interesting entries, the best of which will be published as opportunity offers.

The

SIMPLEX TWO

TRANSMITTER

By J. N. WALKER, G5JU

THERE IS AT PRESENT READILY AVAILABLE on the "surplus" market a valve which has a number of applications in amateur radio equipment. The valve referred to is the VT61/VT61A, known also commercially as the 4074A (S.T.C.) and the DET19 (Osram). It is a double triode, dissipation five watts at each anode, and, as it is rated to work well into the VHF spectrum, good results can obviously be expected at all normal amateur frequencies.

There are two points to be clear about when purchasing the valve. One is the heater voltage — the VT61, also styled the 2C34, runs at 6.3V 0.8A, whilst the VT61A takes 0.4A at 12.6V. Otherwise the two types have identical characteristics. Then there is the basing — most valves available have the American medium 7 pin base (usually ceramic) but some have the standard British 5 pin base. As far as results go, it is immaterial which valves are used and, to save repetition, the VT61 only will be referred to hereafter.

The cathodes are connected together inside the base, and this fact makes the valve less useful than it otherwise might be in some applications, but there are ways of avoiding difficulties. A good supply of anode top caps ($\frac{1}{4}$ " diameter) should be to hand.

The Present Design

With only two VT61 valves, it is possible to build an efficient transmitter for the lower frequencies. The design which follows is an honest-to-goodness job and, to keep it as simple as possible, all frills have been omitted. Suggestions are made later with regard to additions which, whilst not essential, individual constructors may like to incorporate.

The transmitter is intended mainly for use on 1.8 Mc/s, and it has given excellent

results with inputs varying between 2 and 10 watts. By using the second valve as a power doubler, good efficiency is obtainable on 3.5 Mc/s, on which band the input can be increased to 20 watts or so, if desired.

Circuit Details

The complete circuit diagram appears in Fig. 1. One half of V1 is a variable frequency oscillator, operating around the 900 kc/s region and employing a high capacity tuned circuit to ensure good frequency stability. The cathode is earthed directly and a separate grid winding provides regeneration.

The voltage developed at the anode is transferred to the grid of the second triode (in the same envelope), the anode circuit of which is tuned to 1800 kc/s. Again fairly high capacity is used, a fixed condenser C9 being placed in parallel with the variable condenser C8 tuning this stage.

The two halves of the second valve V2 are strapped together and are used as a single triode of low impedance. Neutralisation is essential when the PA is operated straight-through, but, as both the input and output circuits are single-ended, a special neutralising winding is provided, inductively coupled to the input coil L3, to cancel out the positive feedback which would otherwise occur.

Neutralisation is quite straightforward and, once effected, the PA stage handles docilely with no "whiskers" or other manifestations of instability. The VT61 type of valve is a ready oscillator at very high frequencies and anode stopper resistors, fitted close to each top-cap, are essential.

The output stage utilises the well known pi-coupling system and matches well into almost any aerial or feeder. A high value of capacity is required for C15, particularly when a low impedance output is required. Therefore a broadcast receiver type of

twin-gang variable condenser is pressed into service here. The one used in the transmitter illustrated has the two 360pF sections in parallel, but the total capacity is insufficient when feeding a quarter-wave aerial on 1.8 Mc/s and a twin 500pF condenser is recommended in such a case.

Grid bias for all stages is developed solely from the grid current flow in the grid resistors. The key is inserted between cathode and chassis of the final valve, partly because it cannot be inserted earlier without depriving the PA of bias and partly because the oscillator gives a better note if the doubler is allowed to run continuously.

The full radio frequency voltage developed by the PA appears across the RF choke in

Construction

There is nothing tricky about the construction and, whilst layout drawings are provided as a guide, minor variations in the placing of components need cause no concern. Other than that formed by the chassis itself, no screening between stages is required.

The majority of the components forming the oscillator stage are below the chassis, the only items above being the bandspread condenser C2 and the anode stopper R3. Adequate control of frequency is obtained with a direct drive dial on the spindle of C2—the refinement of a slow-motion drive

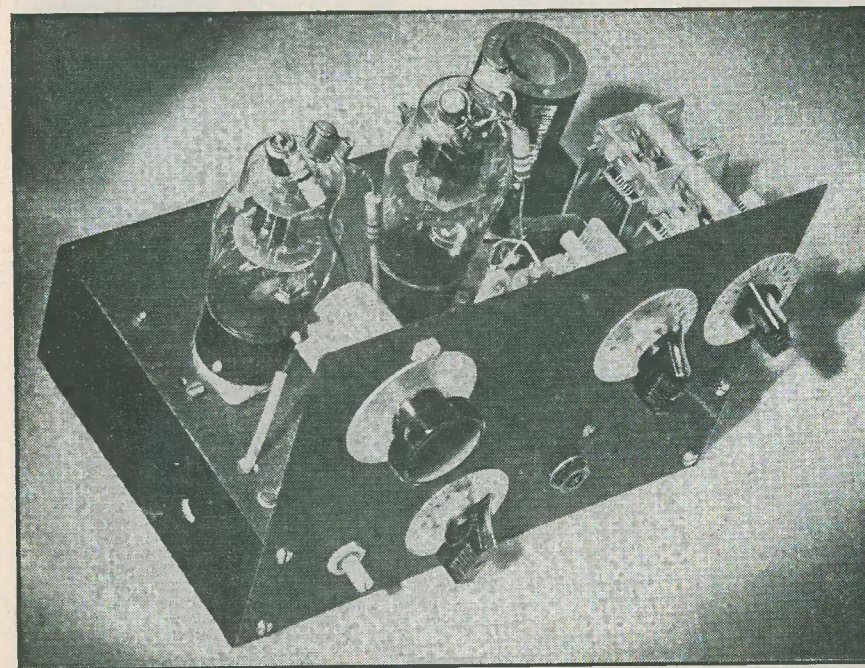

The "Simplex Two" Transmitter—three-quarter front view

the anode circuit of V2, and a low-loss component of high inductance is therefore required at this point. Where the one specified is not used, two smaller chokes should be connected in series, to lower the voltage appearing across each.

is one of the frills which can be added if desired, remembering that V1 will then probably have to be mounted further back from the panel. Once set, C1 is not thereafter touched and so no knob or dial need be fitted to its spindle.

Again, the doubler stage components are practically all below the chassis, whilst the parts forming the final stage are grouped

valveholder used. The panel in the photograph is rather on the small side and an increase in size has been allowed for in the

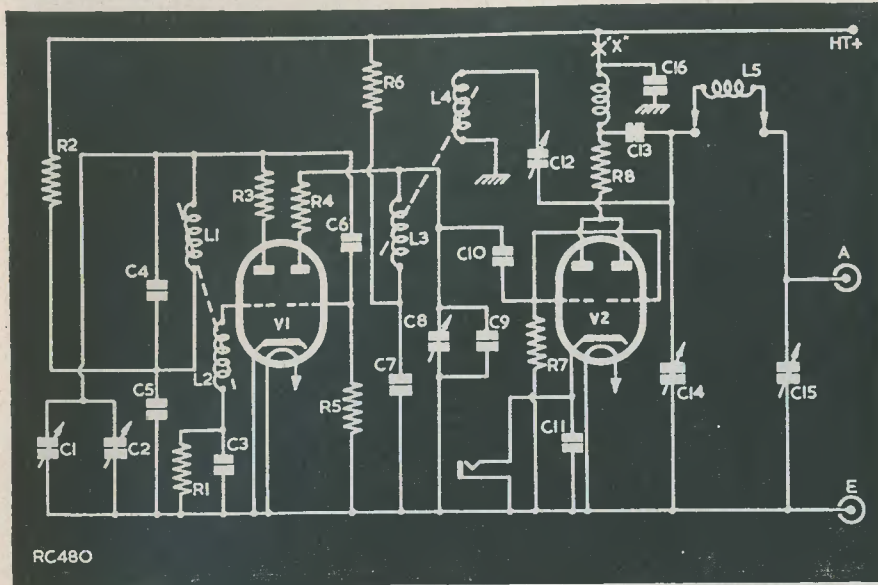

Circuit of the "Simplex Two"

List of Parts and Values

- 1 Chassis 8½" by 5½". Cat. No. 643. Eddystone.
- 1 Panel or Cabinet Cat. No. 644 Eddystone.
- 3 Variable Condensers 140pF (C1, C8, C14) Cat. No. 586 Eddystone.
- 1 Variable Condenser 100pF (C2) Cat. No. 585 Eddystone.
- 3 Knobs and Scales Cat. No. 425 Eddystone.
- 1 Knob and Dial Cat. No. 595 or 844 Eddystone.
- 1 RF Choke Cat. No. 776 Eddystone.
- 1 Coil Holder Cat. No. 964 Eddystone.
- 2 Coil formers Cat. No. 537 Eddystone.
- 2 Coil Formers Cat. No. 646 Eddystone.
- 1 Insulator Cat. No. 1019 or 695 Eddystone.
- 2 Valves VT61 or equivalent (see text).
- 2 Valveholders to suit valves.
- 1 Jack.

Resistors (all ½ or 1 watt)

- R1 10kΩ
- R2,6 1,000Ω
- R3 22Ω
- R4, R8 12Ω
- R5, R7 20kΩ

Condensers

- C1, C8, C14 140pF Variable
- C2 100pF Variable
- C3 500pF Moulded Mica
- C4 400pF Silvered Mica
- C5, C7, C11 .01μF Moulded Mica
- C6, C10 200pF Silvered Mica
- C9 100pF Silvered Mica
- C12 3/30pF Concentric
- C13, C16 .002μF 500V Moulded Mica
- C15 Twin-gang Variable, 360 or 500pF per section.

tidily at one end of the chassis. An output terminal insulator and an earth terminal are mounted on the rear wall which is clear of other parts, excepting the tag strip which anchors the leads to the power cable.

The holes for the valveholders are shown as 1½" diameter but variations in this dimension are likely, according to the type of

drawing. The use of a cabinet instead of a simple panel is another refinement which the constructor may consider justified.

Coils

The coils have to be right to ensure proper frequency coverage, and here the details should be followed fairly closely.

The coils in the exciter stages (L1/L2 and L3/L4) utilise the Eddystone Cat. No. 646 former, which is 1" diameter. The tuned oscillator coil L2 consists of 60 turns 24 gauge enamelled wire close-wound. This takes up most of the available winding space, and the second coil L2 is pile wound with 40 turns of fairly thin wire — 30 or 32 gauge silk covered. A thin application of polystyrene varnish is desirable to hold the turns firmly in place. The former is mounted by fabricating a small L-shaped metal bracket — the vertical part should be of a width to fit between the ribs of the former, whilst it is better to use an 8BA bolt, rather than a 6BA one, at this point. The fixing hole in the former should, of course, be made before winding the coil.

has twenty-five turns. In the case of both coils, the second winding should follow in the same direction as the first, to give the proper phases. The clear end of L1 goes to the stator of the tuning condenser C1 and the other end to HT via R2, which is by-passed by C5. The inner end of L2 goes to the junction of C3 and R1 and the outer end to the grid of the valve.

Again, the clear end of L3 goes to C8 and the other end to HT. The inner of the neutralising winding is earthed and the outer taken to one side (the stationary portion) of the small neutralising condenser. The rod part of the latter is held in place by soldering to the appropriate pin of the coil base.

Finally, there are the PA coils which

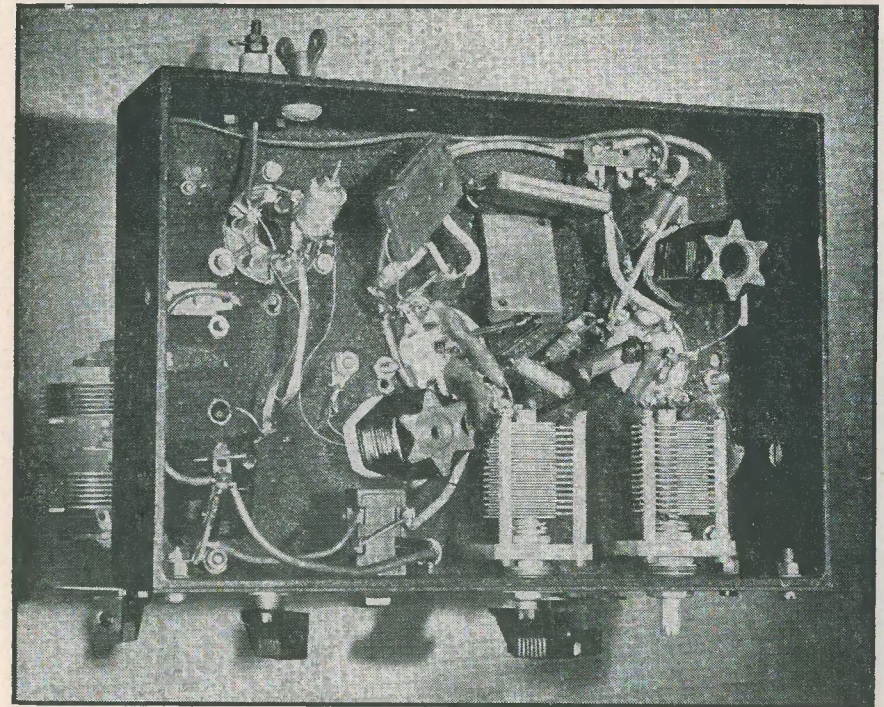

Showing layout of the components below the chassis.

L3 and L4 are constructed in the same way, but this time the main winding has fifty turns and the neutralising winding L4

are wound on 1½" diameter formers (Eddystone Cat. No. 537). The coil for 1.8 Mc/s has 66 turns of 22 gauge enamelled wire and

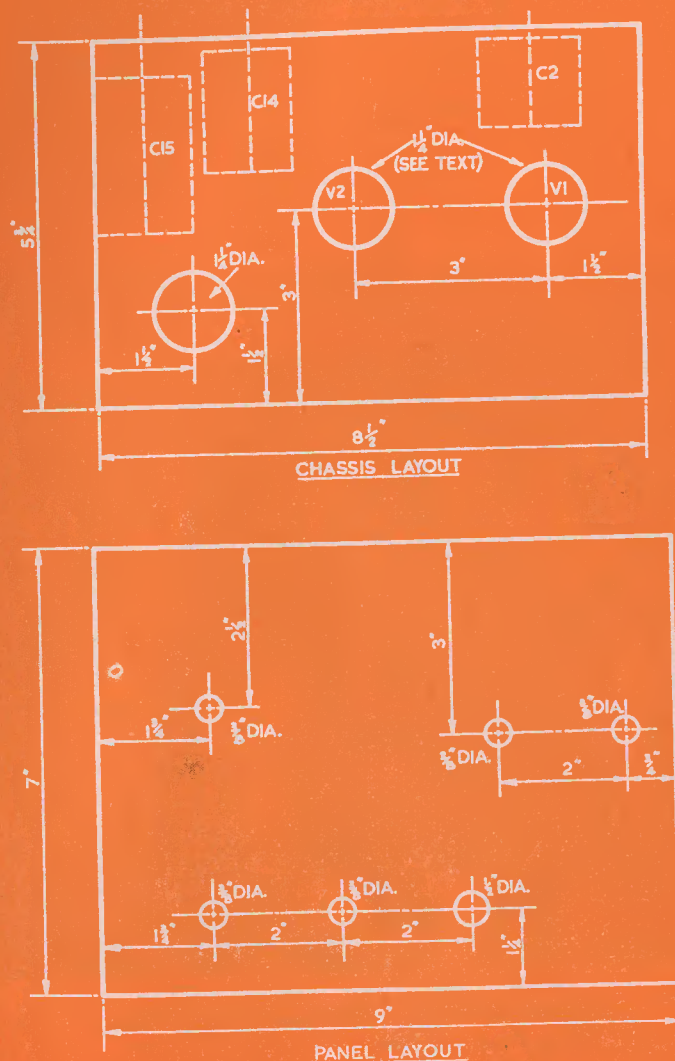

that for 3.5 Mc/s has 42 turns 18 gauge. Possibly 20 gauge could be used for the 1.8 Mc/s coil.

Setting up the Transmitter

Care is required to ensure the valve anode connectors are correctly placed. Usually the top cap of one triode will be on the same side as the grid pin, but it is well not to take this for granted. The best way to check is to follow up the grid wire — it can be seen through the glass — to the electrode structure and then locate the anode connection to the same triode assembly. If the connections are wrongly made, the oscillator will of course fail to function.

After the usual careful check to ensure the circuit diagram has been followed correctly, HT should at first be applied only to the oscillator valve. Indication of oscillation can readily be obtained by placing a voltmeter across R1 — the actual voltage in the prototype at this point is 12, with an applied voltage of 200. The signal should be located on a medium wave receiver and the bandset condenser adjusted, with C2 at full mesh.

A slight difficulty crops up here. If it is intended to use only the 1.8 Mc/s band, the oscillator should be brought dead on 900 kc/s, but if 3.5 Mc/s operation also is required, the VFO is set to 875 kc/s. In the first case, a swing of 900 to 975 kc/s results and coverage is obtained over a major portion of the 1.8 Mc/s band. In the second case, the swing is 875 kc/s to 950 kc/s, equivalent to 1750 kc/s to 1900 kc/s, the portion within the 1.8 Mc/s band occupying 70 dial divisions. The whole of the 3.5 Mc/s band is then covered. A greater portion of the 1.8 Mc/s band can be covered by substituting a 140pF condenser at C2 with a slighter coarser measure of control.

A graph should be drawn of frequency against dial reading to enable the transmitter to be set up quickly on any given frequency.

The connector to the second V1 top cap can now be attached and a voltmeter placed across R6. The reading will drop as the stage is brought to resonance by rotation of C8, and should be in the region of 9 volts (again with 200 volts HT), indicating an anode current of some 10mA. By the way, the anode current of the oscillator is about 14mA.

Neutralisation

Before proceeding further, the PA stage must be neutralised. To carry out this operation, HT is removed from the first valve (both anode caps) and applied only to the PA stage. A meter reading to 50 or 100 milliamperes is plugged into the jack,

and it is well to make provision for quickly switching on and off the HT supply, as the current will be high when the stage is completely stable.

C15 is set to maximum capacity and C8 at near maximum. At first, it is probable the PA will self-oscillate when C14 is rotated. Starting with the neutralising condenser C12 at a low value, it should be increased very gradually, applying HT each time and noting the result. The excursions of anode current will grow smaller and smaller until finally no movement of the milliammeter needle occurs over the whole sweep of C14. It is just as well to ensure that stability is maintained when C8 also is rotated. The actual setting of C12 (a standard concentric trimmer) can be judged from the illustration.

Final Operation

Drive can now be applied to the PA and, on tuning to resonance with C14, a low minimum of some 8mA, dependent on the applied HT, should be recorded. Incidentally, this low minimum anode current is one of the advantages of using a triode for low power work — one can be more certain that as the stage is loaded up, the increase of anode current really means that power is being drawn into the aerial and, one hopes, being radiated.

Loading is effected in the usual way. A good earth should be attached to the chassis, the aerial lead taken to the insulator, and then adjustment made with C15, keeping the stage in resonance with C14, until the proper loading is recorded.

It should be borne in mind that, with a triode, a large difference between off-resonance and in-resonance current should still be recorded when the transmitter is loaded. A similar state of affairs is not necessarily obtained when a pentode or tetrode PA valve is used.

Results

The VT61 valve is rated to accept a maximum input (note, *input*, not dissipation) of 24 watts to the two sections — that is, 300 volts, 80mA. On the 1.8 Mc/s band, the maximum input allowed is ten watts and, on this band, 250 volts HT is ample. Actually, the writer has had some interesting results with much lower voltages. For instance, with 200 volts it is easy to obtain inputs up to 8 watts, and good reports have been obtained with an input of 4 watts at 150 volts. The transmitter continues to function efficiently with only 100 volts and is just right for those looking for a QRP outfit which makes the most of the small power used.

On 3.5 Mc/s, the minimum dip, PA unloaded, is about 12mA with 300 volts

HT. On this band the transmitter can be loaded up comfortably to over 20 watts.

The note has been T9 in every contact but some slight deterioration may occur if the power supply has poor regulation, with a consequent large variation in voltage with keying. Preferably, therefore, the power unit should be of the choke input filter type and be loaded sufficiently to prevent large voltage variations.

It is assumed an external key-click filter is attached to the keying leads. A $0.1\mu\text{F}$ condenser (preferably 500 volts working) in series with a 400 Ω resistor (2 watts or more), placed in parallel with the key contacts, will be found to eliminate clicks.

Refinements

As mentioned at the beginning, the transmitter as described is a basic design, and minor improvements are possible but not absolutely necessary. As shown, the chassis has only a panel affixed to it, but the appearance will be enhanced if the chassis is enclosed in a cabinet.

A slow motion drive added to the oscillator stage will give finer control of the frequency setting, whilst a VR150/30 neon stabiliser valve, used to supply regulated HT to the

oscillator valve, will improve the note slightly, especially where the applied HT voltage fluctuates unduly.

The single jack fitted takes first the meter used for tuning-up, then the key. This may cause some inconvenience where the frequency is changed often and a second jack, wired in series with the existing one, will obviate any difficulty, whilst it will also come in useful for the application of modulation. However, where telephony is contemplated, the second jack should be placed in the anode circuit, not the cathode, actually at the point marked "X". Some may consider it worthwhile wiring in permanently a meter which reads to a maximum of 100mA.

Telephony

The transmitter is quite suitable for telephony operation. The modulation is applied in series with the HT feed to the final valve; and the impedance ratio of the modulation transformer, and the power output from the modulator should be adjusted to suit the actual input of the transmitter. For example, if the latter is 250V, 40mA, the modulator is called upon to work into a load of about 6,000 Ω and five watts of audio will give full modulation.

BOOK REVIEWS

WORLD RADIO HANDBOOK. 8th Edition. Published and edited by O. Lund Johansen. 136 pages. Price 8s 6d. Distributed in England by William Dawson and Sons, Ltd., Cannon House, Macklin Street, London, W.C.2.

The present edition of this useful book is similar in most respects to the 7th edition which was reviewed in the May 1953 issue of this journal. The book is slightly enlarged in order to accommodate additional information.

The section on how to use the book has been elaborated, and one is impressed by the inclusion of a paragraph describing the correct way to report reception conditions. This will be particularly instructive to newcomers to short-wave listening. Similarly, the new section containing a table of the most suitable bands for best short-wave reception of various parts of the world and the most suitable times of the day will prove a valuable guide.

Further new material is a table showing the frequency bands allocated to Broadcasting, Television and Amateurs, and a comprehensive list of the world's television stations with information concerning them is included. In addition, details of the standard frequency transmissions provided by WWV and WWVH have been augmented to include those now radiated by the National Physical Laboratory of Great Britain, and the Radio Research Laboratories at Tokyo, Japan. The international time signals provided by the Royal Greenwich Observatory are also mentioned.

The list of short-wave stations has been greatly increased, but it is noticed that details of the world's FM stations are no longer given.

Our previous review stated that the book was worth the price charged for it; there is no reason to feel that this 8th edition is any less worthy of that view. If anything, value is enhanced by virtue of the additional material offered.

INTRODUCTION TO ULTRA-HIGH-FREQUENCY RADIO ENGINEERING, by S. A. Knight, F.R.S.A. 256 pages, 202 diagrams, 4 plates. Price 21/-. Published by Sir Isaac Pitman and Sons, Ltd. Pitman House, Parker Street, Kingsway, London, W.C.2.

This is a book which gives an authoritative and easily-read insight into the special techniques applicable to UHF radio engineering. Although it is stated on the jacket that the work is primarily intended for those in the technical branches of the Services, it is obvious, at a first reading, that it can appeal to technicians and students in other walks of life. It can hardly fail to interest amateurs who are seeking knowledge in the UHF and micro-wave fields.

The author's approach is mainly descriptive. Sufficient mathematics are used to clarify the theoretical discussions, and should not present difficulty to anyone who has progressed so far in his studies that he finds ultra-high-frequency radio attracting his attention.

Transmission lines, wave-guides and cavity resonators are dealt with in three chapters, developing the theories from simple principles in a logical manner. Cathode-ray tubes and sweep circuits are given a separate chapter before embarking on triode oscillator circuits and the modern klystron and magnetron oscillators. Frequency measurement, wave propagation and aerial systems follow, to occupy the last three chapters.

It is to be expected that the book does not deal exhaustively with any of the subjects around which it is written. It seems to go just far enough into each subject to whet the reader's appetite. Which is, of course, the accepted role of a primer. Having read the book, however, one is apt to wish that the author had quoted references for further reading. Apart from this small criticism there is little else with which one could find fault.

NORMAN CASTLE

A STORAGE RACK FOR RADIO COMPONENTS

by K. PARKES, G3EHM

UNTIL QUITE RECENTLY, the problem of storage of small radio parts in the shack has become more and more acute. I surveyed the heterogeneous collection of tobacco tins, cans, jars and cardboard boxes and realized that as well as looking unsightly, the time involved in finding out where components were located was becoming too long.

A perfunctory method of labelling had been carried out on some of the containers, but the results were far from satisfactory. I realized that the cost of purchasing a complete storage bin capable of holding about 40 drawers was excessive.

What was required, was a neat box about 6" x 5" x 3" deep, in common supply and available for little or nothing. I found that the tin which contained a quantity of cubes

these become available they can be added to the rack described below.

To construct the rack, approximately 20ft of 6" x 1/2" timber will be required; this can be tongued-and-grooved matchboarding. Slots are made in the uprights to receive the shelves. The shelves are screwed to the uprights, and a piece of hardboard at the back completes the job.

The boxes are then placed in the rack, and the fronts are given a coat of black paint to subdue the lurid colour. Sticky labels are affixed and components can then be put in their respective containers.

(It is suggested that a small handle be affixed to the front of each container. This could conveniently consist of a 2-BA terminal, held by a short screw, and not forgetting a washer on the inside. Removal from the rack will thereby be facilitated.

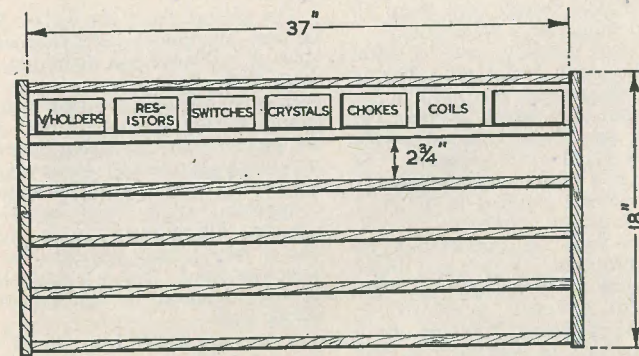

STORAGE RACK FOR COMPONENTS

RC489

of a well-known meat extract was ideal for the purpose. The sale of this commodity is quite high and after tackling various grocers and purchasing some of the product myself, I acquired three dozen of these tins in about four weeks. Naturally, as

Another improvement would be to cover the labels, when finished, with cello tape (Scotch Boy, Speedfix or similar). This should overlap the label in all directions, and besides improving the adhesion will be found to be unaffected by oily fingers.—Ed.)

Radio Miscellany

THE ANNUAL EXHIBITION of the Television Society was held at Kings College from 7th to the 9th January. The Society, which was founded in 1927 to further experiment and research in TV and photo-electric problems, caters primarily for the advanced worker, although, of course, every encouragement is given to the keen novice.

As usual, the Exhibition was of a high order and a wide range of equipment was on show. As far as I could see all the more progressive among the manufacturers were represented. The exhibits ranged from underwater TV, Studio Spotlights and equipment and Zoom Lenses at the one end, to Large-Screen Projection Receivers and Interference Suppressors at the other. From so wide a range it is difficult to single out items which would be of interest to readers who had no opportunity of attending. Any attempt to deal briefly with them all would read something like a catalogue.

One novel idea possibly new to many readers is the Ferguson HaloLight. This is a cold cathode fluorescent surround fitting in a white opaque tray which borders the CRT face. The glow from it is adjustable by an externally fitted series resistor. The effect is pleasing and restful, and it is claimed that increased viewing comfort is obtained and picture presentation enhanced.

While I have had no opportunity of trying it over a protracted period, and under different conditions of room lighting, there would appear to be quite a reasonable basis to suppose it would assist in more comfortable viewing. The cold cathode tube is designed by Atlas Lamps, and it is excited by a small 50-cycle auto-transformer.

Other Highlights

Cyldon had two types of single-knob TV tuners on show, to give a selection of any of the BBC channels. Indeed, model TV12 covers a range of no less than twelve carrier frequencies. Both this and the five-channel model are extremely compact, and no difficulty should be found in accommodating them in the smallest of cabinets. The early advent of alternative programmes will

create a still wider interest for tuners of this type for incorporation into existing sets.

I was particularly impressed with the picture quality of the 30-inch Nera projection model, C30, which gives a clean and bright image. I also saw it under the less favourable conditions—a broadcast of a BBC telefilm—when it was good enough to make me dodge away to view a normal receiver, just to make sure there was nothing special about that particular film-strip. The Cabinet is stylish, compact and practical. The picture was rock steady, and adequate for viewing under normal lighting conditions, if thoughtfully positioned. "Bounce" on scene changes was completely absent, but I had no opportunity of seeing it behave under interference pulses. The makers claim automatic filter circuits almost entirely eliminate the irritating effects of aircraft flutter.

The picture from the 4ft by 3ft model is far less impressive, both from the point of view of brilliance and definition. Obviously there must be a loss on both points, but even after allowing for this it did not seem proportionally as good. I have yet to see a TV picture that size which has satisfied me. A 30-inch picture can be viewed at reasonably close range with pleasure, and will completely satisfy two or three dozen viewers. Bigger than that, it begins to look like a movie seen through the slats of a Venetian blind. One is constantly conscious of the line-iness no matter how far one stands back.

A service which may be of interest to readers, at any time, is being met by "Direct TV Replacements." While they supply all replacements, their great speciality has become the line transformer. Most servicing engineers will agree this is the weak link in most receivers, and readers may recall the experience in obtaining a replacement related in this column some months back. Re-winds can be made on the original core when it is often possible to modify the design slightly to obviate a repetition of the cause of breakdown. The experience gained from stripping break-downs has also led to other improvements, such as fitting

anti-corona rings, etc. This firm normally supply line output transformers from stock, but re-winds of all types are undertaken.

Going Places

I have just finished reading a couple of books on Space Travel. The serious sort, I mean—somehow I have never been able to bring myself to reading Space Fiction. It is amazing the way Guide-Books for interplanetary travel have multiplied within the last few months. Some even give precise specifications for building a Space-Ship, even down to the little details. The only thing they seem to overlook is the radio to keep in contact with Mother Earth. Perhaps they think it's going to be easy; perhaps unnecessary.

These last two books I've read on the subject begin to take a view more sober than the cheerful optimism of earlier works. So much so, that I have almost come to the conclusion that the physical hazards, dangers of cosmic radiations, risk of meteorites, plus the difficulties not yet foreseen, puts the possibility beyond this century. Perhaps by that time radio development, which to use a hackneyed phrase, is still in its infancy, will present no problem.

Centre Tap talks The Television Society Show · SWL's about Himself · The Friendly Spirit

We who have been so closely in touch with electronics, and seen the wonders of TV, Radar and the electronic microscope become realities before our very eyes, should be the last to become disheartened by difficulties. Yet perhaps it is our successes in these spheres which tend to make us over-optimistic. But to escape from the Earth, a speed of some 25,000 miles an hour is needed. At least, to do it without a wildly extravagant fuel consumption and extra bulk. As the fastest rocket yet built does a mere 5,000 m.p.h. or so, perhaps after all there is no need to worry about that radio just yet.

A New Need

Apparently I hit the jack-pot last month in touching upon subjects which are very much in the minds of readers. Many have written regarding the cessation of *The Radio Amateur* as a separate publication, and would like to see most of the more popular features figure in the pages of this magazine. Unfortunately, this is not possible at the moment in view of the many constructional items planned for the coming months. Our older readers will have noticed that the number of pages has grown progressively bigger in

the last couple of years without any lowering of paper and typescript standards. We have been steadily gaining new readers and at the same time keeping the old. At no stage during the 90 odd issues has the circulation slipped back. Each step towards a wider readership and greater influence makes possible a still better magazine. May the process continue.

The keen SWL misses the *Radio Amateur* features which directly appealed to him, and unfortunately he is left without any publication primarily devoted to his needs. The only other one which might have helped to fill the gap has, I understand, packed in after a couple of issues. Surely an all-time record for short runs!

It would be a reasonably accurate estimate to assess the number of keen SWL's at nearly 10,000, and it seems their interests are to be pushed into the odd pages of general radio literature. Perhaps the hope I expressed last month, that the R.S.G.B. will pursue a more vigorous policy to cover BRS needs more fully, will materialise. A couple of pages in the *Bulletin*, or a 4-page monthly supplement, would go a long way to filling this sudden void.

There is one important point, though. It must be run by a BRS member who really spends his time on the bands and knows something of SWL activity. I've spent a long time in the hobby but never do I feel at a greater loss than when in a den of SWL's, who tell me what is really happening on the air. I can only manage one band at a time!

Tuppence Coloured

It is purely a coincidence that I have had something to say on Editorial affairs this last two months. I mention this as there is a growing suspicion that I am the Editor, or rather that he's me, hiding behind a *nom-de-plume*. Perhaps the fact that R.C. has dispensed with an Editorial for three years or so has lent a little support to the idea. An Editor has to carry the can for all sorts of things already, so don't blame him for all my queer ideas and funny prejudices as well. However, having been associated with him since the earliest days of the SWN, I suppose he has gradually grown so used to me putting my spoke in that he no longer regards it as an intrusion,

[cont. on page 464]

ORPHEUS

TAPE RECORDER

PART 4

Described by A. S. TORRANCE

Completion of Component Installation, and Wiring

THE CHASSIS HAVING BEEN PREPARED, as described in the last instalment, and ready for permanent attachment to the tape deck, a start should be made at each end, lightly tightening the jacks at the output end, and the co-ax sockets at the input end. Underneath the inner nuts of the co-ax sockets, add a solder tag to each. It is here that the busbar commences, and at this point is earthed.

The switch may now be installed, and positioned so that the dark brown lead which goes to the recording head is as short as is possible.

Before fitting the meter, the scale printed in this issue can be glued inside, if so desired. It is necessary to remove the existing scale plate, and with this to cut out a paper template the correct size and shape. This latter may then be placed over the printed

and condensers. The constructor may be wondering about the mounting of these; it is, in fact, a question of individual choice — a tag strip, or individual mounting may be employed. Individual mounting involves, perhaps, more trouble, but is probably the best method.

Many of the metal-cased condensers develop an electrostatic charge on the casing, resulting in crackling if the casing should make intermittent contact with the chassis. It is best, therefore, to clip all such

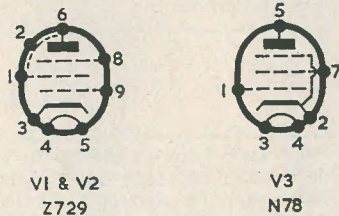

V1 & V2
Z729

V3
N78

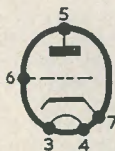

V4
L77



V5
N727

All Osram valves

VALVE BASE DETAILS

NOTE: V3 IN COMPONENT LIST IS SHOWN INCORRECTLY AS N729



RECORDING LEVEL METER SCALE
(Actual size)

scale, positioned so that the relationship between scale and scale plate is correct, and then cut out with confidence.

All the remaining components can now be added, with the exception of the resistors

condensers to the chassis. However, a double tag strip may be used, and the casings bound with tinned copper wire which is returned to the busbar. In such a case, some form of insulation should be used to

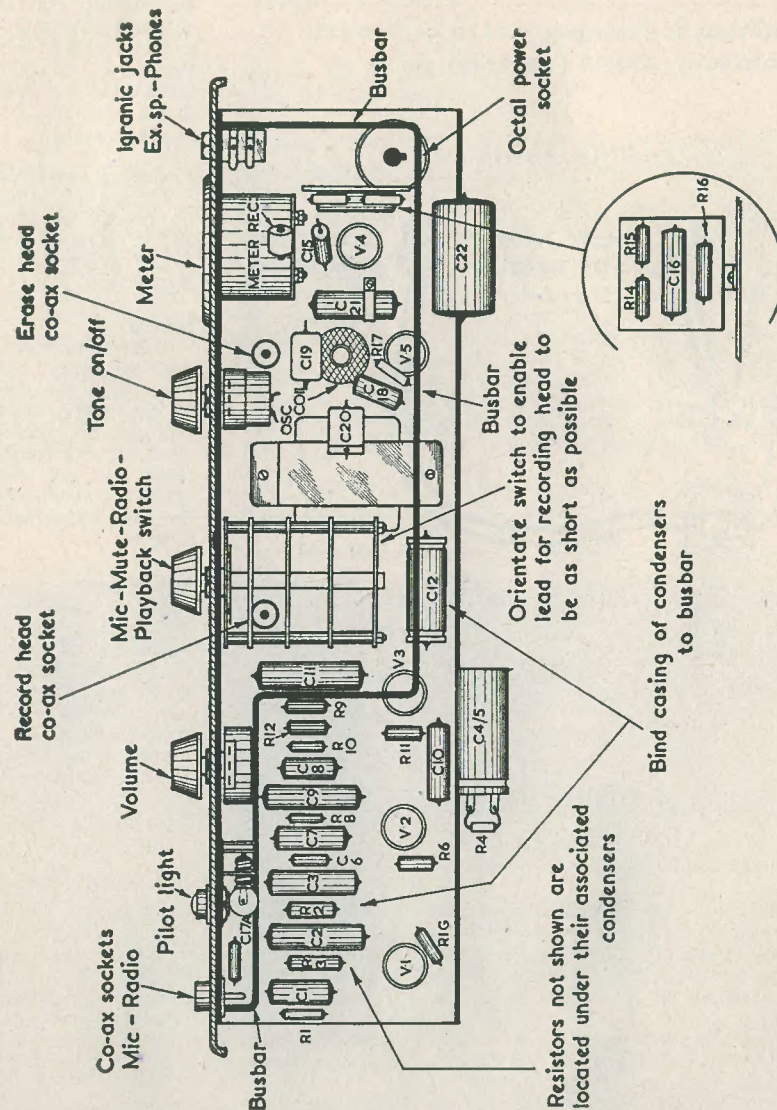

UNDERSIDE OF CHASSIS SHOWING LOCATION OF COMPONENTS

prevent the casings shorting to the chassis direct.

The busbar should now be prepared. This consists of 14 swg tinned copper wire; a lighter gauge should not be employed.

twisted PVC, wire up the heaters to all the valves. Add in the resistors and condensers, completing one stage at a time.

Oscillator Coil

It will be noted that the oscillator coil is not screened; screening was, in fact, found to be unnecessary. The condensers should be mounted in the positions shown in the drawing.

Recording Level Meter

The tag strip is made up exactly as shown, and is mounted before wiring to the L77 and the meter.

Switch

This component is supplied fully wired, but some of the coloured leads will have to be replaced by screened leads. It is advisable to retain on the switch about $\frac{1}{2}$ " of each colour for easy future identification.

Wiring Tests

Before switching on, the usual simple tests should be made to ensure that no inadvertent connection has resulted in a short between HT and heaters, and HT and chassis. A check should also be made that all soldered joints are sound.

Installation Safeguards

It is absolutely essential before fixing the tape deck into the cabinet to make sure that the mechanisation is not fouling either the power pack or the mains input socket. This can easily be determined by temporarily leaving the fitting of the ventilation grilles, when inspection with the aid of a torch will ensure that adequate clearance is being made.

Recording

Lacing in the tape is quite simple, but at all times should be undertaken with care so that no damage is caused to the felt pressure pads. The correct pressure and

[cont. on page 464

Connections to recording head to be reversed if incorrectly phased (see text)

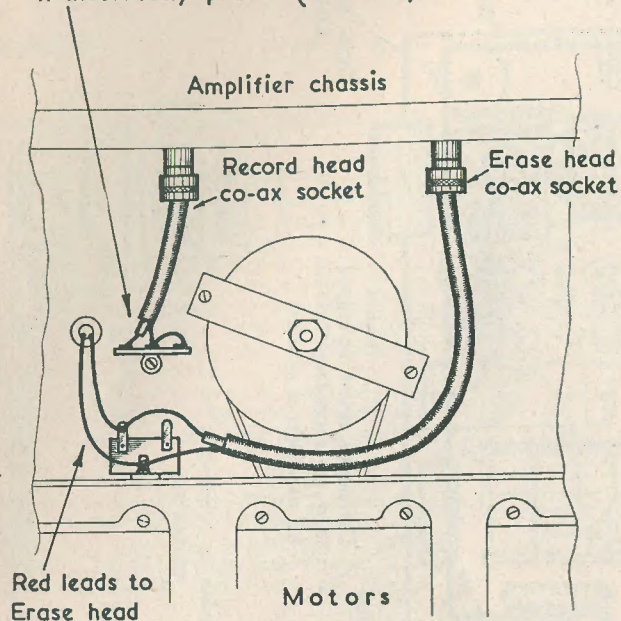

DETAILS OF WIRING TO RESPECTIVE HEADS

As stated earlier, commence at the junction of the co-ax sockets, and run the busbar around the chassis as shown by the heavy black line on the layout drawing. When formed, terminate at the output jacks, but do not earth.

The appropriate wire ends of resistors and condensers may be bent up to the busbar, grouping those of each stage together. It is important that they are not spread out, as the purpose of the busbar is to enable each valve stage to become a separate section, and thus minimise hum effects.

Wiring

Starting at the octal socket with well-

The

ECONOMY FOUR

By A. C. V. SEYMOUR

QUALITY AND EXPENSE are inseparable terms whenever there is a discussion on amplifiers. High fidelity is bought at high cost, runs the argument.

But from the present writer's viewpoint the most serious drawback with amplifiers is that they fall into two sharply defined classes. They are either much too complex, expensive and intractable, or much too simple, inexpensive — and equally intractable.

In the belief that quality need not automatically imply overmuch expense, the writer decided to construct an amplifier, the specification for which was to be as follows:—

1. It should be built around valves that were easily and cheaply obtainable.
2. It should employ conventional circuitry but give the highest possible quality.
3. It should give around 8 watts output.

The circuit finally used: a conventional pentode input, triode phase inverter, and beam tetrode push-pull output stage fulfils all the writer's requirements. It has sufficient gain for a tone-control circuit to be interposed between the signal source and amplifier unit.

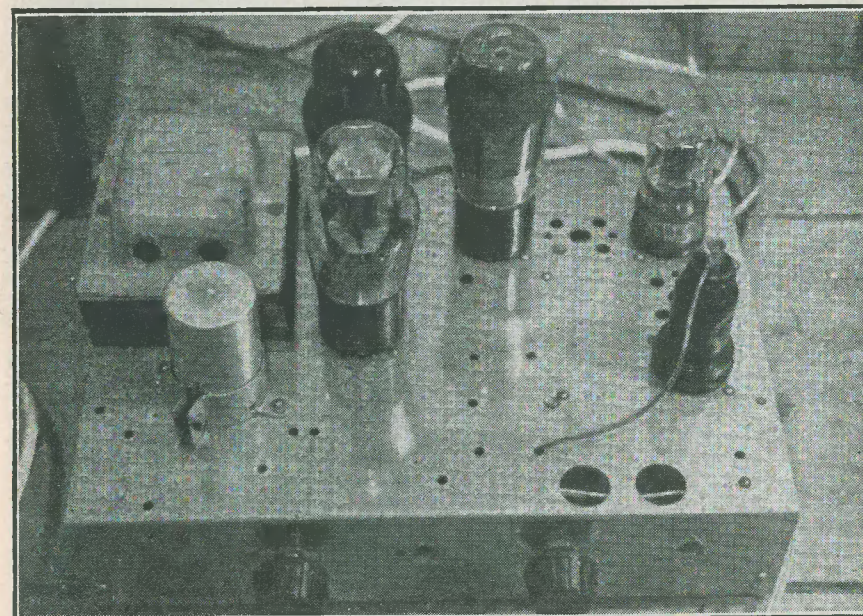

Top view of the prototype

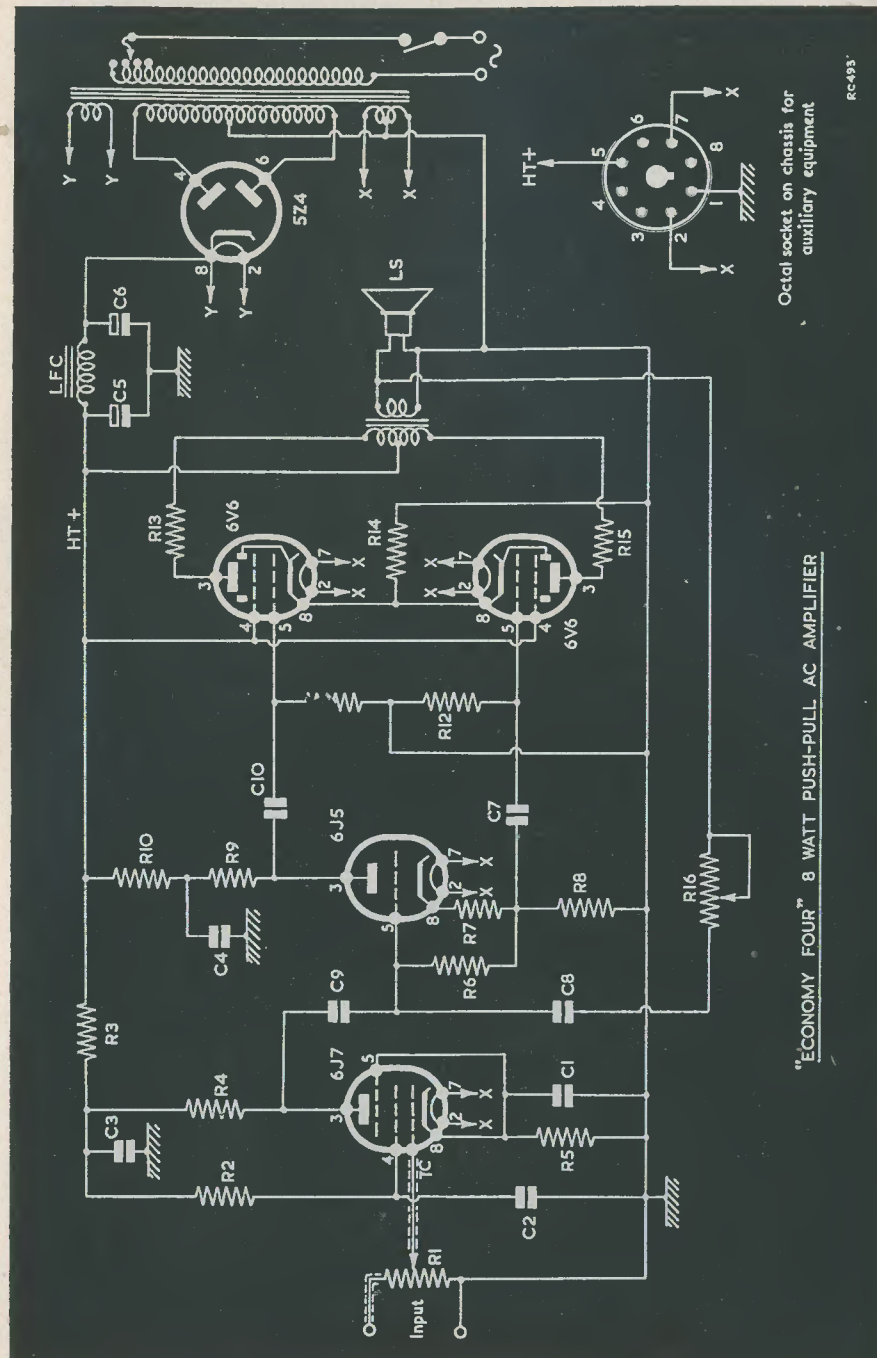

Circuit Details

The input circuit is designed around a 6J7 pentode which was chosen to provide adequate gain. The output from this valve is taken via C9 and the grid leak R6; this latter being joined to the low potential end of the grid bias resistor R7. The load resistance of the phase inverter is split into two parts, R8 and R9.

Across these two resistors the signal voltage is developed and is applied to the succeeding stage via C7 and C10.

The phase inverter circuit was used by the writer for two reasons. Firstly, it obviated the need for an alternative (and expensive!) transformer input to the push-pull stage. Secondly, the phase inverter circuit has much less inherent distortion, mainly because of the simplicity of selecting the correct and *equal* values of load resistance on which the usefulness of this circuit depends.

But this advantage of higher fidelity is bought at the price of a slight loss of gain in the phase inverter circuit.

A tone control is fitted in the feedback line from the secondary of the output transformer. This transformer should match an anode-to-anode load of 10,000Ω into a 3Ω speech coil; a ratio of 60:1.

It will be noticed that the anode feed of the push-pull stage is taken direct from the rectifier cathode. This obviates the use

RESISTORS

All resistors $\frac{1}{4}$ watt unless otherwise specified.

R5, R7	2.7kΩ
R2	2MΩ
R4, R6, R11, R12	270kΩ
R13, R15	47Ω
R14	200Ω 2 watt
R10	27kΩ 1 watt
R9, R8	27kΩ
R3	47kΩ 1 watt
R16	100kΩ tone control potentiometer
R1	1 MΩ volume control potentiometer

CAPACITORS

C2, C9, C10, C7	0.1μF 350V working paper
C1	25μF 25V working electrolytic
C8	0.004μF
C3, C4	8μF 450V electrolytics
C5, C6	16μF+16μF 450V electrolytics

Mains Transformer: 275V-0-275V 80mA; 5V 2A (rectifier); 6.3V 2.5 A heater winding
 Low Frequency Choke: 10 Henry 60mA
 Push-pull output Transformer: 10,000Ω anode-to-anode matching into 3Ω (60:1) 10" speaker.

of a large smoothing choke, since the ripple present is cancelled out by the push-pull action of the valves. There is no cathode by-pass capacitor in this stage for the same reason. Two 47Ω parasitic stoppers are fitted in the anode supply to the 6V6's.

All the valves used in the circuit are readily available and inexpensive. Most constructors have them lying idle in the spares box.

It will be noticed that the LF choke specified by the writer does not appear in the photograph. A resistor, seen in the illustrations, was used instead, but was found to be a false economy and the LF choke is now installed. This choke should be a 10 Henry 60mA type.

The mains transformer should be a 275V-0-275V 80mA type with a 5V 2A rectifier winding and a 6.3V 2.5A heater winding.

It is recommended that an octal base be fitted to the chassis, from which the power requirements for auxiliary equipment can be taken. There is available 250V at 15mA and 6.3V at 1A for this purpose.

Since the output is approximately 8 watts of good quality, the writer uses and recommends a speaker of at least 10" diameter. An 8" speaker was used, but the larger diameter in a good baffle gives much better results.

Construction

A steel chassis should be used to provide best screening results between the output transformer, beneath, and the LF choke and mains transformer above the chassis. All these components should be mounted so that their cores are at mutually opposing axes.

When constructing this amplifier it is important to keep the input circuits well away from the mains and output sections, otherwise there is grave possibility of a high hum level.

Both the leads from the input sockets to the volume control and from control to grid of 6J7 should be screened. This screening should be earthed.

It will be noticed from the circuit diagram that earth returns from cathode, G1, G2 and G3 are taken to one earth point. This is important in the interest of low noise level.

After the heavy units have been fitted, all the smaller components can be mounted.

A word here about electrolytics. Although this is basically an economy circuit, the constructor is strongly advised that the smoothing condensers be of first class quality. The use of ex-W.D. electrolytics is deplored by the writer because they deteriorate so rapidly under certain storing conditions. Thus, their use can lead to repeated replacement of the rectifier valve.

The lead from the tone control to the secondary winding of the output transformer should be left unconnected until the amplifier is ready for testing. The reason for this is that, unless the lead is connected to the correct side of the transformer, positive feedback will occur, resulting in uncontrollable instability. Therefore it is advisable to have both the above-mentioned lead and the earthed lead of the output transformer secondary disconnected until they can be tried to ascertain the correct position.

Heaters should be wired in twisted pair, to cancel out hum.

When using a pick-up fitted with a screened lead, it is essential for the screening to be connected to the earth input socket.

When the amplifier is on test, make sure that the pick-up input leads are fitted into the correct sockets. If they are connected the wrong way round, hum will be appreciable.

If care is taken in its construction, the response and quality of this amplifier will satisfy all but the most fastidious — and there's no satisfying them!

A small valveless compensation unit for LP and standard records is at present under construction, and after trial will be the subject of a further article.

Radio Miscellany

from page 457

When I have a hunch I let him know all about it — and keep it up until he has to take due heed. Mostly my hunches are right and I take very good care he doesn't forget about that either. So when the use of colour in our titles and circuits was first discussed I was very strongly "agin it." As I am still "agin it" I can well imagine a few readers muttering "He's obstinate as well as cranky."

Every reader who knows anything about printing will tell you that it costs quite a bit of extra money. I would have preferred to see the money spent on extra pages, and if it didn't run to it every month, to have an extra large issue each Quarter.

Now the annoying part is that practically every correspondent who has commented on the colour praises it, and even those I have slyly "probed" in ordinary conversation prefer it.

I am still the odd man out. Won't somebody agree with me? Please!

The Friendly Spirit

Last month I spoke of the deterioration of the Ham spirit. Maybe once again I was wrong, but at least a very large number agreed with me.

Since then it has been brought home to me forcibly that, whatever the state of the Ham spirit, there is a very comradely "Constructor spirit" among our readers. Almost without exception, every reader who has appealed under *Can Anyone Help?* has later written to praise the friendly helpfulness of others. One or two have had to spend quite a lot of spare time writing letters of thanks to their correspondents.

It is heart-warming to feel that such a fine spirit still exists, and I would also like

to thank all those who have so willingly helped their fellows in matters of experience, identification and circuits. May you, if you ever need help in those respects, also find an equally hearty response. Moralists are constantly reminding us that this is the most selfish generation ever. Maybe that is true of the general population, but it is good to know that among constructors the fraternal spirit is as strong as ever.

The Orpheus

from page 460

location of these is very important to good recording and erasure.

It is not possible to give much guidance on the recording level, as this will vary with each instrument and must be determined by personal experiment. When satisfied with an average level, the zero pre-set control (VR3) should be set and then left.

Radio Recording

High quality recordings from the local radio stations can easily be made by using a simple crystal diode unit such as that described in *Tape and Wire Recording*. Incidentally, since this was published one of our advertisers, The Teletron Co., have introduced a coil specially designed for crystal diodes which avoids undue damping by the diode of the tuned circuit, and so improves selectivity — a matter of some importance in the area served by the Home and Light Programme transmitters.

It will be seen from the circuit that it is necessary to remove the input plug from its socket after recording and before playing back. Similarly, before rewinding, always turn the switch to "Playback".

Query Corner

A Radio Constructor Service for Readers

Frequency Modulation

I hear that there is a strong possibility that the present B.B.C. service will be augmented by a number of transmitters radiating a frequency modulated signal. What are the advantages of this system?

C. White, Ipswich

Many readers will recall an article in a previous issue which discussed methods of modifying standard receivers to improve medium wave reception. The problem was raised by a listener who reported that in his locality many signals were marred by strong whistles, and others by fading. As the spectrum becomes more congested and the output of transmitters is increased, these reception difficulties have spread until now even the strong local signals are frequently affected. The interference is usually very much worse after sunset, when propagation conditions improve and signals from the more distant stations reach the receiving aerial. The greatest annoyance is caused by adjacent channel interference; this takes the form of a whistle, which is in fact a beat note formed by an unwanted station working on a frequency which is only a few kc/s away from the wanted signal. A whistle will be audible if the ratio of the two signals at the receiver detector stage is less than 100:1. This figure is worthy of some consideration, as it gives some idea of the magnitude of this problem of adjacent channel interference.

The system of frequency modulation has been adopted in some countries largely because it provides much greater freedom from this and other forms of interference. When a listener is first introduced to FM he is immediately struck by the absence of all forms of background noise, his second reaction usually causing him to comment on the improved quality of reproduction.

A brief explanation of the principles involved in this type of transmitter will better serve to indicate how these advantages are obtained. In FM, the amplitude of the carrier signal is kept constant whilst the frequency is varied between certain limits in sympathy with the modulating voltage. The change in carrier frequency depends upon the amplitude of the modulation, whilst the rate at which the frequency changes is governed by the frequency of the modulating voltage. A clearer picture of this action can be obtained from the graphical representation of an FM signal shown in

Query Corner

RULES

- (1) A nominal fee of 2/6 will be made for each query.
- (2) Queries on any subject relating to technical radio or electrical matters will be accepted, though it will not be possible to provide complete circuit diagrams, for the more complex receivers, transmitters and the like.
- (3) Complete circuits of equipment may be submitted to us before construction is commenced. This will ensure that component values are correct and that the circuit is theoretically sound.
- (4) All queries will receive critical scrutiny and replies will be as comprehensive as possible.
- (5) Correspondence to be addressed to "Query Corner," Radio Constructor 57 Maida Vale, Paddington, London, W.9.
- (6) A selection of those queries with a more general interest will be reproduced in these pages each month.

Fig. 1. The upper waveform depicts the carrier and shows the way in which the frequency varies according to the amplitude of the audio modulating voltage below.

At the start of the audio voltage the carrier has its nominal frequency, but as the amplitude rises the frequency increases to a maximum at 90° and then returns to the normal at 180°. During the negative half-cycle the same thing occurs, but this time the carrier frequency is reduced below its

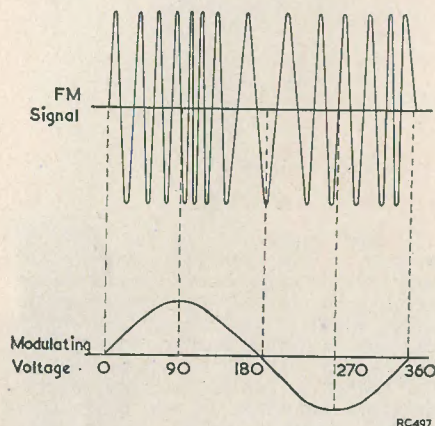

Fig. 1. Showing manner in which the frequency varies in accordance with the modulating signal

nominal value. It follows that if the frequency of the modulating voltage were doubled, the carrier frequency would deviate about its centre value at twice the speed.

The degree to which the modulation is made to alter the carrier frequency has been standardised at 75 kc/s. This figure represents the best compromise between freedom from interference and bandwidth; and an idea of its effectiveness can be gained from the fact that interference from an adjacent channel only becomes noticeable when the amplitude of wanted to unwanted signals exceeds 2:1. Compare this with the 100:1 figure quoted earlier for AM, and the main advantage of FM will be apparent. Because of the bandwidth required for an FM transmission, most stations operate in the VHF band, usually around 100 Mc/s.

Receivers designed for use on FM transmissions differ from the more familiar AM sets in several ways. Firstly, it is usual to employ a superhet, which tunes over part of the VHF band and must therefore have a relatively high intermediate frequency if local oscillator pulling and second channel interference are to be avoided. An IF in the region of 11 Mc/s is normally chosen.

The stage before the detector is usually employed as an amplitude limiter, and prevents variation in signal level and interference pulses being passed on to the detector. The detector stage is of unusual design, as it has to convert variation in signal frequency into an audio voltage. This stage is often referred to as the discriminator because of its ability in discriminating between differences in input frequency.

This short explanation will probably serve as an introduction to a subject which must be new to many readers. It is, nevertheless, a subject which will in time widen the scope of constructors and generally add to the pleasure of our hobby.

Slot Aerial for FM

I am interested in the article in the last December issue of The Radio Constructor describing the use of slot aerials for TV. Is such an aerial suitable for use on the Wrotham FM transmission, and if so could you supply me with modified dimensions?

W. G. James, Cambridge.

In general, any type of aerial which is suitable for television use can be scaled down to work on the present BBC FM transmission from Wrotham in Kent. It is important to remember, however, that this transmitter puts out a signal which is horizontally polarised, and so apart from simply scaling down the dimensions of a TV aerial it is also necessary to rotate it by 90°. Thus, applying this procedure to the slot aerial described on page 276 of the December 1953 issue, the dimensions for 91.4 Mc/s are as follows.

Size of wire netting: 7ft x 2ft 6ins approx.

Size of slot: 5ft x 5½ins.

The slot should be in the centre of the netting, and the whole system must be mounted so that the long side is in the vertical plane. The method of connecting the feeder cable will be the same as for the television aerial.

Volume Gain

Can the proximity of a speaker magnet to a valve affect the overall gain of the valve?

E. Curry, Gravesend

Much, of course, depends upon the strength and direction of the magnetic field, but cases have certainly been known where such a field has produced a substantial reduction in the performance of a valve. This type of trouble usually occurs in small battery receivers where the speaker magnet is in all probability within a fraction of an inch of one of the valves, the most susceptible valve being the R-C coupled amplifier. It appears that the magnetic field deflects a proportion of the electrons which go to

make up the anode current of the valve, and causes a reduction in the amplification. The severity of the trouble is also affected by the type of metal used to make the anode of the valve.

The solution is to employ a loudspeaker which has a low leakage flux, many modern miniature speakers being specially designed to reduce the leakage field to a negligible amount.

FRINGE AREA TELEVISION

By J. GLAZER

PART 3: SYNC AND TIME BASE CIRCUITS

THE SYNCHRONIZING SEPARATOR is that part of the television receiver which sorts out the frame and line timebase locking pulses from the video signal. The separator consists of a high gain pentode, and a single diode, which acts as an interlace filter. The interlacing was found to be exceptionally good with this circuit, and

there was definitely no critical setting with any of the timebase locking controls.

Reference to the circuit diagram shows an EF50 valve as the sync separator, this being fed from the vision unit via a 0.1µF capacitor. The input to this valve has a negative vision signal with positive sync pulses, and the DC level of the signal is

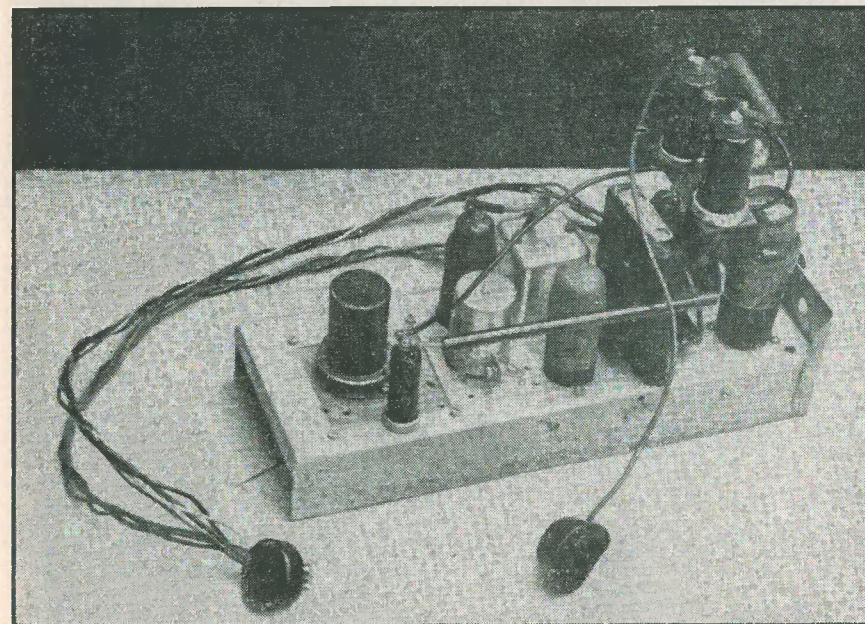

The author's sync and timebase unit

restored by the self-bias circuit, C1 and R1, the cathode of the EF50 being returned direct to chassis. The negative vision signal drives the EF50 beyond anode current

inside an aluminium can, 1 1/4" square by 2" high. The can also contains R23, R24, C9, C10 and C10A. Four leads protrude from the base of the can; these are coloured

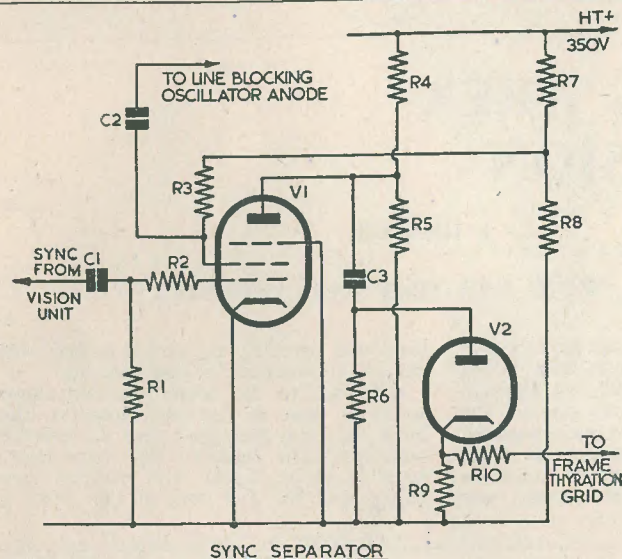

- Sync Separator**
- R1 820kΩ 10%
 - R2 10 10kΩ
 - R3 15kΩ
 - R4 220kΩ
 - R5 47kΩ
 - R6 82kΩ 10%
 - R7 100kΩ
 - R8 33kΩ
 - R9 22kΩ
 - All resistors 1/4 watt except where stated.
 - C1 0.1μF 350V wkg.
 - C2 22pF
 - C3 470pF 10%
 - V1 EF50
 - V2 EA50

RC474

cut-off, and the positive sync pulses cause pulses of anode current to flow. These pulses are negative-going, and are suitable for synchronizing the line timebase, which is of the blocking oscillator type.

The current pulses at the screen of the EF50 are also negative-going, and these are passed through the interlace filter circuit, which incorporates an EA50. This circuit has an RC coupling, which has a critical time constant of 40 micro-seconds. This coupling consists of R6, 82kΩ, and C3, 470pF, and it raises the level of the negative-going frame pulses. The interlace diode acts as a limiter and blocks the line pulses, which completely eliminates the latter from the frame timebase. The frame sync pulses are positive-going at the cathode of the interlace diode, and are suitable for triggering the frame timebase thyatron. The HT voltages on the EF50 are kept low so that interference will not upset the separating.

The Line Timebase

The line timebase oscillator consists of an EBC33 triode in conjunction with a blocking oscillator transformer. There are several suitable transformers on the market, but the one used in the prototype is made by "Denco." This transformer is mounted

as follows:—

- Blue To the line amplifier grid.
- Yellow To the line frequency control.
- Red To the HT line.
- Thin Blue To sync and EBC33 anode.

Screened Lead (Top of can) to EBC33 grid. The line frequency control is a variable resistor of 10kΩ in series with a 33kΩ resistor connected between the grid of the EBC33 and chassis.

The sawtooth waveform generated by the line timebase is amplified by a 6P28 beam tetrode, which has an anode dissipation of 25 watts. This valve, used as the line timebase amplifier, gives first class results, especially when used in conjunction with efficient scanning units. The cathode resistor of the 6P28 is 100Ω, and its decoupling capacitor C11 controls the ratio of the left half of the picture to the right half. Increasing this capacitor will expand the left side of the picture, whilst a reduction will contract it. The anode load of the 6P28 is the primary of the line output transformer. There are three secondary windings on this transformer:

1. The EHT winding (auto).
 2. The EHT rectifier heater winding.
 3. The scanning coils' matching winding.
- The ratio of the latter winding to the primary is usually about 4:1. The line width

control is a variable inductance in series with the scanning coils, and the variable resistor, R30, acts as linearity control.

from the 6P28 was about 23 watts, and it can be varied by trying different values of resistance in the HT supply to the screen

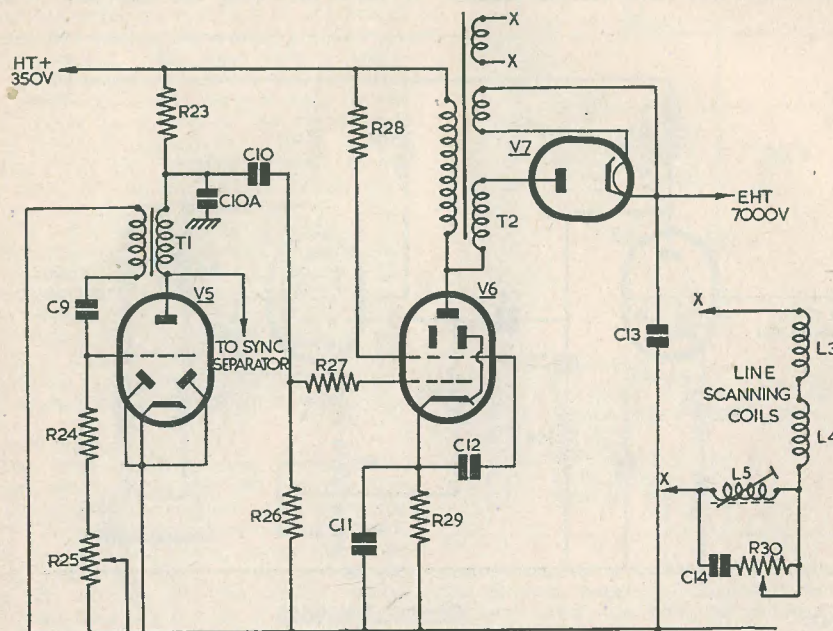

RC475

- LINE TIMEBASE**
- R23 220kΩ
 - R24 33kΩ
 - R25 20kΩ variable (frequency)
 - R26 0.5MΩ
 - R27 270Ω
 - R28 5kΩ 5 watt vitreous
 - R29 100Ω 1 watt
 - R30 2kΩ variable (linearity)
 - C9 0.002μF
 - C10, 10A 0.002μF, 350V wkg.
 - C11 0.05μF
 - C12 0.1μF, 350V wkg.
 - C13 0.001μF, 10kV wkg.
 - C14 0.01μF, 350V wkg.
 - V5 EBC33
 - V6 6P28
 - V7 EY51, or Metal Rectifier Sen-TerCel K3/100
 - L3, 4 Line scan coils, low impedance
 - L5 Width control
 - T1, T2 See text.

The EHT rectifier is an EY51, and a potential of about 7kV is obtained. The writer used a CRM123 CRT which, takes a maximum of 10kV, and added an EHT boost to bring the voltage up to 9kV. This booster consists of two high voltage 0.001μF capacitors, a 2.2MΩ resistor and a 36EHT 100 rectifier. During the flyback period of the scanning stroke, a voltage of approximately 2kV is developed at the anode of the 6P28, and this is rectified and added to the existing EHT voltage. The power required

grid. The best value was found to be 5kΩ, which is decoupled to the cathode by a 0.1μF capacitor. The writer tried various efficiency diode circuits but found none of them really necessary, as the 6P28 easily scanned the twelve inch CRT on normal HT volts.

The Frame Timebase

The frame timebase incorporates a 6K25 gas-triode for generating the necessary waveform. Although the thyatron does not give the voltage output of a blocking

oscillator, it is more simple to operate; and the frame scanning coils do not need as much driving power as the line coils. The 6K25 is fed with the positive sync pulses from the interlace filter diode, and the frame frequency control is a 10kΩ variable resistor

resistor in the cathode bias line, and the height control is a 250Ω variable resistor connected in the HT— line. The frame scanning coils are of the high impedance variety and are fed direct from the anode of the KT61. They are decoupled to the

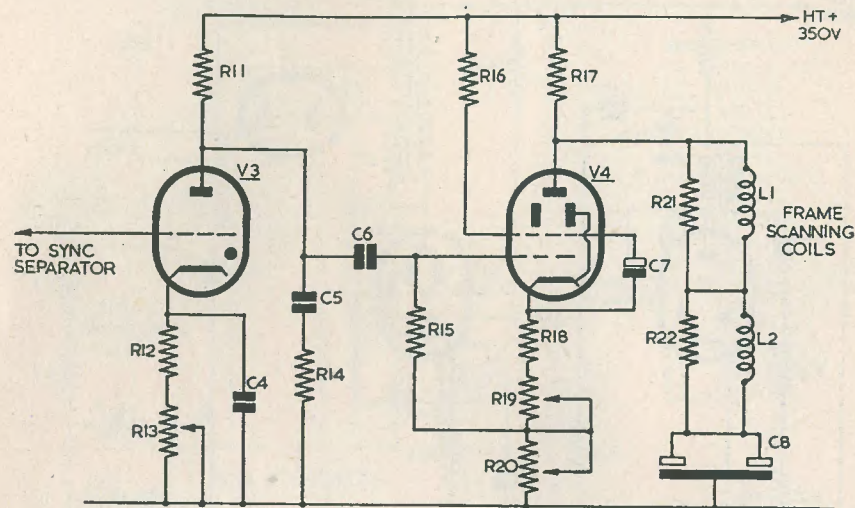

RC477

FRAME TIMEBASE

Frame Timebase

- R11 150kΩ
- R12 22kΩ
- R13 10kΩ variable (frequency)
- R14 220Ω
- R15 1MΩ
- R16 10kΩ 5 watt vitreous
- R17 6kΩ 10 watt vitreous
- R18 47Ω
- R19 100Ω variable wire-wound (linearity)
- R20 250Ω variable wire-wound (height)

R21, 22 33kΩ

- All resistors ½ watt except where stated
- C4 0.5μF
- C5 1.0μF paper, 500V wkg.
- C7 16μF electrolytic, 350V wkg.
- C6 0.5μF, 500V wkg.
- C8 24+24μF electrolytic, 450V wkg.
- L1, 2 Frame scan coils, high impedance, yoke wound
- V3 6K25
- V4 KT61

in the thyatron's cathode. The best value for the anode load was found to be 150kΩ, as this gave maximum output for the HT voltage used. The anode charging capacitor, C5, fixes the oscillating frequency at 50 cycles, and its series resistor, R14, corrects the waveform. The output from the thyatron is taken through a 0.5μF capacitor to the grid of the frame amplifier V4, a KT61 beam tetrode. The screen feed resistor to this valve is 10kΩ, which is decoupled to the cathode by a 16μF capacitor, whilst the anode load resistor has a value of 6kΩ. The frame linearity control is a variable

chassis by a 24+24μF electrolytic capacitor, which prevents any appreciable DC current flowing through them.

Construction

Both the timebase circuits and the synchronising separator are built on the same chassis, which is 12" long by 5" wide and 2" deep. The EF50 is positioned in the centre at one end of the chassis, and the two timebases divide, one on each side of the chassis. The blocking oscillator coil unit is mounted close to the EBC33 and the interlace diode is fixed under the chassis with

its anode pointing towards the EF50 valveholder. The two power valves are positioned in line with their respective timebase components at the far end of the chassis, and the various controls are found at strategic points close to their associated circuits. Small tag strips are mounted at convenient points, but most of the smaller resistors are self-supporting. The line output transformer is mounted between the thyatron and the power valves; the best place for the EHT boost is on top of the transformer (well above the chassis).

The EY51 EHT rectifier is wired to the tag panel on the line output transformer; a metal rectifier can be used, and the "SenTerCel" K3/100 (which is longer than the "Westinghouse" variety) can be mounted down the frame side of the chassis. The 0.001μF EHT smoothing capacitor can then be mounted next to the EF50 valve. If a metal EHT rectifier is used, it will mean a slightly lower EHT voltage, but it will act as its own bleeder resistance and will probably last longer than a valve.

Control Settings

The most assuring thing is the faint whistle that tells us that the line timebase is working and, therefore, we hope, the EHT. Something like a square should present itself on the CRT screen, which should be moderated in brilliance. Assuming that the engineers at the TV transmitting station are doing their job, a mass of jumbled lines should be illuminating the tube screen. Adjustment of the frame and line height

controls will bring the raster to a reasonable size, then by manipulating the frequency controls the picture will sort itself out and

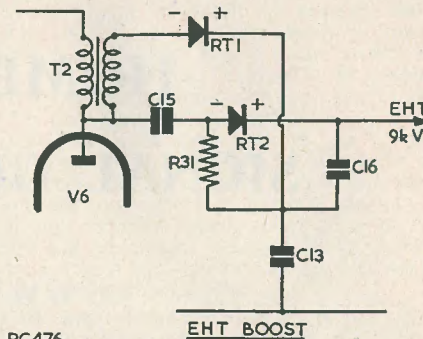

RC476

EHT BOOST

EHT Boost Unit

- RT1 SenTerCel K3/100 or EY51
- RT2 Westinghouse 36EHT100
- R31 2.2MΩ
- C13 0.001μF 10kV wkg.
- C15 0.001μF 10kV wkg.
- C16 0.001μF 10kV wkg.

present itself as it should be. Re-adjusting the controls (especially linearity), on the test card signal, will bring the picture to its true proportions.

(To be continued)

A Versatile Low Current Consumption Miniature Output Pentode

Mullard Ltd. announce the availability of the EL85 A.F. and R.F. Output Pentode. This is a novel-based valve intended for AC mains operation. The heater rating is 6.3V, 0.2A, which is low in view of the maximum cathode current rating of 35mA. The EL85, which has an anode dissipation of 6 watts, may be used as an A.F. output valve or as an R.F. amplifier up to 120 Mc/s. As a class "A" audio amplifier it gives an

output of 2.8 watts when operated with an H.T. supply of 225V and an anode current of 26mA. As an R.F. amplifier, it will deliver 2 watts at 100 Mc/s.

The EL85 should be of great use for equipments requiring moderate power output and where low L.T. drain is important. It is particularly suitable for mobile transmitters and receivers, where it may be used as a driver, modulator, or audio output valve.

HELVETIA 22 - CONTEST

U.S.K.A. announce that their annual contest will be held this year from the 20th March 1500 hrs. GMT to the 21st March 1700 hrs. GMT. This year marks the Society's 25th anniversary, and special efforts will therefore be made to see that this is a very successful contest. Its object is to enable amateur radio stations outside Switzerland to work as many stations as possible in each of the 22 Swiss cantons, thus qualifying contestants for the Helvetia 22 Award. Further particulars may be obtained from:

"H22 — Contest Committee, U.S.K.A., Postbox 1203, St. Gallen, Switzerland."

ALIGNING THE HOMEBUILT SIGNAL GENERATOR

By T. W. DRESSER

OF THE MANY ARTICLES ON HOME-BUILT signal generators published in the technical press of recent years, few have devoted any worthwhile space to the questions of aligning the instrument or checking its performance in other ways. The majority of such articles, in fact, content themselves by advising the builders to use strong BBC signals as a guide, which is all very well in a way but not of much practical use as it stands, having regard to the large number of frequencies the BBC uses on the short, medium and long wavebands. As a result of this lack of precise advice, home constructed generators are rarely even reasonably accurate and, to some extent, this also applies to many of the cheaper commercial types which have been in service for a long time without a check. On occasion the writer has borrowed such a generator to line up a receiver, and the results were so far out that subsequent alignment by ear on a broadcast signal was considerably better! There is no doubt that, all too often, far too much confidence is placed in a low-priced commercial instrument or in an amateur-built version, confidence which can lead to disaster if such a job as lining a double-conversion multi-band receiver is involved. It is a much wiser proceeding, in the long run, to check the instrument periodically against known accurate signals. You can then be certain that the dial indications mean what they say and are close enough for all normal purposes.

There are several ways in which such a check can be carried out. If the use of a crystal-controlled spot-frequency generator can be obtained it is ideal for the purpose, as it will provide sufficient strong harmonics

to give a number of check points above the broadcast band, usually the most difficult part of the coverage to fill in. Obliging dealers will often perform this service for you for a nominal charge, or some member of the local radio society will have such an instrument and will gladly oblige you.

Again, with the help of a good communication receiver, checks can be obtained from WWV, or some other frequency standard station, on 2.5, 5, 10, 15, 20, and 25 Mc/s; these are all useful points to mark in on the dial. Coastal DF beacons provide another check at about 1,100 metres, and the BBC long wave station on 1,500 metres, while the Rugby Post Office transmitter, GBR, will provide others. Reference to any list of stations—the *Wireless World* one, for instance—will give you the precise wavelengths and frequencies.

Another method uses a second signal generator, which need not necessarily be accurate. Tune in a broadcast signal on 200 metres (1.5 Mc/s) or 250 metres (1.2 Mc/s) on a receiver, then feed in a signal from the second signal generator to zero beat with the broadcast signal. Next, disconnect the aerial from the receiver to cut out the broadcast signal, but continue to feed in that from the generator. Harmonics of this signal can now be used to line up the test generator. For instance, 1.5 Mc/s will supply harmonics, and therefore check points, at 3.0, 4.5, 6, 7.5, 9, 10.5, 12, 13.5, and 15 Mc/s, while 1.2 Mc/s would furnish checks at 2.4, 3.6, 4.8, 6, 7.2, 8.4, 9.6, 10.8, 12, 13.2, and 14.4 Mc/s. By judicious choice of a series of original frequencies, it will be seen that the dial could be very finely divided.

Broadcast signals from the BBC and from strong continental stations can be used, and the higher wavelength (lower frequency) markings plotted in from them and their harmonics. As an example, suppose we choose a station on 450 kc/s—then the fifth harmonic comes out at 90 kc/s, the fourth at 112.5, the third 150 and the second 225 kc/s, and so on. Again by choosing a signal at an even figure, say 600 kc/s, plotting can be made much easier.

Using these methods and ideas an amateur signal generator can be adequately calibrated, and that of a commercial instrument given a thorough check over. In the case of the latter, if the error exceeds one per cent or so it would be good policy to prepare a calibration chart showing the precise frequencies, at least at key point dial readings. Similarly, the amateur-built job should be re-checked within a reasonable period, and if the deviation from the original markings is excessive a calibration chart should be made up, as in the case of the commercial instrument, and kept with the generator for quick reference.

RUFUS— The Radio Constructor

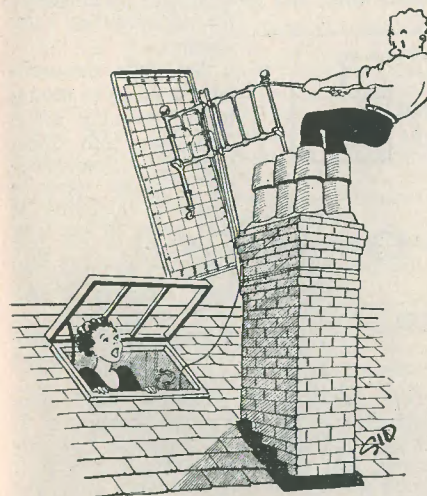

"Rufus, Mother's come to stay and I can't find the spare bed!"

Few amateur signal generators have provision for switching off the RF oscillator and using the audio section alone, yet this is a decided advantage when testing the LF end of a receiver, or an audio amplifier. A scrutiny of the circuit will generally show that this can be done very simply by inserting a single-pole double-throw switch in the circuit, one contact going to the present RF output connection and the other to the AF connection at the output point, while the pole connection goes to the output terminal itself. Variations of this form of switching may be necessary in some instances, but few instruments do not lend themselves readily to some simple form of switching and the advantages obtained by being able to use the audio signal alone are well worth the little trouble involved.

In conclusion, there are a few points which should always be observed if any signal generator is to give of its best. These are:—

(1) Whether battery or mains operated, switch on the generator at least half an hour before use. This will enable it to reach a stable operating condition beforehand, and will also ensure less fiddling in the actual alignment proceeding. If the instrument is in fairly constant use, as in a service shop, leave it on all the time. That way it will remain at a steady temperature, there will be no trouble due to excessive humidity, and the stability will be considerably improved. There is no need to worry about wearing out the valves. More valves are lost by switching on and off, due to contraction and expansion of the filament or heater, than ever go out of commission by ordinary wear and tear.

(2) Don't subject the generator to extremes of heat and cold. In other words, don't keep it in the attic, cellar or outhouse and take it into a warm room to do a job.

(3) Don't bounce it about as if it were a rubber doll. Remember it has compression type trimmers, closely spaced variable condenser vanes, and an inductance which doesn't take kindly to bouncing. It is reasonably robust, but not intended for treatment of that kind!

(4) If you have occasion to change a valve, particularly the RF oscillator, always check the calibration at the first opportunity afterwards. Valve characteristics are not always identical, and slight adjustment to the trimmers may be necessary.

Handle your generator in this way, check the calibration occasionally as outlined, and you will find these little attentions more than repaid by the results you get, and also by the fact that you will no longer have to worry about how far the calibration is out.

10 : ON THE AIR

By A. BLACKBURN

A QUESTION WHICH, sooner or later, must arise with all radio enthusiasts who intend putting their know-how and experience to good use is that of the type of transmitter they should use. Now a lot can be said on this subject, but I am not, for one moment, going to be diverted into a long chat about transmitter types, only to have to admit at the end that the ultimate choice rests with the reader — who only through usage and personal bias can decide what is the best type for himself.

All that I am prepared to do is give you a brief and very general description of the operation of any transmitter, and some of its basic components. Experienced radio amateurs will be full of helpful and sometimes conflicting suggestions on how to get the best from *your* type of transmitter, and the fellow next-door-but-one may be a staunch supporter of an entirely different technique to improve your transmission. The advice you take on that score depends on the

a licence. These conditions are laid down for your own protection, and for the protection of your fellow amateurs. They are not designed to dampen your enthusiasm. And remember, much important development work in present day radio communications was done by the radio amateur of the twenties.

The Post Office authorities set an examination for the aspiring amateur broadcaster, to ensure that he is technically competent to operate, and also include a Morse test. If you pass the exam., you get a licence to operate your transmitter. That's the general idea, but the Radio Society of Great Britain will give you full details.

* * * *

Fig. 1 is a block diagram of a transmitter. The heart of any transmitter is the oscillator, which determines the frequency of the transmitted wave, and provides the initial energy for transmitting the wave.

Obviously, the oscillator is going to need a lot of looking after. The first and most important characteristic it must have is frequency stability. It isn't going to be very much fun, or very efficient, to have to keep retuning a receiver every time the frequency of the received signal wanders about a bit.

One way — and probably the most satisfactory — to ensure high stability is to use the quartz crystal. Someone has discovered that if quartz is cut correctly in a certain way it will behave in very much the same way as an inductance capacity tuned circuit. This means that it will maintain very accurately the frequency at which it will resonate — just what we want, in fact.

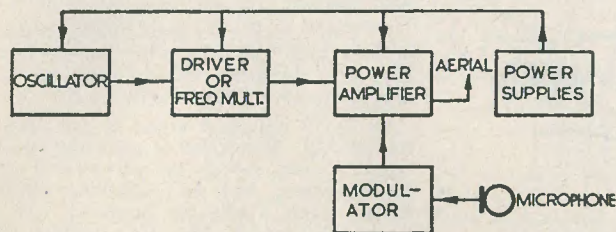

FIG. 1
BLOCK DIAGRAM OF TRANSMITTER

RC482

confidence you place in their knowledge.

If, after pottering about with radio for any length of time, you are really keen to get on the air yourself, and there are no strenuous objections to your staying up all night trying to get that signal from Australia, and erecting complicated structures in the garden, don't be disheartened by the apparent obstacles placed in your way to obtaining

The crystal is usually mounted between contact plates, on a plug-in base and protected by a strong cover. Fig. 2a shows a typical circuit for a crystal oscillator.

There is, unfortunately, a major snag to the quartz crystal. If you want to change

That is rather a complicated idea to fully understand without a great deal more explanation, but it is useful to remember, if you ever come across the fact again, that oscillation is the result of a negative resistance.

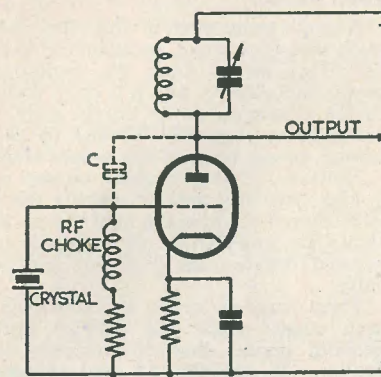

FIG. 2a
CRYSTAL OSCILLATOR

RC483

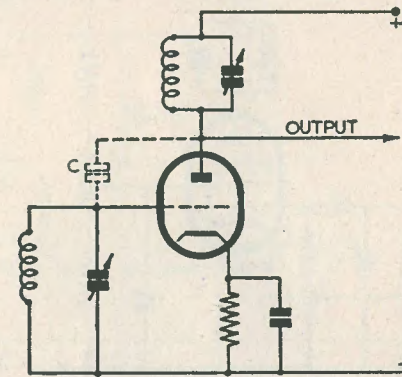

FIG. 2b
LC EQUIVALENT OF CRYSTAL OSCILLATOR

the frequency, you also have to change the crystal. That's because the frequency is fixed. The size of the quartz determines the frequency at which the crystal oscillator resonates. Varying the size will give a different frequency. There are also ways of cutting natural quartz which affect the frequency and stability.

As so often happens, however, you will want the transmitter to operate at any frequency within a given waveband, and not to have to confine yourself to any one particular frequency at one time. This would mean that you would have to have dozens of crystals in order to give a continuous coverage of the band. To meet such need, therefore, there is the continuously tuned oscillator. This is shown in Fig. 2b, and is just a simple oscillator of the same type as that shown in Fig. 2a, but incorporating an ordinary L-C tuned circuit.

There is no catch in this — both the circuits work, even without the inductive coupling between anode and grid. It all depends upon the presence of the anode-to-grid capacity of the valve, shown dotted in the diagram and marked C. When the anode circuit is tuned to a frequency slightly different from that of the grid, the feedback conditions through C are correct to maintain oscillation. That is to say, when the anode circuit is inductive (i.e. when it is just lower than the resonant frequency), the grid resistance becomes negative.

This circuit is called the tuned anode tuned grid (TPTG) oscillator, and has a very good frequency stability. Here again, unfortunately, there is a snag. It appears that for every advantage a piece of equipment may have over another, there is a disadvantage to outweigh it! The difficulty with this type of oscillator is setting it up properly for operation.

In some cases, depending upon the design, you can't count on the oscillation starting as soon as you switch on. When that happens, you have to fiddle with the tuning of the anode circuit until you get a dip in the anode current. This dip indicates oscillation.

As for the oscillators themselves — there are many types each having specific advantages and disadvantages of its own. One of these is the electron coupled oscillator (ECO), shown in Fig. 3. In the circuit shown, the screen grid is used as the anode, the true anode being set aside for another purpose. We will quote 'anode' here to avoid confusion with the true anode. The voltage induced in the upper part of the coil feeds the grid, since the phase conditions are correct to maintain oscillation. The earth connection is normally made at point A.

The true anode circuit contains a circuit which may be tuned to either the fundamental or a harmonic of the frequency to which the grid circuit is tuned. By careful coupling to

the anode, the frequency will remain independent of any load imposed on the oscillator. This is because the anode proper is not concerned in the actual oscillatory circuit.

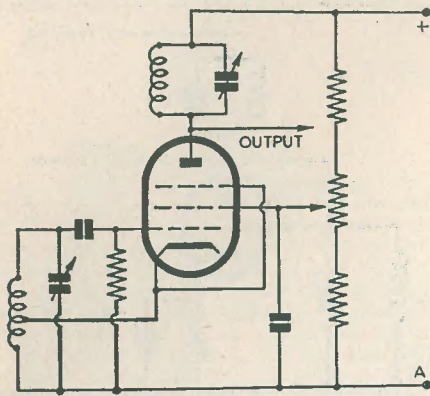

FIG. 3
ELECTRON COUPLED
OSCILLATOR

RC484

Harmonics

I said just now that harmonics could be extracted from the anode, or plate, circuit. The need for this arises very often, particularly when you want to work your transmitter on two bands, one of which is a harmonic of the other. You could, of course, change the coil or crystal in the oscillator, which would have the same result, but it is easier to use a harmonic of the oscillation, although efficiency may suffer somewhat.

Suppose you wanted to use the transmitter on 7 Mc/s and 14 Mc/s. If the oscillator is used without a power amplifier, the output will be less on the harmonic than on the fundamental. There are other reasons why harmonics are entitled to some of our attention, and they and the means for producing them can be explained later on.

Not so long ago — not long enough for you to have forgotten — we tackled a very dry subject, the sine wave. At the time there didn't seem to be very much point in doing a lot of sums and drawing graphs — much more useful to get going with the soldering iron! But here it is again.

When an oscillator produces harmonics, it means that it is not producing a pure sine wave output. We know that any departure from the sinusoidal implies harmonics of a strength depending upon the distortion present in the waveform. The

current flowing to the anode in the electron coupled circuit is in the form of pulses. The frequency of the pulses is the fundamental frequency of the tuned circuit at the grid. The harmonics present in these pulses are selected by the tuned circuit at the anode.

Power Output

A simple transmitter, in which the oscillator feeds the aerial direct, is called 'self-excited'. This type suffers from the limitation of power and stability, and it is often necessary to use a separate power output stage. The oscillator is then only needed to provide enough power to drive the output stage.

However, if the required output power is high, you may need to amplify the oscillator output to drive the final valve. Fig. 1 shows an amplifier for this purpose incorporated between the oscillator and power valve.

There may, of course, be more than one such stage, which has another duty to perform besides that of providing amplification. It can also be used to generate harmonics, when, for instance, you are working on very high frequencies. Crystals are not available for frequencies greater than 20 Mc/s, and even at this frequency they are expensive. So above 20 Mc/s we have to resort to what is called frequency multiplication.

Frequency multiplication is simply a method of getting a harmonic from a valve. The amplifier stages are biased to beyond cutoff, which considerably distorts the output waveform.

Now we come to the output stage — a subject in itself. The authorities place a limitation on the maximum DC power input to the output valve for amateur work, but, you notice, the limitation does not apply to the RF power output.

Because of this limitation, then, we naturally want the maximum efficiency we can get from this stage. That is to say, the maximum conversion of DC power into the anode to RF power output. The best type of stage to use is the Class B, although an extension of this principle, Class C, has also become popular. Class C operation results from biasing the stage well beyond cutoff, which gives a very high efficiency.

Information

Up to now, we have a transmitter that is not capable of producing any more than a continuous carrier containing no information, or means of conveying it, whatever. The most obvious solution which immediately leaps to mind is to interrupt the carrier at short and long intervals, each group of dots and dashes representing a group of

letters. This is a very elementary form of communication, but as you all know, a very widely used one. On the self-excited transmitter the morse key can be inserted in the HT-line, which will prevent the oscillator from working when the key is raised and will start it when the key is depressed.

There are other ways, of course. The key can be just as easily inserted in the cathode circuit. You may also change the bias applied to the valve so that the valve is cut off and unable to oscillate when the key is raised, and be restored to normal working when the key is depressed.

It is not usual, however, to key the oscillator in transmitters using power output stages. The oscillator is allowed to run quite freely and a subsequent stage is keyed — that is, turned on and off by the action of the morse key.

Few of us, however, have spent much of our lives conversing in Morse. To most of us a more familiar and colourful method of exchanging information, however regrettable, is speech. The only serious limitation that speech has as a means of communication is language. That, unfortunately, is unavoidable.

We have, once before, talked about the form of a modulated carrier wave, and if you remember we said that the carrier amplitude is made to fluctuate in accordance with the amplitude and frequency of the audio.

Fig. 4 shows one way of modulating the carrier. Depending upon whether or not the transmitter is of the self-excited type, V_1 can be either the oscillator or the output stage.

The audio fluctuations at the anode of the modulator valve V_2 are applied direct to the anode of V_1 . The audio choke L_2 forms the anode load of V_2 and the capacitor C_1

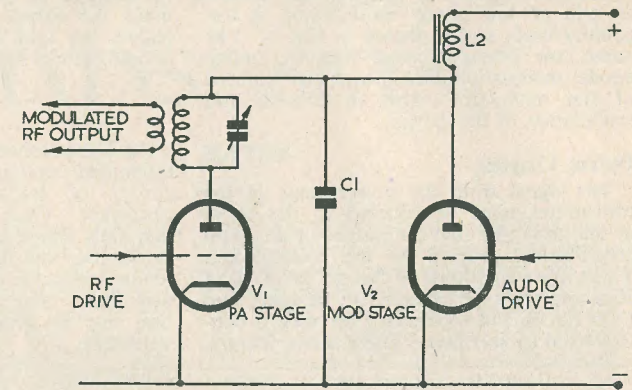

FIG. 4
ANODE MODULATION

RC485

is effective in by-passing the RF which would tend to be developed across L_2 . V_1 , therefore, receives an HT voltage which is fluctuating as the audio signal fluctuates, and the RF output of the stage will be modulated by the audio. This is called anode modulation. In this circuit the power delivered by the modulator must be equal to the power

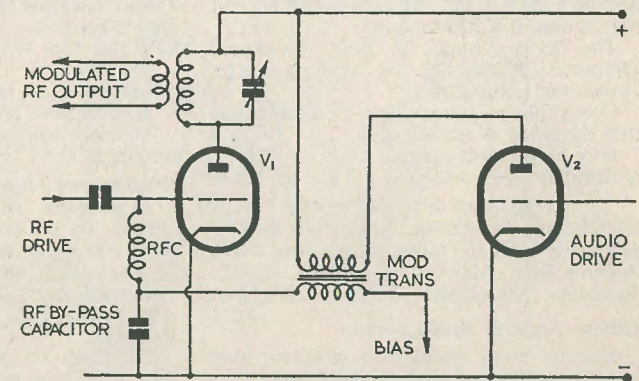

FIG. 5
GRID MODULATION

RC486

required by the transmitter.

It is not good practice to modulate the oscillator, because the HT variation caused by the modulation results in some variation

changed, due to the use of different valves, etc.

Care should be taken, with all the circuits, to see that the rectifiers and condensers are connected in the correct polarity, or the condensers may be damaged.

Fig. 3 also shows how bias may be obtained by the voltage drop across a resistor in the HT negative line, R1 being this component. For a 2-valver using HL2 and 220HPT type valves, or any equivalents, a resistor of 600Ω is suitable. This will provide 6V bias when 10mA flows.

This circuit has the advantage that the receiver itself is isolated from the mains, and a direct earth connection can be employed. Because of this, it is very suitable for 1-valvers. With such receivers, smoothing will not present much difficulty, since the consumption is small, and subsequent stages will not amplify any hum present in the detector stage. It may also be used with 1.4V valve types, such as circuits using the 1S4 or equivalent 1.4V 0.1 Amp. output valves.

Additional Features

As strict economy in current consumption is no longer essential, as when small batteries are used, it is of advantage to add a dial

or pilot bulb. Besides illuminating the dial, this will show when the set is switched on, and it may also serve as a fuse.

With the circuit shown in Fig. 1, a 0.05 Amp. bulb may be wired between the filament chain and 1,600Ω resistor. The voltage rating of the bulb is not important — a 2V to 6V bulb is satisfactory.

With the circuit in Fig. 2, a 0.3 Amp. (6.3V) bulb may be wired in series with the mains dropper. The circuit shown in Fig. 3 is not so easy to deal with, and it is undesirable to impose an additional load on the rectifier and choke, unless a low-consumption bulb such as a 0.06A 2V type be used, when it can be wired in parallel with the valve filaments. An alternative is to wire a 6V bulb in parallel with the LT secondary of the transformer.

Finally, the possibility of following the battery valves with a mains-operated power pentode should not be overlooked. A valve such as the 25A6 (25V, 0.3 Amp.) may have its heater wired in series with the rectifier in Fig. 2, and can draw HT current from the rectifier cathode. A much increased power output is then obtainable, for speaker reproduction, but it is, of course, essential to use a rectifier which can supply the current demanded.

SCOTTISH INSURANCE CORPORATION LTD.



62-63 CHEAPSIDE LONDON, E.C.2.

TELEVISION SETS AND SHORT WAVE TRANSMITTERS

Television Sets and Short Wave Transmitters/Receivers are expensive to acquire and you no doubt highly prize your installation. Apart from the value of your Set, you might be held responsible should injury be caused by a fault in the Set, or injury or damage by your Aerial collapsing.

A "Scottish" special policy for Television Sets and Short Wave Transmitters/Receivers provides the following cover:—

- (a) Loss or damage to installation (including in the case of Television Sets the Cathode Ray Tube) by Fire, Explosion, Lightning, Theft or Accidental External Means at any private dwelling house.
- (b) (i) Legal Liability for bodily injury to Third Parties or damage to their property arising out of the breakage or collapse of the Aerial Fittings or Mast, or through any defect in the Set. Indemnity £10,000 any one accident.
- (ii) Damage to your property or that of your landlord arising out of the breakage or collapse of the Aerial Fittings or Mast, but not exceeding £500.

The cost of Cover (a) is 5/- a year for Sets worth £50 or less, and for Sets valued at more than £50 the cost is in proportion. Cover (b) (i) and (ii) costs only 2/6d. a year if taken with Cover (a), or 5/- if taken alone.

Why not BE PRUDENT AND INSURE your installation—it is well worth while AT THE VERY LOW COST INVOLVED. If you will complete and return this form to the Corporation's Office at the above address, a proposal will be submitted for completion.

NAME (Block Letters)
 (If Lady, state Mrs. or Miss)
 ADDRESS (Block Letters) /JB

“Pick-ups and cartridges incorporating the **ACOS Hi-g** development will track with ease all present day records —and those of the foreseeable future too”

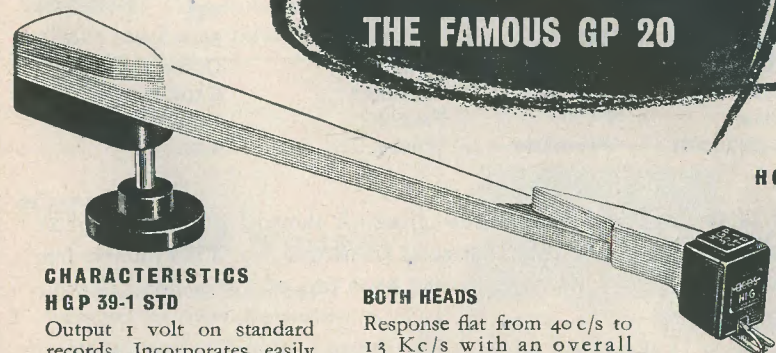
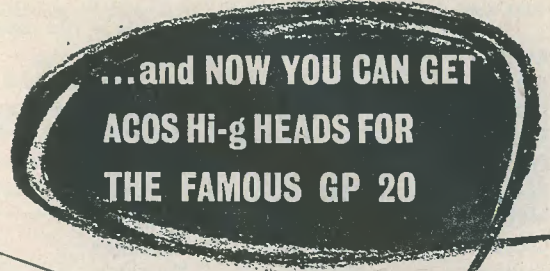

HGP 39 STD

OR

HGP 39 LP

CHARACTERISTICS

HGP 39-1 STD

Output 1 volt on standard records. Incorporates easily changeable 0.0025" sapphire stylus.

HGP 39-1 LP

Output ½ volt on microgroove records. Incorporates easily changeable 0.001" sapphire stylus.

BOTH HEADS

Response flat from 40c/s to 13 Kc/s with an overall response from 20 c/s to 17 Kc/s. Tracking weight 8 grammes.

PRICE

STANDARD OR LP HEAD ONLY
 £1 · 12 · 0 (Plus 10/3 P.T.)
G.P. 20 Hi-g COMPLETE PICK-UP WITH EITHER HEAD £2 · 12 · 0 (Plus 16/8 P.T.)



always well ahead

ACOS devices are protected by patents, patent applications, and registered designs in Great Britain and abroad.

GOSMOCORD LIMITED · ENFIELD · MIDDLESEX

The new home of

Southern Radio & Electrical Supplies

WE have pleasure in advising our *Radio Constructor* friends that we have now re-organised our well-known pre-war Mail Order Department.

Our new premises covering nearly 4,000 square feet of floor space enable us, in addition to the manufacture of our Sorad range of transmitting equipment, chassis, coils, switches, etc., to carry a most comprehensive stock of radio and television components by the leading makers —

ALLEN	AVO	BELLING & LEE	BRIMAR
BULGIN	COSMOCORD	COSSOR	DENCO
EDDYSTONE	EDISWAN	E.M.I.	EVER-READY
ERIE	GARRARD	G.E.C.	GOODMANS
GRUNDIG	HAMRAD	HENLEY	J.B.
MARCONI	MAZDA	MCMURDO	MULLARD
MULTI-CORE SOLDERS		N.S.F.	OSMOR
Q.C.C.	Q-MAX	RAYMART	RADIOSPARES
TAYLOR	T.C.C.	TELCON	WEARITE
WESTINGHOUSE	WEYMOUTH	WODEN	ETC.

Our illustrated brochure *The New Approach* showing our new premises and activities and our 60 page illustrated Catalogue No. 8 is available free of charge. In addition we have detailed price lists of *Viewmaster*, *Teleking* and *Soundmaster*.

Thousands of clients can testify to our "by return" service and all orders are dealt with the day received under the supervision of G2ACC who, after 29 years in the radio industry and backed by technical staff, fully appreciates the many constructional problems.

If you have not yet sampled our service may we suggest you send for our catalogue and give us a trial order ?

SORAD WORKS, REDLYNCH SALISBURY · WILTSHIRE

Telephone DOWNTON 207



**POST THE COUPON TODAY FOR OUR
BROCHURE ON THE LATEST METHODS
OF HOME TRAINING FOR OVER 150
CAREERS & HOBBIES**

PRIVATE AND INDIVIDUAL TUITION IN YOUR OWN HOME

City and Guilds Grouped Certificates in Telecommunications; A.M. Brit. I.R.E. Examination, Radio Amateur's Licence, Radio and Television Servicing Certificates, General Radio and Television Courses, Radar, Sound Recording, etc. Also Courses in all other branches of Engineering and Commerce.

The advantages of E.M.I. training.

★ The teaching methods are planned to meet modern industrial requirements. ★ We offer training in all subjects which provide lucrative jobs or interesting hobbies. ★ A tutor is personally allotted by name to ensure private and individual tuition. ★ Free advice covering all aspects of training is given to students before and after enrolling with us.

POST THIS COUPON TODAY

Please send without obligation your FREE book.
E.M.I. INSTITUTES, Dept. 179K,
43 Grove Park Road, London, W.4.
Phone: Chiswick 4417/8.

NAME

ADDRESS

SUBJECT(S) OF INTEREST

Courses from £1 per month

EMI INSTITUTES

The only Postal College which is
part of a world-wide Industrial Organisation.

TC18

Kendall and Mousley

Electronic Engineers and
Laboratory Equipment Manufacturers

99 DUDLEY PORT. TIPTON, STAFFS.

Instrument cases in steel, complete with light alloy front panel Celours Black (Red and Green 10 per cent extra). Back punched for ventilation. 8" x 9" x 8" at 18/-, 10 1/2" x 12" x 10 1/4" at 21/-. Chassis to suit 7" square by 2 1/2" deep (Light alloy, four sides) 7/6. Chassis to suit 10" square by 7 1/4" deep (Light alloy, four sides) 10/6. Heavier steel case complete with alloy front panel, finished in Black (Red or Green 10 per cent extra). Back punched for ventilation, 9" x 12" x 9" at 30/-, chassis for same 10" x 8" x 2 1/4" (reinforced corners) at 10/6 each. Case complete with chassis and panel £2.0.0 Meter stands, ends only. 2/6 per pair, panel for same 6" square at 1/9 9" x 6" at 2/6 and 12" x 6" at 3/3. Meters can be mounted at extra cost if required. Suppliers of technical publications. A full range of components, by well known manufacturers, are stocked, Mullard, Brimar, Cossor, T.C.C., Dubilier, Erie, R.E.P., Wearite, Elstone, Morganite, etc. High stability 1, 2 and 5 per cent resistors available from stock or to order.

ALL PARTS FOR THE
KIDDIES' CRYSTAL SET

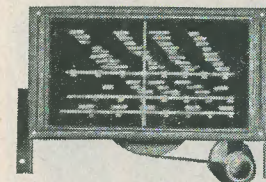

The
S. L. 8.
Spin Wheel
Drive

Complete with 3-1
band glass scale
9" x 4 1/2" — 27/6

The S.L.8. Spin Wheel Drive gives easy control through a ratio 24-1. Fitted with constant velocity coupling, it eliminates strain on the Condenser, providing mechanical and electrical isolation from vibration and noise.

S.L.5, similar but fitted with reverse vernier drive, gives ratios of 18-1 search and 50-1 reverse vernier. 26/6.

Please write for our list of Condensers
and Drives

JACKSON BROS.
(London) Ltd.

KINGSWAY · WADDON · SURREY

Telephone CROYDON 2754-5

Telegrams WALFILCO, SOUPHONE, LONDON

"YOU CAN RELY ON US"

COILS
Wearite "P" Coils.
All types in stock
including A.F.I. R.F.I.
Price 3/-
Midget I.F. Trans-
formers Type 800
21/- per pair. Stand-
ard Type 500/501
(465Kc/s) 20/- pair
HIGH
IMPEDANCE
HEADPHONES
NewEx-Government
Price 12/6 per pair.
SCOTCHBOY
TAPE
1200ft Reels 35/-
Spare Reels 4/3

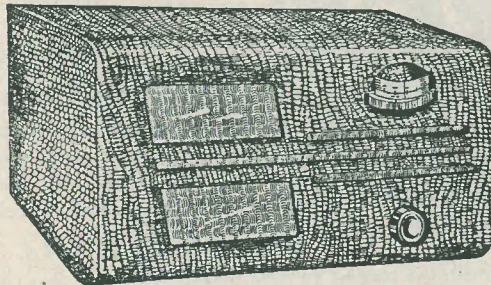

COILS
Osmor Midget iron-
cored "Q" Coils 4/-
each. Leaflet on re-
quest.
Coilpacks Type H.O.
52/-, LM 43/4, MTS
54/2, TRF 43/4, all
including Tax.
TRIMMERS
All new Postage
Stamp Ceramic.
4-70pf 8d. 40-100pf
10d., 20-150pf 1/-
100-550pf 1/3.
LINECORD
3-way .3a at 60 ohms,
per foot 6d ft., .2a at
100 ohms per ft 8d ft.

The "MAXIMITE" AC/DC SUPERMIDGET SUPERHET — Full Plans 1/-
CATALOGUE No. 12 now available
70 pages 250 Illustrations Price 1/-
NOTE OUR NEW ADDRESS

RADIO SERVICING COMPANY
DEPT. K 82 SOUTH EALING ROAD LONDON W.5
Telephone EALing 5737

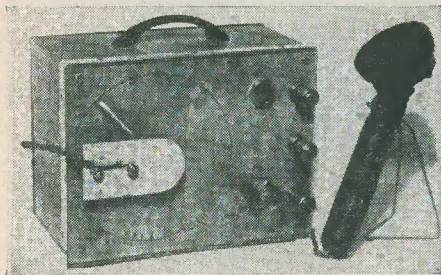

SWAN Mod. CZR Component Bridge

PRICE £5 5s. 0d. complete carriage free

This new Bridge is ideal for experimenters and service engineers. Smart in appearance. Excellent in performance, it will give you new confidence in the components you use.

- ★ 6 Ranges covering 5 ohms to 5 megohms and 10 pf to 25µF
- ★ Total scale length 5 feet 6 inches
- ★ Measurement is swift and accurate
- ★ Portable with self contained power supply and oscillator
- ★ 1 year's guarantee

Our terms are cash with order or C.O.D. Satisfaction or money refunded

SWAN ELECTRONICS,
43 BOURNEMOUTH ROAD, PECKHAM, LONDON, S.E.15

MICROGRAM AMPLIFIERS

S
O
U
L
D
E
R

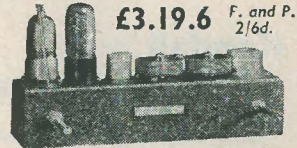

£3.19.6 F. and P.
2/6d.

Fits inside your record player leaving room for speaker. Dimensions 10" x 3 1/2" x 2 1/2". 4 watts quality output. Suitable for all speakers and with standard or L.P. pick-ups. Built-in power pack for 200-250v. A.C. Only. Valves 6J7 and 6V6 available at 20/- per pair extra, if required. Other models with negative feedback, etc. 6d. stamp for illustrated details.

ELECTRO-ACOUSTIC LABORATORIES
TAIN — ROSS-SHIRE, — SCOTLAND

REP HIGH GAIN COILS

Dual Range Miniature Crystal Set Coil with Circuit 2/6
Dual Range Coil with Reaction with 2 Mains and 2 Battery Circuits 4/-
Matched Pair Dual Range T.R.F. Coils with Battery and Mains Circuits 8/- pair

- ★ All coils wound on low loss formers
- ★ Individually tested and guaranteed
- ★ Post 3d on all orders
- ★ Trade supplied

Radio Experimental Products, Ltd.
33 Much Park Street Coventry

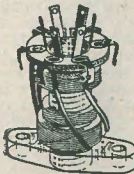

MANUFACTURERS' SURPLUS T.V. COMPONENTS

Scanning coils. Low impedance line and frame 7/6	P.M. Focus Magnets. All with vernier adjustor.
Scanning coils, Low imp. line and frame Aluminium shroud 12/6	35mm Tetrode 15/-
Scanning coils. Wide angle. Low imp. line and frame, 19/6	35mm Triode 17/6
Multi ratio frame output transformer 10/6	All types p.m. magnets. 35mm Less vernier 12/6
Focus coil. 35mm electro magnetic 12/6	Goodmans, with ferroxdue core. For all wide angle tubes 25/-
	Frame blocking oscillator transformer 10/6
	Wide Angle Frame B/O transformer 10/6
	Frame and Line B/O transformers (Auto) 4/6
	Plessey width coils 6/6

SPECIAL—BRAND NEW TCC TV. CONDENSERS

32+100 mfd. 450 v.w. Type CE15PE . . . Price 7/6
0.04 mfd. 12.5Kv. Type CP59VO Visconol . . . Price 7/6

TRIPLEX DARK SCREEN FILTERS
14 x 12 1/2 x 7/8 ins. 7/6
15 1/2 x 13 1/2 x 7/8 ins. 9/6
Postage and packing 5/- per piece extra. (This charge is necessary owing to extra packing required)

GERMANIUM CRYSTAL DIODES

1/6 each

WIDE ANGLE CATHODE RAY TUBES

14" MW36-22	£19 9 3
14" C14B	£20 10 1
16" MW41-1	£22 4 10
16" T901	£22 4 10
17" MW43-64	£23 12 8
17" C17BM	£24 13 0

Carriage and insurance extra

ALLEN WIDE ANGLE COMPONENTS

D.C. 300 latest type Ferroxcube Coil	39/6
GL. 16 Coil	7/6
GL. 18 Coil	7/6
Focus Coil	31/-
FO.305 trans	21/-
Frame B.O. transformer	15/-
Line EHT. transformer	40/-

VCR97 C.R. TUBES

New unused. 35/- Carriage 5/-

SCREEN ENLARGER

For VCR97. Filter type, 17/6. Postage 2/6.

EHT. CONDENSERS

.1 + .1mfd. 3.5Kv. 5/11

SOLON SOLDERING IRONS

220-250 volts. Latest model instrument iron . . 19/8 Standard model . . 19/-

LARGE SCREEN T.V.

Every component in stock for the Magnaview, Tele-King, Viewmaster and Universal television receivers including all cathode ray tubes and valves.

Width and linearity controls. 3/6 each

Colver CLR.901 type pot/meters. Wire wound, most values. 2/6 each

Ion Traps. All types. Price 3/- each. State type number of c.r. tube when ordering.

SPECIAL OFFER

Magnetic recording tape, on Cylond metal spools. By famous British Manufacturer 600 feet. 6/11. Post 1/6 1200 feet. 14/11. Post 1/6

LIMITED QUANTITY. Buy Now and Save Cash

CRT Rr. neck protectors 2/6

R.II32A RECEIVERS

With all valves.
Brand New . . . 79/6
Store Soiled. . . 49/6
Second Hand . . . 39/6
Carriage 10/- extra

THE "UNIVERSAL" LARGE SCREEN AC/DC TELEVISION

by A. S. Torrance, A.M.I.P.R.E., A.M.T.S.
A 28 page booklet giving full instructions for building a Large 17 inch screen television *AC & DC Mains. *PM focusing *Mullard Valves and CR Tube *Five-channel Superhet *Table Model *Convertible into Radio-gram console *Incorporates all latest developments.
Reprinted from the Radio Constructor 3d post free.

NO. 4. COMPLETE SET OF METAL-WORK. Un-assembled. Comprising main chassis, tube supports and valveholders. (Less sound-vision chassis). PRICE 25/- Carriage 3/6 extra.

NO. 5. RESISTANCES. 1/2 Watt. 85 resistances your choice. PRICE 18/- POST FREE.

NO. 6. ONE OF EACH OF THE FOLLOWING: Ion trap IT6; Duo-decal tube holder; low impedance line and frame scanning coils. PRICE 15/- Postage 1/6 extra.



THE NEW ACOS MICROPHONE

A general purpose hand microphone, crystal type. Of robust construction with almost flat response from 50 to 5,000 c.p.s. Suitable for recording equipment, p.a. work etc. PRICE 25/-

CATHODE RAY TUBES MASKS

New aspect ratio.
10in Double D . . . 7/6
12in . . . 14/-
12in Flat face. . . 15/-
12in Old ratio . . . 9/6
14in Rect. . . 21/-
16in Double D . . . 25/-
17in Rect. . . 21/-
12in Soiled . . . 7/6
12in Soiled, Cream, with safety glass . . 11/6
12in Soiled, Black, with safety glass . . 8/6

15 INCH CATHODE RAY TUBE MASKS

Cream rubber. Latest aspect ratio. Overall dimensions: 17in wide, 13in high. Price 17/6. Postage 2/- extra.

ARMOUR PLATE GLASS

9 x8 x 1/2-inch. 3/-
13 x10 x 1/2-inch. 4/-
16 x13 x 1/2-inch. 6/11
17 x15 x 1/2-inch. 7/11

COLLARO 3-SPEED AUTOMATIC RECORD CHANGERS.

MODEL RC3/521. Brand new and unused, in maker's original cartons. Finished in cream enamel and fitted with GP.29 hi-fidelity studio crystal turnover head. LASKY'S PRICE £9/19/6. Carriage FREE.

Westinghouse WX6 Rectifiers. Wire ends. Price 1/6 each.

LASKY'S RADIO

Lasky's (Harrow Road) Ltd. 370 HARROW RD. PADDINGTON LONDON W9
(Opposite Paddington Hospital) Telephones CUNningham 1979 and 7214. All Departments. Hours Mon. to Sat. 9.30 a.m. to 6 p.m., Thurs. half day 1 p.m.

MAIL ORDER & DESPATCH DEPARTMENTS 485/487 Harrow Road Paddington London W10
Terms Pro Forma. Cash with Order or C.O.D. on post items only. Postage and packing on orders value £1-1/- ex., £5-2/- ex., £10-3/6 ex. Over £10 carriage free unless otherwise stated. All goods fully insured in transit

ADCOLA
(Regd. Trade Mark)
SOLDERING INSTRUMENTS

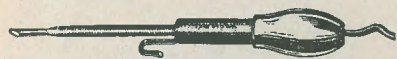

Reg. Design No. 860302 (British, U.S. and Foreign Patents)
Designed for wireless assembly and Maintenance
Supplied for all volt ranges from 6/7v to 230/250v 3/16" Dia. Bit Standard Model 25/6
Sole Manufacturers **ADCOLA PRODUCTS LTD.**
Sales Office and Works Cranmer Court, Clapham High St. London SW4 (MAC 4272)

TELETRON SUPER INDUCTOR COILS
MINIATURE DUST CORE TYPES

Type. HAX. High frequency crystal transformer coil, triple wound for Germanium crystal diodes.
*Q 100. *Gain 33 Times. *No Overlap Performance unequalled.

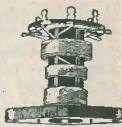

DUAL WAVE T.R.F. COILS
Type. TRF. A/HF. AE. & HF. Transformer Rising characteristic to balance fall in circuit "Q." Matched pairs; Pre-Aligned. pair 7/-

Super-Het Range for S.M.&L.W. AE&Osc., 6/- pair I.F. Transformers, Filters, Etc. p.p. 3d.
Stamp for Circuits & Data

THE TELETRON CO.
266 NIGHTINGALE ROAD LONDON N.9

SMALL ADVERTISEMENTS

Readers' small advertisements will be accepted at 3d per word, minimum charge 2/- Trade advertisements will be accepted at 8d per word, minimum charge 6/- If a Box Number is required, an additional charge of 1/- will be made. Terms: Cash with order. All copy must be in hand by the 5th of the month for insertion in the following month's issue.

All Carriage Paid and Money Back Guarantee

"MEGGER" CIRCUIT TESTING OHMMETER

4 1/2 v. battery operated, 2 ranges 0-1,000 ohms and 100-200,000 ohms. Size 5 1/2 x 4 x 2 1/2 in., complete with fitted leather case, test prod and full instructions. Unrepeatable at £3/19/6.



SET OF TWIST DRILLS
9 drills 1/8-1/2 in. complete with plastic case and stand. Brand New **4/6**

OHMMETER

Four scales, 2 1/2 in. dia., reading 0-5,000 ohms 0-60 mA., 0-1.5 v. 0-3 v. suitable for continuity testing. Will operate from 1.5 v. battery, strong case, with full instructions engraved on back. Brand new **19/6**
Carrying Sling 1/- extra
Telephone orders accepted



Send for Bargain List
TERMS: CASH WITH ORDER. C.O.D. 1/- Extra
SHERMAN'S SUPPLY CO (RCI)
479 HARROW ROAD, LONDON, W10
LADbrook 1718

FOR SALE AVO Valve Characteristic Meter, £35.
Canadian Marconi receiver No. 52, 13 valves, 1.5 to 16 Mc/s, £10. Monitor type 36, AC mains, VCR139, £5. BC603, less valves, £3. All in excellent condition. Please write first to L. Bodman, 68 Terrace Road, Elvington, Dover, Kent.

GENUINE CLEARANCE All new and perfect, e.g., Tape Recorder Amplifier complete in case, offers over £7; IOW. Quality Amplifier offers over £4; 4 valve superhet complete; veneered cabinets 10/- perfect. Many other items real bargain prices e.g., standard dust cored IF's new and perfect only 3/6 pair, 1/- post, or 4 pairs 14/- including postage. List, enquiries welcomed, SAE please. Box No. D105.

VIEWMASTER 10" tube, little used, perfect with cabinet, mask, etc. Buyer collects South London, £25. Wilcox-Gay VFO, as new, £6. Box No. D108.

PREMIER TELEVISION 6", with console cabinet, magnifier, also share tube and valves, can be seen working, price £24 or offer. Phone Watkinson, BYRon 2752 after 6 p.m., (London).

PREMIER VCR97 TELEVISION Complete in Premier cabinet on castors with fitted magnifier, perfect, £12 10s 0d. Walker, 19 Netherpton Road, St. Margarets, Middx. Phone POP 1558.

FOR SALE Globe King receiver with three coils and phones. *Practical Wireless Encyclopedia. Practical Wireless Circuits.* Or exchange ex-WD receiver 1224A or similar required. Box No. D107.

UNUSED GOODS Receiver BC453 (Long Wave) with 12/14 volt unit in Dynamotor, £5. RF25 unit, 19/- RF24 unit, 16/- Pair KT8C, 25/- Hyder, St. Leonards, Bathampton, Bath.

SURPLUS NEW VALVES Guaranteed, 10F1, EF80, ECL80, 10/- each. 6Q7, 12Q7, 5Z4, 6AG5, 7/6 each. EF50, 9002, 9003, 6J5GT, 6U7, 12SG7, 6/- each. Also some slightly used valves, guaranteed Z77's, or equivalent PEN45DD, TH41, EF42, 5/- each, W. Fewell, 308 Nisbet House, Homerton, London. E.9. Postage 3d per valve.

EDDYSTONE 740 Communications receiver for sale. Complete with matching speaker and manual. As new, £30 or offers. Ballance, 153 Burntwood Road, Norton Canes, Cannock, Staffs.

[continued on page 491]

HENRY'S

We have over 20,000 American and B.V.A. valves in stock.

ALL VALVES NEW AND GUARANTEED

OZ4A 7/-	6Q7GT 8/6	9001 6/-	U19 10/-
1G6 6/6	6S17GT 8/6	9002 6/-	6U5 7/6
1R5 8/-	6R7 8/6	9003 6/-	6U5G 7/6
1S4 8/-	6X5G 8/6	9004 6/-	P2 4/-
1S5 8/-	6SA7GT 8/6	9006 6/-	MU14 8/6
1T4 8/-	6S07GT 8/6	954 6/-	PX25 12/6
1A7GT 10/-	6S7 7/6	955 6/-	KT33C 10/-
1C5 8/-	6SH7M 7/6	956 6/-	KT66 12/6
1LN5 8/-	6SK7GT 7/6	1299A 7/6	GU50 12/6
2X2 5/-	6SL7GT 9/-	TZ40 37/6	XP(2v) 4/-
3V4 8/-	6SN7GT 9/-	931A 50/-	XH(1.5) 4/-
3S4 8/-	6SC7 10/-	EA50 2/-	VU111 4/-
5Z3 8/6	6SS7 7/6	EF54	VUI33 4/-
5U4 8/6	6V6GT 7/6	(VRI36) 6/-	VUI20A 4/-
5Z4 8/6	7C5 8/6	EB34 3/6	CV54 5/-
6A7G 8/6	7A7 8/6	EBC33 8/6	S130 7/6
6AC7 6/6	7C7 8/6	EF36 8/6	7475(VS70)
6AG5 7/6	7H7 8/6	EF39 6/6	CV66 6/-
6A8G 8/6	7B7 8/6	EK32 6/6	VR150/308/6
6AM6 9/-	7S7 10/-	EF91 9/-	CK510AX5/5
6B8 7/6	12A6 7/6	EL32 7/6	DI 2/-
6C4 8/6	12C8 7/6	EF50 8/6	AC6PEN 6/6
6CSGT 5/-	12H6 8/6	EF50 (Red. Sy.) 10/-	AC5/
6C6 6/6	12K7GT 8/6	EF50 (Ex-Units)	PENDD 12/6
6D6 6/6	12K8GT 8/6	SP2 8/6	PEN25 6/6
6F6G 6/6	12Q7GT 8/6	VP2 8/6	PEN46 7/6
6GG6 8/6	12SA7GT 8/6	TDD2A 8/6	QP25 6/6
6H6GT 5/-	12S07GT 8/6	DK40 9/-	QP230 8/-
6H6M 8/6	12SG7 7/6	UL41 9/-	SP61 4/-
6J5GT 5/-	12SH7 7/6	UY41 9/-	HL23/DD6/6
6J5M 8/6	12SJ7 8/6	4D1 4/-	TP25 8/-
6J6 9/-	12SK7 8/6	8D2 4/-	VP23 6/6
6AK5 9/-	12SR7 7/6	9D2 4/-	VP41 7/6
6J7G 6/6	14A7 8/6	10D2 4/-	U22 8/6
6J7M 8/6	25Z6GT 8/6	12D2 10/-	ATP4 4/-
6K6 9/-	25Z5 8/6	R3 8/6	TP22 8/6
6K7G 6/6	35Z4GT 8/6	D41 5/-	TH233 10/-
6K7M 7/6	25A6 8/6	D42 5/-	41MP 7/6
6K8G 9/-	35L6 8/6	D63 5/-	42SPT 6/6
6K8GT 9/-	50L6GT 8/6	KT2 5/-	MS/PENB
6L6G 8/6	42 8/6	KTW61 7/6	
1622 11/-	43 8/6	U52 8/6	VT501 7/6
6U5 7/6	75 8/6		
6U5G 7/6	80 8/6		
6L7 7/6	80 8/6		
6N7GT 7/6	866A 15/-		

SETS OF VALVES

Ten EF50 (Ex-Set Brand New Units) 5/- each ... 45/-
6K8G, 6K7G, 6Q7G, 5Z4G, 6V6G (or KT61) ... 37/6
1R5, 1S5, 1T4, 1S4 or (3S4 or 3V4) ... 30/-
TP25, HL23/DD, VP23 PEN25 (or QP25) ... 25/-
6K8G, 6K7G, 6Q7G, 25A6G, 25Z5 or 25Z6G ... 37/6
12K8GT, 12K7GT, 12Q7GT, 35Z4GT, 3 5 L 6 G T or 50L6GT ... 37/6
12SA7GT, 12SK7GT, 12S07GT, 35Z4GT, 35L6GT or 50L6GT ... 37/6
PX25, KT33C, Each KT66, GU50 ... 12/6
PX25's Matched Pair Pairs ... 25/-
TEN 6AM6 (EF91) 80/-

RECEIVER R1355. As specified for "Inexpensive Television." Complete with 8 valves VR65 and 1 each 5U4G, VUI20, VR92. Only 29/-, carriage 5/- Or Brand New in original packing case, 55/-, plus 5/- carriage.

VCR517C Blue and White 6 1/2 in. Tube. This Tube replaces the VCR97 and VCR517 without alteration and gives a full Blue and White picture. Brand new in original crates, 35/-, carriage free.

RECORDING TAPE (Proprietary Brand)
600 feet ... 10/-
1200 feet ... 17/6

Send Postage for new '53 comprehensive 23-page catalogue: containing components and ex-government bargains.

Open Monday to Friday 9 a.m. to 6 p.m. Thursday 1 p.m.

5 HARROW ROAD, PADDINGTON LONDON W2
Telephone Paddington 1008/9, 0401

62A INDICATOR UNIT, complete with 12-EF50's, 4-SP61's, 3-EA50's, 2-EB34 and VCR517C. C.R.T. Double-deck chassis absolute new condition 79/6 Carriage paid.

PYE 45 Mc/s STRIP. Type 3583 Units. Size 15"x8"x2". Complete with 45 mc/s Pye Strip, 12 valves 10 EF50, EB34 and EA50. Sound and vision can be incorporated on this chassis with minimum space. New condition. Modification data supplied. Price £5 carriage paid

CRYSTAL MICROPHONE INSERTS
Ideal for tape recording and amplifiers. No matching transformer required. 8/6 POST FREE.

INDICATOR UNIT TYPE I82A. This unit contains VCR517 Cathode Ray 6" Tube, complete with Mu-Metal Screen, 3 EF50, 4 SP61 and 1 5U4G valves. Offered BRAND NEW (less relay) in original packing case at 67/6. Plus 7/6 carriage.

R.F. UNITS
Type 26. 50-65 Mc/s. Variable Tuning. 2-VR136, 1-VR137. 45/- EACH BRAND NEW.

Type 27. 65-85 Mc/s. Variable Tuning. 2-VR136, 1-VR137. 45/- EACH BRAND NEW.

Type 24. 20-30 Mc/s. Switched Tuning. With 3-SP61's. 15/- EACH BRAND NEW.

Type 25. 40-50 Mc/s. Switched Tuning. With 3-SP61. 19/6 EACH. BRAND NEW.

CLYDESDALE *Prices Slashed*

TI154 TRANSMITTER UNIT

Medium/high powered by C.W.-M.C.W. R/T. 3 ranges 10-5.5 Mc/s. 5.5-3 Mc/s. 500-200 kc/s. Complete with 4 valves, etc., in metal case 14in. x 16 1/2in. x 8 1/2in. External Power Supply required. ASK FOR **39/6** each CARRIAGE No. B/ESA. 7/6 EXTRA PAID

RI155 RECEIVER UNIT

Communications, D.F. and "Ham" 20, 40, 80, 5 ranges 18-7.5 Mc/s., 7.5-3 Mc/s., 1,500-600 kc/s., 500-200 kc/s. and 200-75 kc/s. Complete with 10 valves. S.M. drive, M.E. tuning, B.F.O., etc. in metal case 16 1/2 x 9 x 9in. External Power Supply required. Used, good condition. In transit Case. ASK FOR **£8/19/6** CARRIAGE No. B/H916 7/6 EXTRA PAID

ALSO AVAILABLE

RI155, as above, but loose stored. ASK FOR **£5/19/6** CARRIAGE No. B/H898 7/6 EXTRA PAID

VISUAL INDICATOR TYPE I, REF. 10Q/2

Dual reading left/right D.F. meter for RI155, 2 1/2in. Scale overall dim.: 3 1/2in. x 2 1/2in. in used condition. ASK FOR **12/6** each POST No. B/H862A PAID

Order direct from: Telephone SOUTH 2706/9

CLYDESDALE SUPPLY CO. LTD.
2 BRIDGE STREET GLASGOW C.5

Branches in Scotland, England and Northern Ireland

The "Sonic" Receiver Kit 88/- for A.C. Mains. Covers 2 wave bands, complete in polished wood cabinet, size 12in. x 7in. x 5in.

The "Sonic" quality 4 watt Amplifier Kit 78/-, suitable for gram. or mic., uses 6V6-5Y3-EF36 Valves. Dead easy to follow point to point diagrams, in stages. A child could build either of these, no radio knowledge necessary.

To the lucky people in B'ham we say call for a demonstration. To mail order customers we give our personal guarantee of satisfaction or money back. Post 2/6 extra.

Mains Transformers. 150v-0-150v at 100 ma 6/- each (no heaters). Size 4in. x 3 1/2in. x 3in. potted. Post 1/6 extra

FIELD'S

85 SNOW HILL BIRMINGHAM
Telephone CEN 3136

SMALL ADVERTISEMENTS

continued from page 489]

TELEVISION T.S.701 Ecko, exchange for receiver, AC/DC amplifier, accordion mike, binoculars, or offers. Flowers, 93 Carlyon Avenue, South Harrow, Middx. BYRON 0249 evenings.

WANTED *The Radio Constructor* for May and June 1952. State price to Wood, 31A Braddon Road, Woodley, Cheshire.

WANTED O9J (double beam) or 26J (single beam) cathode ray tube. Condition and price to F. Nightingale, 89 Chesterton Road, London, E.13.

AMATEUR CLEARING SURPLUS—6" T.V. (Premier) chassis £6 10s 0d. Power pack—300v. 250 ma/a—250V 80mA 6.3v at 8 amp, etc., £2 10s 0d. T.V. sound A.P. £2 0s 0d. Pye Strip converted to vision A.P. £1 0s 0d. Transformer—375-0-375—6.3 .7 amp. 4v twice, 5v 3 amp £1 0s 0d. 350-0-350 80 mA on small chassis with choke etc., 6.3v 2 amp. 15/-, 350-0-350 80mA 6.3-3 amp., 5v New, 15/-, Parmeko 700v 20m/amp. 4v new, 15/-, T.V. pattern generator and power pack, A.P. 35/-, 6" Magnavista lens, 15/-, For *Viewmaster*, Scan coils, Line Transformer, Frame od., E.H.T. rect., Focus unit, new, £3 10s 0d lot. R.F. 27 unit new, 25/-, Pye 45 meg. I.F. strip, with VR 65's, £1 0s 0d. Meters, 1/500 mic/amp., 1/300 m/a, 1/- scaled millivolts, 3 for £1 0s 0d, 8 J50 rect., new, £1 0s 0d. Philco car radio requires assembly, and overhaul, 6v, 25/-, 10, 5/- parcels oddments, pots., condensers, resistors, state preferences. Please include for postage. King, 4 Bridge House, Beeches Avenue, Carshalton, Surrey. Phone Whitehall 5294.

ERRATA

A Small Transportable, page 384 February issue, Line 17, R10 should read R8. R10 can be made from a length of line cord element, wound on a 10MΩ resistor to a value of 6 ohm.

TRADE

RADIO CONTROL THAT MODEL HANDBOOK 3/6, with unlimited advice. Carter, 101 High Street, Harlesden, N.W.10.

I.P.R.E. PUBLICATIONS, 5,500 Alignment Peaks for superhets 5/9. Sample copy *The Practical Radio Engineer* 2/-. Membership examination particulars 1/-, Syllabus of TV and radio courses free and post free. Secretary, I.P.R.E., 20 Fairfield Road, London, N.8.

FREE! Brochure giving details of Home Study Training in Radio, Television, and all branches of Electronics. Courses for the Hobby Enthusiast of for those aiming at the A.M.Brit.I.R.E. City and Guilds Telecommunications R.T.E.B. and other professional examinations. Train with the College operated by Britain's largest Electronic Organisation. Moderate fees. Write to E.M.I. INSTITUTES, Postal Division, Dept. RC28, 43 Grove Park Road, London, W.4. (Associated with H.M.V.).

METALWORK, All types cabinets, chassis, racks, etc. to your own specification. Philpott's Metalworks Ltd. (Dept. R.C.), Chapman Street, Loughborough.

OSMOR—for efficient coils, coilpacks, etc. Send 5d. stamp for FREE circuits and lists. Dept. RCC, Osmor Radio Products Ltd., Borough Hill, Croydon, Surrey. Telephone Croydon 5148/9.

[continued on page 492]

TELE-RADIO

(1943 LIMITED)

ALI. CHASSIS 18G. REINFORCED CORNERS
8"x6"x2 1/2" 7/6 14"x 5"x2 1/2" 9/6
10"x6"x2 1/2" 8/3 14"x 8"x2 1/2" 10/6
12"x6"x2 1/2" 8/6 14"x10"x2 1/2" 11/-
12"x8"x2 1/2" 9/6 17"x10"x2 1/2" 12/6

TEST METER CASES

STEEL WITH ALI. PANELS. Black Enamelled
4"x4"x2 1/2" 5/6 8"x6"x3" 8/6
6"x4"x3" 7/- 10"x6"x2 1/2" 10/6

ELLISON TRANSFORMERS & CHOKES.
PRIMARIES 200/250V. UPRIGHT MOUNTING.
MT162 250-0-250v. 60mA. 5v. 2A. 6.3v. 3A. 23/3
MT137 250-0-250v. 120mA. 5v. 3A. 6.3v. 7A. 33/9
MT121 350-0-350v. 80mA. 5v. 2A. 6.3v. 3A. 27/9
MT190 350-0-350v. 120mA. 5v. 3A. 6.3v. 5A. 39/9
DT199 350-0-350v. 120mA. 4v. 5A. C.T. 41/3

6.3v. 5A. 0-4-5V. 3.5A. 41/3
MT178 350-0-350v. 150mA. 5v. 3A. 6.3v. 5A. 48/9
MT175 425-0-425v. 150mA. 5v. 3A. 6.3v. 7A. 63/-
MT235 430-0-430v. 200mA. 5v. 3A. 6.3v. 6A. 6.3v. 6A. 62/3

FT52 2v. 2A. 11/3 FT51 6.3v. 1.5A. 8/3
FT58 0-4-6.3v. 3A. 19/6 SP70 0-6.3v.-12v. 3A.
TC38 5H. 250mA. 22/6
TC76 10H 150mA. 21/9 TC30 10H. 60mA. 6/9
TC74 30H. 20mA. 17/3

* WODEN 40H. 50mA. POTTED SPECIAL PRICE 12/6

WALCHRIS GUITAR PICK-UPS WITH VOLUME CONTROL 30/-
POSTAGE & PACKING EXTRA. C.W.O. OR C.O.D.
189 EDGWARE ROAD LONDON W2
Shop Hours

Telephone PAD. 4455/6 Mon.-Sat. 9 a.m. to 6 p.m.
Thursday 9 a.m. to 1 p.m.

VALVES NEW TESTED AND GUARANTEED

IA4	8/6	6B8	7/6	6X4	8/6	9002	5/6
IA7	12/6	6B8G	7/6	6X5GT	8/-	9006	5/6
IB4	8/-	6BA6	8/6	7C7	8/-	EASO	2/-
IC5	8/-	6F8	8/6	7H7	8/6	EAC91	6/-
IE7	9/6	6G6G	5/9	8D3	7/6	EAF42	9/6
IH5	10/6	6J5GT	5/-	8D3	7/6	EB34	3/-
IN5	10/6	6J5G	5/-	12A6	7/6	EB91	6/6
IR5	7/9	6J7GT	8/6	12AH7	7/6	EB33	8/6
IS5	7/9	6K6	8/6	12AT7	8/6	ECH35	11/6
IT4	7/9	6K7	8/6	12AU7	8/6	6BR7	8/6
3A4	10/6	6K7G	6/6	12AX7	6/9	ECL80	12/6
3S4	7/9	6K7GT	6/6	12K8GT	8/6	EF22	7/6
3V4	7/9	6K8G	8/9	12Q7GT	8/6	EF37A	15/-
5U4G	8/6	6N7	6/9	12SH7	7/6	EF91	7/6
5Y3GT	9/6	6Q7G	8/9	12SR7	7/6	EL91	8/6
5Z4G	8/9	6Q7GT	8/9	25A6	8/-	EL91	10/6
5Z4	8/9	6SA7	8/9	45	8/-	EM34	12/6
6AC7	5/9	6S17	8/6	45	8/6	12AT6	8/6
6AG5	6/9	6S17	8/6	57	7/6	KT32	8/6
6AM6	7/6	6SL7	8/9	76	7/6	KT33C	10/6
6AT6	8/6	6SN7	9/6	807	8/6	KT66	12/6
6BE6	8/6	6SS7	6/9	954	2/6	VR91	8/6
6BW6	8/6	6V6GT	8/6	1625	10/6	VR150/30	8/6
6B7	8/6	6V6G	8/6	9001	4/9		

MATCHED PAIRS 6V6G and gt, 17/-; 6F6G, 17/-; 807, 15/6; 6G6, 12/-; 6J5G and gt, 9/6 per pair.
ELECTROLYTIC CONDENSERS
2 mfd 350vw T.C.C., 1/3; 8 mfd, 350vw, T.C.C., 1/6; 8 mfd, 450vw B.E.C., 1/9; 8 mfd, 500vw, Dub., 2/6 16 mfd, 500vw, Dub., 3/6; 16 mfd, 450vw, T.C.C., 3/6; 32 mfd, 450vw, B.E.C., 4/6; 8+8 mfd, 450vw B.E.C., 3/9; 8+16 mfd, 500vw, Dub., 4/9; 8+8 mfd, 500vw, Dub., 4/-; 32+32 mfd, 275vw, B.E.C., 4/- 2 mfd, 50vw, T.C.C., 1/-; 20 mfd, 12vw, T.C.C., 1/- 25 mfd, 25vw, T.C.C., 1/3.

R. COOPER

32 SOUTH END CROYDON SURREY
Telephone CROYDON 9186

Tele: GRA 6677

MONEY BACK GUARANTEE **DUKE & Co** CWO or COD

621 ROMFORD RD. LONDON, E.12.

SPOTLIGHTS. 8/9. Butlers, X.W.D. Pre-focus fitting. 8" dia.; 6 1/2" deep. Post 1/3.

SIDELIGHTS. 1/9. Infra red glass, ideal tail lamps. New, X.W.D. Post 9d.

T.V. TUBES £3 9", £5 12". Most types from stock. Insured carriage 15/6. Not X.W.D. (Seconds).

AMPLIFIERS. 9/6. New, X.W.D. Contain EF36 valve, 2 trans., 400 ohm relay, v/control, various conds.; resistors, etc. Case measures 5"x5". FREE Drawings. Post 1/6.

AMPLIFIERS. 3 valve, 4 watts output. Ideal for p.u. or mike. A.C. or Universal. 57/6. Also 4 valve, 7 watts output. 77/6. Post 2/6.

METAL RECTIFIERS. 8/9. T.V. type. Salvage, guaranteed. 300 volt at 250 m/A. Also 250 volt at 60 m/A. 8/9. 180 volt at 40 m/A, selenium type, 3/9. Post 1/-

AERIALS. 3d each. Copper plated steel, inter-lock to any required length. 12" long. Post on doz. 6d.

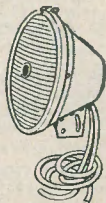

SALVAGE VALVE CLEARANCE SALE

10/9	8/9	6/9	5/9
6F15	154	EB91	6N7
10F1	6BE6	6AM5	6J5
10P13	6BA6	155	7H7
EBF80	6BV6	1T4	7B7
ECL80	8D3	6K7	7C6
EF80	X66	6F6	37
EY51	3V4	EL91	77
PY81	3A8	ECC91	210VPT

Send stamp for our free catalogue for full list. Post on valves 1/- up to 6

TRANSFORMERS.—Manufactured to our specification and fully guaranteed. Normal Primaries. 425 v. 0-425v. 200 ma., 6.3 v. 6 a., 6.3 v. 6 a., 5 v. 3a., 0-2-4-6.3 v. 3 a., ONLY 72/6. 425 v. 0-425 v. 200 ma., 6.3 v. 4 a., 6.3 v. 4 a., 5 v. 3 a. ONLY 50/- 350 v. 0-350 v. 160 ma., 6.3 v. 6 a., 6.3 v. 3 a., 5 v. 3 a. ONLY 42/6. 250 v. 0-250 v. 100 ma., 6.3 v. 6 a., 5 v. 3 a. ONLY 32/6. The above are fully shrouded, upright mounting. Universal Mounting 350 v. 0-350 v. 80 ma., 0-4-6.3 v. 4 a., 0-4-5 v. 2 a. ONLY 18/6. Top shrouded, drop through 260 v. 0-260 v. 70 ma., 6.3 v. 3 a., 5 v. 2 a. ONLY 16/6. The following are upright mounting. EHT for VC97 Tube 2,500 v. 5 ma., 2. -0.2 v. 1.1 a., 2 v. -0.2 v. -0.2 v. 2 a. ONLY 37/6. EHT 5,500 v. 5 ma., 2 v. 1 a., 2 v. 1 a. ONLY 72/6. EHT 7,000 v. 5 ma., 4 v. 1 a. ONLY 82/6. PLEASE ADD 1/6 PER TRANSFORMER POSTAGE.

TRANSFORMER, for use on trains, models, etc., giving outputs of 3 v., 4 v., 5 v., 6 v., 8 v., 9 v., 10 v., 12 v., 15 v., 18 v., 20 v., 24 v., 30 v., at 2 amps from normal mains input. ONLY 17/6 (postage 1/-).

TRANSFORMERS.—Ex. W.D. and Admiralty, built to more than 50 per cent. safety factor, with normal A.C. Mains Primaries. All Brand New and Unused. 300 v. 0-30 v. 200 ma., 5 v. 3 a., 6.3 v. 5 a., C.T., 20 v. 750 ma., 70 v. 100 ma. Weight 12 lb. ONLY 42/6 (postage, etc., 2/6). 330 v. 0-330 v. 100 ma., 4 v. 3 a. Weight 7 lb. ONLY 22/6 (postage 1/6). L.T. 5 v. 0-5 v. 5 a., 5 v. 0-5 v. 5 a., 5 v. 0-5 v. 5 a. By using combination of windings will give various voltages at high current. Weight 11 lb. ONLY 35/- (postage etc., 2/6). L.T. 6.3 v. 7.7 a., 4.2 v. 2.5 a., 4 v. 1 a. ONLY 19/6 (postage 1/6). EHT 1,400 v. 2 ma., 520 v. 10 ma., 300 v. 10 ma. 2 v. 1.5 a. ONLY 21/- (postage, 1/6).

Cash with order, please, and print name and address clearly. Amounts given for carriage refer to inland only.

U.E.I. CORPORATION
The Radio Corner
138 Gray's Inn Rd. LONDON WC1
Open until 1 p.m. Saturdays. We are 2 mins. from High Holborn (Chancery Lane Stn.) and 5 mins. by bus from King's Cross.

RECEIVER CHASSIS TYPE 22

containing a 4 gang and a single gang .0005 condenser, 3 microphone transformers, 3 toggle switches, aerial tuning coil former, approximately 2in. diameter by 8in. long. 2 Yaxley switches, 4 potentiometers, complete set of coils, approximately 100 various resistors and condensers, 100 and 200 μ F condensers 12 volt working. These chassis have been stored in the open with the result that some of the chassis and the front panels are rusty, but the components are usable. Offered in 3 grades according to condition, 5/6, 10/-, and 15/-, carriage on each set is 5/6, or 12/6 for 4. These sets can be supplied with 3 465 IFT'S at a further 5/- per set.

0-5 M.A. Meters moving coil 2" square flush type.
0-50 M.A. Meters moving coil 2" square flush type.
0-20 volt Meters moving coil 2" square flush type.
0-40 volt Meters moving coil 2" square flush type.
All brand new and boxed—price 10/- each, postage 1/3.
12 volt Motors, 2 1/4" long x 1 1/2" x 1 1/2", weight 1 1/2 oz.
Spindle 1/2" x 7/16". Ideal for boats up to 36" long, as used by many competition winners. Price 15/-, postage 1/6, with slight alteration can be made to reverse.

ROTARY CONVERTER. Miniature type 4" x 1 1/2" diameter. Weight 21oz. 12 volt input, 310 volt at 30 m/Amps output. Price 12/6, postage 1/6. Our new 76 page illustrated catalogue ready at end of month, price 1/- inland, post free. 2/6 overseas airmail. We welcome your enquiries—S.A.E. please.

ARTHUR SALLIS
93 NORTH ROAD BRIGHTON SUSSEX
Telephone Brighton 25806

SMALL ADVERTISEMENTS

continued from page 491]

"GLOBE KING" (Regd.) Miniature Single Valve Receiver gets real Dx. Amateur Radio enthusiasts, should send for free copy of interesting literature and catalogue (enclose stamp for postage). Write to makers: Johnsons (Radio), 46 Friar Street, Worcester.

OAK SWITCH SERVICE. Multi-way switches made to specification. Approx. cost:—Ceramic Wafer 5/-, Paxolin Wafer, 2/-, Clicker Plate 2/6. Box No. C117.

BLUEPRINTS. High Gain 10 Meter Converter, with a de-luxe circuit comprising EF91 RF stage, ECC91 double triode mixer and oscillator, EF92 IF amplifier, with stabilised voltage supply via a 7475, 1s 8d post free with full instructions, A.S.W.P., 57 Maida Vale, London, W.9.

KENDALL AND MOUSLEY. Manufacturers of Laboratory Equipment, chassis and instrument cases, also suppliers of B.V.A. valves, Radio and T.V. components, 99 Dudley Port, Tipton, Staffs.

COILS, COILS, COILS. We can supply coils for all frequencies, RF Chokes, Filters, etc. Coils wound to specification—send details for estimate. Send SAE for circuits and Data. The Teletron Co., 266 Nightingale Road, London, N.9.

MANY DEALERS now Stock PANL, the air-drying black crackle. If there is no Stockist in your district send 4/6 to L. Miller, 8 Kenton Park Crescent, Kenton, Middlesex.

Modulated Oscillator (page 395 February issue). We can supply a set of 4 coils, specially wound for this signal generator, on 1/8" iron dust core formers, covering the specified waveband. Price 4/6 each. The Teletron Company, 266 Nightingale Road, London N.9.

VALVES—OVER 3000 in Stock

2D21, EC91, 12AU7, 6BR7, 6CH6, 6BW6, 6SN7, 9/-, EL91, 6F33, 12AT7, EY91, 7/-, EF91, 6/6, 12AX7, 6/6. 6AL5, 6C4, EAC91, EF92, 5/6.

**SKILLMAN
FRANCHISE STREET WEYMOUTH**

1000's and 1000's of "VERIES" and SWL/QSL CARDS

have been supplied for Amateurs in many Countries by

G 6 M N

who knows your requirements

Printer of QSL's since 1925

Send for samples to
G6MN CASTLEMOUNT, WORKSOP, Notts.

THE JASON 3-SPEED GRAMOPHONE MOTOR

A motor designed to suit the most critical taste at a reasonable cost. The cast aluminium turntable is accurately machined and is fitted to a hardened steel shaft turning on a steel thrust ball in a well bearing. The weight of the turntable ensures freedom from rumble and wow.

The speed selector for 78, 45 and 33 1/3 consists of an accurate rubber tyred idler wheel which engages a three step motor pulley. When the motor is out of use the idler wheel is withdrawn from the motor pulley and turntable to prevent deformation of the rubber, thus preventing the appearance of "flats."

A small variation allows the motor to be set to exact speed irrespective of mains voltage or frequency fluctuations.

The whole unit is mounted on a sturdy cast base and is finished in a stove enamel.

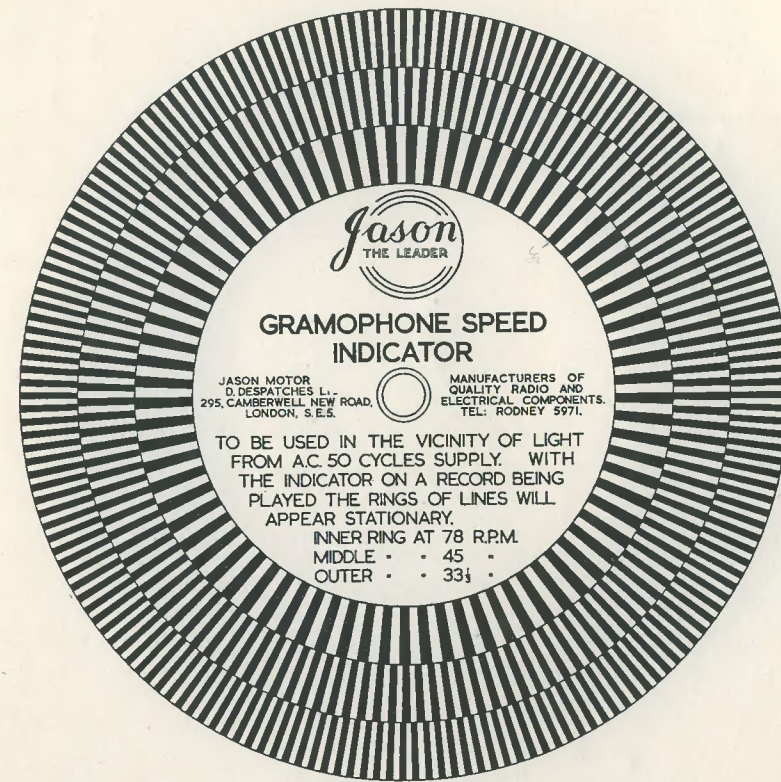

JASON MOTOR
D. DESPATCHES LTD.
295, CAMBERWELL NEW ROAD,
LONDON, S.E.5.



MANUFACTURERS OF
QUALITY RADIO AND
ELECTRICAL COMPONENTS.
TEL: RODNEY 5971.

TO BE USED IN THE VICINITY OF LIGHT FROM A.C. 50 CYCLES SUPPLY. WITH THE INDICATOR ON A RECORD BEING PLAYED THE RINGS OF LINES WILL APPEAR STATIONARY.

INNER RING AT 78 R.P.M.
MIDDLE - - 45 -
OUTER - - 33 1/2 -

Price of complete unit £12 10s. 6d. This includes the cast aluminium base, turntable and drive unit and special motor.

All parts available separately.

Jason Motor Company (D Despatches Ltd.)

295 CAMBERWELL NEW ROAD.
Telephone RODNEY 5971

LONDON SE5