



AT . . .
YOUR . . .
FINGERTIPS

All the information you need for the efficient operation of your station. Prefixes alphabetically and by Country, Zones, Maps, time factors, etc., all for 1/6 in the 'OP-AID'. From your usual dealer or bookstall or direct from us at 1/8 post paid.

A.S.W.P., 57, MAIDA VALE, PADDINGTON, LONDON, W.9

THE MODERN BOOK CO.

Radio Amateur Stations of the World (exclusive of U.S.A.). 8s. 6d. Postage 6d.

G Cali Book: Radio Amateur Stations U.K. 4s. 3d. Postage 3d.
Simple Transmitting Equipment by Amateur Radio. 2s. 0d. Postage 3d.

Television Interference by Amateur Radio. 2s. 0d. Postage 3d.

Magnetic Tape Recording by P. A. Tarry. 6s. 6d. Postage 3d.

The Williamson Amplifier by D. T. N. Williamson. 3s. 6d. Postage 3d.

Wireless Simply Explained by R. W. Hallows. 10s. 6d. Postage 4d.

Home Built Frequency Modulated Receiver by K. R. Sturley. 4s. 6d. Postage 3d.

Inexpensive Television by C. Overland. 2s. 6d. Postage 2d.

Radio Valve Data by 'Wireless World' 3s. 6d. Postage 3d.

Valve & Service Reference Manual by 'Mullard'. 5s. 0d. Postage 3d.

Comprehensive Radio Valve Guide by W. J. May. 5s. 0d. Postage 3d.

Loudspeakers by G. A. Briggs. 3rd edn. 5s. 0d. Postage 3d.

Radio Circuits by W. E. Miller 5s. 0d. Postage 3d.

Radio Instruments and their Construction. 2s. 6d. Postage 3d.

Pianos, Pianists and Sonics by G. A. Briggs. 10s. 6d. Postage 6d.

We have the finest selection of British and American radio books in the Country. Complete lists on Application.

19-23 PRAED STREET, (DEPT. RC) LONDON, W.2

PADDington 4185.

Published by Amalgamated Short Wave Press Ltd and Printed by A. Quick and Co. Ltd

RADIO CONSTRUCTOR

for the Radio and Television Enthusiast

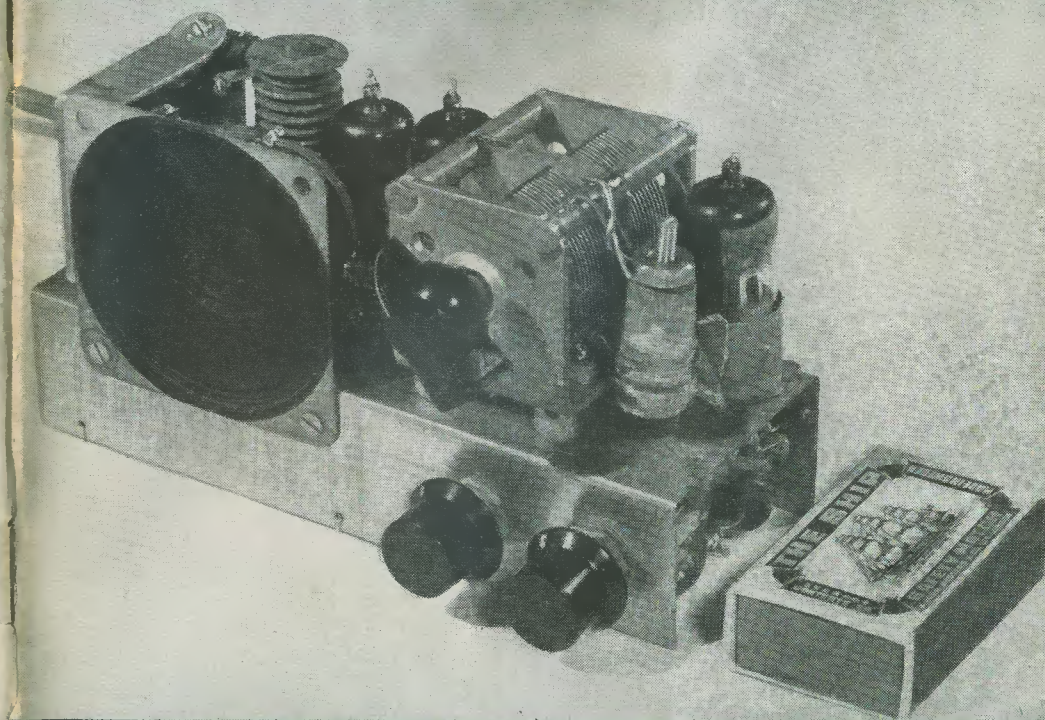

IN THIS ISSUE . . .

Personal Mains Receiver · Transformer Ratio Analyzer
Miniature I-Vale Portable · Armchair Control for TV
Radio Stethoscope · No-Load Adaptor · Harmonic Drive
Design of Iron Cored Chokes · Mainly for the Beginner
Loudspeaker Baffles and Enclosures

etc., etc.

1/6

Help us to Help You . . .

The International Short Wave League exists to organise your hobby for you. It provides you with Club facilities, contests, literature and essential supplies for the full enjoyment of your hobby.

Join your nearest I.S.W.L. Group or, if there is not yet one in your town, why not start one?

The I.S.W.L. is the foremost and most active S.W.L. organisation in the country. Your support will help us to progress even further.

Details from:—

I.S.W.L. H.Q., 57, Maida Vale, London W.9.



**FOR ALL TYPES OF
Television and VHF
AERIAL INSTALLATIONS**

Maintenance to
VHF Transmitting and
Receiving Equipment

Agents for B.M.C. Lightweight

Television Aerials

TRADE ENQUIRIES INVITED

Send for prices and details to:—

**5, PROBERT ROAD, BRIXTON
LONDON, S.W.2.
BRIXTON 7869**

METAL WORK

with a difference!

If you want a well-made, attractive and robust cabinet for that receiver or transmitter; if you need a chassis for a modulator, amplifier or converter; in fact, if you need any metalwork at all for your ham requirements

**YOU CAN DO NO
BETTER THAN TO
WRITE US FOR AN
ESTIMATE**

All metal work "made to measure"

For full details and address of nearest agent, contact—

L. J. PHILPOTT (G4BI)
(E. J. PHILPOTT)

Chapman St., Loughborough

Telephone: 2864



Radio Constructor

Vol. 5, No. 3

Annual Subscription 18/-

October, 1951

Editorial and Advertising Offices—57, Maida Vale, Paddington,
London, W.9
Tel. CUNningham 6518.

Edited by G. W. C. OVERLAND, G2ATV

CONTENTS

Suggested Circuits: Transformer Ratio Analyser, by G. A. French - - - - -	82
RC Quiz, conducted by W. Groome - - - - -	85
Harmonic Drive, Pt. 1, by P. Turner - - - - -	86
"No-Load" Adaptor, by A. E. Thornton - - - - -	89
Design of Iron Cored Chokes, by W. E. Thompson - - - - -	90
Radio "Stethoscope", by Eric Lowdon - - - - -	94
Loudspeaker Baffles and Enclosures, Pt. 1, by J. R. Davies - - - - -	96
A Personal Mains Receiver, by P. T. Pitts, G3GYE - - - - -	100
Mainly for the Beginner—The Valve—How It Works, by H. E. Smith, G6UH- - - - -	103
Armchair Control for TV, by L. W. Evans - - - - -	105
Radio Miscellany, by Centre Tap- - - - -	107
The Radio Show, visited by constructor A. Torrance - - - - -	109
Query Corner—Miniature 1-Valve Portable - - - - -	110
In Your Workshop - - - - -	112
From our Mailbag—Avominor Current Transformer - - - - -	115
Fidelity Reception, by E. Kaleveld, PAØXE - - - - -	116

Editorial

Readers will not need reminding of the current trend which affects us all—the rise in prices. New radio receivers, and new components, are expensive—and it looks as if they will steadily become even more so.

The armament programme on which this country is embarking is resulting in a scarcity of materials, and a diversion of production, so that new receivers and components will also be scarcer, as well as more costly.

These conditions are likely to bring a boom to our hobby. Not only will the financial benefit of building one's own apparatus be enhanced, but it may well be that this will be the only means of acquiring some equipment.

Should this anticipated increase in interest result, there will obviously be larger demands on the surplus equipment now being sold—and, as everyone knows, most of the real bargains here no longer exist. It would seem to be wise, therefore, to stock up with all those valves and components which experience suggests will be wanted in the future. As demand increases, and stocks fall, so do prices rise. This has been happening for some time now in the surplus field, so now is the time to buy.

G2ATV.

NOTICES

THE CONTENTS of this magazine are strictly copyright and may not be reproduced without obtaining prior permission from the Editor. Opinions expressed by contributors are not necessarily those of the Editor or proprietors.

THE EDITOR invites original contributions on construction of radio subjects. All material used will be paid. Articles should be typewritten, and photographs should be clear and sharp. Diagrams need not be large or perfectly drawn, as our draughtsmen will redraw in most cases, but relevant information should be included. All Mss must be accompanied by a stamped addressed envelope for reply or return. Each item must bear the

sender's name and address.

COMPONENT REVIEW. Manufacturers, publishers, etc., are invited to submit samples or information of new products for review in this section.

ALL CORRESPONDENCE should be addressed to Radio Constructor, 57, Maida Vale, Paddington, London, W.9. Telephone: CUN. 6518.

Suggested CIRCUITS for the EXPERIMENTER

The circuits presented in this series have been designed by G. A. FRENCH specially for the enthusiast who needs only a circuit and the essential relevant data.

No. 11: Transformer Ratio Analyser

THIS circuit (Fig. 1) has been developed at the request of readers, and represents an item of test equipment which will have many uses in the amateur workshop. The purpose of the analyser is to determine the ratios existing between windings mounted on a common iron core; such as would be provided by mains or audio transformers, etc., etc., or by auto-transformers. The analyser may also be utilised occasionally to find the ratio of RF transformers; this being feasible if an iron core of some sort can be temporarily inserted inside the former of such a coil.

The analyser has three important advantages. First of all, it allows readings to be obtained quickly and simply. Secondly, the transformer under test is not subjected to any harmful voltages or currents. Thirdly, the ratio figures obtained are those for no-load conditions; and are, therefore, not only accurate in themselves, but are also useful for working out anticipated performance figures.

Principle of operation

The principle on which the circuit functions

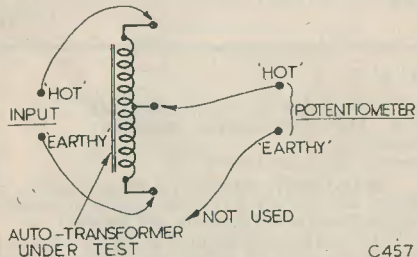

Fig. 2.

C457

is quite simple. An AF tone is fed from an oscillator to one of the windings of the transformer under test, and also to the outside ends of a potentiometer network. A second winding on the transformer has one end connected also to an end of the potentiometer slider. To find the ratio between the two windings of the transformer, the slider is adjusted until the tone heard in the phones is at a minimum, whereupon the ratio between the windings corresponds to that existing in the potentiometer network. If the potentiometer has been fitted beforehand with a calibrated scale, this ratio may be read directly. The process is, of course, similar to that of balancing a bridge.

It will be seen that, to obtain a "minimum", it is necessary for the second winding to have fewer turns than the first, and for it to be connected the correct way round to the analyser test leads. These requirements can be satisfied by using experimental connections at first; although, in most cases, the proper connections may be easily ascertained from a preliminary examination of the transformer before it is connected to the tester.

When an auto-transformer is being investigated it should be connected up to the test leads as illustrated in Fig. 2. A transformer whose tags are marked "I.P.", "O.P.", etc., can be connected in the manner shown in Figs. 3 (a) and (b).

The writer has chosen the terms "Input" and "Pot'meter", and "Hot" and "Earthy", to designate the test leads shown in the diagrams. This was done mainly because these expressions are self-explanatory and clearly denote the function of each lead.

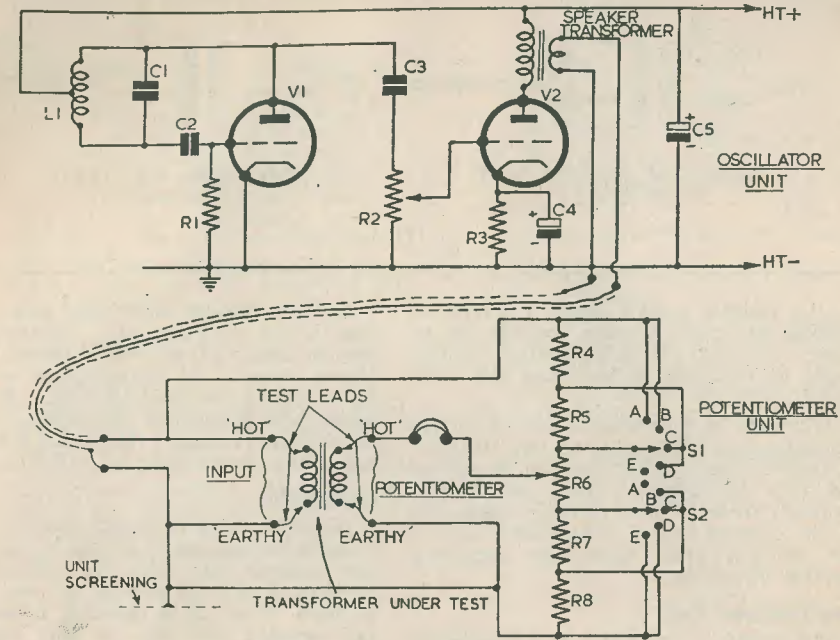

C456

List of Values (Fig. 1)

Capacitors

- C1 — Experimental. (Chosen to give 1,000 c/s tone).
- C2 — 500 pF
- C3 — 0.001 μ F
- C4 — 25 μ F, 25 V wkg. (May be omitted if sufficient gain is available without).
- C5 — 4 μ F (or larger)

Resistors

- R1 — 10 k Ω to 100 k Ω (Experimental).
- R2 — 250 k Ω
- R3 — Value according to particular valve chosen for V2.
- R4 — 10 k Ω
- R5 — 500 k Ω
- R6 — 10 k Ω Wirewound (see text).
- R7 — 500 k Ω
- R8 — 10 k Ω

AF Choke

- L1 — Experimental—suggest tapped output transformer primary, P/P intervalve transformer, or ordinary intervalve transformer with windings connected in series, may be suitable.

Valves

- V1, V2 — See text.

Switches

- S1, S2 — Single pole, five way. Ganged.

Range Switch Positions

- A — Ratios closely approaching unity.
- B — Ratios between unity and 2 : 1.
- C — Ratios between 3 : 2 and 3 : 1.
- D — Ratios between 2 : 1 and ∞ : 1.
- E — Ratios closely approaching ∞ : 1.

Any other suitable identifying terms could, of course, be used in their place.

Range Switching

To enable the analyser to work with greater accuracy, a five-position range switch (S1 and S2) is included in the potentiometer unit. The ranges covered by this switch

are given in the table accompanying this article. It will be noticed that ratios approaching unity and infinity can be accurately determined, this being made possible by the inclusion of the 500 k Ω resistors R5 and R7 in the potentiometer network. Although readings at the infinity end of the scale are obviously limited by the physical capabilities

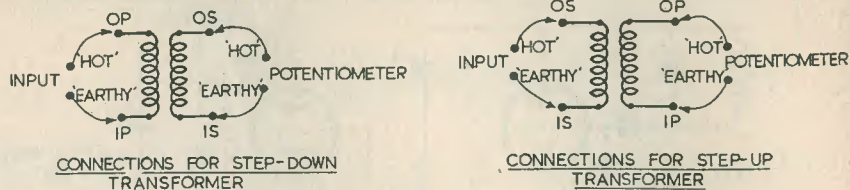

Fig. 3.

of the variable resistor itself, it should be possible to obtain accurate readings to the order of 5,000 : 1. Higher-ratio readings could be obtained by increasing the value of R5.

There will be a certain amount of overlap between ranges but this point is not, of course, a disadvantage. Calibration can be carried out over the common parts of overlap; although there is little point in calibrating to the extreme end of a particular range if the readings given there are adequately covered elsewhere.

The Oscillator Unit

The oscillator unit needs little description; it consisting simply of an AF oscillator (V1) followed by a triode amplifier (V2). The AF output to the potentiometer unit is provided at low impedance by connecting a conventional speaker transformer in the anode circuit of V2.

The diagram shows a Hartley oscillator; although any other oscillator circuit can be used so long as it gives a reliable source of AF at approximately 1,000 c/s with good power. (1,000 c/s will be found an easier tone to work with than 400 c/s). The volume control is essential and will need to be turned down in most cases. However, a high level of volume will probably be needed for checking transformers with high ratios.

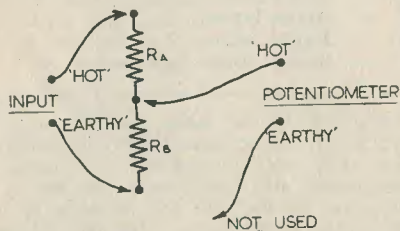

Fig. 4.

Any two triodes (6J5, 6C5, etc.) can be used in the oscillator unit. Alternatively a double valve, such as a 6SN7, could be employed instead. (If battery types are used, V2 should be an "output" valve. An alternative bias supply for V2 will, of course, be needed as well). HT could consist of any voltage higher than, say, 100 volts.

Construction

It will probably be found most convenient to build the analyser in two parts. Although the oscillator unit need not necessarily be screened it will be helpful, in some cases, to have it so. It is essential, however, to use screened wire for the lead from the oscillator to the potentiometer unit. The potentiometer unit must also be screened. The chassis connection to this unit can be taken from the screening of the interconnecting screened wire. The oscillator unit should, in addition, be connected to a good earth.

The test leads from the potentiometer unit could consist of four eight-inch lengths of wire terminated by crocodile clips, these leads being taken through the side of the unit some distance away from the knob of the variable resistor, R6. Longer test leads should not be necessary. The internal wiring inside the potentiometer unit (particularly that in the range-switch circuit), should be kept separated and as short as possible in order to reduce capacitances between leads, and between leads and chassis.

The above precautions are advised in order to prevent poor minima being obtained due to stray capacitances when very high-ratio transformers are being measured. It might further prove helpful to keep the phone leads away from the transformer under test.

It will be necessary to use high-resistance phones (2,000Ω); and it is important to note that, for reliable results, the variable resistor R6 should be a well-made, high grade component.

Calibration

Initial calibrations should be carried out by checking transformers of known ratios. Mains transformers (particularly those made by reputable manufacturers) are the most useful in this respect as, apart from the many alternative ratio figures which can be obtained by taking advantage of the tapped windings, etc., such transformers are wound, insofar as the number of turns is concerned, very accurately. Further calibrations may then be made by using resistors connected as shown in Fig. 4. Using this circuit, the

$$\text{ratios obtained will be equal to } \frac{RA + RB}{RB}$$

Before calibration is commenced, a check should be made at several "spot" points to make certain that readings obtained from resistor ratios correspond with those given by similar transformer ratios. Discrepancies are unlikely; but, should any occur, they will most probably be caused by excessive stray capacitances in the potentiometer unit.

RC QUIZ

Conducted by W. Groome

- (1) Forgetting that he had removed the video valve, Mr. Brain switched his TV on and did a lot of damage to the CRT. What are the circuit conditions which make this kind of accident possible?
- (2) Does reaction increase or decrease selectivity?
- (3) What effect does reaction have on quality of reproduction?
- (4) Why do dial lamps and some valve heaters glow more brightly than normal for an instant when first switched on?
- (5) If one valve is removed from an AC/DC set, what will be the effect upon the other valves?
- (6) Negative feedback is frequently used as an aid to linearity in magnetic timebases. Is it true that it is ineffective over part of the scanning cycle?

(Answers on Page 106)

RUFUS — The Radio Constructor



"G**** portable, calling CQ Ten metre Phone!"

HARMONIC DRIVE

Part One

By P. TURNER

SOME time ago, wondering why a harmonic is what it is, I went and asked a big noise in the one hundred watt class. I think he must have been talking to an American because he said, "Aw, it's dead easy, kid. All ya godda do is use a tooned circyut. Nuthin to it". When I pointed out that I knew that, but why? he said, "Aw, fer Pete's sake, what more do ya wanta know?"

I think his motto is "If in doubt, toon it out".

The thing which had roused my curiosity was this; an electric current produced by a resistance-capacitance circuit, a current which has never been near a tuned circuit can nevertheless set up oscillations of current of a sinusoidal character in a tuned circuit. Now, I have been taking that for granted for a long time, together with a lot of other things. Thinking about this I realised that I did not really understand where a 'harmonic' came from, and I became more and

more certain that this failure to understand was the root of many troubles encountered when my circuits did not behave as they should. I realised that when a circuit is being constructed the 'harmonics' are built in with the components, so to speak, and if the desired harmonic characteristics are not present then there should be some way of putting them in, apart from the usual tinkering. Conversely, of course, if the harmonic characteristics are undesirable then it should be possible to alter them to suit.

Therefore I began to investigate, and here are the interesting things I found out, if you would like to read them.

What the text books forgot to say

First of all I found that I had a grievance. The text books that I have read all said that a vector rotated at the same speed all the time. The truth is that this only happens when it is representing a perfect sine wave. A perfect sine wave has never been observed

by me yet, and I have seen some scores of wave forms displayed on oscillograph screens. At this point I came up against another snag. It was forced upon me that although I use the word 'vector' quite glibly I had not much idea really of what a vector was. There was a second grievance. No text book that I have yet encountered has considered it necessary to explain that a vector is nothing more than a mathematical TRICK. It was when I found out that that was the case, I got the key to the puzzle. I looked up the word to see what it meant and I found

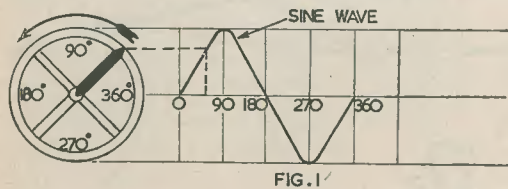
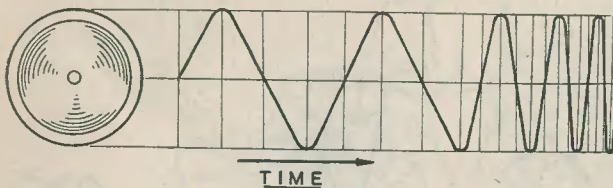

FIG. 1



TIME

FIG. 2A

SWING NOT DYING DOWN BUT IS SLOWING DOWN

C440

it very simple. The old Romans who lived in Britain brought with them a word, 'vehere', meaning 'to carry'. We borrowed it later on and made several new words from it. Vehicle is one of them. The use there is obvious. A vehicle carries people and things.

Vehement is another word we made. Here it means that a person's speech carries great emotion or feeling. Vector is another word that we made, and here it means a line which we draw that carries a meaning or a value. Now that is very interesting, because it means that a vector is not fixed or unalterable, nor is it real. It is no more real than a battleship on a cinema screen. You could use the picture of a battleship on a cinema screen to find out how fast the battleship was going when the film was taken—if you could also see some landmarks on the coast behind it. You can use a vector to find out what a wave form is doing if the landmarks are there, that is, if you know what its speed of rotation is and what value the vector is supposed to represent. If you put the film in the projector upside down the battleship and the water will be upside down at the top of the screen. The battleship will not fall out of the water and the water will not run down the screen; if you turn a vector upside down nothing dreadful will happen (unless you are in school, when the maths. master will probably clonk you on top of the head with an old chair stave like mine used to do. You should just see the harmonics in my skull form). The vector will just go on showing the usual value so long as you turn the scale with it. If you do the more accepted thing and turn the vector without moving the scale, then it will show the same peak value at a different phase. If you put the cinema film in backwards you can make the battleship go backwards just as fast as forwards, and you can make all the shells go back into the guns just as fast as they came out, and all without doing a pennyworth of damage. What is more, the values of speed measured backwards will be just the same as those measured forwards. You can make a vector go backwards if you like; the values it represents will be just the same, only reversed, and to show that they are reversed we usually put a squiggle in front like this, -. It is our old friend the minus sign, but it does not mean minus here. We have borrowed it to mean that we just measured this bit backwards. No real battleship could ever do such things as we have been talking about, but you can make an image of a battleship do them quite easily because it is not real. A vector is not real either and you can make it do what-

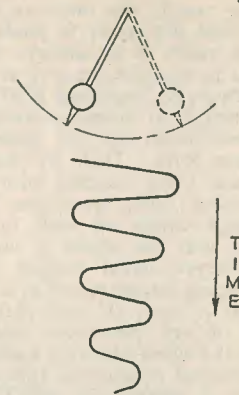

SWING DYING DOWN BUT NOT SLOWING DOWN

C441

Fig. 2 B.

ever you like. Whatever you make the vector do there is a wave form to correspond to its movements, and, of course, the other way round; whatever the wave form does there is a vector movement to correspond.

Where a Sine Wave got its name from

Still being in an inquisitive mood, I decided to look up *sine*, to see what it meant. It comes from another old Roman word, *sinus*, meaning a gulf or the bosom of a garment. (All right then, you look it up). A gulf is a long inlet from the sea into the land, making a sort of wave form of the coast as seen on a map. (Ha, ha. Pardon my pun). So sine does not mean anything very much really. The old fashioned title for a sine wave, drawn as a demonstration of the properties of a circle with no reference to electrical things, is *The Curve of Sines*, or if you wish to be strictly literal, *The Graph of Curving Lines*.

I suppose everyone knows what a sine wave is, but just for a refresher look at Figure 1. This shows a picture of a flywheel on a shaft, slowly going round. One of the spokes has been painted black. If you look at the wheel edgewise the *apparent* length of this spoke, plotted against the number of degrees of rotation of the shaft as an ordinary graph, will form a perfect sine wave. Providing that the flywheel is very heavy and rotates absolutely steadily at one constant speed, you can plot the apparent length of the spoke against time and you will still get a perfect sine wave. The spoke

is doing exactly the same as a vector does, except that the spoke is made of cast iron and the vector is imaginary. When we use a vector to describe the way in which a wave form is varying, we make it of such a length that when it is standing upright it is just the same height as the highest point on the wave form. Then we make use of it in various ways, coupled with other vectors representing other quantities, to work out the things which we wish to know. Now suppose that the wheel is not very heavy, say a bicycle wheel instead of a flywheel, and is being turned round in a jerky manner, a bit at a time. If you plot the apparent length of one particular spoke when you look at the wheel edgewise against the number of degrees of rotation of the wheel, you will still get a perfect sine wave. If you plot the apparent length of the spoke against time, you will get a graph which is definitely not a sine wave. The reason for this is easy to see. When you make a graph you plot *change* of one quantity against *change* of another quantity. If you turn the wheel, you change the apparent length of the spoke and you also change the angle. If you stop the wheel, the apparent length of the spoke stops changing, and so does the angle. The graph just stops dead until you move the

wheel again. If time is the horizontal part of your graph instead of degrees of rotation, when you stop the wheel, time does not stop. So one bit of the graph goes on and a distorted wave is the result. When we talk about a 'distorted' wave we mean one which is not a sine wave. Now that tells us why a tuned circuit always gives something approaching a good sine wave when it is driven at its tuned frequency. A tuned circuit can store energy, and it does not lose it quickly (compared to the time of one oscillation) if it is made of good components and is not damped very much. So if you give it a good push, an electrical one of course, the current will go on swinging backwards and forwards for some time before it dies away. A flywheel is just the same. It stores energy, and if its bearings are not tight and nothing is rubbing on the rim, it will go on turning for some time. In either case you can use either degrees or time for the horizontal part of the graph and you will get a reasonably good sine wave. There is another thing which has similar properties to those of a tuned circuit, even more so than a flywheel. That is a pendulum. It is not so easy to explain where a sine wave comes in with a pendulum. The difference is that the frequency of a flywheel, i.e., the number of revolutions per minute, can change while the frequency of a pendulum or the number of swings per minute cannot change. The peak value of a flywheel sine wave remains the same all the time, but the peak value of a pendulum sine wave dies away as the energy is dissipated. If you look at Figure 2, you will see that the pendulum sine wave is more like the electrical wave you get in a tuned circuit which has been shock excited and then left to die away, than is the flywheel sine wave. This similarity between the way in which electric current moves in a tuned circuit and the motion of flywheels and pendulums is no accidental thing. There is a very real and definite bond. Everything in the universe oscillates in some way and more often than not, it is a rough sine wave motion. The stars and planets swinging round the heavens are all gigantic flywheels; the tides of the oceans, the rolling grumble of a thunder clap, the flutter of a leaf in the wind, the rise and fall of great nations, the industrial boom and slump, all these are oscillations of one kind or another, and they all follow the same general laws. *And so does a quartz crystal resonator*, the vital link between things we can touch and shape; and electric current, a thing we cannot, in the literal sense, get hold of to shape it to our own ends.

(To be continued)

Inexpensive Television

The fourth in our popular Data Book Series, this publication describes the construction of television receivers from ex-Govt. surplus equipment, which is cheap and easily obtainable. This book was published in its original form some twelve months ago, and sold 40,000 copies. With its aid, televisions were built which operated far outside the normal service areas, and in all parts of the country.

The new edition, which is double the size, gives a much wider choice of equipment suitable for conversion, and will be equally popular with all television constructors.

PRICE 2/6 (post 2d.)

from your local supplier or direct from

**AMALGAMATED SHORT
WAVE PRESS LTD.**

57 Maida Vale, Paddington, London
W.9

Phone: CUN. 6518

"No - Load" ADAPTOR

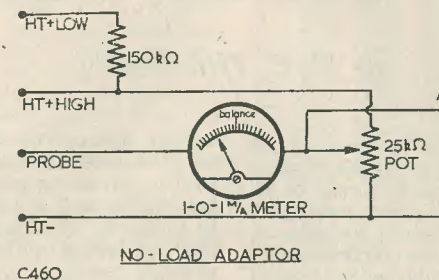

By A. E. THORNTON

MOST fellow experimenters must have been, at one time or another, troubled by the hopeless inaccuracy of a normal voltmeter when investigating high resistance circuits.

Although the normal 1,000 Ω per volt meter is good enough for audio stages of normal receivers, the current drawn by the meter renders it useless for checking anything such as a high-gain pre-amplifier valve, or even the screen and bias of most RF and IF valves.

The circuit described below was developed for reducing the error caused by the meter load, and it has proved very reliable over the long period in which it has been in use by the writer. All that is required is a fairly sensitive centre-zero meter and a potentiometer of about 25 kΩ, a resistor of 150 kΩ, plus a few odds and ends such as terminals, leads, etc.

The circuit is very simple, and merely consists of a means of balancing out the voltage applied via the probe, with a voltage obtained from the variable supply. Balance is indicated by the meter returning to zero, and the voltage is read off terminals A and B with a normal voltmeter. In use, this voltmeter is left connected across A and B during the test as, if balance is found and the meter is then connected, the balance will thereby be upset.

The meter used by the writer was not originally a centre-zero type. It was an RF meter purchased at the low price of 1s. because the thermo-couple was defunct. On inspection, it was found that besides the ordinary zero corrector on the front of the movement, a similar arrangement was fixed to the back. By juggling with this, it was possible to get the pointer to rest in the centre of the scale, without interfering with the working of the front corrector.

A further refinement is the inclusion of a resistor in the probe tip. This serves the double purpose of limiting the current through the meter in the event of maladjustment, and also reduces the effect of the probe lead when this is connected to a tuned circuit. The value of this resistor is determined by the maximum voltage likely to be encountered, and the full scale current of the meter. In my case, the figures were 350V and 1 mA, which gave 350 kΩ.

The source of HT can conveniently be the HT supply of the receiver under test. It was found that for checking below some 50V an improvement was obtained by including in the HT line a resistor of 150 kΩ, as this makes adjustment of the potentiometer more open. The two positive terminals of the balancing supply can be labelled 'HT Low' and 'HT High' as shown in the circuit diagram.

The Design of . . .

IRON CORED CHOKES

By W. E. THOMPSON

THE writer has shown in some of his previous articles that it is possible to make use of transformer stampings that may be on hand to construct items which meet with one's own special requirements as, for instance, in the article "A Useful Heater Transformer", where we saw how we could make a special transformer for use with Mr. Morley's design for a valve tester. In this case we used stampings from a transformer taken from the power pack of an R.1355 radar unit. There are several other ex-Govt. units which yield odd chokes and transformers when they are stripped for components or modified for other uses but, in the main, these items are more or less useless for ordinary requirements because they were designed to work on frequencies other than the standard 50 c/s. If the stampings are removed and new coils wound, it is possible to make components which are useful or fill a special need, provided that one has the "know how" of carrying out the necessary design calculations. This can often result in saving buying such a component, besides which one gains good knowledge of the principles of design involved, plus the pleasure of making one's own equipment. This article is devoted to the design and construction of smoothing chokes, making use of stampings recovered from

surplus gear. The design procedure has been reduced to quite simple calculations so that anyone can produce their own smoothing chokes with a minimum of trouble, and to make the manipulation of formula more clear, a typical design will be worked out in full.

Some consideration of the general properties of smoothing chokes will make our understanding of design clearer. In the first place, we use an iron-cored inductor in the HT smoothing circuit so that the small AC ripple can be reduced to negligible proportions. The higher the value of inductance, the better is the smoothing obtained. At the same time, however, the inductor must also carry a direct current (i.e., anode current for the valves) and, for a given smoothing choke, it is unfortunate that the greater the DC component, the lower the inductance becomes; we can say that, if an inductor has a certain inductance when it carries AC only, this inductance will immediately fall as soon as we superimpose a DC component on the AC. It will be seen, then, that the smoothing choke, carrying as it does both AC and DC, must be so designed that its inductance is a certain value when carrying the required value of DC.

The iron core is used to obtain a high

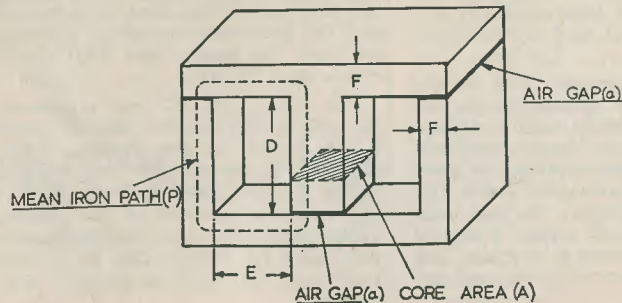

Fig. 1: Typical core for smoothing choke.

C.461

inductance in a relatively small space, and, for a given size of coil, the more iron we put in it the higher will be the inductance. We have to be careful, though, about this fall of inductance with increased DC, and one way of improving this feature is to introduce an air-gap deliberately in the iron circuit. For a specified value of inductance, current, and core size, there is an optimum size of air-gap, and the design procedure which follows takes this requirement into account. It will be as well to point out here that formulae for air-gap determination usually arrive at a figure which gives the ratio of the gap to the mean iron path of the core, further calculation then revealing the total air-gap required.

Reference to Fig. 1 will show that the total air-gap is the sum of the two gaps contained in the iron path (P), so that the actual width of the gap is half the total gap. To reduce the possibility of making errors by forgetting to divide the total gap by 2, the gap ratio figures in Table 1 have been adjusted to take this division into account, so that having worked out the value of (a) the actual gap is given. This figure is then the actual distance by which the T and U stampings are to be separated.

The stampings are usually assembled with all the T's and U's stacked together, that is, all T's on one side and all U's on the other. This method is suitable for all air-gap values greater than about 0.002 in. (2-thousandths of an inch) and, to ensure a uniform gap, it is good policy to insert small pieces of mica in it. When the gap is between 0.002 and 0.005 in. there is not much point in using mica separation, since small irregularities in the dimensions of the stampings may prevent a uniform gap being obtained, so we usually dispense with such separation and simply butt the edges of the stampings as closely as possible. Below 0.002 in. even this is not necessary, the gap being so small, so it is permissible to interlace the stampings just as we do for a transformer. We can therefore summarize core-stacking as follows:—

- Air-gap less than 0.002 in.—Interlace the stampings.
- „ 0.002 to 0.005 in.—Stack T's one side, U's the other, and butt the edges closely.
- „ more than 0.005 in.—Stack T's one side, U's the other, use mica separation in gap.

TABLE 1

$\frac{L \times I^2}{V}$	$\frac{N \times I}{P}$	$\frac{a}{P}$	$\frac{L \times I^2}{V}$	$\frac{N \times I}{P}$	$\frac{a}{P}$
500	3600	.00010	10500	30700	.00081
1000	6300	.00018	11000	32000	.00082
1500	8000	.00024	11500	33000	.00084
2000	10000	.00030	12000	34000	.00086
2500	12000	.00034	12500	35000	.00087
3000	13500	.00037	13000	36000	.00089
3500	15000	.00043	13500	36800	.00090
4000	16200	.00046	14000	37500	.00092
4500	17500	.00050	14500	38500	.00093
5000	18700	.00052	15000	39500	.00094
5500	20000	.00055	15500	40500	.00096
6000	21200	.00057	16000	41500	.00097
6500	22300	.00060	16500	42500	.00098
7000	23500	.00062	17000	43400	.00100
7500	24500	.00065	17500	44200	.00101
8000	25500	.00068	18000	45000	.00102
8500	26500	.00071	18500	45800	.00104
9000	27500	.00074	19000	46800	.00105
9500	28500	.00077	19500	47600	.00106
10000	29500	.00079	20000	48400	.00107

From the headings of the columns in Table 1, it will be seen that to design our inductor, we need to make some calculations concerning the core. We need to know the volume of iron (V), and the mean iron path (P), and to find (V) we must also first find the area of the centre limb (A). In Fig. 1 is shown a typical set of stampings stacked for a core, and the area of the centre limb is shown shaded. Its area is obviously the width of the T multiplied by the thickness of the core. The mean iron path (P) is, as its title implies, the mean dimension of the iron surrounding the winding window, and its length is found by the formula $P = 2(D + E) + 4F$. D and E are the length and width respectively of the winding window, and F is the width of the surrounding iron. Having found A and P, the volume is then $V = A \times P$.

For the actual coil design, we then evaluate

$$\frac{L \times I^2}{V}$$

where L is the inductance in Henries

and I is the direct current in milliamps. The figure thus obtained is looked up in the

column headed $\frac{L \times I^2}{V}$ in Table 1, and the

figures in the same line give values for

$\frac{N \times I}{P}$ and $\frac{a}{P}$. From these figures, we can

then determine the number of turns (N) required for the coil, and the air-gap (a) to be allowed in the iron path. We then need only refer to Table 2, which gives details of some gauges of enamelled wire, to complete the design of the coil. To show how a design

TABLE 2

S.W.G.	Diam ins.	Ohms per yard	Current m/A.	Turns per inch.	Yards per pound
24	.0220	.0632	760	39	221
26	.0180	.0945	510	48	330
28	.0148	.1395	340	58	488
30	.0124	.1984	242	70	694
32	.0108	.2622	184	80	915
34	.0092	.3612	134	94	1200
36	.0076	.5295	90	111	1840
38	.0060	.8491	56	135	2810
40	.0048	1.327	36	174	4570
42	.0040	1.190	25	207	6570
44	.0032	2.990	16	255	10270

is worked out, let us go through the calculations for a typical small smoothing choke.

We wish to make a component with inductance (L) of 20 H to carry current (I) of 30 mA. We have a set of stampings, whose dimensions are as shown in Fig. 2. We proceed as follows:—

$$\text{Area of core (A)} = H \times T = 0.75 \times 0.75 = 0.56 \text{ sq. in.}$$

$$\text{Mean iron path (P)} = 2(D + E) + 4F = 2(1.0 + 0.5) + 4 \times 0.375 = 2 \times 1.5 + 1.5 = 3 + 1.5 = 4.5 \text{ ins.}$$

$$\text{Volume of iron (V)} = A \times P = 0.56 \times 4.5 = 2.52 \text{ cu. ins.}$$

$$\frac{L \times I^2}{V} = \frac{20 \times 30^2}{2.52} = \frac{18000}{2.52} = 7150 \text{ approx.}$$

(This figure is a little more than 7000, so we can make an approximation in Table 1).

$$\text{By interpolation from Table 1, } \frac{N \times I}{P} =$$

$$23700, \text{ and } \frac{a}{P} = 0.00063.$$

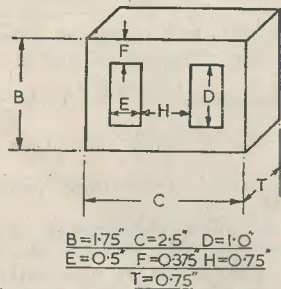

C462

Fig. 2: Dimensions of core in the worked example.

$$\text{Since } \frac{N \times I}{P} = 23700, N = \frac{23700 \times P}{I} =$$

$$\frac{23700 \times 4.5}{30} = 3555, \text{ say } 3600 \text{ turns.}$$

$$\text{As } \frac{a}{P} = 0.00063, a = 0.00063 \times 4.5 =$$

$$0.0028 \text{ in.}$$

(The air-gap being between 0.002 and 0.005 in., we shall stack all T's on one side, and all U's on the other, and butt the edges).

We have now determined that we need a coil of 3600 turns for our inductor; it now remains to settle on the size of wire to be used. We shall probably make a bobbin from paxolin 1/16th in. thick, and we must remember that the bobbin will reduce the available winding space, so allowing for the thickness of the material, the dimensions D and E of the stampings now become 0.875 in. and 0.4 in. respectively. The effective winding area is therefore $0.875 \times 0.4 = 0.35 \text{ sq. in.}$ The wire size must be such that we can get 3600 turns in this space,

$$\text{so the turns per square inch is } \frac{3600}{0.35}, \text{ and if}$$

we take the square root of this we will have the turns per inch. This works out to 102, and Table 2 shows that 36 SWG is suitable since it winds 111 turns to the inch.

We can note in passing that 36 SWG will carry 90 mA, which is three times the 30 mA we specified. The coil can therefore be wound in even layers with turns touching. For smoothing chokes, it is not entirely necessary to interleave each layer with thin paper; to preserve an even winding we can, however, put in a layer of paper say every fifth or sixth layer. A couple of turns of Empire tape round the completed winding give a neat finish. The core is built in as previously mentioned, and the wires leading into the coil terminated on a small tag strip.

We can round off our calculations by finding the approximate resistance of the coil and the quantity of wire we need for it. In Fig. 3 is shown a cross-section of a coil, together with a formula which enables the length of mean turn to be found. The depth of winding (W) can be approximated as follows:— 36 SWG winds 111 turns to the inch, and the layer length in the bobbin is 0.875 in. The turns per layer is then $111 \times 0.875 = 97$. Since the coil has 3600

$$\text{turns, the number of layers is } \frac{3600}{97} = 37.$$

TABLE 3
OUNCES SHOWN AS DECIMAL
PARTS OF A POUND

Ounces	Pound
1	0.0625
2	0.125
3	0.1875
4	0.25
5	0.3125
6	0.375
7	0.4375
8	0.5
9	0.5625
10	0.625
11	0.6875
12	0.75
13	0.8125
14	0.875
15	0.9375
16	1.0

The depth of winding (W) is, therefore, $\frac{337}{111} = 0.3 \text{ in.}$ This is fairly close to the

available depth of 0.4 in., so by the time we have allowed for paper interleaving, we can take 0.4 in. for (W).

Applying the formula given in Fig. 3 to find the mean turn, we have,
 Mean turn = $2H + 2T + 8S + (\pi W)$
 $= (2 \times 0.75) + (2 \times 0.75) + (8 \times 0.0625)$
 $+ (3.14 \times 0.4)$
 $= 1.5 + 1.5 + 0.5 + 1.26$
 $= 4.76 \text{ ins.}$

$$\text{Total length of wire} = \frac{3600 \times 4.76}{36}$$

$$= 476 \text{ yds.}$$

$$\text{Resistance of coil} = 476 \times 0.5295 = 250 \text{ ohms approx.}$$

The coil needs 476 yards of wire, and 36 SWG runs about 1840 yards to the pound

$$\text{(Table 2), so we shall need } \frac{476}{1840} = 0.26 \text{ lb.,}$$

which is a little more than 4 ounces. A quarter-pound reel would probably do.

The figures given in Table 1 are accurate enough to ensure that an inductor will be satisfactory if designed to them. Should a

$$\text{value for } \frac{L \times I^2}{V} \text{ exceed the maximum of}$$

20,000 given, it will mean that the inductor will be running towards saturation, in which case smoothing efficiency will be impaired. The remedy is either to tolerate a reduced value of inductance, or to make the core larger, either of which will bring down the value nearer, or below, 20,000. If it is

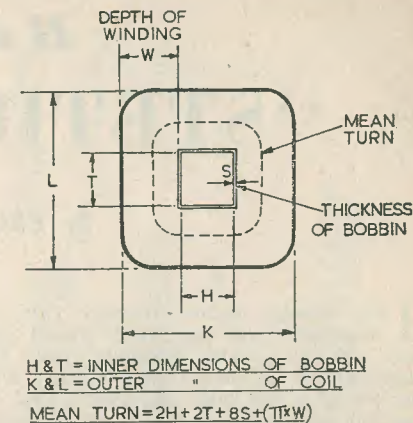

C463

Fig. 3: Calculating length of mean turn.

decided to reduce the inductance, to obtain the same measure of smoothing the filter capacitor will have to be increased. To halve the inductance, we need to double the capacitance to attain the same relative smoothing.

The wire table is by no means comprehensive, since one needs to refer only to even gauges as a rule, and 24 SWG to 44 SWG are those most commonly used in smoothing chokes. The current ratings are based on a capacity of 2000 Amps per sq. in. cross section of wire. The figures for turns per inch have been adjusted in the table to include a small spacing factor to allow for some imperfection in actual windings. A machine-wound coil would probably contain about 5% more turns to the inch.

Table 3 shows ounces as decimal parts of a pound to facilitate computing the quantity of wire required for a coil.

Change in . . .

"OSRAM" VALVE BASES

The General Electric Co. Ltd., is increasing the diameter of the bases of the following types of Osram valves from 30 millimetres to 34 millimetres: types X61M, W61, DH63, Z63, H63, L63, and W63. Some types have already been changed and others are being changed in the near future but the increased size should be borne in mind in connection with screening cans.

The new design will eliminate the trouble of bases becoming loose.

Radio "STETHOSCOPE"

By ERIC LOWDON

THE family doctor doesn't carry a complete X-ray equipment around with him on his visits. Certainly not! His equipment is as simple as possible. With the aid of a few small instruments and his medical knowledge he can make a reasonably accurate initial diagnosis.

The writer, like the doctor, dislikes humping large pieces of equipment on those occasions when a friend wants his set checked, or when working in the field. He has, therefore, taken a leaf out of the medical man's book and devised an emergency kit. It was felt that something rather more than just a multimeter was required, and various small instruments were designed to take over the duties of the more complex equipment normally used in the workshop. One of these, the tuning wand, was described in a previous article, and now we come to what I call the radio "stethoscope". The reason for the name will shortly be quite clear.

As can be seen from Fig. 1 it consists of nothing more than a crystal rectifier, a 0.1 μ F capacitor, and a pair of earphones. It is, in fact, a miniature signal tracer. The construction of the writer's instrument is shown in the other illustrations but, of course, the reader can modify this to suit himself. Instead of using an ex-radar type crystal, for instance, one of the new glass-sealed germaniums by G.E.C. would probably be rather more sensitive, and has the advantage that it has wire connections which can be soldered directly. It is not advisable to solder wires directly to ex-radar crystals since the heat may destroy them. Also, a single high-resistance earpiece could be used instead of a pair, thus considerably reducing the size of the complete assembly.

We will not spend much time on the constructional details since the drawings are (I hope) self-explanatory. Briefly, then, here is the set-up. The body of the probe consists of two sections of paxolin tube, the smaller

piece, which carries the crystal and prod, being a nice, easy sliding fit inside the larger. The end of the brass prod has a small hole drilled into it, just deep enough to accommodate the crystal pin. The complete assembly is held together by a strong rubber band as shown in Figs. 4 and 5. This form of construction ensures that the crystal is bearing firmly against the contacts, without the necessity for using spring contacts which can be troublesome. It also enables the crystal to be easily replaced if necessary. If a glass sealed crystal is used, then this will not, of course, be necessary, one unbroken section of tube can be used, since the wire connections can be soldered directly to prod and capacitor. Incidentally, the capacitor is necessary to prevent heavy direct current from flowing through the crystal when checking for signals at anodes and other high voltage points.

In most districts a receiver can be checked with this instrument from the grid of the first valve right through to the output, without the necessity of feeding in any signal other than the local broadcast transmission. In a few districts, of course, which are remote from local stations, the signal will not be strong enough to be detected at the grid of the first valve, for the instrument is then operating as a simple crystal set without amplification. But no difficulty should be experienced at other points where there is at least one stage of amplification prior to the crystal.

The "stethoscope" will operate in both RF and LF circuits without alteration, but if desired a small switch could be included to short the crystal when checking the LF side of the receiver. Finally, due regard should be paid to the fact that the instrument has quite a low impedance, and in certain parts of the circuit it will affect the output. A few preliminary checks on a circuit which is in good working order will show you what to expect when you come to check faulty receivers.

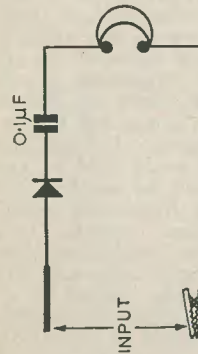

FIG. 1



FIG. 2
THE PROD

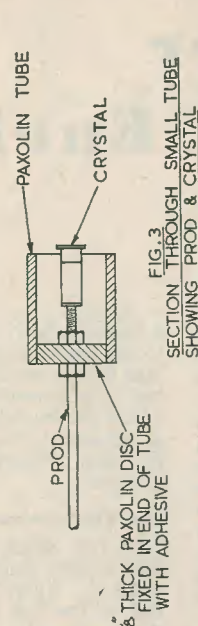

FIG. 3
SECTION THROUGH SMALL TUBE
SHOWING PROD & CRYSTAL

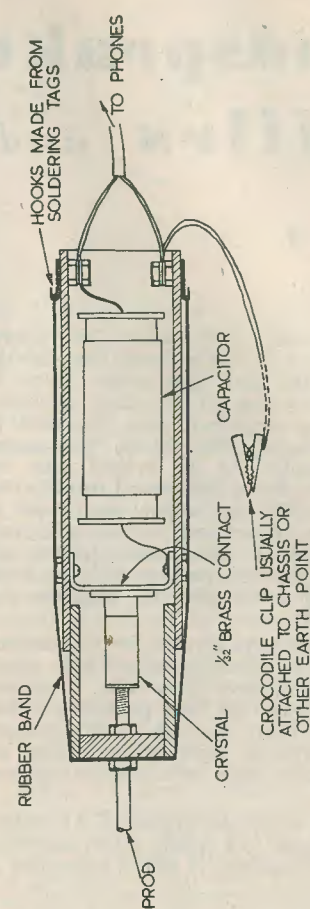

FIG. 4
SECTION THROUGH COMPLETE PROBE SHOWING
DISPOSITION OF PARTS & METHOD OF ASSEMBLY

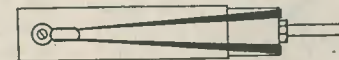

FIG. 5
HOW RUBBER BAND IS ATTACHED
TO PROBE

www.americanradiohistory.com

Loudspeaker Baffles and Enclosures

PART 1

By J. R. DAVIES

HIGH fidelity reproduction has always been one of the ultimate aims of the radio designer and constructor. Even in the very early days of broadcast reception, receivers and amplifiers were advertised as offering, amongst other things, the greatest possible quality. At the present time the technique of offering mechanical reproduction which resembles the original as closely as possible has progressed to an extremely advanced degree: nevertheless, further improvements are still possible and are being very actively investigated by designers and manufacturers.

So far as the home-constructor is concerned, the problem of obtaining high fidelity reproduction is nowadays fairly easy. Excellent amplifiers can be built from published circuits without too heavy a drain on the pocket; or the experienced amateur can design his own equipment, also with very satisfactory results.

However, whilst the design of AF amplifiers has become to a certain extent stabilised, that of the reproducer is still in something of

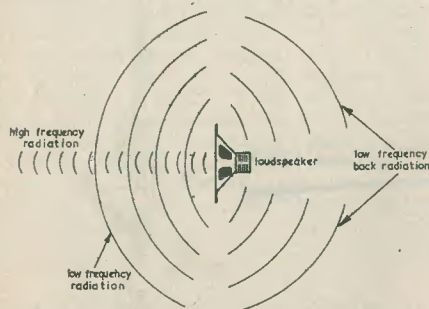

C468

Fig. 1: The manner in which high and low frequency sounds are radiated by a loudspeaker.

a state of flux. It may be an overstatement to say that the weakest point in the chain of high fidelity reproduction is in the loudspeaker, but it is nevertheless very true to state that unless the loudspeaker responds as accurately as possible to the currents fed to it, the ideal of high fidelity reproduction cannot be achieved.

The Loudspeaker

In free space, the present-day diaphragm loudspeaker cannot offer ideally good reproduction. Apart from baffling, this is mainly due to the fact that the sound generated by the loudspeaker is transferred to the conducting medium (air) in a different manner than occurs at the original source before the microphone. Nevertheless, it is possible to reduce the discrepancies by means of suitable baffles and enclosures, and so we may still obtain a reproduction closely approaching the original.

It might be easier to show how these improvements may be carried out if we examine the effect on the surrounding air of a simple, freely suspended loudspeaker, as is shown in Fig. 1. If this speaker were reproducing a complex sound such as would be given by, say, an orchestral programme, it would be found that sound waves at different frequencies would be conducted to the air in quite different manners. The bass tones and lower frequencies would tend to radiate in all directions around the speaker; whilst the middle and higher frequencies would travel in a more directional manner. Indeed, at a figure around (very roughly speaking) 5,000 c/s and above, these frequencies could be considered as moving almost in a beam. Owing to the construction of the present-day loudspeaker, they would be projected directly forward from the diaphragm as shown in Fig. 1, the centre of the cone providing the greatest sound intensity.

It must be remembered that the back of

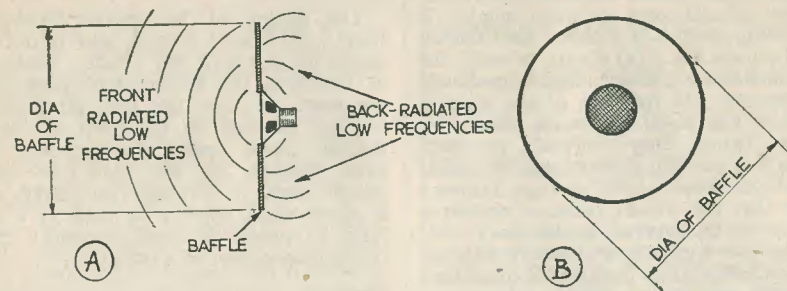

C469

Fig. 2 (a). Side view of the simple baffle showing how the back-radiated low frequency sounds are prevented from reaching front.

Fig. 2 (b). Front view of the baffle. It is more usual to use a square rather than a round baffle in which case the effective diameter is equal to a little more than the length of a side.

the diaphragm also transfers sound energy to the air. In the case of the lower frequencies, this back-radiation is about the same as that at the front; at the middle and higher frequencies the radiation is still probably equal but does not cause many complications in enclosure design since it is directional and may be fairly easily absorbed, should this prove necessary.

The Baffle

Owing to the fact that the low frequencies set in motion at the back of the cone are liable to travel in all directions, it is possible for a proportion of them to carry round to the front of the speaker where, being in opposite phase to the sounds generated by the front of the diaphragm, they are liable to cancel the latter out by a considerable amount. The simplest way of reducing or eliminating this effect is to prevent the sounds from the back reaching the front of the speaker at all, this being done by the use of a baffle, shown in its simplest form in Fig. 2. The diameter of the baffle is of importance, since the lower frequency waves (possessing the longer wavelength) may travel round the edges of an inadequate baffle and still be in antiphase by the time they reach the front. In addition to this, it is also, of course, obvious that, by using a larger baffle, the sounds which eventually reach the front are more attenuated and therefore cause less cancellation. For effective baffling in practice, the flat type of baffle needs to have a comparatively large diameter, this making its installation in the normal home very difficult. For instance, to ensure that there are no losses down to about 50 c/s or so, it is necessary to have a baffle whose diameter is at least five feet, whilst even larger baffles (about ten feet in diameter) are required for reproduction of

the complete AF spectrum.

The Higher Frequencies

Reproduction of the higher frequencies raises an entirely different set of problems. As these frequencies travel out from the loudspeaker in a fairly narrow beam, their effect is only fully noticeable when the listener is directly in front of the loudspeaker. It must be pointed out that this is not necessarily a great disadvantage. If, for instance, two people were sitting fairly close together about ten feet or so from the reproducer and in line with it (vertically and horizontally), they should be able to hear the full AF range as fed into the speaker. In the case of broadcast programmes (restricted to about 7,500 c/s) the top frequencies would probably enable a much greater deviation from the centre line to be made. It must be realised that the above statements are meant to be no more than very rough approximations, since the diffusion of sound from the front of the loudspeaker may vary considerably with different models, and because no account has been taken of room acoustics. In any case, although the difference in intensity of a certain high frequency tone may alter according to the placing of the listener relative to the speaker, the listener himself may not be able to notice the effect until comparatively large changes in position have been made.

Nevertheless, it is still desirable to ensure that the high frequency content is diffused over a wide angle, and this is most commonly done by means of reflectors or horns, or by a combination of the two. With regard to reflectors, it can be seen that if a fairly narrow beam of high frequency sound strikes a smooth curved surface it is liable to be reflected, whereupon the fact that the surface is curved causes

it to be diffused over a wider angle. If the reflecting surface is convex, the state of affairs shown in Fig. 3 (a) occurs, in which the waves radiate over a larger angle immediately after reflection. In the case of the concave reflector of Fig. 3 (b) the waves cross after reflection before they diffuse. In both examples it is possible to show that the waves have a rough "focal point" (see Figs. 3 (a) and (b)) and that the convex reflector enables a focal point to be obtained further back from the listener than is given by the concave reflector. The convex reflector may therefore be considered theoretically as offering greater advantages, since the apparent source of the sound is farther away from the listener, with possibly increased realism and, of course, greater diffusion. However, provided that it is kept within reason, there is no limit to the curvature of either type of reflector, and the

The design of loudspeaker horns is a fairly complicated process and is not really inside the scope of this article. Such things as matching the loudspeaker diaphragm to the horn, and the fact that all frequencies are not handled by the horn in the same manner make design considerations somewhat difficult. In any case, the horn is seldom found in domestic reproducers, except in those cases when it is used in a simple form to guide the high frequency content of the loudspeaker to a reflector.

Tweeters

The high frequency content in domestic reproducers is sometimes handled by separate loudspeakers known as "tweeters", these being mounted close to a second speaker which handles the lower frequencies (and which is known as a "woofer"). The tweeter

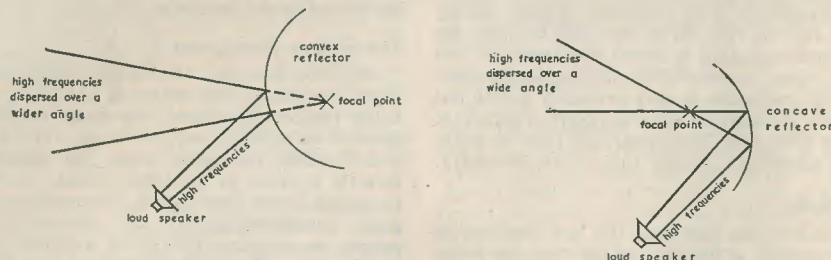

C470

Fig. 3. Showing how high frequency waves may be dispersed by (a) a convex, and (b) a concave reflector.

advantage given by the convex type (insofar as the amount of diffusion is concerned) becomes only slight. In addition, it is often more convenient for structural reasons to use the convex reflector. (It should be remembered that the reflectors shown in Fig. 3 may be curved spherically, and not necessarily in one plane alone).

Apart from reflectors, extensive use can be made of horns to widen the angle of radiation of high frequency sound waves. These horns are so designed that the compressions and rarefactions induced in the throat can travel and "open out" along the air column in the horn without losing any of their energy on its sides, either by friction or by reflection. This point is ensured by giving the horn a smooth inside surface and, most important, by designing it so that its shape causes no interference with the sound waves. The usual curve employed in horn design is exponential.

is a specially designed loudspeaker of small dimensions, and is not necessarily a moving-coil unit. Many tweeters use piezo-electric crystals to drive the diaphragm. The output of the amplifier is usually coupled to the woofer and tweeter by means of a cross-over network which filters out the low and high frequencies and passes them separately to the appropriate loudspeakers.

Tweeters, as such, are not used overmuch these days, as they are liable to give the higher frequencies a "disembodied" effect, and because it is now possible to obtain single loudspeakers with coverages which extend over nearly all the range required. Nevertheless, tweeters are still used in some reproducers, the disembodied effect being overcome by positioning the tweeter so that its output is either coaxial with that of the woofer, or is made to appear to the listener as such. So far as home constructed domestic installations are concerned, mounting a

tweeter close to the woofer on a communal baffle does not really give very good results, although this combination was considered by some as being the reproducer *par excellence* ten years or so ago.

In passing, the writer would like to point out that the term "tweeter" has, to a certain extent, fixed itself by association to the earlier type of speaker mentioned in the preceding paragraphs; that is, either a crystal (or small diameter moving-coil) loudspeaker. In some modern reproducers, the high frequency content is handled by a unit which is different in principle and more advanced in design than these earlier models, and the term "tweeter" is liable to give a somewhat wrong impression if it is applied to these more modern units. (To be continued)

PERSONAL MAINS RECEIVER

Save Pounds with Surpluses

See page 100

SPEAKERS, Plessey 3" 12/6 complete with O.P. Trans: less O.P. 10/6. Perfect, with O.P. 16/6, Less O.P. 12/6.

METAL RECTIFIERS, recommended for set. 7/6

LINE CORD. 0.3A at 9d per foot-

COILS. The famous B.D.C. Dual Wave with drawings of connections 7/6 per pair
Before buying the rest of your gear obtain our TRADE PRICE catalogue. Saves pounds.

EXTRACTS OF BARGAIN LIST

SHORTWAVE SUPERHET 15/6. No. 18 set, receiver. FREE INSTRUCTIONS for conversion to All Wave and Circuit Diagram, included. NOTE. Set with a little alteration makes first class portable or car radio. I.F.'s 465. Change over to P Coils for medium wave. Less valves. There are only a very limited number of these sets, and our previous supplies were quickly sold out.

TYPE 25/1196 SUPERHET RECEIVER. Limited number of these bargains. NOTE price, 12/6 each. With free drawings. These convert easily to A.C. Universal or Battery All-Wave receivers 465 I.F.'s, 4 tuning cons; 28 fixed cons; 32 resist; trans; switches; v/control, v/holders and all the usual parts less valves. post 1/6

RADIO CONTROL UNIT 12/6 including speaker 3 1/4 inch Tweeter, 25 Resistances including wirewound. Various condensers, 2 instrument type fuses, 8 international octals ceramic, 3 Acorns ceramics, V/holders, 7 V/controls. Relay with multi-contacts, 2, Co-ax. connectors. Wire and all the usual parts etc: Clean chassis and cabinet of pleasing appearance. Ideal amplifier or receiver etc: Post 2/- extra.

NICKLE CHROME WIRE .014 on 50yd. spools 4/6. .032 on 25yd. spools 4/6. NOTE:— if you have the facilities to draw wire this can be drawn down to any desired size. (This also increases the length considerably).

BRAND NEW Bias Electrolytic Condensers for only 9d. each. Of famous Solar manufacture, 50 mfd—12V W.D.C. a dozen on the shelf are a good investment. Before buying! inspect our valve list. All types of valves from one shilling (1/-). Money back guarantee. Cash with order please, OR C.O.D. Stamps only for Lists. 621, Romford Road, Manor Park, E.12. Phone GRA: 6677, for postal service. Personal shoppers

DUKE & CO.

219, Ilford Lane, Essex, ILFord 0295.

MODERN PRACTICAL RADIO AND TELEVISION

This work covers every phase of Radio and Television Engineering from many viewpoints and meets a great demand. The author, C. A. Quarrington, A.M.Brit.I.R.E., has been responsible for training Radio and Television Service Engineers and is also well known as a lecturer on Radio and Cathode-ray subjects.

SOME OF THE CONTENTS

Sound — Waves in Free Space — Electricity — Magnetism and Inductance — Capacity — Reactance and Impedance — Alternating Current — Tuned Circuits — Principles of the Thermionic Valve — The Signal Analysed — Detection — Reaction and Damping — H.F. Tetrode and Pentode — High-frequency Amplification — Principles of the Superheterodyne — Frequency-changing Valves — Design of the Superheterodyne — Practical Coil Design — Switches and Switching — Low-frequency Amplification — The Output Stage — Output Valves — Loudspeaker — Automatic Volume Control — Tuning Indicators — Inter-Station Noise Suppression — Automatic Tuning — Frequency Modulation — Power Pack — Decoupling — Gramophone Pick-up — General Mechanical and Electrical Considerations — Five Circuits Analysed — Aerials, Earths, and Noise Suppression — Car Radio — Principles of Low-power Transmission — High Vacuum Cathode-Ray Tube and its Application to Television — Time Base — Television Technique — Television-receiver Design — Adjustments and Faults of a Television Receiver — Measuring Instruments — Ganging Oscillator — Cathode-ray Oscillograph — Voltage and Current Testing — Instability and Motor-boating — Tracing Distortion — Tracing Mains Hum — Tracing Background Noise — Valve Testing — Receiver Alignment (Ganging) — Whistles and Break-through — Loudspeaker Faults — Testing Components — Faultfinding Procedure (A Summary) — Local Interference — Workshop Hints — Accumulator Charging and Maintenance — Simple Mathematics, etc. — Abridged Technical Dictionary.

RADIO CIRCUITS AND DATA

A wide selection of typical and basic circuits with formulae and data, are also included together with a number of Manufacturers' and complete basic circuits showing the latest trends and practices, apart from a comprehensive range of unit circuits.

THE ILLUSTRATIONS

"Modern Practical Radio and Television" is profusely illustrated. It contains 16 full-page plates, over 400 diagrams in the text and 7 large folding insets. Each illustration has been specially selected for its practical utility.

SEND FOR FREE PARTICULARS

To The Caxton Publishing Co., Ltd.
73, Morley Hall, St. George Street, Hanover Square,
London, W.1.

Please send me, free of charge, particulars of "Modern Practical Radio and Television," together with your terms of easy payment.

Name.....

Send this form in unsealed envelope. (1½d. stamp)

Address.....

R.T.7.....

A Personal . . .

MAINS RECEIVER

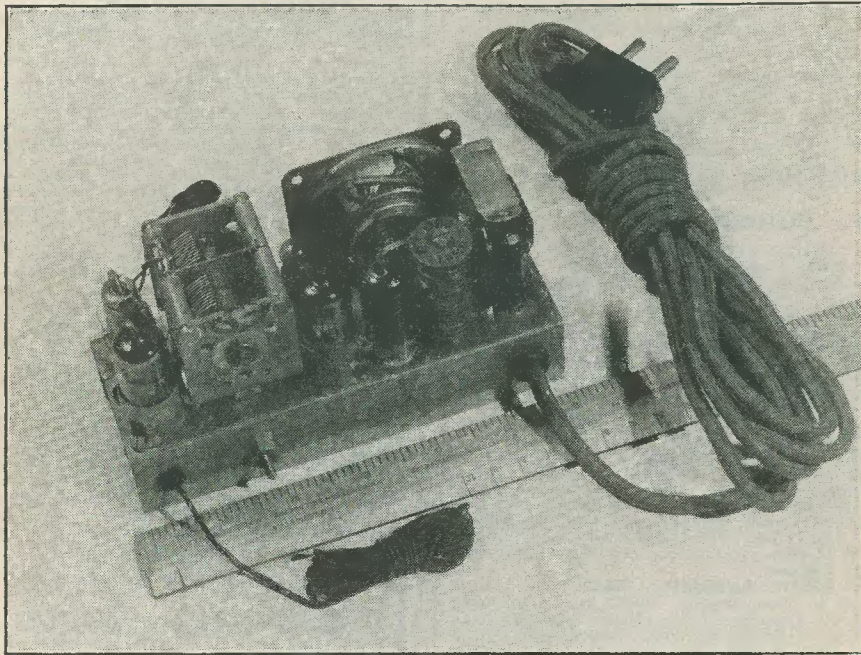

By P. T. PITTS, G3GYE

THE following article has been written in the hope that it will interest constructors who desire a small receiver which is not fragile, and reasonably universal, that is a frequency coverage 1800 kcs—580 kcs, 400 kcs—150 kcs, and for operation on 100—250V, AC or DC supply.

The overall size, including case and knobs, is $6\frac{3}{16}'' \times 3''$, height $3\frac{5}{8}''$.

The circuit, which is quite conventional, has been designed around three button base valves, type 6AG5, obtainable from Government Surplus Stores.

Construction

Tinplate 20 swg is used for the chassis, allowing earth connections to be directly soldered. It is suggested that all holes are drilled and cut from the flat sheet before bending, as shown in Fig. 3. Ample space beneath the chassis allows the use of $\frac{1}{4}$ or $\frac{1}{2}$ watt resistors, and standard type capacitors. However, miniatures are preferred in the interest of neatness and ease of construction.

The method of volume control, shown in Fig. 1 has been found necessary due to the non-variable Mu characteristics of the

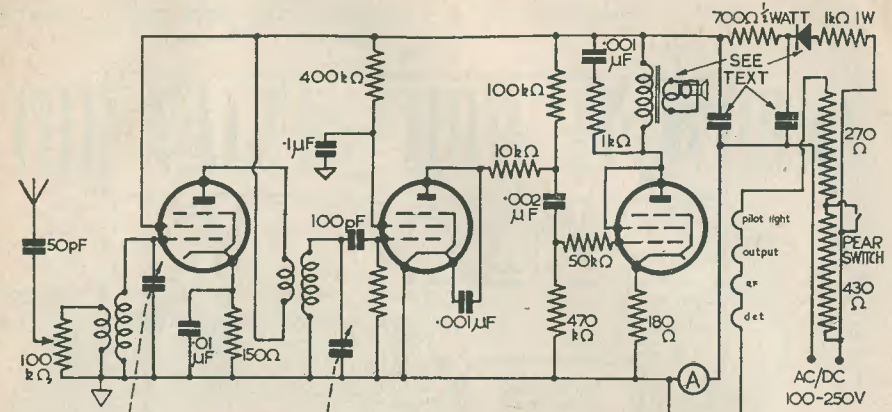

FIG. 1
ALL RESISTORS $\frac{1}{2}$ OR $\frac{1}{4}$ WATT UNLESS STATED
OTHERWISE

C451

6AG5. The control used has a diameter of $\frac{3}{4}''$.

Denco Maxi "Q" chassis mounting coils are used in the original, the formers being cut off from the tag end to within $\frac{1}{16}''$ of the winding, MW only being shown in Fig. 1 and 3. LW may be added, the detector coil being mounted between the MW coil and aerial grommet, the aerial coils being mounted horizontally. Switching of the coils, if both bands are required, is effected on a 4 Pole 3 Way single wafer component, $1\frac{1}{4}''$ diameter. The first position is mains off, the wiring of which is shown in Fig. 2.

The two gang capacitor, 0.00035 μ F per section, measures $2'' \times 1\frac{1}{2}'' \times 1\frac{1}{2}''$, and is mounted on the chassis, the knob being a direct drive vertically above the volume control.

The selenium rectifier is made up from 14 18mm discs and is mounted on the chassis.

A $20 + 20\mu$ F 200V capacitor $3\frac{3}{8}'' \times 1''$, as made by T.M.C., may be used with a dropping resistor in series with the rectifier; see Fig. 1. This resistor is omitted with a Hunts 32+ 32μ F 250V or Ediswan 20 + 20μ F 275V $1\frac{1}{16}'' \times 2\frac{3}{8}''$.

As a greater number of constructors are more likely to have a normal $2\frac{1}{2}''$ speaker than a $3\frac{1}{2}''$ wafer type, the chassis is shown to accommodate the former; however, the larger speaker is recommended and may be fitted if the pilot light is omitted. A pad of cotton wool over the rear aperture of the speaker casing improves results. The speaker

transformer measures $1\frac{1}{2}'' \times 1\frac{1}{2}'' \times 1\frac{1}{4}''$, and has a ratio of 80 : 1 to match a 3 Ω voice coil or 35 : 1 for a 15 Ω speaker.

For operation on 200—250V a 0.3 amp line cord having a resistance of 700 Ω is required. The 270 Ω resistance for use on a 100—115 volt supply may be arranged by having a pear type switch on the 700 Ω line cord to short out 430 Ω when the receiver is used on 100—115V, as shown in Fig. 1.

Should the receiver accidentally be put on

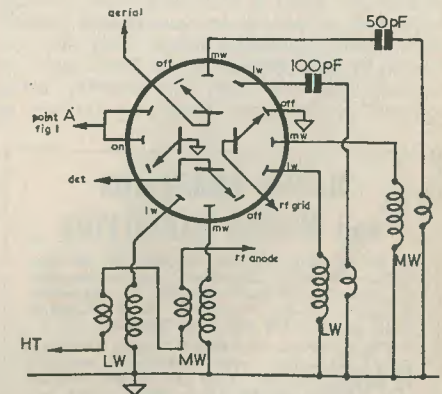
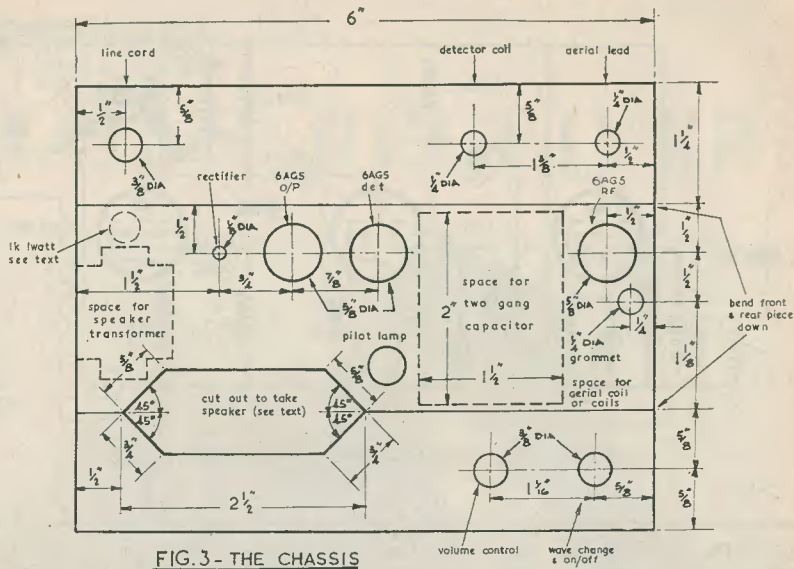

FIG. 2
WAVE CHANGE SWITCH CONNECTIONS
VIEWED FROM FRONT OF RECEIVER

C452



C453

FIG. 3 - THE CHASSIS

a 200-250V supply, when the switch is in the 100-115V position, the pilot lamp will fuse before a valve unless one of the heaters has aged considerably.

The Case

A piece of 18 swg aluminium 1' 13/16" x 2 1/8" is bent 3 9/16" from each end around a 1/4" dia. rod to form the sides and top, countersunk screws being used to fix a base of four-ply wood 6 1/16" x 2 3/16", leaving a space at the rear to accommodate a paxolin sheet with ventilating holes. This sheet is bolted to the chassis; when the chassis is inserted into the case, the paxolin being screwed to the base holds the chassis in

place. To prevent direct pick-up by the aerial coil, which renders the volume control inoperative, a spring contact bonds case to chassis when the latter is inserted. A sheet of plywood is cut to fit the front aperture with holes for speaker, pilot light and controls. This is held by cs screws into the base and a small bracket either side at the top fastened to the aluminium by cs screws. The top and sides may now be covered with rexine before fitting the front covering, which is a white celluloid sheet inlaid on the wood. The surface of the celluloid comes flush with the front edges of the rexine covered sides and top. Holes in the celluloid are as in the plywood, except for the pilot lamp which shines through. For the speaker covering, a fine grille may be fitted between plywood and celluloid, or a design on the celluloid cut out by fretsaw. Station names are engraved and filled in. Small rubber feet are obtainable to screw into the base.

A throw-out aerial, length 6', has been found sufficient in most parts of the country, whilst in the London area this may be coiled and tied behind the set.

Since constructing this receiver, variable-mu RF pentodes and AF pentodes in the button base range have become available. If a constructor wishes to purchase new valves, these would be preferable, an even better performance being obtainable.

**RADIO, TELEVISION
and MODELS EXHIBITION**

is being held by the Institution of Post Office Electrical Engineers, Junior Section, London Centre Radio Group, at Waterloo Bridge House, Waterloo Road, London S.E.1 on the 26th and 27th October.

The emphasis will be on "home construction", together with additional exhibits of interest to the radio and model enthusiast. Admission by programme, price 3d., which includes entrance to the Cinema, from The Hon. Group Secretary, 26 Orchard Avenue, Heston, Middlesex.

Mainly for the Beginner . . .

THE VALVE - HOW IT WORKS

By H. E. SMITH, G6UH.

Foreword

It is not entirely necessary for the home constructor to know what happens inside the valve, when the heater and HT supply are switched on. The only important thing is whether the receiver or amplifier will operate. If it works as per specification, all well and good; but let us suppose one of the stages refuses to function. Is the constructor sufficiently well versed in the fundamental principles to know exactly what procedure to adopt in finding out the reason why the failure has occurred? In this first part of a series, each complete in itself, an effort has been made to explain, in as simple language as possible, the important functions performed by the valve in the reception and amplification of Radio frequency and Audio frequency signals, how to identify components and read circuit diagrams. No complicated mathematics will be entered into, and practical aspects only will be considered.

The Electron. (Its relation to the Atom)

First and foremost, it is necessary to understand what the *Electron* is. An atom of matter consists of a number of Electrons revolving round a positive nucleus (the actual number of electrons being dependent on the substance of which they are a part). The



C453

FIG. 1
THE SPACE CHARGE

Electron, then, may be called the smallest amount of negative electricity that it is possible to imagine. The filament of a valve (or cathode) is composed of millions of atoms. When the temperature of the filament is raised (by applying voltage from the LT accumulator), the movement of the electrons is accelerated. As the filament nears its maximum temperature, the electrons are moving about at such a rate that many of them become detached from the parent nucleus and are hurled through the surface of the filament. No sooner do they leave the filament than they are immediately attracted back to it, because as soon as the electron leaves the nucleus the balance is

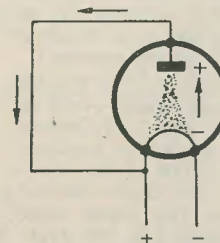
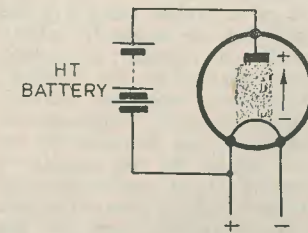

FIG. 2
POSITIVELY CHARGED
ANODE



INCREASING ANODE
VOLTAGE

C454

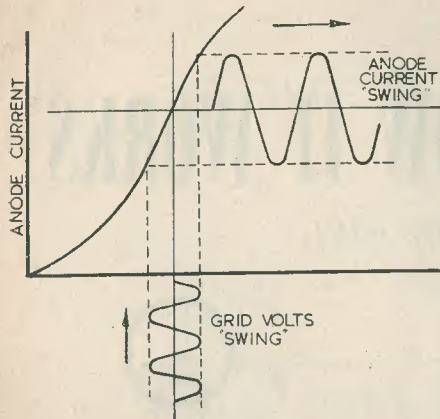

FIG. 3
ILLUSTRATING THE RATIO OF CHANGE IN
ANODE CURRENT TO GRID VOLTAGE
C455

upset, and a positive charge remains. This, of course, attracts the electrons, and results in what is known as a "space charge" (Fig. 1). This can best be visualised as the cloud of steam which hovers over a pan of slowly boiling water; only in this case very little of the "steam" actually escapes, and as soon as it leaves the "water" is immediately drawn back to it.

In actual fact, positively charged particles (or "Ions") are liberated from the filament at the same time as the electrons, but we will not deal with these for two reasons.

- (1) The issue would be confusing.
- (2) They do not play a very important part in our discussion at the moment.

So we will concentrate solely on the electron and its movements.

The Three Element Valve (Triode)

The elements of a triode valve are the filament, the grid, and the anode (or plate). Leaving the grid for the moment, let us look at the anode in relation to the filament. We have our cloud of electrons dancing about in the "space charge", with nowhere to go except back to the filament. If we apply a positive voltage to the anode, we immediately deprive it of some electrons (a positively charged body is always deficient in electrons). In the simple case, we will join the anode to the positive side of our LT accumulator. Some of the electrons will now be attracted to the anode and will flow from filament to anode and round to

filament again as shown in Fig. 2. Increasing the positive voltage on the anode results in a still greater deficit of electrons, and consequently the attraction of the anode will be much greater than the filament. As the space charge is formed, therefore, it will be drawn immediately to the anode, and there will be constant electronic flow (anode current) through the valve as it attempts to restore the balance of polarity.

Electronic flow, therefore, is *always* from negative to positive. There has recently been an effort to prove that *current* flow in a circuit is opposite to electron flow, i.e., from positive to negative. Such "proofs" do nothing but confuse the beginner, and it is far better to settle for the "minus to plus" theory as applied to electrons and current.

The Grid

The grid is the "tap" of the valve. It is used to regulate the electron flow, just as a tap is used to regulate the flow of water. The grid usually surrounds the heater, and if a *negative* voltage is applied to it, it will naturally tend to neutralise the attraction from the anode as it is directly in the path of the electrons forming the space charge. By varying the negative voltage on the grid we may, therefore, control the electron flow and the consequent anode current.

The "slope" of a valve indicates its power to amplify signals. The minute changes in grid voltage produce a larger change in anode current, and it naturally follows that the greater the change in anode current, the greater is the response in the telephones or loud speaker connected in series with the anode. The "slope" figure is usually expressed in milliamps per volt and, as it implies, denotes the ratio of change in anode current to the change in grid voltage (Fig. 3).

Another important characteristic is the "anode resistance" of a valve. This is usually expressed in ohms, and is arrived at by the ratio of anode voltage change to anode current change.

A good valve for use as a "leaky grid" detector would need to have a fairly high slope (Gm.) of between 7 and 10 mA/V, and an anode resistance of between 10,000 and 20,000 ohms. For a leaky grid detector with an anode resistance figure of 10,000 ohms, the actual value of load resistance required will be about *half* of this figure. A pair of 4,000 ohm headphones, therefore, represents approximately the correct loading for the valve.

(To be continued)

ARMCHAIR CONTROL

... for TV

By L. W. EVANS

READERS will doubtless have seen a report in the National Press that an armchair control for TV has been demonstrated at the Festival of Britain Exhibition. The following article will enable the enthusiast to try out a simple form of control, and thus form his own opinion as to its possibilities.

It is held to be a fact by many (including the writer) that once a "viewer" becomes familiar with the technical aspects of television, that medium, to a large extent, loses its *entertainment* value and becomes a critical ordeal.

The writer is not criticising the B.B.C., or suggesting the "Television Service" is not all the experts claim it to be. The fact remains, however, that there *are* changes in contrast level during the course of transmission. These may be attributable to:—

- (a) Variations in light and shade at the studio.

- (b) Variations of signal strength at the receiving aerial (especially "fringe areas").
- (c) Fluctuations of the supply mains voltage (all too common in parts of the country nowadays).

The first contributory factor (a) is under the control of the B.B.C. engineers, and is outside the scope of this article.

The second and third factors (b) and (c), which affect the contrast of our received picture, can be said to be within the control of the viewer, inasmuch as their effects can be counteracted, within limits, by slight adjustment of the contrast control.

It was this fact, namely that adjustments to 'contrast' are often necessary for the best results (especially with the VCR97), that prompted the following experiment.

The "Old Hands" will probably shake their heads and say, "Obviously a confirmed knob-twiddler", and, as far as TV is concerned,

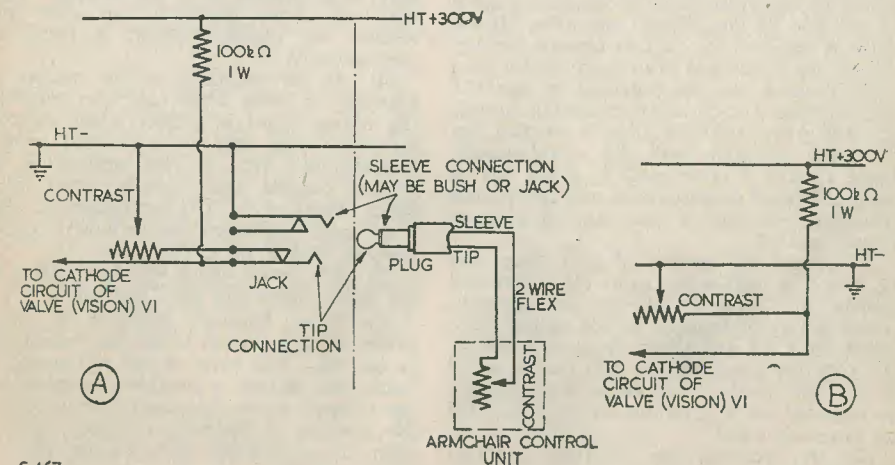

C467

they are quite right!

How many times have you, the reader, upon being invited to 'look-in' at a friend's home, felt a tremendous urge to give that 'soot and whitewash' picture that little (contrast) correction.

With the aim, not of suppressing this urge to adjust, but of making the operation possible without causing annoyance and distraction to one's fellow viewers, the writer decided to try a simple modification to his television. This consisted of rewiring the existing contrast control so that, by inserting a plug into a jack (fitted at the rear of the receiver), the contrast could be controlled from a comfortable position in the family circle.

The results, over a period of six months, exceeded expectations. Having set the brilliance control to the tuning signal, a full evening's programme can now be enjoyed, with correct contrast settings, whether the scenes are 'cine' (film), studio or a mixture of both. The armchair control unit measures 4½ inches long, 2½ inches wide by 2 inches deep. The box could have been entirely homebuilt to smaller dimensions, but the writer favoured using a control unit type 89, which was 'surplus' for 1/6d., and possessed phosphorescent control settings. The conversion of the 'bought' control unit was a simple matter and was carried out as follows. Remove the existing wafer-type switch and 5-way socket (unless you are fortunate enough to find a plug to fit it). In place of the wafer switch, fit a wirewound potentiometer of

same value as the existing contrast control. Using the four original fixing holes, fit the socket part of a suitable multiway plug and socket, varieties of which are much in evidence in the surplus shops. Although only two connections are made to this socket, the writer recommends the multiway type for its robustness. (A suitable plug and socket is the type marked 10H/629 and 10H/635, respectively).

9 feet of two-wire flexible cord and a two-way telephone type plug completes the external part of the unit.

Next fit the telephone type jack in a convenient position at the rear of the television.

Wiring up the unit and the modification to the existing contrast control is illustrated in Fig. 1a.

Fig. 1b gives a typical schematic diagram of a contrast control prior to modification. A useful hint, when wiring up, is to see that the 'earthy' end of the contrast circuit is connected to the 'sleeve' of the telephone type plug, and the slider of the potentiometer in the armchair control unit. The 'positive' or HT side of the contrast control is then wired to the 'tip' of the plug, and the 'tip' spring of the jack. This reduces the possibility of shocks when inserting or withdrawing the plug from the jack.

All that now remains is to utilise your simple armchair control as previously explained. The cost? It should not exceed 7/6d. if you have to buy every part.

ANSWERS TO QUIZ

(1) This disaster may occur when the anode of the video valve is directly coupled to the grid of the cathode ray tube. If the valve is removed, or fails to operate for any reason, the anode end of its load resistor goes more positive, to the potential of the HT line, for there is no current then flowing through it. The grid of the CRT, directly coupled, has the same potential, with dire consequences. Some attempt is often made to avoid this by using a form of potentiometer and capacitance coupling, but care is necessary to preserve picture quality.

To obtain the benefits of grid drive, one of which is high video gain, the writer still prefers the cathode follower arrangement, where failure or removal of the output valve sends the CRT grid down to earth potential. As a further precaution, a grid leak is wired at the tube socket. The slight extra expense is regarded as a good insurance policy for an expensive tube!

(2) By reducing the damping, reaction narrows the bandwidth and so improves

selectivity.

(3) It lowers the audio quality considerably and, because even the simplest super-het with diode detection can give better results, the reaction circuit is little used commercially.

(4) As the resistance of the heaters and filaments is lower when cold, the current in the heater chain is greater when switching on than when they have reached working temperature. This is less serious in low voltage parallel heater circuits than in the series chains of AC/DC arrangements, where it is usual nowadays to include a current limiting resistor of special type.

(5) The series chain will be broken and the other valves will not "light up".

(6) True. Negative feedback is out of action during periods when the output valve is cut off. The valve is cut off during fly-back, and during a considerable portion of the forward stroke, in most modern receivers. No amount of feedback, therefore, can help with the sometimes troublesome left edge of the picture.

Radio Miscellany

THE first edition of the R.S.G.B. Amateur Radio Call Book will satisfy a long-felt want, and those concerned are to be congratulated on the speedy production since its compilation was first announced. That its need was strongly felt in the amateur movement is evidenced by the fact that G-amateur calls are nearly 100% complete, from information supplied by themselves.

It is surprising that such a publication has not been produced before. Several times in post-War years I have urged its need—the last occasion at some length was in our companion journal, the SHORT WAVE NEWS for November, 1949.

If my prompting has had any effect in bringing this most useful handbook to life, may I be permitted to throw in a couple more suggestions: Firstly, I should like to see a larger type face used in subsequent editions. My eyes are not so keen as they were, and after all, such a book is needed for quick reference.

Some of these have been marketed fairly promptly after my appeal. I like to feel that this has not always been simply due to coincidence, and that some small share of the credit for their appearance might be mine.

There are, however, still one or two minor needs I have drawn attention to in the past which have still to be filled. Just in case no enterprising manufacturer noticed them on the first publication, here they are for the second time of asking.

Miniature crocodile clips for experimental tappings on coils, etc.

A full vision tuning dial, with a hinged escutcheon, to enable calibration to be made without dismantling the whole assembly.

Printed art paper scales calibrated in "S" points to stick over the normal scale of the average two-inch milliammeter.

Ganged variable capacitors with a built-in bandspread section driven by a shaft

CENTRE TAP *talks about* R.S.G.B. CALLBOOK - "WANTS" - CORRESPONDENCE

The second is, that through the good offices of the I.A.R.U., future editions of National Call Books such as this and those of the R.E.F. and V.E.R.O.N., etc., might all be of uniform size and style, except perhaps for distinctively coloured covers.

Before leaving the subject, one further suggestion. This time for our readers and not for the publishers. If you have not already thought of it for yourselves, this Call Book will make a very acceptable present for Christmas for overseas Amateurs. The postage, too, on a book is comparatively light. Recently I sent two small parcels to amateurs in Denmark. The heavier of the two contained a bound book and, as the corner of the wrapping was cut away to reveal the contents, the cost of postage was only an eighth of that of the lighter parcel.

Still Coming?

Looking back over the years I can feel some satisfaction in drawing attention to amateur needs which had not, up to that time, been satisfied by commercial products,

far enough away from the 'setter' to allow the use of a full scale slow-motion dial.

Geared tuning mechanism to enable us to get away from the eternal cords and pulleys, so that one can return communications type receivers and measuring gear to a pre-determined setting with certainty.

If any ingenious readers have found ways which get round the need for special components to meet these points, the Editor or I will be pleased to have details.

The free-deck chassis, by the way, which I outlined in RC some time back, does not appear to have been taken up on any sort of scale yet, although judging both from correspondence and what I see first hand there is quite a demand for a chassis something on these lines. Unfortunately the Armaments drive with its consequent shortage of metals for domestic uses now retards the possibility of its widespread production indefinitely.

Sheet Metal Cutting

I returned from holiday just in time to see Inventors' Club in the TV programme

of 22nd August, and hope to see the sheet metal saw which was demonstrated in early production.

The idea of using a stiffening metal strip (usually a steel rule) at the back of a normal hack-saw blade, has often been employed by constructors in chassis cutting, and by model engineers. It not only makes cutting quicker and easier but enables one to make a really straight cut. The great virtue of the demonstrated model was its simplicity, and the speed and ease with which even broken hack-saw blades can be used.

Good luck to the designer, and here's one customer for his version as soon as it becomes marketed.

So it has Other Uses

Wave-change switch contacts have long been a source of receiver noise and crackles, and I guess every reader at some time or the other has advised his listener friends to clean the contacts with carbon tetrachloride. Recently I gave this advice to a very practical young woman.

"Oh! Carbon tet." she said, obviously on familiar terms with it, "I've got some already."

"Have you?" I asked, rather surprised and wondering vaguely what on earth she could use it for—thinking in terms of beauty preparations, etc.

"Yes", she went on brightly, "It has roughly the same refractive index as glass, and I use it in photographic enlarging."

It merely goes to prove you can't be too careful with these modern YLs, and dare not risk putting them off with a "simple" answer. A few weeks back an attractive, but rather severely dressed young woman sat beside me on the 'bus and started to study a complicated-looking circuit. It turned out she was a physio-therapist, and she proceeded to give me a lecture on how it worked. As she explained it in rather the manner I would have expected her to have chosen for an eight-year-old schoolboy, she apparently didn't think I looked over-intelligent. I was glad to escape when we came to my stop.

Points from Letters

Sorry if my small group of regular readers are annoyed that this month's column is made up of scraps and pieces. I must get them off my chest and hope to get away with the excuse

WE HAVE RECEIVED from Messrs. Duke & Co., samples of the TR1196 and Radio Control Units advertised by them elsewhere in this issue. Both items are very reasonably priced, and contain a good assortment of useful components. The TR1196 is well known as the subject of an article on its conversion to an all wave superhet, reprints of which are available from us at 6d. post free.

that it's the after-the-holiday season. A few extracts from recent letters:—

From A. G. (Liverpool). "To your recent hints on glass cutting the following could well be added. When cutting ground glass use the cutter on the smooth side. If the score is made on the ground side, the glass will break anywhere except in the right place."

From T. S. of Warrington. "Other constructors of the Basic Superhet may be interested to know I have effected a very considerable improvement in the performance of mine, especially on the HF bands, by fitting a 717A in place of the 6K7. These UHF pentodes, often referred to as "door-knobs" because of their unusual shape, are still readily available—cheaply. As they are ideal for TV receivers, requiring only about 120 volts HT, the surplus ones may soon get scarce. Fitting, of course, necessitates re-wiring the holder."

From J. W. of Croydon. "It would be interesting to know if the reader you mention who built three Basic Superhets used the valve types suggested in the original. Three of them (6K7, 6K8 and the 6Q7) with numerous others, are, according to an R.C.A. Manual, not recommended for designers of new equipment because they are either approaching obsolescence or have a dwindling demand." (I believe this applies only to the glass types).

"Although, if necessary, the design can be easily modified for more modern types, this fact could well be pointed out if he hasn't already stocked up with spares."

Finally a candid letter from T. M. of Brighton. "I am not yet 17 and so I have only been a reader for about two years, but I enjoy Radio Miscellany. My cousin says he remembers you from pre-War, and as I saw in a book that the readership of a magazine changes completely during the course of seven years, do you use the same stuff over again?"

Well, well, well! I ask you! No wise-cracks that I don't even wait as long as that, please. That certainly seems to put the skids under any ideas I might have had of re-hashing.

Confident

The chap who took out his TV licence the same day as he bought the parts!

Quote

"I think the most enjoyable Club nights are the Junk Sales. Even if your bargain doesn't work when you get it home, you can take it back next time and let some other mug buy it."

THE RADIO SHOW — Earls Court 1951

As seen by Constructor A. TORRANCE

THE unfortunate withdrawal by a considerable number of component manufacturers greatly reduced the interest there might be for the radio-constructor, and a fair comment would be that it was a good furniture display.

Bigger and better TV tubes and cabinets was the keynote here, and it became quite apparent that the visitors were thoroughly aware of this. However, one or two manufacturers introduced gadgets so much enjoyed by the lay public.

The MAZDA "talking tube" which described its own processes from the vision strip and time-bases to the final picture was very well done. EKCO introduced spot-wobble which, by remote control, could be switched in and out by the viewers.

A progressive array of new knobs, switches and fuses were shown by BULGIN, and anyone planning a smart communication set as his winter's programme would do well to consult this firm.

The increased size of TV tubes has induced HAYNES RADIO to produce the necessary focus and deflection assemblies for 16" tubes. These have a very wide angle, and neck diameters have been enlarged to 38 mm. or 45 mm.

The ENGLISH ELECTRIC CO. will probably be co-operating with us soon in giving conversion details for the many of you who have shown a desire to own one of their large tubes.

Of great interest to those of you who will be following colleague A. C. Gee's articles on radio controlled models was the PHILLIPS exhibit. This was a beautifully shaped model liner under the complete control of the operator, who described over the public address system each function as it took place. The public could see it was genuine. Reverse, forward, port, starboard, launching a small aircraft from the deck, and even an internal speaker to give the impression of a dance aboard ship—all this was seen in a tank, large enough to stage a swimming gala, and realistically fitted with a lighthouse, port and docks.

The B.B.C. was well represented and Mr. Brittain, of their publicity department, was particularly kind in spending so much of his time on a tour of the television studio.

This was a fine piece of prefabricated construction. At a cost of £20,000 to the Radio industry, it can be erected in two days with

provision for three cameras, air conditioning and audience seating.

Returning in search of the elusive—WAVEFORMS have introduced an accurate method of measuring those awkward EHT voltages.

This is simply a cylindrical instrument with a fixed prod and flying lead. The lead is attached to chassis and the prod is touched to top anode. An interval flash is observed in the instrument, which drives up a metal ball to a pointer on a scale gauged 3–30 Kv.

Those of you with a more professional interest would be interested in this firm's Radar and Video Sync Generator. This produces line and frame pulses, with a complete pattern for any receiver.

WESTINGHOUSE BRAKE AND SIGNAL CO., LTD., introduced a completely new range of crystal diodes, and proved the efficiency of these in a TV set in which nine valves had been superseded by these little "chaps". In view of the increasing price of materials used in the manufacture of transformers, it is quite certain the WESTINGHOUSE mains rectifiers will be used extensively for this purpose and as replacements.

A great many tape-recorders were on show by R.G.D., Simon Sound Sales and Wearite, etc. Incidentally, the latter firm will shortly be issuing data on a simple conversion for their famous "P" range of coils to cover the 10 metre band.

We feel sure you will admire AVO's fine gesture in producing a meter in Braille. This is no commercial venture, but a helping hand towards our less fortunate fellow enthusiasts. The AVO technician painted a fascinating picture of blind radio workers he had seen tracing circuits, and even soldering in new components. Messrs. AVO are to be highly commended.

METRO PEX introduced a new MAGNA-VISTA filtachromatic lens. The filter is contained inside the lens, and will suit those who seek "daylight" viewing.

Quite a number of new valves were on show by BRIMAR, OSRAM and others; these included Noval and GT types which have been specially designed for longer life. No doubt you will find data sheets available as usual.

Messrs. STRATTON, of Eddystone fame, have a receiver to suit the more critical amateur. This is the 770 M, a double superhet, which accepts FM, NFM, AM, and CW signals. A fine receiver well up to their usual standard.

QUERY CORNER

A "Radio Constructor" Service for Readers

Miniature Portable

Having unsuccessfully made several attempts during the past few years to construct a very small portable receiver, I am writing to ask you if you can recommend me a simple circuit using the smallest possible number of components? It has been my experience with this type of receiver that it is difficult to obtain adequate sensitivity, or when something approaching a reasonably sensitivity is achieved, it is accompanied by instability.

G. McMahon, Dundee.

Our correspondent mentions two of the main difficulties which are encountered in the construction of miniature battery portables. In an effort to increase the sensitivity the constructor is often tempted to add one or more LF stages to the receiver, with a result that there is a marked tendency to instability, and the selectivity is invariably poor.

In general, it is better to add an RF stage before the detector than it is to add a second stage of audio amplification.

Dividing portables into two classes, there is the very small single-valve set intended for operation with earphones, and there is

the three or four valve receiver which normally drives a loud speaker. The three valve set should preferably be of the 1-V-1 class, whilst if a 4 valve receiver is contemplated a conventional superhet circuit cannot be bettered. In this instance, we propose to describe a simple yet efficient single valve receiver which employs a minimum of components and can, with the aid of a little mechanical ingenuity, be packed into a box small enough to fit the average overcoat pocket.

The Circuit

The circuit diagram of this single valver is shown in Fig. 1, and a glance will be sufficient to indicate that it is a departure from standard practice. The valve which is used is the button based heptode normally found in battery powered superhets. In our circuit the valve is performing the dual functions of detector and audio amplifier. This is achieved by arranging the valve in the circuit in such a manner that it may be considered as two triodes in cascade. The first grid and second grids perform the function of a normal detector, whilst the signal grid (g3) and the anode act as an audio amplifier. The frame aerial is tuned by means of a standard miniature capacitor and is connected in a leaky grid detector circuit. The anode of the detector is formed by the screen grid of the valve and is coupled by an RC combination to the signal grid. The reaction circuit is of conventional type, a variable resistor being used as a control in preference to a capacitor, on account of the saving in space which is afforded. Also, with this arrangement the resistor provides what may be regarded as a Vernier control, the preset capacitor being used for coarse adjustment. A 100 Ω resistor and a shunt capacitor are used to prevent RF from reaching the audio circuit. The audio signal is further amplified between the grid 3 and anode of the valve. At the anode further decoupling is necessary because the main electron stream within the valve is modulated by a component of the signal at RF. Standard high impedance headphones are connected directly in the anode circuit; should it be desired to use low impedance 'phones, a matching transformer will be required. In this latter

QUERY CORNER

"Rules"

- (1) A nominal fee of 2/- will be made for each query.
- (2) Queries on any subject relating to technical radio or electrical matters will be accepted, though it will not be possible to provide complete circuit diagrams for the more complex receivers, transmitters and the like.
- (3) Complete circuits of equipment may be submitted to us before construction is commenced. This will ensure that component values are correct and that the circuit is theoretically sound.
- (4) All queries will receive critical scrutiny and replies will be as comprehensive as possible.
- (5) Correspondence to be addressed to "Query Corner," Radio Constructor, 57, Maida Vale, Paddington, London, W.9.
- (6) A selection of those queries with a more general interest will be reproduced in these pages each month.

case the reflected impedance into the primary circuit of the transformer should be between 10 kΩ and 50 kΩ. Thus if 8 Ω moving coil 'phones are used they should be fed from a transformer having a turns ratio of between 35 : 1 and 70 : 1. An electrolytic capacitor is connected directly across the HT battery; this prevents the impedance of the battery appearing in series with the 'phones, and thereby reducing the audio output.

Mechanical Design

It is not proposed to lay down any hard and fast rules regarding the general layout of components and size of cabinet, as in all probability many constructors will already possess a small box into which the receiver can be built. The following general points should, however, be observed if the best results are to be obtained. Valves of the type recommended have been found to be prone to microphony, and to reduce this most annoying defect to a minimum the valve should be wrapped in sorbo rubber and lightly clamped to the main chassis by means of a metal strap passing around the sorbo. The valve holder is not bolted to the chassis, but is simply pushed on to the valve base and connected up with flexible leads. The use of such leads is necessary to prevent vibrations reaching the valve via the lead

wires. Whether or not the batteries are included within the main cabinet, or contained in a separate box, will depend largely upon the size of the main cabinet. A point worth bearing in mind, however, is that if the cabinet is made very small the efficiency of the frame aerial will be reduced, and an additional throw-out aerial may then be necessary in some localities. It is thus preferable to include the batteries within the main cabinet.

Owing to the different sizes of frame aerial which will be used with this receiver, it is impossible to give exact winding details, and even the formula for calculating the number of turns required only permits an approximation to be made, because it is impossible to take all factors into account. It has been found, however, that to wind on 33ft. of 32 swg cotton covered wire will generally permit the full medium wave band to be covered. The reaction winding consists of 9 turns of similar wire wound beside the main winding, and at the earthy end of it. After the coils have been wound around the cabinet the receiver is tested and, if satisfactory wave coverage is obtained, the coils should be protected with a coating of varnish or glue.

To avoid hand capacity effects, the receiver should be constructed on a metal chassis which fits into the cabinet, the latter being

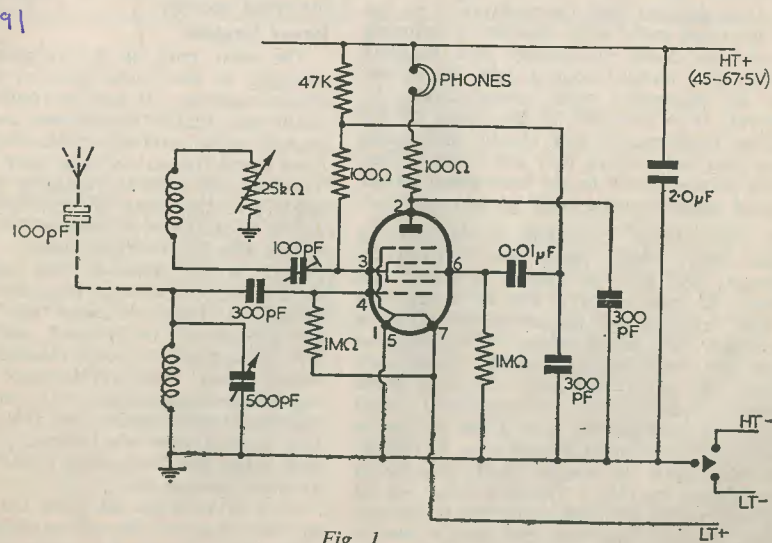

Fig. 1

constructed of wood if it is intended to carry the frame aerial. The chassis may conveniently consist of a flat metal plate with all the components mounted on one side.

Output Pentode

I have been told that it is possible to damage an output pentode by operating it without the anode connected. Is this correct?

D. Evans, Bath.

When the anode circuit of a power pentode is disconnected, the electron stream which normally flows to the anode is interrupted

and many of these electrons are collected by the screen grid. Because of this the screen grid power dissipation is considerably increased and the heat dissipated at this electrode may easily be so high that it glows red, or even white hot. The excessive current in itself might not damage the valve, but the excessive heat invariably liberates gas from the screen grid wires and consequently the vacuum within the valve is impaired. This state of affairs is indicated by a blue or purple glow in the area between the cathode and the anode, a condition which indicates that the valve is irreparably damaged.

IN YOUR WORKSHOP

In this month's article J.R.D. continues his discussion on a subject which has proved to be of interest to many readers—that of Modernising Old Receivers.

Treatment

When the receiver has undergone a superficial examination, the next step consists of making a decision upon the best method of modernisation.

If it is decided that the receiver is so old that the most useful plan consists of stripping the chassis down completely and building a brand-new receiver upon it, then this course may be proceeded with straightaway. If, however, it is intended to use some of the existing components and circuit and make alterations only where they are needed, then it will prove helpful to see how much of the original circuit can be retained or converted.

A start should be made by considering those things which have obviously to be changed; the first to attend to being the valves. In most cases it will be found that it will definitely be advantageous to fit a completely new set of valves. If the original valves are of an obsolete type the valveholders should be altered in order to take more modern replacements. International octal valves are perhaps the best type to use in these receivers, since they are easy to obtain, and may often be bought quite cheaply as Government surplus. The use of a set of new valves may perhaps necessitate a different heater voltage, but this can nearly always be obtained without too much bother. In the case of AC/DC receivers some attention

should be paid to the original heater current. Many of the earlier AC/DC receivers employed a barretter, which is not always necessary when modern valves are used. As the life of the barretter may sometimes be rather short, it can often be replaced by a mains-dropping resistor.

Power Supplies

The next part of the original circuit to consider is the power section, (assuming a mains receiver). It will be found that many of the early mains transformers and smoothing chokes were carefully made and that they have stood the test of time very well indeed. There is little point in replacing such components and they may be retained with little risk of breakdown, so long as the new receiver circuit does not overload them.

Such is not, however, the case so far as electrolytic smoothing capacitors are concerned. If these are more than fifteen years old they should be replaced, even if they are still in apparently good condition. Among other things, their replacement will ensure against possible damage by breakdown in the future and, apart from this, there is the fact that a new electrolytic capacitor will give better HT decoupling at RF than would an older component.

If it is intended to alter the valves used in the receiver it will sometimes prove necessary to make an alteration to the original mains transformer. As most mains

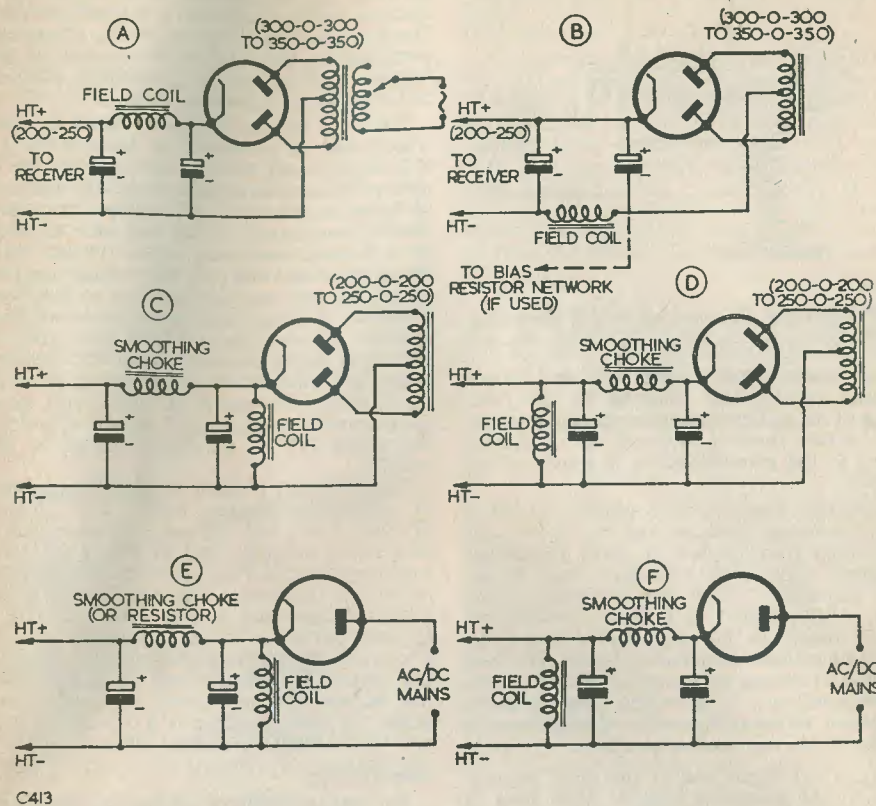

Fig. 1. Common methods of feeding the field coil of an energised speaker.

transformers have a space between the outside of the windings and the laminations, the extra turns required for the new heater voltage can often be wound on the outside of the bobbin without disturbing the existing windings at all. Indeed, it may be possible in some cases to fit the few extra turns required without even removing the laminations. The number of turns per volt of the transformer will have to be found by experiment.

The extra heater windings are, of course, connected in series with the existing windings to provide the new heater voltage. In the rare case of a reduction in heater voltage being required, the extra turns could be connected in antiphase with the existing heater winding; although many constructors may prefer to remove some of the turns of the existing winding instead.

The Loudspeaker

After the power supply circuits, the next part of the receiver to need attention is the loudspeaker. Despite the fact that considerable advances have been made in loudspeaker design in the last fifteen years or so it will sometimes be found that, when the original speaker was a well-made and expensive job, it can still compare very favourably with modern, albeit cheaper, loudspeakers. The original speaker should therefore be examined to see whether it is worth while retaining. A comparison test with a present-day loudspeaker will help considerably in making the decision.

One of the most important things to examine in the loudspeaker is the material of the cone, since this is liable to suffer with age. Particularly is this true of small energised speakers,

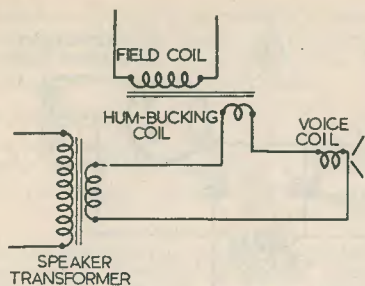

C414

Fig. 2: How the hum-bucking coil is connected.

whose cones often become dry and brittle because of the heat radiated by the field. Some of the earlier permanent magnet speakers may suffer from a decrease in sensitivity owing to the gradual decline in power of the magnet.

Energised speakers were popular in many early receivers because the materials and processing then needed to make permanent magnets were more expensive than is the case nowadays. They are sometimes, however, a little difficult to fit into a modernised circuit owing to the difficulty of energising the field without introducing hum. The best method of feeding an energised speaker which is retained in a modernised receiver is to duplicate, so far as is possible, the field supply circuit which was used originally.

Fig. 1 (a) shows one of the more popular methods of energising speaker fields used in some of these older receivers. Fig. 1 (b) shows another less often-used method, in which the field was connected in the negative HT line. The advantage of the second circuit was that the voltage dropped across the field could be used to provide negative bias supplies. Both methods of field supply

are more or less similar and can be interchanged without causing too much trouble. The speaker field in each case is, of course, energised by the total anode current of the receiver and serves the secondary purpose of acting as a smoothing choke.

When it is decided that an energised speaker, whose field is connected in series with the HT supply, will have to be replaced by a modern permanent magnet model, the question of fitting an alternative HT supply circuit must then be considered. If the field were replaced by a normal smoothing choke (whose resistance would be lower) the HT voltage supplied to the receiver may perhaps rise to too high a value. A simple and inexpensive solution consists of retaining the old field coil in circuit, it being removed from the speaker frame and mounted in a convenient place in the cabinet; whereupon it would still serve as a smoothing choke and would also drop the excess HT to the value needed in the receiver.

Figs. 1 (c) to 1 (f) show four further methods of energising speaker fields. The circuits of Figs. 1 (c) and (d) are not encountered very often, although that of Fig. 1 (e), (and sometimes that of Fig. 1 (f)) was very popular in midget receivers. The unsmoothed energising voltage used in Fig. 1 (e) contains a large proportion of ripple and usually induces a correspondingly large amount of hum in the output but, as the speaker energised in this fashion is nearly always of small dimensions, the bass response is too weak to give any very noticeable audible effect.

Hum-Bucking

As was mentioned above, it sometimes proves difficult to clear the hum which is induced in the output by reason of the field. It will be seen that, in all the circuits of Fig. 1, the DC voltage energising each field has a ripple of some sort superimposed upon it.

The hum induced in the field can often be removed by using the hum-bucking coil which

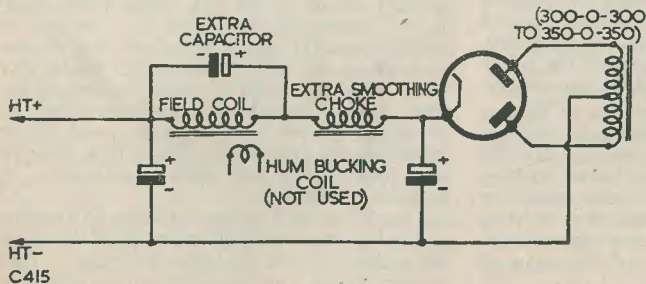

Fig. 3: A suggested method of clearing hum in an energised speaker.

C415

is fitted to most energised speakers. This coil consists of a few turns near the field coil itself, and is connected in series. (and antiphase), with the voice coil, as shown in Fig. 2. The voltages induced in the hum-bucking coil then oppose those in the voice coil and so tend to cancel out the hum.

Hum-bucking coils are not always so effective as they would appear to be in theory, and it is occasionally necessary to use some other means of clearing hum from energised speakers. A suggested scheme is shown in Fig. 3, in which the hum-bucking coil is not used at all, the supply to the field now being smoothed. It may be seen that an extra smoothing choke is fitted, but its comparatively low resistance should cause only a small drop in the available HT voltage. A fairly large capacitor across the field may

sometimes be needed, possibly having as high a value as 32 μ F or so.

Field Voltages

The voltage which should be applied across the field of an unfamiliar energised speaker can be easily calculated if its power dissipation is known. In the majority of cases, a medium-sized energised speaker needs about 10 watts or so to energise its field, whilst a small model needs about 5 watts. The resistance of the field can, of course, be easily discovered; whereupon the applied voltage (or current) required may be calculated from Ohm's law.

Next Month

In next month's issue we shall continue with the subject of modernising old receivers, carrying on to the treatment of the AF, the detector, and the pre-detector circuits.

from our



Mailbag

CURRENT TRANSFORMER FOR USE WITH AVOMINOR UNIVERSAL METER

Additional note by W. E. Thompson

Since my article appeared in the June issue of Radio Constructor, I have had two independent enquiries regarding the modification to the meter shown in Fig. 4 and described in the second paragraph of page 405. As a result of investigating these, I have found that my Avominor, a second-hand instrument, although accurate as a meter, has had its inside operated upon previously for some reason, and in consequence is not in agreement with the wiring of others now known to be correct. As I find myself in the unfortunate position of unwittingly writing material which could be misleading, it is most necessary that I rectify the matter. To apply the modification I described would not, it appears, result in the secondary of the current transformer being connected directly across the instrument rectifier, as I stipulated.

In the paragraph mentioned above, the third sentence, "One wire on the rectifier....

the meter movement" should be replaced by the following: "One wire on the rectifier AC side will be found joined to a resistor bobbin, the upper one of two located on the right-hand side of the meter movement, and above the switch". In all other respects this paragraph will be correct.

The sketch Fig. 4 in the article also needs amending as a result, and a corrected sketch embodying the revision given above is reproduced herewith. Readers would perhaps be well advised to annotate the relevant paragraph and the sketch Fig. 4 on page 405 of their June issues, with a suitable note referring them to this present information, since the main article and this note will eventually appear in Volumes 4 and 5 respectively.

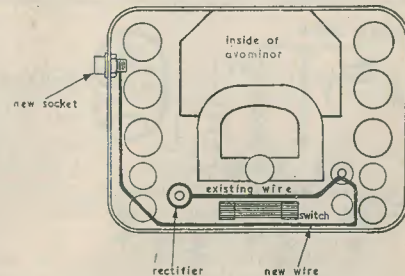

FIG 4
MODIFICATION TO AVOMINOR
(REVISED)

C333

FIDELITY RECEPTION

By E. KALEVELD, PA₀XE

QUALITY has always been a point we tried to achieve in our broadcast set, and when a new set had been constructed (What! Again?) the XYL and yours truly nodded to each other and said, "This is just as it ought to be"...until the unhappy day when we again visited our friend with the £100 radiogram. Usually our set would be on the workbench the next day, the XYL devoid of symphonies, and yours truly of jazz, for some days, and the same procedure described above started all over again.

We once tried a TRF receiver, and it was much better than the superhet BCL box, so that gave us an indication of what direction to look for the solution.

Several weird and wonderful switching arrangements were tried, more or less successful, only more less than more! One upset the calibrations of the dial, the other introduced severe IF instability, until at long last we believe we have found it. As usual, simplicity itself.

With the selectivity wide open, reproduction of the stronger stations was a revelation. Even our friend with the big radiogram admits that, which really means

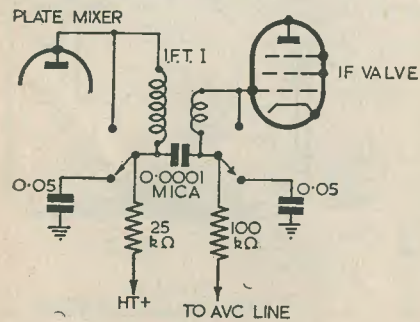

C465

FIG. 1

something. Then, one flick of the switch, and the set is back to a normal superhet, without impairing the sensitivity and selectivity it normally has.

The scheme is very simple indeed, and we only wonder why it has not been extensively used before. There is so little to it, that any BC superhet can be converted to a high quality receiver in one hour, at a cost of a few shillings.

Well, enough now about the conception. We won't bore you with the advantages; they are apparent, and all we need say is, "Try for yourself".

The idea is to switch out the first IF transformer, and use resistance coupling instead, leaving the second transformer in place to drive the detector diode. By so doing, the selectivity curve widens, thus increasing the fidelity. The tuning is not affected, the curve remaining reasonably symmetrical.

Of course, the gain goes down, but the AVC system will take care of most of that, while the rest can be compensated for by the manual gain control. Nearly always there is plenty of gain to spare. On our receiver, which is the standard frequency changer—IF—double diode triode—audio pentode, we can receive with a not-too-good antenna (the best place being given to the transmitting aerial!) about twenty stations at very good strength in the wide-selectivity position.

If you look at the circuit in Fig. 1, you will see that with the switch in the position as drawn, we have a normal IF circuit. The 25 kΩ resistor with its associated 0.05 μF capacitor acts as a decoupling network to the primary of the IF transformer, whilst the 100 kΩ resistor with its bypass capacitor of 0.05 μF acts as an additional filter in the AVC line.

The interstage coupling, therefore, is quite normal, and the receiver has the usual characteristics of selectivity and gain.

In the alternative position of the switch, however, the contacts short out the two IF windings, and disconnect the bypass capacitors, leaving the resistors as anode load and grid leak respectively, coupling between them being provided by the 0.0001 μF mica (plus possible stray capacitances, to be exact). The whole circuit is exactly the same as for a resistance-capacitance coupled audio stage, the only difference being that we are handling RF instead of AF. Which reminds us, RF gets much more easily out of hand than AF does, so keep the leads short and direct, and mount the switch as close to the IF transformer as possible. This is often easily accomplished, as the first IF transformer is mostly at the back of the set, which is a nice, inconspicuous spot for the switch. The latter, incidentally, may be either of the toggle or wafer type (DPDT).

It is most important to see that the leads do not come anywhere near the anode circuit of the IF valve, as serious instability might result. The two resistors should be mounted close to the transformer, with their ends supported if necessary, while the 100 pF coupling capacitor can be fitted directly underneath the base of the IFT. Once again, do keep the leads short and direct, and keep them away from the IF anode!

Whilst we have the receiver on the bench, we might as well inspect the final audio stage and see what can be done about that.

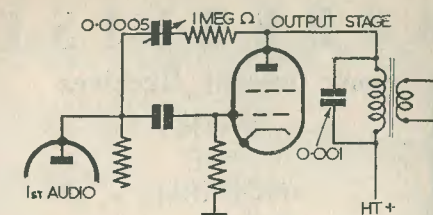

C466

FIG. 2

If it is a home-made set, you yourself know, of course, what circuits you have included, but often the cheap type of manufactured receiver (and home-built ones, too) have nothing but a capacitor and a variable resistor from anode to ground, just right to cut off those high frequencies. If you only knew the trouble studio technicians go to, so as to preserve as much treble as possible, you would agree it is decidedly unfair of you to waste them in a resistance-capacitance network like that. So if your set is of the above-mentioned variety, have a go at the simple negative feedback arrangement shown in Fig. 2. This involves a resistor, and a variable capacitor of the mica type for the sake of compactness. The capacitor limits the feedback at the very low frequencies and provides a very nice bass lift, without affecting the higher frequencies.

TEST CARD "C"

In response to many requests from readers, this magazine recently made an approach to the B.B.C. for the transmission of Test Card "C" for a quarter-hour period two evenings each week; this to be radiated prior to normal programme time.

Our representative was informed that this additional service is impossible for the following reasons:—

- (1) Interference with rehearsal times.
- (2) Adjustment of salaries.
- (3) Additional use of electricity.
- (4) Possible Trade Union activity.

We thereupon communicated with the Editors of "Practical Wireless", who have previously raised this matter, and other well-known contemporaries, and have good reason to believe we shall receive their fullest support in pressing for this service.

Our reasons for asking for this additional service are clear enough. The majority of radio amateurs are in daily employment, and so are unable to take advantage of the present Test Card "C" transmissions. These are primarily intended for the use of the Trade and radio engineers, but we know that they, servicemen in particular, would also welcome the evening transmissions.

We, and our contemporaries, have been and are publishing circuits dealing with the construction of TV gear and we are well aware that you, the constructor, are in the main dependent upon Test Card "C" transmissions if optimum results are to be secured—video signal and pattern generators are too costly as alternatives.

Readers can rest assured that we shall continue to seek this small concession.

MODERNISE ALPHA OFFERS

your present Receiver

WITH
THE
MODERN

OSMOR 'Q' COILPACKS

As specified for conversion of the Type 25 unit of the TR.1196, Type 18 and Wartime Utility receivers and others.

SUPERHET & T.R.F.
These mighty midget coilpacks will cure your radio troubles, and ensure better performance in every way. Easy to assemble, with only five simple connections, the pre-aligned "Q" Coilpack saves hours of frustrated grappling with complicated circuits. All types available for mains and battery sets, complete with full instructions and circuit diagrams.

Send 5d. (stamps) for free circuits and new illustrated lists of Coils, Coilpacks, and all Radio Components.

OSMOR RADIO PRODUCTS LTD. R.C.2
BRIDGE VIEW WORKS, BOROUGH HILL, CROYDON, SURREY.
Telephone: Croydon 1220

BRAND NEW AND BOXED

6V6G, 6V6GT, 5Z4M, 1T4, 1S4, 1R5, 1S5, 78, FW4/500, 6F6, 5U4G, 6X5, VU39, YR150/30, 41, 42, OZ4, PEN46, 82, 25L6G, Y63, 6SL7, 6SQ7, 5Y3, 25A6G, 6SQ7, 6SJ7, 6AL5. All at 9/- each
3Q5, 1C5, 6C5, 6C6, 6D6, 12SK7, MS/PEN All at 8/6 each
KT33C, 807, 6L6, KT66, 5Z4G, 6V6M, 6AM6, EF91, 6SN7, UL41, EBC41, EL41, 6Q7G. All at 11/6 each
EF42, UCH42 ECL80. All at 12/6 each
EF8, EK32, 6G6G, SP13, AC6PEN, 12SH7, 12H6, 6J7, 12A6, 6N7GT, 6AG7, 6B8. All at 7/6 each
INL5, EF39 EBC33, EF36, EL32, 77, 6SK7, KTZ41, MH41, KTZ63, VR137, 6SH7. All at 7/- each
VU111, CV73, 6J5. All at 4/6 each
7193, CV6, 1148. All 2/- each
VU120A, 215SG, 2X2, PEN220, CV9, SP41, SP61, 6H6, EB34, 68, RKR72. All at 4/- each
EF50 (Syvania) 9/6; VR91, 7/6; VR119 (DDL4), 5/-; 9D2, 4/9; 14F6G, 6/-; 2051, 6/-; 954, 2/9; 955 5/-; 956, 2/9.

VOLUME CONTROLS

1/2, 1, and 2 Meg with switch ... 4/3 each
2K, 3K, 5K, 10K, 15K, 25K, ohms, less switch... 1/6 each
10K, 15K, 20K, 25K, 30K, 50K ohms, Wire wound ... 2/6 each
ERIE 1/2, 1, Meg. Double Pole switch ... 5/- each
BUZZERS. For Battery working, suitable for doors, etc. ... 1/6 each
BELL PUSH with warning light, numerous uses, ideal for offices ... 1/6 each
CAR BULBS, 6-7 volt, 18 watt, Headlamp or Spotlight bulb, outstanding value ... 1/6 each
HEAVY DUTY COOKER SWITCHES, ROTARY 30 Amp. 4 position ... 4/- each
SPEAKERS—All 2 to 3 ohms, unless otherwise stated.
ELAC, 3 1/2 in. P.M. Lightweight, ... 13/6 each
GOODMAN, Sin. P.M. Lightweight, ... 13/9 each
AMPLION, 8in. P.M., ... 15/6 each
R. & A., 8in. M.E., 600 ohms field ... 15/9 each
TRUVOX, 6 1/2 in. Lightweight ... 13/9 each
12in. TRUVOX SPEAKERS. 3/4 ohms ... 65/- each
10in. ROLA P.M. 2/3 ohms ... 32/6 each
MAINS TRANSFORMER: Chassis, Mounting Type, 350-0-350V., 120 M/A, 5V and 2.6.3v, Secondary Wax Dipped, built to Government Standards. 25/6
CARRIAGE PAID over £2. **MAIL ORDERS ONLY** C.W.O. or C.O.D. Orders despatched same day as received. Stamp for List.

ALPHA RADIO SUPPLY CO.

5-6, Vince's Chambers, Victoria Square, LEEDS, I.

ADCOLA

(Regd. Trade Mark)

SOLDERING INSTRUMENTS



Reg. Design No. 860302

(British, U.S. and Foreign Patents)

Designed for wireless assembly and maintenance. Supplied for all volt ranges from 6/7v to 230/250v. High Temperature, Quick Heating, Low Consumption, Light Weight.

3/16" Dia. Bit Standard Model 22/6
1/4" Dia. Bit Standard Model 25/0
3/16" Dia. Detachable Bit Type 30/0

Sole Manufacturers: **ADCOLA PRODUCTS LTD.**
General Offices and works: Cranmer Court, Clapham High St., London, S.W.4. (MAC 4272)

Do you value your . . .

Communication Receiver?



Do you realise that you could be held responsible if your SET or your AERIAL caused injury or damage?

A "SCOTTISH" policy will cover damage to your RECEIVER, your liability for injury to Third Parties, and damage to your own property by the aerial FOR AS LITTLE AS 7/6d. A YEAR!

Send for Details to

Scottish Insurance Corporation Ltd.
62/63 Cheapside, London, E.C.2.

IN EVERY RADIO SET THERE ARE

500 reasons why you should use . . .



The average radio set contains about 500 soldered connections — make sure of perfect reception by using only Ersin Multicore for all soldering on your equipment.

The three cores of extra-active non-corrosive Ersin Flux not only prevent the formation of oxides, but actually clear the oxides from the metal to be soldered, saving time and trouble, and ensuring the highest standard of sound precision soldered joints.

MULTICORE SOLDERS LTD.
Mellier House, Albemarle St., London, W.1
REGent 1411

Come to **SMITH'S** of **EDGWARE ROAD** the friendly shop for

We stock everything the constructor needs—our 25 years experience of handling radio parts and accessories enables us to select the best of the regular lines and the more useful items from the surplus market in:—

Loudspeakers and Phones Valves and CR Tubes
Transformers and Chokes Cabinets and Cases
Meters & Test Equipment Capacitors and Resistors
Pickups and Turntables Coils and Formers
Switches and Dials Plugs and Sockets
Metalwork and Bakelite Aerials and Insulators
Books and Tools Motors and Generators
Valve Holders and Cans Wires and Cables
Metal Rectifiers Panel Lights and Fuses
Recorders and Parts

Sleeving, Nuts and Bolts, Tags, Clips, Grommets and all other bits and pieces

NOTHING TOO LARGE—NOTHING TOO SMALL

Everything you need under one roof—including all the parts specified for the popular "Viewmaster" Home-built Televisor, both London and Birmingham models.

No general catalogue is issued owing to constantly varying stocks and prices, but we shall be pleased to quote you.

H. L. SMITH & CO. LTD.

287/9 Edgware Road, London, W.2

Telephone: Paddington 5891

Hours 9 till 6 (Thursday, 1 o'clock)

Near Edgware Road Stations, Metropolitan and Bakerloo

TV

TV

TELEVISION NEWS

keeps you in the TV picture

SEND FOR THE CURRENT ISSUE TODAY.

USE THIS HANDY COUPON!

Regular features include

Free technical advice service ● Summary of month's programmes in advance ● New equipment and sets discussed ● Latest books on TV reviewed ● Authoritative articles on TV developments and techniques ● Commentaries on past and future presentations ● and many other important TV features.

To THE CIRCULATION MANAGER
TELEVISION & GENERAL PRESS LIMITED
119 BRENT STREET LONDON N.W.4.

I enclose P.O. (Stamps value 1s. Send me the current issue of TELEVISION NEWS.

Name _____

Address _____

(Please use BLOCK CAPITALS)

SMALL ADVERTISEMENTS

Readers' small advertisements will be accepted at 2d. per word, minimum charge 2/-. Trade advertisements will be accepted at 6d. per word, minimum charge 6/-. If a Box Number is required, an additional charge of 1/- will be made. Terms: Cash with order. All copy must be in hand by the 12th of the month for insertion in the following month's issue.

PRIVATE

FOR SALE. 5CP1 CRT with mu-metal shield and base. One only—15s. to first applicant. Also 70 only 200 pF ± 1% ceramic, 85 only 1300 pF ± 1% ceramic, 50 asstd 9670, 1950, 1280, 940, 2280, 3420, 2850 pF ± 1% ceramic, all brand new, at 9d. each. 6 only 0.01 uF 2500V at 1/- each. Would exchange for electronic photoflash tube. Apply G. Ullmann, 46 Randolph Gardens, London, N.W.6.

NATIONAL NC156-1 (RBH1) RECEIVER. Good condition. 2 RF stages. IF 1600 kcs. Mechanical bandspread. 5 bands: 300 kcs—17.5 Mcs. Controls: RF gain, AF gain, Noise limiter, Crystal filter phasing and variable selectivity, BFO pitch, AVC on/off, Tone, Send/Receive. Calibrated 'S' meter. £25 or offer.—G1044, 1 Culross Bldgs., Battlebridge Road, London, N.W.1.

CLASS D WAVEMETER and Transformer for AC working, £3.10.0. Also various QRO power transformers, HT and LT. S.A.E. please. 150 watt Mod. transformer and Class B Driver, £2.10.0—Box B 172.

WANTED. Radio Constructor, copies Jan. and Feb., 1950.—R. B. Law, 10 Doncaster Road, Eastleigh, Hants.

MCR1 Communications Rx, 15-2,000 metres, complete with original power pack. Condition as new. Offers over £9.10.0.—Box B 167.

FOR SALE. Eddystone 740, with speaker, 1 pair Brown's type F phones, and Eddystone 'S' meter. Offers to Box B 169.

COMMERCIALY MADE OSCILLOSCOPE (11 × 6 × 9) 2 1/2" tube, £7 or would exchange Wee Megger, E'static TV (Midlands) or quality amplifier gear.—Box B 170.

FOR SALE. Indicator Units type 6, with VCR97 and 9 valves. Brand new £3.10.0, or less tube £2.5.0 only. Taylormeter model 70A, brand new, £9 only. All carriage paid. Post orders only, please.—Wood, 25 Glovers Road, Birmingham, 10.

AMATEUR SURPLUS. Transmitting and Receiving components for sale. S.A.E.'s for list to Box B 171.

AMATEUR SELLING UP. Receivers, components, valves, etc.—Spiteri, 318 Kilburn Lane, London, W.9.

R1155 complete with power pack, 6V6 output, speaker built in wooden cabinet. £12 or offer.—Box B 168.

FIRST FOUR volumes Radio Constructor for sale, £2.10.0. Write first to 22 Norfolk Road, Thornton Heath, Surrey.

TRADE

"PANL"—the air drying black crackle enamel. Price 5/- per tin. Obtainable in London at all branches of Pearl Wallpaper Co. If unobtainable locally, send 5/- to QUALITONE, 10 Mitford Road, London, N.19

E FREE! Brochure giving details of Home Study M Training in Radio, Television, and all branches of I Electronics. Courses for the Hobby Enthusiast or for those aiming at the A.M.Brit.I.R.E., City and Guilds Telecommunications, R.T.E.B., and other Professional examinations. Train with the College operated by Britain's largest Electronic organisation. Moderate fees. Write to E.M.I. INSTITUTES, Postal Division, Dept. RC28, 43, Grove Park Road, London, W.4. Chiswick 4417. (Associated with H.M.V.).

FLEX—SUPER QUALITY Aero Intercom. Leads containing 4 lengths, two screened, total approx. 24ft. 2/3 each. Five for 10/- post free. L. T. S. Ltd., "Bromyhurst", Barton Road, Urmston, Lancs.

"GLOBE-KING" (Regd) Miniature Single Valve Receiver gets real DX — Amateur Radio enthusiasts should send for free copy of interesting literature and catalogue (enclose stamp for postage). Write to makers: Johnsons (Radio), 46 Friar Street, Worcester.

BOOKBINDING. Volumes of Radio Constructor and Short Wave News fully bound, imitation leather, gold lettering. 7s. 6d. post free. Prices for other publications on application.—Jerome Alcock, CHADLE, Stoke-on-Trent.

BLUEPRINTS complete with instructions SWN SW One-Valve battery driven, using DF91 valve. Portable Battery SW Receiver, using three DF91 valves in a TRF circuit.

High Gain 10 Metre Converter, with a de-luxe circuit comprising EF91 RF stage ECC91 double triode mixer and oscillator, IF amplifier EF92, with stabilised voltage supply via a 7475. 1s. 8d. each post free from A. S. W. P. 57 Maida Vale, London, W.9.

THREE IN ONE TRANSFORMER 6/- each Post 1/5.

1. Use as P/P Modulation Transformer P/P 211's to single 211-100 watts. Makes ideal Output Transformer P/P 6L6 to 807's to match High Impedance Relay Speakers. OR,
2. 230 Volts 50 Cycles Input 150.0.150 at 100 m/a Output. Useful for H.T. Eliminators, and Low Voltage Power Supply. Can also be used 300 V. Half-Wave at Lower Current. OR,
3. 230-115 Volt AUTO Step/up or Step/down Mains Transformer. 75 Watts rating U.S.A. Manufacture. Fully Shrouded. SIMPLE : EFFICIENT : GUARANTEED.

ROTARY CONVERTER. 6V D.C. to 220V D.C. 80m/a. Ideal for portable rigs and Car Radio. Brand New and Boxed. Bargain. ... 12/6

813. CERAMIC VALVEHOLDERS. With earthing screen ... 5/-

CONDENSERS VARIABLE. 270 Pfs. 3 Gang. Ceramic Insulation. Ideal for Short Wave Receivers. Size 3 1/2" x 2 1/2" x 1 1/2" ins. Brand New ... 5/-

1155. D.F. LOOP AERIALS ... 8/6

HAND MIKES. Moving Coil with Switch. 2/6

CONDENSERS. 8 Mfd. Electrolytic 600 v Wkg. Screwless Fixing ... 2/-

CONDENSERS. .001 and .0001. Midget Moulded Mica. Wire Ends. ... 6d. each. 4/6 doz.

Money back Guarantee.

Please Add Something For Postage.

NORMAN H. FIELD

68, HURST STREET BIRMINGHAM, 5.

Mail Order Department.

64-65, CHURCH LANE, WOLVERHAMPTON.

SUCCESS?

In Radio, Television and Electronics, there are many more top jobs than engineers qualified to fill them. Because we are part of the great E.M.I. Group we have first-hand knowledge of the needs of employers, thus our Home Study courses are authoritative and based upon modern industrial needs.

POST THIS COUPON NOW

E.M.I. INSTITUTES, Postal Division, Dept. 15, 43, GROVE PARK RD., CHISWICK, LONDON, W.4.
Please send, without obligation, your FREE BROCHURE I have marked the subjects which interest me.

Mechanical Eng. Electrical Eng. Draughtsmanship. Radio. Television. Production Eng. Automobile Eng. Aeronautical Eng. General Cert. of Education (Matric). Civil Service.

Also Courses for—
A.M.I.Mech.E., A.M.I.C.E., A.M.Brit.I.R.E., A.F.R.Ae.S., CITY and GUILDS EXAMS in Mech. Eng., Elect. Eng., Telecommunications, etc.

NAME.....

ADDRESS.....

E.M.I. INSTITUTES — The College backed by an Industry

START HERE

Building a Televisor?

THEN CONSIDER THE FOLLOWING

RECEIVER R.1355, as specified for "Inexpensive Television". Complete with 8 valves VR65 and 1 each 5U4G, VU120, VR92, also a copy of "Inexpensive TV." ONLY 55/- (carriage, etc., 7/6). Copy of book only 2/6.

I.F. STRIP 194. Another of the units specified as an alternative for the "Inexpensive TV." A first-class strip giving tremendous amplification, and well recommended for constructors who have built televisors but have come "unstuck" in the vision or sound-receiver. Complete with 6 valves VR65, and 1 each VR53 and VR92, and a copy of the book, which gives full details of conversion to both stations. Size 18in. x 5 1/2" x 5in. ONLY 45/- (postage, 2/6).

"PYE" 45 mc/s. I.F. STRIP. Ready made for London vision channel. Complete with 6 valves EF50 and 1 EA50. ONLY 60/- (postage, etc., 2/6).

RECEIVER R.3547. This contains the "PYE" Strip, which can be easily removed if desired, and also 15 valves EF50, 3 of EB34, 2 of SP61, and 1 each EA50, EBC33, EF36, also hundreds of resistors, condensers, etc. BRAND NEW IN MAKERS' CASES. ONLY 120/- (carriage 7/6).

Cash with order, please, and print name and address clearly.

U.E.I. CORPORATION,

The Radio Corner, 138, Gray's Inn Road, London, W.C.1. (Phone TERMINUS 7937)

Open until 1 p.m. Saturdays. We're 7 mins. from High Holborn. 5

CLYDESDALE

Bargains in Ex-Services Equipment.

THE R3170A RECEIVER UNIT.

A 16 valve radar receiver chassis, with 5 I.F. stages R.F. section, high cycle power section. Valve types 8/EF50, 2/EA50, EC52, 5Z4, VU111, CV118. Housed in metal case 18 x 9", x 8 finish grey. CLYDESDALE'S £5 19 6 CARRIAGE PAID. PRICE ONLY.

THE R3601 RECEIVER UNIT.

A 14 valve dual chassis radar receiver, with 85 mcs. and 45 mcs. I.F. strips, R.F. section, high cycle power station. Valve types 5/SP61, 4/EA50, 2/EF54, EF50, EC52, 6V6 and VU39A Rectifier, plus antenna switch, relay etc., etc. Housed in metal case 18 x 9 x 8 ins. finish light blue. CLYDESDALE'S £4 12 6 CARRIAGE PAID. PRICE ONLY.

Indicator Unit Type 6. In Makers Original Case.

Containing a VCR97 Cathode Ray Tube, with mu-metal screen, 4/VR91's (EF50), 3/VR54's, (EB34), various w.w. pots., switches, H.V. conds., resistors, etc., built in metal chassis to fit into metal box 18 x 8 1/2 x 7 1/2 ins. All controls are brought to front panel beside viewing screen. CLYDESDALE'S £4 9 6 CARRIAGE PAID. PRICE ONLY.

Order direct from: Phone: SOUTH 2706/9

CLYDESDALE SUPPLY CO. LTD.

2 BRIDGE STREET, GLASGOW, C.5.

Branches in Scotland, England and Northern Ireland.