

SEPTEMBER 1982

RADIO & ELECTRONICS WORLD

ISSN 0262-2572

AUSTRALIA \$1.85c
CANADA \$2.95c
EIRE £1.84p
NEW ZEALAND \$2.20c
HOLLAND F8.25

75p

**720 CHANNEL
AIRBAND RECEIVER**



FULLY SYNTHESISED DESIGN

4/6/10m Preamps
DX-TV Reception Techniques
Mini-Drill Controller

Digital Frequency Display
Improved Noise Squelch
Gate Turn-off Thyristors

History Repeats Itself!

Smartly bound, completely updated and revised, copies of R&EW projects.

Price
£1.20
each



We've got them covered

- The Autobridge, •Lab Quality PSU •2m Power Amplifier
- Multiband Up Converter •CB Selcall •UOSAT receiver •MSF clock.

We've been thinking of producing reprints of the most popular R&EW projects for some time now, but wanted to present them in an attractive fashion without making them too expensive.

When we saw the new Bindit machine we knew we had the answer.

R&EW Project Reprints are bound using the Bindit machine - completely updated and revised projects, perfectly bound between attractive covers.

We think that the Bindit System is such an effective way of collating documents that we feel many offices, schools, colleges etc., might like to know more about the system. For further information fill out the coupon below and send it to Epping Technical Associates Ltd., 94 Theydon Grove, Epping, Essex, or circle No. 250 on the reader response card.

Make your cheques and postal orders payable to *Radio & Electronics World* clearly stating which reprints you would like (all previous articles from October issue onwards in complete form are available) and send your orders to:
R&EW Project Reprints, 200 North Service Road, Brentwood, Essex, CM14 4SG.

Please send me further details of Bindit and accessories.

Name:

Address:

Postcode:

R&EW
9/82



Prices include VAT, postage and packing

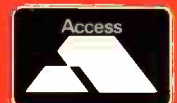

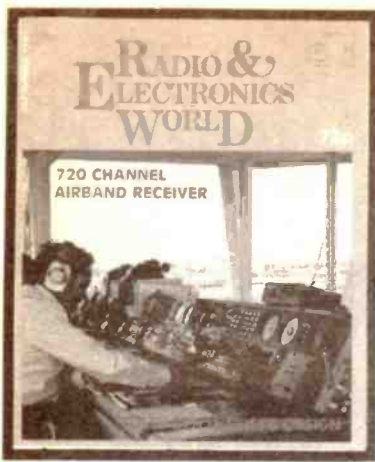

R&EW

SEPTEMBER 1982

Volume 1 No. 12

Contents

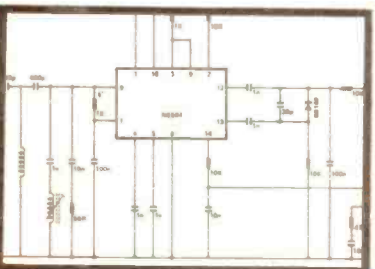
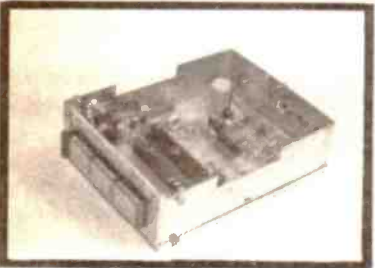
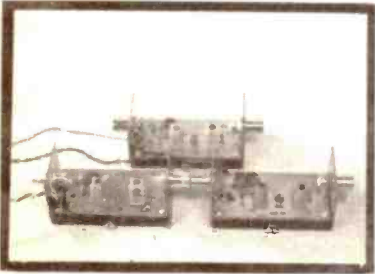

Projects

- 10/6/4m Pre-amp — Three Versatile Designs **10**
- Drill Speed Controller — Practical SMVF **20**
- A/D Converter — Easily Interfaced to your MPU **36**
- 720 Channel Airband Receiver — Eleven ICs, Superb Performance **44**
- Digital Frequency Display — Single Chip DFM **58**
- CB Noise Squeich — Civilise your Rig **73**

Features

- Comment **5**
- Digital Filters **16**
- Gate Turn-Off SCRs — The World of Power Electronics **24**
- Data Brief : KB4448 — PLL Decoder and Auto Blend **27**
- Readers Letters — A Mixed Postbag **30**
- DX-TV — Getting Started — All you Need to Know **40**
- Eastern Promise — Asian Activities **62**
- Circuit Blocks — Multistandard TV Sound **66**
- Sounding Off — Evan Steadman's View **68**
- Data Brief : — World TV Standards **77**
- Data Brief : — Power/Voltage ratios **78**
- Books of the Month — Top Titles **82**
- Data File — SMVF Continued **84**
- Notes from the Past — Memory Lane **93**
- The Last Word — Well Not Quite **96**
- Caption Competition Win a Turner **96**

Reviews

- Marconi 2017 — RF Signal Generator **32**
- DNT M40 — The 'Supertuned' Version **56**
- Hitachi Portable VCR — Excellent Performance, Small Size **70**

News

- New Products — PCB to CB **7**
- Video News — Low Priced Dolby Recorder **14**
- Computing News — The Shape of Things to Come **79**
- News Background — That'll Do Nicely **80**
- Short Wave News — Frank's Log **88**
- DX TV — Global Vision **91**

Information

- Next month's R&EW — Our Birthday Issue **26**
- R&EW Book Service — Post Haste Service **83**
- Project Packs & PCB Service — All Aboard **90**
- Advertisers' Index — Naming Names **96**

The complete volume one Index appears on pages 47 to 50.

Cover Photo: John Mills
Location: Stanstead Airport's Control Tower



TRIED, TESTED AND TRUSTED

See review
in February
Rad. Comm.

IC-720A
Possibly the best choice
in HF. £883.inc.



The main problem that the amateur of today has to deal with is deciding just which rig out of the many excellent products available he is going to choose. Technology is advancing at such a rapid rate and getting so sophisticated that many cannot hope to keep up. Some go too far!

Perhaps one way of dealing with the problem is to look at just what each model offers in its basic form without having to lay out even more hard earned cash on "extras". The IC-720A scores very highly when looked at in this light. How many of its competitors have two VFOs as standard or a memory which can be recalled, even when on a different band to the one in use, and result in instant retuning AND BANDCHANGING of the transceiver? How many include a really excellent general coverage receiver covering all the way from 100kHz to 30MHz (with provision to transmit there also if you have the correct licence)? How many need no tuning or loading whatsoever and take great care of your PA, should you have a rotten antenna, by cutting the power back to the safe level? How many have an automatic RIT which cancels itself when the main tuning dial is moved? How many will run full power out for long periods without getting hot enough to boil an egg? How many have band data output to automatically change bands on a solid state linear AND an automatic antenna tuner unit when you are able to add these to your station?

Well you will have to do quite a bit of hunting through the pages of this magazine to find anything to approach the IC-720A. It may be just a little more expensive than some of the others – but when you remember just how good it is, and of course the excellent reputation for keeping their secondhand value you will see why your choice will have to be an IC-720A!

IC-PS15 Mains PSU £99

IC-2E £159.inc.
IC-4E £199.inc.
The World's most
popular
portables



Nearly everybody has an IC2E – the most popular amateur transceiver in the world – now there is the 70 cm version which is every bit as good and takes the same accessories. Check the features.

Fully synthesized – Covering 144 – 145.995 in 400 5KHz steps. (430-439.999 4E)

Power output – 1.5W with the 9v. rechargeable battery pack as supplied – but lower or higher output available with the optional 6v or 12v packs. Rapid slide-on changing facility.

BNC antenna output socket – 50 ohms for connecting to another antenna or use the Rubber Duck supplied (flexible 1/4 λ whip – 4E)

Send/battery indicator – Lights during transmit but when battery power falls below 6v it does not light, indicating the need for a recharge.

Frequency selection – by thumbwheel switches, indicating the frequency. 5KHz switch – adds 5KHz to the indicated frequency.

Duplex simplex Switch – gives simplex or plus 600KHz or minus 600KHz transmit (1-6MHz and listen input on 4E)

Hi-Low switch – reduces power output from 1.5W to 150mW reducing battery drain.

External microphone jack – if you do not wish to use the built-in electret condenser mic an optional microphone speaker with PTT control can be used. Useful for pocket operation.

External speaker jack – for speaker or earphone. This little beauty is supplied ready to go complete with nicad battery pack, charger, rubber duck.

A full range of accessories in stock.	£ p		
ICML1 10W mobile booster for IC2E	49 00	BC25	Mains charger as supplied 4 25
BP5 11 volt battery pack	30.00	DC1	12 volt adapter pack 8 40
BP4 Empty battery case for 6 x AA cells	5 80	HM9	Speaker microphone 12.00
BP3 Standard battery pack	17 70	CP1	Mobile charging lead 3.20
BP2 6 volt pack	22.00	IC123	cases each 3 60
BC30 Base charger for above	39 00		All prices include VAT



Free carriage on direct sales – call us.

Remember we also stock Yaesu, Jaybeam, Datong, Welz, G-Whip, Western, TAL, Bearcat, RSGB Publications.

The IC4E is going to revolutionise 70 CM!

Please note: Access/Barclaycard owners – goods must be sent to address registered with credit card company.

ASK ABOUT THE NEW RANGE OF **CUE DEE**
ANTENNAS....the winners in recent tests!

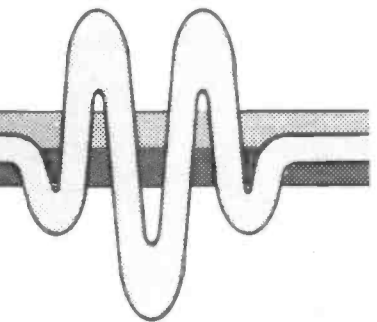

IC-290E £366, IC-490E £445 inc.
Multimode mobiles
 290E-144-146 MHz/490E-430-440 MHz
The best pair since Ericas!

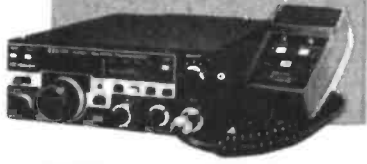

10W RF output on SSB, CW and FM. Standard and non-standard repeater shifts. 5 memories and priority channel.

Memory scan and band scan, controlled at front panel or microphone. Two VFO's LED S-meter 25KHz and 1KHz on FM-1KHz and 100KHz tuning steps on SSB. Instant listen input for repeaters.

IC-730 The best for mobile or economy base station
 £586 inc.



ICOM's answer to your HF mobile problems – the IC-730. This new 80m-10m, 8 band transceiver offers 100W output on SSB, AM and CW. Outstanding receiver performance is achieved by an up-conversion system using a high IF of 39MHz offering excellent image and IF interference rejection, high sensitivity and above all, wide dynamic range. Built in Pass Band Shift allows you to continuously adjust the centre frequency of the IF pass band virtually eliminating close channel interference. Dual VFO's with 10Hz and 1KHz steps allows effortless tuning and what's more a memory is provided for one channel per band. Further convenience circuits are provided such as Noise Blanker, Vox, CW Monitor, APC and SWR Detector to name a few. A built in Speech Processor boosts talk power on transmit and a switchable RF Pre-Amp is a boon on today's crowded bands. Full metering WWV reception and connections for transverter and linear control almost completes the IC-730's impressive facilities.

IC-251 £499 inc.
 IC-451 £630 inc.
Great Base Stations



ICOM produce a perfect trio in the UHF base station range, ranging from 6 Meters through 2 Meters to 70 cms. Unfortunately you are not able to benefit from the 6m product in this country, but you CAN own the IC-251E for your 2 Meter station and the 451E for 70 cms.

Both are really well designed and engineered multi-mode transceivers capable of being operated from either the mains or a 12 volt supply. Both contain such exciting features as scan facilities, automatic selection of the correct repeater shift for the band concerned, full normal and reverse repeater operation, tuning rate selection according to the mode in use. VOX on SSB continuous power adjustment capability on FM and 3 memory channels. Of course they are both fitted with a crystal controlled tone burst and have twin VFO's as have most of ICOM's fully synthesized transceivers.

IC-24G Low-priced mobile
 £169 inc.



The famous IC-240 has been improved, given a face lift and renamed the IC-24G. Many thousands of 240's are in use, and its popularity is due in part to simplicity of operation, high receiver sensitivity and superb audio on TX and RX. The new IC-24G has these and other features. Full 80 channels (at 25kHz spacing) are available and readout is by channel number – selected by easy to operate press button thumbwheel switches. This readout can clearly be seen in the brightest of sunlight. Duplex and reverse duplex is provided along with a 12½ KHz upshift, should the new channel spacing be necessary.

IC-25E
The Tiny Tiger
 £239 inc.



Amazingly small, yet very sensitive. Two VFO's, five memories, priority channel, full duplex and reverse. LED S-meter, 25KHz or 5KHz step tuning. Same multi-scanning functions as the 290 from mic or front panel. All in all the best 2M FM mobile ICOM have ever made.

NEW! Tono Theta 9000E
 £650 inc.



LOOK! A new Trap Dipole!

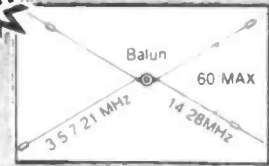

The MT-240X Multi-band trap dipole antenna (80m – 10m) is a superbly constructed antenna with its own Balun incorporated in the centre insulator with an SO239 connector. Separate elements of multi-stranded heavy duty copper wire are used for 80-40-15 and 20-10 Metres. Really one up on its competitors. £49.50 inc. VAT

The TONO range of communication computers take a lot of beating when it comes to trying to read RTTY and CW in the noise. Others don't always quite make it!

Check the many facilities offered before you buy – especially look at the 9000E which also throws in a Word Processor. Previous ads have told you quite a lot about these products – but why not call us for further information and a brochure?

Thanet Electronics

143 Reculver Road, Bevinge, Herne Bay, Kent. Telephone (02273) 63859

Agents (phone first – all evening weekends only except Scotland)
 Scotland – Jack GM8 GEC 031 657 2430 (daytime)
 031 665 2420 (evenings)
 Midlands – Tony G8AVH 021 329 2305
 Wales – Tony GW3 FKO 0874 2772 or
 0874 3992
 North West – Gordon G3LEO Knutstord (0565) 4040
 ansaphone available



BARCLAYCARD
 VISA

DATONG

YET MORE INNOVATION



MODEL DF
DISPLAY UNIT

DOPPLER DIRECTION FINDER

Model DF is a direction finding attachment for use with existing narrow band FM receivers and transceivers.

Two units, the display unit and the special antenna combiner convert your NBFM transceiver plus four omnidirectional antennas into a radio direction finder. A built-in r.f. activated antenna relay diverts the transceiver's output to the normal antenna during transmit or when the DF attachment is switched off.

Features

- Works with any existing narrow-band FM receiver or transceiver. No modifications are needed. The only connections required are to the external speaker and antenna jacks.
- Gives a clear directional readout on a circular array of sixteen bright green LEDs.
- Display holds last reading when signal drops out.
- Very easy to use and install.
- Only a single coaxial cable needed between display unit and antenna combiner.
- Professional quality at remarkably low cost. Display unit uses two PTH circuit boards. Gasket sealed combiner unit houses two conventional double-sided PCBs.

Applications

Model DF costs between ten and a hundred times less than conventional RDF systems, and therefore opens up new application areas for both professional and hobby users.

Possible applications include:- VHF amateur radio, Citizen's Band radio, aircraft spotting, tracking gliders and light aircraft, locating lost model aircraft, private mobile radio systems, coastal and marine radio, tracking and locating anti-social radio operators, locating 'tagged' animals in the wild, helping to identify or trace unknown transmissions, law enforcement.

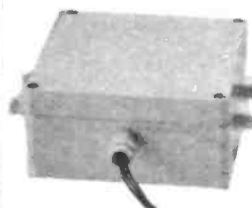

MODEL DFA2 COMBINER UNIT

A complete system needs the display unit and the antenna combiner plus four antennas mounted at the corners of a square spaced apart by 0.05 to 0.3 wavelengths.

For fixed station use, four dipoles are suitable while four magnetically mounted quarter wave whips are ideal for mobile use. Depending on the choice of antenna, the system will operate from 20 to 200 MHz.

Suitable magmount quarter wave whips are available from Datong for VHF use.

* **BASIC DF SYSTEM** (Model DF display unit with Model DFA1 combiner) £125.00 + VAT (£143.80)

* **DF SYSTEM**, as above but with mobile version of combiner, Model DFA2 (as DFA1 but fitted with magmount and 4 metre coaxial downlead terminated with PL259 plug) £131.00 + VAT (£150.70)

COMPLETE MOBILE DF SYSTEM (Model DF display unit, Model DFA2 combiner, and four Model MA1 quarter wavelength magmount antennas cut for 145 MHz) £173.50 + VAT (£199.50)

* Antennas not included



WIDE BAND PREAMPLIFIER - MODEL RFA

Eliminates separate tuned preamplifiers for each band.

Model RFA improves the sensitivity of any receiver or transceiver working in the range from 5 to 200 MHz. It connects in series with the antenna and built-in r.f. activated relay switches the pre-amplifier out of circuit during transmit or when the power is off.

Features:

- Extra wide bandwidth saves the cost of separate narrow band preamps.
- Handles strong signals without overload thanks to special low-noise negative feedback technique. Intercept point better than + 20dbm.
- Low noise figure.
- Carefully chosen gain level minimises receiver overload and cross modulation.
- R.F. activated bypass relay allows easy use with transceivers.
- Rugged diecast aluminium case with SO239 connectors and PTH printed circuit board.

Applications

Application areas include:- weak signal reception of all amateur and satellite bands from 5 MHz up to 200 MHz, long distance reception of VHF FM Broadcasts and VHF TV Signals, CB transceivers, private mobile VHF radio transceivers, reception of marine and aeronautical bands, VHF scanner receivers, compensating for signal loss in long antenna feeders.

The wide bandwidth of Model RFA makes it ideal for use with broadband antennas and scanner receivers.

Broadband Preamplifier, Model RFA: £25.50 + VAT (£29.32)



MODEL S
"CODECALL"

"CODECALL" SELECTIVE CALLING DEVICE - TAKES THE FATIGUE OUT OF LONG TERM MONITORING

"Codecall" is ideal wherever there is a need to monitor a well used radio channel for one particular call over long periods. "Codecall" gives the same convenience as a telephone bell, in that the receiver remains totally silent while monitoring. It therefore causes no disruption to other activities.

In fact the user can totally disregard the radio until a loud beep from "Codecall" warns that the desired signal has been received. The loud intermittent beep then continues, unless cancelled, for over ten minutes after the call is received.

"Codecall" ensures that the communications channel remains at full efficiency at all times. Without "Codecall" the desired call often blends into the general chatter and is missed by the listener, especially when the volume has been reduced to cut down the radio's nuisance level.

Features

- Each "Codecall" unit acts as a call generator and a call receiver.
- No electrical connection is needed at the transmitter, simply hold "Codecall" next to the microphone.
- At the receiver simply plug "Codecall" into the external speaker jack.
- Over four thousand different codes virtually eliminate the chance of false alarms.
- Internal 9 volt battery has long life since no current is used while monitoring a squelched channel.
- Works over any voice link, whether FM, AM, or SSB.
- Codes selected by either three 16-way switches (Model S) or by altering twelve internal wire links (Model L).
- Compact: only 4 x 2.4 x 1.05 inches.

Two Versions

Model S (as illustrated) has three 16-way rotary switches on the front panel giving a total of 4096 combinations immediately available. Model L has no switches, instead the code is set by altering twelve wire links inside the case.

Both models can be used in the same system. The switched version (Model S) is ideal where frequent code changes are required, whereas the linked version (Model L) is suitable where codes are not likely to be altered often, or for unskilled users who might accidentally set the wrong code.

Note: when used by UK Radio Amateurs all transmissions must be identified as required by the licence conditions.

"Codecall" Model L (Link programmed):

£24.00 + VAT (£27.60)

"Codecall" Model S (Switch programmed):

£25.50 + VAT (£29.32)



ALL DATONG PRODUCTS ARE
DESIGNED AND BUILT IN THE U.K.

PRICES

All prices include delivery in U.K. basic prices in £ are shown with VAT inclusive prices in brackets.

FL1	59.00 (67.85)	AD370	45.00 (51.75)	RFA	25.50 (29.32)
FL2	78.00 (89.70)	AD270 + MPU	37.00 (42.55)	Codecall	
PC1	105.00 (120.75)	AD370 + MPU	49.00 (56.35)	(Linked)	24.00 (27.60)
ASP	69.00 (79.35)	MPU	6.00 (6.90)	Codecall	
VLF	22.00 (25.30)	DC144/28	31.00 (35.65)	(Switched)	25.50 (29.32)
D70	43.00 (49.45)	DC144/28		Basic DF System	125.00 (143.80)
D75	49.00 (56.35)	Module	25.00 (28.75)	DF System	131.00 (150.70)
RFC/M	23.00 (26.45)	Keyboard Morse		Complete Mobile DF	
AD270	33.00 (37.95)	Sender	112.20 (129.00)	System	173.50 (199.50)

★ See text for details.

Data sheets on any products available free on request - write to Dept R.C.
DATONG ELECTRONICS LIMITED
 Spence Mills, Mill Lane, Bramley, Leeds LS13 3HE, England. Tel: (0532) 552461

Editorial Offices

117a High Street, Brentwood,
Essex CM14 4SG

Editorial (0277) 213819

Managing Editor
William Poel

Assistant Editor
Gary Evans

Communications Editor
Graham Leighton

Computing Editor
Jonathan C Burchell

Projects Editor
Roger Ray

Project Developments
Jake Oliver

Editorial Secretary
Kim Mitchell

Production (0277) 213819

Production Editor
Jack Burrows

Art/Production Manager
Patrick Haylock

Art Editor
Sally Bennett

Layout
Helen White
Martin Sheehan

Advertising 01-531 7621

Hillcroft House, 16 The Avenue,
Highams Park, London E4 9LD

Subscription 01-868 4854

Subscription Manager
Owen Rundle
45 Yeading Avenue, Rayners Lane,
Harrow, Middx HA2 9RL

Printers
LSG Printers, Lincoln

Photosetting by
Delafield Reprographic Service
200 North Service Road,
Brentwood, Essex CM14 4SG

Distributors 01-274 8611

SM Distribution Ltd

Overseas Agents

Holland Electronics **071-144988**
Postbus 377, 2300 A J LEIDEN

U.S. Project Pack Agents

Radiokit, **(603) 878-1033**
Box 411, Greenville, New Hampshire,
NH030408, U.S.A.

INFORMATION

Classified: 01-868 4854

Back Issues: £1 each inclusive of postage from Subscription Dept, or send reply paid card with cheque or PO.

Broadercasting Limited 1982. All reasonable precautions are taken by R&EW to ensure that the information given to our readers is reliable. However we cannot guarantee it and we cannot accept legal responsibility for it. Information and prices are correct at time of press.

Reproduction of contents is possible with permission from the Editor, however short abstracts or references are allowable providing the source is given.

Publishers Broadercasting Limited

Comment

This is the last issue of the first volume of **Radio and Electronics World** and what a year it's been. Whilst virtually all other publications have been reporting declining sales in a market of unprecedented depression and gloom, we have been out there trying to establish yet another title, with the most generous production and editorial budget ever invested in electronics in the UK.

A brief scan of the titles available on the shelves of a main line station bookstall will reveal just how many titles the prospective purchaser has to choose from. There are around 12 devoted to the model railway enthusiast alone, but it is very obvious that the public's flirtation with CB has vaporised just about as quickly as it had materialised.

However, continuing expansion at **R&EW** means that we are once again looking for another 'editorial assistant', primarily to help Gary Evans with general editorial matters, rather than specialise in any specific area. As you may have noticed, we have a full complement of technical 'editors'!

LIVING AND LEARNING

The prime requirement for any person working with **R&EW** is the ability to learn and absorb new things. It's very likely that the job (and the unsocial hours) would suit a 'new' graduate - not necessarily with electronics qualifications, but certainly with an interest in the subjectmatter we cover, and the ability to write (and recognise) *good* English, with an appreciation of the type of style we have evolved.

If this sounds like it might suit you, then please write in the first instance to the Managing Editor (enclosing an SAE), and an application form will be sent. We can guarantee you one of the most interesting and demanding jobs in publishing, with the scope to expand and broaden your horizons at a rate determined by your own enthusiasm and ability, and not as a result of any predetermined parameters imposed from 'above'.

IT TAKES ONE TO KNOW ONE

Fevered attempts to round up new subscribers are gathering pace in the business. However, we don't feel obliged to drop our subscription rate and thereby annoy all those who have recently paid the 'real' rate. Instead, we offer you an incentive scheme.

If you are already an **R&EW** subscriber, and you recommend/sell a subscription to one of your friends or colleagues (or your firm), then we will extend your renewal date by one month for each introduction. Just send in the new subscriber card with your last wrapper, and we will do the rest. This offer closes on December 31st 1982, although if it catches on, we may continue it indefinitely.

Don't forget that we offer good savings for schools, colleges, universities, clubs etc. for block purchases of a minimum of 25 issues per month. Write in for further details.

ROUND ONE TO THE HO

The concept of using a narrowband channel for technology broadcasting in 2m received the official 'HO' at last. It also got a raspberry or two from radio amateurs who felt the precedent was dangerous.

Well, we rather agree that on balance 144MHz is not the place for anything interesting and worthwhile (tweaking the lion's tale, eh?), but the reply from the HO and the arguments put against the idea have provided us with some useful ammunition for round two, which we had sneakily anticipated as being the real objective anyway.

The independent review of the Radio Spectrum from 30-900MHz is going on at the present time, although once again there is a nasty taste left behind by the fact that the HO press release is dated July 6th., and the last date for submissions was July 27th.

Turn to the Newsbackground pages for more details.

An entire range of low-cost high-performance instruments



sabtronics

'Making Performance Affordable'

5020A 1Hz-200kHz Function Generator
 2033 3½-Digit L.C.D. Hand DMM
 365-S Protoboard
 LP-10 10MHz Logic Probe
 8110A 100MHz 8-Digit Frequency Meter
 8610B 600MHz 9-Digit Frequency Meter
 8000B 1GHz 9-Digit Frequency Meter
 PSC-65 600MHz Prescaler
 AT-001 x1 Passive Probe
 AT-010 x10 Passive Probe
 AT-110 x1x10 Passive Probe (Switchable)

Also Oscilloscopes 15-30MHz Single or Dual trace.

Test our low priced test equipment. It measures up to the best. Compare our specs and our prices—no-one can beat our price/performance ratio.



Illustrated brochure and price list from:
BLACK STAR LTD
 9a Crown Street, St. Ives, Cambs. PE17 4EB
 Tel: (0480) 62440. Telex: 32339

163 for further details

NEW PRODUCTS



SOS CB

Emergency services, breakdown crews, route information and weather reports can all be summoned within seconds using CB radio but for many people the prospect of a radio, microphone and whip aerial fitted to the family car is unwelcome. Furthermore entering the CB fraternity of Good Buddies, fantasy 'Handles', and Stateside trucking lingo is itself a major deterrent for large numbers of sober family motorists.

However the life-saving possibilities of two-way radio cannot be ignored and accidents DO happen, as do punctures, burst hoses and other more serious breakdowns, often late at night or in remote places. In these circumstances the value of CB is obvious and enormous even to the most vehement anti-CB motorist. In order to offer the benefits of CB radio without the installation or the image, SIRTEL (UK) LTD., have just introduced the SOS emergency CB unit from Cobra.

Designed exclusively for the UK market, the SOS radio is

incorporated into a small plastic case that stores in the glove compartment until required. It is in two halves that fit tightly together until released by a single catch. When open, one half of the case comprises a hand-held 40-channel CB radio and stored in the other half are a telescopic, magnetic mount aerial and cigar-lighter power lead.

Within seconds the plug-in components can be connected and the radio activated. With the advent of legal FM in the UK there are thousands of emergency channel-9 monitoring stations throughout the UK, listening-in day and night for distress calls and this, or one of the 'breaking' channels, can be used to summon assistance. With a range of up to five miles the Cobra SOS is just as effective as a conventional CB car installation.

For more information contact:
Sirtel (UK) Ltd.,
 24, Alfric Square,
 Woodston,
 Peterborough.

184 for further details

MODIFICATION KIT TO ARX2 'RINGO RANGER'

Following last years successful introduction of the Ringo Ranger Mark II, a modification kit to allow owners of the original version to update their antennas to the latest specification has been produced by Cushcraft.

The Ringo Ranger is said to be the world's most popular amateur radio colinear antenna, with current sales well into six figure quantities throughout the world. It is also in use for commercial and marine applications.

In 1981, Cushcraft introduced a mark II version of this antenna, incorporating an additional lower section with radials and 'blitz bug' lightning protector. Although the theoretical gain advantage is reckoned to be 1.1db over the original model, in practice the net

effect has proved much greater.

By a technique of shunt coupling to the support mast and a choice of 3 extended quarter wave radials, a modification of the useful radiation pattern has been accomplished. This means that the net effect of the gain, in many cases appears to be greater with the mark II version.

Now, users of the original ranger can also obtain these benefits by the retro-fitment of the ARX2K conversion pack.

It can be fitted to any original ARX2, mounted on a 1.25" diameter supporting mast and is now available from Cushcraft stockists at a price of £14.20. For further details contact.

Communications Products Ltd.,
 P.O. Box 23,
 Halifax,
 West Yorkshire, HX3 6AN.

183 for further details

TONNA (F9FT)

YOUR NUMBER ONE CHOICE FOR 6m, 2m, 70 AND 23cm ANTENNAS



50MHz	L(M)	W(kg)	144/435MHz	L(M)	W(kg)
5 element†	3-5	3-2	£31.74(a)	Oscar Special	
144MHz				9 & 19 element†	3-3 2-0
4 element	1-37	0-5	£14.43(a)	1,296MHz	
9 element fixed	3-30	1-9	£17.14(a)	23 element†	1-64 0-9
9 element portable	3-30	1-7	£19.40(a)	4 x 23 element antennas—power	
9 element crossed	3-50	2-0	£31.68(a)	splitter—stacking frame	
13 element portable†	4-50	2-5	£30.22(a)	135MHz Satellite	
16 element fixed	6-40	4-4	£35.19(a)	9 element crossed	3-5 1-8
435MHz				Telescopic Portable Masts	
19 element	3-20	1-1	£20.13(a)	4 x 1 metre £15.96(a), 3 x 2 metre £19.15(a)	
19 element crossed†	3-30	1-8	£33.36(a)	4 x 2 metre £28.75(a)	
21 element	4-60	2-6	£28.87(a)	ANDREW HELIAX LDF4-50 COAXIAL CABLE	
21 element ATV	4-60	2-6	£28.87(a)	Attenuation per 100ft. 144MHz -0.8dB.	

†Denotes 50Ω ONLY—all others 50Ω OR 75Ω
 NEW POWER SPLITTERS AVAILABLE FOR 2 and 4 ANTENNAS
 PLEASE ADD CARRIAGE AS SHOWN
 (a) £4.00. (b) £1.60. (c) £1.40. MAINLAND ONLY

435MHz-1.6dB. 1296MHz-2.9dB.
 £2.60 per metre (a). 'N' Type connectors for LDF4-50 male or female £9.00.
 MICROWAVE MODULES—LUNAR—ROTATORS—COAXIAL CABLES ETC

CWO—ACCESS—VISA—just telephone. All prices include VAT FOR FULL SPECIFICATION OF OUR RANGE SEND 30p FOR CATALOGUE Callers welcome, but by telephone appointment only please

RANDAM ELECTRONICS (R)

12 Conduit Road, Abingdon, Oxon OX14 1DB.
 Tel: (0235) 23080 (24 hours)

165 for further details

SWITCHED PRE-AMP

The Datong Model RFA is a low noise preamplifier designed for easy external connection to existing receivers or low-power transceivers in the range 5 to 200 MHz.

It is especially suitable for use with older mobile radio telephone equipment and will frequently give an improvement in operating range. Send/receive switching is automatic and uses r.f. sensing and an internal bypass relay. It simple connects in series with the antenna feeder.

Frequency coverage is from 5 to 200 MHz and the unit features excellent large-signal handling (intercept point + 20 dbm) and a gain (9 db) chosen to minimise receiver overload effects.

Applications include:- private

mobile VHF radio transceivers, reception of marine and aeronautical bands, VHF scanner receivers, compensating for signal loss in long antenna feeders. Its wide bandwidth makes it ideal for use with broadband antennas and scanner receivers.

Model RFA is mounted in a diecast case with SO 239 r.f. connectors. It requires 12 volts DC power.

The unit is available from the manufacturers:

*Datong Electronics Limited,
Spence Mills,
Mill Lane,
Bramley,
LEEDS, LS13 3HE.*

185 for further details

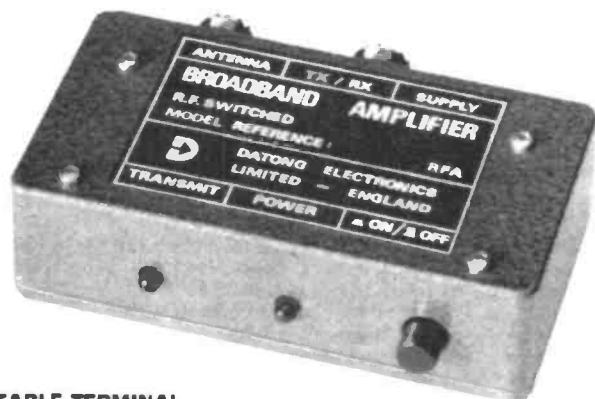

PORTABLE TERMINAL

Hardware Dynamics, a recently formed peripheral specialist, announce the Intercole KD100 portable keyboard and display. The unit comprises a splash and dust proof ASCII keyboard employing flexible membrane switches with audible feedback and a two-line by forty character LCD display.

It has an RS232 interface capable of operating over 100m lines as standard, and up to 3km with the optional balanced line drivers. The baud rate is normally set at 1,200 but can be adjusted to any standard value up to 9,600 at the factory.

The keyboard has the standard typewriter-style QWERTY layout generating the full upper case ASCII alphabet and incorporates two-key scroll operations by utilising XON and XOFF control signals.

The variable intensity display has a viewing area of 160 x 17mm and presents 3.15mm wide by 4.45mm high characters in a clear dot matrix format.

Power is provided by six AA rechargeable cells that give a nominal running time of three hours or it can be used via the charge unit direct to 240V 50Hz mains.

Overall the KD100 measures 330 x 220 x 65mm and weighs only 2kg.

For further information contact:
*Hardware Dynamics,
103 Colleton Drive,
Twyford,
Berks, RG10 OAX.*

186 for further details

STRIPPING OFF

Micro-strip, is a new wire stripper which is self-adjusting for depth of incision and gripping pressure and will deal with all PVC insulations.

A patented self-adjusting floating can adjusts the stripper's mechanism to the correct stripping depth and at the same time automatically sets the gripping pressure exerted on the insulation by the gripping jaws, thereby preventing damage to the insulation.

The Micro-strip will deal with all sizes of wire up to a maximum of 1.5mm diameter without any adjustment; for very thin or thick insulations, an adjustment mechanism is provided.

further information contact:
*AB Engineering Company,
Timber Lane,
Woburn,
Milton Keynes MK17 9PL.*

187 for further details



6 inputs... 6 colours... words too

You'll never need overprinted or special chart paper again.

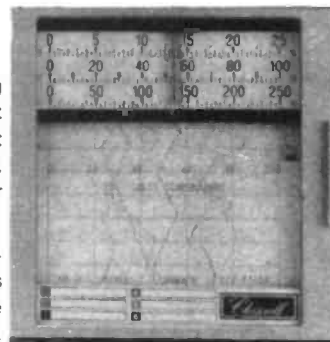

Model 306 Multipoint

- Disposable six pen dotting head records in six different colours on 4" (100 mm) chart ... prints time, day number, chart speed, scales and other data in plain language.

- Up to three different linearising signal conditioners (each assignable to any of the six inputs) for all known T/C's, RTD's, d/p cells and other non-linear signals.

- Printing of two alarm set points appears as regularly-spaced pairs of colour-keyed dots.

Southdownview Road
Worthing, Sussex.

Tel: Worthing
(0903) 205222

EI *Chessell Ltd*

164 for further details



Bigger and Better for 1982
the colourful Wilmslow Audio brochure
— the definitive loudspeaker catalogue!

Everything for the speaker constructor — kits, drive units, components for HiFi and PA.

50 DIY HiFi speaker designs including the exciting new dB Total Concept speaker kits, the Kef Constructor range, Wharfedale Speakercraft, etc.

Flatpack cabinet kits for Kef, Wharfedale and many others.

- ★ Lowest prices — Largest stocks ★
- ★ Expert staff — Sound advice ★
- ★ Choose your DIY HiFi Speakers in the comfort of our ★
two listening lounges
(Customer operated demonstration facilities)
- ★ Ample parking ★

Send £1.50 for catalogue
(cheque, M.O. or stamps — or phone with your credit card number)

- ★ Access — Visa — American Express accepted ★
also HiFi Markets Budget Card.



☎
0625 529599

35/39 Church Street, Wilmslow, Cheshire SK9 1AS



Lightning service on telephoned credit card orders!



162 for further details

GAREX (G3ZV1) SX200-N

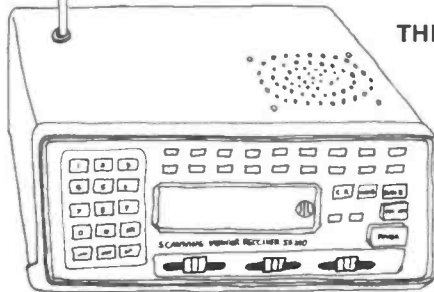

THE ULTIMATE
SCANNER

COMPARE THESE FEATURES

- * SPECIALLY DESIGNED FOR EUROPEAN MARKET
- * MICROPROCESSOR CONTROLLED 32,000 CHANNELS
- * AM & FM ALL BANDS
- * WIDER COVERAGE: 26-58, 58-88, 108-180, 380-514MHz; includes 10m, 4m, 2m & 70cm Amateur bands.
- * 5kHz & 12½kHz FREQUENCY INCREMENTS
- * 16 MEMORY CHANNELS WITH DIRECT ACCESS
- * 2 SPEED SCAN/SCAN DELAY CONTROL
- * 2 SPEED SEARCH UP AND DOWN
- * SEARCH BETWEEN PRESET LIMITS UP AND DOWN
- * 3 SQUELCH MODES inc. CARRIER & AUDIO
- * RELAY OUTPUT FOR Aux. CONTROL
- * INTERNAL SPEAKER
- * EXTERNAL SPEAKER & TAPE OUTPUTS
- * LARGE GREEN DIGITRON DISPLAY BRIGHT/DIM
- * AM-PM CLOCK DISPLAY
- * 12V DC, 230V AC OPERATION
- * 12 MONTH WARRANTY FACTORY-BACKED SPARES & 'KNOW-HOW' AND THE ALL-IMPORTANT PRE-DELIVERY CHECK BY GAREX THE

MAIN SERVICE & SALES AGENTS £264.50 inc VAT Delivered

NEW *** REVCON *** ***NEW***
A new top quality 16-element, all British made, VHF/UHF broadband fixed station aerial from Revco. Ideally suited to SX200 and other VHF/UHF Receivers.
PRICE £24.95 inc

SR-9 monitor: 2m FM with 144-146MHz full coverage VFO + 11 xtal controlled channels; ideal for fixed, FM, P use. 12V DC operation £47.50
Marine Band SR-9, 156-162MHz, same spec. and price.

CRYSTALS FOR NR-56, SR-9, SR-11, HF-12, TM-56B All 2m channels from £145.00 to 33 (145.825). Also 144.80, 144.825, 144.85 Raynet at £2.46 (+20p post per order). Over 40 popular marine channels at £2.85 (+20p post).

RESISTOR KITS a top-selling line for many years. E12 series, 5% carbon film, 10Ω to 1M, 61 values, general purpose rating ¼W or ½W (state which)

Starter pack 5 each value (305 pieces)	£ 3.10
Standard pack 10 each value (610 pieces)	£ 5.55
Mixed pack, 5 each ¼W + ½W (610 pieces)	£ 5.55
Giant pack, 25 each value (1525 pieces)	£13.60

NICAD RECHARGEABLES physically as dry cell: AA(U7) £1.30; C(U11) £3.35; PP3 £5.55. Any 5+: less 10%, any 10+: less 20%.

CRYSTAL FILTER 10.7MHz, 12½kHz spacing, ITT 901C £6.90
10.7MHz, 25kHz spacing, type 914B or 909B £6.90

HT TRANSFORMER multi-tap mains pri.: 5 secs: 35V 200mA, 115V 150mA, 50V 500mA, 150V 300mA, 220V 300mA £5.50

PYE RADIOTELEPHONE SPARES (s.a.e. full list) Ex. equip., fully guaranteed, Cambridge AM10

10.7MHz I.F. £3.65 2nd mixer £3 455KHz block filter 12½KHz £9.40 ditto 25KHz £3. 455KHz AM IF £4.95 Audio bd. £1.95 WESTMINSTER W15/W30 AM Rx RF 68-88MHz or 148-174MHz £6.95 10.7MHz IF (inc. 12½KHz xtal. filter) £8.25 2nd Osc £2.10 455KHz IF £5.65 455KHz block filter (12½KHz) £7.35 Squelch £1.45 QQ206-40a (quick-heat) RF tested £11.95 Aerial relays £1.50

PYE SPARES ARE OUR SPECIALITY - COMPLETE UNITS ALSO AVAILABLE

GAREX FM DETECTOR and squelch conversion for Pye R/T equipment Ready assembled, full instructions. Tailor-made, easy-fit design, replaces existing squelch board, with minimum of modifications. For AM Cambridge £6.30; for Vanguard AM25B (Valve RX) £6.10; for Transistor Vanguard AM25T £6.95

MAIN DISTRIBUTOR OF REVCO AERIALS & SPECIAL PRODUCTS (trade enquiries welcome)

PRICES INCLUDE UK P&P and 15% VAT

GAREX ELECTRONICS

7 NORVIC ROAD, MARSWORTH, TRING, HERTS HP23 4LS
Phone 0296 668684. Callers by appointment only.

NEW PRODUCTS

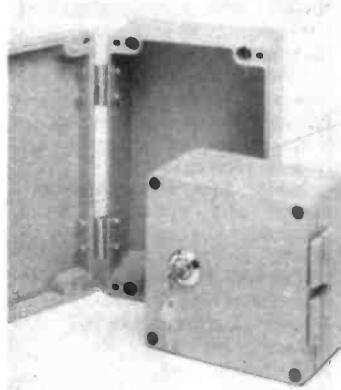

TURN KEY CASES

The new 'Bopal' range of housings from West Hyde are ideal where security of installation coupled with protection is required.

The enclosures feature hinged lids which are fitted with cylinder locks

as standard; however, square key locks or slotted-head screws can be supplied to special order when these are more appropriate. A neoprene gasket ensures that the enclosure remains dustproof and hoseproof in temperatures up to 90 degrees.

Inside, pads with a number of tapped holes are provided at each end for earthing and PCB mounting purposes.

The enclosures are available ex-stock from West Hyde in a range of six sizes chosen to suit most requirements.

Further details are available from:-

*West Hyde Developments Ltd.,
Unit 9,
Park Street Industrial Estate,
Aylesbury,
BUCKS.
HP20 1ET.*

188 for further details

DIY PCB

The CM100-CIRCUIT MAKER is a comprehensive kit that enables professional quality circuit boards, to be produced. The CM100 provides all the necessary hardware and chemicals to produce positive photographic film masters from published circuit layouts enabling either single or double-sided boards to be made easily and quickly from these masters.

The kit is aimed at everyone interested in electronics from R and D engineers to enthusiastic novices who need a simple, low cost production system. The CM100 can produce PCBs photographically without the need of darkroom, expensive camera equipment or ultra-violet light.

As well as containing six double-sided copper clad fibreglass circuit boards, plus everything else required

to complete the process, the kit contains comprehensive instructions, workbench charts and 'trouble shooting' charts to help the first time user complete the operation from womb to tomb!

A special feature of CM100 is the specially designed frame which can be used as an exposure frame for the photographic part of the process, as well as a component assembly frame. The foam back is heat-resistant which allows the frame to be used to hold the components firmly in place for lead cropping and soldering.

Please contact:
*Electrolube Ltd.,
Blakes Road,
Wargrave,
Berks.*



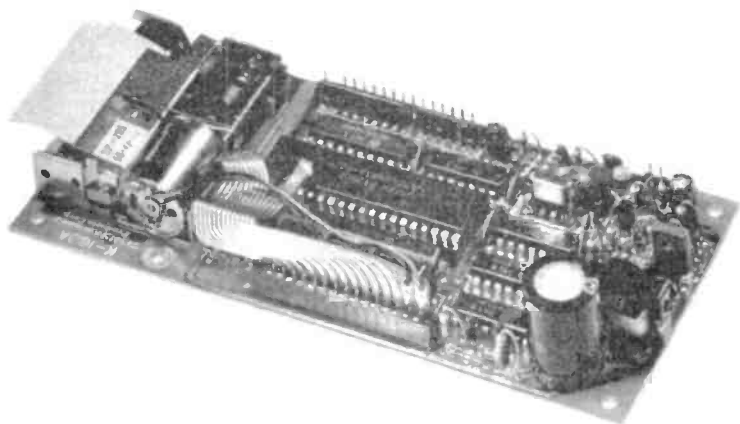

MINIATURE PRINTER

the K160 is another in the range of thermal printers from Roxburgh. It is a PCB mounted 16 column miniature thermat printer. Consisting of a print head, the SP285, with the power supply, drive electronics and interface to a microprocessor bus.

A feature of the K160 is that only a +5VDC supply is required as an inverter is used to generate the thermal elements' voltage. As the K160 also interfaces directly to an 8 bit parallel bus, incorporating it into a microprocessor system is extremely simple.

ASCII data is sent to the K160's

microprocessor which controls all timing, drive and character generating functions of the print head.

It also has programmable line feed and self test programs. The K160 uses 38mm wide thermal paper and prints at 1.75 lines per second. The right two columns are offset by one column which can be useful for printing units or exponential powers. For further information please contact:

*Roxburgh Printers Limited,
22 Winchelsea Road,
Rye,
East Sussex.*

159 for further details

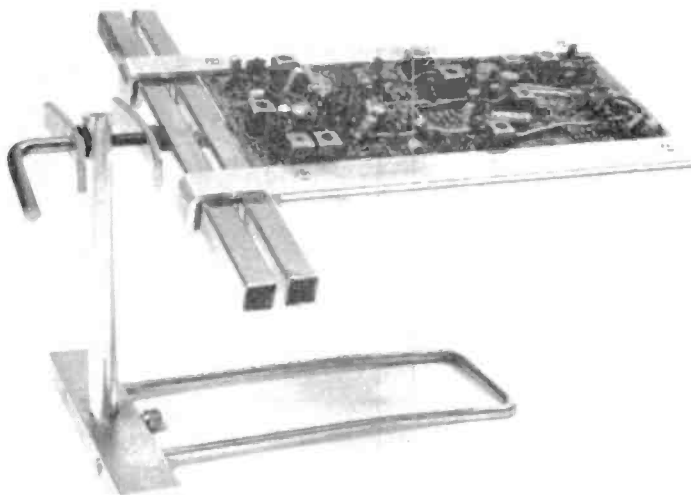

BRITISH JIG

A new printed circuit board holder/assembly jig, the CNC 10, has just been announced by Carlton Nichol & Co. PCBs are held between two rails, which are locked into position by means of one central clamp. Adjustment for different board sizes is therefore a simple operation and there is a high degree of accessibility to the PCB.

The holder is designed to accept boards of up to 8" x 8", although longer boards (maximum 8" wide) may be held since they can project beyond the ends of the rails. When in position, a PCB may be rotated

through 360 degrees and locked at any angle. The holder can be folded flat for carrying and storage simply by loosening one bolt. There is also an optional foam pad with clip available to enable the user to insert a number of components prior to soldering.

The CNC 10 costs £16.10 and the foam pad is £5.63. Prices are inclusive of VAT but £1.50 should be added to cover postage.

Please contact for further details:-
*Carlton Nichol & Co. Ltd.,
Goldkey Industrial Estate,
Kelvedon,
ESSEX.*

160 for further details

GERALD MYERS

1st GRADE COMPONENTS & ACCESSORIES BY RETURN

JUMBO BULK BARGAIN CLEARANCE PACK. £50 worth of components for £12. Each pack contains Transistors, ICs, Capacitors, pots, connectors, resistors, radio and electronic devices. Hundreds already sold. Money back if not delighted. Please add £3 carriage.

MULTI PAC BARGAINS. 25, assorted presets, sliders, skeleton etc. £1.50 P&P 30p.

50 assorted new potentiometers £4.25.

100 mixed high wattage resistors, wirewound etc. £3.25 P&P 35p.

150 mixed capacitors, most types, Amazing value. £4.00.

TV SERVICE PACK. Contains at least £25 worth of TV components and spares. Loads of hard to obtain TV spares. ONLY £6. P&P 75p.

GPO TYPE TELEPHONES (Modern) as new, mostly black. £4.00. P&P £1.75.

SEND 45p for GREEN CAT. Contains 1000s of components and accessories at unbeatable prices. Cat cost deducted when ordering.

NEW ELECTRONIC DISCOUNT CENTRE Open at 12 Harper Street, Leeds 2. Above Union Jack Clothing Store. Open 9 to 5.30pm. Weekdays and Saturdays. CALLERS WELCOME.

POSTAGE 15p in the £ unless otherwise stated. Prices include VAT.

DEPT REW

MYERS ELECTRONICS, 12 HARPER STREET, LEEDS LS2 7EA.
Telephone Leeds 452045.

166 for further details

MASTER ELECTRONICS NOW!

The PRACTICAL way!

You will do the following:

- Build a modern oscilloscope
- Recognise and handle current electronic components
- Read, draw and understand circuit diagrams
- Carry out 40 experiments on basic electronic circuits used in modern equipment
- Build and use digital electronic circuits and current solid state 'chips'
- Learn how to test and service every type of electronic device used in industry and commerce today. Servicing of Radio, T.V., Hi-Fi and microprocessor/computer equipment.

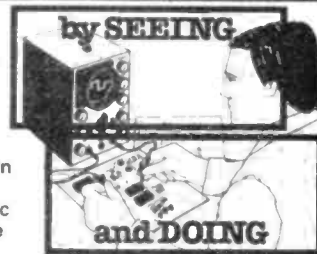

New Job? New Career? New Hobby?
Get into **Electronics** Now!

FREE! COLOUR BROCHURE

Please send your brochure without any obligation to

NAME

ADDRESS

..... BLOCK CAPS PLEASE

POST NOW TO:

**British National
Radio & Electronics School**
Reading, Berks. RG1 7BR

I am interested in:

COURSE IN ELECTRONICS as described above

RADIO AMATEUR LICENCE

MICROPROCESSORS

LOGIC COURSE

OTHER SUBJECTS

REW 9/82

4/6/10M PRE-AMPLIFIERS

Graham Leighton with concise details of a series of high performance pre-amplifiers.

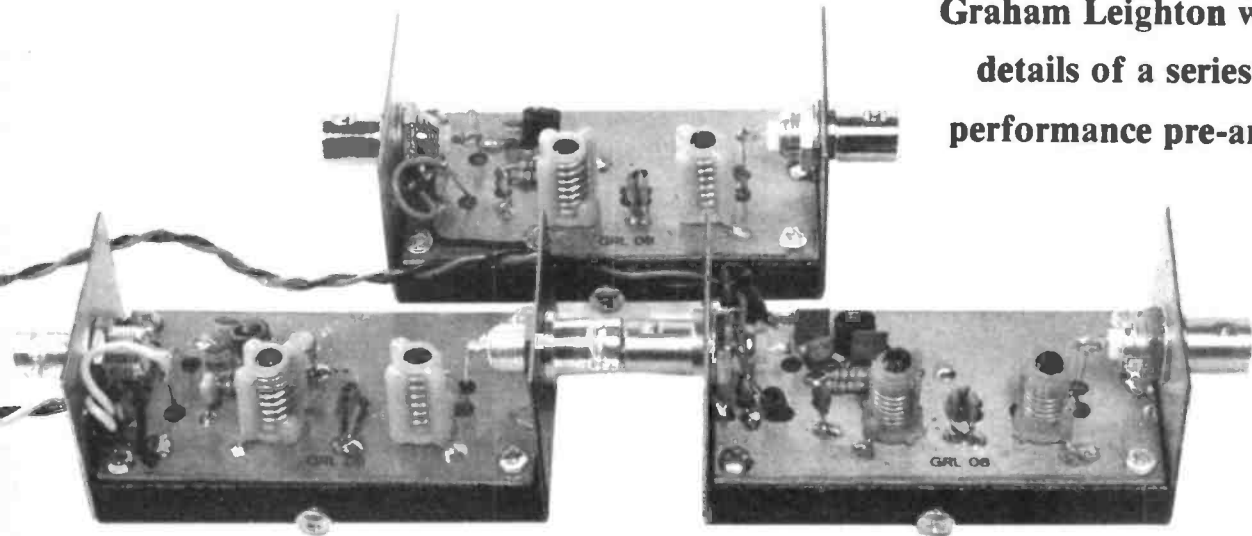

L to R 10m, 6m and 4m Preamplifiers.

THESE PREAMPLIFIERS WERE originally designed for use with the up converter published in last month's R&EW but will also provide additional gain and selectivity in other 4,6 and 10 metre systems.

The design uses a PCB which is common to all three preamplifiers, the only differences being in the area of the input band-pass filters. The loss in these filters is typically 1-1.5dB which does add directly to the noise figure, but the reduction in out of band spurious was thought to be a significant advantage in view of the nature of the bands covered. When used in conjunction with the up converter the increase in sensitivity was from about 1uV to 0.2uV for 12dB sinad(FM). The gain (about 20dB) is all that is needed to overcome the conversion losses in the converter but can cause problems if used with an already sensitive receiver. Making R2 a variable resistor gives about 45dB of gain control. If this control is to be mounted away from the PCB, the leads should be well screened and decoupled.

PARTS LIST

Resistors - all ¼ W 10%

R1, 2 10k
R3 220R

Capacitors

C1, 2, 3 See Table 1.
C4, 5, 6, 7 10n ceramic
C8 100n monolithic ceramic

Inductors

L1, 2 See Table 1

Semiconductor

Q1 3SK45

Miscellaneous

PCB, case, sockets, Fair-Rite 28-43002402 core, 15cm of 0.25mm enam. wire.

WINDING T1

Take a 15cm length of 0.25mm wire. Wind one turn through a Fair-Rite 28-43002402 core. Form the tap by folding back and twisting together about 6mm of wire. Wind a further four turns onto the former.

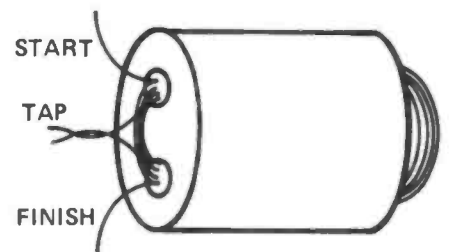

NOTE:
Q1 IS 3SK45
C1,C2,C3,L1 & L2 ARE SELECTED
TO SUIT REQUIRED FREQUENCY RANGE

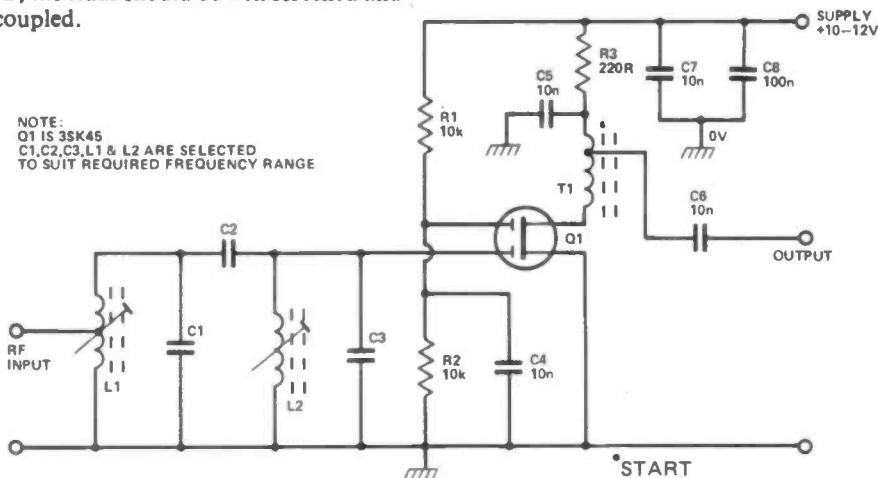

Circuit Diagram

CIRCUIT DESCRIPTION

The input is matched to Q1 by the input filter comprising L1,L2,C1,C2,C3. The responses of the three filters are shown in Fig. 1,2 and 3. The input match is not particularly good as it has been sacrificed in favour of noise and out of band rejection performance. The gain may be altered by varying gate 1 voltage (by reducing the value of R2).

The output is matched to 50R by the monofilar transformer T1. The reactive component is not removed, but in practice the output return loss (VSWR) is adequate (about 8dB).

3SK88 and BF960 FETS were tried in the 6 and 4M versions and gave improved gain and noise figures but it wasn't thought worthwhile to specify these for most purposes.

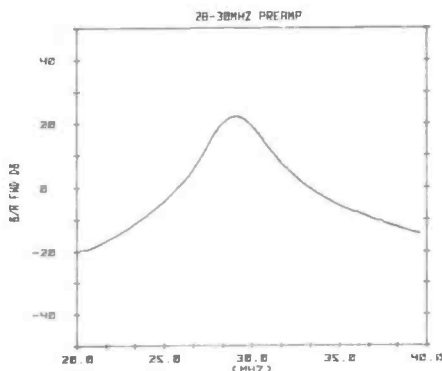

Figure 1

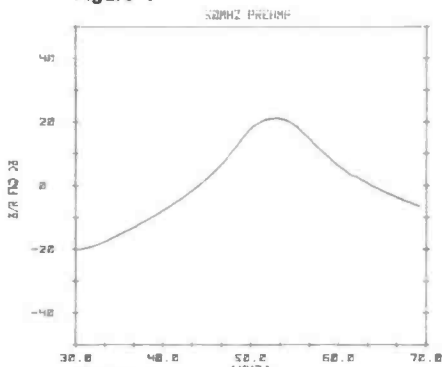

Figure 2

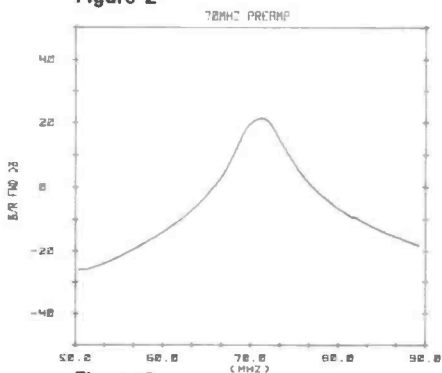

Figure 3

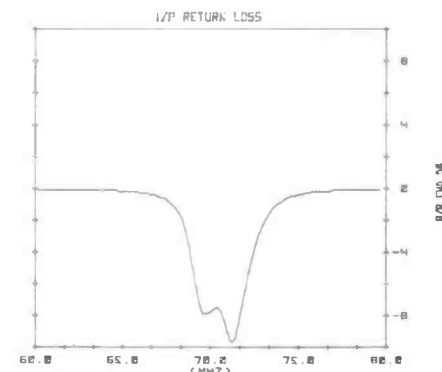

Figure 4

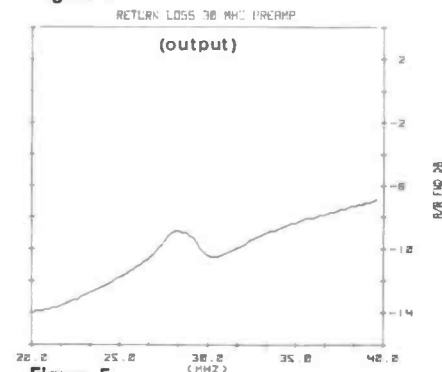
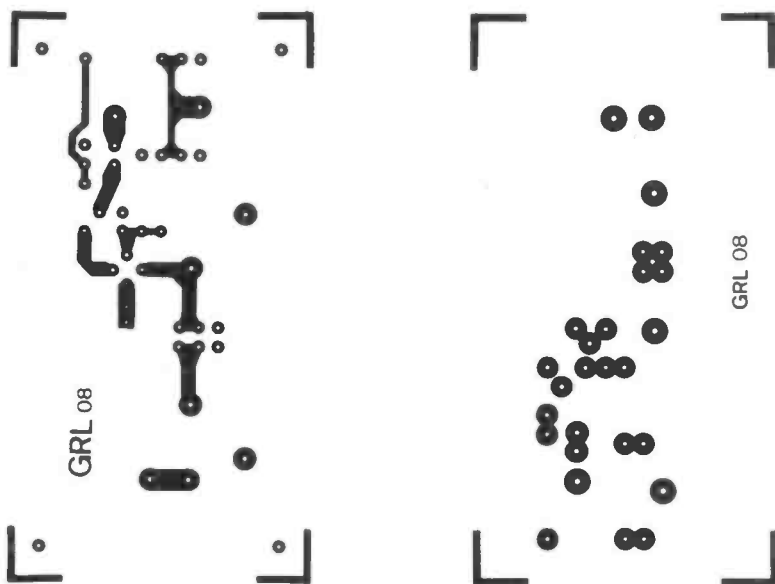
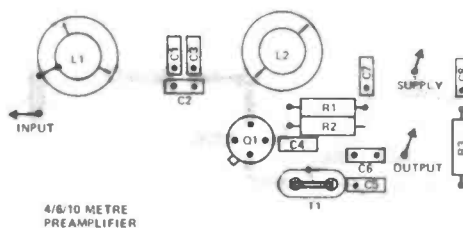

Figure 5



PCB Foil Pattern Track Side

PCB Component Side



Component Overlay

Frequency	L1, L2	C1	C3	C2	L1 Tap Position (from Earth)	Approx. Core Position - relative to top of former
28MHz	6½t	150p	150p	15p	¾t	Level
50MHz	6½t	47p	39p	5p6	¾t	1mm below
70MHz	5½t S18	27p	27p	1p8	¼t	2mm above

TABLE 1

CONSTRUCTION AND TESTING

All the components are assembled onto the PCB. Any that require an earth connection should have this soldered directly to the earth plane. The uncommitted earth pads are for guidance only. Attach the tap to L1 as listed in Table 1.

Set the cores of L1 and L2 to the positions indicated in Table 1. The use of ready made coils means that the tuning should not be too far out. Connect a 10-12V power supply; the current drawn should be about 8-10mA. Find a signal in the middle of the band and connect the preamp to the receiver. Peak the signal by adjusting L1 and L2. Repeat this with signals at the band edges. Recheck over the entire coverage of the preamp.

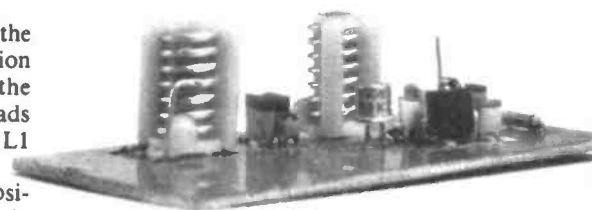

28-30MHz Preamplifier (note the method of attaching the tap)

■ R & EW

Your Reactions..... Circle No.

Excellent - will make one 120

Interesting - might make one 121

Seen Better 122

Comments 123

CRYSTALS MANUFACTURED TO ORDER

Prices shown are for "one off" to our standard amateur specs; closer tolerances are available. Please send us details of your requirements.

A Low frequency fundamentals in HC13/U or HC6/U

Total tolerance ± 100ppm 0° to +70°C	
6 to 9.999kHz HC13/U	£32.80
10 to 19.99kHz HC13/U	£31.00
20 to 29.99kHz HC13/U	£23.08
30 to 59.99kHz HC13/U	£21.73
60 to 79.99kHz HC13/U	£15.69
80 to 99.99kHz HC13/U	£13.08
100 to 159.9kHz HC1366/U	£11.32
160 to 399.9kHz HC6/U	£7.83
400 to 499.9kHz HC6/U	£7.00
500 to 799.9kHz HC6/U	£7.83

B High frequencies fundamentals/overtones

Adj. tol. ± 20ppm, Temp. tol. ± 30ppm - 10°C to +60°C	
800 to 999.9kHz (fund) HC6/U	£11.01
1 to 1.499MHz (fund) HC6/U	£11.25
1.5 to 2.59MHz (fund) HC6/U	£5.36
2.6 to 20.9MHz (fund) HC6/U	£4.87
3.4 to 3.99MHz (fund) HC18 & 25/U	£5.75
4 to 5.99MHz (fund) HC18 & 25/U	£5.36
6 to 21MHz (fund) All Holders	£4.87
21 to 25MHz (fund)	£7.31
25 to 30MHz (fund)	£9.00
18 to 63MHz (3 O/T)	£4.87
60 to 105MHz (5 O/T)	£5.61
105 to 125MHz (5 O/T)	£8.44
125 to 149MHz (7 O/T)	£8.62
149 to 180MHz (9 O/T)	£12.75
180 to 250MHz (9 O/T)	£13.50

Delivery—Mid range 1MHz to 105MHz normally 4/6 weeks.

Other frequencies 6/8 weeks.

Holders—Low Frequencies 6 to 150kHz HC13/U, 150kHz to 3.4MHz HC6/U, 3.4MHz to 105MHz HC6/U, HC18/U or HC25/U, over 105MHz—HC18/U and HC25/U.

HC33/U (Wire ended HC6/U) is available on request as per HC6/U. HC17/U (Replacement for FT243) available as per HC6/U at 35p surcharge on the HC6/U price.

Unless otherwise specified, fundamentals will be supplied to 30pf circuit conditions and overtones to series resonance.

CRYSTALS FOR MICROPROCESSORS

Please let us know your requirements eg 4MHz HC18/U. 1 off £2.00, 100 off £1.10, 1000 off 99p, 2500 off 50p.

ANZAC MD-106 DOUBLE BALANCED MIXER

5 to 500MHz supplied with full details for only £8.95.

COMMERCIAL AND PROFESSIONAL CRYSTALS NEW FASTER SERVICE

We are now supplying crystals to most commercial and MIL specifications in the range 1MHz to 60MHz ordered in small quantities in 21 weeks AT NO EXTRA CHARGE. We also have even faster EXPRESS SERVICES available for that VERY URGENT order.

We can also supply crystals for commercial applications e.g. Microprocessor, TV etc. at very competitive prices. Let us know your needs and we will send you a quote by return, alternatively telephone or telex our Sales Engineer Mr Norcliffe who is normally available in the office for technical enquiries between 4.30 and 6.30p.m.

TWO METRE CRYSTALS

CRYSTAL FREQUENCY USE (TX or and HOLDER)	4MHz-TX-HC6/U	6MHz-TX-HC25/U	8MHz-TX-HC6/U	10MHz-RX-HC6/U	11MHz-RX-HC6/U	12MHz-TX-HC25/U	14MHz-RX-HC25/U	18MHz-TX-HC6/U	4MHz-RX-HC6/U	4MHz-RX-HC25/U	12MHz-RX-HC25/U
144.4 (433.2)	b	c	b	e	e	b	c	c	e	e	e
144.800	b	c	b	e	e	b	c	c	e	e	e
144.825	b	c	b	e	e	b	c	c	e	e	e
144.850	b	c	b	e	e	b	c	c	e	e	e
145.000/ROT	a	c	a	c	c	c	b	b	e	e	c
145.025/R1T	a	c	a	c	c	c	b	b	e	e	c
145.050/R2T	a	c	a	c	c	c	b	b	e	e	c
145.075/R3T	a	c	a	c	c	c	b	b	e	e	c
145.100/R4T	a	c	a	c	c	c	b	b	e	e	c
145.125/R5T	a	c	a	c	c	c	b	b	e	e	c
145.150/R6T	a	c	a	c	c	c	b	b	e	e	c
145.175/R7T	a	c	a	c	c	c	b	b	e	e	c
145.200/R8R	a	c	a	c	c	c	b	b	e	e	c
145.300/S12	e	e	e	e	e	e	e	e	e	e	e
145.350/S14	e	e	e	e	e	e	e	e	e	e	e
145.400/S16	e	e	e	e	e	e	e	e	e	e	e
145.425/S17	e	e	e	e	e	e	e	e	e	e	e
145.450/S18	e	e	e	e	e	e	e	e	e	e	e
145.475/S19	a	a	e	b	b	b	b	a	a	a	a
145.500/S20	a	a	e	b	b	b	b	a	a	a	a
145.525/S21	a	a	e	b	b	b	b	a	a	a	a
145.550/S22	a	a	e	b	b	b	b	a	a	a	a
145.575/S23	a	a	e	b	b	b	b	a	a	a	a
145.600/R0R	a	c	a	c	c	c	b	b	e	e	c
145.625/R1R	a	c	a	c	c	c	b	b	e	e	c
145.650/R2R	e	e	e	e	e	e	e	e	e	e	e
145.675/R3R	e	e	e	e	e	e	e	e	e	e	e
145.700/R4R	e	e	e	e	e	e	e	e	e	e	e
145.725/R5R	e	e	e	e	e	e	e	e	e	e	e
145.750/R6R	e	e	e	e	e	e	e	e	e	e	e
145.775/R7R	e	e	e	e	e	e	e	e	e	e	e
145.800/R8R	a	c	a	c	c	c	b	b	e	e	c
145.950/S38	a	c	a	c	c	c	b	b	e	e	c

PRICES: (a) £2.15, (b) £2.55, (c) £2.80 and (e) £4.87

AVAILABILITY: (a), (b) and (c) stock items normally available by return (we have over 5000 items in stock). (e) 4/6 weeks normally but it is quite possible we could supply from stock. N.B. Frequencies as listed above but in alternative holders and/or non stock loadings are available as per code (e).

ORDERING: When ordering please quote (1) Channel, (2) Crystal frequency, (3) Holder, (4) Circuit conditions (load in pf). If you cannot give these, please give make and model of equipment and channel or output frequency required and we will advise if we have details.

EXPRESS SERVICE

Many types of made to order crystals are available on our "EXPRESS SERVICE"—with delivery of three days on our class "A" service. Telephone for details.

70cm CRYSTALS

Due to the much higher multiplication involved compared with 2 metres all our stock 70cm crystals are to a much higher tolerance than our standard amateur spec. crystals.

We are stocking the following channels:—R80, R82, R84, R86, S88, R810, R811, R813, R814, R815, SU18 and SU20 TX and RX for use with: PYE UHF Westminster (W15U), UHF Cambridge (U10B), Pocketone (PF1) and UHF PF70 Range and Sorno CQL/CQM 662 all at £2.55.

For other channels and/or equipments crystals can be made to order to the same closer tolerances as our stock range at a cost of £5.72 for frequencies up to 63MHz and £6.58 for 63–105MHz or to our standard amateur specifications see "CRYSTALS MANUFACTURED TO ORDER" Prices opposite.

4m CRYSTALS FOR 70.26MHz—HC6U
 TX8-7825MHz and RX6-7466MHz or 29-7800MHz £2.55.

10.2465MHz "ALTERNATIVE" I.F. CRYSTALS—£2.55
 For use in Pye and other equipment with 10.7MHz and 455kHz I.F.s to get rid of the "birdy" just above 145.0MHz. In HC6/U, HC18/U and HC25/U.

CRYSTAL SOCKETS (LOW LOSS)

HC/6U and HC13/U 25p each, HC25/U 20p each plus 20p P&P (P&P free if ordered with crystals).

CONVERTER/TRANSVERTER CRYSTALS—HC18/U
 All at £3.00, 38-6666MHz (144/28), 42MHz (70/28), 58MHz (144/28), 70MHz (144/4), 71MHz (144/2), 96MHz (1.296/432/144), 101MHz (432/28), 101.50MHz (434/28), 105-6666MHz (1.296/28) and 116MHz (144/28).

TEST EQUIPMENT FREQUENCY STANDARD CRYSTALS

200kHz and 455MHz in HC6/U £3.50
 100kHz in HC13/U and MHz in HC6/U £2.95
 5MHz in HC6/U and 10MHz and 10.7MHz in HC6/U and HC25/U £2.80.

AERIALS

MULTI-BAND INVERTED "V" TRAPPED DIPOLE
 80 Thru 10m—Rated @ 2kW—Only 26m long.
 Introductory offer £32.00 + VAT (£36.80 INC VAT) P&P £2.50

THE ARAKI RANGE OF AERIALS

10m whip only 1.3m long with magmount	£18.00	P&P	£3.00
10m whip only 1.3m long with guttermount	£15.20	P&P	£3.00
2m 5/8 λ whip with magmount	£18.00	P&P	£3.00
2m 5/8 λ whip with guttermount	£13.20	P&P	£3.00
2m 1/4 λ whip with magmount	£12.50	P&P	£2.50
2m 1/4 λ whip with guttermount	£9.70	P&P	£2.50
2m/70cm DIBAND whip with magmount	£20.90	P&P	£3.00
2m/70cm DIBAND whip with guttermount	£18.10	P&P	£3.00
2 Base Station Aerials			
2m 5/8 λ Ground plane 3.5db gain	£18.95	P&P	£3.50
2m 5/8 + 5/8 Colinear 6db gain	£25.00	P&P	£3.50
70cm 5/8 + 5/8 Colinear 5db gain	£25.00	P&P	£3.50

The Araki Range are handmade of top quality anti-corrosion treated aluminium or stainless steel.

TERMS: CASH WITH ORDER—MAIL ORDER ONLY.
 PRICES INCLUDE P&P (BRITISH ISLES) EXCEPT WHERE STATED OVERSEAS CHARGED AT COST.

PLEASE ENCLOSE S.A.E. WITH ALL ENQUIRIES

155 for further details

AUGUST '82 EVENTS: MOBILE RALLYS

AUGUST						
M	T	W	T	F	S	S
2	3	4	5	6	7	8
9	10	11	12	13	14	15
16	17	18	19	20	21	22
23	24	25	26	27	28	29

August 1	RSGB National Mobile Rally	Woburn	RSGB
August 8	25th Annual Derby Mobile Rally	Lower Bemrose School	Mike Darn, 22 Reservoir Road, Brockwell, Chesterfield, S40 4HF
August 15	Preston ARS 14th Annual Mobile Rally	Walton-le-Dale County High School	Mrs D Stevens, 13 Arrowsmith Close, Houghton, Preston PR5 0DV
August 29	BARTG Rally	Sandown Racecourse nr. London	Edward Batts, G8LWY, 27 Cranmer Court, Richmond Rd., Kingston-upon-Thames, Surrey
August 29	Torbay Mobile Rally	ITT Social Centre, Old Brixham Road, Paignton	Details from G4DZD or G2CWR. Tel: 0803 523063

NB: Would Rally organisers please send details of forthcoming events to the Editor — and please also include a list of exhibitors.

BAND 2 TUNERHEADS (Varicap Tuning) EF5804

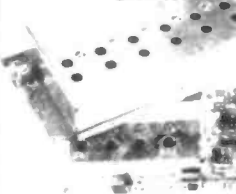

2 MOSFET of stages MOSFET mixer, JFET IF preamp, with internally amplified PIN diode AGC. Tuning voltage for 88-108MHz is 2-8V. Buffered LO output. AGC input 145 x 70 x 24mm.
Stock No. 1-24 25+
40-05804 Bkt 24.95 19.65

7255 The latest complete FM tunerhead from RF input to stereo output. MOSFET RF stages, HA11225 IF and KB4437 stereo decoder. 7255 special offer price: **£30.00 plus VAT**

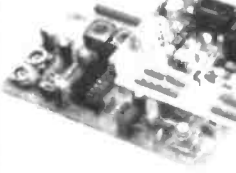

911225A The 911225A is the 7230 'edited' and shrunk into a screened metal case, 97 x 56 x 24mm. The unit is ideally suited to use with synthesised tuner systems.
Stock No. 1-24 25+
40-91225 Buit 20.82 16.25

944378 'Hyperfl' series decoder module with the TOKO KB4437 pilot cancel PLL IC birdy filter and the KB4438 muting stereo audio preamp with 26/38kHz pilot tone filtering.
Stock No. 1-24 25+
40-04378 Buit 19.95 18.05



DFCM500 Wide range digital frequency/capacitance meter. Frequency ranges; 0-1MHz, 1-50MHz and 80-500MHz. 8 digit LED display, mains or Ni-Cad battery operation.
Stock No. 1-24 25+
40-01500 Kit 95.95 86.50

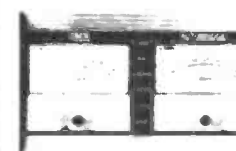

AUTOBRIDGE
An Automatic power tracking VSWR and self-ranging power meter. Complete Kit: All PCBs, board mounted components, meters, case (undrilled), transformer etc.
Stock No: 40-40400 **£52.86 + £1.50 P&P**

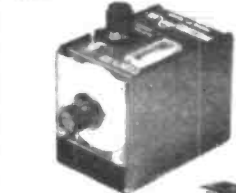

FET DIP OSCILLATOR
An essential piece of test equipment for the RF constructor. GDO or WM function covering 1.6-215MHz in five ranges. Audio and meter indication. Kit includes; fibre glass PCB, all components, all hardware, punch, painted and screen printed case, wire etc. for coils and printed scale.
Stock No: 1-24 25+
40-16215 Kit 17.90 16.20



10.MHz SSB GENERATOR
PCB. All components, eight-pole crystal filter.
Stock No. Price
40-10700 **£29.65**

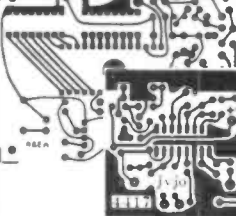

R&W PROJECT AND DATABRIEF PCBs
High quality glass fibre printed circuit boards for projects and Databriefs published in Radio & Electronics World.
27MHz Deviation Meter PA105 **£1.98**
TV Pattern Generator MC145151 **£3.39**
2m Pre-amp KB4417 (Undrilled) **£0.97**
0-30V PSU **£0.60**
2m PA Mk II ULN3859 (Undrilled) **£0.84**
SSB Exciter HA12017 **£2.16**
Up Converter **£4.75**



2m PRE-AMP
Very compact low-noise MOSFET 2m pre-amp. Gain 22dB. Noise figure; less than 1.5dB. I/p and o/p impedance; 50 ohm size; 34 x 9 x 15mm. From April '82 R&W.
Stock No. 1-24 25+
40-14400 Kit 2.55 2.30



70cm PRE-AMP
Compact low-noise pre-amp. Gain at 433MHz; 13dB. I/P and O/P impedance 50ohms. Size 50 x 10 x 17mm. From March '82 R&W.
Stock No. 1-24 25+
40-07000 Kit 3.90 3.60



2m POWER AMP
20 watt 144MHz linear power amplifier. 10dB gain, 2W input - 20W output. Automatic switched relay. Bypasses power amp in receiver mode. Developed from original class C version in Dec 81 R&W. High power output relay. Pre-drilled heatsink, optional RX pre-amp. Kit only.
Stock No. 1-24 25+
40-14421 Less Preamp 28.50 25.65
40-14422 With Preamp 30.40 27.36

AND THERE'S PLENTY MORE IN THE CATALOGUE 70p inc.

CMOS-TTL :

4001	0.11	4515	1.25	74LS10	0.12	74LS138	0.30
4007	0.13	4516	0.60	74LS11	0.12	74LS139	0.30
4009UB	0.25	4518	0.35	74LS12	0.12	74LS145	1.20
4010	0.30	4820	0.60	74LS13	0.20	74LS151	0.30
4011	0.11	4521	1.30	74LS14	0.30	74LS153	0.37
4012	0.14	4522	0.89	74LS20	0.12	74LS154	0.99
4013	0.25	4526	0.60	74LS21	0.12	74LS155	0.38
4017	0.22	4527	0.80	74LS22	0.12	74LS156	0.37
4018	0.40	4528	0.65	74LS28	0.14	74LS167	0.30
4019	0.38	4529	0.70	74LS27	0.12	74LS168	0.30
4020	0.55	4531	0.85	74LS28	0.15	74LS180	0.37
4021	0.55	4532	0.80	74LS30	0.12	74LS161	0.37
4022	0.55	4534	4.00	74LS32	0.12	74LS162	0.37
4023	0.15	4536	2.50	74LS33	0.15	74LS163	0.37
4024	0.33	4538	0.95	74LS38	0.12	74LS164	0.40
4025	0.15	4539	0.80	74LS40	0.13	74LS165	0.60
4027	0.28	4843	0.80	74LS42	0.30	74LS168	0.70
4030	0.35	4549	3.50	74LS47	0.35	74LS169	0.85
4043	0.50	4553	2.70	74LS48	0.45	74LS170	0.90
4044	0.60	4554	1.20	74LS49	0.55	74LS171	0.90
4046	0.60	4555	0.35	74LS51	0.13	74LS174	0.40
4049UB	0.24	4556	0.40	74LS54	0.14	74LS175	0.40
4050	0.24	4557	2.30	74LS55	0.14	74LS181	1.05
4051	0.55	4558	0.80	74LS73	0.21	74LS190	0.80
4050	0.75	4559	3.50	74LS74	0.16	74LS191	0.50
4066	0.30	4560	2.50	74LS75	0.22	74LS192	0.46
4068	0.18	4561	1.00	74LS76	0.20	74LS193	0.42
4069UB	0.14	4562	2.50	74LS78	0.19	74LS194	0.35
4071	0.18	4566	1.20	74LS83	0.40	74LS195	0.38
4072	0.16	4569	1.70	74LS85	0.60	74LS196	0.50
4073	0.18	4581	0.18	74LS86	0.14	74LS221	0.50
4075	0.16	4572UB	0.22	74LS92	0.31	74LS241	0.80
4078	0.95	4580	3.25	74LS93	0.31	74LS242	0.70
4077	0.18	4581	1.40	74LS95	0.40	74LS243	0.70
4078	0.18	4582	0.70	74LS96	1.20	74LS244	0.60
4081	0.12	4583	0.80	74LS107	0.25	74LS245	0.80
4083	0.30	4584	0.27	74LS109	0.20	74LS257	0.40
4175	0.80	4585	0.45	74LS112	0.20	74LS258	0.37
4502	0.60	40174	1.05	74LS113	0.20	74LS260	0.70
4503	0.50	40195	1.08	74LS114	0.19	74LS266	0.22
4506	0.70	74LS00	0.10	74LS122	0.35	74LS273	0.70
4507	0.37	74LS01	0.10	74LS124	1.80	74LS279	0.35
4508	0.75	74LS02	1.20	74LS125	2.35	74LS280	0.32
4810	0.95	74LS03	0.11	74LS125	0.24	74LS366	0.34
4511	0.45	74LS04	0.12	74LS126	0.24	74LS367	0.32
4512	0.55	74LS05	0.13	74LS132	0.42	74LS368	0.35
4514	1.25	74LS08	0.12	74LS133	0.24	74LS373	0.70

REMEMBER - THE LOWEST PRICED NICADS : AA 80p; C £2.35; Sub D £2.15; D £3.05; PP3 £3.70

Memory Micros Linears:

LM10CN	3.88	SL1611	1.60	KB4433	1.52	U265	3.16
L149	1.86	SL1612	1.60	KB4413	1.95	U266	2.43
U2378	1.28	SL1613	2.06	KB4436	2.63	LC7137	7.50
U2478	1.28	SL1620	2.17	KB4437	1.75	ICM72168	19.50
U2578	1.28	SL1821	2.17	KB4445	1.29	ICM7218C	19.95
U2678	1.28	SL1822	2.40	KB4446	2.75	ICM7217A	9.50
LM324	0.45	SL1625	2.17	NE5044	2.26	SP8647	8.00
LM339N	0.68	SL1630	1.62	MC5229	9.60	95H90	7.80
LF347	1.60	SL1640	1.89	SL6270	2.03	HD10551	2.46
LM348	0.90	SL1641	1.89	SL6310	2.03	HA12009	8.00
LF351	0.49	TDA2002	1.25	SL6440	3.38	HD44015	4.45
LF353	0.78	ULN242	3.05	SL6600	3.75	HD44752	8.00
LM390N	1.00	LM3909	1.48	SA5610	1.48	MC145181P	6.00
ZN419CE	1.98	CA3089	1.84	SL6640	2.75	Z80A	3.75
LM227E/B	6.28	CA3130E	0.80	SL6690	3.20	Z80A P10	3.50
NE544	1.80	CA3130T	0.90	SL6700	2.35	Z80A CTC	4.00
NE555N	0.20	CA3140E	0.46	SA56710	1.48	Z80A DMA	9.98
SL560C	1.98	CA3189E	2.20	LS7225	3.65	Z80A DART	7.50
NE564	4.29	CA3240E	1.27	ICM7555	0.94	Z80A S10/1	11.00
NE567	1.30	MC3357	2.88	ICL8038CC	4.50	Z80A S10/2	65.00
UA741CN	0.20	ULN3859	2.95	TK10170	1.87	Z80A S10/9	9.95
TBA820M	0.78	LM3900	0.60	TK10321	2.75	Z8001	65.00
ZNA1034	2.10	LM3909N	0.68	HA11223	2.15	8255	2.58
LM1035	4.50	LM3914N	2.80	HA11225	1.45	6800P	2.50
TOA1062	1.95	KB4412	1.95	HA12002	1.22	6809	8.75
TOA1083	1.95	KB4417	1.80	HA12402	1.95	6802	3.50
TOA1090	3.05	KB4208	1.08	HA12411	1.20	88A00P	4.25
HA1197	1.00	KB4423	2.30	HA12412	1.55	88B00P	4.55
MC1350	1.20	KB4424	1.65	LF13741	0.33	2114-4.2	1.49
HA1370	1.90	KB4430	2.30	MM50375	3.85	4116-2	1.59
HA1388	2.75	KB4431	1.95	MM53200	3.90	2732	4.00
SL1610	1.60	KB4432	1.95	U264	2.27	2716	3.00

Coils, Filters: Toko, Murata, NTK, Cathodeon.

SFE6.0MA	0.80	CDA10.7MA	0.70	10M15D	14.50
CFSE10.7	0.80	SFE27MA	0.94	LF8A	1.95
SFE10.7MA	0.45	SAF10.7MC-Z	3.75	LF86/CFU455H	1.95
CFSB10.7	0.50	MF45510AZ12118.55	11.95	LF88	1.95
SFE10.7MJ	0.50	MFL45501L	1.95	LF810	1.95
SFA10.7MF	0.75	10M15A	1.95	LF12/CFU455F	1.95
SFE10.7MFL	0.70	21M15A	3.45	LFH6S/	
SFE10.7MX	0.95	45M15A	5.95	CFW455HT	2.45
CFSH10.7M1	0.50	75M25A	6.90	LFH8S	2.45
CFSH10.7M2	0.50	10M22D	17.20	LFH12S/	
CFSH10.7M3	0.50	10M8D	15.50	CFW455FT	2.45

TOKO FIXED VALUE CHOKES (E12 Values)

7BA - 1 to 1000uH	16p	10RB - 1 to 120mH	33p
8RB - 1 to 33mH	19p	10RB - .15 to 1.5H	43p

RETAIL SHOP OPENING HOURS

Monday to Thursday 8.30-6.30
Friday 8.30-8.30 Saturday 9.00-5.30

ALL PRICES SHOWN EXCLUDE VAT. P&P 50p per order.

TELEPHONE (STD 0277) 230909 TELEX 995194 AMBIT G POSTCODE CM14 4SG
200 North Service Road, Brentwood, Essex



Peter Luke looks at the latest recorders from Hitachi and at TV separates. He also has a timely appeal for recorder manufacturers

THERE CAN BE no doubt that the most healthy of consumer markets at the moment is that for Video Recorders. The number of models becoming available seems to be following an almost exponential growth curve, with the price/performance ratio of each new offering showing an improvement over its forerunners.

The inevitable lull in demand that will fall between the 'buy a video recorder to record your favourite sporting event' campaigns that appeared during this summer of sporting overkill, and the 'buy a video recorder to record your favourite film' during the end of year festive season, will mean that it won't only be the leaves that are falling this Autumn. Healthy price cuts across the range should mean that there will be plenty of video bargains over the next few months.

The 'low end' of the VHS range is the area that will probably see the most dramatic reductions. The budget VHS machines are still considerably higher in price than their Betamax counterparts, but a determined sales drive could see these fall to the sub £400 level of the Sony Standard.

HELLO HITACHI

Two new models from Hitachi, the VT 9300 - to replace the VT 8300 - and the VT 9500, give Hitachi a broad product range with which to enter the Winter sales battle.

The VT 9300 at £459 is the lowest priced machine in the range yet offers an impressive array of features.

The mechanical tape counter of earlier machines has been replaced by an electronic counter. This shares the same display as the clock, switching between tape counter and time display being accomplished by a front panel switch. The speed at which the visual search facility whisks the tape before you, has been increased to nine times normal speed while the operation of the one event,

ten day timer has been made particularly simple by the use of just three buttons, 'start', 'length' and 'day'.

Auto rewind, a test pattern generator, video and audio input/output sockets and a wired remote control facility are also featured on the 9300 and make it a very attractive machine for its low price.

The VT 9500 slots into the middle of the Hitachi range at £565 (the 8700 at around £700 is top of the tree) and is worthy of note as it is one of the few machines to feature Dolby noise reduction at a price below £650.

All the features of the 9300 are incorporated although the timer is now of a ten day three event specification and the remote control gives you distant encounters of the infra red kind.

A host of trick functions, still frame, frame advance, audio dub etc. are also included.

The inclusion of Dolby should go a long way to improving the noise performance of the audio side of the recorder and we'll return to a full report on the machine as soon as we can secure a review sample.

PICMY PORTABLE

When considering the purchase of a video recorder the first decision to make is whether or not to opt for a portable system. The initial outlay for a 'go as you please' video system is higher than an equivalent performance mains model but the flexibility of portable machines and the option to complete a 'home movie' system with the purchase of a camera at a later date, will sway the cheque book in their favour for a good number of people.

We review a VHS portable elsewhere in this issue but to keep the Beta flag flying take a quick look at the F1 from Sony here.

The F1 is billed as the UK's smallest video machine and its size, not much larger than this page of R&EW, does indeed belie its specification.

In conjunction with the TT-F1 tuner the recorder offers all the features expected of a top of the range mains recorder while its use with the HVC4000 colour camera provides a light weight portable system. It's here that the small size and weight of the recorder come into their own.

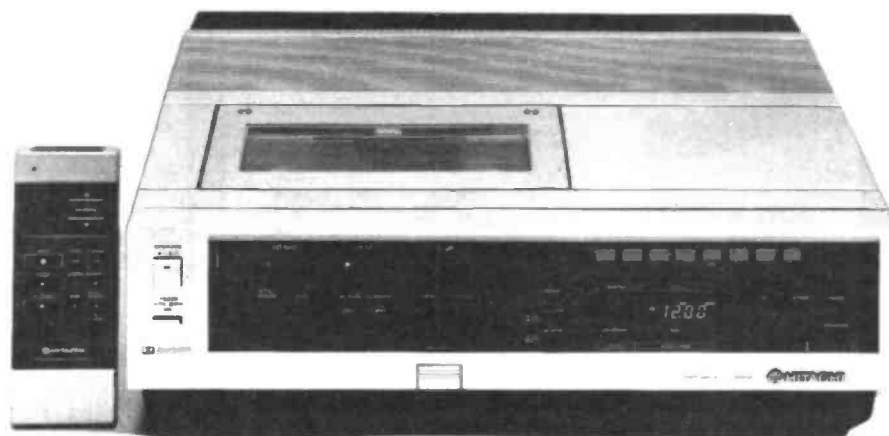

The camera can also be used with a new Sony innovation, their nega-posi adapter. This enables any photographic negative or transparency to be shown on the TV screen, and naturally recorded. Who's for a 'video album'?

Also part of the F1 range of add-ons is the PCM F1. This turns the video recorder into a digital audio recorder - the first on the UK market.

If those awfully nice Sony people can be persuaded to part with the F1, TT-F1, PCM-F1 et al we'll return to them for an 'in depth' look in true R&EW style.

SONY SEPARATES

The radiograms and music centres of the fifties and sixties made way for Hi-Fi separates as the consumer demanded more in the way of flexibility and quality, and many see the traditional TV set evolving in the same way over the next few years.

Sony - yes them again - have launched the PROFEEL component TV system to be the first major manufacturer with the hardware available to meet the demand of this projected market.

The system is built around a 20" monitor - a far more sensibly sized 27" model will be available by 1983.

The monitor is based, naturally enough, on a Trinitron tube and is capable of handling PAL, SECAM and NTSC encoded colour signals, as well as providing an RGB input for high definition applications. The monitor also provides a stereo amplifier with tone controls to drive the SS-X1A speakers that are another item in the Profeel range.

The tuner features 12 program channels and uses an automatic digital tuning system. A variety of switching and control functions make sure that the unit is flexible enough to cope with developments in TV over the next few years.

An add-on Teletext/Prestel adapter will soon be made available for the system.

TIME FOR A CHANGE

As recorders at the budget end of the price scale sink below the £400 barrier in ever increasing numbers, buying a recorder becomes a very real proposition for an ever growing number of people.



When buying such a machine the consumer must be prepared to do without some of the more advanced features of the expensive models. Still frame, variable speed playback and audio dub are all very nice but life can go on without them. Indeed many people with recorders that offer these facilities will rarely use them.

An (optional) wired remote control is not quite as nice as an IR unit included as standard, but then the exercise would do most of us a bit of good anyway.

In short all the above are luxuries which will hardly be missed and nobody would expect to find in a basic machine. They also have one thing in common - they cost the manufacturer money to include as part of the machine.

You may have noticed that no mention has been made of a recorder's timer. Look at a budget priced machine and it's odds on that the timer will be a one event type, to get a multi event timer you'll have to add at least £100 to the cost of a low priced model.

Strange this as a timer capable of handling more than one program over the 7/14 day capability of a recorder is almost a must. Strange also that the provision of this extra capability would cost the manufacturer nothing. Indeed it would be no surprise if, in the area of the timer circuitry, the only difference between some manufacturer's budget and 'all singing'

recorders was whether or not a particular pin on the dedicated MPU responsible for timer operation was tied to earth or not.

The decision to restrict low cost recorder to these one event timers seems a particularly mean marketing decision. All it would take would be for one of the Sonys or Hitachis of the world to produce a machine with a £400 price tag with a multi event ten day timer and the budget end of the market would be theirs - until of course the rest followed, for in a world of sheep, all it takes is for one to lead the way.

Portable video and 'separate' TV systems combined with existing audio installations and perhaps a microcomputer all go to make for an audio/video - entertainment/educational/business complex that should turn that corner of the living room that used to be occupied by a boring old TV into an extremely 'busy' and exciting area over the next few years.

■ R & EW

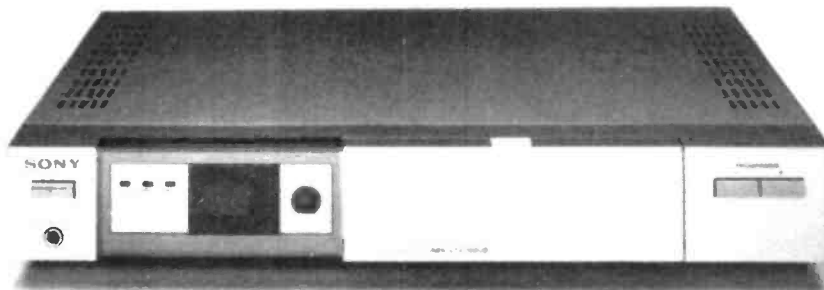

Your Reactions.....	Circle No.
Immediately Interesting	60
Possible application	61
Not interested in this topic	62
Bad feature/space waster	63

SWITCHED CAPACITOR FILTERS

Throw out your active filter cookbooks for the 'in' word in filter design today is digital. Michael Graham explains the operation of these digital filters.

THE 'BUZZ' WORD IN FILTERS over the past few years has been 'active', with designs for low pass, high pass and band pass filters based on an op amp or two plus a few Rs and Cs making repeated appearances in various publications. The 'In' filter at the moment though is the digital filter and digital rather than analogue designs are likely to become the standard filter building block in many applications.

The major advantage of a digital filter is that its centre frequency is determined, not by external resistors and capacitors, but by the frequency of a clock signal applied to it. Thus, while one or two active filter blocks are relatively simple and cheap to implement, the design of a third octave spectrum analyser to cover the audio frequency range would require over 30 separate filters and a host of precision capacitors and resistors. A digital design to accomplish the same task, would require only one digital filter with its clock frequency being swept over a suitable range. The age of the three chip spectrum analyser is upon us.

IN THE BEGINNING

Digital filters are not new, the first designs dating back to the late 60's—these designs in turn being a 'digitization' of a mechanical commutating filter.

A commutating filter consists of a series of low pass filters (Fig 1) that are cascaded and sequentially switched, Fig 2 shows a 'mechanical' representation of such a filter.

The low pass filter of Fig 1 may be considered as an integrator with a time constant $\tau = RC$. Its 3dB low-pass response is given by $f_{\text{low-pass}} = 1/(2\pi RC)$.

If such sections are cascaded, and sequentially switched at a rate of f_c times per second, the time constant will increase by a factor of n and the new, low-pass 3dB point will be given by

$$f_{\text{low-pass}} = 1/(2\pi n RC)$$

If however a signal at the commutating frequency is applied to the filter, each capacitor will see continually 'see' the same, fixed voltage, each time it is switched into the circuit. Thus each capacitor will charge to a particular voltage and as each is switched into circuit the input signal will be reproduced at the filter's output as a series of discrete steps. This process is independent of the phase of the

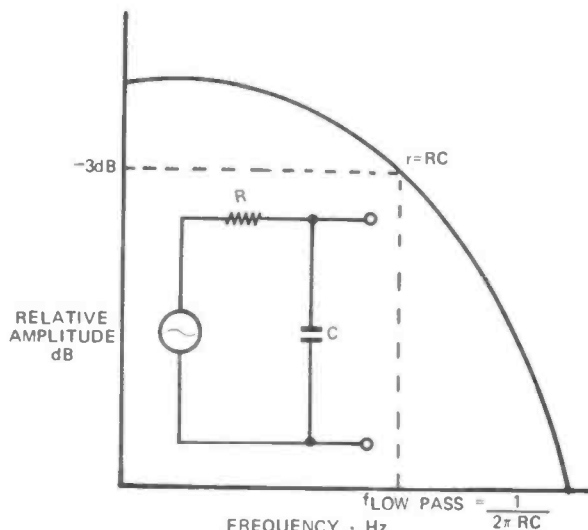

Figure 1: A basic low pass filter.

input frequency with respect to the commutating frequency f_c , although the particular voltages that any capacitor charges to will depend on the phase of the signal.

The commutating filter will therefore pass any input signal at its commutating frequency and its harmonics. The commutating frequency can thus be thought of as the filter's resonant frequency.

The overall response of the filter is shown in Fig 3 and, for obvious reasons, is known as a comb response. A low pass filter can be used to attenuate the signals passed at harmonics of the commutating frequency to yield a high performance low-pass filter.

ENTER THE IC

Mechanical switching of filters is, of course, not a practical proposition, the commutating being far more easily achieved with the use of ICs. Fig 4 shows an eight section filter in which the mechanical action of the switch in Fig 2 has been taken over by a CMOS IC.

A clock signal is applied to a ripple counter which produces a 3 bit BCD output which is fed to a 4051 BCD to decimal converter. Thus the input clock signal causes each of the first eight outputs of the 4051 to switch on in turn, and to switch the capacitor associated with each output into the circuit.

As before, the filter's resonant frequency is a function of the clock signal and of the number of poles (capacitors) in the filter.

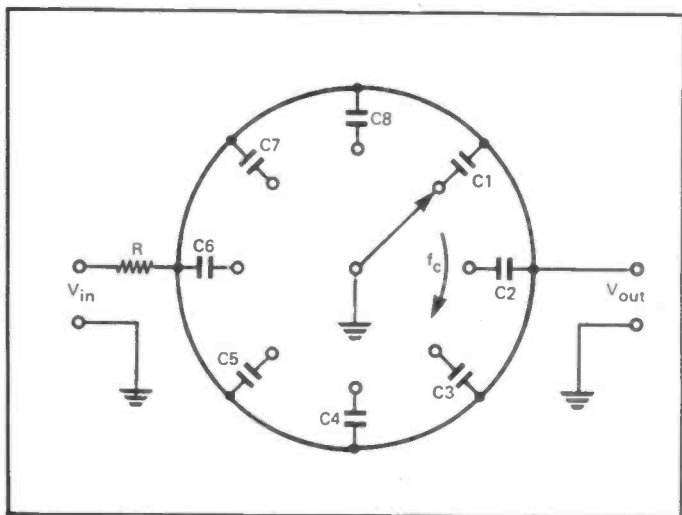

Figure 2: A 'mechanical' commutating filter.

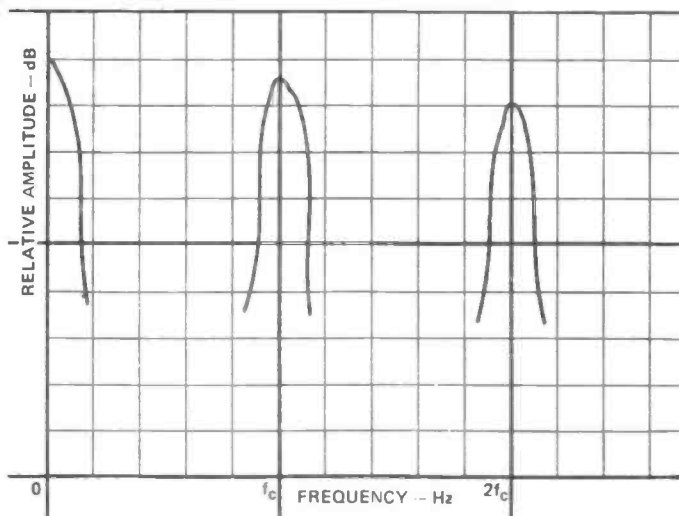

Figure 3: A commutating filter passes signals at the commutating frequency and its harmonics.

The circuit of Fig 4 has eight poles and its primary low pass frequency will be.

$$f_{\text{low pass}} = \text{clock frequency}/8$$

The bandwidth of the filter will be 2 divided by the number of poles.

If the resistor shown in Fig 4 has a value of 10k and the capacitors 10n the filter will provide a filter tunable over the range 10kHz to 1MHz with a Q of 80.

Additional decoders can be added to the Fig 4 circuit to provide filters with more sections. The more sections that a filter passes the smoother its output becomes and the bandwidth is reduced.

The capacitors used in the filter should have a tolerance of less than 10% and the only point to watch when driving the filter is that the input signal level does not exceed the positive supply voltage of the CMOS ICs.

As mentioned above, for a true low pass performance, the output of the commutating filter must be additionally low-pass filtered in order that only the 'prime' resonant frequency is passed and not its harmonics.

SWITCHING CAPACITORS

Operation of the commutating filter depends upon switching capacitors in and out of circuit. There is however another form of digital filter, referred to as a switched- capacitor filter, that operates in a fundamentally different way. Confused? You won't be-just read on.

The switched capacitors of a switched capacitor filter replace the resistor of an RC filter. It may seem rather odd to replace a resistor by a switched capacitor but the reasoning behind it can be understood by reference to Figs 5 & 6.

In Fig 5, with the switch in position A the capacitor C will charge to a voltage V1, discharging to voltage V2 as the switch is moved to position B (assuming V2<V1). The amount of charge flowing into V2 will therefore be C (V1-V2).

If the switch is operated at a frequency fs the average current flow from V1 to V2 will be equal to C (V1-V2) fs a deft application of OHM'S law shows that, since R=V/I, a resistor would give the same average current flow if its value were made equal to 1/Cfs.

With the mechanical switch replaced by a couple of FETs as in Fig 6, it would seem that any resistor in an RC filter could be replaced by a switched-capacitor. Life is rarely that simple, however, and the internal cross-coupling and various parasitic capacitances of ICs mean that this simple solution is not a practical proposition. These problems can be overcome however and the switched-capacitor/resistor substitution made in one of the most common forms of low-pass filter-the integrator.

Figure 7 shows such a low pass filter with the familiar input resistor replaced by a switched-capacitor combination.

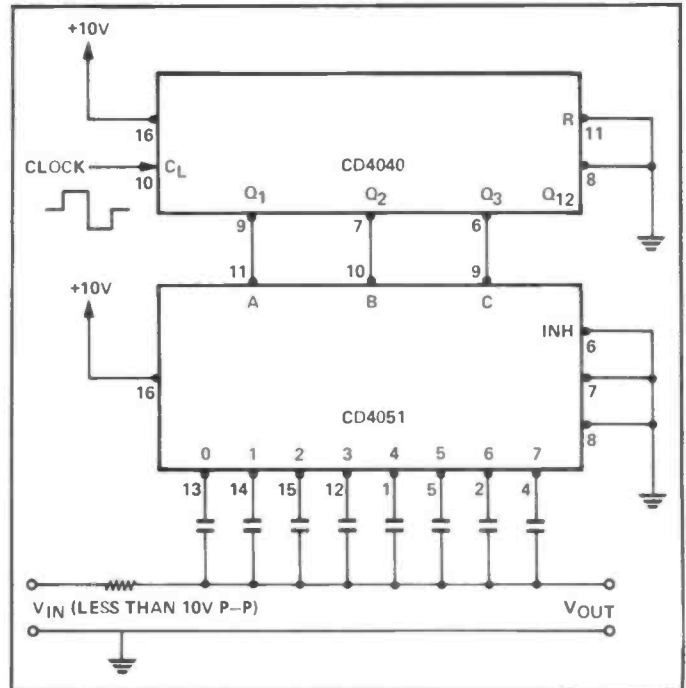

Figure 4: 8 pole low pass commutating filter

The operation of the standard integrating low-pass filter is fairly straightforward. A low frequency signal will 'see' the capacitor as a fairly high impedance and standard op-amp theory will show that in this case the gain will be high. As the frequency of the signal increases however, so the reactance of the capacitor increases and the effect of this negative feedback reduces the gain of the op-amp at higher frequencies. Thus the action is that of a low-pass filter whose 3dB point is determined by the particular value of capacitor and resistor (or switched- capacitor) chosen.

The advantage of using a switched capacitor instead of a resistor in the circuit of Fig 7 is that the filters cut-off point can be varied by changing the frequency at which the capacitor is switched.

The circuit of Fig 8 overcomes some of the parasitic capacitance problems referred to above and can also be used to simulate a passive L-C circuit.

Circuit action is as follows:- A clock signal φ is applied to Q1 and Q3 and an inverted clock signal (φ) fed to Q2 and Q4. During the first half cycle of the clock, Q1 and Q3 will therefore be on and the capacitor will charge to the voltage Vin. If Vin is positive, the capacitor will charge up such that point b will be positive with respect to a. During the second half cycle, Q1 and Q3 will be off,

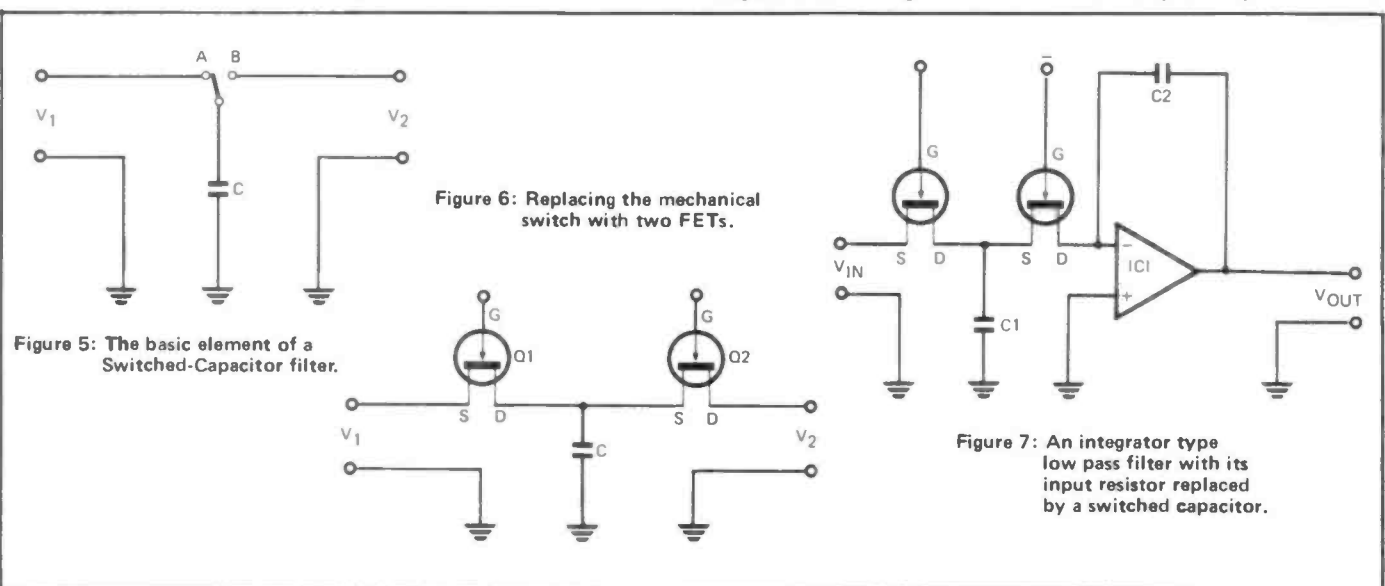

SWITCHED CAPACITOR FILTERS

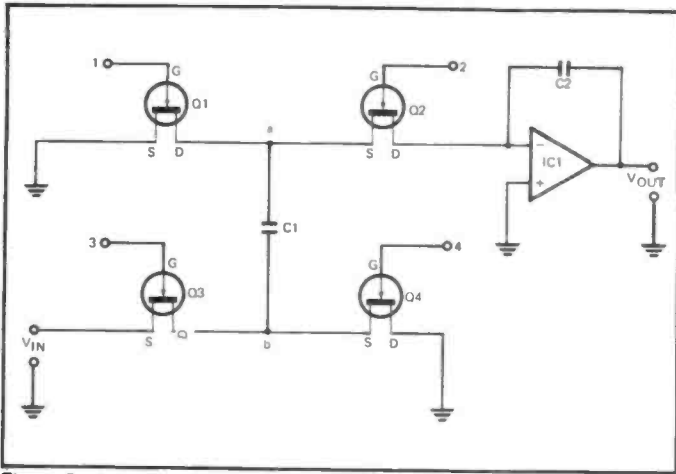

Figure 8: A switching arrangement that overcomes problems due to parasitic capacitances.

while Q2 and Q4 are turned on. As point a is negative with respect to b the effect will be that of a non-inverting integrator. The output will have the 90° phase lag of an ideal integrator plus a few degrees caused by internal delays.

If the phase of the clock signal applied to the various transistors is now altered such that the ϕ clock signal is applied to Q2 and Q3 and the $\bar{\phi}$ signal to the other two devices we have the following situation.

During the first half cycle Q1 and Q4 will be on and the capacitor will be grounded. During the second half cycle, Q2 and Q3 will be on and the discharged capacitor will act as a short circuit applying V_{in} to the op-amp. The circuit now behaves as an inverting integrator with a phase lag somewhat less than 90°.

By combing such circuits in a series fashion with alternating clock drive configurations it is possible to eliminate the effects of phase angle errors. By using such circuits it is possible to simulate a wide variety of filters that have their centre frequency adjustable via an external clock signal.

PRACTICAL POINTS

A typical switched capacitor filter IC is the MF10 from National Semiconductor this is in fact a dual device offering two filters which may be configured as lowpass, highpass, allpass, bandpass or notch filters. Each section, together with the clock, requires only three or four resistors to provide the various 2nd order functions.

Figures 9 and 10 show the pin out and block diagram of the device while Fig 11 shows a notch filter tunable up to a frequency of 10kHz when fed with an input of 1MHz maximum. The device features a clock control pin that can provide either 50:1 or 100:1 clock to centre frequency ratios. This pin may also be tied low to inhibit the filter's action add a VCO and a couple of op-amps and you have that four chip spectrum analyser.

As you can see, digital filters are bound to make an impact on low frequency filter designs over the next year or so and we'll be returning to this subject in future issues of R&EW.

■ R & EW

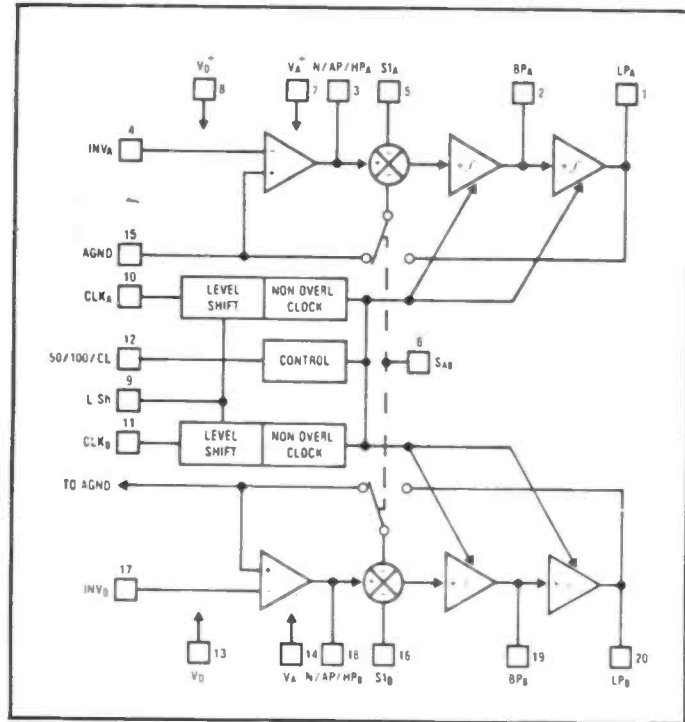

Figure 9: Block Diagram of National's MF10 switched capacitor filter.

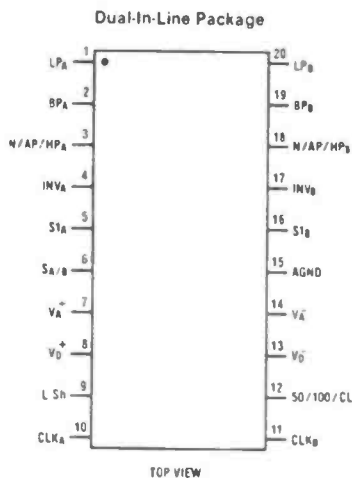

Figure 10: The MF10's Pin-out.

Your Reactions		Circle No.	Circle No.
Immediately Interesting	52	Not Interested in this Topic	54
Possible Application	53	Bad Feature/Space Waster	55

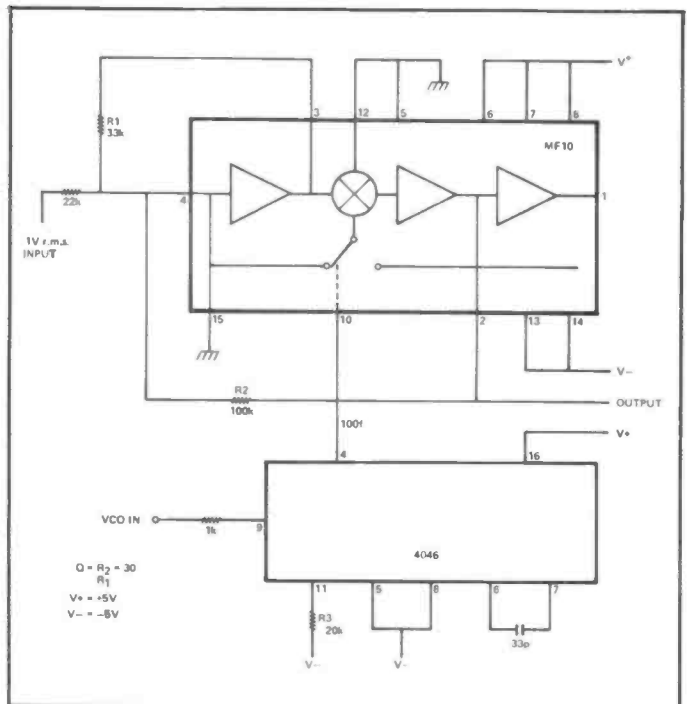
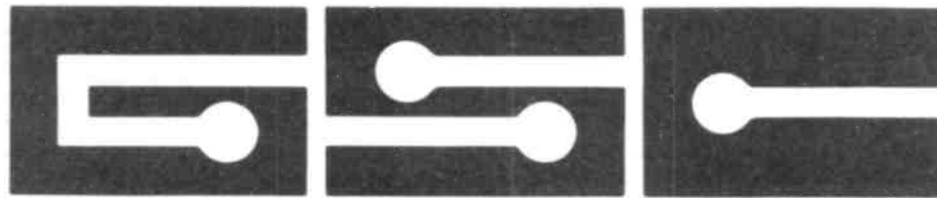

Figure 11: The heart of a minimum chip spectrum analyser based on a switched capacitor filter.



**for bread-boarding and test
equipment**

Tomorrows tools for todays problems

GLOBAL SPECIALTIES CORPORATION



G.S.C. (UK) Limited, Dept. 35BB
Unit 1, Shire Hill Industrial Estate,
Saffron Walden, Essex CB11 3AQ.
Telephone: Saffron Walden (0799) 21682
Telex: 817477

GLOBAL SPECIALTIES CORPORATION (UK) LTD Dept 35BB
Unit 1, Shire Hill Industrial Estate, Saffron Walden, Essex.

Name _____

Position _____

Address _____

FREE Catalogue
tick box

232 for further details

MINI DRILL CONTROLLER

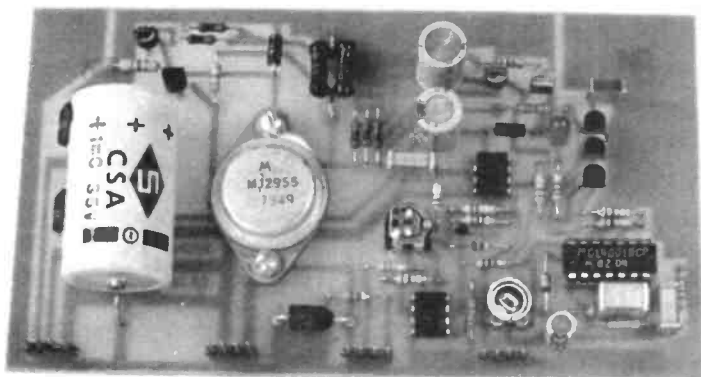

Ray Marston
describes a practical
implementation of his SMVF circuit.

MINI-DRILLS ARE WIDELY USED in PCB production and in model engineering. They are normally designed for use with nominal 12V power supplies and draw maximum 'stall' currents of up to 2 or 3 amps. The speeds of such drills can easily be varied by adjusting the mean voltage value that is fed to the drill motor, and many such 'mini-drill controller' circuits have been published in recent years. Most previously published designs have, however, been of either the 'variable DC-voltage' or the 'fixed-frame variable pulse-width' types, and have given poor speed regulation, for reasons that have already been fully explained in 'Data File Nos 9 & 10'.

Our new mini-drill controller, by contrast, works on the brand new 'amplified-feedback Switched-Mode Voltage Follower' principle, and inherently gives fully-variable speed control with superb self-adjusting speed regulation. The basic action of this circuit is such that it continuously compares the speed-dependent 'dynamo' voltage of the drill motor with the DC voltage that is set on an input control pot, and automatically adjusts the mean output voltage (to the motor) to maintain the dynamo voltage and speed at the desired value, irrespective of loading conditions. Thus, the circuit may supply only 2V (mean) to a mini-drill when it is running lightly-loaded at low speed, but may increase the mean drive to (say) 10V to maintain that speed when the loading becomes very heavy.

IT'S A FRAME.

The new circuit feeds a variable-frame switched-mode output signal to the mini-drill. Power is fed to the motor (as a pulse of energy) during the mark part of each cycle, and under this condition the circuit's output transistor is fully saturated and dissipates very little power; the system is thus highly efficient. During the space part

of the cycle the circuit monitors the motor's dynamo voltage and thus measures the true speed of the motor; the results of this measurement determine the length of the space period and hence the mean power that is fed to the motor in that cycle.

The new controller/regulator circuit is shown in Fig. 1. This particular design is specifically intended for use with '12V' mini-drills that draw maximum mean 'stalled' currents of up to 3 amps. The circuit can be modified to accept motors of even heavier rating by simply reducing the value of one resistor (R24) and increasing the power rating of the supply transformer.

The Fig. 1 circuit incorporates comprehensive 'overload' and 'short-circuit' protection, and has a visual fault indicator (a LED). The overload protection circuit comes into operation if mean load currents exceed 3 amps, and under this condition power to the mini-drill and the LED is pulsed on and off once per second. The 'short-circuit' protection comes into operation if a resistance of less than 2R nominal appears across the output terminals, and in this event causes automatic 'shut down' that gives a mean output current of only 3 mA; in this mode, which is indicated by the LED turning fully on, the circuit 'samples' the output once every 500 mS to see if the short still exists, and finally restores full power within 500 mS of the short being removed.

CONSTRUCTION AND USE.

The full circuit of the mini-drill controller/regulator is shown in Fig. 1. Construction should present very few problems. Note, however, that RV1 is a dual-gang linear pot, and that the two halves are wired to the circuit in anti-phase (as indicated by the 'spots'). Also note that monitor-resistor R24 needs a power rating of 2.5 watts. Output transistor Q8 dissipates about 3 watts under maximum load conditions, and should be fitted with a small heat sink. The

power supply connections to the main circuit should be made at the specific points indicated, with the positive connection going to the 'hot' side of R24 and the negative to the negative output terminal.

The circuit has two control pots (RV1 and RV3) and one pre-set pot (RV2). RV2 and RV3 must be adjusted to suit the characteristics of the individual mini-drill motor that is in use, as follows.

(1). Set RV1 to zero, RV2 to mid value, RV3 to maximum. Connect the mini-drill and an analogue voltmeter (to read 12V nominal) across the output terminals. Switch on and wind RV1 up to maximum value, noting that the drill speed increases. With RV1 at maximum and with the mini-drill unloaded, adjust RV2 to give a reading of 12 volts on the meter.

(2). With RV1 still at max., reduce the value of RV3 (pulse width) until 'skip cycling' or erratic operation begins to occur and the output voltage begins to rise. Increase the RV3 value slightly, so that 'skip cycling' stops, and note the RV3 setting. Now repeatedly and slowly vary the value of SPEED control RV1 from max to min to max, etc., to find the 'ideal' setting of RV3 (somewhere greater than the above-noted value) at which skip-cycling is minimal and drill rotation is acceptably smooth. Note that, when the drill is unloaded, rotation will inevitably feel slightly rough at very-low-speed settings, but this roughness diminishes when the drill is loaded.

(3). Once the 'ideal' setting of RV3 has been found, adjust RV1 to give an output voltage reading of about 2 volts with the drill unloaded. Now increase the loading and check that the output voltage increases and the drill speed stays almost constant. Finally, stall the motor and check that the output rises to between 6 and 10V, indicating that the circuit is functioning correctly. All adjustments are then complete and the unit is ready for use.

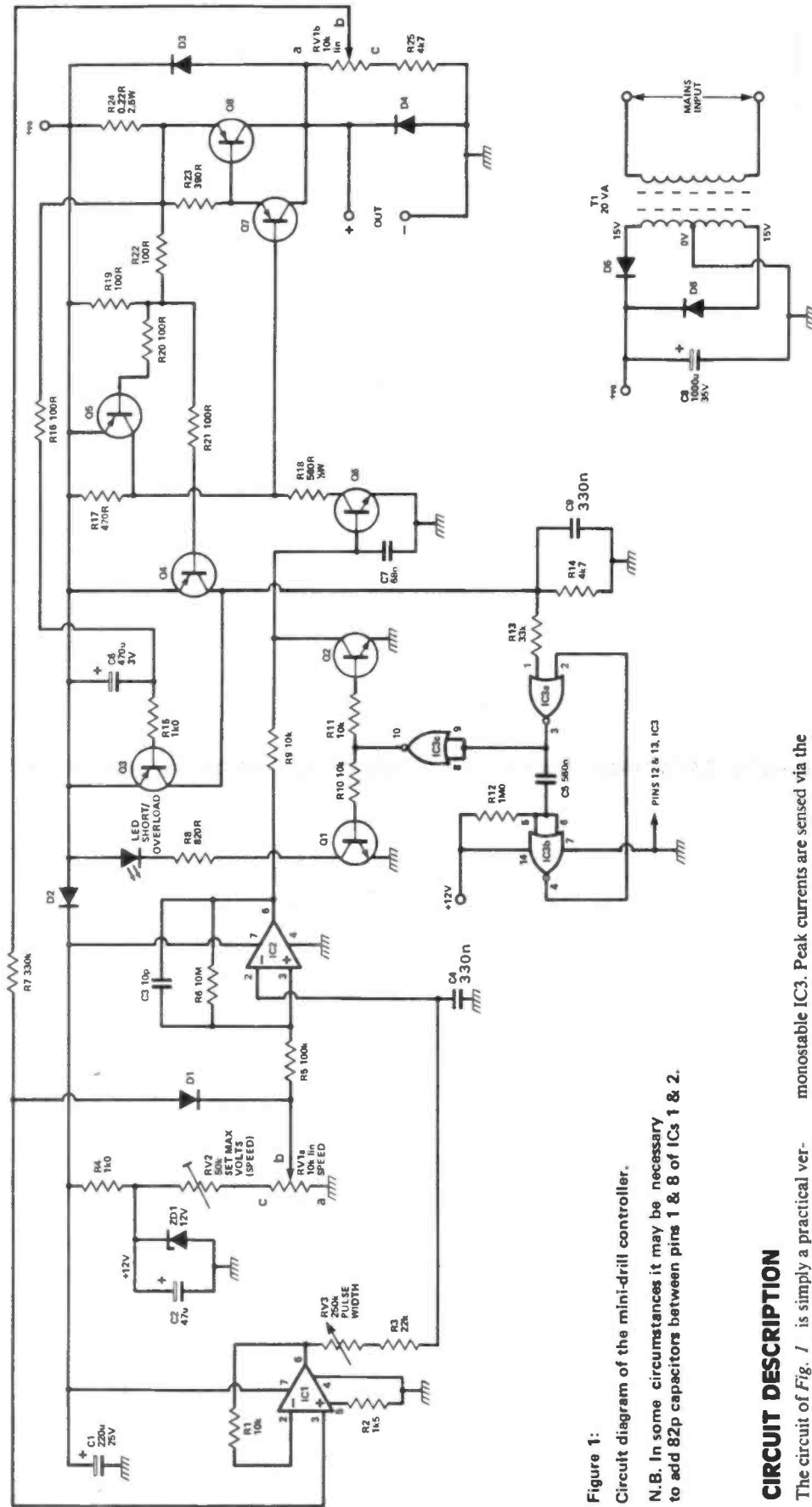

NOTE: RV1-RV3 ARE GANGED BUT WIRED IN ANTI-PHASE
 D1 IS 1N4148
 D2 & D3 ARE 1N4001
 D4, D5, D6, D7 & D8 ARE BC238
 Q1, Q2 & Q3 ARE BC238
 Q4, Q5, Q6, Q7 & Q8 ARE BC309
 Q9 IS BC238
 IC1 & IC2 ARE 7410
 IC3 IS 555

Figure 1: Circuit diagram of the mini-drill controller.
 N.B. In some circumstances it may be necessary to add 82p capacitors between pins 1 & 8 of ICs 1 & 2.

CIRCUIT DESCRIPTION

The circuit of Fig. 1 is simply a practical version of the 'amplified-feedback SMVF' circuit given in Fig 3 of 'Data File No 10'. IC1-IC2, RV1, etc., form the basic circuit, but with slight additional offset biasing given by R2 to compensate for poor-quality RV1 pots that do not quite give zero resistance in the 'low' position. The IC1-IC2 supply is decoupled from the main supply via D2-C1, and the switched-mode output of IC2 is fed to Darlington output transistors Q7-Q8 via the Q6 driver stage.
 The circuit has comprehensive output protection, via monitor resistor R24. Mean output currents are sensed via Q3 and integrating components C6-R16; Q3 turns on when mean currents exceed 3 amps and thence activated

monostable IC3. Peak currents are sensed via the R19 and R22 divider, which feeds the bases of Q4 and Q5. When peak currents reach 6 amps, Q5 starts robbing base drive from Q7-Q8, and Q4 turns on and fires the IC3 monostable. When the IC3 monostable fires, it activates the fault-indicator LED via Q1, and simultaneously removes all Q6 base drive via Q2, thereby disabling the IC3 monostable pulse. In the event of a 500 mS monostable pulse. In the event of a shorted output, this circuitry limits the mean output current to about 3 mA. Note that C9 reduces the rise times of the monostable trigger signals, enabling the circuit to power slightly capacitive loads without triggering the 'short circuit' protection circuitry.

MINI DRILL CONTROLLER

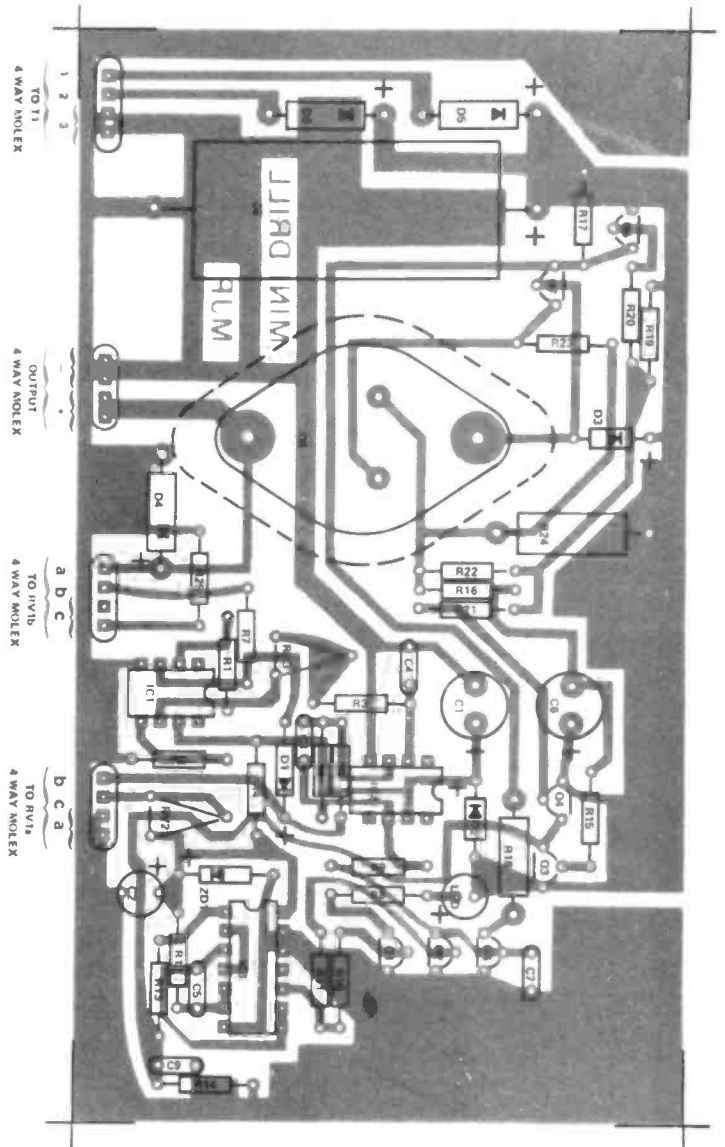
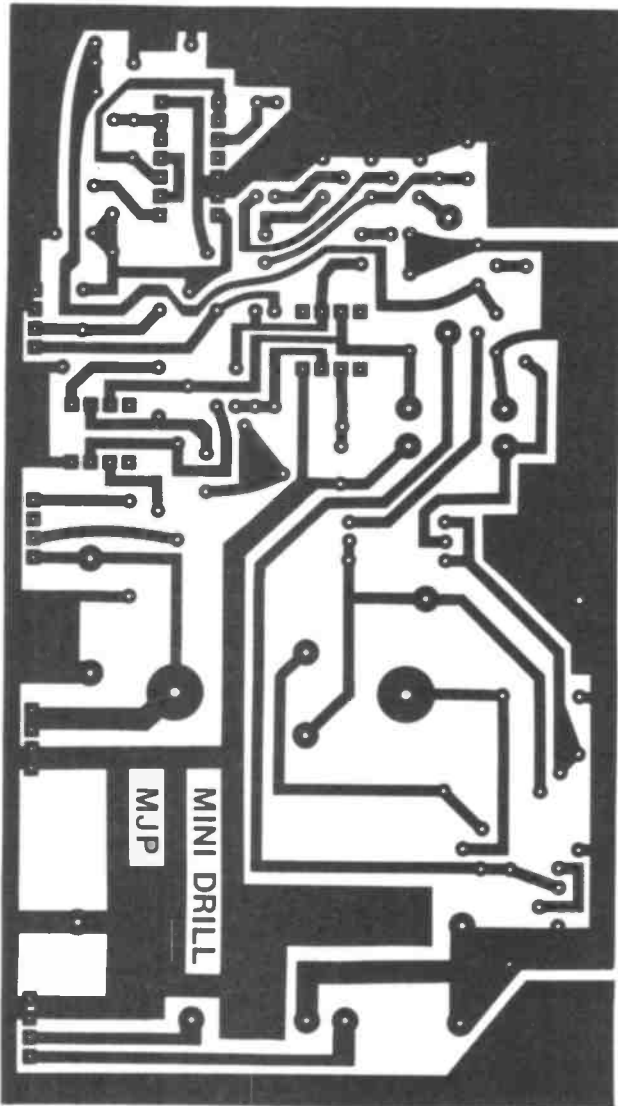

Figure 2: The mini-drill controller's PCB foil pattern.

Figure 3: The overlay for the mini-drill controller.

PARTS LIST

Resistors (all 1/4W unless stated).

R1,9,10,11	10k
R2	1k5
R3	22k
R4,15	1k0
R5	100k
R6	10M
R7	330k
R8	820R
R12	1M0
R13	33k
R14	4k7
R16,19,20,21,22	100R
R17	470R
R18	560R
R23	390R
R24	OR22 - 2.5W

Potentiometers

RV1	10k linear dual
RV2	47k preset
RV3	500k preset

Capacitors

C1	220u 25V Electrolytic
C2	47u 16V Electrolytic
C3	10p Ceramic
C4,9	330n Polyester
C5	680n Polyester
C6	470u 6V3 Electrolytic
C7	68n Polyester
C8	1000u 35V Electrolytic
C10,11	See text

Semiconductors

Q1,2,6	BC238
Q3,4,5	BC309
Q7	BC640
Q8	MJ2955
IC1,2	3140
IC3	4001B
D1	IN4148
D2,3	IN4001
D4,5,6	IN5401
LED	RED 5mm

Miscellaneous

PCB, case, connecting wire etc.

Note that, once RV2 and RV3 have been initially set to suit a particular mini-drill, they are unlikely to ever need re-adjustment while that drill is in use.

If you wish to make a more powerful version of the Fig. 1 circuit, simply increase the rating of the mains transformer and reduce the value of R24 to give the desired 'limit' current.

■ R & EW

Your Reactions.....	Circle No.
Excellent - will make one	84
Interesting - might make one	85
Seen Better	86
Comments	87

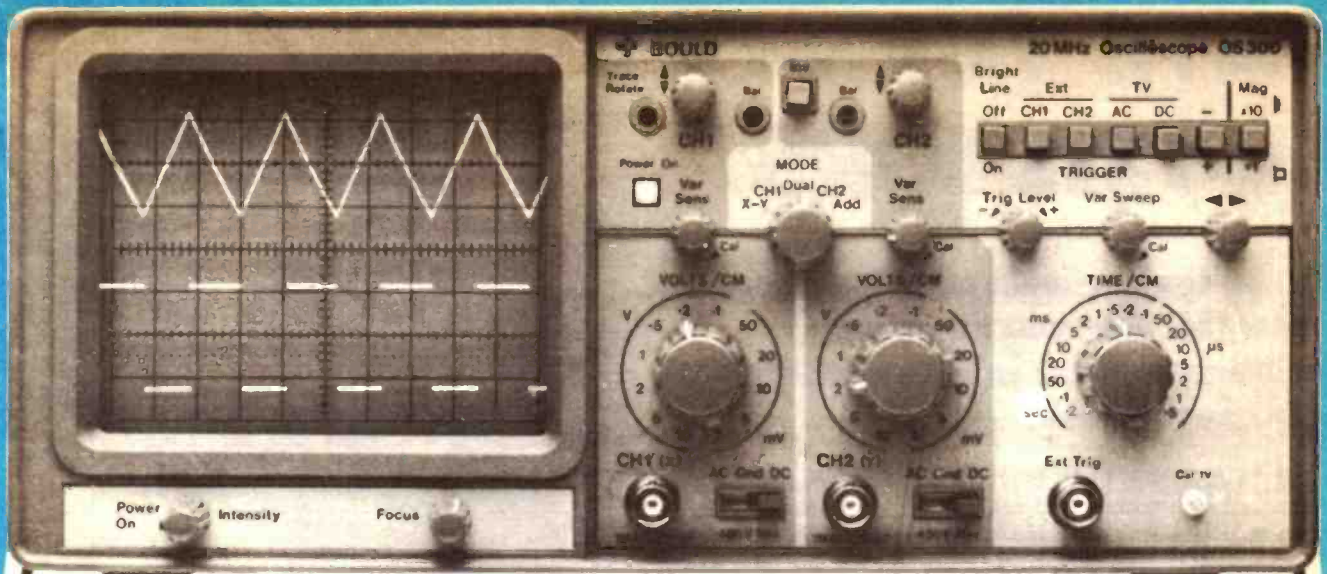

The new Gould OS300 Dual Trace 20MHz Scope

A tough, professional instrument you can trust – at a price you can afford! ★ Max. sensitivity 2mV/cm. ★ Stepped and continuously variable attenuator and timebase controls. ★ D.C. coupled triggering and "active" T.V. sync separator. ★ 'Add' and 'Invert' for differential measurements. ★ X-Y facility. Built to do more – safely, reliably and for longer.

Ask for our 8-page data sheet for full details and applications information.



Electronics & Electrical Products

Gould Instruments Division
 Roebuck Road, Hainault, Ilford, Essex IG6 3UE.
 Telephone: 01-500 1000. Telex: 263785



DON'T MISS US.

If you have any difficulty in obtaining your copy of R&EW use the coupon to place a regular order with your newsagent or alternatively send it to our subscriptions department together with a cheque/PO for £12.00 UK, £12.50 overseas and you'll receive a year's worth of R&EW delivered to your door.

R&EW Subscriptions,
 45, Yeading Avenue,
 Rayners Lane,
 Harrow,
 MIDDLESEX, HA2 9RL.

- *Please reserve me a copy of Radio & Electronics World.
- *Enclosed is payment for a year's subscription to Radio and Electronics World.

*Delete as appropriate

Name

Address

.....

Place a regular order with your newsagent or subscribe, they're the only ways to make sure you don't miss an issue of R&EW.

GATE TURN-OFF THYRISTORS

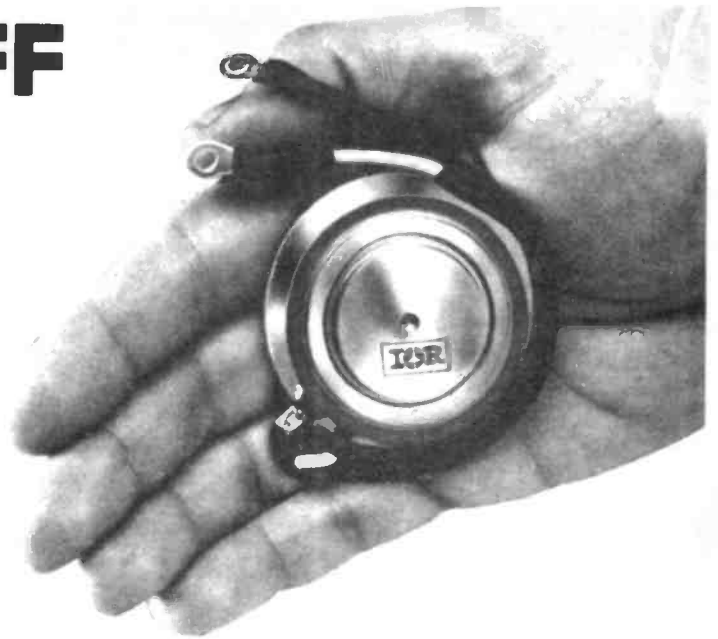

Michael Graham looks at the high power devices that overcome the major disadvantage of the conventional SCR in DC applications.

GATE TURN OFF THYRISTORS differ from conventional devices in that they may be turned OFF (as well as ON) via their gate electrode. Thus one of the major disadvantages of general purpose SCRs in DC applications - the fact that the gate loses control of the device once it has been turned ON - can be overcome with the use of a GTO.

Figure 1 shows a conventional SCR configured as a DC power control switch and serves to illustrate the drawbacks of general purpose SCRs in DC applications. With SW1 closed and SW2 open, when power is first applied to the circuit, the SCR is 'blocked' and acts like an open circuit switch. Closing SW2 applies a small positive

gate current to the SCR and this causes the device to turn ON (to act like a forward biased silicon diode).

Once the SCR is in the ON state, the gate loses control of the device and, while it is carrying a significant forward current, SW2 will have no effect on the circuit operation.

To turn the SCR OFF, the magnitude of the current flowing in its anode circuit must be reduced to a value below its 'minimum holding current'. In Fig. 1 this is achieved by the simple expedient of including SW1 in the anode circuit. In many applications, however, it is impracticable to interrupt the anode circuit and auxiliary commutating circuits must be used to turn the SCR off (Fig. 2). These commutating circuits add to a circuit's complexity and are often bulky and expensive to include.

AT LAST-THE GTO

The Gate Turn-Off thyristor (GTO) overcomes this turn-off problem for it can be turned off by the application of a negative pulse of current to its gate terminal.

The current required to turn off the GTO is only a fraction of the anode current carried by the device-usually around one-fifth-at a relatively low voltage-about 20V for a typical device. This is in contrast to any auxiliary turn-off circuits for use with a conventional device which must carry full anode current at peak anode voltage.

These low current/low voltage turn-off requirements combined with the fact that a relatively short 'turn-off' pulse-no longer than

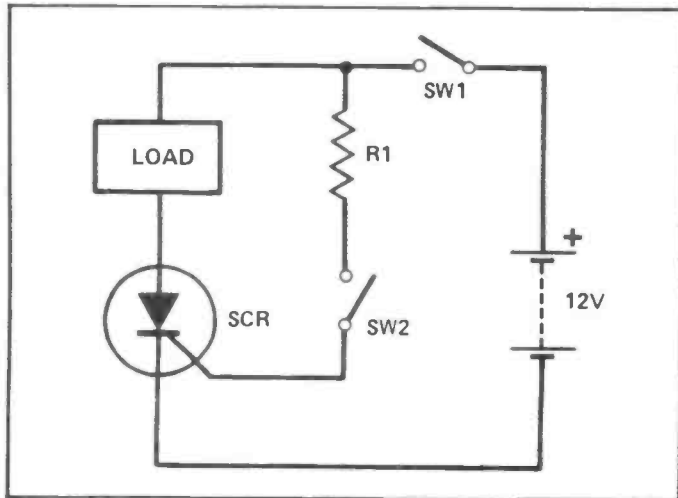

Figure 1. Conventional SCR in a DC power control circuit.

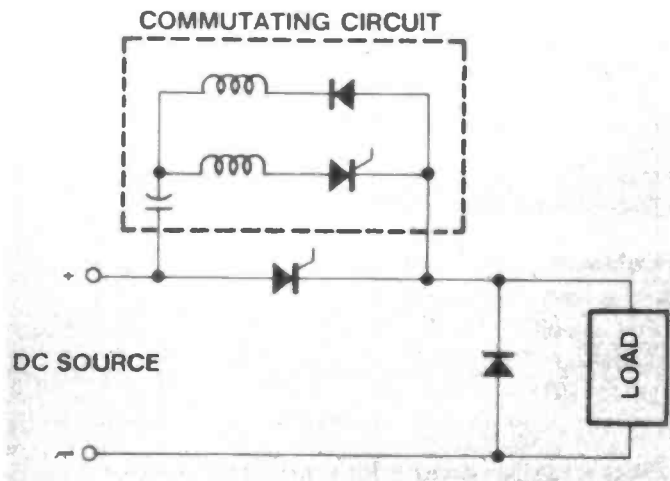
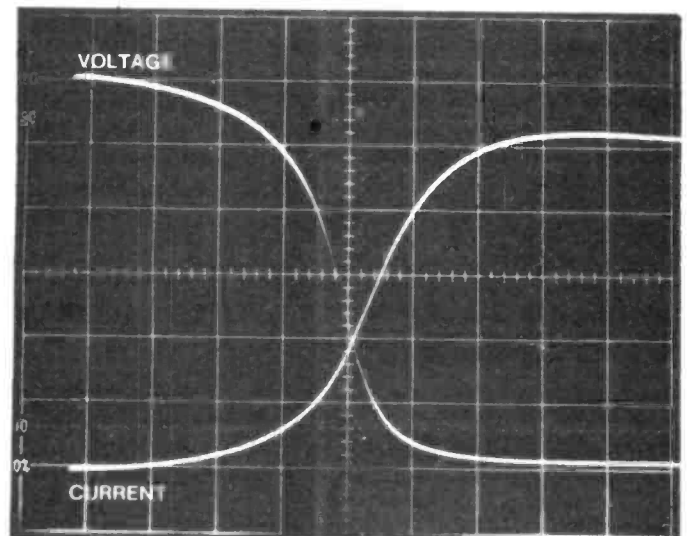

Figure 2. In order to turn-off a conventional SCR an auxiliary commutating circuit is required.



$I_{GFM} = 10A$ $E = 1.55 \times 10^{-1} J$
 $t_{gt} = 4.70 \mu s$

Figure 3. Anode voltage and current shown during device turn-on.

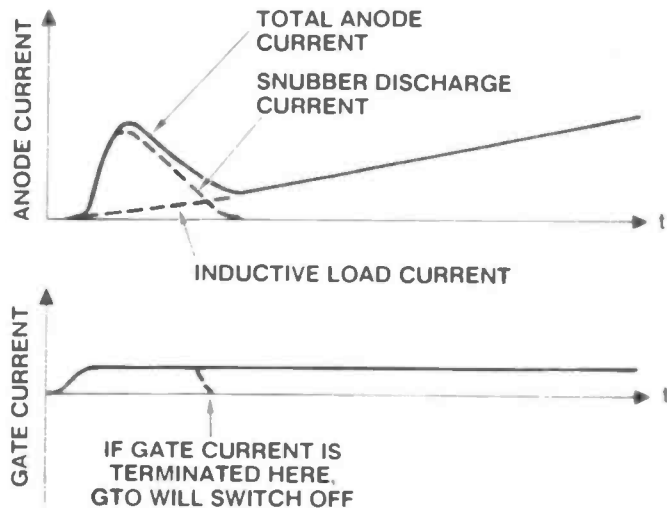

Figure 4. Waveforms of anode and gate current during turn-on with an inductive load.

a few microseconds will interrupt anode current, means that the energy required to turn off a GTO is far less than that required for a conventional thyristor.

Gate Turn-Off thyristors are not fundamentally new, having first appeared in the 60s, but it is only recently that devices with a satisfactory 'mix' of parameters have started to appear.

DEVICE CHARACTERISTICS

The major feature of the GTO is its ability to be turned OFF via its gate terminal however along with this major attribute come a number of other characteristics that mean a GTO should not be thought of as being 'just like a conventional SCR but with the extra ability to turn off.'

The characteristics of a GTO in a number of important respects can be summarized as follows.

Turn-on-A GTO has a generally faster turn-on time than a conventional device and this will generally mean that the device will be subject to a high rate-of-rise of anode current. The gating signal must have a sharp leading edge and must rise to a relatively high level until the anode voltage has reached its steady level. Fig. 3 shows the turn-on performance of a typical high-power GTO **Latching current-**A GTO has a relatively high latching current and Fig. 4 illustrates how this particular aspect of the GTO's performance can give rise to problems at turn-on. With a low rate-of-rise of anode current, such as may be found in inductive circuits, care must be taken to ensure that gate current is applied for a long enough period of time, long enough for the anode current to have risen above the devices latching current. In most applications a GTO should be supplied with a continuous (positive) gate current during the time that it is ON.

Turn-off-A GTO is turned off by applying a negative current to its gate terminal. Typical turn-off performance is illustrated in Fig. 5 while Fig. 6 shows the test circuit on which these measurements were taken.

The negative gate current builds up relatively slowly due to the inductance of the gate circuit. After a storage time of several microseconds, the anode current decreases very rapidly while anode voltage simultaneously starts to rise.

The rate-of-rise of anode voltage at turn-off must be limited to a safe value and for this reason the snubber circuit (Ds, Cs and Rs of Fig.6) must be included. The snubber circuit provides an alternative, capacitive, discharge path for anode current.

One final difference between GTO devices and conventional SCRs is that the GTO has a relatively high conduction voltage drop. This means that the average current through the device must be low in comparison to the peak permissible turn-off current.

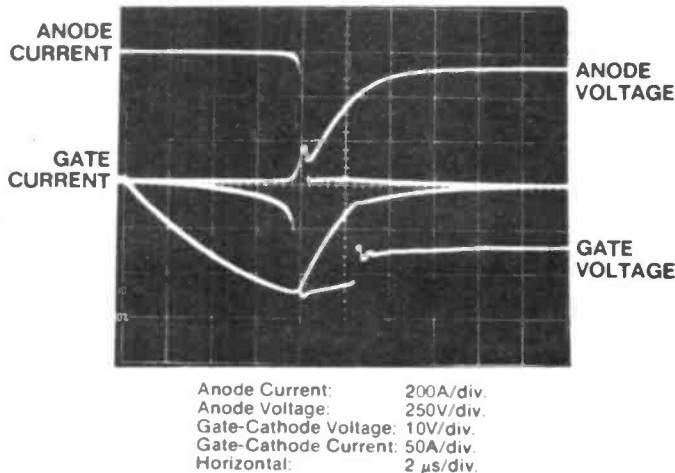

Figure 5. GTO turn off waveforms.

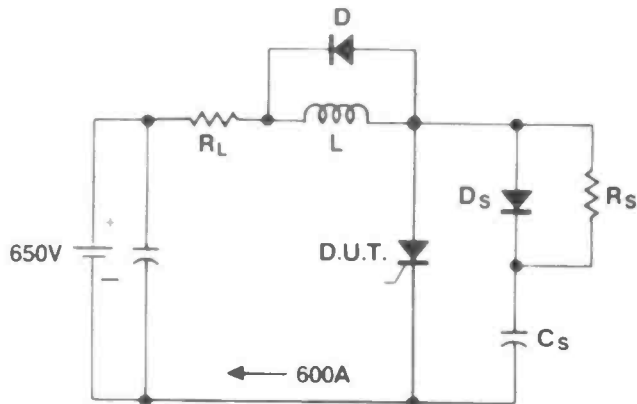

Figure 6. A GTO test circuit showing the snubber network that is required to limit the rate-of-rise of anode voltage during turn-off.

SWINGS AND ROUNDABOUTS

The GTO has one major advantage over the general purpose devices in common use today. This advantage has to be weighed against other performance characteristics - specifically the high conduction voltage drop, the need for a snubber network and the special drive requirements, make the GTO more or less suitable for differing applications.

The high conduction voltage drop with the need to keep mean current levels down fits applications such as motor control circuits in which peak and instantaneous currents will be well in excess of mean current levels. In other cases peak and mean values will be much the same and the GTO will be less suitable.

The GTO is best suited to operation in relatively low frequency circuits (up to 1 or 2kHz) at relatively low levels of average- to-peak current. Typical applications in this category are variable frequency drives for motors and uninterruptable and stand by power supply systems.

Next time you take a trip on the underground give some thought to the GTOs that may well be part of the motor's control circuitry.

■ R & EW

Your Reactions			
	Circle No		Circle No
Immediately Interesting	64	Not Interested in this Topic	66
Possible Application	65	Bad Feature/Space Waster	67

WHAT TO LOOK FOR IN OCTOBER



SCANNING FM RECEIVER

R&EW - in conjunction with Larsholt - present a superb synthesized FM tuner.

Features include eight station memories, switched IF bandwidths and a built in clock display.

The automatic scanning facility of the tuner will sweep the band until it reaches a station which it will then hold for five seconds. During this time the station can be selected, scanning to the next station resumes if the channel is not required.

The tuner is built around a series of modules, making construction a straightforward matter and its performance is what we have come to expect of Larsholt who have been producing state-of-the-art receivers for many years.

GaAs FET PRE-AMPLIFIER

The 23cm GaAs Fet Pre-amplifier published in our August issue has proved very popular and next month Roger Ray describes versions for 2m and 70cm use.

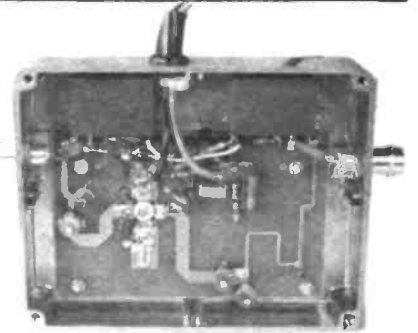

70cm PA

A stripline design that is straightforward to build and align.

Intended for use with low power FM transceivers, the amplifier operates from a 13V supply and provides an output of at least 10W for a 1.5W input.

RADIO & ELECTRONICS WORLD

The complete electronics magazine

Place an order with your
newsagent now to reserve
your copy of the October issue.

VIDEO RECORDER DNR

A non-complementary noise reduction system that can vastly improve the quality of a video recorder's audio track.

The circuit with only 2 IC's and a handful of other components mimics the behaviour of National's new single chip DNR IC, which is unfortunately only available to OEM manufacturers.

When used with an external speaker/amplifier combination, the improvement in a film's sound track, for example, is quite spectacular.

METAL DETECTORS IN SECURITY

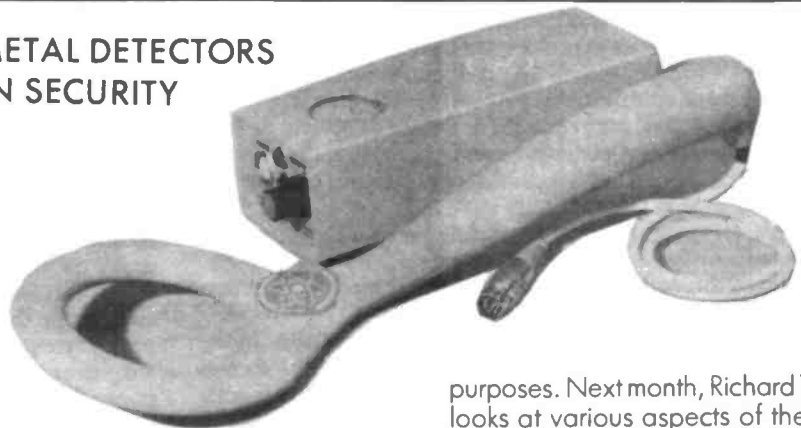

In recent years Metal Detectors have increasingly been used for security

purposes. Next month, Richard Turner, looks at various aspects of the metal detector's use in a wide range of security applications.

COMMUNICATIONS, DATA, VIDEO, COMPUTING, COMMENT, NEWS, COMMENT,
COMMUNICATIONS, DATA, VIDEO, COMPUTING, COMMENT, NEWS, COMPUTING,
COMMUNICATIONS, DATA, VIDEO, COMPUTING, COMMENT, NEWS, DATA, VIDEO,
COMMUNICATIONS, DATA, VIDEO, COMPUTING, COMMENT, NEWS, COMMUNIC

ARTICLES DESCRIBED
HERE ARE SCHEDULED, HOWEVER THE FINAL
CONTENT MAY VARY TO SOME EXTENT.

R&EW Data Brief

KB4448

PLL stereo decoder with auto blend

The KB4448 is a low cost PLL stereo decoder designed for car radio applications, or 'DX' stereo reception where maximum separation cannot be usefully employed as a result of high noise levels. The KB4448 'blend' control is fed from the meter output of the CA3089/3189/KB4420 series of FM IF ICs, and is otherwise used in exactly the same fashion as the MC1310 family of PLL decoders.

Two further features are provided in the shape of a DC VCO 'switch' to mute the oscillator during mono or AM reception, and a separation optimisation present to balance out IF phase errors.

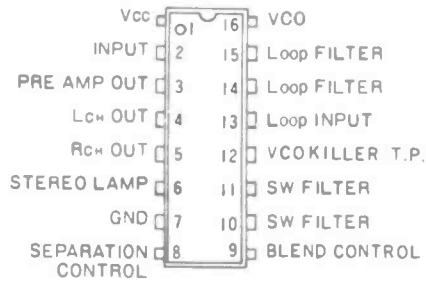

Pin Assignment

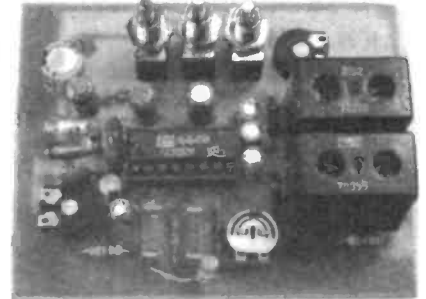

Ta = +25°C Vcc = 8.5V

Test Item	Symbol	SPECIFICATION			Unit	Test Condition
		MIN.	TYP.	MAX		
Supply Current	I _{CC}	15.0	20.0	25.0	mA	Quiescent, 9 Pin open
Output Voltage	V _{OUT}	184	260	367	mVrms	R _L = 3.3 kΩ, Mono
Channel Balance	C.B.			1.5	dB	Mono
Input Impedance	Z _{in}	25	50	120	kΩ	
Max. Input Voltage	V _{in max.}	600	1300		mVrms	THD = 1%, 1 kHz Mono
Mono T.H.D.	THD ₁		0.06	0.5	%	Mono
Stereo T.H.D.	THD ₂		0.08	0.5	%	Stereo
Separation	SEP	40	50		dB	Stereo
Stereo Lamp on Level	IND _{on}	6	9	12	mVrms	
Stereo Lamp off Level	IND _{off}	4	7		mVrms	
Carrier Rejection	C _{rej}		30		dB	Stereo De-Em = 50μs
Capture Range	VCO _c		3		%	Pilot = 30 mVrms
Blend Voltage (6 dB Sep.)	V _{blend}		0.9		V	Stereo
Blend Voltage (20 dB Sep.)	V _{blend}		1.3		V	Stereo
Min Separation	SEP _{min}			1.5	dB	9 Pin = 0 Volt.
Blend Control Current	I _{blend}		5		μA	9 Pin = 5 Volt.
Compelling Mono Voltage	V _{mono}		3.0		V	
VCO Killer Voltage	VCO _k		4.5		V	
SCA Rejection Ratio	SCA		80		dB	f = 67 kHz
Signal to Noise Ratio	S/N		75		dB	Mono
Ripple Rejection Ratio	SV _{rej}		30		dB	f = 200 Hz 500mVrms

Unless Otherwise Note: Mono 300 mVrms f = 1 kHz
Stereo 270 mVrms (L+R). Pilot = 30 mVrms, f = 1 kHz

Electrical Characteristics Data

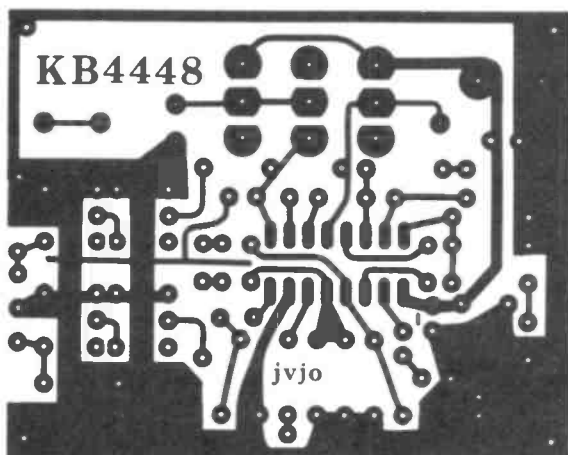

PCB Foil

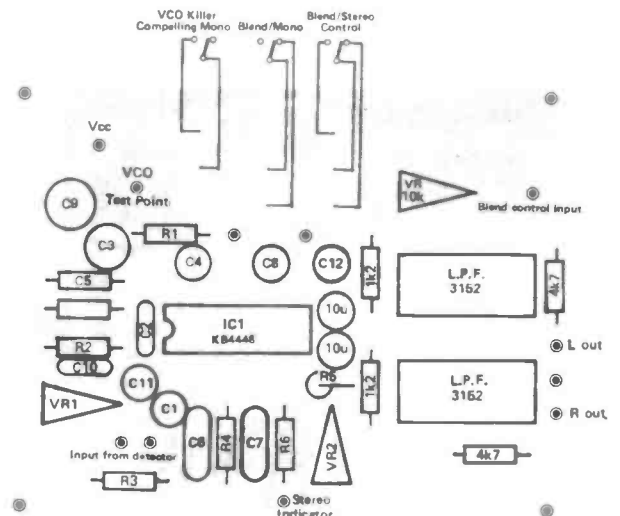

Component Overlay

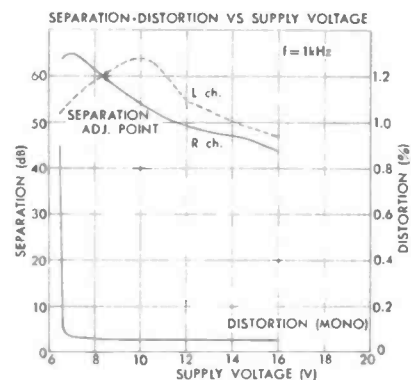
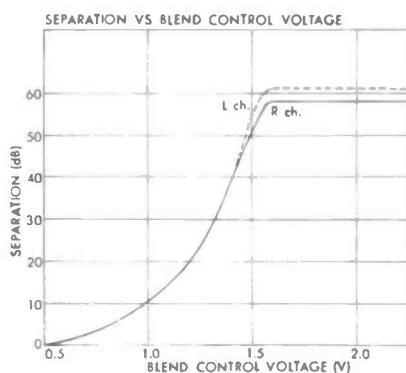
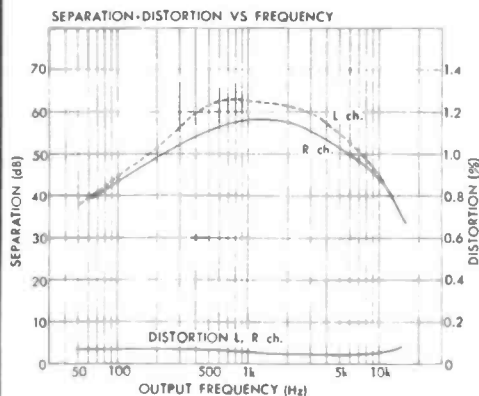
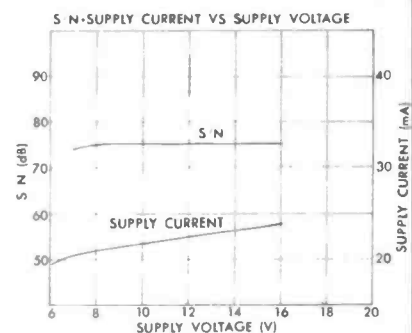
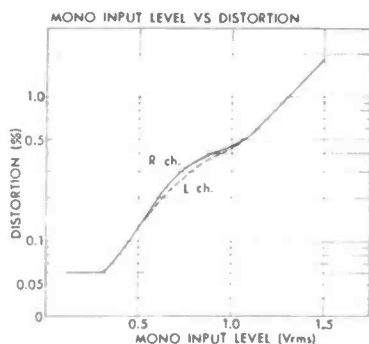
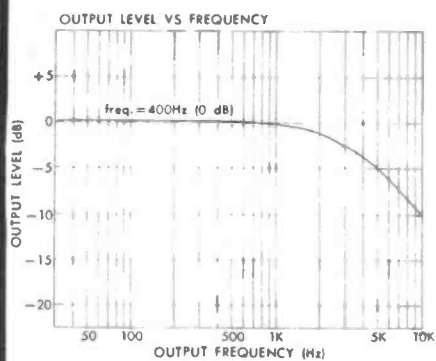

Electrical Characteristics

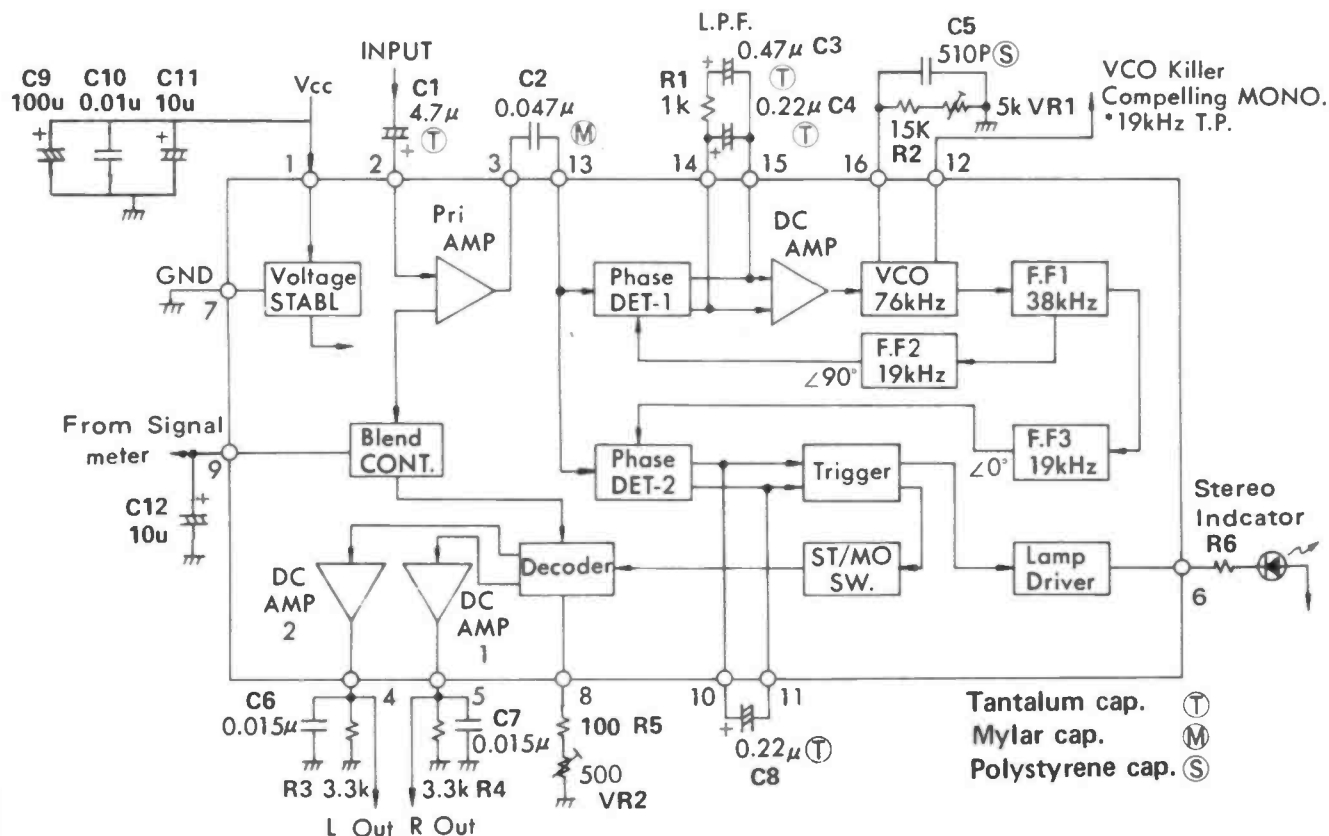

System Block Diagram

G4JDT
HARVEY

EAST LONDON HAM STORE

G8NKV
DAVE

H. LEXTON LIMITED 191 FRANCIS ROAD LEYTON E.10
TEL 01-558 0854 TELEX 8953609 LEXTON G

RADIO & ELECTRONIC ENGINEERS

ENGINEERS ALWAYS AVAILABLE ON THE PREMISES

MAIN (UK) SERVICE CONTRACTOR TO HITACHI SALES (UK) LTD

171

GASFET MASTHEAD PREAMPS

DRESSLER AMPLIFIERS



EXCLUSIVE TO US

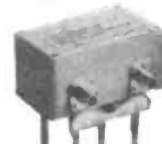

D70 A.T.V.
D70c 70cm
D200C 125W FM 190W PEP

£500
£295

D200:300 FM 600W PEP
D200S 400 + FM 1kW PEP

£495
£600

VV700GAAS £79.00
VV2GAAS £40.00
VV200GAAS £69.00
VV2000GAAS £79.00

These are high power 240V linears using 4C x 150 or 4C x 250 or 4C x 350 Eimac
Tubes NOT using the grounded Grid system.
Fully protected, no thermal damage to PA finals possible.

Powered by the linear or with separate interface.
0.7 - 0.9dB signal to noise
0.2dB insertion loss
3SK97 GASFET Available separately £4.50

ICOM 173
HF TRANSCEIVERS
IC730 200W £586.00
IC2KL 500W linear £839.00
IC2KLPS Power Supply £211.00
IC AT 100 100W auto A.T.U. £249.00
IC AT500 500W auto A.T.U. £299.00

ICOM
ACCESSORIES
BP5 IIV Pack £30.15
BP4 Empty case for 6XAA £5.80
BP3 STO Pack £15.50
BP2 6V Pack £22.00
DC1 12V adaptor £8.40
WM9 Mic speaker £12.00
CP1 Mobile Charging load £3.20
LC1/2/3 cases £3.50
BC30 base charger £39.00
MML1 10W Booster 49.00

TRIO/KENWOOD 174
TS930S POA
TS830S HF Transceiver £680.00
TS130S HF Transceiver £530.00
TR8400 UHF mobile £320.00
TR9500 UHF Multimode £460.00
TR7800 VHF mobile £268.00
TR7850HP FM 2m £295.00
TR7730 2m FM £230.00
TR9000 £370.00
TR9130 £380.00
TS530S HF Transceiver £520.00
TR2500 2mtr Portable £200.00
Many Trio/Kenwood accessories avail

YAESU 176
FT1 £1295.00
FT902 DM POA
FT101Z POA
FT101ZDFM POA
FT101ZDAM POA
FT102 POA
FT707 200W PEP POA
FP707 PSU POA
FC707 ATU POA
FV707 DM VFO POA
FT707 + FP707 + FC707
SPECIAL PRICE POA
FT277ZD Soco all extras inc POA
FT7670X POA
FT902DM Sommerkamp POA
FC902 ATU POA
FV901 DM VFO POA
SP901 speaker POA
YO901P Scope POA
FTV901 Transverter POA
FT208 VHF POA
FT708 UHF POA
FT290 Multimode POA

ALL ACCESSORIES AVAILABLE

CUSHCRAFT ANTENNA
HF, A3 20/15/10 3 ele beam 8dB £170.00
AV3 20.15.10 Trapped vertical £39.95
AV5 10.15.20.40.80. Trapped vertical £84.95
214B 14 ele boomer 05.2dB £59.95
ARX 2B Ring Ranger 6dB vertical £32.00
CS100 Speaker £13.50
A144.44 ele Yagi £18.25
A144.77 ele Yagi £23.00
A144.11 11 ele Yagi £29.95
ARX2K Conversion Kit RINGO Mk1 to Ringo MkII £14.18

MICROWAVE MODULES 177
MMA 144V 2m Preamp £34.90
MML 144/25 RF AMP £59.00
MML 144/40 £77.00
MML 144/100S New with Preamp £129.95
MMT 432/144 2-70 Transverter £184.00
MMT 2B/144 10m Transverter £99.00
MMS1 Morse Talker £115.00
MM 4000 RTTY
SEE IT WORKING AT OUR SHOP
£299.00 inc. keyboard
Full range stocked

STANDARD 178
CPB 58 £79.50
CPB 78 £67.50
C78 70cm Portable £219.00
C58 2mtr. Port:ssb/FM £239.00
CM88 Mounting tray £19.95
CL8 Carry case £8.95
Battery charger 7.95
Set Nicads. 11.00

ROTATORS ETC 182
DIAWA
DR7600X £135.00
DR7600R £144.00
DR7500R £105.00
KENPRO
KR250 £44.00
KR400 £90.00
HAM IV £189.00
CHANNEL MASTER 9502 CN620 1.8-150MHz Pwr/swr £52.00
CN2002 2.5 kW PEP auto ATU £190.00

DATONG 183
PCI G/C converter HF on 2mtr £120.75
VLF very low frequency converter £26.30
FL1 frequency agile audio filter £67.85
FL2 multimode audio filter £99.70
ASP/B auto RF speech processor (Tri-o) £78.35
ASP/A auto RF speech processor (Yaesu) £79.35
D75 manually controlled RF Sp/Processor £56.35
RFC/M RF speech clipper module £26.45
D70 Morse tator £45.45
AD270 indoor active antenna £37.95
AD370 outdoor active antenna £51.75
MPU1 PSU for above £6.90
+ Full range stocked

RECEIVERS ALL ON SPECIAL OFFER
R600 Trio/Kenwood
R1000 Trio/Kenwood
FRG7 Yaesu
FRG7700 Yaesu
FRG7700 Memory
FR7700 Tuner
FRV7700 A/B/C/D/E Convertors
C2001 inc. M/Adaptor £148.00
POA
PHONE
HOT LINE
01-566 1415

ICOM 175
PORTABLES
IC2E FM 2m £159.00
IC202 SSB £169.00
IC402 70cm £242.00
IC4E FM 70cm £199.00
All accessories available— see below

ICOM MULTIMODES 180
IC251 2m £495.00
IC451 70cm £630.00
IC290 2m £366.00

ICOM FM MOBILES 181
IC24G £165.00
IC25E £235.00

ICOM 720A G/C
IC720A 200W £883.00
PS15 Power Supply £99.00
PS20P/S with speaker £130.00
IC730 200W £586.00

ALL ACCESSORIES AVAILABLE - PLUGS SKTS CO-AX 2MTR COLINEAR £31.50, 70CM COLINEAR £31.50



PRICES INCLUDE VAT AT THE PRESENT RATE OF 15%
OPEN MON-FRIDAY 9:00-5:30. SATURDAY 10:00-3:00. INSTANT HP FACILITY AVAILABLE
EASY ACCESS M2-M11-M1 NORTH CIRCULAR ROAD-EASY PARKING





READERS LETTERS

Facts and opinions; Yours and Ours
A mixed postbag this month - everything from Valery Dumbar to Frank Baldwin taking in the R1000 on the way.

Good on yer....

Sir:

Yours is the first British publication I have read with a fair balance between information and hobbyist interest. The only problem is getting the mag here, so I will have to subscribe. Do overseas subscribers have access to information and PCB services - and can I order back issues?

I wonder if any of your readers can help me obtain a copy of the record 'Always Argyle', by Valery Dumbar, on Club Records - or so I believe. The Australian version sounds like it is played through an old-fashioned gramophone with a cotton wad stuffed in the horn - but I would gladly send a copy to whoever can send me the original British Version.

Yours etc.

J. Boers

17 Cabarita Way North Yunderup 6208
West Australia

R&EW:

Yes, all the usual services are available to overseas readers, but there is a price to be paid, we're afraid. The cost of sending a back issue by air to Australia is about £31! And that doesn't include the R&EW. The surface rate is £1.25 per copy (including the R&EW), with an average 6-12 weeks transit time.

As far as the record is concerned, we invite our readers to get directly in touch with you. I would suspect that there are one or two who would be only too glad to see 'Always Argyle' winging its way to the Antipodes.

Cause for concern

Dear R&EW:

With reference to recent instalments of Frank Baldwin's column, I feel I must point out that there has been a lack of consistency with regard to the attitudes towards 'certain' stations.

In May's column you state 'There are many other types of signal that can be picked up on a decent receiver, but to which it is illegal to listen to in the UK without a special licence, and we will not deal with such subjects in these pages...'

Yet in June and July's columns you openly list and discuss Clandestine Radio Stations.

Section 3 of the Wireless Telegraphy Regulations 1970 permits the reception of authorised broadcasting stations and licenced amateur radio stations. Nothing else, not even Standard Frequency Transmissions.

Now whilst I agree that the majority of clandestine radio stations that you have listed so far are probably authorised by the country from which they originate, a far greater number are not in any way authorised by their country of origin or any other. Don't mislead your readers into thinking that such signals are legal to listen to.

I would in fact have preferred R&EW to take the bull by the horns, as they seem to have done over a large number of other subjects, and to have disregarded this aspect of the Wireless Telegraphy Regulations 1970, much as the CB media ignored the fact that it was illegal to transmit on 27MHz.

I am certain that there are a large number

of SWL's whose outlook is stifled by the old-fashioned approach of UK magazine publishers. The non-broadcast, non-amateur sections of the HF spectrum hold some fascinating listening if only one knows what and when to listen for.

In fact, a large amount of information listing aero, marine and other fixed station frequencies is readily available in this country if only one knows where to look for it, so one is hardly revealing state secrets by printing frequency or station lists in a magazine.

So may I please request that R&EW try tilting at this particular windmill, and become the first UK magazine to adopt a sensible attitude towards SWL'ing by talking about non-broadcast/amateur listening.

TG
Nottingham

R&EW:

Don't tempt us! The various Wireless Telegraphy Acts must now rate as some of the most discredited and meaningless legislation ever to pass through Parliament. There is a long overdue revision getting under way, and let's hope that it doesn't succumb too heavily to the influence of the HO, who have hitherto seemed to have a curiously overpowering effect on politicians whenever there was a chance of a good technical bamboozling.

The whole thing should be thrown open for more discussion than is usually the case i.e. something more substantial than allowing the RSGB a token gesture or two. Pray that the next revision isn't another infamous Whitehall farce as the result of the usual mix of the unspeakable in pursuit of the unenforceable, or we shall find CB operators from 1.6MHz to 30MHz, with the HO curiously powerless to act, except to tell you not to listen to the airband or the like.

Tell us like it is

Dear R&EW:

The numbers on the reaction card do not necessarily represent my opinion on any particular article, and I would suggest that each article should include an 'Academic Interest Only' option.

One of the reasons I decided to subscribe was your approach to the FRG7700/R1000 review. Unfortunately after wallowing inside these two receivers for two months, you forgot to put them to the test, by which I mean that in my opinion, the final article was an anti climax. I was hoping to read several pages devoted to the performance 'on the air'. Attached not only to a 6 element beam at a height of "n" feet, but also to a miserable 150' end fed, slung between two houses at less than rooftop height. The performance of each being evaluated by a fairly active CW operator, as well as an SSB person.

Subsequent articles have been done in isolation - no comparisons. What about a TS5830S/TS530S against the FL101/902 for example?

The title of the magazine suggests that you cover a multitude of sins, so I suppose I must expect you to wander off into other applications, and even CB.

I would prefer any computer articles to have an application to radio, and not extolling its virtues as such. Similarly Video Recorders.

Let's face it, there are more than enough dedicated magazines in these two fields. (Having said that, however, my Hitachi 8500 (Granada variant) is not immune to 27MHz FM).

EHR
Glenrothes

R&EW:

It's getting more obvious with each issue that R&EW is reaching more and more readers outside the communications fraternity. We have always aimed our content at a fairly broad span of the market, although we are undeniably biased towards communications topics, since communication is the link between all aspects of electronic science, if you'll forgive the phraseology.

We don't want to keep harping on it, but we do carry more editorial space (and always have done) to allow us the luxury of being more things to more people, and when we can get more external contributors on-line, then we will be able to cover yet more space, and try and broaden the horizons of our readers a little further.

Incidentally, we carry a user report of the FRG7700 every month - Frank Baldwin uses the memory version when listening around to compile his column. We would prefer to leave the subjective commentary on such things up to our readers, and so how about writing in and telling us your likes and dislikes in amateur equipment?

Users of TS830/530 and FL101/902 please note!

Dear Sir:

Many thanks for an excellent magazine which I have read from the first issue.

The mix of projects, features and information seems to strike the right balance and your articles seem to contain more 'meat' than those in some other publications.

I find your data brief feature of particular interest introducing as it does new or unusual circuits complete with a PCB layout. In many of the data briefs however, no mention of the price/availability of the boards is made. Are they available from yourselves?

Keep up the good work.

NH,
Norbury, SW16.

R&EW

Thank you for your comments about R&EW. We have had a large number of enquiries regarding PCBs for both Projects and Data Briefs.

All PCBs for R&EW designs are available from our project pack office and a collated list of the boards for all our projects back to our first issue last October appears elsewhere in this issue. Also listed are the Data Brief boards - these boards are supplied undrilled in order to keep the cost down.

The components used in both Projects and Data Briefs are readily available from one or more of the advertisers in this issue while our project pack service offers a convenient way to purchase all the components for many of our projects with one order - saving on postage and nerves.

BNOS

PROFESSIONAL STABILISED POWER UNITS



12 AMP 12/12A
£81.40

25 AMP 12/12A
£120.45

13.8V; 12/25 Amp Continuous
Over voltage crowbar; fold back
current limit; short circuit
protection; shut down indication
current meter; regulation better
than 0.1%; R.F. proofed.

V-J PRODUCTS

100 Watt 2 METRE LINEAR AMP

V-J 100/PL

1 - 18 Watts RF in; 10dB Gain
Linear all mode operation;
Receive Preamp 12dB gain
straight through operation.
Size: 145 x 80 x 165mm



R&EW PROJECTS



2m - 28MHz

£25.25

70cm - 28MHz

£26.35

DUAL PURPOSE

70cm - 144 MHz

70cm - UHF TV

£32.45

30 Watt

2 Metre Linear

£55.00

2/3 Watts RF in 20/30 Watts RF O/P

Linear all mode operation

Built-in Receive Preamp.

SAE for further details.

Barclaycard/Access Welcome. All prices shown include VAT.

BNOS Electronics, DEPT REW, Greenarbour, Dutton Hill, Great Dunmow,
Essex. CM6 3PT. Telephone: 0371 84 767

NI CAD BATTERIES

TYPE	1-9	10-24	25-99
AA	0.5AH	0.90	0.85 0.82
C	2.2AH	2.40	2.30 2.20
SUB'D	1.2AH	2.30	2.15 2.00
D	4.0AH	3.40	3.20 3.05
PP3	0.11AH	3.90	3.65 3.40

VAT INC. CARRIAGE FREE

NI CAD CHARGERS

Multi Cell Charger

Charges up to 4 AA, C or D

cells and 1 PP3 at any time.

Cell test facility incorporated.

FERRITE RINGS

	1-9	10-24	25-99
Small	0.42	0.38	0.35
Large	0.80	0.78	0.70

CARRIAGE FREE ON ALL UK ORDERS

189 for further details

electronics

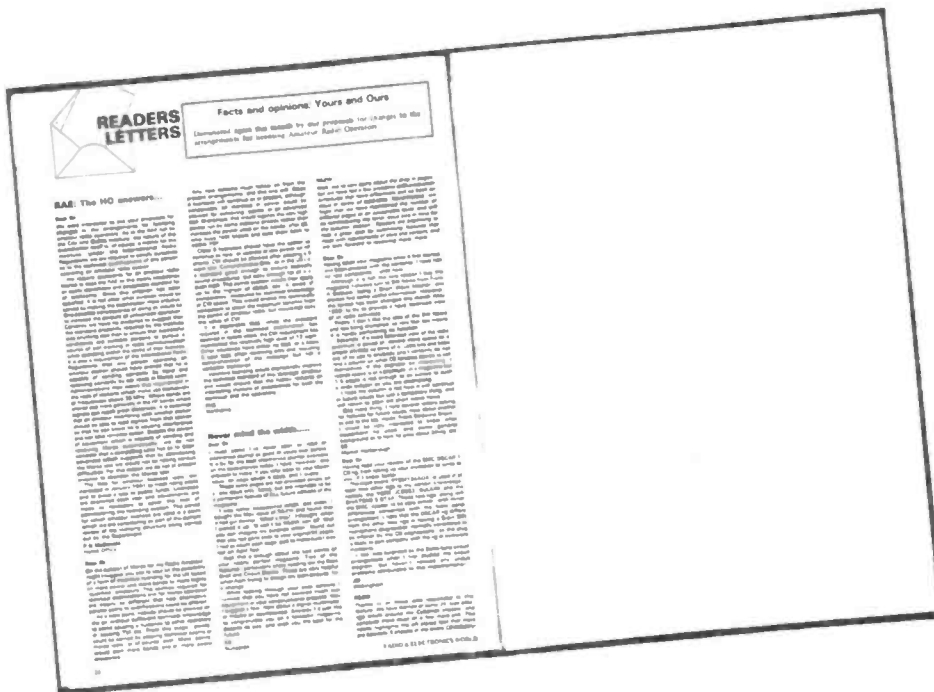

R&EW is looking for someone to
take over responsibility for the
magazine's
Advertising Department.

We are looking for someone with
drive and enthusiasm, having no
preconceptions about age and
experience.

Remuneration will take the form
of a basic salary plus a sliding
scale commission — both
negotiable.

If you feel you could rise to the
challenge offered by this post
write or phone for an
appointment.

The Editor
RADIO & ELECTRONICS WORLD
117A High Street
Brentwood
Essex CM14 4SG
0277-213819

CAN YOU FILL THIS SPACE?

Marconi Instrument's 2017

In the blue corner: A.M.(Tony) Rudkin of Marconi Instruments, provides an MI view of the project to develop the generator. William Poel in the R&EW corner.

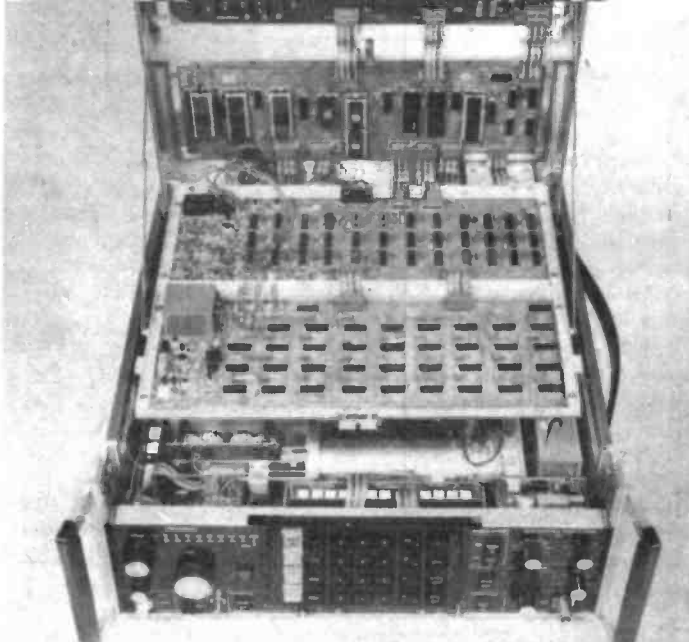

TRUST MARCONI INSTRUMENTS to sweep away their erstwhile image of ex-WD battleship grey signal generator leviathans of the test bench, with a workmanlike and robust piece of gear, slimmed down to a mere 63lbs.

It's very nice, but the 2017 won't be finding its way into the cheap second hand test gear ads for quite a while yet. Maybe if MI want to establish their modern market image more rapidly, they might offer owners of things like TF144s a special trade-in deal - say £6000 off the 2017's asking price of £8000 odd. Perhaps Lord Weinstock would like to try a little open cast mining on his group's fabled cash mountain?

Notwithstanding that, the 2017 is value for money. Its main claim to fame being the use of a servo tuned cavity in the master oscillator section. The *de facto* standard of the *genre* being the HP8640B, whose fabled low sideband noise content is at last challenged, and generally fairly roundly upstaged by the facilities of the next generation.

The Adret and Fluke generators both offer impressive performance in this respect, as well, with the Fluke instrument employing a delay line in the phase locked loop, rather than opting for the electromechanics of the cavity. The budget concious 2018 and 2019 generators reviewed back in the January '82 issue

achieve results that are good enough for all but the most demanding R&D applications, although having said that, the requirements of point-to-point communications systems are increasingly stringent as the strong signal performance of receiver front-ends makes the whole question of sideband noise less academic.

Compare the graphs of sideband noise from the 2017/18/19 family, and you will see that the 'close-in' noise of the HP 8640 and the MI 2017 is quite immaculate. The different scaling factors and parameters of the measurements don't help when making exact comparisons, but the 8640/2017 differences are so minor as to be at an academic level.

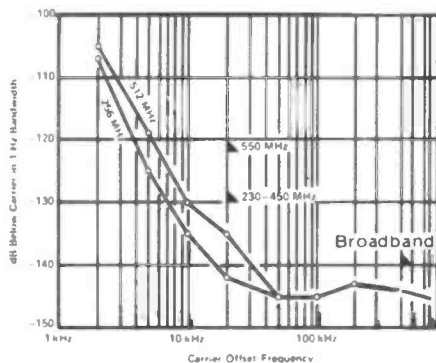

Graphs of sideband noise for the HP 8640 (above) and the 2017 (below).

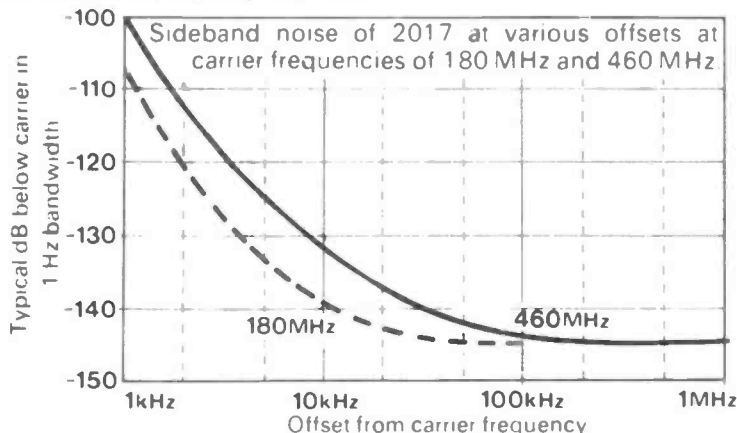

ONE PICTURE IS WORTH A LOT OF WAFFLE...

Marconi Instrument's latest sales literature provides excellent support for the product range, and we can do no better than reproduce the centre fold of the sales brochure.

The ability to use push button entry for fast setting (there are also ten complete 'front panel' memories for recalling standard test routines) coupled with the operator ease of rotary controls for vernier twiddling was appreciated by all who used the generator. None of the panel control functions were difficult to assimilate, and it was generally agreed that operation was a good deal more straightforward than with any of the famous TF series predecessors. The unambiguous nature of digital displays makes the return to 'guess the scale' analogue instruments rather tiresome.

The 50W reverse power protection (built-in, not an option) has probably cost MI thousands in lost service charges, and hastened the demise of less thoughtful generators when engineers familiar with the 2017 family have been obliged to revert to lesser machines. The WPF (Wally Protection Factor) is very high, although well seasoned campaigners can probably manage to do untold harm by tipping their tea over the push button panel. A fully sealed keyboard wouldn't present too many problems, would it?

INSIDE THE 2017 With Tony Rudkin

Users of cavity tuned generators are frequently unwilling or unable to accept the long set-up times and lack of programming ability. The 2017 updates the concept, combining the convenience of manual operation, and adding the speed and versatility of GPIB programming (IEEE bus), with the introduction of microprocessor control.

NEEDS MUST...

One of the most important measurements made on modern receivers is the ability of the device to reject unwanted signals on

adjacent channels or in totally different frequency bands.

In these tests, the generator (or generators) tuned to frequencies other than the wanted channel will be at a relatively high level compared with the signal at the wanted channel frequency (ratios of 70 to 100dB are getting to be commonplace). Under these conditions, noise in the output will find its way into the receiver bandwidth, and will result in an unduly pessimistic measurement of the rejection ratio.

WHY A CAVITY TUNED OSCILLATOR?

The decision to use a cavity tuned oscillator was not an obvious one, and initial investigations concentrated on the possible use of synthesised oscillator techniques. Such oscillators tend to trade speed of setup and convenience for noise performance. Noise performance can be improved through the use of multi-loop techniques, but the resultant complexity of a system that is designed to avoid all the possible spurious relationships arising from an approach began to point to the use of a cavity oscillator instead.

The well tried and tested cavity was given a new lease of technological life with the introduction of a servo operated motor drive that could achieve setup times of under ten seconds, and permit an interface

to bus control to be implemented. A proven cavity design was readily adapted for use with motor drive, and the heart of the 2017 was established.

Experiments with active devices showed that the optimum frequency range for the oscillator was 256 to 512MHz, and any attempt to extend this frequency range upwards resulted in a significant noise penalty. Using 256 to 512MHz as the basic range, higher frequencies were made available by locking a slave oscillator to the cavity output through a phase locked loop incorporating a divide by two stage. Lower frequencies were obtained by using digital dividers. In this way, low noise and complete freedom from spurious (non-harmonic) signals could be guaranteed. To avoid an excessive number of divider stages, a frequency translation system was used to extend the range from 4MHz down to 10kHz so that the total band of 10kHz to 1024MHz could be covered in nine ranges.

The circuit function of a cavity is effectively a high Q parallel resonant network formed by the inductance of the stator and the capacitance between the end of the stator and the sliding plunger. The profiles of the fixed and moving parts are carefully arranged to give a linear tuning law, such that each millimetre of movement of the plunger produces the same frequency

change. Coupling to the active oscillator circuit is arranged by small coupling coils. An electrical input for fine frequency control is achieved by means of a variable capacitance diode. This input also allows frequency modulated RF signals to be obtained.

MICROPROCESSOR AIDED TUNING

The normal mechanical drive to the cavity permits manual control of frequency through a front panel tuning knob and this, in conjunction with an electrical fine tune facility, allows smooth analogue control with excellent resolution. Retaining the benefits of this form of tuning was an important objective in the overall design of the generator as the disadvantages of a stepping system, which would have been the only method of imitating rotary control on a synthesized design, were clearly recognised. Stepping is ideal for moving the frequency in fixed increments (e.g. from channel to channel), but is virtually impossible to use as a means of searching for receiver responses unless very small steps are chosen.

Having tuned the generator and found a response, the operator may wish to make a number of measurements at the frequency and a facility for locking the generator tuning if desirable.

In updating the tuning and locking process the digital frequency display (at the

2017 – the complete signal generator

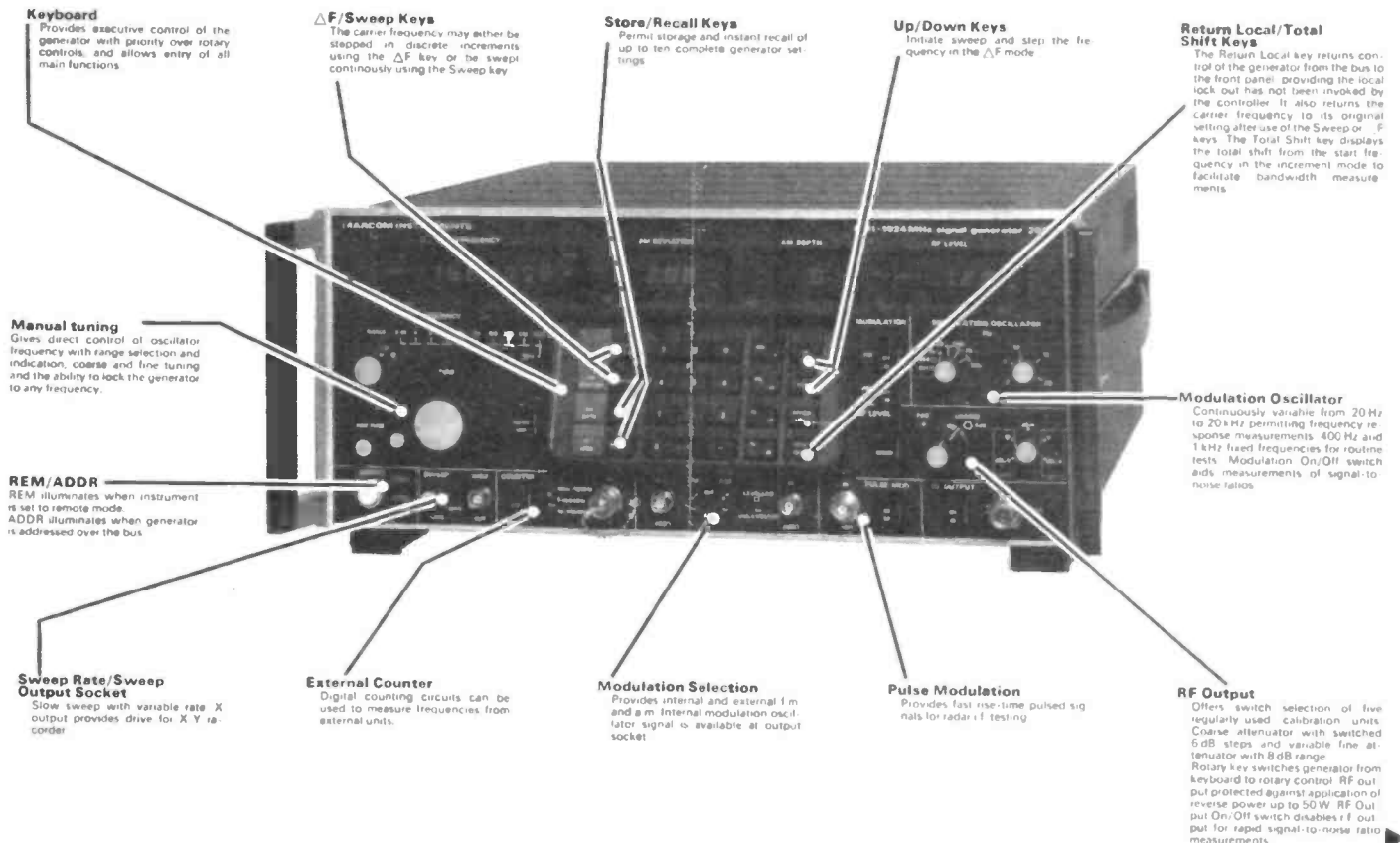

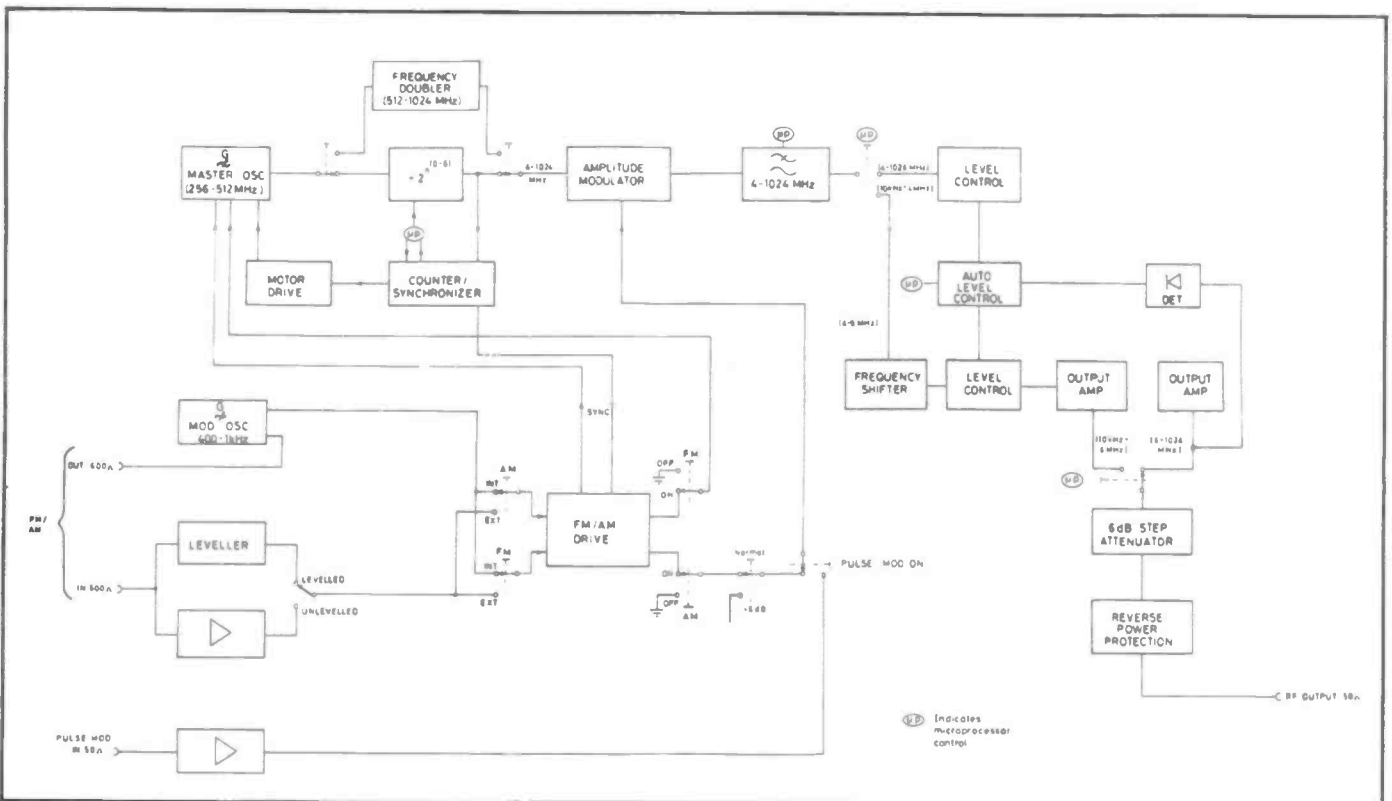

Block Diagram of the 2017.

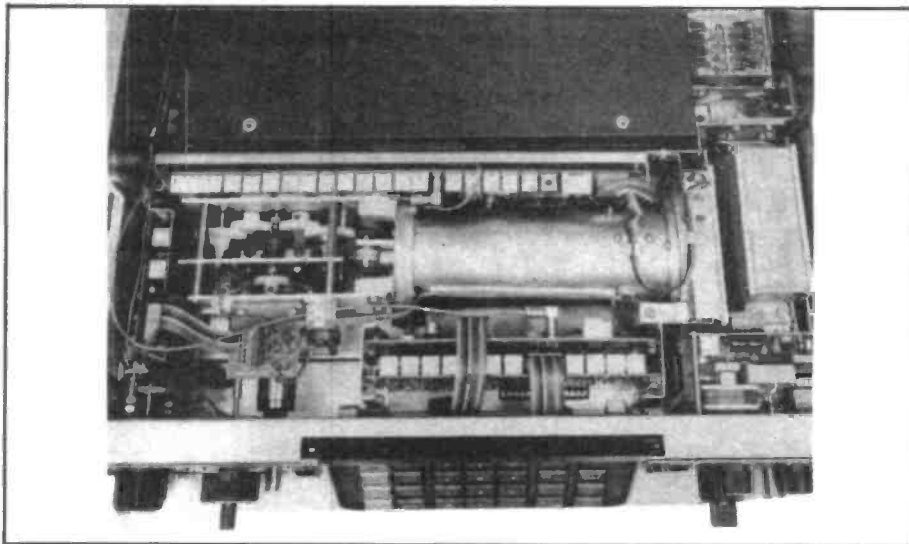

time of locking) is interpreted by a microprocessor and, after modification, is fed to a variable ratio divider circuit. The variable ratio divider reduces the oscillator frequency to a convenient low frequency which is compared with a similar frequency derived from a high stability crystal reference oscillator by a series of fixed dividers. Any error at the phase comparator is amplified and used to control the oscillator frequency. In this way the oscillator is included as part of a single loop phase locked network with a stability and accuracy related to the performance of the crystal reference oscillator.

Although some receiver tests require complete freedom of tuning, many checks

simply involve setting the frequency to the wanted channel and manual adjustment is a tedious way of achieving this facility. By motorising the cavity tuned oscillator and using a digital keyboard to enter the channel frequency information the tuning process can be simplified considerably with a significant reduction in test times. When an instruction is entered the generator effectively compares the wanted frequency with its present setting and if the change cannot be accommodated by varying the DC voltage fed to the fine tune input of the oscillator, the microprocessor initiates a search routine. In this mode the microprocessor first selects the correct range, directs the motor to turn in the

correct direction at maximum speed until the frequency is within 0.5% of the wanted value, and then completes the mechanical tuning to within 0.1% by running the motor at a reduced speed. Final tuning is then accomplished electrically using the phase locked loop formed by the variable ratio divider. The two speed tuning process prevents overshoot and hunting in the motor/oscillator combination and ensures a fast response time.

Stepping the frequency in precise increments for moving to adjacent channels (or when making bandwidth measurements) is simplified by allowing the user to enter a step size and to operate UP and DOWN keys as required. The microprocessor retains the original carrier frequency information for future reference, and each time an UP or DOWN key is pressed it calculates the new value and passes the instruction to the tuning system. At any time the operator can press a TOTAL SHIFT key to determine the frequency shift from the original starting frequency. A RETURN key allows the frequency to be reset to its original value.

■ R & EW

Your Reactions.....	Circle No.
Immediately interesting	56
Possible application	57
Not interested in this topic	58
Bad feature/space waster	59

BE A SHARP BUSINESSMAN

for only £278 +VAT

COMPUTER AND 4-COLOUR PRINTER

The sensational new PC-1500 Pocket Computer approaches the Personal Computer in ability. Add the revolutionary CE-150 Graphic Printer and a cassette recorder and you have a complete, battery powered, Business Computer System that travels in your briefcase!

SHARP CE-150
4-colour Graphic
Printer
£130.39 + VAT;
Total £149.95



SHARP PC-1500
'Basic' Pocket
Computer
£147.78 + VAT;
Total £169.95

Price includes **SECURICOR 24 HOUR DELIVERY***.
Same day despatch, subject to availability.

BUSINESS APPLICATIONS



Quick and accurate data processing in daily business. Estimates, records and charts of sales, salaries, invoicing and all other data crucial to efficient business operations can be easily programmed, calculated and summoned.

ENGINEERING APPLICATIONS

Technical calculations in fields such as mathematics, statistics, measurements and mechanics are done superbly and easily. The calculator more than meets the requirements of engineers and scientists.

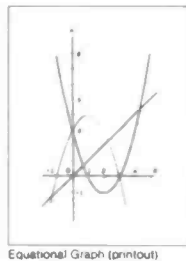
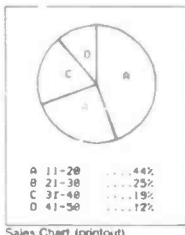

MANAGEMENT APPLICATIONS

Balance sheets, so crucial to management analysis, and profit calculations by break-even point analysis are instantly yours with the PC-1500. By using the integral clock, calendar and alarm functions, this computer can also be used as a schedule reminder.



HOBBY APPLICATIONS

Many popular computer games can be played, including Blackjack, utilising the random number function. Use the clock and alarm for speed games. The Computer Graphics will draw virtually any pattern.



TEMPUS

38 Burleigh Street, Cambridge CB1 1DG.
Tel: 0223 312866

BASIC LANGUAGE

The most simple computer language is used for programming ease. Additional BASIC terms provide variables including two-dimensional arrays, variable strings and many other advanced features.

LARGE MEMORY

16K bytes of ROM and 3.5K bytes of RAM, with 2.6K bytes in the user area. Adding the optional CE-151, 4K byte memory module, expands the RAM to 7.5K bytes. An 8K byte memory module will be available soon. The PC-1500 is battery powered and program and data memories are fully protected, even when switched off.

MINI-GRAPHIC DISPLAY

The 7 x 156 dot matrix allows almost any display, including game symbols. Line width is 26 characters and/or numbers.

HIGH SPEED DATA PROCESSING

The C-MOS 8-bit CPU enables swift data processing. Complicated technical or business calculations require far less time.

QWERTY TYPEWRITER KEYBOARD

The first in a pocket computer. Lower case letters are available. With the optional CE-150 colour graphic printer, the PC-1500 can serve as a small personal typewriter. Word Processor software will be available soon.

SIX SOFTWARE KEYS

These can serve as reservable keys, or as definable keys to define programs.

CE-150 4-COLOUR GRAPHIC PRINTER/CASSETTE INTERFACE

Automatic program, data and calculation printing. It prints virtually any drawing in either red, black, green, or blue. Characters are printed in nine different sizes and in lines ranging from 4 to 36 digits in length. You can control the printer completely and direct the printing either up, down, left, or right. As a cassette interface it will connect up to two cassette recorders, one for data and program storage, the other for their recall. The CE-150 has a built-in rechargeable battery and is supplied with a mains adaptor, type EA-150.

AVAILABLE SOON

* RS-232C interface. * Software board to serve as input keys in graphics, or pictures, previously drawn on a template. * ROM (MASK ROM) module also applicable. * A wide range of business software.

DIMENSIONS

PC-1500: 195Wx25.5Hx86Dmm (7-11/16x1x3-3/8") Wt 375g (0.83lb)

CE-150: 330Wx50Hx115Dmm (13x2x4 inches). Wt 900g (1.98lbs)

Full 12 MONTHS guarantee, with EQUIPMENT LOAN SERVICE during downtime.

SAME DAY DESPATCH of orders - Systems by SECURICOR 24 hour service, (to attended premises only) or by first class registered post. AT NO EXTRA COST

SEND FOR FULL DETAILS to TEMPUS, the Portable Computer Specialists.

To: Tempus, FREEPOST, 38 Burleigh St, Cambridge CB1 1BR.

INFO.	ITEM	QTY	PRICE	TOTAL
	PC-1500 Pocket Computer		£169.95	
	CE-150 Four Colour Printer		£149.95	
	CE-151 4K Byte RAM Module		£ 49.95	
			Total inc VAT	

For information only tick appropriate box

I herewith enclose a cheque or Postal Orders value £ _____
or I wish to pay by Access B'card Visa.

My number is: _____

Name: _____

Address: _____

R&EW/82

A-D CONVERTER

A multi-purpose 8 bit design by J C Burchell

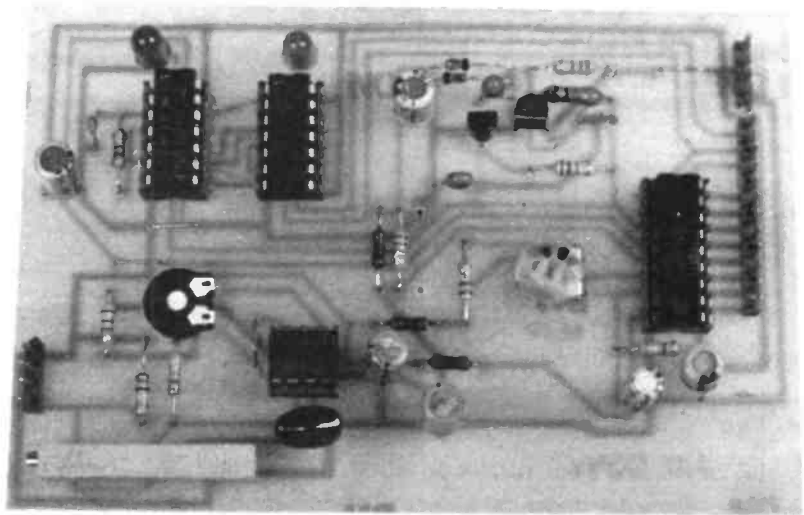

THIS FOUR IC DESIGN provides an 8 bit digital representation of an Analogue input, the device is sufficiently general purpose to be interfaced with any microprocessor having an 8 bit input port and one or two strobe lines available.

The board is designed around the Ferranti ZN427 8 bit successive approximation D/A converter. This contains all the building blocks for this type of converter in one IC, namely a voltage switching D to A converter, a 2V5 reference source and a fast comparator combined with the successive approximation logic. See Fig 1.

SUCCESSIVE APPROXIMATION

Most Analogue to Digital converters work by using a Digital to Analogue converter and a comparator. An external circuit sets

the Digital to Analogue converter to different output values and the comparator compares the output of the converter with the analogue input which is to be converted. When the converter declares these to be equal, the logic is stopped from changing the Digital to Analogue converter, and the current digital setting of the input to the converter is equal to the digital equivalent of the analogue input.

One simple technique for implementing this technique is to connect an 8 bit counter to the inputs of an 8 bit D/A. The counter is then clocked, until the equality condition occurs. The main limitation of this technique is that the conversion time is not constant and can vary from 1 to 255 clock periods, which may be an appreciable length of time.

An alternative technique is that of

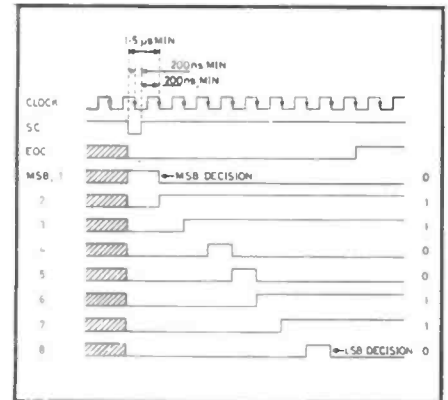

Figure 2: Timing diagram for a conversion

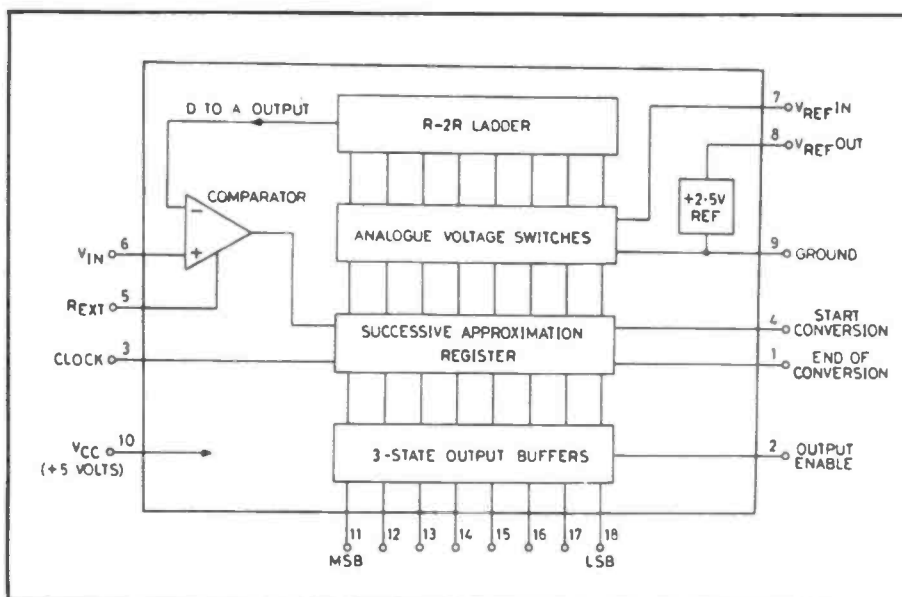

Figure 1: Block diagram of ZN427

successive approximation which has the advantage of always producing the output in a constant number of clock cycles although the logic required is more complicated. In the successive approximation technique the MSB (Most Significant Bit) of the D/A converter is set to 1 and all the other bits are set to 0. This will produce an output from the D/A converter equal to $1/2(V_{ref\ in})$. This value is compared to the input voltage V_{in} , and a decision is made on the first negative clock pulse whether to keep or reject the MSB as a 1. (The MSB will be set Zero if $1/2 [V_{ref\ in}] V_{in} < \text{Bit } 2$ is then changed on the same clock edge from a zero to a 1 (The output of the converter is now Bit 1 as decided by the previous cycle and Bit 2 high). Again on the next clock edge a decision is made as to whether or not to keep bit 2 high, by comparing the D/A output with V_{in} . This process is repeated for all 8 bits so that when the End Of Conversion (EOC) output goes High the digital output from the converter is a valid representation of V_{in} . The binary data is

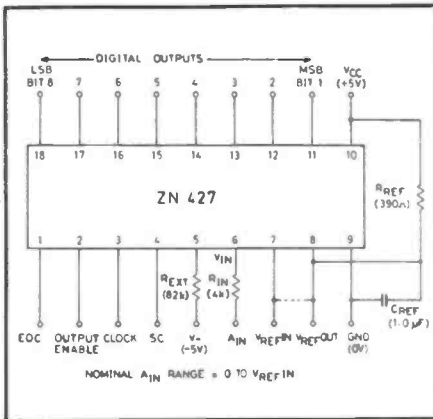

Figure 3: The circuit configuration for basic operation.

latched until the next Start Conversion pulse is received.

The ZN427 may be clocked at over 600 kHz giving a conversion time in the order of 15 microseconds per conversion cycle. The detailed timing diagrams of Fig 2 illustrate the conversion process in more detail.

THE D TO A CONVERTER

The converter is of the voltage switching type and uses an R-2R ladder network of the type shown in Fig 4. Each 2R element is connected either to 0V or Vref in by special low offset transistor switches.

A binary weighted voltage is produced at the output of the R-2R ladder whose output is equal to:

$$D \text{ to } A \text{ output} = \frac{n}{256} (V_{ref \text{ in}} - V_{os}) + V_{os}$$

Where n = the digital input to the D/A from the successive approximation register. And Vos is a small offset voltage produced

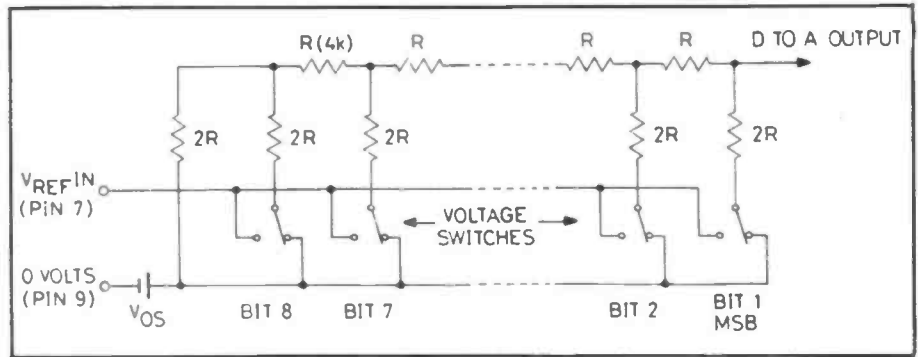

Figure 4: Details of the R-2R ladder network

Analogue Input (AIN) (Nominal code centre value)	Output Code (Binary)
FS - 1 LSB	11111111
FS - 2 LSB	11111110
3/4 FS	11000000
1/2 FS + 1 LSB	10000001
1/2 FS	10000000
1/2 FS - 1 LSB	01111111
1/4 FS	01000000
1 LSB	00000001
0	00000000

Figure 5: Setting up and coding details

by current flow in the package lead resistance. Typical values for Vos are 2mV and its effect can be removed by the setting up procedure. The input resistance of the converter is in the order of 4k

The basic input range of the ZN427 is 0-Vref in or 0-2V56, giving a LSB step of 10 mV.

Figure 5 gives the Logic coding for the ZN427's 8 outputs and setting up instructions to establish the right operating points.

PARTS LIST

Resistors - all 1/4W 10%

- R1 1k8
- R2 6k8
- R3 15k
- R4,10 4k7
- R5 390R
- R6 56k
- R7 680k
- R8 See text
- R9 See text
- R11,13 100R
- R12 1k0

Presets

- RV1 1M0
- RV2 10k
- RV3 10k (Multiturn)

Capacitors

- C1 100p
- C2,12 4n7
- C3 68n
- C4 47u
- C5 4u7
- C6,10 100n
- C7,8 47n
- C9,11 22u

Semiconductors

- IC1 ZN427
- IC2 4093
- IC3 4013
- IC4 3140
- Q1 BC309
- Q2 BC239

Miscellaneous

PCB, sockets, connectors etc.

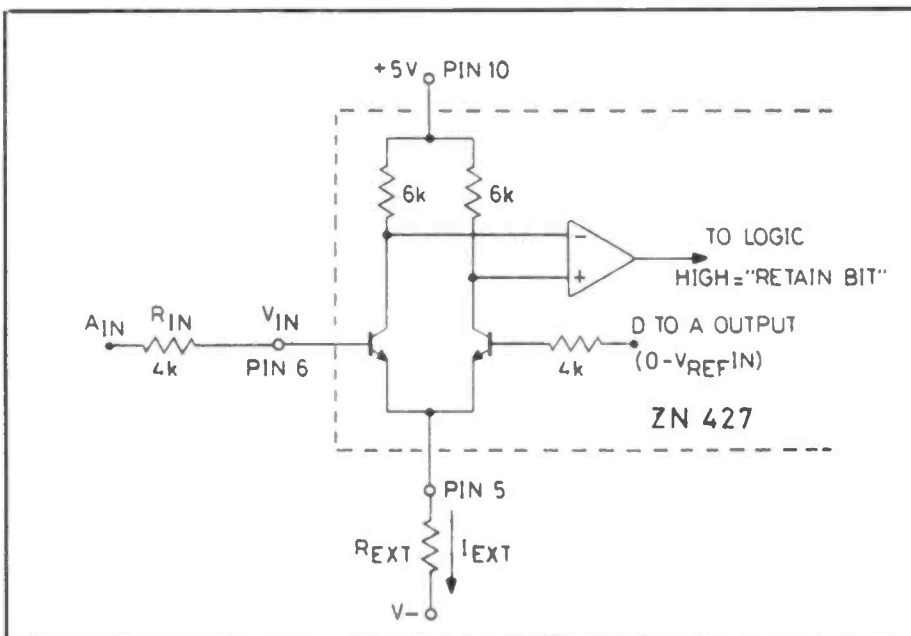

Figure 6: The equivalent circuit of the ZN427's comparator.

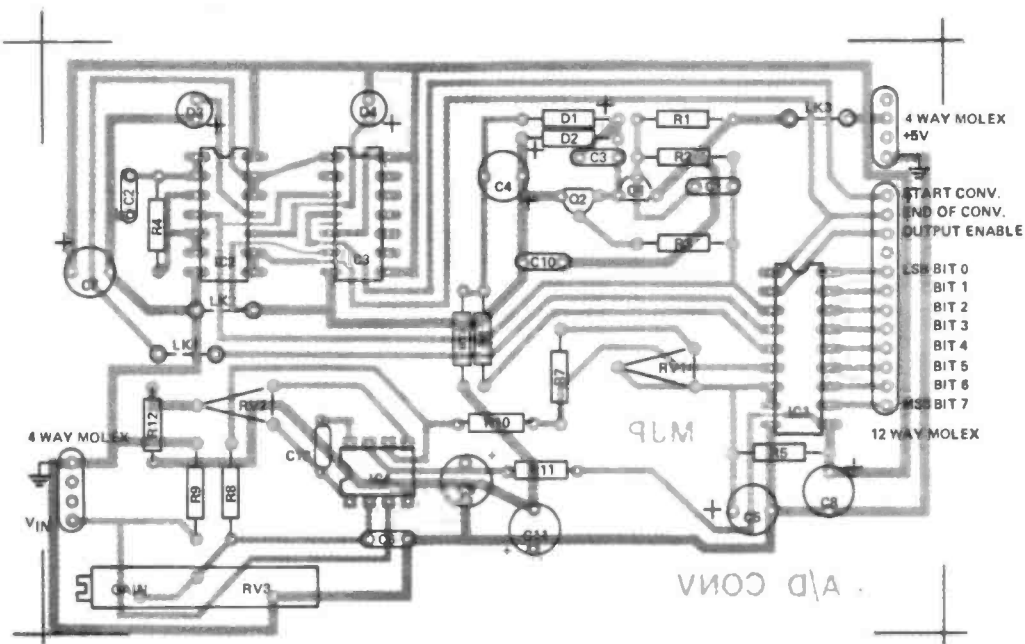
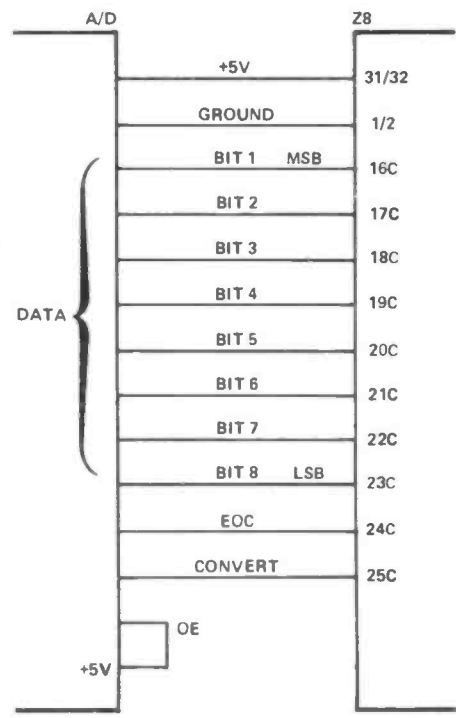

Figure 8: PCB overlay



```

20 REM SIMPLE PROG TO READ
  A/D CARD
30 @ 246 = % IF : @ 247 = %41: REM
  SET-UP PORTS 3 and 2.
40 @ 3 = %10 : @ 3 = 0 : REM
  ISSUE CONVERT PULSE
50 IF AND (@ 3, 8) <> 8 THEN
  50 : REM WAIT
60 PRINT @ 2 : REM PRINT VALUE
  AT 2
70 GOTO 40 : REM AND AGAIN
    
```

Figure 10: Z8 Interface and program

■ R & EW

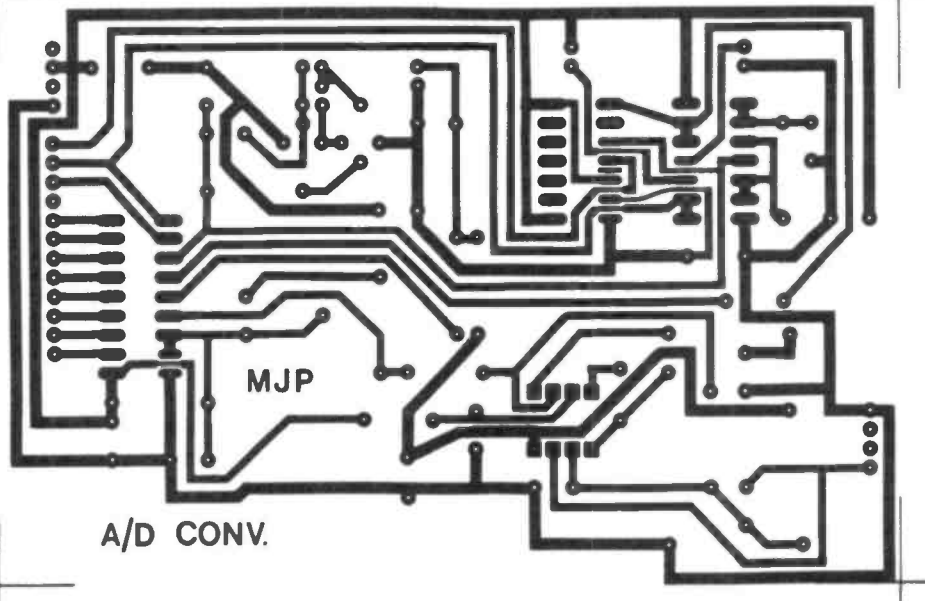

Figure 9: PCB Foil of board

CIRCUIT DESCRIPTION

The circuit diagram of the complete D/A is shown in Fig 7, Figs 8 and 9 give the PCB foil and overlay details.

The 1M ohm pot allows for adjustment of the offset voltage present in the D/A. The clock frequency is provided by the schmitt trigger oscillator formed from IC1a. This clock frequency is then further buffered and applied to the ZN427. Transistors Q1 and Q2 are clocked by the same clock signal and provide a negative charge pump to generate the small amount of negative rail required by IC1 and the op-amp input circuitry.

The 4013 D type latch is used to ensure that the start conversion pulse generated from the

Convert, pulse which may arrive asynchronously, is within the timing spec of the 427. The output enable pin must be held high to prevent the outputs from being tri-stated. The EOC line will go high at the end of a conversion, if EOC is connected to OE then the outputs will always contain valid data.

The conversion is initiated by the falling edge of a positive going pulse on the Convert line.

Input buffering is provided by the 3140 op-amp which may also be used to provide input signal gain.

The supplies to the op-amp are filtered by an RC combination low pass filter to remove signal and clocking noise.

Offset null is provided by the 10k pot, and

should be adjusted to provide 0V output from the op-amp with the input shorted to ground.

INTERFACING

Figure 10 details the interface to a Z8 computer and a BASIC program to generate the start pulse and read the value of the converter. NB line 50 looks to see if the converter EOC is true, with a BASIC program this is not required as the conversion takes place far more rapidly than the Interpreter interprets, however if the program is re-written in machine code then line 50 should also be coded as otherwise false readings may be taken.

Your Reactions.....	Circle No.
Excellent - will make one	72
Interesting - might make one	73
Seen Better	74
Comments	75

DX-TV

GETTING STARTED

Garry Smith and Keith Hamer look at the fascinating world of DX-TV.

FOR YEARS, THE AMATEUR RADIO ENTHUSIAST has known that with the aid of certain types of ionospheric propagation, communication is possible over vast distances. Indeed, this is becoming more readily appreciated by the layman too, following the introduction of CB radio in the UK.

Practically all radio frequencies are influenced by the ionosphere, so it should come as no surprise to *R&EW* readers that television signals can be propagated outside their normal limits, sometimes over several-thousand miles.

In the past, a certain amount of technical expertise has been required for long-distance television reception (DX-TV) since suitable equipment hasn't readily been available. Consequently, the layman could not discover the hobby by accident. Due to the specialised nature of the hobby it has tended to be looked upon with suspicion and sometimes ridicule, unlike the readily accepted radio reception over long distances.

The majority of television viewers have suffered the effects of long-range television signals, perhaps without realising it. The line-pairing effects and distorted pictures that the television broadcasters apologise for during 'abnormal' weather conditions is due to signals extending outside their normal service areas.

HIGH PRESSURE VIEWING

Different frequencies are affected by different forms of propagation. UHF frequencies are influenced by the troposphere, hence the term 'tropospheric propagation'. This type of reception is normally associated with anticyclonic weather conditions (high-pressure systems), occurring during settled periods. Signals tend to be slow-fading and best during the evening or early morning with signals from as far as 600 miles, or occasionally further. Band III (170-230MHz) and Band II (FM radio) frequencies are also affected, with Band I(40-70MHz) to a lesser degree.

Another type of propagation which affects mainly the BBC-1 405-line frequencies (Band I) is Sporadic-E (normally abbreviated to 'Sp.E'). Signals are reflected by patches of ionised gases some 75 miles above the surface of the Earth. Since reflection takes place, a 'skip' or 'hop' distance is involved, typically 700 miles. Very short-skip distances (250 miles or less) are rare. Occasionally the signal is reflected again producing multi-skip reception. Sp.E ionisation occurs mainly between mid-May and late August and was responsible for the 'Continental interference' patterning throughout the summer, although it can occur at any time of the year. 'Openings' are completely random and can present themselves at any time of the day or night. On some days there may be nothing whilst on others there may be several openings. There are times when an opening lasts all day with signals from every direction on every Band I channel.

The FM radio Band II is frequently affected (Eastern European and Italian television services have channels close to this Band), and on rare occasions the lower Band III channels can be received. The 2-metre band is a useful indication of how high the maximum usable frequency (MUF) has risen.

Signals propagated by Sp.E ionisation can vary considerably in strength, even over a period of seconds although the higher the frequency at which reception occurs, the more stable and slower-fading it tends to be. Signals on the lower Band I channels can

very often be strong (signal strengths can be in excess of the local transmitter) but with a reduced video bandwidth. Colour and sound tend to be more easily resolved on the higher channels where the signal is generally stable..

SEEING SPOTS.

Another form of propagation which has allowed the TV-DX enthusiast to experience extremely long-distance reception is 'F2-Layer propagation'. This is dependent upon high sunspot counts, peaking every 11 years, although it is thought that an extremely high MUF occurs every 22 years. Since the reflecting layer is some 250 miles above the Earth, reception of transmitters located over 6,000 miles away has been possible. Australian transmitters have been received many times during the 1980-81 peak in the UK. Maximum activity has occurred during November to February with very strong signals from the East and West but weaker ones from the African continent Trans-Equatorial skip(TE) has permitted reception of several African countries, on a fairly regular basis, for several years. Both F2 and TE propagation suffer from multiple images and reduced video bandwidth, although sound and colour have been detected on rare occasions. Frequencies affected have been the lower Band I channels, around 50MHz.

EQUIPMENT REQUIRED

To resolve a transmission from another country, a receiver capable of covering the necessary frequencies, or Bands, as well as the particular system in use, is required. Television broadcasting throughout the world takes place on channels grouped into broadcast bands. Band I covers 40-70MHz, approximately. Band III is 170-220MHz, whilst Bands IV and V cover the UHF spectrum, 470MHz - 860MHz vision. Sometimes, channel allocations are non-standard and fall between bands, for example, Eastern Europe has three television channel allocations between 77MHz and 94MHz.

There are several variables in television standards, i.e., the number of scanning lines, AM or FM intercarrier sound, channel bandwidth, sound and vision spacing, vision modulation (positive or negative), and colour system (PAL, SECAM or NTSC). The

Channel	Vision Carrier (MHz)	Television Transmission System	Remarks
B2	51.75	"A"	"B" channels are used by the UK 405-line system. The sound channel is 3.5MHz below the vision carrier frequency.
B3	56.75		
B4	61.75		
B5	66.75		
E2	48.25	"B"	"E" channels are used by Western European countries (except France) such as Spain, Norway and West Germany. An additional channel E2a (49.75MHz) is used by Austria. The sound channel is 5.5MHz above the vision carrier frequency.
E3	55.25		
E4	62.25		
IA	53.75	"B"	"I" channels are used in Italy. Channel IC is also used by Albania. The sound channel is 5.5MHz above the vision carrier frequency.
IB	62.25		
IC	82.25		
R1	49.75	"D"	"R" channels are used by Eastern European countries i.e. Poland, Hungary, Czechoslovakia, Rumania, Bulgaria and the USSR. The sound channel is 6.5MHz above the vision carrier frequency.
R2	59.25		
R3	77.25		
R4	85.25		
R5	93.25		

Table 1: Vision Frequencies of Bands I and II Television Channels.

UK system at UHF is 625 lines, FM intercarrier sound with 6.0MHz spacing, 8.0MHz channel band width, negative-going vision modulation and PAL colour. The UK system at VHF (Bands I and III) is 405 lines scanning, AM sound with 3.5MHz spacing, 5.0MHz channel bandwidth and positive-going vision modulation. Dual-standard receivers in this country were necessary due to the incompatibility of the two systems.

Many countries adopted a 625-line system right from the start, with FM intercarrier sound and negative-going vision modulation. The only switching necessary was between broadcasting Bands I, III and later IV and V. The sound and vision spacing is a little different from that used in the UK. In general, Western Europe, the Middle East, India, Australasia and Africa have a 5.5MHz spacing whereas in Eastern European countries a separation of 6.5MHz is employed. The colour system in use (PAL or SECAM) usually depends upon the politics of various countries. France still has a dual-standard service. On VHF, 819 lines scanning, AM sound and positive vision modulation is used with a huge 14MHz channel bandwidth. On UHF, 625 lines scanning is used with AM sound (6.5MHz spacing), positive vision modulation and SECAM colour. Japan, the USA, Canada and countries with an American influence have a 525-line system, FM sound with 4.5MHz spacing, negative vision modulation and NTSC colour. This system is used on all Bands.

Most of the reception encountered in the UK will be 625 lines with negative-going vision. The FM intercarrier sound will be either 5.5MHz or 6.5MHz. Apart from the sound and vision spacing, this type of television system is similar to the UK 625-line one, except that transmissions take place in Bands I and III as well as UHF.

VISION IS EASY

Assuming the normal domestic television aerial points towards the Continent, during a good tropospheric opening it should be possible to receive foreign pictures, sometimes in colour, by simply tuning through the UHF channels on a standard UK receiver. The sound channel will not be resolved of course since the UK standard has a 6.0MHz spacing. It should be possible to re-align the intercarrier sound stage to resolve the Continental sound on some receivers although later intercarrier circuitry makes use of fixed ceramic filtering set to 6MHz. Fortunately, 5.5MHz filters are available.

Possibly the easiest way of resolving foreign transmissions on Bands I and III channels is to purchase one of the many small-screen portables available. The Plustron TVR5D, for example, has switchable sound to enable the selection of 6.0MHz or 5.5MHz intercarrier sound. A receiver having coverage in Bands I and III usually has a tuning scale marked channels '2-4'(Band I) and '5-12'(Band III). The band selector switch is often marked 'low VHF'(Band I), 'High VHF'(Band III) and 'UHF'. Colour receivers are available too, and one in particular is the JVC CX-610 GB.

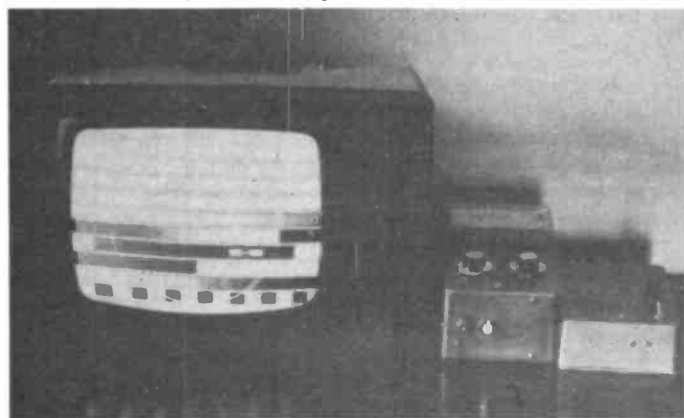

Photo 1: A compact DX-TV receiving system, using a standard UK portable receiver. The multi-band DX tuner is seen to the right of the receiver. The output of the tuner unit feeds an i.f. frequency conversion unit (far right) providing an output at around channel 31. The receiver is displaying a test card from Czechoslovakia.

This is a 5-inch multi-standard receiver capable of resolving PAL or SECAM colour transmissions on the UK 6.0MHz, Western European 5.5MHz and Eastern European 6.5MHz intercarrier systems. Band I tuning extends into the Band II F.M. frequencies, thus permitting reception of certain OIRT (Eastern-bloc countries) channels not found on many European sets. Most large-screen Grundig colour receivers already possess a multi-band tuner but bear in mind that the sound is aligned for the 6.0MHz standard.

FRONT END MODS.

The keen experimenter could modify a standard receiver to provide VHF coverage. Inexpensive varicap VHF tuners are available from mail-order companies such as Manor Supplies or Sendz Components and are usually the ELC 1042 variety - the UHF version being the ELC 1043. Tuners such as the ELC 2000 or 2060 are multi-band and coverage in Band I extends well into the F.M. radio region. All varicap tuners require a stabilised 12V supply for general powering and a stabilised 30V rail from which the tuning voltage (0-30 volts) is derived. A suitable 30V stabiliser is the TAA 550 I.C. which is fitted as standard in most varicap tuning supplies. Band switching is achieved by applying 12V to the appropriate input pin connection on the tuner. Modifications and additions of this type demand a certain level of competency on the part of the individual. It must be stressed that most UK-produced receivers use AC/DC techniques in which the chassis is **live** and any additional controls and switches must be fitted in such a way so that no metal parts are exposed or able to be touched. Battery/mains portables usually have an isolating transformer fitted and therefore have a safe chassis, although internal space may limit the extent of modification. Incidentally, in the interests of maintaining family peace, it is best not to modify the domestic receiver since the head of the house may demand that her 'Crossroads' should take priority over your rare Arabic DX signal!

As the Continental signals will have a wider overall channel and video bandwidth than the 405-line signals, basic modifications such as those described, retaining the wide IF bandwidth, will probably result in poor selectivity. This will be noticeable when trying to resolve signals which are very close to an existing 405-line transmission since the receiver cannot reject the unwanted signal

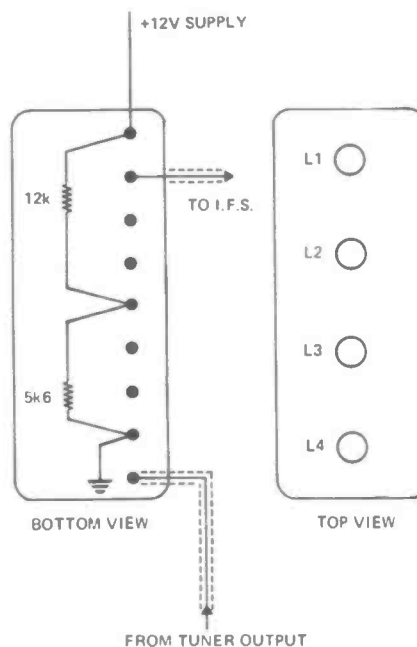

Figure 1: Connection data for the Philips G8 selectivity module. One or more modules may be used to tailor the IF bandwidth and improve overall selectivity. L1, 2, 3 and 4 can be peaked to reduce the IF bandwidth. Adjust using a weak signal. Alternatively, L2 can be adjusted to notch out an adjacent carrier, e.g. to remove channel B4 vision carrier from a weak channel E4 signal. L1, 3 and 4 are then adjusted for optimum results.

very effectively. Reducing the IF bandwidth by tailoring the IF response can work wonders and selectivity modules, such as the Philips G8 type, can be aligned to modify the response IF. The module can be fitted between the tuner output and the IF input. An IF bandpass filter can be connected across the IF input and peaked as necessary to narrow the bandwidth. A signal which is almost lost in the noise and obscured by adjacent channel interference can very often be separated by this arrangement. It should be noted that if the IF bandwidth is decreased, the HF detail in the picture is reduced making a strong signal appear with low definition. The bandwidth can be made switchable for best results. The full bandwidth is necessary, of course, if the sound or colour is required.

DOUBLE STANDARDS

If a dual-standard receiver is available, different sections of the receiver can be made to be switched independently, e.g., Band switching (or switching between the VHF and UHF tuners). This will be the main requirement with the rest of the set in the 625-line wide IF bandwidth position. The IF strip can be made to switch between the narrower 405-line IF bandwidth and the wider 625-line bandwidth to allow a choice of bandwidths and an improvement in receiver selectivity when the 405-line position is chosen. If the vision detector section is made switchable, positive or negative -going vision may be selected, thus allowing the Continental and UK standards or the French standard to be resolved.

For those who lack confidence in receiver modifications of the type described above, there are various other ways of seeing long-distance broadcast television pictures. A device known as an 'upconverter' (it converts VHF frequencies to UHF) may be connected to the aerial input of a single-standard (UHF) British receiver with the DX aerial fed into the input of the device. Tuning is effected by means of the normal receiver tuning controls over a portion of the UHF band. The selectivity of the system will depend upon that of the set. It is possible to feed the IF output of an external varicap tuner into an upconverter, thus converting the IF to a fixed UHF channel. If filtering (e.g. a bandpass filter or a G8 selectivity module, or even two) is connected between the tuner IF output and the upconverter input, a very selective system can be obtained. Unfortunately, an upconverter tends to be rather pricey but an inexpensive UHF video modulator, suitably modified, may be used.

AERIALS

The very mention of long-distance reception tends to conjure up an elaborate aerial system with a variety of amplifiers to boost the signals. This is not so in practice and for experimental Sporadic-E work, fairly simple aerials such as a dipole cut to the middle of Band I, are explored will suffice. If the dipole is cut to the middle of Band I, at say 55MHz, reasonable results will be obtained on most channels. The dipole should be mounted horizontally as most Continental transmissions are horizontally polarised. A reflector can be added behind the dipole to increase its pick-up power.

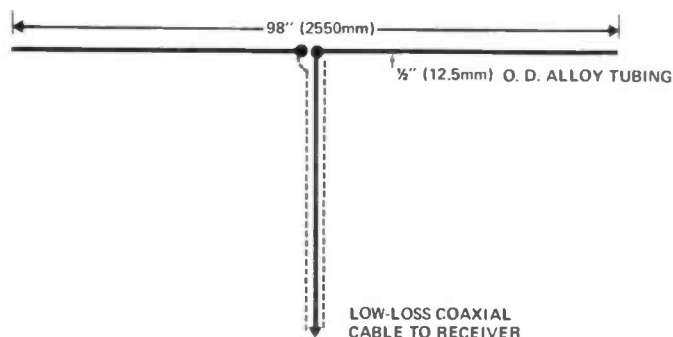

Figure 2: Dipole aerial for Sporadic-E reception cut to the middle of Band I.

Adding elements in front of the dipole increases the overall gain but makes the array more directional, making some form of rotatable system necessary. By cutting the reflector to the lower channel frequencies, the dipole to mid-band and the directors to the higher channels, an array possessing a reasonably wide bandwidth coverage can be obtained over the Band I spectrum. Obtaining the necessary hardware for constructing Band I arrays may prove difficult since aerial manufacturing has been geared up to UHF aerials over the last decade. There are specialists engaged in Band I aerial manufacture and there are worth considering.

Commercially available aerials can be obtained for Band III of the wide-band type (the Jaybeam ABM 11 for example) and there are many systems available for UHF reception. Generally, for a given number of elements, the overall gain for a wide-band system is less than that of a single channel (or grouped) type.

Wide-band aerials are available covering the whole of the UHF spectrum and at first glance this type of system may seem attractive. However, because most follow the Yagi design, the highest gain is on the higher UHF channels and since DX reception is less common towards the upper Band V channels, a grouped system or semi-wideband type for the lower UHF channels may be better. Semi-wideband types normally cover up to channel 48 and are sometimes designated 'Group K'. The Wolsey Colour King is a departure from the Yagi type and is occasionally referred to as a 'bow tie' aerial:

The use of a mast-head aerial amplifier at UHF is recommended, but first a word of warning. Most preamplifiers tend to overload very easily when operated close to transmitters of high field strengths, producing cross-modulation and other spurious effects. The newcomer to TV-DXing is all too easily tempted to use several stages of amplification in the belief that it will procure a DX signal from practically nothing. Experience has shown that unless the amplifier used has a lower noise figure than the tuner in the receiving equipment, it is unlikely to offer any viewable improvement in the signal unless it is used at mast-head to compensate for cable losses.

The use of wideband amplifiers for Bands I and III can be a problem when operating close to local UHF transmitters with the local UHF group appearing in Band I or Band III. Various filtering techniques can be employed in such cases to make the amplifier accept only the band required. For instance, where FM radio breakthrough occurs at the lower end of Band III (channels 6 and 7), the Band III section of a VHF TV diplexer can be connected at the amplifier input to act as a high-pass filter with the Band I input terminated with a 75R resistor.

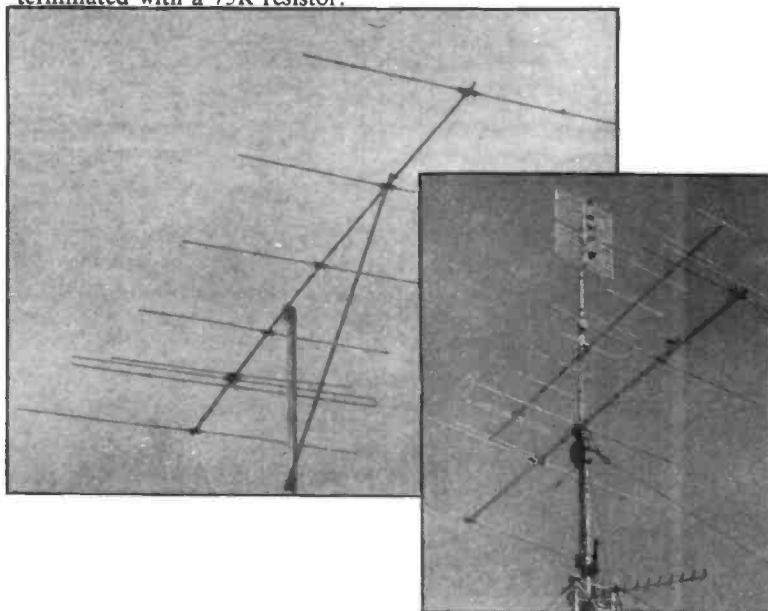
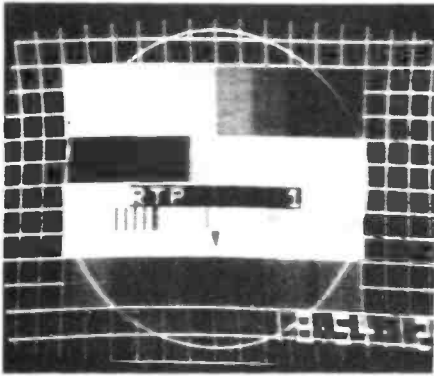
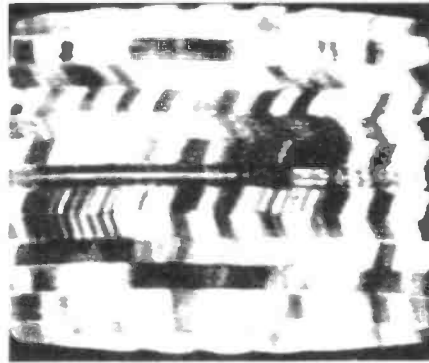

Photo 2: A home constructed 6-element wideband Band I array for Sporadic-E reception mounted at 16 feet. Inset: A typical DX-TV aerial installation employing a Wolsey Colour King UHF array, a Jaybeam ABM11 Band III aerial and home-constructed Bands I/II array. The aerials are fully rotatable.



The FuBK Electronci test card received from RTP-Portugal via Sporadic-E ionization.



The PM5544 test card received on channel E2 from Zimbabw via F2/TE (Trans-Equatorial skip).

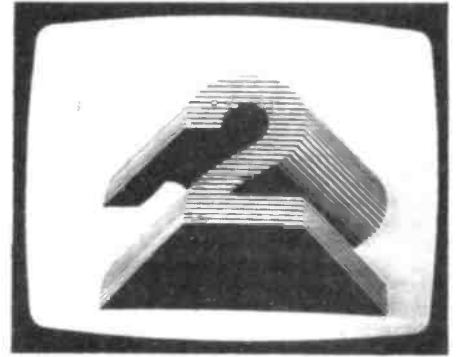

Dutch Second Network identification caption radiated by NOS.

Due to the widespread use, and in certain cases abuse, of CB radio, overloading from the 27MHz carrier can be a problem, especially if an amplifier is used for Band I. The overload can produce a strong harmonic appearing at twice the carrier frequency at around 55MHz or on the Continental channel E3 vision frequency at 55.25MHz. In most cases a simple high-pass filter (see Fig. 1) will reduce the problem. The CB installation in many instances is guilty of radiating harmonics and the use of a low-pass or band-pass filter on the rig concerned should cure this.

To reduce the likelihood of overloading problems in Band I, and bearing in mind that the DX signal can appear stronger than the local transmission, we personally recommend that a mast-head amplifier is not used for Band I. However, the installation of good quality low-loss coaxial cable is recommended for all bands to preserve as much of the original signal as possible without having to resort to unnecessary amplification.

The newcomer is sometimes a little dismayed that, after having built up a DX-TV installation, nothing can be received initially. Sporadic-E reception is by far the most interesting for the novice since most European Band I transmitters can be received. But, as its name suggests, reception is 'sporadic' and it should be emphasised that there are periods during the main annual Sp.E Season when reception is non-existent.

PERMANENT RECORD

Off-screen photography and even video recordings of DX signals (to show the disbeliever!) is a spin-off from the hobby and provides a permanent record of reception.

A written log should be kept noting details of the time, channel, propagation mode, whether a programme or test card, etc for each signal received. A personal appreciation of overall signal strength and quality can be included since the signal usually varies considerable over short periods.

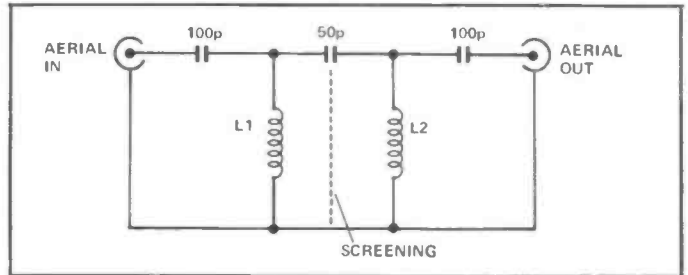

Figure 3: Simple high-pass filter to attenuate signals below Band I. Coil details: L1,L2 3 turns of No. 16 enamelled copper wire. Each coil 1/4" in diameter spaced over

IDENTIFYING SIGNALS.

Identification of DX-TV signals and their origin can be difficult at first but after gaining experience, few difficulties arise. Fortunately, many test cards carry identification of some description, but like test transmissions in the UK, many European test cards are shown for only brief periods. A note should be made of any captions and occasionally the programme content may give an indication of origination. For example, bull fights are shown in great detail on Spanish television just as football is shown relentlessly in the UK.

Weather charts are also useful as an aid to identifying long-distance television reception.

See data brief on page 77 for more information regarding the frequencies and transmission standards of broadcasting authorities around the world.

R & EW

Your Reactions		Circle No.	Circle No.
Immediately Interesting	76	Not Interested in this Topic	78
Possible Application	77	Bad Feature/Space Waster	79

R&E's WORLD

MIKE TURNER



720 CHANNEL AIRBAND RECEIVER

Design by: Keith Mitchell

A fully synthesised design using only eleven ICs and featured very low power

The aeronautical VHF communications band occupies eighteen megahertz of the spectrum from 118 MHz to 136 MHz. This is divided into 720 channels spaced by 25kHz, starting with 118.000MHz and ending with 135.975MHz.

Modulation is A3: amplitude modulation with double sideband and carrier. Very old fashioned, but almost impossible to change now that it is fossilized as an international standard. One of the popular reasons put forward this strange anachronism is the fact that a weak AM signal can be noticed in the background of a strong one-whereas a weak FM distress call might go completely unnoticed when swamped by the capture effect of only a marginally stronger transmission.

Area coverage by a ground station on a single frequency is achieved, when required, by the simple expedient of having three separate ground transmitters.



The receiver in situ at Stantead Airport's Control Tower.

One transmission exactly on frequency, one 7kHz high, and the third 7kHz low. The 7kHz heterodyne produced in the receiver is removed by a low pass audio filter. The use of this system, would appear to prevent the powers that be from yet again doubling the number of channels, by halving the channel spacing, as occurred with land mobile radio about 7 years or so ago.

BLOCKS AWAY...

The block diagram shows the configuration of the receiver which is constructed on one printed circuit board containing in total eleven integrated circuits.

The circuit breaks down into four blocks. The RF stage, first local oscillator and mixer stages is an Ambit VHF front end module type EF5402 with a suitable coil set for the frequency range and the AGC externally accessed. The second and third sections contain the synthesizer and the frequency selector logic, while the intermediate frequency and audio stage complete the system.

Figure 1: Block diagram of the receiver.

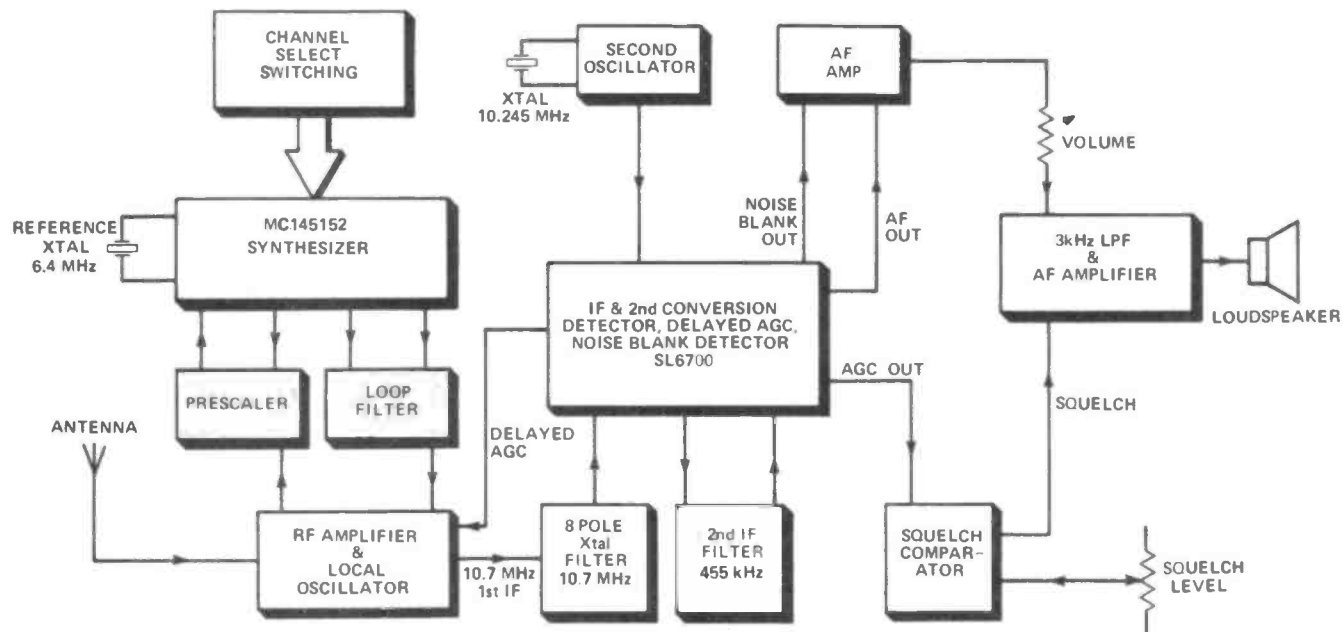

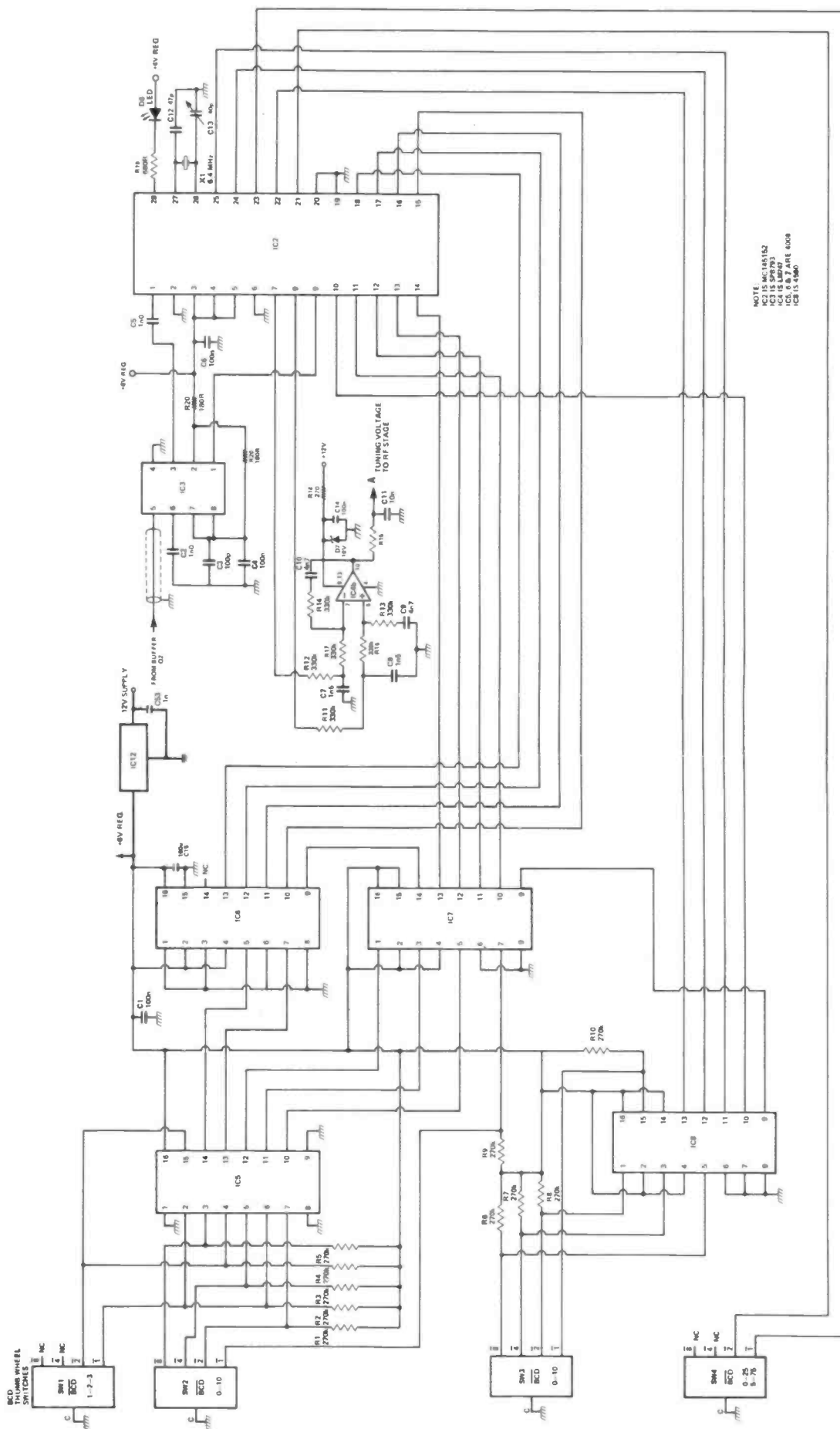
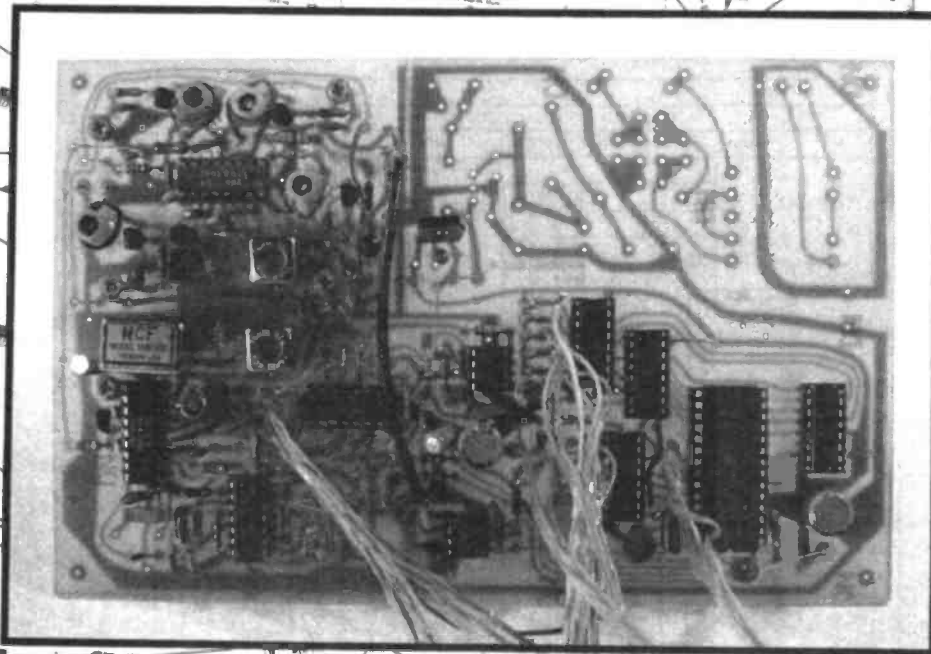

Figure 2: The synthesizer and the frequency selector logic



RF STAGE

Ambt's EF5402 module is based on the AEG TDA1062 IC, which contains a VHF RF amplifier, VHF local oscillator and a double balanced mixer. It also has a buffer transistor for feeding a pin diode at the input for AGC. This IC has a remarkably good dynamic range; an important factor in this application. Tuning is by varactor diodes and each tuned circuit is fed from its own preset potentiometer across the tuning voltage supply. This allows a good frequency range for a small voltage swing, and easy alignment together with first class tracking. Tracking is also improved by the use of an FET source follower, prior to the input to the IC, which reduces the loading on the input tuned circuit. With a proper choice of FET, the noise figure is also improved.

The 10.7 MHz IF output from T1 is at low impedance, suitable for feeding a short length

of miniature coaxial cable leading to the IF and audio stages.

A delayed positive going AGC voltage from the IF stage is directly applied to pin 6 of IC1 from where a transistor in the IC feeds a pin diode across the input.

FREQUENCY SYNTHESISER

For details of the theory involved in frequency synthesis, readers should refer to Ian Campbell's series of articles in Jan, Feb and March R&EW.

The main synthesiser device, IC2, is Motorola's new MC145152. This contains a reference frequency oscillator and divider, phase detector, and programmable divide by N and divide by A counters with an output for controlling a dual modulus prescaler. The prescaler used is Plessey's amazing SP8793, which divides by 40 or 41 with input

frequencies up to 250MHz using only 5mA of supply current. It is the use of these division ratios which makes the switched programming of IC2 relatively simple using thumbwheel or pushbutton BCD complement code switches.

One half of a 747 dual operational amplifier is used as the loop filter. The extra filtration of the 1n5 capacitors on the input help to give a smooth output together with a fast acquisition time. The other half of the 747 is 'loaned' to the IF and audio stages and is used as the mute comparator.

The loop reference frequency is 25kHz, the same as the channel spacing, and is obtained from a 6.4MHz crystal across pins 26 and 27 of IC2. The necessary division by 256 is accomplished in the IC by connecting the programming pins 4 and 5 to supply and 6 to earth as shown in the circuit diagram. The exact frequency is trimmed using the variable loading

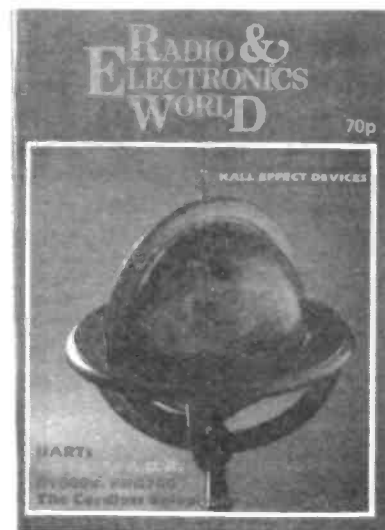
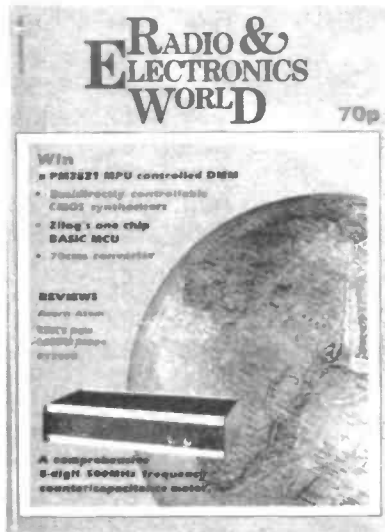
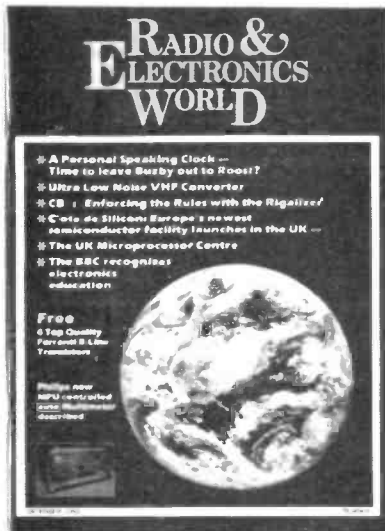

INDEX 1981-2

PROJECTS

A/D Converter	Sept. '82	36
Autobridge	July '82	48
Automatic Modulation Meter - part 1	Nov. '81	58
Automatic Modulation Meter - part 2	Dec. '81	8
CB Deviation Meter	Oct. '81	50
Converter PSU	Mar. '82	83
CB Rig - Part 1	Feb. '82	48
CB Rig - Part 2	Mar. '82	47
CB Rig - Part 3	Apl. '82	47
CB Rig - Part 4	May '82	26
CB Selcall	June '82	38
DC Pre-Amp - Part 1	July '82	56
DC Pre-Amp - Part 2	Aug. '82	38
DFM/Capacitance Meter - Part 1	Nov. '81	30
DFM/Capacitance Meter - Part 2	Dec. '81	42
DFM/Capacitance Meter - Part 3	Jan. '82	30
DMM 3.5 Digit	Jan. '82	9
Electronic Ignition	July '82	11
Frequency Counter	Sept. '82	58
GaAs FET Pre-Amp	Aug. '82	34
Higher Fidelity - Part 1	Oct. '81	66
Higher Fidelity - Part 2	Nov. '81	79
Higher Fidelity - Part 3	Dec. '81	70
In-Car Security Alarm	Mar. '82	63
Key-Pad Security Lock	Apl. '82	83
Mains Timer - 2 Channel	June '82	29
Mini-Drill Controller	Sept. '82	20
Multiband Up Converter	Aug. '82	75
Noise Squelch	Sept. '82	73
ph Meter	May '82	59
Power Booster 18W	Aug. '82	11
PSU 0-30V	June '82	59
Radiation Monitor	Apl. '82	12
Radio Control Receiver	July '82	70
Radio Control Transmitter	June '82	11
'Rewbichron' MSF Clock	Apl. '82	54
RS232 A-D-A Converter	Dec. '81	28
Simple DVM	Nov. '81	67
SSB Exciter	July '82	28
State-of-The Art 2m Receiver	Oct. '81	32
Time Code Receiver	Oct. '81	79
TV Antenna Selector	Feb. '82	61
TV Masthead Amplifier	Jan. '82	73
TV Pattern Generator	Feb. '82	61
TV Splitter/Distributor	May '82	31
UHF Receiver Converter	Nov. '81	10
Universal Logic Probe	Dec. '81	66
UOSAT Receiver	May '82	12
Voyager In-Car Computer	May '82	46
'Watervole' - Part 1	Oct. '81	71

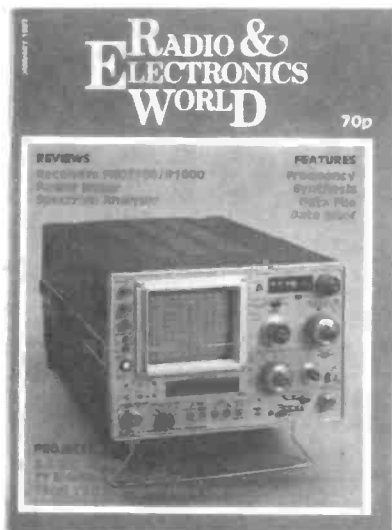

'Watervole' - Part 2
 We Speaking Clock
 Wind Speed & Direction Indicator
 Z-8 Development System - Part 1
 Z-8 Development System - Part 2
 Z-8 Development System - Part 3
 Z8 Start-Up Board
 ZX81 Expansion Board
 ZX81 Keyboard Upgrade
 720 Air Band Receiver
 4/6/10m Pre-Amp
 23cm/2m/10m Converter
 70cm Pre-Amp
 70cm 2m/TV Converter
 2 Metre Pre-Amp
 2m Power Amplifier
 2m PA

Nov.	'81	47
Oct.	'81	16
Aug.	'82	47
Feb.	'82	12
Mar.	'82	12
Apl.	'82	31
July	'82	79
Aug.	'82	67
June	'82	52
Sept.	'82	44
Sept.	'82	10
Mar.	'82	77
Mar.	'82	37
Jan.	'82	60
Apl.	'82	74
June	'82	76
Dec.	'81	60



FEATURES

Amateur Radio - What It's About
 ASC11 LCD Display System
 CD4017B Applications File
 Circuit Blocks - IR Link & Nicad Charger
 Circuit Blocks - ZX81 Eeprom Programme
 Circuit Blocks - Smart Lamp Dimmer
 Circuit Blocks - In Circuit Tester
 Circuit Blocks - Multi-standard TV IF
 Cordless Telephones
 Data Brief - Mosfets for VHF/UHF
 Data Brief - LC7137
 Data Brief - TDA1083
 Data Brief - TK10321
 Data Brief - MC145151
 Data Brief - ULN2283B
 Data Brief - KB4417
 Data Brief - KB4413
 Data Brief - KB4412
 Data Brief - ULM2240
 Data Brief - MC3359
 Data Brief - LM1035
 Data Brief - HA12017
 Data Brief - Ferrite Cross Check
 Data Brief - LH1605
 Data Brief - KB4436
 Data Brief - 4448
 Data Brief - European TV Standards
 Data Brief - Power Measurements
 Data File No. 1 - Power Supplies
 Data File No. 2 - Waveform Generation
 Data File No. 3 - 22 CMOS Circuits
 Data File No. 4 - Comparators and Windows
 Data File No. 5 - 32 Useful Circuits
 Data File No. 6 - Delay lines
 Data File No. 7 - SCR Circuits
 Data File No. 8 - Practical SCR/Triac Circuits
 Data File No. 9 - DC Motors Controlled
 Data File No. 10 - DC Motors Controlled
 Data Sheet: Receiver Performance Parameters
 Design Ideas

Dec.	'81	84
Apl.	'82	61
Mar.	'82	53
May	'82	66
June	'82	69
July	'82	36
Aug.	'82	22
Sept.	'82	66
Dec.	'81	17
Dec.	'81	15
Jan.	'82	21
Feb.	'82	33
Feb.	'82	33
Mar.	'82	25
Mar.	'82	39
Apl.	'82	27
Apl.	'82	39
May.	'82	37
May.	'82	71
June.	'82	17
June.	'82	57
July	'82	17
July	'82	74
Aug.	'82	15
Aug.	'82	73
Sept.	'82	77
Sept.	'82	78
Sept.	'82	78
Dec.	'81	23
Jan.	'82	25
Feb.	'82	77
Mar.	'82	93
Apl.	'82	92
May	'82	76
June	'82	80
July	'82	81
Aug.	'82	80
Sept.	'82	84
Feb.	'82	67
Oct.	'81	44

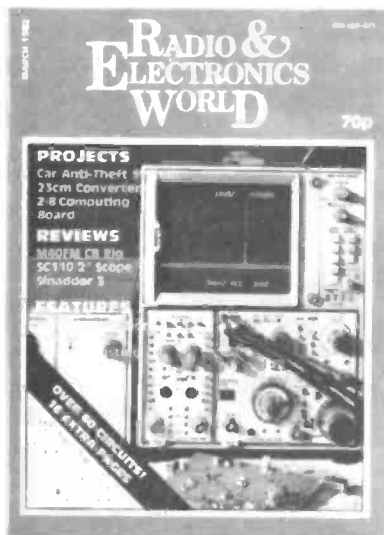
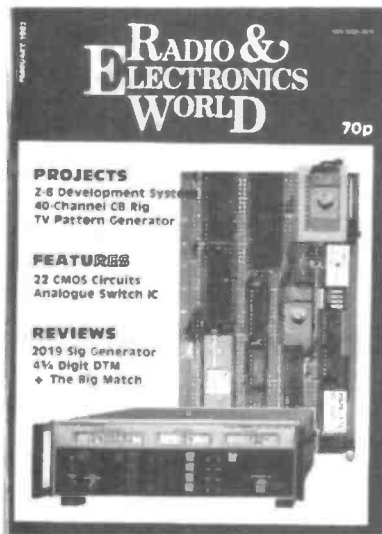

4748 1872

RADIO & ELECTRONICS WORLD

70p



RADIO & ELECTRONICS WORLD

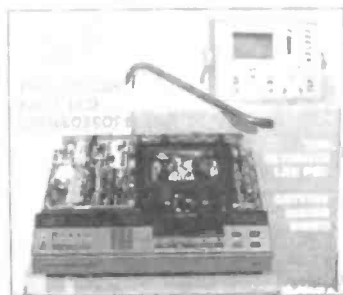

Z8015 Keyboard and Mouse Programmer
 16 Channel 12-bit A/D Converter
 Remington-Minor 40 Laser-Printer System

C28016 New 128K Microcomputer
 EPIC071 Personal Microcomputer
 A DEC run 4-19821 Audio Processor

Doppler DF System - Part 1
 Doppler DF System - Part 2
 DX-TV Starting Out
 Feedback - project Mods and Up-Dates
 Gate Turn Off SCR's
 Hall Effect
 Helical Filter Design
 Low Cost GaAs FETS
 Metal Detectors In Medicine
 Meteostat
 Motorola's 60MHz CMOS Synthesiser Devices
 PLL Frequency Synthesis - Part 1
 PLL Frequency Synthesis - Part 2
 PLL Frequency Synthesis - Part 3
 Power Mosfets - Part 1
 Power Mosfets - Part 2
 Power Supplies
 Satellite TV Broadcasting - Part 1
 Satellite TV Broadcasting - Part 2
 Satellite TV Broadcasting - Part 3
 Selcall Update
 Using The RS232
 Using UARTS - Part 1
 Using UARTS - Part 2
 Using UARTS - Part 3
 Video Recorders Explained
 What Do We All Do If the Bomb Drops...?
 Which Computer Do I Buy
 Wldeband RF Transformers
 ZX81 Display File Explained
 ZX81 Histograms
 12 Rig CB Review

June	'82	46
July	'82	21
Sept	'82	40
Feb.	'82	72
Sept.	'82	24
Dec.	'81	38
Jan.	'82	67
Aug.	'82	63
Apl.	'82	36
Aug.	'82	42
Nov.	'81	55
Jan.	'82	70
Feb.	'82	39
Mar.	'82	29
June.	'82	65
July	'82	32
July	'82	54
Mar.	'82	69
Apl.	'82	68
May.	'82	52
July	'82	37
Jan.	'82	57
Dec.	'81	56
Jan.	'82	34
Mar.	'82	74
June	'82	22
Oct.	'81	54
July	'82	40
Aug.	'82	17
Aug.	'82	28
Dec.	'81	27
Apl.	'82	77



REVIEWS

Acorn Atom
 Amstrad's CB 900 / 1
 Books
 Books
 Books
 Books
 Books
 Books
 Books
 Books
 Cambridge Superkit
 Casio FX900 Computer
 Codecall 4096
 C58 Transceiver
 DNT
 DR600
 First Impressions of the BBC Computer
 FT290R - Pros & Cons.
 Genie 11
 GSC 2001
 HAI 2002 Explained
 Hitachi VCR
 ICOM IC290
 ICOM IC25

Nov.	'81	64
Dec.	'81	88
Oct.	'81	88
Dec.	'81	92
Jan.	'82	86
Feb.	'82	88
Mar.	'82	104
Apl.	'82	106
May	'82	90
Aug.	'81	61
May	'82	34
June	'82	43
Apl.	'82	18
Sept.	'82	56
June	'82	68
Oct.	'81	28
Nov.	'81	36
June	'82	44
Aug.	'82	30
Nov.	'81	72
Sept.	'82	70
Aug.	'82	52
Aug.	'82	55

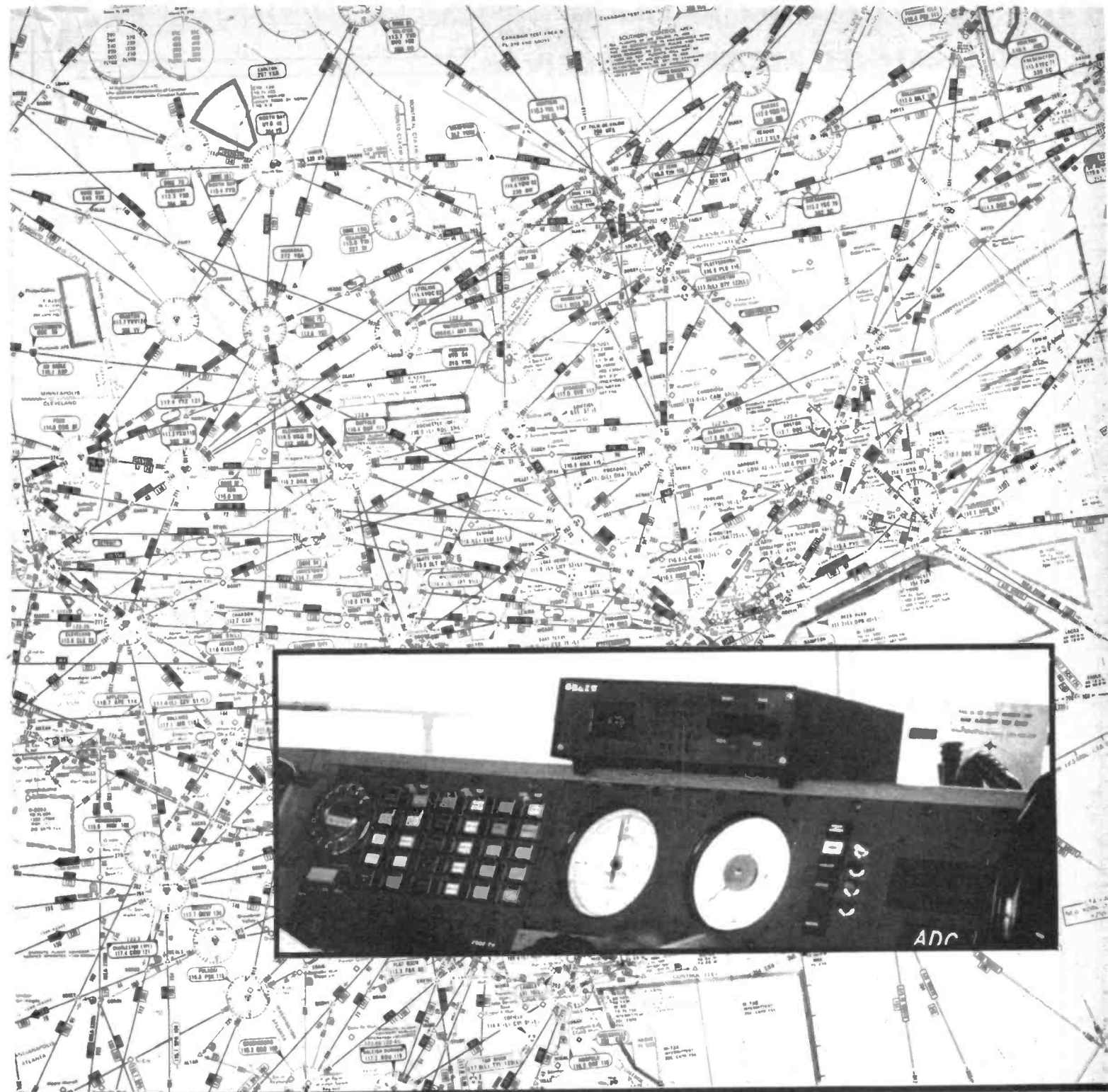

capacitor at pin 26.

The total division value required by the programmable divider is Local Oscillator (LO) frequency in MHz-which is the same as 40 x local oscillator frequency. Ian Campbell's February article shows that the total division ratio of a dual modulus counter is: $(N \times M) + A$

...where M and $(M + 1)$ are the prescaler division ratio, N is the number programmed into the divide by N counter, and A the number in the divide by A counter.

Using a divide by 40 and 41 prescaler then requires the divide by N counter to be programmed with the binary number representing the number of whole MHz required, and the divide by A counter to have the decimal part of the frequency in the binary equivalent of from 0 to 40.

All that is now required is to convert the

output of the BCD code switches used for frequency selection to binary numbers to feed the synthesizer programmable dividers after first adding the 10.7MHz IF offset.

CMOS binary adders type 4008 (ICs 5, 6, 7 & 8) and a BCD adder type 4560 (IC8) do this job. Consider first the whole numbers of MHz. These are represented by the outputs from switches SW1 and SW2. SW2 gives a binary output of the numbers from 0 to 10, and these are fed to the binary adder IC5 (except for the 1 output which is unaffected by the addition process). SW1 only uses the 1, 2 and 3 switch positions representing 10, 20 and 30, and the 1 and 2 outputs are wired as 1010 (Binary 10) and 10100 (Binary 20) to IC5.

The outputs from IC5 are fed to ICs 6 and 7 together with the 1 output from SW1. Binary 100 (1100100) is hard wired to IC6 and IC7 'B' inputs as is Binary 10 (1010) for the integer of

the IF offset. The outputs from IC6 and IC7 go to the programming inputs of the divide by N counter of IC2 in the main synthesiser section.

SW3 and SW4 select the decimal part of the required frequency, and IC8-a BCD adder-is used to add seven (Binary 0111) to SW3 output-the remainder of the IF offset. SW4 is required to give a binary output of 0 to 3 (0 to 11) so it is modified (with Letraset?) to read 0-2-5-7 instead of 0-1-2-3, representing 0, 25, 50 and 75 kHz. The outputs from SW4 and IC8 go to the divide by A counter inputs of IC2 except for the carry out output of IC8, which goes to the carry in input of IC7.

All the IC2 programming inputs have pullup resistors internally in the IC, so SW4 requires complementary binary outputs, with the common terminal connected to ground. To simplify purchasing, BCD code switches with

720 CHANNEL AIRBAND RECEIVER

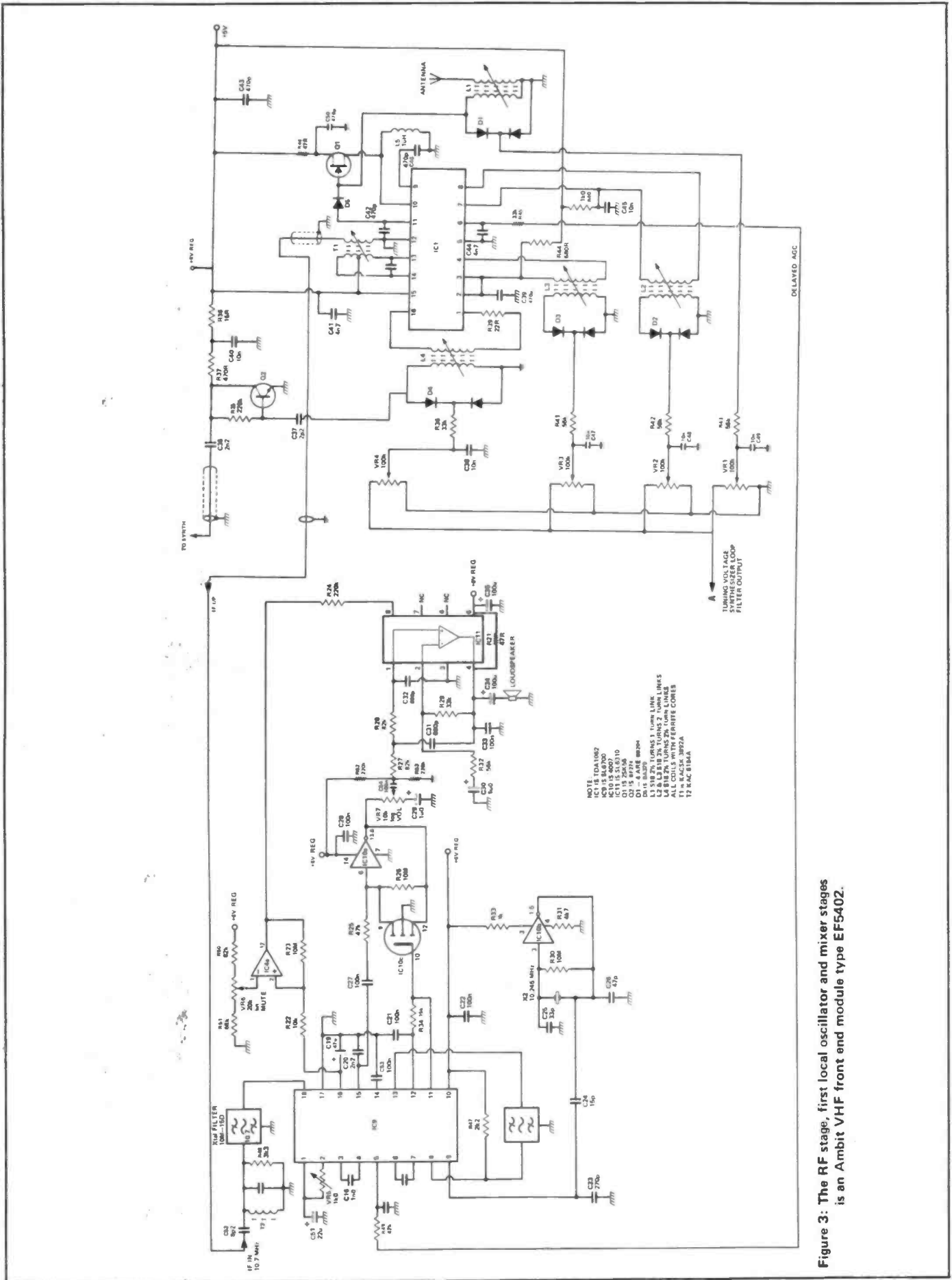
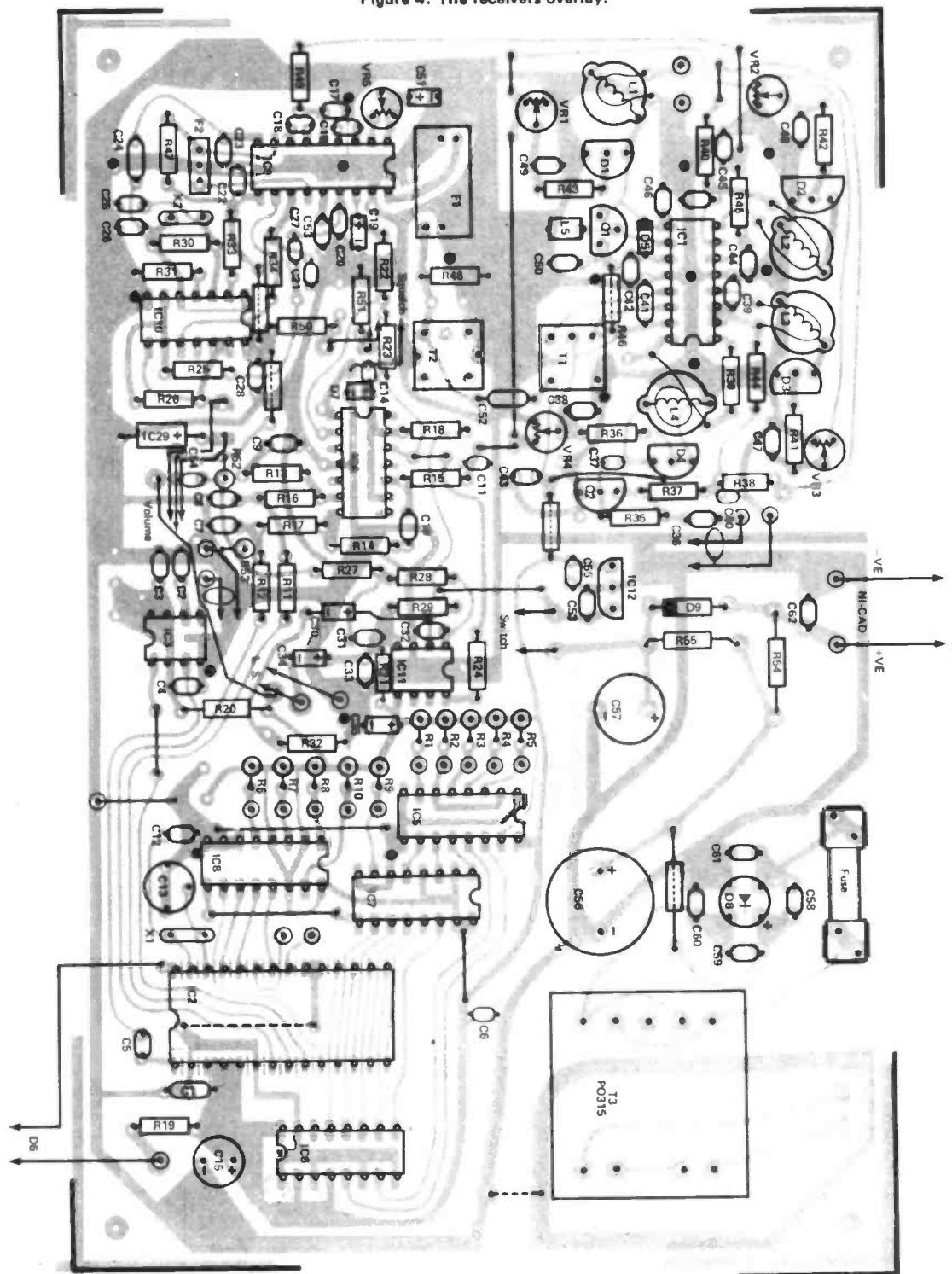

Figure 3: The RF stage, first local oscillator and mixer stages is an Ambit VHF front end module type EFS402.

Figure 4: The receivers overlay.



complementary outputs were used for SW1 to SW4, pull-up resistors being fitted at the necessary IC5, IC7 and IC8 inputs.

It is possible to select out of band frequencies with the switches, and a signal which could be used to mute the receiver in these circumstances can be obtained by 'and'-ing IC5's carry out and S1's outputs and 'or'-ing SW1's 2 output with SW2's 8 output.

INTERMEDIATE FREQUENCY AND AUDIO STAGES

The intermediate frequency stage is a dual conversion system with a 455kHz second IF.

It uses a Plessey SL6700 IC (IC9) which contains two AGC controlled amplifiers, a double balanced mixer, a linear detector, and AGC generator with a controllable positive going delayed output, and a noise detector with a presettable monostable output. The main selectivity in the receiver is provided at the input to IC9 by an 8 pole crystal filter type 10M-15D. This has a 10.7 MHz tuned circuit at its input, with an adjustable core to tune out the input reactances at the filter, and give a ripple free passband.

The filter output is directly coupled to pin 18 of IC9, and as long as the stray capacitance

is minimised, should be well matched. 1nO capacitors couple the 10.7MHz IF amplifiers at pins 3 and 4 and the IF to mixer input from pins 6 to 7.

10.245MHz second local oscillator output from IC10 is injected at pin 9, and the mixer output passes through the 455kHz IF filter to the detector input at pin 13. A 1k Ω preset resistor from pin 1 to pin 2 adjusts the delay on the delayed AGC output at pin 5, which is fed through an 82k resistor to the AGC input on the RF board.

IC 10 is a 4007 used in an unintended role as a versatile array of MOSFETS. One pair of

Figure 5: The board's foil pattern.

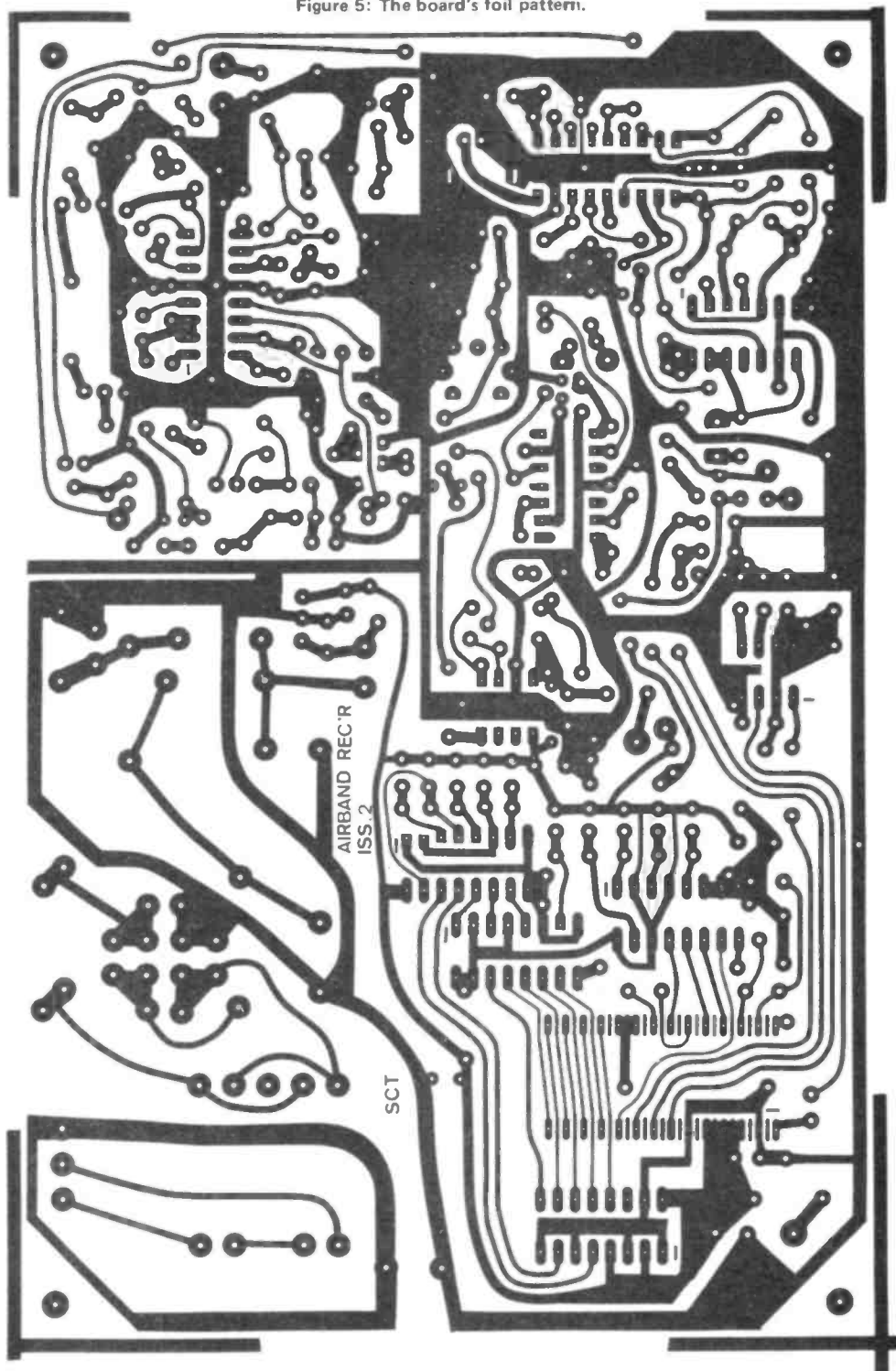

complementary devices is used as a crystal oscillator for the second local oscillator using the usual circuit, but with 4k7 source and drain resistors to reduce power consumption and frequency drift. A second complementary part is used as a linear audio amplifier, with the remaining N channel device wired across the feedback resistor, so as to cancel the gain when switched on by the noise blanking monostable output of IC9, (Pin 11) going positive. A further improvement in pulse interference noise is obtained by limiting in the IC10 CMOS amplifier. Any distortion produced by this is of a 'soft' nature, and is made even less obtrusive by low pass filtering in the output stage.

The audio output from IC10 passes through the volume control to IC11, a Plessey SL6310. This is a power operational amplifier with a muting facility, and uses only half a milliamp of supply current when muted. As it is configured as an operational amplifier, it is easy to combine low pass filtering with the power amplification, and the circuit is designed for a cut-off frequency of 3kHz. Muting is accomplished by taking pin 8 of IC11 high and a comparator is made from the other half of IC4 dual operational amplifier to do this. It is fed from pin 16 on IC9 which is the connection for the AGC time constant capacitor, and the other input is the mute

control, a potentiometer across the regulated power supply.

Part two next month will describe the alignment of the receiver.

R & EW

Your Reactions.....	Circle No.
Excellent - will make one	96
Interesting - might make one	97
Seen Better	98
Comments	99

S.E.M. UNION MILLS, ISLE OF MAN

Tel: MAROWN (0624) 851277

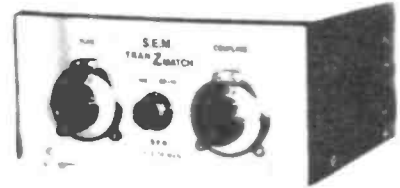

Our equipment is in use in over 100 countries.

SENTINEL AUTO 2 METRE or 4 METRE PRE-AMPLIFIER

Uses a neutralised strip line Dual Gate MOSFET giving around 1dB N.F. and 20dB gain, (gain control adjusts down to unity) and straight through when OFF. 400 W P.E.P. through power rating. Use on any mode. 12V 25mA. Sizes: 1½" x 2½" x 4" £28.00* Ex stock.

PA5 Same specification as the Auto including 240 V P.S.U. £33.00*.

SENTINEL STANDARD 2 METRE or 4 METRE PRE-AMPLIFIER

Same specification as the Auto (above) less R.F. switch. £15.00* Ex stock.

PA3 Same specification as the Sentinel Auto above. 1 cubic inch p.c.b. to fit inside your equipment. £10.00 Ex stock.

70cm versions of all these (except PA5) £4.00 extra. All ex stock.

NEW SENTINEL 2 METRE LINEAR POWER AMPLIFIER/PRE-AMP

These units now feature either POWER AMP alone or PRE-AMP alone or BOTH or STRAIGHT THROUGH. Plus a gain control on the pre-amp from 0 to +20dB. Noise figure is around 1dB using a neutralised dual gate mosfet.

The power amplifiers use the latest infinite S.W.R. protected transistors with AIR LINE circuits to give highest power gains. Ultra LINEAR for all modes and R.F. or P.T.T. switched. 13.8 V nominal supply. SO239 sockets.

Three Models:

1. SENTINEL 35 Twelve times power gain. 3W IN 36W OUT. 4 amps. Max. drive 5W. 6" x 2½" front panel, 4½" deep. £62.50 Ex stock.
2. SENTINEL 50 Five times power gain. 10W IN 50W OUT. Max. drive 16W 6 amps. Same size as the Sentinel 35. £74.50 Ex stock.
3. SENTINEL 100 Ten times power gain. 10W IN 100W OUT. Max. drive 16W. Size: 6½" x 4" front panel, 3½" deep. 12 amps. £100 Ex stock.

All available less pre-amp for £8.00 less.

S.E.M. TRANZMATCH

The most VERSATILE Ant. Matching system. Will match from 15-5000 Ohms BALANCED or UNBALANCED at up to 1kW. Link coupled balun means no connection to the equipment which can cure TVI both ways. SO 239 and 4mm connectors for coax or wire feed. 160 10 metres TRANZMATCH £89.60. 80 10 metres £62.60. EZITUNE built in for £19.50 extra. (See below for details of EZITUNE). All ex stock.

3 WAY ANTENNA SWITCH 1Kw SO239s £15.00 Ex stock.

S.E.M. 2 METRE TRANZMATCH

5½" x 2" front panel, 3" deep. SO239s £25.30 Ex stock.

S.E.M. EZITUNE

Clean up the bands by tuning up without transmitting.

Connects in aerial lead, produces S9 + (1 - 170MHz) noise in receiver. Adjust A.T.U. or aerial for minimum noise. You have now put an exact 50 Ohms into your transceiver. Fully protected, you can transmit through it, save your P.A. and stop QRM. £25.00* Ex stock.

S.E.M. AUDIO MULTIFILTER

To improve ANY receiver on ANY mode. The most versatile filter available. Gives "passband" tuning, "variable selectivity" and one or two notches. Switched Hi-pass, Lo-pass, peak or notch. Selectivity from 2.5KHz to 20Hz. Tunable from 2.5KHz to 250 Hz. PLUS another notch available in any of the four switch positions which covers 10 KHz to 100 Hz. 12 V supply. 12 V supply. Sizes: 6" x 2½" front panel, 3½" deep, all for only £57.00 Ex stock.

SENTINEL AUTO H.F. WIDEBAND PRE-AMPLIFIER 2-40 MHz, 15dB gain. Straight through when OFF. 9-12 V. 2½" x 1½" x 3". 200W through power. £19.55* Ex stock.

SENTINEL STANDARD H.F. PRE-AMPLIFIER

Same specification as above pre-amp but with no R.F. switching. £12.62* Ex stock.

S.E.M. IAMBIC KEYS

The ultimate auto keyer using the CURTIS custom LSICMOS chip. Tune and sidetone Switching. £34.50 Ex stock. Twin paddle touch key. £12.50 Ex stock.

FREQUENCY CONVERTERS. SENTINEL D.G. MOSFET 2 or 4 metre converters N.F. 2dB, Gain 30dB, 1 F.S. 2-4, 4-6, 28-30 MHz 9-12V. £24.73 Ex stock.

SENTINEL 'X' 2 METRE CON. Same as above plus mains power supply £28.80 Ex stock.

SENTINEL LF. 10KHz-2 MHz IN. 28-30 MHz OUT. £20.80 Ex stock.

SENTINEL TOP BAND 1.8-2.3 MHz IN. 14-14.5 MHz OUT. £20.80 Ex stock.

12 MONTHS COMPLETE GUARANTEE INCLUDING ALL TRANSISTORS.

Prices include VAT and delivery. C.W.O. or phone your credit card number for same day service.

* Means Belling Lee sockets, add £1.90 for SO239s or BNC sockets. Ring or write for more information. Place orders or request information on our Ansaphone at cheap rate times.

172 for further details

SABTRONICS

"Making Performance Affordable"



DAROM SUPPLIES Dept AR1
4-6 Sandy Lane, Stockton Heath,
Warrington, Cheshire WA4 2AY
Telephone (0925) 64764

MULTIMETERS	2010A	2015A	2033	2035A	2037A
Style	Bench	Bench	Hand	Hand	Hand
DC & AC Volts	100uV-1000V	100uV-1000V	100uV-1000V	100uV-1000V	100uV-1000V
DC & AC Current	0.1uA-10A	0.1uA-10A	10uA-2A	0.1uA-2A	0.1uA-2A
Resistance	0.1Ω-20MΩ	0.1Ω-20MΩ	1Ω-20MΩ	0.1Ω-20MΩ	0.1Ω-20MΩ
Basic DC Accuracy	0.1%	0.1%	0.5%	0.1%	0.1%
Display	LED	LCD	LCD	LCD	LCD
Temp Measurement					-50°C-+150°C
PRICE £	71.00	83.00	36.75	62.00	67.00

Carriage £1.00
Express delivery £5.00

ADD VAT on ALL prices. All prices correct at 02.02.82 E&OE

Access Visa

Mains Adaptor
£4.95

Touch and hold probe for DMMs
£13.00

Freq. Meters	8110A	8610A	8610B	8000B
Range	20Hz-100MHz	20Hz-600MHz	10Hz-600MHz	10Hz-1GHz
Sensitivity	30mV	<150mV	<30mV	<35mV
LED Digits	8	8	9	9
Max Resolution	0.1Hz	0.1Hz	0.1Hz	0.1Hz
PRICE £	67.00	82.00	99.00	155.00

173 for further details

Hitachi Oscilloscopes

performance, reliability, exceptional value and immediate delivery!

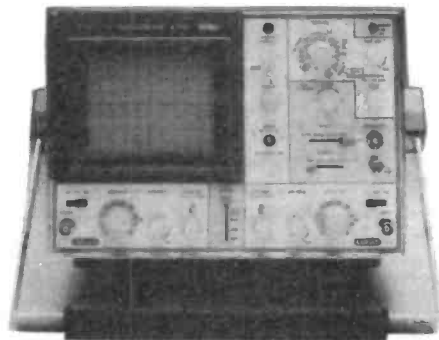

Hitachi Oscilloscopes provide the quality and performance that you'd expect from such a famous name, in a range that represents the best value for money available anywhere.

- | | |
|--------------------------------------|--|
| V-152 15MHz Dual Trace | V-650 60MHz Dual Trace, Dual Timebase |
| V-202 20MHz Dual Trace (Illustrated) | V-1050 100MHz Quad Trace, Dual Timebase |
| V-302 30MHz Dual Trace | Available soon:- |
| V-352 35MHz Dual Trace | V-209 20MHz Dual Trace, Battery Portable |
| | V-509 50MHz Dual Timebase, Portable |

Prices start from around £230 and we hold the range in stock for immediate delivery.

For colour brochures giving detailed specifications and prices, ring 0480 63570.

Reltech Instruments 46 High St., Solihull, W. Midlands. B91 3TB

YOU MAY RECALL THE recent review in R&EW of the DNT M40 mobile CB set and that our conclusions were that its performance left more than a little to be desired. The failings were almost all to do with the receiver performance which was, frankly, absolutely atrocious. Although it can sometimes be very useful to have a receiver which allows you to listen to all of the 40 channels simultaneously, it is much more practical to be able to select them one at a time like everybody else. The problem is basically a design fault and to quote from our original review 'a delightfully sensitive first stage is followed by a simple bi-polar mixer of quite indescribably bad performance'. An engineering error of this kind is even more surprising because DNT have such a high reputation for CB sets produced to other European specs. (Although one never knows of course how much this is attributable to natural Tutonic nationalistic



DNT M40S

Supertuned for your protection Review by J L Forrest BSc.

fervour for a home grown product, DNT being a German company which designs its equipment in the Fatherland, but uses Hong Kong production facilities to keep the prices of its products competitive).

The British importers of the DNT equipment, Radiotechnic of Jersey, were aware of the problems with this set almost from day one of legal CB back in November and they immediately set about effecting a cure. The redesigned version, called the DNT M40 Special supertuned by Radiotechnic recently appeared on the UK market. The long delay between identification of the problem and its solution being due partially to the large amount of work that was necessary in a complete front-end redesign of the receiver, and then to the long wait for the specially designed crystal filters to arrive from Japan. The modifications are carried out in the UK by Clearstone,* a company with an extremely high reputation in private mobile radio equipment. Both they and Radiotechnic, are to be congratulated on an extremely successful modification which has certainly been well worth the wait. We have always had a preference for the laid-back European design style typified by the DNT sets. The rather garish appeal of the more extrovert Far East origin products is presumably designed for those customers who judge a piece of equipment's performance by the number of dials and lights it's got. For mobile use particularly the number of controls on the panel should be kept to an absolute minimum since driving a car these days is difficult enough without also trying to work one's way through the front panel of a 'guess which knob does what?' CB set. SMC's OSCAR

1 is a fine example of how excellent performance can be obtained from a set with only three main front panel controls.

The M40 Special also falls into the category of functional rather than impressive in looks. The set is physically identical externally to the original product except that it now has several aluminium self-adhesive stickers attached announcing its Supertunedness by Radiotechnic. A few brief measurements were performed initially in the laboratory to check the function and performance of the set and frankly the results were surprising, since the receiver performance is now nothing short of quite exceptional. Briefly, the receiver sensitivity was found to be better than 90 nanovolts for 10dB quieting with adjacent channel rejection and intermod performance both better than 70dB. These are figures of which a very expensive private mobile radio set would be extremely proud and certainly better than most other CB sets currently available (unless of course YOU know better).

The set was then installed in a car to test its performance under normal operating conditions, which was where the original set had been previously found to be so inadequate. Unfortunately, to a certain extent the modifications appear to have gone from one extreme to the other in that with the new super-duper crystal filters the receiver bandwidth is so narrow that even slightly over-deviated signals cause considerable audio distortion, to the point where breakers using some of the grottier power mics are almost totally unreadable.

This is perhaps not a fair criticism in that the set should not expect to have to received overmodulated copies assuming that all the

other sets transmitting to it conform to the Government's specification. However, in a real world, these things do tend to happen and a small army of rig doctors through the length and breadth of the UK have been responsible for considerable tweaks to many many rigs resulting in at least 50% of the copies on the DNT being somewhat distorted. This is more than compensated for, however, by the sensitivity of the set which seems to pull tiny signals out of almost nowhere and of course emphasises the exceptional advantages of the noise muting inherently obtained from the MC3357 IF decoder, although DNT appear to be one of the only companies using that circuit in the mode for which it was intended. Some rigs noticeably the Cobras going to considerable lengths to effect 'conventional' (i.e. like it used to be done in the days of REAL AM) carrier sensitive squelch control using the 3357 with substantial extra external circuitry. A significant extra benefit of very narrow receiver filtering is that substantial rejection of unwanted AM CB signals and single-sideband signals is obtained since their 3.5kHz frequency offset is enough to put them well down the shoulders of the filter characteristics.

The improvements to the receiver have also highlighted some of the other inadequacies of the set which were completely masked by our preoccupation with the appalling receiver performance previously, for example, the squelch control range is really inadequate for mobile use in that even when it is set fully shut, considerable noise is allowed to come through with quite weak signals. If like me, you like to keep the squelch reasonably shut

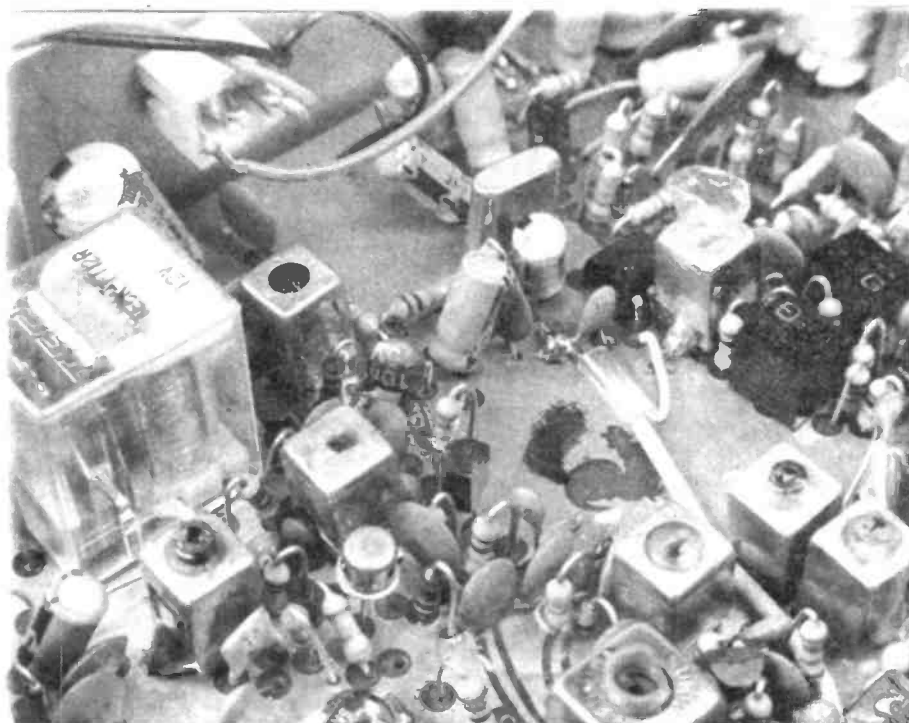

Open view showing internal layout.

when running (for example) long journeys on the motorway, so that you only receive the strong signals relevant to your own area for traffic information, you will find the DNT Special's squelch range inadequate. This is really quite a trivial criticism however, but a more major failing is in the microphone supplied as standard with the set. Although light, comfortable to hold and to use, and supplied with an extra-long curled lead terminated in a DIN plug which fits into the front rather than into the side of the transceiver (which is far more useful especially for in-dash mobile mounting) the microphone is of a type designed to be noise cancelling mechanically rather than electronically. This is achieved by mounting the microphone capsule in the bottom half of the microphone and feeding the sound pressure to it from the actual orifice in the front via a very narrow slit. This does indeed have the effect of cancelling substantial amounts of vehicle background noise, but it also has the effect of removing any trace of bass particularly from male voices, while making the received audio very punchy. The overall effect is to make the received audio quality from this transmitter unpleasant to listen to for the chap with whom you are trying to converse. The problem is completely cured however, by fitting a conventional hand-held microphone, and is particularly easy to fit in this case because due to the relay transmit/receive switching within the set wiring up the plug is relatively simple.

Radiotechnic have arranged to retro-fit free of charge the new crystal IF filters to any DNT set obtained in the UK with which the customer is dissatisfied, and if you are

one of these all that you need to do is to despatch your set (suitably packaged to cope with the Post Office's ravages) with a cheque or postal order for £1.20 to cover return post, packing and insurance to: Interservice Electronics, 87 Park Street, Southend, Essex who will modify the set and return it to you as soon as possible. Hopefully this is within 48 hours, but certainly you should have your modified rig back within 7 to 10 days, a wait which is most certainly worthwhile in view of the exceptional increase in performance.

The free modification is only of the IF filters and if you wish to have the full Supertune mods then a charge of £11.45 including post and packing is made for fitting the JFET mixer transistor, improved front-end, and the various other modifications, again this must be considered an exceptionally reasonable charge.

Summarising, the new supertuned DNT M40 FM Special is now among the top handful of UK legal CB rigs, with a receiver performance which is quite exceptional and well ahead of the rest in its class albeit with problems of distortion when receiving overmodulated signals. The transmitter quality is good when the supplied microphone is replaced with a more conventional one unless of course you happen to like sounding like a Dalek on the radio, and the controls and functions operate smoothly and very effectively, which combined with the set's compact dimensions makes it ideal for mobile use. At a typical retail price of around £85.00 this must now be considered very good value for money indeed and can be strongly

recommended.

Two final quick points: firstly, the B40 (which is the home-based version of the M40 and has a sort of benign growth on the back containing the mains power supply) has always been fitted with the improved supertuned circuitry since legal day, so if you possess one of these you should not be having problems and therefore it is not worth sending it to Interservice for any expected improvements. We have not had the opportunity of trying one of these but look forward to perhaps confirming this in the future, with perhaps additionally the big DNT home-base unit when it eventually reaches the UK market. Secondly, the DNT sets come equipped internally for Selcall facilities, there is an edge-connector on the PCB which accepts an add-on Selcall decoder which is now readily available from DNT dealers for under £25.00 per unit. The system uses the conventional PMR 5-tone calling system and has the unusual facility that it allows the called rig to transpond, in other words it retransmits the calling tone so that an 'acknowledge' light illuminates on the calling and on the called receiver so that both users know that contact has been established.

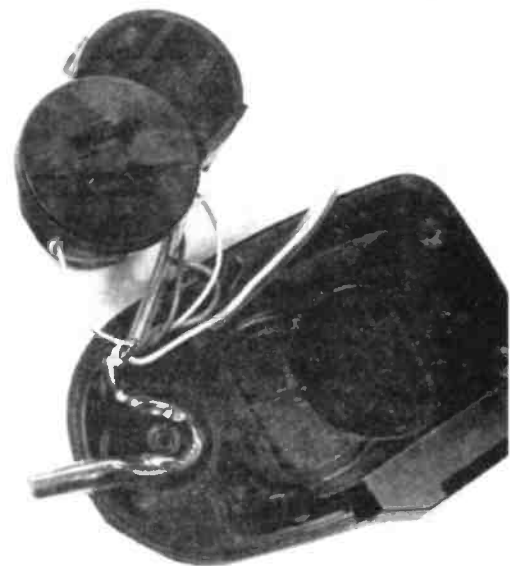

Photo of disassembled mike showing internal construction.

*Since this article went to press Radiotechnic have made other arrangements for the supertuning of the M40S, but they assure us that similar high quality will be maintained. We will keep you informed.

■ R & EW

Your Reactions.....	Circle No.
Immediately Interesting	92
Possible application	93
Not interested in this topic	94
Bad feature/space waster	95

ONE CHIP DFM

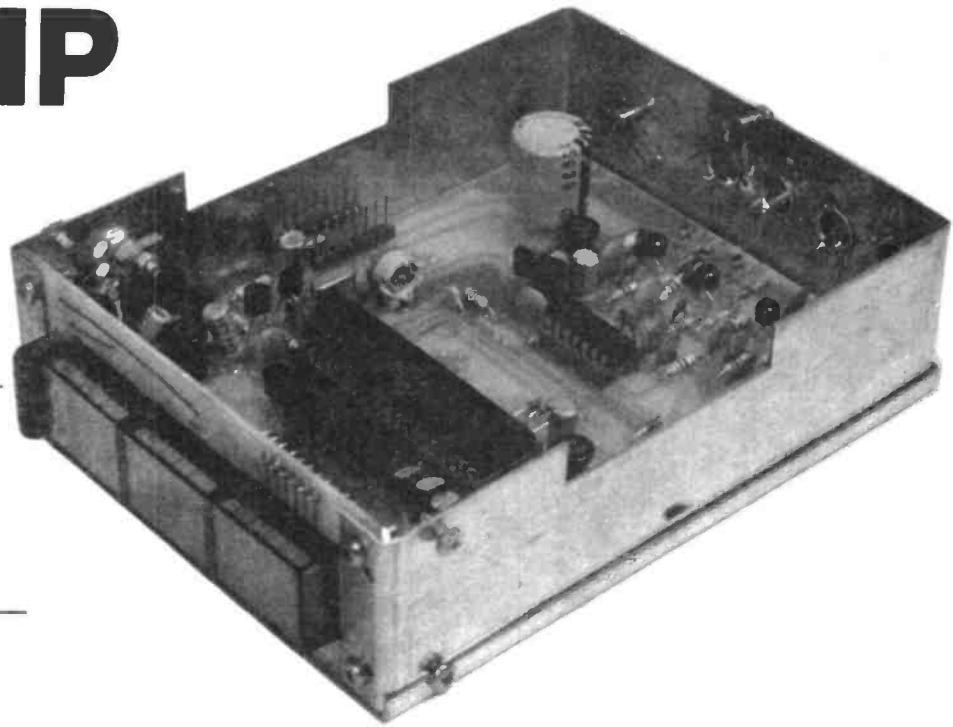

An advanced Digital Frequency Display - with a single IC counter/display.

If you can think of an application for a combination of fairly standard logic parts in CMOS, that promises a market potential of one million plus, then the chances are that someone, somewhere has either got - or is designing — a single MOSLSI integrated circuit to simplify that function. The classic example is the calculator LSI, followed

closely by the digital timepiece.

Because your TTL to do all that probably takes 5 amps minimum, and the Japanese firm of OKI Electric has a single LSI that does it all, with a scattering of external parts.

It is 'retrofitable' to almost any radio receiver you can think of — and

particularly the Yaesu FRG7 communications receiver interpolation IF, to provide the finishing touch of accuracy to an otherwise excellent general coverage receiver. It also provides all the previously mentioned clock and timer functions, providing an ideal precision control centre for the keen SWL or amateur.

CIRCUIT DESCRIPTION

The circuit of the internal arrangement of the MSM5524 IC reveals a complexity of function that can only easily be realized with the aid of LSI technology. The functional arrangement is largely self-explanatory, although sections on such topics as control instruction format must be taken as read, as these are basically in the form of mask programmed ROM.

The MSM5524 output can drive either LED or Futaba FLUORESCENT ARRAYS. The drive LEDs, both digit and segment drivers are employed in this design. The digits are driven from darlington sources to ensure good saturation, so that brightness does not alter according to the number of segments lit. The use of VMOS drivers could permit the use of really large filament type displays.

The IF offsets and general functions are readily programmed using pins that fulfill more than one function on a time division multiplex system, where a digit drive line is shared with the offset programming according to the internal timing sequence (Fig. 1).

The MSM5524 general application circuit is shown in Fig. 2, where as well as the various input circuitry is shown, it can be seen just how simple function selection and setting has been kept, simply through earthing pins — not even cross coupling pins of the IC. This also enables a diode matrix to be used whereby these function switches are reduced to single pole operation types.

The crystal timebase could scarcely be simpler, leaving only the input shaping and prescaling up to the discretion of the designer. Here again, OKI have a unique answer in the shape of the MSL-2312RS prescaler, which uses both ECL for VHF divide by 100

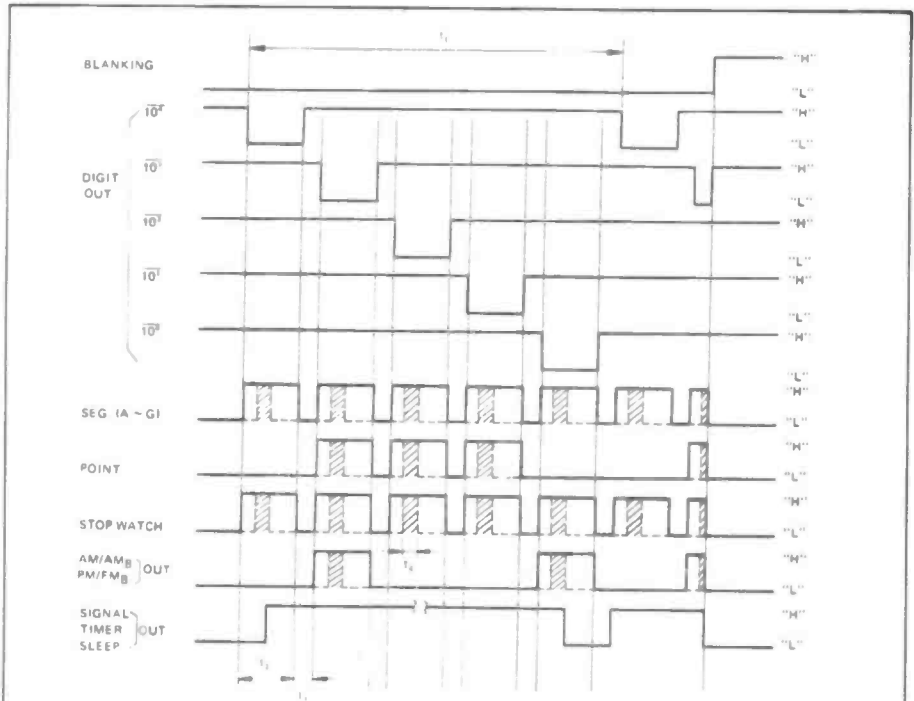

Note: 1) $t_1 \approx 1.5$ ms, $t_2 \approx 0.29$ ms, $t_3 \approx 0.019$ ms, $t_4 \approx 0.078$ ms

2) For MSM5524, the level "L" of each output signal of SEGMENT OUT (A ~ G), POINT, AM/AM_B OUT, PM/FM_B OUT and STOP WATCH is floated.

3) The POINT output is synchronized to the digit signal of 10^1 for lock display, to the digit signal of 10^0 for FM band display and to the digit signal of 10^1 for SW band display.

Fig. 1
Timing Waveforms

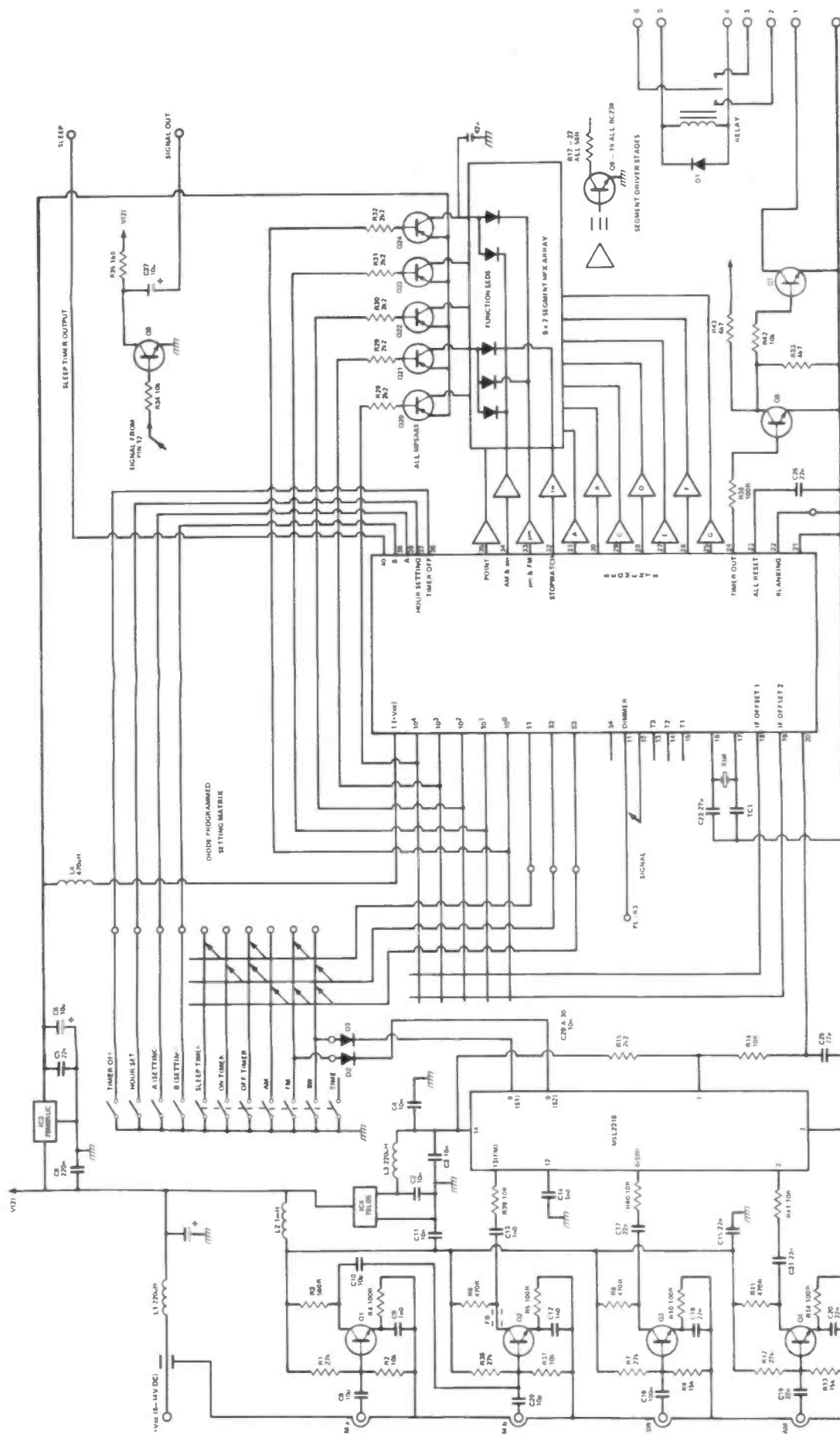

Fig. 2 Circuit Diagram of DFM/Clock based on MSM 5524 IC

prescaling, and LP Schottky TTL for the SW count of up to 39,999 MHz. The direct AM input (no division) also provides a useful pulse shaping capability, that enables the prescaler to be used to great advantage at the 'front end' of all types of LF/HF and VHF frequency counters. The actual input of the prescaler — and thus the division ratio used — is selected on one of the two prescaler select lines, S1 or S2, leaving both ungrounded, enables the direct (AM) count to proceed.

Before this prescaler, some form of transistor buffer amplifier is necessary to avoid loading local oscillators, and to provide enough drive to operate the logic of the 2312 divider. Simple single transistor circuitry, using high FT transistors, is adequate to provide drive from sources of 10-20 mV. A similar circuit is used, and is entirely stable at all frequencies of operation.

It is important to begin to consider the question of radio frequency interference — any many of you with instrument-type frequency counters will probably be surprised to see just how little consideration some commercial designs have given to the problems of the radiation of timebase signals, and display multiplexing frequencies. In a radio receiver where signal levels of 1 μ V are eagerly sought, the question of radio frequency interference (RFI) is of paramount concern to the thinking in the design. The timebase in the CMOS counter is reasonably low level, and compared to the power of the prescaler logic, and the display driving system, quite negligible.

The power of the prescaler is considerable, and the use of ECL and low power Schottky techniques ensures fast pulse edges that must be as restrained as much as possible. Power supply radiation is the main danger, since if permitted — HF and VHF harmonic radiation would very readily flow down the power lines and into the radio input circuitry. Simple 'capacitor to ground' (the universal panacea of the textbook) is very rarely just that. At DC and audio frequencies, a ground lead can be assumed, in some instances where little current flows, to be a ground (earth) lead. The moment the impedance of that ground becomes significant — either by increasing the current flow, or the frequency of the AC — the question of exactly *what* comprises an earth becomes very important. To decouple the prescaler with a simple capacitor will certainly divert some of the RF to ground, but then the ground itself will cause a path for radiation until it reaches the ultimate ground in the circuit — usually the power supply ground or 'chassis'. This is a problem that can only be reduced by making the ground plane as low an impedance as possible, thus presenting as much of a short circuit to HF and VHF as possible.

The second most significant source of RFI is the display strobing system for the LED readouts — this is a much lower frequency than the other types of RFI previously discussed, but nevertheless with a waveform that promises harmonic radiation is not carefully treated. The best cure is prevention, so all leads to the display are kept as short as possible, with the whole display being mounted inside a screened enclosure. Some rounding of the waveform with capacitors on the digit drive outputs can assist — but most of the remedial action must be observed in the careful supply decoupling (once again), and the use of good RF capacitors, such as disc ceramics and tantalum beads.

It is almost impossible to incorporate the setting switch in the box, since in many instances all the functions and hence all the switch positions will not be required. However, the lines themselves should carry no direct

content of switching signals — and will only act as passive radiators in a relatively high impedance fashion, permitting a relatively simple form of decoupling — a capacitive feedthrough at the side of the screen can ensure the best possible HF decoupling of radiated RFI, and likewise the power connection uses a capacitive feedthrough as a final touch.

The time switch function capability of the IC is used to operate a transistor switching arrangement, which may be used for switching in its own right — although it is a far more flexible solution to use it to operate a relay — and the PCB includes provision for a general purpose relay. The timer output is active low i.e. when the 'on' timer setting is reached and this reverts to high when the 'off' timer setting is reached.

Depending on the setting of the T1, T2 and T3 pins, a time signal is available internally generated, and available at the signal out pin 12. The options are shown in Table One — and it is particularly interesting to note the hourly time signal capability. It is not surprising that the IC is also used simply for its clock and time

T ₁	T ₂	Content of SIGNAL OUT
L	L	1 Hz (continuous)
H	L	10 Hz (continuous)
L	H	800 Hz (continuous)
H	H	Time signal *

* Time signal output

Table One

capabilities, forgetting the potential for frequency display.

Setting is achieved by pressing the hours/minutes setting button in discrete impulses to advance the respective counter one

unit at a time, but if held down for more than 1.6 seconds, the IC then advances the time by 10 units per second until released, whereupon fine setting is achieved by simply pressing the setting button once or twice as necessary. See Table Two for full details.

One other feature of the circuit is the hour set button — this simply resets the clock display to the hour nearest the displayed time for fine corrections in conjunction with the radio time signal for instance.

E.G. display reads 7.58 — by pressing the hour set at the 6th pip of the 8 o'clock time signal, the clock sets to 8.00. The same applies for times from 7.31 through to 8.29 — the time resets to 8:00. However, the clock is quartz accurate, and the use of a crystal means that if the reference is set accurately to 3.2768 MHz, then there is not likely to be much call for resetting the time more than once or twice a year.

The many functions available are largely directly selected by simple push button operation, but the stopwatch timer function is 'accessed' by various momentary combinations of display select switching and the A and B setting switches.

Finally, it should be noted that there is little danger of any unwanted side effects of using only part of the circuit capability and simply ignoring the unwanted parts. Many constructors may wish to use either just the DFM, or the FM and timer functions only. It is a simple matter to miss out the unrequired sections and their associated switches.

Next months construction and use

Your Reactions.....	Circle No.
Excellent - will make one	116
Interesting - might make one	117
Seen Better	118
Comments	119

('H': Open or V_{DD}, 'L': GND)

Display select	A	B	Operations
CLOCK	L	L	Reset of the clock counter, AM 1 ^H 00 ^M 00 ^S
	H	L	Minute: UP, hour: HOLD, second: counting up (Carry-over to 'minute' is prohibited.)
	L	H	Hour: UP, minute: HOLD, second: counting up (Carry-over to 'minute' is prohibited.)
	H	H	Normal operation
ON TIMER	L	L	Reset of on-timer, AM 0 ^H 00 ^M
	H	L	Minute: UP, hour: HOLD (Carry-over to 'hour' is prohibited)
	L	H	Hour: UP, minute: HOLD
	H	H	HOLD of the setting time
OFF TIMER	L	L	Reset of off-timer, AM 0 ^H 00 ^M
	H	L	Minute: UP, hour: HOLD (Carry-over to 'hour' is prohibited)
	L	H	Hour: UP, minute: HOLD
	H	H	HOLD of the setting time
SLEEP TIMER	L	L	Reset of sleep timer counter, 00 ^M
	H	L	Counting down (00 ^M ~ 59 ^M ~ 00 ^M)
	L	H	Stop of counting down (HOLD of the setting time)
	H	H	Normal operation (with the display counting down)

Note: Operation of counting up or down

If the input signal level of the terminal A or B is turned from "H" to "L" and the width of the "L" level is 0.1 ~ 1.6 sec, "1" is counted. If the width of the "L" level is more than 1.6 sec, "1" is counted immediately after the level is turned from "H" to "L" and counting "1" is continued at 10Hz after 1.6 sec.

Table Two

Spoilt for choice

14D-10
2mV/cm at 10MHz

14D-15
15MHz
Active TV sync.

14D-10V
Line selector
Active TV sync.
2mV/cm at 10MHz

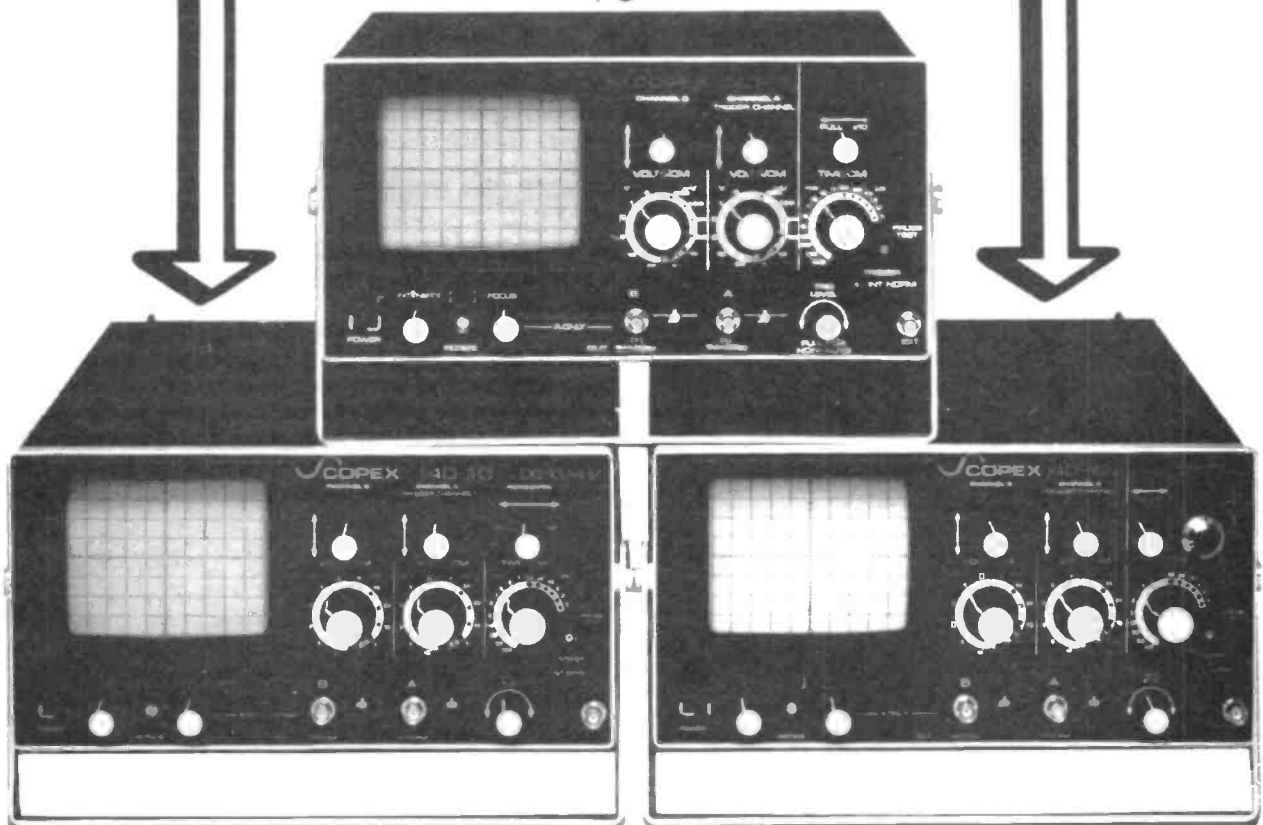

Scopex Instruments now offer you an unrivalled choice of oscilloscopes at under £300.

The straightforward and successful 14D10 with a sensitivity of 2mV/cm at 10MHz on both channels at £240 + VAT. The new 14D15 15MHz dual trace 5mV/cm with active TV sync separator at £250 + VAT and the sophisticated 14D10V 10MHz dual trace 2mV/cm active TV sync. separator and line selector at £290 + VAT. All these above prices include two probes, mains plug and carriage U.K. mainland. 10cm X 8cm display, add and invert facility, probe compensation, pushbutton x-y and trace rotate are all standard features of this 14D range.

You the customer decide the extras you need to fulfil your specific requirement.

An Independent British Company

Credit Cards and Orders
contact our Sales department at:

SCOPEX
Pixmore House
Pixmore Avenue, Letchworth,
Herts SG6 1HZ Tel: (04626) 72771.

Please send me full details of the 14D range.

R&EW9/82

Name _____

Company _____

Address _____

Tel: _____

EASTERN PROMISE

MADE IN JAPAN — a phrase that a few years ago conjured up images of a cheap and nasty copy of some highly marketable Western consumer item - is today a byword for quality and reliability. Most people, far from peeling off a 'made in Japan' sticker, will leave this indication as to its oriental origin prominently displayed.

The fact that something is made in Hong Kong, does not as yet instil the same sort of confidence as to the quality of the product, but this far flung British colony can manufacture equipment to a reasonable standard at low cost. It can also turn out the most incredible junk - no not the floating variety - but combinations of plastic and electronics that defy the imagination.

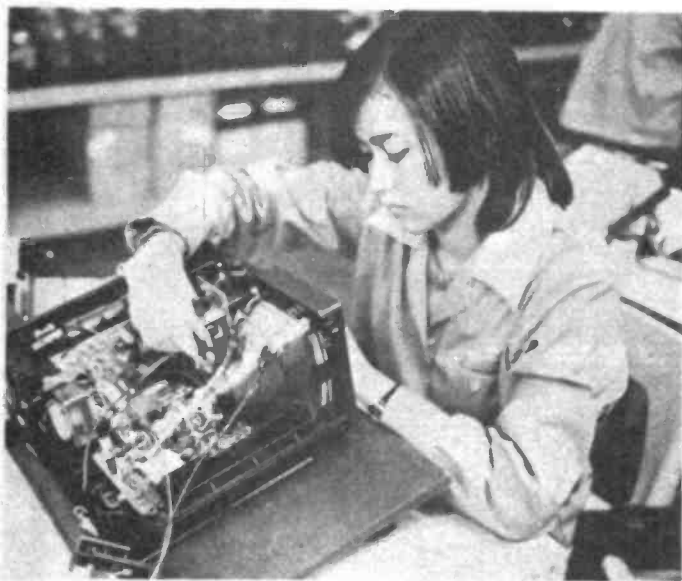

Gary Evans samples some of the delights of Hong Kong enterprise and looks at some less than spectacular offerings of this far flung colony.

KING KONG

The growth in Hong Kong's exports of consumer electronics goods (245% increase in TV exports and a 229% growth in telecommunication equipment during 1981) would deserve something more than the Queen's Award for Export Achievement if repeated by a British firm operating in a similar area.

At R&EW we receive a number of Publications detailing the collective activities of various Far Eastern Manufacturers and we thought we'd pass on some of the high and not-so-high- lights.

The index of Advertisers reveals that few of the industrious Hong Kong firms are household names in this country. Hands up those who have heard of Tat Ming Elec Ltd., Howdy Ent. Co. or Cony (yes we do mean Cony). The Swiss Watch & Jewellery Mfg. Co., Holland Elec. Trading Co., and Leeds Elec. Eng. Ltd., have a more familiar ring to them but the only thing Swiss, Dutch etc., about them is probably the sign over the door.

WHAT'S IN A NAME

The names of the manufacturers are, however, very rarely seen on the finished product. A deft application of a label or two and a Far Eastern TV bears the brand name of your favourite high street multiple.

TV sets have been very good to Hong Kong over the past few years. When China opened up its market to the boys from Hong Kong after years of severe restrictions on the import of consumer goods, the industry received a tremendous boost. Couple this with the fact that Hong Kong, unlike many other Far Eastern countries meets the criteria to be met before a PAL licence is granted and that the US excludes Hong Kong from the artificial trade barriers



that it raises in the face of other countries in Hong Kong's area of the world and you can see why 'They're selling them as fast as they make 'em'.

Britain was the largest importer of Hong Kong made colour TV sets last year - the Chinese market swallowing up the lion's share

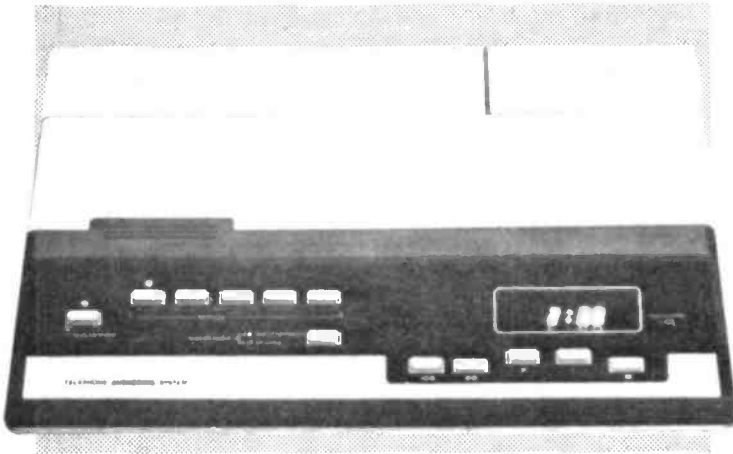

of monochrome sets. Massive capital investment in production facilities and R&D labs is ensuring that supply will keep up with demand. Figures of 30,000 sets per month are quoted for the initial output of one plant at present under construction with an output of double that after the first year.

These are the sort of levels required if firms are to be able to meet the orders pouring in from the world over. 50,000 TV sets within this year will be shipped to Britain under a contract just signed by one company.

The other area in which many firms predict growth is the three-in-one TV/radio/cassette player - again Britain provides a healthy market for these units.

Recent problems with China over allegations of bribery and corruption have put a temporary halt to the Chinese market, but most Hong Kong traders are confident that their newly acquired production expertise and a continued increase in demand for TV sets World Wide, will mean they will continue to prosper for some time yet.

MINI-MID-FI

While the quality end of the hi-fi market is not one in which Hong Kong has been active, mid-fi is an area in which they are prepared to compete.

The jewel of this market at the moment is the mini-systems which are apparently called mini-compos in the trade.

The market for Personal Cassette players - Sony Walkman et al - seems to be on the wane and many production lines have switched to the mini-compo as their staple output.

The mini-compo market, unlike that for TVs, is seen as transient and competition is, to say the least, cut-throat. Most manufacturers produce a range of models with the low end featuring mechanical tape transport controls, lower output power and generally, less frills. The top end models incorporate 'soft-touch' tape motion controls, 25CU output power, Dolby noise reduction and metal tape capability.

New models are appearing all the time, with a typical development time - from drawing board to full production - being about six months.

One factory alone is turning out 5000 sets a month with many appearing over here in one form or another.

HELLO CALLER

The majority of telephone accessories that have appeared over here during the past 18 months or so have their origins in Hong Kong.

The removal of various restrictions imposed by the phone companies in America was all the stimulus that was needed to make this one of Hong Kong's fastest growing markets. In the States, as of March this year, telephone subscribers can connect virtually anything they like to the phone lines providing it is connected via protective circuitry registered with the FCC. Further any wiring beyond the telephone companies' jack is totally the concern of the

user. Any hope of British Telecom adopting this common sense approach before the year 2000?

The market for phones has shown considerable changes over the past two years, while radio telephones used to account for the majority of equipment they exported, now they only take a 22% slice of the market, with 'electrical line' instruments in one form or another taking the other 78%.

The MPU is making the variety of functions available on even the smallest hand phones amazing, although the two most popular features are still push button dialling and auto re-dial.

The specification for a more ambitious model runs along the lines of:- last number re-dial, ringer on/off, sixteen 15 digit memories for frequently used numbers, 12/24 clock, LED read out of last seven digits dialled, call duration timer, long distance



call lock, automatic re-dial of an engaged or unanswered call and a mute button. All this in a hand held phone!

Cordless telephone sales are picking up although, once again, their use in this country would be in breach of the law. These phones operate on 1.7/49 MHz and feature ranges of anything from 33m for a small hand held unit to 250m plus for larger models.

The other area in which sales are measured in 1000s per week is the telephone answering machine.

Again, the functions available vary from a basic, timed duration call recorder to all-singing-all-dancing voice activated remote control machines. One model even features a remote control system that is voice activated obviating the need for a bleeper - 'all you have to do is whistle'.



EASTERN PROMISE



Finally an advert that, with caption, speaks for itself and sums up Hong Kong. People capable of producing well engineered high technology goods at an unbeatable price while at the same time turning out some extraordinary tat, but perhaps that just reflects the state of their world wide markets. **■ R & EW**

WHICH CAME FIRST?

The resourcefulness of the Hong Kong traders has to be admired. If there isn't a market for a product the reason must be that the consumer doesn't know what he's missing, sums up the attitude - nothing a bit of advertising will not take care of.

One firm is making a nice living from onyx stones inlaid with LCD clocks and calculators. Every boss should have one.

Perhaps you're feeling a little hot under the collar? How does an air cooler grab you? Put a few ice cubes in its midst, switch on its battery powered motor and we're assured you'll be rewarded with a cooling feeling. The over enthusiastic probably are rewarded by a sinking feeling but then the same firm have a battery operated Fire Engine to get you out of that one. They think of everything.

If you think a burglar's life is a boring one - why not a musical car alarm? You can teach it two songs of your choice and play them in its ten voices with an odd sound effect or two. Suggestions for an appropriate tune on a post card please to



This model is only available for North and South America.

ENFIELD ELECTRONICS

WHEN ORDERING, PLEASE ALLOW 12 DAYS FOR DELIVERY.

NOISE FILTER SYSTEM

A sophisticated combination of filters designed to eliminate interfering noises from all vehicular sources including ignition spark, alternator/generator, other accessories, metal to metal contact etc.

Contents:- Generator noise filter, alternator noise filter, Dual line noise filter and ignition noise filter.

Price £8.50
Order No. NFS-1000

A superb stereo headphone

Specifications:

- 1) sensitivity 110dB at 1,000Hz with 1mw
- 2) Frequency response: 20-19,000Hz
- 3) UNIT impedance 8 ohms
- 4) matching impedance 4-16 ohms
- 5) Maximum input 0.5 watts per channel
- 6) Individual slide volume control (stereo/mono switch)
- 7) 10 foot coiled cord with stereo phone plug
- 8) Leathery-soft ear pads and head cushion

price £5.95.
Order No. LE-76VS

This 3 1/2 inch super horn (Flush Flange) piezo ceramic tweeter converts electrical energy into acoustic energy at an efficiency in excess of 50%, a level not possible with any other type of loudspeaker. Economy is added to high efficiency by the elimination of crossover networks, because the unit rejects low frequency power. It has a high impedance of over 1,000 ohms at 1 kHz and 20 ohms at 40 kHz and it presents no added load to the amplifier.

A Super Special Offer of £4.65
Order No. LO52

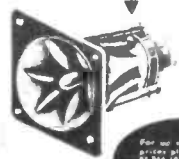

For all in the money prices please ring 01-366-1873. Please add 15% VAT. £1.00 p & p per item ordered.



Altai Multitester & Transistor Tester
DC volts 0-1v-5v-2.5v-10v-50v-250v-1000v ± 3%
AC volts 0-10v-50v-250v-1000v ± 3%
DC current 0-50uA-2.5mA-25mA-0.25A ± 3%
Resistance:
Minimum 0-2.2-200-200k ohms } ± 3%
Midscale 20-200-20k-200k ohms }
Maximum 2k-20k-2m-20m ohms }
As a transistor tester

Leakage current 0-150uA at X1k range } ± 5%
0-15mA at X10 range }
0-150mA at X1 range }
Price £14.95
Order No YN 360TR

Universal NI-CAD. battery charger. All plastic case with lift up lid. Charge/Test switch. LED indicators at each of the five charging points.

Charges:- PP3 (9V), U12 (1.5V penlite), U11 (1.5V "C"), U2 (1.5V "D"), Power:- 220-240V AC, Dims:- 210 x 100 x 50mm.
Super Special Offer at only £7.50.
Order No. MW 398



IDEX

stereo headphone

Sensitivity 98dB at 1kHz with 1mw.
Frequency response 20-25,000 Hz. Impedance 35 ohms.
Maximum input 0.4 watts. 7ft cord with 3.5 stereo phone plug.

Price £7.50
Order No. MHD-3

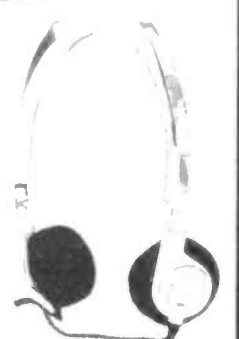

AS YOU HAVE SEEN FROM OUR PREVIOUS ADVERTISEMENTS, WE STOCK A VAST RANGE OF PRODUCTS—GIVE US A RING FOR YOUR NEEDS—WE STOCK EVERYTHING FOR THE ELECTRONICS ENTHUSIAST AT VERY COMPETITIVE PRICES.

208 Baker Street, Enfield, Middlesex.
01-366 1873.





MICROWAVE MODULES LTD

THEY'RE ALL NEW... AND FIRST CLASS!

MM2001

RTTY TO TV CONVERTER



NOW WITH EXTRA FACILITIES!
— SUITABLE FOR UOSAT

This converter, MM2001, contains a terminal unit and a microprocessor controlled TV interface, and requires only an audio input from a receiver and a 12 volt DC supply to enable a live display of "off-air" RTTY and ASCII on any standard domestic UHF TV set.

The MM2001 will decode these speeds:

RTTY 45.5, 50, 75, 100 baud
ASCII 110, 300, 600, 1200 baud

A printer output (Centronics compatible) allows hard copy of received signals. This unit is compatible with amateur and commercial transmissions.

MML144/30-LS

144MHz 30 WATT LINEAR & Rx PREAMP



FEATURES

- 30 WATTS OUTPUT POWER
- SUITABLE FOR 1 OR 3 WATT TRANSCEIVERS
- LINEAR ALL MODE OPERATION
- STRAIGHT THROUGH MODE WHEN TURNED OFF
- ULTRA LOW NOISE RECEIVE PREAMP (3SK88)
- EQUIPPED WITH RFVOX

This new product has been developed from our highly successful MML144/25. It is suitable for use with 1 watt or 3 watt transceivers and the input level is switch selectable from the front panel. Other front panel mounted switches controlling the switching circuitry allow the unit to be left in circuit at all times. The linear amplifier and the ultra low noise receive preamp can both be independently switched in and out of circuit. In this way maximum versatility is afforded.

USE THIS NEW AMPLIFIER WITH YOUR FT290R, C58, TR2300 etc. AND HAVE MOBILE OR BASE STATION PERFORMANCE AT A REALISTIC COST!

MML144/100-LS

144MHz 100 WATT LINEAR & Rx PREAMP

(appearance as 30 Watt model)

100 WATTS OUT FOR 1 OR 3 WATTS INPUT ON 144MHZ.

FEATURES:

- 100 WATTS RF OUTPUT SUITABLE FOR 1 WATT OR 3 WATT TRANSCEIVERS
- STRAIGHT THROUGH MODE WHEN TURNED OFF
- ULTRA LOW NOISE RECEIVE PREAMP (3SK88)
- EQUIPPED WITH RFVOX
- SUPPLIED WITH ALL CONNECTORS

This new two stage 144MHz solid state linear amplifier has been introduced as a result of the large number of low power transceivers currently available. When used in conjunction with such transceivers this unit will provide an output of 100 watts.

Several front panel mounted switches controlling the switching circuitry allow the unit to be left in circuit at all times. The linear amplifier and the ultra low noise receive preamp can both be independently switched in and out of circuit. In this way maximum versatility and flexibility is available to the user at the flick of a switch.

USE THIS NEW AMPLIFIER WITH YOUR FT290R, C58, TR2300 etc. AND HAVE MOBILE OR BASE STATION PERFORMANCE

MTV435

435 MHz TELEVISION TRANSMITTER



FEATURES:

- 20 WATTS PSP OUTPUT POWER
- BUILT IN WAVEFORM TEST GENERATOR
- TWO VIDEO INPUTS
- AERIAL CHANGEOVER FOR RX CONVERTER
- TWO CHANNEL USING PLUG IN CRYSTALS

This high performance ATV transmitter consists of a two channel exciter, video modulator and a two stage 20 watt linear amplifier. The unit will accept both colour and monochrome signals, and a sync pulse clamp is incorporated to ensure maximum output. An internal pin diode aerial gto switch allows connection of the aerial to a suitable receive converter when in the receive mode. (MMC435/600 - £27.90). Full transmit/receive switching is included together with an internal waveform test generator which will assist the user in adjusting the gain and black level controls.

£169inc. VAT (P&P £2.50)

£65inc. VAT (P&P £2.50)

£145inc. VAT (P&P £3)

£149inc. VAT (P&P £3)

ALL MICROWAVE MODULES PRODUCTS ARE FULLY GUARANTEED FOR 12 MONTHS (Including PA Transistors)

SPACE PERMITS ONLY A BRIEF DESCRIPTION OF THESE NEW PRODUCTS. HOWEVER A FULL DATA SHEET IS AVAILABLE FREE ON REQUEST. OTHER NEW PRODUCTS INCLUDE:

MMS2	- ADVANCED MORSE TRAINER	- £155.00 inc VAT (p&p £2.50)
MML28/100-S	- 10 METRE 100 WATT LINEAR/RX PREAMP	- £129.95 inc VAT (P&P £3.00)
MMK1691/137-5	- 1691 MHz WEATHER SATELLITE CONVERTER	- £115.00 inc VAT (P&P £2.50)

OUR ENTIRE RANGE OF PRODUCTS WILL BE EXHIBITED AND ON SALE AT MOST OF THE 1982 MOBILE RALLIES BY OUR SALES TEAM



WELCOME

MICROWAVE MODULES

BROOK FIELD DRIVE, AINTREE, LIVERPOOL, L9 7AN, ENGLAND
Telephone: 051-523 4011 Telex 628608 MICRO G
CALLERS ARE WELCOME. PLEASE TELEPHONE FIRST.

HOURS:
MONDAY - FRIDAY
9 - 12.30; 1 - 5.00

194 for further details

**G4JDT
HARVEY**

EAST LONDON HAM STORE

**G8NKV
DAVE**

H. LEXTON LIMITED

191 FRANCIS ROAD LEYTON E.10
TEL 01-558 0854 TELEX 8953609 LEXTON G

RADIO & ELECTRONIC ENGINEERS

ENGINEERS ALWAYS AVAILABLE ON THE PREMISES

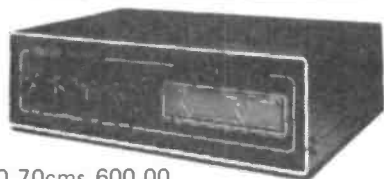

GASFET MASTHEAD PREAMPS

DRESSLER AMPLIFIERS

EXCLUSIVE TO US

D70 70cms	600.00	£500.00
D200S 2mtr 400 + FM 1kW PEP		£600.00
D200 2mtr 300 + FM 600W PEP		£495.00
D200C 2mtr 125W FM 190W PEP		£295.00

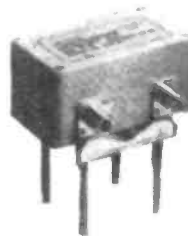

VV700GAAS	£79.00
VV200GAAS	£69.00
VV2000GAAS	£79.00
VV interface	£18.00
0.7 - 0.9dB S-Ns	
0.2dB insertion loss	
3SK97 GASFET	

These High Power 240V linears using Q6/40 or 4CX.250 or 4CX 350 EIMAC tubes not using grounded grid system fully protected, no thermal damage to PA final possible.

Also Available: ICOM YAESU TRIO/KENWOOD STANDARD DATONG MICROWAVE MODULES JAYBEAM CUSHCRAFT

ALL ACCESSORIES AVAILABLE - PLUGS SKTS CO-AX 2MTR COLINEAR £31.50, 70CM COLINEAR £31.50

Access



PRICES INCLUDE VAT AT THE PRESENT RATE OF 15%
OPEN MON-FRIDAY 9:00-5:30. SATURDAY 10:00-3:00. INSTANT HP FACILITY AVAILABLE
EASY ACCESS M2-M11-M1 NORTH CIRCULAR ROAD-EASY PARKING

BARCLAYCARD

VISA

195 for further details

CIRCUIT BLOCKS

Multistandard FM TV sound IF - design by Graham Leighton

WITH THE ARRIVAL OF satellite television and the multitude of sound subcarriers present on terrestrial TV services a tunable demodulator is quite useful to the experimenter in these fields. The outline design described here covers most of the signals likely to be found in Europe. It can't, however, cope with the AM subcarriers present on some French language and 405 line transmissions. The frequency range covered is about 5 to 7.5MHz.

The demodulator uses a 5V PLL IC, NE564, which has its VCO frequency preset by the voltage applied to a BB109 varicap diode. The frequency range may be altered by changing this voltage or the 39pF capacitor. A high pass filter is used, in conjunction with a series tuned trap, to reduce the luminance and chrominance levels present on the composite signal.

The input impedance is approximately 50R which maybe fed from a higher impedance source via an emitter follower if required.

SETTING UP

Once completed, there are only two things to set up; the VCO frequency and the chroma trap (at 4.43MHz). The input should be connected to the output of a vision demodulator (before any sound trap!). Tune the receiver to a signal and adjust the VCO frequency for best audio. The diroma trap (2K241 + 1n) should then be adjusted for minimum interference to the sound signal. The VCO output appears at pins 3 and 9 of the NE564 and its frequency may be measured at this point. Make sure that loading by the counter does not 'pull' the oscillator.

IN USE.

It is easier if switched, preset voltages are used to tune the VCO to those frequencies most often needed. This demodulator has been used successfully to receive sound on TV signals from UK(6MHz), Spain, Holland and Italy (5.5MHz) and the USSR (6.5MHz).

If system M or N signals are to be received the VCO range, high pass filter and the chroma trap may need some adjustment. (see Data Brief on p77 of this issue for details of TV standards).

FM DEMODULATOR AT 5V

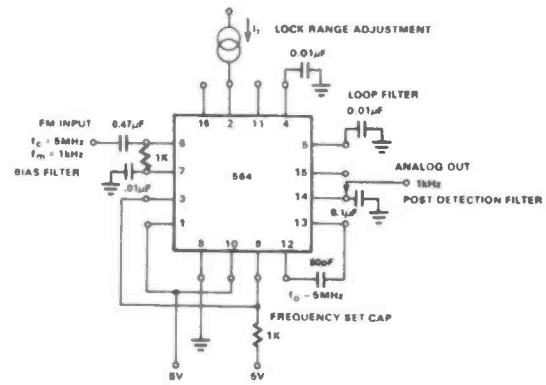

NE564 Application Circuit

BLOCK DIAGRAM

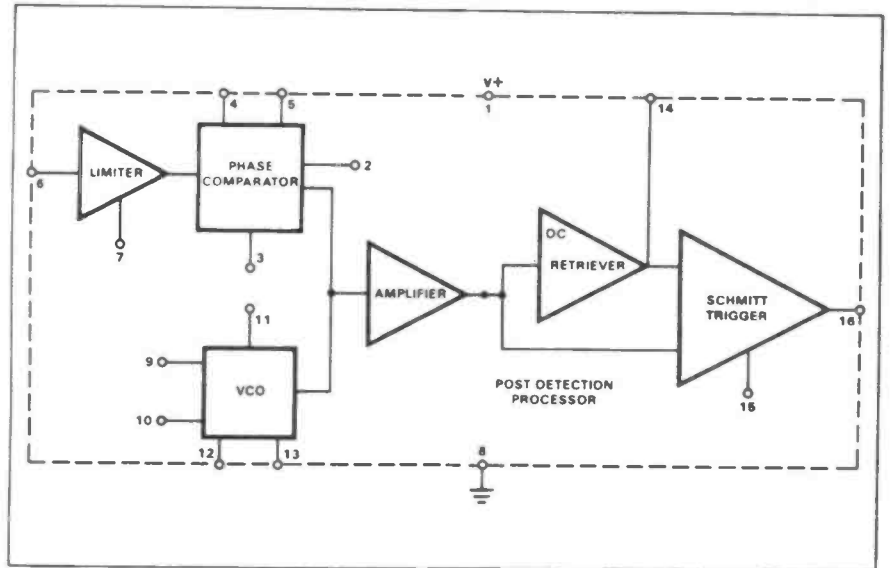

Internal Block Diagram of NE564.

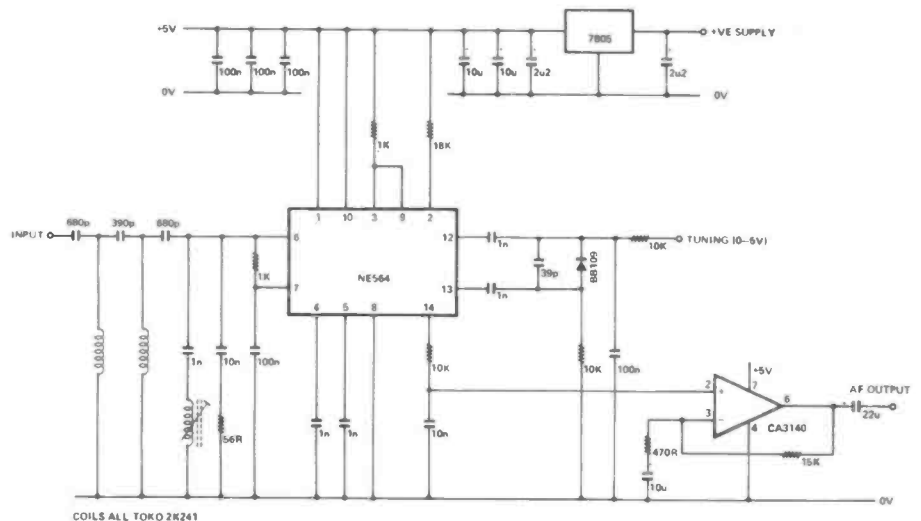

Circuit diagram of the Multistandard sound IF strip.

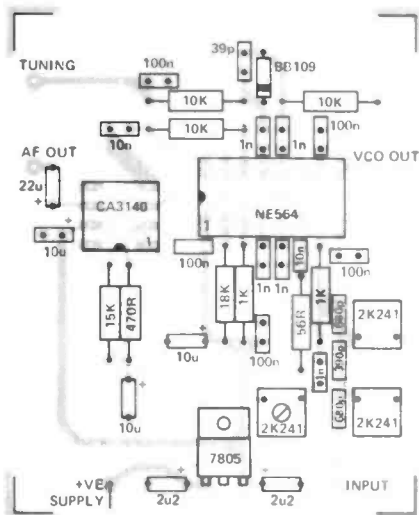

PCB Overlay

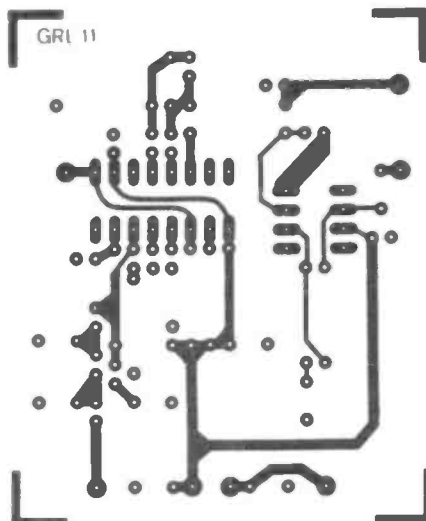

Track Side

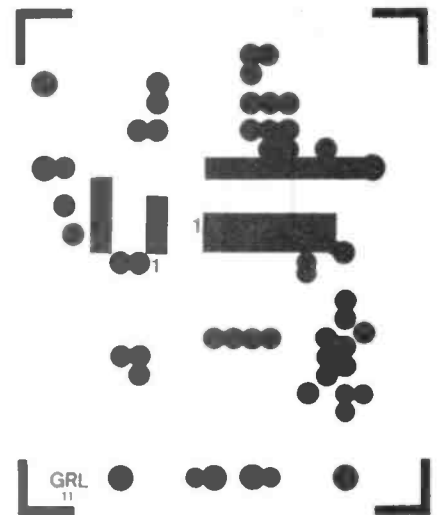

PCB component side

TYPICAL PERFORMANCE CHARACTERISTICS

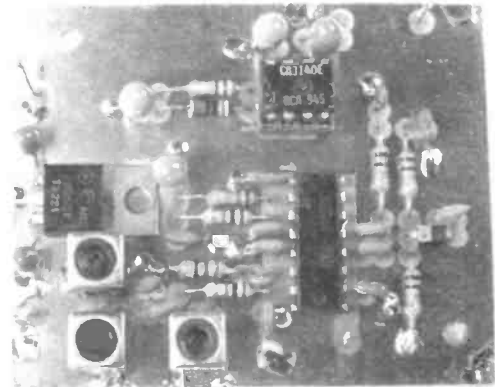
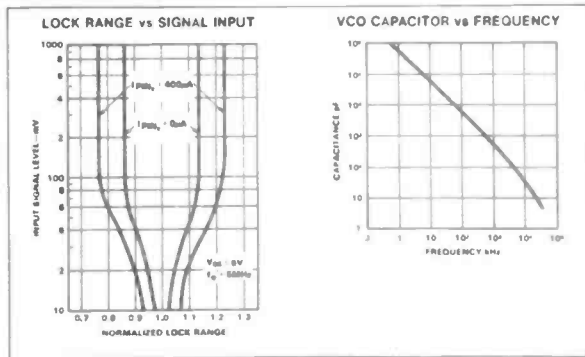

Are your meters good enough?
 If your recordings are spoilt by uneven levels and overloads-install Soundex professional PPM's now.



The Soundex PPM 402 is a quality meter at a price you can now afford!

Developed from the BBC and VU scales it has a closely specified electrical performance with a meter scale providing high clarity and accuracy of indication. Special Features include:—

- Bipolar rectification.
- Closed loop meter drive
- Wide frequency response
- Low current consumption
- Amplitude dependant amplifier
- Attack and decay circuits

Send for technical literature on the new 402

Bulgin Electronics

One of the Bulgin Group of Companies **Soundex Ltd**
 Park Lane, Broxbourne, Herts, Tel: Hoddesdon 64455

174 for further details

Sounding Off

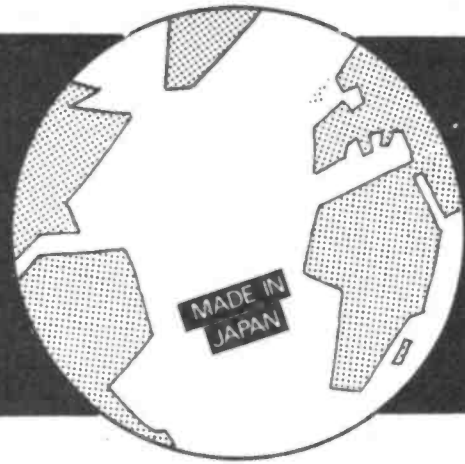

AH. SO's.

The view from the top of Evan Steadman.

Got a yen to learn more about the status of the inscrutable Japanese?

Well, you may not have - but they're a source of continuous fascination to me.

Bearing in mind that they were in tatters after the war, it's amazing that they are forecasted to achieve the highest standard of living on earth in less than fifty years after their fun and games with Mr. Hitler.

And don't gimme that stuff about the advantages they enjoyed because, with all the factories smashed, they had to erect proper buildings and offer generous grants to industrialists, unencumbered with obsolete equipment.

Today, in Britain, there are umpteen regions that will gladly give you a new, purpose-built factory free and for nothing if only you'd go there. And the Government will subsidise everything else - including the first 100 rolls.

Well, can you believe Britain's going to be, say, the second richest nation in the world by 1999? You can? Ho, ho, ho!

(For your info, a new report says we'll have around 3% of the world's wealth by the end of the century, versus the Japanese 'share' of 12%).

But to electronics.

Oddly, the little wonders don't seem to be doing much on the fashionable computer fronts: networks or, say, micros.

You'll have to read about their efforts to acquire IBM's secrets by industrial espionage. Well, that *is* a risky way of trying to catch up. Or a desperate one?

Current assessments, despite Fujitsu's 1975 bold claims that they would overtake IBM by 1985, indicate that they have only 6% of the current market. And that the entire Japanese computer industry is less than a quarter of the size of Big Blue.

To say nothing of the fact that Mitsui are selling Uncle Clive's ZX over there 'cos they can't match it, yet. (*What about Casio and Sharp's hand held wonders, Evan? - ed.*)

Now Semicons.

Obviously the Japs have done well. But in memories - and not the wilder technologies like advanced processors. Genuine doubts are now being expressed that, if the approach to semi design isn't nuts and bolts, or cramming more into less chip, they're not exactly the cat's whiskers.

When it is though, cor blimey

I've just been looking at Seiko's new television watch. (And if, by the time you read this, everybody's seen one, don't blame me. This rag has long lead times you know.)

Anyway, the LCDs garner together 32,000 dots in a 1.2 inch screen. And present a very clear picture.

You'll be able to buy one before the next All-Electronics Show. But you may have to go to Japan and pay a bit less than £300. (Or come and see mine in the Organisers' office, of course.)

I could never understand, in the old days, why outfits like the TI (which then employed me), didn't actually make 'things' with their components.

Then came calculators which *everyone* made; and almost everyone lost their knickers on, except you've guessed.

But the point's still valid. The Japanese seem to be much more successful at vertically integrating their hitech. Hence, their accelerating riches.

Any road, the Japanese are now into fashion garments - despite the fact that the kimono is strictly a minority interest.

They're applying high workmanship and innovative design to textiles - and flogging the quality garments at low prices throughout the States. Sales were 60% up, last year!

So off they jolly well go!

Trying harder. Doing better. But not where conceptual concepts are truly at the edge of the envelope.

And next month I'll explain where all those instrument orders have gone to... (Or not, as the case may be.)

STRUTT LTD

COMPONENT	PRICE		
	1+	25+	100+
2SC 1306	1.55	0.95	0.50
2SC 1307	2.80	1.70	1.12
2SC 1957	0.90	0.50	0.47
2SC 1969	2.95	1.60	1.35
2SC 2029	1.75	1.10	0.85
2SC 2230A	1.15	0.80	0.45
741	0.17	0.11	0.09
BA 521	2.55	1.55	1.00
MB 3712	3.65	1.65	
PLL 02A	5.65	3.50	
TA 7205P	2.20	1.30	0.85
TA 7502	2.20	1.60	1.20
TA 7310	2.10	1.15	0.70
UPC 1182	2.45	1.50	1.20
10.24046 MHz Crystal	2.60	0.80	0.60
2708 EPROM 450ns	2.25	1.99	1.60
2716 EPROM 450ns	2.25	1.99	1.60
1000 mixed resistors 1/4 watt	4.00		
100 mixed transistors	1.50		
Electrolytics:			
4.7uF 30V (Pkt of 9)	0.50	14 pin DIL Skt (Pkt of 5)	0.50
10uF 25V (Pkt of 8)	0.50	16 pin DIL Skt (Pkt of 4)	0.50
47uF 16V (Pkt of 7)	0.50	TIL 209 LEDs (Pkt of 5)	0.50
100uF 16V (Pkt of 5)	0.50	BC 157 (Pkt of 6)	0.50
470uF 35V (Pkt of 4)	0.50	BC 183LA (Pkt of 6)	0.50

Please include 50p on all orders. All prices EXCLUDE VAT.
Please send S.A.E. for full list to;

STRUTT LTD, 3d Barley Market St., Tavistock, Devon PL19 0JF
Telephone: 0822-5548.

193 for further details

SWITCHED MODE POWER SUPPLIES INTERFERENCE PROBLEMS?

- * Storage inductor
- * EMI filters

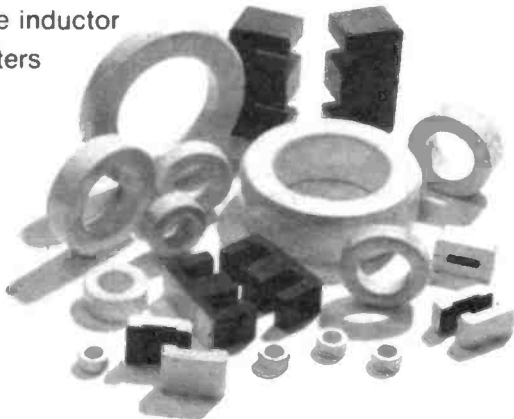

MICROMETALS DUST IRON CORES

The perfect solution, from the experienced manufacturer. Micrometals also manufacture the biggest range of cores for resonant applications — contact Ambit for more details

Ambit International UK representative
200 North Service Road Sole agent
Brentwood Stocking distributor
Essex CM14 4SG
telephone (0277) 230909 telex 995194 AMBIT G

CAMBRIDGE LEARNING SELF-INSTRUCTION COURSES

A PRACTICAL DIGITAL ELECTRONIC KIT FOR ★ LESS THAN £20 ★



SUITABLE FOR
BEGINNERS

NO SOLDERING!

Learn the wonders of digital electronics and see how quickly you are designing your own circuits. The kit contains: seven *LS* TTL integrated circuits, breadboard, LEDs, and all the DIL switches, resistors, capacitors, and other components to build interesting digital circuits; plus a very clear and thoroughly tested instruction manual (also available separately). All this comes in a pocket size plastic wallet for only £19-90p inc VAT and p&p. This course is for true beginners:

- needs no soldering iron.
- asks plenty of questions, but never leaves you stuck and helpless.
- teaches you about fault-finding, improvisation, and subsystem checking.
- the only extra you need is a 4V battery (Ever Ready 1289, or similar), or a stabilised 5V power supply.

Using the same breadboard you may construct literally millions of different circuits. This course teaches boolean logic, gating, R-S and J-K (flipflops, shift registers, ripple counters, and half-adders. Look out for our supplementary kits which will demonstrate advanced arithmetic circuits, opto-electronics, 7-segment displays etc.

It is supported by our theory course

DIGITAL COMPUTER LOGIC AND ELECTRONICS ~~£8.50~~ £6.00 for beginners, and our latest, more advanced text,
DIGITAL COMPUTER DESIGN £7.00

Please send for full details (see coupon below).

GUARANTEE No risk to you. If you are not completely satisfied, your money will be refunded upon return of the item in good condition within 28 days of receipt.

CAMBRIDGE LEARNING LIMITED, UNIT 157 RIVERMILL SITE, FREEPOST, ST IVES, CAMBS, PE17 4BR, ENGLAND.
TELEPHONE: ST IVES (0480) 67426. VAT No 313026022

All prices include worldwide postage (airmail is extra - please ask for prepayment invoice), Giro A/c No 2789159.

Please allow 28 days for delivery in UK

Please send me:

.....SUPERKIT(S) @ £19.90

.....Free details of your other self-instruction courses.

I enclose a *cheque/PO payable to Cambridge Learning Ltd for £..... (*delete where applicable)

Please charge my:

*Access / American Express / Barclaycard / Diners Club Eurocard / Visa / Mastercharge / Trustcard

Expiry Date..... Credit Card No

Signature.....

Telephone orders from card holders accepted on 0480 67426 Overseas customers (including Eire) should send a bank draft in sterling drawn on a London bank, or quote credit card number.

Name.....

Address.....

Cambridge Learning Limited, Unit 157 Rivermill Site, FREEPOST, St Ives, Huntingdon, Cambs, PE17 4BR, England. (Registered in England No 1328762).

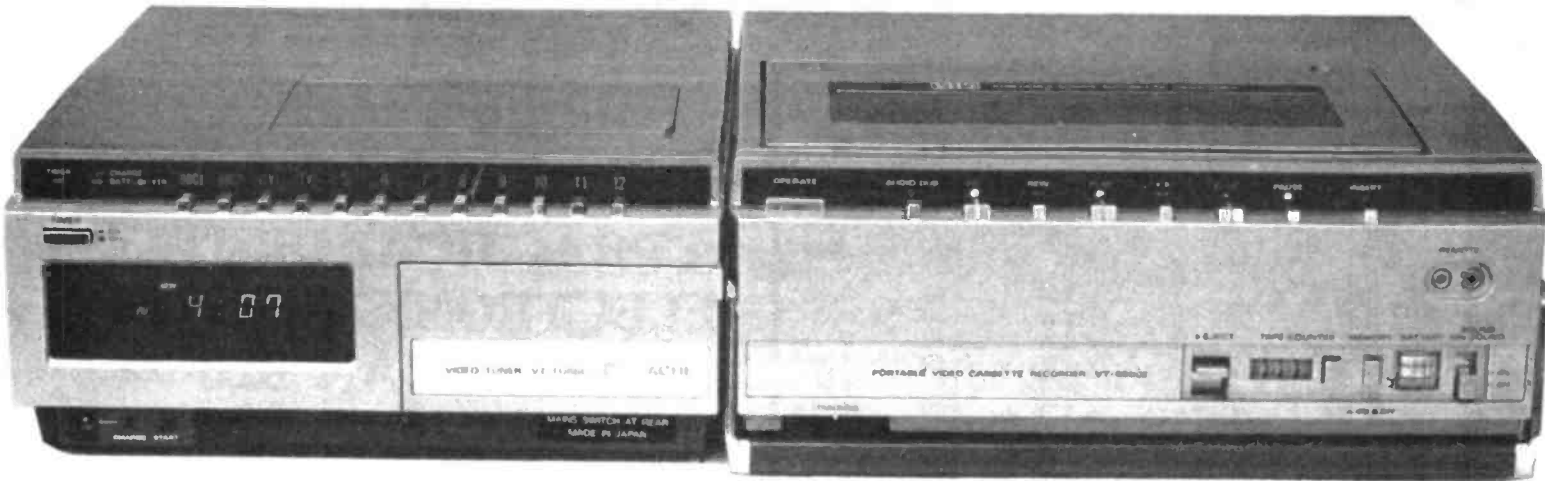

HITACHI PORTABLE SYSTEM

Peter Luke examines Hitachi's go-as-you-please video system.

IT SEEMS THE NORM for any review of portable video equipment to begin with a description of how the ensemble was strapped to the reviewer's side, hustled off to the great outdoors, and the vidicon pointed at virtually anything that moved. This review departs from this course as, while an acceptable performance in the role of an electronic 'movie making' system is obviously of import, the majority of portable systems will spend most of their time tied to the AC mains recording off-air TV and playing back the latest video software releases. Their performance in this situation, when compared with top of the range mains recorders, will be a major factor in determining whether many people 'go portable' or not.

VHS PAL?

The recorder on test in this review is the Hitachi VT-6500E, together with companion VT-TV65E tuner/timer/charger and VK-C600E colour camera. Hitachi are firmly in the VHS camp and the machine thus adopts the most popular of the video formats.

In its domestic role the recorder and tuner unit are linked by two cables, one carrying an RF signal from the recorder to the tuner via a co-ax lead, the other carrying various control and power lines between the two units via a multi cored cable.

As mains is first applied to the tuner the clock display flashes 12:00 until the clock is set to the correct time, or any time for that matter, but there would be little point in setting it to the wrong time would there?

Setting the clock is a straightforward operation involving the use of an AM/PM button (push once for an AM time, twice for PM), buttons corresponding to the digits 0-9 (some of these also double as 'day of the week' selectors) and an HR/MIN button whose function is, naturally enough, to separate the entries for hours and minutes. Simple isn't it?

Having set the timer up, the TV is connected to the tuner and a spare channel tuned to the RF modulator's frequency - around CH37 although this can be adjusted within the range CH30 - CH39 if using CH37 results in any interference in your

locale. To aid tuning, the recorder features a test pattern generator producing a B/W display that can unmistakably be identified as the video recorder's output.

The final step in the commissioning procedure is to connect an aerial to the tuner and 'bring in' your local broadcast stations on any one of 12 channels. Adjustment of these is accomplished by means of thumb-wheel switches concealed behind a hinged flap on the top of the recorder.

ALL SYSTEMS GO

Pressing the recorder's eject lever, nicely interlocked to prevent a cassette being ejected in anything but the stop mode, causes the cassette compartment to fly up. It 'flies up' at quite a rate, lacking the 'whoosh' of a damped eject, it's as well to make sure nothing's on top of the recorder before ejecting a cassette.

The tape transport functions are all solenoid operated resulting in, what manufacturers care to call, featherlite selection of all modes. The controls have a certain intelligence which allows the selection of, say, play from fast forward, the recorder realising that it should 'stop' before carrying out the command. This logic was faultless in operation and could not be caught out even by very rapid selection of various combinations of rewind/search directions. The transport was also very quiet in operation apart from the occasional whir and click as the tape was wound and unwound from the video heads.

The front panel LEDs indicating the selected transport function were bright enough to be seen in all but the highest of ambient light levels.

Despite the multi-way cable between the recorder and timer there seemed a certain lack of communication between the two units, the worst effect of this being that the tuner seemed not to know whether the recorder was recording or not and so could not provide a channel interlock in the record mode. This is a failing of some



The recorder is connected to the tuner unit via two cables, one a co-ax lead carrying the RF output of the recorder the other a multi-cored cable carrying various control signals.

mains recorders and does mean prying hands must be kept away from the recorder if one half of a film you're recording is not to be replaced by the 'News At Ten'.

CABLE CONTROL

The remote control unit is connected to the recorder via a wire link and is unusual in that it not only duplicates most front panel controls but also provides a few additional functions. This is presumably because of the small amount of front panel space available. Thus to obtain the recorder's trick video effects - visual search, slow etc. the Remote Control Unit *must* be fitted.

The visual search facility worked well and, although the familiar VHS noise bands made an appearance in this mode, they were not as obtrusive as those on some other machines.

The slow mode did not produce a true slow display, but rather, had the effect of pulsing the frame advance button at anything from once every five seconds to five times a second, depending on the position of the remote's speed control.

As stated above the remote control can activate most of the recorder's functions but unfortunately could not change the channel selected on the tuner, back to that lack of communications between the two.

The remote control unit duplicates most front panel controls and some extras, notably the 'trick video' functions.

a program that spans midnight will have its 'stop day' shifted to the next, for example, if 12:15 PM is entered as a stop time for a programme finishing in the early hours, this will be altered to the (correct) 12:15 AM time and the day advanced, while any grosser error will result in 24 hours being added to the stop time.

A useful feature is a battery back up for the clock when the recorder is in the timer mode. The clock will continue to keep time for anything up to one hour in the event of a power failure, a helpful feature that would avoid the annoyance of missing a program after a momentary power cut.

Mentioned for the sake of completeness is the fact that the clock's display can be dimmed, although as the 'normal' display is so unobtrusive even at low lighting levels, this feature seems hardly worth while.

The subjective quality of the playback picture was about as good as can be expected from VHS players although the sound channel's performance was not quite as good as some machines. This defect was only apparent when using an external amplifier/speaker combination, the sound over the TV's speaker being about par.

In a domestic environment the recorder/timer combination performed as well as a mains counterpart and offered all the trick functions of the more expensive of these plus the versatile timer. Lack of a remote channel switching, an IR remote link and a tape indexing system, are about the only differences between the combination and a top of the range mains machine. Whether or not the extra £100 or so that you will have to add to the price of such a mains machine in order to get your hands on the Hitachi will depend on how much the VT-6500E's portability is valued.

WALKIES

For portable use, the recorder is disconnected from its timer and connected to a camera, in this case the VK-C600E. This is a colour camera with 6:1 zoom, CRT viewfinder and a built in uni-directional microphone.

Before using the camera it is necessary to adjust its 'white balance'. To this end a couple of LEDs (one green the other red) visible through the viewfinder are used in conjunction with the camera's white balance control. The control is adjusted until both LEDs are extinguished while the camera is viewing a white object.

With this adjustment made the camera is ready for point-and shoot recording.

The recorder is first switched to record, control of the transport is then automatically transferred to a button on the front of the camera. This is pushed once to start recording and again to stop. A LED in the viewfinder indicates that a recording is being made - other LEDs indicate low light, low battery and white balance as previously mentioned.

The zoom can be operated either manually or, via a rocker switch, be 'power driven'.

In addition to the white balance adjustment the camera has a number of other controls. Two of these are 'exposure' controls and two 'function' selectors.

The exposure setting of the camera can be modified if the subject is largely backlit while the sensitivity of the overall system can be increased to cope with lighting levels down to 75 lux.

The 'viewfinder' can be switched to monitor either the camera's output or that of the video recorder. Useful for playing back a recording on site to verify that everything is OK. Finally a control allows the camera to be put into a, power saving, standby mode in which the majority of its electronics, including the CRT, are powered down. Consumption in this case



TIME OUT

For unattended recording the timer offers a very generous 8 event 21 day timer capability and is quite straightforward to use with plenty of prompt symbols appearing on the recorder's display.

The timer is a fairly intelligent animal that will simply ignore any nonsense times, thus 13:30 would not be accepted (12 hour format only) nor would 10:73 (we have not decimalised time yet). It is also aware that most programs start before they finish and

The VK-C600E colour camera features a 6 to 1 zoom lens, CRT viewfinder and a built in microphone.



The recorder in its 'Captain Fantastic' gear - ready for a 'portable' recording session.

is about one quarter of the 6.7W usually consumed yet the camera takes only a few seconds to 'warm up'.

If the recorder is left in the pause mode for longer than about five minutes it will itself go into a standby mode to prevent excessive head wear, recording will commence again if the camera pause is operated.

The camera was used with the pistol grip supplied as standard, the recorder being carried in a rather 'captain fantastic' like silver plastic shoulder bag, also supplied.

The results obtained were of a technically excellent quality (full marks to Hitachi) if low on artistic merit (5 out of 10 to the cameraman).

The camera happily coped with wide variations in light levels, found when a test recording was made in a wooded area on a sunny day.

The sound quality was adequate, although operating the power zoom caused a distinct whir to be recorded. For any 'serious' applications an external microphone should be used; the camera features an external mic socket.

The internal batteries of the recorder provided a recording time of around half an hour and could be recharged from the tuner/timer in about one hour.

For extended shooting sessions the recorder could be powered from a car's battery via an (optional) adaptor to fit a cigarette lighter socket.

Additional, external, battery packs are also available and these can be charged via the VT-TU65E.

The combination was fairly heavy, and despite a padded shoulder strap, became rather wearing after about half an

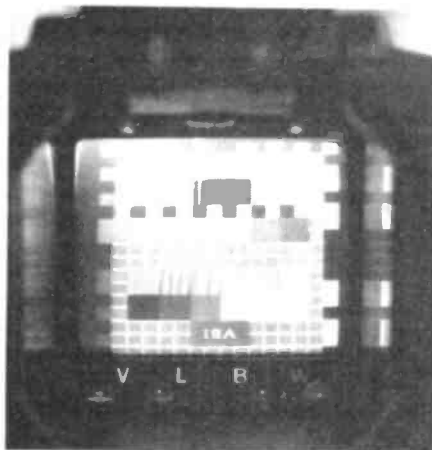

The camera viewfinder is in fact a miniature CRT tube. The viewfinder also incorporates several 'function' LEDs.

hour. The strap arrangement can, however, be adjusted to provide a 'back pack' like support for a more even distribution of the weight. In this case, for one man operation, the remote unit would have to be connected, and attached to the front of the harness.

PLAY IT AGAIN

The playback quality was good, with picture disturbance between 'takes' being minimal a reflection of the excellent 'clean edit' performance of the recorder.

The recorder also features an insert facility. This can be used to insert a scene (title etc.) between shots already on tape. To make use of the facility the end point of the insert is located and the recorder's tape counter zeroed. The tape is now wound back to the point at which the insert is to begin. The pause mode is used to freeze the picture at this point, record selected and the insert button pressed.

Releasing the pause will record the new

video source, recording stopping automatically when the counter reaches zero.

This function worked well, with little picture disturbance being evident at the punch in and punch out points.

The insert mode only affects the video signal, sound being undisturbed. The audio dub function can, however, be used to record a new sound track for an existing video sequence and in conjunction with the sound-on-sound switch, can superimpose a new sound track onto an existing track.

These 'post production' facilities of the recorder make the assembly of a final tape from a series of shots an easy task and produce an acceptable end product.

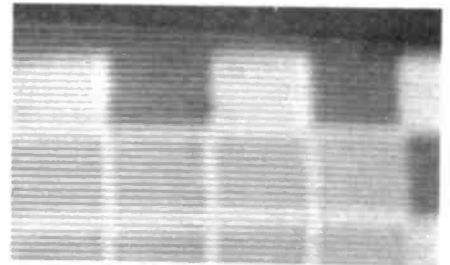

The still frame performance of the recorder is about as good as you can get from a VHS machine.

The audio/video in/out sockets make dubbing from another recorder possible without too much degradation in signal quality.

All in all the recorder worked well in its portable persona and would, with practice, allow the production of high quality video tapes of outdoor events.

ROUNDING OFF

The above comments show the VT-6500E to be a good all round home/portable combination.

The presentation of the system is excellent, although the same cannot be said for the manuals, these tipifying the worst of Japanese/English translations.

Another minor gripe is that the timer/tuner, without the recorder connected to it will not function. The modulator is part of the recorder, this does allow the recorder to be used to display its output on a TV minus the timer unit, but does mean that the tuner on its own cannot be used, even to display an off air signal on a monitor (all the video/in/out connections are on the recorder).

These are minor grumbles however, and if you can do without the luxury of IR remote control and the convenience of an index function, the recorder performs with the best of them in a domestic situation plus offering the go-as-you-please flexibility of a portable system.

■ R & EW

Your Reactions.....	Circle No.
Immediately Interesting	80
Possible application	81
Not interested in this topic	82
Bad feature/space waster	83

CB NOISE SQUELCH.

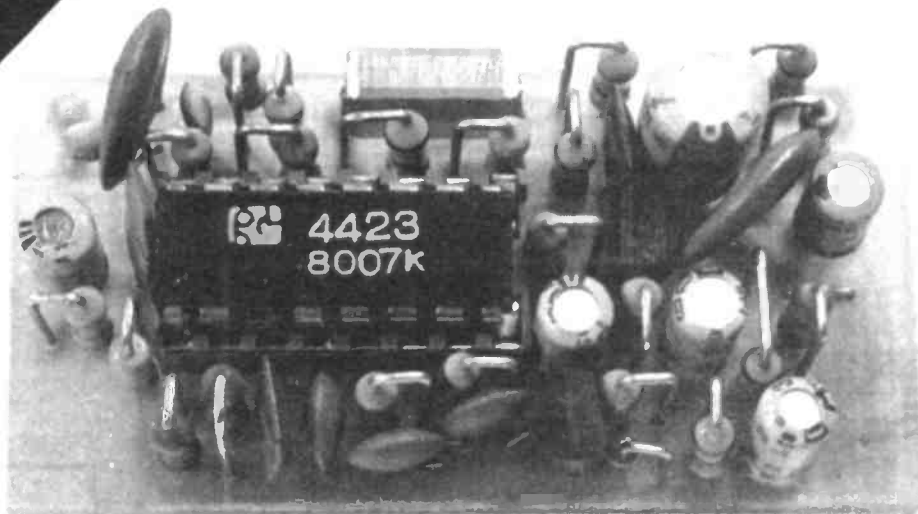

A single IC interference blanker combined with noise-operated squelch. Design by J.L. Forrest BSc.

TO THE UNCONVERTED, the first confrontation with an FM CB set is a terrifying experience. After discovering that the UK is swarming with people who converse in some weird mid-Atlantic Esperanto, and apparently all have criminal records which necessitate using an alias, the first real fright comes about 100 milliseconds after the other guy stops talking, and that quite innocent-looking little box gives forth with the most incredible racket.

As a combined result of the somewhat undignified rush by the Government to cobble together a workable system specification, and the apparent inability of indigenous manufacturers to compete with Messrs. Foreign Parts in value for money terms, all the new equipment straining the retailers' shelves ready for the nano-boom on go-like-L-day was designed and produced in the Far East. Generally, as tests in this (and lesser magazines) have shown, most of the sets available were competent, successful designs, but it was inevitable that they inherited a lot of functions from their AM predecessors already long in 'phone-number-quantity production, since the time available for development to the new UK spec was very short and the predicted intense market competition left no margin for extra technical frills.

Most of the deficiencies can be quite easily overcome with very little extra circuitry, and one such simple addition, which is well within the capability of anyone who can wield a soldering iron with relative dexterity, is described here, although it must be pointed out at this stage that any internal modifications to your CB set will certainly invalidate its guarantee, for which no responsibility can be accepted by R&EW.

That said, you will probably find that the addition of this little module will effect a very dramatic improvement to your CB set.

WHAT IS SQUELCH?

In an AM set, the squelch is controlled by received signal strength, usually by rectifying and smoothing the output from the IF strip to derive a DC control voltage to unmute the audio output. The threshold at which the squelch opens is adjusted by (would you believe) the Squelch control on the front panel, and the same signal-proportional DC level is almost universally used to drive the S-meter, or equivalent RF level indication. The Squelch knob therefore merely sets the S-meter reading at which the set unmutes. Unfortunately, there is no way the receiver can tell the difference between wanted modulation such as speech, and unwanted mush like interference or atmospheric, so anything of adequate strength to overcome the existing Squelch setting gets listened to, whether you like it or not. With AM this is not a problem, since noise and interference are generally quite tolerable, and weak signals just fade out into the background, so it is possible to find a setting for the Squelch which is a good compromise between not hearing too much noise and not missing any readable signals.

In the absence of any carrier input, however, the output from an FM demodulator is (very) loud random noise, since (as a gross over simplification) it sees an input of an infinite number of infinitesimal carriers, and wanders aimlessly about trying to demodulate them all. This noise is significantly louder than the

normal output due to a well modulated carrier, and is exceptionally obtrusive, especially to those unaccustomed to FM radio communications.

The background noise reduces immediately a carrier is received, roughly in proportion to the carrier strength, but the depth and quality of modulation also has some bearing on the S/N ratio so that weak signals can sometimes be far more readable than stronger ones. This makes finding a compromise squelch level very difficult, and the 'lay' user generally sets the squelch threshold higher than the level of weak signals, to avoid the worst of the noise, thereby rendering their set deaf to all but very local transmissions.

A further problem common to most squelch systems is the short burst of noise at the end of each transmission, as it takes a finite time for the set to react and mute. Without this delay any conversation would be continually interrupted by periods of silence as incoming signal level varied, at the extreme rendering any communication impossible.

INTERFERENCE

Another deficiency becomes only too apparent if your set is used mobile, because FM receivers are very prone to impulsive interference like ignition noise.

Some of the more sophisticated (and expensive) transceivers now appearing on the

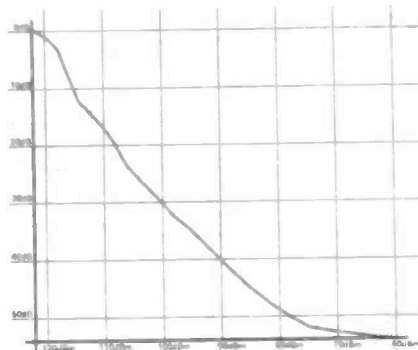
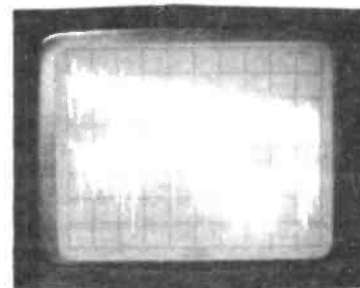

Figure 1: Input RF signal strength vs. output noise for the Amstrad CB901.



The audio response (10dB/div - 0.5kHz) of channel 'noise', and conversation on the bottom trace. The noise is over 15dB above an average conversation level.

market have a Noise Blanking circuit to eliminate most of the interference problem, very similar in operation to the type fitted to up-market FM car radios. The IC (TDA1001A) which performs this function has been around for quite a time. A second source available from TOKO as KB4423/4436, is the device which forms the basis of the circuit described here.

BACK TO THE SQUELCH

So what can be done about the squelch problem? The solution is to use the same sort of system as in all professional FM radio equipment, a Noise Squelch.

Fig 1 shows the relationship between input RF signal strength and output noise for the Amstrad CB901, (which has, incidentally, a very good design of a carrier squelch, and is significantly better in this respect than most of its competitors). You can see that the noise level reduces at a much faster rate than the carrier increases, so it would seem that a squelch which mutes the receiver when there is noise, rather than unmuting when there is carrier, will give a more sensitive and more useful muting action. The only problem remaining is to distinguish noise from wanted signals, and this is something that can be done with FM systems very easily.

Fig 2 shows the noise output spectrum from the FM demodulator on the Amstrad.

There is significant energy in the spectra out to 20kHz and beyond, which is very helpful since we know that the wanted audio is band-limited to around 3kHz before transmission, and so the amount of signal present above about 5kHz gives a very convenient measure of the presence or otherwise of noise.

Fig 3 is a block diagram of a typical noise squelch circuit, the output from the demodulator being split by a high-pass filter into a 'noise only' path, and an 'everything else and therefore probably audio' path, which frequently has a low-pass filter added, since there is little point in feeding the unwanted muck out to the loudspeaker, anyway. The noise path then rectifies and integrates the noise signal, and compares the resulting DC level in a Schmidt trigger with the level set by the Squelch threshold mutes the audio output,

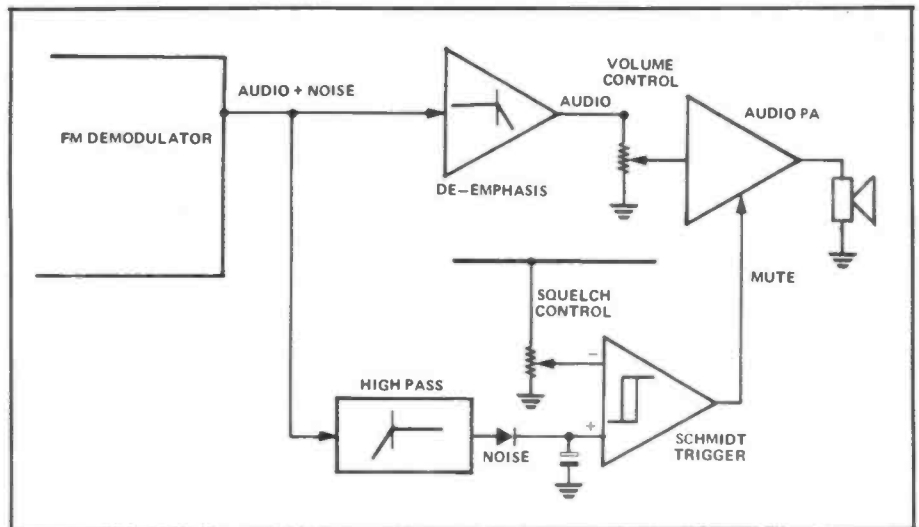

Figure 3: Typical Noise Squelch Circuit.

which is incidentally another major failing in most CB sets, but we'll come back to that later on. One dual op-amp and a handful of other cheap components, and there's the noise squelch.

Actually the circuit described from now on uses a different technique, but the basic operation is very similar. Fig 4, shows the KB4423's block diagram and we'll run through the KB4423 quickly, and see how it works.

INTERFERENCE BLANKER

The circuit within the KB4423 consists of five unity-gain buffers (emitter followers) A-D, and H, a noise gate J which is operated by a monostable (one-shot) F, itself triggered by a noise threshold detector E.

The input is fed through buffer A, which presents a nice low driving impedance to the CR filter networks which split audio and noise, each filter having a buffer to provide the necessary feedback. The main purpose of the low pass filter in the audio path is to function

as a delay for the signal, to allow the noise detector time to open the noise gate before the interference actually gets there, but it also usefully attenuates the HF mush which is present on low-level signals, improving their readability.

The noise gate operates as a Sample-and-Hold circuit; when the gate opens its output is stored on a holding capacitor C_H which uses buffer C as a voltage follower to feed the final output from the circuit.

In the noise path, after filtering using buffer D the HF information feeds a Schmidt trigger threshold detector E, whose output fires a monostable F. This generates a fixed width blanking pulse to open the noise gate for long enough to obliterate the noise in the audio path.

Since the original purpose of this IC was for use in car-radios for wide-bandwidth, high quality VHF reception, provision was made to reduce the noise detector sensitivity with AGC fed back from the blanking pulses, so that the odd prolonged bursts of interference didn't blot out the audio completely, instead the circuit resorts to eliminating the worst, on the grounds that some noise is better than dead silence. This function is achieved using a capacitor C_N on pin 12 to integrate the blanking pulses brought out on pin 10, pin 12 feeding the base of a PNP transistor within the IC, so that as C_N charges up the threshold of the noise detector is raised, reducing its sensitivity. At the extreme, when C_N charged to the full V_{be} of the control transistor, the interference threshold is raised by some 18dB, which useful point we will be using shortly.

The initial sensitivity of the device is set by a resistor R_S on pin 13, to allow adjustment for receiver front-end gain. Since there is some DC present on this pin, capacitor C_S is used to isolate it. The normal threshold (with no AGC operating) is around 30mV with an R_S value of 3k3, but again there is about 18dB of adjustment range as R_S is varied from about 1k to 10k. Also jolly useful, as we shall again shortly see.

The remaining buffer H is normally used in VHF stereo applications, and it drives a resonant RC filter tuned to 19kHz interposed between C_H and ground. The only remaining block in Fig 4 is the internal supply regulator G, and as it's all inside the IC we don't need to bother with it much except remember that it needs a dropper resistor R_G between it and the supply rail.

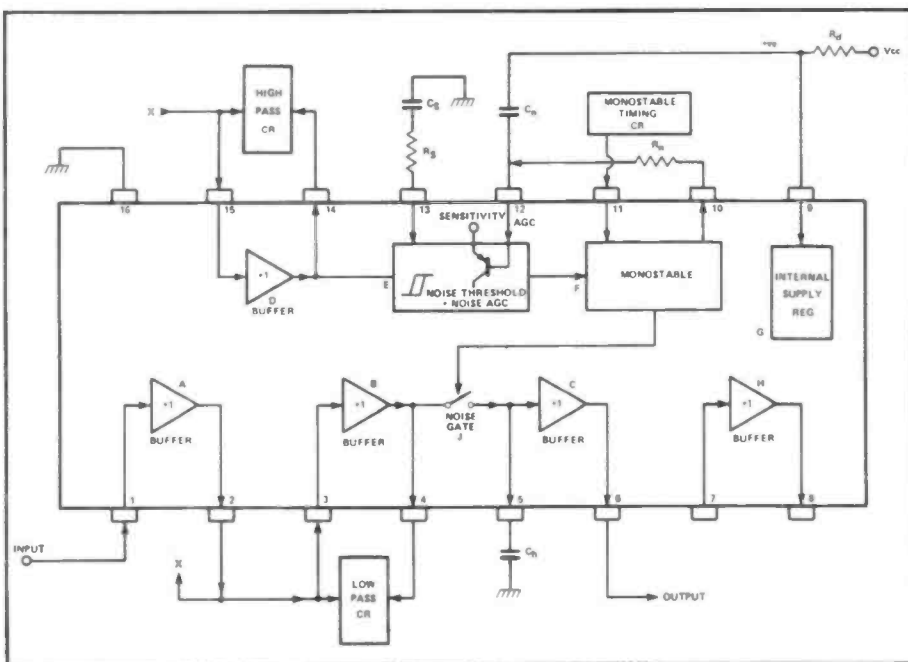

Fig.4: Internal Block Diagram of KB4423 I.C.

CIRCUIT DESCRIPTION

If we look back to our original requirements for a noise squelch, we remember that we need a DC signal proportional to noise level to operate a conventional output squelch and the KB4436 provides us with just that on pin 12, from the pulse integrating capacitor C_9 . As the signal in the noise path increase, C_9 charges up from zero (relative to supply rail) to a maximum of the V_{be} of the internal PNP transistor, so we can use pin 12 to drive another, external, transistor which in turn operates the original mute circuit in the CB set. Fig 5 gives the full circuit of the combined noise squelch and interference blanker. The signal chain in the original path is broken after the FM demodulator, but before the de-emphasis components, if any, and the demodulated signal feeds in via C_1 . The particular value of C_1 is not very important, and in most cases can be omitted depending on the particular CB set being modified. R_1 , as given in the component list, will suit most applications. (full details on adapting specific sets is shown in table 1). DC bias for the first buffer is provided via R_1 from R_{20} and R_{21} . The input is buffered to pin 2 and then fed to the two filters. The low-pass is calculated to give fastest roll-off at about 5kHz, and the high-pass set to -3dB at 6.5kHz, but with some 6dB peaking to increase the response between 7 and 10kHz where most of the noise energy is found.

Continuing through the audio path there is C_5 , the holding capacitor, which at 6n8 is a good compromise between hold time (the input impedance at pin 5 when the gate is open is 4M) and HF tracking, while R_5 prevents excess current damage to the gate transistors, and further limits HF response to the input bandwidth. R_6 and C_6 give the 75uS de-emphasis.

The audio muting is performed at this point, using D1 as a diode switch. D1 is normally forward biased by the DC voltage present on pin 6, which is an emitter follower output with more than enough current capability for the task. R_7 provides the necessary path to ground at the other end of D1, with C_7 isolating the DC from the output which can therefore be fed straight to the volume control with no problems, although the PA function in some rigs may operate a trifle strangely if this is done.

To mute the output Q2 grounds the cathode end of D1, which the IC doesn't mind with R_6 in the way, and a thump-free soft mute is obtained. An added benefit of this approach is that the module can be easily inserted in the original circuit with a minimum of wiring.

Because the collector of Q1 follows the noise envelope on C10, but an amplified version of it, some sloth has to be incorporated in the control of D1, which is the purpose of the

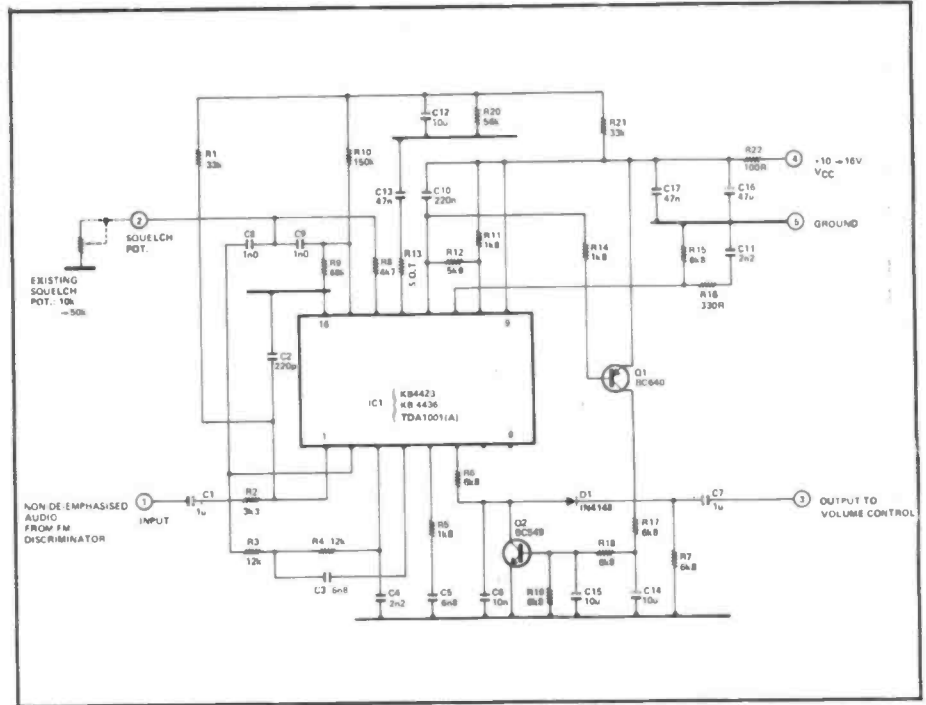

Figure 5: Circuit Diagram of the module described.

damped integration network $R_{17}, 18$ and $C_{14}, 15$. The fade rate is almost dominated by the effect of R_{19} , and again the value chosen is a compromise between open and close times for the mute. Increasing R_{19} to about 33k will give a very gentle soft fade in and out of the audio output, which some may consider very pleasant, and which is very reminiscent of the squelch on President and Cobra AM rigs.

Returning to the noise path, the filter is quite conventional, except that the final resistor is split into two, R_9 and R_{10} , to provide the DC bias for pin 15 (not necessary in the low-pass because there is a DC path through R_3, R_4 from the output of the first buffer).

The blanking pulse length is set to around 30uS by R_{15} and C_{11} , with R_{16} to protect the internal discharge transistor from too much current, and to prevent RF radiation by slowing down the pulse edges a bit. The pulses from pin 10 are integrated by C_{10} , via R_{12} , and R_{11} sets the pulse-rate to voltage ratio as a good compromise for the correct operation of the squelch control.

The voltage on pin 12 is used via R_{14} to turn

on a PNP transistor Q_1 , and which drives the muting circuit via the integrating network as herein aforementioned. Q_2 is quite important, as its $V_{ce(sat)}$ has a lot of effect on whether the mute is or not, and BC109 types (or plastic equivalents like BC549, BC550) work best. The sensitivity adjustment function on pin 13 is used to set the Squelch control range to match different sets, the problem being that it is most convenient to utilise the existing potentiometer in the set being modified, which is usually 10k linear. This is because there is a compromise between the 'shut' squelch setting being adequately insensitive at one extreme, and the need to ensure that the squelch can be fully open at the other, which is potentially tricky in very (electrically) noisy environments, like a car. However, by suitable tinkering with the timing components on pins 10 and 12 the present circuit has been evolved, where a 10k lin pot can be used to ground the feedback point in the low-pass filter, thereby adjusting both the amplitude of the noise signal and the cutoff frequency, and gives a very satisfactory c/g n -

A good starting point for R_{13} is 1k8 in most applications, but if you want to use the CB as a home-base, or in a well-suppressed car, a lower value of 470R is preferable, especially if you want to render the set deaf to all but really quiet copies as might be the case if the set is left running in the background just to listen for the odd interesting bits.

The rest of the circuit is pretty self-evident, with the necessary supply decoupling to allow the power to be derived directly from the on/off switch, rather than having to hunt for a 'clean' feed in amongst the receiver.

The only point worthy of further comment concerns the input. If your rigs is of Cybernet or similar origins, and uses an AN240 FM demodulator IC, then you don't have a problem, and the feed to this module can be taken direct from the IC output (pin 12 on the AN240), and the output returned to the other side of the capacitor, usually 22n, next along the track from pin 12, and which should be removed to fit this module.

Some FM demodulators, however, allow a large amount of residual 455KHz 2nd. To get

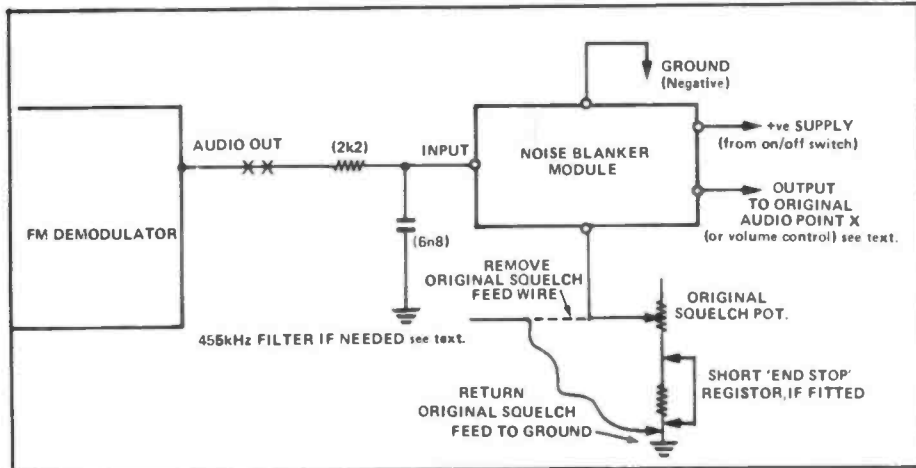

Figure 6: Wiring the Noise Blanker module into a CB set.

CB NOISE SQUELCH

through to their output, and steps must be taken to prevent this IF signal reaching the input of the Noise Squelch module, since it will see it as just a lot of noise, and stay very firmly (but politely) muted. Worst offenders for this IF leakage are the LA1230 (Amstrad) and the TA7130P (Shogun, Convoy, etc.), but fortunately all the sets concerned have RC networks at the offending IC output for the audio de-emphasis, and a simple component substitution can achieve adequate filtering of the 455KHz signal, as shown in Fig 6A single pole RC low-pass filter of 2k2 and 6n8 or 10n will do the trick.

CONSTRUCTION

The PCB is designed to be as small as possible, without suffering from the parasitic 60MHz oscillation of which this family of ICs is occasionally prone, and it should be reasonably straightforward, if a little fiddly, to assemble. There is bags of space for it inside the case of all the sets we've seen, and is easily held in place with a double-sided sticky pad.

Wiring in is self explanatory from Fig. 6 provided you pay heed to the possibility of 455KHz breakthrough, as mentioned earlier.

For those with rigs where the incorporation of the module into the original circuit is not obvious.

The only point to watch particularly is that this squelch circuit does radiate a small amount of RF when blanking, so position it as far away from the input section of the CB set as possible.

*Footnote The 'ringing filter' amplifier on the IC, pins 7 & 8, can be used for a tone squelch system, (the receiver only unmutes when commanded by a particular transmitter - otherwise known as Selcall) and this application, for which there is provision on the PCB for this circuit, will be described in a subsequent article.

■ R & EW

Your Reactions.....	Circle No.
Excellent - will make one	60
Interesting - might make one	61
Seen Better	62
Comments	63

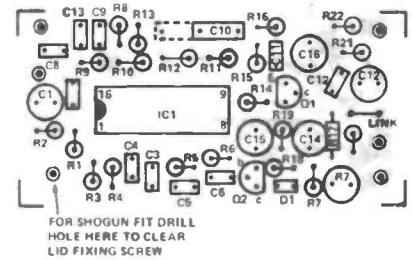
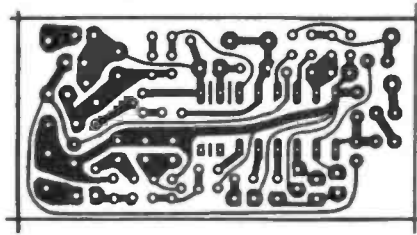

COMPONENTS LIST

Resistors (all 1/4W 5%)

R1, 21	33k
R2	3k3
R3,4	12k
R5,11,14	1k8
R6,7,15,17,18,19	6k8
R8	4k7
R9	68k
R10	150k
R12	5k6
R13	See Text
R16	330R
R20	56k
R22	100R

Capacitors

C1,7	1u 16V
------	--------

C2	220p ceramic plate
C3,5	6n8
C4,11	2n2
C6	10n
C8,9	1n0 ceramic plate
C10	220n
C12	10u 16V
C13,17	47n
C14,15	10u 16V
C16	47u 16V

Semiconductors

IC1	KB4436
Q1	BC 640
Q2	BC 549
D1	IN 4148

Miscellaneous

PCB, Solder pins, connecting wire etc.

AMSTRAD 900/901; TRANSCOM GBX 4000; FIDELITY 2001; etc.

Remove C93, C95, C96. Replace C94 (22n) with 2n2.

Connect module input (Pin 1) to + side of C95 holes, and output of module (Pin 3) to - side of C95.

Remove wire from "non-grounded" end of Squelch pot, and solder to grounded end. Connect new wire from "non-grounded end to module pin 2.

Connect power and ground as obvious.

SHOGUN

Remove R38, C37, C38. Check that C36 is actually 10n as shown on circuit diagram; some Shogi (Shoguns) have C36 and C37 reversed - if that is the case, ensure that C36 is really 10n.

Connect junction of C36 and R37 to input of module.

Connect output of module to junction of C38 and R39.

Short out R330 (adjacent to Squelch pot) and remove link pin between top and bottom of PCB feeding track to C71.

Connect wiper of Squelch pot to module pin 2. Remove (or just cut) D71.

Find power and ground as obvious and connect.

CYBERNET 134 BOARD (Fidelity 2000, Binatone 5-Star, York 861/863 et al.)

Remove C87. Connect AN240 side of C87 hole to module input (Pin 1), and other side to module output (pin 3).

Remove wire from "non-grounded" side of Squelch pot, and ground it.

Connect new wire between non-grounded side and module pin 2.

Connect power and ground as obvious.

FEEDBACK

UHF/VHF CONVERTER (FEB '82)

23cm CONVERTER (MAR '82) MULTIBAND UP CONVERTER (AUG '82)

The oscillator circuit in the above converters can be reluctant to start with some makes of crystal. Changing the damping resistor to 3k3 to 3k9 (from the

original value of 2k7) cures the problem.

If the converters are to be used outside the range specified, the resonant frequency of the tuned circuit can be ascertained by removing the damping resistor and measuring the free running frequency of the oscillator.

UOSAT RECEIVER (MAY '82)

The formula for calculating the crystal frequency is $FRx - 10.7 \text{ MHz}$

9

ZX80/81 EXPANSION BOARD (AUG '82)

RAM Check Program should read PRINT PEEK 16388*256+PEEK16389 Under construction head, last sentence should read except IC1 & 9

In parts list IC9 should be 74LS 138 IC10 should be 4049

EUROPEAN TV CHANNELS AND STANDARDS

UK TV Channels and Nominal Carrier Frequencies (MHz)

Channel	Vision	Sound
Band I		
405 lines		
1	45.00	41.50
2	51.75	48.25
3	56.75	53.25
4	61.75	58.25
5	66.75	63.25
Band III		
6	179.75	176.25
7	184.75	181.25
8	189.75	186.25
9	194.75	191.25
10	199.75	196.25
11	204.75	201.25
12	209.75	206.25
13	214.75	211.25
Band IV		
625 lines		
21	471.25	477.25
22	479.25	485.25
23	487.25	493.25
24	495.25	501.25
25	503.25	509.25
26	511.25	517.25
27	519.25	525.25
28	527.25	533.25
29	535.25	541.25
30	543.25	549.25
31	551.25	557.25
32	559.25	565.25
33	567.25	573.25
34	575.25	581.25
Band V		
39	615.25	621.25
40	623.25	629.25
41	631.25	637.25
42	639.25	645.25
43	647.25	653.25
44	655.25	661.25
45	663.25	669.25
46	671.25	677.25
47	679.25	685.25
48	687.25	693.25
49	695.25	701.25
50	703.25	709.25
51	711.25	717.25
52	719.25	725.25
53	727.25	733.25
54	735.25	741.25
55	743.25	749.25
56	751.25	757.25
57	759.25	765.25
58	767.25	773.25
59	775.25	781.25
60	783.25	789.25
61	791.25	797.25
62	799.25	805.25
63	807.25	813.25
64	815.25	821.25
65	823.25	829.25
66	831.25	837.25
67	839.25	845.25
68	847.25	853.25

VHF Channels used in Europe

Italy: 625 lines					
Ch	MHz	Ch	MHz	Ch	MHz
Band	I	Band	III		
A	53.75/59.25	D	175.25/180.75	G	201.25/206.75
B	62.25/67.75	E	183.75/189.25	H	210.25/215.75
C	82.25/87.75	F	192.25/197.75	H1	217.25/222.75
Ireland: 625 lines					
Ch	MHz	Ch	MHz	Ch	MHz
Band	I	Band	III		
A	45.75/51.75	D	175.25/181.25	G	199.25/205.25
B	53.75/59.75	E	183.25/189.25	H	207.25/213.25
C	61.75/67.75	F	191.25/197.25	J	215.25/221.25
France: 819 lines					
Ch	MHz	Ch	MHz	Ch	MHz
Band	I				
F.2	52.40/41.25	F.6	173.40/162.25	F.9	190.30/201.45
F.4	65.55/54.40	F.7	177.15/188.30	F.10	199.70/188.55
Band	III	F.8A	185.25/174.10	F.11	203.45/214.60
F.5	164.00/175.15	F.8	186.55/175.40	F.12	212.85/201.70
Other European Countries: 625 lines					
Ch	MHz	Ch	MHz	Ch	MHz
Band	I	Band	III		
E.2	48.25/53.75	E.5	175.25/180.75	E.9	203.25/208.75
E.2A	49.75/55.25	E.6	182.25/187.75	E.10	210.25/215.75
E.3	55.25/60.75	E.7	189.25/194.75	E.11	217.25/222.75
E.4	62.25/67.75	E.8	196.25/201.75	E.12	224.25/229.75

TV Standards

Colour Subcarrier 4.433 MHz						
Country	No. of Lines	System	Vision BW(MHz)	Modulation Vision	Sound	sound sub-carrier(MHz)
UK	405	A	3	Positive	AM	-3,5
Italy & Europe	625	B	5	Negative	FM	+5,5
Ireland & UK	625	I	5,5	Negative	FM	+6,0
France	819	E	10	Positive	AM	+11,15
	625	L	6	Positive	AM	+6,5
Europe	625	G,H	5	Negative	FM	+5,5

UHF Receiving Aerial Groups, Frequencies and Colour Codes

Group	Channels	Frequencies (MHz)	colour code
A	21-34	470-582	Red
B	39-53	614-728	Yellow
C/D	48-68	686-854	Green
E	39-68	614-854	Brown
W	21-68	470-854	Black

Power and Voltage Ratios in Decibels

The decibel notation is basically a method of expressing power ratio, the number of decibels (N dB) being given by

$$N \text{ dB} = 10 \log_{10} \frac{P_2}{P_1}$$

where P_1 and P_2 are the two power levels under comparison.

On the assumption of constant impedance the notation is also used for voltage ratio, giving

$$N \text{ dB} = 20 \log_{10} \frac{V_2}{V_1}$$

where V_1 and V_2 are the two voltage levels.

In the above expressions the denominator (P_1 or V_1) is the reference level, so that a power or voltage may be expressed as " N dB with respect to x watts or volts". This is often contracted to dB μV (to mean decibels with respect to 1 μV), dBm (with respect to 1 mW), dB W (with respect to 1 watt), etc.

Where the numerator of the ratio is less than the denominator N becomes negative; this may be expressed as " $-N$ dB" or " N dB down", positive values of N being regarded as " N dB up" by analogy.

Tables I and II facilitate rapid conversion between decibels and voltage or power ratios. To convert decibels to voltage or power ratio use Table I; to convert voltage or power ratio to decibels use Table II.

Table I covers dB ratios up to 20 dB only. For values of N greater than 20 proceed as follows.

Let X be the whole number of times that 20 can be divided into N , to leave a remainder that falls within the range of the table. Look up the voltage or power ratio corresponding to this remainder on the appropriate side of the table. For voltage ratio "up" multiply by 10^X , and for voltage ratio "down" divide by 10^X . For power ratio multiply or divide, as appropriate, by 10^{2X} .

Table II covers voltage and power ratios from 1 to 10. For power ratios outside this range move the decimal point to the left or right to bring the figure within the range, then add 10 dB for each position that the point is moved to the left, or subtract 10 dB for each position that it is moved to the right. For voltage ratios use the same procedure, but add or subtract 20 dB instead of 10 dB. Ratios close to 1 and to 10 are given in smaller increment than the rest of the table for convenience of conversion when errors are to be expressed in decibels.

Table I

Ratio Down		DECIBELS	Ratio up	
VOLTAGE	POWER		VOLTAGE	POWER
1.0	1.0	0	1.0	1.0
.9886	.9772	-1	1.012	1.023
.9772	.9550	-2	1.023	1.047
.9661	.9333	-3	1.035	1.072
.9550	.9120	-4	1.047	1.096
.9441	.8913	-5	1.059	1.122
.9333	.8710	-6	1.072	1.148
.9226	.8511	-7	1.084	1.175
.9120	.8318	-8	1.096	1.202
.9016	.8128	-9	1.109	1.230
.8913	.7943	1.0	1.122	1.259
.8710	.7586	1.2	1.148	1.318
.8511	.7244	1.4	1.175	1.380
.8318	.6918	1.6	1.202	1.445
.8128	.6607	1.8	1.230	1.514
.7943	.6310	2.0	1.259	1.585
.7762	.6026	2.2	1.288	1.660
.7586	.5754	2.4	1.318	1.738
.7413	.5495	2.6	1.349	1.820
.7244	.5248	2.8	1.380	1.905
.7079	.5012	3.0	1.413	1.995
.6683	.4467	3.5	1.496	2.239
.6310	.3981	4.0	1.585	2.512
.5957	.3548	4.5	1.679	2.818
.5623	.3162	5.0	1.778	3.162
.5309	.2818	5.5	1.884	3.548
.5012	.2512	6	1.995	3.981
.4467	.1995	7	2.239	5.012
.3981	.1585	8	2.512	6.310
.3548	.1259	9	2.818	7.943
.3162	.1000	10	3.162	10.000
.2818	.07943	11	3.548	12.59
.2512	.06310	12	3.981	15.85
.2239	.05012	13	4.467	19.95
.1995	.03981	14	5.012	25.12
.1778	.03162	15	5.623	31.62
.1585	.02512	16	6.310	39.81
.1413	.01995	17	7.079	50.12
.1259	.01585	18	7.943	63.10
.1122	.01259	19	8.913	79.43
.1000	.01000	20	10.000	100.00

Table II

Voltage or Power Ratio	dB Voltage	dB Power
1.0	0.0	0.0
1.1	0.83	0.41
1.2	1.58	0.79
1.3	2.28	1.14
1.4	2.92	1.46
1.5	3.52	1.76
1.75	4.86	2.43
2.0	6.02	3.01
2.5	7.96	3.98
3.0	9.54	4.77
3.5	10.88	5.44
4.0	12.04	6.02
4.5	13.06	6.53
5.0	13.98	6.94
5.5	14.81	7.40
6.0	15.56	7.78
6.5	16.26	8.13
7.0	16.90	8.45
7.5	17.50	8.75
8.0	18.06	9.03
8.5	18.58	9.29
9.0	19.08	9.54
9.25	19.32	9.16
9.5	19.55	9.27
9.6	19.65	9.32
9.7	19.74	9.87
9.8	19.83	9.91
9.9	19.91	9.95
10.0	20.0	10.0

DURING THE SUMMER SEASON the lull in the stream of new hardware coming to the market is quite noticeable. There is a 'Birth Bulge' in the late spring as manufacturers rush to launch their new models before the media decamp for far off shores (witness the Sinclair Spectrum), followed by a similar gaggle of product launches in the early autumn (Commodore are due to begin marketing their extended range during September/October). This brief respite in the activities of the market readers has allowed time for a visit to a company that has been quietly working away at some interesting products for some time now.

The company in question is SPT Electronics and their area of expertise is the production of printer interfaces. The use of micros in the office of today is more and more becoming an accepted fact and the range of 'jobs' systems are performing is becoming more diverse. In the majority of tasks, some form of hard copy output is required a while the dot matrix printer performs a sterling job when it comes to cheap reasonable quality print-out, the standard is hardly 'letter quality'.

The most sensible avenue of approach if letter quality documents are required is to utilise the office typewriter, which with one of SPT's interfaces, can be linked to any of the top selling micro systems around.

SPT produce interfaces for the Olivetti Daisy Wheel, the Brother EM1 or EM2, the Smith-Corona EL2000 and the Silver-Reed EX55 typewriters. These little block boxes (well, two-tone grey actually) permit all the typewriters to handle the output from machines in the Commodore, Tandy, Apple and Acorn (BBC) stables with designs for other machines in the pipeline.

Thus if you have a computer system, a typewriter and a desire to link the two - SPT are the people to talk to.

BIGGER THINGS.

Another part of the SPT group of companies specializes in converting standard TV sets into video monitors complete with video and sound in/out sockets, as well as PAL/SECAM/NTSC capability if you so desire. Add one of these to a souped up printer interface and you begin to see SPT's ultimate aim - a

Figure 1: SPT's Central Counter Terminal links data lines with a microcomputer and a typewriter.

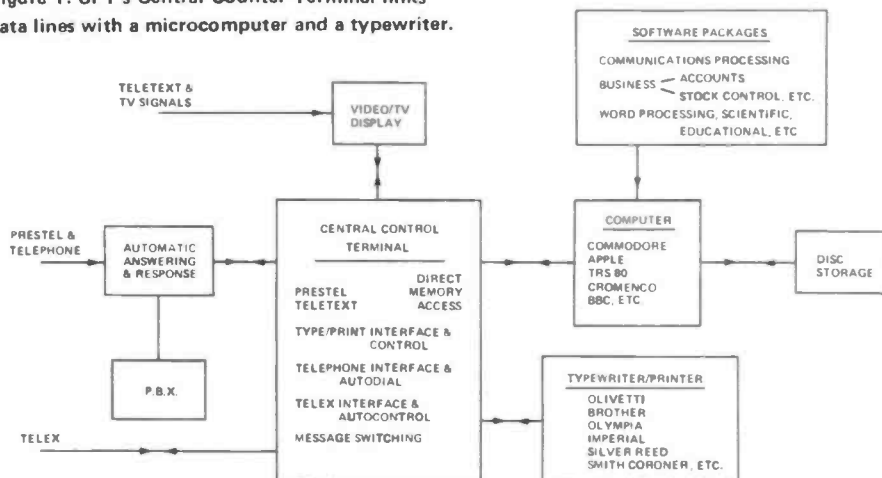

Gary Evans looks at a range of Printer Interfaces and at a Spectrum add-on.



'communications processing system'.

This is bound to be a tremendous market growth area during the next few years for with all the divergent sources of data coming into the office, and home (teletext, Prestel, telephone, telex) and the increasing availability of hardware/software combinations to process such data - the need for some form of controlling the interaction between the various elements of a data processing system is evident.

SPT aim to produce a unit that will interface to British Telecom lines (God and Busby willing) and to teletext software, in turn producing an output in a form suitable for connection to any micro system.

The diagram shows the sort of thing they have in mind and the system is so versatile that the free use of 'etc.', on the drawing can be forgiven.

The design work is well under way, its pace at present being dictated by the speed

at which British Telecom operate, and the latter part of this year should see the first systems emerging from the SPT labs.

Heybridge Industrial Estate,
Maldon,
Essex.

SPECTRUM PLUS

Like the ZX81 before it, the Sinclair Spectrum is giving rise to a whole new industry dedicated to producing various add-ons for the machine.

The first such item to come to the attention of R&EW is a 24 line input/output port from Kempston (Micro) Electronics. This is NOT a modified ZX81 port, but a device purpose designed for the Spectrum. Designed around a single MOS chip the port imposes virtually no DC load on the Spectrum's data lines, and only a minimal AC load on the address lines.

The port makes use of the Spectrum's IN and OUT commands, and provides three 8 bit I/O ports which can be written to or read from by one BASIC command.

The port can either be used with the company's two slot mother board, or with a stackable edge connector - in either case the microdrive and printer can be used in tandem with the port.

The port is available fully built and tested for £16.50 inclusive of VAT, but add 70p to cover post & packing.

The two slot mother board costs £16.95 and the stackable connector £5.50, again prices include VAT, p&p for two or more items is £1.00.

60 Adamson Court,
Hillgrounds Road,
Kempston,
Bedford, MK42 8QZ.

NEWS BACKGROUND

"That'll do nicely"

Spurred on by the comments in last month's correspondence columns, we take a look at one aspect of the Wireless Telegraphy Act, bearing in mind that 'ignorance of the law is no defence...'

The creeping acceptance of the indiscriminate use of the radio spectrum by all and sundry took on a new dimension the other day when a solicitation from American Express arrived at the R&EW HQ. The things you can obtain by mail order with the magic plastic rectangle are quite mind boggling, and the expensively produced "Repertoire" included a few things that we thought you might like to see.

The general concept of flattering the American Express user with lavish flog sheets like these is probably very sound, so how about £695 for one of these little charmers from an edition of seven by Malcolm Woodward? Try loading that up on topband....

And here's an offer any red blooded reader would have difficulty in refusing....

For those quiet evenings in...



But lurking towards the back of this particular issue was a very tempting page of cordless telephony. We must assume that those responsible didn't really know what they were doing, since even the advertisers in places like 'Exchange and Mart' are obliged to include a rather more ferocious form of disclaimer than the one sanctioned by American Express:

"All equipment carries 12 months parts and labour warranty and although it complies with F.C.C. and European Community standards of telephone communications approval, it is however



subject to whatever standards are eventually established by British Telecom."

Well, there's a thing! We must assume that American Express lawyers checked the text, and that the disclaimer is valid, but we are in no doubt as to the fact that the equipment displayed is in contravention of all sorts of aspects of the various Wireless Telegraphy Acts if it is actually connected to a telephone and used. Maybe you are supposed to stand them on the mantelpiece alongside your piece of limited edition sculpture?

It would be unfair to single out American Express for this particular 'offence', since the cordless telephone phenomenon is apparent in many erstwhile respectable retailing operations in this country. However, we are quite certain that most of the senior staff responsible cannot have a clear idea of the ramifications for their customers if they get nabbed red-handed by the Radio Regulatory Division. Try this for size, Mr.H.R.Freedberg:

Penalties in connection with contravening the WTA include:

A £400 fine, and up to 6 months in the pokey on a *first* offence, and a virtually bottomless pit on subsequent offences.

That any prosecution (and there have been some) also includes confiscation of the equipment goes without saying. Maybe you can use your credit card to pay the fine "that'll do nicely..." as they say.

To their credit, (geddit?), American Express have responded rapidly and effectively when we pointed out this possible problem, and we have no doubt that anyone dealing with AMEX can expect nothing less than a thoroughly sound deal.

The Wireless Telegraphy act places great power in the hands of the Home Office and its officers, yet curiously this does not extend to stopping the importation and sale of such things as cordless telephones and illegal CB (via the Isle of Man route). However, you have redress under the *Sale of Goods Act* against whoever sold you the equipment, if they did not make it plain that you could not legally use the equipment in the UK. And here, we fear, American Express are walking a fraying tightrope. It would be an interesting defence to cite the rather nebulous American Express disclaimer (whether or not you bought the offending instrument from them), although we have no desire to be the test case.

ARE YOU RECEIVING ME??

As mentioned last month, you must not listen to anything that is not either an *authorised* broadcast, or a licenced amateur transmission. This rather foolish generalisation in the WTA has tended to reduce the whole of the Act to a laughing stock, and the subject of both wilful and inadvertent civil disobedience. As someone once remarked, unenforceable law is bad law, so as long as the means of ignoring the law are freely accessible and hard to detect, then this aspect of the WTA is thoroughly disreputable and should be changed.

The more fair minded people at the HO agree that the interpretation should state that the offence occurs at the point at which information gleaned through listening to transmissions that are not either authorised broadcasts, or conversations between licenced amateurs (no mention of CB?), is acted upon in connection with some other statutory offence. And there's enough of those already... conspiracy, the dreaded 'sus', breach of the peace etc.

The current review of the rules concerning the integrity of computer information may like to take this aspect of electronic information transmission into account at the same time, since there is a danger that if left to the HO, the whole question may become impossibly bogged down in technical minutiae, and end up as utterly unenforceable, once again.

The CB lobby managed to railroad political opinion, although the result of that was an unedifying piece of in-fighting that resulted in a partial compromise solution that would have been a magnificent solution, but for the lateness of its arrival. Can the educated opinion of R&EW readership prevail, and present us with sound and reasoned proposals to lay before

NEWS BACKGROUND

the politicians? Write in and let us hear what *you* would do with the WTA, how you would enforce it, and how you would pay for its enforcement.

If the Home Secretary can have his arm twisted by the frequently illogical, and intemperate views of the CB fraternity, the cool reason of our readers should prove to be quite irresistible. Or are we being too naive??

FORM AN ORDERLY QUEUE

Last month's *News Background* featured some of the ways in which Mrs. Thatcher *et alia* are seeking to inspire and assist British Industry. Well, (possibly with one eye on the unprecedented figures for company liquidations and failures), the support has been increased from 25% to 33% of qualifying costs.

The scope of such funding can easily reach a scale that justifies the employment of a full time 'manager', simply watching over the administration of the paperwork and applications involved in getting the most out of the schemes available.

Maybe we are now approaching the point at which we might ask if it is not perhaps more appropriate to consider changing the structure of company taxation to provide more incentive for investment, than to concentrate too heavily on the 'rich aunt' approach of dishing out that taxpayers vicarious 'largesse'. That, after all, would be more in keeping with the government's declared policy of less interference and lower taxation?

OLD DOGS, OLD TRICKS?

We have always tried to give the Home Office (HO) the benefit of the doubt, when so many others have been ready and willing to accuse them of the worst atrocities since Adolf Hitler. However, the Reichmarshall himself, (The Right Honorable William Whitelaw MP), appears to be attempting another blitzkrieg on the public accessibility of the radio spectrum.

In a Press Release dated July 6th, the HO asks that anyone wishing to submit evidence to the independent review of the Radio Spectrum do so by July 27th at the latest. The subject of the first phase is the use of the VHF Band 1 and Band 3 frequencies released from 405 line TV broadcasting.

The report on their interim findings will be available by September 1st this year, and this rather scant timescale would seem to indicate the HO have already made their plans for the frequencies well in advance.

Well, here's our suggestions, what do you reckon?

1. 50.000 to 53.250MHz to amateur use.
2. 53.250 to 54.000MHz to CB.
3. 49.000 to 50.000MHz to cordless phones etc.

Why? The 6m amateur band already exists elsewhere, and is a very ideal medium for amateur communication. The propagation characteristics tend to make it unsuitable for other forms of broadcasting/communication - as evidenced by the ease with which the Louisiana State Police can be heard drawing over a pretty average VHF scanner receiver.

750kHz for yet more CB may seem profligate, but it could be a good compromise between equipment costs and the need to provide a reasonably usable frequency if we are all to concede that anything around 27MHz is likely to be reduced to the level of a farce through inadequate range and AM/SSB interference.

The emergence of illegal sets for 45MHz should have sent shivers down the spine of any half responsible HO official, only too well aware of the gross inadequacy of their attempts to curtail illegal use elsewhere.

And cordless phones? Well, another *fait accomplis*, along with mickey-mouse walky talkies and the like. A Megahertz may be a shade on the generous side, but the size of the industry created and the numbers of jobs supported might well justify the usage - as long as the government has the nerve to ask that Messrs. Foreign go away in view of the way they have eagerly and wilfully collaborated in supplying illegal equipment through the back door, even going to such lengths as supplying naughty CB in cases marked as foodmixers. A MHz devoted to Private Mobile Radio would arguably contribute less than one quarter the total revenue and job creation capacity - if that.

Band 3 VHF (circa 180MHz) is an ideal place for the type of narrowband community broadcasting that has become technically possible in the past five years.

2MHz of 10kHz channels would provide 200 slots for all types of specialised interest broadcasting - such as the use we had proposed for 10kHz in the 2m amateur band. The equipment is cheap and would provide a very real opportunity for UK job creation - and we might even pioneer the concept for other countries for once. Can you imagine Japanese bootleggers eagerly opening crates marked 'Scotch Whiskey' to unload the latest consignment of community broadcasting system equipment from the buzzing factories of the UK? You can't? Well, you've got no imagination then!

It would provide space for such specialised interests as software broadcasts to computer users, and suitably coded and identified, a receiver could be capable of monitoring the 'index' channel to be directed to whichever of the locally available channels contained information of interest to the listener, by checking his preference codes.

Such information might then be recorded



on cassette to avoid the problems of trying to produce a 'Radio Times' for such a cornucopia of information. (Mind you, you could still look it all up on 'REWTEL'!)

SMALLPOX VACCINE

The response from the HO to our application for the idea in 2m very generously provides absolutely no grounds for any technical objection to the concept, seeking to hide behind the terms of the amateur licence and the general traditions of the Amateur Service.

Well, until not so many years ago, smallpox and typhoid were fairly traditional, but that's no real argument for their retention, is it?

There's a lot more we could say about the other MHz that are being released, but these suggestions are likely to be the most controversial and potentially interesting if the various factions of interest within the HO and the telecoms business can be persuaded to think a shade more laterally than has been their usual practice.

Over to you.

R&EW BOOK SERVICE

Use the reply paid coupon for ordering.

★BOOKS OF THE MONTH★

ADVANCED COMPUTER DESIGN

By Don Lancaster

1981; 469 pages; 230 x 315mm;
Hardback £18.95

This book as the title suggests, is not a book for beginners. It is aimed at final year undergraduates in computer science or engineering, or as a book for postgraduate studies. The author assumes therefore that the reader is acquainted with machines and their architecture down to register level, with storage structures commonly used to represent numeric and non-numeric data, and with elementary compiling techniques. To put it another way, it is assumed the reader knows what he is talking about!

The first chapter is entitled 'background and notation'. It sets down the ground rules for the discussion, introducing the way of thinking behind the book. The formal grammar is defined, along with all the symbols used. There is a section on terminology, so that words which may cause confusion or ambiguity are defined.

The rest of the book is split into three parts. The first part (Chapters 2-7) describes the principles of interpretive machines. The principles behind how a machine translates the instructions is given to a sequence of events which carry out that instruction. The DEC PDP11 and ICL 1900 are used as examples here. The next step is to look at the computers at the microcode level. Here the IBM 360 is added to the list of machines looked at. In chapter 4 the 'Do-It-Yourself' side is examined in the form of the AMD 2900 bit slice series of components, and how these may be linked together to form a machine as we normally know it.

Chapter 5 is the chapter I enjoyed most, the microprogrammed machine is optimised to suit the programs being run on it. The most commonly used instructions should be made to run the fastest, but which ones are those? In addition the instruction set should be tailored to suit the language or application being used on the machine by carefully selecting the user level instruction set of the machine. Chapter 6 looks at the results obtained by optimising the instruction set towards Fortran or Cobol. Chapter 7 is the autopsy of the previous chapters, and the possible paths ahead.

Part Two covers Chapters 8-13. If it takes one man ten days to dig a hole, how long does it take 200 men to dig the same hole? The cost of hardware is rapidly falling, so why not simply use more of it to solve a problem faster? Problems like "you can't get 200 men down the hole at once", are looked at here. Both pipelined and parallel machines are examined here (are they different?). The floating point systems (AP-120B), the Cray-1, the Iliac IV and the ICL-DAP are all used as example machines. The principle of 'active memory arrays' or AMA's are introduced. Most people think of doing one thing followed by another, which makes pipelined machines easier to understand than parallel machines,

although both are doing more than one thing at once. These chapters look at methods of using the parallel nature of array processors to their advantage. After all, if there are 1024 places to send the data to then one must be better than another one.

Part 3 consists of chapter 14-19. It starts off with an introduction which contains the words, "experienced computer engineers will probably find some of the material 'difficult' at first reading". This section looks at the principles of abstraction. It is now generally agreed that an organised and structured way should be taken when designing or using systems. This is one way. It is looked at with examples using the Carnegie-Mellon experimental machine, a Plessey PP250, and a Cambridge University experimental machine. The ICL Basic Machine Language (BLM) is covered in chapter 16, and the IBM system 38 in chapter 17. The rest of this section continues the argument forwards.

In conclusion this book is an excellent update on current trends in computer science. There are 15 pages of references, all of which are major references, as opposed to something which may vaguely refer to the subject in hand. The only negative point in my opinion is the use of yet another language specific to a book or university course. In this case it is called 'P'. Knuth uses 'mix', Horowitz and Sahni use 'sparks' and so on. Enough now from the top of my soapbox, and back to one of the better books it has been my pleasure to read.

KM

SECURITY ELECTRONICS

2nd Edition

By John E Cunningham

1981; 192 pages; 135 x 215mm;
Paperback £5.25

Recent events have put the subject covered by this book very much in the public mind. It is an unfortunate comment on the times in which we live that security systems and their enforcement are now big business, and it is therefore no surprise to learn that this second edition is already in its fourth printing.

The book details the operation principles of various electronic security devices and systems from simple home alarms to complex systems for the protection of e.g. government property.

The opening chapter outlines the various types of electronic intrusion alarms followed by chapters giving detailed descriptions of electromechanical, photoelectric, ultrasonic, microwave and proximity detectors.

The author then describes systems for the detection of objects - very important where there may be the possibility of sabotage, hi-jacking or the removal of stolen goods in employees' clothing. This is followed by details of alarm and signalling systems, accessories and auxiliary equipment.

A chapter entitled Practical Applications deals with the difficulty of deciding on the best system to employ in a particular situation bearing in mind the methods likely to be used by those seeking to avoid its safeguards; the economics of the choice are also discussed. The remaining chapters deal with electronic eavesdropping, car protection, personnel identification and finally the use of computers in security systems.

A most useful book for anyone setting up a security system, and it is rounded off with a comprehensive glossary.

JB

RADIO BOOKS

AMATEUR ANTENNA TESTS AND MEASUREMENT by HD Hooton	£7.45
BEGINNERS HANDBOOK OF AMATEUR RADIO By C Laster	£9.70
CB RADIO CONSTRUCTION PROJECTS by Len Buckwalter	£2.95
FERROMAGNETIC CORE DESIGN by M F Doug DeMaw	£19.95
MICROWAVE DEVICES AND CIRCUITS by Prof S Liao	£28.00
QUESTIONS AND ANSWERS ABOUT CB OPERATIONS by LG Sands	£2.85
TV ANTENNAS AND SIGNAL DISTRIBUTION SYSTEMS by M J Salvati	£8.20

GENERAL BOOKS

ABCs OF INTEGRATED CIRCUITS by R P Turner	£4.45
ACTIVE FILTER COOKBOOK by Don Lancaster	£11.20
BASIC ELECTRICITY/ELECTRONICS Vol 3 Understanding Electronic Circuits 2nd Edition by Training & Retraining Inc	£9.70
BEGINNER'S HANDBOOK OF IC PROJECTS by D L Heiserman	£10.35
CMOS COOKBOOK by Don Lancaster	£9.70
DESIGN OF OP-AMP CIRCUITS - with experiments by H M Berlin	£8.20
DESIGN OF PHASE-LOCKED LOOP CIRCUITS - with experiments by H M Berlin	£8.20
DESIGN OF VMOS CIRCUITS - with experiments by R T Stone	£8.95
EFFECTIVELY USING THE OSCILLOSCOPE by R G Middleton	£7.45
HOW TO BUILD A FLYING SAUCER by T B Pawlicki	£4.75
HOW TO BUILD YOUR OWN STEREO SPEAKER by Christopher Robin	£7.15

INTEGRATED CIRCUIT PROJECTS by R P Turner	£4.90
LINEAR INTEGRATED CIRCUITS By S D Prensky & A H Seidman	£15.95
LOGIC AND MEMORY EXPERIMENTS USING TTL BOOK 1 by D G Larsen & P R Rony	£8.95
LOGIC AND MEMORY EXPERIMENTS USING TTL BOOK 2 by D G Larsen & P R Rony	£9.05
99 PRACTICAL ELECTRONIC PROJECTS (2nd Edition) by Herbert Friedman	£4.45
ONE EVENING ELECTRONIC PROJECTS by Calvin R Graf	£4.90
OP AMP HANDBOOK by F W Hughes	£16.45
OPERATIONAL AMPLIFIER CHARACTERISTICS AND APPLICATIONS by R G Irvine	£19.95
OSCILLOSCOPES by S Prentiss	£11.15
PRACTICAL LOW-COST IC PROJECTS (2nd Edition) by Herbert Friedman	£4.45
PRINCIPLES OF BIO-MEDICAL INSTRUMENTATION & MONITORING by R J Traister	£19.95
SECURITY ELECTRONICS (2nd Edition) by J E Cunningham	£5.65
SON OF CHEAP VIDEO by Don Lancaster	£7.45
SCRS & RELATED THYRISTOR DEVICES by C Laster	£9.70
TTL COOKBOOK by D Lancaster	£8.95
THE 555 TIMER APPLICATIONS SOURCEBOOK - with experiments by H M Berlin	£5.65
UNIQUE ELECTRONIC WEATHER PROJECTS by Tom Fox	£6.70



COMPUTER BOOKS

APPLESOFT LANGUAGE by B D & G H Blackwood	£8.20
ATARI ASSEMBLER by Don & Kurt Inman	£10.35
BASIC BUSINESS SOFTWARE by E G Brooner	£8.95
BASIC PROGRAMMING ON THE BBC COMPUTER by P Cryer	5.95
CALCULATOR CLOUT - PROGRAMMING METHODS FOR YOUR PROGRAMMABLE by M D Weir	£7.15
CIRCUIT DESIGN PROGRAMS FOR THE TRS-80 by Howard M Berlin	£10.90
COMPUTER GRAPHICS PRIMER by M Waite	£11.20
COMPUTER LANGUAGE REFERENCE GUIDE by Harry L Helms	£5.95
CP/M PRIMER by S Murtha & M Waite	£11.20
CRASH COURSE IN MICROCOMPUTERS by Louis E Frenzel	£14.95
DIGITAL CIRCUITS AND MICROCOMPUTERS by D E Johnson et al	£9.50

DIGITAL CONTROL USING MICROPROCESSORS by P Katz	£17.95
EXPERIMENTS IN ARTIFICIAL INTELLIGENCE by J Krutch	£6.70
GUIDEBOOK TO SMALL COMPUTERS by W Barden Jnr.	£5.20
HANDBOOK OF SEMI-CONDUCTOR MEMORIES by M M Cirovic	£19.15
HOW TO DEBUG YOUR PERSONAL COMPUTER by J Huffman	£7.95
HOW TO PROGRAM AND INTERFACE THE 6800 by A C Staugaard Jnr	£11.95
HOW TO TROUBLESHOOT AND REPAIR MICROCOMPUTERS by John D Lenk	£7.95
INTIMATE INSTRUCTIONS IN INTEGER BASIC by B D & G H Blackwood	£5.95
INTRODUCTION TO MICRO-COMPUTERS FOR THE HAM SHACK by Harry L Helms	£4.45
LOGIC DESIGN OF COMPUTERS by M P Chinitz	£11.95
MICROCOMPUTER DICTIONARY by C J Sippl	£11.95
MICROCOMPUTER INTERFACING WITH THE 8255 PPI CHIP by P F Goldsbrough	£7.45
MICROPROCESSOR SOFTWARE, PROGRAM CONCEPTS AND TECHNIQUES by G A Streitmatter	£15.95
MOSTLY BASIC: APPLE II by H Berenbon	£9.70
MOSTLY BASIC: PET by H Berenbon	£9.70
MOSTLY BASIC: TRS-80 by H Berenbon	£9.70
PET BASIC: TRAINING YOUR PET COMPUTER by R Zamora et al	£11.95
PET PERSONAL COMPUTER FOR BEGINNERS by S Dunn	£5.95
PRACTICAL HARDWARE DETAILS OF Z-80, 8080, 8085 & 6800 MICROCOMPUTER SYSTEMS by J W Coffron	£18.35
PRACTICAL TROUBLESHOOTING TECHNIQUES FOR MICROPROCESSOR SYSTEMS by J W Coffron	£16.75
A PRIMER ON PASCAL by R Conway et al	£12.70
PROGRAMMING AND INTERFACING THE 6502 - WITH EXPERIMENTS by Marvin L De Jong	£11.95
THE S100 AND OTHER MICRO BUSES by E C Poe & J C Goodwin	£7.45
SMALL BUSINESS COMPUTER SYSTEMS by P J Best	£9.70
SOFTWARE MAINTENANCE GUIDEBOOK by R L Glass & R A Noiseux	£18.40
SYSTEMS PROGRAMMER'S PROBLEM SOLVER by W S Mosteller	£15.20
THE 8080 A BUGBOOK by Peter R Rony	£9.70
8085A COOKBOOK by Titus	£10.45
TRS-80 ASSEMBLY LANGUAGE by H S Howe	£7.95
TRS-80 INTERFACING BOOK 1 by Jonathan A Titus, Christopher Titus & David G Larsen	£8.20

TRS-80 INTERFACING BOOK 2 As for Book 1	£8.95
USING THE UNIX SYSTEM by R Gauthier	£15.50
VIDEO/COMPUTERS, HOW TO SELECT, MIX AND OPERATE PERSONAL COMPUTERS & HOME VIDEO SYSTEMS by C J Sippl & F Dahl	£6.35
Z-80 MICROCOMPUTER DESIGN PROJECTS by W Barden Jnr	£10.45
Z-80 MICROCOMPUTER HANDBOOK by W Barden Jnr	£8.95
Z-80 MICROPROCESSOR PROGRAMMING AND INTERFACING BOOK 1 by Nichols et al	£9.70
Z-80 MICROPROCESSOR PROGRAMMING AND INTERFACING BOOK 2 by Titus et al	£11.95
6502 SOFTWARE DESIGN by Leo Scanlon	£9.70
6809 MICROCOMPUTER PROGRAMMING AND INTERFACING - with experiments by A C Staugaard	£11.20
THE 68000: PRINCIPLES AND PROGRAMMING by L J Scanlon	£11.20
YOUR OWN COMPUTER by M Waite	£5.55
16 BIT MICROPROCESSORS by Titus et al	£10.45

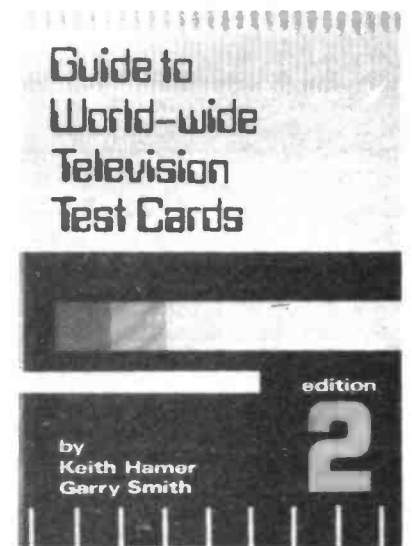

GUIDE TO WORLD-WIDE TELEVISION TEST CARDS

By Keith Hamer and Gary Smith

£2.85

Make all cheques/postal orders payable (in sterling only!) to R&EW Book Service. Orders should be sent to R&EW Book Service, 200 North Service Road, Brentwood, Essex CM14 4SG. Note: All prices exclusive of postage and packing please add 75p for first book ordered, plus 25p for each additional title on same order.

in model locomotives to about 80% in good-quality mini-drills.

It follows from the above that, if we could somehow amplify the APPARENT dynamo efficiency of a motor to (say) 95%, and then feed that signal to the SMVF circuit in place of the true dynamo voltage, the SMVF circuit would automatically provide that motor with near perfect speed/load regulation, even if the motor were of the very poorest quality. In practice, this action can be achieved by using an 'amplified feedback' technique. Fig. 3 shows the basic circuit, and Fig. 4 shows the circuit waveforms.

Figure 3 is similar to the basic SMVF circuit, except that peak-voltage limiter D1-R5 is wired between the output and RV1 slider, and the R4-C1 integrator is fed from the D1-R5 junction. If we assume that the forward volt drop of D1 is 500mV, that R5 is very large relative to RV1, that R4 is very large relative to R5, and that RV1 slider potential is at 2V, it can be seen that during the MARK part of the cycle the voltage at point 'A' limits to 2V5 peak, while in the SPACE part of the cycle the waveform at 'A' is equal to the motor's speed-dependent dynamo voltage.

Figure 4 shows the waveforms and formulae of the circuit under this condition. Note that the mark slope at point 'B' is fixed (at any given input voltage), but that the space slope depends on the speed-dependent dynamo voltage of the motor; the slope increases (and the space period decreases) as V_D decreases, so the mean output voltage at point 'C' increases as the motor voltage falls, thereby raising the motor drive and tending to return the speed to its original value. The circuit actually regulates the mean voltage at point 'A', holding this value very close to the input voltage. The voltage at point 'A', however, is predominantly determined by the dynamo voltage, so the action of this 'amplified feedback' version of the SMVF circuit is such that it holds the generated dynamo voltage (and thus the motor speed) constant at the same value as the input voltage (from RV1 slider), automatically adjusting the mean output voltage to obtain this action. Since V_D is inevitably less than the applied motor voltage, the maximum RV1 value must be less than 12 volts (when driving a 12 volts motor); pre-set RV2 allows the maximum voltage to be set.

Table 1 shows measured waveform values of the Fig. 3 circuit at various 'dynamo' values. Note that when V_D is below 1V95, the space slope is large relative to the circuit's hysteresis voltage, so the slope is virtually linear. At 1V95 however, the true 'linear' slope would actually be only 0V15 (compared to a hysteresis value of 0V12), so the slope becomes exponential and takes up an effective value of 0V097; this exponential characteristic gives very sharp regulation near the 'lower threshold' value, which determines the maximum attainable dynamo voltage.

In Table 1, we've introduced an 'applied power factor', which is the square of the effective applied voltage (mean output less V_D), together with a 'normalised' value in which all values are divided by 4.2. Note that, when the motor is stalled, the effective applied power is 34.3 times greater than when the motor is lightly loaded; the basic SMVF circuit would increase the applied power by a factor of only 3.8 under the same circumstances.

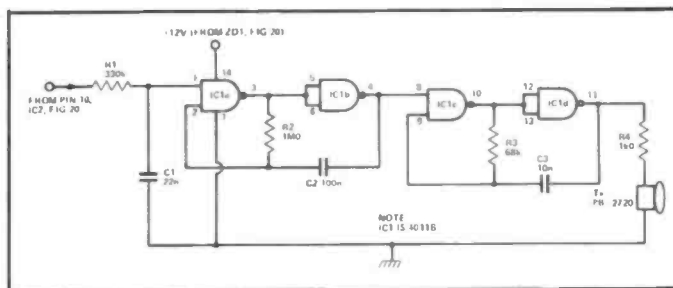

Figure 2: Add-on pulsed-tone (1 kHz tone pulsed at 6 Hz) 'FAULT' indicator for use with Fig 1.

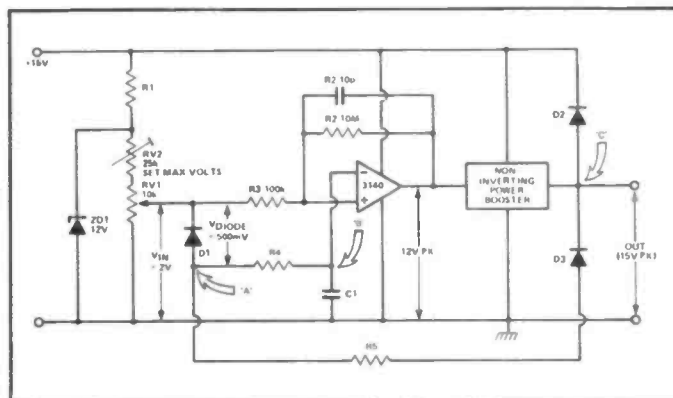

Figure 3: Basic 'Amplified-Feedback' SMVF motor controller circuit.

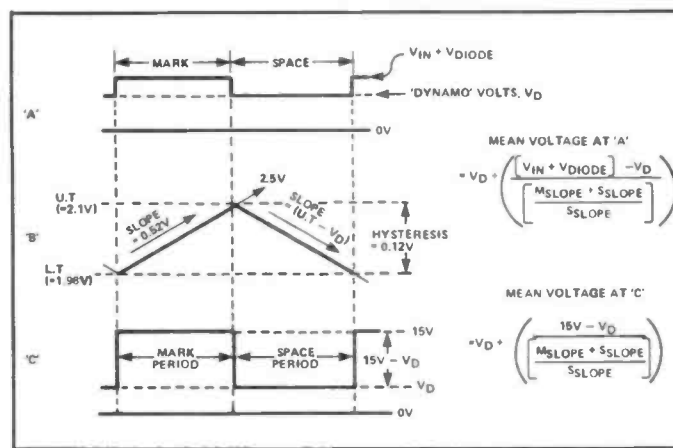

Figure 4: Basic waveforms and formulae of the Fig. 3 circuit.

SPEED-DEPENDANT 'DYNAMO' VOLTAGE	MARK SLOPE, VOLTS	SPACE SLOPE, VOLTS	MARK PERIOD, mS	SPACE PERIOD, mS	V _{MEAN} AT 'A'	V _{MEAN} AT 'C'	APPLIED-POWER FACTOR	NORMALISED POWER FACTOR
1.95V	0.52	.097	1.92	10.3	2.036V	4.00V	4.2	1
1.90V	0.52	0.2	1.92	5.0	2.07V	5.54V	13.25	3.15
1.50V	0.52	0.6	1.92	1.67	2.035V	8.72V	52.1	12.4
1.0V	0.52	1.1	1.92	0.91	2.02V	10.52V	90.6	21.6
0V	0.52	2.1	1.92	0.48	2.00V	12.0V	144	34.3

Table 1: Waveform values of the Fig. 3 circuit, at $V_{in} = 2V$, at various 'dynamo' values.

SPEED-DEPENDANT 'DYNAMO' VOLTAGE	MEAN OUTPUT VOLTAGE USING:-			
	$V_{DIODE} = 0.25V$	$V_{DIODE} = 0.5V$	$V_{DIODE} = 1.0V$	STANDARD SMVF CIRCUIT
1.95V	4V	4V	4V	4V
1.90V	7.47V	5.54V	4.05V	4V
1.50V	10.8V	8.72V	6.5V	4V
1.0V	12.2V	10.52V	8.25V	4V
0V	13.3V	12.0V	10.07V	4V
REGULATION FACTOR	42.1	34.3	24.1	3.8

Table 2: Performance of the Fig. 3 circuit (at $V_{in} = 2V$) at three values of V_{diode} and of the 'standard' SMVF circuit.

The regulation efficiency of the Fig. 3 circuit is in fact heavily dependent on the forward voltage (V_{diode}) of the limiting diode or device. Table 2 shows the output voltages obtained from the Fig. 3 circuit, at various values of V_D , with three different values of V_{diode} . The table also shows the output of the basic SMVF circuit under the same conditions, and the 'regulation factors' (ratio of unloaded-to-stalled effective applied voltages).

Note from Table 2 that the 'stalled' output voltage depends on the value of V_{diode} . In practice, the stalled voltage is almost the same as the output voltage that is obtained within a purely resistive load. Table 3 shows the performance of the circuit (with a V_{diode} of 0V5) at various values of input voltage when driving a resistive load.

The Fig. 3 circuit suffers from a couple of practical defects, and Fig. 5 shows how these can be overcome. The first defect is that, since R5 must be very large relative to RV1, and R4 must be very large relative to R5, unrealistically large R4 values are called for. In Fig. 5, this problem is overcome by interposing a unity-gain 3140 non-inverting buffer amplifier between the D1-R5 junction and R4, enabling R4 to be given any value in the range 10k to 1M. A useful benefit of this buffer is that it eliminates the need for additional offset biasing circuitry, as described earlier.

The second defect concerns the 'ceiling ratio' of the circuit, that is, the value of V_{diode} relative to V_D (as seen by R4 input), expressed as a percentage of V_D . Thus, in Fig. 3, when V_D is 1 volt, V_{diode} is 0.5 volts, giving a ceiling ratio of 50%, but when V_D is 5 volts, V_{diode} is still 0V5 giving a ceiling ratio of only 10%. In practice, because of the 'dirty' nature of dynamo voltage, motor regulation becomes highly erratic if ceiling ratios fall significantly below about 15%; in model railways, because contact is made with the motor via rotating wheels on dirty track, ceiling ratios of at least 30% are needed for stable operation.

Thus, for stable operation over the entire speed-control range, without loss of regulation sensitivity at low speeds, the ceiling ratio needs to be stabilised over the entire V_{in} range. In Fig. 5 this is achieved via RV1b, which is ganged to RV1a but connected in anti-phase. Thus, when RV1a is set low to give only 1 volt input, RV1b is high and feeds almost the full 1 volt V_D to R5, giving a ceiling ratio of 50%. When RV1a is set high to give (say a V_D of 5V, RV1b is low and feeds only one third of 5V V_D to R5, giving a ceiling

V_{IN}	MARK SLOPE	SPACE SLOPE	MARK PERIOD mS	SPACE PERIOD mS	V_{OUT}
0.5V	0.505V	0.615V	1.98	1.62	8.24V
1.0V	0.51V	1.1V	1.96	0.91	10.25V
2.0V	0.52V	2.1V	1.92	0.47	12.02V
4.0V	0.54V	4.08V	1.85	0.24	13.25V
6.0V	0.56V	6.06V	1.78	0.16	13.74V

Table 3: Performance of the Fig. 3 circuit, at various input voltages, when feeding a resistive load (roughly equivalent to a 'stalled' DC motor).

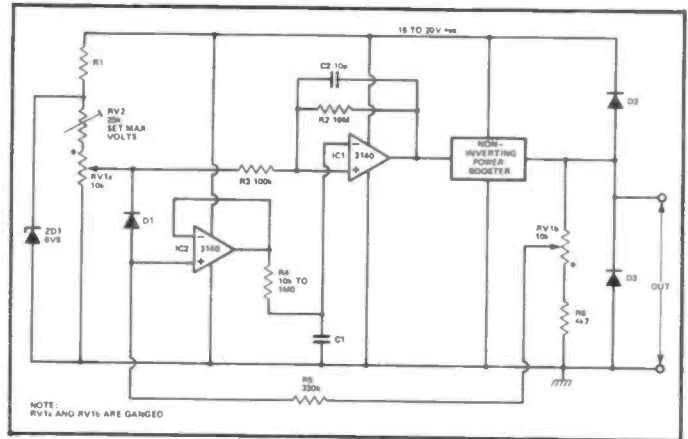

Figure 5: Improved version of the 'amplified feedback' SMVF circuit.

ratio of 28%, and hence very stable operation and regulation. Note that, because of the 'divider' action RV1b, the circuit needs an input voltage (at maximum RV1a setting) of only 1V67 to produce a V_D of 5V.

The Fig. 5 circuit can be implemented using any of the power booster and overload-protection circuits described earlier, and gives superb motor speed-control and regulation.

■ R & EW

Your Reactions			
	Circle No.	Circle No.	
Immediately Interesting	88	Not Interested in this Topic	90
Possible Application	89	Bad Feature/Space Waster	91

Can YOU fill this space if so see page 31 for details.

NORTH WEST COMMUNICATIONS (LIVERPOOL)

FAST BECOMING THE LARGEST SUPPLIERS OF EQUIPMENT IN THE NORTH



GBXKS TONY
SPARES & SERVICE

G8TBK GARY
MAIL ORDER



For all your amateur radio requirements – plugs, sockets, components etc. – all on mail order just a 'phone call away.

Introducing the New REFTEC 934 MHz MOBILE TRANSCEIVER

20 channels
8 Watts maximum to MPT 1321

We are now taking orders for the above which has just been released and is on display at the address shown.

Ideal for local communications up to 20 miles – Price £226 inc. VAT.

Aerials also available –

- ¼ wave mobile £11.70 inc. VAT
- Mobile co-linear £20.70 inc. VAT
- Base station co-linear £32.00 inc. VAT

117 OXFORD ROAD, WATERLOO, LIVERPOOL L22 7RE
051-920 7483

MIZUHO CDE RSG8 PUBLICATIONS

157 for further details

WOOD & DOUGLAS

A new range of products are available from us to cover the increased interest in video transmission

TVUP2 TV UPCONVERTER is a two r.f. stage receive converter with a crystal controlled local oscillator. The PCB accepts signal at 70cms and outputs them at channel 36 on a standard TV set. The TV output is filtered and there is a 'de-sense' input to allow monitoring of local signals without compression. Overall gain is 25dB minimum, noise figure better than 2.5dB.

Kit - £19.60 Assembled - £26.95

TVM 1 TV MODULATOR converts any 70cms transmit strip into a series modulated DSB video transmitter. The PCB accepts composite video signals and incorporates a sync pulse clamp and black level adjustment. With an external pass transistor the board will source up to 2 Amps current drive.

Kit - £ 5.30 Assembled - £ 8.10

ATV-1 VIDEO TRANSMITTER a boxed finished video transmitter giving 3W p.s.p. The unit is housed in a vinyl-topped enclosure measuring 8" x 5" x 2". Video input is via two independently switched BNC inputs, each having a front panel mounted level control. There is a receiver output via a pin diode aerial switch for connection to an UpConverter such as the TVUP2. The rear panel also has a monitor output for waveform inspection on an oscilloscope. The unit has internal preset controls for black level and sync stretching circuitry. The unit is unique in that it is double mode. There is a NBFM modulator included to allow station identification at 70cms simply by plugging a microphone into the front panel socket. The whole unit runs from a 14V maximum PSU and will give good reliable service in either mode. A one year guarantee is offered on parts and labour.

Boxed ready to go at £87.00

ATV-2 Video Transceiver the natural progression from the ATV-1. The highly successful ATV-1 and TVUP2 circuitry have been combined to give a complete video station. All you require is a standard TV set and a camera. What could possibly be easier?

Boxed ready to go at £119.00

incidentally, as both these units have NBFM facilities you will not be left high and dry with a white elephant should video be removed from 70cms. Simply plug in a new crystal and you can work your local FM repeater.

70LIN10/3 B is a 3W to 10W linear designed as a video booster for the ATV-1/2 to give 10W minimum output from our very popular video transmitters. The board is straight through with no power supply connected or when in receive mode. It has automatic r.f. sensed change-over when transmission takes place. The unit is of course usable for NBFM operation with the new handheld transceivers such as the IC4-E.

Kit - £28.95 Assembled - £39.10

Just a few examples of our ever increasing range. An SAE will bring you the latest details and prices. Technical enquiries can be answered between 7-9pm on either 07356 5324 or 0256 24611. Kits when stock are return of post otherwise allow 28 days. Assembled /boxed items, allow 20/40 days. Prices include VAT at the current rate. Please include 70p postage and handling on total order except boxed items which should be £1.00 for recorded delivery.

All prices include VAT at the current rate. Please add 70p to your total order for post and handling. Kits contain allpcb components but no external hardware. Crystals are not supplied for transceivers but are for converters, synthesisers etc. Kits when stock are 2-3 days, otherwise up to 28 days depending on component availability. Assembled modules 20-40 days depending on stock. Non-amateur frequencies can be supplied for assembled modules but we reserve the right to charge up to 20% excess to cover handling costs. All postal enquiries require an SAE please; a large one if full lists are required! Non-technical enquiries only can be taken 10am-4pm on 07356 5324. For technical information please call 07356 5324 or 0256 24611 between 7pm-9pm, as we are part-time.

Kits are available from the following agents:-

- Amateur Radio Exchange, Northfield Road, EALING. 01-579 5311
- J. Birkett, 25 The Strat, LINCOLN. 0522 20767
- Darwen Electronics, 13 Thorncliffe Drive, DARWEN, Lancs. 0254 771 497
- United Trading AB, Box 16024, 200 25 MALMO, SWEDEN. 040 94 89 55.

9 HILLCREST, TADLEY BASINGSTOKE, HANTS RG26 6JB



155 for further details

PACKER COMMUNICATIONS

PMCRYSTALS

SOTA

MIRAGE

KENPRO

HANSEN

MARCO TRADING

Over 10 million resistors in stock!!

¼W 5% Carbon Film – 5¼ million ¼W 5% Carbon Film – 5 million
Full range of values.
¼W – £3 per 1,000 ¼W – £3.50 per 1,000

DEVELOPMENT PACKS: These famous resistor packs are now available in two sizes. Carbon film 5% resistors, every value individually packed in a clearly labelled bag. 10 of every value in the E24 range between the values stated:

¼ Watt Pack: 10 ohm to 1 Meg (1610 resistors) £5.00 per pack + VAT
½ Watt Pack: 10 ohm to 2M (650 resistors) £6.00 per pack + VAT

MULTIMETER SPECIAL Russian type U4324 (Advertised elsewhere in this magazine for over £15.00 each recently).

d.c. Voltage: 0 & 1.2 3 12 30 60 120 600 1200.
a.c. Voltage: 3.6 15 60 150 300 600 900.
d.c. intensity mA: 0.06 0.6 6 60 600 3000.
a.c. intensity mA: 0.3 3 30 300 3000.
d.c. resistance: 0.2 5 50 500 5000 kOhm.
g.e. level dB – 10 to -12.

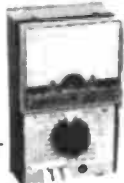

FANTASTIC SPECIAL PRICE £12.00 including P.P and VAT

TRANSFORMERS



British made transformers at very attractive prices.

Primary	Secondary	Current	1-	10-	100-
240v.	4.5-0-4.5v	400mA	50p	45p	32p
240v.	6-0-6v	100mA	58p	52p	43p
240v.	6-0-6v	500mA	65p	60p	48p
240v.	9-0-9v	200mA	75p	70p	58p

Manufacturers note: We can supply FROM STOCK, 1000+ quantities of the above transformers and adaptors below.

These very high quality British made two pin European adaptors are ideal for driving Radios, cassette recorders, TV games, callusers etc. The adaptors fit the UK shaver socket.

EUROPEAN ADAPTORS



REF.	D.C. Voltage	Current	1-	10-	100-
EOB	4.5V	200mA	50p	45p	32p
EM3	6V	200mA	£1.00	80p	55p
EO9	6V	400mA	£1.50	£1.25	85p
ET4	9V	150mA	£1.50	£1.25	85p

Please note that there is no extra P/P charge on the above transformer/s & adaptors.
Export please add Sea/Air mail at cost.
Callers welcome Mon-Fri 9-5.

We've moved to larger premises!

This advert is only a fraction of our range, send 25p for our latest catalogue. Please add 35p P/P to all orders. (Free over £5.00). Add 15% VAT to total. Send orders to:

MARCO TRADING Dept. RWB,

The Maltings, High Street, WEM, Shropshire

Special Offer Test Equipment Catalogue available upon request. Send S.A.E. or Telephone.

All orders despatched by return of mail.

Tel: (0939) 32763

156 for further details

SHORT WAVE NEWS FOR DX LISTENERS

Frank A. Baldwin

All times in GMT, bold figures indicate the frequency in kHz.

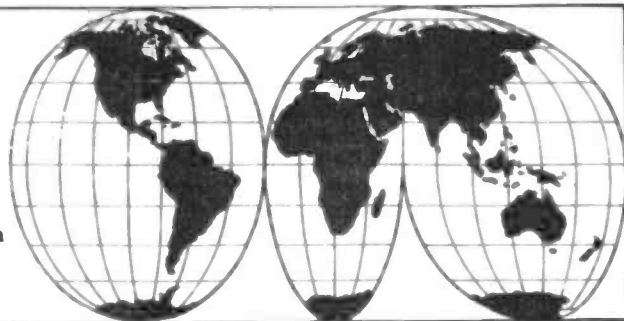

In keeping with the last instalment of this running narrative I commence this month with some of the results obtained whilst operating over the amateur bands.

1800-2000 kHz

The trouble with Top Band over the past few weeks has been the rather heavy summer static, this registering itself as loud bangs and crashes usually just when the very call sign one is interested in logging is about to be transmitted. Despite this annual hazard, and with the noise limiter only partly coping, the following were finally entered into the logbook.

From West Germany the sole entrant for the period was DL9SAN, putting in a very strong signal whilst working some G stations. Then there was the Frenchman F8VJ also having several QSO's, whilst higher up the band HB9G from Switzerland was busy working, what was to him, Dx.

On another evening at the beginning of the month and just prior to the arrival of the summer static Czechoslovakia was, for some reason, alive with Top Band activity. Out of the welter of calls the following emerged as readable - OK1DFF, OK1MMW, OL2BCC, OL4BDY, OL4BFK.

Then there was Sweden being represented by SM5JPN and on a later occasion a bit further up the band the USSR put in an appearance in the shape of UA2FCW, UK2PCR, and UA3SAG.

Yugoslavia also put in an appearance in the form of YU2HDE, busily working away with some local Europeans and a couple of G stations.

Also heard was RG5GFM and 4N0SM, the first presumably a Russian but from where does the latter signal originate?

7000-7100 kHz

Mostly covered by Eastern Europeans, with whom this band seems to be a firm favourite, at least at the CW end, one must really winkle out any Dx that is available at the time one is on the band - and that isn't often.

With the passband control at 0.4 kHz, battle commenced one evening and the final outcome showed up as - KA1IK, K1DBP and N4AE from the USA with PY1URQ from Brazil and XE1CCK from Mexico. Quite a struggle to land the last one, pile-up's soon occur on this band if a Dx signal shows up!

14000-14350 kHz

Two sessions on this band produced many calls but only the following would presumably interest the amateur band Dxer.

From Saudi Arabia there was some very slick operating from HZ1WS and I would suggest swotting up the dots and dashes to in excess of about 20 wpm for any success with this one.

PY1ALM from Brazil and 5Z4GS from Kenya completed the haul of that evening whilst over the long route one morning around 0530 or so signals came in from Australia and New Zealand, these being from VK2DQU and ZL4GR respectively.

21000-21450 kHz

I wouldn't term the Canary Islands as being Dx on this band but there aren't all that many of them, so I'll commence with EA8ABR who preceded the gaggle of Japanese represented by JA1BN, JA2PXY, JA4DZ, JA6GU and JA7FS - all busily working the USA and/or Europe.

For the same reason as the EA8 I will make mention of OD5LX from the Lebanon and then go on to bring in the Brazilians PY2ROJ, PY3YEX, PY7WF together with the nearby Venezuelans YVIAD and YV4DDT.

Winding up the list for this band we have ZS6BUY and 9U5W both of whom are African based, the former in South Africa and the latter in Burundi.

28000-29700 kHz

I must confess that I don't have any reason for not visiting this band more often than I do at present so perhaps I should mend my ways. One single foray did result in the following log entrants.

From Brazil PY6AEK, from Paraguay ZP5NW, from South Africa ZS5MY, from Cyprus 5B4FQ, from Kenya 5Z1WS.

CLUB NEWS

A welcome letter from A.C. Lindsay G4NRD provided me with the following information on the local club activities - and very interesting they are at that.

Worcester & District Amateur Radio Club

In addition to rag-chews which have proved popular, a construction project on the same evenings has now been commenced, these meetings being held on the third Monday of each month at the Old Pheasant, New Street, Worcester.

The Club programme is as follows:-

Monday 16th August, (Old Pheasant) Members projects and natter night.

Saturday & Sunday 4th & 5th September, N.F.D. 2m and HF Contest, Club entry at Kempsey Common.

Monday 6th September, (Oddfellows) RSGB Call by H.S. Pinchin G3VPE.

Monday 20th September, (Old Pheasant) Members projects and natter night.

Monday 3rd October, (Oddfellows) Simple Aerials - and how to tune them - by D. Yates.

The Club Secretary may be contacted by writing to 15 Paxhill Lane, Twynning, Nr: Tewkesbury, Gloucs.

CITIZEN BAND

In the last issue of this learned journal I promised to mention some of the additions to the CB set-up here and, in keeping with that dire threat I had better commence with the SWR troubles.

Whatever adjustments were made to the Wotpole twig made not the slightest betterment to the lowest reading attainable on the SWR meter. Disdaining the 'woe is me' attitude I finally intalled a twig matching unit which, when finally adjusted brought the SWR down from 1.7 to 2.3, depending on the weather apparently, to around 1.2 to 1.

It's not that the better SWR will make much difference to the signal, it is just that I feel happier with an improved reading. More important than SWR readings, at least in my opinion, is the height of the QTH and therefore the twig. Is there any real estate going cheap atop Snowdon?

Then there is the power microphone with built-in compression pre-amp (Ham Master 4500) which has proved a big help with distant contacts but careful usage is required to avoid over-modding. As this is not a trade review feature I will not describe these ancillaries more fully.

AROUND THE DIAL

Netherlands

Hilversum on 6020 at 1718, OM with announcements in the Arabic programme for the Middle East, North East Africa and Europe, scheduled on this channel from 1630 to 1720.

Austria

Vienna on 6155 at 1725, Austrian music in typical style in the German programme for Europe, the Middle

East and South and East Africa, timed from 1700 to 1830, after which the English transmission to the same target areas commenced with a newscast and a talk about smoking in Austria. The English session is scheduled from 1830 to 1900.

Poland

Warsaw on 6095 at 1729, interval signal prior to the commencement of the Finnish transmission to Europe, timed from 1730 to 1800.

Switzerland

Berne on 6165 at 1748, OM with the German programme for Europe, the Near and Middle East, Africa and South America, scheduled from 1730 to 1800. All about the British in Hong Kong.

Berne on 9535 at 1532, OM with a newscast of world events in the English transmission intended for Europe, the Near and Middle East and Africa, scheduled from 1530 to 1600.

USSR

Moscow on 6010 at 1810, OM with news in the English languaged World Service, also logged in parallel on 5920 and 5980.

Sweden

Stockholm on 6065 at 1835, when the English programme - all about Swedish food - was heard, the session being timed from 1830 to 1900 and directed to Europe and Africa.

Stockholm on 21555 at 1434, OM in Swedish in a relay of the Domestic Service First Programme to Swedish Embassies, ships, firms and Swedes abroad, scheduled on this channel from 0930 to 1200 and beamed to the Middle East, South Asia and East Africa, the Middle East and Africa from 1200 to 1800. Switch the function control to USB for this one, it's in SSB.

Stockholm on 21700 at 1440, OM replying to listeners' questions in the English programme for North America and South Asia and timed here on this frequency from 1400 to 1430.

Italy

Rome on 7175 at 1445, OM with a football match commentary - Turin scored - in a relay of the Domestic Service Radio 2 Programme to the Mediterranean Basin, on this channel from 0500 to 2229.

Greece

Athens on 9855 at 1355, OM and YL with a duet in Greek, also logg-

ed in parallel on 9815 but the former channel providing the best reception.

Athens on 17650 at 1852, OM with songs in Greek together with music unmistakably of Greek origin.

Vatican City

Vatican on 6210 at 1940, OM with a religious talk in the English programme for the UK and Eire, scheduled from 1930 to 1945, then into the Italian transmission.

W. Germany

Cologne on 21600 at 1516, OM with the English programme beamed to Central and East Africa and timed from 1500 to 1550. It was all about medical aid and the doctors of W. Germany.

Romania

Bucharest on 11775 at 1526, OM with announcements of programmes, frequencies and times in the English transmission intended for Asia and scheduled from 1500 to 1530.

Yugoslavia

Belgrade on 9620 at 1540, OM with the English programme for Europe, the Middle East, the Far East and South and South East Asia, scheduled from 1530 to 1600.

Portugal

Radio Renascenca, Lisbon, on 9680 at 1557, OM with a talk in Portuguese in a relay of the Lisbon Domestic Service for Portuguese subjects in Europe and radiated from 1445 to 1800 Sundays only in this time slot.

Belgium

Brussels on 17595 on 1815, Om with on 1815, OM with announcements of frequencies and times followed by a programme review at the commencement of the English transmission to Europe and Africa, scheduled from 1815 to 1900 at the latter time into the Spanish programme.

Argentina

Liberty on 17740 at 2208, YL in English with an anti-Task Force programme which also included a Tom Jones' record 'My, My, My Delilah'. The YL - I'm not sure if her name is Liberty or whether the station is titled Radio Liberty - has a very husky voice which causes her announcements to be difficult to copy at this distance, particularly as it is also Americanised.

United Arab Emirates

Dubai on 15320 at 1910, Om with a at 1910, OM with a newscast of world events in Arabic in the programme of that language directed to Europe and North and East Africa from 1730 to 2100.

Canada

Montreal on 5995 at 1731, YL with at 1731, YL with station identification and a newscast in the German programme for Europe, scheduled from 1730 to 1800, this being a relay from the BBC transmitter at Daventry.

Montreal on 21695 at 1904, OM with news in the English transmission for Europe, timed from 1900 to 1930 (not Saturday or Sunday).

North Korea

Pyongyang on 9977 at 1845, OM with a programme about internal affairs then YL with station identification at the end of the English transmission to the Middle East and Africa, scheduled from 1700 to 1845. At the latter time the National Anthem preceded sign-off.

China

Radio Peking on 11600 at 1515, OM with a talk about Chinese/American relations in the English programme directed to South Asia and timed from 1500 to 1600.

Radio Peking on 9900 at 1513, a programme of music and songs in a transmission for Nepal, scheduled from 1500 to 1600.

Radio Peking on 12110 at 1738, YL and OM alternate with announcements in a Chinese programme intended for Europe, North Africa and Asia, scheduled from 1730 to 1830.

Radio Peking on 15880 at 1734, much talking in the scheduled Turkish programme, listed from 1730 to 1800.

Brazil

Radio Brazil Central, Goiania, on 4985 at 0110, OM with a ballad in Portuguese with a backing of guitars. This one has a 24-hour schedule and a power of 5kW.

Radio Jornal do Brasil, Rio de Janeiro, on 4875 at 0112, OM announcer presenting a programme of local recorded pops. The schedule is from 0900 to 0530 and the power is 10kW.

Radio Difusora Taubate, Taubate, on 4925 at 0117, OM with a sports commentary in Portuguese. Taubate is on the air from 0830 to 0400 and has a power of 1kW.

Venezuela

Ecos del Torbes, San Cristobal, on 4980 at 0115, OM with promos, local-style pops. The schedule is from 0900 to 0400 and the power is 10kW. This is one of the easiest Latin American stations to log on the 60 metre band and one that should attract beginners to the short wave listening game. If you have a tape recorder and are keen on the genuine LA (Latin American) music and pops then this is your best bet.

Radio Yaracay, San Felipe, on 4940 at 0120, OM with a ballad in Spanish then into a piano recital - somewhat unusual programme content for an LA station at this clock time. Radio Yaracay is on the air from 1000 to 0400 and the power is 10kW. Another relatively easy to receive LA station.

Radio Juventud, Barquisimeto, on 4900 at 0124, local-style pops and songs, OM announcer in Spanish. Another easy one for beginners and also a good frequency marker for those that need one around this part of the dial. The power is 10kW.

KONTAKT

The European name of Aerosol Excellence. Special cleaners for all electrical contacts and switches.

Kontakt 60
Dissolves oxides and sulphides, removes dirt, oil, resin and traces of metal abrasion. Protects against erosion. Ensures perfect contacts.

Kontakt 61
Special cleaning, lubricating and anti-corrosion fluid for NEW (non oxidised) and specially sensitive contacts. An excellent lubricant for all electrical and electro mechanical systems.

Spray Wash WL
A rapid cleaner for reliable washing and degreasing of electrical equipment and components. For removal of dirt, grease, oil, soldering residues and other impurities.

ALSO AVAILABLE:

A COMPLETE RANGE OF INDUSTRIAL AEROSOL SPRAYS

SK10 Soldering Lacquer, K75 Cold Spray, K70 Plastic Spray, K88 Oil Spray, K701 Vaseline Spray, K90 Video Spray, K33 Graphite Spray, K100 Antistatic Spray, K101 Fluid Spray and, of course, Positiv 20 positive photo resist for printed circuits.

Details from:

Special Products Distributors Ltd.

81 Piccadilly, London, W1V 0HL
Tel: 01-629 9556. Telex: 26500 (answerback RACEN). Cables: Speciproduct, London, W1

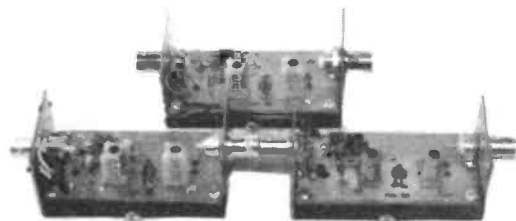

4/6/10m PRE-AMPLIFIER

PCB, all components, case (undrilled) and sockets.

Stock No.	Frequency	Price (inc. VAT)
40-08004	4m	£6.53
40-08006	6m	£6.53
40-08010	10m	£6.53

CB NOISE SQUELCH

PCB and all components.

Stock No.	Price (inc. VAT)
40-44362	£3.85



DRILL SPEED CONTROLLER

PCB and all components.

Stock No.	Price (inc. VAT)
40-29550	£8.83



A/D CONVERTER

PCB and all components.

Stock No.	Price (inc. VAT)
40-42700	£16.68



DFM

Pre-built unit.

Stock No.	Price (inc. VAT)
40-55230	£48.88

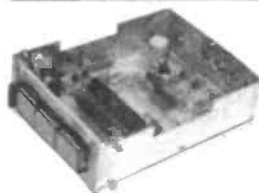

AIRBAND RECEIVER

PCB, all components (with or without mains PSU), pots and 4 thumbwheel switches.

Stock No.	Price (inc. VAT)
40-72001 with PSU	£70.51
40-72002 less PSU	£67.51

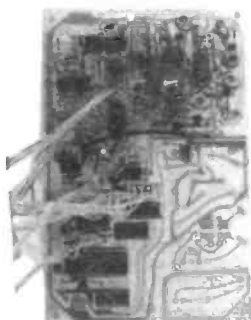

ALL PRICES INCLUDE VAT @ 15%
PLEASE ALLOW 21 DAYS FOR DELIVERY.
POSTAGE AND PACKING 50p per order.

200, North Service Road, Brentwood, Essex CM14 4SG

Issue	Project	Price
December	DFCM01	£4.96
	DFCM02	£3.57
	DFCM03	£3.72
	DFCM04/5	£3.97
	Logic Probe 2m PA (Mk.II)	£1.10 £5.91
January	UHF/VHF Converter	£3.51
	TV Pre-Amp	£1.28
	TV Pre-Amp PSU LC7137	£0.96 £2.73
February	TV Pattern Generator	£6.55
	TV Antenna Selector	£4.65
	TV Antenna Select PSU TK10321 (Undrilled)	£0.96 £2.04
March	70cm Pre-Amp	£1.38
	23cm Converter	£8.33
	Converter PSU MC145151	£1.77 £2.95
	ULN2283B (Undrilled)	£0.46
April	Radiation Monitor	£3.27
	Rewbichron Logic Board	£6.76
	Rewbichron Rx Board	£3.04
	2m Pre-Amp	£1.11
	Key Pad Security Lock KB4417 (Undrilled)	£1.79 £0.69
May	KB4413 (Undrilled)	£0.58
	UOSAT	£10.17
June	4-way Distribution Amplifier	£5.91
	pH Meter	£5.04
	KB4412 (Undrilled)	£1.43
	ULN2240 (Undrilled)	£0.94
	Radio Control Tx	£3.58
July	2ch Mains Timer - Display	£6.40
	PSU	£2.07
	Triac £2.07	£2.07
	Switch	£0.85
	CB Selcall	£3.33
	ZX81 Keyboard - A	£2.99
	ZX81 Keyboard - B	£2.99
	0-30v PSU	£4.50
	2m PA Mk II	£5.91
	ULN3859 (Undrilled)	£0.96
LM1035 (Undrilled)	£1.29	
August	SSB Exciter	£3.87
	HA12017	£2.48
	DC Controlled Pre-Amp	£12.00
	Radio Control	£1.84
	Autobridge	£3.50
	Autobridge RF Head	£2.25
September	Autobridge LED	£0.73
	18W Power Booster	£3.74
	ZX81 Expansion Board	£9.60
	Ga As Fet Pre-Amp	£4.37
	Ga As PSU	£1.54
	Multiband Up Converter	£5.46
	KB4436 (Undrilled)	0.67
	Switch Mode Power Supply (Undrilled)	£2.92
October	CB Noise Squelch	£1.20
	Drill Speed Controller	£4.76
	4/6/10m Pre-Amp	£1.86
	A/D Converter	£3.73
	Airband RX	£8.83
	DFM	£4.83
	DFM Display	£2.07
4448 (Undrilled)	£0.93	

All Prices Include VAT at 15% Postage & Packing 50p per order.
Please allow 21 days for delivery.

200, North Service Road, Brentwood, Essex CM14 4SG



Reception Reports

Compiled by Keith Hamer and Garry Smith.

AS IF BY MAGIC, the 1982 Sporadic-E Season commenced on cue during May. The first sign of Sporadic-E(Sp.E) activity occurred on the 2nd with a programme from RTVE-Spain at 0954BST on channel E4 (62.25MHz). On the 3rd, strong signals were seen from the USSR on channel R1 (49.75MHz) possibly originating from the TSS outlet at Leningrad or Minsk (240kW and 150kW ERP respectively). Programmes from Czechoslovakia (CST) were also noted on R1. Italy (RAI) made an appearance during the early afternoon period on channel IA (53.75MHz vision).

Sp.E activity then declined somewhat with only short-duration signals from Spain, Hungary (MTV) and Sweden (SR). The FuBK electronic test card appeared briefly from Switzerland on channel E3 (55.25MHz) carrying the usual identification. '+ PTT SRG 1' from the transmitter at Uetliberg.

May 9th was quite a good day for Sp.E with possible reception from the USSR on channels R1 and R2 (59.25MHz) and definite reception from Hungary on R2 at 1255 BST with a female announcer and the letters 'rtv' in the background. This identification is rather strange as the Hungarian service is normally denoted by the initials 'MTV' (Magyar Televizio). SECAM colour was resolved and recorded on a standard Sanyo VCR. SECAM signals were also detected during a football match from an unidentified station on channel R3 (77.25MHz). This channel lies within the Band II spectrum which is normally used for FM sound broadcasts by Western European countries but Eastern-bloc states operate television services between 77.25MHz and 93.25MHz (vision). At 1300

BST on the 9th, programmes were received from ARD (West Germany) on channel E2 (48.25MHz) via Sp.E. At 1311, Austria made an appearance with the PM5544 test card but not on the usual channel E2a (49.75MHz). This reception was on channel E3. The test card identification was 'ORF FS 1'. The E2a transmitter at Jauerling is often received in the UK as it has an ERP (Effective Radiated Power) of 60kW but reception from the E3 outlet is rather rare as the ERP is officially listed by the EBU as only 100 watts. The E3 transmitter is located at Breitenstein.

Sp.E activity declined once again until May 16th, but in the interim period enhanced tropospheric conditions prevailed, details of which will be given later. Over the years it has been noticed that the annual Sp.E Season (caused by the ionization of the Earth's 'E' layer by the Sun) commences during the early part of May to be followed by a brief respite until about the second week of the month.

The increase in Sp.E activity on May 16th resulted in reception from the USSR(TSS) on channel R1 with SECAM colour plus unidentified stations on R2. Yugoslavia (JRT) was seen on E3 from the Belgrade studios with the identification 'tvb 1' on programme captions. The FuBK test card from the Zagreb studios was noted on channel E4 in PAL colour with the identification 'JRT ZGRB 1'. Programmes were received from Italy on channel IA and video recordings in SECAM were made from the MTV channel R1 transmitter at Budapest with the clock caption at 1217. MTV then closed down and radiated a line-sawtooth pattern.

On May 20th, the FuBK test card was

received from Portugal on channel E2 with the identification 'RTP -- PORTO'. The normal identification is 'RTP 1'. A little later in the day colour bars were noted from Spain with the identification 'Control Central RTVE 09'. The pattern included a digital clock showing British time + 1 hour.

On the 24th at 1713, the PM5544 was observed on channel E4 from Iceland with the identification 'RUV ISLAND'. There are two E4 transmitters in Iceland located at Skalfell (300kW ERP) and Gagnheiði (80kW ERP).

Scandinavian transmitters were well to the fore on May 25th with several Norwegian (NRK) PM5544's in evidence with individual transmitter identification details including 'NORGE MELHUS' (channel E2), 'NORGE STEIGEN' (also E2), 'NORGE HEMNES' (E3) and 'NORGE HADSEL' (E4). Many of the signals were received in good quality colour (PAL) with sound. Sveriges Radio (Sweden) were logged at 1746BST on channel E3 with the 'TV 1 SVERIGE' PM5544 test card. Signals from TSS (including the News programme 'BPEMR') and TVP-Poland (also with their News programme identified by 'dt') were noted on channels R2 and R1 respectively.

The 26th was a 'Spanish day' at this location with colour bars on E2 (from the Navacerrada outlet), two colour patterns on E3 floating with each other and carrying the identifications 'rtve LA MUELA 3' and 'rtve GAMINITEIRO 3' (50kW and 35kW ERP respectively) plus flamenco dancing on channel E4 in colour and with sound, floating with a colour pattern including the identification 'rtve MADRID 4'. The Madrid transmitter is officially listed by the EBU as having an ERP of only 2kW: At 1724, the Spanish colour test card was displayed on all Band I channels with the identification 'tve tve 1'. It is interesting to note that in Spanish television programme guides, not only are the times of trade test transmissions shown but also full details about the accompanying music. Signals from RUV-Iceland were also received on the 26th during the early afternoon period with the PM 5554 test card on channel E4.

May 30th was an interesting day with R1 signals present from about 0800 BST and a music programme from Italy on channel IA at 0948. At 1020, an outside broadcast

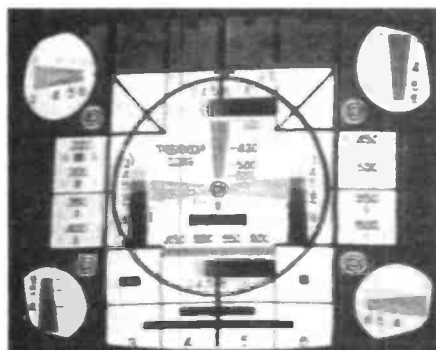

Figure 1. the USSR monoscopic '0249' test card on channel R3.



Figure 2. An identification caption from Magyar Televizio (Hungary) on R2.

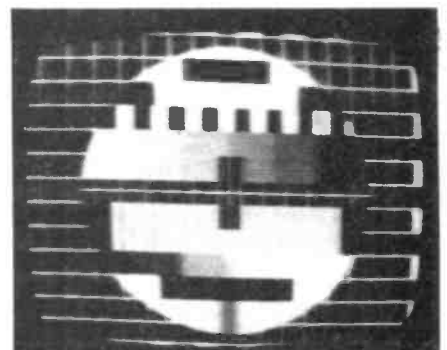

Figure 3. Polish test card received on channel R1.

from RTS-Albania was received in Band II(TV) on channel IC (82.25MHz) followed at 1032 by a childrens' programme. The sound channel was also present. Despite high signal strengths, colour was not resolved which seems to suggest that RTS still have only a monochrome service. Signals from Yugoslavia were in evidence at 1020 on E3. It is always wise to check for Albanian reception on channel IC whenever signals from Italy and/or Yugoslavia are present as Albania is geographically close to both countries. At 1158 there appeared a signal from one of the 800 or so 'private/pirate' television systems in Italy. Due to a loop-hole in Italian law, it would appear that anyone with sufficient financial resources and a colour camera or two can start broadcasting to the public. Many of the local stations transmit illegally taped UK programmes or material originally radiated by the official networks of RAI. The private station received here on 30th was NCT located at Udine in the north of the country. Although this station is estimated

to have only a relatively low-power transmitter, it is often received in the UK on a non-standard channel between IA and E3.

On the 31st, reception began at an extremely early hour, in fact at 0455 BST: Strong video was present on channel R1 with the TSS 'Leningrad' electronic test card which was followed by a digital clock. At a more respectable hour (1840) strong signals were seen from Yugoslavia (JRT) on E3 with a pop-music programme followed by the news programme, 'Dnevnik' at 1930. JRT was also noted on E4 with commercials identified by the initials 'ep'. On channel R2, a feature film was present at 1940 (with subtitles) and this is suspected to have originated from Rumania (TVR). Also on the 31st, signals were noted from the following countries:- Italy (RAI) with teletext transmissions known as 'Televideo'; Czechoslovakia (CST) with their electronic test card and identification 'RS-KH'; Spain (RTVE) with several test cards/patterns including standard colour bars, the familiar 'tve tve

1' colour electronic test card, a 'Tele Murcia' identification caption plus two colour patterns floating over each other on E3, one of which carried the identification 'rtve AITANA 3'.

On several occasions during the month, standard colour bars have been noted on R1. It is suspected that these signals came from MTV-Hungary as transmissions from Austria and Eastern-bloc countries have been noted simultaneously with the colour bars on the frequency, 49.75MHz.

Good tropospheric conditions occurred during May with reception from the Netherlands (NOS) on several UHF and Band III channels, France (TDF), Eire (RTE), West Germany (ARD and ZDF), East Germany (DDR:F on channel E11), and Belgium (BRT and RTB:F). From West Germany, transmitter identification captions were received from the stations at Cuxhaven (channel E48), Hamburg (E30), Ostfriesland (E33), Bielefeld (E33) and Wesel (E35 and E48).

□ R & EW



Figure 4. 'Nord Center Television' (Italy) identification caption.

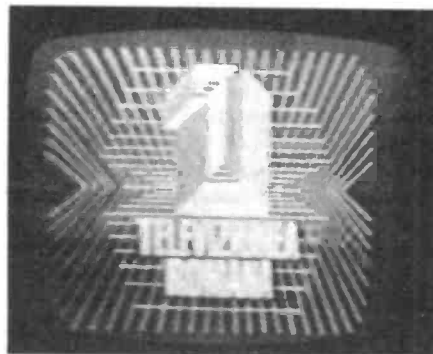

Figure 5. Rumanian 1st. Network identification caption on channel R3.



Figure 6. Spanish news summary programme caption on channel E4.

R&EW PANEL SIGNS

Giving that professional look to the front panel of your latest creation can be a bit of a problem.

Dry rub down lettering can be used for control markings and scales but unless used with skill the results can be less than flattering.

The R&EW label system solves the problem by providing a set of symbols and scales that are printed on the reverse side of a thin, clear plastic sheet.

Identify the word/symbol you require, cut around it, peel the backing paper off and stick it in place on your project.

The results are perfect every time.

Three different sets of panel markings are available, black wording, white wording and a set of scales.



The wording sets contain over 1000 words covering 300 terms — the dial set contains one large horizontal tuning scale, frequencies and 12 control panels.

Any one will cost you only £1.50, but buy two and we'll give you the third one free that's just

£3.00

for the complete set of R&EW Panel Markings.

All prices include VAT and post and packing.

Send your order to:
R&EW PANEL SIGNS
117A High Street
Brentwood
Essex CM14 4SG

VOLUME SQUELCH RF GAIN

NOTES FROM THE PAST

Radio and Electronics Constructor, the magazine from which R&EW evolved, started publication in August 1947. Centre Tap wrote for R&EC for many years - some of his material is as relevant today as it was 30 years ago, while other items give an insight into the radio enthusiast's world when valves 'ruled the waves'. This month we begin a series of journeys down memory lane.

August 1951.

There are many people in this country who regard radio repairing and servicing as a racket. Most of us know of instances where friends have been rooked over trivial repairs, and of cases where practically new sets have been put miles out of alignment and sometimes damaged by clumsy and ignorant botchers.

Such racketeering was once even more widespread. So much so, that radio servicing has a name which conscientious repairers find constant difficulty in living down. Indeed, they are often immediately suspected of pulling a fast one whenever they estimate for a repair entailing any of the more expensive replacements.

Many a worthy housewife after the set, working perfectly, has been re-installed, has complained 'It doesn't sound the same as before' and is secretly convinced that the repairer has pinched the best of her valves and replaced them with worn out ones!

One shudders to think what goes on in the world where there is a less enlightened public. For instance the servicing notes from an Indian magazine says, with delightful frankness, 'Many servicemen do not read the manufacturer's instructions at all.'

SPIVS

There, too even the dealer seems to have his own troubles. Another issue tells us of the following, under the heading 'Blackest Profiteer'. The rather quaint, but expressive wording, is retained. 'A dealer in Karachi having branches in many places sold one yard of Drive Cord for annas eight only to another dealer when that Drive Cord is available at Rs. 1/12 for 500 yards. What A Margin of Profit! Wants to be rich the next morning, it seems.'

At that rate of profit I should imagine he would get rich that morning without waiting for the next!

Mail Order houses, too, come in for castigation under the heading 'Bogus Price Lists'. It tells us 'Some Dealers publish price-lists and on receiving the same, if one places an order immediately the prices are raised or part order is obeyed. For example if you order valves some They will send you, but others will be out of stock. Then what is the need of printing a Price list. The above Karachi Dealer Published a price-List showing Capacitors' discount 50% & 5%. When you go and purchase well it is 50% only on the very day.'

It's a wicked world. Apparently there are other forms of spivery besides selling nylons from Oxford Street pavements.

TRANS-ATLANTIC TV

Following my recent mention of the reception of a recognisable picture in New York of a Baird transmission, the question of the first (and probably the only) occasion when a TV transmission from America was received in England, has been raised. This occurred in September, 1930, when Douglas Walters, G5CB, then living in West London, received recognisable pictures transmitted by the General Electric Co. in New York. He has for some years been an engineer with the

Baird Company, and was closely associated with their pioneering experimental work.

At the time of reception (which was confirmed by cablegram) he was fortunate in having experimental discs other than the then standard British 30-line. A 60-line disc gave a clearly recognisable picture, although it was of incorrect aspect ratio.

Synchronisation could only be effected by running the disc motor too fast and controlling the speed by braking with the thumb and finger on the shaft. The thrill of being the first to see American TV from this side of the Atlantic was well worth far greater discomfort than the resultant soreness and blisters!

I know of no other authenticated claim of reception of trans-Atlantic TV in this country and, by all the rules, it will be a long time before there is another. The transmission was then around 15 Mcs. and with the present frequencies Dx of this nature could only occur under the rarest of freak conditions. Readers will remember that in the winter of 1948/49 a South African amateur, ZS1P, during a period of high sun spot activity was able to receive satisfactory pictures and sound from Alexander Palace, plus considerable interference from other TV and navigation aid transmissions.

Who knows what chaos may be in store during similar conditions when there are as many TV stations in operation as there are broadcasters today?

A FORGOTTEN ART?

Younger readers - by that I mean those born after the Armistice of 1918, who could at the most have been but 12 years old at the time of Mr. Douglas' feat - can scarcely appreciate quite what an achievement trans-Atlantic TV was. Home constructed receivers, built bread-board fashion, were still the order of the day. The mass-produced factory-built set was in its teething stage, and the enthusiastic constructor was still finding plenty of scope for activity in building sets for his friends and relatives. The screened-grid valve was already an established favourite but multi-electrode valves, on the horizon, were regarded with grave suspicion by constructors who did not like the superhet circuit - sometimes from experience but more often because of its reputation for poor quality. They were 'new-fangled and' did not very easily fit in with the sort of wireless that the handyman-constructor felt he understood.

It may sound funny today, but when 'high-efficiency' was sought for short-wave work it seemed quite reasonable and natural to pull off the bases from detector and RF valves and solder them direct into the circuit in an aim to reduce capacitances. To keep the set at its peak of sensitivity one had it on the brink of oscillation, and to keep it at that point one dare not go near it for fear that it 'spilled over'. Hence we used eighteen-inch extension rods on all the controls, and the reaction has to be capable of superfine adjustment.

Even for broadcast listening the straight set died hard, but the handyman went into a decline as the commercial superhet made possible by efficient multi-electrode valves beat him even on grounds of cheapness. By 1935 he was a rare bird, doomed to early extinction.

CLASSIFIED ADS

BARGAIN OFFER

ANNUAL BOUND VOLUMES RADIO & ELECTRONICS CONSTRUCTOR

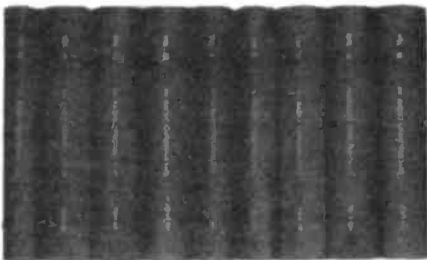

Each of these handsome bound volumes contain more than 150 practical articles in their 700-800 pages of text, published in 12 monthly issues of R&EC.

12 monthly issues to August 1978 (Vol. 31), 1979 (Vol. 32), 1980 (Vol. 33).

* Volume 33 contains Ian Sinclair's Databus Series — How Microprocessors Work Selection & Bussing, CPU Registers; Addressing Memory The Accumulator; Inputs & Outputs; Interrupts; Status Register; Signed Binary Arithmetic; Computing Languages.

ONLY £4.95 each inclusive of post and packing.

Subjects cover - Amplifiers, Amplifier Ancillaries, Calculators, Electronics, 'In Your Workshop', Receivers, Receiver Ancillaries, Television, Test Equipment etc. etc.

12 monthly issues to July 1974 (Vol. 27), 1975 (Vol. 28), 1976 (Vol. 29), 1977 (Vol. 30).

ONLY £3.95 each inclusive of post and packing.

Please send remittance payable to 'RADIO & ELECTRONICS WORLD' stating volumes required to:—

DATA PUBLICATIONS
45, Yeading Avenue,
RAYNERS LANE, HARROW
Middlesex HA2 9RL

WORLDS BIGGEST INFORMATION SERVICE. By return post service/workshop manuals, huge stocks TV/VCR/audio/foreign & U.K. examples over 300 different C.T.V./over 2000 Sony alone. Any single service sheet £1 and s.a.e. Repair data named T.V. £6.50 (with circuits £8.50). S.A.E. brings free-50p magazine/price lists/bargain offers/unique T.V. publications/quotations-TISREW, 76 Church Street, Larkhall (0698-883334), Lanarkshire ML9 1HE.

BI-KITS STEREO AMPLIFIER CHASSIS, cabinet, and two 7 inch speaker kits to match £20 ONO. Box No. REW15.

TR2300. 2m FM transportable with case and 10W booster amp., 'rubber duck' £170 ONO. Phone (0277) 822720. G3XDG.

T&J ELECTRONIC COMPONENTS. Quality components, competitive prices. Send 45p cheque or postal order for illustrated catalogue, 98 Burrow Road, Chigwell, Essex IG7 4BH.

PRINTED CIRCUIT BOARDS & LABELLING. Designer and manufacturer to freelance and industrial users. Try me for:- Conventional single and double sided PCB production (non PTH). hand produced artworks & photography. Quickly made prototypes. Self adhesive labels and signs in flexible vinyl. Screen process printing. - G.N. Slee, 78 Derry Grove, Thurnscoe, Rotherham, South Yorkshire, S63 0TP. Phone: (0709) 895265.

ZX-EPROM PROGRAMMER £27.75 (A), 25V supply for (A) £7.75. (B)Eeprom read card £8.25, Eprom programmed with breakout, life & tool kit £8.25 simple to use, connect to ZX80/81. P&P. on A & B £1.00 (UK). Orme, 2 Barripper Road, Camborne, Cornwall, TR14 7QN. S.A.E. for more details.

TV DX VHF TO UHF CONVERTER. Receive VHF DX signals on UHF television. S.A.E. Data, lists. H. Cocks, Cripps Corner, Robertsbridge, Sussex TN32 5R7. Telephone 058-083-317.

FOR SALE. 'Experimental Microwaves' by A.W. Cross. MI publications. £7.00 Box No. REW 24.

INTERESTED IN OSCAR? Then join AMSAT-UK. Newsletters, OSCAR NEWS journal, prediction charts etc. Details of membership from: Ron Broadbent, G3AAJ, 94 Herongate Road, Wanstead Park, London E12 5EQ.

DIGITAL MULTIMETER, wide ranges. Plus capacitance kit 75% built. Cost £80, will accept £40 o.n.o. 4 Riversley Road, Gloucester, GL2 0QT.

WANTED Continental socket type connector for Filius Pentacon projector, rectangular pins, two in same plane. Carrick, 31 Salcombe Road, Plymouth, Devon, PL4 7NE.

SONY ICF2001 RADIO. No faults, as new, very sensitive and stable. £100. No offers. GM4DHJ, QTHR. Telephone: 041 889-9010.

OPTICAL FIBRES for use in communications, electrical isolation, remote sensing, illumination, etc. Introductory package contains five sample lengths of Silica, glass and plastic fibres totalling ten metres plus a forty page fibre optics guide with theory, uses, practical circuits, etc. Send £5.99 to Quantum Jump Ltd., 53 Marlborough Road, Tuebrook, Liverpool.

MOTOR SPEED CONTROLLER for radio control systems. Digital proportional design. No servos required. Uses special IC to control speed and reverse of DC electric motors. Just plug controller into receiver. Zero to maximum speed in forward and reverse. Motor supply 1.5V to 12V at 10A max. Size 75mm x 54mm x 25mm. Supplied ready for use, with attractive case. No extras needed. Price £13.95 inc. p&p. To:- P.D. Crisp, 32 Churchill Crescent, Wickham Market, Woodbridge, Suffolk, IP13 ORW.

ZYCOMM Z5800 Handheld 2M F.M. 'Synth' auto-tone burst, 1-5 watts, 'rubber duck', remote mic., 2 nicd. packs, charger plus 5/8 'magmount', also Drae v.h.f. wavemeter. £210 o.n.o. Phone: Camberley (Surrey) 66387.

WANTED: RA37 VLF Converter for use with Racal RA17L Comm. receiver. Please ring 0782 632351 (Staffs.) Good price paid.

YAESU 290R 2M Multimode with case £190 o.n.o. Would exchange for HF C.W. only transceiver. Ring: 0232-623-197.

TRIO 2300, Ni-Cads - as new in original packing. 12 volt 2 amp PSU. £150. Why pay more? Telephone: 01-769-0260.

RADIO JUMBLE (Lords, N.W.1.) Once-only one-day rummage sale-Bonanza. Everything audio/radio, vintage/modern, secondhand, 2nd October (Saturday) 12.30 a.m./4.30 p.m., St. John's Hall, Prince Albert Road (near Regent's Park), London N.W.1. Parking excellent. Sell off your unwanted equipment... Stall space half-price. Admission 90 pence (only 50 pence with this advertisement). Stall booking: Mr. Lord, 67 Liverpool Road, London N1 ORW (01-837-7811).

CLASSIFIED ADS

I.B.M. GOLF-BALL TYPEWRITER with solenoids for computer interface. £90, or offer? Telephone Hemel Hempstead 53732, evenings.

TELETEXT. WANTED TELETEXT DECODER. Prefer early Wireless World version but others considered. Please ring: 0726- 2563.

JOIN THE INTERNATIONAL SW LEAGUE. Free services to members including QSL Bureau, Amateur and Broadcast Translation, Technical and Identification Dept.-both Broadcast and Fixed Station, DX Certificates, contests and activities for the SWL and transmitting members. Monthly magazine *Monitor* containing articles of general interest to Broadcast and Amateur SWLs, Transmitter Section and League affairs, etc. League supplies such as badges, headed notepaper and envelopes, QSL cards, etc. are available at reasonable cost. Send for league particulars. Membership including monthly magazine etc., £9.00 per annum UK overseas rates on request, Secretary, 88, the Barley Lea, Coventry, W. Midlands.

THE RADIO AMATEUR INVALID & BLIND CLUB is a well established Society providing facilities for the physically handicapped to enjoy the hobby of Amateur Radio. Please become a supporter of this worthy cause. Details from the Hon Secretary, Mrs R E Woolley, 9 Rannoch Court, Adelaide Road, Surbiton, Surrey KT6 4TE.

CATALOGUE NO.18. Many thousands of surplus mechanical and electronic bargains. 30 pages of interesting reading price 30p. J.A. Crew, Spinney Land, Aspley Guise, Milton Keynes.

WORLD RADIO & TV HANDBOOK. Listing broadcast times/frequencies. nearly 600 pages, £10.99. **BROADCASTS TO EUROPE**, quarterly list, £1.30 (£4.50 yearly). Access/Visa welcome. Pointsea, 25 Westgate, North Berwick, East Lothian, EH39 4AG.

RADIO & ELECTRONICS CONSTRUCTOR back issues for volume 34, Sept 1980 to Aug/Sept 1981, all twelve issues in handsome Cordex Binder with title on spine for only £5.60 plus £1.60 for p&p. From Data Publications, 45 Yeading Avenue, Rayners Lane, Harrow, Middx. HA2 9RL.

IC TEST SOFTWARE written for Gen-Rad 1732 digital IC test systems. Ideal for goods inwards checking etc., competitive service. Contact: Micro-Developments (UK) Ltd., 01- 656-7782.

BROOKMANS KSM LABORATORY STABILISED D.C POWER SUPPLY, type 2TV505C. input: 220-250V a.c. Output: 2 separate outputs of 0-50 volts d.c. Fully adjustable for voltage and current range adjustable from .01-5amps. Unit in perfect working order. Offers? Own collection. Camera Clinic, Black Horse yard, Chester-le-Street, Co. Duham, DH3 3AY. Telephone: (0385) 882678.

PYE WESTMINSTER W15AM dash mount, complete with cradle, mic and d.c. leads. As new, working on 70.26 MHz. Comes with mag base and 1/4 wave whip. £80 o.n.o. Tel: 0245- 351673.

AIRCRAFT COMMUNICATIONS HANDBOOK including Spot MF, HF, VHF, UHF. Frequencies, airports, air traffic control centres, weather reports, broadcast times, beacons, long range stations, call signs, maps, etc. 384 pages £7.50, post & packing £1. PHL Electronics, 97, Broadway, Frome, Somerset' BA11 3HD.



SMALL ADVERTISEMENTS

Advertisements must be prepaid and all copy must be received by the 4th of the month for insertion in the following month's issue.

The Publishers cannot be held liable in any way for printing errors or omissions, nor can they accept responsibility for the bona fides of Advertisers.

Where advertisements offer any equipment of a transmitting nature, readers are reminded that a licence is normally required. Replies to Box Numbers should be addressed to: Box No..., Radio & Electronics World, 45 Yeading Avenue, Rayners Lane, Harrow, Middlesex.

CLASSIFIED ADVERTISEMENT ORDER FORM - PLEASE COMPLETE BELOW

Write Your Ad. Below In the boxes - one word per box please. Underline words required in Bold type. Your name, address, and/or telephone number, if to appear, must be included in the boxes and must be paid for. Telephone numbers

count as two words. Please use **BLOCK CAPITALS**.

-Advertisements are accepted on the understanding that the details stated comply with the conditions of the Trade Description Act, 1968.

-Whilst every care is taken to ensure accuracy, we do not accept liability for inaccuracies should they occur.

-Cancellations must be notified by telephone or in writing by the 6th of the month preceding publication.

				£2.00
£2.04	£2.16	£2.28		£2.40
£2.52	£2.64	£2.76		£2.88
£3.00	£3.12	£3.24		£3.36
£3.48	£3.60	£3.72		£3.84
£3.96	£4.08	£4.20		£4.32

RATES

All cheques should be made payable to Radio & Electronics World.

12p per word -
minimum charge £2.00

Tick this box if you require a box number charged at 30p

I enclose remittance of £ : p

NAME

ADDRESS

POSTCODE

Post your completed form to **RADIO & ELECTRONICS WORLD, Classified Ads., 45, Yeading Avenue, Rayners Lane HARROW, Middlesex.**

A recent meeting with the PR manager of a large firm with fingers in most of the consumer electronic pies, gave an insight into how 'The man in the street' is seen by the manufacturer.

From the consumer's point of view, it seems that the never ending stream of new/updated models across the range of hi-fi/TV and video units is a ploy by manufacturers to maintain high price levels. If the economies of scale reaped by continuing to manufacture established models for something more than a year are employed, it would not seem unreasonable to expect prices to come down.

Granted this is a simple view of things, but as a ready explanation for the plethora of products available in the hi-fi stores it has a certain attraction. The PR manager in question offered a view 'from the other side of the fence' however. He was just as bewildered as anyone by the astonishing range of goods his employers produce with the differences between various versions of a similar audio/video component often being the provision of this or that gimmick. The blame for this state of affairs was, however, laid fairly and squarely on the consumer.

The discussion was centred on video recorders, and as this latest consumer toy nicely illustrates his points, we'll follow the line of reasoning with recorders as an example. The fact that there are a number of different video formats slogging it out in the market place makes the case a little stronger, but it can equally well be applied across the board.

The argument can be applied to any of the features of video recorder (trick video etc.) but as stereo recorders are just starting to appear let's take this particular gimmick and examine it more closely. Who wants stereo sound? No broadcast transmissions in stereo are envisaged until at least the end of 1983, very few 'video films' have stereo sound track, very few people have stereo TV sets and very few people bother to listen to their recorder's audio output via their hi-fi. In short stereo is largely a waste of time.

The marketing men pronounce that stereo is what people want and so the R&D labs get busy adding stereo to their company's particular machine. One company launches a stereo machine and the others feel obliged to do the same for fear that people will think their models are out of date. It is particularly important for those marketing machines to a different format to get on the

bandwagon for, if they don't, people will begin to question if it is technically possible or not.

The best seller in the market thus becomes the machine with a stereo capability. People pay more for the privilege of owning such a machine but, when they get it home do not, indeed cannot make any real use of the facility.

SILLY ISN'T IT?

The same arguments apply to most trick functions-still, variable speed playback etc. which cost money yet are hardly used. The exception is visual search-a useful facility-but then this is now appearing on the budget machines that the more cost conscious of us are buying in ever increasing numbers.

Thus the reason behind the extreme range produced by many manufacturers is a mindless quest on the part of the consumer for more and more gimmicks which he can use less and less.

Of course this may not be the whole story-which came first, the chicken or the egg? And there may be a suspicion that the consumer's desire is not more than a little heightened by the various ad campaigns that the hi-fi industry specialises in.

ITT TO THE TEST

We're currently being told that Sony use a comedian, Ferguson use a musician and ITT use a well at the launch their cinevision 200 projection TV system, they chose to use a children's program detailing the materials necessary to build a Wendy play house. Interesting - but not a lot.

After a cautious approach by the R&EW representative at the party however, the man in charge actually did throw up a test card onto the screen. We're glad to report that this demanding test showed the projection TV to be capable of an excellent performance. We felt rather guilty about the suspicions that had crossed our minds, but then why didn't they put the test card up in the first place?

THE LAST WORD.

CAPTION COMPETITION

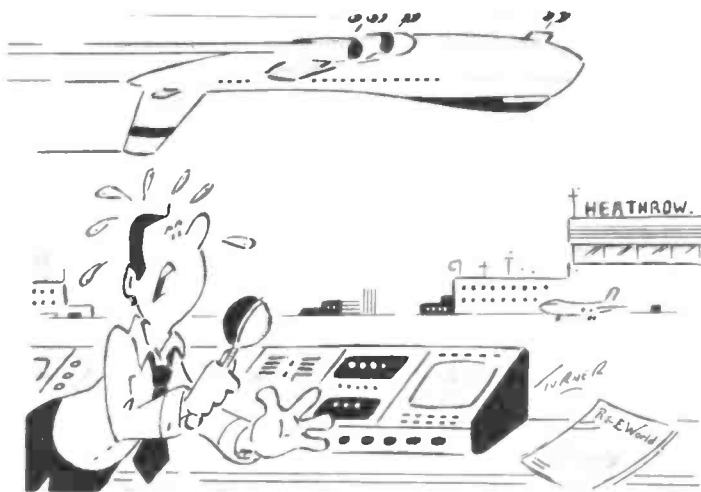

We like to think our readers have a sense of humour - who said you've got to have to read R&EW? - and from this month we give any budding cartoonists amongst you a chance to come up with a line or two for a Mike Turner cartoon. As you can see, the theme is in keeping with this month's cover, with the situation offering endless possibilities. Its up to you.

The prize for the caption which, in the Editor's opinion is the best of those to reach us by **31st**, will be the original Turner cartoon.

Send your entries to:

R&EW Cartoon Competition,

117A High Street, Brentwood, ESSEX, CM14 4SG.

Advertisers' Index

Ambit International	13,89
Blackstar Ltd	6
BNOS Electronics	31
BNR&ES	9
Bulgin	67
Cambridge Learning	69
Chessell	7
Darom Supplies	55
Datong	4
Enfield Electronics	64
Garex Electronics	8
Gerald Myers	9
Gould Instruments	23
GSC UK Ltd	19
H. Lexton Ltd	29,65
Marco Trading	87
Micrometals	69
Microwave Modules	65
North West Communications	87
P.M. Electronic Services	12
Randam Electronics (R)	6
Reltech Instruments	55
Sinclair	I.B.C.
Scopex	61
Special Products Distributors	89
Strutt Ltd	69
Tempus	35
Thanet Electronics	2,3
Wilmslow Audio	7
Wood & Douglas	87

DISCOVER

'The World of Radio & Electronics'



The third issue of Ambit's new style concise *'price-on-the-page'* component catalogue is available now. We have listened carefully to the comments and suggestions arising from the first two issues, and are pleased to say that we have now managed to incorporate many of the aspects of stock and service policy that have been requested.

New ranges include:

'Fair-Rite' ferrite cores: toroids, baluns, tube cores, multihole ferrite beads etc., for HF/VHF RF designs. The Z8-TBDS and support systems. A new range of battery chargers, more instruments, more tools, more books, more components.

Prices have changed — in both directions, although mainly reduced. A further 3 £1 discount vouchers are included, making the initial investment of 70p immediately returnable with interest.

Thanks to a substantial expansion of the staff, orders are being despatched within 24 hours of receipt — and a new guaranteed *'Blue Chip'* service is available if you're in a panic at 4.30pm on a Friday.

It all adds up to *more* of what you want, and *less* of what you don't want.

Available for 70p direct from:

Ambit International, 200 North Service Road, Brentwood, Essex CM14 4SG