

*Practical*

FEBRUARY 1988 £1-20

# Wireless

ISSN 0141-0857

*The Radio Magazine*

**Build the PW "Orwell"  
High Performance MW Receiver**  
Part 1



**Directivity Gain in Transmitting Antennas**  
**The ICOM IC-761 HF Transceiver Reviewed**



# Yaesu's FT-736R. Because you never know who's listening.

Why just dream of talking beyond earth?

With Yaesu's new FT-736R VHF/UHF base station, you can discover some of the best DX happening in ham radio. Via moonbounce. Tropo. Aurora. Meteor scatter. Or satellites.

You see, the FT-736R is the most complete, feature-packed rig ever designed for the serious VHF/UHF operator. But you'd expect this of the successor to our legendary FT-726R.

For starters, the FT-736R comes factory-equipped for SSB, CW and FM operation on 2 meters and 70 cm, with two additional slots for optional 50-MHz or 1.2-GHz modules (220-MHz North America only).

Crossband full duplex capability is built into every FT-736R for satellite work. And the satel-

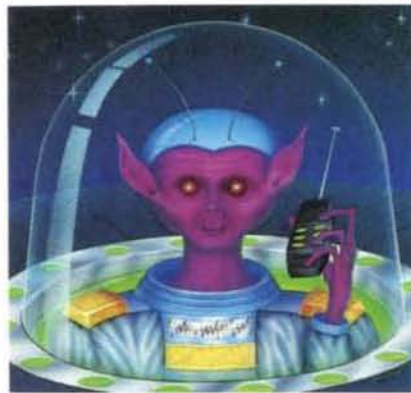

lite tracking function (normal and reverse modes) keeps you on target through a transponder.

The FT-736R delivers 25 watts RF output on 2 meters, 220-MHz, and 70 cm. And 10 watts on 6 meters and 1.2-GHz. Store frequency, mode and repeater shift in each of the 100 memories.

For serious VHF/UHF work, use the RF speech processor. IF shift. IF notch filter. \*CW Narrow Optional and FM wide/narrow IF filters. VOX. Noise blanker. Three-position AGC selection. Preamp switch for activating

your tower-mount preamplifier. Even an offset display for measuring observed Doppler shift on DX links.

And to custom design your FT-736R station, choose from these popular optional accessories: Iambic keyer module. FTS-8 CTCSS encode/decode unit. FVS-1 voice synthesizer. FMP-1 AQS digital message display unit. 1.2-GHz ATV module. MD-1B8 desk microphone. E-736 DC cable. And CAT (Computer Aided Transceiver) system software.

Discover the FT-736R at your Yaesu dealer today. But first make plenty of room for exotic QSL cards. Because you *never* know who's listening.

## YAESU

\*CW narrow optional



UK Sole Distributor **South Midlands Communications** S.M. House, School Close,  
Chandlers Ford Industrial Estate, Eastleigh, Hants SO5 3BY. Tel: (0703) 255111

Prices and specifications subject to change without notice. FT-736R shown with 220-MHz option installed.

# Practical Wireless

The Radio Magazine

FEBRUARY 1988 (ON SALE 14 JANUARY 1988)

VOL. 64 NO. 2 ISSUE 971

## NEXT MONTH

Beginning  
A New Series  
For Beginners:  
Understanding  
Circuit Diagrams

A "Digital Dial"

The Howes SWB30  
SWR/Power Meter  
Reviewed

plus

All the usual  
features

Don't miss  
it—place  
your order with  
your  
newsagent now!

On sale  
February 11

Contents subject to last-minute revision

- 20 PW Review**  
Icom IC-761 HF Transceiver  
Ken Michaelson G3RDG
- 26 Amateur Radio in Australia—3**  
Greg Baker
- 28 Vertical Antennas**  
P. Newton
- 30 Making Waves—a Guide to Propagation—3**  
A. J. Harwood G4HHZ
- 35 PW Review**  
S.E.M. QRM Eliminator  
Geoff Arnold G3GSR
- 36 PW "Orwell" MW Receiver—1**  
R. F. Haigh
- 42 Directivity Gain in Transmitting Antennas**  
F. C. Judd G2BCX
- 46 Battle of the Beams—2**  
D. V. Pritchard G4GVO
- 49 Errors and Updates**  
Letter—"Morse", Jan. 1988  
Making Waves—2, Jan. 1988
- 50 Practically Yours**  
Glen Ross G8MWR

### Regular Features

72 Advert Index	55 On the Air	29,33,68
32 PW Binders	54 PCB Service	Swap Spot
52 Book Service	15 PW Services	14 Write On
14 Comment	51 Short Wave Magazine	33 PW Programs
16,24,45	40 Subscriptions	
News Desk		

#### Editorial and Advertisement Offices:

Practical Wireless  
Enefco House  
The Quay  
Poole, Dorset BH15 1PP  
☎ Poole (0202) 678558 (Out-of-hours  
service by answering machine)  
Prestel 202671191

**Advertisement Manager**  
Roger Hall G4TNT ☎ 01-731 6222

**Editor** Geoff Arnold T.Eng FSERT G3GSR  
**Assistant Editor** Dick Ganderton C.Eng. MIERE G8VFH  
**Art Editor** Steve Hunt  
**Technical Features Editor** Elaine Richards G4LFM  
**Technical Projects Sub-Editor** Richard Ayley G6AKG  
**Editorial Assistant** Sharon George  
**Technical Artist** Rob Mackie  
**Administration Manager** Kathy Etheridge  
**Clerical Assistant** Claire Horton  
**Accounts** Annette Martin

THIS MONTH



**Why did we design and produce the HF125 receiver?** Simply to provide the keen short wave listener with a receiver which offered not only all the facilities he or she needed in an HF receiver, but to give at the same time a level of performance which would cope easily with HF conditions likely to be encountered in Europe.

You all know the problems, high power broadcast stations pounding in at night blotting out the weak signals you wanted to hear – and many of the unwanted signals were generated in your receiver itself. That we succeeded in designing a receiver which could solve the listening difficulties is obvious from comments from reviewers, but we also did it at an attractive price.

The HF125 performance ranks equal to or better than imported receivers at twice its price, and its success stretches around the world.

So what did the reviewers say. I'll give you a few comments, but for the full story why not send a stamped addressed envelope marked "HF125" and we will return a fully descriptive brochure with all the review comments included.

**Quotes**

"What is particularly important is the fact that so much attention has been paid to RF and IF performance; areas so lacking in many Japanese sets. Short Wave Listeners will be particularly pleased about the many choices of selectivity on AM." – Angus McKenzie

"I tuned straight to the 40 metre amateur band to see how it stood up to the battering from high powered propaganda broadcasters when attempting to resolve relatively weak amateurs striving to get contacts. The simple answer was, no problem." – Chris Lorek

"After an hour, drift was less than 50Hz in each instance. This is comparable with receivers in much higher price classes." – World Radio and TV Handbook

"I have no doubt that the Lowe HF125 represents extremely good value for money, and the performance far exceeds so much of its competition, including some receivers costing rather more." – Angus McKenzie

"It's refreshing to find a receiver that does exactly what it claims." – World Radio and TV Handbook

**The HF125 costs £375 including vat. Need I say more?**

**Specification**

Frequency coverage	30kHz to 30 MHz continuous coverage	Image and spurious responses	>75 dB rejection.
Detection Modes	AM SSB (USB, LSB) CW FM (narrow band) (Optional with D-125 unit) Synchronous AM (Optional with D-125 unit)	Audio output	0.75 W into internal loudspeaker. 1.25 W into external 4 ohm loudspeaker.
Tuning	By spin-wheel – continuous tuning in 15.6 Hz steps. Step size increases with faster tuning knob rotation. MHz quick selection by push button. Keypad frequency entry. (Optional with K-125 keypad unit and interface).	Connections	Antenna input: 50 ohm via SO-239 socket. 600 ohm + GND terminals. Active whip antenna. (Optional P-125 unit) External loudspeaker output – 3.5mm jack. Headphones output – 6mm mono/stereo jack. Record output (100 mV) – 3.5mm jack. 12V DC power input – 2.1mm power jack.
Memories	30 frequency memories in two banks of 15	Power supply	External 12V DC supply at approx 250 mA. Internal NICAD batteries and charger to give typically 8 hrs. operation (Optional P-125 unit).
I.F. Filter bandwidths	2.5kHz, 4kHz, 7kHz, 10kHz 400 Hz audio filter (CW mode only). (Filters are user selectable).	Size	Approx 255 x 100 x 200mm (W x H x D)
Sensitivity (>500kHz)	SSB mode: <0.3µV for 10 dB S/N AM mode: <0.7µV for 10 dB S/N @ 70% mod.	Weight	Approx 1.8 kg (Basic receiver) Approx 2.5 kg with P-125 option fitted.
Dynamic range	>90 dB at 50 kHz from tuned frequency. >80 dB at 20 kHz from tuned frequency.	Specification subject to change without notice.	

**HF 125 SHORT WAVE RECEIVER**

HP125 .....	£375.00 inc VAT, carriage £8.00
D125 .....	£59.50 inc VAT, carriage £1.00
K125 .....	£59.50 inc VAT, carriage £1.00
P125 .....	£69.51 inc VAT, carriage £2.50
C125 .....	£23.88 inc VAT, carriage £2.50

**For the Air Enthusiast**



**R535 VHF/UHF**

As the hobby of airband listening has grown, many people have become fascinated by the to and fro of radio contacts between pilot and control. Much of this takes place on the VHF airband between 118 and 136 Mhz, and one specialist manufacturer in particular has produced a range of receivers designed to give the finest performance one could ask for. That manufacturer is Signal Communications, and thousands of listeners all over the world are using Signal radios.

As a good manufacturer, Signal have listened to comments from users of their receivers, and have noted that there has been an increasing demand for a receiver to listen not only to the VHF airband, but also to the UHF airband as well.

That receiver is the new R535, and is destined to be a landmark in airband listening. The R535 has all the performance we have come to expect from Signal, and the sensitivity is outstanding. However, the story does not end there because Signal have also put in every possible operating feature that the airband listener could possibly want, including 60 memory channels which can all be scanned at high speed; frequency scanning where the receiver will continuously look for stations between any frequency limits the user wishes to choose; and so on and so on.

Too much to say in a small space, so why not drop us a line and ask for full details of this listeners dream receiver. VHF and UHF airband in a small package of high performance. What more can we ask apart from the price? Well, it costs just £249 including vat.

**BY THE WAY**

The scanning monitor receiver which led the way to wide range coverage with high performance is still available. I'm talking about the AR2001, which has 25 to 550 MHz coverage, AM, communications FM and broadcast FM, memories, scanning etc. etc. This landmark in radios now costs only £325 including vat, and I should hurry if I were you because stocks are strictly limited.

**FURTHER NEWS** comes of a synthesised hand held airband radio which has caused us all to say "Just what we wanted". This latest advance in pocket size (yes, pocket size) receivers has everything you could ask for. Its called the WIN-108, and covers the entire VHF airband from 108 to 136 MHz in 25kHz steps. Scanning, memories, searching for new signals, direct frequency keypad entry, – everything. Ask for details; by the time you read this, we will have them in stock.

**Kantronics packet radio**

When I first heard of packet radio, I said "What?", and that is the reaction of many radio amateurs. However, I never expected it to be so much fun, and judging by the demand and the queue to get at our demonstration station here at Matlock, a lot of other people are also finding it truly fascinating.

There are several companies offering ready made packet systems, and the descriptions are usually full of terms you don't understand (including some of our own ads in the past). What for example is "enhanced generic command structure"? Sounds very much like something taught at Sandhurst or West Point.

From the equipment available, we chose to represent Kantronics, because their units are sheer delight to see, to use, and to enjoy. For full information on this most interesting aspect of our hobby, just send a couple of first class stamps and ask for "Kantronics".

Prices range from £159 to £298, and I know I haven't told you what packet radio will do – send for the info . . .



<b>Glasgow:</b> 4/5 Queen Margaret Road.	Tel. 041-945 2626.	<b>Cardiff:</b> c/o South Wales Carpets, Clifton Street.	Tel. 0222 464154.
<b>Darlington:</b> 56 North Road.	Tel. 0325 486121.	<b>London:</b> 223/225 Field End Road, Eastcote, Middlesex.	Tel. 01-429 3256.
<b>Cambridge:</b> 162 High Street, Chesterton.	Tel. 0223 311230.	<b>Bournemouth:</b> 27 Gillam Road, Northbourne.	Tel. 0202 577760.

**Note. All our shops open Tuesday to Saturday inclusive.**



## The TS140S from Kenwood

Every once in a while, something comes along which marks a true turning point in amateur radio equipment. Such was the case when **Trio-Kenwood** introduced the **TS120 series**; the first of the small solid state transceivers to appear.

Following the trends of the last few years towards more "sophisticated" equipment (really meaning more and more complicated), we have seen Kenwood engineering directed more towards better performance, particularly in HF transceivers; performance which has become a standard of excellence for others to try to match.

Study of recent reviews of equipment which has been introduced to try to match **Kenwood's TS940S** reveals just how far behind some manufacturers have fallen: I am reminded of some lines from Kipling which run (more or less): "They stole everything I had, but they couldn't steal my mind, So I left them sweating and stealing, A year and a half behind."

Well, the chaps at Kenwood have not been asleep, and they have come up with a new transceiver which I believe will mark another turning point in HF equipment. This is the **TS140S**, and I can tell you that from a short "hands-on" session which I was given in Germany recently, I am certain that the **TS140S** will satisfy many many users.

The new **TS140S** is about the same size as the **TS430** or **TS440**, and on the face of it is similar (yawn) to other transceivers of the genre in that it gives you 100 Watts of RF on all the amateur bands, in all modes including FM; has a general coverage receiver covering 500 kHz to

30 MHz; and has loads of facilities that you might expect – BUT – Kenwood have studied what the radio amateur has been saying and have refined and simplified the operation of the **TS140S** to make it a real dream to use.

Not only that, they have given the user a receiver section with real performance which matches today's expectations, and remember that Kenwood have consistently set the standards for the last few years.

**Obviously it is imposible to describe all the features and facilities of the TS140S in a few paragraphs, so why not drop us a line and ask for complete information. What's that? Oh, the price. Not yet finally determined, but quite a bit less than £950 but not quite as low as the £750 we have been asking for the TS530S and TS430S in recent weeks.**

In my opinion, the **TS140S** in combining performance with simplicity at an attractive cost will give real satisfaction to the radio amateur who wants to enjoy his hobby of communicating, rather than counting the buttons on the front panel. And who am I to make this pronouncement? Well, I'm John Wilson and I am one of the original gang of three which became Lowe Electronics Ltd. I haven't written for the magazines for many years, but the **TS140S** really attracted me so I thought I should tell you about it rather than bore you with a specification. Hope you like it too.

**73, G3PCY/5N2AAC**

## LOWE ELECTRONICS LTD.

Chesterfield Road, Matlock, Derbyshire DE4 5LE  
Telephone 0629 580800 (4 lines)

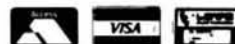

# ICOM

## RECEIVERS



### **IC-R7000, 25-2000MHz. Commercial quality scanning receiver**

The ICOM IC-R7000 has established itself as an advanced technology, continuous coverage communications receiver. With 99 programmable memories the IC-R7000 covers aircraft, Marine, FM Broadcast, Amateur Radio, television and weather satellite bands. For simplified operation and quick tuning the IC-R7000 features direct keyboard entry.

Precise frequencies can be selected by pushing the digit keys in sequence of the frequency or by turning the main tuning knob. FM wide/FM narrow/AM upper and lower SSB modes with six tuning speeds: 0.1, 1.0, 5, 10, 12.5, 25KHz. The IC-R7000 has 99 memories available to store your favourite frequencies including the operating mode. Memory channels can be called up by pressing the memory switch then rotating the memory channel knob, or by direct keyboard entry. A sophisticated scanning system provides instant access to the most used frequencies. By depressing the Auto-M switch, the IC-R7000 automatically memorises frequencies that are in use whilst it is in scan mode, this allows you to recall frequencies that were in use. The scanning speed is adjustable and the scanning system includes the memory selected frequency ranges or priority channels. All functions including the memory channel readout are clearly shown on a dual-colour fluorescent display. Other features include dial-lock, noise-blanker, attenuator, display dimmer and S-meter and optional RC-12 infra-red remote controller, voice synthesizer and HP2 headphones.

### **IC-R71E, General coverage receiver.**

The ICOM IC-R71E 100KHz to 30MHz general coverage receiver features keyboard frequency entry and infra-red remote controller (optional) with 32 programmable memory channels, SSB, AM, RTTY, CW and optional FM. Twin VFO's scanning, selectable AGC, noise blanker, pass band tuning and a deep notch filter.

With a direct entry keyboard frequencies can be selected by pushing the digit keys in sequence of frequency.

The frequency is altered without changing the main tuning control. Options include FM, voice synthesizer, RC-11 infra-red controller, CK70 DC adaptor for 12 volt operation, mobile mounting bracket. CW filters and a high stability crystal filter.



**Icom (UK) Ltd.**

Dept PW, Sea Street, Herne Bay, Kent CT6 8LD. Tel: 0227 363859. 24 Hour.

# Count on us!

## MOBILE

### IC-900 Super multiband FM system

This new addition to ICOM's Ham radio equipment is a multiband FM transceiver system that allows the mobile operator to customize a communications system for his favourite bands. Up to 5 optional band-units can be installed with the IC-900 for instant access to a wide range of frequencies from the 28MHz HF band to the 1240MHz UHF band. Only a small remote controller is necessary for control of all these bands. A flexible optical fibre is used between the Remote Controller and the Interface Unit. The IC-900 has independent full duplex capability on all bands, providing simultaneous receive and transmit operation. The function display on the Remote Controller shows two separate operating frequencies simultaneously. The IC-900 system transceiver is equipped with 10 fully programmable memory channels in each Band Unit. The system can therefore store up to 50 different memory channels. This revolutionary new concept is available from your ICOM dealer. Also feel free to contact ICOM(UK) LTD for assistance or information. The IC-900 Multi-band system consists of a Remote Controller, Interface unit B and a series of specially designed Band Units.

UX19	28-30MHz	10 watts
*UX59	50-54MHz	10 watts
*(No mobile operation allowed in UK)		
UX29	144-146MHz	25 watts
UX29H	144-146MHz	45 watts
UX49	430-440MHz	25 watts
UX129	1240-1300MHz	10 watts



### Multibander system block diagram

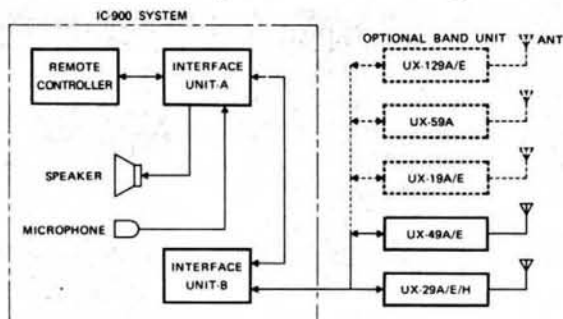

**Helpline:** Telephone us free-of-charge on 0800 521145, Mon-Fri 09.00-13.00 and 14.00-17.30. This service is strictly for obtaining information about or ordering Icom equipment. We regret this cannot be used by dealers or for repair enquiries and parts orders, thank you.  
**Datapost:** Despatch on same day whenever possible.  
**Access & Barclaycard:** Telephone orders taken by our mail order dept. instant credit & interest-free H.P.

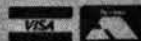

# ICOM

## BASE STATIONS



### IC-275E/475E 25 Watt 2 metre/70cm. Multimode Transceivers.

#### Tech Talk from ICOM: THE EXCITEMENT OF SATELLITE COMMUNICATIONS

An ever increasing number of radio amateurs are joining the excitement of Phase 111 - type satellite communications. This new medium combines the communications range of the 20 and 80 metre bands with the line-of-sight reliability of 2 metres. It's equivalent to a totally new band, and a vast technical background is not necessary for enjoying the action. ICOM is able to help you enjoy the fascinating new capabilities of OSCAR and future amateur satellites. Its all mode 2 metre and 70cm base transceivers bring the operating conveniences of low band units to the VHF and UHF amateur bands. They can be used for local FM operations via repeaters or for SSB/CW communications via Phase 111 satellites. The IC-127IE all mode 23cm transceiver is in a class of its own, providing mode L satellite uplink capability. (Mode L: 1269MHz uplink, 436 downlink) (Mode U: 435 uplink 145 downlink). Satellite relayed signals are somewhat weak in nature and the IC-275E's low noise/high

sensitivity receiver gives the highest performance for hearing everyone regardless of their uplink performance. The noise blanker prevents pulse type electrical interference from masking desired DX signals, the selectable AGC can follow fast fades associated with spin modulation. There are also the 99 mode memories which can be used for intermixed FM repeater and SSB/CW operators. When the IC-275E is equipped with the optional mast mounted AG25 GaAsFET pre-amp, it becomes a satellite operations dream come true. ICOM's IC-475E 70cms transceiver has a front panel continuously adjustable power output to allow for daily signal variations. This overcomes the practice of over loading a satellites on-board receiver. The IC-475E also includes 99 all mode memories for the ultimate in operating flexibility. Using the ICOM CT16 satellite communications interface these base stations will track together via the ICOM CI-V system. If you are interested in joining today's most exciting era of amateur communications ie, OSCAR and future Phase 111 satellites, ICOM is the logical choice for top performance equipment.

**Icom (UK) Ltd.**

Dept PW, Sea Street, Herne Bay, Kent CT6 8LD. Tel: 0227 363859. 24 Hour.



# Count on us!

## MORE BASE STATIONS

### IC-1271E, 1.2GHz Multimode Transceiver



ICOM, a pioneer in 1.2GHz technology are proud to introduce the first full feature 1240-1300MHz base station transceiver. Features include: multimode operation, 32 memories, scanning and 10 watts RF output. The IC-1271E allows you to explore the world of 1.2GHz thanks to a newly developed PLL circuit that covers the entire band, a total of 60MHz, SSB, CW, and FM modes may be used anywhere in the band making the IC-1271E ideal for mobile, DX, repeater, satellite or moonbounce operation. The IC-1271E has outstanding receiver sensitivity, the RF amplifiers use a low noise figure and high-gain disc type GaAs FET's for microwave applications. The rugged power amplifier provides 10 Watts

which can be adjusted from 1 to 10 Watts. A sophisticated scanning system includes memory scan, programme scan, mode-selective scan and auto-stop feature. Scanning of frequencies and memories is possible from either the transceiver or the HM12 scanning microphone. 32 programmable memories are provided to store the mode and frequency in 32 different channels. All functions including memory channel are shown clearly on a seven digit luminescent dual colour display. The IC-1271E has a dial-lock, noise blander, RIT, AGC fast or slow and VOX functions. With a powerful 2 Watt audio output the IC-1271E is easily audible even in a noisy environment. The transceiver operates with either a 240V AC (optional) or 12 volt DC power supply.

**IC-AG1200 Masthead pre-amp.** Designed to use with the IC-1271E, the D.C. voltage and T/R switching for the amplifier is superimposed on the R.F. coaxial cable and switched by the pre-amp switch on the IC-1271E front panel. The new pre-amp provides excellent performance as a low noise microwave amplifier (0.6 noise figure typical).

### IC-575, 28/50MHz Dual band multimode base station.

The ICOM IC-575 base station was developed to meet the demand for advanced communications for the recently acquired 6m band. Similar in appearance to the IC-275/475 2m and 70cm base stations, the beauty of this new transceiver from ICOM is that it gives you the best of both worlds, 6 & 10m in one compact unit. The IC-575 covers 28-30MHz and 50-54MHz. Operating modes are SSB, CW, AM & FM. Power output is 10 watts (AM 4 watts) with a front panel control to reduce output for QRP operations. A pass band tuning circuit narrows the I.F. passband width, eliminating signal in the passband. A built-in notch filter eliminates beat signals with sharp attenuation characteristics. Some PLL systems have difficulty meeting the lockup time demands placed on them by new data communications. This is why ICOM developed the DDS (Direct Digital Synthesizer) method. With a lockup time of just 5msec the DDS method allows the IC-575 to handle data communications such as packet or AMTOR. 99 programmable memories can store frequency, mode, offset frequency and direction. A total of four scanning functions for easy access to a wide range of frequencies, memory scan, programmed scan, selected mode memory scan and lock out scan. The IC-575 has an internal A.C. power supply, but can also be used on 13.8v DC for mobile or portable operation. Optional accessories available are the UT36 voice synthesizer, the IC-FL83 CW narrow filter, SP7 external loudspeaker, HP2 communication headphones and SM8/SM10 desk microphones. Other transceivers available in this range are: IC-275E 2m multimode 25w, IC-275H 2m multimode 100w, IC-475E 70cm multimode 25w, IC-475H 70cm multimode 75w.



**Helpline:** Telephone us free-of-charge on 0800 521145, Mon-Fri 09.00-13.00 and 14.00-17.30. This service is strictly for obtaining information about or ordering Icom equipment. We regret this cannot be used by dealers or for repair enquiries and parts orders, thank you.

**Datapost:** Despatch on same day whenever possible.

**Access & Barclaycard:** Telephone orders taken by our mail order dept, instant credit & interest-free H.P.

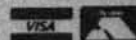



# South Midlands C

SCHOOL CLOSE, CHANDLERS FORD IND. EST., EAST

## ★ UNREPEATABLE SPECIAL OFFER ★

# FT726R(2)

# £699 inc. VAT



430/726 70 cms UNIT ..... Special offer £199  
50/726 6m UNIT ..... £249

SAT/726 SAT UNIT ..... Special offer £59  
21/24/28 HF UNIT ..... £269

Special offer prices of modules apply only if purchased together with FT726R.

### COMPARE THE COMPETITION!

The FT726R 2m base station, at only £699, is £240 cheaper than its nearest rival. Add 70cms at £199, you now have 2m & 70cms capability for less than the oppositions 2m bases.

**WITH 12 MONTH WARRANTY AND FREE FINANCE AVAILABLE**

## BEST VALUE ON 2M, 70CMS & 23CMS

NEW  
FT2311R  
£475.00 inc.

- ★ 45(35)\*(10)†/5(4)\*(1 or 5)† WRF Output
- ★ Easy 'one touch' push button operation
- ★ Reversible sloped front panel
- ★ Large green easy to read LCD
- ★ Ten memories (independent Tx & Rx)
- ★ Switchable 12.5/25kHz steps
- ★ Priority channel monitoring
- ★ C/w Hand mic and mobile mounting bracket

#### OPTIONAL ACCESSORIES

SP55	External Speaker .....	£19.55
YH1	Headset (C/W Mic) .....	£19.99
SB10	PTT Switch Unit .....	£22.00
MH 10F8	Speaker/Mic .....	£25.00
MH 14A8	Speaker/Mic (C/W Tone Burst) .....	£23.00
MF 1A3B	Boom Mic (Via SB10) .....	£25.00

THE **FT211RH**,  
THE **FT711RH**  
and the NEW **FT2311R**



\* FT711RH †FT2311R

FT211RH  
and FT711RH  
£349.00 inc.

## SMALL ON SIZE – LARGE ON FEATURES



### FT23R & FT73R

- ★ 144-146 or 430-440MHz
- ★ Diecast solid chassis
- ★ 5W O/P (With Opt. FNB11)
- ★ 10 Memory channels
- ★ 6 Digit LCD display
- ★ One touch operation

### FT727R

- ★ 144-146 & 430-440MHz
- ★ 5W O/P on 2m & 70cms
- ★ 10 Memory channels
- ★ Large clear LCD display
- ★ One touch operation
- ★ Computer capability



**FT23R From £249**

**FT73R From £269**

**FT727R £425**

LEEDS  
SMC (Northern)  
Nowell Lane  
Industrial Estate  
Leeds LS9 6JE  
Leeds (0532) 350606  
9-5.30 Mon-Sat

CHESTERFIELD  
SMC (Midlands)  
102 High Street  
New Whittington,  
Chesterfield  
Chest. (0246) 453340  
9.30-5.30 Tues-Sat

BUCKLEY  
SMC (TMP)  
Unit 27, Pinfold Lane  
Buckley, Clwyd  
Buckley (0244) 549563  
10-5 Tues, Weds, Fri  
10-4 Sat

JERSEY  
SMC (Jersey)  
1 Belmont Gardens  
St. Helier, Jersey  
Jersey (0534) 77067  
9-5 pm Mon-Sat  
Closed Wed

N. IRELAND  
SMC N. Ireland  
10 Ward Avenue  
Bangor  
County Down  
0247 271875

BIRMINGHAM  
SMC (Birmingham)  
504 Alum Rock Road  
Alum Rock  
Birmingham B8 3HX  
(021-327) 1497/6313  
9.00-5.00 Tues-Fri  
9.00-4.00 Sat

AXMINSTER  
Reg Ward & Co Ltd  
1 Western Parade  
West Street,  
Axminster  
Devon EX13 5NY  
Axminster (0297) 34918  
9-5.30 Tues-Sat



Southampton Showroom open 9.00-5.00 Monday to Friday, 9.00-1.00 Saturday. Service Dept open Mon-Fri 9.00-5.00.  
AGENTS: JOHN DOYLE, TRANSWORLD COMMS, NEATH (0639) 52374 DAY (0639) 2942 EVE

DAVID STENNING, G4JA, LOUTH 0507 604967

# Communications Ltd. YAESU

WIMBORNE, HANTS. SO5 3BY TEL: 0703 255111 FAX: 0703 263507 TLX: 477351

## INTRODUCING THE FT736R FROM YAESU



The FT-736R is a solid-state, frequency-synthesised VHF and UHF amateur transceiver incorporating up to four band modules covering the 50, 144, 430 and 1200 MHz amateur bands. The standard model provides 25 watts RF power output on the 144 and 430 MHz amateur bands in SSB, CW, and FM modes, with any two of the remaining three bands installable as options (10 watts output on the 50 and 1200 MHz bands). An 8-bit CMOS main microprocessor and 4-bit i/o coprocessor provide exceptional digital integration and control: including selectable tuning rates or mode-dependent channelized tuning in selectable steps for each mode. Operating conveniences usually found only on HF transceivers, such as front panel adjustable IF shift and IF notch, a noise blanker, all-mode VOX and three-speed selectable AGC are included. GaAs FET receiver RF amplifiers are provided in the 430 and 1200 MHz band modules. The innovative memory system includes one hundred general purpose memories plus ten full duplex cross-band memories, all of which store mode and receive and transmit frequencies independently. In addition, fourteen vfos are provided: two general purpose plus one PMS (Programmable Memory

limit Scanning) on each band, two special-purpose full duplex vfos, and up to four clarifier (receiver offset) memories, one per band. Each of the two full duplex vfos can be selected so that its receive and transmit frequencies and modes can be displayed and tuned independently, or linked to tune synchronously in opposite directions for satellite operation. You can retain twelve satellite uplink/downlink modes in the special vfos and ten full duplex memories at all times. Of course, metering of either transmitter or receiver parameters is selectable during full duplex communications. For CW operators, the FT-736R offers quick-changeover semi break-in and includes provisions for an optional internal electronic keyer and narrow (600Hz) CW crystal filter. Naturally, with FM the predominant mode on the VHF and UHF bands, the FT-736R includes all manner of convenience features for both FM simplex and repeater operation, special narrow FM mode (to cut adjacent channel interference in crowded areas), Automatic Repeater Shift when tuned to 2-meter repeater subbands and a 1750Hz Burst Tone Generator is installed as standard. An enhanced CAT (Computer Aided Transceiver) System allows addition and customization of features and user-designed controls from an external computer. The FT-736R also includes a  $\pi$ -switched DC supply line for masthead preamplifiers, activated from the front panel, and digital input connection directly to the modulator for high performance packet radio tnc interfacing. Optional add-on accessories include the TV-736 Amateur Television Modulator/Demodulator for ATV operation, FIF-series CAT Interface Units, SP-767 External Loudspeaker, FMP-1 AQS Message Processor, and FVS-1 Voice Synthesiser and FTS-8 CTCSS Tone Squelch Unit (both mount internally).

### OPTIONAL ACCESSORIES

FEX 736/50	50MHz module	£239.00	XF455MC	600Hz CW Filter	£60.00
FEX 736/1.2	1.2GHz module	£425.00	SP767	External Spkr c/w Audio Filters	£69.95
FMP-1	AQS Message Processor c/w display	£189.00	MD-1B8	Desktop Microphone	£79.00
FTS-8	CTCSS Tone Squelch Unit	£45.00	MH-1B8	Hand Scanning Microphone	£21.00
FVS-1	Voice Synthesiser Unit	£33.00	FIF232Cvan	CAT/INC Interface for Packet & CAT	£T.B.A.
Keyer Unit B	Internal Iambic Keyer Unit	£15.95	FIF232C	CAT Interface for RS232 O/P	£75.00
TV-736	Fast Scan TV (ATV) Mod/Demod Unit	£159.00	FIF65A	CAT Interface for Apple II series	£60.00

See inside front cover for more details.

**FT736R R.R.P. £1450.00** complete with 2m x 70cms.

## A SELECTION FROM OUR CATALOGUE

VHF/UHF FIXED ANTENNAS	VHF LINEAR AMPS	ANTENNA ROTATORS																																																																																																																																																																																																																																																																				
<p>5% off new prices</p> <p><b>JAYBEAM 2 Metre</b></p> <table border="1"> <tr> <th></th> <th>Normal Price</th> <th>Offer Price</th> </tr> <tr> <td>H0/2M</td> <td>Halo head only</td> <td>£9.78</td> <td>£9.29</td> </tr> <tr> <td>HM/2M</td> <td>Halo with 2ft mast</td> <td>£11.50</td> <td>£10.93</td> </tr> <tr> <td>UGP/2M</td> <td>Ground plain folded radiator</td> <td>£16.96</td> <td>£16.11</td> </tr> <tr> <td>C5/2M MK2</td> <td>Vertical Colinear 4.8dbd</td> <td>£90.85</td> <td>£86.31</td> </tr> <tr> <td>LR1/2M</td> <td>Vertical Colinear 4.3dbd</td> <td>£37.95</td> <td>£36.05</td> </tr> <tr> <td>LR2/2M</td> <td>Vertical omnidirectional</td> <td>£29.61</td> <td>£28.13</td> </tr> <tr> <td>LW5/2M</td> <td>5 Element Yagi 7.8dbd</td> <td>£18.69</td> <td>£17.76</td> </tr> <tr> <td>LW8/2M</td> <td>8 Element Yagi 9.5dbd</td> <td>£23.98</td> <td>£22.78</td> </tr> <tr> <td>LW10/2M</td> <td>10 Element Yagi 10.5dbd</td> <td>£29.04</td> <td>£27.59</td> </tr> <tr> <td>LW16/2M</td> <td>16 Element Yagi 13.4dbd</td> <td>£42.55</td> <td>£40.42</td> </tr> <tr> <td>PBM10/2M</td> <td>10 Element Parabeam 11.7dbd</td> <td>£57.50</td> <td>£54.63</td> </tr> <tr> <td>PBM14/2M</td> <td>14 Element Parabeam 13.7dbd</td> <td>£70.15</td> <td>£66.64</td> </tr> <tr> <td>Q4/2M</td> <td>4 Element Quad 9.4dbd</td> <td>£37.09</td> <td>£35.24</td> </tr> <tr> <td>Q6/2M</td> <td>6 Element Quad 10.9dbd</td> <td>£48.59</td> <td>£46.16</td> </tr> <tr> <td>D5/2M</td> <td>5 over 5 slot fed Yagi 10.0dbd</td> <td>£33.93</td> <td>£32.23</td> </tr> <tr> <td>D8/2M</td> <td>8 over 8 slot fed Yagi 11.1dbd</td> <td>£46.58</td> <td>£44.25</td> </tr> <tr> <td>5XY/2M</td> <td>5 Element crossed Yagi 7.8dbd</td> <td>£36.23</td> <td>£34.42</td> </tr> <tr> <td>8XY/2M</td> <td>8 Element crossed Yagi 9.5dbd</td> <td>£46.00</td> <td>£43.70</td> </tr> <tr> <td>10XY/2M</td> <td>10 Element crossed Yagi 10.8dbd</td> <td>£57.50</td> <td>£54.63</td> </tr> <tr> <td>PMH2/C</td> <td>2 Way harness circ. polarisation</td> <td>£13.51</td> <td>£12.83</td> </tr> <tr> <td>PMH2/M</td> <td>2 Way harness for 2 Metres</td> <td>£14.89</td> <td>£14.15</td> </tr> <tr> <td>PMH4/2M</td> <td>4 Way harness for 2 Metres</td> <td>£36.80</td> <td>£34.96</td> </tr> </table> <p><b>JAYBEAM 4M/6M</b></p> <table border="1"> <tr> <th></th> <th>Normal Price</th> <th>Offer Price</th> </tr> <tr> <td>DB4</td> <td>4M/6M Dual Band 4 Ele</td> <td>£117.88</td> <td>£111.99</td> </tr> <tr> <td>4Y6M</td> <td>6M 4 Ele 7dBd</td> <td>£49.45</td> <td>£46.98</td> </tr> <tr> <td>4Y4M</td> <td>4M 4 Ele 7dBd</td> <td>£40.54</td> <td>£35.81</td> </tr> <tr> <td>PMH2/4M</td> <td>4M 2 Way Phasing</td> <td>£20.87</td> <td>£19.83</td> </tr> </table> <p>POSTAGE ON SMALL ITEMS £1.50 POSTAGE ON LARGE ITEMS AND ANTENNAS £4.50</p> <p><b>Limited Offer</b></p>		Normal Price	Offer Price	H0/2M	Halo head only	£9.78	£9.29	HM/2M	Halo with 2ft mast	£11.50	£10.93	UGP/2M	Ground plain folded radiator	£16.96	£16.11	C5/2M MK2	Vertical Colinear 4.8dbd	£90.85	£86.31	LR1/2M	Vertical Colinear 4.3dbd	£37.95	£36.05	LR2/2M	Vertical omnidirectional	£29.61	£28.13	LW5/2M	5 Element Yagi 7.8dbd	£18.69	£17.76	LW8/2M	8 Element Yagi 9.5dbd	£23.98	£22.78	LW10/2M	10 Element Yagi 10.5dbd	£29.04	£27.59	LW16/2M	16 Element Yagi 13.4dbd	£42.55	£40.42	PBM10/2M	10 Element Parabeam 11.7dbd	£57.50	£54.63	PBM14/2M	14 Element Parabeam 13.7dbd	£70.15	£66.64	Q4/2M	4 Element Quad 9.4dbd	£37.09	£35.24	Q6/2M	6 Element Quad 10.9dbd	£48.59	£46.16	D5/2M	5 over 5 slot fed Yagi 10.0dbd	£33.93	£32.23	D8/2M	8 over 8 slot fed Yagi 11.1dbd	£46.58	£44.25	5XY/2M	5 Element crossed Yagi 7.8dbd	£36.23	£34.42	8XY/2M	8 Element crossed Yagi 9.5dbd	£46.00	£43.70	10XY/2M	10 Element crossed Yagi 10.8dbd	£57.50	£54.63	PMH2/C	2 Way harness circ. polarisation	£13.51	£12.83	PMH2/M	2 Way harness for 2 Metres	£14.89	£14.15	PMH4/2M	4 Way harness for 2 Metres	£36.80	£34.96		Normal Price	Offer Price	DB4	4M/6M Dual Band 4 Ele	£117.88	£111.99	4Y6M	6M 4 Ele 7dBd	£49.45	£46.98	4Y4M	4M 4 Ele 7dBd	£40.54	£35.81	PMH2/4M	4M 2 Way Phasing	£20.87	£19.83	<p><b>B.N.O.S.</b></p> <table border="1"> <tr> <th></th> <th></th> <th>Price</th> </tr> <tr> <td>LPM144-3-50</td> <td>2M 50W out 3W in</td> <td>£145.00</td> </tr> <tr> <td>LPM144-10-50</td> <td>2M 50W out 10W in</td> <td>£145.00</td> </tr> <tr> <td>LPM144-1-100</td> <td>2M 100W out 1W in</td> <td>£275.00</td> </tr> <tr> <td>LPM144-3-100</td> <td>2M 100W out 3W in</td> <td>£275.00</td> </tr> <tr> <td>LPM144-10-100</td> <td>2M 100W out 10W in</td> <td>£205.00</td> </tr> <tr> <td>LPM144-3-180</td> <td>2M 180W out 3W in</td> <td>£355.00</td> </tr> <tr> <td>LPM144-10-180</td> <td>2M 180W out 10W in</td> <td>£355.00</td> </tr> <tr> <td>LPM144-25-180</td> <td>2M 180W out 25W in</td> <td>£305.00</td> </tr> </table> <table border="1"> <tr> <th></th> <th></th> <th>Price</th> </tr> <tr> <td>LPM432-1-50</td> <td>70cms 50W out 1W in</td> <td>£255.00</td> </tr> <tr> <td>LPM432-3-50</td> <td>70cms 50W out 3W in</td> <td>£255.00</td> </tr> <tr> <td>LPM432-10-50</td> <td>70cms 50W out 10W in</td> <td>£215.00</td> </tr> <tr> <td>LPM432-3-100</td> <td>70cms 100W out 3W in</td> <td>£395.00</td> </tr> <tr> <td>LPM432-10-100</td> <td>70cms 100W out 10W in</td> <td>£395.00</td> </tr> <tr> <td>LPM432-25-100</td> <td>70cms 100W out 25W in</td> <td>£355.00</td> </tr> </table> <table border="1"> <tr> <th></th> <th></th> <th>Price</th> </tr> <tr> <td>LPM50-3-50</td> <td>6m 50W out 3W in</td> <td>£175.00</td> </tr> <tr> <td>LPM50-10-50</td> <td>6m 50W out 10W in</td> <td>£175.00</td> </tr> <tr> <td>LPM50-10-100</td> <td>6m 100W out 10W in</td> <td>£235.00</td> </tr> </table>			Price	LPM144-3-50	2M 50W out 3W in	£145.00	LPM144-10-50	2M 50W out 10W in	£145.00	LPM144-1-100	2M 100W out 1W in	£275.00	LPM144-3-100	2M 100W out 3W in	£275.00	LPM144-10-100	2M 100W out 10W in	£205.00	LPM144-3-180	2M 180W out 3W in	£355.00	LPM144-10-180	2M 180W out 10W in	£355.00	LPM144-25-180	2M 180W out 25W in	£305.00			Price	LPM432-1-50	70cms 50W out 1W in	£255.00	LPM432-3-50	70cms 50W out 3W in	£255.00	LPM432-10-50	70cms 50W out 10W in	£215.00	LPM432-3-100	70cms 100W out 3W in	£395.00	LPM432-10-100	70cms 100W out 10W in	£395.00	LPM432-25-100	70cms 100W out 25W in	£355.00			Price	LPM50-3-50	6m 50W out 3W in	£175.00	LPM50-10-50	6m 50W out 10W in	£175.00	LPM50-10-100	6m 100W out 10W in	£235.00	<table border="1"> <tr> <th></th> <th></th> <th>Price</th> </tr> <tr> <td>KR250</td> <td>Bell type twist switch control</td> <td>£78.00</td> </tr> <tr> <td>AR40</td> <td>Bell type turn push control</td> <td>£125.00</td> </tr> <tr> <td>KR400RC</td> <td>Bell type 360 deg. round meter</td> <td>£169.00</td> </tr> <tr> <td>AR50</td> <td>Bell type 5 position pre-select</td> <td>£149.00</td> </tr> <tr> <td>CD45</td> <td>Bell type meter readout</td> <td>£219.00</td> </tr> <tr> <td>KR600RC</td> <td>Bell type 360 deg. round meter</td> <td>£219.00</td> </tr> <tr> <td>HDR300</td> <td>Bell type digital readout</td> <td>£699.00</td> </tr> <tr> <td>KR800SDX</td> <td>Bell type 450 deg. variable speed</td> <td>£325.00</td> </tr> <tr> <td>KR1000SDX</td> <td>Bell type 450 deg. variable speed</td> <td>£368.00</td> </tr> <tr> <td>KR2000RC</td> <td>Bell type heavy duty round meter</td> <td>£445.00</td> </tr> <tr> <td>KR2000</td> <td>Bell type meter control +/- 90 deg.</td> <td>£445.00</td> </tr> <tr> <td>KR400</td> <td>Bell type meter control +/- 180 deg.</td> <td>£139.00</td> </tr> <tr> <td>KR500</td> <td>Elevation meter calib. +/- 90 deg.</td> <td>£149.95</td> </tr> <tr> <td>KR500B</td> <td>Heavy duty version of KR500</td> <td>£259.95</td> </tr> <tr> <td>KR5400</td> <td>Azimuth/elevation dual control</td> <td>£279.00</td> </tr> <tr> <td>KR5400A</td> <td>Azimuth/elevation computer control</td> <td>£339.00</td> </tr> <tr> <td>KR5600</td> <td>Azimuth/elevation heavy duty</td> <td>£369.00</td> </tr> <tr> <td>KR5600A</td> <td>Azimuth/elevation HD comp. control</td> <td>£389.00</td> </tr> <tr> <td>KR010</td> <td>Intell. vface KR5400A/KR5600A</td> <td>£275.00</td> </tr> </table> <p><b>ROTATOR HARDWARE</b></p> <table border="1"> <tr> <th></th> <th></th> <th>Price</th> </tr> <tr> <td>S0425</td> <td>Ubolt clamps AR22/AR40 std.</td> <td>£10.18</td> </tr> <tr> <td>S0463</td> <td>Ubolt clamps CD45 etc. heavy duty</td> <td>£16.68</td> </tr> <tr> <td>KS050</td> <td>Rotary bearing 1 1/2" mast</td> <td>£19.95</td> </tr> <tr> <td>KS065</td> <td>Rotary bearing 2" mast</td> <td>£29.95</td> </tr> <tr> <td>KC038</td> <td>Rotary bearing for KR400/KR600</td> <td>£16.95</td> </tr> </table> <p><b>ROTATOR CONTROL CABLE</b></p> <table border="1"> <tr> <th></th> <th></th> <th>Price</th> </tr> <tr> <td>RC5W</td> <td>Sway for KR400RC etc.</td> <td>per mtr. £0.48</td> </tr> <tr> <td>RC6W</td> <td>Sway for KR250/400/500 etc.</td> <td>per mtr. £0.66</td> </tr> <tr> <td>RC8W</td> <td>Sway for CD45/KR2000RC etc.</td> <td>per mtr. £0.72</td> </tr> </table> <p>Carriage on Rotator Cable £1.90 up to 20 metres, over 20 metres £2.65.</p>			Price	KR250	Bell type twist switch control	£78.00	AR40	Bell type turn push control	£125.00	KR400RC	Bell type 360 deg. round meter	£169.00	AR50	Bell type 5 position pre-select	£149.00	CD45	Bell type meter readout	£219.00	KR600RC	Bell type 360 deg. round meter	£219.00	HDR300	Bell type digital readout	£699.00	KR800SDX	Bell type 450 deg. variable speed	£325.00	KR1000SDX	Bell type 450 deg. variable speed	£368.00	KR2000RC	Bell type heavy duty round meter	£445.00	KR2000	Bell type meter control +/- 90 deg.	£445.00	KR400	Bell type meter control +/- 180 deg.	£139.00	KR500	Elevation meter calib. +/- 90 deg.	£149.95	KR500B	Heavy duty version of KR500	£259.95	KR5400	Azimuth/elevation dual control	£279.00	KR5400A	Azimuth/elevation computer control	£339.00	KR5600	Azimuth/elevation heavy duty	£369.00	KR5600A	Azimuth/elevation HD comp. control	£389.00	KR010	Intell. vface KR5400A/KR5600A	£275.00			Price	S0425	Ubolt clamps AR22/AR40 std.	£10.18	S0463	Ubolt clamps CD45 etc. heavy duty	£16.68	KS050	Rotary bearing 1 1/2" mast	£19.95	KS065	Rotary bearing 2" mast	£29.95	KC038	Rotary bearing for KR400/KR600	£16.95			Price	RC5W	Sway for KR400RC etc.	per mtr. £0.48	RC6W	Sway for KR250/400/500 etc.	per mtr. £0.66	RC8W	Sway for CD45/KR2000RC etc.	per mtr. £0.72
	Normal Price	Offer Price																																																																																																																																																																																																																																																																				
H0/2M	Halo head only	£9.78	£9.29																																																																																																																																																																																																																																																																			
HM/2M	Halo with 2ft mast	£11.50	£10.93																																																																																																																																																																																																																																																																			
UGP/2M	Ground plain folded radiator	£16.96	£16.11																																																																																																																																																																																																																																																																			
C5/2M MK2	Vertical Colinear 4.8dbd	£90.85	£86.31																																																																																																																																																																																																																																																																			
LR1/2M	Vertical Colinear 4.3dbd	£37.95	£36.05																																																																																																																																																																																																																																																																			
LR2/2M	Vertical omnidirectional	£29.61	£28.13																																																																																																																																																																																																																																																																			
LW5/2M	5 Element Yagi 7.8dbd	£18.69	£17.76																																																																																																																																																																																																																																																																			
LW8/2M	8 Element Yagi 9.5dbd	£23.98	£22.78																																																																																																																																																																																																																																																																			
LW10/2M	10 Element Yagi 10.5dbd	£29.04	£27.59																																																																																																																																																																																																																																																																			
LW16/2M	16 Element Yagi 13.4dbd	£42.55	£40.42																																																																																																																																																																																																																																																																			
PBM10/2M	10 Element Parabeam 11.7dbd	£57.50	£54.63																																																																																																																																																																																																																																																																			
PBM14/2M	14 Element Parabeam 13.7dbd	£70.15	£66.64																																																																																																																																																																																																																																																																			
Q4/2M	4 Element Quad 9.4dbd	£37.09	£35.24																																																																																																																																																																																																																																																																			
Q6/2M	6 Element Quad 10.9dbd	£48.59	£46.16																																																																																																																																																																																																																																																																			
D5/2M	5 over 5 slot fed Yagi 10.0dbd	£33.93	£32.23																																																																																																																																																																																																																																																																			
D8/2M	8 over 8 slot fed Yagi 11.1dbd	£46.58	£44.25																																																																																																																																																																																																																																																																			
5XY/2M	5 Element crossed Yagi 7.8dbd	£36.23	£34.42																																																																																																																																																																																																																																																																			
8XY/2M	8 Element crossed Yagi 9.5dbd	£46.00	£43.70																																																																																																																																																																																																																																																																			
10XY/2M	10 Element crossed Yagi 10.8dbd	£57.50	£54.63																																																																																																																																																																																																																																																																			
PMH2/C	2 Way harness circ. polarisation	£13.51	£12.83																																																																																																																																																																																																																																																																			
PMH2/M	2 Way harness for 2 Metres	£14.89	£14.15																																																																																																																																																																																																																																																																			
PMH4/2M	4 Way harness for 2 Metres	£36.80	£34.96																																																																																																																																																																																																																																																																			
	Normal Price	Offer Price																																																																																																																																																																																																																																																																				
DB4	4M/6M Dual Band 4 Ele	£117.88	£111.99																																																																																																																																																																																																																																																																			
4Y6M	6M 4 Ele 7dBd	£49.45	£46.98																																																																																																																																																																																																																																																																			
4Y4M	4M 4 Ele 7dBd	£40.54	£35.81																																																																																																																																																																																																																																																																			
PMH2/4M	4M 2 Way Phasing	£20.87	£19.83																																																																																																																																																																																																																																																																			
		Price																																																																																																																																																																																																																																																																				
LPM144-3-50	2M 50W out 3W in	£145.00																																																																																																																																																																																																																																																																				
LPM144-10-50	2M 50W out 10W in	£145.00																																																																																																																																																																																																																																																																				
LPM144-1-100	2M 100W out 1W in	£275.00																																																																																																																																																																																																																																																																				
LPM144-3-100	2M 100W out 3W in	£275.00																																																																																																																																																																																																																																																																				
LPM144-10-100	2M 100W out 10W in	£205.00																																																																																																																																																																																																																																																																				
LPM144-3-180	2M 180W out 3W in	£355.00																																																																																																																																																																																																																																																																				
LPM144-10-180	2M 180W out 10W in	£355.00																																																																																																																																																																																																																																																																				
LPM144-25-180	2M 180W out 25W in	£305.00																																																																																																																																																																																																																																																																				
		Price																																																																																																																																																																																																																																																																				
LPM432-1-50	70cms 50W out 1W in	£255.00																																																																																																																																																																																																																																																																				
LPM432-3-50	70cms 50W out 3W in	£255.00																																																																																																																																																																																																																																																																				
LPM432-10-50	70cms 50W out 10W in	£215.00																																																																																																																																																																																																																																																																				
LPM432-3-100	70cms 100W out 3W in	£395.00																																																																																																																																																																																																																																																																				
LPM432-10-100	70cms 100W out 10W in	£395.00																																																																																																																																																																																																																																																																				
LPM432-25-100	70cms 100W out 25W in	£355.00																																																																																																																																																																																																																																																																				
		Price																																																																																																																																																																																																																																																																				
LPM50-3-50	6m 50W out 3W in	£175.00																																																																																																																																																																																																																																																																				
LPM50-10-50	6m 50W out 10W in	£175.00																																																																																																																																																																																																																																																																				
LPM50-10-100	6m 100W out 10W in	£235.00																																																																																																																																																																																																																																																																				
		Price																																																																																																																																																																																																																																																																				
KR250	Bell type twist switch control	£78.00																																																																																																																																																																																																																																																																				
AR40	Bell type turn push control	£125.00																																																																																																																																																																																																																																																																				
KR400RC	Bell type 360 deg. round meter	£169.00																																																																																																																																																																																																																																																																				
AR50	Bell type 5 position pre-select	£149.00																																																																																																																																																																																																																																																																				
CD45	Bell type meter readout	£219.00																																																																																																																																																																																																																																																																				
KR600RC	Bell type 360 deg. round meter	£219.00																																																																																																																																																																																																																																																																				
HDR300	Bell type digital readout	£699.00																																																																																																																																																																																																																																																																				
KR800SDX	Bell type 450 deg. variable speed	£325.00																																																																																																																																																																																																																																																																				
KR1000SDX	Bell type 450 deg. variable speed	£368.00																																																																																																																																																																																																																																																																				
KR2000RC	Bell type heavy duty round meter	£445.00																																																																																																																																																																																																																																																																				
KR2000	Bell type meter control +/- 90 deg.	£445.00																																																																																																																																																																																																																																																																				
KR400	Bell type meter control +/- 180 deg.	£139.00																																																																																																																																																																																																																																																																				
KR500	Elevation meter calib. +/- 90 deg.	£149.95																																																																																																																																																																																																																																																																				
KR500B	Heavy duty version of KR500	£259.95																																																																																																																																																																																																																																																																				
KR5400	Azimuth/elevation dual control	£279.00																																																																																																																																																																																																																																																																				
KR5400A	Azimuth/elevation computer control	£339.00																																																																																																																																																																																																																																																																				
KR5600	Azimuth/elevation heavy duty	£369.00																																																																																																																																																																																																																																																																				
KR5600A	Azimuth/elevation HD comp. control	£389.00																																																																																																																																																																																																																																																																				
KR010	Intell. vface KR5400A/KR5600A	£275.00																																																																																																																																																																																																																																																																				
		Price																																																																																																																																																																																																																																																																				
S0425	Ubolt clamps AR22/AR40 std.	£10.18																																																																																																																																																																																																																																																																				
S0463	Ubolt clamps CD45 etc. heavy duty	£16.68																																																																																																																																																																																																																																																																				
KS050	Rotary bearing 1 1/2" mast	£19.95																																																																																																																																																																																																																																																																				
KS065	Rotary bearing 2" mast	£29.95																																																																																																																																																																																																																																																																				
KC038	Rotary bearing for KR400/KR600	£16.95																																																																																																																																																																																																																																																																				
		Price																																																																																																																																																																																																																																																																				
RC5W	Sway for KR400RC etc.	per mtr. £0.48																																																																																																																																																																																																																																																																				
RC6W	Sway for KR250/400/500 etc.	per mtr. £0.66																																																																																																																																																																																																																																																																				
RC8W	Sway for CD45/KR2000RC etc.	per mtr. £0.72																																																																																																																																																																																																																																																																				

Prices subject to fluctuation.

### FREE FINANCE . . .

On many regular priced items SMC offers. Free finance (on invoice balances over £120) 20% down and the balance over 6 months or 50% down and the balance over a year.

You pay no more than the cash price!

Details of eligible items available on request.

### FREE S.M.C. SERVICE INTERLINK DELIVERY . . .

Free interlink delivery on major equipment. Small items, Plugs, Sockets, etc. by post £1.75. Antennas, Cables, Wire & larger items. Roadline up to £5.00. Interlink delivery available, upon request, for items other than radios, from £7.30 depending on weight. Same day despatch whenever possible.

### GUARANTEE

Importer warranty on Yaesu Musen products. Fully staffed and equipped Service Department. Daily contact with the Yaesu Musen factory. Tens of thousands of spares and test equipment. Twenty-five years of professional experience.

• 2 years warranty on regular priced Yaesu products.

# South Midlands Communications



## HF ANTENNAS

Due to large purchase before price increases SMC are able to offer the following fantastic savings for a limited period only.

**15% OFF HY-GAIN. 5% OFF JAYBEAM**



		New Price	Our Price	p&p
12AVQ	Vertical 10-15-20M	86.85	73.82	3.75
14AVQ	Vertical 10-15-20-40M	116.60	99.11	3.75
18AMT	Vertical 10-15-20-40-80M	189.20	160.82	3.75
18V	Vertical 10-15-20-40-80M tapped coil	53.35	45.35	3.75
105BA	5 Ele. Yagi 10 metres	242.00	205.70	3.95
153BA	3 Ele. Yagi 15 metres	148.50	126.23	3.95
203BA	3 Ele. Yagi 20 metres	248.90	242.17	4.90
204BA	4 Ele. Yagi 20 metres	462.00	392.70	6.50
205BA	5 Ele. Yagi 20 metres	548.90	466.57	9.40
DB10-15A	3 Ele. Yagi 10-15M	229.90	195.42	4.80
TH3JNR	3 Ele. Yagi 10-15-20M	328.90	279.57	4.50
TH2MK3	2 Ele. Yagi 10-15-20M	306.90	260.87	4.50
EX14	5 Ele. 10-15-20M 'Explorer'	548.90	466.57	7.50
TH5MK2	5 Ele. 10-15-20M 'Thunderbird'	713.90	608.82	7.70
TH7DXX	7 Ele. 10-15-20M 'Thunderbird'	830.50	705.93	9.75
MM3	Minibeam 10-15-20M	327.75	311.36	4.50
VR3 MK3	Vertical 10-15-20M	73.60	69.92	2.90
TB3 MK3	3 Ele. Yagi 10-15-20M	316.25	300.44	5.90
TB2 MK3	2 Ele. Yagi 10-15-20M	212.75	202.11	4.90
TB1 MK3	Rotary Dipole 10-15-20M	105.80	100.51	3.35
TB3/SSKIT	Converts TB3 MK2 to TB3 MK3	62.68	59.55	2.50
HQ1	Mini Quad 6-10-15-20M		199.00	4.00
G4MH	Mini Beam 10-15-20M		98.00	4.50
TD-HP	Trapped Dipole 10-20-40-80M		49.00	2.65
G5RV	H.F. Dipole		16.68	2.65
HF3VNB	Vert. 12-17-30M 1000 PEP		73.15	3.00
<b>MOBILE ANTENNAS</b>				
TRIBANDER 86	Antenna Two Sections 10-15-20M		41.11	2.20
GWBASESTND	Base Standard		11.99	1.00
LFCOILS	Loading Coil 30M/40M/80M/160M		9.60	1.00
LFWHIP	Telescopic Whip		7.76	1.00
FLEXIWHIP	Antenna Mast + Tele Whip (10M Basic)		30.42	2.20
FPCOILS	Loading Coil 15M/20M/40M/80M/160M		9.60	1.00
FLEXI 10	Mobile 80-40-30-20-17-12-10-2 Coils		67.79	2.35
PL SERIES	PL259 Mount 20M/40M/80M/160M		19.49	2.35

SCHOOL CLOSE, CHANDLERS FORD IND. ESTATE  
EASTLEIGH SO5 3BY. Tel: 0703 255111  
AND ALL BRANCHES



## LAKE ELECTRONICS

### QRP KITS AT QRP PRICES

Our full kits include PCB and all essential parts. There are NO "accessories" or "extras" like cases, mains transformers or knobs to find up unless, of course, you prefer to "build in" to another piece of equipment in which case we shall be very pleased to supply the PCB and board components alone.

Comprehensive instructions supplied with each kit include circuit diagrams, lay-outs, alignment details (where necessary) and trouble shooting hints.

The range includes the "CARLTON" DIRECT CONVERSION RECEIVER which covers three popular Amateur Bands, 20m, 40m, 80m - SSB and CW. Originally produced as a very successful educational project, it can be accompanied by the TU1 TUNER - in it's simplest form a neat and effective Aerial Tuner for the SWL.

It has full coverage, Top Band to 10 metres. A more comprehensive tuner is the TU2 - with it's built-in SWR bridge you have a QRP ATU capable of handling up to 20 Watts. The addition of the AF2 AUDIO FILTER, an outboard Active Filter, - enables headphone reception of CW with a 3dB bandwidth of just 200Hz. The PCB can, if you prefer, be built in to a receiver.

An example of our Test Gear is the CM1 CAPACITANCE METER - a self contained and accurate meter with a linear scale which help you to identify those unknown capacities from a few pF to 1µF.

For full details of these and the rest of our range, including QRP transmitters and test gear, send a large SAE to:

LAKE ELECTRONICS, 7 MIDDLETON CLOSE, NUTHALL, NOTTINGHAM NG16 1BX.  
or ring Alan, G4DVW on (0602) 382509

Books for radio amateurs

**FDK**

**ELLIOTT ELECTRONICS**

for the Radio Enthusiast

INSTANT HP AVAILABLE

OSY OLD MAN TO

**THE 'HAM SHACK'**

APPOINTED DISTRIBUTOR

AERIAL ACCESSORIES AND MASTS

**JAYBEAM AMATEUR ANTENNAS**

RIGS, ANTENNAS, SWR BRIDGES, POWER SUPPLIES, TEST GEAR, COMPONENTS, MORSE KEYS, COAXIAL CABLES, ROTATORS, MICS, PLUGS AND SOCKETS, SWITCHES

Call us on (0533) 553293  
OR COME AND LOOK AROUND AT  
26/28 Braunstone Gate, Leicester



# SPECTRUM COMMUNICATIONS

MANUFACTURERS OF RADIO EQUIPMENT AND KITS

## FM CONVERSION FOR YAESU AND KENWOOD (TRIO) TRANSCEIVERS

FD311X RECEIVE BOARD	£52.50
FM2000 TRANSMIT BOARD (for rigs with AM)	£18.50
FM3000 TRANSMIT BOARD (for CW/SSB only rigs)	£28.50

STATE RIG TYPE WHEN ORDERING, OR WE'LL FIT THEM £44.00 EXTRA, INC. SECURICOR CARRIAGE.

## RECEIVE PREAMPS

2, 4, 6, or 10 metres RF switched and DC sensing, 100W transmit handling power, gain 0-20dB adjustable by panel control, NF 1dB on 2M, 2dB on 4 & 6M, 3.5dB on 10M, 13.5V negative ground operation. Excellent performance at a reasonable price. Well made attractive boxed unit 77x70x39mm, an asset to any Ham shack. Types RP2S, RP4S, RP6S, & RP10S. PCB KIT £12, PCB BUILT £16.75, BOXED KIT £20.25, BOXED BUILT & TESTED £27.



## 4 and 6m EQUIPMENT

**RECEIVE CONVERTERS** 4 or 6m antenna input, 10 or 2m i.f., variable gain 0-26dB, n.f. less than 3.5dB. Buffered local oscillator output, types RC4-10, RC4-2, RC6-10 and RC6-2. PCB kit £17.25, PCB built and tested £24.50, boxed kit £29.25, boxed, built and tested £41.00.

**TRANSMIT CONVERTERS** 4 or 6m variable power 80mW to 2.5W, 2m or 10m drive 10mW to 100mW. Local oscillator input matches receive converters. Types TC4-10H, TC4-2H, TC6-10H, TC6-2H. PCB kit £27.50, PCB built and tested £37.75, boxed kit £39.50, boxed built and tested £53.00.

**TRANSCEIVE CONVERTERS** Single board version of receive converter and 500mW transmit converter. 10m drive 25mW to 500mW. Types TRC4-10 and TRC6-10. PCB kit £39.00, PCB built and tested £54.00, boxed kit £54.00, boxed, built and tested £83.25.

**TRANSCEIVE CONVERTERS** Separate receive converter and 2.5W transmit converter in a single boxed unit, 2m or 10m drive 10mW to 100mW only, requires r.f. sensing switch and attenuator for use with 2.5W 2m rigs. Types TRX4-10H, TRX4-2H, TRX6-10H and TRX6-2H. Boxed kit £60.00, boxed and built £99.50.

**TRANSCEIVE CONVERTERS** As above but including an interface providing RF sensing attenuation and PTT switching. 1/2W-5W 2M drive. Types TRX4-2I and TRX6-2I. Boxed kit £67.00, boxed and built £115.00.

## CB to 10m

**CB TO 10 FM CONVERSION BOARDS - THE FIRST COMMERCIALY AVAILABLE**, suits all UK FM CB rigs to give 29.31 to 29.70MHz. Size only 63x40x13mm. Built and aligned board SC29 £15. Or send your rig and we'll fit it. £28 inc. return P&P for mobiles. £31 inc. for base rigs.

**MULTIMODE CB CONVERSIONS**, send your 120 channel rig and we'll convert it to give 28.01 to 29.70MHz in straight sequences without gaps. Colt 1200DX, Cobra 148, Hy Gain 5, Multimode 2, Major M360, Tristar 747 & 777, Super Star 360, Concorde, etc., £62 inc. return P&P. Jumbo or Colt Excalibur 1200, £65. 80 Channel rigs such as Stalker 9 or Major M588 are modified to give 28.31 to 29.70MHz in straight sequence without gaps, £55.00 inc. return P&P. 200 Channel in 4 bands of 50 are converted to give 28.00 to 30.00MHz or 28.00 to 29.70MHz as required. Super Hy Gain 5, Lafayette 1800, Super Star 2000. £45.50 inc. return P&P. Nato 2000 £52.50, Super Star 2000-5x40CH £70. Colt 1600, 4x40CH, £65.50.

VAT & P&P INC PRICES Delivery within 14 days subject to availability. 24 hr answering.

UNIT B6, MARABOUT INDUSTRIAL ESTATE, DORCHESTER, DORSET. TEL: 0305 62250



# RST

MAIL ORDER CO.  
Langrex Supplies Ltd.,  
Cimax House,  
159 Fallsbrook Road,  
Streatham, SW16 6ED.

**SPECIAL EXPRESS  
MAIL ORDER SERVICE**

AZ31	£ p	EM81	2.50	PL519	6.00	6AK5	5.99	6KD6	8.00
CL33	4.00	EM87	2.50	PL802	6.00	6AL5	1.50	6L6G	5.00
DY867	1.50	EN91	6.50	PY33	2.50	6AN6	6.02	6L6GC	5.75
DY802	1.50	EY51	2.75	PY81	1.50	6AN5	4.75	6L7	2.50
EB8CC	10.33	EY86	1.75	PY82	1.75	6AN8A	3.50	6L6E	7.50
E180F	12.05	EY88	1.75	PY83	1.25	6AC25	3.25	607	3.75
E810F	35.48	EY500A	3.00	PY88	2.00	6AR5	25.00	6RH8B6KN8	
EABC80	1.25	EZ80	1.50	PY500A	4.00	6AS6	8.66		10.00
EB91	1.50	EZ81	1.50	PY800	1.50	6AS7G	8.75	6SA7	3.00
EBF80	1.50	QY501	3.00	PY801	1.50	6AT6	1.25	6SC7	2.75
EBF89	1.50	GZ32	4.00	PY801	1.50	6AU5GT	5.00	6SJ7	3.25
EC91	8.00	GZ33	4.75	QQV02-6	38.00	6AU6	2.50	6SK7	3.50
ECC33	4.50	GZ34	4.00	QQV03-10	26.25	6AW8A	3.75	6SL7GT	3.00
ECC35	4.50	GZ37	4.75	QQV03-20A	48.38	6B7	3.25	6SN7GT	3.00
ECC81	1.75	KT61	5.00	QQV06-40A	46.00	6B8	3.25	6SS7	2.75
ECC82	1.75	KT66	15.00			6BA6	1.50	6SG7M	2.50
ECC83	1.75	KT77 Gold Lion				6BA7	5.00	6UBA	2.25
ECC85	1.75		12.00	QV03-12	6.80	6BE6	1.50	6V6GT	4.25
ECC88	3.50	KT88	15.00	R18	3.00	6BH6	2.50	6X4	3.00
ECC91	8.93	N78	15.00	R19	9.24	6BJ6	2.25	6X5GT	1.75
ECF80	1.50	OA2	3.25	SP41	6.00	6BN6	2.00	12AX7	1.75
ECF85	3.00	OB2	4.38	SP61	4.00	6BQ7A	3.50	12BA6	2.50
ECH42	3.50	OC3	2.50	U19	13.75	6BR7	6.00	12BE6	2.50
ECH81	3.00	OD3	2.50	U25	2.50	6BR8A	3.50	12BY7A	3.00
ECL80	1.50	PC86	2.50	U26	2.50	6BS7	6.00	12E1	2.00
ECL82	1.50	PC88	2.50	U37	12.00	6BW6	6.00	12HG7	4.50
ECL83	3.00	PC92	1.75	UAB30	1.25	6BW7	1.50	30FL12	1.38
ECL86	1.50	PC93	1.75	UBF89	1.50	6BZ6	2.75	30P4	2.50
EF37A	5.00	PC900	1.75	UCH42	2.50	6C4	1.25	30P19	2.50
EF39	2.75	PCF80	2.00	UCH81	2.50	6C6	3.50	30PL13	1.80
EF41	3.50	PCF82	1.50	UCL82	1.75	6CB6A	2.50	30PL14	1.80
EF42	4.50	PCF86	2.50	UCL83	2.75	6CD6GA	5.00	572B	65.00
EF50	2.50	PCF87	3.00	UJ83	2.50	6CL6	3.75	500	45.00
EF54	5.00	PCF802	2.50	UL41	5.00	6CH6	13.00	807	3.75
EF55	3.50	PCF805	1.70	UL84	1.75	6CW4	8.00	811A	18.33
EF80	1.75	PCF808	1.70	UY41	4.00	6D6	3.50	812A	47.50
EF86	3.50	PCH200	3.00	UY85	2.25	6D05	7.50	813	65.00
EF91	2.95	PCL82	2.00	VR105/30	2.50	6DC6B	4.75	866A	35.00
EF92	6.37	PCL83	3.00	VR150/30	2.50	6EA8	3.00	872A	20.00
EF183	2.00	PCL84	2.00	Z759	25.00	6E5	1.85	931A	18.50
EF184	2.00	PCL85	2.50	Z803U	25.00	6F6	3.00	9050	7.50
EH90	1.75	PCL86	2.50	ZD21	3.25	6G6	2.75	5763	4.50
EL32	2.50	PCL805	2.50	3B28	50.00	6H6	6.00	5814A	4.00
EL33	4.00	PD500	6.00	4CX250B	58.00	6HS6	3.77	5842	12.00
EL34	4.00	PL200	2.50	5U4G	3.00	6J5	4.50	6000	14.00
EL36	2.50	PL36	2.50	5U4G	3.00	6J6	8.93	6146A	12.00
ELL80	25.00	PL81	1.75	5V4G	2.50	6J7	4.75	6146B	12.00
EL81	5.25	PL82	1.50	5Y3GT	2.50	6J8A	6.50	6550	10.00
EL84	2.25	PL83	2.50	5Z3	4.00	6J6C	6.00	6883B	12.50
EL86	2.75	PL84	2.00	5Z4GT	2.50	6J58C	7.50	6973	7.50
EL91	7.25	PL85	2.50	6X0L2	1.75	6K5GT	2.75	7025	4.50
EL95	2.00	PL508	5.50	6AB7	3.00	6K7	3.00	7027A	8.00
EL360	18.50	PL509	6.00	6AH6	5.00	6K8	3.00	7360	10.00
								7586	15.00
								7587	23.00

Open daily to callers: Mon-Fri 9 a.m.-5 p.m.

Valves, Tubes and Transistors - Closed Saturday

Terms C.W.O. only, allow 7 days for delivery. Tel. 01-677 2424/7.

Prices excluding VAT add 15%

Quotations for any types not listed S.A.E.

Prices correct when going to press 946708

## PRACTICAL WIRELESS KITS

Other 50MHz receiver	Jan 88	41.30	<b>COMPONENTS</b>
Semiconductor Tester	Dec 87	13.40	<b>DIODES</b>
RTTY Tuning Indicator	Nov 87	23.90	2N3904...14
Blenheim v.h.f. to h.f. receive converter	Sept 87	26.60	2N3906...14
Downlow. Freq. to Voltage Converter	June 87	19.70	2N4124...35
Side Tone Oscillator	June 87	9.60	IN916...16
AXE. Signal Tracer	May 87	49.00	1N4001...05
Itchen. LCR Bridge	April 87	27.90	1N4002...05
Woodstock. Short Wave Converter	March 87	26.50	555...22
Masthead Preamp For 144MHz	Feb 87	39.30	555 CMOS...64
Westbury Basic Wobulator	Jan 87	16.50	741C...29
High Z Mosfet Voltmeter	Dec 86	25.30	2N4124...35
Taw. VLF Converter	Nov 86	14.20	CA3140E...40
Active Antenna	Nov 86	17.80	CA3240E...100
Automatic Nicad Charger	Oct 86	18.20	ICM7555...64
Simple 50MHz Converter	Sept 86	21.50	LF351...14
Arun Parametric Filter	May 86	49.30	LM358...43
Meon 2.50MHz Transverter (144MHz IF)	April 86	41.00	LM566...128
RTTY/Morse Modem (No Case)	Jan 86	31.85	MC1458...40
Two Tone Oscillator	Dec 85	23.30	MC1496...140
Meon. 50MHz Transverter (28MHz IF)	Oct 85	41.00	SO42P...230
Capacitance Meter	Oct 85	21.30	SLB1...575
Fet Dip Oscillator	Oct 85	19.90	SL1821...790
Add On BFO (Inc. C804 + Optional Comps.)	Aug 85	12.95	SL178...310
Triambic Keyer	Feb 85	18.45	SL6440...465
Morse Sending Trainer	July 84	12.00	TB810...98
Auto Notch Filter	June 84	25.90	TL071...45

<b>RECHARGEABLE NI-CAD BATTERIES</b>	
AA (HP7)	500mAh 1.05
C (HP11)	1200mAh 2.10
D (HP2)	1200mAh 2.25
PP3 Type	4.25

<b>MEON COMPONENTS</b>	
31 333MHz Crystal	2.95
22MHz Crystal	3.45
22pF Trimmer	19
65pF Trimmer	25
S18 Yellow, Aluminium	70
Axial Chokes	35
Toko 10K Coils	50
Relay 2PCD	1.70
BNC Socket 50R Square	82
5 pin din sockets	16
T05 Heatsink	16
Diecast Box (Eddystone)	4.65
1uF Multilayer Ceramic	0.42
<b>BEGINNERS MORSE KEY</b>	
Well Designed Key Fully Adjustable	£2.90
<b>ADVANCED MORSE KEY</b>	
All Metal Professional, High Speed Key, Fine Adjustment	£5.80

**PRICES DO NOT INCLUDE VAT, WHICH SHOULD BE ADDED TO THE TOTAL ORDER VALUE AND P&P CHARGES. P&P = 70p UNLESS SPECIFIED. ARTICLE REPRINTS 50p (IF REQUIRED). ALL KITS ARE COMPLETE (LESS BATTERIES), UNLESS SPECIFIED INCLUDING PCB, CASE, ALL COMPONENTS, CONNECTORS AND HARDWARE. ALL COMPONENTS ARE NEW AND TO FULL SPECIFICATION. CHEQUE, P.O., OR ACCESS TO:**

**CPL ELECTRONICS, 8 Southdean Close, Hemlington, Middlesbrough, TS8 9HE**  
TEL: 0642 591157.

Other kits are available plus a wide range of components etc.  
ACCESS, MAIL OR TELEPHONE ORDERS WELCOMED. FREE PRICE LIST ON REQUEST.

# POCOM

SWISS MADE BY POLY-ELECTRONIC

## Communication decoders

### AFR-1000 Automatic CW-RTTY Decoder



The microprocessor-controlled POCOM AFR-1000 CW-RTTY Decoder automatically processes radio teletype signals in accordance with Baudot No. 1 and No. 2, ASCII, ARQ/FEC (SITOR/SPECTOR/AMTOR) and CW (Morse telegraphy) standards and corresponds to the latest state of the art. The AFR-1000 Automatic Decoder is remarkable for its value for money. Its moderate price makes it particularly suitable for the cost-conscious RTTY beginner. Unlike the other models in the AFR series, however, it cannot be upgraded for special codes.

#### FEATURES

- Fully automatic recognition of CW, ARQ-FEC and BAUDOT No. 1 and No. 2 teletype signals with automatic decoding, independently of the shift position.
- Baud rate analysis in the range from approx. 30 to 250 bauds.
- Extremely fast phasing of ARQ-FEC signals (Typical: 1-5 seconds).
- Special narrow-band quadrature discriminator for all usual LF shifts of 50-1000Hz and CW Morse telegraphy.
- Swiss technology and quality - 1-year guarantee.

The POCOM AFR-1000 is extremely easy to use and very simple to operate. The AFR-1000 is simply connected to the loudspeaker outlet on the shortwave receiver. Operation is confined merely to choosing the mode required. No tiresome testing of the baud rate and shift position. Two LED's indicate the active operation states in each case.

The baud modulation rate measurement facility is a complete new innovation in a unit in this price range. Knowledge of the baud rate permits reference to special codes, specific radio services, etc., and makes it possible to shed light upon a radio teletype signal. The display is provided on the screen or printer linked to it to 1/1000 baud (e.g. 96.245 bauds) with quartz accuracy and within a measuring range of approx. 30 to 250 bauds.

### AFR-2000 All Mode CW/RTTY Decoder



### AFR-2000 All Mode RTTY Decoder

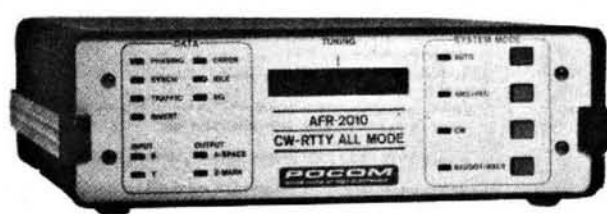

The technology of models AFR-2000 and AFR-2010 meets the highest demands. Their exceptional value for money will not be so easy to obtain in the near future. By choosing one of these units, you will be deciding in favour of the latest receiver on the market - enabling you to receive more and do less setting! Teletype reception has never been so easy!

**DEWSBURY ELECTRONICS, 176 LOWER HIGH STREET**  
Stourbridge, West Midlands, DY8 1TB  
Tel: Stourbridge (0384) 390063/371228

## TX - 3 RTTY/CW/ASCII TRANSCEIVE

The high performance, low cost system

Split-screen, type-ahead operation, receive screen unwrap, 24 large memories, clock, review store, callsign capture, RTTY auto CR/LF, CW software filtering and much more. Needs interface or T.U. **BBC-B/Master** and **CBM64** tape £20, disc £22. **SPECTRUM** tape £35 inc. adapter board (needs interface/TU also).

See reviews Dec 87 & Jan 88 issues.

For **VIC20** we have our RTTY/CW transceive program. Tape £20.

## RX - 4 RTTY/CW/SSTV/AMTOR RECEIVE

This is still a best-selling program and it's easy to see why. Superb performance on 4 modes, switch modes at a keypress to catch all the action. Text and picture store with dump to screen, printer or tape/disc. An essential piece of software for trawling the bands. Needs interface. **BBC-B/Master**, **CBM64** tape £25, disc £27. **VIC20** tape £25. **SPECTRUM** tape £40 inc. adapter board (needs interface also). The **SPECTRUM** software-only version (input to EAR socket) is still available £25.

**TIF1 INTERFACE** Perfect for TX3 and RX4, it has 2-stage RTTY and CW filters and computer noise reduction for excellent reception. Transmit outputs for MIC, PTT and KEY. Kit £15 (assembled PCB + cables, connectors) or ready-made £25, boxed with all connections. Extra MIC leads for extra rigs £3 each. State rig(s).

**WORLD AND UK/EUROPE MAP LOCATOR** Maps, great circles, distances, bearings, contest scores. Lat/long, locators, NGR, hundreds of placenames. **BBC-B/Master**, **ELECTRON ONLY**. Tape £10.

**LOCATOR** Distances, bearings, contest scores. Lat/long, locators. **SPECTRUM**, **CBM64**, **VIC20** tape £7.

And for **BBC-B/Master**, **SPECTRUM**, **ELECTRON**, **CBM64**, **VIC20**.

**MORSE TUTOR** 1-40 wpm. Learn by ear, practise using random letters, figures, punctuation, words. 40 plain language texts supplied or type your own. With learning guide, tape £6.

**LOGBOOK** Date, band, mode, call and remarks. Instant callsearch. Log printout. Tape £8.

**RAE MATHS** Unlimited practice and testing for the exam calculations. Tape £9.

All **BBC** and **CBM64** programs are available on **DISC** at £2 extra.

Prices include VAT and p&p, 1st Class inland, airmail overseas, normally by return. Eire, C.I., BFPO deduct 13%.

 **technical software (P.W.)**   
Fron, Upper Llandwrog, Caernarfon LL54 7RF.  
Tel. 0286 881886

# WIN

## A 600MHz FREQUENCY COUNTER!

IN THE NEW STYLE  
WINTER 1987/88  
**Cirkit CATALOGUE**

- Oscilloscope Digital Storage Unit
- Temperature Controlled Irons
- 5 and 50W RF Power Heads
- £££s of Discount Vouchers
- Easy to Enter Competition
- Quantity Price Discounts
- PCB Prototyping System
- 2 new HF Receiver kits
- 24 hour order line
- Component Packs
- 12 new books
- Special Offers



**PACKED WITH NEW LINES**

Available from your local newsagent or direct from Cirkit at

**Cirkit** the address shown below



**Cirkit Distribution Ltd.**

Park Lane, Broxbourne, Herts EN10 7NQ  
Telephone (0992) 444111 Telex: 22478

## CRICKLEWOOD ELECTRONICS LTD

It's no secret!



... that there is a real difference at Cricklewood Electronics. That's why you should never be without the **FREE CRICKLEWOOD ELECTRONICS COMPONENTS CATALOGUE**, for sheer variety, competitive prices and service from the U.K.'s number one 100% component shop. No gimmicks, no gadgets or computers, just components, millions of them, all easily available by mail order, calling or credit card telephone orders. Just pick up the phone (or a pen) to get your **FREE** copy now (no SAE required). You have nothing to lose.

**CRICKLEWOOD ELECTRONICS LTD.**  
40 Cricklewood Broadway NW2 3ET.  
01-450 0995 & 01-452 0161  
ALL MAJOR CREDIT CARDS ACCEPTED  
Telex 914977 Phone or write today

**R.A.S. (Nottingham)**

**G6XBH**  
**G1RAS**  
**G8UUS**

**Radio Amateur Supplies**  
Tel: 0602 280267



**Visit your Local Emporium**

Large selection of New/Used Equipment on Show

**AGENTS FOR:**  
F.D.K.  
AZDEN  
ICOM  
YAESU  
ALINCO  
KEMPRO

**ACCESSORIES:**  
Welz Range  
Microwave Modules  
Adonis Mics  
Mutek Pre-Amps  
Barenco Mast Supports  
DRAE Products  
BNOS Linears & P.S.U.'s

AGENTS FOR CELLNET AND VODAFONE RADIOS  
**AERIALS**, Tonna, Halbar, New Diamond Range of Mobile Whips, Jaybeam  
BRING YOUR S/H EQUIPMENT IN FOR SALE

JUST GIVE US A RING

Monday: CLOSED Tuesday-Saturday: 10.00am to 5.00pm

**3 Fardon Green, Wollaton Park, Nottingham NG8 1OU**  
Off Ring Rd., between A52 (Derby Road) & A609 (Ilkeston Road)



## TONNA F9FT THE VHF/UHF ANTENNA SPECIALIST

<b>50MHz</b>		<b>435MHz</b>	
20505 5 element	£41.69(a)	20909N 9 element	£28.62(a)
<b>144MHz</b>		20919N 19 element	£34.35(a)
20804N 4 element	£27.60(a)	20438 19 element crossed	£39.66(a)
20808N 4 element crossed	£34.96(a)	20921N 21 element 432MHz	£44.57(a)
20809N 9 element fixed	£30.87(a)	20922N 21 element ATV	£44.57(a)
20089N 9 element portable	£33.12(a)	<b>1296MHz</b>	
20818N 9 element crossed	£57.86(a)	20623 23 element	£30.36(b)
20813N 13 element portable	£46.00(a)	20696 4 x 23 element - power splitter - stacking frame	£160.00(a)
20817N 17 element	£61.54(a)	20655 55 element	£46.20(a)
<b>144/435MHz</b>		20666 4 x 55 element - power splitter - stacking frame	£230.00(a)
20899N 9 & 19 element Oscar	£57.86(a)		

All prices include VAT. Please add carriage (a) £5.00. (b) £2.20.  
ACCESS or VISA cardholders telephone your order - immediate despatch.  
Callers welcome but by telephone appointment only please.  
**SEND 50p FOR OUR CATALOGUE WHICH CONTAINS FULL SPECIFICATION OF ALL OUR ANTENNAS, POWER SPLITTERS, STACKING FRAMES, COAXIAL CABLES ETC.**

SOLE UK DISTRIBUTOR  
**RANDAM ELECTRONICS (P)**  
12 Conduit Road, Abingdon, Oxon. OX14 1DB.  
Tel: (0235) 23080 (24 hours)

## J. BIRKETT

RADIO COMPONENT SUPPLIERS



25 The Strait  
Lincoln, Tel. 20767  
(LN2 1JF)  
Partners J.H.Birkett.  
J.L.Birkett.

**EX-MILITARY COMMUNICATIONS RECEIVERS R210.** Frequency 2 to 16MHz, in 7 Switched Bands, AM, SSB, CW, FCO. Aerial Inputs 80 ohm. Balanced Line, Long Wire or Whip, CW Filter, BFO, Noise Blanker, 10KHz-100KHz Crystal Calibrator. Complete with 240 volt Power Pack, Loudspeaker, Headphones Jack and Pair of Lightweight Headphones. Price £79.80. Carr. £12.00. Mainland Only.  
**LOCKFIT TRANSISTORS BC149** (a 6 for 50p, 2N706 (a 6 for 50p).  
**200 ASSORTED MINIATURE POLYESTER CAPACITORS** for £1.00.  
**CARBON MIKE INSERTS** (a 25p each or 5 for £1.00).  
**D TYPE CONNECTORS** 15 Way Socket (a 50p, 37 Way Socket (a 60p).  
**VERNITRON CERAMIC FILTERS** 10.7MHz (a 6 for £1.00).  
**MURATA CERAMIC FILTER** 455KHz (a 6 for £1.00).  
**SOLID DIELECTRIC VARIABLE CAPACITORS** 17+27+87+145p.f., 18+18+88+146p.f., 24+24+24+270+270p.f. All (a 50p each).  
**VHF POWER TRANSISTORS BFW16A** (a 75p, 2N3553 (a 85p, BLY55 (a £2.50, BLY97 (a £3.00, UHF BFR64 (a £4.00).  
**LARGE TELESCOPIC AERIALS** 10" Closed S4" Extended (a £2.30).  
**VHF MONITOR RECEIVER KIT** Consisting of Tuner Module, 10.7MHz I.F. Module, AF Amplifier, Loudspeaker, Telescopic Aerial with Instructions, no Case or Knobs (a £15.95 (P.P. £1.00).  
**X BAND GUNN DIODES** (a £1.65, DIODES Like 1N23 (a 45p, SIM 2 (a 45p).  
WOOD AND DOUGLAS KITS AVAILABLE BY POST AND FOR CALLERS, AND C.M. HOWES COMMUNICATIONS KITS STOCKED ALSO. ACCESS AND BARCLAY CARDS ACCEPTED, P.P. 60p UNDER £5, OVER FREE.

**SCOPES.** Solartron CD1400 general purpose DC to 15 Megs at 100 Mill/V Cm Dual Beam, timebase 0.5 US to 200 Mill/Sec Cm, 5" flat tube with 4kV size 13x7x17" tested with book £95. Also Scopex type 4D-10 general purpose DC to 10 Megs at 10 Mill/V Cm dual trace, timebase 1 Us/Cm to 100 Ms/Cm lightweight transis size 6x12x14" tested with book £125. **A.F. OSC** Services type CT439 sinewave freq 10c/s to 100Kc in 4 ranges O/P var by fine and coarse atten up to 3v into 600 ohm fitted O/P voltmeter, neat unit in case size 8x10x8" with cover for use on mains or int battery, transis unit with high resolution scale tested £65. **AERIAL SWITCH** long wire aerial selector swt type J part off TL154/R1155 equip good cond £16.50. **POWER UNIT.** General purpose HT/LT bench p.u. for 240v I/P gives 250/300v DC smoothed at 250Ma & 6.3v AC at 5 amps, HT & LT fuses in neat case size 11x10x10" with term connections tested. £26.50. **METER** Services type CT471 Elec multimeter AC/DC volts, AC/DC current, 5 ranges of ohms, RF probes to 1 Gz at 40 Mill/V FSD in case size 9x8x8" reqs 3x HP2 batt tested with book £75. **VARIACs** two types for panel mounting 240v I/P O/P 0 to 270v at 2 amps. Price £18.50 or at 4 amps £26.50. **SPEAKER UNIT** Army AFV spk in metal case size 5 1/2" dia 3 1/2" deep semi weatherproof int spk 3 ohm new £8.50. **DISH AERIALS** Airborne radar X band 32" dia 5" deep dual some perforations new boxed £28.50. **H.F. PRE SELECTORS** made for Army by Marconi these tune 2/29 Mc/s in 4 bands with direct cal with 10.1 slow motion dial each band as two tuned circs with high Q coils, as 75 ohm I/P & O/P connections mounted on 19" Chassis ass size 19x7x14", well made unit useful for use with older type Rx,s to remove image/second channel signals £28.50. **PANEL METERS.** Mixed all M.C. types new 2/3" dia 6 for £7.50. **GATE UNIT** special purpose unit sold for parts contains tuning cap twin gang 135pf per section, small 1" dia -30 to +60°C, 2x large Vinkors, meter 50-0-50 Ua, Rot swt, transis, diodes, trans, push swt, 2x pairs 25 way connec, in metal case size 13x9x5" supplied in fitted carrying case £18.50. **RADAR DISPLAY** Airborne P.P.I. display unit 9" dia CRT ex Nimrods as int EHT unit, Vid Amp, Shift Amp but req ext Power & Scanning Amp, CRT P7 with mag deflection, size 15x12x21" £45. **PHOTO FLASH CAPS** Sprague rapid discharge type 215 uf at 2.5 Kv Pk size 8x4x10" £17. **SIG GENs** American services type USM-44 equiv to Hewlett Packard 608 series high grade unit covering 10/420 Mc/s in 5 bands, as int AM mod at 400 & 1000 c/s with low spurious F.M. O/P var & metered int crystal check at 5 megas supplied in transit container £95. Also small stock of TS419 & TS403 L & S Band Sig Gens. **TEST SET PRIM-10** American services Grid Dip Osc covers 2/400 Mc/s with 7 plug in coils as 4 functions GDO, Osc Det, Absorption W.M. & Sig Gen, as direct freq cal & meter indication supplied in metal storage box size 11x9x5" this holds head unit & coils supplied tested with book, for 115v about 25 watts £65. **SIG GENs** Marconi TF995/A2. 1.5/220Mc/s. 5 bands AM/FM good class units in table case tested with book £115. **TEST METERS.** AVO Model 8 Mk3/5 general purpose 20k ohm per/V test meter supplied tested but less leads & batteries £48. **TRANS.** All 230/240v C core Sec 50/60v at 5 amps. £14.50 E core Sec 21v at 10 amps (can be tapped down to 16v) £14.50 Mains Isol 240/240 at 500 watts £17.50. **HAND GENY** Army type output 13.8v adjustable 12/14 stabilised at 1 amp £24.50 quantity available. **ARENOLD CAPSULE** Smiths 2 1/2" dia connected by small bore pipe to 1/2" threaded union, new. £3.50.

Above prices include Carr/Post & VAT. Goods ex equipment unless stated new. SAE with enquiry or 2x18p stamps for List 41. Open to callers 10.30 till 5pm, closed Mon/Thurs. Phone if wishing to collect tested items.

## A.H. SUPPLIES

Unit 12, Bankside Works, Darnall Road, Sheffield S9 5HA  
Phone: 444278 (0742)

# ARE COMMUNICATIONS

## A NEW STANDARD IN TECHNOLOGY

### THE FULL DUPLEX HANDIE FROM STANDARD

A World First. Transmit on 2 metres and receive on 70cms (or vice-versa) at exactly the same time. Not only is that unique from a Handie, but with the following specification and at a fraction of the size of it's nearest competitor, is there really any other rig that compares?

- Dual band operation 144-146 and 430-440MHz, Full duplex.
- Receiver coverage: 130-169.995 and 410-470MHz.
- Programmable step sizes 5/10/12.5/25/50KHz.
- 5 watts output on both bands (With optional CNB120).
- Dual synthesised VFO's.
- Dual synthesised CTCSS tones 67-250.3Hz (With optional CTD/N500).
- Programmable Repeater Offset on either band between 0-39.9MHz.
- Reverse Repeater facility.
- Dual Watch priority channel.
- Programmable Call Channel on both bands.
- Ten programmable memories, including repeater offset, tone squelch etc, on both bands.
- Four different scanning modes.
- Battery save facility.
- Switchable Frequency lock and TX inhibit, from keyboard.
- Switchable 20dB Attenuator.
- High or Low power control.
- Squelch defeat switch.
- Illuminated Wide Angle L.C.D. display.
- Digital 'S' Meter/Power output display.
- Low battery Warning indicator.
- TX LED indicator.

**UP GRADE NOW.**  
**THE NEW STANDARD C-500.**  
**New price £369**



Opening Hours London Mon/Fri 9.30 to 5.30  
Merseyside Tues/Sat 10.00 to 5.00



A.R.E. Communications Limited, 6 Royal Parade, Hanger Lane, Ealing, London W5A 1ET, England  
Professional Tel:01-997 4476 Fax:01-991 2565 Telex:94016185 AREC G

A.R.E. Communications Limited, 38 Bridge Street, Earlestown, Newton-Le-Willows, Merseyside WA12 9BA  
Amateur Tel:09252 29881 Fax:01-991 2565 Telex:94016185 AREC G

## Cheque Books and Black Boxes

Amateur radio is becoming more and more a cheque-book and black-box hobby. I feel this is for two main reasons, the main one being RAE instructors teaching people to pass the exam rather than teaching them amateur radio. There is to me a large difference, and it shows when listening to h.f. or 144MHz.

If one has the nerve to talk technically on GB3WD about satellites, TNCs, or even something basic like resistors in series, then the QSO suffers from dead keys and the inevitable "break-break" without a callsign. When one responds to the station calling "break" there is no response.



But if the QSO consists of drivers commenting on the standard of the other drivers around them, complete with colourful descriptions of the offending driver's lack of a father or the like, there never seems to be a "break-break" or dead keying.

In the 3½ years that I have had a licence, standards have fallen, and I wonder what they will be like in five

years time. The RSGB in their wisdom are trying to get licence conditions changed to be more flexible, but is this a good idea? Looking at their proposals, I cannot really believe that they represent the majority of decent amateurs. There is certainly a place for a novice licence on, say, 28MHz with a maximum 10 watts for a probationary period of one year after passing the RAE. Then allow the newcomers above 30MHz if all is well with their operating procedure. Doing this should discourage some of the "lids" currently on v.h.f. and more so these days on h.f. Having to wait a year would clear a lot as they would not have the patience to wait.

**Vince Bobin G1FBH  
Kingsbridge, S. Devon**

## Scrap the RAE?

I am one of many who read of those who wish to abolish the Morse test in pursuit of an "A" licence. I have been an s.w.l. for many years, and although I can read c.w. at over 25 w.p.m. and feel confident at passing the RAE, I am happy to remain an s.w.l.

I listen to some of the late G4 and early G0 amateurs and am appalled by their operating practice (or lack of it). I can only conclude that they never listened on the h.f. bands before entering the hobby.

To then listen to the same type of people advocating the abolition of the Morse test is too much for me to bear. I feel that Morse is part and parcel of amateur radio

## PW COMMENT

### Realism

IN DEVELOPED COUNTRIES where the business and private use of radio is expanding at a near-explosive rate, there have been moves over the past couple of years to tighten up legislation relating to casual listening. In particular, the cellular telephone lobbies in several countries have been pressuring governments to bring in swingeing laws restricting availability and ownership of scanning receivers.

Now, don't get me wrong. I like to think my telephone conversations are private to just me and the person at the far end. I know, though, that if they are carried over an open radio link without some form of encryption or scrambling, it's quite likely that someone else will be able to hear us too. That eavesdropping may not even be deliberate—cordless phones have been known to break through on medium wave broadcast receivers and on audio systems; cellular telephones have been heard on TV receivers.

So, although confiscating every listening enthusiast's scanner or general coverage receiver may appeal to the companies trying to sell their radio telephone equipment, it's not a practical solution. It would take a police state even to begin to gather in the receivers made illegal. Not convinced? Well, consider for example the fact that there are reckoned to be around 700 million receivers in use in the USA, 63½ million receivers in the UK; every one of these would need to be checked out by the "thought police" to ensure they didn't cover any "naughty" frequencies. And even that does nothing to reduce that risk of conversations being accidentally overheard.

In the USA, radio listening was in the past covered by the Communications Act, which in essence allowed an individual to listen to any radio transmission, providing they didn't divulge the contents of what they heard. The Electronic Communications Privacy Act (ECPA) was brought in there recently, removing the American citizens' age-old right to listen to public service, government, marine or aeronautical transmissions. The Federal Communications Commission (FCC) said the proposed law was unenforceable, and more or less intimated that they wouldn't waste time and effort by even trying to enforce it. But the Bill became law even so.

Now, in the state of California at least, a new realism has dawned. The Public Utility Commission there now requires all cellular phones to be labelled to warn users that their conversations are not private. The Commission found that most cellular phone users had no idea that they could be overheard on even an old TV set.

Robert A. Hanson, writing in the October 1987 issue of the

US magazine *Popular Communications*, points out that a cellular telephone salesperson claiming that "federal law protects cellular privacy" doesn't make privacy a fact. In fact, the ECPA, far from achieving the Cellular Telephone Industry Association's desire of securing the prevailing public impression that "a phone is a phone", has focused a very bright spotlight on the lack of cellular phone privacy. Many people who use cellular in the USA for important business deals or other matters requiring privacy are shocked by the revelation that they are actually broadcasting on an ordinary f.m. transmitter. A typical reaction is that, "I've stopped using cellular except for the most casual conversations. I really question whether cellular is worth having any more."

This idea that conversations using radio links are somehow private extends even to CB users. A few years ago, I heard two locals on 27MHz who were shocked to discover, following a comment from another station "on the side", that their discussions could be overheard. They seemed to think that shifting off the calling channel onto a working channel conferred some magical power by which they could be heard by no-one but each other!

As I mentioned in October 1986 *PW*, i.c.s are available for incorporation into cordless and cellular phones, which will encrypt speech signals using a digital time division multiplexing system. The solution to the problem will be for all these instruments to use such a system, which would certainly secure them against accidental reception, and will also defeat all but the most sophisticated intentional listening.

Labelling cellular and cordless phones with the modern-day equivalent of the wartime "Walls have ears" posters is a step in the right direction, at least making users aware of the problem, but the real solution is the addition of some rather more modern technology.

In the UK, too, a new realism is dawning in some quarters. Reading a British Telecom International brochure describing the Maritime "Data over VHF Radio" service for offshore sailors, I was impressed to see the following statement, under a heading "Security at Sea": "Radio frequencies are entirely within the public domain and voice transmissions of a confidential nature clearly run certain risks. A considerable reduction in the risk of interception is one of the many benefits of data transmission over conventional means of communication." Obviously it's part of a sales drive for the new Data service, but the BTI Coast Stations still provide and sell the traditional v.h.f. voice services too. Full marks, BTI, for warning the customer about the problem! **Geoff Arnold**



and that anyone too lazy or incapable of learning the code has no right on the amateur bands—h.f. or otherwise. Perhaps the next thing will be demands to scrap the RAE because it, too, has no bearing on amateur radio.

**R. N. Bell**  
*Reading*

## Database

I have been reading *Practical Wireless* for just over a year with interest. In your lists of stations you make a long story of changes to wavelengths, times of broadcasts and so on.

I would have thought there would be a call for these lists to be put on tape or microdrive for all these amendments. After all, that is what computers are for, to call up the answers.

**J. F. Richards**  
*Reading*

*We don't know of anyone that produces a computer database of broadcast station frequencies and schedules for distribution to enthusiasts, though organisations like WRTV are now keeping their*

*own records on computer.*

*For the listening enthusiast, whether a computer database would be the best way of holding the data will depend on the particular interest and way of working. For some applications, a card index or a book can still beat a computer hands down for speed and convenience of reference.—Ed.*

## Another Bouquet

Whenever I read one of the radio magazines, there is always someone complaining about this, complaining about that. What about a compliment for a change?

Late one Friday night (10.30pm), I rang Spectrum Communications to place an order for a kit, and got an answerphone. Fine—I gave my name, address, charge card details and what I wanted, and then waited about a week. Nothing!

I rang them again after 4pm one Monday, and spoke to a very pleasant young lady who apologised for the delay, due to their

Send your letter to the Editorial Offices in Poole, the address is on our Contents page. Writer of the Star Letter each month will receive a voucher worth £10, to spend on items from our PCB or Book Services, or on *PW* back numbers, binders, reprints or computer program cassettes. And there's a £5 voucher for every other letter published.

Letters must be original, and not duplicated to other magazines. We reserve the right to edit or shorten any letter. Brief letters may be filed via our Prestal Mailbox number 202671191. The views expressed in letters are not necessarily those of *Practical Wireless*.

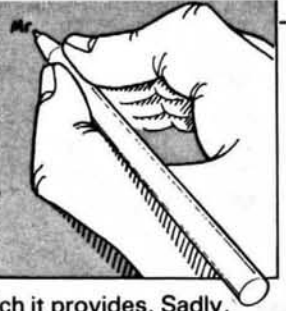

answerphone having gone wrong. I gave her all the details and she promised the order would be in the post first thing on Tuesday, and should be with me within a few days. It arrived first post on the Wednesday. All I can say is "Thank you Spectrum, for a very fine service".

**C. Horwood G1NPK**  
*London E11*

PS: I only hope I can build it now!

## The London 2m Repeaters

I am concerned that the London 144MHz repeaters are bringing amateur radio into disrepute. Any repeater is vulnerable to abuse, of course, and this must be weighed against the utility

which it provides. Sadly, with the London repeaters, the balance seems to lie in favour of the abusers.

The nature of this abuse ranges from mere vulgarity to the extremes of obscenity, blasphemy, racial insults and personal vilification. Vendettas are quite common, taking forms which vary between persistent jamming and off-the-air dirty tricks. Although some of the offenders are anonymous "pirates", many give their call signs without fear.

Do these repeaters serve the legitimate interest of amateur radio? I doubt it, and believe that the argument for closing the London repeaters is very strong.

**J. Winsor G1XYC**  
*London SE20*

# OUR SERVICES

## QUERIES

We will always try to help readers having difficulties with a *Practical Wireless* project, but please observe the following simple rules:

1. We cannot give advice on modifications to our designs, nor on commercial radio, TV or electronic equipment.
2. We cannot deal with technical queries over the telephone.
3. All letters asking for advice must be accompanied by a stamped, self-addressed envelope (or envelope plus International Reply Coupons for overseas readers).
4. Write to the Editor, "Practical Wireless", Enefco House, The Quay, Poole, Dorset BH15 1PP, giving a clear description of your problem.
5. Only one project per letter, please.

## COMPONENTS, KITS AND PCBs

Components for our projects are usually available from advertisers. For more difficult items, a source will be suggested in the article. Kits for our more recent projects are available from **CPL Electronics**, and from **FJP Kits** (see advertisements). The printed circuit boards are available from our **PCB SERVICE** (see page 1 of this issue).

## CONSTRUCTION RATING

Each constructional project is given a rating, to guide readers as to its complexity:

### Beginner

A project that can be tackled by a beginner who is able to identify components and handle a soldering iron fairly competently.

### Intermediate

A fair degree of experience in building electronic or radio projects is assumed, but only basic test equipment is needed to complete any tests and adjustments.

### Advanced

A project likely to appeal to an experienced constructor, and often requiring access to workshop facilities and test equipment for construction, testing and alignment. Definitely not recommended for a beginner to tackle on his own.

## BACK NUMBERS AND BINDERS

Limited stocks of most issues of *PW* for the past 18 years (plus a few from earlier years) are available at £1.30 each, including post and packing to addresses at home and overseas (by surface mail).

Binders, each taking one volume of *PW*, are available price £3.95 to UK addresses, or overseas, including post and packing. Please state the year and volume number for which the binder is required. Prices include VAT where appropriate.

## CLUB NEWS

If you want news of radio club activities, please send a stamped, self-addressed envelope to **Club News**, "Practical Wireless", Enefco House, The Quay, Poole, Dorset BH15 1PP, stating the county or counties you're interested in.

## ORDERING

Orders for p.c.b.s, back numbers and binders, *PW* computer program cassettes and items from our Book Service, should be sent to **PW Publishing Ltd.**, FREE-POST, Post Sales Department, Enefco House, The Quay, Poole, Dorset BH15 1PP, with details of your credit card or a cheque or postal order payable to **PW Publishing Ltd.** Cheques with overseas orders must be drawn on a London Clearing Bank.

Credit card orders (Access, Mastercard, Eurocard or Visa) are also welcome by telephone to Poole (0202) 678558. An answering machine will accept your order out of office hours.

## SUBSCRIPTIONS

Subscriptions are available at £14 per annum to UK addresses and £18.50 overseas. For further details, see the announcement on page 40 of this issue. Airmail rates for overseas subscriptions can be quoted on request.

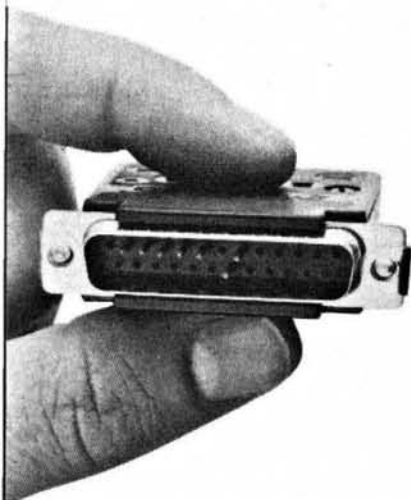

## Loopback Plug

The RS232 Loopback plug, available from Inmac, is a quick way to check the performance of an RS232 terminal, MODEM, multiplexor or transmission line without the need for a breakout box.

It works by interconnecting pins 2 to 3, 4 to 5, 6 and 8 to 20 to verify data transfer. Male and female versions are available at a cost of £12 each.

**Inmac (UK) Ltd.,  
Westerly Point,  
Market Street,  
Bracknell,  
Berks RG12 1EW.**

## Can You Help?

A. Pinnington has a CR100/B28 receiver and would like to know if anyone has a manual for it. A list of components would be useful too. If you can help, contact Mr Pinnington at 73 Overchurch Road, Wirral, Merseyside L49 4NW.

Bill Barrett has a combined s.w.r. and power meter manufactured by Oskerblock Electronic Eng. Co. Ltd. of

Tokyo. The model number is SWR200-B. Does anyone have any information about this equipment? Write to Bill Barrett, Stevina, Ludchurch, Narbeth, Dyfed SA67 8JF.

Another reader is looking for information on mods for the SX-200 scanner, the Philips PL-2999 and the Yaesu FT-290R. If you can help, then write to Jimenez. Hotel Balj, 29630 Benalmadena, Spain.

## Eisteddfod 1988

The Newport ARS will be running GB1ECC on v.h.f. and GB2EC on h.f. Both stations will count towards

the award. Short wave listeners can claim the award for hearing the required number of stations, the details must include the date and QSO number heard.

## MARS AGM

At the AGM of the Midland Amateur Radio Society they elected a new committee. In the photograph you can see the new club President, Peter Haylor G6DRN, being congratulated by Stewart Laing G8ODT, the retiring President.

The club now has a committee of 11 and 6 club officials. If you would like to know more about the club and their meetings, then contact:

**Tom Brady G8GAZ,  
MARS Publicity Manager,  
57 Green Lane,  
Great Barr,  
Birmingham B43 5LE.**



## Rally Calendar

**January 31:** The Belle Vue/Norbreck radio rally will be held in Norbreck Castle Hotel Exhibition Centre, Queens Promenade, North Shore, Blackpool. Doors open at 11am and admission is £1, OAPs 50p and under 14s free. Many large traders will be there as well as many lesser known specialists. There will be a bring and buy stand, RSGB Morse tests and Talk-in on S22. There is ample free car parking. **Peter Denton G6CGF 051-630 5790.**

**March 6:** The Barry College of Further Education Radio Society are holding their 8th radio rally at the Barry Leisure Centre. The doors open at 11am (10.30am for the disabled). Many trade stands will be there as well as the usual bring and buy as well as an RSGB book stand and Morse testing facilities. The Leisure Centre facilities (swimming pool), licensed bar and cafeteria) will also be available. **Mike Adcock GW8CMU on 0446 711426.**

**March 13:** The Bury Radio

Society are holding their annual "Hamfeast" at the Castle Sports Centre, Bolton Street, Bury. More details from **C. D. W. Marcroft G4JAG, Bury RS, Mosses Community Centre, Cecil Street, Bury.**

**March 13:** The 3rd Wythall radio club rally will be held at Wythall Park, Silver Street, Wythall. It's south of Birmingham on the A435, 3km from Junction 3 on the M42. The doors open 12 noon. There will be the usual trade stands, RSGB Morse tests, flea market, free parking and Talk-in on S22. Admission is 50p but OAPs and accompanied children free. **Chris GOEYO on 021-430 7267.**

**March 20:** The 1988 Cambridgeshire Repeater Group Junk Sales Rally Extravaganza will be held at the Philips RCS (Pye Telecom) Canteen, St Andrew's Road, Chesterton, Cambridge. Doors open at 10.30am The day features trade stands, the monster junk sale auction and the bring and buy. Refreshments will be available and there is

ample free car parking. All proceeds from the event go to finance the Group's repeaters.

**June 5:** The Bolton ARC are holding their rally at the Deane Sports Complex, New York, Bolton. The newly built complex is complemented by excellent access from the motorway network, and offers full catering, parking and disabled facilities including lifts to the main areas and a licensed bar. More details from **D. Bates G6HFF, 3 Braemar Gardens, Bolton Greater Manchester BL3 4TU.**

**July 31:** The Scarborough ARS Mobile Rally will be held at the Spa, Scarborough. Doors open 11am. As well as traders there will be a licensed bar and cafeteria facilities. More details from **I. G. Hunter G4UQP on 0723 376847.**

**September 18:** The Bristol Radio Rally will take place at the Historic Bristol Old Station located at Temple Meads in central Bristol. More details from **D. S. Farr G4WUB on 0272 839855.**

## Drillboy

For those who still believe in "chassis bashing" one of the biggest problems is the front panel. Even if you buy a ready-formed box, you still need to drill holes for the various controls.

Electronic & Computer Workshop Ltd have a gadget that sounds very useful. It fits to almost any popular electric drill and ensures that the drill is kept at 90 degrees to the work. It is a spring-loaded guide that will grip firmly onto most surfaces—flat, curved and angles.

Drillboy also has the advantage of collecting and holding the waste material—sawdust, metal swarf, etc., from the drilling operation.

The all-in mail-order price direct from ECW, including P&P and VAT is £8.95. **Electronic & Computer Workshop Ltd, Unit 1, Cromwell Centre, Stepfield, Witham, Essex CM8 3TH.**

## Desoldering Pump

Cooper Tools have introduced two anti-static models to their Weller manual desoldering pump range.

They come with either a fine (1.9mm) or general (3.2mm) anti-static nozzle and both allow one-handed operation. When used in conjunction with a soldering iron, they remove, by suction, all the solder around components requiring replacement on circuit boards.

**Cooper Tools Ltd.**  
Sedling Road,  
Wear,  
Washington,  
Tyne & Wear NE38 9BZ.



## Conductive Silver Epoxy

The Silverfast 650 silver filled epoxy adhesive has the excellent electrical properties of pure silver and is simple to mix and apply for all types of electrical bonding.

Supplied as a two-part (resin and hardener) adhesive, Silverfast 650 is mixed using equal volumes or weights of each part. Once mixed, working life is from one to two hours. Curing time is 24 hours at room temperature or two hours at 60°C.

Applications for the epoxy range from bonding heat-sensitive components to p.c.b.s to waveguide plumbing.

More details from:  
**Silverfast Ltd.,**  
**Anglia Microwaves Ltd.,**  
**Radford Business Centre,**  
**Radford Way,**  
**Billericay,**  
**Essex CM12 0BZ.**

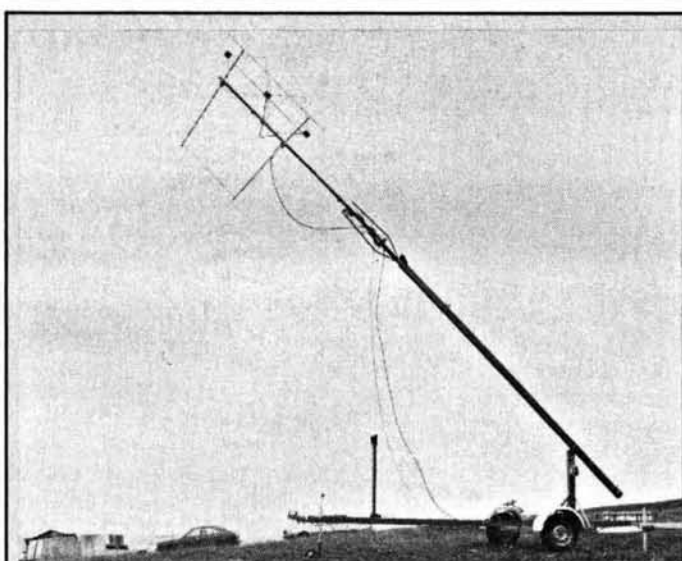

## Tennamast

You may recall the name Tennamast from a few months back when we published our QRP Contest Results. They were the company who sponsored the Scottish award.

For those of you who don't know, they make wind-up and tilt-over masts. They have many different

types available, as their catalogue shows, but they can always build specials to order.

If you want more information you can write or telephone, they have a 24-hr answering service.

**Tennamast (Scotland),**  
**81 Mains Road,**  
**Beith,**  
**Ayrshire KA15 2HT.**  
**Tel: 05055 3824.**

## From the AGM

The 1987 Annual General Meeting of the RSGB on December 5 was attended by 193 members. Among interesting points to emerge from discussion of the accounts for the year ending 30 June 1987 were: book sales were down 20 per cent in volume; the recent large increases in book prices were currently under discussion by Council; the Morse Test operation had yielded an income of around £20 000 against costs of about £15 600; the recent mailshot to non-members had cost about £5000, and had produced some 950 new members.

The Extraordinary General Meeting which followed approved two changes to the Society's Articles of Association. The first now allows a member to instruct a proxy-holder how to vote on individual resolutions. The second requires a candidate for Council who will have reached the age of 70 before the end of his or her term of office to state that fact on the ballot paper.

The Open Forum discussions which

concluded the meeting included the following topics:

1. The future of the hobby, and the likely effect of the proposed "Student" licence on recruitment of new blood. Discussions with the DTI and other interested parties such as Scouts and educational bodies were continuing. The net increase in UK Amateur Licences during the 12 months to June 1987 had been only 60.
2. The revised form of UK Amateur Licence was still under consideration by the DTI. Mid-1988 was the current target date for completion, and full UK participation in the CEPT (European) Amateur Licence arrangements was expected to follow.
3. A proposal for overcoming the QRM suffered by RSGB 144MHz Slow Morse transmissions in the London area was currently under consideration by the VHF Committee.

It was announced that the 1988 AGM would be held on Saturday, December 10. The idea of holding AGMs outside London was discussed, and not

## Transformers

Avel-Lindberg are marketing a range of stacked lamination transformers with secondary load ratings of 1.2, 3, 6, 12 and 20VA.

This new range have completed-item plating of the bright zinc and passivated clamp mounting, where appropriate, p.c.b. tags plated to BS2011, fine winding wires skinned to the tags for extra mechanical strength and an optional insulated terminal cover which gives mechanical and electrical protection on the clamped versions.

The range is designed to operate at full rating at 25°C and with a maximum temperature rise of 55°C.

The twin primary windings of 0 to 120V, can be series or parallel connected, operate from 50 to 60Hz. The numbers of turns on the secondary windings are very accurately controlled by electronic digital counters which ensure a correct voltage balance for the twin 3.0, 4.5, 6, 9, 12, 15, 17.5, 20 and 24V windings which can be series, parallel or independently connected.

More details from:  
**Avel-Lindberg Ltd.,**  
**South Ockendon,**  
**Essex RM15 5TD.**

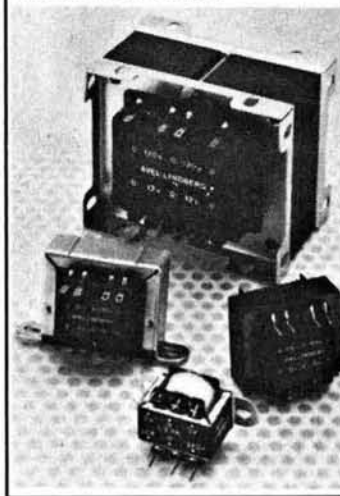

surprisingly met with a mixed response. Wherever they may be held, the check-in procedure needs to be streamlined drastically compared with this year. To take 25 minutes to transit the queue up the front steps and across the foyer of the IEE building, as I did at this year's meeting, is not really on!

**G3GSR**

## Enclosures

A versatile range of small electrical/electronic housings has been launched by West Hyde Developments.

The Elesett case range is moulded in a two-tone grey colour scheme in high-impact polystyrene. The side and end panels come in either polystyrene or anodised aluminium. They are removable and completely flat for ease of machining or printing. The plastics panels are reversible to provide an additional choice between recessed or flush external surfaces.

As an extra feature, the top moulding offers a choice of a plain surface or shallow grooves. Small ventilation

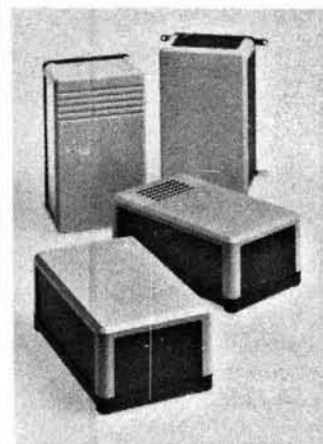

louvres in the top and base are a further option.  
**West Hyde Developments,**  
 9-10 Part St Ind Estate,  
 Aylesbury,  
 Bucks HP20 1ET.

## BARTG

At the recent AGM, the subscription rates for the membership year of 1988 were set at:

UK ..... £8.00  
 Europe ..... £11.00  
 Overseas surface  
 mail..... £11.00  
 Overseas air mail ..... £16.00

The 1988 membership years runs from January to December. All members will receive 4 copies of *Datacom*, BARTG's quarterly journal, which usually runs to 100+ pages.

BARTG is the specialist interest group for those interested in using amateur radio with teleprinters, facsimile, Packet and AMTOR.

**BARTG.**  
 Mr and Mrs Beedie,  
 Ffynnonlas,  
 Salem,  
 Llandeilo,  
 Dyfed SA19 7NP.

## Coaxial Antenna Switch

The CAS-A2 remote coaxial antenna switch has been designed and manufactured in the UK to enable the remote switching at the masthead of two antennas from one feeder.

The unit is fully weatherproofed and uses Greenpar silver-plated "N" type connectors. It has a low insertion loss and may be used up to 1000MHz with a maximum power of 150W p.e.p.

The unit requires 11-14V d.c. fed by a supply wire through a fully r.f. decoupled d.c. input to the relay.

The price for the unit is £59.95 from:  
**Nevada Communications,**  
 189 London Road,  
 North End,  
 Portsmouth,  
 Hants PO2 9AE.

## Soldering Stations

Adcola have added to their range of soldering stations. The 151 had an i.e.d. temperature read-out. Adcola claims that this visual indications is of the actual tip temperature and is accurate within  $\pm 2$  per cent.

As with all Adcola equipment, it is available in the FumeX form. This is a system for removing soldering iron fumes from the tip of a soldering iron.

For full information, Adcola will supply a Hand



Soldering Catalogue.  
**Adcola Products Ltd,**  
 Adcola House,  
 113 Gauden Road,  
 London SW4 6LH.

## Coaxial Connectors

Greenpar are producing fully crimped versions of their 50Ω sub-miniature coaxial connectors.

These connectors feature crimp retention of both braid and contact for a fast, consistent and reliable termination. The new parts are available as plug, jack and bulkhead jack and they conform to the standard SMB specifications.

Also available in SMB and SMC versions are low profile elbow connectors which

have a solder centre contact and crimped outer.

The standard finish is a gold plated or bright nickel plated body with gold plated centre contacts. New data sheets are available, showing part numbers, dimensioned outline drawings, performance data and step assembly instructions.

More details about these connectors from:  
**Greenpar Connectors,**  
 Cambridge Road,  
 Harlow,  
 Essex CM20 2ER.

## AX.25 TNCs

Siskin Electronics have announced two more AX.25 terminal node controllers from Pac-Comm.

The Tiny 2 is a new low-cost TNC designed for use on v.h.f. and u.h.f. at a speed of 1200 baud. It uses standard TNC-2 ROMS and so is capable of being used for NET/ROM, TCP/IP, etc.

Its main features are: 32K RAM and 32K ROM standard, latest 1.1.5 software, extruded aluminium case only 127 x 178mm, supports RS-232 and t.t.l. computers and needs 12V d.c.

The Tiny-2 is being

introduced at a special price of £99.95 inc VAT (plus P&P).

The Micropower-2 is a very low power TNC drawing only 40mA at 9-13V d.c. It is small and lightweight (127 x 178 x 35mm and 624g) and is perfect for portable or solar power operation! It is similar in features to the Tiny-2, but built and tested to a higher specification, with additional options available early this year. The Micropower-2 is £159.95.

**Siskin Electronics,**  
 PO Box 32,  
 Hythe,  
 Southampton SO4 6WQ.



## Desoldering Station

The Adcola 555 desoldering station has a heating element in the tip which gives a uniform temperature throughout its length. This, coupled with the use of a diaphragm pump, should get over the problems of

continual tip blockages sometimes suffered when doing lots of desoldering.

The 555 normally requires a 5A 240V supply, but is available in 110 and 220V versions.

**Adcola Products Ltd,**  
 Adcola House,  
 113 Gauden Road,  
 London SW4 6LH.

## CQ-TV Award

This award is available to both transmitting and receiving enthusiasts, in any part of the world, whether they are members of the BATC or not.

The award is for contacts made using fast-scan high definition television systems only.

**The Transmitting Award** is available for pictures transmitted which have been successfully identified by another station. Two points may be claimed per kilometre. If the contact becomes a successful two-way exchange of pictures, then 10 bonus points may be claimed by each station regardless of distance. For contacts on the 1.3GHz band or above, points are doubled.

**The Receiving Award** is available for any picture positively identified—claim for a one-way contact. Otherwise the rules are as for the transmitting award.

The points are divided into five grades. **Bronze** for 1000 points. **Silver** for 5000 points. **Gold** for 10 000 points and **Diamond** for 100 000 points.

Points gained for an existing award may be

added in when applying for a higher grade.

A station may be worked only once per day for the purpose of this award, but it is quite possible for it to be gained by working the same station many times. Contacts through TV repeaters do not count.

Upon qualification for the Bronze award, a certificate will be issued together with a Bronze seal. The certificate may be up-graded later with silver and gold seals. The Diamond Award is in the form of a specially made trophy.

Applications should include log details consisting of callsign, date of QSO, band, location of the station worked and points claimed. Contacts made from other than the home station should be clearly marked. QSL cards are not required, but the application should be checked and signed by either a licensed amateur or a BATC member.

Certificate applications should include a large (12 x 8.5in) s.a.e. Applications to: **Awards Manager, Mike Wooding G6IQM, 5 Ware Orchard, Barby, Nr Rugby CV23 8UF.**

## Catalogues

We have received a copy of the Solex catalogue this month. It's full of laboratory, test and measuring equipment. Products range from Thandar logic probes at about £21 each to Soar cable length checkers at about £550. If you would like more details, contact: **Solex International, 44 Main Street, Broughton Astley, Leics LE9 6RD.**

A greatly expanded selection of phase shifters and wide-band couplers feature in the latest edition of the Arra (Antenna and Radome Research Associates) microwave device catalogue. It is now

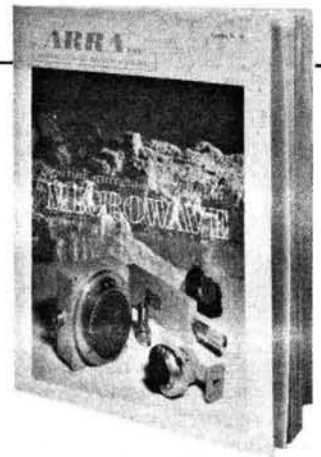

available from the UK distributor, Anglia Microwaves Ltd.

More details from: **Anglia Microwaves Ltd., Radford Business Centre, Radford Way, Billericay, Essex Cm12 0BZ.**



## Signal Generator

STC Instrument Services now offers the compact Marconi 2022C signal generator. This has frequency, phase and amplitude modulation over a wide frequency range from 10kHz to 1000MHz.

It is designed for use in maintenance, service applications, production and education. The unit features microprocessor control

which enhances the speed of operation via direct keyboard entry of the required settings. A non-volatile memory which stores up to 100 settings further reduces measurement time.

For further details, contact: **STC Instrument Services, Dewar House, Central Road, Harlow, Essex CM20 2TA.**

## Blank Tape Levy

A few months ago we reported that a blank tape levy was being discussed in Parliament. Now we have received a press release from the IFPI (International Federation of Phonogram and Videogram Producers).

"The British Government has made a hasty and

unprincipled *volte face* in deciding to retain the existing law on home taping of pre-recorded music. This will perpetuate an anomalous state of affairs and in the view of many will be in breach of the UK's obligations under the Berne Convention to protect the rights of copyright owners."

## Micro-ohmmeter

Megger Instruments Ltd have introduced the Ducter D203 to their range of low resistance ohmmeters.

This new addition automatically compensates for thermal e.m.f. effects, which means that readings are faster and more accurate.

The eight full-scale ranges, from 199.9µΩ to 1999Ω, give resolution down to 0.1µΩ on the 3.5 digit l.c.d. display. The unit can be operated from either mains supplies or internal rechargeable batteries.



**Megger Instruments Ltd, Archcliffe Road, Dover, Kent CT17 9EN.**

## Derby 144MHz Contest

Following their successful first DADARS 144MHz contest, the club have decided to repeat the event this year. Briefly, the rules are:

Date: 13 March 1988  
Time: 1300 to 1700UTC  
Mode: Any mode, but band plans must be observed. Fixed, /A and /P all permitted.

Exchange: Callsign, RS(T), serial number (starting 001) and administrative county.

Scoring: G3ERD = 10 points, all others score 2. Final score is number of points by number of counties. Each country outside UK counts as a county.

Logs: Must be sent to Derby & District ARS, 119 Green Lane, Derby DE1 1RZ by March 30.

Awards: (1) Full legal power, (2) Low power—30W max output and (3) s.w.l. Specify whether single or multi-op.

If you require a full list of the rules, send an s.a.e. to the club.

# PW REVIEW



*On first making the acquaintance of the Icom IC-761 "top of the line" transceiver, at the Birmingham National Exhibition Centre during the April 1987 RSGB Exhibition, Ken Michaelson G3RDG was frankly rather overawed by the sheer size of it. Having tested it at his home QTH, he found it to be a thoroughly workmanlike unit, and tells us about his impressions of it. The test measurements were made in the PW lab by Geoff Arnold G3GSR.*

The IC-761 is an all-mode multi-purpose base station h.f. transceiver incorporating a general-coverage receiver. It contains everything including the power supply. There is a built-in antenna tuner, the Icom IC-CR64 special high stability crystal unit which uses a temperature compensating oven heater and provides a frequency stability of better than  $\pm 100\text{Hz}$  between  $-10^\circ$  and  $+60^\circ\text{C}$ , and for the c.w. man, full as well as semi break-in. Automatic keying is also available with the simple connection of an iambic paddle.

An RTTY mode caters for both RTTY and AMTOR. The only snag about this is that it is impossible to use f.s.k. with the European tones of 1275 and 1445Hz. The IC-761 is set up to respond to the tones used in the USA, what I call the "high" tones of 2125 and 2295Hz. Of course, one can use a.f.s.k., injecting the tones into the rig via the microphone socket, but when this option is employed the c.w. filters cannot be used. There is a "narrow" setting of the existing RTTY tones using the filters, but this also operates at 2125/2295Hz. The point about all this is that pretty well all modems available in the UK are designed to respond to the European tones, and will not respond to 2125/2295Hz. I do not know what modification, if any, is available for the IC-761 to lower the frequency for those of you who wish to operate f.s.k.

## The Manual

Reading the manufacturer's specifications reveals only the bare bones of the unit; actual operation puts flesh on the bones. First, however, a thorough inspection of the Instruction Manual is necessary. I have commented before on the excellent quality of the printing of Icom manuals and the amount of clearly given information available. This one, comprising 68 A4 (210 x 297mm) pages plus circuit and block diagrams, is no exception.

The manual begins with an exploded drawing of the front panel controls, with the function of each clearly labelled, plus a reference to every page where you will find further information about that particular knob, button or indicator. The rear panel connectors are similarly dealt with in another drawing.

The following pages carry more detailed descriptions of each feature, and alongside each one there is a small drawing of the front or rear panel in dotted lines, with the item under discussion picked out in heavy black lines. Further sections deal with installation, system interconnections, general operation and antenna tuner operation, functions operation, memory and scanning operation, circuit description, maintenance and adjustments, and finally, installing options. A number of internal views identify

major components and preset adjustments.

## Control

The IC-761 has 32 memories which store both frequency and mode. It can be linked to any computer having an RS-232 socket, by using the serial port on the rear panel and the CI-V remote control interface which is fitted as standard. This facility enables a computer to control frequency, mode, VFO A/B selection and memories. The transceiver's operating system is held permanently in ROM and is not dependent on the lithium battery, which is used only for memory back-up.

I think that the tuning knob is really the heart of operating a transceiver, and the control on the IC-761 in my opinion makes the rig. It is beautifully smooth and has a soft-touch rubber ring around it, which adds to the pleasure of operation. There is also the facility of an adjustable friction brake, by which means the operator can alter the "drag" to suit his or her preference. I have commented on the smoothness of the Icom tuning knobs in past reviews, and I think that other manufacturers could well learn something from Icom in this regard.

The tuning knob has three rates of frequency change. When turned relatively slowly, the frequency changes in 10Hz steps, but turning the knob faster

*Practical Wireless, February 1988*

# REALISTIC® PORTABLE SCANNERS



## ...THE PROFESSIONALS CHOICE

**A** Realistic PRO-32 Programmable 200-Channel Scanner. Stay tuned to the action with this full-feature microprocessor-controlled scanner - all in a hand-held size. Scan up to 200 channels in these bands: 68-88 MHz VHF-Lo, 108-136 MHz (AM) Aircraft, 138-174 MHz VHF, 380-512 MHz UHF. Features two scan/search speeds, easy-to-read LCD display, squelch control, priority function and lock-out key for bypassing unwanted channels. Built-in speaker and earphone socket. Requires 6 "AA" batteries. Memory backup requires 3 silver-oxide batteries.

20-9133 ..... £249.95

**B** Realistic PRO-38 Programmable 10-Channel Scanner. Listen to HAMS, VHF marine and much more! A compact-sized microprocessor-controlled portable scanner with direct keyboard frequency entry so you'll never have to buy crystals! Features include LCD display, review key for displaying frequencies, keyboard-lock switch and squelch control for noise-free listening. With built-in speaker, earphone socket and handy belt-clip. Scan 10 channels in these bands; 68-88 MHz VHF-Lo, 136-174 MHz VHF-Hi and 406-512 MHz UHF. Requires 5 "AA" batteries. 20-9139 ..... £129.95

# Tandy®

Tuning You Into A World Of Better Listening

Over 400 Tandy Stores and Dealerships Nationwide.

Tandy (U.K.), Tandy Centre, Leamore Lane, Bloxwich, West Midlands. WS2 7PS.

# ★ MAKER'S SPECIFICATIONS

## TRANSMITTER

**Frequency coverage:** 1.8 - 2.0MHz (160m)  
3.45- 4.1MHz (80m)  
6.95- 7.5MHz (40m)  
9.95-10.5MHz (30m)  
13.95-14.5MHz (20m)  
17.95-18.5MHz (17m)  
20.95-21.5MHz (15m)  
24.45-25.1MHz (12m)  
27.95-30.0MHz (10m)

**RF power output:** a.m.: 40W max.  
c.w./f.m./RTTY: 100W max.  
s.s.b.: 100W p.e.p. max

**Carrier suppression:** More than 40dB below peak output

**Unwanted sideband:** Better than -55dB with 1kHz a.f. input

**Spurious emissions:** More than 60dB below peak output

**Microphone:** Impedance 600Ω

**Deviation (f.m.):** ±5kHz max.

**RTTY shift:** 170Hz, 850Hz

## RECEIVER

**Frequency coverage:** \*General coverage:  
100kHz-30.0MHz Ham bands (as for Transmitter)

**Intermediate frequencies:** 70.4515MHz, 9.01MHz, 455kHz, 9.01MHz\*  
\*not used on f.m.

**Sensitivity:** Input in μV for 10dB S/N with pre-amp ON less than:

Mode	100 to 500kHz	0.5 to 1.6MHz	1.6 to 30MHz
s.s.b./c.w./RTTY	0.5	1.0	0.15
a.m. (Narrow)	3.0	6.0	1.0
f.m. (for 12dB SINAD)	0.3 from 28-30MHz		

**Squelch sensitivity:** Less than 0.3μV

**Selectivity:** (-6/60dB)  
s.s.b. (filter switch on) 2.4/3.8kHz  
c.w./RTTY (filter switch on) 500/1000Hz  
a.m. 6/18kHz  
f.m. 15/30kHz

**Notch filter:** Better than -45dB

**RIT variable range:** ±9.9kHz

**Audio output:** More than 2.6W into 8Ω with 10% t.h.d.

## ANTENNA TUNER

**Output matching range:** 16.7-150Ω unbalanced

**Minimum power output:** 8W

**Band switching time:** 3 seconds or less

**Auto tuning time:** 3 seconds or less

**Auto tuning accuracy:** To v.s.w.r. 1.2:1 or less

**Insertion loss:** 0.5dB or less (when tuned)

## GENERAL

**Antenna impedance:** 50Ω unbalanced (tuner off)

**Power requirements:** 200-240V a.c.  
650VA max. transmit  
80VA max. receive

**Frequency stability:** Better than ±100Hz in the range -10° to +60°C

**Dimensions:** W424 x H150 x D390mm excluding projections

**Weight:** 17.5kg

# ★ PW LAB TESTS

## TRANSMITTER

### Outputs in c.w. mode:

Freq. (MHz)	Max. Output (W)	Spurious outputs at 100W (dBc)			
		Harmonics			Other
		2nd	3rd	Higher	
1.81	110	-60	-67	—	—
3.51	115	-68	-66	—	—
7.01	120	-70	—	—	—
10.11	120	-63	-64	—	—
14.01	120	-60	-66	—	—
18.11	120	—	-62	—	—
21.01	120	—	—	—	—
24.91	120	—	—	—	—
28.01	115	—	—	—	—
29.01	115	—	—	—	—

Notes: dBc = dB referenced to carrier.  
— = better than -70dB.

### 2-tone Intermodulation products:

(100W p.e.p. at 14.1MHz using 700 and 1900Hz tones)  
Wanted signals 0dBc  
3rd order products -45/-45dBc  
5th order products -44/-46dBc  
7th order products -47/-46dBc  
9th order products -48/-48dBc

**Carrier suppression:** 46dB (1kHz modulation)

**Unwanted sideband suppression:** -70dB (1kHz modulation)

**Audio response (s.s.b.):** 280-2550Hz (-3dB)

**Maximum deviation (f.m.):** 5kHz

## RECEIVER

**Sensitivity:** (input p.d. in μV for 10dB S + N/N with pre-amp in circuit and Filter switch in Out position)

Freq. (MHz)	c.w./s.s.b.	a.m. (70% mod)	f.m. (3kHz dev)	Input for S9
1.81	0.13	0.41	—	27
3.51	0.12	0.34	—	24
7.01	0.14	0.34	—	23
10.11	0.11	0.33	—	19
14.01	0.12	0.35	—	24
18.11	0.13	0.39	—	24
21.01	0.13	0.32	—	24
24.91	0.11	0.38	—	21
28.01	0.09	0.31	—	20
29.01	0.10	0.57	0.21*	20

Note: \* = for 12dB SINAD

**Blocking dynamic range (s.s.b.):** (single signal, 20kHz off-channel) 110dB

**Dynamic range (s.s.b.):** (two-signal)  
Signal separation from carrier (kHz)      Dynamic range (dB)

20/40	86
50/100	108

**Squelch threshold:** 0.9-460μV (f.m.)

**S-Meter calibration:** (at 14.01MHz u.s.b.)

Reading	Input required	
	μV p.d.	dBμV
S1	1.13	1.0
S2	1.36	2.7
S3	1.72	4.7
S4	2.27	7.2
S5	2.96	9.4
S6	4.5	13
S7	7.3	17
S8	13	22
S9	23	27
S9 + 20dB	244	48
S9 + 40dB	2.2mV	67
S9 + 60dB	14.1mV	83

**Image and i.f. rejection:** Better than 88dB

**AGC threshold:** 1dB gain reduction threshold 1.1μV (s.s.b.)

**RF attenuator:** 22dB at 14.01MHz

**Pre-amplifier:** 8dB at 14.01MHz

**Selectivity: (-6/60dB)**  
c.w. 0.50/1.0kHz  
s.s.b. 2.1/3.4kHz  
a.m. 5.9/16\*kHz  
f.m. 15.8/24\*kHz  
\* for -50dB

**I.F. Notch filter:** 52dB

**Audio output:** 3.1W into 8Ω with 10% t.h.d.

### Test equipment used:

2017 and 2019 signal generators, TF2370 spectrum analyser, 2435 frequency meter, TF2304 modulation meter, TF2337A distortion and SINAD meter, TF2005R two-tone generator, TF893A power meter, TF2163S attenuator, all by Marconi Instruments; Bird Model 43 r.f. power meter plus power attenuators; Hatfield Instruments signal combiner.



increases the steps to 50Hz. The third option is brought into operation by pressing the TS (tuning speed) switch, which increases the steps to 1kHz, ideal for moving rapidly up or down the band.

There are three other ways of changing frequency, the first of which is by use of the UP and DOWN keys. In the HAM BAND mode, these keys step between the amateur bands, going to a preset "initialisation frequency" in each band. In the GENERAL COVERAGE mode, the tuned frequency changes in 1MHz steps. In both modes, the band change "rolls over" to the opposite extreme of the frequency coverage when the upper or lower limit is reached.

The second tuning method is to enter the required frequency directly, using the keypad to the right of the main tuning knob. One can either key in just the megahertz reading, for example "14" for 14MHz—the display will show 14.000.0—or key in the actual frequency required. Frequencies below 1MHz require the "0" key to be pressed first. Having keyed in a frequency, it is activated by pressing ENT to enter, or cancelled by pressing CE (clear entry). The action of the keypad microswitches is very definite and satisfying.

The third tuning method is to use the UP and DOWN buttons on the associated microphone. These change the frequency at the rate of 10Hz for a single press. Sustained pressure on the button results in a continuous change in frequency in the direction selected.

The frequency display, in addition to showing the operating frequency in 10mm-high digits at 100Hz resolution, also includes indication of emission mode, scanning and filter status, r.i.t. and ΔTX offset, v.f.o. in use, split frequency operation, and memory channel selected.

If the optional voice synthesiser board type IC-EX310 is fitted, a touch on the VOICE button will cause the rig to announce the current tuned frequency in a "female" voice. The speed and volume of the speech are adjustable internally.

The various emission modes and the optional narrow c.w. and RTTY filters (if fitted) are selected by means of four MODE buttons and a FUNCTION button. Pressing a MODE button alone selects s.s.b ("normal" sideband—in other words, l.s.b. below 10MHz and u.s.b. above 10MHz), c.w., RTTY or a.m. Pressing the FUNCTION button before a MODE button gives s.s.b. ("reversed" or opposite sideband—u.s.b. below 10MHz and l.s.b. above 10MHz), c.w. narrow, RTTY narrow or f.m.

Different values of receive bandwidth are selected by means of the FILTER switch, using different combinations of internal 2nd (9MHz) and 3rd (455kHz) i.f. filters. At the -6dB points, the bandwidths available are 2.4/2.6kHz on s.s.b., 2.4kHz/500Hz on c.w. and RTTY, 6kHz/2.6kHz on a.m.,

*Practical Wireless, February 1988*

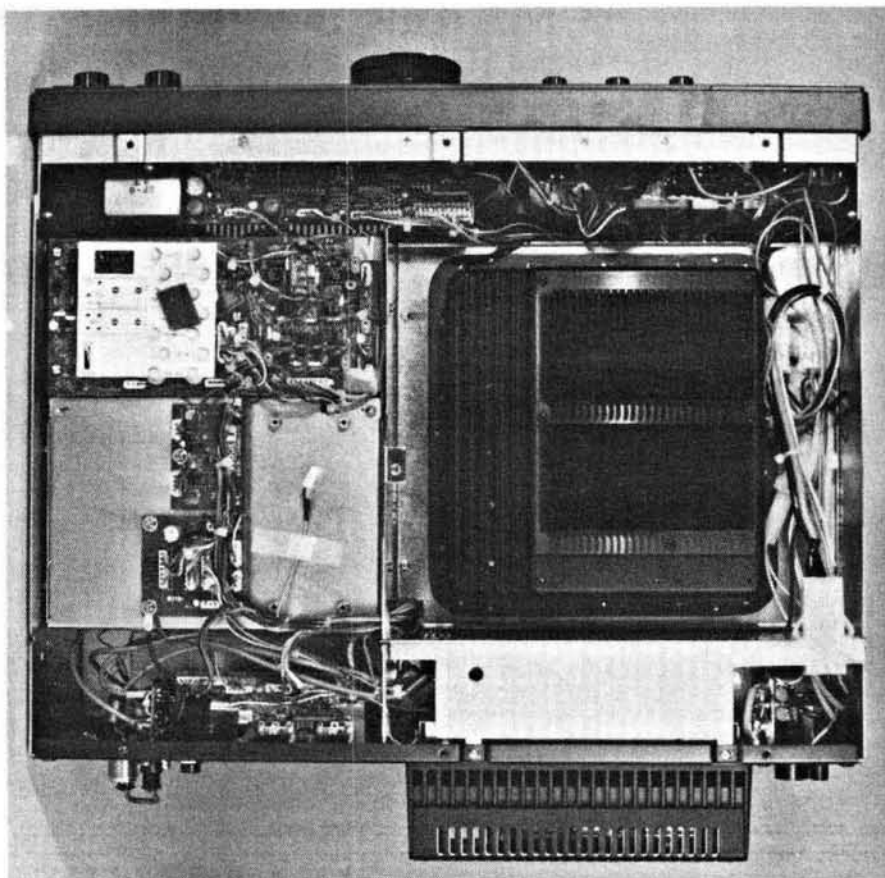

and a fixed bandwidth of 15kHz on f.m. The optional narrow filters previously mentioned give a further selection of 500Hz/250Hz on c.w. and RTTY.

Combined with the facilities of IF SHIFT and PBT (passband tuning), which as usual with Icom rigs, work like magic, these filters allow a contact to be continued in spite of seemingly impossible QRM.

The transmitter r.f. power output is adjustable from about 8 watts up to the full rated output of the transceiver by means of the RF PWR control. The transverter socket on the rear panel gives an output of approximately 30mV.

## Scanning

The IC-761 offers three scanning modes, with the option of either having the scanning stop permanently when a signal opens the squelch, or pausing for 10 seconds and then resuming scanning. The three modes are:

1. **Programmed scan**—the receiver scans between the frequencies entered in memory channels 01 and 02. When in HAM BAND mode, these two frequencies must be in the same amateur band.
2. **Memory channel scan**—the receiver scans every memory channel having frequency information programmed into it, but skips blank channels.
3. **Selected mode memory scan**—the receiver scans every memory channel containing frequencies with the same emission mode as the displayed frequency.

## Operation

The antenna system at this QTH is by no means an elaborate one, being just a compressed 80m dipole. It is fed with 4.5 metres of 300Ω ribbon, changing to 50Ω coaxial cable for the remainder of its run to the shack. The antenna is really a little short for my favourite part of the 3.5MHz band, but with the aid of a KW109 Supermatch it is possible to get a 1:1 v.s.w.r. reading. I was therefore very interested to see how the automatic a.t.u. provided in the IC-761 functioned.

To operate it one has to be in RTTY mode, with the RF PWR control at the 9 o'clock position to give about 15W output. Activating the TRANSMIT switch for a couple of seconds was followed by a few clicks and whirrs, and when the tuner had completed its job the s.w.r. reading was about 1:1. The auto tuner does not function in the GENERAL COVERAGE mode or when scanning. This was not a great hardship in my case at least, as the dipole was sufficient to get good signals from most of the available spectrum.

I tried a CQ call on about 3.650MHz l.s.b., and after a few tries back came a station in Littleport, Cambs. We had a pleasant QSO, and the distant station reported that the transmitter audio quality was excellent. Several more satisfactory contacts were made on the same band during the next few hours, and then in the early evening several 'phone QSOs were made on 40m, where the rig's excellent filtering facilities were utilised to the full. The

automatic a.t.u. successfully coped with my 80m antenna on this band.

While on 40m, I heard a packet radio station, and connected up my PK-232, micro and monitor to see what it was. In due course, I decoded the station, which turned out to be I2LLO starting a new experimental bulletin board. Quickly arranging various leads, I called I2LLO using a.f.s.k., and received an immediate reply. This proved that the IC-761 would work perfectly on packet, without having to use f.s.k., though I must admit that conditions were quite good at the time.

While the leads were connected, I decided to try both RTTY and AMTOR, and contacted G3PLX's mailbox using AMTOR without any trouble on 7.030MHz. It was obvious that the transmit/receive changeover time was sufficiently fast to operate the mode without any modifications being required. I then went on to complete an RTTY contact on 14MHz. The auto a.t.u. also coped with my antenna on that frequency, and although the power output was a little below the maximum, I was given a 599 report.

The performance on the lowest fre-

quencies was very good, sufficient for me to copy the FAX transmissions from the German Meteo station Offebach on 134.2kHz. Even with the untuned antenna, the signal strength appeared adequate. Using the general coverage receiver on the broadcast bands gave perfect copy on pretty well every station heard, even with my limited antenna.

## Conclusions

I could continue at length describing the IC-761. It is a very sophisticated, high-precision unit, giving an impression of silky smoothness in operation.

During the short time I have used it, only the top of the many and varied facilities has been touched. It incorporates the best features of the recent Icom designs; the keypad and the rotary memory switching control from the IC-R71/R7000 receivers, together with a clear, unambiguous display area and correctly positioned controls. I would consider that any amateur deciding on this rig would have no cause to change it for a number of years.

The price of the IC-761 is £2459.00 including VAT. Thanks are due to Icom (UK) Ltd., Sea Street, Herne Bay, Kent CT6 8LD, telephone 0227 363859, for the loan of the review units. **PW**

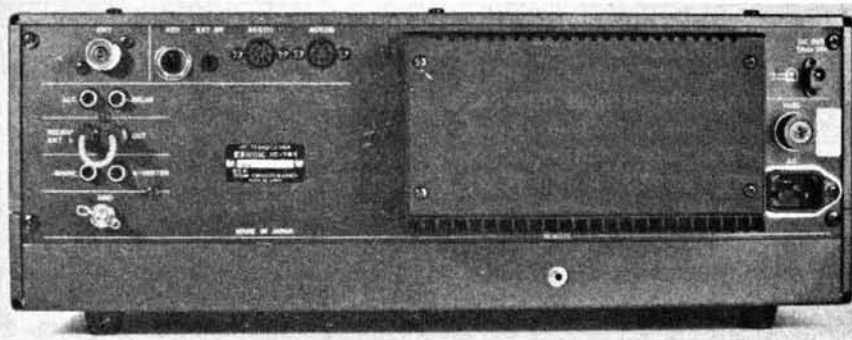

## NEWS DESK

# EXTRA

### Mobile Radio Microphone

The new IQD 900 series mobile radio microphone offers both f.f.s.k. encoding and decoding and is particularly suitable for use of Band III. Housed in a telephone style handset, and microprocessor controlled, the unit provides automatic numerical identification and selective calling.

When used with IQD's radio-to-telephone interconnect Smartpatch 5700, the 900 series allows full call-logging. It can also act as a MODEM and, when connected to a mini printer,

allows the mobile to receive printout of data sent from the base station.

The microphone is used in a manner similar to a cellular telephone, except that the user presses the p.t.t. before speaking into the mouthpiece. The keyboard allows digits to be entered and stored. These are then sent in a burst of f.f.s.k. on pressing the SEND button. Microphone audio is muted during tone transmission and the microphone element is used as a tone monitor speaker.

**IQD Ltd.**  
North Street,  
Crewkerne,  
Somerset TA18 7AR.

### Digital Multimeter

TMK Instruments model G60 is a fully autoranging digital multimeter with a range hold facility. Results are shown on a large, clear 3½ digit, l.c.d. together with polarity, decimal point, units of measurement, overrange indication and a low battery early warning indicator.

Functions include d.c. volts in five ranges to 1000V with a basic accuracy of 0.5%, a.c. volts in four ranges to 750V, resistance in six ranges to 20MΩ with a switchable continuity buzzer and diode test facility. Current measurement, both d.c. and a.c., is available in two ranges to 10A.

Dual slope integration is the operating principle



employed with a measurement sample rate of two per second. All voltage ranges are protected to 1000V d.c. or d.c. plus a.c. peak, and have an input impedance of > 10MΩ, other ranges protected to 250V a.c. and fused.  
**Harris Electronics (London) Ltd.**  
138 Grays Inn Road,  
London WC1X 8AX.

### Inductors

Toko Inc., have announced the introduction of their 43 Series of Chip Inductors. They are available with inductances ranging from 1μH to 1mH with rated currents up to 250mA d.c.

The Toko range have been developed for surface mounting and the structure is such that the function and performance are comparable

with inductors currently used in various electronic equipment.

The 43 series are available in two versions for either dip or reflow soldering and packed in trays or reels for automatic insertion. Full technical data and price information can be obtained from:  
**Circuit Holdings PLC.**  
Park Lane,  
Broxbourne,  
Herts EN10 7NQ.



# ELEMENTARY MATHEMATICS!

## The problem:

I want to operate 2m and 70cm mobile. I want full duplex facilities so that I can transmit on one band whilst listening on the other. What are my choices and what is the best solution?

2m FM transceiver	£300.00
70cm FM transceiver	£350.00
2m/70cm duplexer	£26.00
<b>Total cost of above:</b>	<b>£686.00</b>

The above are based on typical market prices.

## The solution:

### DUAL BANDER

- ★ 2M/70cms
- ★ 25 Watts
- ★ Full Duplex
- ★ Built-in Diplexer/Dual VFO
- ★ Small size/21 memories

**£449!**

### ALD-24E



What can you say about this transceiver other than praise? The new ALINCO ALD-24E has brought the cost of dual banders down to a price that makes it a serious option to the 2 metre only rig. Just think of the pleasure of being able to select 2m or 70cms at the press of a button. No aerial switching (duplexer built in) and full duplex operation. The ALINCO actually has two completely separate transceivers built into its small case measuring 5.5" x 2" x 6.5". It has all the features of the ALR-22E (see below) at a huge saving over its competitors. We could mention the extended receiver coverage of 138-174MHz & 420-454MHz at no extra charge, but then everybody would want one! So we thought that we'd simply invite you to send for the full colour brochure instead.

### ALR-22E 2M FM MOBILE



### THE RADIO COSTS

**£249**

### THE SCANNER COMES FREE!

- ★ 25 Watts FM
- ★ 21 Memories
- ★ Rx 138-174MHz
- ★ Mini-size

ALINCO products are hitting the market in a big way. And the ALR-22E must rank as today's best buy. When you buy the ALR-22E you don't just purchase a 2 metre mobile, you purchase a vhf scanner as well. For no extra cost we will extend the frequency coverage to 138-174MHz. All this for a price that puts the competition in the shade! Features include 21 memory channels, programmable scan, priority channel options, programmable splits, reverse repeater button, dual speed scanning optional delay, back-lighted LCD display, dual vfo, lithium battery back-up, 25/12.5kHz steps, mini size measuring 5.5" x 1.5" x 6.5", up/down microphone control, quick release mobile bracket plus mounting hardware, superb sensitivity, 5 watt low power position, manual or electrical tuning, 12 months parts and labour warranty etc. With a specification like this we suggest you phone for colour brochure, today.

### 2M MICRO HANDHELD

- ★ 3 Watts FM
- ★ Memory Channel
- ★ Battery Save
- ★ Smallest in World ALX-2E

**£189!**

The ALX-2E is a truly pocket transceiver. Capable of 3 watts output it covers the full 140-150MHz using the familiar thumbwheel dial. Features include memory channel, scanning, priority, battery saver, tone-burst, 600kHz shift etc. Supplied complete with nicad pack, AC charger, 12v DC charger, and helical. Accessories available include case, car cigar adaptor, headphone/mic, various batt. packs etc.



### ALINCO 2m LINEARS

The new ALINCO amplifiers are great value. Compact, reliable and low priced. Now you can boost the power of your handheld without boosting your overdraft!



**ELH 230D<sub>2</sub>**  
1-3 & 5w i/p 30w out  
Gasfet pre-amp  
Vot or PTT  
Full protection  
£75.00 inc vat

**ELH260D**  
1-3w i/p 50w out  
Switch pre-amp  
Vox or PTT  
Output meter  
£119.00 inc vat

### NEW REVEX METER

#### W570

- ★ 1.6-1300MHz
- ★ RMS/PEP
- ★ 0-200 watts



The REVEX VSWR/Power meter will provide all your needs from HF to UHF. Fitted with dual sensors, the first covers 1.6-230MHz and the second 400-1300MHz. The ranges are 5,20 and 200 watts FSD, both average and pep. "N" sockets are fitted to the UHF sensor. Made by the WELZ factory, the W570 will provide all your needs.

**£119 plus £2 post.**

### UK'S BEST FREQUENCY GUIDES

#### UK LISTENERS CONFIDENTIAL FREQUENCY LIST

Everything you have ever wanted to know about stations between 1.6 & 30MHz. Includes aviation, marine, military, press, broadcast and more. Not an import, but a proper UK written book of 130 pages.  
**Price £5.95 + 90p post.**

#### COMPLETE GUIDE TO VHF/UHF FREQUENCIES 26-1300MHz (New 1988 Edition)

Now you can learn exactly where all the main users of this spectrum are located. It includes all emergency services, aviation, civil & military, pmr, telephones, cellular, and many other services including duplex splits.  
**Price £5.95 + 90p post.**

#### VHF/UHF AIRBAND FREQUENCY GUIDE

A complete list of aviation frequencies of civil & military users. A proper manual with text and photos and free supplement of the latest changes. Don't waste money on cheap photo sheets, get the proper book at this bargain price.  
**Price £5.95 + 90p post.**

### SONY COMMUNICATIONS

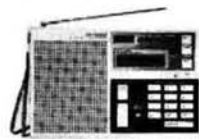

£169 FREE SECURICOR

**FREE 24 HOUR DELIVERY ON SONY OVER £100**

We are appointed UK stockists with Warranty facilities.  
**Not all dealers are!**

#### ICF 7600DS

7600DS	AM/SSB Pocket size 150KHz-30MHz	£169.00
2001D	AM/USB/LSB all band + Airband VHF	£329.00
AIR-7	108-174MHz hand-held plus b'cast	£247.00
PRO80	HF/VHF AM/SSB handheld plus b'cast	£329.00
AN-1	Active antenna for 7600/2002	£49.00
AN-3	VHF antenna with 50ft coax	£45.00
ACD-4	Mains AC adaptor Air7/PRO 80	£16.95
BP23	Ni-cad battery pack	£16.95
DCC-12A	DC car adaptor all models	£16.95

### NEW EDITION

#### HF OCEANIC AIRBAND COMMUNICATIONS

Completely updated and expanded, this new edition provides a comprehensive list of frequencies and editorial about this fascinating subject. Covering both civil and military users, the latest edition of this popular guide will tell you all you could ever wish to know about this fascinating subject. The large A4 format is professionally typeset and provides rapid access to the complete HF aviation network.  
**£3.50 + 70p p&p**



RETAIL & MAIL ORDER:- 18-20, Main Road, Hockley, Essex SS5 4QS.

Tel: (0702) 206835, 204965

RETAIL ONLY:- 12, North Street, Hornchurch, Essex RM11 1QX.

Tel: (04024) 44765

Visa and Access by telephone. 24hr. Answerphone.

# Amateur Radio in Australia

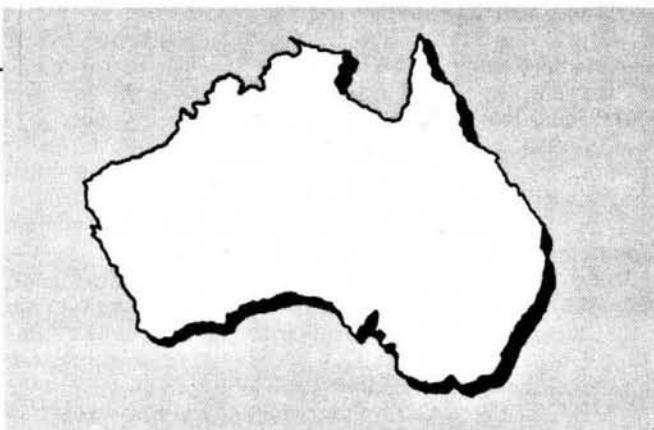

*Here's the next report from Greg Baker, keeping us up to date with the news from Down Under.*

Summer is over and good February rains at my QTH seem to have reduced the fire danger somewhat. When you live in the bush, as I do, fires are a constant summer worry and I am always glad when autumn arrives.

## Repeaters

VK5RWH, Australia's first 1.3GHz (23cm) ATV repeater became operational in December 1986. With input frequencies of 444.250MHz (vision) and 449.750MHz (sound) and output frequencies of 1246.250MHz (vision) and 1251.250MHz (sound), VK5RWH is installed on Willunga Hill, 40km south of Adelaide. It uses an Alford slot transmitting antenna, and until finances of the Southern Amateur Television Group allow upgrading, has power output of 1 watt. The repeater was needed because the existing Adelaide 430MHz (70cm) ATV repeater VK5RTV gave poor coverage into southern Adelaide.

From September 1986, the Department of Communications (DOC), permitted repeater cross-linking within Australia. In general, up to three repeaters can be interlinked to extend the range and area of coverage of individual operators. In addition, DOC will consider requests to interlink more than three repeaters for Wireless Institute of Australia (WIA) regular scheduled broadcasts or for the Wireless Institute Civil Emergency Network (WICEN) during emergencies.

Repeater linking frequencies will be authorised only on amateur bands above 50MHz. Apart from usual repeater licensing conditions, the cross-links will need to be set up so that amateurs are not re-transmitted on bands they are not authorised to use. This provision is to ensure that holders of limited licences who are restricted to 50MHz and over are not retransmitted through 29MHz f.m. repeaters. In addition, provisions have been made to enable repeaters to be permanently or temporarily interlinked to give flexibility at all times.

The first interlinked repeaters will be 144MHz (2m) repeaters in Victoria. The Victorian Division of the WIA,

following the disastrous 1983 Ash Wednesday fires, plans to cross link three separate sets of three repeaters in bush fire prone areas to extend the range of emergency traffic. These will be in East Gippsland, 300km east of Melbourne (VK3REG Cann River, VK3REB Nowa Nowa and VK3RGO Omeo), in north eastern Victoria, 250km north east of Melbourne near the New South Wales (NSW) border (VK3RNE Wodonga, VK3RPB Bright, and VK3RNC Corryong), and in north western Victoria, 400km north west of Melbourne, near the NSW-South Australian border (VK3RMA Mildura, VK3RVL Robinvale, and VK3RON Ouyen). VK3RVL is located on top of a wheat silo!

Given the cost of providing mains power to mountain top locations and the relatively high solar radiation incidence in Australia, it is often more economical to power repeaters by solar energy. Typical installations are those of the Glen Innes Radio Club's northern NSW 144MHz repeater VK2RNE and the Swan Hill District Radio Club's Murray River 144MHz VK3RSH.

These systems use solar panels putting out 12 volts nominal regulated into a 12 volt battery bank. VK2RNE uses two Solarex panels, charging at over 5 amps in good conditions, with a locally designed and built regulator and two Century 613PG 110Ah 6 volt home-lighting batteries in series. This is sufficient for the 144MHz repeater and a heavily used co-sited v.h.f. CB repeater. To overcome the problem of electrolyte stratification which arises when stationary cells are continuously trickle charged, the cells are charged at 10 to 15 amps from a generator during regular maintenance perhaps four times a year. This allows the cells to gas and stir the electrolyte.

VK3RSH uses a single panel putting 2.4 amps peak unregulated into a bank of six ex-Australian Telecom 200Ah two volt cells. While these lead acid cells have a high leakage current, they have proved very satisfactory since October 1985 when they were installed. One problem with solar power

is, of course, the possibility of insufficient solar radiation to charge the cells either due to heavy usage or to inclement weather. VK3RSH has been no exception, with poor weather closing the repeater on several occasions. Unfortunately, inclement weather also means impassable roads to the repeater, so boost charging from a generator has not been possible. Nonetheless, the choice between a solar-powered repeater with a few days a year out, and no repeater is not really a choice at all. Australia has two solar panel manufacturers, Solarex and BP Solar. The silicon cells themselves are imported, but connected and encapsulated locally. Retail prices are about \$A11.50 (£5 at current exchange rates) for the cheapest panes per peak watt (Solarex X100GT 42 watt peak polycrystalline, silicon encapsulated, \$A490 (£210), and BP Solar BP1244HP 45 watts peak monocrystalline, ethylene vinyl acetate encapsulated, \$A520 (£220)).

My own QTH, though only 300m from an 11 000 volt main, would cost in the vicinity of \$A6 000 (£2 600) to grid connect. Given this large outlay, we have chosen to run the house on solar power exclusively, and currently have two interconnectable systems, the smaller as an emergency back up to the larger.

One has 12 GL3641/12 (now BP1238) BP Solar panels putting 40 peak watts into three banks of six series connected Century 227PG two volt cell each of 225Ah capacity. This makes 675Ah at 12 volts. The other system uses one X100G and one X100GT Solarex panel putting about 80 peak watts into another six Century 227PG two volt cells.

Total capacity is thus about 900Ah used for lighting, radio, equipment, television and refrigeration.

## Examples and Licensing

The number of licensed amateurs has increased marginally to 16 480 (3010 novice, 2960 limited, 1170 combined, 9240 full call, and 100 beacons), the annual licence fee for full calls has

*Practical Wireless, February 1988*

grown to \$A26 (£11) and WIA membership fees are up to about \$A34 (£14.50) depending on state division.

The licensing debate sparked by Jim VK3PC and Roger VK2ZTB has died down with no changes in sight, to be replaced by discussion on examinations. DOC has floated the idea that amateur organisations become responsible for amateur examinations and licence recommendations to DOC. It has requested comment from amateur clubs, colleges of Technical and Further Education (TAFE), the WIA and the commercial amateur press.

Subject to strict DOC guidelines, educational institutions and amateur clubs would be able to conduct radio certificate examinations, including telegraphy receiving and sending tests at five and 10 w.p.m.

The move to devolve amateur exams is part of a continuing process for DOC, which has already withdrawn from all examination functions except those for amateurs and certain marine operators. Apart from the obvious cost and manpower savings to DOC from such a proposal, they see that prospective amateurs would be able to be given greater choice of examination times, dates and places. At the moment, examinations are only conducted four times per year, during business hours of weekdays, and only in major cities and towns. DOC believes that out of hours examinations would become possible as well as examinations in more centres if their proposal was put in place.

Amateur press debate to date (which no doubt has parallels with the UK experience) hinges around two main points. The first is what role the WIA would play and the second is the issue of conflict of interest.

Debate on the role of the WIA appears to be a continuation of a tussle between members and non-members which has been underway for some years. Many non-members are con-

cerned at what they see as the "big brother" position of the WIA. They fear that if the DOC proposal to hand over the current question bank to WIA goes ahead, WIA will be in a more dominant position with respect to amateurs and prospective amateurs than they are at the moment.

In addition, given the purely voluntary nature of WIA positions and the fact that personnel are stretched to the limit with their current work load, there is the fear that the WIA would not be able to handle examinations in any case.

As regards telegraphy tests, there has also been suggestion in some circles that the WIA is not able to provide sufficient competent or willing operators to conduct c.w. transmitting examinations. In part this could be overcome by recording candidates' Morse transmissions for later marking, and this too would be of help to those in areas remote from examination centres.

Other critics of the proposal see that a conflict of interest could arise if course instructors were to devise examinations or when self-taught non-members front an examination set by an organisation such as the WIA. This is in part a maintenance of standards argument. With many schools and colleges already adjusting pass marks to improve pass rates, whether to attract students or course funding, the fear in some circles is that despite DOC's watchdog role, standards would fall. This is countered by those who suggest that DOC maintain, as it does now, a large question bank that are drawn on by examining bodies, and that completed examination papers be returned to DOC or WIA for marking. Others suggest, on the other hand, that current DOC standards are not strict enough in any case, and that handing over the question bank to WIA would help improve standards.

DOC wants to have the examination

question resolved and a new system in place by 1 January 1988.

**VK amateurs, s.w.i.s and anyone else with information of interest to PW readers can contact me at PO Box 93, Braidwood, NSW, 2622, Australia.**

## Other News

An Australian company, Captain Communications, have developed a new re-usable, solderless and easy to use PL259 connector. The centre conductor is crimped and the braid and outer sheath are held with a so-called shield lock. Confident that the connector is secure they have challenged anyone to part the connector from the cable. Given that most conventional PL259's are not re-usable and the new Teflock PL259 is at least on the local market, cheaper than imports. Captain Communications are confident of good sales.

And an item from *Amateur Radio Action* magazine on personalised number plates. For an annual fee, some Australian states allow motor vehicle owners to specify their own number plates. In NSW this fee is \$A180 (£77) per annum. Currently there are 4 000 such plates, including four amateur call-signs—VK2AGE, VK2AOT, VK2COD and VK2KEW. South Australia apparently does not yet have a system flexible enough to handle VK5 call signs, but authorities are working to allow it in the future.

# RADIO SHACK FOR SCANNERS – AND AMATEUR EQUIPMENT

**THE FINEST EVER SCANNER AT AN UNBEATABLE PRICE  
25-520, 760-1300 MHz, 300 MEMORIES ALL FOR £349.95**



**£349.95  
(P&P £3.45)**

Continuous tuning from 25 to 520 MHz and 760 to 1300 MHz 300 permanent memories in ten banks of 30 plus an additional ten channels used for temporary storage when in search mode. Switchable audio squelch allows you to ignore blank carriers. Three reception modes, AM, FM, (Wide) and FM (Narrow). Adjustable step size, 5kHz, 12.5 kHz and 50 kHz. Sensitivity (NFM) 0.5uV for 20dB S/N up to 1100 MHz Extremely attractive, information packed blue LCD display Headphone jack socket, tape recorder socket, external speaker socket, attenuator switch, 240 Volt operation and 13.8 VDC with optional mobile power lead.

MAIN AGENTS FOR

ICOM KENWOOD YAESU



AND ALL LEADING MAKES



**RADIO SHACK LTD**

(Just around the corner from West Hampstead Station on the Jubilee Line)

Giro Account No. 588 7151 Telephone: 01-624 7174 Telex: 23718

188 BROADHURST GARDENS,  
LONDON NW6 3AY



# Vertical Antennas

Vertical antennas are an interesting section of a fascinating subject. Many is the operator, on the 3.5MHz band or elsewhere, who will declare roundly that on the basis of his tests "verticals just don't work!" and will produce some "evidence" in support of his proposition, says P. Newton.

Imagine, if you will, a pin, stuck to a sheet of polished metal with Blu-Tack or similar. Note the reflection of the pin in the metal, Fig. 1. Now, do the same experiment but with a piece of matrix board, Fig. 2. In one case, there is quite clearly an image of the pin in the substrate, and in the other there is virtually no reflection. Don't be confused by any shadows from the lighting. You can always use a "borrowed" handbag mirror, of course, but remember the mirror is silvered on the underside so the analogy isn't exact.

Bear in mind that light waves and radio waves are the same animal; only the frequency has changed. Then, place the shiny metal and pin on a table and look at it. Notice a few things:

1: If you look at it from vertically above the pin, you can't really say it is visible, and certainly the image is quite invisible. Therefore, we can say that vertically upwards is hardly a preferred direction!

2: If now you bring the eye slowly downwards until you are looking horizontally across the mirrored surface, now you can see the pin but not the image. As you slowly traversed down to this position from the first one, note that initially you could see all of the reflected image, but as you come nearer to the horizontal there came a time when the image progressively started to disappear off the edge of the mirror, until at the horizontal the image was invisible.

What is the difference between the shiny metal or mirror analogy and the vertical in the back yard? Simply that the pin is thousands of wavelengths long (it's a perfect analogy of a vertical a couple of kilometres high!) and, of course, that our practical ground looks far less conductive than the metal base, although not quite as bad as the matrix board used in the experiment. Even if we used the handbag mirror, the reflector equates to an estate which is tens of kilometres square. So, at first sight the best (and only) place a vertical is of use is /MM over a calm sea!

## Questions

We should now be asking ourselves just what has the last few minutes of experimentation added to our antenna knowledge?

1: Quite clearly, any vertical antenna fed against ground requires us to carry out operations analogous to the silver-

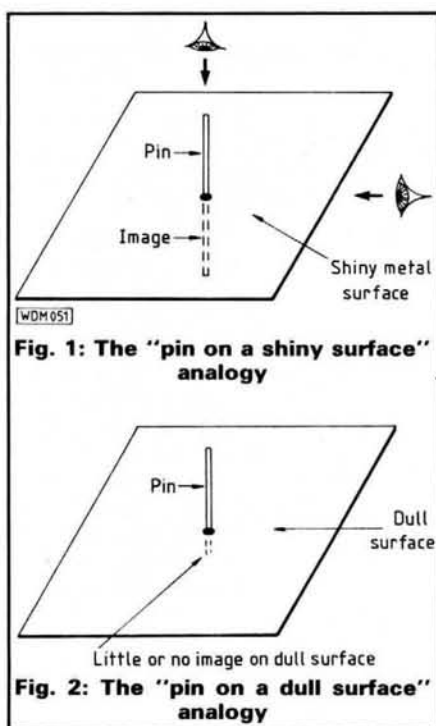

ing on the back of the mirror, to create the image. When a vertical antenna is operating, fed against ground, the capacitance between the vertical above ground and the image in the ground must set up currents in the ground which need to get back to the feed point. Thus we "silver the mirror" by laying down as many radials as we can, Fig. 3.

2: The currents induced in the ground are only going to be significant (in terms of feed-impedance questions) within a short distance from the feed-

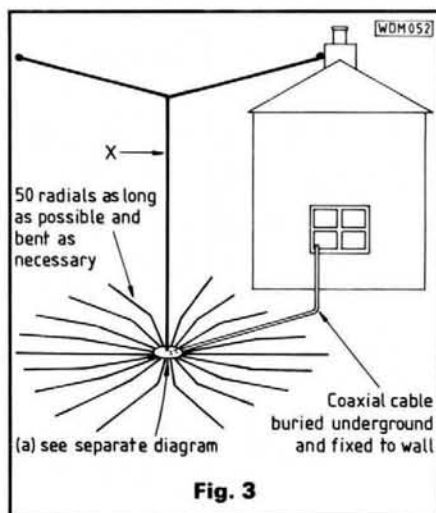

point. For example, even the broadcasters only use a radial farm extending out no more than a half wavelength long. Beyond this distance, the currents are small enough that longer radials won't have a significant effect on the feed point impedance. However, were we able to take a large estate of land, smooth it and copper-plate it, we would see a difference in the radiation pattern of the antenna.

The diagrams shown in the text books indicate that maximum radiation occurs straight along the ground, but clearly this must assume perfect ground extending from under the antenna in all directions out to infinity. This never occurs in practice, and the degree to which any given site deviates from perfection varies enormously. Thus a vertical antenna, fed against ground, needs a super earthing system to both "silver the mirror" to provide a good image and to provide good-to-better soil conductivity outwards for many wavelengths.

Why the inconsistency in behaviour, then, of grounded systems as compared with horizontal dipoles? Basically the horizontal dipole has both "legs" up in the air. "Silvering the mirror" under a horizontal dipole will serve to reveal an "image" dipole in the ground. This image will, in conjunction with the real dipole, operate as a phased pair, but this is only a matter of, at most, 3dB.

In the vertical case, we have other effects to take into consideration. There is the effect of varying ground conductivity under the antenna (and hence the formation of the image without which the quarter-wave vertical can't be fed), the effect of the ground quality out in the deep field and the further effects in the ground closer in. So a variation of 50dB would not seem in any way amiss, and is indeed quite clearly seen in practical cases. This is why people who are prepared to take the trouble, or to find a suitable site, or both, can manage to brew up such enormous signals on the 1.8MHz band by attention to the earth rather than the antenna itself. The commonly offered explanation of, "Oh, he's running over the top in power!" doesn't ring true.

## What to Do

Obviously, if one only has a small garden, there is going to be a big *Practical Wireless*, February 1988

attraction for the vertical antenna, if only because of its small space requirement. This being the case, we must simply work at everything that is within our control and accept that we may have a site where grounded vertical "won't work", in which case we are going to have to scratch about a bit.

First and foremost we must "silver the mirror". In my garden, which is about 7.5 x 7.5m, the vertical sits in the middle (or as near as I can get it). Running outwards from it are fifty radials, each buried about two or three centimetres in the ground, all soldered to a couple of "earth tags" made from the lid of a food tin. In turn, these are bolted to the earth fixings holding the antenna to the stub post sticking out of the ground. The coaxial feed is also buried two or three centimetres and runs into my house.

In my case, there are no trees of any significant size near enough to be a nuisance, although at a previous QTH a ground-mounted vertical was totally useless simply because it was surrounded by trees. So, if you have trees, then get your vertical up and into a ground-plane configuration.

However, how do we satisfy ourself that a vertical will work at our QTH before parting with hard-earned cash? The best solution is to build a single-band one, on a favoured band, and "see what happens" for a few operating sessions. Don't forget to compare notes with someone else to get a comparison view of "conditions".

If the ground-mounted arrangement won't work well enough you can try using a vertical dipole; bear in mind that the vertical dipole and the elevated ground-mounted arrangement requires the presence of the image before it can be even fed properly.

## Traps and Loading Coils

Almost all the books will tell you that the losses in these are quite devastat-

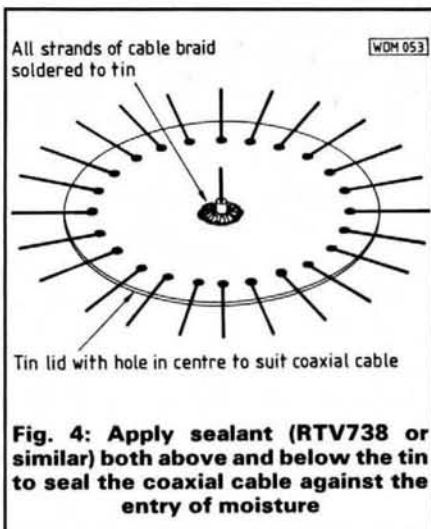

ing, but keep a sense of proportion about this. In truth, a 1.8MHz mobile whip might have a radiation resistance of 0.1Ω and coil resistance of 25Ω, plus another 100Ω or so in the earthy side of the system. So only the odd milliwatt can ever radiate. However, if the 1.8MHz mobile whip is, say, 100kHz off tune, far less still will be radiated.

To give a practical example. A series of whips having loading coils from "superb" to "abysmal" were made. At resonance they all produced 59 signals out to 48km or more; off resonance none was audible at 2km! All the tests used the same rig, and the field-strength meter used for tune-up confirmed that our results were sensible. The loading coils accounted for maybe 6dB variation, but incorrect tuning could produce a 60dB fall-off simply because you can't get the power into the antenna. If you can bring the system to resonance with your a.t.u., you can make it accept power, but you can't predict where it will put the power.

Thus, if you use a trapped vertical, follow the instructions at first. Get it tuned, as per the instructions, measure field strength for a given power and then see if you can improve it. Check

each time with the field strength meter and the same power and compare the v.s.w.r., which should not normally get worse. As far as I can tell, on 14MHz, a grounded quarter-wave cut for the band, compared with 14MHz from the 14 AVQ over the same ground is down by a dB or less. Certainly a difference small enough that I can't measure it with home-brewed test equipment, even though I can see it.

Possibly the easiest way to create a "temporary" ground-mounted vertical for tests, is to hang it up from a catenary suspended between a mast and the house. To connect the coaxial cable, perhaps the easiest arrangement is to take a tin-lid and drill a hole in its centre, through which the coaxial cable can be poked. The sheath can then be unstranded and the strands soldered to the tin and some fifty radials soldered around the periphery. The inner can be soldered to a piece of wire of the right length, and the other end tied to the catenary without benefit of insulator if you use terylene cord for the catenary. Lay the radials about two or three centimetres under the soil surface; bear in mind that they will be detuned by the presence of earth around them, so the length of the radials isn't too critical. If you come to the fence and have a bit left over, bend it round and cut it off!

Go back to the shack and measure your s.w.r. across the band. If the best s.w.r. falls near the bottom of the band a bit needs to be trimmed off; if too high, a bit added on. Get the best s.w.r. to lie in the middle of the band, or of your favoured section.

## Conclusions

Vertical antennas take up little real-estate when ground-mounted, but to get them to work properly calls for a vast amount of time to be spent on laying out ground radials. Even then your site may not prove to be amenable.

# SWAP SPOT

Have PRO-30 16 channel v.h.f. Hi/Lo scanner direct access to 22 884 frequencies, boxed. Archer antenna and Garex antenna, charger plus re-chargeables inc, less than 12 months old. Would exchange for incubator to the value of £300. Tel: 0676 40679 Thursdays. D622

Have Yaesu FT-757 line up. Rig, FP-757HD, p.s.u. and FC-757 auto a.t.u. guaranteed till February '88, as new, boxed, 5hrs on the air. Would exchange for ham band transceiver (7B?) or general coverage receiver plus cash. Garry Grigg. Tel: (0625) 530200 (evenings). D624

Have Standard C58 multimode 144MHz portable/mobile, scanning mic, Heatherlite mic, soft case plus strap, NiCads, mobile mount, MM linear/pre-amp. Would exchange for handheld 144MHz f.m. only transceiver plus cash. Garry Grigg. Tel: (0625) 530200 (evening). D624a

Have 144MHz/430MHz multimode, base/mobile comprising FDK  
*Practical Wireless, February 1988*

Got a camera, want a receiver? Got a v.h.f. rig, want some h.f. gear to go with your new G-zero? In fact, have you got anything to trade radio-wise?  
If so, why not advertise it FREE here. Send details, including what equipment you're looking for, to "SWAP SPOT", *Practical Wireless*, Enefco House, The Quay, Poole, Dorset BH15 1PP, for inclusion in the first available issues of the magazine.  
A FEW SIMPLE RULES: Your ad. should follow the format of those appearing below, it must be typed or written in block letters; it must be not more than 40 words long including name and address/telephone number. Swaps only—no items for sale—and one of the items MUST be radio related. Adverts for ILLEGAL CB equipment will not be accepted.  
The appropriate licence must be held by anyone installing or operating a radio transmitter.

Multi 750E, FDK 430MHz Expander, matching FDK mains p.s.u. (scanning, duplex, etc, etc.). Would exchange for h.f. gear or w.h.y? Also wanted 144MHz linear and accessories for Trio 2400. John. Tel: 08482 314. D628

Have photographic lights, two Courtney electronic flash heads, flash meter, brolys, snoot, tripods, reflector, back drops, barns, etc. Immaculate, cost £400, also Akai 4000 reel-to-reel tape deck. Would exchange for u.h.f. scanner or general coverage receiver. Derek. Tel: 09252 21416. D646

# Theory

Part 1 of this series showed how to calculate the field strength and power flux density in free space at a given distance when the transmitter power and the gain of the antenna system are known. We found out in Part 2 how to calculate the received voltage or power when an antenna of known characteristics is placed in a wave front. Putting these together enables us to obtain a basic formula for the performance of a communication system and is fairly easy to do, says A. J. Harwood  
C Eng MIERE G4HHZ.

# Making Waves—A Guide to Propagation

## Part 3—Getting it together

Let's specify the conditions of our system as one having a transmitter of power  $P_t$  watts and a transmitting antenna with a power gain of  $G_t$  over isotropic source. The receiving antenna has an isotropic gain of  $G_r$  and is  $D$  metres from the transmitter. We know that the field strength  $E$  is given by:

$$E = \frac{\sqrt{30 \times P_t}}{D} \text{ volts per metre}$$

and the power flux density is:

$$\frac{P_t}{4\pi \times D^2} \text{ watts per square metre.}$$

Also the aperture  $A$  of the receiving antenna is related to the gain by:

$$A = G \times \frac{\lambda^2}{4\pi}$$

The power  $P_r$  delivered to a matched load is equal to the power flux density multiplied by the aperture, so we get:

$$P_r = P_t \times G_t \times G_r \times \left( \frac{\lambda}{4\pi \times D} \right)^2 \text{ watts}$$

The received power is equal to the product of the transmitted power, the transmit and receive antenna isotropic gains and the expression in brackets.

$$\left( \frac{\lambda}{4\pi \times D} \right)^2$$

which is often referred to as the path attenuation. However, this is a little misleading as it gives the impression that the attenuation due to propagation increases as the frequency increases. As we saw in the last article, however, the factor  $\lambda^2$  in fact belongs to the receiving antenna aperture, the attenuation of the wavefront is in fact independent of frequency for free space.

We now have our basic formula which holds good for free space, it certainly gives the correct result for communication between two satellites and, provided the receiving dish is looking well up into the sky and not at some obstruction then the results are quite useful if one of the satellites is mother earth although we do have to take into account some effects due to the presence of the atmosphere. Let's

have another look at the DBS satellite problem just to see how to use our formula.

If we take the 0.6m diameter dish with a gain of 2860 (34.6dB) we used previously to deliver 7 picowatts to a satellite receiver, what do we need up in the sky? The distance from the British Isles to the satellite in the allotted orbital position at 31 degrees west over the equator is 39 000 kilometres or  $3.9 \times 10^7$  metres and the wavelength is 0.025 metres. By rearranging the formula we can get:

$$P_t \times G_t = \frac{P_r}{G_r} \times \frac{(4\pi \times D)^2}{\lambda^2}$$

Putting in the numbers gives:

$$P_t \times G_t = \frac{(7 \times 10^{-12})}{2860} \times \frac{(4\pi \times 3.9 \times 10^7)^2}{0.025^2}$$

which gives a product of transmitter power and transmitting antenna gain of 94 0591 watts, almost a megawatt! In practice it is intended that the effective isotropic radiated power or e.i.r.p. (which is what the product of transmitter power and isotropic antenna gain is known as) directed towards the edge of the satellite service area will be about 800 000 watts and the maximum e.i.r.p. at the centre of the area will be over one and a quarter megawatts provided by a travelling wave tube delivering about 110 watts to an antenna with a gain of around 14 000 (41.5dB). I leave it to the interested reader to work out the dimensions of such an antenna.

Problems like this are often presented in the form of a link budget, usually expressed in dB, as shown in the right hand column below:

Parameter	Factor	dB
Transmitter power	120 watts	20.8dBW
Losses transmitter to antenna	0.9	0.5dB
Transmit antenna gain	14 000	41.5dB
Path loss	$2.6 \times 10^{-21}$	205.8dB
Additional path loss	0.7	1.5dB
Receive antenna gain (for 0.6m dish)	2860	34.6dB

Multiplying the factors and adding the dB figures gives:

Power to receive front end            8.8pW    -110.9dBW

(The slight discrepancy between the 8.8pW and the -110.9dBW is due to rounding off numbers but is not important in this type of calculation.)

This gives the received power level at the centre of the service area and to ensure that we get the desired coverage the transmitting antenna must have a radiation pattern which gives the correct e.i.r.p. at the edge of the area. The additional path loss is something that must be considered in the real world and is caused by attenuation due to the atmosphere, in particular the water vapour content which absorbs some energy at these frequencies. How much absorption is calculated from statistical experimental evidence obtained from measurements taken over a period of many years on existing satellites. This is an area where experimental work is continuing in order to refine the propagation prediction techniques used.

Now that we know how to do the basic calculations for a system in free space we can begin to look at what happens when we come down to earth. The idea that power is transferred by a wavefront passing through an area leads to the question as to how much of the area can be obstructed before there is a significant effect on the received signal. This problem was studied by the physicist Fresnel as part of his work on the propagation of light.

Fresnel considered what happens when the wave passes through an area centred on a point on the path from the transmitter to receiver and at right angles to the path. He divided this area into a number of zones as shown in Fig. 3.1. The boundary of the first zone is defined by all the points on the circle where the path length from the transmitter to the edge of the zone and on to the receiver is a half wavelength longer than the direct path; the second zone is bounded by the circle for which the path is two half wavelengths longer and

*Practical Wireless, February 1988*



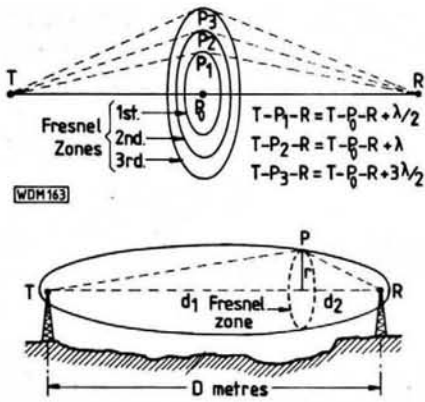

Fig. 3.1

so on; the zones are referred to as Fresnel zones. Plotting the edges of a zone at all the possible locations along the path results in an ellipsoid with the transmitting and receiving antennas at the foci.

The energy passing through the first zone is in antiphase to that passing through the second and in phase again with that of the third, and the total energy arriving at the receiver is the sum of that arriving through all the zones after taking into account the phase difference and this sum can be evaluated.

Using the notation of Fig. 3.1, the radius of the first Fresnel zone can be calculated and, to a close approximation, is given by:

$$r = \sqrt{\frac{d_1 \times d_2 \times \lambda}{(d_1 + d_2)}}$$

We can see that the zone is largest at the centre point of the path and its radius is then given by:

$$r = \frac{\sqrt{D \times \lambda}}{2}$$

since  $d_1 = d_2 = D/2$

At each antenna it is a half wavelength in radius and extends for a quarter wavelength behind them. It is also possible to work out what happens if a screen is brought into the transmission path and it is found that when the screen just touches the lower edge of the first zone then the received signal is about 20 per cent greater than the free space value, whilst if the screen just touches the transmission path thus bisecting all the zones then the received field strength is equal to half the free space value. How the field strength at the receiving point varies as the screen is brought into the transmission path is shown in Fig. 3.2. For practical purposes it can be assumed that if the first Fresnel zone is clear of any obstruction then the received field strength is approximately the freespace value.

Let's look at some common transmission paths to see what sort of

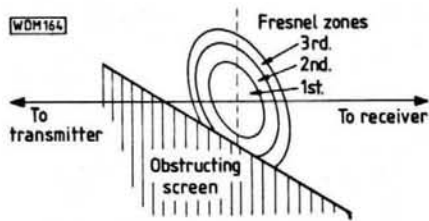

Fig. 3.2

clearance we need at the midpoint to ensure free space propagation conditions. If we take a microwave link operating on 3GHz (a wavelength of 0.1 metres) over a 15 kilometre path the mid path clearance needs to be:

$$0.5 \times \sqrt{15000 \times 0.1} = 19.36 \text{ metres}$$

which can easily be achieved if the terminals are placed reasonably high.

For u.h.f. television at 600MHz ( $\lambda = 0.5$  metres) and a path of 20 kilometres, the clearance works out at 50 metres which for a main station with say a 250 metre mast on an elevated site will ensure Fresnel clearance for most roof mounted receiving antennas. For a small relay with a path length of 5 kilometres the Fresnel zone is about 25 metres radius at the mid path so clearance can also be achieved even with a transmitting antenna height of around 30 metres sited on a reasonably high location overlooking the service area.

There's a different story however when we come to Band II v.h.f. radio. With a wavelength of 3 metres and a 20 kilometre path the zone is 123 metres diameter at mid path. Even with transmitting antennas mounted on tall structures and receiving antennas at

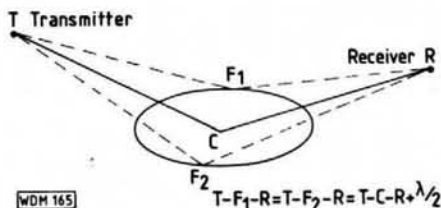

Fig. 3.3

Fig. 3.4. In television reception, the maximum and minimum field strengths occur at different heights on different channels since, although the difference in path length is the same for each channel, the phase difference is due to the difference in wavelengths

Fig. 3.1. The first Fresnel zone is bounded by points such that the distance (T - P - R) is one half wavelength longer than T - R. It is an ellipsoid with a radius:

$$r = \sqrt{\frac{d_1 \times d_2 \times \lambda}{(d_1 + d_2)}}$$

At the midpath this is  $0.5 \times \sqrt{D \times \lambda}$

Fig. 3.2. If an obstructing screen is brought into the transmission path the field strength varies as shown. When the first Fresnel zone is just unobstructed, the field strength is a little greater than the free space value, if the obstruction just touches the transmission path the received field strength is a half the free space value

rooftop height it is unlikely that Fresnel zone clearance will be obtained for a large number of the receiving locations.

A knowledge of the received signals which are found in situations where the path is obstructed is also useful when planning a communications system. It is common to refer to an area where the obstruction is out of the illuminated zone; one where the obstruction comes above the path as the diffraction region. Calculation of signal levels in the diffraction region is important when it comes to estimating the level of a signal which is a possible source of interference such as a distant transmitter using the same frequency in a broadcasting network.

One other way in which the Fresnel zone is important is when we consider reflections. In this case the area which needs to be considered is one where the path from the transmitter through the centre of the reflecting area and on to the receiver is a half wavelength shorter than the path via the edge of the area as shown in Fig. 3.3. For a coherent reflection to occur this area must be clear of obstructions and have a high reflection coefficient, that is little energy is absorbed by the surface

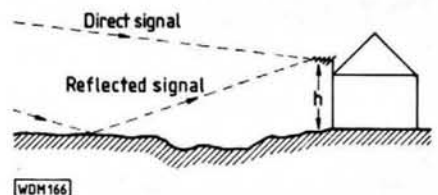

Fig. 3.4. In television reception, the maximum and minimum field strengths occur at different heights on different channels since, although the difference in path length is the same for each channel, the phase difference is due to the difference in wavelengths

and most of it reflected. If these conditions are met then the field strength at the receiver can be calculated by considering the direct and reflected signals as simple rays. They can then be added taking account of their amplitudes and relative phase. Their phase difference is equal to the path length difference in wavelengths, with one wavelength corresponding to 360 degrees of phase, and a phase change of about 180 degrees at the reflection point.

An interesting case of reflections occurring is often encountered in normal domestic television reception. In the United Kingdom four channels are transmitted from each station on frequencies in u.h.f. Bands IV and V with a spread of about 80MHz from the

highest to the lowest (although it can be over twice as great for certain stations). Because for a particular location the transmitting and receiving antennas are common to all four services then the geometry is the same for each channel and hence the path length difference will also be the same. However the phase difference between the direct and the reflected signal also depends on the wavelength which varies between channels. The maximum and minimum values of the combined direct and reflected signal occur where these are in phase and antiphase respectively and will consequently happen at different locations for each channel. If the transmission path is unobstructed and the reflection is a

strong one then the maximum signal level will be about twice the free space field strength and the minimum can be extremely small. The sort of plot of the resultant field strength to be expected for different heights above ground is shown in Fig. 3.4. It is quite possible in practice to have positions where the field strengths are approximately equal on three channels, since the direct and reflected signals are almost in phase, but on the remaining channel they almost cancel and a much lower signal is received. The solution is to choose the position of the receiving antenna carefully and aim for a location such as A on Fig. 3.4, where the spread between channels is not great, and avoid those such as B.

# Tidy up your shack

## NEW STYLE PW BINDERS

**Only £3.95 each** (Including Post, Packing and VAT)



Are you tired of sifting through cardboard boxes and carrier bags to find that useful item in PW?

Our **smart new style** binders, covered in blue plastics, are a must for your library, keeping your radio magazines in good condition and easily accessible.

## HOW TO ORDER

PW Binders are £3.95 each (including Post, Packing and VAT). Send a postal order, cheque or international money order with your order, stating number required to **PW Publishing Limited, FREEPOST, Enefco House, The Quay, Poole, Dorset BH15 1PP**. Payment by Access, Mastercard, Eurocard or Visa also accepted on telephone orders to Poole (0202) 678558. Normally despatched by return of post but please allow 28 days for delivery.



**0202 678558**   (24 hour Answer Service)

# HAVING DIFFICULTY GETTING YOUR COPY OF PRACTICAL WIRELESS ?

Then place a regular order with your newsagent **NOW!**



Dear Newsagent, please reserve/deliver my monthly copy of PRACTICAL WIRELESS

Distributed by Comag

Name \_\_\_\_\_

Address \_\_\_\_\_

Signed \_\_\_\_\_

## PW RADIO PROGRAMS CASSETTES

Each cassette costs £3.75  
(including p & p and VAT)

### FOR THE SINCLAIR SPECTRUM (16/48K)

#### Cassette 3

QRA Locator/Contest Score Calculator  
Distance & Bearing Calculator  
Spurious Mixing Product Calculator  
Callsearch File  
Radio Logbook  
Orbits Calculator (RS3-RS8 and OSCAR 8)  
TV Colour Test-pattern Generator

#### Cassette 5

Antenna & Feeder Calculator  
Radio Range Calculator  
Single-layer Coil & Resonance Calculator  
QSL Card Printer  
Meter Shunt & Multiplier Calculator  
Reactance/Impedance Calculator

### FOR THE BBC Model B

#### Cassette 6

Transmission Lines Calculator  
Tuned Output Stage Design

#### Cassette 7

Universal Locator/Contest Score Calculator  
Bearing & Distance Calculator  
ATV Test Card Generator  
Logbook  
Satellite Tracking

### FOR THE SINCLAIR ZX81

#### Cassette 1

Morse Tutor\*  
QRA Locator/Contest Score Calculator\*  
Distance & Bearing Calculator\*  
Spurious Mixing Product Calculator\*  
Morse Tutor  
Callsearch File  
Radio Logbook  
Orbits Calculator (RS3-RS8 and OSCAR 8)

#### Cassette 2

Structured Morse Learning Course

#### Cassette 4

Antenna & Feeder Calculator  
Radio Range Calculator  
Single-layer Coil & Resonance Calculator  
QSL Card Printer  
Meter Shunt & Multiplier Calculator  
Reactance/Impedance Calculator

\* These programs will run in 1K  
Remainder require 16K of RAM

### FOR THE DRAGON 32

#### Cassette 6

Transmission Lines Calculator  
Tuned Output Stage Design

Send your order, asking for **PW Radio Program No. (followed by the cassette number as quoted above)** to:

Practical Wireless,  
Enefco House,  
The Quay, Poole,  
Dorset BH15 1PP

Please make cheques payable to **Practical Wireless**



## SWAP SPOT

Have nearly new Theasby bandpass filter 2.5kHz to 80MHz, Sony active antenna, Sony ICF-2001 three years old in excellent condition. Would exchange for radio capable of good reception of 473, 792, 1197 USA programmes. Tel. Longdown 370. Tegenza, Ranchi, Longdown, Exeter, Devon. *D728*

Have brand new Pan-Crusader 'X' 12-band all mode professional digital receiver plus instruction handbook. Would exchange for Sony CRF-230 onward models of receiver, or for Grundig, Panasonic or other modern digital receiver. Amoroso, 60 Highfield Road, Salford, Lancashire M6 5LA. Tel: 061-743 1570. *D729*

Have 8K ram pack and Cosmic Cruncher cartridge for VIC20. Would exchange for CEFAX/ORACLE TV adaptor unit plus cash if necessary. 16 Lateward Road, Brentford, Middlesex TW8 0PL. Tel: 01-751 4135. *D735*

Have Datong v.h.f. 144MHz receiver converter Type 144/28 in mint condition. Would exchange for legal CB rig in good condition or 50MHz or w.h.y? Walshe, 9 St Stephens Gardens, Northallerton. Tel: 0609 71636. *D740*

Have FDK-725X 144MHz f.m. 30 watt mobile, dual v.f.o., variable power, Heatherlite mobile safety mic to suit, gutter mount with 5/8λ and 8/8λ whips v.g.c. Would exchange for Cobra 148, Nato 2000 etc., (28MHz?). Tel: 01-247 6097 daytime. *D743*

Have Protel 6000 base mic graphic equalizer 3 compression settings suitable for ham or CB. I.C. ES880 echo chamber, both boxed in mint condition value £130. Would exchange for any 0-30MHz receiver, digital preferred. T. Atkinson, 41 Willow Crescent, Leadgate, Consett, Durham. *D751*

Have FT-790R all mode 430MHz transceiver plus B.N.O.S. 432 1-50 watts linear amp, and Welz-SP-425 s.w.r.-power meter. Would exchange for RTTY terminal unit ST5/MC (BARTG approved), must be in mint condition. (cash adjustment also) or w.h.y? B. J. West, 11 Mynydd Court, Blaendare Road, Pontypool, Gwent NP4 5RR. *D762*

Got a camera, want a receiver? Got a v.h.f. rig, want some h.f. gear to go with your new G-zero? In fact, have you got anything to trade radio-wise?

If so, why not advertise it FREE here. Send details, including what equipment you're looking for, to "SWAP SPOT", Practical Wireless, Enefco House, The Quay, Poole, Dorset BH15 1PP, for inclusion in the first available issues of the magazine.

A FEW SIMPLE RULES: Your ad. should follow the format of those appearing below, it must be typed or written in block letters; it must be not more than 40 words long including name and address/telephone number. Swaps only—no items for sale—and one of the items MUST be radio related. Adverts for ILLEGAL CB equipment will not be accepted.

The appropriate licence must be held by anyone installing or operating a radio transmitter.

Have 432MHz receiver, crystal controlled on RB2 repeater, s.s.b. generator around 5.2MHz, transceiver (on 3.5MHz low power) with 8MHz crystals. Would exchange for Microdrive + cartridge (any condition) J. Brown, 45 Marlborough Avenue, Falmouth, Cornwall TR11 4HS. *D763*

Have CWR-610E RTTY c.w. decoder complete with Novex monochrome monitor and HK-704 Morse key, self-contained needs no computer. May also be used for c.w. practice both sending and receiving. Exchange for 144MHz/430MHz hand-held, test equipment or w.h.y? Tom. Tel: 01-582 7444. *D769*

Have FT-270RH 45 watt f.m. 144MHz mobile in excellent condition box, etc. Would exchange for 144MHz handheld (with cash adjustment) or w.h.y? Jon. Tel: 0249 712009 (Wilts). *D773*

Have military v.h.f. receiver (19 to 157MHz) plus matching p.s.u. No 24 inch leads. Modes c.w., s.s.b., f.m., a.m. all in v.g.c. Would exchange for Europa "C" v.h.f. transverter for 144MHz or FRG-7. Cash adjustment either way (EI/GI only). G. Fitz-Gerald EI6DP. 40 Maigne Way, John Carew Park, Limerick. Tel: Limerick 061-43584. *D778*

Have HRO (5T) table model plus 2 sets of general coverage coils and manual. Would exchange for Codar CR70A or Lafayette HA600. Gerry, Rose Cottage, Church Lane, Newtimber, Hassocks BN6 9BT. Tel: Poynings 538, after 6pm. *D800*

Have Marconiphone model 248 wood cabinet, and Eddystone metal cabinet for Eddystone type 358X receiver. Would exchange or cash adjustment for Eddystone diecast 688 loudspeaker and signal strength meter 669 for Eddystone 888A receiver. Tel: 0926 400876. *D806*



# PW REVIEW



*Having recently become plagued at his home QTH by severe interference from nearby TV receivers and home computers, Geoff Arnold G3GSR has been trying out a QRM Eliminator from S.E.M.*

The principle of this type of interference eliminator is that a signal taken from an auxiliary antenna is mixed with the signal from the main antenna in such a way that the interference is cancelled out.

Ideally, if the main antenna is picking up "wanted" signal plus interference, the auxiliary antenna should pick up only the interference, otherwise some of the "wanted" signal will also be cancelled out in the mixing process. Difficult though this may sound, it is usually possible to come quite close to the ideal.

Several factors come into play here. First, much of the interference from TV sets, computers and the like is propagated by the magnetic field rather than by electromagnetic radiation, and so has a very limited range. Anyone who has tried to operate, for example, a 2m hand-held alongside a computer will have discovered this.

Secondly, a vertical auxiliary antenna will favour the reception of man-made noise such as TV timebase interference, which is generally vertically polarised, whereas a horizontal main antenna, such as a dipole, will give maximum rejection of such noise.

Finally, close to any source of electromagnetic radiation, although the famous "inverse square law" still applies, the field strength effectively falls off much more quickly than at a great distance. Perhaps a simple example will help to explain why this is so.

Imagine two identical antennas, spaced 10 metres apart, with one of them, *A*, at 10m from the source of interference, *I*, and the other one, *B*, at 20m from *I*. As the distance *BI* is twice

*Practical Wireless, February 1988*

*AI*, the interference at *B* will be only a quarter as strong as at *A* (because  $2^2 = 4$ ). If the "wanted" signal is coming from a transmitter that is perhaps hundreds of kilometres away, an extra 10m will produce no noticeable difference between the strength of that signal picked up by the two antennas (Fig. 1).

So, though we can't prevent the auxiliary antenna picking up "wanted" signal, we can generally arrange that it picks up the interference more strongly than the main antenna. When the interference signal from the auxiliary antenna is then attenuated to the correct level to balance out the interference picked up by the main antenna, the "wanted" signal from the auxiliary antenna will be attenuated by the same amount. It should therefore be very much smaller than the "wanted" signal coming from the main antenna, which is just the state of affairs we require.

## Practice

So much for the theory, now for the practice. The S.E.M. QRM Eliminator is housed in a two-part metal box measuring 158 x 60 x 58mm, with the four controls, Band-change, Gain and Phase A and Phase B, on the front panel. At the rear are three SO-239

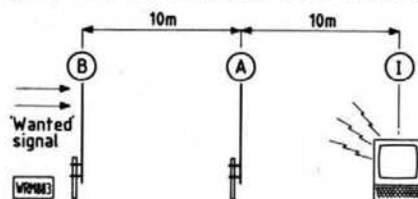

Fig. 1: A simple example of the "inverse square law"

sockets for the two antennas and receiver, plus a "phono" socket for the 12V d.c. 50mA power supply. A second "phono" socket allows the unit to be controlled and protected by the p.t.t. line of an associated transceiver.

The operating instructions (a single A4 sheet) supplied with the unit describe a simple procedure for adjustment of the Gain and Phase controls until the sharpest notch is achieved, plus advice on the selection of a suitable auxiliary antenna. Either a second h.f. antenna or the feeder of a 144MHz band antenna are suggested.

As already discussed, the ideal arrangement for the two antennas is that their pick-up of the interference field should be as different in strength as possible. It follows, therefore, that the worst arrangement is where the two antennas have to be close together and of similar layout—perhaps where your antenna farm is limited to "long wires" in a loft immediately above the operating room.

With this in mind, our testing of the review unit was carried out under what were perhaps rather unfair "worst case" conditions, with a 10 metre "long wire" in the bungalow loft for the main antenna, and an adjustable length of wire strung up to the curtain rail in the operating room for the auxiliary antenna. If the QRM Eliminator would work with this set-up, it should work virtually anywhere.

Did it work? Yes, it did, though with some pretty delicate adjustment of the three variable controls. Obviously my auxiliary antenna was much shorter than it should have been—I found that

# Constructional

This m.w. receiver designed by Raymond Haigh uses signal processing techniques normally associated with communications grade receivers. The combination of high sensitivity and good selectivity with provision for accepting a variety of antennas, makes this design the "ultimate" medium wave DX receiver.

# The PW "Orwell" Medium Wave Receiver

Part 1

Eavesdropping on the domestic, medium wave broadcasts of distant towns and countries can be a fascinating pastime. Real DX reception is, however, much more difficult than on the short wave bands, and good receiver selectivity and a directional antenna system are essential.

Low cost portables are not suitable for serious medium wave listening. Inadequate selectivity, spurious responses and poor audio quality make the clear reception of all but the most powerful local transmissions difficult. Even the best portable receivers have limited DX capability: it is not easy to connect a loop antenna, and any attempt to use a long wire invariably results in overloading and cross modulation problems.

For this reason communications type equipment is often used by medium wave enthusiasts. This is an expensive solution if one's interests lie mainly in medium wave listening, and the receiver described in this article has been designed as a more economical means of achieving an acceptable level of performance.

## Circuit Description

The complete circuit of the receiver is given in Fig. 1.1.

Long wire and loop antennas are connected to the m.o.s.f.e.t. signal frequency amplifier via antenna transformer T1 which provides alternative coupling ratios. The r.f. amplifier stage increases sensitivity and selectivity, reduces spurious responses and improves a.g.c. performance.

Ferrite rod antenna, L1, is connected into circuit by means of a switched stereo jack socket (SK5) which isolates T1 when the rod antenna is in use. Ganged variable capacitor C3 tunes either of these inductors, and C1 and C2 are individual trimmer capacitors.

The r.f. signal from the antenna is applied to gate 1 of Tr1 via the d.c. blocking capacitor C4. This capacitor is required here because gate 1 is held positive with respect to earth in order to improve the a.g.c. and r.f. gain



control action. The operation of the a.g.c. circuit, which includes d.c. amplifier Tr2, is described in detail later.

The amplified r.f. output at the drain of Tr1 is developed across the primary of h.f. transformer T2. A tap on the secondary winding ensures the necessary match to the low impedance input at pin 2 of the Hitachi HA1197 i.c. The primary/secondary turns ratio of T2 is, in fact, too high for optimum signal transfer. However, the receiver has gain to spare and under-coupling increases the selectivity of the tuned circuit formed by T2 and ganged capacitor C10.

The Hitachi a.m. tuner i.c. contains a further stage of r.f. amplification, the frequency changer, two i.f. amplifiers, automatic gain control and signal strength meter circuitry, together with an extremely linear detector. The 24 transistors and 17 diodes on the chip afford high sensitivity, exceptional a.g.c. performance, and low distortion.

Resistor R16 is included, in accordance with the manufacturer's recommendations, to protect the input stage of the device. The load resistor for the r.f. amplifier is R15; pre-set R17 adjusts the S-meter range, and R18 fixes

the gain of the second i.f. amplifier.

Most of the i.f. selectivity is derived from X1, a Toko combined i.f. transformer and ceramic filter assembly. The manufacturers claim that this unit is equivalent to at least four single-tuned i.f. transformers, and quote a performance of 25dB down at a bandwidth of  $\pm 9$ kHz.

The first and second i.f. amplifier stages are coupled by means of the series tuned i.f. coil, L2. This arrangement, together with the r.f. and h.f. stage signal frequency tuning, gives the receiver a degree of selectivity at least equal to the best portable receivers, but not so great that audio quality is excessively degraded. If additional selectivity is desired then the receiver can be used with a *Q* multiplier type loop antenna, a suitable design of which, can be found in the *PW* reprint *Wires & Waves*.

Padder capacitor C13 ensures correct tracking with the 158 $\mu$ H oscillator coil, T3. The a.g.c. voltage is filtered by means of R20, R21, C25 and C26. Resistor R22 and capacitor C27 filter any residual r.f. from the audio output, which is wired to a phono socket (SK6) so that signals can be tape recorded at a permanently set level.

*Practical Wireless, February 1988*

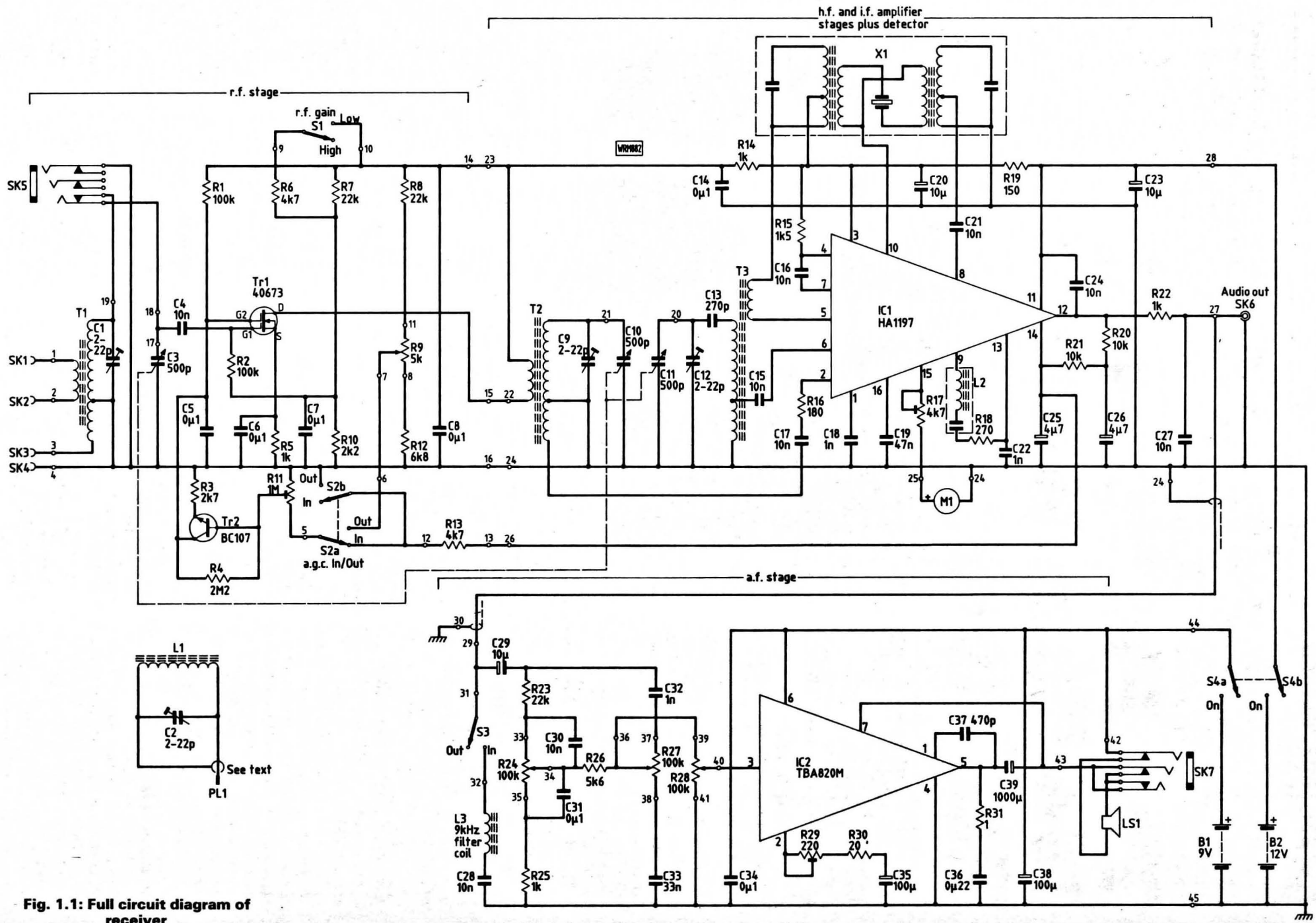

Fig. 1.1: Full circuit diagram of receiver

A simple audio processing unit precedes the internal a.f. amplifier. European channel spacing is 9kHz and this can result in an audio whistle at this frequency. The 36mH inductor, L3, and the 10nF capacitor, C28, form a series-tuned notch filter, resonant at 9kHz, which eliminates the problem without noticeably affecting treble response. Potentiometers R24 and R27, with associated resistors and capacitors, form a conventional passive tone control network offering bass and treble boost and cut. Because of the modest power output of the audio amplifier, maximum bass boost should only be applied at low volume levels or when using earphones.

The a.f. gain or volume control, R28, adjusts the input to the TBA820M audio amplifier i.c. Powered by a 9 volt supply, this device is capable of delivering a low distortion 1.5 watts into the receiver's 4 ohm speaker. Low quiescent current, typically 4mA, make it particularly suitable for battery powered equipment. External component count is reduced to a minimum in this application by omitting the

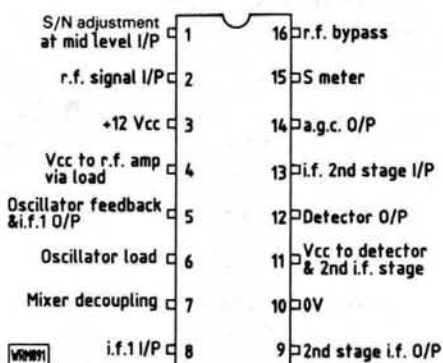

Fig. 1.2: Pin-out details of HA1197 a.m. receiver chip

ripple rejection capacitor at pin 8, and by connecting the speaker to battery positive. Pre-set potentiometer R29 controls the negative feedback at pin 2: reducing its resistance increases the gain of the i.c.

A switched jack socket (SK7) isolates the internal speaker when phones are being used. A stereo socket is fitted in the prototype, as most phones are now wired in this way.

The r.f. amplifier and tuner section of the receiver require a 12 volt supply for proper operation. The audio amplifier power supply must not, however, exceed 9 volts with the specified 3 ohm speaker. Current drains are modest, amounting to 17mA for the r.f. amplifier and tuner, and 30mA for the audio amplifier when speech is being reproduced at good volume. Battery operation was accordingly chosen for the prototype receiver. This avoids any connection with the domestic electricity supply and the risk of direct injection of mains borne interference. Separate batteries are used: a pack of 8 R6 (AA) size cells for the tuner, and a PP9 for the audio amplifier.

## Automatic Gain Control

The HA1197 i.c. produces an a.g.c. voltage which becomes increasingly positive with respect to earth as the signal level rises. This voltage ranges from 1.3 volts under no-signal conditions, to 2.3 volts with signals almost strong enough to saturate the device.

## SHOPPING LIST

### Resistors

0.5W 5% Carbon film

1Ω	1	R31
20Ω	1	R30
150Ω	1	R19
180Ω	1	R16
270Ω	1	R18
1kΩ	4	R5, 14, 22, 25
1.5kΩ	1	R15
2.2kΩ	1	R10
2.7kΩ	2	R3
4.7kΩ	2	R6, 13
5.6kΩ	1	R26
6.8kΩ	1	R12
10kΩ	2	R20, 21
22kΩ	3	R7, 8, 23
100kΩ	2	R1, 2
2.2MΩ	1	R4

### Potentiometers

5kΩ lin	1	R9
100kΩ	3	R24, 27, 28

### Horizontal skeleton preset

220Ω	1	R29
4.7kΩ	1	R17
1MΩ	1	R11

### Capacitors

Ceramic

470pF	1	C37
1nF	3	C18, 22, 32
10nF	7	C4, 15, 16, 17, 21, 24, 27
47nF	1	C19
0.1μF	6	C5, 6, 7, 8, 14, 34

Polystyrene 5%  
270pF 1 C13

Polyester  
10nF 2 C28, 30  
33nF 1 C33  
0.1μF 1 C31  
0.22μF 1 C36

Electrolytics  
4.7μF 2 C25, 26  
10μF 3 C20, 23, 29  
100μF 2 C35, 38  
1000μF 1 C39

Trimmers  
2-22pF 4 C1, 2, 9, 12

Variable capacitors ganged  
500pF 3 C3, 10, 11

### Inductors

RWO6A6408N	2	Antenna and h.f. transformers T1, T2
YMRS16726Z	1	Oscillator transformer T3
CFU050 D	1	2 x IFT plus ceramic filter, unit X1
YMCS2A740A	1	i.f. coil L2
CLNS30569Z	1	9kHz filter L3

(All the above inductors are manufactured by Toko, available from Cirkit<sup>(1)</sup>)

### Semiconductors

Transistors	
40673	1 Tr1
BC107	1 Tr2

### Integrated circuits

HA1197	1	IC1 <sup>(1)</sup>
TBA820M	1	IC2

### Miscellaneous

Ferrite rod 9.5mm dia x 140mm, F14 grade (1)<sup>(1)</sup>; 26 s.w.g. enamelled copper wire; ¼ inch stereo jack sockets chassis mounting with 3 sets of insertion break contacts (2); ¼ inch stereo jack plug; Phono socket chassis mounting; 4mm terminal (4); Toggle switch s.p.s.t. (2); Toggle switch d.p.d.t. (2); Jacksons 6/36 dial drive assembly (Cat No 4103/A)<sup>(2)</sup>; 50μA f.s.d. meter; Control knobs (5); 4Ω 2W loudspeaker; p.c.b.s; 14 pin d.i.l. i.c. holder; 8 pin d.i.l. i.c. holder; Veropins; Connecting wire; miniature screened cable; Battery holder; Battery connectors; Nuts; Bolts; Washers; Materials for cabinet.

<sup>(1)</sup> Cirkit Holdings plc, Park Lane, Broxbourne, Hertfordshire EN10 7NQ. Tel: (0992) 444111

<sup>(2)</sup> Electrovalue Ltd, 28 St Judes Road, Englefield Green, Egham, Surrey TW20 0HB. Tel: (0784) 33603





Control of the gain of the m.o.s.f.e.t. r.f. stage can be achieved by varying the voltage on gate 2 of the device. The gain increases as gate 2 becomes more positive with respect to gate 1, reaching a maximum when the difference is approximately 2.5 volts. The a.g.c. voltage produced by the i.c. must, therefore, have its polarity reversed and amplified before it is applied to gate 2 or Tr1. This function is performed by Tr2, the necessary control voltage being developed across the collector load resistor, R1. Pre-set potentiometer R11 determines the a.g.c. voltage input to the base of Tr2, thereby setting the operating range of the circuit.

The voltage on gate 2 of the Tr1 cannot be reduced to zero by this means, and accordingly gate 1 has to be made approximately 1 volt positive with respect to earth in order to optimise a.g.c. performance. This is done by connecting R2 to the potential divider network formed by R7 and R10. The high/low gain switch brings R6 into circuit, increasing the potential on gate 1 to approximately 3 volts, and thereby reducing the gain of the r.f. stage to less than unity.

Switch S2 immobilises the whole a.g.c. network by shorting the control voltage to earth. (The value of isolating resistor R13 is too low to prevent this.) This switch also connects the manual r.f. gain potentiometer, R9, into circuit. Without this facility for switching



out the a.g.c. function, it would be difficult to resolve weak signals very close or identical in frequency to powerful transmissions as the latter would actuate the a.g.c. system and reduce the gain of the receiver.

### Tuning Capacitor

The three-gang 500pF section air-spaced capacitor used in the prototype, is no longer available commercially. However, this kind of component can often be salvaged from the older types

of valve receiver; commonly found in second-hand shops and jumble sales. If a second-hand component is used, make sure it is clean and dry, and that the vanes do not short together. Its maximum capacitance should not be less than 365pF or the l.f. coverage of the receiver will be curtailed. Any built-in trimmers must be removed. Provision has been made to use Varicap diodes as an alternative form of tuning, details will appear in the Appendix in Part two of this project.

### 35►

an odd bit of wire about 2 metres long would give a noticeable improvement in signal-to-noise ratio when TV time-base QRM was affecting the 21 and 28MHz bands, but to be effective down at 1.8 and 3.5MHz, it had to be increased to around 4 metres in length.

Although S.E.M. specify that the unit works only down to 1.5MHz, I found it still to be extremely effective at 828kHz (our local ILR station Two Counties Radio), but it had pretty well run out of steam by the time it was down to around 750kHz.

### Mechanical Finish

It is a great pity that the overall impression of this very effective little unit was let down by the detail of the mechanical finish. For example, the four controls had shafts cropped to different lengths, so that each knob stood off the panel by a slightly different amount. Similarly, inside the unit, a corner of the p.c.b. had been filed off to make it fit within the case. None of these points affect the working of the QRM Eliminator but I felt that it deserves a better standard of presentation.

The QRM Eliminator is available price £85.00 including carriage and VAT from S.E.M., Union Mills, Isle of Man, telephone 0624 851277, to whom we give our thanks for the loan of the review unit. **PW**

*Practical Wireless, February 1988*

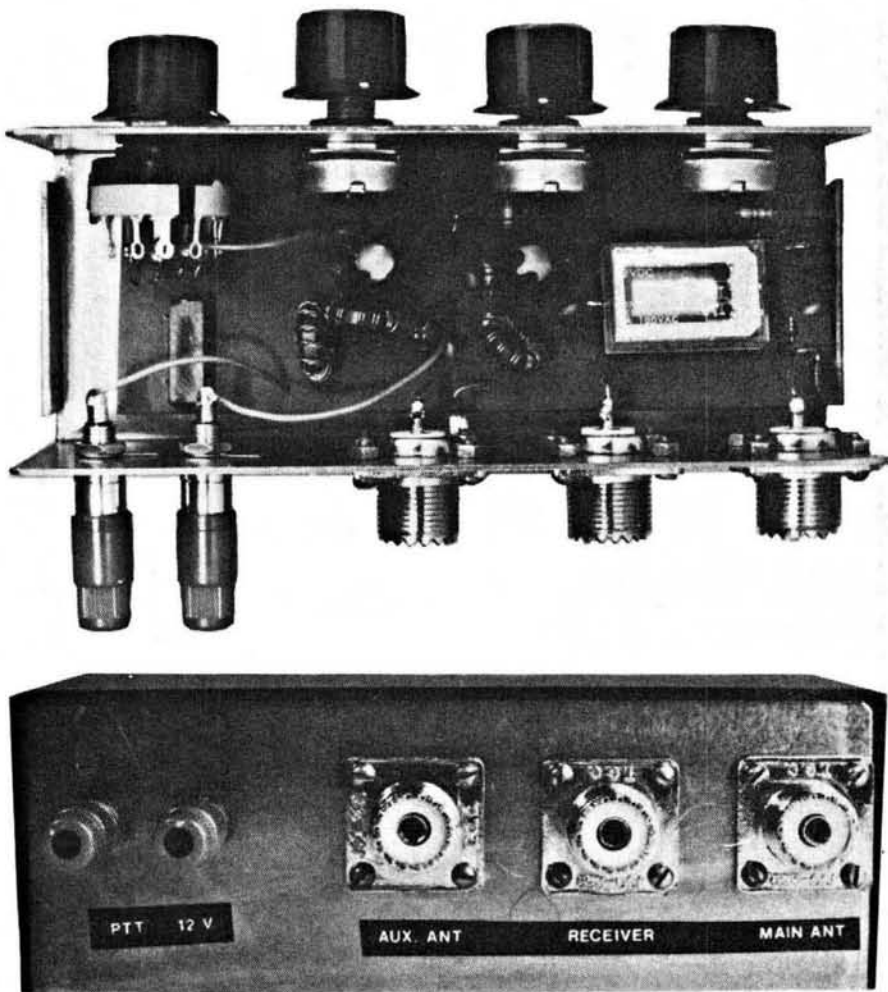

# TAKE ADVANTAGE OF THIS GREAT SUBSCRIPTION OFFER

## Introducing

Two and three-year subscriptions for *Practical Wireless* readers in the UK

You can save money and avoid the inevitable cover-price increases over the next two or three years!

One Year — £14.00  
 Two Years — £26.00  
 Three Years — £36.00

Wherever you live, a Postal Subscription will ensure that you receive your copies of PRACTICAL WIRELESS and/or SHORT WAVE MAGAZINE regularly, through your own letterbox, before it gets onto your newsagent's shelf. Order a Joint Subscription and you will qualify for the Special Discount.

Fill in the Order Form below and post it to: PW Publishing Ltd., FREEPOST, Subscriptions Dept., Enefco House, The Quay, Poole, Dorset BH15 1PP (no stamp required). Credit Card Orders taken on (0202) 678558.

Overseas subscriptions outside Europe are now despatched by Accelerated Surface Post for faster delivery.



Please indicate the type of subscription required:

Special Joint Subscription



- See above (UK)
- £17.00 (UK)
- £27.00 (UK)
- £18.50 (Overseas)
- £19.00 (Overseas)
- £30.00 (Overseas)

(Prices correct at November 1987)

To commence with issue dated .....

To: PW Publishing Ltd., FREEPOST, Subscriptions Dept., Enefco House, The Quay, Poole, Dorset BH15 1PP (no stamp required).

Name .....

Address .....

.....

I enclose cheque/PO (Payable to PW Publishing Ltd) £.....

Charge to my Access/Visa Card the amount of £.....

Card No.

Valid from  to

Signature.....

# C.M.HOWES COMMUNICATIONS

Eydon, Daventry,  
Northants NN11 6PT  
(mail order only)  
Phone: 0327 60178

## READY TO GO ON 6M!

We are proud to announce the new **HC266 2M to 6M transverter**. Ready built and tested, the HC266 makes an exciting addition to the range of **HOWES** products. If you have a 2M rig that produces somewhere between 1 and 10W of output, you could be on 6M with a **HOWES HC266**.

Operating from a 13.8V DC supply, the **HOWES HC266** gives full band coverage (50 to 52MHz) with a clean 10W of RF output on FM, SSB or CW when driven with a 144 to 46MHz transceiver (FT290, TR9000 etc). The standard version will accept 1 to 5W of 2M drive, a 5 to 10W input is available as an option. The transverter incorporates Automatic Level Compensation which adjusts the gain automatically to suit your transceiver's output, within the specified range.

Other technical features include:

- ★ SWR protection circuit, that automatically reduces power under mismatch conditions, or if you forget the antenna!
- ★ Both PTT and RF VOX facilities are provided.
- ★ Low spurious outputs obtained by careful filtering. The second harmonic is at least 85dB down on the 10W output.
- ★ High quality components are used in the construction, ie SO239 sockets with silver plated contacts and PTFE dielectric.
- ★ Operators Manual supplied complete with block and circuit diagrams. A Service Manual is also to be available to repair shops and customers as an extra.

We have not just concentrated our design effort on the internals. The HC266's custom manufactured case has been specially designed to look smart and blend in neatly with modern station equipment. Finish is in dark grey paint with white lettering.

A matching 4M transverter and 10M input versions are "in the pipeline", along with an interface unit, that allows 100W HF rigs without low level outputs (TS440s, Ten-Tec etc) to drive transverters.

The **HOWES HC266** is not only a nice transverter, it is also backed up by proper documentation, spares and service. It is available direct from us by mail order, or from selected retail shops.

The price: **£179.90 inclusive of post and VAT.**

## NEW KIT!

The **SWB30** is more than just an **SWR Indicator** kit. It is also an attenuator, a dummy load, and a power indicator. It doesn't work in the same way as most SWR meters either, so what have **HOWES** come up with this time? Well you get a nice little meter unit, custom made specially for us, and a kit of parts to build the electronics. When using the built up unit, your tuning signal is fed to a resistive bridge circuit via a power attenuator, the result is less radiated signal while you tune up, and a decent match is always presented to the rig whilst you twiddle the ATU. You can use the **SWB30** with transmitters up to 30W RF, and all bands up to 2M. The kit costs **£11.90 plus 90p P&P**. Interesting, useful and easy to build, it is also available as an assembled PCB at **£16.50 plus P&P**.

An SAE will bring you a copy of our catalogue, and further information on any item you are interested in. Don't forget our range of super little QRP kits and beginners receivers, there is simply not enough space to even start to list them here.

73 from Dave G4KQH, Technical Manager.



### HELPING TO BUILD YOUR STATION

### AUDIO FILTERS MODELS FL2, FL3, FL2/A

Model FL3 represents the ultimate in audio filters for SSB and CW.

Connected in series with the loudspeaker, it gives variable extra selectivity better than a whole bank of expensive crystal filters. In addition it contains an automatic notch filter which can remove a "tuner-upper" all by itself.

Model FL2 is exactly the same but without the auto-notch. Any existing or new FL2 can be up-graded to an FL3 by adding Model FL2/A conversion kit, which is a stand-alone auto-notch unit. Datong filters frequently allow continued copy when otherwise a QSO would have to be abandoned.

Prices: FL2 **£89.70**, FL3 **£129.37**, FL2/A **£39.67**



### ACTIVE RECEIVING ANTENNAS

Datong active antennas are ideal for modern broadband communications receiver - especially where space is limited.

- highly sensitive (comparable to full-size dipoles).
- Broad-band coverage (below 200 kHz to over 30 MHz).
- needs no tuning, matching or other adjustments.
- two versions AD270 for indoor mounting or AD370 (illustrated) for outdoor use.
- very compact, only 3 metres overall length. ● professional performance standards.

Prices: Mod-1 AD270 (indoor use only) **£51.75** Both prices include mains power unit.  
Model AD370 (for outdoor use) **£69.00**



### MORSE TUTOR

The uniquely effective method of improving and maintaining Morse Code proficiency. Effectiveness proven by thousands of users world-wide.

- Practise anywhere, anytime at your convenience.
- Generates a random stream of perfect Morse in five character groups.
- D70's unique "DELAY" control allows you to learn each character with its correct high speed sound. Start with a long delay between each character and as you improve reduce the delay. The speed within each character always remains as set on the independent "SPEED" control.
- Features: long life battery operation, compact size, built-in loudspeaker plus personal earpiece.

Price: **£56.35**

Our full catalogue plus further details of any product are available free on request. All prices include VAT and postage and packing. Goods normally despatched within 3 days subject to availability.



**DATONG ELECTRONICS LIMITED**

write to dept. P.W.  
Clayton Wood Close  
West Park  
LEEDS LS16 6QE  
Tel: (0532) 744822 (2 lines)



## J & M (Amateur Radio) G4GKU

36, WESTGATE, ELLAND,  
W. YORKS HX5 0BB.  
PHONE: (0422) 78485  
Ask for John G4GKU

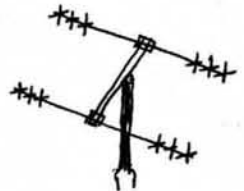

**NOW** 10m, 15m, 20m

### A TRI-BAND MINI BEAM AT A SENSIBLE PRICE

## £69.95

(TRADE ENQUIRIES WELCOME)

Direct from the manufacturer at a money saving **£69.95** complete. Or in kit form or as spare parts. Ask for a quote.

**PART EXCHANGE  
BARCLAYCARD VISA**



# Directivity Gain Transmitting Antennas

This article, written by F.C. Judd G2BCX, is a complete revision and update of that published in August 1980 (also in *Wires and Waves*) which covered the directivity gain versus beam width of uni-directional (beam) antennas.

In this article, we will look at omni-directional antennas and bi-directional antennas as well as beams.

## Radiation Directivity

All transmitting antennas are directive, i.e. radiation is always in some particular direction, or directions, both horizontally and vertically. For example, a dipole is directional although the magnitude of radiation is equal at all angles in the plane perpendicular to the axis of the antenna. In the opposite plane, it varies from maximum to zero twice in 360 degrees. Thus the measured, or calculated, magnitude of the radiation in that plane provides the well-known cosine or figure-of-eight pattern. Therefore when a dipole is operated vertically it is said to be omni-directional but the vertical radiation maintains the familiar cosine (figure-of-eight) pattern. When a dipole is operated horizontally, the horizontal radiation is directive (cosine pattern) and the vertical radiation is omni-directional. The above assumes a "free-space" location.

However, there is no antenna that radiates equally in all directions around it, both horizontally and vertically, although it would be desirable to have one for the purpose of estimating the directivity gain of directional antennas, as well as to provide a reference to which such gain may be related.

## The Isotropic Radiator

This is a purely hypothetical conception otherwise known as a "point source radiator" and which is assumed to radiate equally in all directions at the same time. The point source can best be visualised as being at the centre of a sphere, as illustrated in Fig. 1(a), the sphere having a surface area equal to  $4\pi r^2$ . If the power radiated from the source is  $P_r$ , then, for the distance  $r$  to any point P on the surface of the sphere, the unit power ( $P_u$ ) will be:

$$P_r/4\pi r^2$$

Because the radiation from an isotropic (point source) radiator can be regarded as uniform in all directions, its "gain" would be absolute unity. This what makes this otherwise non-existent radiator useful as a reference against which to compare the directivity gain of antennas with maximum radiation in specific directions. For example, if the point source radiator could be replaced by a real directional antenna, the radiation from this reaching the surface of the sphere, as in Fig. 1 (b), would be concentrated over an area formed by the cross-section of that radiation taken between the angles intersecting the points where the magnitude of the radiation is 3dB down from maximum, ( $-3\text{dB} = 0.707$  of magnitude at maximum).

Assuming the cross-section area to be circular, as in Fig. 1(b), and with a diameter of say, 30 degrees, then its area would be:

$$\frac{\pi}{4} \times (d)^2 = \frac{\pi}{4} \times (30)^2 \\ = 706.8 \text{ square degrees}$$

The ratio of this area to that of the sphere, also in square degrees, is a direct ratio of the directivity of the real antenna with reference to the isotropic source. From this, the "directivity gain" of the real antenna can also be determined with reference to either the isotropic radiator or to a dipole. First the surface area of the sphere from:

$$4\pi \times (57.295)^2 \approx 41253 \text{ square degrees}$$

where 57.295 is the number of degrees in a radian. The directivity power gain of the real antenna with a cross-section area of 706.8 square degrees would be:

$$\frac{41253}{706.8} = 58.36$$

The directivity gain in decibels would be:

$$10\log_{10} \times 58.36 = 17.66\text{dBi}$$

in which the "i" simply indicates "gain over an isotropic"

## Radiation Patterns

As will be seen later, these play an important part in the application of the

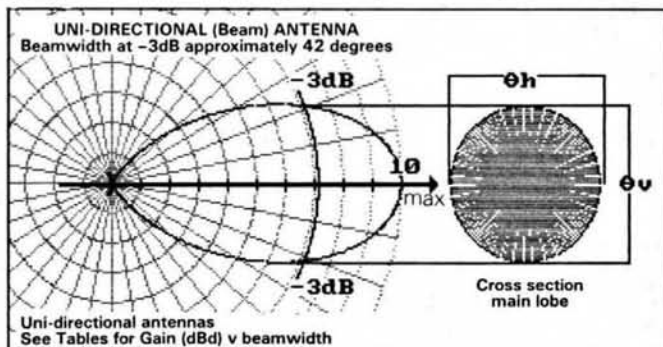
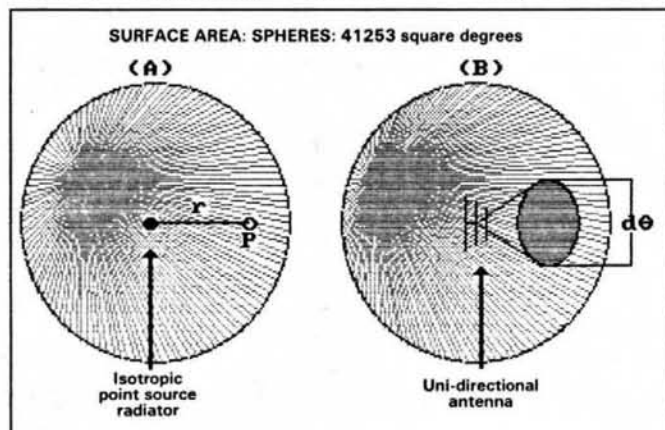

Fig. 2: Cross-section area. Main lobe of uni-directional (beam) antennas

Fig. 1: Conception of the isotropic source radiator

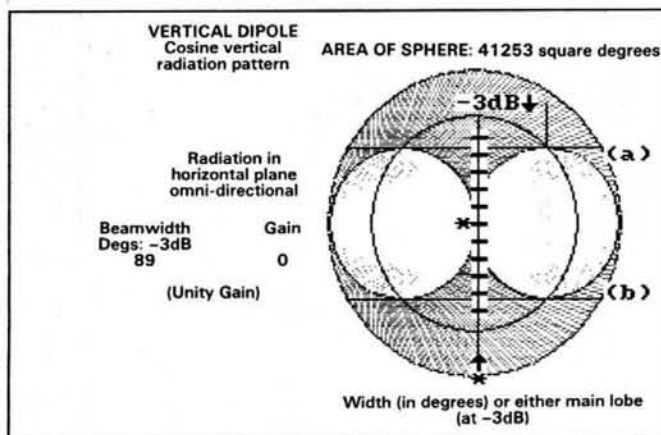

Fig. 3: Vertical dipole, beamwidth and gain

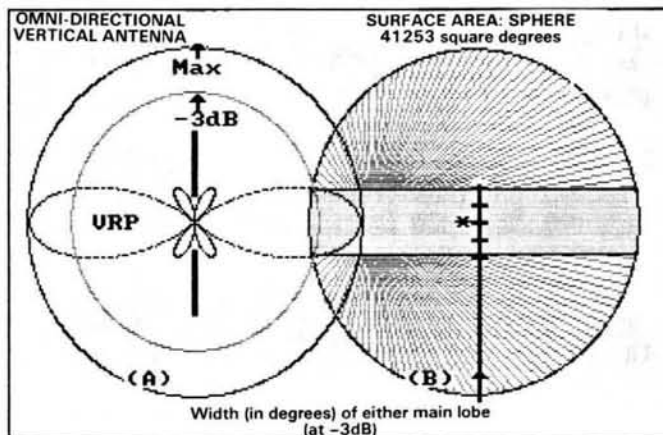

Fig. 4: Total beamwidth, omni-directional antennas

theory dealt with in this article. Radiation patterns are normally plotted in polar co-ordinates against a linear scale commonly calibrated 0 to 10 for the magnitude of radiation as the example in Fig. 2. This also shows how the 0.707 point (-3dB) is established for a major lobe or lobes.

It should be noted however, that the cross-section area of a major lobe may not always be circular and with uni-directional (beam) antennas may be slightly elliptical, if the main lobe width, at -3dB, is greater for the vertical than for the horizontal radiation for example. The gain is then derived from the beamwidth for both modes of operation. For example, if the beamwidths were respectively 40 degrees (horizontal) and 35 degrees (vertical) the directivity gain would be:

$$10 \log_{10} \times \frac{41253}{0.78534 \times 40 \times 35} = 15.74 \text{dBi}$$

It is more usual and perhaps better understood by most to refer to directivity gain with reference to a dipole (gain expressed as dBd). Since the power gain of a dipole over an isotropic radiator is 1.64 (2.14dBi) it is only necessary to subtract 2.14 from the directivity gain of an antenna quoted in dBi (reference to an isotropic source). In the example given previously, this would be 15.74 - 2.14 which gives 13.6dBd.

Unfortunately few manufacturers of transmitting antennas for the amateur bands provide radiation patterns for both horizontal and vertical radiation. If a polar pattern is supplied it may be for horizontal radiation only. Often only a brief and not always accurate description of an antenna may be supplied together with a figure for "gain" which may be doubtful and/or misleading. In order to make use of the tables given in this article one must know the beamwidth of the main lobe, or lobes, for horizontal or vertical radiation. From this a fair approximation of directivity gain may be ob-

tained. An accurate figure for gain in either dBd or dBi is necessary to obtain the beamwidth of the main lobe or lobes.

The tables included with this article take into account the fact that the main lobe (or lobes) may be slightly elliptical so the beam width for either horizontal or vertical radiation from uni-directional antennas may be used. For bi-directional antennas (simple broadside or endfire antennas) the cross-sectional area of the two main lobes may be taken as being circular. Measurements made with real antennas indicate that the tables will provide directivity gain to within 1dB or less, and beamwidth to within a very few degrees.

## Side and Rear Lobes

Most uni-directional and bi-directional antennas have small side or rear lobes, (or both) and these radiate some of the total r.f. power supplied to the antenna. Generally the percentage is small, at least for the types of antenna dealt with in this article. Nevertheless it must be remembered that power radiated by the main lobe(s) will be the total power supplied less that radiated by any side or rear lobes.

This does of course determine the e.r.p. (effective radiated power) from any main lobe. The e.r.p. is derived from the power supplied to the antenna multiplied by the power gain of the antenna main lobe or lobes. For example a 100 watts is supplied to a uni-directional antenna with a main-lobe directivity gain of say 12dBd which is a power gain of 15.85. Assuming no loss in either the transmission line or the antenna and that there are no side or rear lobes, the e.r.p. would be 100 x 15.85 or 1585 watts. If a total of say 10 per cent of the power supplied were radiated by side or rear lobes then the main lobe e.r.p. would be 1585 less 10 per cent which equals 1426.5 watts.

Whilst the directivity gain in dBd or dBi, or related power gain for major lobes, is constant it remains that the

larger the magnitude of any side or rear lobes, the greater will be the per cent power loss in the major lobes. Hence one reason for making sure that directional antennas have minimal side and/or rear lobes and another good reason why manufacturers of transmitting antennas should supply true radiation patterns for both horizontal and vertical radiation or quote the relevant side/read lobe magnitudes with reference to that of major lobe(s).

## Directivity Gain and Beamwidth

The basic terms for deriving these factors have been dealt with and illustrated by Figs. 1 and 2, but can be extended to include omni-directional and bi-directional as well as uni-directional antennas.

When operated vertically, the radiation from a dipole becomes omni-directional on the horizontal plane but the vertical radiation retains the conventional cosine (figure-of-eight) pattern as in Fig. 3. The area of radiation is formed by the beamwidth at -3dB of one of the main lobes (approximately 89 degrees) and by (a) and (b) in Fig. 3, which extends all round the sphere (360 degrees). The total area of radiation is therefore 89 x 360 = 32040 square degrees. Although 89 is very close, it is a computer "rounded" figure. Taking 32027/360 we get a beamwidth of 88.96388889 degrees which is much more precise, but why 32027?

First an allowance is made for the fact that the cross-section of a major lobe may be circular or elliptical. Taking the area of a sphere, 41253/0.78534 gives 52525, which divided by the power gain (1.64) of a dipole over an isotropic radiator is 32027. Directivity gain in dBd now becomes:

$$10 \log_{10} \left( \frac{32027}{\theta_h \times \theta_v} \right)$$

in which  $\theta_h$  and  $\theta_v$  are the horizontal and vertical dimensions (in degrees)

for the cross-section area of the main lobe, or lobes. Using this for the directivity gain of a vertical dipole in dBd it becomes:

$$10\log_{10} \left( \frac{32027}{360 \times 88.9638889} \right) = 0\text{dBd}$$

The same would apply with a dipole horizontal (remember in a free-space location) in which the vertical radiation becomes omni-directional with the -3dB beamwidth of either main lobe at very nearly 89 degrees. Hence the dipole has unity gain (0dBd).

## Other Vertical Omni-directional Antennas

The most popular is the vertical collinear antenna normally consisting of two or more half-wave radiators driven in phase. Radiation in the horizontal plane is omni-directional but vertical radiation is similar to that of the dipole except that the beamwidth of the two main lobes is narrower and there are usually four small side lobes, depending on the number of half-wave sections and the spacing between each. See the vertical radiation pattern (v.r.p.) in Fig. 4. Like the vertical dipole, the area of vertical radiation is formed by a main lobe half-power beamwidth as (A) and the 360 degrees around the sphere as (B).

Directivity gain (dBd) is obtained from:

$$10\log_{10} \left( \frac{32027}{(\text{beamwidth (degrees)} \times 360)} \right)$$

Tables 1 and 2 cover a -3dB beamwidth range from 20 to 59 degrees and take element spacing into account.

Remember that e.r.p. (main lobes) is determined by the percentage of power taken by the side lobes from the total power supplied to the antenna.

## Bi-directional Antennas

When operated horizontally, the dipole is a bi-directional antenna. Others

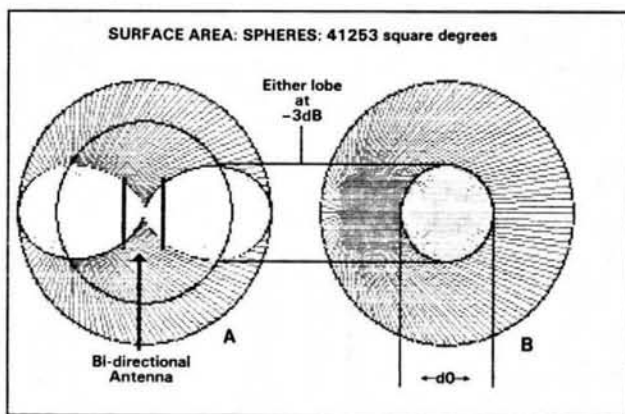

Fig. 5: Bi-directional antennas, major lobe(s) cross-section area at -3dB

such as simple broadside or endfire antennas also have two major lobes of equal magnitude but with a circular cross-section area at -3dB from maximum directivity as illustrated in Fig. 5. Part (A) shows the vertical radiation pattern of a two-element endfire antenna and (B) the circular cross-section area of either of the two major lobes. If the antenna were horizontal the radiation pattern and the cross-section area would be the same.

However, the r.f. power supplied to the antenna is shared equally by each major lobe and this must be taken into account when determining the directivity gain from either main lobe. Note however, that the radiation patterns of even simple two-element broadside or endfire antennas depend on the spacing between the elements and the phase relationship of the current flowing in each element. The directivity gain in dBd for either of two symmetrical lobes is:

$$10\log_{10} \times \left( \frac{32027}{(\text{Beamwidth (degrees)})^2} \right) / 2$$

Example: Beamwidth at -3dB = 60 degrees. Directivity gain is:

$$10\log_{10} \left( \frac{32027}{60} \right) / 2 = 4.746 \text{ (rounded 4.75)dBd}$$

See Table 3

The Tables 3, 4 and 5 cover a beamwidth range from 20 to 169 degrees in steps of 2 degrees. Note: These tables cannot be used for broadside or endfire antennas if the two major lobes are not symmetrical or if there are more than two major lobes.

## Uni-directional (Beam) Antennas

As with each of the antenna systems already dealt with, a "free-space" location is assumed particularly where vertical radiation is concerned. Refer to Fig. 2 for an illustration concerned with the gain of uni-directional antennas with reference to a point source (isotropic) radiator. However, Tables 6 and 7 cover a range of beamwidths at -3dB from 20 to 122 degrees in steps of 2 degrees. The directivity gain (dBd) is derived from:

$$10\log_{10} \left( \frac{32027}{(\text{beamwidth (degrees)})^2} \right)$$

The beamwidth may be that for horizontal or vertical mode but again a reminder that any side and rear lobes use some percentage of the total power supplied to the antenna and which be taken into account when determining the main lobe e.r.p. from antenna power gain and the power supplied. The directivity gain of the main lobe is not affected by side or rear lobes.

Gain: Vertical omni-directional antennas Using beamwidth (vertical radiation) and either of the two main lobes			
Beamwidth -3dB		Beamwidth -3dB	
Degrees	(Gain) dBd	Degrees	(Gain) dBd
20	6.5	30	4.7
21	6.3	31	4.6
22	6.1	32	4.4
23	5.9	33	4.3
24	5.7	34	4.2
25	5.5	35	4.1
26	5.3	36	3.9
27	5.2	37	3.8
28	5.0	38	3.7
29	4.9	39	3.6

Note: With vertical collinear antennas the beamwidth also depends on the spacing between each driven element

Table 1: For vertical omni-directional antennas: Gain versus beamwidth

Gain: Vertical omni-directional antennas Using beamwidth (vertical radiation) and either of the two main lobes			
Beamwidth -3dB		Beamwidth -3dB	
Degrees	(Gain) dBd	Degrees	(Gain) dBd
40	3.5	50	2.5
41	3.4	51	2.4
42	3.3	52	2.3
43	3.2	53	2.2
44	3.1	54	2.2
45	3.0	55	2.1
46	2.9	56	2.0
47	2.8	57	1.9
48	2.7	58	1.9
49	2.6	59	1.8

Note: With vertical collinear antennas the beamwidth also depends on the spacing between each driven element

Table 2

Gain: Bi-directional antennas Using beamwidth (horizontal or vertical) or either main lobe			
Beamwidth -3dB		Beamwidth -3dB	
Degrees	(Gain) dBd	Degrees	(Gain) dBd
20	9.52	37	6.85
22	9.10	39	6.62
24	8.73	41	6.40
26	8.38	43	6.19
28	8.06	45	6.00
30	7.76	47	5.81
32	7.48	49	5.63
34	7.21	51	5.45
36	6.96	53	5.28

Applies: Broadside and endfire antennas with two symmetrical main lobes and side lobes smaller than -15dB

Table 3: Bi-directional antennas. Gain and beamwidth

Practical Wireless, February 1988

Gain: Bi-directional antennas using the beamwidth (horizontal or vertical) of either main lobe			
Beamwidth -3dB		Beamwidth -3dB	
Degrees	(Gain) dBd	Degrees	(Gain) dBd
54	5.20	71	4.01
56	5.05	73	3.89
58	4.89	75	3.78
60	4.75	77	3.66
62	4.60	79	3.55
64	4.47	81	3.44
66	4.33	83	3.34
68	4.20	85	3.23
70	4.08	87	3.13

Applies: Broadside and endfire antennas with two symmetrical main lobes and side lobes smaller than -15dB

Table 4

Gain: Bi-directional antennas using the beamwidth (horizontal or vertical) of either main lobe			
Beamwidth -3dB		Beamwidth -3dB	
Degrees	(Gain) dBd	Degrees	(Gain) dBd
88	3.08	129	1.42
93	2.84	134	1.26
98	2.62	139	1.10
103	2.40	144	0.94
108	2.19	149	0.80
113	2.00	154	0.65
118	1.81	159	0.51
123	1.63	164	0.38
128	1.46	169	0.25

Applies: Broadside and endfire antennas with two symmetrical main lobes and side lobes smaller than -15dB

Table 5

Gain: Uni-directional (beam) antennas from beam-width of main lobe at -3dB			
Beamwidth -3dB		Beamwidth -3dB	
Degrees	(Gain) dBd	Degrees	(Gain) dBd
20	19.0	46	11.8
22	18.2	48	11.4
24	17.5	50	11.1
26	16.8	52	10.7
28	16.1	54	10.4
30	15.5	56	10.1
32	15.0	58	9.8
34	14.4	60	9.5
36	13.9	62	9.2
38	13.5	64	8.9
40	13.0	66	8.7
42	12.6	68	8.4
44	12.2	70	8.2

Table 6: Uni-directional beam antennas. Gain and beamwidth

## Linear Antennas N Half-waves Long

It is possible to get an approximation of directivity gain from the main lobes of linear antennas N half-waves in length as such antennas always have four defined major lobes. The method used is based on that featured in this article and which might be dealt with at a later time.

## Effective Radiated Power

To calculate the effective radiated power in a major lobe it is necessary to know the power gain for that lobe

$$\text{Power gain} = 10^{xy}$$

$$\text{with } xy = \left( \frac{\text{Gain dBd major lobe}}{10} \right)$$

Example:

The e.r.p. for a uni-directional (beam) antenna (single major lobe).

Gain (Table 6) 12.2dBd: Power gain  $10^{1.22} = 16.59$ : r.f. power to antenna 10 watts: e.r.p.  $10 \times 16.59 = 165.9$  watts

Example:

The e.r.p. for omni-directional antenna.

Gain (Table 1) 5dBd: Power gain  $10^{0.5} = 3.16$ :

r.f. power to antenna 20 watts: e.r.p.  $20 \times 3.16 = 63.2$  watts

Example:

The e.r.p. for a bi-directional antenna (two lobes).

Gain (Table 3) each main lobe 5dBd: Power gain (each lobe)  $10^{0.5} = 3.16$ : r.f. power to antenna 20 watts: e.r.p. (each lobe)  $20 \times 3.16/2 = 31.6$  watts

As already mentioned, the percentage of power radiated by any side or rear lobes must be deducted from the e.r.p. for a major lobe

Gain: Uni-directional (beam) antennas from beamwidth of main lobe at -3dB			
Beamwidth -3dB		Beamwidth -3dB	
Degrees	(Gain) dBd	Degrees	(Gain) dBd
72	7.9	98	5.2
74	7.7	100	5.1
76	7.4	102	4.9
78	7.2	104	4.7
80	7.0	106	4.5
82	6.8	108	4.4
84	6.6	110	4.2
86	6.4	112	4.1
88	6.2	114	3.9
90	6.0	116	3.8
92	5.8	118	3.6
94	5.6	120	3.5
96	5.4	122	3.3

Table 7

## References

*Antennas* by John D. Kraus PhD. McGraw-Hill Book Co. Inc. *Antenna Radiation Patterns Computerised* by Dr L. W. Brown and F. C. Judd.

*Practical Wireless* Feb and March 1987. *Power Gain from TX Aerials* by F. C. Judd. *Practical Wireless* August 1980. *VHF/UHF Manual* by Jessop 4th Edition. RSGB.

# NEWS DESK

# EXTRA

## One Megawatt Radio Source

Marconi Communication Systems has received an order from the UK Atomic Energy Authority for the second phase of a project connected with a particle beam acceleration.

Marconi was commissioned to provide a design specification for a one megawatt radio frequency source. Now they have been contracted to design the equipment. The third stage will be to

construct, install and commission it.

The r.f. source consists of a klystron, which is capable of delivering one megawatt, continuous wave at 350MHz, a waveguide system for transmitting the power to the experiment or a test load and a control and instrumentation package for the system.

When operated at full power, the klystron consumes approximately 1.4MW from a 90kV d.c. supply and requires a tonne of cooling water per minute!

## DXpedition

Regular listeners to the Voice of the Andes realise that few countries in the world can boast the variety of contrasting environments found in the small nation of Ecuador — snow covered volcanoes where ice meets fire, exuberant and intricate jungles, colonial cities and beautiful Pacific beaches. Listeners have been able

to hear about it for years on HCJB. Now the station is organising a listeners tour to Ecuador.

You can combine a South American holiday and a DXpedition from March 27 to April 9. The two weeks will cost \$650 excluding air fares from Europe.

**HCJB-UK.**

**131 Grattan Road, Bradford, West Yorkshire BD1 2HS.**

## FT-102 User

If you are the owner of an FT-102, then this user group will be of interest to you.

The aim is to provide a forum for exchange of information about the 102 series of equipment and the range of accessories/add-

ons which are/were available for this range. So if you have information, or want information about either the FT-102 or the group then write to: **FT-102 User Group, c/o G14PCQ, 58 William Alexander Park, Belfast.**

# The Battle of the Beams—Part 2

D. V. Pritchard Dip Ed G4GVO continues the story of the “Crooked Beams” as he tells us about X-Gerät—The Secret Apparatus.

As early as 1934, when *Knickebein* was in its infancy, a German scientist began to have doubts about its efficiency if exposed to jamming. He was Staatsrat (Privy Councillor) Dr H. Plendl of the Deutsche Versuchsanstalt für Luftfahrt (German Aeronautical Research Establishment) and he began to produce designs for a new system for accurate blind bombing.

Under his leadership, a new department was formed at Rechlin (the German equivalent of Farnborough) which began research in June of that year. This was in co-operation with another department led by a Dr W. Kühnold which was also engaged on beam techniques for blind landing. The beams of Kühnold’s system, however, had an aperture angle of about 5°, corresponding to an 8km beamwidth at a range of 100km, and were clearly unsuitable for accurate pin-pointing of targets. Obviously a beamwidth of not more than 0.1° was required and this, at that time, could only be attained with reasonable antenna dimensions and suitable power if a frequency between 66 and 77MHz was employed. Accordingly, experiments were begun with an 80-watt transmitter designed by a Dr Ochmann which was code-

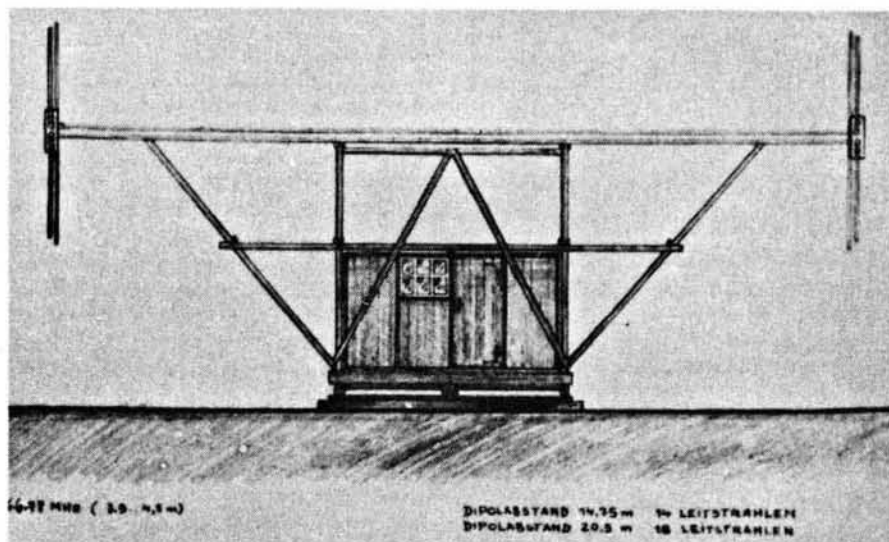

The layout of a typical X-Gerät installation with operating cabin and antenna array of a rotating platform  
Photographs by courtesy of Fritz Trenkle

named *Bertha 1*, but as this was not powerful enough a second was designed, *Bertha 2*, which delivered 500W and was tunable over the required range.

Preliminary tests carried out over Lake Müritz near Mecklenburg in 1935 resulted in ranges of only 1500m. Stationary beam antennas which could

be phased to swing through about 10° were used, and the airborne equipment consisted of two t.r.f. receivers developed at Rechlin and an analyser for unlocking the 2000Hz modulated dot-dash system of the adopted and improved *Knickebein* apparatus. Unfortunately full details of both transmitter and receivers are no longer available.

Fig. 2.1: Block diagram of X-Gerät feed system and capacity switch for pulsing

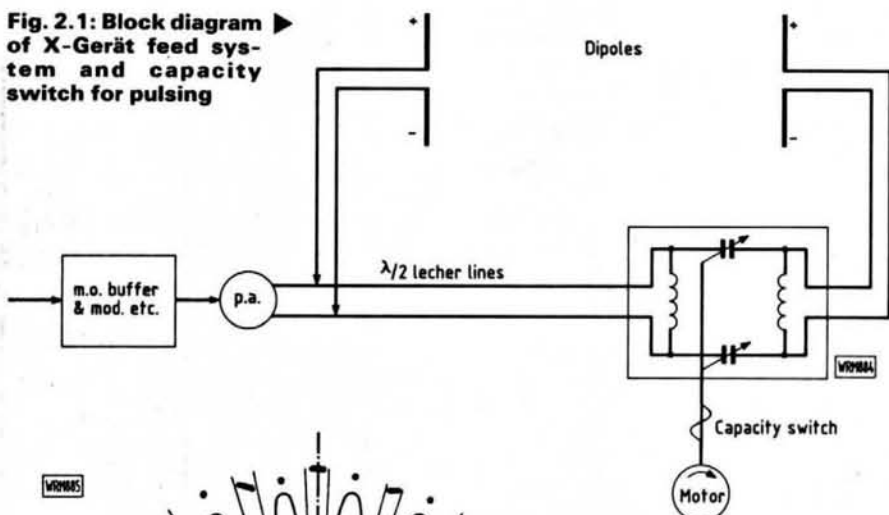

Fig. 2.2: Antenna pattern of X-Gerät system

## Wotan 1

By 1938, the system had been greatly improved. Dr Kühnold had developed ground installations capable of easy dismantling and removal, with an operating cabin and antenna array mounted on a platform which could rotate through 360°. The antennas were mounted on a gantry and spaced at 14.75m (3.5 wavelengths). Originally, simple half-wave dipoles were employed, but before long directors and reflectors were added for extra power and range; these were energised with pulses at 120 per minute via a vacuum switch (soon replaced by a capacitor, nicknamed a “mill switch”, designed by Dr K.H. Fischer). The schematic block diagram of this system is shown in Fig. 2.1 A half-wave Lecher line is used in conjunction with the “capacity” switch and its associated inductances to pulse both dipoles with the required dot-dash sequence.

The array generated a fan of 14 beams each with a bandwidth of 0.05° (Fig. 2.2), and 8 of these installations

*Practical Wireless*, February 1988



were erected in Germany, followed by many more on the coasts of occupied Europe. By now the airborne equipment had also been drastically improved by Dr H. Hanel and Dr Rücklin of Telefunken, who had designed and developed a superhet for 66 to 77MHz (code-named *Anna*), while an analysing system designed by Dr Plendl known as the AVP (Anzeige-Verfahren von Plendl) was being mass-produced by Siemens.

At the same time a Dr K. Müller set up a Mobile Research Unit which produced some versatile mobile stations under the code-name *Möbelwagen* or "Furniture Vans". He was also responsible for the clever camouflaging of their antenna—a feature which was later to prove troublesome for British counter attacks.

The complete system was known as *Wotan I*.

## Principle of Operation

One of the 14 beams was selected to act as a director beam which, on being aimed towards the target, provided a flight-path for the aircraft; this system was similar to Knickebein in that the pilot could plot his course according to a direction indicating meter which told him if he was right or left of the beam. The official German layout of the beam approach system and its associated cross beams at points before the target is shown in Fig. 2.3, while Fig. 2.4 represents not only the director beam and reserve beam, but also the cross beams and the associated fans of beams which enabled stray aircraft to plot their courses to the correct one. The main beams of the system used for the devastating raid on Coventry in

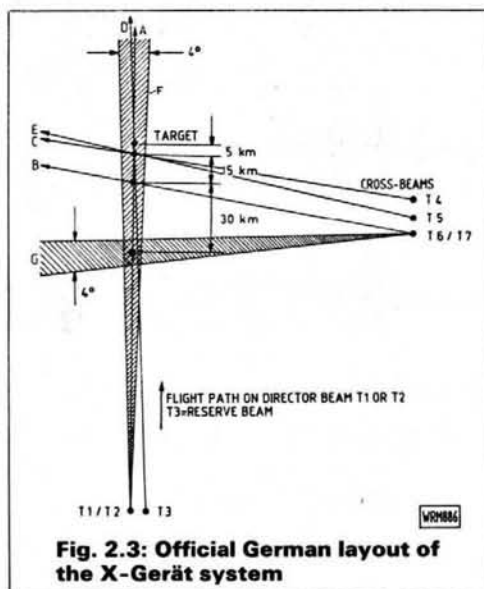

1940 is shown in Fig. 2.5, and Fig. 2.6 is another official German layout showing the disposition of all beam systems in use at that time. (In this series the author has concentrated only on the more widely known systems.)

In practice the bombers did not fly along the director beam immediately after take-off, but used either normal navigational methods or one of the fan beams in order to present a smaller target for British radar and to try and cause confusion. The director beam was usually joined sometime after crossing the English coast.

At approximately 30km before the target, the aircraft would encounter the coarse advanced cross beam which, like the other beams, was similarly pulsed with dots and dashes but on a different frequency. Before reaching this point the bomber's radio operator would have consulted a table giving the characteristics of his particular type of

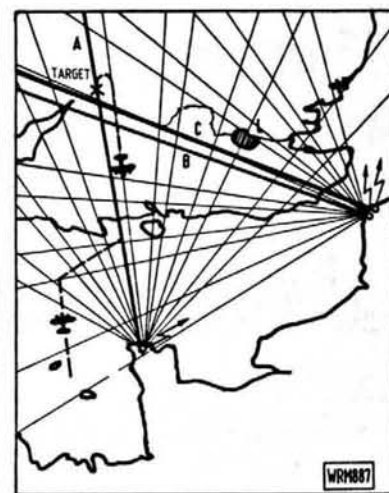

Fig. 2.4: German layout of beams showing main beams and associated fans

machine and fed them into a combined calculator and stopwatch called the *X-Uhr*, or "X-Clock". This was an incredibly accurate mechanism designed at Rechlin by a Dr Hepper. A small upper dial on the left-hand side showed how long the instrument had been running, while the lower dial was used for calculating the "flight-path ratios"—that is to say, information about the aircraft's type, height and speed was inserted to give a flight-path ratio of, say, 2.78:1 for 18km, or 3:1 for 6km according to circumstances.

On arriving in the dash-zone of the advanced cross beam the operator would listen for the (very brief) continuous note produced by the merging of dots and dashes, and press the clock's top button. This started the green "minute" hand and the black sweep-hand simultaneously and, according to the inserted data, the time taken for the bombs to drop was now fed in.

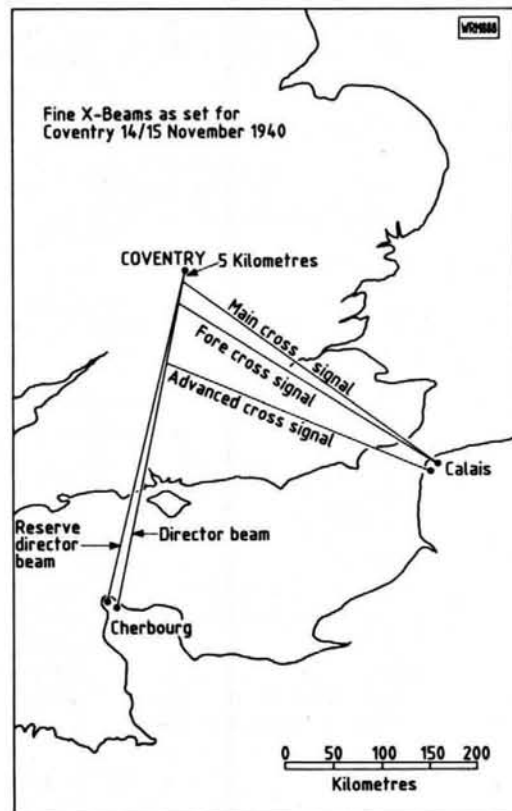
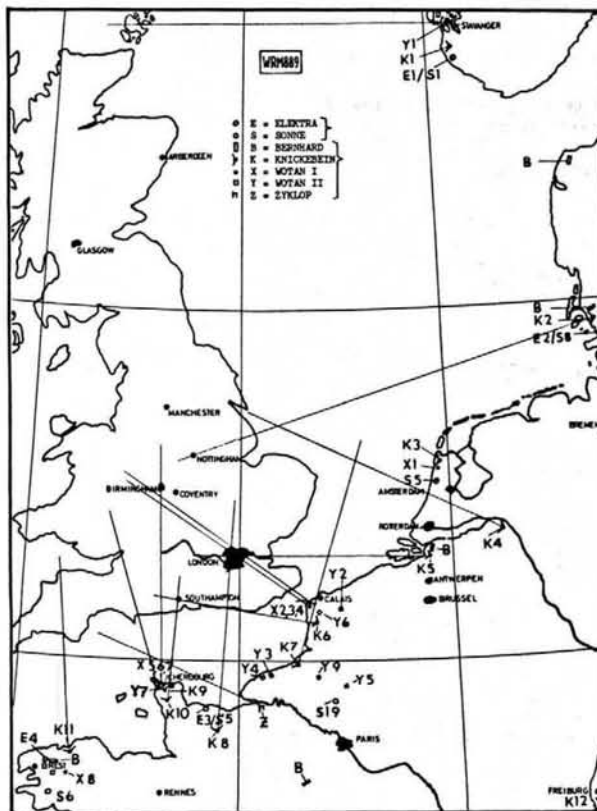

Fig. 2.5: The X-Gerät system for K. Gr. 100

Fig. 2.6: Official German layout showing the disposition of all beam systems in use at that time



At the "fore-cross-signal" a button on the left was pressed whereupon the green and black hands stopped and the red "hour" hand started. By pressing the third button at the main cross beam the red hand would stop at the same point as the previous ones and, if the correct data had been given, the bombs would be automatically released.

After tests by a research squadron, the system was finally installed in Ju 52's and He 111's of *Kampf-Gruppe 100*, a Group led by an outstanding Luftwaffe officer, Major Viktor von Lossberg. Quarter-wave whips were mounted on top of the fuselage behind the cockpit and these, in conjunction with the whip antenna for RT operation which was situated further back, gave rise to the nicknamed "Three-master".

The airborne equipment was installed in the radio operator's position and repeaters for the course meters were fitted in the cockpit for the pilot's benefit. A motor generator fed from the aircraft's batteries (rotary converter) was placed at the bottom of the installation and immediately above it were two audio units, to the left of which was the power distribution panel and, above, the twin receivers for the director and cross beams, the Anna receiver being on the right.

## Intelligence Breakthrough

The phone shattered Dr R.V. Jones' sleep in the early hours of a morning during the first week of September, 1940.

"We've got something new here! God knows what it is, but I'm sure it's something for you!"

The excited voice of Professor Frederick "Bimbo" Norman, a cryptographer at Bletchley Park, shook Jones into consciousness. They had broken some new Enigma traffic in which radio beams were mentioned, including the information that the beam-width was 8 to 10 seconds of arc, or an angle of 1:20 000, suggesting that the beam was no wider than about 20m at 320km!

Then came the electrifying word X-Gerät! Whatever X-Gerät was, it was being installed in aircraft of *Kampf-Gruppe 100*, one of the Luftwaffe's crack squadrons.

Jones hustled the intelligence services into greater activity. Across the Channel the Resistance organisations pulled out all the stops, and British Signals Intelligence (including Voluntary Interceptors—a body of dedicated radio amateurs) doubled their efforts. Their activities prompted Jones to record his appreciation: "*Our community of radio amateurs in Britain was to prove an invaluable reserve, both in Signals Intelligence and Signals proper, as well as furnishing many of the staff for our rapidly increasing number of radar stations*".

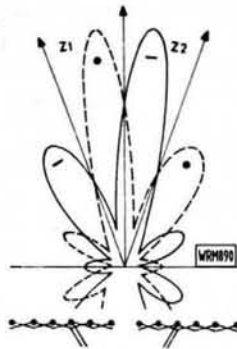

Fig. 2.7: Beam patterns of mobile X-Gerät

It was that well-known amateur of his day, Rowley Scott-Farnie G5GI, then an officer in RAF Signals Intelligence and a close friend of Jones, who reported beam signals from the Calais and Cherbourg areas around 70MHz. By September 24, 6 beam stations were identified: 2 north-west of Cherbourg, 3 near Calais and the last near Brest. The Germans had code-named them *Weser, Spree, Rhein, Elbe, Isar and Oder*. Evidently K.Gr.100 was working through a book of numbered targets and by the time the stations were identified Jones had the actual directions for the beams—and even that the Germans had specified them to the nearest 5 seconds of arc, an accuracy of about 10m at 320km!

But how could such an accuracy be possible on 70MHz?

## The "Anna" Numbers

Further decoded German transmissions revealed the existence of coarse and fine beams, including a mention of centimetres. This latter, however, referred to the precision with which a monitoring vehicle had to be positioned to orientate the director beam. Frequent mention of something called "Anna" was made, usually associated with a number between 10 and 85, and often a multiple of 5. By October 17, Jones had collected 10, 15, 25, 30, 35, 44, 47, 55, 60, 75 and 85. Another set of numbers gave crystal frequencies (typically 8750kHz, since  $8750\text{kHz} \times 8 = 70\text{MHz}$ ) and he suspected that Anna referred to the dial on the aircraft receiver, if not the aircraft itself. Since one set of numbers ended in 0 or 5, and the other in 0 or 0.5, simple deduction showed that the Anna reading had to be divided by 10 and either added to, or subtracted from, a constant number.

Learning from the Enigma traffic that a certain Feldwebel Schumann at a beam station at den Helder had signed a return for 3 crystals for 69.5, 70 and 71.1MHz and that his station was ordered to transmit on Anna numbers 30 and 35, it was clear that the constant had to be 66.5 if one-tenth of the Anna number had to be added, or 73 if it had to be subtracted. As he knew that crystals for 75MHz existed, the second possibility could be dis-

missed; and when he obtained further confirmation from the two crystals whose frequencies were not exact or half integers, the problem was solved. Other information that emerged from the Anna numbers was that both the coarse and fine beams lay between 66.5 and 75MHz.

## Measurement Inaccuracy

The immense value of Anna numbers was that if the transmitted orders to the beam stations could be decoded in time, he could then tell 80 Wing the frequencies to be jammed. Incredibly, his interpretation of the numbers was rejected because our monitoring services thought there were frequencies outside the range he had found. Dr Jones' hackles rose—a posture they were seldom slow in assuming—and plain words were spoken. "*These, it transpired, were due to bad measurement of the frequencies of the German beams on the part of the countermeasures organisation, a feature that was to plague us through the whole battle. The fault in this case probably lay not with the observers, but with the calibration of our receivers which were not up to the German standards of precision*". His findings were accepted.

Dr Robert Cockburn of the Telecommunications Research Establishment, having successfully prescribed "Aspirins" for the Knickerbein "Headaches", now developed "Bromides" for this new system which was code-named "Ruffian". We now knew that the director beam was radiated from near Cherbourg and the cross beams from the Calais area; as insurance against the failure of the main director beam (Weser) a reserve beam was provided by the adjacent station (Spree). The accuracy of the beams was so great that in calculating their paths it was necessary to take into account that the earth is not a sphere, but flattened towards the poles; this made a difference of 275m in where a beam from Cherbourg would cross London!

## Countermeasures and Counter Arguments

Cockburn's jammers came into operation in October, but at this time K.Gr.100 began to drop flares over its targets and this was hailed by some of Jones' antagonists as proof that the beams didn't work, or that the Germans were so unsure of them that they were using flares to find out where they were. However, Jones silenced these critics by pointing out that there was no evidence that K.Gr.100 was upset by our countermeasures (which was true) and were not only using the system, but acting as pathfinders for other Luftwaffe groups.

*Practical Wireless, February 1988*

Yet other problems had to be overcome.

If the Enigma transmissions to the beam stations could be broken in time (they were usually sent out in the afternoon preceding a raid) we would know where and when K.Gr.100 was going to attack, and our fighters could be ready for them; our jammers, too, could be set on the correct frequencies. For this to be possible the cryptographers at Bletchley Park strained all their resources—and it was a magnificent effort, for they achieved this incredible feat late in October. Dr Jones was then able to tell Fighter Command the exact place of the attack, the time of the first bomb to within 10 minutes, the exact speed of the bombers, their line of approach to within 90m, and their height to within 2 or 3 hundred metres!

Yet our night fighters repeatedly failed to find the enemy. Jones wrote: "I almost began to wonder whether the only use the Duty Air Commodore made of my telephone calls was to take a bet with the rest of the Command as to where the target would be for that night". On top of this was the growing suspicion that our jamming was not working. Why not?

The answer soon came—but not before tragedy struck.

## Moonlight Sonata

On November 10 Jones received an Enigma decrypt of a transmission to the beam stations which told them to prepare operations against target numbers 51, 52 and 53, giving the beam settings at the same time. It took only a few minutes to work out that 51 was Wolverhampton, 52 was Birmingham, and Coventry was 53. Then another signal was passed to him which contained orders for a major operation under the code-name *Moonlight Sonata*. Four target areas were mentioned but there was no indication of the order of the attacks. Frantic guesses were made by the Air Staff and the best they could come up with was that Moonlight Sonata might mean a target in southern England. Strangely, no attack had been made on Wolverhampton, and on November 14 everyone braced themselves for the coming night and whatever Moonlight Sonata might mean.

Tragically, it was one of those afternoons when Bletchley Park failed to break the Enigma signals in time, and

80 Wing asked Jones which frequencies should they set their jammers on, giving a list of frequencies as determined by our monitoring aircraft. "I could see at once that the measurements must be wrong, in that they did not match up with the figures I knew from the Anna code. I therefore made a mental correction of the measurements as far as I could—for example, 68.6 should have been 68.5, if our receivers had been properly calibrated, or 70.9 should have been 71.0. But deciding what, for example, 66.8 meant was more of a lottery. The only other clue that I spotted was that there seemed to be a convention that the director beams would generally be on frequencies between 66.5 and 71.5 and the cross beams between 71.5 and 75.0MHz, the division being presumably due to operational convenience. Remembering that we needed to knock out the main and reserve director beams and at least one of the cross beams, I then made my mental gamble and suggested a set of frequencies to Addison which he said he would adopt. All this took no more than five minutes on the telephone: but I was well aware that in these snap decisions I was probably gambling with hundreds of lives. Sobering though this thought was, the fact remained that someone had to do it, and I was easily in the best position."

Then on the night of November 14/15 Coventry was attacked, with heavy civilian casualties. What had gone wrong? The next day the decoded Enigma signals to the beams stations arrived and Jones' wretchedness turned to bewilderment. He had guessed the frequencies correctly—so where was the failure?

## Incompetence and Carelessness

The failure arose originally from a silly inter-service squabble which led on to a ghastly mistake. On November 6 one of K.Gr.100's Heinkels became lost over southern England and ditched on Chesil Beach. The Army took over, secured a rope around the fuselage and set about salvaging it, when a naval inshore vessel arrived and demanded to know what the Army thought it was doing. As the aircraft

was in the water salvage was a Navy matter and, taking the rope aboard, dragged the aircraft deeper into the sea, breaking the rope in the process. The X-Gerät equipment aboard, now heavy with silt and corrosion, was fortunately discovered and rushed to 80 Wing and then on to Farnborough for investigation.

On November 21 Jones, accompanied by Scott-Farnie and their assistants, went to see it for themselves. They learned that Farnborough had examined the audio filter and found it set to 2000Hz. But our jammers had been modulated at 1500Hz, which meant that while our carrier frequencies were correct the modulation tone had no effect on the beams.

"It was one of those instances, of which I have since found many, where enormous trouble is taken to get the difficult parts right and then a slip-up occurs because of lack of attention to a seemingly trivial detail. Of all the measurements in connection with the German beams, easily the simplest was to determine the modulation note, because this could be done at any time in comfort; and yet whoever had done it had either been tone deaf or completely careless, and no one had ever thought of checking his measurements. I was so indignant that I said whoever had made such a mistake ought to have been shot." It is hard to believe that the citizens of Coventry would have disagreed with this opinion.

Jones' anger was further increased by the fobbing-off he encountered. He was told that the modulation note was originally 1500Hz but the Germans had changed their filters to avoid jamming. This ridiculous excuse was countered by Jones who pointed out that if that had been the case we would obviously have heard the change in note for ourselves. In any event he was able to prove that K.Gr.100 had been using the same filters since the start of their operations.

On his insistence the jamming modulation frequency was changed and when, later, the Germans attacked Birmingham their bombs fell wide of the target, most of them outside the city. Gradually they came to realise we had broken X-Gerät and their confidence in the system diminished, and Britain which knew nothing about Dr Jones and his scientific war went on "business as usual".

**In Part 3, G4GVO tells how Wotan's "other eye"—the Y-System—was successfully countered.**

## ERRORS & UPDATES

### Letter—"Morse" January 1988

The Morse code equivalent of "ES" is, of course, "dit di-dit", and not as was shown on page 14 of that issue in the letter about American Morse.

*Practical Wireless, February 1988*

### Making Waves, Part 2 January 1988

The decibel equivalent of 50 picowatts is -103dBW, not as shown in the third column of page 52, where the minus sign became separated from the figures.

# Practically Yours

By Glen Ross G8MWR

Several readers have mentioned a need for a simple method of testing diodes and transistors. The two requirements are easily combined into a single piece of test gear and have the added advantage that construction and setting up are well within the scope of the newcomer to home construction.

## Measurement System

It is easy enough to roughly check transistors using only a simple multi-range testmeter, but all that this method will tell you is whether the unit is basically in good condition or is a dud. The tester to be described will also measure the actual current gain of the transistor with reasonable accuracy and so gives a far better picture of the device. It can handle both *nnp* and *ppp* devices and will also measure forward and reverse conduction of diodes. The current gain, or beta, of the transistor is measured on one of two ranges giving full scale readings of 100 and 300, and is therefore capable of handling all the gains likely to be found in practice.

## The Circuit

This is shown in Fig. 1 and consists of the actual test circuit and a stabilised supply to power it. Basic power may be obtained from a 12 volt supply but it is probably better to fit a PP3 battery inside the case as the maximum current drawn is only around 25 milliamps and even that is only drawn for the few seconds it takes to complete a test. The supply is Zener stabilised to 4.7 volts and it is essential that this value of Zener is used if the readings are to mean anything as the various biasing resistors are calculated for this voltage. An l.e.d. is fitted to remind you to switch off when not in use. Switch S1a is used to select *nnp* or *ppp* operation and this is achieved by simply reversing the supply lines to the

transistor. The same switch also changes the voltage applied to a diode when it is being tested for forward and reverse current.

## Gain Test

This is achieved by injecting a known current into the base of the transistor and reading the collector current, the ratio of the two currents being the gain of the transistor. Two levels of bias current are provided by R1 and R3 and these are selected by S2b. The meter is shunted to read 10 milliamps full scale deflection by R2 and is protected against an accidental short circuit, perhaps due to a faulty transistor, by the Zener dropper R5 which, even on a 12 volt supply, will limit the meter current to a safe level.

## The Meter

This is a one milliamp unit and one should be chosen which has a good length open scale, preferably with a 0-10 scale divided into fifty units. This will give easy reading on the 300 beta scale where the actual reading has to be multiplied by three. The internal resistance of the meter is of no importance as it is shunted by a variable resistor to give the required ranges.

## Build and Set-up

The front panel layout is in no way critical. The setting up procedure is simple and requires no extra instruments to do the job. It is important that the following steps should be carefully followed and completed in the order shown.

Connect the unit to a suitable power supply or fit the PP3 battery. Switch the unit on and the l.e.d. D2 should light, if it does not then try reversing the connections to the l.e.d. Now switch the range switch S2 to the diode position and set R4 to the maximum resistance position. Connect a short length of wire between the test terminals marked E and C and carefully adjust R4 to give full scale deflection

on the meter. Leave everything connected as before and switch the supply off. Next connect a length of wire between the points marked X and Y on the circuit diagram and set R2 to minimum resistance. Switch the unit on and slowly adjust R2 until a reading of one tenth of full scale is shown on the meter. Switch off and remove both wires that were fitted in the previous steps.

## Setting Beta Ranges

Connect a small transistor which is known to be in good working order with the emitter, base and collector leads going to terminals E, B, and C respectively and switch the selector switch to NPN or PNP as required. The range switch should be set to 100 and when the unit is switched on a reading will be obtained and this should be noted. Switch off and set the preset R1 to the maximum resistance position and the range switch to 300. Switch the unit on and slowly adjust R1 until a reading of one third of full scale is shown on the meter. This completes the calibration of the unit.

## Using It

To test a transistor connect it to the terminals, set the range switch to 300 and the selector switch to NPN or PNP. Switch the power on and if the reading is less than one third of full scale switch to the 100 range. If there is no reading throw the transistor away.

To test a diode connect it between the E and C terminals and set the selector to the diode position. Operate the PNP/NPN switch and you should get a high reading in one position and a low one in the other, if not scrap the diode. Sometimes you get something for nothing; the meter can also be used as an ohmmeter by connecting the resistor as though it were a diode, a graph of the calibration should be drawn up using a few test resistors of known values. **PW**

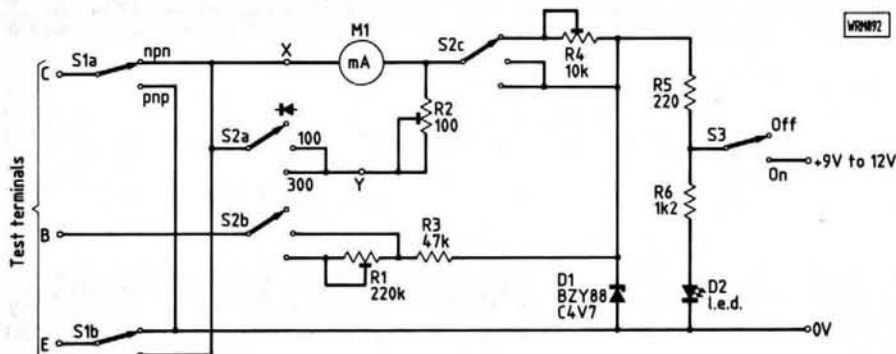

Fig. 1: The actual test circuit and a stabilised supply

Practical Wireless, February 1988

# Reg Ward & Co. Ltd.

1 Western Parade, West Street, Axminster, Devon, EX13 5NY.

Telephone: Axminster (0297) 34918



FT767	HF Transceiver	1550.00	(—)	IC761	New Super HF Transceiver	1465.00	(—)	TS940S	9 Band TX General Cov RX	1995.00	(—)
FEX767(2)	2m Module (767)	169.00	(2.50)	IC751A	HF Transceiver	949.00	(—)	AT940	Auto/ATU	244.88	(2.50)
FEX767(70)	70cm Module (767)	215.00	(2.50)	IC735	New HF Transceiver	365.00	(3.50)	SP940	Ext Speaker	87.55	(2.50)
FEX767(16)	6m Module (767)	169.00	(2.50)	AT100	100W ATU (75/1745)	150.00	(3.00)	TS930S	9 Band TX General Cov RX	1695.00	(—)
SP767	Speaker	69.95	(2.00)	AT150	150W ATA (735)	185.00	(3.50)	AT930	Auto/ATU	206.03	(2.50)
FT290	NikIt New Super 290	429.00	(—)	PS55	Ext PSU (735)	315.00	(3.00)	SP930	Ext Speaker	90.94	(2.50)
FT290	2m M/Mode Port/Transceiver	379.00	(—)	IC505	50MHz multi-mode portable	459.00	(3.00)	TS440	180-Tm Transceiver 9 Bands	1138.81	(—)
MMB11	Mobile Bracket	37.50	(1.50)	IC290D	2m 25w M/Mode	542.00	(—)	AT440	Auto/ATU	144.82	(2.50)
NC11	Charge	10.50	(1.50)	IC298	25W FM	358.00	(3.00)	PS50	10Duty PSU	222.49	(2.50)
CSC1	Carrying Case	6.50	(1.50)	IC298	2m 40W FM	399.00	(3.00)	SP430	Matching Power Supply	173.78	(3.50)
YHA15	2m Helical	7.50	(1.50)	IC295	2E New Mini HH	225.00	(3.00)	SP230	External Speaker Unit	66.49	(2.50)
YHA440	70cm V2wave	12.50	(1.50)	IC292	2m The Original HH	269.00	(3.00)	SP430	Matching Speaker	40.81	(2.50)
YM49	Speaker Mike	22.00	(1.50)	IC275E	New 2m 25 Base Stn	1039.00	(—)	MB430	Mobile Mounting Bracket	15.80	(2.50)
MMB15	Mobile Bracket	14.55	(1.50)	IC4E	70cm HH	299.00	(3.00)	FM430	FM Board for T5450	48.05	(2.50)
FT23	2m Mini HH	223.50	(2.50)	IC48E	70cm 25W FM Mobile	443.00	(3.00)	SM220	Station Monitor	343.62	(3.50)
FT73	70cm Mini HH	243.50	(2.50)	IC490	70cm 10W M/Mode	617.00	(—)	BS8	Band Scope Unit (830/940)	77.00	(2.00)
FN89	Spare Battery Pack (23/73)	25.00	(1.50)	IC700	2m/70 Dual Band FM Mobile	556.00	(3.00)	TL922	10/180 ZK Linear	1485.00	(7.00)
FN810	Spare Battery Pack (23/73)	30.00	(1.50)	IC12E	23cm HH	428.00	(3.00)	TH21	2M Mini HH	185.00	(2.50)
FN811	Spare Battery Pack (23/73)	46.00	(1.50)	ICR71	Gen Cov RX	825.00	(—)	TH41	70cm Mini HH	218.00	(2.50)
NC18C	Charger (23/73)	12.35	(1.50)	IC7000	VHF/UHF Scanner	967.00	(—)	TH205	2M HH	215.26	(2.50)
NC28	Charger (23/73)	15.40	(1.50)	AH7000	25-1300MHz Discone	82.00	(2.50)	TH215	2M HH Keyboard	252.13	(3.00)
NC29	Base Charger (23/73)	53.00	(2.50)	SP3	Ext Speaker	61.00	(2.00)	TR751	2M 25W M/M Mobile	599.00	(—)
PA6	Car Adap/Charger (23/73)	18.00	(1.50)	CK70	DC Cable (R70/R71)	7.00	(1.50)	TSR11	2M 25W Base Stn	940.00	(—)
MH12A2B	Speaker Mic	27.00	(1.50)	EX257	FM Board (R70/R71)	41.00	(2.00)	R2000	70cm 25W Base Stn	1094.05	(—)
FT727	2m/70cm HH	425.00	(3.00)	GC5	World Clock	14.38	(1.50)	RC2000	Gen Coverage HF/RX	599.00	(—)
FN83	Spare Battery Pack	41.00	(1.50)	AD2	Waterproof Bag all loom HH	70.15	(2.00)	R5000	118-174MHz Converter (R2000)	161.54	(2.00)
FN84	Spare Battery Pack	46.00	(1.50)	BC35	Desk Charger	29.90	(1.50)	VC20	NEW General Coverage HF/RX	875.00	(—)
FN85	Empty Cell Case	10.00	(1.50)	BP4	Battery Pack 8.4V (2/4E/02/04E)	9.20	(1.50)	BT7	118-174MHz Converter (R5000)	167.21	(2.00)
FR3500M	NEW 60-500MHz Scanning RX	509.00	(—)	BP5	Empty Battery Case (2/4E/02/04E)	9.20	(1.50)	DC21	Empty Battery Case TH2141	11.86	(1.50)
MMB10	Mobile Bracket	10.00	(1.50)	BP7	Battery Pack 10.8V	60.95	(2.00)	ER2	DC Power Supply TH2141	25.00	(1.50)
NC9C	Charger	11.50	(1.50)	BP8	Battery Pack 13.2V (02/04E only)	74.75	(2.00)	HNC1	Ext. Battery Case TH2141	55.77	(1.50)
PA3	Car Adaptor/Charger	21.85	(1.50)	CP1	Battery Pack 8.4V	71.30	(1.50)	PE21	Headset with Vox TH2141	32.91	(1.50)
FN82	Spare Battery Pack	27.50	(1.50)	DC1	12v Charge Lead BP3/7/8	6.90	(1.50)	BC8	Nicad Pack TH2141	24.36	(1.50)
YM24A	Speaker Mike	27.00	(1.50)	FA2	DC/DC converter operate from 12v	17.25	(1.50)	SC8	Desk Charger TH2141	99.00	(2.00)
FT726R	2m Base Station	349.00	(3.00)	FA3	2m Helical BNC	9.20	(1.50)	SMC30	Soft Case TH2141	11.86	(1.50)
FR3800	HF Receiver	639.00	(—)	MA9	70cm Flexible 1/4D Antenna (BNC)	3.20	(1.50)	MC50	Speaker/Mic TH2141/2600	28.31	(1.50)
FRV800	Converter 118-175 for above	100.00	(2.00)	HS10	Speaker/Mic	21.85	(2.00)	MC25	4P Desk Mic	46.08	(2.50)
FR17700RX	A.T.U.	59.00	(2.00)	HS10SB	Head set Boom Mike	14.38	(1.50)	MC80	8P Desk Mic	85.22	(3.00)
MH188	Hand 600 8pin mic	21.00	(1.50)	LC1	Vox Unit HS10 (02/04E only)	25.30	(1.50)	MC85	Electric Desk Mic	53.98	(2.50)
MD188	Desk 600 8pin mic	79.00	(1.50)	LC3	PTT SW Box HS10	20.70	(1.50)	MC25	Desk Mic Audio Level Comp	99.00	(2.00)
MF1A3B	Boom mobile mic	25.00	(1.50)	LC11	Leatherette Case 2E/4E + BP5	6.90	(1.50)	MC30	8P Flat Mic	85.22	(3.00)
YH77	Lightweight phones	19.99	(1.50)	LC14	Leatherette Case 2E/4E + BP3	6.90	(1.50)	MC35	4P Flat Mic	21.72	(1.50)
YH55	Padded phones	19.99	(1.50)	SM6	Leatherette Case 02E/04E + BP3	9.20	(1.50)	MC55	Mobile Mic (6br 8p)	52.67	(2.50)
YH1	LWlight Mobile H/est-Boom mic	19.99	(1.50)	SM8	Leatherette Case 02E/04E + BP5/7/8	9.20	(1.50)	H55	HF Low Pass Filter	32.26	(2.00)
SB1	PTT Switch Box 208/708	22.00	(1.50)	SM10	Shoulder Strap	10.35	(1.50)	H56	Receiver ATU (Mizuh0)	67.28	(2.50)
SB2	PTT Switch Box 290/790	22.00	(1.50)	SMCS 2U	600ohm 8P Base Mic	46.00	(2.00)	H57	Lightweight H/phones	37.54	(2.00)
SB10	PTT Switch Box 270/2700	22.00	(1.50)	SMCS 2N	1.3K/600Ω 8P Base Mic	82.00	(2.00)	SW100A	Deluxe H/phones	45.50	(2.00)
FF501DX	Low Pass Filter	38.50	(1.50)	SMCS 2N	Comp/Graphic Mike	116.00	(2.50)	SW100B	SWR/Power Meter 1.8-150MHz	52.76	(2.00)

### Dating Products

PC1	Gen. Cov. Con.	137.40	(2.00)
VL1	Very low frequency conv.	34.90	(2.00)
FL2	Multi-mode audio filter	89.70	(2.00)
FL3	Audio filter for receivers	129.00	(2.00)
ASP/B	r.f. speech clipper for Trio	82.80	(2.00)
ASP/A	r.f. speech clipper for Yaesu	82.80	(2.00)
ASP	As above with 8 pin conn	89.70	(2.00)
D75	Manual RF speech clipper	56.35	(2.00)
D70	Morse Tutor	36.30	(2.00)
RFA	RF switched pre-amp	66.30	(2.00)
AD270-MPU	Active dipole with mains p.s.u.	51.75	(2.00)
AD370-MPU	Active dipole with mains p.s.u.	69.00	(2.00)
DC144Z6	2m converter	39.67	(2.00)
ANF	Automatic notch filter	67.85	(2.00)
SRB2	Auto Woodpecker blander	86.25	(2.00)

### Miscellaneous

2N 50239 Switch	18.95	(2.00)
2 way 'n' Sxks Switch	23.50	(2.00)
3 way 50239 Switch	16.90	(2.00)
3 way 'n' Sxks Switch	21.91	(2.00)
2 way Switch 'n' Sxks deluxe	27.00	(2.00)
30W Dummy load	30.25	(2.00)
100W Dummy load	45.00	(2.00)
200W Dummy load	65.00	(2.00)

### SWR/PWR Meters

1.8-150MHz PWR/SWR	37.00	(2.50)
1.8-60MHz PWR/SWR/PEP	79.95	(2.50)
1.8-100MHz PWR/SWR/PEP	67.95	(2.50)
1.8-200MHz PWR/SWR/PEP	99.95	(2.50)
140-525MHz PWR/SWR/PEP	58.95	(2.50)
1.8-200MHz PWR/SWR/PEP	119.95	(2.50)
1.8-200-430-800-1240MHz	168.95	(2.50)

### CW Keyers

VIBROPEX Iambic Standard	63.33	(3.00)
Iambic Deluxe	78.09	(3.00)
Vibrokeyer Standard	63.98	(3.00)
Vibrokeyer Deluxe	78.09	(3.00)
The Original Standard	73.54	(3.00)
The Original Deluxe	82.74	(3.00)
BENCHER BY2 Squeeze Key, Black base	67.42	(2.50)
Squeeze Key, Chrome base	76.97	(2.50)

Instant credit available. Mail/Telephone order by cheque or credit card. Cheques cleared before goods despatched. (E&OE)

OPEN TUES.-SAT. 9.00-5.30 (CLOSED MONDAYS)

STOCK ITEMS USUALLY DESPATCHED WITHIN 48 HRS.

DELIVERY/INSURANCE PRICES IN BRACKETS

## Acknowledged to be the best 2 Metre Multimode



**TR751E**  
£599.00 inc. VAT, Carriage £8.00

LOWE ELECTRONICS LIMITED Chesterfield Road, Matlock, Derbyshire DE4 5LE Telephone 0629 580800 (4 lines)

# Short Wave Magazine

## FIRE ON ALPHA

*Drama on a North Sea oil rig*

*The dramatic story of the part played by radio communications, when fire struck the Forties Alpha oil rig.*

REVIEW

We look at the Howes TRF3 receiver kit

REGULARS

Airband, Scanning, Bandscan, Seen & Heard

.....JANUARY ISSUE OUT NOW.....JANUARY ISSUE OUT NOW.....



0202 678558

Practical Wireless

0202 678558



# BOOK SERVICE

The books listed have been selected as being of special interest to our readers. They are supplied from our editorial address direct to your door. Some titles are American in origin.

## HOW TO ORDER

Add 75p per order postage (overseas readers add £1.50 for surface mail postage) and send a postal order, cheque or international money order with your order (quoting book titles and quantities) to **PW Publishing Limited, FREEPOST, Enefco House, The Quay, Poole, Dorset BH15 1PP**. Payment by Access, Mastercard, Eurocard or Visa also accepted on telephone orders to Poole (0202) 678558. Books normally despatched by return of post but please allow 28 days for delivery.

★ A recent addition to our Book Service. O/P = Out of print, O/S = Out of stock.

### RADIO

#### AN INTRODUCTION TO RADIO DXING (BP91)

R. A. Penfold

How to find a particular station, country or type of broadcast and to receive it as clearly as possible. 112 pages £1.95

#### A TV-DXERS HANDBOOK (BP176)

R. Bunney

Information on transmission standards, propagation, receivers including multi-standard, colour, satellites, antennas, photography, station identification, interference, etc. Revised and updated 1986. 87 pages O/P

#### BEGINNER'S GUIDE TO RADIO (9th Edition)

Gordon J. King

Radio signals, transmitters, receivers, antennas, components, valves and semiconductors, CB and amateur radio are all dealt with here. 266 pages £6.95

#### BETTER RADIO/TV RECEPTION

A. Nallawalla, A. T. Cushen and B. D. Clark

An Australian publication giving guidance and advice both to listeners seeking reliable reception of some distant radio station, and to DX listening hobbyists. 134 pages £9.95

#### BETTER SHORTWAVE RECEPTION (USA)

W. S. Orr W6SAI & S. D. Cowan W2LX

Receivers, antennas, propagation, DX listening techniques for the short waves and v.h.f. 158 pages £5.50

#### COMMUNICATION (BP89)

(Elements of Electronics—Book 5)

F. A. Wilson

Fundamentals of line, microwave, submarine, satellite, digital multiplex, radio and telegraphy systems are covered, without the more complicated theory or mathematics. 256 pages £2.95

#### FOUNDATIONS OF WIRELESS AND ELECTRONICS (10th Edition)

M. G. Scroggie and S. W. Amos

Covering d.c. and a.c. circuits, L, C, tuned circuits and selectivity, valves, semiconductors, transmission lines, antennas, radiation, oscillation, modulation, detection, amplification, superhet receivers, c.r.t.s, waveform generators and switches, computers and power supplies. 551 pages £8.95

#### GUIDE TO BROADCASTING STATIONS

19th Edition (1987/88)

Philip Darrington

Frequency and station data, receivers, antennas, Latin American DXing, reporting, computers in radio, etc. 240 pages £6.95

#### ★ GUIDE TO FACSIMILE STATIONS

7th Edition

Joerg Klengenfuss

This manual is the basic reference book for everyone interested in FAX. Frequency, call sign, name of the station, ITU country/geographical symbol, technical parameters of the emission are all listed. All frequencies have been measured to the nearest 100Hz. 252 pages £12.00

#### ★ GUIDE TO FORMER UTILITY TRANSMISSIONS

3rd Edition

Joerg Klengenfuss

This manual is built on continuous monitoring of the radio spectrum from the sixties until the recent past. It is a useful summary of former activities of utility stations and provides information to the active radio monitor in the classification and identification of radio signals. 126 pages £8.00

#### ★ GUIDE TO UTILITY STATIONS

6th Edition

Joerg Klengenfuss

This book covers the complete short wave range from 3 to 30MHz plus the adjacent frequency bands from 0 to 150kHz and from 1.6 to 3MHz. It includes details on all types of utility stations including FAX and RTTY. There are 15802 entries in the frequency list and 3123 in the alphabetical call sign list plus press services and meteorological stations. 494 pages £19.00

#### ★ HF OCEANIC AIRBAND COMMUNICATIONS (2nd Edn.)

Bill Laver

Aircraft channels by frequency and band, main ground radio stations, European R/T networks, North Atlantic control frequencies. 24 pages £3.50

#### INTERFERENCE HANDBOOK (USA)

William R. Nelson WA6FGG

How to locate and cure r.f.i. for radio amateurs, CBers and TV and stereo owners. 253 pages £6.75

#### INTERNATIONAL RADIO STATIONS GUIDE (BP155)

Revised and updated in 1985, this book shows the site, country, frequency/wavelength and power of stations in Europe, the Near East and N. Africa, North and Latin America and the Caribbean, plus short-wave stations worldwide. 128 pages £2.95

#### QUESTIONS & ANSWERS

RADIO

Eugene Trundle

Basics of electrical theory, radio and semiconductors, receivers, amateur and CB radio, and test equipment. 110 pages £2.95

#### RECEIVING STATION LOGBOOK (RSGB)

Standard logbook for the s.w.l. in horizontal A4 format. 32 lines per page. 50 pages O/S

#### SATELLITE TELEVISION

Peter S. Pearson

How satellite TV works, setting up your own TVRO terminal, the costs, the programmes available. 72 pages £4.95

#### SCANNERS

Peter Rouse GU1DKD

A guide for users of scanning receivers, covering hardware, antennas, accessories, frequency allocations and operating procedure. 177 pages £7.95

#### THE COMPLETE VHF/UHF FREQUENCY GUIDE

This book gives details of frequencies from 26–2250MHz with no gaps and who uses what. There are chapters on equipment requirements as well as antennas, etc. 60 pages £4.95

#### UK LISTENERS CONFIDENTIAL FREQUENCY LIST (4th Edn. 1987/88)

Bill Laver

Covering the services and transmission modes that can be heard on the bands between 1.635 and 29.7MHz. 124 pages £5.95

#### VHF/UHF AIRBAND FREQUENCY GUIDE

A complete guide to the airband frequencies including how to receive the signals, the frequencies and services, VOLMET and much more about the interesting subject of airband radio. 74 pages £5.95

#### WORLD RADIO TV HANDBOOK (1987)

Country-by-country listings of long, medium and short wave broadcasters and TV stations. Receiver test reports. English language broadcasts. The s.w.l.'s "bible". 576 pages O/S

## DATA & REFERENCE

#### DIGITAL IC EQUIVALENTS AND PIN CONNECTIONS (BP140)

A. Michaels

Equivalents and pin connections of a popular selection of European, American and Japanese digital i.c.s. 256 pages £5.95

#### ★ GUIDE TO WORLD-WIDE TELEVISION TEST CARDS

Edition 2

Keith Hamer and Garry Smith

The main purpose of this book is to assist long distance television enthusiasts (TV DXers) around the world with signal identification. There are 240 test cards, identification slides and clock captions pictured. It is in "semi-alphabetical" order, that is the stations are in alphabetical order in their geographical sections. 52 pages £2.95

#### INTERNATIONAL DIODE EQUIVALENTS GUIDE (BP108)

A. Michaels

Possible substitutes for a large selection of many different types of semiconductor diodes. 144 pages £2.25

#### INTERNATIONAL TRANSISTOR EQUIVALENTS GUIDE (BP85)

A. Michaels

Possible substitutes for a popular selection of European, American and Japanese transistors. 320 pages £3.50

#### LINEAR IC EQUIVALENTS AND PIN CONNECTIONS (BP141)

A. Michaels

Equivalents and pin connections of a popular selection of European, American and Japanese linear i.c.s. 320 pages £5.95

#### NEWNES COMPUTER ENGINEER'S POCKET BOOK

This is an invaluable compendium of facts, figures, circuits and data and is indispensable to the designer, student, service engineer and all those interested in computer and microprocessor systems. 203 pages Hardback £8.95

#### NEWNES ELECTRONICS POCKET BOOK

Presenting all aspects of electronics in a readable and largely non-mathematical form for both the enthusiast and the professional engineer. 315 pages Hardback £8.95

#### ★ NEWNES RADIO AMATEUR AND LISTENER'S POCKET BOOK

Steve Money G3FZX

This book is a collection of useful and intriguing data for the traditional and modern radio amateur as well as the short wave listener. Topics such as AMTOR, packet radio, SSTV, computer communications, airband and maritime communications are all covered. 160 pages £8.95

#### NEWNES RADIO AND ELECTRONICS ENGINEER'S POCKET BOOK

(17th Edition)

Keith Brindley

Useful data covering maths, abbreviations, codes, symbols, frequency bands/allocations, UK broadcasting stations, semiconductors, components, etc. 201 pages Hardback £6.95

#### NEWNES TELEVISION AND VIDEO ENGINEER'S POCKET BOOK

Eugene Trundle

This is a valuable reference source for practitioners in "entertainment" electronic equipment. It covers TV reception from v.h.f. to s.h.f., display tubes, colour camera technology, video recorder and video disc equipment, video text and hi-fi sound. 323 pages £9.95

#### OSCILLOSCOPES, HOW TO USE THEM, HOW THEY WORK (Revised 2nd Edition)

Ian Hickman

This book describes oscilloscopes ranging from basic to advanced models and the accessories to go with them. 133 pages £5.95

#### POWER SELECTOR GUIDE (BP235)

J. C. J. Van de Ven

This guide has the information on all kinds of power devices in useful categories (other than the usual alpha numeric sort) such as voltage and power properties making selection of replacements easier. 160 pages £4.95

#### ★ RADIOTELETYPE CODE MANUAL

10th Edition

Joerg Klengenfuss

This book provides detailed descriptions of the characteristics of telegraph transmission on short waves, with all commercial modulation types including voice frequency telegraphy. It provides comprehensive information on all RTTY systems and c.w. alphabets. 96 pages £8.00

## RSGB RADIO DATA

### REFERENCE BOOK

G. R. Jessop G6JP

The 5th Edition of an essential book for the radio amateur's or experimenter's workbench. 244 pages **Hardback £8.56**

## SEMICONDUCTOR DATA BOOK

A. M. Ball

Characteristics of about 10 000 transistors, f.e.t.s, u.j.t.s, diodes, rectifiers, triacs and s.c.r.s. 175 pages **£7.50**

## TRANSISTOR SELECTOR GUIDE (BP234)

J. C. J. Van de Ven

This guide has the information on all kinds of transistors in useful categories (other than the usual alpha numeric sort) such as voltage and power properties making selection of replacements easier. 192 pages **£4.95**

## PROJECT CONSTRUCTION

### HOW TO BUILD ADVANCED SHORT WAVE RECEIVERS (BP226)

R. A. Penfold

Greater satisfaction can be gained from the hobby of shortwave listening when using home constructed equipment. This book gives full practical constructional details of a number of receivers as well as some add-on circuits like S-meters and noise limiters. 118 pages **£2.95**

### HOW TO DESIGN AND MAKE YOUR OWN P.C.B.s (BP121)

R. A. Penfold

Designing or copying printed circuit board designs from magazines, including photographic methods. 80 pages **£1.95**

### INTRODUCING QRP

Collected Articles from *PW* 1983-1985

An introduction to low-power transmission, including constructional details of designs by Rev. George Dobbs G3RJV for transmitters and transceivers from Top Band to 14MHz, and test equipment by Tony Smith G4FAI. 64 pages **£1.50**

### POWER SUPPLY PROJECTS BP76

R. A. Penfold

This book gives a number of power supply designs including simple unregulated types, fixed voltage regulated types and variable voltage stabilised designs. 91 pages **£2.50**

### PRACTICAL POWER SUPPLIES

Collected Articles from *PW* 1978-1985

Characteristics of batteries, transformers, rectifiers, fuses and heatsinks, plus designs for a variety of mains-driven power supplies, including the *PW* "Marchwood" giving a fully stabilised and protected 12V 30A d.c. 48 pages **£1.25**

### SOLID STATE SHORT WAVE RECEIVERS FOR BEGINNERS (BP222)

R. A. Penfold

There is a strange fascination in listening to a broadcast which has been transmitted over many thousands of kilometres. This is even more the case when you've built the receiver yourself. This book contains several designs that will give a fairly high level of performance. 93 pages **£2.95**

## AMATEUR RADIO

### A GUIDE TO AMATEUR RADIO (RSGB)

Amateur Radio—the hobby, the equipment, workshop practice, the licence, the RAE (including sample questions). 154 pages **£3.62**

### AMATEUR RADIO CALL BOOK (RSGB)

Spring 1987 Edition

This useful work now incorporates a 48-page reference section of useful information for amateur radio enthusiasts. 310 pages **0/5**

### AMATEUR RADIO LOGBOOK

Standard logbook for the transmitting amateur in horizontal A4 format. 25 lines per page. 96 pages **£2.30**

### AMATEUR RADIO OPERATING MANUAL (RSGB)

A mine of information on just about every aspect of amateur operating, including international call sign series holders, prefix lists, DXCC countries list, etc. 204 pages **£6.16**

### HOW TO PASS THE RADIO AMATEURS' EXAMINATION (RSGB)

G. L. Benbow G3HB

The background to multiple choice exams and how to study for them with nine sample RAE papers for practice, plus maths revision. 91 pages **£3.15**

### INTRODUCING MORSE

Collected Articles from *PW* 1982-1985

Ways of learning the Morse Code, followed by constructional details of a variety of keys including lambic, Triambic, and an Electronic Bug with a 528-bit memory. 48 pages **£1.25**

### PASSPORT TO AMATEUR RADIO

Reprinted from *PW* 1981-1982

The famous series by GW3JGA, used by thousands of successful RAE candidates as an aid to their studies. Plus other useful articles for students of amateur radio. 96 pages **£1.50**

### PROJECTS IN AMATEUR RADIO AND SHORT WAVE LISTENING

F. G. Rayer G3OGR

Full constructional details are given for all projects, including housing the units in a suitable case. All the projects are either on p.c.b. or matrix board. 90 pages **£4.95**

## QUESTIONS & ANSWERS

### AMATEUR RADIO

F. C. Judd G2BCX

What is amateur radio? The Radio Amateurs' Exam and Licence. The technology, equipment, antennas, operating procedure and codes used by amateurs. 122 pages **£2.95**

### RADIO AMATEUR'S GUIDE

#### RADIO WAVE PROPAGATION (HF Bands)

F. C. Judd G2BCX

The how and why of the mechanism and variations of propagation in the h.f. bands. 144 pages **£8.95**

### RADIO AMATEUR'S MAP OF NORTH AMERICA (USA)

Shows radio amateurs' prefix boundaries, continental boundaries and zone boundaries. 760 x 636mm **£2.25**

### ★ THE INTERNATIONAL VHF FM GUIDE

7th Edition

Julian Baldwin G3UHK & Kris Partridge G8AUU  
The latest edition of this useful book gives concise details of repeaters and beacons worldwide plus coverage maps and further information on UK repeaters. 70 pages **£2.85**

### THE MORSE CODE FOR RADIO AMATEURS (RSGB)

Margaret Mills G3ACC

A guide to learning to send and receive Morse code signals up to the 12 w.p.m. required for the RAE. 19 pages **£2.88**

### THE SATELLITE EXPERIMENTER'S HANDBOOK (USA)

A guide to understanding and using amateur radio, weather and TV broadcast satellites. 207 pages. **£9.25**

### THE SECRET OF LEARNING MORSE CODE

Mark Francis

Designed to make you proficient in Morse code in the shortest possible time, this book points out many of the pitfalls that beset the student. 87 pages **£4.95**

### VHF HANDBOOK

#### FOR RADIO AMATEURS (USA)

H. S. Brier W9EGQ & W. I. Orr W6SAI

VHF/UHF propagation, including moonbounce and satellites, equipment and antennas. 335 pages **£7.95**

### VHF/UHF MANUAL (RSGB)

G. R. Jessop G6JP

Theory and practice of amateur radio reception and transmission, between 30MHz and 24GHz. 520 pages **Hardback £12.92**

## ANTENNAS (AERIALS)

### AERIAL PROJECTS (BP105)

R. A. Penfold

Practical designs including active, loop and ferrite aerials plus accessory units. 96 pages **£1.95**

### ALL ABOUT CUBICAL QUAD ANTENNAS (USA)

W. I. Orr W6SAI & S. D. Cowan W2LX

Theory, design, construction, adjustment and operation of quads. Quads vs. Yagis. Gain figures. 109 pages **£5.50**

### ALL ABOUT VERTICAL ANTENNAS (USA)

W. I. Orr W6SAI and S. D. Cowan W2LX

Theory, design, construction, operation, the secrets of making vertical work. 191 pages **£7.50**

### AN INTRODUCTION TO ANTENNA THEORY (BP198)

H. C. Wright

This book deals with the basic concepts relevant to receiving and transmitting antennas. Lots of diagrams reduce the amount of mathematics involved. 86 pages **£2.95**

### BEAM ANTENNA HANDBOOK (USA)

W. I. Orr W6SAI & S. D. Cowan W2LX

Design, construction, adjustment and installation of h.f. beam antennas. 198 pages **£6.75**

### HF ANTENNAS

#### FOR ALL LOCATIONS (RSGB)

L. A. Moxon G6XN

Taking a new look at how h.f. antennas work, and putting theory into practice. 260 pages **£6.17**

### OUT OF THIN AIR

Collected Antenna Articles from *PW* 1977-1980

Including such favourites as the ZL Special and '2BCX 16-element beams for 2m, and the famous "Slim Jim", designed by Fred Judd G2BCX. Also features systems for Top Band, medium wave/long wave loop designs and a v.h.f. direction finding loop. Plus items on propagation, accessories and antenna design. 80 pages **£1.80**

### SIMPLE, LOW-COST WIRE ANTENNAS FOR RADIO AMATEURS (USA)

W. I. Orr W6SAI and S. D. Cowan W2LX

Efficient antennas for Top Band to 2m, including "invisible" antennas for difficult station locations. 191 pages **£6.75**

### SIMPLE, LOW-COST WIRE ANTENNAS FOR RADIO AMATEURS (USA)

W. I. Orr W6SAI and S. D. Cowan W2LX

Efficient antennas for Top Band to 2m, including "invisible" antennas for difficult station locations. 191 pages **£6.75**

### ★ THE 1988 ARRL HANDBOOK FOR THE RADIO AMATEUR

This, the sixty-fifth edition is available only in hardback, the first time the ARRL have done this. New construction projects are the theme of this edition, there is a deluxe memory keyer, receiver projects, a linear QSK converter, a low-powered balanced Transmatch and a d.t.m.f. decoder. Updated every year, this provides useful reference material for the radio amateur. It also includes 18 pages of p.c.b. track pattern for you to build your own boards. 1157 pages **£19.25 (hardback)**

## THE ARRL ANTENNA BOOK

14th Edition (USA)

A station is only as effective as its antenna system. This book covers propagation, practical constructional details of almost every type of antenna, test equipment and formulas and programs for beam heading calculations. 327 pages. **£9.10**

## THE ARRL ANTENNA COMPENDIUM Volume 1 (USA)

This book makes fascinating reading of hitherto unpublished material. Among topics discussed are quads and loops, log periodic arrays, beam and multi-band antennas, verticals and reduced size antennas. 175 pages **£9.25**

## THE RADIO AMATEUR ANTENNA HANDBOOK (USA)

W. I. Orr W6SAI and S. D. Cowan W2LX

Yagi, quad, quagi, l-p, vertical, horizontal and "sloper" antennas. Towers, grounds and rotators. 187 pages **£6.75**

## TWO-METRE ANTENNA HANDBOOK

F. C. Judd wrote this book for radio amateurs new to the 144-146MHz band. The range of antennas described will cater for most situations, particularly those where space is a problem. **£5.95**

## WIRES & WAVES

Collected Antenna Articles from *PW* 1980-1984

Antenna and propagation theory, including NBS Yagi design data. Practical designs for antennas from medium waves to microwaves, plus accessories such as a.t.u.s, s.w.r. and power meters, and a noise bridge. Dealing with TVI. 160 pages **£3.00**

## 25 SIMPLE INDOOR AND WINDOW AERIALS (BP136)

E. M. Noll

Designs for people who live in flats or have no gardens, etc., giving surprisingly good results considering their limited dimensions. 64 pages **£1.75**

## 25 SIMPLE SHORT WAVE BROADCAST BAND AERIALS (BP132)

E. M. Noll

Designs for 25 different aerials, from a simple dipole through helical designs to a multi-band umbrella. 80 pages **£1.95**

## 25 SIMPLE TROPICAL AND MW BAND AERIALS (BP145)

E. M. Noll

Simple and inexpensive aerials for the broadcast bands from medium wave to 49m. 64 pages **£1.75**

## AUDIO FREQUENCIES

### AUDIO (BP111)

(Elements of Electronics—Book 6)

F. A. Wilson

This book studies sound and hearing, and the operation of microphones, loudspeakers, amplifiers, oscillators, and both disc and magnetic recording. 320 pages **£3.50**

## THEORY & CALCULATIONS

### BEGINNER'S GUIDE TO ELECTRONICS

Owen Bishop

For youngsters thinking of a career in electronics; theory and applications in computers, radio, TV, recording, medical and industrial electronics. 240 pages **£4.95**

### CARE AND FEEDING OF POWER GRID TUBES (USA)

This handbook analyses the operation of EIMAC power grid valves and provides design and application information to assist the user of these valves. 156 pages **£6.75**

### PRACTICAL ELECTRONICS CALCULATIONS AND FORMULAE (BP53)

F. A. Wilson

This has been written as a workshop manual for the electronics enthusiast. There is a strong practical bias and higher mathematics have been avoided where possible. 249 pages **£3.95**

### RADIO FREQUENCY INTERFERENCE (USA)

What causes r.f.i.? Are all r.f.i. problems difficult, expensive and time-consuming to cure? These questions and many more are answered in this book. 84 pages **£4.30**

### THE SIMPLE ELECTRONIC CIRCUIT AND COMPONENTS Book 1 (BP62)

The aim of this book is to provide an inexpensive but comprehensive introduction to modern electronics. 209 pages **£3.50**

## COMPUTING

### AMATEUR RADIO SOFTWARE (RSGB)

John Morris GM4ANB

Using a computer for c.w., RTTY, data, plus calculations for antennas, distance, bearing, locators, satellites, sun, moon and circuit design. 328 pages **Hardback £9.41**

### AN INTRODUCTION TO COMPUTER COMMUNICATIONS (BP177)

R. A. Penfold

Details of various types of modem and their applications, plus how to interconnect computers, modems, and the telephone system. Also networking systems and RTTY. 96 pages **£2.95**

**AN INTRODUCTION TO  
COMPUTER PERIPHERALS (BP170)**

**J. W. Penfold**

Covers monitors, printers, disk drives, cassette recorders, modems, etc., explaining what they are, how to use them and the various types of standards. 80 pages £2.50

**MICROPROCESSING SYSTEMS  
AND CIRCUITS (BP77)**

(Elements of Electronics—Book 4)  
**F. A. Wilson**

A comprehensive guide to the elements of microprocessing systems, which are becoming ever more involved in radio systems and equipment. 256 pages £2.95

**FAULT-FINDING**

**ARE THE VOLTAGES CORRECT?**  
Reprinted from *PW* 1982-1983

How to use a multimeter to fault-find on electronic and radio equipment, from simple resistive dividers through circuits using diodes, transistors, i.c.s and valves. 44 pages £1.50

**PRACTICAL HANDBOOK OF  
VALVE RADIO REPAIR**

**Chas E Miller**

The definitive work on repairing and restoring valved broadcast receivers dating from the 1930s to the 60s. Appendices giving intermediate frequencies, valve characteristic data and base connections. 230 pages Hardback £15.95

**QUESTIONS & ANSWERS  
RADIO REPAIR**

**Les Lawry-Johns**

How to fault-find and repair valved and transistorised receivers, car radios and unit audio equipment. Suggested lists of tools and spare parts. 106 pages £2.95

**SERVICING RADIO,  
HI-FI AND TV EQUIPMENT**

**Gordon J King**

A very practical book looking at semiconductor characteristics, d.c. and signal tests, fault-finding techniques for audio, video, r.f. and oscillator stages and their application to transistor radios and hi-fi. 205 pages £8.95

**TELEVISION INTERFERENCE MANUAL (RSGB)**

**B. Priestley**

TV channels and systems, spurious-radiation TVI, strong-signal TVI, audio breakthrough, transmitter design. 78 pages £2.94

**TEST EQUIPMENT FOR  
THE RADIO AMATEUR (RSGB)**

**H. L. Gibson G2BUP**

Techniques and equipment for tests and measurements on devices, systems and antennas. 142 pages Hardback £7.88

**TRANSISTOR RADIO FAULT FINDING CHART  
(BP70)**

**C. E. Miller**

Used properly, should enable most common faults to be traced reasonably quickly. Selecting the appropriate fault description at the head of the chart, the reader is led through a sequence of suggested checks until the fault is cleared. 635 x 455mm (approx) £0.95

VISA 0202 678558

Practical Wireless

0202 678558

# PCB SERVICE

Printed circuit boards for recent *PW* constructional projects are now available from the *PW* PCB SERVICE. The boards are fabricated in 1.5mm glass-fibre, and are fully drilled and roller tinned. All prices include VAT and postage and packing for UK orders. Add £2.00 per order for despatch to overseas addresses.

Orders and remittances should be sent to: **PCB Service, Practical Wireless, Enefc House, The Quay, Poole, Dorset BH15 1PP. Cheques should be crossed and made payable to Practical Wireless.**

When ordering, please state the Project Title and Issue Month as well as the Order Code. Please print your name and address clearly in block capitals, and do not send any other correspondence with your order. You may phone your order using Access or Visa. A telephone answering machine will accept your order outside office hours.

**Please allow 28 days for delivery. Always check the latest issue of *PW* for the current details of price and availability. Please enquire for earlier p.c.b.s.**

PROJECT TITLE (Issue)	ORDER CODE	PRICE
PW Marchwood (7/83)	WR161	£3.32
Bug Key with Memory (10/84)	WR189/WR192	£10.35
PW Teme—TX (11/84)	WR196	£4.83
PW Teme—VFO/Doubler (12/84)	WA001	£3.76
PW Teme—RX (1/85)	WA002	£5.46
PW Triambic Keyer (2/85)	WAD280*	£4.26
FRG-7 BFO Mod (2/85)	WAD249	£4.00

SOME EARLIER BOARDS			
WR068	£6.90	WR177	£6.90
WR095	£4.98	WR178	£6.90
WR137	£6.04	Above 3	£17.25
WR143	£9.49	WR179	£8.63
WR144	£8.63	WR183	£8.63
WR156	£6.90	WR184	£8.63
WR160	£6.90	WR185	£8.63
WR165	£6.90	WR187	£6.04
WR166	£8.63	WR190	£6.04
WR168	£8.63	WR194	£6.04
WR169	£8.63	WR195ab	£3.54
Above 4	£19.84	WAD280	£9.49
WR167	£10.35	WAD246	£6.90
WR176	£6.90	WR126	£10.35

PW Colne (4/85)	A004	£4.14
PW Colne (5/85)	A005	£4.08
PW Colne (6/85)	WR198	£5.01
Battery Charge Control (6/85)	WR197	£4.97
Crystal Tester (7/85)	WAD302	£3.94
Add-on BFO (8/85)	WR200	£3.43
UHF Prescaler (9/85)	WR201	£3.42
PW Meon 50MHz	WR202	£4.76
Transverter (10/85)	WR199	£8.28
Capacitance Meter (10/85)	WR203	£3.74
WQ MW Loop (11/85)	WR204	£3.45
RTTY/Morse Modem (1/86)	WR205	£6.73
Crystal Calibrator (1/86)	WR206	£3.78
Simple Audio Oscillator (3/86)	WR207	£2.90
RF Speech Processor (3/86)	WR209	£5.50
PW Meon Filter (4/86)	WR208	£5.21
PW Arun Parametric Filter (5/86)	WR211	£4.04
FRG-7 CIO Mod (6/86)	WR210	£9.87
Simple 50MHz Converter (9/86)	WR213	£3.61
NiCad Charger (10/86)	WR215	£4.86
Active Antenna (11/86)	WR217	£3.30
PW Taw VLF Converter (11/86)	WR216	£3.24
High Impedance MOSFET	WR222	£3.82
Voltmeter (12/86)	WR223	£3.82
Modifying the SRX-30D (12/86)	WR214	£3.99
Basic Wobulator (1/87)	WR224	£4.52
2m Mast-head Pre-amp (2/87)	WR218	£5.33
PW "Woodstock" (3/87)	WR219	£3.37
PW "Blandford" (4/87)	WR225	£5.28
PW "Itchen" (4/87)	WR227a	£11.11
PW "Axe" (5/87)	WR226a	
	WR228	
PW "Downton" (6/87)	WR298	£4.49
Side-tone Oscillator (6/87)	WR230a	£5.07
Mains On/Off for Battery Radio (9/87)	WR231	£4.24
PW "Blenheim" VHF to HF Converter (9/87)	WR232	£3.82
A High-stability VFO (10/87)	WR233	£5.04
RTTY Tuning Indicator	WR234	£3.65
PW "Otter" 50MHz Receiver	WR235	£3.97
	WR236	£5.99
	See article	—
	WR237	£6.95
	WR238a	£9.52



# On The Air

## On The HF Bands

Reports to Paul Essery GW3KFE  
287 Hoel-y-Coleg, Vaynor, Newtown, Powys SY16 1AR.

There is to be a change in postal arrangements this end, please send your letters direct, to arrive by or if possible a bit before the due date. Address them to: E. P. Essery GW3KFE, 287 Hoel-y-Coleg, Vaynor, Newtown, Powys SY16 1AR.

### Conditions

As always, some days are better than others. However, there is no doubt the bands are far livelier than they were a year ago, even on the bad days. Since writing last month's piece, there have been some more gales, plenty enough to make me peep out of the window to see whether the familiar sight of mast and guys was still there on several occasions; and for the end-fed there has been no lack of rain to keep the earth resistance low! The 28MHz band has been better than for many a year, as we shall see.

### Forthcoming Events

Brought to us by courtesy of my ears, *DX News Sheet*, *The DX Bulletin*, *W1WY*, *The Canadian Amateur*, and your good selves. Thanks to everyone!

VK2AU is to be in 5W1 and KH8 over the December/January period. The QSL address will be: PO Box 99, Merrylands 2160, Australia.

Jan Mayen activity is scheduled for the rest of the winter by JX8XY.

That SORASD station has been noted again, as has SO1A on the 3.5MHz band.

Returning to the Mount Athos effort, DXNS has it that G0BTY was told by SV1JG that two IRCs only were required for those needing a QSL to ensure a direct reply. If that is so—and at the time of writing it is unconfirmed—then they have removed a large barrier to acceptance of the operation for DXCC credit. On the other hand, may I ask if those who were fool enough to fork out the original exorbitant charge will receive a refund? If not, I still believe that the operation should be disallowed, as the only way to prevent this habit of daylight robbery spreading.

ZL1AMO's DXpedition to Auckland & Campbell Is., ZL9 is due in February. It will, I understand, be supported by NCDXF—and I hear that Ron will be accompanied by ZL1BQD and ZL1BN.

It is nice news to hear that the USSR and Canada have signed reciprocal licence agreements—initially this was to aid communications with the joint USSR/Canada ski expedition to cross the North Pole from Russia to Canada; the agreement is between November 1987 and February 1988, but one hopes it will lead to something more permanent.

Baker/Howland Is are becoming increasingly rare in DXCC terms; Jim Smith VK9NS and Kirsti VK9NL are proposing an operation there in March, with up to ten in the party. By the time you get to read this it's probably too late to volunteer, but those who go will probably find this uninhabited spot unpleasant but interesting and with plenty of action.

XU1SS is being heard of more lately, usually around 14.165MHz, usually Mondays to Thursdays.

JE3MAS, who also sports WH6X, will be on Zanzibar Island for a couple of years, using the call 5H3HK—QSL via JH4RHF.

### The 28MHz Band

David Corfield (Matlock) has made a return to the bands recently, and has an FRG-7 receiver fed either from a random wire or an active antenna. He noted much activity at times, and in the DX line, W4ZR and PY5EG.

GM4ELV (Glasgow) says he found the bands very varied: however his QRP at 5 watts produced contacts with 4X4HQ, 5B4TI, AY3F, YV1AVO, PY3PG, A22BW, ZS6ARM, ZS6P, ZS6AOO, ZS1ESC, ZS1ZO, ZP5HF, ZD8MB, PZ1AP, ZD8MAC, ZP5JAL, SV1DO, SV1AHH, 4X5000, KP4VZ, LU7EMZ, WD8KWT, PT2ZDR, VU2RCK, J28DN and Z23JO.

G3NOF (Yeovil) notes the big improvement in conditions on the band, although there has been a daily variation; some days just edging open, others wide open. Don made his number on s.s.b. with A71BJ, CE3DFY, CP6XD, CP8HD, CX2AAL, EA9IB, EA9RY, FH8CB, FM5CL, FM5WQ, FR5DX, FY5EM, J28EO, J37ZY, J73LC, JW0B, HI8FHD, HK3GHI, K5WA, KP4BZ, KV4AD, PY5CC, PY5EG, PY5ZBA, TU1BS, TZ6FC, V1KS/4U (=YKI), VP8BKK, VU4GDG/CE (Andaman Is.), YB0BAQ, YB0TK, Y13BGD, Z23JO, ZC4AP, ZD8MAC, ZS6AOJ, 3D6BW, 4X5000, 5H3RB, 5T5NU, 9J2BO and 9M2HB.

G4HZW (Knutsford) noted quite a bit of activity, with contacts out to 4X6MH, 5N27BHF, 8P9HQ, 9J2EZ, 9Q5NW, CE3DQO, D44BC, FR5DX, HC1OT, I, HBO, J28EO, LU1ABT, P4OV, S79WS, SP, T18CBT, UA6, UL7ACI, VU2SJV, VU4GDG on Andaman Is., YB0WR, YV3BKC, ZC4DX, ZC4EE, Z21GT, ZS3BI, ZS4NS, ZS7ANT (Antarctica) and ZY5EG. As usual, the rig was TS-820 plus 2-element quad.

G4WJM's doings on the band were mentioned by G3BSN; he seems to have found VU2ZAP on c.w., and KP4FBA on sideband for DX, plus Europeans such as DL, EA, F, I, UA and UK. The rare ones included such as AY1DZ from Argentina, CX9DH, PS8AM, PT7DX, PT7WX, VK2UZ, YB0TK, ZS6TB, ZS6WRS, plus OD5PL, and ZB2IP.

I noticed that November also has been blessed with good conditions; it seems that the solar flux got up to between 95 and 100 for all the first three weeks of November, while the A index, which tells about absorption, stayed below 10 most of the time. I suspect the latter was an enormous help—and of course the presence of activity is the final piece in the jigsaw.

So: G3NOP noted short-path openings to VS6, JA, BY, VU, VK in the mornings, Africans morning and afternoon, and North Americans 1300–1600Z, mostly from the East Coast but some Middle West signals. Nothing was heard of the West Coast Ws, the VEs were mostly VE3s, and ZL and the Pacific were absent. QSOs using s.s.b. were made with CE5HFQ, CE6OS, FP5HL, FR5DX, 5EL, HBO/DL8OH, HI8FHD, HI8PJP, HSOA, J28EO, JF6FVC, JI6BVF, KB5DVD, KP2J, KP4JN, N5FJ, N0IDW, ON7VD/5N6, PY1ZAO, PY2ZDR, SORASD, S79WS,

SU1ER, TI2JJP, T18CBT, TR1G, TU2QT, VK2JHW, VK2NYA, VS6CT, VU2CVP, VU2RSK, VU4GDG/APR, WB5SKQ, WBOCEI, WBORMO, W5UAW, YB0HOB, YB0JH, ZC4EE, ZD7AF, ZD7BJ, ZS3BI, ZS3GB, ZS6AOJ, 4S7NMR, 5H3RB, 5N27BHF, 5N9BHA and 8P9HQ.

G4HZW (Knutsford) says November was the best month on the band for three years; as he says, "not weak Ws using kilowatts but 50 watts to a dipole at S9+". Tony notes particularly AP2P, BV2DA, BV2FA on c.w., GD4XTT, JH6QPD, OH, UA3-4-5-6, UL7AAC, UM8MIG, RA9XBM, RA0AA, S79WS, SM, TR8SA, VK4KRP, VK8NHM, VK8RC, W1-2-3-4-5-8-9-0, XX9WW and YB0HOB. Quite like old times!

### The 1.8MHz Band

It seems as though most of the 1.8MHz band merchants suffered in the October breezes; hence not much news. G3BDQ (Hastings) was in the thick of it: although the guys held, the mast broke at about the 6m level below the top, damaging three of the sections. In addition the high point 6m above at the house end broke—the fixings broke and saved the mast, thankfully. So John has now only a piece of wire about 2.4m high and 600mm from the wall, rising to a maximum of 6m. Before the storm, G3BDQ worked RA9ABK, RA9SSN, UC2AGC, UZ3TWY, UA3YCE, UB5EAQ and YO3CD; after the wind, the improvised antenna just mentioned managed to make it to OK3KIL, C31LBB, UC2WAZ, RA9CSV, SP9GDB all on c.w., plus IK0BYO on phone who said John was the biggest signal on the band, thus causing a hollow laugh! Everyone locally lost antennas; John's Tonna for 50MHz survived, but although the garage roof was still off when he wrote, the house and greenhouse roofs have been repaired. Windspeeds of 177 k.p.h. were recorded, sustained for 15 seconds at a time, while the average was 137–145 k.p.h. No wonder they were short of electricity for three days!

G2HKU (Sheppey) has had to drop his mast for repairs after a guy parted in the hurricane but he was thankful that he lost nothing worse than a few tiles off the ridge of the house. Ted managed s.s.b. with ON7BW and ON4CW, while the c.w. went over to UQ2GKL, UA2FGA, DF1LX, DJ1RL, OL1BLN, LA5UF and GI3PDN.

BY on the 1.8MHz band? I hear that BY4WNG is active on all bands 1.8–28MHz; he is Chao Meng, who is a student at Nanjing Institute of Technology. You might catch him on the DU9RG net on 7.088MHz for a sked.

### The 3.5MHz Band

Unusually, G3NOF mentions this band; he made it on s.s.b. to RW9USA and SORASD.

G3BDQ was moved to try out his improvised skywire on the band with s.s.b., when lots of EUs were worked to celebrate "Hastings Day" on October 14.

The c.w. of GM3JDR connected with VU2GDG/TS; nothing else mentioned.

A new reporter is GI0GDF, who is ex-

GOGDF and G6PYE. He first became interested at the age of eight and has been interested ever since, leading to the tickets mentioned. In England he had a dipole at 4.5m on 3.5MHz, and a couple of watts out; but in GI he has a garden 7.6m long, alas. Were that not bad enough, he has the Radio Ulster transmitter 1km away to add a bit of receiver-overload QRM to the story; nonetheless G10GDF is still playing with antennas and hoping to work a few countries; as he says, at this power level every QSO is an adventure and a pleasure.

G0HGA (Stevenage) also uses QRP, and on this band she had a one-hour ragchew with GM3TMK, plus QSOs with DL1BAC, YU3VD, and Gotaways IK2DZR and DL9MCD.

## The 7MHz Band

GM3JDR (Aukengill) has a long list for both periods, so we must mention the best of the bunch for this month: FT8XD, C21XX, ZL7TZ, VU4GDG/TS, FG4BO, ZS, UA9s, UI8, ZL1MN, YBs, YCs, UL7s, VK1BA, lots of JAs, OAs, UJ9XWA, TP2CE, VKs, PY, VK8MQ, UA0s, 4Z9AAC, VU40TTG, TR8JJC, VU2DX, W6s, VK7GK, VS6UO, RO4OR, RO5OY, 4K1A, 4K1C, 4KOE, KV7Q, SORASD, VK8AV and SU1MR.

G2HKU used c.w., after completing repairs, to work UA3ABM and RG0G.

G3BDQ also preferred c.w. for VK8AV, VK3MR, UL7CAD, K3IPK at 2017Z on October 29 which was a mite early, VU40HSM, 4S7RO, UA9LQ, UA9SIH, VE1CJO. N2RM was worked around 2000Z on November 22, when all around was Ws at 599!

Unusually, G3NOF had a spin round and he raised EA8ACH, KP2A, FJ5BL and UB4CWW all on s.s.b.

Just one station is mentioned by GM4ELV; his QRP made it on c.w. over to OY9JD.

## New Bands

Locally, there has been much noting of American s.s.b. activity on 24MHz during the good conditions. GM3JDR offers VE2JR on 18MHz, this month, and the previous month made it to FG5XC and UL7MU on 10MHz, plus VE2LI on 18MHz.

A first report from G4ZAU (Oswestry) who stayed with 10MHz; Dudley has a TS-930S and a dipole at 6m above ground. This yielded contacts with 9H1BB, VP2MDY, JA2IFP, C30BBE, VE3DZR, VK2EZA, VK3IO, VK6AKG, WB2QHQ, PZ1BV, F/3A2ALR, JR8AUT, VE1BB, LA3YY/MM, VK2OO, VK5NM, W1FZY, W3ARK, K1GOW, KA1PCQ, KA3PDR,

KA8VLW, N2CPL, UA1ZQ, UQ5GBO, UA9IWZ, G3DOT/LA, OZ9N/SM7KFD, KB1DA, K3DV, K4RF, K4AWY, UA1NH, UB3JWA, UA6XE, UV9UWW, PA0VG/EA5 and three QSOs with JA3SVG/MM who was heading northwards from the Western Approaches up the Irish Sea.

G3BSN (London SW9) noted the beacon DK0WCY as a good condition-indicator on 10MHz, so Phil contacted the usual Europeans plus CT3DJ, F2DW, HB0XDJ, HB9GDV, OH2BGG, KB1CV and K2SWZ.

## The 14MHz Band

G3BDQ used the remains of his antenna system, as already described, to work 4K1AH (Mirny Base) for whom QSLs go via UZ1AWO, W6THN, 4K0E (QSL to UA1ADQ), N8BZK, K7GN, KD6JD and WOJCB (Nebraska) all on the key, while s.s.b. made it to VK2EQ, VK4ABT, UH9BWD, 4B2V and EA9UE.

G3NOF noted long-path openings to VK/ZL/JA between 0730-9030, but little from the Pacific. T32BB was worked, short path, at 1743 and around noon there were openings to Asia. QSOs using s.s.b. were made with A92EM, AA4VK/CT3, CT3EU, FJ5AB, FP5CJ, FR5DX, FR/G/FH4EC, FY5EM, FY5YE, HC8DX, P40SS, PJ1B, PJ0J, S79D, T32BB, VE7DGI, VE8CDX (The Canadian/USSR expedition), VK2CLB, VK3AQI, VK6ZQ, VK9ZG, VP8BDD (Antarctica), VP9AD, WB4PJB/VP5, ZL2BEJ, ZL4AK, ZS3GB, 3B1FP, 7X4CV and 8P9HR.

Just the one contact for G2HKU, a c.w. one with HK3RQ. As for David Corfield, he offers NM4H, plus dozens of East Coast Ws and Europeans, with the band still open as late as 2030.

G0FUS used his FT-200 and c.w. to raise VE6EO, W0MLD/ID9, VE3PVW, UZ9WWR, UA9MCT, RA9UM, VK6WT, 4X6IT, JA8BGR, RV0YF and UL8GBI, while s.s.b. was the mode for 4X6KF, VP9LB, TK5UC, W5ESI/MM1 in the Atlantic, G6ZY/EA6, G4GEO/EA5, SK0SX and ZL1BYC.

On now to GM3JDR; Don made it to UA0LFS, UA0ZDN and VU4GDG/TS.

**Your next  
three deadlines  
are: January 27,  
March 2 & March 26**

## The 21MHz Band

Naturally, with activity so high on 28MHz, 21MHz has been really popping. G0HGA found here 3 watts to a CB vertical enough for EA5AIO, UA3LHA, UA3DNJ, UA1AEP, RA3GKJ, UB5SBX, YU4YA, UA3LHE, LZ1KBG, YO8CF, UY5MV, SP5YQ, HA3KX and EA4RCT.

G3NOF says he found the long path to JA open around 0800, YB/YCs peaking around noon, along with VKs, South America around 1700, and band closure about 1800Z. Don made his s.s.b. react at BY5QA, BY5RA, BYAC, C30W, CW4C, DF9ZP/VP9, DX1DBT, FM4DN, FM5CL, FY5YE, HB0/DL80H, HC8DX, HL1AZE, HL5FEE, HU1YS (=YNI), JF6ITM, JG3AGC, JG6KLB, K7EHI (Utah), KG4GN, KT7V (Wyoming), P40V, PJ1B, PJ0J, RL8PYL, S79WS, TA2/N4EXR, TA4A, TZ1GH, TZ6MG, VE7DGI, VE7IG, VE7JY, VP9AD, VU2XX, VU40SMN, VU4GDG/TS, VK2EQ, VK2JU, VK8NHM, W7EG (Oregon), WA4TLI/CT3, XX9T, YCs, YIOBIF, ZF2KK/9, ZL2ADX, 5T5MH, 5T5BC, 5N8ZHN, 7P8PD and 9Y4DG.

GM4ELV (Glasgow) managed JH7WKQ and H25MF, using his QRP to a half-sized G5RV but with a good take-off.

Just one for G2HKU, thanks to all the hurricane repairs, and that was a c.w. one with W1HT.

David Corfield noted N2OR, WB6FDR and many other American and Canadian stations.

Next we have G0FUS (Winchester), he sticks as far as he can to c.w. with his FT-200 and dipoles which vary between 3 and 4.5m a.g.l. The band gave AY5HOD (=LU), LU1HDC, LU8OYH, RB5LAF, U1CZ and T77T, the last on s.s.b.

Turning to GM3JDR, we find he worked AY1DZ, ZS1AAX, JAs, VK9AB, FM/F6EYS, UA0YM and VS6BL.

## Final Thought

An editorial by VY1CW in the *Canadian Amateur* covers the question of encroachment on our bands as seen over there. Bill makes the point that lots of these people keep using our bands because the gear is cheaper, and competitors don't overhear them. Information overheard giving precise locations of fishing pots and lines was passed to another amateur who had access to "proper" marine radio, and who broadcast the information to everyone else. Thus when the pirate went to pull his pots, he found the whole area thick with competitors. Apparently, both the pirates promptly sold the amateur gear on returning to port—reason given, "no secrecy any more!"

## VHF Up

Thanks to a fine spell of tropospheric propagation at the beginning of November, there are plenty of reports from readers this month. The event was a good example of how a widespread temperature inversion can make real DX QSOs possible from v.h.f. to microwaves.

## Awards News

Another two readers have joined the 144MHz QTH Squares Century Club. Jaap Nap PE1JVH from Breukelen (CM65d) is the third Dutch operator to achieve a QTHCC award and his certificate, No. 83, was issued on Nov 5 for 101 squares confirmed out of 139 worked up to Oct 26

Jaap's station consists of Yaesu transceivers FT-480R and FT-290R, a BF981 pre-amp, 60W Yaesu amplifier type FL-2050 and 14-ele Parabeam at 15m a.s.l. fed by Pope H-100 cable. 94 QSOs were on tropo, six via Es and one by Ar mode. Best tropo DX was EA1OD at 1244km, best Es contact EA8BEX at 3172km.

Howard Staddon G6STI from Hayes End in Middlesex (ZL38d) was issued with certificate No. 84 on Nov 7 for 101 confirmed out of 123 worked. His station comprises a Yaesu FT-726, a 250W amplifier and 17-ele Yagi antenna from Tonna. High power is seldom used due to TVI problems. The confirmations were for QSOs from June 1983 onwards but no

Reports to Norman Fitch G3FPK  
40 Eskdale Gardens, Purley, Surrey CR2 1EZ.

propagation mode breakdown was listed.

Any reader thinking of applying for QTHCC membership should first write to the Poole address requesting a copy of the rules and an application form, enclosing an s.a.e. Please do not send any cards without the form.

## Worked All Britain

John Fitzgerald G8XTJ (BKS) reports that the WAB Large Squares award for 70MHz has gone to Jerry Russell G4SEU and that some 50MHz awards are probably in the pipeline. The Winter Activity Award continues till the end of February under the same rules as last winter.

WAB nets take place on 144.43MHz as

follows: London area, Fridays 2030, Sundays 1030; North of England, Wednesdays and Fridays from 2000; Hampshire, Tuesdays from 2030. Most serious WAB activity takes place in the 144.43-144.46MHz part of the band.

## Beacon Matters

Geoffrey Holland G3GHS, Honorary Secretary of the Mid Cornwall Beacon and Repeater Group, has written about the situation of the GB3CTC beacons. The 70MHz and 144MHz ones have been back in service for some time, the Gas Board having agreed to the antennas being re-installed on the old mast, yet to be dismantled, due to delays elsewhere. They might suddenly cease when site work starts however.

The Group are being given a new 432MHz TX which should give a cleaner signal. If the old antenna and cable are in reasonable condition service could be resumed on this band. Final papers concerning the 1296MHz beacon were still awaited at Nov 12.

The RSGB has offered the Group equipment for a 50MHz beacon and they have agreed to install it, provided the necessary site clearance and paperwork could be obtained quickly. More news is awaited.

In the December VHF Up, I mentioned that Godfrey Hands PA3EUS, alias GOFBG, (JO21NX) promised more details of an intelligent beacon PI7PRO. He has now sent further information as follows: QRG 144.840MHz, temporary location CM67e, power 10W, antenna 10m above street level vertically polarised. In the future it will be 120m a.s.l. with a horizontally polarised antenna.

Its frequency will be phase locked to the MSF TX with a crystal oscillator taking over if Rugby goes off the air. The beacon is semi-intelligent and will report propagation conditions as they occur. Godfrey quotes two typical messages; "PI7PRO-A40" which signifies Auroral conditions at QTE 40° and "T150" meaning a tropo opening in the direction 150°. Once every ten minutes all this information will be sent at about 180 words per minute for m.s. operators. All reports to PA2VST whose QTH is R.V. Broderodestr 32, NL-1471 CP, Kwadyk, Netherlands.

## Meteor Shower Information

The next recognised major shower is the Lyrids in April, however there are a couple of minor ones, which could be useful, coming up. The Kappa Cygnids peaks on Jan 17 and its Right Ascension is 295° and the Declination +51° so the radiant is above the horizon all day in the UK. The best times for the various directions are: NE/SW 1530-2030; E/W around 0430 and 2000; NW/SE 0400-0900; N/S 0600-0930 and 1500-1830.

The Alpha Aurigids shower lasts from Feb 5 to 10, RA 74° and DEC +43° and is available again all day as far as radio reflections are concerned. Best times are: NE/SW 0000-0330 and around 1700; E/W around 0300 and midday; NW/SE 1230-1630 and around 2300; N/S 2230-0230 and 1330-1800. There is no guarantee that either shower will be all that useful and sometimes better results are obtained on so-called random meteors.

## The 50MHz Band

The t.e.p. tests from southern Africa were successful with G and GM being worked as reported last month. The informative VHF News sheet from Hal Lund *Practical Wireless*, February 1988

## Annual v.h.f./u.h.f. table January to December 1987

Station	70MHz		144MHz		430MHz		1296MHz		Total Points
	Counties	Countries	Counties	Countries	Counties	Countries	Counties	Countries	
G1KDF	—	—	98	16	70	12	33	8	237
G4NBS	54	7	68	19	53	19	42	10	220
G6XVV	—	—	89	26	60	14	20	9	218
G6HKM	—	—	75	27	54	13	33	7	209
G1LSB	—	—	75	29	63	23	—	—	190
G1SWH	—	—	97	12	58	11	—	—	178
G1GEY	—	—	74	26	47	12	—	—	159
G1EHJ	—	—	58	12	53	9	—	—	132
G4MUT	26	1	49	16	29	10	11	4	131
G8LHT	—	—	66	22	29	10	3	1	131
G6AJE	—	—	54	17	40	8	7	2	128
G4SEU	58	6	43	16	3	1	—	—	127
G4DEZ	—	—	34	10	42	11	19	10	126
G4ZTR	36	5	32	11	24	6	21	6	114
ON1CAK	—	—	80	34	—	—	—	—	114
G4VOZ	61	6	—	—	34	7	—	—	108
G6MXL	22	5	42	11	18	7	8	3	105
GW4FRX	—	—	77	28	—	—	—	—	105
GW6VZW	—	—	68	24	9	2	—	—	103
G3FPK	—	—	78	24	—	—	—	—	102
G4WJR	—	—	78	10	—	—	—	—	88
G4TGK	—	—	66	19	—	—	—	—	85
G8XTJ	—	—	66	17	—	—	—	—	83
G4AGQ	15	1	31	12	13	4	1	1	76
G4YIR	—	—	60	15	—	—	—	—	75
G1CRH	—	—	64	11	—	—	—	—	75
G6OKU	—	—	54	15	4	1	—	—	74
G0HDZ	—	—	53	11	—	—	—	—	64
G6MGL	—	—	25	6	25	2	1	3	62
GM4CXP	2	2	33	17	3	4	—	—	61
GW4HBK	48	7	—	—	—	—	—	—	55
G0HGA	—	—	43	11	—	—	—	—	54
G1VTR	—	—	16	2	22	5	—	—	45
G2DHF	11	2	21	5	3	1	—	—	43
G3KEP	13	3	12	3	7	3	—	—	41
G44HUY	—	—	32	6	—	—	—	—	38
G4WND	25	4	—	—	—	—	—	—	29
G6XRK	—	—	8	6	—	—	—	—	14

Three bands only count for points. Non-scoring figures in italics.

ZS6WB includes news that ZS3E worked CT4KQ and 9H1FL on Oct 16 and later 9H1BT. The 5B4CY and 9H1SIX beacons have been copied in Bulawayo by Z21FT. During October A22KZ had many QSOs with 9H1BT, 9H1CG and 9H1FL in Malta and with SZ2DH in Greece. Since Nov 7 the Pretoria beacon on 50.0225MHz has been beaming towards Australia. It sends on c.w. "de ZS6LW" continuously. Plans are afoot to install an omni-directional antenna, and beams towards the UK and South America, using time-sharing with the VK beam.

Dave Ackrill G0DJA (WMD) is modifying his relay control of his PW Meon transverter to facilitate running packet radio on the band. Ron Reynolds G6WEM (ESX) is building a Meon transverter so hopes to be QRV soon. John Pilags G8HHI (SRY) is already active on the band.

John Palfrey G4XEN took part in the Oct 18 contest, his best DX being CT4KQ at 1407km, thanks to Es propagation. But John's 10W to a dipole did not attract GJ4ICD's attention even though Geoff was peaking to S5 at times. Paul Thompson G6MEN (SPE) would like some cross-band skeds with Europeans who cannot transmit on 50MHz. Anyone interested can contact him via PO Box 32, Shrewsbury, England SY1 1ZZ. He can conduct conversions in French and German if required.

Geoff Brown GJ4ICD sent Issue No. 1 of the *International 6 Metre Digest* published by Harry Schools KA3B. This mammoth number ran to 26 pages of A4. It includes letters from 50MHz operators from many countries, DX and beacon news, photographs of stations, etc., e.m.e. and Ar notes and a long history of the 50MHz band from 1 March 1946 up till 1982. He plans to cover from then to now in later issues. Geoff wrote that anyone wanting copies of the November and

December issues should send a large self-addressed envelope and five IRCs. UK readers please note that UK stamps are not valid in the Channel Islands or in the Isle of Man.

Bob Nixon G1KDF (LNH) thought the Oct 18 contest poorly supported and wondered if that was in part due to some having lost antennas in the gales a couple of days earlier. Via Es he worked EA1MO who was worth 149 points.

## The 70MHz Band

Denis Jones G3UVR (MSY) has now worked 49 locator squares on the band thanks to some of the expeditions of last summer. In the Fixed Contest on Oct 25 Tony Collett G4NBS worked 48 stations in 28 counties in rather poor conditions. He thinks activity is on the increase and best DX were G3JYP and G3FDW (CBA) from Cambridge.

John Jennings G4VOZ (LEC) has been concentrating on f.m. mode with a horizontal antenna both to build up his counties score and with an eye to packet radio. Recent QSOs were with G1DOX (CBA), G6WZA (SOM), G4JE (ESX), G8CVF (MSY), G6REG (NHM), GW6ZMN near Cardiff and G6SKO (DYS). On Nov 17 he had a three-way c.w. QSO with G3CJ (GLR) and G4GYK/P (AVN), a somewhat rare event on the mode.

## The 144MHz Band

Most of the reports this issue refer to the excellent tropo conditions between November 3 and 8. But first, mention of an Aurora on Nov 3 about which I was alerted by John Nelson GW4FRX (PWS) at 1735. John worked SM6CLU/6 (JO68), LA9UX (JO59), SK7JD (JO87 and quite rare), OH1AU (KP10), SM0HAX (JO99) and SM7GWU (JO78) between 1816 and 1837.

At G3FPK, GMOEWX (WR49j) was

heard at 1813, later SM0HAX. Three minutes after I worked LA8SJ (JO59HQ) someone switched the Ar off and GW4FRX noted the same phenomenon. The only other reader mentioning this event was G6MEN who worked GM4ISM (XP) at 1825.

Now to the tropo starting with **Johan Van De Velde's ON1CAK** letter. The Belgian stations worked into LA, OZ and SM from Nov 3. On the 4th, Johan worked GW3KJW (XM), G6OHXN (YP), SP6HEI (IL), SP3RBF (HL) plus GM, OK, SM and Y stations. The 5th brought GD, GI and GM contacts and OY9JD (WW) for a new tropo record QRB of 1420km, plus EI stations. The next day brought more GD, GI, GM, OZ, SM and Y QSOs and on the 7th, amongst British Isles stations, Johan worked into OK and SP, the latter in new squares JK and JL. His British Isles counties tally for 1987 on Nov 8 was 80, a performance most Gs, will envy. He is still looking for Fermanagh, Orkney and Shetland.

GODJA kept to c.w. 2.5 or 25W only and using an indoor 5-ele Yagi. In the contest weekend, Nov 7/8, Dave worked OK1DEF (JO60), OK2TU (JN89), GU4HUY (GUR), nearer Europeans but missed Y23MB.

**Angela Sitton G0HGA** (HFD) is a c.w. devotee for whom OK and Y contacts provided two all-time new countries. She found that, "With just 10W and very deaf 'front end' to a 4-ele . . . only 3m a.g.l. . . ." she was able to work lots of continentals so is now a confirmed v.h.f. DX'er. She has recently installed a vertically polarised HB9CV antenna as an experiment.

New for **Mark Page G1EGC** (BKS) were SP3MIC (IM) and SP2NJI (JM) on the 7th. SP9DAB (JK) was heard plus stations working YO, YU and UB5. **Tony Wayland G1HJW** (ESX) reports the band opening up to OZ and SM in the late evening of the 3rd, with DLs and GM8FFX (GRN) the next day, and more OZ and SM contacts on the 5th. On the 6th the band was wide open to both German states, OK and SP, best DX being OK2KZR/P (JN89), OK3KGW/P (JN99), SP6HEI and SP3RBF. The conditions were still good on the 7th, QSOs being made with two more OZs, five OK1s, two Y3s and SP6GZZ (JO81).

Welcome to **John King G1XFE** (DYS) who runs just one watt of s.s.b. to a 5-ele. Jaybeam antenna. He copied the ON4VHF beacon on 144.985MHz for the first time on Nov 5 and then worked ON4KFM and ON4BG. The next day he contacted DC0KV and ON1KVL. Apologies to **Dick Bacon G3WRJ** (HFD) for omitting his c.w. ladder entry last time. He now has 157 stations worked this year in 11 countries.

Welcome to **John King G1XFE** (DYS) who runs just one watt of s.s.b. to a 5-ele Jaybeam antenna. He copied the ON4VHF beacon on 144.985MHz for the first time on Nov 5 and then worked ON4KFM and ON4BG. The next day he contacted DC0KV and ON1KVL. Apologies to **Dick Bacon G3WRJ** (HFD) for omitting his c.w. ladder entry last time. He now has 157 stations worked this year in 11 countries.

**Bryan Llewellyn G4DEZ** (ESX) was home for the lift and spent most of his time on other bands. In a ten minute period in the early hours of the 7th he worked OK, SP3 and Y3 stations. He reckons he has only been QRV for about 20 days in the last eight months. **David Sewell G4FVK** (CBE) lists D and F stations on Nov 6/7 and OK1ADS/P (JO60) worked on c.w.

G4NBS only re-erected his antenna about half an hour before working 11 new

squares in the lift. Tony lists DL4RU (JN69), Y31VA (JO64), OZ1KYG (JO55), OK1UMA (JN79), OK2KZR/P, OK1KRU/P and OK1VRU/P (JN79), Y23NL (JO61), OK3KGW/P, OZ5BU and OZ1EAJ (JO65 and 100th square), DC7MH (JO62) all on s.s.b. plus SP3JBI (JO91) on c.w. Subsequently he worked more of the same plus F and HB9.

**Ian Cornes G4OUT** (SFD) was able to boost his c.w. ladder total considerably during the four days of the lift and his total was 262 up to Nov 8. On the 5th and 6th OK and Y were two new countries and he worked seven new squares. The c.w. contest produced another 13 new squares and Ian listed 36 DX contacts in D, F, GM, HB9, ON and PA.

G4XEN worked many stations on Nov 6 but none were in new squares. On c.w. John worked 14 OK1s, three OK2s, five OK3s, SP2DDV (JN), SP6AAT (IL), SP6BIB (IK), SP9EWU and SP9HWY (JK). He participated in the six hours c.w. contest on the 8th when conditions were beginning to go down. But they were still good into Germany and his final score for 1987 was 40 per cent up on 1986.

**June Charles G4YIR** (ESX) worked, on c.w., four OKs, two Ys, a DF in Berlin and an HB9, missing out on the SPs though. **Colin Ford G4ZVS** (WMD) is another keen c.w. operator and the lift coincided with his winter holiday period so he spent a lot of time operating. In two hours from 1500 on the 6th he worked 18 OKs, seven Ds, five Ys and one each EI, F, ON and OZ. Best DX was OK3KGW/P at 1451km.

Colin entered the c.w. contests on the 7/8 Nov when many DX stations were available. Among others he mentions HB9BZA/P (JN36), OK1KEI (JO70) and F6IOC/P (JN36). While many continentals were worked, not many G stations were, but perhaps they were all beaming to the east?

**Keith Killigrew G6DZH** (HWR) added five new squares in the Nov 3-7 period. He lists contacts in D, GM, OK, Y and probably the best DX, SP3MFI (JO91BS) at 0104 on the 7th. **Ela Martyr G6HKM** (ESX) sent a colour print of the collapsed telescopic tower laying across the roof of the wooden shack. However, she can use another mast but can only have one antenna on it at a time. Using a 9-ele Tonna Yagi she did add another five squares in the lift, HL, HM, IL, GO and JK. To further complicate matters, the rotator malfunctioned requiring a visual check to see where it was aiming the antenna.

On the evening of the 4th, Ela worked four SPs, five Y2s, an OK and many Ds, rounding off with GM4DGT (CTR). The 6/7th was very rewarding with 23 OZs, seven SMs, six each Y2s and SPs and 10 OKs including her first YL OK station. Most QSOs came from her CQ calls.

G6MEN did not operate much in the lift but Paul did work some D and OK stations, best DX from YM27j being OK3KGW/P on c.w. **Mike Law G6OKU** (DYS) added six more countries and ten squares in the periods Nov 4-7 and the best DX were OK1VFA (JO70), SP6GZZ (JO81) and OK2VQF/P (JN99) at 1435km.

G6WEM remarks on the greatly improved operating standards during the lift. Ron's list starts at 2020 on Nov 3 with OZ1KLB (JO55). The following day brought GM0FRT and three Ds one of whom DK3NZ/A (JO51GT) was running 20W to 16 8-ele Yagis. The 5th brought

Starting date 1 January 1975.  
No satellite or repeater QSOs.

**QTH Locator Squares Table**

Station	Band (MHz)			Total
	1296	430	144	
G3IMV	17	116	405	538
G8GXP	30	140	307	477
G4JCD	59	119	253	431
G4KUX	—	80	345	425
G3UVR	75	125	224	424
G4NQC	63	99	250	412
G3XDY	81	137	185	403
G4RGK	38	106	253	397
G3JXN	82	129	175	386
G6DER	70	105	182	357
G4XEN	—	106	250	356
G1EZF	32	86	234	352
DL8FBD	—	69	274	343
G8XVJ	18	88	236	342
G3COJ	44	102	186	332
G4DEZ	44	38	246	328
G4DHF	—	—	307	307
G6HKM	26	101	177	304
G6XVV	25	84	211	300
G4SWX	—	—	293	293
G4TIF	—	106	184	290
G8PNN	62	97	128	287
G8HHI	31	106	148	285
G4FRE	63	136	84	283
HB9AOF	55	80	141	276
G6MGL	50	89	135	274
G0DAZ	—	91	183	274
I4YND	—	—	270	270
G8ATK	42	89	138	269
G4NBS	59	103	102	264
G6YLO	32	104	128	264
G4MUT	28	90	145	263
G1KDF	27	86	144	257
G4SSO	—	67	190	257
G1LSB	—	126	125	251
G1EGC	—	70	171	241
G6DZH	—	87	149	236
G3NAQ	—	75	154	229
G3FPK	—	—	224	224
G4IGO	—	—	223	223
G4SFY	—	—	222	222
G4MJC	—	33	184	217
GM4CXP	—	31	184	215
G4MEJ	—	—	211	211
GW8UCQ	—	81	128	209
G6STI	21	58	123	202
G8LFB	—	—	202	202
G4HGT	—	52	142	194
G4YCD	—	36	155	191
G1GEY	—	48	139	187
GMOBPY	—	57	129	186
G8MKD	—	49	137	186
G4XEK	—	—	178	178
G4YUZ	—	—	177	177
E15FK	—	35	137	172
G8ZDS	—	43	129	172
G4DOL	—	—	172	172
ON1CAK	—	—	167	167
G6AJE	5	63	97	165
GJ6TMM	—	31	128	159
G4COM	—	52	100	152
GW8VHI	—	48	102	150
G1JUS	—	—	146	146
G4AGQ	1	41	102	144
GW4FRX	—	—	144	144
G4FVK	20	46	75	141
G6XRK	—	1	117	118
G1DOX	28	34	53	115
G8LHT	2	31	81	114
G4TGM	—	—	113	113
G6MXL	10	36	66	112
GW6VZW	—	6	103	109
G8XTJ	—	—	106	106
PA3EUS	—	18	57	75
GMOGDL	—	17	54	71
G4ZTR	17	15	37	69
G0FEH	—	—	65	65
G1CRH	—	—	59	59
G0HDZ	—	—	55	55
GU4HUY	—	—	54	54
G1NVB	—	—	49	49
G8PYP	—	—	49	49
G2OHV	1	4	27	32
G1VTR	—	23	6	29

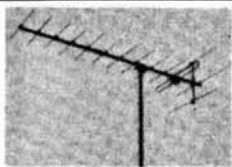
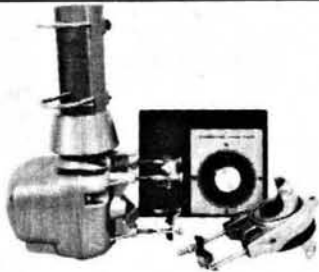

**FERNSEH-ANTENNA**  
High Gain Wideband  
VHF Band 3 Aerial  
for TV DXing

**AUTOMATIC ANTENNA ROTATOR**

Special Seasonal Offer — We have recently advertised the above two items separately at special prices. This month we are again breaking our own price barrier — the automatic antenna rotator is now only £38, and the S1814 Band 3 high gain aerial is down to £28. If the two items are purchased together, the total price is only £64 an even further saving.

The rotator is ideal for DXing, Amateur and domestic use to turn your aerial for reception of alternative ITV regions. The system comprises of two major components, the automatic control console and the rotator head unit. The additional support bearing shown, may be fitted if larger multiple aerials are to be fitted. The attractively styled Control Console features continuous indication of aerial heading, showing the aerials position at all times. The rotator support mast can be up to 2" in diameter, stub/rotation mast is up to 1 1/2" in diameter.

The Fernseh-Antenna pictured is a 14 element high gain (11.5dB) wideband array covering all VHF channels in Band 3 (175-230MHz). The aerial is gold lacquered for complete protection from corrosion, has a folded dipole for peak efficiency and comes complete with plated mast clamp, which has a 2" grasp capability.

- COLOROTOR Automatic Antenna Rotator and Control Console (uses 3 core control cable) ..... £38.00
- SUPPORT BEARING for heavier load applications ..... £17.00
- FERNSEH-ANTENNA S1814 High Gain 14 element Wideband 3 Aerial ..... £28.00 (Carriage & insurance on aerial £4.95)

If Rotator and Antenna are purchased together, total price is £64.00 + Carriage.

Aerial techniques is the company that knows the TV-DXing hobby. We carry a large and comprehensive range of aerial equipment for every type of installation, together with a vast range of filters, amplifiers, cables, rotators, masts and supporting hardware. Send today for a copy of our glossy covered illustrated Catalogue at 75p, in the unlikely event that this doesn't list what you want, we can obtain it quickly.

All prices inclusive of VAT & Carriage.

Delivery normally 7-10 days.  
ACCESS & VISA Mail and Telephone orders welcome.



**AERIAL TECHNIQUES (PW)**  
11, Kent Road, Parkstone,  
Poole, Dorset, BH12 2EH. Tel: 0202 738232.



**LOSING DX?**

**ANTENNA FAULT?** Storm damage? Poor reports? CHECK fast with an **ANTENNA NOISE BRIDGE**, measure **RESONANCE 1-160MHz** and **RADIATION RESISTANCE 2-1000 ohms**, also use for feeder lengths, phasing lines, RF resistance and hence Q of loading coils, traps etc, **only £26.20**, get **ANSWERS** and **MORE DX**.

**ANTENNA TUNER** for outside or **INDOOR** antennas, end-fed **LONG WIRES** or dipoles, **BOOST DX** and reduce interference **100kHz-30MHz** in 6 overlapping ranges, **IDEAL** for FRG7700 etc or **10W tx**, **only £29.90**, hear **WEAK DX**.

Each fun-to-build kit (ready-made to order) includes **ALL parts**, **CASE**, **pcbs** are fibre-glass, **connectors**, **instructions**, **by-return postage** (Europe same, Giro 21.923.4000) and **FREE "Kit News"**.

**CAMBRIDGE KITS**

45 (PB) Old School Lane, Milton, Cambridge.

**VALVES**

\*High Quality \*\*Very High Quality Prices correct as at 20/9/1987 but may fluctuate. 15% VAT incl.

A1065	1.40	EF819	0.80	EF86	1.40	EVS1	0.50	PFL200	1.10	UBF89	0.70
A2283	7.00	EC52	1.00	EF89	1.80	EY81	0.75	PFL200*	2.20	UC34	0.65
A2900	12.75	EC31	4.40	EF91	1.80	EY86/7	0.80	PL26	1.10	UC235	0.80
AN8	1.15	EC32	1.85	EF92	2.15	EY88	0.85	PL81	0.85	UCH42	2.50
ARP3	1.15	EC31	0.95	EF95	0.95	EZ80	0.70	PL82	0.70	UCH81	0.75
ARP26	0.70	EC32	0.95	EF96	0.95	EZ81	0.70	PL83	0.80	UCL32	1.00
ATP4	0.80	EC33	0.80	EF103	0.75	EZ81	0.70	PL84	0.80	UHF41	1.85
B12H	0.90	EC34	0.80	EF184	0.75	GM4	0.90	PL504	1.25	UFB8	1.00
CY31	1.40	EC35	0.75	EF182	0.75	G1901	1.30	PL508	2.00	UFB5	1.20
DAF70	1.75	EC36	1.10	EF190	1.85	G22	1.40	PL520	5.65	UL84	2.70
DAF96	0.90	ECC189	0.95	EH90	0.85	G23	4.20	PL519	3.85	UM80	0.90
DE722	32.80	ECC204	0.85	EL32	0.85	G23*	4.40	PL802SE	3.45	UM80*	1.00
DP92	0.85	ECF80	0.95	EL34	2.40	G237	3.95	PR80	0.70	UM84	0.70
DP96	0.85	ECF82	0.95	EL34*	5.15	KT86*	15.50	PR1800	0.85	UY82	3.70
DH76	0.75	ECF802	1.00	EL82	3.70	KT77*	14.00	PR82	0.75	UY85	0.80
DL32	1.85	ECH42	1.20	EL84	0.95	KT88	37.00	PR88	0.80	VR105/30	1.45
DY86/87	0.85	ECH81	0.70	EL86	0.95	KT88*	25.00	PR500A	2.10	VR150/30	1.80
DY882	0.70	ECH84	0.80	EL90	1.75	ML4	3.20	QDV8/10	5.85	Y818A	1.70
EBC22	2.80	ECL80	0.85	EL91	6.50	ML5	3.20	QDV8/10*	7.50	X86	1.80
EBCCC	11.50	ECL82	0.75	EL95	1.25	MX120/01	27.50	QDV8/20A	27.50	Z149	0.75
E1148	0.50	ECL85	0.75	EL504	2.70	N78	9.30	QDV8/40A	28.50	Z759	19.00
EAT6	1.80	ECL86	0.95	EL509	5.85	OA2	0.70	QDV8/40A*	49.50	Z800U	3.45
EB34	0.70	EFL8	2.50	EL519	7.70	OR2	0.80	QDV8/12	5.75	Z801U	3.75
EB81	0.80	EP22	3.50	EL821	0.40	PL82	0.85	SP61	1.80	Z803U	21.15
EB83	1.85	EP29	2.15	EL822	0.95	PL84	0.85	TT21	37.50	Z807	2.45
EB89	0.80	EP80	0.80	EL855E	4.50	PL86	0.80	TT22	37.50	V43	2.75
EC31	0.90	EP82	0.80	EM80	0.80	PL805/85	0.85	UAB30	0.75	V14	0.65
EBF90	0.95	EP85	0.80	EM87	3.00	PD500/510	0.95	UAF80	0.70	V185	0.65

VALVES AND TRANSISTORS Telephone enquiries for valves, transistors, etc. Retail 749 3934, trade and export 743 0889. POSTAGE: E1-£3 55p; E3-£5 65p; E5-£10 85p; E10-£15 £1.05; E15-£20 £1.60. Minimum order £1.00. Delivery by return.

**COLOMOR (ELECTRONICS LTD.)** 170 Goldhawk Rd, London W12  
Tel: 01-743 0899 or 01-749 3934. Open Monday to Friday 9 a.m.-5.30 p.m.

**AKD**

Unit 5  
Parsons Green Estate  
Boulton Road  
Stevenage  
Herts SG1 4QG



**THE FILTER SPECIALISTS**



**MAIL ORDER DEPT.**  
Stock Items Normally  
Despatched within 48 hours,  
21 days latest.  
**TEL. 0438 351710**

**TV INTERFERENCE PROBLEMS??!!**

Are you having trouble receiving a watchable picture on your TV? If so, the cause may be airborne interference. For many years AKD has manufactured a low cost range of in-line interference suppression filters that are easily inserted into the aerial system to help reduce the effects of interference from local taxi radio, CB, amateur radio, airport radar, etc. Each filter is terminated in standard aerial co-ax plug and socket and requires no external power. Fitting could not be more simple. No technical knowledge is needed. There are 13 standard stocked filters in our range, but individual filters can be tuned to reject interference at specific frequencies if required. If you are not sure which filter type to order or have any questions regarding interference phone our helpline on 0438 351710 and ask for John who will be pleased to assist you in making the best choice of filter.

**THE FILTER RANGE IS AS FOLLOWS:**

**FILTER TYPE RBF1**

A range of filters designed to eliminate Radar Blip, especially noticeable on video recorders. Stocked on channel 36 and 846MHz (RAF Boulmer interference) can be tuned at our factory from 420MHz to 890MHz. **£6.75 each**

**FILTER TYPE TNF2 (Suitable for UHF TV only)**

A range of Tuned Notch filters stocked on generally useful frequencies used by Amateur Radio operators, CB users, Private Taxi companies. Can also be factory tuned to reject any spot frequency up to 300MHz. Now stocked at 50 & 70 MHz. **£7.75 each**

**FILTER TYPE HPF1**

Used in weaker reception areas for general interference problems. Use with UHF TV, Video & Pre-Amps **£6.75 each**

**FILTER TYPE HPF5**

Used in strong signal area for severe interference on UHF only **£7.00 each**

**FILTER TYPE BB1**

A general purpose filter that can be used on its own or together with other filters in our range for severe interference problems. Ideal at the input of VCR and Pre-Amps. **£6.75 each**

**WA1 WAVEMETER £24.95**

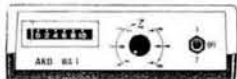

Our Waveabsorption meter for 2 Mtre transmitters meets licensing requirements range 120MHz to 450MHz, very sensitive, can also be used as field strength meter within its range. Requires PP3 type battery (not supplied).

**HFC1 CONVERTER £49.00**



For the FRG 9600/965 our new HF Converter, connects to the aerial socket, and powered direct from the 8 Volt o/p of the FRG 9600. Tune from 100, 1MHz to 160MHz, gives tuning range of 100kHz to 60MHz, uses double balanced mixer, with low pass filter on input. **\* Can be supplied with BNC termination for other scanners \***

**WA2 WAVEMETER £24.95**

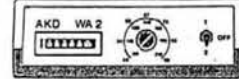

Our Wave absorption meter for the 50 & 70 MHz Bands. Meets licensing requirements. Can also be used as field strength meter within its range. Requires PP3 battery (not supplied).

**Unifilter 'CLAMP-ON' RADIO-FREQUENCY CHOKE**

PHONE OR SAE FOR PRODUCT SPECIFICATION & APPLICATION NOTES

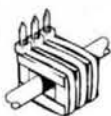

Allows leads to be toroidally protected without the need to cut or remove plugs or connectors. Ideally suited for moulded plugs, leads, ribbon, and large diameter cables. Can easily be fitted and stacked in multiples to increase rejection. 'UNIFILTER' works by suppressing the interference currents that flow along the outside of cables without affecting the signals or power flowing inside. This means that you don't need to worry about upsetting normal operation or invalidating guarantees. Suitable for both reducing the emission of, or rejecting the effect of, 'common mode' interference as experienced on computer, hi-fi & speaker leads, as well as the normal mains & aerial cables.

**UF 4 KIT (SUITABLE FOR SMALLER INSTALLATIONS) £9.89**

**UF 8 KIT (FOR MULTI INSTALLATIONS) £19.55**

ALL PRODUCTS ARE AVAILABLE FROM US DIRECT MAIL ORDER OR WHY NOT MAKE USE OF OUR ACCESS & VISA FACILITIES TO ENSURE MINIMUM DELAY

ALL AKD PRODUCTS CARRY THE USUAL AKD 2 YEAR GUARANTEE. PRICES QUOTED ARE CORRECT AT TIME OF GOING TO PRESS AND INCLUDE VAT, POSTAGE & PACKING

**TRADE ENQUIRIES WELCOME**

Props: RT & VEL Wagstaffe. Technical Adviser: John Armstrong

two Fs and G1YAA (ZP) for a new square. The 6th was an excellent day, 18 DX QSOs logged including SP6HEI, SP3RFB and several OKs and Ys.

**Jim Rabbitts G8LFB** (LDN) started his "innings" on Nov 3 with OZ and SM contacts, the next day bringing OK and Y stations, with OZs again on the 5th. On the 6th he worked SP6GZZ, SP3JBI, SP3CMX (HM), SP6HEI and SP2NJI (JM). The next day, more SPs, 3MFI, 3BLR (HM), 3MIC, 6GWB/6 (IK) and 6BTI (IL), finally finishing in the early hours of the 8th with two HB9s. Yet all that only brought two new squares.

**Julie Yates G8MKD** (WMD) lists 57 DX stations worked in the Nov 4-7 period, the 6th being the most rewarding day. Her tally was 27 Ds, 10 OKs, eight Ys, seven ONs, two each HB and PA and one F contact, best DX being OK3KGW/P at 1457km.

**Steve Damon G8PYP** (DOR) reports that the lift conditions appeared to favour stations to the north and east of Wimborne, Nov 6 being the best day with DL3LAL (JO43) and DL4EBX (JO31) new squares. On the 7th Steve observed strange conditions; a series of fast-moving ducts more like Sporadic-E. This reminds me that someone else mentioned this and christened it Sporadic Tropo. He struggled to get an RS41 report from HB9SLU/P (JN37) at 0250 on the 8th when those in ZL square were exchanging S9 reports.

**G8XTJ** worked F6DUA (ZG) on Nov 5 and the next day was excellent for John. G4IJM (CVE) was the first station heard from that county in seven years and has already QSLed. Next he contacted DF0RR (JO62), OK1KEI/P and then SP6HEI after 90 minutes trying to "get in." The SP's signal ranged from inaudible to S9. OZ2KSR/P was new and the first time John has worked into the "I" column of squares. On the 7th, OK1AQF/P (JO60) was contacted.

**Irwin Brown G11JUS** (ATM) worked six new squares in the Nov 4-7 period being F3GJ (CI), DF8WS (DJ), DK8ZB/P (EK), DL/I4BXN (FJ), OK1KRY/P (GJ) and OE5KE (HI) at 1558km. Lots of QSOs were made with stations worked in earlier lifts.

**Alex McCreddie GMOBPY** (BDS) wrote that the opening was the first decent one for a long time for his part of Scotland. On Nov 4-6 the duct seemed to be very narrow just to CK, BK and DK squares. On the 5/6th it moved further north and deeper into W Germany with the OKs appearing on the 7th, best DX being OK3KGW/P. Alex quotes GU3EUL (ALD) as his most satisfying contact as he is unique and reckons the "D" in DX stands not for distance but difficulty.

**M Rodgers GMOGDL** (CTR) also reports narrow ducting up to Nov 5 with the better DX worked on the 6th and 7th. The afternoon of the 6th brought OK1KEI, DL3LAL (JO54), OE5MKM (JN78) and OK1JKT/P (JO60). On the 7th, best DX was DL6FBL/P (JO40). Much the same pattern reported by **Derrick Dance GM4CXP** (BDS) whose tally on the 7th was 17 OKs, eight Fs, six Ds and one HB9 and ON.

**Paul Baker GW6VZW** (GWT) lists DK3NZ/A (FL), DL8HCZ (FN) and F6DDW (DI) as new squares worked over the Nov 4-7 period. Also contacted were OK1KHI (HK) and the TV6BAZ station on Batz Island (XI). Later Paul discovered a faulty connector which resulted in his only hearing the loudest signals.

One of the most favoured stations in the lift seems to have been John Nelson

GW4FRX (PWS) whose final totals were 23 SPs, 59 Ys, 84 OKs plus assorted OZ, SM7, OE and HB9 at times. The stations up to the "J" column of squares were all very strong, many only running low e.r.p. Nothing was heard from east of longitude 20° and I have no reports of anyone working into the "K" column of squares.

At 1725 on the 6th, John had a ten minute "pile-up" of SPs calling him, many around 50dB over noise. Using the IARU standard of S9 for a 5µV signal at the RX, that equates to 11dB over S9.

John was able to get the power and antenna details from several stations while noting the accurate signal strengths in terms of dBm. The strongest station for which he has their information was SP2NJI whose 10W to a 6-ele Yagi registered 60dBm or slightly over.

I have calculated the free space path loss for the distances involved in six cases using John's known station performance and the estimated performance at the DX end. The calculated losses range from 9dB to a "gain" of 11dB in the case of SP2NJI who should have been only 49dBm.

From his local RAF station, John has obtained data for 0001 on Nov 7 which shows a surface temperature of +4°C dropping to +1° at 1500ft. Thereafter it rose to +10° in the next 600ft, a substantial inversion. Moreover the tephigram suggests this inversion extended to about 10°E longitude, i.e. the D/Y border, from a point a little west and north of GW4FRX (YM26h). Another observation was that John's two 17-ele Yagis had to be aimed 10-15° more northerly than the calculated great circle QTE, for the strongest received signals.

## The 430MHz Band

G1EGC's station consists of an Icom IC-490E, 100W 4CX250B amplifier, muTek pre-amp in the shack and two 17-ele Cue Dee Yagis fed through LDF4-50 cable. Mark worked 23 new squares in the Nov 4-7 period and from his long list of DX I pick out F6CCH (ZG) and SP6GZZ on the 5th, OZ1JPT (GO), OK1KKH/P (HJ) and SP6MLK/P6 (IK) on the 6th and OK2KZR/P on the 7th. At 0425 on the 7th he had a half hour chat with SP6GWB/P6 and Mark advises it is well worth while staying up for these lifts as the middle Europeans never seem to go to bed.

**Paul Brockett G1LSB** (LCN) also sent a long list of choice DX in the Nov 3-8 period and which gave him eight new squares. These were FC1CLQ (DI) and DF1NP/A (FI) on the 4th; Y35YC (HN), Y25QL (GL), OK2KZR (IJ) and F6HEO (BG) on the 6th and on the 7th, SP6GZZ (IL) and OE5XBL (GI).

**Les Coote G3AHB** (AVN) worked Y22ME at 1630 on the 6th for his best DX so far at 1110km and the next day HB9AMH/P at 2330 who was very loud. G3UVR added AG, GL, HL, II, IJ, IL and JJ squares in the lift but did not identify actual stations. **G4FVX**, now with 46 squares, worked Y22ME and OK1KKH/P on c.w. and DJ5GR on s.s.b.

G4NBS has been having awful interference problems with a neighbour for ages now and seems to be under threat of a licence change if the DTI receives further complaints of interference "... to anything in the house ..." to quote Tony. Nevertheless he has added some nice DX in the lift including OK2KZR/P on c.w., his 100th square, OK3LQ (II), SP3JMZ (IM) and SP6MLK/6. All the more interesting DX was on c.w.

## Annual c.w. ladder

Station	Band (MHz)				Points
	70	144	430	µWave	
G4ZEC	—	601	—	—	601
G4XEN	—	400	34	—	434
G4ZVS	—	310	—	—	310
G4OUT	—	262	—	—	262
G4NZU	2	243	4	—	249
G0HGA	—	198	—	—	198
G3WRJ	—	157	—	—	157
G4WHZ	—	139	—	—	139
G4YIR	—	129	—	—	129
G4VOZ	102	—	23	—	125
G4ZNI	—	112	—	—	112
G0DJA	—	101	—	—	101
GM4CXP	—	87	—	—	87
G0GKN	—	84	—	—	84
EI5FK	—	29	35	—	64
GU4HUY	—	63	—	—	63
G6XVV	—	31	16	12	59
G4YTR	—	56	—	—	56
G4AGQ	15	21	14	1	51
G2DHF	15	28	1	—	44
GW4HBK	27	—	—	—	27
G0HDZ	—	9	—	—	9

Number of different stations worked since January 1.

G4VOZ worked eight countries outside the UK on Nov 6/7 including Y23LI/M and F6BJH but few were interested in any other than rubber stamps QSOs. G4XEN worked SP6GZZ on the 4th, LX1JX (DK) on the 5th and in a "... marvellous c.w. session ..." on the 6th, OK3LQ and OK3CGX, the later his best DX of 1339km, OZ2KZR and OK1KKH plus three Y2s.

While most contributors seemed to concentrate on the continental DX, a few did listen to the west, one being G6DZH who worked EI5FK (VL) and EI4EY (VM) in the late evening of the 6th. Keith also worked his share of the D, F, OZ, OK and Ys on offer, though.

G6MEN uses a Yaesu FT-790R, 30W amplifier and 19-ele Tonna Yagi. OK1KHI (HK) was Paul's best DX and Y22ME his first Y contact, both on the 7th. G6STI has been on the band since Feb 86 and also runs a '790R and 19-ele Tonna but with a 40W amplifier. New squares in the lift were F6IPG (YH) and OZ7IS (GP) on the 5th, FC1GXX (ZF) and Y24BO (GM) on the 6th and Y24XN/P (GK) on the 7th plus Fs in BF, BG and BI.

**David Law G6OYL** (YSS) wrote a first contribution and his station consists of a Kenwood TS-770E, 2C39A 50W amplifier, BFQ69 pre-amp and two home-made 17-ele Yagis to the DL3WU design. From 1730 on Nov 5 he started working into southern France, later into Y, OK and SP, OZ and SM. In fact, the opening was virtually in all directions during the 5th to 7th. David's choicest DX included SP6MLK/6, SP6GZZ, SP9EWU, and SP6BTI (IL), OE1RVW/3 (HH) running one watt to a single Yagi, OE5VRL/5 and OE5XDL (HI) and OK2BSO (JJ).

G8HHI worked OZs and an LA in EQ, GP and DS squares on Nov 5. Next day John worked three Y2s in GL, GM and HM, Y35YC, DL8FBD (EK), OK1DIG/P (GK), OK1KKH/P (HJ) and SM7DEZ (GP). On the 7th SP6MLK/6, OK1MAC/P and HB9AMH/P were worked. Gordon Emmerston G8PNN (NLD) lists three new squares: OE3XUA (HH) and OK1KKH/P on the 6th and F6HEO (BG) on the 7th.

From Eyemouth, G6OBPY found the band "patchy" with something interesting now and then such as HB9MIN/P on the 4th and Y23BD on the 5th. G6OGDL reports the same very selective ducting on

the 5th as noted on 144MHz. The next day brought DH3NAN (FK76j) at 1615 but FD1GYA/P (BF) faded out while GM6BIG was working him but as some consolation, three Fs in BI were contacted. ON7ZM and ON5RU gave GM4CXP an all-time new country on the band.

## The Microwave Bands

GODJA mentions RSGB promoted Microwave Activity Days throughout the winter being the first Sunday in the month. G3AHB is on 1.3GHz and Les reports reception of beacon GB3MHL at S7 on Nov 6 at 1537, it remaining audible till 0715 on the 8th. G3TDG (KNT) was worked on the 6th and on the 7th, HB9AMH/P at 2335, the QRB being 820km.

G3UVR found six new squares on 1.3GHz in the lift: AG, BF, BG, EK, FP and IK which brings Denis's total to 75. John Tye G4BYV (NOR) worked DL6NAQ/P and DC9BU/A in EK on 3.4GHz, QRB 672km and DKONA (FK) at 775km. They were heard on 5.6GHz but John's 10W they could not find. He mentions the Martlesham Microwave Round Table on

## The Dutch to get 50MHz

From March 1, all Dutch amateurs can apply for 50MHz permits for c.w. only, 30W TX output. No antenna restrictions are planned and the allocation is from 50 to 50.45MHz. This is for an experimental period of 5 years.

Nov 8 at which test gear was available and RSGB microwave components and a bring and buy sale were on offer.

G4DEZ spent most of the lift period on 1.3GHz and worked into D, Y, LX and OK. On the morning of the 8th Bryn had a ten minute chat with HB9AMH/P at S9 each way. G4FVX is at 20 squares worked on 1.3GHz and David worked DD3KL (DK) and DKONA (FK) in the Nov lift.

G6HKM came on 1.3GHz towards the end of the lift. On the 8th a CQ call produced QSOs with seven German and three Dutch stations. Ela also added AVN, CNL, GLR, LNH, LEC and SRY to her county tally for the 1987 table. In the Nov 17 leg of the Cumulatives she had 16 QSOs and heard GI4OPH for her first ever GI. Stations

worked included PE1EWR now running 80W, G8TFI (GLR), G8NEY/P (AVN), G4TCP/P (SRY) and G1KDF (LNH) just completed at RS31 each way.

G6STI has been on 1.3GHz since the end of May 1987 and Howard uses a Yaesu FT-726 with transverter running one watt "... to a very old 24-ele quad ..." Best DX to date is 682km and in the lift new squares were DL2KBB (DK) and seven Fs in AK, BF, BG, BI, ZF, ZG and ZH.

Haydn Barker G6XVV (YSS) has had little time for the hobby lately but did get on 1.3GHz in the lift with 0.5W to a 1.4m dish below roof height. He managed to work to BI and BG squares. G8HHI on 1.3GHz worked G1DOX (CBA), G8PNN and F1EAN (AG) on Nov 5, DL6NAQ/P, OK1DIG/P and DL2KBB on the 6th and DK3FB/P (DL) on the 7th to bring John's band squares total to 31. He runs a Kenwood TS-780, Microwave Modules transverter and 2C39 PA at 50W to a Jaybeam 15-over-15 antenna.

G8PNN is now up to 62 squares on 1.3GHz, latest additions being F9MJ (ZG), FD1GYA/P, F6DKW (BI) and F6HEO in the lift.

Finally it is certainly not the intention to drop the microwave bands reports as a couple of readers thought. The remark on page 64 in the December issue referred to the microwave column of figures in the Annual c.w. ladder. A reminder that this year the v.h.f./u.h.f. table will include 50MHz and that all bands will count for points but do not be put off entering if you only use one or two bands since there is an individual band table at the end of the year as will be seen in next month's VHF Up.

**Your deadlines for the  
next three issues are:  
January 27, March 2 & March 26**

## RTTY

This month's logging has been interrupted by a very interesting trip to The Gambia so my apologies for the small chart.

## RTTY

Despite the small amount of time available for logging, I did manage to catch a couple of very good openings on 28MHz. The first one was fairly short-lived and occurred in the late afternoon. During this opening I logged CE3BBW working WB7AJO, both stations were only about S2-3 but the band noise was very low so they were good solid copy.

The second opening lasted from mid-day through to late afternoon and produced lots of good DX. My log included the following on 28MHz RTTY: S79WS (Seychelles), 3B8FP (Mauritius), LU2DGO (Argentina), 9Q5BG (Zaire) and PS7KM (Brazil). Signals during this second opening were much stronger and very stable producing some very good copy.

## Reports

I'm still desperately short of reports from readers. The column will represent your interests much more accurately if I could have some feedback. Reports can comprise whatever is most convenient for you, the basic requirement is call sign, band, date and time. If you have access to

a photocopier then the simplest way is to just copy your log for the period concerned. Any information can either be posted to the address above or to my Prestel mailbox 925470071.

## AMTOR Tutorial

I know AMTOR has been around for quite some time, but I'm sure there are plenty of newcomers who would like to know a little more about it.

I suppose the first question must be what is AMTOR and why is it used? Well, the name AMTOR is an acronym for Amateur Teleprinter Over Radio and comprises a computer controlled data transmission system which features full error correction with an effective transmission rate of 50 baud. It is generally used in a similar way to conventional RTTY, i.e. for live keyboard QSOs with fellow amateurs. The main advantage is that any errors are automatically corrected leaving the operator free to converse normally without having to repeat essential information like reports and QTH. This all sounds very good but how did it start and who invented AMTOR?

AMTOR is based on a commercial system called TOR (Teleprinter Over Radio). The first use of TOR is reported to be by Dr Van Duuren of the Netherlands PTT in 1958, where it was used to provide error

correction on a radio link between Karachi and Amsterdam. This original set-up was rather large comprising about 4 or 5 racks of valved equipment occupying about 60 cubic feet!

Since this original use TOR has been expanded and standardised and one of the most common commercial versions is known as SITOR (Simplex Teleprinter Over Radio) and is defined in CCIR recommendation 476-4. This system is used extensively for ship-to-shore communications and is the basis of the present AMTOR system.

AMTOR was actually pioneered by Peter Martinez G3PLX in an article in the RSGB magazine *Radio Communication* in August 1979. This initial introduction was followed by a constructional article in June/July 1980 which described a single board convertor to enable stations equipped with RTTY to convert to AMTOR. This was the turning point for AMTOR and resulted in it being accepted as a standard. In fact I still use the mark 2 version of this convertor in my shack.

That's a simplified history so now on to the details of how it actually works.

There are actually two main operating modes in AMTOR. The first is known as FEC (Forward Error Correction) or mode B. This mode is used primarily for CQ calls. The second is known as ARQ (Automatic Repeat Request) or mode A and is used for the main part of the QSO and provides the full error correction.

Before I discuss the inner workings of AMTOR you need to understand the codes used. In conventional RTTY the typed characters are converted into a 5 unit code called ITA2 (International Telegraph Alphabet No. 2). When using AMTOR the

**Your deadlines for the  
next three issues are:  
January 27, March 2 & March 26**

typed characters are converted into a special 7 unit code. This 7 unit code although having a possible 128 different values only actually uses 35 values. The reason for this is explained by the error correction technique employed. If we imagine that each unit of the 7 unit code can either be a 1 or 0 then in AMTOR each of the 35 possible combinations comprises four 1s and three 0s. This makes error detection easy as any character that does not contain four 1s and three 0s must be an error, simple isn't it.

Mode A or ARQ is the main AMTOR mode and is easily recognised by the characteristic "chirp chirp" signal it produces. If we assume that contact has been established between two stations A and B I will describe the error correction system used by AMTOR.

Characters that are typed at the keyboard of station A are transmitted in groups of three characters at a time. Once the first three characters have been sent station A drops to receive mode and awaits a response from station B. When station B receives the group of three characters the AMTOR software will check to see if the characters are valid. If all is well station B will send an acknowledgement, conversely if there were any errors station B will send a repeat request. One other possibility is that due to interference, etc. station B may not receive anything and so will not send any acknowledgement. This is catered for by the fact that station A will only wait 240ms for a response from station B before automatically re-sending the three characters.

As you can see this simple system ensures error free transmission of messages. The only weakness in the error correction system is that if a character is corrupted but still contains four 1s and three 0s it will not be detected as an error. Experience has shown that this is only a very minor weakness.

The AMTOR ARQ system relies very much on timing in order to achieve a satisfactory throughput of data and error correction. The timing elements comprise 210ms to send the three character group followed by 240ms to receive the acknowledgement. This makes a total of 450ms for the transmission of three characters and corresponds to an effective rate of 50 baud but requires a rate of 100 baud over

the radio link. In order to continue this timing sequence the AMTOR software automatically sends idle characters during breaks in typing.

One feature not yet mentioned is the selcal. This is a very powerful feature which allows you to enter a selcal comprising four alphabetic characters to make contact with a particular station. The selcal normally comprises your callsign with the number omitted i.e. my callsign is G4WNC so my selcal would be GWNC. In order to start a QSO with a station you select mode A, ARQ and enter the selcal of the station you want to contact. If that station is on frequency and in AMTOR mode then his transmitter will automatically respond to your call. One other special feature is the change-over from transmit to receive which is achieved by using a unique combination of two characters (+7). When this sequence is detected a transmit/receive change-over is automatically executed.

Now to describe the second AMTOR mode known as mode B or FEC. This mode uses the same 7 unit code as mode A but comprises a continuous transmission rather than the alternate transmit/receive switching of mode A.

The use of the 7 unit code means that the same error detection method can be used as in mode A, i.e. four 1s and three 0s for a valid character. The error correction employed is rather different in that the transmitting station sends each group of three characters twice. These groups are spaced five characters apart to minimise the chance of both groups being affected by the same burst of interference. As with mode A any gaps in the flow of characters from the keyboard are automatically filled with idle characters.

This error correction system produces results significantly better than conventional RTTY but not as good as ARQ.

When operating AMTOR, mode B is normally used to make a CQ call which would normally include your selcal so that any potential contact can respond in mode A using your selcal. One point to note when making a CQ call is that the receiving station can only lock on to your signal when you are sending idle characters so make sure you send plenty of idles at the start and during your CQ call.

The only other mode to mention is a mode exclusive to AMTOR known as

Prefix (Country)	Band (MHz)				
	3-5	7	14	21	28
A, K, W (USA)			AR	R	R
CE (Chile)					R
DA, F, J, K, L, (W. Germany)	R	R	R		
EA, C (Spain)			R		
EA6 (Balearic Is)				R	
F (France)		R	R		
G (England)	AR	R	AR		
GI (N. Ireland)		R			
GM (Scotland)	R				
GW (Wales)	R		R		
HB (Switzerland)			A		
I (Italy)			APR	R	R
LA (Norway)			A		
LU (Argentina)				R	R
LZ (Bulgaria)			R	R	
OE (Austria)			AR		R
OH (Finland)			R		
OK (Czechoslovakia)					R
PP, Y (Brazil)				R	R
PZ (Surinam)					
S79 (Seychelles)					R
SG, K, L, M (Sweden)			AR		
SO, P (Poland)			R		
UA, V (USSR)				R	R
VE (Canada)				R	
Y (E. Germany)			R		R
YO (Romania)				R	
YU (Yugoslavia)			R	R	
ZS (South Africa)			AR		
3B8 (Mauritius)					R
5L2 (Liberia)				R	
9O6 (Zaire)					R

### The much-depleted data communications chart

mode L. This mode allows you to monitor a QSO between two stations using mode A. Although this is very useful you will find that you receive quite a few double characters or have some characters missing, this is because the error correction system only works between the two stations in QSO.

Well that's a simple summary of how AMTOR works, perhaps in another issue I will give some more practical details of how to get the best out of AMTOR. One point I will make is that in my view, and several other amateurs I have spoken to, AMTOR is by far the best mode for live keyboard QSOs and is more effective than Packet!

That's all for this month but please, please send me some reports.

## Amateur Satellites

Reports to Pal Gowen G3IOR  
17 Heath Crescent, Hellesdon, Norwich, Norfolk NR6 6XD.

### OSCAR-10

The return of AO-10 on November 16 was greeted with delight by many of the keen operators who had waited patiently for the chance to re-employ the transponders. Almost without exception, operator behaviour has been impeccable, with users aware of the necessity of keeping away from the eclipse periods, and utilising just that amount of power in maintaining effective communications to sustain the spacecraft's batteries. Your scribe, who had not been on the satellite for over a year, seized the opportunity, and made some good QSOs with VK2, W1, 2, 6, 9, and 0, plus several old friends around Europe.

At first it was thought that the beam antennas had self switched in during the power-off period, as the characteristic "spin modulation" consisting of two slow signal strength peaks followed by one larger one with each rotation of the satel-

lite rotation were evident, but signal analysis showed that it is in fact the monopole antenna that is responsible for radiating the downlink. Signals are quite weak when the satellite is at apogee, especially to the east, but substantial when it is at or close to perigee, and inverse square law sums show that the signal enhancement at this time is mainly due to sheer proximity.

The spin fade is due to one either looking at the monopole through the rotating beam antennas, or by passive reflection by them, this producing the rapid QSB normally associated with using a linearly polarised antenna for the satellite. Indeed, a change of polarisation or circularity can give very different effects even though the radiator on the spacecraft in itself linearly polarised. A change of vertical to horizontal, or even right-hand circular to left-hand circular polarisation on the uplink and on the 145MHz downlink through a pass, as the satellite changes in its orientation to the observer, can often produce far clearer

and much smoother signals.

The spin rate of the satellite has noticeably decreased now, and current observations put this currently at 24 r.p.m. and slowing down still. Like the satellite attitude, nothing can be done about this, as the radiation damaged memory of the internal housekeeping unit dictates that the translation of commands into action by the magno-torquers is impossible, so future angulation for optimum sun-angle, earth antenna pointing, and attitude maintenance cannot be determined. Even so, we are fortunate to have a functioning satellite still, which if used with care, should continue to provide us with all continent DX communications.

The period to use the satellite in early January is from Mean Anomaly 221, through perigee, to MA 139, soon after which follows the period of eclipse. Later schedules, when prepared, will be given out on the numerous AMSAT nets, and these should be followed closely to avoid



Satellite	RS5	RS7	RS10/11	METEOR 1/30	COSMOS 1766	METEOR 2/14	METEOR 2/15	METEOR 2/16
Internat Design	81-120C	81-120E	87-054A	80-051A	86-055A	83-039A	87-001A	87-068A
Object	12999	13001	18129	11848	168810	16735	17290	18312
Epoch Year	1987	1987	1987	1987	1987	1987	1987	1987
Epoch Day	303.19061229	304.03387348	301.50039549	300.75641396	306.71436462	304.59301838	304.36698026	304.08367078
Inclination	82.9630	82.9678	82.9239	97.7217	82.5269	82.5452	82.4630	82.5589
RAAN	194.9473	186.1813	319.5943	27.3526	224.4732	359.0325	270.7825	330.9856
Eccentricity	0.0009246	0.0023607	0.0010257	0.0043473	0.0023623	0.0013124	0.0014109	0.0013871
Arg of Perigee	97.7019	8.3702	269.8809	77.4009	220.4696	238.0335	121.0993	67.4400
Mean Anomaly	262.5074	351.7766	90.1071	283.2073	139.4836	121.9557	239.1555	292.8198
Mean Motion	12.05067730	12.08702803	13.71881116	14.98335553	14.73548305	13.83763587	13.83569646	13.8326960
Decay Rate	1.2e <sup>-7</sup>	1.3e <sup>-7</sup>	9.7e <sup>-7</sup>	1.184e <sup>-05</sup>	8.9e <sup>-07</sup>	6.0e <sup>-8</sup>	6.0e <sup>-8</sup>	4.0e <sup>-07</sup>
Orbit Number	25809	25897	1744	40196	6801	104.12286	104.13756	104.14429
Nodal Period	119.55187	119.19258	105.02429	96.16553	97.78378	26.15952	26.16366	26.16476
Long. Incr.	30.01488	29.92496	26.38191	24.04118	24.75555	7222	4136	1023
Beacon Freq.	29.330	29.340	29.357	137.020	137.400	137.850	137.850	137.400
	29.452	29.501	29.403			04 Nov 1987	04 Nov 1987	04 Nov 1987
			145.857			7270	4187	1078
			145.903			0131.84	0119.45	0129.03
			29.407			69.45	154.80	97.19
			29.453					
			145.907					
			145.953					
Ref. EQX	06 Nov 1987	06 Nov 1987	01 Nov 1987	03 Nov 1987	08 Nov 1987			
Orbit No.	25892	25970	1792	40290	6879			
Time (HHMM. MM)	0157.29	0149.82	0001.74	0048.82	0015.78			
Long. W	242.87	249.33	83.18	20.39	191.01			

Satellite	OSCAR-9	OSCAR-10	OSCAR-11	NOAA9	NOAA10	FO12	SALYUT 7	MIR
Internat Design	81-100B	83-058B	84-021B	86-123A	86-073A	86-61B	82-033A	86-017A
Object	12888	14129	14781	15427	16969	16909	13138	16609
Epoch Year	1987	1987	1987	1987	1987	1987	1987	1987
Epoch Day	305.03708608	299.31218565	299.74776146	294.34653927	304.23391457	296.50546216	308.63839241	308.92682777
Inclination	97.6405	27.4526	98.0868	99.0669	98.7109	50.0144	51.6113	51.6248
RAAN	326.2911	355.5741	2.9363	261.1519	333.2037	350.8958	297.9920	149.4408
Eccentricity	0.0003910	0.6026677	0.0014471	0.0014638	0.0013080	0.0011163	0.0001773	0.0042643
Arg of Perigee	97.0673	251.2486	48.2436	210.5027	169.8184	252.2286	50.6872	351.7425
Mean Anomaly	263.1016	37.1198	311.9999	149.5293	190.3260	107.7322	309.4347	8.2289
Mean Motion	15.30475640	2.05883145	14.62174702	14.11524737	12.44393694	12.44393694	15.31536210	15.84604728
Decay Rate	4.877e <sup>-5</sup>	-7.3e <sup>-07</sup>	2.23e <sup>-06</sup>	8.5e <sup>-07</sup>	2.04e <sup>-6</sup>	-2.5e <sup>-7</sup>	1.9985e <sup>-04</sup>	4.9191e <sup>-04</sup>
Orbit Number	33766	3286	19492	14711	5808	5436	31750	9828
Nodal Period	94.14701	699.17370	98.54176	102.05113	101.28568	115.65326	93.95449	90.80333
Long. Incr.	23.53403	175.34837	24.63595	25.51099	25.32114	29.23935	23.88756	23.09229
Beacon Freq.	21.002	145.810	145.826	137.620	137.500	435.797	19.953	143.625
	145.825	145.987	435.025	137.770	136.770	435.913	142.42	166.140
	435.025		2.4015GHz					
	2.401GHz							
Ref. EQX	06 Nov 1987	03 Nov 1987	06 Nov 1987	06 Nov 1987	04 Nov 1987	04 Nov 1987	10 Nov 1987	08 Nov 1987
Orbit No.	33842	3302	19642	14932	5862	5580	31833	9877
Time (HHMM. MM)	0008.59	0157.30	0018.06	0017.33	0046.27	0141.94	0117.56	0024.05
Long. W	75.43	76.76	36.22	132.05	77.35	112.92	156.19	279.37

damage to the batteries and power system. It may well be that as the satellite saw 100 per cent facing solar illumination on December 28, an increase in user time may be permitted when the period of apogee eclipse has passed, but for the next few months they will last up to 101 minutes each orbit.

The beacon, whilst only a plain carrier devoid of content, thus serves as a useful indicator of spin rate and approximate attitude. It also suggests limits of battery discharge, as it will frequency modulate with peaks of power demand if low in voltage supply. Users, whilst using the lowest possible power uplink to the spacecraft, should keep an eye on the beacon, and if any sign of frequency instability occurs, cease operations immediately, or a danger evolves that the current transponder on lock could be negated for all time, leaving a totally dead satellite.

## Ariane & Phase III-c

The postponed Ariane V-20 launch from the 0217 to 0321 UTC window of November 18 to 21, due to minor launch vehicle problems, brought a slight further delay to the future OSCAR-13 mission, as the V-21 launch, originally set for December 1987 is now deferred to February 1988 to permit a change of the third stage. This probably means that we shall see the V-22 launch of Phase III-c in mid-March if all goes according to the new plan.

Fifty-four satellites are now awaiting launch via ESA, at a budget of some 2.5 billion \$US, and fifty Ariane launch-rockets

are now bulk ordered for the 1990-1997 time frame.

Although the V-20 mission was a perfect launch, problems occurred on the direct broadcasting TV-SAT-1, which failed to deploy one of the two solar panels on which it depends for power. When finalised in geostationary position, attempts will be made to free the jammed panel by firing all fourteen of its thrusters to jolt the mechanism. If this fails, then only two of the four channels planned will be operable, and much diplomacy will be required to decide who has what!

Work on our new Phase III-c elliptical orbiter is now proceeding at a fast pace, and in Marburgh final thermal-vacuum tests are underway, as well as tests of the thrust booster, to be ready for final integration with Ariane IV.

AMSAT have launched a plea for funds to insure the new satellite at a cost of \$10 000, and already AMSAT-UK have donated \$1000 toward this. If any enthusiasts wish to contribute they may send donations via AMSAT-UK, G3IOR, or direct to AMSAT, P.O. Box 27, Washington DC 20044, USA.

## Fuji-OSCAR-12

It would appear that FO-12 has been maintaining its planned schedule at last, the operating modes and periods being dictated by the times it is in line of sight of Tokyo for commanding.

Partly thanks to the lack of use, brought about in the main by the lack of knowledge as to when it is on, the satellite exhibits a

highly sensitive receiver, non-attenuated by many strong signals. Many QSOs result between users of the RS satellites and FO-12 users, each not realising that the respondent is in fact listening to a different spacecraft. It also picks up signals emanating from the downlink of OSCAR-10, producing clear although relatively weak signals on the FO-12 downlink. On Thursday November 26, OSCAR-10 and FO-12 were in line of sight to each other, and although weak, perfectly readable signals originating from 18CVS were heard as i.s.b. via FO-12, having resulted from a QSO on u.s.b. he was having with I2EF and IOLYL on AO-10.

On the same day at 2136, G4CUO made a QSO with WA3ETD, ably assisted by John's XYL N1DYL, transmitting 435.060MHz i.s.b. to AO-10, which downlinked on 145.940MHz as u.s.b. to FO-12, which re-transmitted the signal back as i.s.b. on 435.860MHz, giving a readable signal at both ends of the contact. OSCAR-10 was at MA 35 at the time, fairly close to perigee. The next step planned by David G4CUO, following much pathfinding, is to find a time when AO-10 is in sight of FO-12, and FO-12 is in sight of RS-11, so that a triple trans-satellite test can be performed.

Fuji-Oscar-12 is found to be exhibiting marked circular polarisation changes as it performs a pass. Here in the UK, on approach from the west, "JA" mode shows considerable enhancement of signal using left-hand circular polarisation. When it recedes to the east, right-hand circular is much to be preferred. On Mode

"JD" the situation is reversed, as opposite polarisation is transmitted. This tells us that the satellite is "flat-on" to earth, and that we are seeing the top-side of the spacecraft on approach, and the bottom as it goes away from us, as dictated by the on-board stabilising magnets within earth's field. When at a high angle at the time of closest approach, little difference can be seen.

## RS-10 & 11

All systems are go on the new RS-10/11 system, with the ROBOT, Transponder(s), Telemetry and Codestore all performing well. The codestore messages are providing regular equatorial crossing data, and news of contests, activity periods and results, though mainly in the Russian language. It would appear that the COSMOS 1861 Navsat is on stand-by, as regular Mode "KA" (21 + 145MHz to 29MHz) transponding has been running now for many weeks alternating between RS-10 and 11.

A very new and desirable feature has been incorporated in the transponders that explains the enormous dynamic range of the systems. Apparently the bandpass can be sectionalised into individually ground command computer controlled 4kHz segments, each with their own a.l.c. level. This can be changed by command to 24 or 16kHz bandpasses, 6 or 4 sections of 4kHz according to level and requirement.

With the rapid improvement of the 21MHz band, many stations using the 15m uplink section for terrestrial s.s.b. QSOs can be heard at enormous strength on the 29MHz downlink. Whilst this is very interesting propogationally speaking, it can be a problem finding a clear frequency for more than a few minutes at a time. The ten metre band is now coming to life, and should be demonstrating similar downlink sub-horizon DX to that of the 15m uplink as the solar-flux improves.

Further sources of QRM are resulting in blocking the ROBOT, they being QSOs on the uplink frequency, the presence of OSCAR-9 and 11 using 145.825, but mainly the fact that despite the IARU agreement of over ten years ago, f.m. repeaters persist in using 145.825MHz in the space-band, it once being R-9 before the agreement. Even simplex v.h.f. f.m. QSOs are often evident on the downlink, due to indiscriminate use of the 145.800—146.000MHz reserved for the amateur satellite service.

The recent threat of Mexico to use the 435MHz space band for land-mobile has been averted by prompt action of AMSAT through the IARU, but now the JARL are considering allowing 10kHz channel spaced f.m. simplex from their 727 000 radio amateurs (30 per cent of whom are in Tokyo) in the band, a suggestion that is provoking much protest among the international community of satellite users. In the UK, the Syledis system is an existing constant source of QRM, and there are now rumours that Fylingdales will be moving up in frequency to our band!

## OSCAR-9 & 11

The UoSAT pair continued with regular transmissions providing WOD surveys on various channels of interest (mainly the Channel 3 radiation data), DIGITALKER, and CCCD attempts to obtain good pictures. A new diary, for the first time in a new 4th language was loaded in November, but despite the fact that all worked

perfectly on ground tests, problems possibly due to multipathing in the increased ionised layers arose, with the result that many readers were unable to obtain the bulletins. **Walter Unsworth G1LKY** of Lincoln was one so afflicted, getting just a line of "6s" instead of the needed information. Walter, after checking his Spectrum and G4HLX programme, rang G3IOR then **Jeff Ward G0/K8KA** at the University of Surrey command centre, who explained the situation, adding that with the existing inoperable software installed, it was impossible to load the bulletins, or indeed new software to bring about the change required. As the UoS have found a way out of impossible problems many times before now, we hope that all is functional by the time you read this information!

## AMSAT-UK Colloquium 1988

The date set for the next event at the University of Surrey is set for the 29—31 July 1988. As it was very heavily booked last year, visitors are recommended to book early with G3AAJ rather than risk disappointment. Papers on the event are called for, and should be supplied by 2 May 1988.

## Keplerian Elements

This set has been resolved from the NASA two line element set for us by **Birger Lindholm** of Dalsbruck, Finland. We have included precision equatorial crossing and nodal periods this time, as several readers have used the rounded up EQX's and to single decimal point add-on values, which can result in an incremental drift from the precise times. A number of readers have been dividing the Keplerian mean motion (number of orbits per day) into 1440 (the number of minutes per day) to give the period, but the result is the anomalistic period, which differs from the nodal period according to the satellite inclination. The anomalistic period is the elapsed time, in minutes, between each perigee of the satellite, whilst the nodal period is that time between two successive ascending nodes of the satellite, hence equator crossings. They are only alike if the inclination of the satellite is 63.4 degrees, the intended inclination for the comping Phase III-c, to maintain the perigee in the south and hence the apogee at that latitude north.

A further point is that as the earth appears to rotate 360 degrees per day (24 hours or 1440 minutes), a satellite with a two hour period (120 minutes) would have the earth rotate by 360/24 x 2 degrees, e.g. 30 degrees increment, it would at first seem feasible to merely divide the period in minutes by four to get the increment. Alas, this is not the case, as even if the earth did not rotate, we would still see a mid-night, dawn, mid-day and dusk back to mid-night annually as a "day" because the earth goes round the sun close to once a year. This gives us the difference of a Solar day, e.g. exactly 24 x 60 = 1440 minutes per day, the time it takes the earth to rotate about its axis slightly greater than 360 degrees with respect to fixed stars, and the Sidereal day, that amount of time that it takes for the earth to rotate exactly



A "Christmas card" scene of the G3IOR satellite antenna system for 144 and 430MHz, well detuned by snow

360 degrees with respect to fixed stars. A solar day is 1440 minutes, but a sidereal day is 1436.07 minutes. Thus, if one ratios the nodal period and the increment, it is rarely 4:1. The "RS" satellites have a ratio of some 3.953, are thus a little earlier each 'day' for the same equivalent crossing, whilst weather-satellites such as NOAA-10, dependant upon constant earth lighting angles, are almost exactly four.

Those using some satellite computer programs may find that with the coming of the new year their predictions may go astray. It is possible that the new sidereal time values, usually as lines stating "IF Y2 = '87' LET G2 = 0.2753606" may not automatically update in some of the older programs. Whilst this can be overcome by calling January 1 1988 December 32 1987, January 2 December 33, etc., it is better to update your program with the new values following:

1987—0.2753606  
1988—0.27469296  
1989—0.27676777

## UA/VE Polar Expedition

The joint Soviet-Canadian expedition is all set now to take off on February 7, with UA3CR currently signing UA3CR/VE8 where he is path and route planning. As planned, the UoSAT digitalker and DCE will be used for COSPAS/SARSAT positioning and QTCs, and the RS-10 & 11 satellite for transponded and codestore loaded messages. The COSMOS-1861 housed with RS-10/11 carries a COSPAS/SARSAT system, so it should serve well. Listeners to UoSAT and RS-10/11 should be able to follow progress of this all-amateur adventure first-hand.

## DIY SAT

If any affluent readers wish to have a try, the USSR Glavkosmos launch agency are offering "Get Away Special" type launches for small satellites at \$US 15 000 per kilogram as packages aboard or put out from MIR.

Your dates for  
the next three  
months are: Jan 27,  
March 2 & March 26

# S.E.M.

**Manufacturers and Suppliers  
of Communications Equipment**  
UNION MILLS, ISLE OF MAN  
Telephone: (0624) 851277

**S.E.M. QRM ELIMINATOR.** Unique design gets rid of any local interference. Connect in your aerial lead and removes QRM before it gets to your receiver (you can transmit through it). Any sort of interference, it can be nest to your rx (your computer) or several miles away, e.g. power lines. £69.50 ex stock.

**S.E.M. TRANZMATCH MKIII.** The only Aerial Matcher with UNBALANCED and TRUE BALANCED OUTPUTS. 1 Kw 1.8-20 MHz, £120. Built-in EZITUNE, £39.50. Built-in Dummy Load, £9.90. Ex stock.

**EZITUNE.** Allows you to TUNE UP on receive instead of transmit. FANTASTIC CONVENIENCE. Boxed unit, £45.00. P.C.B. and fitting instructions to fit in any ATU, £39.50.

**FREQUENCY CONVERTERS.** V.H.F. to H.F. gives you 118 to 146 MHz on your H.F. receiver, £49.50 ex stock. H.F. to V.H.F. gives you 100 KHz to 60 MHz on your V.H.F. scanner, £49.50 ex stock.

**TWO-METRE TRANSMATCH.** 1Kw, £32.00 ex stock.

**DUMMY LOAD.** 100 W. THROUGH/LOAD switch, £24.00 ex stock.

**VERY WIDE BAND PRE-AMPLIFIERS.** 3-500 MHz. Excellent performance. £32.00 or through when OFF, £37.00 ex stock.

**R.F. NOISE BRIDGE.** 1-170 MHz. Very useful. £45.00 ex stock.

**IAMBIC MORSE KEYS.** 8-50 w.p.m. auto squeeze keyer. Ex stock. Ours is the easiest to use. £45.00. First class twin paddle key, £20.00 ex stock.

**TWO-METRE LINEAR/PRE-AMP.** Sentinel 40: 14x power gain, e.g. 3 W - 40 W (ideal F290 and Handshields), £85.00. Sentinel 60: 6x power, e.g. 10 W in, 60 W out, £95.00. Sentinel 100: 10 W in, 100 W out, £135.00. All ex stock.

**H.F. ABSORPTION WAVEMETER.** 1.5-30 MHz, £39.50.

**MULTIFILTER.** The most versatile audio filter. BANDPASS H.P. L.P. and two notches. Frequency and Bandwidth 2.5 KHz-20 MHz, £75.00 ex stock.

**HIGH PASS FILTER/BRAID BREAKER.** Cures T.V.I., £7.50 ex stock.

**CO-AX SWITCH.** Three-way + earth position. D.C.-150 MHz, £25.00 ex stock.

**12 MONTHS COMPLETE GUARANTEE INCLUDING TRANSISTORS**

Prices include VAT and delivery. C.W.O. or phone your CREDITCARD NO. Ring or write for further data. Orders or information requests can be put on our Ansaphone at cheap rate times.

## COMMUNICATION CENTRE OF THE NORTH

The largest range of communications equipment available in the North. Full range of receivers, transceivers, antennas, power supplies, meters. Ali tubing - wall brackets - rotators - insulators.

We are the original amateur radio suppliers in the North West with 20 years experience in all types of equipment. Wide range of Base, Mobile, Antennas for all applications. Full range of equipment on display. Guaranteed after sales service. Official Kenwood stockist for North.

Also stockists for Tonna, Welz, G.Whips, Jaybeam, RSGB Publications, Diawa, Microwave Modules, Capco Antenna Tuners, Butternut Antennas, Cushcraft Antennas, MJF Accessories.

### RECEIVERS

Full range of receivers for all modes and frequencies.

KENWOOD R5000 General Coverage Receiver	£875.00
VC20 VHF Converter for R5000	£167.00
KENWOOD R2000 General Coverage Receiver	£595.00
VC10 VHF Converter for R2000	£161.00
JRC NRD 525 General Coverage Receiver	£1,195.00
CMK165 VHF/UHF Converter for NRD525	£391.35
HF125 General Coverage Receiver	£375.00
AR2002 Wide Band Scanning Receiver	£487.00
R535 VHF/UHF Airband Receiver	£249.00
R537S Hand Held Airband Receiver	£69.50
AT1000 SWL Antenna Tuner	£69.00

Please send SAE for full information and up-to-date prices as these fluctuate to change in sterling rates.

For the caller a wide range of Aluminium Tubing, Clamps, etc. at competitive prices, i.e. 12" x 2" Ali Tubing **£10.95.**

Full range of RSGB and ARRL publications in stock.

Part Exchanges welcome. Second hand lists daily.

Send S.A.E. for details of any equipment.

HP terms. Access/Barclaycard facilities.

Open 6 days a week. 24 Hour Mail Order Service.

Goods normally despatched by return of post.

Phone 0942-676790.

**STEPHENS JAMES LTD.**  
47 WARRINGTON ROAD, LEIGH, LANCs. WN7 3EA.

# GAREX ELECTRONICS

## WEATHER SATELLITE SYSTEM

This is the genuine MICROWAVE METEOSAT system, 24 hour geostationary (prediction charts not required).

Not to be confused with cheaper, computer add-on devices that normally utilise the VHF Satellites which are only usable for a few minutes at a time.

Our complete plug in and go package requires no computer, no software, and can be up and running, including dish alignment within 10 minutes.

Nothing more to buy: Dish, Microwave Receiver, Frame Store, 12" B/W Monitor AND ALL PLUGS & CABLES **£995.95**

Expandable to include VHF Satellites and colour. Designed by Timestep Electronics, now supplied by Garex.

## VHF SYSTEMS

VHF Active Antenna + 35mm cable **£74.75**

VHF 10 Channel Receiver **£155.25**

Colour Frame Store (suits VHF & Microwave) **£454.25**

SAE for full details and prices of other 'separates'

★★★★★ ★★★★★ ★★★★★ ★★★★★

## GAREX VHF RECEIVERS

The celebrated Timothy Edwards designs now owned & manufactured by GAREX.

☆ A simple but versatile design capable of covering spot frequencies in the range 25-200MHz.

☆ Excellent sensitivity (typically better than 0.4uV for 12dB SINAD).

☆ Double superhet (10.7MHz and 455kHz IFs).

☆ Choice of IF bandwidths from weather satellite to '12.5kHz' PMR standards.

☆ The basic receiver is single channel crystal controlled. Multichannel options.

☆ 2 watt audio output stage having a low quiescent current.

☆ Size: 153 x 33mm. Requires 10-14v DC supply.

### PRICES:

Stock Versions: (fully assembled, aligned & tested boards) 6m, 4m, 2m & Weather Sat. versions: **£49.95**

Complete cased versions & special options: details & prices on request. Crystals can be supplied if required; most popular 2 metre frequencies and the currently active Weather satellites are readily available. Crystal prices on request.

Mains power supply module: **£15.50**

## THE GAREX VHF PREAMPLIFIER

☆ Compact size: 34x9x15mm

☆ Up to 26dB gain

☆ Can be made for any frequency in the range 40-200MHz

☆ 3dB bandwidth ±3MHz (at 145MHz)

☆ Uses BF981 (0.7dB NF at 200MHz)

☆ Input & output impedance 50 ohms

☆ 1dB compression: +10dBm

☆ Saturated output: +15dBm

☆ Supply voltage 8-17v DC at 5-10mA

Stock Versions: (fully assembled, aligned & tested boards) 6m, 4m, 2m, & Weather Sat: **£11.45**

Other versions: prices & details on request.

## ☆ NEW ☆ HIGH PERFORMANCE 2 METER PRE-AMPLIFIER

☆ 3 band-pass stages for improved selectivity.

☆ 16dB gain with 1dB NF.

☆ RF switched (failsafe action); gas-filled relays assembled, tested PCB (boxed version on request) **£42.50**

## Main Distributors for REVCO ELECTRONICS LTD.

Ask for details of the latest REVCO "Whippet" and "Kwikfit" antennas and solderless co-axial adaptors (see PW June 87).

Prices include UK P&P and 15% VAT

Ask for details of our Interest Free Credit



## GAREX ELECTRONICS

HARROW HOUSE, AKEMAN STREET, TRING HP23 6AA

TEL: TRING (044282) 8580

and CHEDDINGTON (0296) 668684

Callers by appointment only

Although the sun, seen through cloud in Fig. 1, is 149 million kilometres away, its random activity has a marked and often sudden effect on the propagation of terrestrial radio waves. Periodically, dark patches, called sunspots, appear on the sun's disc. For over 50 years, communications engineers and short wave enthusiasts have known that eruptions from active areas around these spots are responsible for fade-outs and sometimes total blackouts on the h.f. bands and aurora, which has strange effects on propagation in the v.h.f. bands. Radio waves reflected from an auroral display are easy to identify because c.w. transmissions develop a low pitched rasp, described as tone-A and s.s.b. signals become a ghostly whisper.

One object of this column is to place the date and time of such events and associated happenings, on record for posterity. Therefore, the regular reports that I receive about auroral and magnetic disturbances from **Neil Clarke G0CAS** (Ferrybridge) and **Ron Livesey** (Edinburgh), about filaments, solar flares and radio noise from **Cmdr Henry Hatfield** (Sevenoaks), the numbers of sunspots observed by **Jim Knight's** group in Johannesburg, members of the London Solar Society, **Patrick Moore** (Selsey) and **Ted Waring** (Bristol) are most valuable.

This time, Henry, using his spectrohelioscope, observed 6 filaments on October 26, 9 on November 5 and 12 on November 21. "The groups on November 21, were large and probably contained more than 10 spots in each, but this observation was greatly hampered by cloud," said Henry. He also recorded radio noise from the sun, at 136MHz, on October 26 and 31 and November 2 and 22.

Neil tells me that the mean sunspot number for October was 61.1 compared to 33.5 in September and he enclosed his computer print out, Fig. 2, showing the variations in solar flux for the month and the peak of 119 s.f.u. on the 15th.

From Patrick's log, I selected his sunspot drawings for October 13 and 28 and November 16, Figs. 3a, b and c. Despite overcast skies, which limited the number of observations, Ted counted 8 spots on November 3 and 21 on the 20th.

"The magnetometer used by Karl Lewis (Saltash) indicated unsettled-to-storm conditions on days 14 and 15, storm from 1420 to 2145 on the 11th, after 1200 on the 13th, between 1700 and 2015 on the 21st, after midday on the 27th and up to 2145 on the 28th," wrote Ron Livesey in his October report. Ron is the auroral co-



Fig. 1

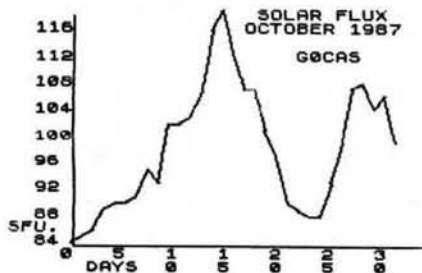

Fig. 2

ordinator for the British Astronomical Association. He tells me that aurorae, including arcs and active ray structures, were seen on the nights of 14/15, 17/18 and 22/23 by observers in north Scotland, 24/25 from Ulster and 27/28 from Ireland, Nova Scotia and Scotland.

**Dave Coggins** (Knutsford) noted that a number of broadcast stations between 7 and 15MHz took on an auroral tone around 2150 on the 20th. "They were weak and some had a ghostly whisper," said Dave.

## The 28MHz Band

November 9 was a "Red Letter Day" for **Jim Hicks G4XRU** (Worthing) because, at 1550 he heard a WD4 calling "CQ" on 29.6MHz f.m. While driving between Horsham and Worthing, at 1615, he had a RS59, both ways, QSO for 3 minutes before the band closed suddenly with a K6 in Florida. Jim, secretary of the Southern 10 Metre FM Group, used a converted CB rig, with a 50W p.a. feeding a 610mm helical antenna mounted on the rear of his car.

"During the last few weeks I have heard signals from CE, LU, OY, PY, S79, VO, VU, Ws 1, 2, 3, 4 and 5, ZC4, ZS, Z21, 5N and 9K," wrote **Dave Coggins** on November 17. **Greg Lovelock G3III** (Shipston-on-

Stour) has also noticed the band perking up and in Bransgore.

**John Levesley G0HJL**, using modified CB equipment and a loaded vertical antenna, received signals from CT, DL, EA, F, HA, I, LU, OK, SP, TR, UB, VU, YU, ZC4 and 4Z4 on October 23, worked UA6 and logged HAs on the 24th, received EA, UA and ZS on the 30th, SV and SV5 on November 7, SV5, UA and VK on the 8th, UA, VO and VK on the 9th and UA on the 20th.

## Propagation Beacons

One of the most important contributions that the amateur movement has made to scientific research is the installation of a world-wide chain of radio beacons. New readers may like to know that a beacon is strategically sited, by international agreement and provides a low-power signal on a fixed radio frequency. Periodically this signal, usually a tone, is interrupted with the beacon's idet and sometimes information about the site.

I learnt from the October issue of *Region 1 News*, that the beacons CT3B (Funchal), JA2IGY (Ise City), KH6O/B (Honolulu), LU4AA (Buenos Aires), OH2B (Espoo), W6WX/B (Standford), ZS6DN/B (Pretoria), 4U1UN/B (New York) and 4X4TU/B (Tel Aviv) which are operational on 14.100MHz are sponsored and supported by the Northern California DX Foundation.

**Dave Coggins** has been listening around the 24MHz band and reports hearing the Brazilian beacon, PY2AMI, on 24.900 MHz.

As usual my thanks are due to **Chris van den Berg** (The Hague), **Dave Coggins**, **Henry Hatfield**, **Don Hodgkinson G0E2L** (Hanworth), **Bill Kelly** (Belfast), **Greg Lovelock**, **Ted Owen** (Maldon), **Fred Pallant G3RNM** (Storrington) and **Ted Waring** for their consistent monitoring of the 28MHz beacon channels which enabled me to compile the monthly chart seen in Fig. 4.

**Chris** and **Fred** added **VE3TEN** (Ottawa—28.175MHz) to their scores on October 27 and November 9, 15, 16, and 25. The highlight for **Don** and **Ted** was hearing **VS6TEN** (Mt Matilda—28.290MHz) for the first time on November 13 and again on days 18, 20 and 23. It is possible that **Don** also heard **VU2BCN** (28.295MHz) at 1332 on the 14th. "It was not strong enough for me to positively identify," he said. **Ted** was pleased to add **VK4RTL** (Townsville—28.270MHz) on the 22nd, to his list

Fig. 3 (a, b & c)

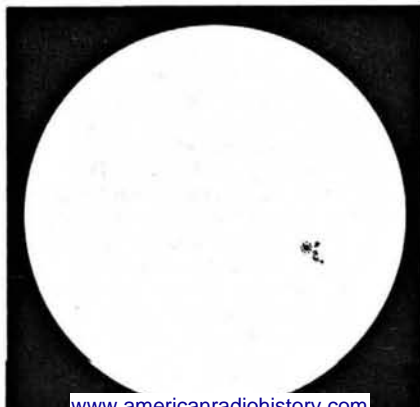

of first-timers. "The Bermuda beacon, VP9BA, was loud and clear on November 4," remarked Henry.

## Tropospheric

The atmospheric pressure indicated the right conditions, Fig. 5, which gave us the tropospheric-opening between November 4 and 8. While it was in progress, many continental operators were heard working through the 144MHz repeaters in the UK.

"I expect there are a few hoarse amateurs at the moment!" wrote Ian Davidson (Carmarthen) on the 7th. He heard stations from France, Germany, Guernsey, Northern Ireland and the West Midlands working through GB3WW, his local repeater in Dyfed.

Some of the signals that Bill Kelly heard through the repeaters in Appleby (GB3EV-R4), Buxton (HH-R4), Dover (KS-R1) Maidstone (KN-R4), Princetown (WD-R4), Reading (RD-R3), Stockport (MN-R2), St. Ives (SI-R1) and Waterford (EI3WRC-R2), between the 5th and 7th, came from stations in Belgium, France, Germany, Guernsey and Northern Ireland.

"144MHz was chock a block with signals from areas similar to v.h.f./u.h.f. TVDX booming in," wrote Simon Hamer from New Radnor.

## 934MHz

"During the evening of October 29, Ralph Rowlet GR-587 (Upper Caldecote) found lift conditions and worked stations in Birmingham and Leicestershire," wrote John Raleigh DW-04 from Bedford. John, secretary of The Four County 32cm Club told me that he contacted stations in Leeds, Lincoln and Nottingham on November 5, Kent, London and Sussex on the 6th and Essex on the 7th. "Many other stations were heard calling from all over southern England on the 6th," said John.

Also on the 6th, Ralph Rowlet, had contacts in Doncaster and Liverpool and Tony Collins WAC-01 (Bedford) exchanged words with operators in Gainsborough and Lincoln.

	October 87											November 87											WRM89L									
Beacon	26	27	28	29	30	31	1	2	3	4	5	6	7	8	9	10	11	12	13	14	15	16	17	18	19	20	21	22	23	24	25	
OFOABR																																
OKOTEN																																
OLIGI																																
E6RCH																																
LYAM																																
KO4EC																																
LULUS																																
PY2AM																																
PY2GB																																
VP9BA																																
V86TEN																																
ZS1LA																																
Z66PW																																
Z21ANR																																
AN3ZK																																
SBACY																																

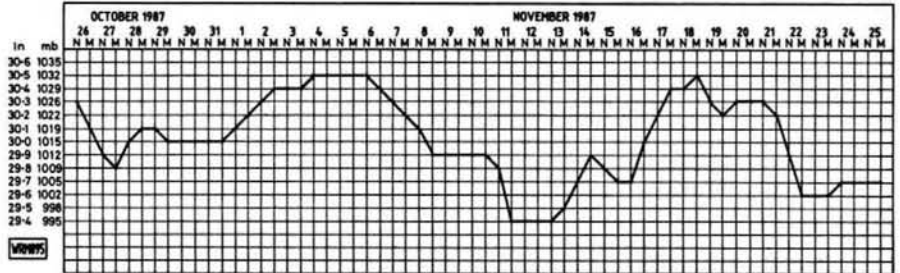

John Levesley UK-627, contacted a station in Jersey at 166km and heard signals ranging from Cornwall to East Sussex on the 5th and worked into Swansea (210km) at 2135 on the 6th and Coventry (160km) at 1503 on the 7th. Between 1940 and 2100 on the 7th, John operated from Stoney Cross in the New Forest and made 11 contacts with stations from Bath to Southend-on-Sea. On the 14th and 15th, he made local contacts while mobile or portable in south Yorkshire, his best being Leeds, around 64km.

Despite appalling weather conditions, nearly 190 members were on the air from 17 counties and 574 contacts were made during the contest, on October 18, organised by John Levesley, the contest manager and Dorset area representative for the 934MHz Club UK.

Our congratulations to the leading point scorers, UK-78, UK-1154 and UK-612 and UK-1243, UK-1132 and UK-310 in the home-base and mobile/portable single-operator sections, respectively. The longest home-base contact of 164km was achieved by UK-975, North Yorkshire and UK-1132 in Lincolnshire and 121 miles was chalked up in the portable section by UK-409, Mull of Galloway and UK-387 in Limavady.

**The next three deadlines are:**  
**January 27,**  
**March 2 & March 26**

# Broadcast Round-up

Peter Shore

With long winter nights there's little better than to closet oneself in front of a receiver and tune around the short wave bands to see what is happening here, there and everywhere. However, conditions at the beginning of December were not as good as they might have been, and reception from the west, particularly during the evening, was poor. Let us hope that reception improves as winter continues.

The mystery surrounding the Radio Beijing relays which I mentioned in last month's column appears to have been solved. You will recall that Radio Beijing had been noted between 0000 and 0300 on 9.77MHz in English and Chinese, and it was thought that the transmitter was located either in North America or in south-west Europe. It transpires that, after much research and scratching of heads, relays of Radio Beijing are now coming from the African country of Mali, where short wave transmitters near Bamako have been renovated by the People's Republic of China. Back in the early 1970s, these transmitters were used for an external service from Mali (the 1971 *WRTH* lists frequencies for this service as 15.145, 17.71 and 17.725MHz, all with 100kW power). Sat-

ellite equipment has been installed by the Chinese, and the service seems to have been inaugurated at the beginning of November. Further details of times and frequencies are in the News section.

Meanwhile, Radio Exterior de Espana is to be relayed over transmitters in the People's Republic in return for the use of the Noblejas transmitting site, south-east of Madrid. No date has yet been given for the commencement of these relays.

Where will it all end—will Radio Beijing's programmes be coming from BBC sites like Rampisham and Daventry before too long? Or will there be an agreement between Moscow and Beijing...?

Radio Australia is to be broadcast nationwide to Australia between midnight and dawn starting on Australia Day, 26 January 1988. No details of the frequencies for this service have yet been given.

The use of the 13MHz band by private short wave broadcasters has been approved by the Federal Communications Commission in the United States. WYFR already uses 13.695, and WHRI is using 13.76. This band provides excellent clear channels at the present, and the Soviet Union together with some other Eastern

Bloc countries, as well as Deutsche Welle are installed comfortably here. Radio Australia is also reported to hope to be able to use the new band "very soon" according to an item in the station's communication programme *Talkback*. I wonder when the BBC will grab a piece of the action.

Have you ever listened to *Six Continents* on BBC Radio—it's a review of what the world's radio stations have been saying, taken from programmes monitored by the BBC at their Caversham Park Monitoring Service. Now the Poles have a similar programme, called *The West Calling*, which opens with the interval signals of a number of Western broadcasters. The programme broadcasts a selection of recording taken off air from VoA, Radio Free Europe, the BBC and other radio stations in Polish. A new idea generated by glasnost, perhaps.

## Europe

NOTE: all times are UTC (GMT)

BRT Brussels is on the air in English:  
 0030-0055 on 5.91 and 9.925MHz  
 0800-0825 on 5.91 and 17.60MHz  
 1000-1025 on 15.51 and 17.61MHz  
 1330-1355 on 15.59 and 17.60MHz

1630-1655 on 15.51 and 17.61MHz  
1830-1855 on 9.86, 6.035 and  
1.512MHz  
2200-2225 on 5.91, 6.035 and  
1.512MHz

in French:

1030-1055 on 15.51 and 17.61MHz  
1400-1425 on 15.59 and 9.86MHz  
1730-1755 on 15.51, 17.61 and  
1.512MHz

2030-2055 on 6.035 and 1.512MHz  
2230-2255 on 5.91 and 9.925MHz

In Czechoslovakia, a relay of Moscow  
First domestic radio has begun on  
1.584MHz with 1kW from the roof of the  
Soviet Embassy in Prague. Radio Finland  
continues to have problems with its trans-  
mitters at the Pori site. However, when the  
station does manage to get on the air, its  
schedule is:

0530-0555 on 6.12, 9.605 and  
11.755MHz

0730-0755 on 6.12, 9.56,  
11.766MHz and 963kHz

1505-1530 on 11.85 and 15.185MHz  
1930-1955 on 6.12, 9.53,  
11.755MHz and 963kHz

2200-2225 on 6.12, 9.67MHz and  
963kHz

You can tune into Rome when RAI broad-  
casts in English:

0100-0120 on 9.575 and 11.80MHz  
0350-0410 on 9.71, 11.905 and  
15.33MHz

0425-0440 on 5.99 and 7.275MHz  
1935-1955 on 7.275, 7.29 and  
9.71MHz

2025-2045 on 7.235, 9.575 and  
11.80MHz

2200-2225 on 5.99, 9.71 and  
11.80MHz

in Italian:

0415-0425 on 5.99 and 7.275MHz  
0435-0510 on 9.71, 11.80 and  
15.33MHz

0830-0930 on 9.585, 11.81, 15.33,  
17.78 and 21.615MHz

1555-1635 on 5.99, 7.29 and  
9.575MHz

1700-1745 on 7.235, 9.71, 15.385,  
17.78 and 21.69MHz

1830-1905 on 15.245, 15.45 and  
17.78MHz

From Lithuania, Radio Vilnius has broad-  
casts to Europe in English at 2230 on  
6.10MHz and 666kHz medium wave. Lith-  
uanian can be heard on the same channel in  
the half-hour before at 2200.

Radio Moscow's hour for Great Britain  
and Ireland is currently heard at 2000 on  
5.905, 5.92, 5.935, 6.02, 6.03, 6.175,

7.115, 7.15 and 7.17MHz, although re-  
ception can sometimes be very poor.

## Middle East

Iran's domestic programming can be  
heard well in the United Kingdom on 6.22  
and 4.99MHz—try from 1500 and  
throughout the evening. Iraq's External  
Service to Europe can be heard with  
French at 1900, German at 2000 and  
English at 2100 on a new frequency of  
7.295MHz.

Israel Radio come back on the air late in  
November following a strike by journalists.  
The current English language schedule is:  
0000, 0100 and 0200 on 9.845, 9.435  
and 7.46MHz

0500 on 17.615, 11.655, 9.46, 9.435,  
9.385, 7.41 and 7.355MHz

1100 on 21.625, 17.635, 15.65,  
15.64, 15.485, 15.095 and 9.385MHz

and 1800 on 11.585, 9.925, 9.46 and  
9.385MHz

2000 and 2230 on 11.655, 9.845,  
9.435, 9.01, 7.46 and 7.355MHz

Easy Hebrew can be heard at 2300 on  
9.845, 9.435, 9.01 and 7.46MHz.

## Africa

The BBC World Service relay in Lesotho  
has changed frequency to 3.255, although  
day-time 6.19 continues. Radio Mozam-  
bique is heard in English at 1800 on 4.855.

Some rearrangement of South Africa's  
domestic frequencies has taken place—R  
Suid Afrika is now broadcasting on 7.23  
and 9.555MHz, whilst Radio Oranje has  
moved to 7.285. Radio 5 continues on  
9.665. Reports come from the United  
States that Radio Uganda has been heard  
in English on 15.435, but no time has been  
given. Other reports suggest that 15.325  
might be used.

## Asia

Radio Afghanistan moved some fre-  
quencies at the beginning of November:  
the European service with Dari and Pashto  
at 1730, German at 1830 and English at  
1900 are now heard on 6.02 and 4.76,  
with both transmissions thought to come  
from the USSR.

The schedule for Radio Beijing has be-  
come rather more complex in recent  
weeks with the additions of numerous  
relays in various parts of the world. How-  
ever, a summary of English and one or two  
other important languages appears to be:  
0000 in English, 0100 in Cantonese, 0200  
in Standard Chinese to North America on

11.715-M; 9.77-M and 9.665MHz

1600 in English to Africa on 15.13-M;  
11.715-M; 11.60; 9.57 and 5.25MHz.

1700 in English to Africa on 11.60, 9.57  
and 4.13MHz and 1900 in English to  
Europe on 11.50, 9.74 and 5.25MHz  
1930 in French to Africa on 11.79-M,  
9.88, 9.745-M; 7.80, 7.31, 7.185 and  
4.02MHz

2030 in English to Mid East and Africa on  
11.79-M; 11.515; 9.745-M, 9.44 and  
6.955MHz

2230 in English to Europe on 3.985-S  
2230 in Portuguese to Europe on 6.165-S  
The suffix "M" indicates that the trans-  
mitter is thought to be located in Mali, and  
"S" indicates that the transmitter is  
known to be in Switzerland. The 2230  
English service is heard well in the United  
Kingdom.

Voice of Free China programmes from  
Taiwan can be heard in English: 0200 and  
0300 on 15.345, 11.745, 11.74, 9.765,  
7.445, 5.985 and 5.945MHz

0700 on 5.985MHz

2200 and 15.37, 11.805, 9.955 and  
7.355MHz

## North and South America

The station which was mentioned in last  
month's column, KUSW in Salt Lake City,  
Utah, was due to go on the air on Decem-  
ber 7, using the frequencies given last  
month, with the exception of 0000-0300  
when 11.66 might be utilised in place of  
11.68. The station's address is: PO Box  
7040, Salt Lake City, Utah 84107, USA.

The Voice of America's *Worldwide  
Shortwave Spectrum* programme has been  
replaced by a new show *Communications  
World*. The new show, which will be  
produced and presented by Gene Reich,  
will form part of the weekend *Magazine  
Show* sequence, and is to be broadcast at  
1210 and 1710 (to Asia), at 2110 to  
Europe and to the Americas at 0110 on  
Sundays.

WCSN, the Christian Science Monitor  
from Boston, altered some frequencies  
recently and can now be found:

0000-0600 on 9.85MHz

0800-1000 on 7.365MHz

1000-1200 on 11.945MHz

1600-1800 on 15.28MHz

1800-2200 on 21.515MHz

2200-2400 on 9.495MHz

Radio Surinam International has a new  
frequency of 17.838 for its transmission  
at 1700 in Dutch, English and Sranan  
Tongo.

## SWAP SPOT

Have Icom IC-730 h.f. rig plus muTek TVVF 144a 144MHz  
transverter, 28MHz i.f. and 4CX250B 430MHz linear. Would  
exchange the lot for 8 track reel-to-reel recorder, Transcam-Fostex or  
similar. Conrad G6ZTU. Tel: (0226) 791196 D648

Have Uniden model 2030 144MHz mobile. 12 channels plus 7-  
element folded Yagi. Would exchange for h.f. general coverage  
receiver. Tel: (06462) 2825. D656

Have IC-202 144MHz s.s.b./c.w. rig. Would exchange for HW8,  
Micron or similar QRP rig. Tel: (0742) 421781. D652

Have KW2000A transceiver, recently overhauled by manufacturers.  
Demonstration with owners pleasure. Would exchange for ICF-  
7600D in good condition. GOA QI QTHR. Tel: 01-445 0528 (evening  
or weekends). D662

Have Realistic PRO-2009 8-channel scanner v.h.f./u.h.f. hardly used.  
Would exchange for any short wave receiver in good condition with  
good antenna. Mr. M. Mayer. Tel: 0203 373294. D665

Have CBM 64, datasette, joystick, business/games programs, Comm-  
in 64 board, ST5 t.u., IC-2E, IC-27E, all in very good condition.  
Would exchange for general coverage receiver (portable or base);  
430MHz module for FTV-901, 144MHz/430MHz dual bander, h/d  
rotator; h.f. beam or w.h.y? Mr J. Merson GM4MOA, 4 Low Street,  
Buckie, Banff AB5 1UX. D680

Have Pan-Crusader "X" 12-band digital communications receiver,  
m.w., l.w., 4 s.w., 5 v.h.f., u.h.f. Modes u.s.b., l.s.b., c.w. Would  
exchange for Sony ICF-2001D of w.h.y? Tel: 061 743 1570. D684

Have AR88D unmodified, perfect example of this receiver. Would  
exchange for SRX30 or FRG-7 or similar "lightweight", cash  
adjustment if required. Allan. Tel: 031-661 6085. D692

Have Yaesu FT-23R 144MHz transceiver, mint and still under  
guarantee. Charger, manual, mobile extras including antenna. Would  
exchange for h.f. digital receiver Trio, Yaesu, Sony ICF-2001D, ICF-  
7600DS, or Grundig Satellit, Panasonic, with s.s.b. w.h.y? Cash  
adjustments. G4VLB. Tel: 061-480 1549. D693

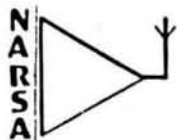

# BELLE VUE / NORBRECK RADIO AND ELECTRONICS EXHIBITION

by the Northern Amateur Radio Societies Association

at the

**NORBRECK CASTLE HOTEL EXHIBITION CENTRE  
QUEENS PROMENADE, NORTH SHORE, BLACKPOOL**  
(Formerly held at Belle Vue, Manchester)

on **Sunday, January 31st, 1988**

Doors open at 11 am

The North's Premier Amateur Radio & Electronics Event

- ★ Inter-Club Quiz
- ★ Bring & Buy Stall
- ★ R.S.G.B. Book Stall
- ★ R.S.G.B. Morse Tests (Book direct via R.S.G.B.)
- ★ Overnight Accommodation at reduced rates (contact hotel directly)
- ★ Grand Raffle
- ★ Amateur Computer Stands
- ★ Club Stands
- ★ Restaurant & Bar
- ★ Free car parking
- ★ Attractions for Ladies

★ ALL THE USUAL "BELLE VUE" TRADERS ★

**RADIO TALK-IN ON S22 and SU8**

ADMISSION £1 (OAP's 50p, under 14's free) BY RAFFLE TICKET AND EXHIBITION PLAN

Business Manager: Peter Denton G6CGF 051-630-5790

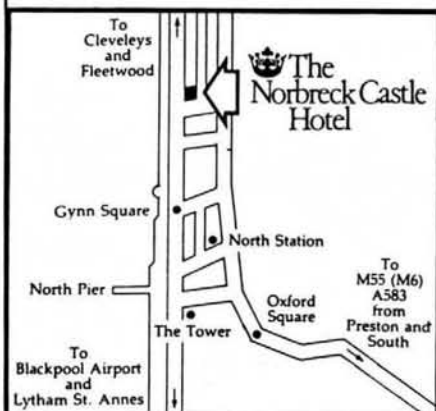

## ICOM (UK) LTD/RETAIL.

Everything you need for your shack is available from Icom UK's retail shop. Andy G6MRI is on hand with new and secondhand stock from ICOM plus Yaesu, Kenwood, MET, Tono, Jaybeam, Welz, Drae, BNOS and many more. RSGB publications also available, if Andy can't help, you've got a problem. Why not call in, we are on the corner of Stanley Road and Kings Road, Herne Bay, Kent and open 9 - 5.30 mon-sat, lunch is 1-2.15, 1/2-day closing thursday afternoons open 9-1.00. BCNU.

Credit facilities available, plus VISA & ACCESS accepted.



## ICOM (UK) LIMITED.

2 Stanley Road, Herne Bay, Kent CT6 6SH. Tel: 0227 369464.



## SPECIAL NOTICE TO READERS

Although the proprietors and staff of *PRACTICAL WIRELESS* take reasonable precautions to protect the interests of readers by ensuring as far as practicable that advertisements in *PRACTICAL WIRELESS* are bona fide, the magazine and its Publishers cannot give any undertakings in respect of claims made by advertisers, whether these advertisements are printed as part of the magazine, or are in the form of inserts.

While the Publishers will give whatever assistance they can to readers having complaints, under no circumstances will the magazine accept liability for non-receipt of goods ordered, or for late delivery, or for faults in manufacture. Legal remedies are available in respect of some of these circumstances, and readers who have complaints should address them to the advertiser or should consult a local Tradings Standards Office, or a Citizen's Advice Bureau, or their own solicitor.

## MAKE YOUR INTERESTS PAY!

More than 8 million students throughout the world have found it worth their while! An ICS home-study course can help you get a better job, make more money and have more fun out of life! ICS has over 90 years experience in home-study courses and is the largest correspondence school in the world. You learn at your own pace, when and where you want under the guidance of expert 'personal' tutors. Find out how we can help YOU. Post or phone today for your FREE INFORMATION PACK on the course of your choice. (Tick one box only!)

Electronics <input type="checkbox"/>	Radio, Audio and TV Servicing <input type="checkbox"/>
Basic Electronic Engineering (City & Guilds) <input type="checkbox"/>	Radio Amateur Licence Exam (City & Guilds) <input type="checkbox"/>
Electrical Engineering <input type="checkbox"/>	Car Mechanics <input type="checkbox"/>
Electrical Contracting/Installation <input type="checkbox"/>	Computer Programming <input type="checkbox"/>
GCE over 40 'O' and 'A' level subjects <input type="checkbox"/>	

**ICS** Name \_\_\_\_\_ P. Code \_\_\_\_\_  
Address \_\_\_\_\_  
International Correspondence Schools Dept EES 28, 312/314 High St., Sutton, Surrey SM1 1PR. Tel: 01-643 9568 or 041-221 2926 (24hrs).





# TELECOMMUNICATIONS ENGINEERS

**Thameswey** – one of the fastest growing operating districts within British Telecom, is looking for Telecommunications Engineers in Reading, Basingstoke, Aldershot, Guildford, Slough, Bracknell and surrounding areas.

We are looking for people who, ideally, have electronic/electrical experience or who have an academic background, preferably in maths and science subjects. There are also vacancies for people without qualifications who can demonstrate a practical aptitude as training will be provided.

You must be at least 18 years of age, in good health and hold a current driving licence.

Starting salary will range from £5,649-£8,806 depending on age and experience. We offer the first class benefits of a large progressive company, including excellent training, a good pension scheme and every opportunity for advancement.

To apply, just complete the coupon and return it to:

**The Engineering Recruitment Manager,  
British Telecom DP112,  
Thameswey District,  
49 Friar Street,  
Reading RG1 1BA.**

Name \_\_\_\_\_  
Tel No: Day \_\_\_\_\_ Evening \_\_\_\_\_  
Address \_\_\_\_\_

Date of birth \_\_\_\_\_  
Type of Driving Licence: HGV/CAR/NONE\*  
Currently Employed. Yes/No\*  
When could you start work \_\_\_\_\_  
\*Delete which is not applicable  
Qualifications: (GCE; City & Guilds; BTEC; HNC etc)

Job History (last 4 jobs)  
From: To: Employer: Type of Work: Reason for Leaving:

Please state why you wish to be considered for a Technician Post:

British Telecommunication plc is an Equal Opportunities Employer. Applications are welcome from Male and Female applicants.

**British TELECOM**  
It's you we answer to

## For Sale

USED AMATEUR EQUIPMENT bought, sold, exchanged, SAE for latest list. Secondhand price guide updated monthly. Useful guide for buying/selling. £2. ATU mods add top band to SEM KW, etc £6.50. Call MARTYN G4SUI-GEEFOR ENTERPRISES, 112 Leeds Road, Mirfield, West Yorks. WF14 0JE. Tel: 0924 495916. Personal callers by arrangement.

TRIO TS430S, with FM, all filters, car bracket, £760. Tel. Port Talbot 882708.

RARE BITS FOR YAESU at bargain prices. CW filters FT707, 902, 1012Z 107 600Hz £29.99p.p. 300Hz £35p.p. – FT101B/E CW 350Hz or 250Hz £39.99p.p. – original JAP. NEC 12BY7A £13p.p., 6JS6C NEC £38 pair p.p., 6146B G.E. £27p.p. – DBM for quieter RX FT101 Mk1/E £17p.p. – (Breaking for spares FT401 & FT200 S.A.E. All enquiries NO Callers). Mains transformers for FT101ZD £75p.p. – Epicyclic drives FT401/101 2 for £8p.p. Arriving soon? FM Boards FT101ZD – Phone or S.A.E. – FT726 6M units £29 Cash/Cheque – MD1B8 Mic £69p.p. – NC18C Chargers £10.50p.p. – FT101 Mk1/B Clipper £46p.p. D.I.Y. Kit £29p.p. ALSO Fabulous Black Star 600MHz counters £140 Cash p.p. HOLDINGS/AMATEUR ELECTRONICS LTD (G3LLL), 45 Johnston Street, Blackburn BB2 1EF. Tel. (0254) 59595.

## Miscellaneous

QSL CARDS New 1988 Impact Designs. Single and multi-colours, personal designs and with American style raised print. For the best value around send s.a.e. to: CONTACT CARDS, 11 Winchcombe Road, Bispham, Blackpool FY5 3HJ.

QSL CARDS. Gloss or tinted cards. SAE for samples to: TWROG PRESS, Dept PW, Penybont, Gellilydan, Blaenau Ffestiniog.

## Q.S.L. Cards

FILTERS FOR TX'S AND RX'S HF 6m 2m VHF UHF. High Harmonic rejection. Rejection filters for those living near broadcasting stations. Also attenuators, connectors, rf leads and other accessories. SAE details. WAVEBAND ELECTRONICS, c/o PW Box 19.

WAVEGUIDE, FLANGES & DISHES. All standard sizes & alloys (new material only) from stock. Special sizes to order. Call: EARTH STATION 01-228 7876. 22 Howie Street, London SW11 4AR.

**QZV LOOP ANTENNAS COMPLETE WITH ATU FOR HIGH FREQUENCY HAM BAND TRANSMISSION (SWR One to One 40, 15 and 10 and One Point Five to One 80 and 30 AND SWR's, AND LONG AND MEDIUM WAVE BANDS FOR BCL's Loops 21 inches square or triangle. D.I.Y. projects. No special skills required. Circuits, Parts Lists with sources of supply and full assembly data. HIGH FREQUENCY LOOP 80 to 10 Metres £3. LONG AND MEDIUM WAVE LOOP FOR BCL's £3. LONG WAVE MEDIUM WAVE AND SHORT WAVE LOOP 1500 to 10 Metres FOR THE BCL AND SWL £3. SHORT WAVE ATU FOR USE WITH EITHER A LOOP OR LONG WIRE ANTENNA £4.  
SAE for details. Callers welcome any day any time.  
F. G. Rylands, 39 Parkside Avenue, Millbrook, Southampton  
Tel. (0703) 775064**

HEATHKIT U.K. Spares and Service Centre. CEDAR ELECTRONICS, Unit 12, Station Drive, Bredon, Tewkesbury, Glos. Tel. (0684) 73127.

**MORSE CODE PREPARATION**  
Cassette A: 1-12 wpm for amateur.  
Cassette B: 12-25 wpm for professional examination preparation.  
Each cassette is type C90.  
Price of each cassette (including booklets) £4.95  
Morse key with separate battery (PP3) – driven solid-state oscillator and sound transducer produces clear tone for sending practice. Price of key with electronic unit £9.58.  
Price includes postage etc. Europe only.  
**MH ELECTRONICS (Dept PW)**  
12 Longshore Way, Milton, Portsmouth PO4 8LS

MAKE YOUR OWN PCBs the easy way – TEC-200 – used extensively in USA and Europe – now available in UK. Single sheet (A4) – 80p; 5 sheets – £3.90; 10 sheets – £7.60. Phone PDQ ASSOCIATES, (0452) 42336, for details.

**PRINTER CARTRIDGES**  
Your used Printer cartridges can be re-inked 10/20 times if the Nylon/Linen ribbon is in good condition. Plastic Film Ribbons are not suitable for re-inking. Cost is £1.50 per cartridge, including postage UK. Foreign enquiries postage extra.  
**CASUAL ELECTRICS (0535) 663203**  
178, Long Lee Lane, Keighley, W. Yorks BD21 4TT

**TO FILL THIS SPACE  
PHONE KATHY ON  
0202 678558**

**★ BAKER ★**

**GROUP P.A. DISCO AMPLIFIERS** post £4

150 watt Output, 4 input Mixer pre-amp. Illustrated £39  
150 watt Output, Slave 500 wv. Input. Mono £80, Stereo £155  
500 watt Heavy duty mono slave amplifier £275  
150 watt P.A. Vocal, 8 inputs. High/Low Mixer Echo Socket £170  
60 watt Mobile 240v AC and 12v DC. 4-8-16 ohm + 100v line £89  
Compact PA amp 20 + 20 Stereo or 40 watts Mono £55  
30 watt Guitar/PA Amplifier, 2 inputs, Treble, Bass etc. £59  
30 Watt Guitar COMBI, 12in. Speaker, Treble, Bass etc. £95

**FAMOUS LOUDSPEAKERS FULLY GUARANTEED**

Make	Model	Size	Watts	Ohms	Price	Post
GOODMANS	HE WOODER	8in.	80	8	£16	£2
BAKER	DISCO/GROUP	10in.	50	8/16	£22	£2
BAKER	MID-RANGE	10in.	100	8	£30	£2
BAKER	DISCO/GROUP	12in.	75	4/8/16	£24	£2
BAKER	DISCO/GROUP	12in.	120	8/16	£34	£2
GOODMANS	DISCO/GROUP	12in.	120	8/15	£30	£2

**LOUDSPEAKERS REPLACEMENT TYPE STATE IMP REQUIRED.**  
2in. 3in. 5in. 6x4in. 7x4in. £2.50. 8x2in. 8x5in. £4 P&P 75p.  
8in. £5. 10in. £7.50 PP £1. Many others in stock.

**MAINS TRANSFORMERS** All 240V Primary Price Post  
250-0-250V 80mA. 6.3V 3A. 0, 5, 6V 2A. £10.00 £2  
350-0-350V 250mA. 6.3V 6A CT. £16.00 £2  
220V 250mA. 6V 1 Amp £3.00. 220V 45mA. 6V 2 Amps. £4.00 £1  
Auto Wound 120V/240V. 150W £10. 250W £12. 500W £18. Post £2  
**LOW VOLTAGE TRANSFORMERS** £5.50 each post paid  
9V, 3A; 12V, 3A; 16V, 2A; 20V, 1A; 30V, 1 1/2A; 2A; 35V, 2A; 20-40-60V, 1A; 12-0-12V, 2A; 20-0-20V, 1A.

**VARIABLE POWER SUPPLY** 0 to 12 volts up to 400 M.A. D.C. Ready made on P.C. board. Size 5x2 1/2x2in. £8.50 P.P. £1.

\* NEW + NEW + NEW + NEW + NEW + NEW + NEW + NEW + NEW + R.C.S. VARIABLE VOLTAGE D.C. BENCH POWER SUPPLY 0 to 20 volts up to 1.5 amps D.C. fully stabilised. Compact unit size 9x5 1/2x3 inches. Twin panel meters for instant voltage and current readings. Overload protection. Fully variable operates from 240V A.C. £36. P.P. £2.

**PANEL METERS** 50µA, 100µA, 500µA, 1mA, 5mA, 100mA, 500mA, 1 amp, 2 amp, 5 amp, 25 volt, VU 2 1/4x2 1/4in. £5.50 post 50p

**MINI MULTI TESTER** Volts AC-DC, ohms, milliamps £8.50

**DELUXE RANGE DOUBLER METER** 50K 0.P.V. £25.00 PP £1  
Ohms to 20meg. AC/DC volts to 1000V. Amps 50µA to 10A.

**PROJECT CASES: Black Vinyl Covered Steel Top, All Base**  
4 x 2 1/2 x 2 1/4in. £3.00; 6 x 4 x 1 1/2in. £4.00; 8 x 5 x 2in. £4.50;  
11 x 6 x 3in. £6.00; 11 1/4 x 6 x 5in. £10.00; 15 x 8 x 4in. £13.50.  
**ALUMINIUM PANELS** 18 s.w.g. 12 x 12in. £2.50; 14 x 9in. £2.40;  
6 x 4in. 65p; 12 x 8in. £1.50; 10 x 7in. £1.50; 16 x 6in. £1.00;  
14 x 3in. £1; 12 x 5in. £1.15; 16 x 10in. £2.70; 16 x 6in. £1.90.  
**ALUMINIUM BOXES: PLEASE ADD EXTRA POSTAGE.**  
4 x 2 1/2 x 2in. £1.35; 3 x 2 x 1in. £1.15; 6 x 4 x 2in. £2.20; 8 x 6 x 3  
£3.40; 12 x 5 x 3in. £4.00; 6 x 4 x 3in. £2.50; 10 x 7 x 3in. £4.00.  
**HIGH & LOW VOLTAGE ELECTROLYTICS** Many others in stock.  
20/500V 75p 470MF 400V £3 20+20/350V 75p  
32/350V 50p 680MF 350V £3 32+32/500V £2.35  
47/350V 75p 2200MF 400V £3 32+32/500V 85p  
220/400V £2 8+8MF 450V £1 80+40+20/350V 95p  
470MF 63V 40p. 1000MF 40V 50p. 100V £1.20. 1200MF 76V £1.  
1500MF 63V 80p. 100V £1.20. 2000MF 63V £1.50. 100V £1.80.  
2500MF 50V 70p. 3300MF 63V £2. 4700MF 63V £3.  
6800MF 100V £5.50. 30,000MF 25V £2.50.  
**AIR-SPACED GEARED TWIN GANGS** 365 + 365 + 25 + 25p £2.00.  
VERNER DIALS: 0-100. 36mm. £3.00. 50mm. £3.50.  
**MORSE CODE TAPPER & BUZZER** Practice Set £3.00.  
**RESISTORS, CAPS, DIODES, TRANSISTORS 1000s IN STOCK**

**RADIO COMPONENT SPECIALISTS**

337 WHITEHORSE ROAD, CROYDON  
SURREY, U.K. Tel: 01-884 1665  
Post 6p Minimum. Callers Welcome.  
List, Large S.A.E. Delivery 7 days Closed Wednesday

# YOUR LOCAL DEALERS

**STOKE ON TRENT**  
**MRZ COMMUNICATIONS LTD**  
 ICOM - Amateur/PMR/Marine/Air.  
 YAESU - Amateur MRZ Desk PSU  
 for ICOM/YAESU Portables.  
 UK and EXPORT  
 Tel: (0782) 619658

**IRELAND**  
**Radcom Electronics**  
 Icom, Yaesu and most Amateur  
 Radio Accessories ex stock.  
**NEW PREMISES:-**  
**Unit 4, Albert Quay,**  
**Cork City.**  
**Tel: 021-632725 and**  
**088 553947**  
 (Mon-Fri 9-5 and Sat 9-3.45)

**LONDON**  
**Henry's**  
 27MHz/934MHz Rigs &  
 accessories in stock.  
 Lists - S.A.E. (A4) - 26p  
 Full catalogue (TG/P) -  
 large S.A.E. £1.00  
**404 Edgware Road,**  
**London W2 1ED**  
 Tel: 01-724 0323  
 (Open 6 days a week)

**ESSEX**  
**Selectronic**  
 The UK's leading suppliers of  
 934MHz personal radio  
 equipment  
**203 High Street, Canvey**  
**Island, Essex**  
**Tel: 0268 691481**  
 (Open Mon-Sat 9-5.30)  
 Amateur radio equipment also in stock

**HERNE BAY**  
**ICOM (UK) LIMITED**  
 The Official Icom importer  
**2 Stanley Road**  
**Herne Bay, Kent**  
**CT6 5SH**  
**Tel: 0227 369464**  
 (Open Mon-Sat 9-5.30,  
 except Thurs 9-1)

**SOUTHAMPTON**  
**South Midlands Communications**  
 Official Yaesu Importer  
**S.M. House, School Close,**  
**Chandlers Ford Industrial Estate,**  
**Eastleigh Hants SO5 3BY.**  
**Tel: 0703 255111**

**PORTSMOUTH**  
**Telecomms**  
 Importers of the Nevada  
 range of 934MHz equipment  
**189, London Road,**  
**North End, Portsmouth,**  
**Hants, PO2 9AE**  
**Tel: 0705 662145**

**DEVON**  
**Reg. Ward & Co. Ltd.**  
 The South-West's largest amateur  
 radio stockist. Approved dealer for  
 Kenwood, Yaesu and Icom  
**1 Western Parade,**  
**West Street, Axminster,**  
**Devon, EX13 5NY**  
**Tel: 0297 34918**  
 (Closed 1:00-2:00 and all day Monday)

**BUCKINGHAMSHIRE**  
**Photo-Acoustics Ltd.**  
 Approved Kenwood, Yaesu and  
 Icom dealer (part exchange  
 always welcome)  
**58 High Street, Newport Pagnell,**  
**Buckinghamshire MK16 8AQ**  
**Tel: 0908 610625**  
 (Tues-Fri 9:30-5:30, Sat 9:30-4:30)  
 Closed Mondays

**LONDON**  
**D & D ELECTRONICS**  
**(Kennington)**  
*The sort of shop you used to see in*  
*Lisle St. All sorts of surplus supplies,*  
*so come along and browse or send*  
*SAE for info. sheets.*  
**3a Braganza Street**  
**London SE17 3RD**  
**Tel: 01-793 0054**  
 (Open 6 days a week)

**LONDON**  
**AMCOMM OF LONDON**  
 Approved dealer for Yaesu  
 and Icom  
**373 Uxbridge Road,**  
**London W3 9RN**  
**Tel: 01-992 5765**  
 (Mail order a speciality)

**DERBYSHIRE**  
**Low Electronics**  
 The official importer of the  
 Kenwood range of equipment  
 (See main ad. for the full list  
 of all our shops)  
**Chesterfield Road, Matlock,**  
**Derbyshire, DE4 5LE**  
**Tel: 0629 2817/2430/4057**

**MERSEYSIDE**  
**MGR SERVICES**  
 Wirral based communications  
 ICOM - YAESU - M. MODULES - HOWES  
 - CIRKIT - WOOD & DOUGLAS -  
 PART-EX - AERIALS - PMR - MARINE -  
 MET ANTENNAS - ALINCO -  
 HEATHERLITE - SPECTRUM COMMS  
**48, Shrewsbury Road,**  
**Orton, Birkenhead, L43 2HZ.**  
**Tel: 051 653 3437**  
 (Callers by appointment 9 am-9 pm, Mon-Sat)

**PLEASE MENTION  
 PRACTICAL WIRELESS  
 WHEN REPLYING TO ADVERTISEMENTS**

**WEST SUSSEX**  

**BREDHURST ELECTRONICS LTD.**  
**High St., Handcross,**  
**West Sussex**  
**Tel: (0444) 400786**  
 Situated at the Southern end of M23. Easy  
 access to M25 and South London.  
 Open Mon-Fri 9am-5pm except Wed 9am-  
 12.30pm. Sat 10am-4pm.  
 MAIL ORDER  RETAIL

## INDEX TO ADVERTISERS

Aerial Techniques .....	59	J. & M. Amateur Radio .....	41
A.H. Supplies .....	13	J. & P. Electronics .....	70
A.K.D. ....	59	Lake Electronics .....	10
A.R.E. Communications .....	13	Low Electronics .....	2, 3, 51
Birkett, J .....	13	Maplin .....	Cover 4
Bredhurst .....	34	Mauritron .....	70
British Telecom .....	71	MH Electronics .....	71
Cambridge Kits .....	59	N.A.R.S.A. ....	69
Casual Electrics .....	71	Radio Component Specialists .....	71
Cirkit .....	12	Radio Shack Ltd .....	27
Colomor Electronics .....	59	Random Electronics .....	13
Component Centre .....	70	R.A.S. Nottingham .....	12
C.P.L. Electronics .....	11	RST Valve .....	11
Cricklewood Electronics .....	12	Rylands, F.G. ....	71
Dataman .....	70	Scientific & Engineering Software .....	70
Datong Electronics .....	41	S.E.M. ....	65
Dewsbury Electronics .....	11	Short Wave Magazine .....	51
Elliott Electronics .....	10	South Midlands Communications Ltd .....	Cover 2, 8, 9, 10
E.R.A. ....	34	Spectrum Communications .....	10
FJP Kits .....	70	Stephens James .....	65
Garex Electronics .....	65	Tandy .....	21
Golledge Electronics .....	70	Technical Info Services .....	70
Howes C.M. Communications .....	41	Technical Software .....	12
ICOM(UK) Ltd .....	4, 5, 6, 7, 69	Ward, Reg & Co Ltd .....	51
ICS Intertext .....	69	Waters & Stanton .....	25
		Withers, R. Communications Ltd .....	Cover 3

**BASE STATIONS**

**Good News for FT767 owners. Kenwood owners take note!**  
**IMPROVED YAESU FT767 RWC/MK2 HF-UHF BASE STATION**

We are pleased to announce that we have now improved the synthesizer (see reviews) leading to better dynamic range by up to 20dB which now puts this transceiver in a class of its own! This modification is only available from RWC and is fitted FREE to all New units sold by us, or we will modify any existing unit for £59.50 inc. return carriage. Available at some Yeasu dealers.  
FT767 RWC MK2 COMPLETE TOP CLASS BASE STATION (EX. VHF-UHF) £1499.00  
FT767 RWC MK2 COMPLETE TOP CLASS BASE STATION (EX. VHF-UHF) WITH 2M FITTED £1599.00  
FT757 MK2 NEW IMPROVED HF TRANSCEIVER £295.00  
FT726R MULTIMODE BASE STATION WITH 2MTRS. (SPECIAL PRICE) £699.00  
ICOM IC735 SUPER MINI HF ALL BAND TRANSCEIVER £892.50  
ICOM IC275E 2MTR 25W BASE STATION, CW AC PSU £949.00  
NEW ICOM IC575 6M 10W BASE STATION, 26-56 MHZ RECEIVER TX10 AND 6M £949.00  
Many more Makes and Models in stock. Please enquire.



ICOM IC735

FT67GX RWC MK2



**NEW**

**HANDHELDS**

\* = Extended RX coverage available, call for details.  
YAESU FT727R 2.5W (5W) DUAL BANDER CW CH-RGR £395.00  
\*YAESU FT23RFNB10 2.5W (5W) 2MTRS CW CH-RGR £249.00  
\*YAESU FT73RFNB10 2.5W (5W) 70CM CH-RGR £259.00  
ICOM IC002E QUALITY 2.5W (5W) BP3 CW CH-RGR £225.00  
\*ICOM MICRO 2E MINI 2.5W 2MTR CW CH-RGR £209.00  
CTE1600 (VY SIM. IC2E) 2.5W 2MTR CW CH-RGR £189.00  
KENPRO KT400EE 2.5W 70CM CW CH-RGR £195.00  
\*KENPRO KT220EE 2.5W (5W) 2MTR LCD CW CH-RGR £199.00  
KENWOOD/TRIO TH21E 2W 2MTRS. (WHILE STOCKS LAST) £139.00

**PORTABLES**  
FT690R/MK2 2.5W MULTIMODE. JOIN IN THE FUN! £399.00  
FT690R/MK2 AS ABOVE CW NICADS AND CHARGER £425.00  
FT290R/MK2 2.5W MULTIMODE. IMPROVED RECEIVER £385.00  
FT290R/MK2 AS ABOVE CW NICADS AND CHARGER £429.00  
FT290R/MK1 2MTR MULTIMODE SPECIAL PRICE £329.00

**MOBILES**  
\*YAESU FT211E 45W 2MTR NEW SUPER MOBILE FREE SUN 5/8 MOBILE ANTENNA CW SO239 (GMOUNT) £299.00  
\*ICOM IC28E 25W SUPER MINI MOBILE FREE SUN 5/8 SO239 GUTTERMONT ASSY+EXT LOUDSPEAKER £359.00

NEW LICENCEES CALL FOR SPECIAL DEALS

INSURED P&P £10



**NEW**

**SCANNERS**

YAESU FRG9600/RWC



**FRG 9600**  
We supply the Yaesu FRG 9600 modified receiver to Government departments and professional users. We offer more options and facilities than any other company. We transform the basic unit by improving sensitivity and adding extra bands. No other scanner has this many options and modes available. Call now for much more information. Overseas dealer required for our kit.

Modified Yaesu receivers. NOBODY can tune 'em like WE can!  
YAESU FRG9600 RWC/MK1 60-905MHZ IMPROVED RECEIVER £465.00  
YAESU FRG9600 RWC/MK2 60-905MHZ 'N' CONNECTOR £495.00  
YAESU FRG9600 RWC/MK3 100KHZ-950MHZ MULTIMODE £595.00  
**NEW YAESU FRG9600 RWC/MK5 100KHZ-950MHZ ACTIVE F/END** £625.00 **NEW**  
YAESU FRG9600 MK3/AH7000/G5RV/PA4C AC PSU, COMPLETE 100KHZ-950MHZ ALL BAND, ALL MODE RECEIVING STATION £699.00  
ICOM ICR7000 25-2GHZ ALL MODE SUPER RECEIVER £857.00  
ICOM ICR7000/AH7000 ABOVE WITH MATCHING DISCONE £945.00  
**UNIDEN-BEARCAT UBC100XL SUPER HELD CW NCDS PSU** £189.00  
**NEW UNIDEN-BEARCAT UBC175XL SUPER DESK-TOP CW PSU** £179.00  
**NEW UNIDEN-BEARCAT UBC50XL NEW MINI SCANNER VHF/UHF** £99.00  
REGENCY MX7000. SAME COVERAGE. SAME MAKE AS ACR2002 £399.00  
FDK AIR BAND HANDHELD THUMBWHEEL MINI CW NCDS PSU £139.00  
FDK AS ABOVE COVERAGE 140-173.00MHZ FM BANDS £139.00  
MANY MORE MAKES AND MODELS IN STOCK. PLEASE CALL FOR DETAILS.  
INSURED P&P £10 ON SCANNERS.

**SHORT WAVE RECEIVERS**  
YAESU FRG8800 SHORT WAVE ALL MODE 100KHZ-30MHZ £572.50  
YAESU FRG8800/FRV8800 AS ABOVE WITH VHF CONVERTER £659.00  
ICOM ICR71 100KHZ-30MHZ A TOP CLASS RECEIVER £799.00

**NEW PRODUCTS**

**INTERNATIONAL MODEL 877R AIR-BAND RECEIVERS**

This new tunable receiver covers 52-174 Mhz as well as CB in three bands and is a cost-effective alternative to handheld scanners. The receiver is fitted with a Helical antenna and has good performance for a radio with this coverage. It is ideal for monitoring Air Band, the two-metre and PMR/Marine bands as well as Band 2 FM Broadcast. A squelch control is also provided. Two versions are currently available.

Model 877R, for use with Dry cells £39.50  
Model 877R, c/w nicads and charger £49.50

DEALERS CALL FOR TRADE PRICES

Sorry, not now available mail order. Please visit our new Show Rooms for a free demonstration.

**IDEAL INTRODUCTION TO VHF LISTENING**



**NEW**

**RAYCOM PRODUCTS**

**NEW ICOM TYPE COMPATIBLE NICAD PACKS, EMPTY CELL CASES AND DESK TOP CHARGER**

A new range of professional Heavy Duty long life nicad packs, imported from the USA, available exclusively at RWC.

10AF 10V 800 mA LONG LIFE, ICOM EQUIV BP58 £55.00  
12AF 12V 600 mA LONG LIFE, ICOM EQUIV ALNT BP7 £52.50

(Both above units for use in ICOM BC3080 OR RAYCOM NC580)

MT1 EMPTY Cell case for self assembly of up to 10x Nicads for a cost effective replacement for packs such as BP3 etc. there is ample room for a DC jack, c/w instructions £8.50. AA NICADS tagged 1.2V 500mA Nicad cells for above £1.60. NC580 Desk-Top charger for all Icom type Nicads above 400mA, two charging positions 50mA & 80mA 14hr charge £39.50

Trade and Dealer enquiries welcome. Call for more details.

P&P £2.50 per order

**Business radio users call now!**



**NEW**

**ANTENNAS & ACCESSORIES**

ICOM AH7000 SUPER DISCONE 25-1300MHZ INC POST £79.00  
NEW RAYCOM AIR BAND DISCONE 118-170 MHZ 6 ELEMENTS £12.50  
RAYCOM DISCONE 60-600 MHZ 8 ELEMENTS SO239 SOCKET £27.50  
SUN MOBILE 5/8 SO239 C/W SO239 MOULDED LEAD/GMOUNT £22.50  
G5RV 1/2 SIZE HF MULTIBAND HF ANTENNA (INC POST) £15.00  
G5RV FULL SIZE MULTIBAND HF ANTENNA (INC POST) £17.50  
G5KW/W3DZZ 7.1MHZ TRAP DIPOLE ASSY. SO239/COAX FED £23.50  
G5KW/W3DZZ 7.1MHZ MULTIBAND AS ABOVE. BALANCED FED £22.50  
G5KW/W3DZZ 7.1MHZ 2X TRAPS, FOR SELF ASSY. ANT £9.95

Hundreds of other types of base and mobile antennas in stock  
JAYBEAM, TONNA, MET, SUN, HOXIN, POPULAR MODELS IN STOCK.

NEW RWC are now appointed dealers for the West Midlands for Butternut, Cushcraft and MFJ products. Please ask for details of the range currently available.

**MOD KITS**

**RWC MOD KITS, ANNOUNCEMENT**

We apologize to customers waiting for various mod kits, supplies of crystals and components are inconsistent and demand for kits varies, so there is occasionally a delay before we can send your kit of parts, please be patient. Rome was NOT built in a DAY! Kits still available:

SANYO LC7137 SYNTHESIZER CB-10MTRS.  
LCLDINT CB-10MTRS. FT757GX Mk1 FAST TUNING MOD. STORNO COM713 PMR-2MTR KIT. PVE A200 E-BAND 50MHZ KIT, call for technical details, prices and delivery.

**WANTED DEAD OR ALIVE**

Your used equipment. We also offer a very comprehensive range of guaranteed used equipment, e.g. Amateur band transceivers, SW receivers, scanning receivers, PMR and accessories. As far as we are aware we are the only company in the UK to offer a bi-weekly computerized used equipment list and special offers list.

Send a large SAE for copies.  
ALL USED EQUIPMENT CARRIES 3 MONTH WARRANTY

**RAY WITHERS COMMUNICATIONS LTD**

Manufacturers, Importers and Suppliers of World Famous Communications Products  
INTERNATIONAL HOUSE, 963, WOLVERHAMPTON ROAD, OLDBURY, WARLEY, WEST MIDLANDS, B69 4RL. TEL: 021 544 6767 (PBX). VODAFONE: 0836 282228.  
TELEX: 336483 G. FAX: 021 544 7124. PRESTEL MBX: 0214218216

Amateur Radio. Business Radio. Radio Telephones. Sales. Service Accessories and Antenna Systems.

Ordering Information: For fast delivery please order by Telephone, Telex or Fax, or send cash/cheques/drafts by post. All Credit/Charge cards accepted. £1000.00 Instant Credit available subject to status, we also offer our RWC Chargecard. Please call for further details and information. We do NOT advertise products that are not normal stock items. All prices correct at time of going to press. However, prices subject to change without prior notice, E6OE.

Most other products advertised in this magazine are available at RWC/RAYCOM.

STOP PRESS. . . PLEASE NOTE NEW ADDRESS

★ WE WILL MATCH OR IMPROVE ANY GENUINE ADVERTISED PRICE ★



1988 BUYER'S GUIDE TO ELECTRONIC COMPONENTS

# Maplin



**UNIQUE**



Make your own  
**DIGITAL WATCH KIT**  
1/2 PRICE OFFER  
**ONLY £1**  
SEE INSIDE COVER.  
NO SOLDERING.  
SUITABLE FOR  
AGES 10+

**VISIT OUR NEW  
SHOP IN BRISTOL  
NOW OPEN AT  
302 GLOUCESTER ROAD  
Tel: (0272) 232014**

**GET YOUR COPY OF THE NEW MAPLIN CATALOGUE ON SALE NOW**

Pick up a copy from any W.H. Smith for just £1.60 or post this coupon now to receive your copy by post for just £1.60 + 49p p & p. If you live outside the UK send £2.75 or 12 International Reply Coupons. I enclose £2.00.

Name \_\_\_\_\_  
Address \_\_\_\_\_  
Post Code \_\_\_\_\_

Send to Maplin Electronic Supplies Ltd., P.O. Box 3, Rayleigh, Essex S58 8LR.

**AVAILABLE NOW IN ALL W.H. SMITH STORES GET YOUR COPY NOW!**

£1.60

NEW! RADIO CONTROL MODELS  
100'S OF NEW PRODUCTS  
AT LOW, LOW PRICES