

D.C. VALVE -VOLTMETER

Practical Wireless

9^D
EVERY
MONTH

Editor
F. J. CAMM

Vol. 21 No. 471

NEW SERIES

SEPTEMBER, 1945

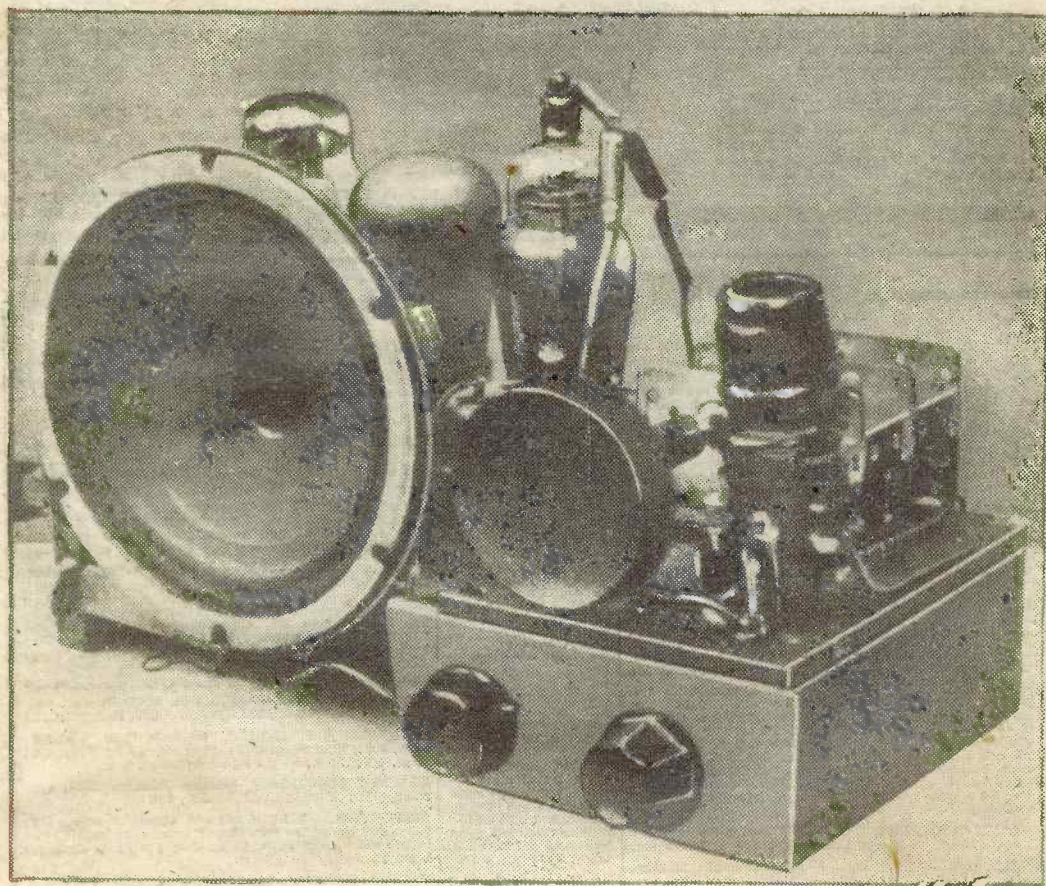

Front View of a Compact Three-valve Midget Battery Receiver.
Full Constructional Details are Given in This Issue

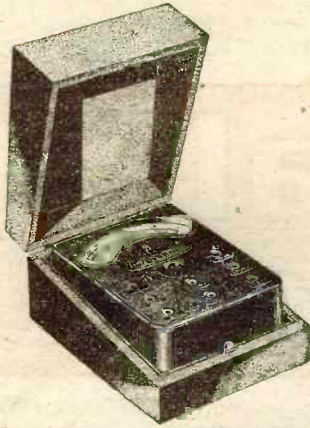

The D.C. AVOMINOR

Electrical Measuring Instrument

A 2½-inch moving coil meter for making D.C. measurements of milliamps, volts and ohms. The total resistance of the meter is 100,000 ohms, and full scale deflection of 300 v. or 600 v. is obtained for a current consumption of 3mA. or 6mA. respectively.

Supplied in velvet lined case, complete with pair of leads, interchangeable testing prods and crocodile clips, and a comprehensive instruction booklet.

Size: 4" x 3" x 1½".

'AVO' Precision

ELECTRICAL TESTING INSTRUMENTS

Registered Trade Mark

"AVO" Instruments, by their simplicity, extreme versatility and high accuracy, make possible that economy of time which is the essential feature of servicing and maintenance.

These two compact pocket-size instruments, with the "Avo" high standard of accuracy, are particularly recommended where extremely small size and economy of weight are primary considerations.



The UNIVERSAL AVOMINOR

Electrical Measuring Instrument. An accurate moving coil meter providing 22 ranges of readings of A.C. voltage, D.C. voltage, current and resistance, on a 3-inch scale. Total resistance 200,000 ohms. Self-contained for resistance measurements up to 20,000 ohms, and by using an external source of voltage the resistance ranges can be extended to 10 megohms. The ohms compensator for incorrect voltage works on all ranges. Suitable for use as an output meter when the A.C. voltage ranges are being used. Complete with leads, testing prods, crocodile clips, and instruction booklet.

Size: 4½" x 3½" x 1½".

Orders can now only be accepted which bear a Government Contract Number and Priority Rating.

Sole Proprietors and Manufacturers:—

AUTOMATIC COIL WINDER & ELECTRICAL EQUIPMENT CO., LTD.
Winder House, Douglas Street, London, S.W.1
Phone: VICTORIA 3404-8

PREMIER RADIO

MORRIS AND CO., (RADIO) LTD.

METERS. First grade army type Universal Test Meters in shockproof bakelite cases, ranges 10, 100, 500 volts at 1,000 ohms per volt A.C. and D.C., 1, 10, 100 mA. D.C., 0-50,000 ohms, £8 15s. 0d.

FIRST GRADE METERS. 3½in. diameter, 1 milliamp, £2 12s.; 500 microamps, £2 18s. 6d.; 4½in. 1 milliamp, £3 5s. 0d.; 500 microamps, £3 11s. 6d. Westinghouse Meter Rectifier for either type. 10-. Multiple shunts 10, 100, 500 mA., 10/-; Any value multiplier, 2/6 each.

GRAMOPHONE MOTORS. Manual Type (double spring). Complete with all accessories. New, but shop soiled, 42/-.
SUPER QUALITY AMPLIFIERS. 12 watts output, high and low gain inputs with mixer, treble and bass controls, two DB 30-11,000 cycles, negative feedback, 2, 4, 8, and 15 ohms output, £14 14s.

A.C./D.C. AMPLIFIERS. 5 watts output, high gain, three-stage, feedback, £8 3s. 0d.

BATTERY CHARGERS for 2 v. batt. at 1 a., 25/-; for 2, 4 or 6 v. batt. at 1 a., 45/-; for 8 v. batt. at 1 a., 30/-; for 2, 6 or 12 v. batt. at 1 a., 45/-; for 6 v. batt. at 4 a., £3 10s.

MAINS TRANSFORMERS. 200+300 v., 60 ma., three 4 v. 2-3 a. windings, 25/-; 350+350 100 mA., 5 v. 2 a., 6.3 v. 2-3 a., 25/-; 350+350 150 mA., two 4 v. 2-3 a., two 4 v. 1 a. windings, 38/-; 350+350 150 mA., 5 v. 2 a. 6.3 v. 2 a., 6.3 v. 2 a., 36/-; 500+500 250 mA., 5 v. 3 a., 6.3 v. 2 a., 6.3 v. 4 a., 65/-; 425+425 200 mA., 4 v. 2-3 a., 4 v. 2-3 a., 4 v. 3-6 a., 47/-; 350+350 150 mA., 4 v. 1-3 a., 4 v. 2-3 a., 4 v. 3-4 a., 36/-; 500+500 150 mA., four 4 v. 2-3 a. LT windings, 47/-.

1-VALVE BATTERY S.W. RECEIVER. with 2-volt valve, 4 coils, 12-170 m. bandspread tuning, 55/- including tax.

STEEL CHASSIS. 10" x 8" x 2½in., 7/-; 16" x 8in., 8/6; 20" x 8in., 10/6.

MOVING COIL SPEAKERS. Rola 6½ or 5in. P.M., no trans., 26/-; Plessey 8in. P.M. with trans., 25/6. Goodmans 3½in.

SHORT-WAVE COILS.

18 octal sockets, 4-pin aerial coils, 9-15, 12-26, 22-47, 41-94, or 76-170 m. 2 6 each; 150-550 or 250-550 m. 3/-; 490-1,000 or 1,000-2,000 m., 4/-; 6-pin H.F. trans., 9-15, 12-26, 22-47, 41-94, or 76-170 m., 2/6. K.W. chokes, 16-100 m., 1/3; 5-200 m., 2/6.
SHORT-WAVE CONDENSERS. all brass easily ganged, 15 mmfd., 2.11; 25 mmfd., 3/3; 40 mmfd., 3/3; 100 mmfd., 3/11; 140 mmfd., 4/8; 250 mmfd., 5/8; shaft couplers, 7/4; flexible ditto, 1/6.
MIDGET "P" TYPE COILS. 12-35, 16-47, 24-100, 91-261, 250-750, 700-2,000, 300-557, available as H.F. trans., aerial, or osc. coils, 2/3 each. Suitable Yaxley type wave-change switches, every type available; detectors, 2/- each; wafers, 1/- each. Suitable small 2-gang condensers; 0.005, 15/-; suitable matched pairs iron-cored 465 K.C. I.F. trans., 15/- pair; midret type, 21/- pair. Suitable 60 mmfd. trimmers, 1/-; osc. padder 750 mmfd., 1/6.

P.M. no trans., 30/-. Midget, standard or P.P. trans. for any above, 10/6. Super quality giant Match-unker output transformers, match any tube single or P.P. to any voice coil, 7-watt, 22/6; 15-watt, 30/-; 30-watt, 49/6; 60-watt, 59/6.

CHOKES SEL. 300 ohms, 40 mA., 4/6; 30H., 400 ohms, 50 mA., 9/6; 30H., 100 mA., 400 ohms, 15/-; 30H., 185 ohms, 150 mA., 25/-; 25H., 250 mA., 120 ohms, 38/6; 15H., 500 mA., 62 ohms, 65/-.

SMOOTHING CONDENSERS. 50 mf., 12 v., 2/3; 25 mf., 25 v., 2/3; 30 mf., 50 v., 3/6; 3 mf., 250 v., 3/9; 2 mf., 350 v., 4/6; 4 mf., 450 v., 7/6; 8+8 mf., 500 v., 8/6; 8+16 mf., 500 v., 9/6; 16 mf., 100 v., 5/-; 16 mf., 350 v., 6/6.

SUNDRIES. 2 mm. Systoflex, 2½d. yd.; resin-cored solder, 6d. per coil or 4/6 per lb.; screened 2-pin plugs and socket, 9d.; ditto, 8-pin, 2/-; Octal sockets, 70d.; ditto, anaphenol type, 1/3. Morse buzzers, 1/11. Valve screens, 1/2. Knobs, 6d. Pointer knobs, 1/1. Crocodile clips, 4d. "Gain" and "tone" indicator plates, 7½d. Fuses, any size, 5d. Fuse holders, 6d. 6-volt vibrators, 4-pin, 12/6. Crystal pickups £3 18s. 9d., including tax.

AMERICAN VALVES. Many types in stock at controlled prices, including 6V6, 6BE, 5Y3, 5Z4, 25L6, 75, 6K7, 6AZ, 4Z5, 1C5, 12BK7, 25Z6, 25Z6, 42, 80, 1N5, 1H5, 1T5, 85Z4

ENAMELLED COPPER WIRE. 1lb. reels, 16 or 18 g., 6/6; 20 g., 3/3; 22 or 24 g., 3/10; 26 or 28 g., 4/2; 20 g., 1/4; 22 g., 4/6; 34 g., 5/-; 36 g., 5/6; 38 g., 6/3.

REACTION CONDENSERS. bakelite dielectric, .0001, 2/9; .0003, 2/11; .0005, 3/3; .0003 ditto, 3/3.

RESISTANCES. 360 x 180 x 60 x 60 ohms, .5 amp., 5/6; 500 x 100 x 100 x 100 x 100, 2 amp., 5/6; 40,000 ohms tapped every 5,000 ohms, 10 w., 5/-; 1 w., res., 6d. each; 1 w., 9d. each.

VOLUME CONTROLS. any value, 3/9; with switch, 6/8.
ELECTRIC CLOTHES PRESSING IRONS, pre-war quality. Weight 5lbs., 33/6.

OUR 1945 LIST IS NOW AVAILABLE. All enquiries must be accompanied by a 2½d. stamp.

ALL POST ORDERS TO: JUBILEE WORKS, 167, LOWER CLAPTON ROAD, LONDON, E.5. (Linhurst 4723.)

CALLERS TO: Jubilee Works, or 169, Fleet Street, E.C.4. (Central 2833.)

Practical Wireless

13th YEAR
OF ISSUE

EVERY MONTH.
Vol. XXI. No. 471. SEPTEMBER, 1945.

and PRACTICAL TELEVISION

Editor F. J. CAMM

COMMENTS OF THE MONTH

BY THE EDITOR

Universal Language?

THE Editor of an American radio magazine has made the suggestion that we need a universal auxiliary language. This is not the first time that such a suggestion has been made. In fact, ever since the commencement of broadcasting the need for some international language acceptable to all nations has been felt. The idea is, therefore, by no means new, and Samuel Morse, when he invented the international morse code, provided the only practicable solution to date, in that he produced a code rather than a language which was acceptable to all countries. Esperanto was an ingenious but ill-fated attempt to provide by means of language what Morse had done by code.

All of these schemes for international languages must fail, not through any lack of merit, but simply because national pride in a language, its idioms, colloquialisms, and the fact that a particular language is designed around national characteristics rather than upon the rules of orthography, etymology, syntax and prosody, makes a standard universal language not only unacceptable, but impossible.

How, for example, can an international language overcome the differences between, say, English and French or German? In France inanimate things are given a gender; in this country they are not. The beauty of expression in classical literature would be lost if it were edited to conform to some universal standard. The polyglot diction adopted throughout the world is the one fact which supports the existence of the Tower of Babel, and the fact that from earliest times nations have developed their own vocabularies, enlarged and improved them, and taken into those vocabularies words from other languages, or derived from other languages, indicates the impossible task, after these thousands of years in the history of the world, to set it all aside and start afresh.

In any case, those nations who approved Esperanto failed to persuade their people to adopt it. One of the objections is that the word Esperanto itself sounds Spanish, and other countries naturally objected to adopting a language which would have provided world-wide propaganda for a particular country. Each country thinks its own language the best, and therefore the one

which should be adopted throughout the world.

It would, of course, enormously add to the interests of radio if a common language could be devised, for we should be able to tune in to the broadcasts of other nations and understand the spoken word, as now we are able to understand music and mathematics, the only two international arts using a universally understood form of expression. Mathematical symbols and the musical notation are understood throughout the world and so are musical sounds.

A universal language would, too, considerably cheapen the cost of transmission, for we should not need translators and announcers who could speak foreign tongues. At the same time, the population of the world would have to start learning this new language, and to take care of the combined vocabulary of all of the hundreds of different languages in the world would need a new vocabulary of tens of thousands of words. Would a new universal language permit politicians to adroitly circumnavigate a subject, and to speak with their tongues in their cheeks, bearing in mind that words are made to conceal thoughts? Would the new vocabulary permit the double entendre? Otherwise how would a radio comedian earn his living?

English is spoken by more people than any other language, if we exclude the Chinese, and the American journalist concerned says that in the interests of world understanding and lasting peace, "the United States would be willing to pay the cost of making English a universal language... let the United States tell the world that it stands ready to lend-lease radio sets for a certain percentage of each nation's inhabitants... this would require a minimum of 50 million sets a year for a term of years."

Certainly, a bold suggestion, but we greatly fear that that is what it will remain. "Let nation speak peace unto nation" is the motto of the British Broadcasting Corporation, and it is certainly the spirit of other nations to do so too. We doubt whether that wish would extend to the adoption of a language which, because of its universality must be as colourless as a mathematical formula.

Universal agreement must come before a universal language.

Editorial and Advertisement Offices:
"Practical Wireless," George Newnes, Ltd.,
Tower House, Southampton Street, Strand,
W.C.2. Phone: Temple Bar 4363.
Telegrams: Newnes, Rand, London.
Registered at the G.P.O. for transmission by
Canadian Magazine Post.

The Editor will be pleased to consider articles of a practical nature suitable for publication in "Practical Wireless." Such articles should be written on one side of the paper only, and should contain the name and address of the sender. Whilst the Editor does not hold himself responsible for manuscripts, every effort will be made to return them if a stamped and addressed envelope is enclosed. All correspondence intended for the Editor should be addressed: The Editor, "Practical Wireless," George Newnes, Ltd., Tower House, Southampton Street, Strand, W.C.2.

Owing to the rapid progress in the design of wireless apparatus and to our efforts to keep our readers in touch with the latest developments, we give with no warranty that apparatus described in our columns is not the subject of letters patent.

Copyright in all drawings, photographs and articles published in "Practical Wireless" is specifically reserved throughout the countries signatory to the Berne Convention and the U.S.A. Reproductions or imitations of any of these are therefore expressly forbidden. "Practical Wireless" incorporates "Amateur Wireless."

ROUND THE WORLD OF WIRELESS

Developing Far East Telecommunications

COL. H. J. WELLINGHAM, who, as Press Liaison Officer, is one of the senior officials of Cable and Wireless, Ltd., has returned to London after a 20,000 mile tour covering Egypt, India and Ceylon.

During his visit he has discussed with military and communications officials the re-establishment of telecommunications in the Far East, the speeding of delivery of S.E.A.C. Forces' telegrams, and the development of the photo-telegraph circuits between the United Kingdom and India and Ceylon.

Overseas Press Traffic

IT is interesting to note that during the first two months following VE Day Cable and Wireless transmitted a greater volume of press traffic overseas than during the corresponding period following D Day last year.

The total number of press words transmitted from May 8th to July 2nd inclusive this year was more than 14,700,000, compared with about 13,300,000 from June 6th to August 1st, 1944. The Australian total rose from

Eclipse Recorded by Radar

A RADAR set used in the Battle of Britain formed part of the apparatus used in an elaborate series of experiments conducted in many parts of the country early in July to ascertain what effect, if any, the eclipse of the sun would have on radio transmission and reception.

For several days before the eclipse the staff of the research station at Datchet, of the Department of Scientific and Industrial Research, had been making preparations. With the aid of various precision instruments and cathode-ray tubes various members of the staff checked up every few seconds and took readings which later, when examined in detail, will tell experts whether or not the eclipse affected their instruments.

"Listening-in" for U-boats

SCIENCE played a big part in helping to detect lurking U-boats in the Battle of the Atlantic, and the little submarine chasers with their "Asdic" apparatus did sterling work.

Listening-in was an exciting and fascinating job, and regularly the little ships of the Royal Navy did the job effectively. Mostly manned by R.N.V.R. ship's company, they tagged along with convoys, and went on patrols searching for submarines.

If you were in one of those gallant little ships, escorting a convoy from the Thames to the Tweed and back again, you felt that the ship did everything, including imitating a roulette wheel. In submarine waters, constant listening watch was kept on the Asdic (Asdic means anti-submarine detecting gear), and when a beam struck the steel hull of a submarine the echoing noise was heard in the headphones of the two listeners.

The sub-chaser then altered course so that it would pass ahead of its under-water prey. Throttles were opened up to full speed. When directly above the submarine a depth charge "pattern" was dropped... and one more enemy submarine was very much under water. That's the broad principle of attack, and the efficiency and daring with which it was carried out was a constant headache to Hitler's U-boat commanders.

Radio Eireann

OFFERS have been made by British, American, and Canadian commercial broadcasting companies for the use of Radio Eireann. Agents from these organisations have already visited Dublin, and it is reported that if they can devise a scheme for broadcasting programmes in the Irish language, they may be granted radio time.

Broadcasting in Eire is operated by the Post Office, and the Government's main objective is to have its programmes outstandingly Irish.

In return for the use of short-wave facilities the rival companies are prepared to engage the best Gaelic speakers in the country, who would use Eire's Home



Listening-in on the Asdic apparatus of a submarine chaser whose duties were principally to accompany convoys in infested waters and to go on patrols in search of U-boats. A constant listening watch was maintained.

approximately 2,100,000 to more than 2,436,000; the Indian total from 1,350,000 to 1,914,000; South African, 825,000 to 1,087,000; and New Zealand's total from 300,000 to nearly 330,500. The Canadian total declined from 700,000 to 584,250.

From January to December, 1944, of the total of nearly 705,000,000 words handled on the Company's network, press traffic comprised 139,000,000 words, and commercial traffic approximately 250,000,000 words. Government telegrams contained 238,840,000 words.

9,801,000 Wireless Licences

ON May 31st, the total number of wireless licences in Great Britain had reached the figure of 9,801,000, an increase of 73,000 for the month.

Service mainly but would also be allowed some time daily on the short-wave programmes.

Reopening of Shops

THE President of the Board of Trade, Mr. Oliver Lyttelton, announced in the House on June 12th, that from Monday, June 18th, licences to reopen closed retail businesses will be granted to any ex-trader, whether or not he was in the Forces, whose name is in, or eligible for inclusion in, the Register of Withdrawing Traders.

It was stated also that ex-traders who wish to open in a district, or in a business other than that in which they were formerly engaged, will be permitted to do so, provided that this will not prejudice the interests of others on the Register.

Export Relaxations

A NEW Order by the Board of Trade, which came into force on June 11th, indicates that the list of goods requiring export licences is greatly reduced, and all the remaining countries are removed from the list of territories to which the export of *all* goods is controlled. The goods which may now be exported without licences form a long list, but they include wireless receiving sets, and a wide range of electrical products.

R.A.F. Recruits' University Training

DURING the war, hundreds of young men were given six months' courses at universities throughout the United Kingdom at the entire expense of the Royal Air Force. The chosen candidates were admitted to the universities as ordinary undergraduates, and enjoyed the same privileges and amenities whilst training for the R.A.F. The illustration on this page, from a photograph taken at a famous university, shows an R.A.F. pupil receiving instruction.

Future of Radio Luxembourg

IT is reported that Radio Luxembourg, the second most powerful station on the Continent, is shortly to become the official transmitter in Europe of the United States Government.

The station was captured intact last September by a special task force of the American 12th Army Group, acting under the direction of the Psychological Warfare Division of Shaeff.

Since then it has been, in effect, the voice of Shaeff under the control of Brig.-Gen. Robert A. McClure, with Col. William S. Paley as his deputy chief.

For some months it has relayed important B.B.C. programmes and O.W.I. transmissions from New York.

"High-grade Material"

THAT opinion is firmly held by the Director of the B.B.C. Far Eastern Service, John Morris, who speaks from intimate acquaintance with intellectual and official Japan. Formerly Professor of English literature in Keio University, Tokyo, he was at one time also an adviser to the Japanese Foreign Office (and is the author of "Traveller from Tokyo"). In his view, a short programme of high grade material, directed to cultured Japanese, is likely to be more fruitful of results than would many hours of would-be popular entertainment.

However, apart from listeners in

Japan itself, there are large numbers of Japanese soldiers and sailors on active service who are able to listen to British news, since, in order to hear their own broadcasts from Tokyo, they cannot be forbidden the use of short-wave receivers.

The broadcast is limited at present to a half-hour daily, made up of ten minutes of factual news, occasionally extended to 15 minutes—and 15 to 20 minutes news talks given by people with a world reputation in their particular subjects. Propaganda, as understood by the Axis partners, is not indulged in. But in reporting the war a strong point is made that it was British ideas and the British system of leadership—in short, Democracy—that triumphed over Nazi ideology and totalitarianism.

Among items of fairly regular inclusion in the programme is the leading article from *The Times*, which has always been highly regarded in official Japan.

Cultural Material

AS opportunities increase, the B.B.C. hopes to make extended use of cultural material, including modern British music. Japanese intellectuals are keen students of English literature, and Mr. Morris is certain that they feel resentment and frustration at being denied the opportunity to hear what people like E. M. Forster, H. G. Wells, Somerset Maugham, and T. S. Eliot—to name only a few writers popular in Japan—are saying. By giving talks by and about contemporary writers we can make the Japanese realise the extent of their intellectual isolation from the rest of the world, and can use this idea to implant the feeling that their statesmen have misguided and misled their country.



The C.O. instructing an R.A.F. pupil in the wireless direction-finding cubicle in a well-known university.

An Introduction to Communications Receivers

In This, the First of a Short Series of Articles, the Requirements and General Specification of a Communications Type of Receiver are Explained

By FRANK PRESTON

ALTHOUGH it is not possible to give a precise definition of the term "communications receiver," the type of instrument to which this name is generally applied should have certain features which are not normally provided on receivers of other types. It may be argued that any receiver which is used to pick up a message sent out by a transmitting station is a communications receiver; unfortunately, this is sometimes done by the optimistic set designer or maker!

Perhaps the first requirement of a receiver of the type under consideration is that it shall have a high degree

second detector with A.V.C., and an output stage. In addition, a beat-frequency oscillator is provided. This may be switched in or out of circuit; when in use it is coupled to the second detector, where it produces a beat or heterodyne note with the received signal, so that C.W. (morse) can be heard. The B.F.O. is, of course, switched out of circuit when telephony reception is desired.

Another feature which is often incorporated in the A.V.C. system is a noise-limiter or noise-suppression device, which increases the signal-noise ratio and therefore permits the reception of signals whose field strength is exceptionally low. To permit of accurate tuning when the A.V.C. is in use, it is customary to provide a meter type of tuning indicator. This is normally referred to as a signal-strength or, as an abbreviation, an "S" meter, for the simple reason that it indicates the relative strengths of signals as well as the correct tuning point.

Fig. 1 is a simplified block diagram showing the circuit details which have been mentioned above.

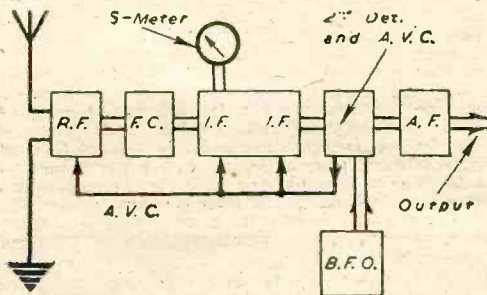

Fig. 1.—This block diagram shows the arrangement of stages in a typical communications receiver.

of sensitivity combined with a high signal-noise ratio. In addition, it must be highly selective and, preferably, should be provided with a control by means of which the selectivity can be varied according to requirements: these are governed by reception conditions at any particular time. The set must be capable of receiving both C.W. and telephony, and should have an effective A.V.C. system.

Those are some of the more obvious essentials for a receiver which is required for the reliable reception of signals from any range and at any time of day or night.

A Precision Instrument

During the past ten years the communications type of receiver has been developed extensively, particularly in the U.S.A., with the result that it can now be regarded as a precision instrument; indeed, the accuracy of frequency calibration of the modern communications receiver is often better than that of many second-grade wavemeters. Along with the development has grown up the custom of giving reasonably precise details of performance. For example, the makers of one well-known receiver define the sensitivity in these terms: "Input (30 per cent. modulation) required for 0.05 watt output—Less than 2 microvolts." This definition is expanded by giving a list of inputs (in microvolts) required over the various frequency ranges to produce a two-to-one signal-noise ratio.

A Typical Circuit

Before considering the various details of a typical specification it will be a good plan to form an idea of the type of circuit arrangement which is generally employed in a good-class communications receiver. In most cases there is a variable-mu R.F. stage, preceding a triode-hexode frequency changer. This is followed by two stages of intermediate-frequency amplification, a

Frequency Range

An average frequency coverage for a communications receiver is approximately 30 mc/s (10 metres) to 500 kc/s (600 metres), but there is no particular uniformity in this respect. Indeed, some communications receivers are specially designed to cover either the long-wave or ultra-short-wave band.

It is customary in designing present-day receivers to employ a series of built-in coils in conjunction with a switching system, by means of which those required for any particular range can be brought into circuit. On the other hand, there are some receivers still on the market which employ plug-in tuning units. In either event, there is invariably provision for band-spread tuning, of either the mechanical or electrical type. In passing, it might be mentioned that the form of band-spread referred to as mechanical comprises the use of a reduction drive—often with two alternative gear ratios

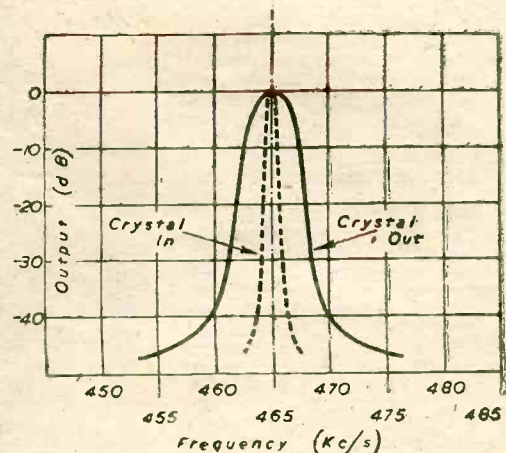

Fig. 2.—Typical response curves for a good communications receiver with the crystal in and out of circuit. These curves show the band width for varying degrees of attenuation and assume an intermediate frequency of 465 kc/s.

—while, with electrical band-spread, a low-capacity condenser is connected in parallel with the main ganged condenser and used as a fine-tuning device. Many sets have both forms of tuning.

Band-spread Tuning

Sometimes, instead of providing a dual-ratio geared drive for mechanical band-spread, use is made of what has been described, for obvious reasons, as flywheel tuning. With this system, a low-gear drive is employed throughout, but a relatively heavy flywheel is mounted on the shaft carrying the tuning knob. Due to this, it is possible to sweep rapidly from one part of the band to another by "spinning" the tuning knob. Provided that the condenser and drive are well designed and nicely balanced, this system operates very satisfactorily.

In the case of the electrical band-spread system, where use is made of an auxiliary fine-tuning condenser, the dial of the main tuning condenser is calibrated in megacycles or kilocycles (according to the frequency range) and the dial of the fine-tuning condenser is also frequency calibrated for particular bands; the 10, 20, 40 and 80-metre bands, for example. Thus, if it were desired to tune to a signal on 7.150 mc/s (40-metre band) the main tuning control would be set to 7.300 mc/s (the upper frequency limit in the 40-metre amateur band) and then the band-spread control would be adjusted to the final frequency.

Different types of tuning scale are employed by different manufacturers, but in practically all cases the tuning dials are marked off around four or more concentric arcs. In some examples there are blanking plates or shutters, operated by means of the band-selector switch, which obscure all except those scales relating to the band actually selected.

Sensitivity and Selectivity

And now we can examine the chief items to be found in the performance specification of a typical communications receiver. Mention has already been made of the sensitivity, but it should be mentioned that the method of quoting the sensitivity has been practically standardised in terms of the signal input in microvolts, for a signal with 30 per cent. audio modulation, required to give the standard output of 50 milliwatts, or 0.05 watt. Clearly, high sensitivity is useless if the background noise is high. Signal "readability" is more dependent upon the ratio of signal level to noise level

than upon signal strength alone; that is why sensitivity is often stated in terms of microvolts signal input required to give the standard output for a signal-noise ratio of two-to-one. Such a ratio is just about the lowest required to ensure a readable signal.

In describing a normal domestic receiver it is customary to give it in terms of band-width—say 9 kc/s. A more accurate description of selectivity is necessary when referring to an instrument as accurate as a good communications receiver, and therefore the selectivity is more likely to be defined in terms such as: 3 kc/s at 3 dB down; 6 kc/s at 15 dB down; 10 kc/s at 40 dB down. These figures can best be understood by referring to the tuning curve shown in Fig. 2, from which it will be seen that the band width is the distance across the curve at various points down the decibel scale. Sometimes the selectivity is described as adjacent channel selectivity, and the frequency figures quoted for any particular degree of attenuation are then half of those given above, the measurement being taken from the centre line of the curve to the curve itself.

It is probably better to think in terms of the overall selectivity, however, since it is this which governs the permissible frequency separation between two signals if either is to be received free from interference by the other.

The Crystal Gate

It is usual practice in high-grade communications receivers to provide a crystal gate in one of the I.F. circuits so that, when necessary, the overall band-width can be reduced to something in the region of 250 kc/s in conditions where there are two or more strong signals only slightly separated in frequency. A representative tuning curve when the crystal gate is in circuit is also shown in Fig. 2.

When using the crystal gate there must inevitably be a loss of quality, but this is preferable to the loss of a signal! However, to ensure that the quality loss is no greater than is necessary to permit of good reception, provision is often made for shunting the crystal with a tapped, variable resistance. By this means the band-width for a given dB drop can be varied between, say, 300 c/s and 6 kc/s. The crystal control mounted on the front of the receiver would take the form of a rotary switch with about six positions, the first being marked "off" or "out" and the others being numbered. In the first position the crystal gate would

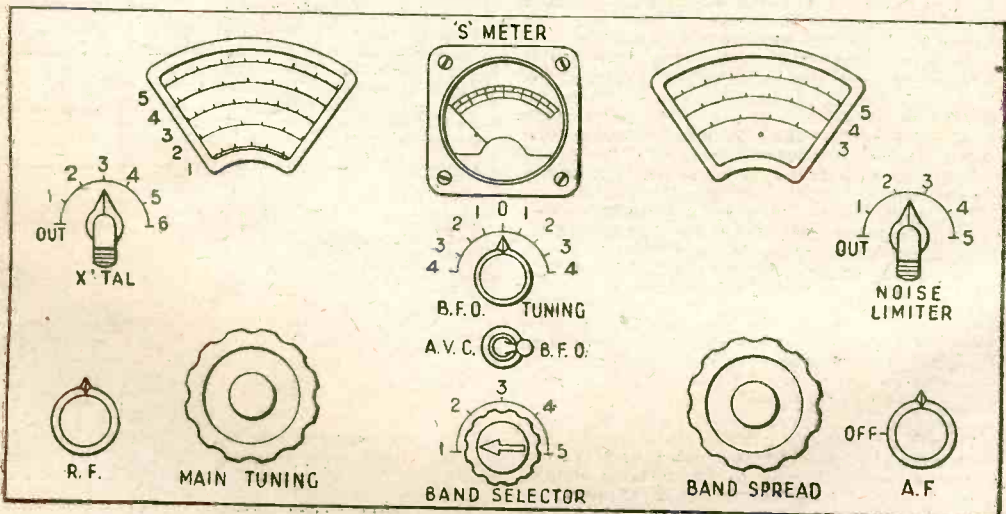

Fig. 3.—The panel and controls of an "imaginary" communications receiver. The types of controls are representative of those generally provided.

be short-circuited and in the others there would be various values of resistance in shunt with the crystal.

Image Ratio

Another important item in the specification of a communications receiver is that of image ratio. As is known, in all types of superheterodyne receiver, second-channel or image interference is present to some degree. When receiving a signal on 7.00 mc/s, for example, the oscillator section of the frequency-changer would normally be tuned to 7.465 mc/s (assuming the common intermediate frequency of 465 kc/s). But the intermediate frequency amplifier would also respond to a signal on 7.930 mc/s, since this would beat with the oscillator frequency to produce the I.F. Thus it will be seen that if signals on each of the two frequencies mentioned were applied to the input of the receiver at the same time there would be a danger of interference with the wanted signal by the unwanted signal. The unwanted signal is described as the image, and the receiver should be so designed that the image cannot "get through" at sufficient strength to cause interference. This is done by increasing the selectivity of the pre-mixer tuned circuits and, preferably, by the use of R.F. amplification before the mixer stage.

How this result is achieved will be discussed later in this series of articles. At the moment we are concerned only with the signal-to-image (briefly described as image) ratio. The ratio is determined by applying alternately signals of equal form and amplitude on the wanted and image frequencies, while the receiver is tuned to the wanted frequency, and comparing the I.F. outputs obtained.

In general, the image ratio is so high that image interference is negligible at frequencies below, say, 5 mc/s, but even with an extremely well designed receiver the ratio may well fall to, say, 20 : 1 at frequencies in the region of 30 mc/s. A ratio as low as this, however, is quite satisfactory and it is only when the ratio falls below about 10 : 1 on 30 mc/s that image interference may be expected to reach serious proportions. As a matter of interest, the image ratios of one good communications receiver are approximately 50,000, 5,000, 1,000, 100 and 25 to one at frequencies of 500, 1,500, 3,000, 15,000 and 30,000 kc/s.

Fig. 3 illustrates the controls of an "imaginary" communications receiver. The names assigned to many of the controls are self-explanatory, or will be understood from the brief explanations given above. Mention has not been made before, however, of the knobs marked R.F. and A.F.; these are merely volume controls operating on the R.F. and A.F. amplifiers.

A switch is marked A.V.C.-B.F.O. The object of this is to cut out the automatic volume control and at the same time to switch in the beat-frequency oscillator for use on C.W. reception. It is necessary to disconnect the A.V.C. when using the B.F.O. because the output from the oscillator would introduce so marked an A.V.C. effect that the receiver would be rendered relatively very insensitive.

Another knob is described as the B.F.O. tuning control. This is used on C.W. to vary the pitch of the C.W. note, after carrying out the main tuning with this knob set to its midway or zero position, at which the B.F.O. is tuned to the intermediate frequency. Turning the knob in either direction from zero makes the C.W. audible and gradually increases the pitch from zero to, say, 1,200 c/s. This control can also be used in certain instances, which will be referred to later, to eliminate interference.

The last control calling for explanation is that described as the noise limiter. This is a variable resistor in the second-detector circuit which, in effect, acts in opposition to the A.V.C. The result is that receiver sensitivity can manually be reduced slightly to cut down the noise in order to render a very weak signal audible through it.

A more detailed description of the circuits of a typical communications receiver will be given in later articles of this series.

Impressions on the Wax

Review of the Latest Gramophone Records

H.M.V.

THIS month I find myself in a bit of a quandary. I have but a few records, so far as titles are concerned, on which to pass my opinion, and yet I still lack sufficient space. This embarrassing position is due to the fact that the major item in my selection for this month is a work of such magnitude and complexity, that although it consists only of seven (six and a-half to be exact) records, a single page would not enable one to do justice to it, if I attempted to review it in the strict musical sense. It is one thing to comment on a masterpiece when one's judgment is based on knowledge of the composer, his characteristics, etc., and generally expressed views, but are such comments the true individual opinion of the reviewer, or are they merely a reiteration of, shall we say, accepted views expressed by a certain school of thought? Each and every music lover forms his or her opinion from the reactions their musical senses experience, or the passions, moods, thoughts, call it what you will, created when they listen to music. One's musical senses can undoubtedly be sharpened by a natural gift or by musical education, but, even so, this still leaves, if one is honest about the matter, the individual to be his own judge, and the greater one's musical senses are developed the less likely one is to agree with another of equal standing on all points about interpretation, presentation and the actual composition. Take, for example, the major recording released this month by H.M.V., which has been recorded under the auspices of the British Council. It is Gustav Holst's "The Planets." This work is, without any shadow of doubt, a masterpiece in the strict sense of the word, and it is acknowledged as Holst's finest composition. It is, as mentioned before, too vast for me to attempt to analyse; it is a work which *should* be heard by all music lovers. So far as the record enthusiast is concerned, the recordings form one of the rare opportunities which will allow him to hear a concert performance in its complete form of a work which calls for the fullest resources of a large modern orchestra. The recording, which is made by the B.B.C. Symphony Orchestra, conducted by Sir Adrian Boult, is superb; and this, together with the outstanding performance by the B.B.C. Symphony Orchestra, makes the series of records concerned an artistic triumph. There are seven records—H.M.V. DB6227-6233, Album No. 387—arranged as follows:

Nos. 1 and 2, "Mars—the Bringer of War" (DB6227 both sides); Nos. 3 and 4, "Venus—the Bringer of Peace" (DB6228, both sides); No. 5, "Mercury—the Winged Messenger" (DB6229, one side blank); Nos. 6 and 7, "Jupiter—the Bringer of Jollity" (DB6230, both sides); Nos. 7 and 8, "Saturn—the Bringer of Old Age" (DB6231, both sides); Nos. 10 and 11, "Uranus—the Magician" (DB6232, both sides); and, finally, Nos. 12 and 13, "Neptune—the Mystic" (DB6233, both sides). The full title of the recording is "The Planets" Suite Op. 32.

Webster Booth, with the City of Birmingham Orchestra, conducted by George Weldon, has recorded, on H.M.V. C3420, recit, "Thy Rebuke Hath Broken His Heart," and the aria "Behold and See," and recit, "He Was Cut Off," and aria "But Thou Didst Not Leave," from Handel's "Messiah." The recording is one which will be greatly appreciated by lovers of The Messiah, as Webster Booth gives a fine rendering, and this is richly enhanced by the City of Birmingham Orchestra's outstanding performance. In addition to the pure quality of Mr. Booth's voice, his true expression and understanding, I never fail to appreciate his perfect diction. Every word is crystal clear, and it is a great pity that more of our tenors do not cultivate the same highly essential quality.

A pianoforte solo recording is always welcome, especially so when the artist is Solomon and the composition by Chopin. I recommend H.M.V. C3433.

New Records for Old

By "EXPERIMENTALIST"

IT is impossible to repair a damaged record so that it sounds as good as new. Irrespective of a clean break and a neat join, there is always a "clicking" sound, such as that produced by a bad scratch.

However, an attempt was made to repair the record, using gummed paper. Unfortunately, it was not discovered, until too late, that the halves had shifted by a single groove during the "gumming up" process. "Supposing the disc was tried as it is, what would be

foxtrot number, Alas, another surprise was in store—two surprises, to be more correct!

It was found that the record could not be played from the beginning. The needle kept working out towards the edge of the disc. In other words, the needle had to be placed near the finale of the recording so that it worked towards the introduction!

Close inspection showed this effect to be due to the extraordinary manner in which the "spirals" run, one half portion of the disc serving as a "throw-back" upon the second half. As a result, the record plays longer in duration, i.e., about double the length of time of the opposite side.

The music is virtually played backwards, but is heard in the conventional manner, since the disc is revolving in the proper anti-clockwise direction. Thus, the music, and some of the singing, is heard as normally played, but in interrupted half sections, from the end to the beginning.

The foxtrot number "Thinking of You" was converted into a close resemblance of a Russian March. At least, it had a military swing and a "foreign" air to it not unlike Russian music, the needle clicks seeming to be part of it.

Trying the Experiment.

Knowing that many readers are of an inquiring, inventive turn of mind, some will doubtless want to try out the experiment with old records themselves and thus hear the "effects" obtainable which, if not sensational, are interesting. The experiment is one that is better than the playing of a disc backwards in order to obtain novelty and satisfy curiosity.

First of all, an old 8 in. or 10 in. record is cut into equal halves, as shown by the dotted lines at Fig. 1. The black, plastic composition used in making gramophone records is, by the way, easily broken if scored, just like plain glass, using the point of a penknife as the scoring instrument. A rule is placed over the centre of the disc and a light score made. A similar score is made on the opposite side by continuing the first score around the edges so as to "tick off" the surface edges as guide marks for the ruler.

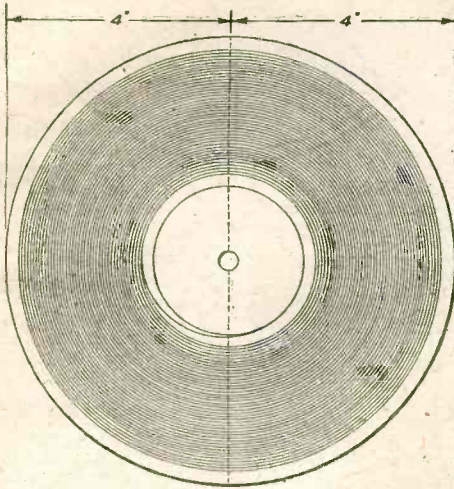

Fig. 1.—How the record disc is scored on both sides prior to breaking in half.

the result?" the writer wondered. Well, although the idea seemed childish and nonsensical, a test was carried out and, to put matters mildly, the result was remarkable—astonishing and rather unexpected, in fact.

A Queer Result

It is all a queer business. You listen to a tune many times and get to know it, including the voice of the vocalist. You also know the words of the lyric. A record never varies. One can, after repeated hearings, go over the whole recording, memorising every sound, from the introduction to the finale.

The mechanical sameness remains in the mind. It comes as a bit of a surprise, therefore, to hear such a record played when repaired as mentioned. You expect to hear some familiar part of it, and this is so.

At the same time, you imagine that it will make no sense, seeing that its continuity is severely interrupted. In a way, you are right again, particularly where the vocal passages are concerned. What, however, *actually* happens?

We get a "foreign language" effect. This, together with a unique "rhumba" melody, creates a new, amusing record.

As you doubtless know, the song entitled "Some Day, Somewhere, We'll Meet Again" is a waltz melody. The tempo (three beats to a bar) became changed to a rhumba beat, being aided and abetted, so to speak, by the rhythm introduced by the inevitable clicking of the pick-up needle over the joins.

The Reverse Side

The reverse side of the repaired (?) record was tried out. This side used to play "Thinking of You"—a

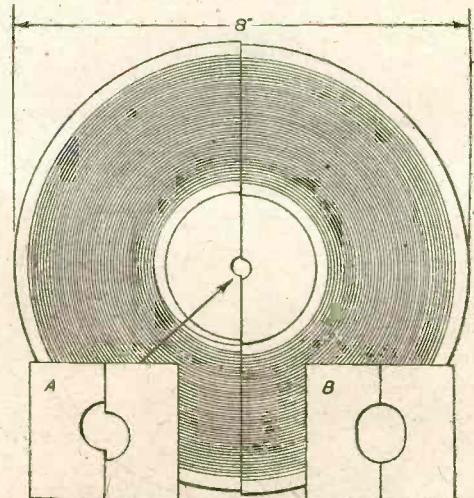

Fig. 2.—How the halves are set together, with one groove out of true alignment. B shows how the spindle hole is treated.

One may, incidentally, refrain from scoring the opposite side. However, it was found that while the composition is easily broken with a single score, the unscored side has a slightly rough, jagged edge. Two cuts keep the roughness to the centre of the thickness of the disc, so that only a little truing with a flat file is necessary.

Alternatively, the cut edges can be trued with a small iron plane, such as a block plane, more particularly if the edges are supported on a woodworker's shooting-board. A fine grade of glasspaper, or emery cloth, held on a flat piece of wood, will, when rubbed along the cut edges; also help to make them level, but there is the possibility of dubbing over the edges so that, when the halves are placed together, a distinct form of "crack" is seen across the disc. The needle, instead of riding easily over the joint, is more inclined to stick and this fault, of course, must be avoided as much as possible.

Joining the Halves

Having cut and trued the halves neatly, place them closely together so that the sound track is out of true alignment by one groove. An exaggerated view is shown at Fig. 2. The left-hand half, it will be noticed, is higher than the right-hand portion. This makes a "face" side, i.e., the side you want to hear played in the normal, but short way, from the introduction to the finale.

Now, while the record is slightly eccentric, by a fraction of an inch, it may be necessary to file the spindle

hole (see A) as shown by the inset, B. The elongated hole enables the halves to be joined out of true by a couple of grooves, should you want to try this out.

The halves are best joined by means of two $\frac{1}{16}$ in. discs of gummed paper and small edge tabs, as indicated at Fig. 3, the latter being sufficiently long for gumming on the other side. The gummed paper holds the halves together in a rigid manner that permits easy, carefree handling.

Other Experiments

Other experiments, which



Using a penknife for scoring an old record

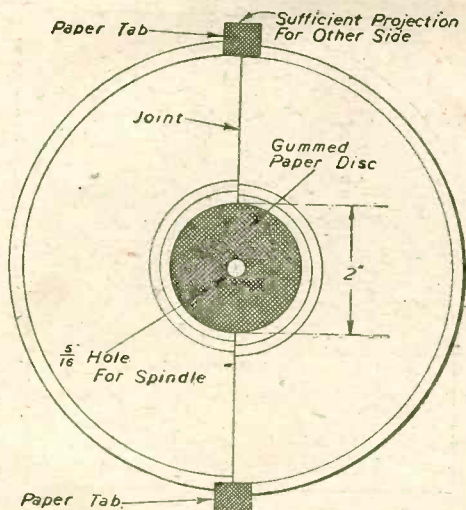

Fig. 3.—How the joint is held by a gummed paper disc and tabs.

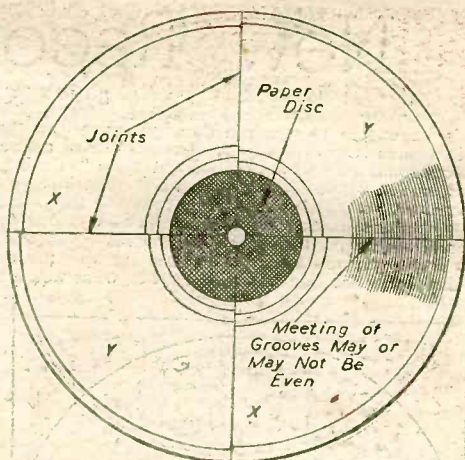

Fig. 4.—A record disc cut into four equal sections, with two sections reversed and placed between the other two sections.

the writer tried, are simple to follow. One of the halves was reversed, this giving a peculiar form of "oriental" music which might be regarded as "light, honourable music" by the Japs. The opposite side gave similar results.

The half sections were then cut to make four quarter segments, as shown at Fig. 4. Two of the segments were reversed (Y) and placed between the other two segments (X). This unusual form of "record" produced a mumbo-jumbo that would sit up and take notice!

As pointed out in the diagram, some of the sound grooves may, or may not, meet evenly, but it is a fault which makes little difference to the muddled recording. Tests carried out with a roin. disc gave equally amusing results.

An old "Columbia" disc playing "What'll I Do?" (a waltz) on one side and "Burning Kisses" (a foxtrot) on the reverse side, created very up-to-date "rhumba" music, particularly the "Burning Kisses" melody, which has a touch of "snake" music, reminiscent of the East, in some of its passages.

Incidentally, a great deal depends on how the records are cut. It is possible to make identical records produce different "music" on account of the varying position of the two joins.

The chorus of most melodies, such as song waltzes and fox-trots, usually consists of 32 bars of music. The first and second 8 bars are very similar, the second lot leading up to the "middle bit" which lasts for another 8 bars. The latter introduces one to the last 8 bars which, again, sound like the first and second 8 bars.

Consequently, one half of a cut record might break the last 4 bars of the first 8 bars and introduce the first 4 bars of the second 8 bars, and so on throughout the whole recording. Thus, the needle is forced to skip certain passages. These same passages, in an identical record cut differently, might be heard. The whole procedure gives plenty of food for thought.

An A.C. Short-wave Four

Details of Coil Stowage Cover, Chassis Sides, and Valve Base Connections

By R. SHATWELL

(Concluded from page 379, August issue)

PLACE one piece on each side of the piece to be joggled, one above the joggle line and the other below, with a gap of about $1/32$ in. between them, and clamp the whole tightly in a vice, lengthwise. The two strips will then force a step in the metal as required, the thickness of the two strips determining the depth of the step. The coil stowage cover is fixed by pushing the joggled end under the outer edge of the hole in the back cover of the set, and drilling through the back at the position the hole in the cover plate takes up. A 4 B.A. nut is then soldered to the inside of the back. The cover then fixes quite securely with a screw. If a thin strip of brass is soldered into the slot

such as detector decoupling, output bias condenser and resistance, and the .5 mfd. across the H.T., are mounted close up to the coil stowage partition. The det./L.F. mica coupling condenser will have fixing holes and is fixed to the back lip of the H.F. shelf with a 6 B.A. countersunk head screw. The .0002 detector grid condenser is screwed to the top of the front panel above the bandspread condenser, and only a 2-in. grid lead is necessary which need not be screened. The aerial coupling condenser is similarly mounted and only a short lead is necessary to the 6K7 grid. If a silver mica condenser is used instead of the foot mounting type it will have to be suspended between the bandspread condenser and 6J7 grid, with the grid leak across it. The .5 mfd. condenser across the H.T. is not shown in the theoretical circuit, but was found necessary to cut out the last trace of hum, caused by the power supply line, which was a multicore cable. No bias condenser is fitted to the L.F. valve, as some slight feedback is obtained by omitting this, which improves the quality and makes the amplifier more stable. The connections to the secondary of the output transformer should be reversed to see if any difference is noticeable and the best position used.

All earthed points in the H.F. and det. stages should be jointed together as well as to the chassis. If this procedure is not carried

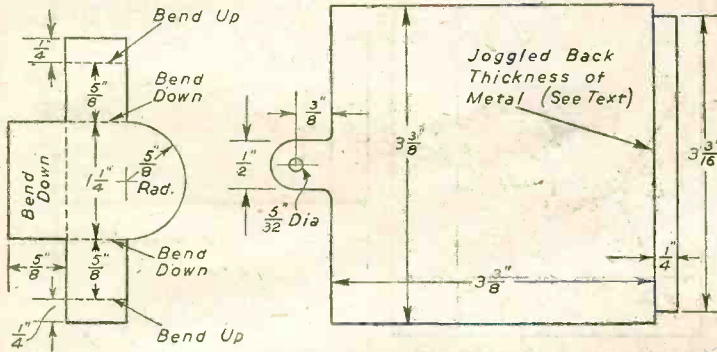

Fig. 6.—Details of coil stowage cover.

on the screw it can be fastened or unfastened without a screwdriver. A similar method can be used with the lid.

The whole set is assembled with 6 B.A. round-headed screws, apart from the bracket carrying the aerial and earth sockets, which requires countersunk head screws so as to clear the cover. If the whole is given a matt black finish and dials fitted, quite a professional appearance results. One method of acquiring a good matt finish is to give the metal a coat of quick-drying enamel, and allow to dry thoroughly. Then, if a piece of cotton wool is soaked in enamel diluted slightly with methylated spirits and held inside a piece of very fine silk, entirely free from fluff, and dabbed over the surface until the enamel is just beginning to go tacky, quite a reasonable surface will be obtained. Try this first on an odd bit of metal, as the type of enamel used makes or mars the finish.

Wiring

The heaters and pilot light are wired with twisted flex, going to the filament sockets on the power input valve holder. H.T.+ goes to the plate of this holder and H.T.— to the grid. It will be found necessary to wire the valveholders and then mount them. The simplest method of wiring is to begin with the output stage and work back, when the H.T. supply will automatically follow on, saving long H.T. wiring. The output transformer is mounted in the set, on the front panel immediately above the power input and pick-up sockets. Wiring will be found to be amazingly convenient if some thought is given to it, and the only long leads are those between the H.F. and L.F. sections. No screened leads are necessary. All the large condensers,

out some rather erratic tuning may result.

The set as described is suitable for use through a vibrapack, if well smoothed, or A.C. mains through a transformer and rectifier. To run as A.C./D.C., the 6AG6 in the output stage would have to be changed for a 25L6 for which the bias resistor is correct, and the heaters would have to be series fed. The main modification would be that the chassis would have to be isolated from the H.T.— line, the only link between the two being by a .01 mica condenser. This would

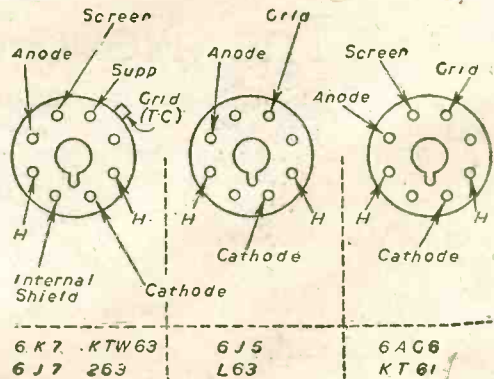

Fig. 8.—Valve base connections.

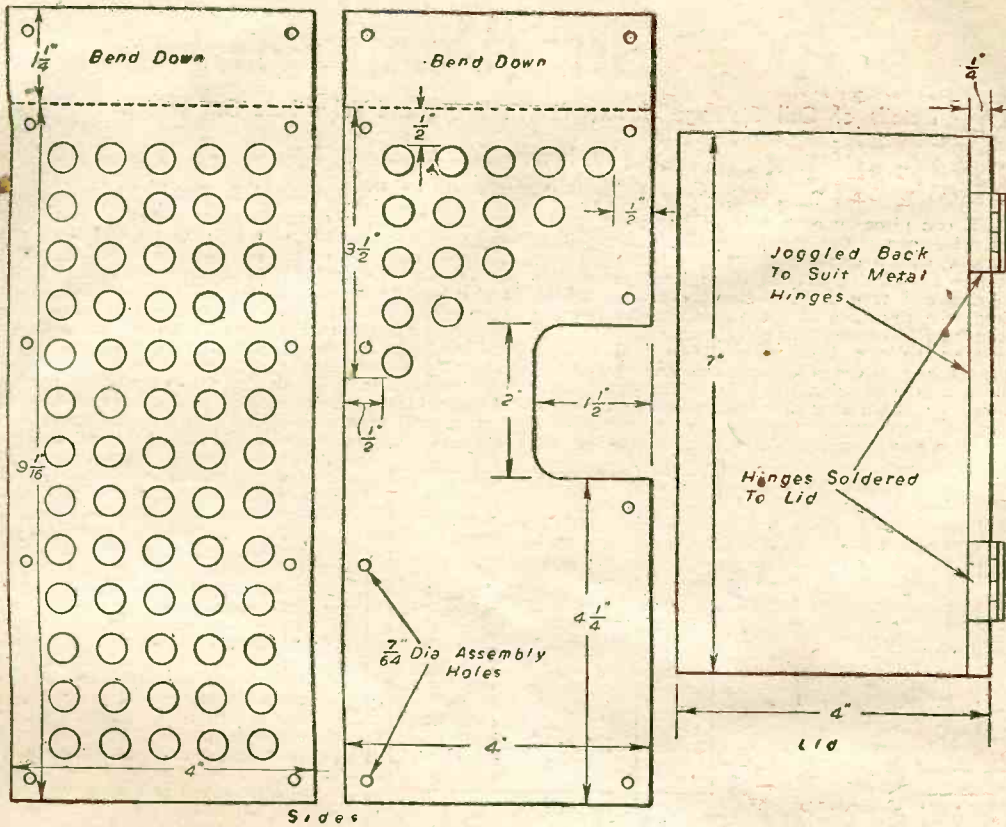

Fig. 7.—Sides and lid of chassis.

mean isolating all controls also. A battery version of this has been used and proved very satisfactory, although, of course, not so powerful. The valves used were SP₂, SP₂, P₂Q₀ and KT₂, and H.F. gain was modified to work on the screen of the first SP₂. Automatic bias was fitted, but a small bias battery could easily

be fitted inside the set, behind the H.T. switch. Finally, if desired, a slide can be fitted in the space under the bandset control to take a card for logging stations that are likely to be used frequently. It should be noted that the H.T. switch is not an On/Off switch, the set must be switched off at the power unit.

The New Wavelengths

THE HOME SERVICE

ENGLAND—

London Region	..	342.1 metres (877 kc/s.).
Midland Region	..	296.2 metres (1,013 kc/s.).
North Region	..	449.1 metres (668 kc/s.). 285.7 metres (1,050 kc/s.).
West Region	..	514.6 metres (583 kc/s.). 203.3 metres (1,474 kc/s.).

SCOTLAND 391.1 metres (767 kc/s.).

WALES 373.1 metres (804 kc/s.).

NORTHERN IRELAND 285.7 metres (1,050 kc/s.).

This list is provisional and may be altered after notice has been given.

THE LIGHT PROGRAMME

1,500 metres (200 kc/s.), a long wavelength receivable over the whole country.

261.1 metres (1,145 kc/s.), for use in urban areas where for technical reasons the long wavelength is not well received.

Electrolytic Condensers

THEIR CONSTRUCTION, USE AND REPLACEMENT

This Article by "The Experimenters" will Answer Many of the Questions which are Frequently Asked Regarding One of the Most Important Components in a Modern Receiver

UNLIKE most components in a piece of radio equipment, electrolytic condensers generally suffer from deterioration and require to be replaced at intervals. Fortunately, the intervals are usually long, but in view of the present difficulties in buying electrolytics, replacement presents a serious problem.

There are probably more electrolytic condensers being made in this country to-day than ever before; why, then, the difficulty in obtaining them? The reason is simply that the Services require as many as are made—and often even more! No doubt the position will now improve, but it will probably be some time before these condensers are again readily available. When the change-over from the manufacture of radio equipment for the armed forces to the production of civilian receivers comes about, one may well expect that set manufacturers will be able to absorb the bulk of the production of condensers for a few months. After that time we may look forward to buying our needs for replacement.

In order to understand why electrolytic condensers tend to "wear out" it is necessary to know something about their form of construction. A knowledge of this will also lead to a more intelligent use of the components.

Condenser Construction

It is well known that the ordinary type of "mica" condenser consists of a multiple sandwich of metal foil and mica sheets. In the case of so-called "paper" condensers, the mica dielectric is replaced by waxed or other specially impregnated paper. When a fixed condenser of relatively high capacity (say above .01 mfd.) is required, it is usual to make a long "sandwich" of metal foil and waxed paper—or to deposit a film of metal on the paper dielectric—and to make this into a "swiss roll." In the ordinary way such a condenser has an appreciable inductance, in addition to the required capacity. The inductance is an undesirable feature and therefore various methods are adopted for reducing the value of inductance. One method is to fit a metal plate at each end of the roll so that the "turns" of the two "inductances" (the foil sheets) are effectively short-circuited. Other methods are also employed, but in any case it is not strictly correct to refer to the condensers as being non-inductive; low-inductance, if you like, but with all the normal methods of construction a certain amount of inductance remains.

High Capacity—Small Dimensions

With all the various types of condenser which have been mentioned, the capacitance, often called capacity is proportional to the area of overlap of the metal plates and the dielectric constant of the insulating material used as dielectric, and inversely proportional to the thickness of the dielectric. By way of example it might be stated that a mica-dielectric condenser in which the mica is .002 (two thousandths) in. thick and the area of overlap of the plates is 15 sq. in., is approximately .007 mfd. This assumes a dielectric constant of 5.5 for mica, which is an average figure for various samples.

In the case of an electrolytic condenser having an effective working area (which will shortly be explained) of 15 sq. in. the capacity would be something like 8 mfd.—more than a thousand times that of the corresponding mica condenser. This at once demonstrates the principal

advantage of the electrolytic type of condenser; far greater capacity in far less space.

The reason for this advantage is two-fold; the dielectric constant of the dielectric employed is about 10; the thickness of the dielectric that can be effectively employed is very considerably less. In fact, a dielectric .00004 in. thick is suitable for use with voltages up to about 500.

Electrolytic Construction

There are various types of electrolytic condensers—wet and dry types in metal containers and dry types in waxed cardboard tubes or cartons. All depend upon the same principle, which is that if a certain chemical liquid is placed between two sheets of aluminium, aluminium oxide will be deposited on the face of one aluminium sheet when a source of D.C. is applied to the two plates. The liquid generally employed is a solution of sodium borate and boric acid in water.

The usual type of wet electrolytic consists of an oxide-coated aluminium rod or tube immersed in the chemical solution. The solution is actually the second electrode, but the outer aluminium case is used to make contact with the electrolyte. Dry electrolytic condensers may be similar in general construction except that the chemical solution is made into jelly form and is soaked into a thin strip of cloth or absorbent paper. In order to obtain a still higher capacity in small space dry electrolytics are often made into a foil-treated paper roll similar to that of the tubular paper condenser, the two wire-end connections being made to the two sheets of aluminium foil.

Condenser Polarity

One extremely important aspect of the electrolytic condenser is that it is polarised; that is, correct positive and negative connections must be carefully observed, or the condenser will be ruined. The aluminium on which the oxide is deposited forms the positive electrode, whilst the dielectric or the second sheet of foil constitutes the negative electrode. In many respects the electrolytic condenser may be regarded as a rectifier, for if D.C. is applied correctly in respect of polarity the condenser will pass a negligible current, whereas if the polarity is reversed a relatively heavy current will be passed and the action of the condenser will be destroyed.

From this it will be clear that electrolytic condensers cannot be used in A.C. or H.F. circuits. Not only would they be useless, but they would very soon break down.

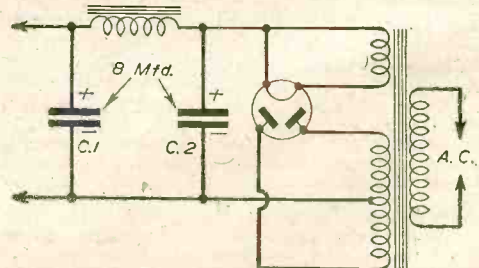

Fig. 1.—A full-wave rectifier and smoothing system, showing a pair of 8 mfd. electrolytic smoothing condensers.

Deterioration

Why do electrolytics deteriorate in use? There are two main reasons. The first is that there is a tendency for the electrolytic eventually to dry up. The second is that in smoothing circuits there is a ripple or fluctuating voltage present. This may in some respects be compared to an alternating voltage, for the rise and fall in voltage may be considered as the backward and forward flow of current; this is true, although the polarity does not in fact change. As a result of this action there is a tendency

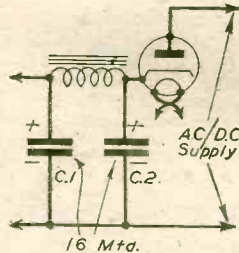

Fig. 2.—A typical half-wave rectifier and smoothing circuit as used in A.C./D.C. receivers.

for the very slow and gradual formation of an oxide film on the surface of the negative electrode. When this occurs the condenser acts as if it consisted of two condensers in series. And we know that the overall capacity of two condensers in series is less than that of either condenser.

In some designs the danger of oxidation on the aluminium negative electrode has been eliminated by the use of plating with a metal such as cadmium, but this is normally applied only to metal-cased condensers, which are to-day less widely used than those built in paper tubes.

Deterioration of tubular electrolytics sometimes shows itself in the form of a sticky chemical which oozes from the ends. This is in part due to leakage of the paste electrolyte, but in some cases it would appear to be due to chemical action resulting from the use of impure electrolyte or aluminium. When slight leakage of this sort is noticed a cure can sometimes be effected by running a little Chatterton's Compound or wax over the crack which will be found between the paper tube and the wax end filling. On the other hand, once this trouble has started it is generally a sign that a replacement condenser will soon be required.

Alternative Condensers

When a new electrolytic is unobtainable it is generally satisfactory to employ a paper condenser of similar capacity provided that there is sufficient space for it, and that a condenser of sufficiently high capacity is available. But paper condensers, of over 350 volts working, are usually far too bulky in capacities over 4 mfd. It will often be found, however, that an 8 mfd. electrolytic smoothing condenser can be replaced by another condenser of only half the capacity without circuit efficiency falling off too severely. In the case of bias-resistor by-pass condensers, which are usually low-voltage 25 mfd. electrolytics, use can often be made of 2 mfd. paper condensers, but these are rather less satisfactory.

Symptoms of Failure

It is not always easy to tell when an electrolytic is failing, but there are various signs which give an indication that the condensers should be tested. For example, if an H.T. smoothing condenser has suffered a loss in capacity mains hum will be more noticeable. In addition, it is often found that the volume level falls and that there is a form of "ripple" superimposed on the reproduction, particularly on speech, which sounds "thin" and "wavery." This result would be noticed should either of the condensers marked C.1 and C.2 in Fig. 1 become open-circuited or should their capacity fall. If C.2 were defective in this respect there would undoubtedly be a reduction in volume level because the

voltage output of the rectifier would be less than when an effective condenser was in use.

If either condenser were to become internally short-circuited, due to a breakdown of the oxide dielectric, there would again be a drop in volume; there might even be a complete absence of signal. In addition, there would be marked overheating of the rectifying valve, transformer and, if C.1 were defective, of the smoothing choke. It is possible that mains hum would be noticeable, but the level of sound of all kinds would be fairly low. The first signs of a smoothing condenser having a low internal resistance would be a falling-off in power and, very often, blue-glowing of the rectifying valve. Continued use of the condensers would probably result in failure of the rectifier due to gross overload.

Precisely the same symptoms—although perhaps more noticeable in character—would be present in the event of faults in the smoothing condensers shown in Fig. 2, which relates to the half-wave rectifier in an A.C./D.C. receiver. There would also be an equal, or greater, risk of the rectifier valve being ruined should the condenser marked C.2 develop a partial or complete short-circuit. It is for this reason, that the smoothing condensers in any receiver should be thoroughly tested before replacing a rectifying valve which has failed in service.

Condenser Testing

It is not quite as easy to test an electrolytic as other types of fixed condenser because of the rectifier action previously mentioned. If an electrolytic is connected across an ohm-meter (remembering to observe correct polarity!), a small current will flow for a few seconds after connection has been made to the condenser terminals. In consequence, the condenser will appear to suffer from leakage. But the current should fall to zero in a few seconds, so that the indicated resistance is in excess of the full-scale reading, which is generally 10,000 ohms. If this is not the case, the condenser should be suspect.

Should a test be made by connecting a source of, say, 6 volts D.C., and then discharging the condenser through a pair of phones, the condenser should be connected to the supply for about five seconds.

Bias by-pass condensers, as shown in Fig. 3, seldom give trouble. This is due to the low voltage at which they require to operate, and to the fact that they are in parallel with a resistor. Should such a condenser become open-circuited there would be a loss in volume because the bias resistor would produce negative feedback. Reproduction quality might be improved, and would seldom be impaired. Short-circuit of a bias condenser would result in marked distortion as a result of the removal of negative grid voltage and consequent overloading of the valve. In addition, the valve would overheat, and there might also be overheating of the H.T. supply circuits consequent upon the increased current drawn by the unbiased valve.

Let us hope that electrolytic condensers will soon be available to the public again in sufficient quantities to ensure replacement of those which fail in service.

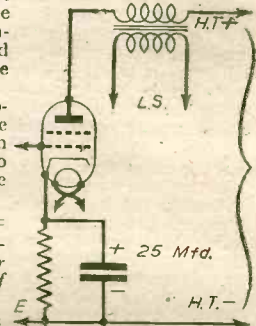

Fig. 3.—An electrolytic condenser acting as by-pass for the cathode-bias resistor of an output tetrode.

REFRESHER COURSE IN MATHEMATICS

8/6 by post 9/-

From: GEORGE NEWNES LTD.

Tower House, Southampton Street, Strand, W.C.2

Sir Ambrose Fleming

The Grand Old Man of Radio: His Pioneer Work for Wireless and Electricity

IN his earlier days he was frequently dubbed the "Wizard of Wireless," this ingenious professor and electrical engineer who was the first to harness a heated filament to the furtherance of wireless communication and electrical science generally, and, afterwards, for years previous to his death, which has recently occurred at Sidmouth on April 19th last at the ripe old age of 95, Sir Ambrose Fleming had often been affectionately styled the "Grand Old Man of Radio."

For Sir Ambrose was not one of your dry-as-dust theoreticians who can do anything with the differential calculus but who, in practice, cannot be relied on to coil half a dozen turns of wire neatly. On the contrary, Fleming was an essentially practical man from the very start. In his lifelong devotion to electricity and wireless, he distinguished himself continually as an engineer, inventor, researcher, discoverer, professor, experimenter and, lastly, but by no means least, as a gifted and capable author and journalist, as a popular expositor of the technical intricacies of wireless science for the multitudes of its intelligent and interested adherents.

John Ambrose Fleming hailed from Lancashire, although he was Scotch by descent. His father, the Rev. James Fleming, was a Congregational minister at Lancaster, in which town the boy Fleming was born on November 29th, 1849.

The lad was brought up on strict yet sensible lines, and, showing an early liking and capability for science, he was allowed to study for such a career. He learnt chemistry under Sir Edward Frankland (himself a Lancaster man) in the old "Royal College of Chemistry," and graduated B.Sc. at London in 1870.

Association with Clerk-Maxwell

Soon afterwards the young graduate took a post as junior science master at Rossall School, Lances, but in 1874 he transferred to an analogous position at Cheltenham College. Three years later he decided to devote himself to further scientific study and experiment. He threw up his teaching and went up to Cambridge, there to become one of the two original research students who worked under the famous electrician James Clerk-Maxwell, in the first days of the now celebrated Cavendish Laboratory. Fleming was

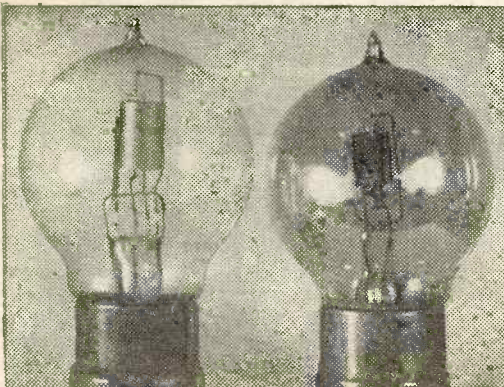

Fig. 1.—A development of Fleming's discovery. Two of the earliest three-electrode valves used for early broadcast receptions.



Fig. 2.—An early Marconi valve dating from about 1914. It constituted the pre-broadcasting development of the Fleming valve.

made a "Foundation Scholar" of St. John's College, Cambridge, and, after taking his Cambridge degree, he was elected a Fellow of St. John's.

Fleming's first research under Clerk-Maxwell was concerned with the British Association standards of electrical resistance. Before he went to Cambridge, Fleming, if anything, had been chemically inclined. Now, under the distinguished aegis of Clerk-Maxwell, electrical science became his ruling passion and his devotion to it remained with him to the end of his days.

Fleming, to some extent, was a man who happened to be born at the right time. The years of his early manhood coincided with the rise of electrical engineering as a science and as a large-scale industry. Owing to his association with Clerk-Maxwell at Cambridge, Fleming, as it were, was able to drink at the fountain head of electrical knowledge, and it was from thence onwards that he gave his heart and soul together with the whole of his amazing mental and physical energies to the furtherance of electrical technology and its utilitarian development.

Eighteen-seventy-four was the year of Fleming's first semi-public appearance as a lecturer, for it was then that he read his first scientific paper to the newly founded London Physical Society. Sixty-five years later, being then in his 90th year, he gave a memorable address to the same society, in which he contrasted vividly the present conditions of scientific research with those obtaining in his early days.

Edison Electric Lighting Company

In 1881, Dr. Fleming (as he was known then) was appointed professor of physics and mathematics in University College, Nottingham, but he did not hold this post for long. Other interests were rising, interests which appealed to him powerfully.

It was in the above-mentioned year that electric lighting first came into practical being, mainly as a

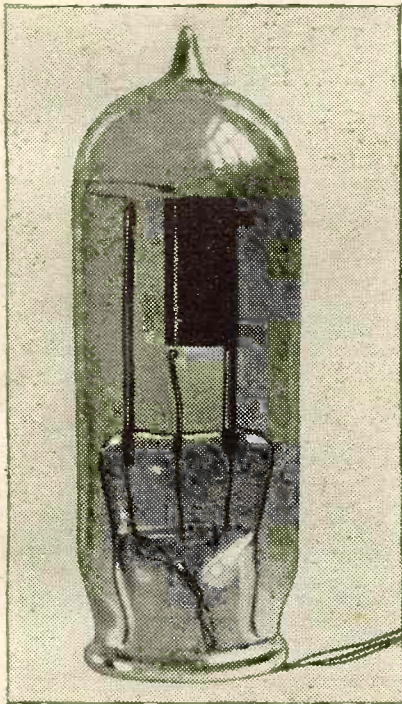

Fig. 3.—A two-electrode valve made on the Fleming principle about 1920.

result of the pioneering experiments of Thomas A. Edison, in America. The Edison Electric Lighting Company was formed in London to exploit the Edison patents, and in the following year (1882) Fleming accepted the post of "electrician" to this pioneer concern, a position which he retained for more than 10 years.

Indeed, at that time Fleming was one of the few who knew anything about electrical engineering. His practical knowledge quickly earned increasing renown for him, so much so that he became appealed to and even pressed from all sides to undertake electrical consultative work.

He became technical adviser to the early London Electric Supply Corporation and to the City of London Electric Lighting Company. At a later date, too, he was appointed expert adviser to the then very infantile Marconi's Wireless Telegraph Company, in which capacity he played a very considerable part in designing the equipment for the earliest Atlantic wireless transmissions.

Despite his many-sided industrial consultative work, Fleming found the time—and the energy—to carry on with his academic career. It was in 1885 that he was appointed to the new professorship of Electrical Engineering in University College, London. Here he placed the then new science of electrical engineering on the curriculum of technical training. Perhaps, indeed, his election to the coveted Fellowship of the Royal Society, which came about in 1892, was, in effect, a recognition of this fact.

Without any doubt, Sir Ambrose Fleming was best known to our present generation in connection with the revolution in wireless communication methods which he brought about by his invention of the two-electrode valve, a device which he patented (No. 24,850) on November 16th, 1904.

The story of the valve's origin has often been told,

best of all, in fact, by its inventor himself. It was Fleming himself who first likened the action of the device to that of a one-way valve. In fact, he termed it an "oscillation valve," and it was at once found to be of value in wireless telegraphy as a detector of radio waves. The Fleming patent was at once acquired by the Marconi's Wireless Telegraph Company, by which it became immediately used.

The Edison Effect

Although the first radio valve was given to the world in 1904, its beginnings may be traced back to 1882, the year of Fleming's appointment as electrical adviser to the Edison Electric Lighting Company, of London. In this technical capacity he was brought into close touch with the early incandescent electric bulbs and the then many problems associated with them. Fleming was particularly perturbed by the essential fragility of the carbon filaments, for they seemed to fracture at the slightest shock. He noticed, too, that after these filaments had been burning for some time, the interior glass of the bulb became darkened.

Edison himself noticed this phenomenon, also. He found that if he placed a small metal plate within the lamp bulb and connected it outside the bulb to the positive end of the filament, he obtained a very feeble current. This discovery was named the "Edison effect," but Edison himself was unable to explain it, nor did he ever try to use it in any way.

The characteristic darkening of the interior glass of the carbon filament bulb, particularly after the filament had suddenly burnt out by overheating, intrigued Fleming. He wondered why such a phenomenon should occur. Then he discovered that almost invariably the darkened lamps had down one side a thin hair-line of clear glass, which looked almost as if a fine point had been drawn down the darkened area, leaving a perfectly clear line behind.

Continuing his investigations, Fleming saw that the clear line was in the plane of the curved carbon filament and on the opposite side to the burnt-out portion of the filament. It at once became clear to him that the unbroken portion of the filament had acted as a sort of screen and that a spray or a discharge of finely atomised carbon had proceeded from the overheated part of the filament, thereby effectively blackening the interior walls of the lamp bulb.

In 1883, Fleming came out with a scientific paper on "Molecular Radiation in Incandescent Lamps." In 1885, further experiments on the same subject caused him to read another paper "On Molecular Shadows."

Sir William Preece, the Post Office engineer, obtained

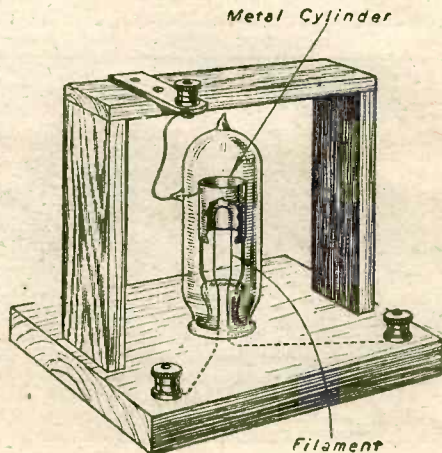

Fig. 4.—A sketch of the original Fleming two-electrode valve.

in 1884, some lamps from Edison, lamps in which the latter inventor had fitted metal plates for the purpose of demonstrating the "Edison effect." Preece dabbled a good deal with these special lamps and confirmed Edison's rather over-publicised "effect." But there Preece left the matter. Perhaps it was beyond him.

Lamp-blackening Problem

Other work claimed Fleming's attention for three or four years, but, in 1888, he reverted to the lamp-blackening problem, and he had a number of special lamps made for him by the old Edison and Swan lamp factory. These Fleming lamps were very strangely shaped. They had long glass side tubes proceeding from them, and others were shaped like a capital "L." The filaments were in every case of a horseshoe shape and were, of course, carbon ones, for the metal filament lamp had not then been invented.

Numerous experiments were conducted by Fleming in his laboratory with these almost fantastically-shaped lamps, and they were described in various Royal Society and Physical Society papers which Fleming wrote. Preece knew of the experiments, but he did not appear to be particularly interested in them. All the same, he was a witness of their accuracy, and he agreed with Fleming's observation that the particle discharge from a heated filament would not twist itself round a right-angled bend. Hence, announced Fleming, the molecular particles apparently travel in straight lines.

Carrying on with his lamp experiments, Fleming's next plan was to enclose the negative leg of the lamp filament in a tiny glass tube. He at once found that the particle discharge promptly ceased. Then he experimented with altered positions of the internal metal plates of the lamps and discovered that, by so doing, he was able to vary the intensity of the particle discharge from the filament.

Electric Particles

Eventually, he tried the effect of placing a miniature metal cylinder round the negative leg of the filament, but without there being any contact between cylinder and filament. At once his indicating galvanometer gave a relatively strong current reading. Clearly, therefore, the metal cylinder was catching all the electric particles which were being emitted from the filament.

At the time of these experiments, the conception of the electron as a particle of negative electricity had not yet arisen. Fleming was surely but slowly groping for the true explanation of the phenomenon, but had not yet arrived at it fully.

He proceeded to experiment with electric arcs in the air and he found that the same type of phenomenon manifested itself. The result was another original scientific paper (published in 1889) on "Electrical Discharge between Electrodes at Different Temperatures in Air and High Vacua."

In many respects, these lamp investigations of

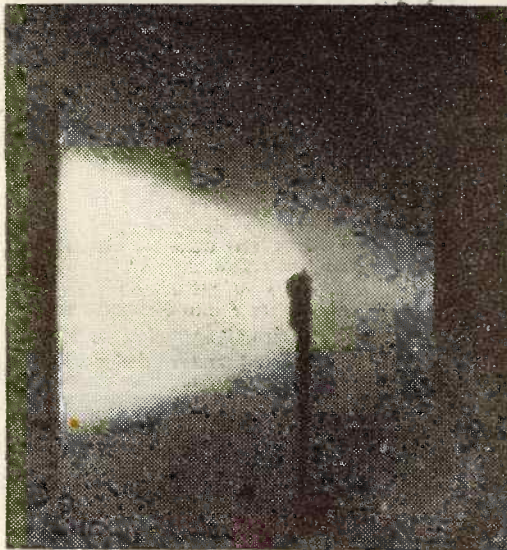

Fig. 6.—A photograph showing the electron's path from the filament to the plate of a specially-constructed valve. A high filament current and an extra-sensitive film were used to record the luminous path.

Fleming were occupations of his leisure hours. They had no direct utilitarian end in view, and, in consequence of the pressing claims of other work, academic and industrial, they became more or less relegated to the background of his electrical studies. It is, however, interesting—and important—to note Sir Ambrose Fleming's statement that before Sir J. J. Thomson had, in 1897, made his discovery of "electrons," he (Sir Ambrose) had recognised the filament emission which took place in his lamps to be due to the projection of negatively-charged particles.

A study of Fleming's original papers will reveal the truth of this historical claim, for therein lies preserved Fleming's own experimental data and evidence showing that by surrounding the negative filament of a lamp with a metal cylinder and by heating the filament to a minimum temperature an electrical current, negative in sign, can be made to flow from the filament to the cylinder, but not from the cylinder to the filament.

The Coherer

It seems clear, therefore, that around the years 1889-1890 the fundamentals of the valve had, in effect, been worked out. Wireless transmission, of course, had not then arrived, and even when, in 1899, Fleming himself was engaged in part of the design for the Marconi Company's first transatlantic transmitter, the idea of hitching his lamp discoveries to the detection of radio waves did not occur to him.

In those early days the "coherer," or tube of metal filings, was used to detect signals, the filings adhering or "cohering" together whenever a signal arrived and thereby providing a conducting path for a current.

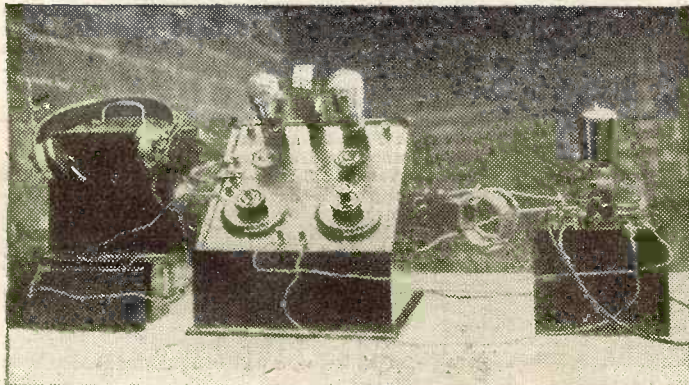

Fig. 5.—Two-valve receiver and note-magnifier. An early reception circuit in popular use after valves had become common.

in 1884, some lamps from Edison, lamps in which the latter inventor had fitted metal plates for the purpose of demonstrating the "Edison effect." Preece dabbled a good deal with these special lamps and confirmed Edison's rather over-publicised "effect." But there Preece left the matter. Perhaps it was beyond him.

Lamp-blackening Problem

Other work claimed Fleming's attention for three or four years, but, in 1888, he reverted to the lamp-blackening problem, and he had a number of special lamps made for him by the old Edison and Swan lamp factory. These Fleming lamps were very strangely shaped. They had long glass side tubes proceeding from them, and others were shaped like a capital "L." The filaments were in every case of a horseshoe shape and were, of course, carbon ones, for the metal filament lamp had not then been invented.

Numerous experiments were conducted by Fleming in his laboratory with these almost fantastically-shaped lamps, and they were described in various Royal Society and Physical Society papers which Fleming wrote. Preece knew of the experiments, but he did not appear to be particularly interested in them. All the same, he was a witness of their accuracy, and he agreed with Fleming's observation that the particle discharge from a heated filament would not twist itself round a right-angled bend. Hence, announced Fleming, the molecular particles apparently travel in straight lines.

Carrying on with his lamp experiments, Fleming's next plan was to enclose the negative leg of the lamp filament in a tiny glass tube. He at once found that the particle discharge promptly ceased. Then he experimented with altered positions of the internal metal plates of the lamps and discovered that, by so doing, he was able to vary the intensity of the particle discharge from the filament.

Electric Particles

Eventually, he tried the effect of placing a miniature metal cylinder round the negative leg of the filament, but without there being any contact between cylinder and filament. At once his indicating galvanometer gave a relatively strong current reading. Clearly, therefore, the metal cylinder was catching all the electric particles which were being emitted from the filament.

At the time of these experiments, the conception of the electron as a particle of negative electricity had not yet arisen. Fleming was surely but slowly groping for the true explanation of the phenomenon, but had not yet arrived at it fully.

He proceeded to experiment with electric arcs in the air and he found that the same type of phenomenon manifested itself. The result was another original scientific paper (published in 1889) on "Electrical Discharge between Electrodes at Different Temperatures in Air and High Vacua."

In many respects, these lamp investigations of

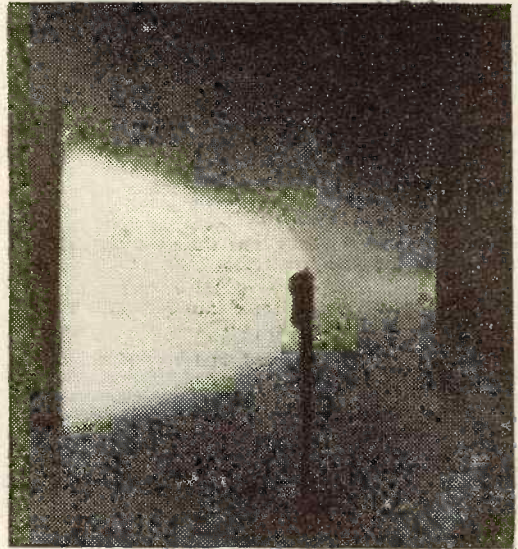

Fig. 6.—A photograph showing the electron's path from the filament to the plate of a specially-constructed valve. A high filament current and an extra-sensitive film were used to record the luminous path.

Fleming were occupations of his leisure hours. They had no direct utilitarian end in view, and, in consequence of the pressing claims of other work, academic and industrial, they became more or less relegated to the background of his electrical studies. It is, however, interesting—and important—to note Sir Ambrose Fleming's statement that before Sir J. J. Thomson had, in 1897, made his discovery of "electrons," he (Sir Ambrose) had recognised the filament emission which took place in his lamps to be due to the projection of negatively-charged particles.

A study of Fleming's original papers will reveal the truth of this historical claim, for therein lies preserved Fleming's own experimental data and evidence showing that by surrounding the negative filament of a lamp with a metal cylinder and by heating the filament to a minimum temperature an electrical current, negative in sign, can be made to flow from the filament to the cylinder, but not from the cylinder to the filament.

The Coherer

It seems clear, therefore, that around the years 1889-1890 the fundamentals of the valve had, in effect, been worked out. Wireless transmission, of course, had not then arrived, and even when, in 1899, Fleming himself was engaged in part of the design for the Marconi Company's first transatlantic transmitter, the idea of hutching his lamp discoveries to the detection of radio waves did not occur to him.

In those early days the "coherer," or tube of metal filings, was used to detect signals, the filings adhering or "cohering" together whenever a signal arrived and thereby providing a conducting path for a current.

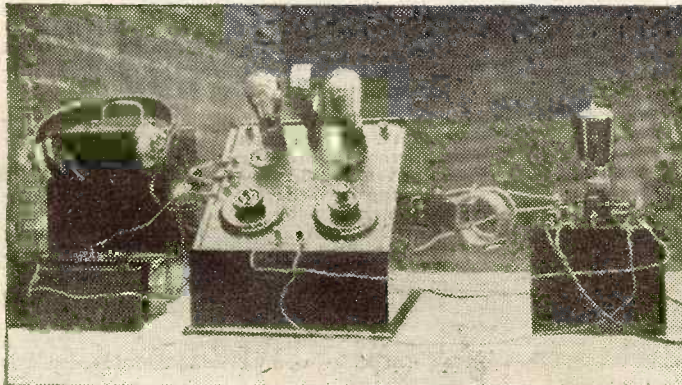

Fig. 5.—Two-valve receiver and note-magnifier. An early reception circuit in popular use after valves had become common.

But, at its best, the coherer was a clumsy and uncertain device, for the metal filings played all sorts of tricks and they had to be mechanically tapped apart after they had cohered together following the arrival of a signal in order that they could again become free to detect a further signal.

Fleming realised that what the radio receiving station required was a device which would comb out or rectify the radio-received current oscillations and which would convert them into one-way current impulses. He spent a considerable time in experimenting with various complicated chemical rectifiers. Marconi himself improved on the coherer by inventing the magnetic detector, and a few years later came the carborundum and silicon "crystal" detectors.

Faced with the failure of his chemical rectifiers, another line of thought came into Fleming's mind.

"Why not try the lamps?"

He went to his cupboard and rooted among the accumulations to be found therein. The old filament lamps which he had previously experimented with were there intact. Aided by an assistant, he constructed an oscillatory circuit comprising two Leyden jars, a large frame-wound coil and an induction coil. He then made another circuit in which was inserted one of the lamps and a galvanometer. This latter circuit was tuned to the same frequency as the first one.

Birth of the Valve

It was at five o'clock in the evening, Fleming records, when the two circuit hook-ups were finally completed.

Oscillations in the primary circuit were at once started, and Fleming had the immediate delight of perceiving that a steady flow of current passed through the lamp circuit and was plainly indicated by the galvanometer.

The rectifying valve had been born.

For the invention of his thermionic valve principle, the Royal Society of Arts awarded to Dr. Fleming its highest distinction, the Gold Albert Medal, in 1921. The Royal Society, at an earlier date (1910) also conferred on him its gold and silver Hughes Medals.

The "N.P.L."

As far back as 1885, Fleming read a paper before a meeting of the Institution of Electrical Engineers (of which he was then vice-president) in which he stressed the paramount necessity of establishing a national standardising laboratory for scientific apparatus and equipment. It was this paper which gave the first impulse to a movement among scientists, which movement ended ultimately in the foundation of the now celebrated National Physical Laboratory at Teddington, Middlesex.

Dr. Fleming was author of many books. His "Principles of Electric Wave Telegraphy" was for many years a standard work on wireless, and is now a radio classic. He was a writer of popular articles, too; and, as a particularly lucid and delightful lecturer on popular electrical subjects, he was well known by audiences at the Royal Institution, the Royal Society of Arts and other societies.

The crowning honour of knighthood came to him at a later date and during his retirement from the majority of his former activities.

The New Programmes

THE HOME SERVICE.—The Home Service will be radiated from 6.30 a.m. to midnight each weekday, and on Sundays from 8.0 a.m. to midnight.

NEWS.—News broadcasts will be timed for 7.0 and 8.0 a.m., and 1.0, 6.0, and 9.0 p.m., with a News Summary at 11.0 p.m. All bulletins will last for 10 minutes, except the most widely listened to 9.0 o'clock News, which will be a quarter-hour bulletin. The midnight News will be dropped, as will the 7.0 a.m. bulletin on Sundays. "News Letter" on Sundays at 7.30 p.m., contributed by the B.B.C. News Division, will review the happenings of the past seven days. "Programme Parade" will now be heard three times daily during the week.

DRAMA.—"Saturday Night Theatre," one of the most widely appreciated programmes of the week, retains its place in the Home Service.

VARIETY.—Listeners will be given three big variety shows weekly on Monday, Thursday and Saturday, as well as a considerable number of smaller shows on the other days of the week.

MUSIC.—There will be two big events each week, on Wednesday evenings, and on Sunday afternoons. On Wednesdays the B.B.C. Symphony Orchestra will continue to broadcast from the Albert Hall every other week, and there will be studio operas and concerts of "music of our time" to alternate with these broadcasts.

OUTSIDE BROADCASTS.—The Home Service hopes to take the microphone to the people wherever there is festival, excitement, tradition in this and other lands.

TALKS.—Talks will not invariably follow the 9.0 o'clock News, but this time on Sunday nights will be reserved for major personalities, who will be heard talking on some subject of topical or enduring interest. "Foreign Affairs" and "War Commentary" will alternate on Mondays at 9.15, "American Commentary" is continued on Thursdays, and on Fridays talks by B.B.C. correspondents abroad will be featured.

SPORT.—Sport in the Home Service will largely be a matter of magazine reconstruction after the event.

THE LIGHT PROGRAMME.—This new programme will be radiated from 9 a.m. till midnight every day.

NEWS.—News in the Light Programme will be heard at 9 a.m. and 12.30, 7, 10 and 11.50 p.m.

STAR SERIES.—Richard Tauber, the Scottish comedian, Harry Gordon, Robb Wilton and Max Wall are among the stars who will appear in a special series of shows for the Light Programme.

THRILLERS.—"The Armchair Detective," a weekly review of detective fiction with dramatised excerpts from the books reviewed, and a new Peter Cheyne series are scheduled for immediate performance. "Appointment with Fear" and Paul Temple will both return to the air on the Light Programme in September.

BANDS.—First-class brass bands and military bands—there is no country in the world with greater instrumental talent of this kind than Great Britain—will be heard at times when the many, and not merely the few, can hear them.

PLAYS AND FEATURES.—A special series of "From the London Theatre" will be broadcast on Wednesday evenings, with a repeat on the following Sunday. "The Robinson Family," a five-day-a-week serial, which began in the Overseas Service in 1941, and chronicled the doings of a typical British family in wartime, will now be heard for the first time by British listeners. "Saturday Night Theatre" will have its place in the Light Programme, too, when it is repeated on Sunday afternoons.

BEEES AND QUIZZES.—General knowledge tests of differing types will have a home in the Light Programme from the Sunday "Transatlantic Quiz."

THEATRE ORGANS.—There will be considerably more theatre organ broadcasts in the new programme.

RECORDS.—"Forces' Favourites" will now appear in the Light Programme on Mondays and Fridays, with a companion request programme, "Family Favourites," on Wednesdays.

TALKS.—The Light Programme will have its own book and film critics, who will be heard on Wednesdays and Thursdays.

Use **ERSIN** **MULTICORE** **SOLDER**

contains 3 cores of
non-corrosive Ersin Flux

Radio Experimenters are now able to use "The finest Cored Solder in the World," Ersin Multicore. The three cores of extra active flux ensure speedy soldering and eliminate high resistance or dry joints.

Available from electric and radio shops, ironmongers, etc.

Nominal 1-lb. reels:

13 S.W.G. 4/10 ea.

16 S.W.G. 5/3 ea.

Size 2 cartons:

16 S.W.G. 6d. ea.



**MULTICORE SOLDERS LTD. COMMONWEALTH HOUSE,
LONDON, W.C.1. Tel. CHAncery 5171/2**

CELESTION

LOUDSPEAKERS

From 2½ to 18 inches diameter

VALVEHOLDERS

Full range of British & American types.

Celestion Limited
Kingston-upon-Thames
Telephone: KINGston 5656-7-8

Exide

IN PARLIAMENT

In the House of Commons :

Mr. EVELYN WALKDEN asked the President of the Board of Trade why 120-volt Exide Batteries which are sold at 11s. 1d. are in short supply and other 120-volt batteries of less reliable make, and sold at 15s. 6d., only are available . . .

Mr. DALTON : Wireless batteries are now in short supply, owing to the heavy demands of the Services, and it is necessary, therefore, to make use of the output, although small, of the higher cost producers. Prices are controlled under the Price of Goods Act, 1939, and those charged for both classes of battery referred to by my Hon. Friend have been investigated and approved by the Central Price Regulation Committee.

Mr. WALKDEN: While appreciating what my Right Hon. Friend has said, is he not aware that batteries are used largely by people in small homesteads who cannot understand why good batteries cannot be obtained while there is a plentiful supply of inferior ones. . . ?

Mr. DALTON : I am very anxious to get a fair distribution of whatever supplies there are, but the best batteries are required for the Services in a very great and increasing quantity. . . .

(Extracts from Hansard, Jan. 16)

**THE CHLORIDE ELECTRICAL STORAGE
COMPANY LTD.**

GROSVENOR GARDENS HOUSE · LONDON · SW1

Use **ERSIN** **MULTICORE** **SOLDER**

contains 3 cores of
non-corrosive Ersin Flux

Radio Experimenters are now able to use "The finest Cored Solder in the World," Ersin Multicore. The three cores of extra active flux ensure speedy soldering and eliminate high resistance or dry joints.

Available from electric and radio shops, iron-mongers, etc.

Nominal 1-lb. reels:
13 S.W.G. 4/10 ea.
16 S.W.G. 5/3 ea.

Size 2 cartons:
16 S.W.G. 6d. ea.



MULTICORE SOLDERS LTD. COMMONWEALTH HOUSE
LONDON, W.C.1. Tel. CHAncery 5171/2

CELESTION

LOUDSPEAKERS

From 2½ to 18 inches diameter

VALVEHOLDERS

Full range of British & American types.

Celestion Limited
Kingston-upon-Thames
Telephone : KINGston 5656-7-8

Exide

IN

PARLIAMENT

In the House of Commons :

Mr. EVELYN WALKDEN asked the President of the Board of Trade why 120-volt Exide Batteries which are sold at 11s. 1d. are in short supply and other 120-volt batteries of less reliable make, and sold at 15s. 6d., only are available . . .

Mr. DALTON : Wireless batteries are now in short supply, owing to the heavy demands of the Services, and it is necessary, therefore, to make use of the output, although small, of the higher cost producers. Prices are controlled under the Price of Goods Act, 1939, and those charged for both classes of battery referred to by my Hon. Friend have been investigated and approved by the Central Price Regulation Committee.

Mr. WALKDEN: While appreciating what my Right Hon. Friend has said, is he not aware that batteries are used largely by people in small homesteads who cannot understand why good batteries cannot be obtained while there is a plentiful supply of inferior ones. . . ?

Mr. DALTON : I am very anxious to get a fair distribution of whatever supplies there are, but the best batteries are required for the Services in a very great and increasing quantity. . . .

(Extracts from Hansard, Jan. 16)

**THE CHLORIDE ELECTRICAL STORAGE
COMPANY LTD.**

GROSVENOR GARDENS HOUSE · LONDON · SW1

*It's the hidden
details that
count*

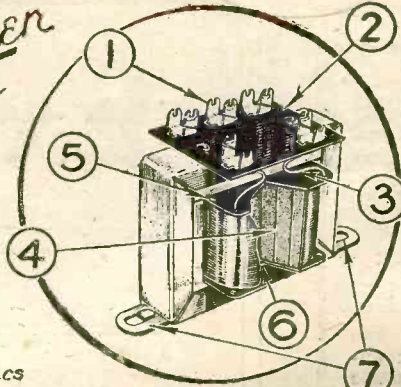

The choice of Critics

A.F. Voltage and Small-power Transformers and Chokes for all types of electronic apparatus, in all normal ratings and in a diversity of physical sizes.

- 1—Heavily silver-plated non-rotatable solder-tags for connections.
- 2—Tropic-grade synthetic-resin-bonded tag boards for high insulation resistance under all conditions.
- 3—Colour-coded leads, welded to instrument-wire in bobbin.
- 4—Layered and sectionalised windings of highest-grade h.c. instrument wire.
- 5—Synthetic-resin-bobbin holding windings in immovable formation.
- 6—Bobbin and windings vacuum-impregnated and coated waterproof materials.
- 7—Core shrouded and tightly clamped with maintained iron-circuit and fixing centres.

Over 100 Types to choose from

(State priority Nos. when ordering).

BULGIN

A. F. BULGIN & CO., LTD.

BYE-PASS ROAD, BARKING, ESSEX.

RIPPLEWAY 3474 (5 lines)

(The Name "BULGIN" is a registered Trade Mark)

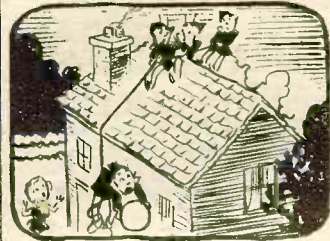

The "Fluxite Quins" at Work.

"This aerial's too weighty for me;
Lend a hand, you chaps!" hollered EE.
"We shan't finish to-night.
Where's that lad with FLUXITE?"
"Pull hard," shouted OI, "and you'll see."

See that **FLUXITE** is always by you—in the house—garage—workshop—wherever speedy soldering is needed. Used for over 30 years in government works and by the leading engineers and manufacturers. Of all ironmongers—in tins, 8d., 1/4 and 2/8.

Ask to see the **FLUXITE POCKET BLOW LAMP**, price 2/6.

To **CYCLISTS**: Your wheels will NOT keep round and true unless the spokes are tied with fine wire at the crossings and **SOLDERED**. This makes a much stronger wheel. It's simple—with **FLUXITE**—but **IMPORTANT**.

The **FLUXITE GUN** puts **FLUXITE** where you want it by a simple pressure. Price 1/6, or filled, 2/6.

ALL MECHANICS WILL HAVE

FLUXITE

IT SIMPLIFIES ALL SOLDERING

Write for Book on the **ART OF "SOFT" SOLDERING** and for Leaflets on **CASE-HARDENING STEEL and TEMPERING TOOLS with FLUXITE**, also on **"WIPED JOINTS."** Price 1d. EACH.

FLUXITE LTD. (DEPT. W.P.)
BERMONDSEY ST., S.E.1.

The B.B.C. Monitoring Service

Interesting Particulars of the Remarkable British Listening Post

NOW that the war in Europe is ended the inside story of the B.B.C.'s Monitoring Service can be told. This service was undertaken throughout the war by the B.B.C. on behalf of the Ministry of Information, and its results have been used by the late War Cabinet, by the military and naval services, and by the Press of the free world. From a small listening post, consisting of a few young men, the Monitoring Service has grown to an elaborate organisation employing

Von Krosigk's broadcast announcing the liquidation of the German Eighth Army on February 17th, 1945, was flashed out within six minutes and reached Washington five minutes before the Associated Press carried the news as urgent.

The news of the capture of Rome, broadcast by our own United Nations Radio, was flashed out within seven minutes, while Rumania's acceptance of the Soviet peace terms on August 23rd was circulated so quickly that at least one of our own newspapers, a provincial daily, was baffled to receive the news on its rebound from Washington some 20 minutes later.

The word "monitor" requires explanation. Before the war there was, by international agreement, a technical station at Brussels which checked on all wavelengths and warned broadcasting stations when they wandered too far off their allotted frequency. This, a machine, was the "monitor," Latin for adviser.



Fig. 1.—The editorial room, where the daily digest is prepared.

over 600 persons of various nationalities and monitoring, at its peak, a million and a quarter words a day.

This remarkable organisation, which is the largest listening post in the world, is now stationed in a rambling country mansion at Caversham, near Reading, and in its lofty rooms the various departments are housed.

News Flashes

Among the various achievements of the Monitoring Service, it may be mentioned that when Karen fell the news was picked up in Arabic from a Cairo transmission and flashed to the Prime Minister 10 minutes before the operational telegram from the War Office arrived. When Mussolini resigned, Monitoring picked up the news in Italian at 22.51 D.B.S.T., flashed it to News Department of the B.B.C. at 22.53. At 22.58 it was on the air in B.B.C. news for Europe in English. At 22.59, having been written in Spanish, checked and revised, it went out on the B.B.C. Spanish Service.

When Holland was invaded Hilversum was putting out, minute by minute, "Parachutists over . . . parachutists coming down . . ." Monitoring were phoning these messages through to the Air Ministry before the parachutists had touched down.



Fig. 2.—The Hellschreiber machine, that tapped Goebbels news and service instructions to his network of newspapers and broadcasting units.

Official listening-in to other nations' broadcasts did actually start in this country—done by the B.B.C.—as long ago as the Italo-Abyssinian campaign. But the application of the word "monitor" to such listeners, derived from the Brussels machine, did not occur until the time of Munich. The Monitoring Service of the B.B.C. did not become a definite unit until the late summer of 1939.

Before the German surrender it was listening to about one and a quarter million words a day in 32 languages. Some 300,000 words were daily transcribed into English, of which approximately 100,000 words were published in a Daily Digest of World Broadcasts, and twenty-five to thirty thousand a day flashed as an urgent service on teleprinter to 19 War, Government and B.B.C. departments. In addition, the daily Monitoring Report, giving the main slants of world radio propaganda and news and a short daily report for the War Cabinet offices, were issued. Specialists were catered for in the German, French and Italian languages by the production daily of a miniature Digest in these languages, and certain special services in the language as broadcast were given to selected centres, either as a standing dish or by special request, from time to time.

The Hellschreiber Machine

Morse messages, as well as speech, are also monitored, while the Hellschreiber machine is an intriguing instance of the engineer being hoist by his own petard. A German invention, it does for radio what the tape machine does by land-lines. An elaborate Hellschreiber organisation was used by Goebbels for service and instructions to his network of newspapers and broadcasting units all over Germany

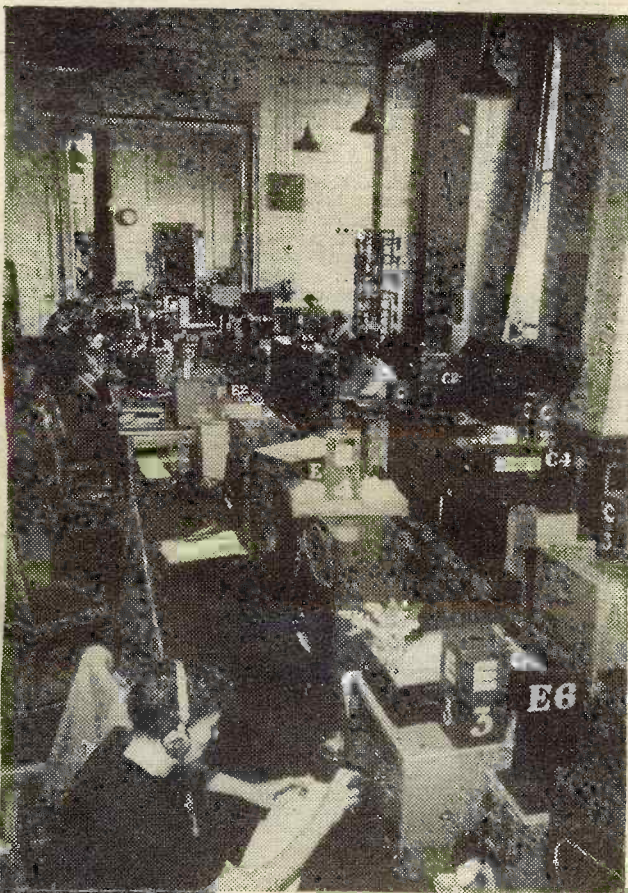

Fig. 4.—The main listening room.



Fig. 3.—Part of the Morse room.

and Occupied Europe. The B.B.C. secured one, and then more, of these machines, and were able to monitor fully both his instructions and news. This was kept secret at first, since we did not know whether the Goebbels outfit knew or suspected that we were eavesdropping systematically on all his private whispers; or whether, though he knew it, he could do nothing about it, since his own Hellschreiber organisation was too valuable and elaborate to be scrapped.

All main voice broadcasts are not only heard by the individual "monitors" (the actual listeners), but are simultaneously recorded on equipment very similar to that of a dictaphone, to ensure that what the monitor hears can be checked again. The moment a monitor has finished his (or her) spell of listening and made such notes as he requires for his own guidance, he goes into the Information Bureau to "confess." This means that he reports every item monitored to a supervisor who is versed in the requirements of all consumers of the service. This supervisor indicates the appropriate treatment

(Continued on page 431)



ON YOUR WAVELENGTH

By THERMION

Tuning Coils

IN the earliest days of broadcasting selectivity was not an urgent problem, as stations were few and low in power. In addition listeners did not expect really good quality, and consequently no one was disappointed. In any case, it is doubtful if the loss of quality caused by inefficient tuning would be apparent above the general distortion of the poor speakers of the period. Looking backwards, during the past 20 years, it seems that the tuning coil has gone through more evolution of shape than any other component. For many years the two-pin coils with standard main held sway. At the beginning of broadcasting the only characteristic possessed by a coil was the ability to tune it to the wavelength required, and the question of heavy losses was entirely forgotten. This was to some extent beneficial, as it compensated for the unsuitability of the three-electrode valve as a high-frequency amplifier. A little later several types of tuning coil made their appearance that were designed to overcome some of the disadvantages of the previous models. Among them was the honeycomb coil, which possessed extremely low self-capacity, but had the disadvantage of an increased high-frequency resistance and consequently gave rise to flat tuning. The first really efficient coil was so arranged that every turn was air-spaced from its neighbour and, in addition, each turn was practically a true circle.

Plug-in Coils

THE old plug-in coil is still in use to some extent to-day and whatever may be said against it, it possesses the advantage of extreme flexibility and gives the user a possible range of from 3-25,000 metres. The plug-in coil properly made and wound can have an efficiency of at least 70 per cent. of the modern screened coils.

The successor to the plug-in coil was the 6-pin type, which for many years was considered to be the last word in design, but these coils still had the disadvantage that they had to be changed for long and short wavelengths, and the multiplicity of pins often resulted in a momentary wrong connection, with occasional disastrous results. This juncture marked the beginning of the dual-range coil, which, although used almost exclusively to-day, was far from popular, as the small permissible amplification of an ordinary three-electrode valve was such that the losses thus introduced by the dual-range switch and unused winding could not be tolerated. The neutrodyne circuit became very popular and necessitated a special type of coil. The reason for the introduction of this circuit was that valves had reached the stage of efficiency where the condenser effect between grid and anode caused terrific instability and oscillation, unless some means were introduced to stop it. This could take the form of an inefficient coil, or a potentiometer to apply a small positive bias to the valve grid, but both those methods were unsatisfactory, as they either ruined selectivity or range, or both. The function of the

neutrodyne was to balance out the troublesome grid anode capacity by means of a small condenser adjusted so that an equal amount of energy was fed from anode to grid in reverse to that fed through the capacity of the valve itself.

Screening

FOLLOWING immediately on the problem of efficient coil design came the question of adequate screening one from the other. A common form was the 6-pin coil in a copper can, but such an arrangement was unsatisfactory, as the proximity of the metal to the coil greatly reduced the efficiency of the latter, and to overcome this difficulty two special forms of coil were introduced. One was the binocular coil, which consisted of two coils, usually small, placed side by side so that the field was limited, and the other was the toroidal coil, which was wound on a small mandrel like a spring, and then curved round until it resembled an unduly bulky curtain ring. Both these arrangements had the great disadvantage that far more wire was necessary to reach the tuning range, which resulted in an increase of H.F. resistance and impaired selectivity. Just before the advent of the screen-grid valve, super-high efficiency, low-loss coils appeared. Whatever may have been the merits of this type of coil when used in some form of neutrodyne circuit, there is much to be said against it when used with a screen-grid valve.

The position to-day is that the screen-grid valve is of very high efficiency indeed, and when associated with a really efficient coil it becomes almost impossible to make the set stable. In fact, with a modern type of mains screen-grid valve and a 4-in. low-loss coil, nothing less than $\frac{1}{16}$ in. sheet copper with soldered joints is adequate for screening. Therefore, for practical purposes, two combinations suggest themselves. A high-efficiency valve with a medium-efficiency coil, or vice versa; as the efficiency of the coil will be impaired by the presence of the necessary screening, anyway, it is obvious that the first arrangement is preferable.

I have a full collection of all types of coil, and it is interesting to look back on our early components.

THE B.B.C. CHARTER

[The time draws near when the B.B.C. Charter is due for revision.]

The time draws near when we can kick;

Let's exercise our vision.

We need to make our voices heard

When subject is "Revision."

The pipers look to us for pay—

Should we not call the tune?

The moment to decide this point

Is coming very soon.

Or must We take what They decide

And never dare to grouse?

Surely the one who pays the rent

Is Master of the House?

Or can be if he has the pluck

To let not servants rule,

To pay and let them call the tune

Spells "Master is a Fool."

For items Most of Us dislike

Our fiat should suffice,

Whilst others should not be wiped out

So long as we say "Nice."

When Windbags bore us at the mike,

When crowscrites scream and shout,

Surely we ought to have more power

To order them "Get Out!"

Soon comes our chance—don't let it pass,

Be unperturbed by fears.

Remember, if we miss this chance

We're ticked for ten more years. "TORCH."

Our Roll of Merit

Readers on Active Service—Fifty-seventh List

G. O. T. Kibbler (Lieut., R.E.M.E.).

J. A. Hawkins (L/Cpl., R.E.M.E.).

A. R. M. C. Lennon (Gnr., C.M.F.).

H. G. Swan (Driver, Malta Force).

N. Taylor (A.C.I., R.A.F., S.E.A.A.F.).

C. Clarke (L/Cpl., B.L.A.).

C. Brooks (L.A.C., R.A.F.).

W. Hardwick (L/Cpl., C.M.F.).

Midget Battery Three

Constructional Details of a Compact and Satisfactory Receiver

As the illustrations show this receiver is a neat and compact model complete with speaker, yet nothing in the way of efficiency has been sacrificed to reduce dimensions, and the set gives a very satisfactory performance. Fig. 1 shows the circuit—a H.F.-Det-Pen. with V.M. volume control, two tuned circuits and transformer coupling between the detector and output stages. A small moving coil speaker is used, with matching transformer.

Layout

The layout is shown in Fig. 2. The chassis is made from wood, a piece of 3-ply $9\frac{1}{2}$ in. by $4\frac{1}{2}$ in. being used for the top and two strips of $\frac{3}{4}$ in. thick wood $1\frac{1}{2}$ in. wide for the two side runners. Another strip of plywood screwed to the rear ends of the side runners forms the back, as shown in Fig. 3. It will be seen that one corner of the chassis is cut off, and that the speaker is slightly back from the front edge. This is to enable the set to fit in the cabinet mentioned later.

The rear runner of the chassis should have a hole drilled for the battery leads, and also a terminal insulated from the wood with ebonite washers for the aerial connection. This will be seen in the diagrams.

The three valveholders are secured below the chassis with small bolts, and it will be necessary to cut a small piece from the shorter side runner to enable the output valveholder to be fitted. To simplify wiring their sockets are best arranged as shown in Figs. 2 and 3.

The reaction condenser and combined volume control and switch are mounted on a small panel bent up from a scrap of metal. It has a flange to bolt to the underside of the chassis, and is also screwed to the front of the longer runner. It should be noted that this method of fixing renders the spindles of the two components

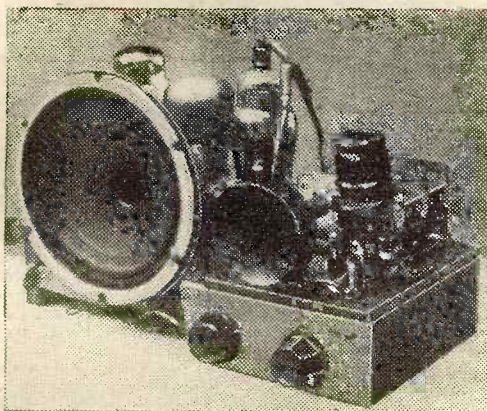

Front view of chassis.

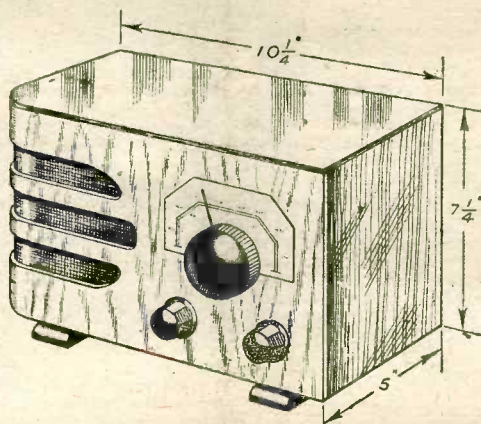

Fig. 4.—The cabinet with dimensions.

common, and this must be remembered as some volume controls have the spindle in contact internally with the slider of the potentiometer element. If this is the case with the one used it will be necessary either to insulate the potentiometer from the metal or use a small plywood panel for the components.

The detector coil (winding details of which will be given later) is fixed to one runner by means of a small bracket, and the L.F. transformer to the other, as shown in Fig. 3.

The magnet of the speaker rests on the top of the chassis, and a V-shaped portion of the chassis will have to be removed to accommodate the cone. The size of this will depend upon the actual speaker used, and no difficulty should arise. Small brackets are then made which bolt to the holes normally used for fixing the speaker to the baffle and to the chassis. These will need to be of fairly stout material, and a third bracket at the back of the speaker will make it quite secure.

The output transformer is screwed at one side of the speaker, and the coupling H.F.C. at the other. If the latter component is meant to mount upon a metal chassis and is open at the bottom, then a disc of metal (zinc is suitable) should be cut for it to stand on. This is earthed with the circular screen to prevent stray interaction.

It will be seen that the tuning condenser is at the back of the chassis, the spindle being extended. This was done to admit of the two tuning coils being kept well away from each other, as the chassis is not screened. The coils are also at right-angles, and if the layout is followed no H.F. instability should result.

Insulated wire should be used for connecting up, and the smaller parts are suspended in the wiring. It was not found necessary to screen any of the leads, although the lead from the anode of the H.F. pentode could be screened if instability should arise.

Long pieces of flex plaited together form the battery cable, so that the batteries can be placed out of sight in a cupboard, which has much to recommend it. The

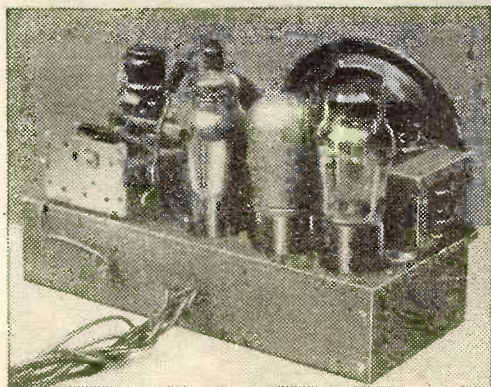

Rear view of chassis.

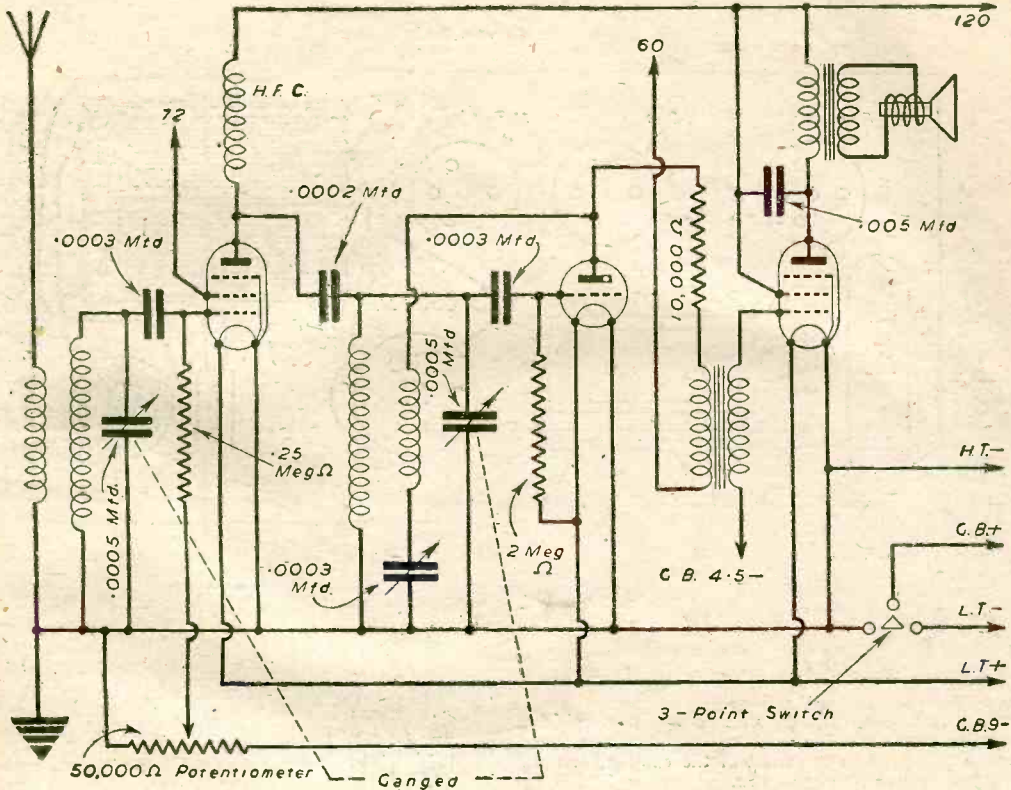

Fig. 1.—Theoretical circuit diagram.

earth connection was made to L.T. minus, although an earth terminal can be fixed on the rear runner if desired.

When completed, the valves should be inserted and batteries connected up. Two small knobs are fitted to the potentiometer and reaction condenser, and a large knob with pointer to the tuning condenser. The receiver may then be tried upon various parts of the wave-range and the trimmers on the gang condenser adjusted for maximum response. This will be easier if volume is kept low, as a loud signal does not provide such an accurate tuning point. It should be noted that reproduction will not be at its best until the set is placed in a cabinet, as the speaker as it is mounted on the chassis has no baffle whatever.

Coils

These are wound on 1in. diameter varnished cardboard tubes; 90 turns of 32 S.W.G. enamelled wire form the grid windings of each. The reaction winding is 55 turns of similar wire wound 1/4in. below the grid coil. The aerial coupling winding is similarly placed on the H.F. coil, but only 30 turns are used. Fig. 3 shows the connections to the detector coil, each winding being in the same direction. With the aerial coil, the top of the grid winding goes to the tuning condenser; the bottom of this winding and the top of the aerial coupling winding

- LIST OF COMPONENTS**
- Two 4-pin and one 5-pin chassis valveholders.
 - Small two-gang tuning condenser, .0005 mfd. each section, with trimmers.
 - .0003 mfd. reaction condenser.
 - 50,000 ohm potentiometer with 3-point switch, small type.
 - Two .0003, .0002 and .005 mfd. condensers.
 - 10,000 ohm, .25 and 2 megohm resistors.
 - Screened coupling high-frequency choke.
 - L.F. transformer for direct coupling.
 - 5in. M.C. P.M. speaker with transformer for pentode output.
 - Shaft coupler, knobs, wire and formers for coils, etc.
 - Valves: H.F. pentode, detector, and economy output pentode.

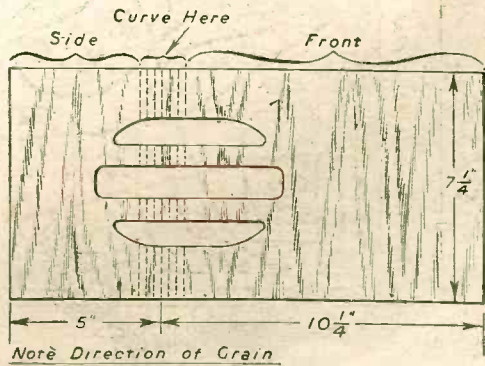

Fig. 5.—The front and side of cabinet.

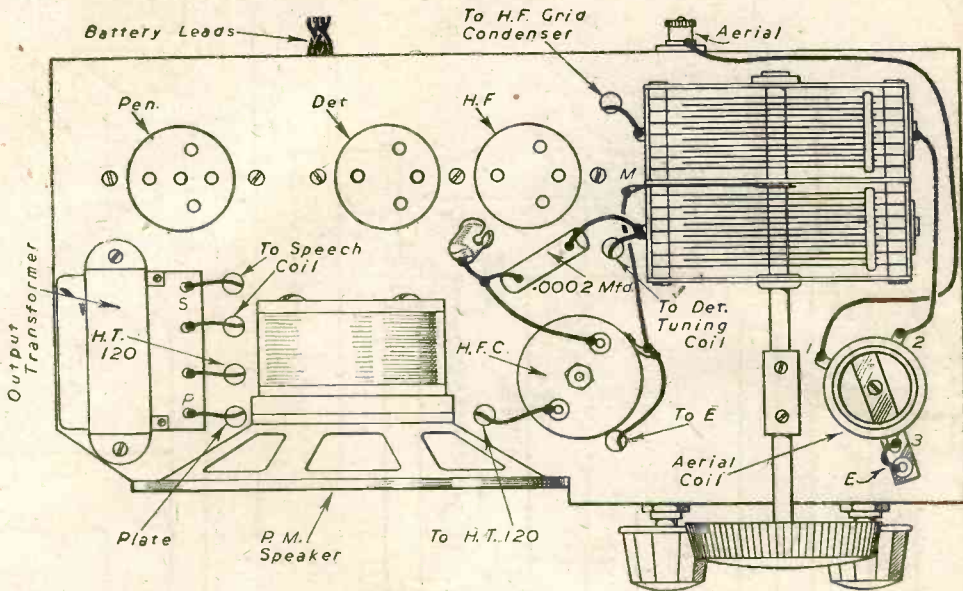

Fig. 2.—Layout of components.

both go to the earth line; finally, the bottom end of the coupling winding goes to the aerial terminal.

These coils tune the medium band only. When stations have been located they should be marked upon a dial fixed to the front of the cabinet, and the names printed or typewritten in.

If it is desired to try transformer coupling between

H.F. and Detector stages, 20 turns of wire wound on a length of insulating tape bound round the bottom end of the detector grid winding can be used. One end of the winding goes to the anode of the H.F. valve and the other to H.T. 120. In this case, no H.F.C. will be required. In the original set this gave a slight increase in selectivity, but some loss of signal strength, especially near the top end of the tuning range.

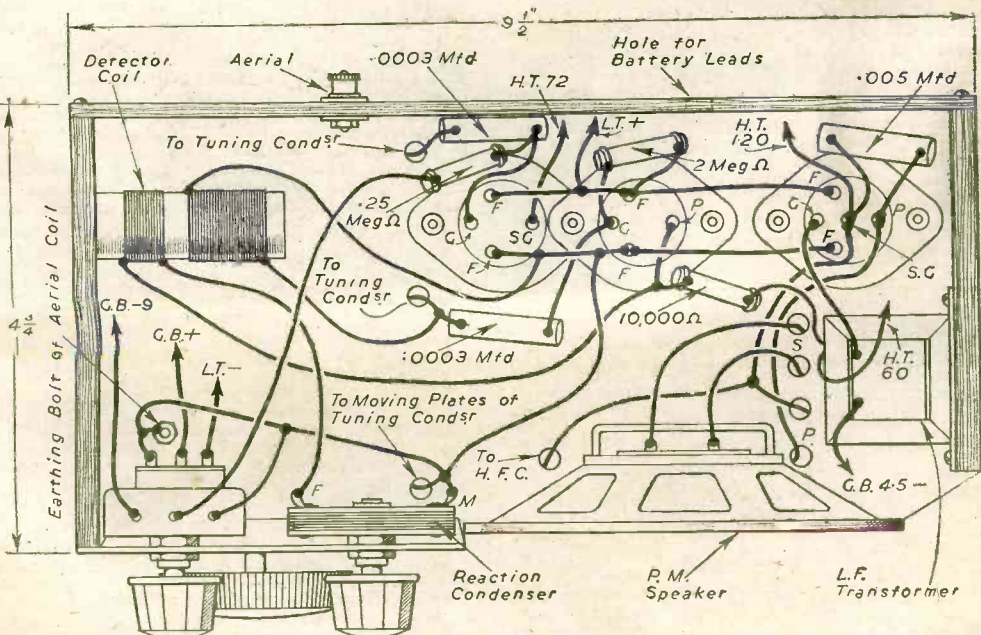

Fig. 3.—Wiring of sub-chassis.

Cabinet Construction

An attractive cabinet is not difficult to make if the design shown in Fig. 4 is followed. Oak or mahogany can be used, and reference to the dimensions given will show that only a very small piece of wood will be needed. As the bottom does not show, it can be of deal, while the front and one side is made from a piece of faced ply the size shown in Fig. 5.

The dimensions given are for wood $\frac{3}{4}$ in. thick. A piece $7\frac{1}{2}$ in. \times 5 in. makes the flat end. The top is $10\frac{1}{2}$ in. \times 5 in., and one front corner is rounded as shown. The bottom piece is cut the same shape as the top, but $\frac{3}{4}$ in. shorter, so that it can fit inside the cabinet. These parts are secured together with thin cabinet nails, the heads being sunk with a small punch. The front should now be placed in position, and secured to the top, side and bottom. It should then be carefully curved round the corner and secured along the side. To facilitate this operation, the grain should run from top to bottom of the wood, and the ply should be thin. With thick, hard ply it may be necessary to steam the wood well along the place to be curved before putting on.

When completed, the cabinet should be carefully

chamfered round the top and then thoroughly sand-papered so that all edges are absolutely smooth and even. A coarse grade of sandpaper is used at first, and a finer grade for finishing off.

Four small rubber feet are secured to the bottom of the cabinet, and it is given a thin coating with a suitable high-gloss varnish. A back $10\frac{1}{2}$ in. \times $7\frac{1}{2}$ in. is made from ply, with a hole for the aerial terminal and a slot for the battery cable. Half a dozen large holes should be drilled along the top of this piece, and covered on the inside with cloth glued in place. The completed back is secured by means of six small screws.

The fret in the cabinet is covered with silk, and the best way to do this is to cut a piece of thin ply about $6\frac{1}{2}$ in. \times 2 in., with a round hole about $\frac{1}{4}$ in. in diameter near one end. This piece is then covered with silk and curved round inside the cabinet so that the circular hole comes opposite the speaker when the receiver is placed in the cabinet. It is then secured with short screws put in from the inside. When finally in position the felt surround of the speaker cone should come right against this internal baffle, and the set secured in position with wood screws driven up from the bottom of the cabinet into the side runners.

The Quest for Quality

Can Perfect Quality be Obtained? Is High-fidelity Worth While?
Does It Ensure Enjoyable Listening? Questions Answered by 2CHW

I WAS recently speaking to a reader about amplifiers, and, as one would expect, the question of quality arose. He said, "I hear so much perfect quality reproduction during my business activities, but I cannot secure the same results at home." "Perhaps," he added, "I am seeking the impossible." To qualify his statement, I would add that his work enabled him to listen to equipment which is as near perfect as modern radio engineering can produce, and one can fully understand that having a keen musical ear his senses had become super-critical, and it was perfectly natural for the reproduction obtained from a normally good amplifier to fall short of his requirements when compared with the "ideal" equipment and conditions which he had made his standard. The amplifier he was using at home was a perfectly good job, so also were the pick-up and speaker, but, even so, the complete installation lacked that something which distinguishes "high-fidelity" apparatus from that which most of us use.

In the present circumstances, I had to admit that I thought he was seeking the impossible, especially if he insisted on holding to his comparison, but, at the same time, I could not see any reason why he should not be able to construct an installation which would give him highly satisfactory reproduction in the post-war periods, provided he was prepared to give due consideration to all the factors involved.

What is Quality Reproduction?

Expressed in a few words, it can be said that quality or high-fidelity reproduction is that which provides a signal which is a faithful reproduction of the original. At a glance, this qualification seems feasible, and, with due appreciation of the progress made in the science of electro-acoustics, one which could be satisfied by careful designing. If, however, the true or literal interpretation of "faithful reproduction of the original" is applied, a little consideration will show that the quest for quality becomes very much like searching for the end of a rainbow. In fact, so far as the average listener is concerned, it is very doubtful if he will ever achieve his aim, and, what is even more disconcerting, it is also very problematical whether he would recognise and enjoy quality reproduction in the strict sense if he were able to obtain it.

If the original signal, whether radio or record, is to be faithfully reproduced, there must, of course, be a complete absence of distortion. Most of us are able to recognise and register displeasure of the more common forms of distortion. The musician and those blessed with a musical ear, can detect more subtle forms which the less sensitive would not know existed. If the matter is taken a step further, the technician with his laboratory equipment, will, no doubt, be able to state and show that distortion exists even in the reproduction passed by the musician. What is quality to one listener, is a headache to another possessing more discerning ears, and, conversely, that which sounds good to the latter will not be appreciated by the former. This actual state of affairs immediately brings forth the question, who is to decide what constitutes quality reproduction? Demonstrations have proved that each individual has his or her own opinion on the matter, and it seems that the problem involved is very much like that concerning likes and dislikes with respect to music. There are the so-called "low-brows" and the "high-brows." Some suggest that the former fail to appreciate classical music owing to lack of understanding or musical education. Can this apply to listeners of reproduced music. I mean so far as quality is concerned, or can the whole problem be debunked by admitting that what matters most is perfect enjoyment of the reproduced signals, irrespective of whether this or that form of distortion is present so long as the results satisfy the taste of the listener?

While every radio and gramophone enthusiast is ready to give due credit to the technician, is he—the technician—the one to decide whether this or that set or amplifier gives quality reproduction, or is he likely to be too concerned with "straight-line" outputs, etc., to the possible detriment of pleasing reproduction? Graphs, characteristics and figures, etc., are vitally essential to the designers, but they are meaningless if only applied to, say, one section of a complete reproducing system. For example, a high-fidelity amplifier would not get a chance of doing justice to its designer if it were used in conjunction with a pick-up and speaker of inferior capabilities, or even with first-class items, if the room was acoustically unsuitable for good reproduction.

It would seem that the musician might be the safer judge, provided he could train himself to realise that he was being asked to judge a reproduction or an imitation of the actual sounds. Listening to, say, the London Philharmonic Orchestra in the Albert Hall is a totally different proposition to hearing a reproduction of it in the average room. When listening to the former, assuming one is near enough for comfortable volume, a perfect tonal balance and volume ratios are obtained, but with the reproduction or imitation, these vital characteristics of the "live" performance will be dulled if not severely mutilated. The volume ratio, whether considering radio or records, will not be true: the frequency band will be restricted or affected by considerations governing transmission and reception conditions, and, in the case of records, the actual recording processes and the characteristics of the pick-up. Is it feasible to attempt to faithfully reproduce a symphony orchestra in the average room? Is the average amplifier and loudspeaker capable of coping with such a task, bearing in mind our accepted definition of quality reproduction?

A baffle-mounted loudspeaker is not a highly efficient piece of apparatus; it needs considerably more power at its input than that which it radiates. Reliable figures give the power radiated by a symphony orchestra as 30 R.M.S. watts, and the power required from the amplifier to allow a suitable baffle-mounted loudspeaker to radiate the same power as the orchestra is 600 R.M.S. watts. There are, however, other considerations which make these figures less disturbing than they at first appear. The amplifier might have a "straight-line" output, but what of the frequency response curve of the speaker? Good makes of modern moving-coil speakers can have good response curves, but one is yet to come across a model which carries a satisfactory line right down to, say, the 30 or even 50 c/s. region, and which is free from those awkward resonance peaks and troughs.

Assuming that we accept the speakers available as being as good as the rest of the installation, how often is due consideration given to their effective baffling? We are told that for adequate baffling down to 30 c/s. a baffle of 36.3ft. square is theoretically necessary. We also understand that care must be taken to ensure that the sound radiations from the rear of the cone must not reach the front 180 deg. out of phase, otherwise a cancellation will take place and produce a pronounced dip in the speaker's response. While admitting that there are such things as "infinite" baffle boxes or cabinets and, at least, one well developed speaker loading system, the majority of speaker mountings or cabinets can hardly be considered as being ideal for quality reproduction. Cabinet boom or resonance can, to the less critical ear, produce an apparent low-note response, but to the discerning listener this is nothing more than distortion of a very irritating type. Similarly, resonance peaks towards the upper end of the frequency scale, due to unsatisfactory design or production of the speaker, might be mistaken for good top-note response, but if we are after quality this becomes just as bad as the so-called low-note response.

Frequency

The full frequency range of an orchestra will extend from 30-12,000 c/s. If our ears are good we should be capable of appreciating the full range when listening to a "live" performance. Unfortunately, however, the sensitivity of the human ear varies greatly with individuals and age, and, speaking in a general sense, most of us are not really sensitive to the frequency bands on the extreme limits. This may or may not be a blessing, according to the way you look at it, but the effect becomes very obvious if tests are made by restricting the frequency limits. For quality, our "straight-line" installation (not the amplifier only) must be capable of reproducing the full frequency band, and while it may be able to do this when the volume control is turned right up, the results obtained when the volume is turned down to suit the room in which the reproduction is taking place will be totally different. Theoretically, the regulations will reduce all frequencies by the same ratio, but owing to the peculiarities of the ear the

upper and lower frequencies will be cut or attenuated to such a proportion that they may be lost, whereas, the band between, say, 500 and 2,500 c/s will be level. This is commonly called "scale distortion," and is often looked upon as being due to the design of the amplifier, but a simple test will soon reveal that it is nothing of the kind. If one listens to a band in the open, or an orchestra in a large hall, the same effect can be observed by varying one's position with respect to the source of sound, or, in other words, it is due to a peculiar selective property of the ear which becomes more operative as the intensity of the sound decreases.

If the upper frequencies are cut, sounds lose their brilliancy and transients suffer. If the lower frequencies are cut, the whole body of the reproduction vanishes, while if both top and bottom are attenuated—within reasonable limits—reproduction will not be too bad to the majority whose ears are not super-critical. For example, what would be called by many as being very good quality might cover a frequency range of 75-10,000 c/s; good reproduction 150-5,500 c/s; and a surprising number of listeners will tell you that their set gives perfect reproduction, although in actual fact its frequency range might be restricted from, say, 150-3,500 c/s.

Is High-fidelity Needed?

Such a question is likely to cause quality enthusiasts to shudder, as it is really equivalent to saying what is wrong with distortion. Let the facts be faced, and let us ask ourselves whether it is not time we did *debunk* some of this high-fidelity talk and admit that we are using the term in anything but its literal sense. It is one thing to hear Constant Lambert conducting the Liverpool Philharmonic Orchestra playing, say, Rimsky-Korsakov's "Ivan the Terrible" in a suitable hall, in which the listener has all the opportunities of hearing a "live" performance in every sense. It is a totally different proposition to attempt to imitate that performance in the average room. Whatever the technician may say about high-fidelity being essential for such a reproduction, does not, in my view, cut any ice when it comes to my enjoyment of that particular work under the conditions which it would be reproduced in my home. For one thing, the performance to which I should be listening would be in miniature; the true delicate graduations and the fortissimo passages would not bear the same ratio as those of the "live" performance; the overall frequency band may be restricted and, finally, the very listening atmosphere would be totally different. Assuming that I have sufficient musical sense or understanding of the work to which I am listening, my hands would be on the volume controls and, highly probably, the frequency corrector control, to enable me to hear the reproduction to my utmost satisfaction. Is it not the ambition of every user of a radio or amplifier to secure reproduction which his own particular musical taste leads him to believe is high-fidelity? Let us be a little more frank about the meaning of the words, and let us admit that we are not so concerned about high-fidelity from the technician's point of view, but only vitally interested in securing the best quality reproduction consistent with our own individual ideas as to what provides the most satisfactory results and, of course, the greatest enjoyment for our musical senses.

A New Vest Pocket Book!

RADIO VALVE DATA POCKET BOOK

By F. J. CAMM

5/-, or 5/6 by post from

GEORGE NEWNES, LTD., Tower House,
Southampton Street, Strand, London, W.C.2.

A D.C. Valve-voltmeter

Details of a Serviceable Low-reading Instrument — By "NINEJAY"

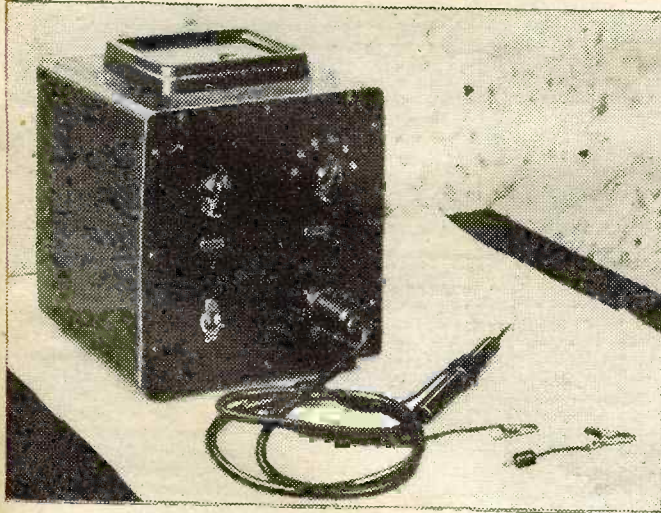

Fig. 1.—Meter, complete with plug and prod.

WHILST the ordinary high-grade multimeter can measure D.C. voltages with a high degree of accuracy in many circuits of a receiver, there are, on the other hand, many other circuits where the true D.C. voltage can be measured only with a meter having a very much higher ohms-per-volt ratio. For example, the measurement of D.C. voltages in A.V.C., most grid and some anode and screened-grid circuits, is not possible with a meter having a resistance of 200-1,000 ohms-per-volt. To check these circuits for suspected faults with the ordinary meter usually means testing each component separately, so that in nearly all cases some unsoldering is inevitable. This is often a very tedious and time-consuming job, which could be simplified or avoided with the aid of a suitable high impedance D.C. voltmeter.

A micrometer with series multiplying resistors is out of the question, as a suitable one would be required to give a full scale deflection for a micro-ampere or so. Apart from expense, a meter like this would naturally have the disadvantage of being very delicate and in use would require more than special care.

From a practical point of view, the difficulty can be easily overcome by using instead a simple D.C. voltmeter, otherwise known as an electronic voltmeter. Due to present conditions, commercially made D.C. valve-voltmeters are not readily obtainable, but, fortunately, these meters are simple to construct and most of the parts needed are similar to those used in the servicing of broadcast receivers.

There are many types of D.C.

valve-voltmeters, but the writer favoured the one to be described, because, in his opinion, it was nearest to the type ideal for radio servicing. Among its advantages are its low loading of the circuit under test (the resistance of the meter is 11 megohms on all ranges). As it has a centre-zero scale, positive or negative voltages may be checked with the same ease. Another advantage of the centre-zero scale is that for most tests the earthy lead from the meter may be clipped to the chassis, leaving a very useful hand free. D.C. voltages in H.F. circuits may be checked with practically no loading or detuning effects. This meter will also serve as an output meter when connected across the signal diode load resistor, or, in some cases, when connected to the A.V.C. line (e.g., the grid of an A.V.C. controlled valve). The performance of the orthodox oscillator in superhets can instantly be checked by measuring the D.C. voltage across the grid leak. It is extremely unlikely that the meter could be damaged by over-volting.

The principal disadvantages of the meter is that it is not linear when reading negative voltages. It is highly desirable to have the milliammeter's scale redrawn, because comparing meter readings with a graph may often lead to errors as well as being very irksome. Due to having a centre-zero scale, it is also desirable that the milliammeter have a long scale.

Theory and Design

Before giving constructional details, it might be of interest to briefly consider the theoretical operation and design of the meter. The fundamental circuit of the meter is given in Fig. 4.

In this meter advantage is taken of the fact that the grid volt anode current curve of a triode operated under class "A" conditions is reasonably straight.

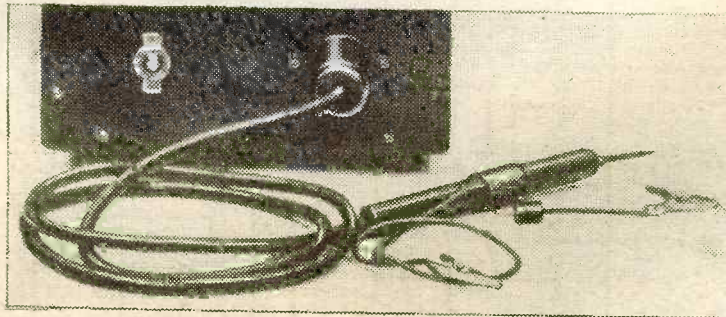

Fig. 2.—The plug and prod.

R1, 1 megohm, $\frac{1}{2}$ watt or less; R2, 7.5 megohm, $\frac{1}{2}$ watt or less; R3, 1.5 megohm, $\frac{1}{2}$ watt or less; R4, 750,000 ohms, $\frac{1}{2}$ watt or less; R5, 150,000 ohms, $\frac{1}{2}$ watt or less; R6, 50,000 ohms, $\frac{1}{2}$ watt or less; R7, 50,000 ohms, $\frac{1}{2}$ watt or less; R8, 2,000 ohms, wire-wound; R9, 2,000 ohms, wire-wound; R10, 10,000 ohms, wire-wound; R11, 6,000 ohms, 1-watt; R12, 25,000 ohms, 2-watt; R13, 5,000 ohms, 1-watt; R14, 200 ohms, 1-watt; V1, 6C5; V2, 6X5; C1, .002, mfd. mica; C2, C3, 8 mfd., 450 v.w.; S1, 6-way single-pole switch; S2, single-pole toggle switch.

*The writer used two 50,000 ohms, 1-watt, in parallel for R12.

As already stated, this meter has a centre-zero scale, so if an 0-1 milliammeter is used, the cathode current for zero volts will be .5 milliamps. When the positive of a D.C. voltage is connected to the free end of R₁, Fig. 4, and the negative is connected to H.T.—, the cathode current will increase. If the negative of the same D.C. voltage is now connected to the free end of R₁, Fig. 4, and the positive to H.T.—, the cathode current will decrease. These variations of cathode current are proportional to the magnitude of this D.C. voltage as well as to its polarity. The voltage necessary to give a full scale deflection is that voltage which will cause the cathode current to increase from .5 to 1 milliamp. Now this voltage, when its negative is connected to the free end of R₁, Fig. 4, and the positive is connected to H.T.—, will cause the cathode current to decrease to a very low value. This reading is calibrated as a full scale deflection for negative voltages. The value of R₃, Fig. 4, chiefly determines the voltage necessary to give a full scale deflection. In practice, in order that the meter may give a full scale deflection for a chosen voltage (within limits, of course), R₃ is variable though once adjusted does not have to be altered unless the valve has to be replaced with another of different characteristics. R₃, Fig. 4, by virtue of its place in the circuit, has a degenerative effect, and so adds to the stability of the meter.

R₁, Fig. 4, may be connected to R₂ by means of a screened flexible cable. Due to the high resistance of R₁ (one megohm or higher), this cable may be any length desired. R₁, Fig. 4, together with the capacitance of the screened cable and C₁ act as a filter for A.C. of high or low frequencies, but D.C. voltages in H.F. circuits may be measured with minimum loading or detuning effects, as the capacitance of the cable and C₁ are very well isolated from the circuit under test by the high resistance of R₁. In case of over-volting the meter with a positive voltage, R₁ limits the grid current to a very low value, and R₄ limits the cathode current to less than 4 milliamps. Most 0-1 milliammeters are very robust, and the flag is not likely to be damaged by an occasional overload of less than 4 milliamps. Should the meter be over-volted with a negative voltage, the only effect will be to reduce the cathode current to zero.

In practice, R₂ is a number of resistors used in conjunction with a single-pole multi-way switch to extend

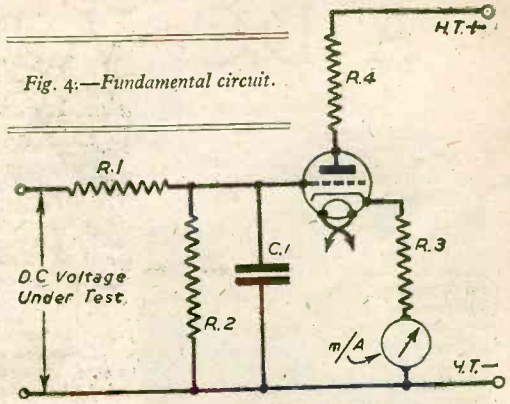

the range of the meter. A practical total value for R₂ is 10 megohms, and this gives a very high ohms-per-volt ratio.

Constructional Details

The practical circuit diagram is shown in Fig. 3. R₈ is for adjusting the meter to zero (.5 milliamp.), and compensates for mains voltage variations. This is known as the "Set Zero" control. It is not essential to conform to the circuit of the power supply, and any power supply giving a smoothed output of about 200 volts will do. A 6C5 was chosen because of its small physical dimensions, but other types with nearly similar characteristics could be substituted without any alteration in component values.

It is essential that R₈ and R₉, Fig. 3, be wire-wound, as the stability of the calibration is chiefly dependent on them. Most variable potentiometers have a tapered element, and R₈ should be connected to give the greatest spread, as this will make R₈ easier to adjust. The shaft on R₈ should be left about a 1/16 in. and slotted so that it may be adjusted with a screwdriver.

Special attention should be given to the insulation of C₁, the valveholder for the 6C5, the screened flexible cable, the plug and its socket and the range switch, as

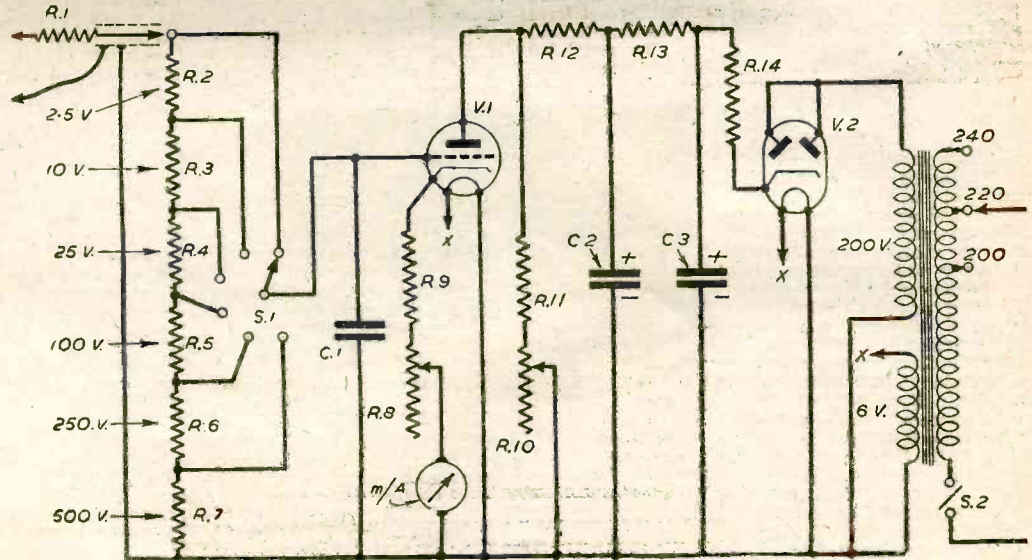

Fig. 3.—Theoretical circuit.

inferior insulation cannot be tolerated in this section of the meter.

The layout of the components can be seen from the photographs. No dimensions are given for the chassis, as its size largely depends on the transformer and valves that are used. To save height, the electrolytic condenser was "dropped" through the chassis. The transformer was mounted under the chassis as a precaution against any stray field from it de-magnetising the milliammeter. Long bolts are necessary for the transformer, as they are also used for holding the component mounting strips and the transformer's primary connections.

To make component moun-

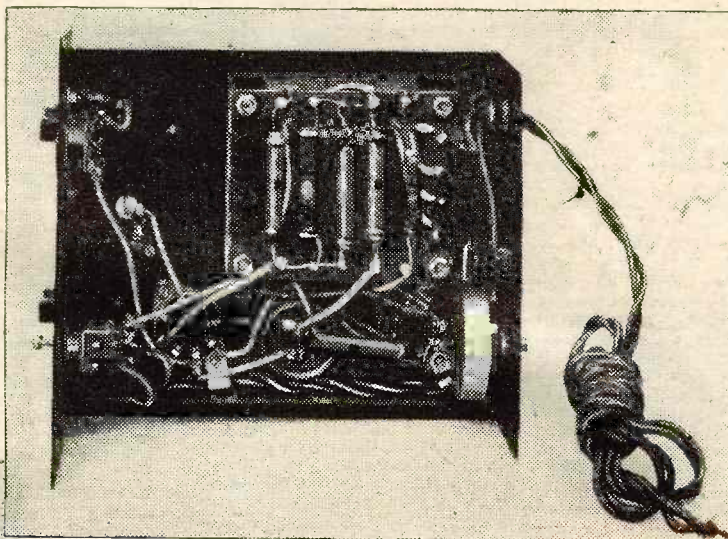

Fig. 6.—Bottom view of chassis.

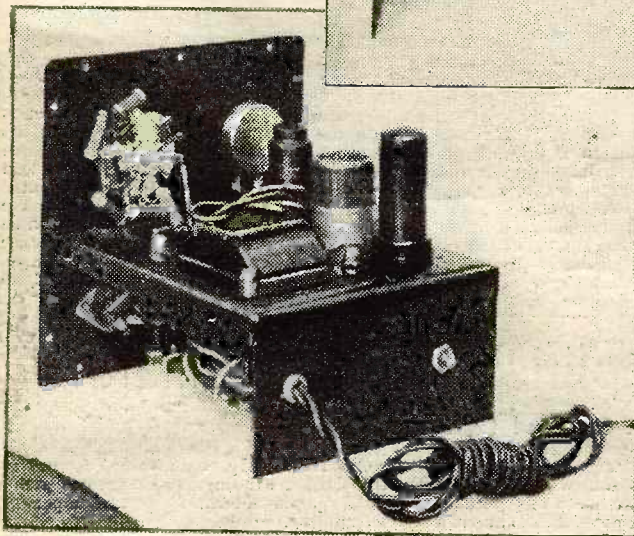

Fig. 5.—Top view of chassis.

strips, get some $\frac{1}{4}$ in. 6 B.A. screws and remove dirt or plating off them by screwing through a 6 B.A. die. Mark off on paxolin strips the spacing of the resistors and drill holes to suit a 6 B.A. tap. Tap holes, and screw the screws home, and then tin them. The wire or wire ends of the components should be looped around the screws and soldered. The strips should be arranged so that the resistors clear the transformer bobbin. On account of its simplicity, no difficulty should be encountered in the layout and wiring of the meter.

Either a wooden or a metal cabinet can be used to house the meter. Although the power taken by the meter does not exceed 15 watts, provision for ventilation should be made by slotting the bottom and boring some holes in the back of the cabinet. Mount the cabinet on four rubber feet.

Constructing the Prod and Plug

The construction of the prod is shown in Fig. 3. The body is a $\frac{1}{2}$ in. piece

of $\frac{1}{2}$ in. outside diameter bakelite tubing such as is used in aerial lead-in tubes. The screened flexible cable should be good quality, rubber covered, single core microphone flex. By leaving this cable a sufficient length, the meter can be left in a permanent position on the bench. The use of a socket in the prod allows the choice of either a prod or a crocodile clip.

The correct order for making up the prod is as follows: Firstly, round off socket end of the tube, as this allows the end of the prod to be more easily seen in an awkward or congested section of a receiver. Next solder a metal band around one end of the cable's screen. Tap two holes for 6 B.A. screws on opposite sides of the tube. When finally assembling the prod, 6 B.A. screws are screwed tightly against the metal band, so holding the cable firmly in the tube. A binding of cotton thread is wound around socket so that it may be jammed tightly into the end of the tube. The socket, one megohm resistor and core of the cable are soldered together. The free end of the cable is pulled through the tube in the proper direction, and the socket is pushed home. A soldering tag for the earthy lead is put on one of the 6 B.A. screws and both screws are tightened. The earthy lead (about gins. long) is now soldered to the tag and a piece of light rubber tubing is now pulled over the

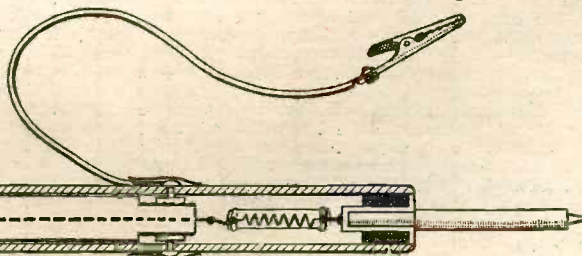

Fig. 7.—The prod.

heads of the 6 B.A. screws. This rubber tubing, as well as insulating the screws, will help to prevent the earthy lead from prematurely breaking off where it is soldered to the tag. If it is not possible to get a suitable piece of rubber tubing, insulating tape will do, the only difference being that the rubber tubing makes a more finished looking job. This completes the construction of the prod.

A jack plug and socket are suitable for connecting the cable to the meter, but the writer intends to use a prod type diode rectifier with the meter, and for this a 3-pin plug and socket are necessary. A very neat and efficient screened multi-pin plug can easily be made from a dud American metal valve and a piece of cork. The writer used an old 6Q7 for the plug.

To make plug, remove base and electrodes from metal shell. Twist off grid terminal with a pair of pliers. An opening at the grid terminal end of shell can be easily and neatly made by grinding around the edge on a carborundum grinder. Fit a cork tightly into this opening. Remove cork and bore a hole in its centre, slightly smaller in diameter than the cable. Split cork in two. Pull cable through shell and solder leads to appropriate pins, making sure that the screen of the cable and the shell are soldered to the one pin. The pieces of cork are used to wedge the cable tightly in the neck of the shell. The cork may be coloured the same as the shell with black boot dye.

Calibrating the Meter

Although difficulty may be anticipated in getting the meter to cover each range exactly, actually it is an easy and straightforward job. For calibrating, a multi-range D.C. voltmeter of high accuracy and a D.C. supply that can be varied between 2.5 and 500 volts are required. Ordinary $\frac{1}{2}$ -watt carbon resistors are used for R₂, 3, 4, 5, 6, 7, and as these resistors usually have a tolerance of plus or minus 20 per cent. select those resistors that are nearest to the specified value. If a

large selection of resistors is not available, then it is recommended to use the solid carbon type, as their resistance can be increased by filing or scraping a piece off them. Resistors R₂, 3, 4, 5, 6, 7 are soldered on the range switch, and the switch is set to the 2.5-volt range. With a 2.5-volt D.C. supply connected to give a positive reading, the meter is adjusted to give a full scale deflection by means of R₈. Any adjustment to R₈ will necessitate the resetting of the set zero control. Switch to the 500-volt range and connect a 500-volt D.C. supply, so as to give a positive reading. If R₇ is not the correct value, the meter will not give an exact full scale deflection. Different values for R₇ should be tried, or, if a solid carbon type is used (if the reading is low), its resistance can be increased. In the same manner, the meter is adjusted for the other ranges in the following order: 250, 100, 25, 10, to give an exact full scale deflection. Any alteration in values to R₃, 4, 5, 6, and 7 will only be a small fraction of the total value of R₂, 3, 4, 5, 6, 7, and when the meter is switched to the 2.5-volt range it should still give a full scale deflection for that voltage, and so, fortunately, there is no need to alter R₂.

Whether or not it is intended to re-draw the scale, it is advisable to draw a graph of the positive and negative readings for one of the ranges. This graph can be used for all the ranges and will serve until the scale is re-drawn.

Operational Notes

When using the meter, make sure that the set is earthed, because the earthy lead from the meter has much the same effect on the set as an earth. If no earth were used, connecting or disconnecting the earthy lead would be responsible for the set giving irregular results.

D.C. grid voltages should be measured between the cathode or filament and the grid. The meter should be connected across the grid resistor of the output stage when checking for H.T. leakage or a "gassy" valve. Under normal conditions there will be no reading.

"Phase" in Amplifiers and Oscillators

A Simplified Explanation

QUESTIONS involving the *phase* of voltages and currents in valve networks are always somewhat perplexing, because, for one thing, we have to deal with a mixture of steady and alternating potentials.

Indeed, many find difficulty in grasping the idea of *alternating* quantities in circuits where the supply is essentially "D.C." from a battery or other H.T. source. There is often much "argument" as to whether a current flows from "+" to "-" or *electrons* in the opposite direction; or whether a "pulsating D.C." should properly be called an *alternating* current.

For instance, when a true alternating e.m.f. (E_a) is applied between grid and cathode of an amplifying valve Fig. 1 (a), the anode current (I_a) will increase and decrease above and below its "mean value" (I_0), as in Fig. 1(b). Because there is no actual reversal of this current, it does not seem very correct to term it an "A.C. component"—actually, the direction of flow is from + to — all the time (retaining the old ideas, for the moment, of what the conventional + and — signs were intended to indicate).

The difficulty is a real one to many beginners. It is not so easy to get hold of the idea that when a current *decreases* below its mean value, the effect produced in an A.C. device is exactly the same as with a current that reverses. Our "datum line" need not necessarily be zero, as in ordinary A.C. circuits.

Thus, if we put a transformer in series with the valve, Fig. 2(a), the *induced* e.m.f. developed by this "changing D.C." in the primary and secondary will be a true *alternating* voltage, which reverses its direction on both

sides of "zero." The steady mean value, I_0 , has no effect in the transformer windings, so we are left with a pure A.C., or, rather, a pure alternating e.m.f. component, about a zero datum line.

Again, when we couple one valve to the grid of another through a condenser C, Fig. 2(b), the potential across the plates is simply increasing and decreasing, in accordance with the voltage fluctuations across the valve, i.e., a "pulsating potential." But, actually, C is *charging and discharging*; if we draw the circuit as in Fig. 2(c), it becomes clear that an alternating current flows in C and the grid-leak R, developing true alternating potentials across the latter—the condenser blocks any steady D.C.

The "Sign Conventions"

When considering questions of *phase*, it is not very helpful to rely too much upon + and — "signs." They can be quite misleading, as a simple illustration will show.

Consider a transformer connected to an A.C. supply, Fig. 3. The + and — signs attached to the primary may denote, (a) the *applied voltage* acting from A to B (over one half-cycle); or, (b) the induced *back e.m.f.* acting from B to A. These two e.m.f.s are in mutual opposition, i.e., 180 deg. out of phase, but the signs do not indicate the fact.

The phase of the e.m.f. induced in the secondary will not be very clear if considered from the point of view of the "sign" at some given secondary terminal. In fact, it is rather a hopeless method of tackling a problem

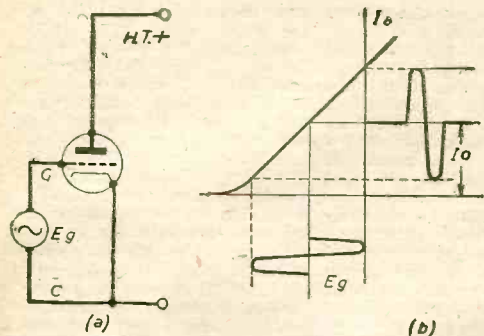

Fig. 1.—Alternating current, or “pulsating D.C.?” An old question is explained.

which is quite simple when regarded in the light of A.C. principles.

Signs have really little to do with the matter; because it is the same magnetic flux which induces e.m.f.s in both windings, the secondary e.m.f. must necessarily have the same phase as the back e.m.f. in the primary—both are at 180 deg. to the primary supply voltage.

But, when connected to grid and cathode of a valve, the phase of the terminal voltage can be reversed 180 deg. by the simple expedient of changing-over the two secondary connections—internally or externally. The same thing can be done by changing-over the two primary connections. But it still remains true that the induced e.m.f.s in both windings are at 180 deg. to the supply voltage—this fact is not altered by the terminal connections.

“Current” or “Electron” Flow?

Much confusion again arises concerning the conventional and electronic directions of “flow.”

It is not proposed to go fully into this question now. A correct account of thermionic valve action can only be given in terms of electron flow, but, like the sign conventions, there is no need to allow this to confuse the issue.

First, the positive direction of the applied e.m.f. is pretty clear; it is from + to - of the H.T. source, around the external circuit. This, of course, is a steady e.m.f., but if we consider an alternating e.m.f. applied to grid and cathode:

The grid will become “positive” with respect to cathode during the half-cycle when the e.m.f. is directed from cathode towards the grid, and vice versa. Hence this is necessarily the positive half-cycle of the grid-cathode e.m.f.

When setting out to define what we mean by a positive half-cycle of the resulting A.C. in the anode circuit, the question of “direction” of flow does not enter into the matter. The anode current varies in-phase with the grid-potential (at least, at all ordinary frequencies); a positive half-cycle is that which coincides with the positive half of a grid cycle, i.e., a current increase.

There is no other way of defining the phase of the alternating current in a valve circuit. What we call the “negative half-cycle” in ordinary A.C. systems means a current flowing the other way about through the circuit. The corresponding “direction” in a valve circuit is equivalent to a decrease in the magni-

tude of the anode current. True, in ordinary A.C. theory it is largely immaterial which particular direction we choose to call “positive” or “negative.” There is no reason, too, why we shouldn’t adopt the “convention” of calling an e.m.f. directed from grid to cathode (and the resulting anode current decrease) the positive “half-cycle”—provided we keep to this assumption throughout.

But it would be an artificial and illogical way of looking at things. From first principles the grid is positive with respect to cathode when the e.m.f. is acting towards the grid, i.e. from C to G in Fig. 1(a). It seems merely confusing the issue to adopt a convention which violates the plain facts of the case.

Phase Inversion

Another difficulty many come up against is the 180 deg. phase-reversal, or phase-inversion, which takes place in a valve with a load resistance in the anode circuit, such as in Fig. 2(b) and (c).

This is shown in Fig. 4(a) and (b). E_g represents the alternating e.m.f. applied to the grid. V_a is the amplified output voltage, and it will be noted that the curve is turned completely “upside down,” or “inverted,” with respect to E_g —a fact that could easily be demonstrated by an oscilloscope.

In Fig. 2(b) and (c) we note that V_a is the voltage applied to the grid of the next valve: there will be a slight loss and phase-shift due to the coupling condenser C, but for all purposes V_a represents the “signal” applied to the next valve both in magnitude and phase.

If this next valve also had a resistance in its anode circuit, V_a would be amplified, and again reversed 180 deg. Thus, the output voltage of the second valve would have shifted a complete cycle (360 deg.) relative to the input voltage of the first.

In other words, both would be in-phase. If we took a connection, through a condenser, from output to input sides, Fig. 5(a), conditions of self-oscillation (positive feedback) would exist. The input signal becomes augmented by the in-phase voltage injected-back from the output side; this is amplified again, resulting in more feedback, a larger augmented signal, and so on.

A whistle or howl will probably build-up, at a frequency determined by the CR constants of the network—for if no tuned-circuits are used a sine-wave oscillation of the same shape as the original signal would not be generated. However, the circuit illustrates a very important point, which must apply to any oscillator, namely, oscillations will be generated only if the reaction arrangements are such as to give a total phase-shift of 360 deg. (a full cycle) around the oscillator network.

Simple Oscillators

It is only when such a phase-shift occurs that a valve can be made to “oscillate.”

In Fig. 5(a) we have illustrated the point by including a second valve as a phase-reversing stage. As said above, it is really a type of oscillator rather complicated in its mechanism, and in the waveform generated. Actually,

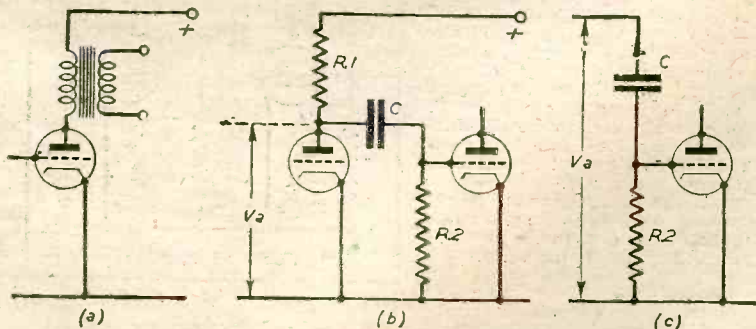

Fig. 2.—Showing how a varying current, Fig. 1 (b) develops true alternating voltages in a transformer and condenser circuit.

these types are called *multi-vibrators*; they are extremely useful for certain purposes, because they can be made to oscillate at frequencies as low as *one cycle per second*, or *per minute*, and produce abundant harmonics owing to the distortion of the waveform.

There is plenty of scope for the experimenter in trying-out "relaxation oscillators" (another name for multi-

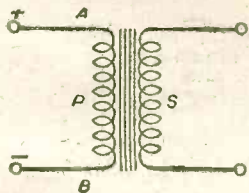

Fig. 3.—Ambiguity of "signs" in denoting phase. The + and - signs in the diagram denote an e.m.f. acting in the direction A to B, or a back e.m.f. from B to A.

vibrators) as frequency multipliers, etc. But a more familiar type of oscillator is shown in Fig. 6(a).

Here a sine-wave oscillation is generated in the tuned-anode circuit, its frequency being very nearly the natural frequency of L and C. Positive feed-back to the grid to maintain the oscillation takes place via the reaction coil L_g . The necessary 360 deg. phase-shift is very easily obtained, simply by reversing the connections of the grid-coil relative to the anode coil.

It will be helpful to understand this point clearly. When oscillating at its natural frequency the LC circuit behaves very much like a pure resistance. There is thus a 180 deg. phase-reversal in the valve. A further 180 deg. shift is essential to give the total 360 deg. required to maintain oscillation, i.e. the e.m.f. fed-back to the grid via the reaction coil must be itself at 180 deg. to the anode-to-cathode voltage V_a .

This sounds pretty complicated, but the matter should become quite clear on comparing with Fig. 6(a). If the coils are wound in the same direction, and the bottom end of L_1 is joined to anode, then the top end of L_g must be joined to grid. No phase-reversing stage is necessary, because the desired "shift" can be obtained by these connections.

The Hartley oscillator, Fig. 6(b), gives the necessary phase-shift without using a reaction coil. The opposite ends of the tuned-circuit will have opposite potential signs (+ and -, or - and +) during successive half-cycles of oscillatory current. By tying the centre-point of the coil to cathode via +H.T. a potential is thus returned to the grid through condenser C, which is at 180 deg. to the potential V_a across the valve—since V_a is itself at 108 deg. to E_g , a total phase-shift of 360 deg. is obtained.

In general, to maintain an oscillation, the voltage fed-back to the grid must, then, be at 180 deg. to the anode-to-cathode voltage across the valve.

Negative Feedback

But, considering again a single amplifying stage with a resistance load in the anode circuit; suppose we coupled the anode back to the

grid through a condenser of suitable capacity, Fig. 5(b).

If a signal is applied to the grid we are now feeding-back a portion of the phase-reversed output voltage V_a , which will thus be in *mutual opposition* to the signal e.m.f. The two e.m.f.s will be as indicated by the curves in Fig. 4(b); the resultant effect will be to reduce the amount of signal on the grid to a very small value—the *difference* of the incoming and fed-back voltages.

This is a very simple illustration of *negative feedback*. Because the effective-value of E_g in causing grid-potential changes has been much reduced, the overall amplification of the stage may become very small—depending on the value of the condenser, resistances, etc.

It explains why no sort of oscillation can be generated in a simple stage of this kind merely by coupling the anode and grid through a condenser. The phase is such as to give negative feedback, although it is possible to include further reactances in the grid circuit which would shift the phase of the fed-back voltage another 180 deg. (360 deg. in all) to give a multivibrator oscillation.

The method shown is not a very usual one of applying negative feedback, but it does show that the voltage-phase at the anode end of any resistance load is always antiphased to the signal e.m.f. on the grid.

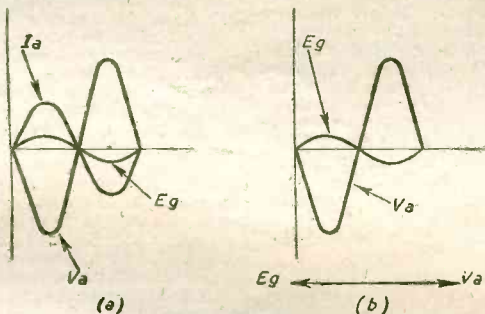

Fig. 4.—"Phase-inversion" in an amplifying stage with a simple resistance in the anode circuit. The anode current I_a is in phase with E_g , but both are antiphased to the output voltage V_a .

The Cathode-follower

This remains true even if the resistance load is on the cathode side, Fig. 7.

The -H.T. end of R is, in effect, the anode side, because it is tied to anode through the low resistance of the H.T. battery, or a large capacity bypass condenser, as far as alternating potentials are concerned.

During a positive grid half-cycle, I_a increases, giving an increased voltage drop across R, and phase-reversal comes about in all cases because this means that the potential of the anode end of the resistance is then falling. In Fig. 7, the cathode end becomes

"more positive," which, in effect, is the same as making the grid (connected to -H.T. end) "more negative."

Hence, in a circuit of this type, there would be no (Continued on page 431)

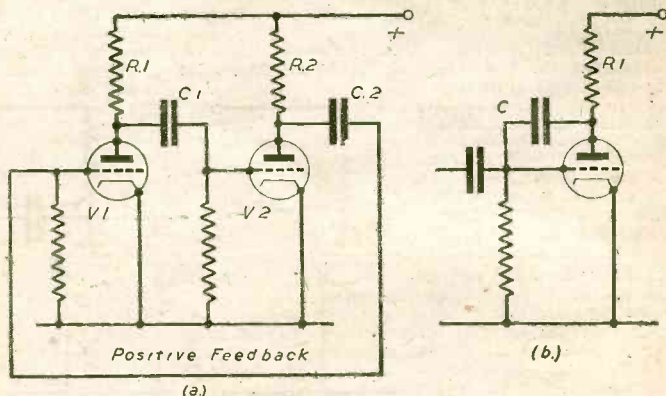

Fig. 5.—Multivibrator type of oscillator (a)—total phase-shift of 360 deg. gives a positive feedback to grid of V_1 . If a condenser C were connected from anode to grid of a single valve (b) the feedback would be negative.

GALPINS

ELECTRICAL STORES

408, HIGH STREET,
LEWISHAM, LONDON, S.E.13.

TERMS: Cash with Order. No C.O.D.
All prices include carriage or postage.

ELECTRIC LIGHT CHECK METERS first-class condition, electrically guaranteed, for A.C. mains, 200/250 volts 50 cy. 1 phase 5 amp. load, 12/6 each.

ROTARY CONVERTER, input 40 volts D.C., output 75v., 75 m/A, A.C., also would make good 50v motor or would generate. £2.

AUTO TRANSFORMERS. Step up or down, tapped 0-110-200-220-240. 1,000 watts. £5.

POWER TRANSFORMER, 4kW. double wound, 400 volts and 220 volts to 110 volts, 50 cycle, single phase. Price £20.

AUTO TRANSFORMER, step up or step down 500 watts, tapped 0-110-200-220-240 volts. £3 10s.

1/2 WATT WIRE END RESISTANCES, new and unused, price per doz., 5/-, our assortment.

MOVING-COIL AMPMETER by famous maker, 2in. dia., flush mounting, reading 0-10 amps., F.S.D., 20 m/A. Price 27/6.

METAL RECTIFIERS, large size, output 50 volts 1 amp. Price 35/-.

SMALL MAINS TRANSFORMERS, input 230 volts, output 11 volts 1 amp., 11/-.

METAL RECTIFIERS, large size, output 12 volts 1 amp., 17/6.

FIXED RESISTANCES, size 12in. by 1in., fireproof, resistance 2 ohms to carry 10 amps., 3/- each; set of 16 mounted in steel frame, only 35/-.

TRANSFORMER CORE for re-winding only, complete with clamps, size approx. 2 1/2 kW. Price 25/-.

CABINET LOUDSPEAKER, for extension only, 5 watt output, 8in. dia. cone, high quality, size of cabinet 16 x 14 x 1 1/2 x 3 1/2 in. thick, cabinet slightly marked at top. Price £3.

SMALL M.L. ROTARY CONVERTER, in cast all. case, size 14 x 4 1/2 x 4 1/2 in., permanent magnet fields, converters need attention, not guaranteed. 30/-.

POWER TRANSFORMER suitable for arc welding, input 230 v., 50 cycle I.P.H., output 50 volts at 200 amps., price £17; another 150 amps., £15; another 100 amps. £12.

DYNAMO, slow speed only 500 r.p.m., output 25 v. 10 amps., shunt wound, adjustable brush gear, ball-bearing, condition as new, weight 60 lbs., a real high-grade job. Price £7 10s.

50-VOLT MOTOR, D.C. input 4 amps., 1/2 h.p., ball-bearing, double-ended shaft 3/4 in. dia., slow speed only 500 r.p.m., shunt wound, condition as new, also make good slow-speed generator. Price 45/-.

50-VOLT D.C. MOTOR, shunt wound, ball-bearing, 1/2 h.p., speed 900 r.p.m., in new condition, make good generator. Price £7.

AUTO TRANSFORMERS, tapped 0-110-200-220-240v. 1 1/2 kW. £7 10s.; 2 kW. £10.

MOVING COIL AND M.I. METERS, FOR FULL DETAILS OF ABOVE AND OTHER GOODS, SEND FOR LIST. 2/- PLEASE NOTE change of address. Now returned to London.



For the laboratory, amateur transmitter, and wherever QUALITY and RELIABILITY are essential, WEBB'S offer unrivalled stocks and service. All apparatus and components are guaranteed—if your needs call for discrimination WEBB'S can help—DON'T come to us if you want obsolete or second-hand material!

Comprehensive stocks enable us to quote for EVERYTHING IN RADIO—our regular adverts show merely a few interesting lines.

PORTABLE AMPLIFIER CASE
Comprising chassis, cover and base plate. Overall size 16in.x8in.x9in. high, chassis depth 2 1/2 in., removable top cover adequately ventilated top and sides, fitted two carrying handles. Chassis drilled in front for four controls, cut for seven valves, side entries for mains cable, and speaker plug. Well finished in black-crackle, this makes an ideal amplifier case ... 52/6

Packing and carriage 2/6 extra (with slight delay in despatch owing to shortage of packing). Callers from stock.

LOUD SPEAKERS
Magnavox Mains Energised, 2,200 ohms field, speech coil, 2 1/2 ohms, with pentode transformer.
8in. type, baffle aperture 7 1/2 in. ... £1 10 0
6 1/2 in. type, baffle aperture 5 1/2 in. ... £1 8 6
Permanent magnet speakers in variety from 2in. miniatures to:
Vitavox K12/20 high fidelity 20 watts overall diameter 12 1/2 in., baffle aperture, 10 1/2 in. A heavy duty speaker combining punch, high efficiency and fidelity. Flux density 17,000 lines per sq. cm. ... £1 1 0 0

CONDENSERS
T.C.C. metal cased 4 mfd. 500v. working 10/0
T.C.C. metal cased 8 mfd. 500v working 16/0

KEYS
Webb's operating key, well balanced G.P.O. type bar key, heavy lacquered brass on polished wood base, front and back controls ... £1 8 6

Webb's Amateur Key, similar high grade lacquered brass, slightly lighter, but perfectly balanced, front and back controls, ... £1 2 6

Practice Keys —
G.P.O. Bar type on wood base ... 4/-
U.S.A. type, all metal Key ... 3/6

BOOKS
Technical books a speciality, a few only as shown:
Introducing Radio Receiver Servicing (Squire) ... 6/-
Radio Data Charts (Wireless World) ... 7/6
Foundations of Wireless (Sowerby) ... 7/6
Radio Simplified (Clarricoats) ... 4/6
First Course in Wireless (Decibel) ... 4/6
Basic Radio (Berton Hoag) ... 21/-
Radio Interference Suppression (Ingram) 5/-
Introduction to Valves (Henderson) ... 5/-
Radio Technique (Mills) ... 21/-

WEBB'S RADIO, 14, Soho St., Oxford St., London, W.1. Telephone, Gerrard 2089
Note our revised SHOP HOURS: —
10 a.m. to 4 p.m. Sats., 10 a.m. to 12 noon.

ELECTRADIX

MOVING COIL HEADPHONES P.M., best headbands. Here is a wonderful opportunity to secure highly sensitive headphones with coils energised by the famous ALNI magnets. These moving coil sound units have a 45-ohm, 1/2" coil.

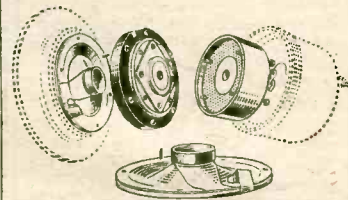

They can also be used as miniature mikes or as a miniature loudspeaker if matching transformer is used. Size 1 1/2" overall, in bakelite case with 3" iron flange. As new. Price each 12/6, or per pair 24/-
Brown type double steel headbands 2/6 pair; heavy good quality cords 3/-, light-weight cords 2/6.

CRYSTAL SETS. The famous Wall-nut table model Crystal Set in G.P.O. polished case, variable condenser, tuned tapped A.T.I. semi-perm detector, 42/-.
Mark II converted ex W.D. wavemeter type in box with lid, 55/-.
Crystal set assembly comprising Condenser, Coil, Detector and Terminals with wiring diagram, 9/6.
Catwhisker detectors, 2/6. Spare crystal, 1/-.
Semi-perm detectors, 2/6. Spare crystals, mounted, 1/6. Aerial wire 7/22, copper cotton-covered, 5/- 100ft. Copper indoor aerial wire in 30ft. lengths, 2/-.



MIKES. Recording and announcers' hand-mikes, multi-carbon, metal clad, service type, by Tannoy and Truvox, with neat switch in handle, 21/-.

BELLS. Large iron-clad A.C. 230/50v. mains bells, "Tangent," 6" gong, as new £2/2/0, to tiny Townsend Buzzers at 10/- each.

WIRE. Single silk-covered magnet wire, 28 gauge 7/6 lb., 30 gauge 9/- lb., 32 gauge 12/6 lb. Enamelled and S.C.C. wire, 18 gauge 3/2 lb. Twin bell wire 100 yds. for 12/-.

SMALL D.C. MOTOR GENERATORS by E.D.C. and others, for use with Receivers and Car Radio; take the place of H.T. Batteries. Drives off 12-volt accumulator and gives 230 volts D.C. 30 m.a. output, off 6-volt gives 110 volts 15 m.a. Originally made for Government radios. Two commutators, ball bearings, laminated field, insulated brush gear, covered armature windings. A splendid job. In new condition. 75/-.

MAGNETS. Midget ALNI perm steel disc magnets, 3/16" dia. with centre hole 3/16" dia., of tremendous magnetic force: unlimited uses, 3/6 each. Horse-shoe permanent-steel magnets, various sizes from 3/6 each.



INVISIBLE RAY CONTROL. Photo cell Raycraft Set with bakelite selenium bridge, 10,000 ohm sensitive Relay, megostat, etc., with booklet. 42/-.

ELECTRADIX RADIOS
214, Queenstown Road, Battersea, London, S.W.8.
Telephone MACaulay 2159

8 + 8 MFD

Condensers are components mostly required nowadays. Sometimes we have a small supply which is distributed at the official price. At present we are offering well-known makers' products 100% guaranteed by us:

- KNOBS**, bakelite, 9d.
- VALVE HOLDERS**. All bases in stock, 1/-.
- DIALS**. Medium wave stations printed, 1/7.
- CEMENT**. Per tin, 5/-.
- SOLDER**, Pound, 5/8.
- PLASTIC WOOD**. Large Jar, 3/-.
- SCRATCH REMOVING POLISH**, 3/-.
- TWO-GANG CONDENSERS**. Special midget condensers, with trimmers, 15/6.
- THREE-GANG CONDENSERS**. Standard type, 12/6.
- MAINS TRANSFORMERS**. RME 200/230 volts 300-0-300, 4 v. 4 amps., 4 v. 2 amps., 6.3 v. 3 amps., 5 v. 2 amps., 37/6.
- SPEAKER TRANSFORMERS**. Universal output (Pentode and Power), 6/6.
- UNIVERSAL model**, 8/-.
- VOLUME CONTROLS**. Most values in stock, with switch, 6/-.
- POTENTIOMETER**. Wire wound, variable, 0-10 ohms, complete with knob, 3/9.
- TRIMMER SCREWDRIVERS**. Non-capacity ebonite, 1/9 each.
- RESISTORS**. 1 watt, card of 36 assorted values, 27/6.
- VARIABLE MAINS DROPPER RESISTORS**. 2 or 3 amps., 5/6.
- Resistors in cages to permit fixing outside set, 3 amps., 7/0 ohms, 11/9.
- DROPPERS** ready to fit, 1 doz. assorted.
- Coesor**, Ferrand, Decca, T.R.F. COILS. Set of medium wave coils (Aerial and H.F.), complete with diagram, 9/6.
- LINE COIL**. 2-core, 3 amp., 60 ohms, per foot, 1/-; 3-core, 3 amp., 60 ohms, per foot, 1/1; 3-core, .15 amp., 100 ohms, per foot, 1/2.
- SPEAKERS**. 8in. Rola, less transformer, 23/-; 6in. Celestion, with transformer, 27/-; 3in. Goodman, less transformer, 30/-.
- VIBRATORS**. Brand new American "MALLORY," 6 v. 4-pin, fully guaranteed, 13/6.

MODERN AIDS

- "TESTSCOPE", the best pocket instrument for tracing faults. Enables 28 tests AC/DC, complete with leads, 37/6.
- TRIMMER TOOL KITS**. 14 tools in wallet, 30/-.
- ELCO**. Electrical Light-weight Soldering Iron (state voltage), 13/6.
- "FLIK-O-DISK" a novel calculator of Ohm's law problems, 6/6.
- PYROBIT IRON**, 22/-.
- MOVING COIL METERS**, 30 amps. charge, discharge, bakelite base, 19/6.
- CAR AERIALS**, telescopic, nickel-plated, 21/-.
- FLAT IRONS**, 200-240 v., 27/6.
- ELECTRIC TEA KETTLES**, 230/250 v., 55/-.

RADIO LITERATURE

- Television, 1/-.
- Test Gear Construction, 1/6.
- Amplifier Manual, 2/-.
- Equivalent Charts, our unique booklet, 1/7.
- Manual of Circuits, 2/-.
- Short Wave Handbook, 2/-.
- Handbook on American Midget Sets, 2/7.
- Wireless Terms Explained, 3/-.
- Manual of British and American Valves, 3/6.
- Radio Inside Out, 4/6.
- Radio Simplified, 4/6.
- Basic Radio, 5/-.
- Introducing Radio Servicing, 6/-.
- Receiver Circuits Book, 6/-.
- Various Service Sheets, 10/6 per doz.
- Various Service Diagrams, 7/6 per doz.
- Giant World Radio Map, 5/-.
- For VALVES see our July Advt.
- Orders under 10/- C.W.O., otherwise C.O.D. Stamp with enquiries, please.

EXPORT ORDERS INVITED

J. BULL & SONS,

(Dept. P.W.)
246, HIGH STREET,
HARLESDEN, N.W.10

YOU can become a first-class RADIO ENGINEER

We are specialists in Home-Study Tuition in Radio, Television and Mathematics. Post coupon now for free booklet and learn how you can qualify for well-paid employment or profitable spare-time work.

T. & G. RADIO COLLEGE

NORTH ROAD, PARKSTONE, DORSET.

(Please note new address.)

(Post in unsealed envelope, 1d. stamp.)
Please send me free details of your Home-Study Mathematics and Radio Courses.
NAME

ADDRESS

P. 64.....

RADIO SPARES

- MAINS TRANSFORMERS**. Primaries 200/250 volts. Secondaries, 350-0-350 volts.
- TYPE A**. 80 ma. 4v. 3a., 4v. 2 1/2a. -- 32/6
- TYPE B**. 80 ma. 6.3v. 5a., 5v. 2 1/2a. -- 32/6
- TYPE C**. 100 ma. Ratings as type A -- 34/6
- TYPE D**. 100 ma. Ratings as type B -- 34/6
- TYPE E**. 120 ma. Ratings as type A -- 37/6
- TYPE F**. 120 ma. Ratings as type B -- 37/6
- TYPE H**. 200 ma. Three L.T.s of 4v. and 4v. for rectifier. Ratings as required -- 47/6
- TYPE I**. 200 ma. Three L.T.s of 0.3v. and 5v. for rectifier. Ratings as required -- 47/6
- Secondaries 500-0-500 volts.
- TYPE J**. 200 ma. L.T. windings as type I 52/-
- TYPE K**. 200 ma. L.T. windings as type H 52/-
- TYPE L**. 250 ma. L.T. windings as type I 56/-
- TYPE M**. 250 ma. L.T. windings as type H 56/-
- Secondaries 250-0-250 volts.
- TYPE N**. 200 ma. L.T. windings as type H 47/6
- TYPE O**. 200 ma. L.T. windings as type I 47/6
- TYPE P**. 300 ma. L.T. windings as type H 60/-
- TYPE Q**. 300 ma. L.T. windings as type I 60/-
- Secondaries 400-0-400 volts.
- TYPE R**. 120 ma. 4v. 3a., 4v. 2 1/2a. -- 40/-
- TYPE S**. 120 ma. 6.3v. 5a., 5v. 2 1/2a. -- 40/-
- TYPE T**. 80 ma. L.T. windings as type B -- 35/-
- TYPE U**. 80 ma. L.T. windings as type S -- 35/-
- Secondaries 425-0-425 volts.
- TYPE V**. 120 ma. L.T. windings as type R 39/-
- TYPE W**. 120 ma. L.T. windings as type S 39/-
- Types H to Q are provided with two L.T. windings, centre tapped.
- Please note that owing to dimensions and weight of types H to Q, kindly add 2/6 for carriage and packing.
- MULTI RATIO OUTPUT TRANSFORMER**. 120 ma. 15 taps, tapings for 6L6's in push-pull; 6X4's in push-pull; low impedance triode; low impedance pentode; high impedance triode. 37/6; complete instructions with each Unit.
- Orders accepted by post only. Please help us to eliminate clerical work by sending cash with order. Please include postage with order. PRICE LIST, 3/6, stamp.

H. W. FIELD & SON

Colchester Road, HAROLD PARK, ESSEX

M. WILSON Ltd.

(Late Austerity Radio Ltd.)
Same Management

GRAMOPHONE AMPLIFIER CHASSIS 4-VALVE, 4-WATT

Assembled on black Crackle-finished, chassis fitted with separate Tone Control, Volume Control with on/off switch, sockets for microphone, gramophone and extension speaker. Hum free, good quality reproduction. A.C. only. Input 200/250 v. Size overall, 8 x 6 1/2 x 7 1/2 in. Ready to play. Price, including 10 Gns. valves and speaker

4-VALVE, 6-WATT

With PX4 output. Specification as above. Theoretical and practical Blue Prints of the above available separately, 3/6 per set.

BLUE PRINTS.

of the following circuits. Theoretical and Practical. 3/6 per set of 3 (1 Theo. and 2 Prac.).
No. 1. A.C. T.R.F. 3 valves, Medium Wave only.
No. 2. A.C. T.R.F. 4 valves, Short Wave only.
No. 3. A.C. T.R.F. 4 valves, Short and Med. waves.
No. 4. A.C. Superhet 4 valves, Short and Med. waves.
No. 5. A.C./D.C. Superhet, 4 valves, Long, Medium and Short Wave.
No. 6. A.C./D.C. Superhet, 4 valves, Long, Medium and Short Wave.
No. 7. Battery T.R.F. 3 valves, Long, Medium and Short Wave.
No. 8. Battery T.R.F. 3 valves, Short Wave only.
No. 9. Battery T.R.F. 3 valves, Short Wave only.
Priced list of components sent with each set of Blue Prints.

FOR OVERSEAS READERS

2 New Tropical Circuits

No. 17. Small Communication Type AC and AC/DC Superheterodyne Receivers. Brief specification: 6 Wavebands, 5-2,000 metres. Radio Frequency stage, 7 Valves, Int. Octals., including beat frequency osc. and rectifier, 465 k/c.s. Overall measurements: 16in. x 8in. x 8in., in black crackle finish. Shortly available for export.

No. 18. Battery 4-Valve Superhet, 3 Wavebands, 10-60, 200-557, 700-2,000 m. Priced list of components sent with each set of Blue Prints, 3/6 per set of 3.

MAINS TRANSFORMERS, to suit all circuits, built to specification. See last month's advertisement for Standard Models.

WESPECTORS, WX6, 4/-.

ULTRA S.W. COILS (plug in), air spaced, silver copper wire, R.F., H.F., and Osc., Range 1, 4.5-8 m.; Range 2, 4.5-17 m., 2/3 each; 6/6 set of 3.

3 WAVEBAND COILS, 10-60, 200-550 and 900-2,000 m. (on one former), A. and H.F. also A. and Osc., 12/6 pair.

Toggle Switches, Miniature, on-off, single pole, 2/6. D.P., D.T., 4/3.

Metal Rectifiers, small, chassis mounting 45 volts, 40 ma., 7/6 each.

Chassis, silver sprayed, undrilled, 10 x 8 x 2 1/2, 7/6, 8 x 6 x 2 1/2, 4/6.

Small 2-gang .0005 Condensers fitted with 4 push button switch, 8/6.

MAINS ENERGISED SPEAKERS, 8in., with transformer, 1,000 or 1,200 ohms., 25/-.

WEARTE I.F. TRANSFORMERS, 465 k/c.s., 15/- pair.

VALVE HOLDERS, 4, 5, 6, 7, and 9 pin. Enthal, 6d. each. International and MAZDA OCTAL, 6d. each.

TO OVERSEAS TRADERS! Wholesale and Retail Enquiries are invited. Orders can be executed for B.L.A., C.M.F. and S.E.A.C.O. customers.

307 HIGH HOLBORN,
LONDON W.C.1. Phone: HOLborn 4631

phase-reversal of the output voltage if taken off the cathode end of R —the potential at this point is changing in the same phase as the grid-signal. But because the grid is returned to the "anode end" ($-H.T.$), all the output voltage would be fed-back to oppose the signal, in reversed phase.

That is, of course, if R were the only load resistance. In consequence, to get any output voltage whatsoever, it follows that the voltage gain of the stage cannot be greater than 1.0—the output voltage must, in fact, be slightly less than the signal e.m.f., otherwise there would be no resultant e.m.f. applied to the grid.

We have outlined, very briefly, a cathode-follower stage, which employs 100 per cent. negative feedback simply by inserting the load resistance on the cathode side. An example of a similar kind, resulting in some loss of amplification, would be to use a cathode bias resistor without a bypass condenser to the A.C. component. If the capacity of this is made smaller than it should be for effective bypassing of the lower frequencies, a useful degree of "current feedback" (at the expense of "gain" at the lower frequencies) could be obtained to reduce bass response—where necessary.

Reactances in the Anode Circuit

Complete phase-inversion (180 deg.) comes about in a stage having a pure resistance load, because, when I_a rises, the p.d. across the resistance increases, in phase with the current. Therefore, the volts left on the valve must fall by the same amount.

Illustrations have been given to show that this "fall" really represents a voltage in direct phase-opposition to the grid signal, i.e., during a positive grid half-cycle, a falling voltage has the same effect as a negative half-cycle of true alternating e.m.f., opposing the signal.

It leaves no room for argument as to whether a "falling d.c." is the same as reversal during the negative half of an A.C. cycle. As previously stated, it is exactly the same in effect, as we saw in the case of a transformer or condenser.

But one word of caution: it must not be thought that the phase-shift is necessarily 180 deg. in any amplifying stage. It is far from true to say the output voltage becomes completely "inverted" from every stage in an amplifier. The statement is only true for a purely resistive load.

For instance, with a transformer primary, the inductive reactance is far greater than any resistance: the latter can be entirely neglected by comparison. In a reactance, however, the voltage drop is not in phase with, but at

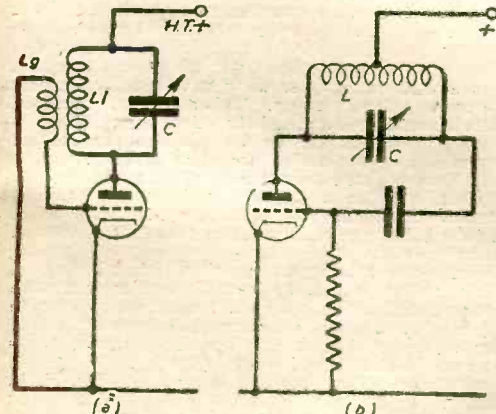

Fig. 6.—Oscillators generating sine-wave oscillations. The grid-exciting voltage is shifted 180 deg. by the valve, then another 180 by the couplings.

90 deg. to the alternating current. Since the current itself is in phase with E_g , this means the output voltage, up to the primary, will be at about 90 deg., not 180 deg., to E_g .

What about the secondary e.m.f.? Well, as a final exercise in tracing out "phase-shifts," the reader might think it out for himself. The following suggestions will help:

First, I_a and E_g are in phase. The voltage drop across the primary will be (leading or lagging?) 90 deg. on I_a , and therefore on E_g . The voltage across the valve is at 180 deg. to the "drop" across the primary—though not to E_g . Finally, the induced e.m.f. in the secondary

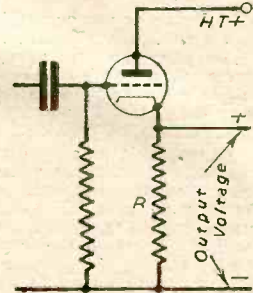

Fig. 7.—Negative feedback in the Cathode-follower.

has the same phase as the back e.m.f. in the primary—but we can reverse the voltage applied to a valve a further 180 deg. by swapping-over the secondary or primary connections.

It is here that phase problems begin to become slightly intricate. Yet, it is necessary to have some understanding of them in order to follow various practical methods of negative feedback, etc., and all we have attempted to do here is to consider the general principles of the subject.

THE B.B.C. MONITORING SERVICE

(Continued from page 416)

—this for immediate flash, that to be given in full, or something else to be summarised for the daily Digest.

In the editorial room the daily output of 300,000 words of transcript is sub-edited, and prepared for the daily Digest, while in the Publishing Department stencils are cut for the duplicating machines, and girls operate stapling machines for binding together the sheets forming the daily Digest.

The above is only a brief description of the work of the B.B.C. Monitoring Service, and the accompanying illustrations show how some of the work is carried out.

THREE NEW VEST-POCKET BOOKS!

WIRE AND WIRE GAUGES

By F. J. CAMM 3/6 or by post 3/9

NEWNES ENGINEER'S POCKET BOOK

By F. J. CAMM 10/6 or by post 11/-

MATHEMATICAL TABLES & FORMULÆ

By F. J. CAMM 3/6 or by post 3/9

Obtainable from all booksellers, or by post from George Newnes, Ltd. (Book Dept.), Tower House, Southampton Street, London, W.C.2

Electrical Contact Springs

A Discussion which Took Place at a Meeting of the Radio Section
of the Institution of Electrical Engineers, on May 22nd, 1945

THE discussion was opened by Dr. L. B. Hunt, M.Sc., and Dr. H. G. Taylor, A.M.I.E.E., who pointed out in their introductory remarks that the characteristics on which the design of a spring was based, were generally the pressure required to secure a satisfactory contact and the amplitude of the movement from the unstressed position.

The materials most often used for contact springs were nickel-silver, phosphor-bronze or beryllium-copper. Sometimes cadmium-copper, chromium-copper or brass were used. The limiting features were the stress induced in the material and the question whether it would withstand the corrosion conditions which existed. The higher the safe stress which a material could withstand, the greater was the permissible deflection. For static loads it was possible to compare materials on the basis of their proof stress, namely, that stress which gave a permanent set of 0.1 per cent., though the working stress should be less than this. If the loading of a spring was repeated at frequent intervals, fatigue was liable to take place, and a lower stress had to be selected.

"Springiness" depended on the ratio of maximum safe operating stress to modulus of elasticity. A material with a low modulus would, therefore, have a higher deflection for a given applied force than one with a high modulus. For this reason copper alloys with a modulus less than two-thirds of that of steel were in many cases more suitable. This was of importance where there was a tolerance on the size of a spring contacting member, since the maximum size must not overstress the spring, and the minimum size must still provide adequate contact pressure. Beryllium-copper was the most springy of the possible materials, followed by phosphor-bronze. Copper was the least springy, owing to its low proof stress.

Precipitation-hardening alloys, such as beryllium-copper, had the advantage that their best properties were produced by heat treatment, and any necessary forming could be done prior to this operation. With non-heatable alloys, on the other hand, the degree of forming was limited by the permissible sacrifice of spring properties, since clearly the harder the material the greater was the necessary deflection to produce a given permanent set and, therefore, the greater the stress and risk of fracture. The minimum permissible radius of right-angled bends varied with the type of material, with its hardness, and with the direction of the bend with respect to the direction of rolling of the material. A summary of a large series of tests was given in a paper by the openers, entitled "Electrical Contact Springs," published in the *Journal*, 1945, 92, Part III, p. 38.

Resistance to Tarnishing

In many cases the material of which a contact spring was made was suitable for the actual contact, but where pressures were light and a very low contact resistance was required, special materials must be employed. Platinum was widely used for this purpose. Platinum, rhodium and gold gave complete resistance to tarnishing. For particular circumstances, silver was a valuable contact material, but it was unsuitable in the presence of sulphur compounds. Electro-deposition of contact materials was widely used and was the only practicable way of using rhodium, which, in addition to being entirely free from tarnishing at ordinary temperatures, possessed remarkable wear-resisting properties. Its Vickers

pyramid hardness might be as high as 800. Comments on the design of light-duty contacts together with tables of the physical properties of contact materials in their solid and electro-deposited form, were given in the above-mentioned paper.

In the discussion which followed, it was apparent that the current practice of leaving the choice of alloy composition and cold-working temper to the judgment of the metal manufacturer, after showing him drawings of the part to be produced, did not altogether find favour with component manufacturers, who called for more detailed methods of specifying physical properties in order that tests might be devised to check the uniformity of successive batches of raw material. The metallurgists, on the other hand, thought that tests of modulus, proof stress and Vickers hardness were sufficient to control the product. The range of temps available from cold-rolling could be related to the Vickers hardness.

Working Spring Alloys

Difficulties in working some of the modern spring alloys were discussed; for example, change of shape during heat treatment and the possible deterioration of silver plating on re-entrant surfaces which had to be plated before forming and heat treatment. It was pointed out that the former difficulty might be overcome by "nesting" and wiring parts which would fit together to give mutual support; otherwise jigs would have to be devised. Normally, the temperature required for heat treatment should not affect silver plating, but if it did, the solution was to use bimetallic strip in which the contact and spring metals were rolled together.

If component manufacturers wished to make the best use of improved spring alloys they would have to modify the design of contacts; many complicated shapes could only be formed in 70/30 brass. Rotary-type wafer-switch contacts—formerly of silvered brass—were now being made in 50/50 copper-silver alloy. This was a better spring material, but required a higher contact pressure to give a low contact resistance.

The performance of platinum in relay contacts could still be regarded as the standard by which other metals should be judged. Gold alloys with silver, nickel or zirconium had been used in enemy countries, but were in the nature of a substitute. In high-speed telegraph relays a palladium-copper alloy gave greater freedom from cratering and pick-up. This alloy also gave good results in contact with nickel-chromium wire. Rhodium-plated phosphor-bronze or beryllium-copper contact arms were also successful in this application.

Rhodium was an excellent contact material for use in r.f. circuits where a low and uniform contact was essential. Platinum and palladium had been used, but were inferior to rhodium from the point of view of mechanical wear.

Silver-to-silver contacts were useful when good wiping action could be provided. For slide-wire contacts rhodium-to-rhodium or rhodium-to-silver gave good results. In the latter case the track should be silver and the contact rhodium, otherwise a silver smear would be left, which might tarnish.

In his concluding remarks the chairman, Mr. H. L. Kirke, said that the subject, although somewhat specialised was, nevertheless, of first importance, as there were few operations in radio engineering which did not involve the use of spring contacts. If the discussion resulted in the production of better valve-holders, he would regard the time as well spent.

Practical Hints

Transformer Testing Unit

WHEN making quick checks on mains transformers I find the following gadget very useful. It consists of a 15 watt bulb placed in series with one lead of the mains, as shown in the diagram. When testing the transformer, the switch S is left open and the transformer is connected by means of the two test prods. If the transformer is in order it will take its normal no load current, say 15 mA. This current has to pass the bulb and will make it glow slightly. The V.D. across the bulb is very small, and therefore the transformer will get approximately its normal mains voltage.

If the transformer is not in order it will try to draw a heavy current off the main. This will cause a large V.D. across the bulb and it will glow very brightly. This will not cause any fuses to blow, as the maximum

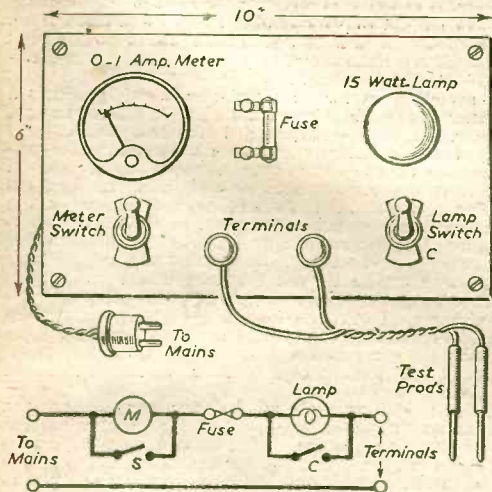

Panel layout and circuit diagram of a simple transformer testing unit.

current passed by the bulb is only $15/230$, i.e., .068 mA. This method also provides a very easy way of testing transformers for their primary. If it is required to obtain the correct current, then the bulb should be shorted out by means of switch C and the switch across the meter opened. When commencing to test a transformer this switch should be closed, as a short in the transformer might cause the meter to be damaged.—H. GOTTSCHALK (Macclesfield).

Easier Meter Readings

IN some types of test equipment a normal type of panel-mounting meter is employed and the scale is accordingly restricted in size. If the instrument is being used for various ranges it may be desirable to draw up a new scale with all the ranges clearly marked. This cannot be done on the existing meter dial, and in such a case it is worth while modifying the meter in the following manner: Remove the front and make the necessary arrangements for mounting the meter slightly behind the panel. A suitable aperture should then be cut in the panel and covered with glass, celluloid or similar material. The appropriate scale should be then drawn up and the pointer extended to the necessary length. To avoid upsetting

THAT DODGE OF YOURS!

Every Reader of "PRACTICAL WIRELESS" must have originated some little dodge which would interest other readers. Why not pass it on to us? We pay half-a-guinea for every hint published on this page. Turn that idea of yours to account by sending it in to us addressed to the Editor, "PRACTICAL WIRELESS," George Newnes, Ltd., Tower House, Southampton Street, Strand, W.C.2. Put your name and address on every item. Please note that every notion sent in must be original. Mark envelopes "Practical Hints."

SPECIAL NOTICE

All hints must be accompanied by the coupon cut from page iii of cover.

the meter movement by altering the balance of the needle the ideal plan is to lengthen it by sticking on a bristle taken from a broom or brush, the bristle being of a suitable thickness to provide easy reading.—R. POTTER (Wembley).

Morse Practice Set

BELOW are given details of a useful morse practice set that enables multi-way communication to be effected without the use of four or more line wires. This practice set is useful to beginners as the operator can hear in his 'phones what he is transmitting and so correct timing is soon acquired.

The coil marked "X" (Fig. 3) is the primary of an output transformer, its resistance being so low that the buzzer's operation is not impaired. The line wire (L2), can be earthed, leaving only two other direct connecting wires. These two are absolutely necessary as earthing either would produce such a high resistance that the buzzer would not work. Any number of stations can be wired into the circuit (these being as in Fig. 2). By connecting 'phones across L1 and L2, and tapper across L1 and L3. For practice by oneself, the phones can be connected directly across the transformer primary (Fig. 1).—D. R. BATE (Bristol).

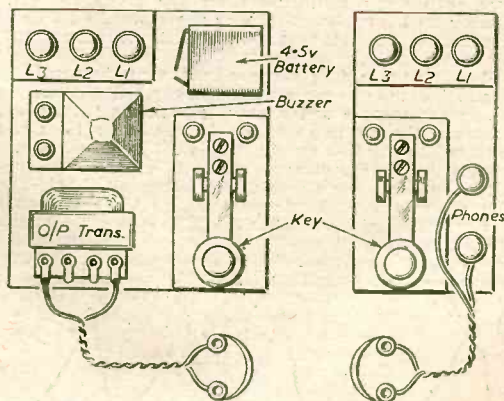

Fig. 1.

Fig. 2.

Morse practice units for multi-way communication.

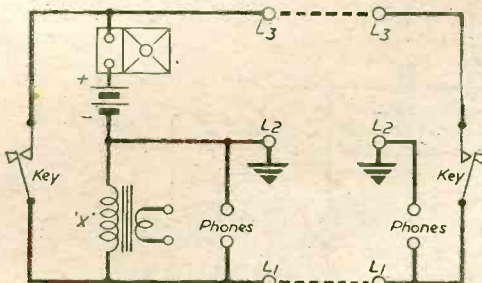

Fig. 3.

Circuit and details of a morse practice lay out.

Open to Discussion

The Editor does not necessarily agree with the opinions expressed by his correspondents. All letters must be accompanied by the name and address of the sender (not necessarily for publication).

Time Base

SIR,—Recently, when I was constructing a small oscilloscope, I stumbled on the following hard valve time base circuit, which I think your readers may find useful. I have tried it with an EL50 and an SP42, with equal results, so I presume that almost any high-gain pentode will do.

Variation of R_4 (velocity control) from zero to $1\text{ m}\Omega$ alters the frequency from 20 kc/s. to $12\frac{1}{2}$ c/s. A slow-motion drive or a smaller pot. in series is therefore an advantage, but once set, it remains steady. It works equally well with all H.T. voltages between 200 v. and 350 v., the amplitude if sawtooth in all cases being about $\frac{1}{2}$ of the H.T. voltage. Resistors R_1 , R_2 , and R_3 are rather critical, deviation affecting amplitude of output and linearity.

Condenser C_2 should be kept small (as shown) to preserve the first flyback, and increasing C_1 has adverse effects on linearity.

The output waveform is shaped as in the top sketch.

The screen and suppressor have similar waveforms, with large pulses superimposed on each point, whilst the control grid has small +v. giving pulses during each flyback.

I have never seen a hard-valve self-running time base with fewer components for the range covered. Neither do I know whether I have stumbled on a new circuit. It's virtue is that it works well. Anode current is about 3 mA.

My theory regarding its operation is that, disregarding C_1 and R_4 (suppose the control grid earthed) the circuit becomes that of a square-wave generating transistor. However, the anode potential of the valve is, in fact, anchored to the CR, Cr R_4 . This CR is connected as an amplified delayed time-constant, so the effective CR tying down the anode of the valve is CR ($U+1$). The valve is a high-gain pentode, so $U+1$ is large, and consequently the effective CR is large. Thus, the anode potential steadily rises (as C_1 changes) until the valve "transitrates" for one cycle, giving the flyback.—P. F. PURCHASE (London).

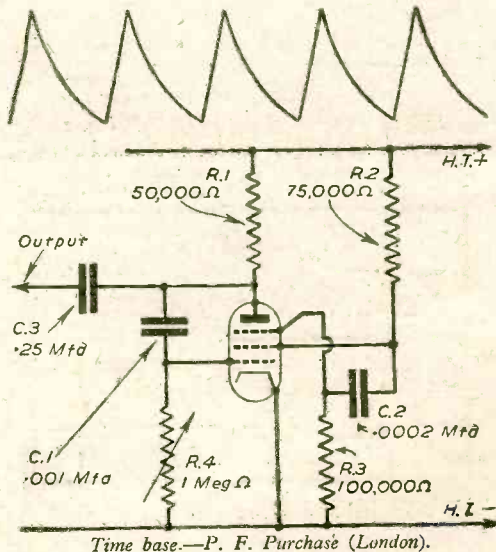

"Thermion" Right

SIR,—I think Thermion is perfectly right, and Mr. A. F. Gowling definitely wrong.

To publish nothing but technical articles would make PRACTICAL WIRELESS very dry indeed, and I think its circulation would experience a drop. The great majority of its readers like some matters of general interest, and is it not on record that "A little nonsense now and then is relished by the wisest men."

And does Mr. Gowling, of Potts Wood, want to be included amongst these.—K. T. HARDMAN, Liverpool.

"Some Correspondence Answered"

SIR,—I was interested to read your paragraph in this month's PRACTICAL WIRELESS entitled: "Some correspondence answered."

Carping criticism is certainly the most unhelpful of all, though I think that many of the people who make it do, so in good enough faith but in ignorance of certain vital facts. This is almost certainly the case with your correspondent, Mr. Gowling.

I myself work for an association which produces a monthly journal, besides a fair variety of printed leaflets, memoranda, etc., and although I am not on the editorial staff I am sufficiently in touch with things to have shared some of the worries over the paper quota, exclusion of advertisements owing to lack of space, use of small type, etc. Indeed, it has sometimes been a wonder that anything has been produced at all, what with the aforementioned considerations, and blocks and proofs going astray owing to bombing. If Mr. Gowling realised some of these points, I do not think he would be quite so critical over this aspect of journal production.

With regard to advertisements, I always have them bound in with the rest of the matter. After the lapse of years they form a useful and informative supplement, especially in journals of a technical and semi-technical nature.

I don't think anybody will be sorry to see PRACTICAL WIRELESS in larger type (and larger page) when the paper situation eases. Looking back through some 1939 issues recently in search of information was very grateful to my eyes. And a detailed circuit or wiring diagram deserves a large spread.

I think I see Mr. Gowling's point about dropping certain features. As you say, a journal that is 100 per cent. technical is very dry; but at the same time, we would not want to read in PRACTICAL WIRELESS chit-chat about, say, the performers in B.B.C. variety shows. Normally there are papers that cater specially for that type of thing. My last letter to you, written, I think, in 1941, deprecated the appearance of articles on musical biography and history in PRACTICAL WIRELESS. A modicum of non-technical matter is desirable and acceptable, though I think that most of your readers will prefer the emphasis on the word "Practical" in the title of the journal.

These are only small points, however. I think the paper has kept up to an excellent standard through trying times, and I think you can afford to ignore your carping critics.—W. H. MACKINTOSH (London).

Economy Superhet

SIR,—I wish to point out an error in your July issue of PRACTICAL WIRELESS, the misprint in question being a circuit in page 313, dealing with Mr. P. Stearn's "Economy Superhet." The A.V.C. diode anode is shown connected directly to the primary of I.F.3.

A D.C. blocking condenser should be in this circuit.—D. J. ROTHMAN (London).

(Continued on page 436)

RADIO SALES

BCMALES LONDON W.C.1

Can we help YOU? Send your enquiries with a S.A.E. We can't list everything, ask for it per C.O.D. if it's not shown.

SPEAKERS. Celestion 6in. with trans., 30/-; Goodmans 3in. 3 ohms less trans., 30/-; Rola or Celestion 8in., 28/6; less trans., 21/-.

VOLUME CONTROLS. Various values, with S.W. 5/6; less S.W. 4/6, mainly Centralab.

GANG CONDENSERS. 2 gang small, with trimmers and feet, 15/-.

COILS. MW TRF pairs, 5/6. MW OSC 465 kc., 2/3.

I.F. TRANS. Standard 465 kc., 18/- pr.

ELECTROLYTICS. 50 mfd./50 v., 5/-; 50 mf./12 v., 2/6; 25mf./25 v., 2/6; 10 mf./50 v., 2/6.

SPEAKER TRANS. 3 w. pen., 7/6 Midget pen., 6/- with C.T. 16/6. All for 3-5 ohms speech coil. Midget trans. takes 1a 50-60 ma.

MAINS TRANS. 350-0-350, 6.3 and 5 v. LTS or 350-0-350, 4 v. and 4 v. LTS. Rect. windings C.T. 35/-.

MAINS DROPPERS. 3 amp. 750 ohms, 5/6. 2 amp. 850 ohms, 4/6. With two sliders and feet. High class jobs.

RESISTORS. 1 w. 4d., 1 w. 6d., 1 w. 9d., 50 assorted 1, 1 and 1 w. 17/6.

CONDENSERS. Paper, mica and s. mica. .0001-.0005 9d., .01-.05 1/-, .25 1/6, .5 2/6, 1 9d., 50 assorted, all types, £1.

MIDGET CHOKES. 15 Hy. 60 ma., 7/6.

VALVE HOLDERS. Octal both types, 9d. 4 and 5 pin. English, 6d. 4, 5, 6, 7 pin. Amer., 9d. English 7 and 9 pin. 9d.

Mikes, crystal or carbon, Morse keys, solder wire, sleeving, irons, tags, ins. tape, flux. Send 1d. for full 4 page list or ask for it per C.O.D. If Cash with order, please send postage.

VALUE! MATT has it

LINE CORD.—2-wav. 2/6 per yd.; 3-wav. 3/- per yd. (approx. 60 ohms per foot).

SPEAKERS.—"Celestion," P.M., 2in. less trans., 27/-; 8in. P.M., with trans., 27/6; 6in. P.M. (multi-radio trans.), 28/6; "Rola," 6in. P.M., with trans., 28/6.

Two-gang Condensers.—0.0005, with trimmers, 12/6. Midget Coils, H.F. and Aerial, 5/- per pair.

Volume Holders (all types), 15/-; **Volume Controls**, less switch, 2/9; with switch, 3/9.

Mains Transformers, 4v. and 5v., 27/6. **Kohlermet (Crystal) Pick-ups**, metal, 58, 63/13/6. **Senior de Luxe**, £3/13/6.

Condensers. All types in stock. 2's, 8's, 16's, 20,20, 300v. working. 1. .01, .25, .05, 25 x 25, etc.

Resistances, 1 and 1 watt. All values, 1/- each; 9/6 doz. 1 watt, 6/6 doz.

ACCUMULATORS, Glass, 2v. 45 amp., 14/6. **Do. Celluloid Portable**, 2v. 17/6. Let us quote you for ALL your requirements Cash with order, plus postage.

MATT RADIO SERVICE (Kingston 4881)

152, Richmond Road, Kingston-on-Thames, Surrey.

BERRY'S (SHORT WAVE) LTD.,

for Quality Radio and Electronic Products including: P. Coils, 2,3 and 2/6 I.F.'s, 7/6 each. Multiband 1-1 S.M. Dial with driving head, 35/-; 3-1, 25/-; 8 M. Drive scutechion and glass, 8/6. Speakers, 2in., 27/-; 3in., 30/-; also 6in., 6s 12in. Jinks and Jackplug, 2/6 each. Vortexion 20w. Amplifier for Mains or Battery, £19.13.9. Ceramic trimmers, condensers, stand-offs, formers, valve bases, etc. Fuseholders, Single 2/6, Twin 3/6. Volume Controls, 4,3, with switch, 5/9. Send S.A.E. for complete List "P" to—
25, HIGH HOLBORN, LONDON, W.C.1.
Phone: Holborn 6231.

COULPHONE RADIO

PROMPT MAIL ORDER SERVICE NEW GOODS ONLY

Orders over 5/- post and packing free. Tungfram and B.V.A. Valves. Over 2,000 in stock. List prices.

Mains Trans., 350v.-3-350v. 100 mA. 4v. 6v. 4v. 2in., or 8.3v. 3 a. 5v. 2a., 26/6 Transf. Bobbins, as above... 15/6

P.M. Speakers, less transf. 3in., 29/-; 6in., 21/6; 5in., 21/-; 8in., 22/6; 10in., 35/-; With pen. transf., 6in., 27/-; 8in., 27/6; 10in., 42/6.

8in. M.E. 1,200 ohm. field pen. trsf. 32/6

Power-Pen, Output Transf., 40mA, 8/6

Parafed L.F. Transfs. 4. 1 ... 6/-

5-way Cable, 10d. yd.; 3-way, 6d. yd. Mains Dropper Resistors, 300 ohms, 2 ad. taps, 3 amp. with fixing feet 4/6

Push-back Wire, 50ft., 2/9; 100ft. 4/0 Carbon Resistors, 1 w., 6d.; 1 w., 9d. Standard values 50 Ω. to 5 meg. Resin Cored Solder... 4/- lb.

Tinned Copper Wire, 1 lb. ... 2/3

Sleeving, 2mm. A.I.D. Speci. 2d. yd. Moving Coil Microphone... 95/-

Mike Floor Stand, chromium ... 42/-

Tubular and Silver Mica, all sizes Valve-holders, Eng. & Amer., 6d. each

Vol. Controls with sw., 4/6; less sw. 3/6

Smoothing Iron Elements, 450v., 2/3

Fire Sprals, 750 w., 2/-; 1,000 w., 2/6

Stanco Soldering Irons, 230v., 17/6

Speaker Field Coils, 2,000 ohms, 9/6

Smoothing Chokes, 15 Hy. 200 mA, 200 ohms ... 21/-

Tuning Condensers, .0005 with trimmers, 2 gang, 11/6; 3 gang, less tr. 13/6

Tuning Coils, M. & L. wave, with reaction circuit ... Pair 12/6

Millicoumeters, 4in. B.S., 1st grade, 0-1 mA. Knife edge pointer... 70/-

Electrolytic Condensers, Limited supplies, 8mf. 450v., 8/9; 2mf. 350v., 3/6; 25mf. 25v., 50 mfd. 12 v. (both are priced 2/6); 25mf. 50v., 2/-; 50mf. 50v., 3/6.

Line Cord, 3 amp., 60 ohm per ft., 2 and 3-way, 3/6 per yard. Stamped addressed envelope for list. NEW LINGTON, Nr. Preston



Varley
TRANSFORMERS AND CHOKES
for Reliability
OLIVER PELL CONTROL LTD
CAMBRIDGE ROW, WOOLWICH, S.E. 18
TELEPHONE: WOOLWICH 1422



FOR THE RADIO SERVICE MAN, DEALER AND OWNER

The man who enrolls for an I.C.S. Radio Course learns radio thoroughly, completely, practically. When he earns his diploma, he will KNOW radio. We are not content merely to teach the principles of radio, we want to show our students how to apply that training in practical, every-day, radio service work. We train them to be successful!

INTERNATIONAL CORRESPONDENCE SCHOOLS

Dept. 94, International Buildings, Kingsway, London, W.C.2.

Please explain fully about your instruction in the subject marked X.

- Complete Radio Engineering
 - Radio Service Engineers
 - Elementary Radio
- If you wish to pass a Radio examination, indicate it below.
- British Institute of Radio Engineers
 - P.M.G. Certificate for Wireless Operators
 - City and Guilds Telecommunications
 - Wireless Operator, R.A.F.
 - Wireless Mechanic, R.A.F.

Special terms for members of H.M. Forces and discharged and disabled members of H.M. Armed Forces.

Name..... Age.....
(USE BLOCK LETTERS)

Address.....

(Use penny stamp on unsealed envelope.)



CONCORDIA L.V. TRANSFORMERS

Designed by transformer specialists to suit given conditions of service. Types available for Radio, Bell, Lighting, Mines, type, phase changing. Concordia also design and make transformers up to 50 kVA, to customers' requirements, air or oil cooled, and arrange for any enclosures (damp-proof, totally enclosed, etc.).

Sales Agents, **ELCORDIA LTD.**
2, CAXTON STREET, S.W.1.
Phone: Abbey 4266.

Adapting Potentiometer

SIR—Being in the position of having to quarter the value of a cathode bias potentiometer, and having no spares and only a minimum of tools, I devised the following method:

The potentiometer was connected normally, as shown.

The circuit was then reconnected as follows:

Both ends of the potentiometer were connected to chassis, and the slider left on the cathode, as shown. This is, when the slider is central, effectively two parallel

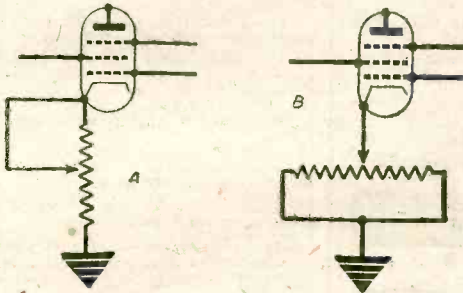

Adapting Potentiometer.—G. Read (London).

resistors, each of value half the original value, i.e., totally a quarter of the original resistance.

The only disadvantage is that the potentiometer now is not "minimum to maximum" on full rotation, but "minimum - maximum - minimum."—G. READ (London).

South American Transmissions

SIR—I think some of your readers will be interested to hear about some South American transmissions which have been received here in recent months, some of which I have not seen mentioned before in your paper.

Argentina: There appear to be quite a number of S.A.V. transmitters now in operation—LRR Radio Rioldo, 11.88 Mc/s. (approx.), relays the medium-wave LC8 in Rosario. Station identification is a series of musical notes, followed by the announcement "LC8 Radio Rosario y LRR Radio Rioldo. . . ." Usually a very good signal by 21.00 G.M.T. here at R6 to R7, QSA5.

LRR Buenos Aires, 9.66 Mc/s., relaying the medium-wave LR1, is a well-known transmitter and now announces its call in conjunction with LRX1. I have not heard LRX1 on a separate frequency, however. Usually heard at about R5, QSA5, by 21.00 G.M.T.

LRS Buenos Aires, in the 32m. band, 9.30 Mc/s. (approx.), relays the medium-wave LR4 in the same city. Announces its call in conjunction with LRS1, which also has not been heard on a separate frequency. Is a variable signal, but usually heard well after 22.00 G.M.T.

LR1 Radio Belgrano, Buenos Aires, 9.64 Mc/s. (approx.), relays the medium-wave LR3; has been heard at R6, QSA5 at 21.00 G.M.T., but unfortunately cannot usually be received after about 21.05, as it uses the same frequency as a Daventry transmitter (probably GSZ), which commences transmission at this time.

The Paraguayan station ZP15 (mentioned below) has been heard relaying LRP Radio Belgrano, Buenos Aires, but this transmitter has not yet been logged here.

Paraguay: Two transmitters are operating in the 25m. band:

ZP15 on 11.95 Mc/s. (approx.), relays the medium-wave ZP5. In announcements mentions "Radio Internacion de Paraguay." Usually received at R5, QSA4-5 by 21.00 G.M.T.

ZP13 on 11.855 Mc/s. (approx.), relays the medium-wave ZP3. In announcements mentions "Ora Popular de Paraguay." Received at R5-6, QSA5 after 21.00

G.M.T. The identification of both these stations is sometimes difficult, due to the fact that they both take parts of their programmes from Buenos Aires and occasionally from Santiago de Chile. ZP13 often suffers from side-band splash from GSE, 11.86 Mc/s. The old ZP14 transmitter at Villa Rica has not been heard for a long time.

Brazil: PRE9 Fortaleza, 15.165 Mc/s. is invariably a good signal and commences transmission at 21.00 G.M.T. with a recording of "Ave Maria."

PRL7 Rio de Janeiro, 9.72 Mc/s. is always a terrific signal here from 20.30 G.M.T. onwards, usually being R8-R9.

Cuba: Two stations on the 32m. band are received fairly well at times:

COBC Havana, 9.35 Mc/s. and COCX Havana, on 9.24 Mc/s. (approx.). Both are heard best after 22.00 G.M.T., when the average signal is R4-5, QSA4. COBC actually gives his call in English as well as Spanish, which is quite an event among the Latin-American stations.

The Central American transmitters are not well received now on the 47m. and 62m. bands and are probably "out of season" until the autumn.

Ecuador: HCJB Quito, always comes in very well on the 12.455 Mc/s. channel by 21.00 G.M.T. The 9.958 Mc/s. transmission is received on the average at R5-6 by 22.00 G.M.T. The 15.115 Mc/s. transmission is usually weak at all times, being only about R3-4, QSA3.

Other transmissions of interests, received recently, are:

VLG7 Melbourne, 15.16 Mc/s., received at odd times fairly well during the last hour of transmission, before closing its early morning session at 22.00 G.M.T. (approx.).

VLG6 Melbourne, 15.315 Mc/s., sometimes heard working with VLG7 after 23.00 G.M.T., with prisoner-of-war news.

Tokyo, 15.225 Mc/s. (approx.), does not correspond with any of the Tokyo frequencies on my station list. English news is given at 09.30 to 10.00 G.M.T. daily.

With reference to Mr. Bower's inquiry in the June issue about the present lack of signals on the 13, 11 and 9m. bands, I think the explanation is, that at the present stage of the sunspot cycle, these wavelengths are unusable for DX working. The sunspot minimum years were 1943-1944, and so in the period 1946-1950 we can expect these high frequency bands to become active again. The best years for U.H.F. DX working in the last 11-year cycle were 1935-1939, when quite an appreciable amount of DX working was carried out on 5 metres. Signs of increasing sunspot activity are already evident, and I observed a fairly large group of spots crossing the centre of the sun on May 2nd of this year, although none have been seen since. Incidentally, I would be interested to see any reports of DX signals on 10 metres or below, which would indicate increasing activity in this region. The best signals to look for at the present time would be commercial transmitter harmonics.—G. ELLIOTT (Gosport).

Midget Receivers

SIR—It was with great interest that I read F. G. Rayer's letter on his Matchbox Receiver. I must admit it is very ingenious, but one is apt to forget that the set needs batteries and they will certainly take up a large amount of room.

I have been a keen "midget set" builder for some time, and my best effort is a set which is housed in a box 7in. x 7in. x 4½in., inclusive of all batteries. It is an ordinary straight receiver using 3 Hivac midget valves as detector L.F. and output. I use a frame-aerial which is wound round the box and a 2½-in. Celestion P.M. loud-speaker. I get excellent reproduction which is undistorted at a very good volume. The set is very economical on the batteries, and the dimensions of the receiver could be reduced by using smaller batteries, which are available, and a bit of ingenuity.—J. BOND (Perthshire).

All-pentode Three

SIR,—I had a three-valve straight Cossor battery set which, though efficient for the design intended for S.G. det. power output, moving reed speaker, did not in view of present conditions come anywhere near ideal requirements. However, as the set had a set of very high "Q" powdered core tuning coils and other required components already on the chassis, I decided the best thing to do would be to scrap the existing valves and convert the circuit into a highly efficient all-pentode receiver.

The new valves are V.P.2B., H.F., S.P.2 det., Cossor H.P.T., or Osram K.T.2 output; former valves being S.G. det. power output. Regarding the tuning coils providing modern efficient ones are used, these can be of the open core type if desired, though results will not be so good as when using the type stipulated in the circuit. The circuit itself is the usual T.R.F. stages with transformer para-feed output.

This circuit, though, is designed for optimum results from the valves and coils used, and for successful results these must be adhered to.

It will be noticed that no mu bias is given to the V.P.2B. This is because I find when using high-gain valves, bias control only is not sufficient to completely "zero" both signals on home stations; however, with this point in view, I earthed the H.F. coil and made the rest of the circuit stable for this action by arranging the detector as shown, especially reaction. Incidentally, a standard .0001 mfd. variable condenser can be used in place of the series combination, as shown in circuit. Volume control, without hiding any defect, if any, in the preceding stages is made through a .5 m/ohms pot. meter fed to the output valve.

There is one important point, however, concerning the V.P.2B. On this type of valve only there are four grids, the extra one between grid and screened grid going to H.T.—through a 50,000 ohms resistance. This need not be decoupled by a .1 mfd., thus saving an extra condenser for other work; decoupling the S. grid is essential though.

It will be noticed that only two leads are required for H.T., and auto-bias for the output valve.

Providing the circuit is adhered to, the performance of the set, even on a small outdoor roof aerial, is A1.

stations simply ripping in. At a later date band-pass tuning could be used for further increased selectivity, using, of course, a three-gang condenser and suitable band-pass coils, bought or made from articles in the PRACTICAL WIRELESS.

A further word to conclude, although the circuit appears conventional with slight exceptions, the performance is well worth the extra expense and time involved in remodeling an old-type circuit.

I use this set personally for "den" use, or if required for strict family use in the place of buying a new receiver with their "cheap!" prices.

In conjunction with a mains unit the performance is nearly equal to a small-type superhet. The valves are Mullard V.P.2B. and S.P.2 and Cossor H.P.T.—T. M. E. PREECE (Hayes).

Voltage Dropping Condenser

SIR,—In his most interesting letter on the "capacitor dropper" in the August issue, Mr. Baker has neglected to make any comparison between the magnitudes of the surges on switching-on when using this method and when using a resistive dropper.

In the case of a resistive dropper for the set taken by Mr. Baker as an example—that is heaters requiring .3A at 69 volts—the value of the resistor is given by $\frac{230-69}{.3}$ say 540 ohms. The "hot" resistance of the

heaters is 230 ohms; when cold the value will be very much less, perhaps 50 ohms. This gives a total resistance of 590 ohms, and an R.M.S. surge current of $\frac{230}{590} = .390$ amps. If we follow Mr. Baker, and assume zero "cold" resistance, we get the R.M.S. surge to be $\frac{230}{540}$ or .426 amps., the peak value, which looks much more imposing, being .602 amps.

The worst surge obtainable with a capacitor system was shown to be .3146 amps. by Mr. Baker, and I therefore submit that his concluding paragraph is most misleading. One point in connection with valve life should, however, be mentioned; it is best to fit a fuse in the heater circuit in case of capacitor breakdown, and to use a component of adequate voltage rating.

I have had occasion to incorporate the system in one receiver, and have had excellent results over the last two months.—S. N. RADCLIFFE (Dorset).

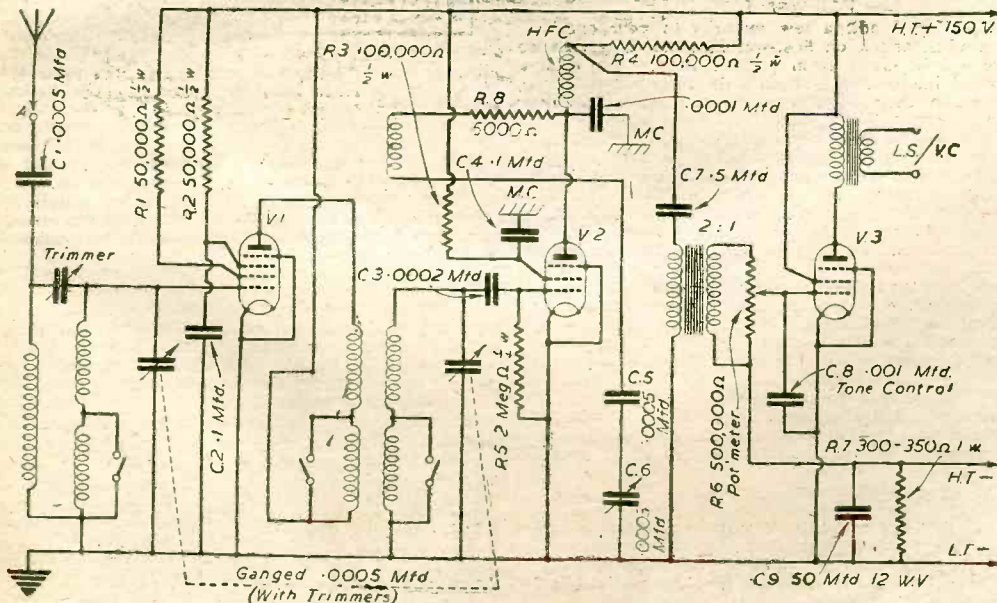

All-pentode Three.—T. M. E. Preece (Hayes).

"Absence of L.T."

SIR,—Re the matter of "Absence of L.T." I suggest that it is only valves of the mains types working at high anode voltages that are affected by the H.T. being switched on before the L.T. This is due to a condenser effect between cathode and anode. This effect is chiefly noticeable in rectifying valves working at high voltages. The H.T. switched on before the cathode has got heated and while it is still non-emitting, causes the cathode (and anode) to vibrate in sympathy with the alternating voltage, just as the plates of a flimsy air-spaced condenser would be alternately attracted to each other and released.

This phenomenon is noticeable, I repeat, in rectifying valves of the mercury vapour type which operate at voltages of not less than 1000 as a rule. Commercial mercury vapour rectifiers may take up to half an hour to reach operating voltage.

However, this scarcely affects battery valves for three reasons: (1) The H.T. current is pure D.C. of some 100 or 120 volts in the case of the "All-wave Five"; (2) The cathode is usually comparatively small (and is, of course, usually the filament), and in the case of triode, and multigrid valves is a centimetre or so from the anode which all helps to reduce condenser effect; (3) The filaments being made for small battery power heat up almost immediately the L.T. voltage is applied.

Hoping this will clear up the discussion and thanking you for such a good radio periodical.—D. W. PUTTRICK (Oundle).

SIR,—With reference to the letter in your June issue of PRACTICAL WIRELESS, written by F. Brook (Maidstone), relating to "Absence of L.T."

We should like to point out that he is quite wrong. Transmitting and Receiving apparatus required to be run on "stand-by" is fitted with delay circuits, which prevent the H.T. being applied before L.T., this allows the cathodes to reach operating temperature.

If Mr. Brook would care to study a circuit of any communication receiver, he will find that with the "Send/Receive" switch in the send (or stand-by) position, the H.T. negative line is broken, thus eliminating the high voltage supply to the valves, the L.T. only being "ON."—C. DRAKELEY (R.A.F.).

Post-war Market

SIR,—May I add a few remarks to your excellent leading article on Post-war Market. It is that we have a break-away from pre-war tuning dial design. I should like to see full-vision dials of the National type, as used in their FB7, etc., also the McMurdo Silver receiver type. These would be ideal for band-spread calibration and band-width marking. I know certain Bristol firms have in the past featured full-vision types, but what is required for short-wave work is, in my opinion, a really long and wide scale of a reasonably large diameter scale. When such are available I shall certainly use them. We have had some excellent dials in the past and no doubt our manufacturers can meet requirements and thus make available to the home constructor the type of dial only to be found on expensive communication receivers. Some years ago Messrs. Eddystone put on the market their deservedly popular band-spread outfit. I hope we may see this with a larger, improved dial scale and in two and three gang form. Eventually, ex W.D. receivers will be available. Should this be the case I trust that complete circuit and service data will be included, even if only as an extra. Same would be worth while. In conclusion, let me add the sincere wish that amateur transmitting will soon be allowed and licences granted, and everyone get back to normal radio activities. PRACTICAL WIRELESS will, no doubt, again become a weekly paper. Let's have it the original size and type format. Let the S.W. clubs keep their plans and activities before enthusiasts. If other readers have ideas relative to improvement in S.W. components I trust we will see them outlined in the correspondence pages of PRACTICAL WIRELESS.—A. W. MANN (Middlesbrough).

Interference Prevention

SIR,—In connection with your article in the March issue of PRACTICAL WIRELESS on Interference Prevention, I am sending a method of using a frame aerial which I found of great use last autumn when there was a strong heterodyne whistle on the North Regional wavelength. This frame arrangement (see circuit below) was the only way of cutting the interference out that I could find, a frame aerial connected in the normal way was useless.

When used to eliminate the whistle, it was found that it was not necessary to screen the connecting leads (although they were about 4ft. long), the interference being balanced out when the frame was correctly adjusted. As the heterodyne seems now to have almost disappeared, the arrangement is used, and is very effective, for the prevention of "selective" fading on the Home and Forces programme from which we suffer in this part of the country.

The frame aerial together with its tuning condenser and coupling condenser were mounted on a turntable and placed a short distance from the receiver. The coupling condenser and tuning condenser adjustments are critical and vary for different receivers. The set with which this arrangement is to work needs to be fairly sensitive as the radio frequency input is, of course, small.

When adjusting this circuit, the aerial is turned on its turntable and the tuning condenser is moved above and below the resonant point of the station it is desired to hear, the correct setting of the tuning condenser is not necessarily at resonance—in the case of the whistle, the interference was cut out when the tuning condenser was moved a short distance on the high frequency side

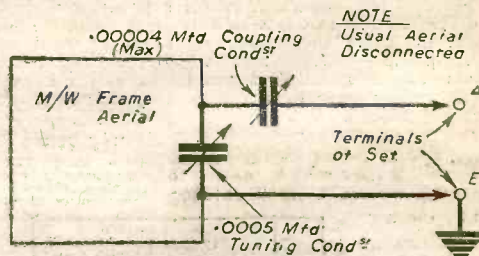

Circuit diagram used for preventing "selective" fading.—H. R. HARFORD (Trowbridge).

of the North Regional channel, the position of the coupling condenser decided the degree of "dip" in the whistle as the tuning condenser and/or aerial was moved, the correct position being found by experiment.

The success of this aerial is, I believe, due to the fact that its directional properties are affected by the rotation of the tuning condenser as well as by the usual method of turning the aerial on its turntable.

I send this circuit to you in case it may be of interest. It gave me complete freedom from the very annoying heterodyne (which, I should mention, only became audible after dark and which was heard on straight as well as super-het receivers in this district; it seemed that a foreign station was responsible) and which proved successful with a number of receivers on which it was tried. The arrangement is now, as I have said, very useful for combating "selective" fading.—H. R. HARFORD (Trowbridge).

Communications Superhet

SIR,—I should like to point out a mistake appearing in Mr. P. Stearn's circuit of his Communications Superhet in the July issue of the PRACTICAL WIRELESS. He takes his A.V.C. from the anode of V₃, but he must have a blocking condenser, about .0002 between here and the diode anode, to prevent H.T. + voltage in the A.V.C. line, which would have disastrous results.—C. M. DREW (Elstree).

WIZARD 4-VALVE UNIVERSAL MEDIUM WAVE, also DORSET 3-VALVE BATTERY RECEIVER

Build your own set. Simplicity itself. Both give splendid tone and volume. VERY clear point to point wiring instructions, circuit diagram, full-size component lay-out drawings. British valves. Any components sold separately by us. Your queries answered free S.A.E.

WIZARD 4-valve Receiver circuit, including alternative wiring for 7- and 5-pin valves. 5/-

DORSET Battery 3 circuit, including additional instructions for fitting tone control and pick-up. 3/6. No Callers. Write—

WELDONA RADIO ACCESSORIES LTD., 23, Wellington Road, Swanage, Dorset.

POST-WAR TELEVISION

The advance in Radio Technique will offer unlimited opportunities of high pay and secure posts for those Radio Engineers who have had the foresight to become technically qualified. How you can do this quickly and easily in your spare time is fully explained in our unique handbook.

Full details are given of A.M.I.F.E., A.V.I.R.E., R.E. City & Guilds Exams, and particulars of up-to-date courses in Wireless Engineering, Radio Servicing, Short Waves, Television, Mathematics, etc., etc.

We guarantee "NO PASS—NO FEE." Prepare for to-morrow's opportunities and post-war competition by sending for this very informative 122-page guide NOW—FREE and without obligation.

BRITISH INSTITUTE OF ENGINEERING TECHNOLOGY (Dept. 242), 17, Stratford Place, London, W.1.

RELAYS

for A.C. and D.C.

The wide range of LondeX Relays covers especially the Wireless and Electronic fields.

Ask for details and catalog 503/PW



LONDEX LTD.
Anerley Works, 207, Anerley Road, London, S.E.20. Phone: 8YD 6238/9

A FREE BOOK

for all interested in

MORSE CODE TRAINING.

There are Candler Morse Code Courses for Beginners and Operators.

Send for this Free "BOOK OF FACTS" It gives full details concerning all Courses.

THE CANDLER SYSTEM CO. (S.L.O.)
121, Kingsway, London, W.C.2.
Candler System Co., Denver, Colorado, U.S.A.

CLASSIFIED ADVERTISEMENTS LITERATURE, MAPS, etc.

BRITISH SHORT-WAVE LEAGUE—S.A.E. for membership details and sample monthly "Review." The S.W. Listener's Handbook, 2/9 post free. Write NOW to H.Q., 53, Madeley Rd., Ealing, London, W.5.

RADIO SOCIETY OF GREAT BRITAIN invites all keen experimenters to apply for membership. Current issue "R.S.G.B. Bulletin" and details. 1/- below.

AMATEUR RADIO HANDBOOK (300 pages), paper cover. 4/- cloth. 6/6. Radio Handbook Supplement (140 pages), paper cover. 2/9; cloth. 5/-—S.G.B., 28-30, Little Russell Street, London, W.C.1.

WEBB'S Radio Map of the World. Locates any station heard. Size 40in. by 30in., 4.6. post 6d. On linen, 10/6, post 6d.—Webb's Radio, 14, Soho Street, London, W.1. GERRARD 2089.

MORSE & S.W. EQUIPMENT

MORSE Practice Equipment for class-room or individual tuition. Keys, audio oscillators for battery or main operation. Webb's Radio, 14, Soho Street, London, W.1. Phone: Gerrard 2089.

"H.A.C." Short-wave Receivers. Famous for over ten years. Improved one-valve model now available. Complete kit of components, accessories, with full instructions, only 1/6.3. postage 3d. Easily assembled in one hour. S.A.E. for free catalogue.—A. L. Bacchus, 109, Hartington Road, London, S.W.8.

RECEIVERS & COMPONENTS

MOVING COIL HAND MICROPHONES P.M. Energised by Alni Magnets, 45 ohms, 1/4in. Coil. Fitted with switch in handle, 12/6 each. Moving Coil Headphones, P.M. Energised by Alni Magnets, 45 ohms, 1/4in. Coil. Ideal for Mikes, Miniature Loudspeakers, etc. 1/4in. overall in Bakelite cases with 3in. front flange. 7/6 each. Per pair with headband, 16/6.

Threat Microphones fitted with elastic bands, phone plug, etc. 7/6 each. Synchronous Motors, "Sangamo," 200-500 volts A.C. 50 C. Self-starting, fitted Reduction Gears. Ideal Movements for Time switches, Industrial, Dark Room, Electric Clocks, etc.

Rotar Speed 200 r.p.m. Final Speeds available: 1 rev. 12 mins., 22/6; 1 rev. 30 mins., 25/-; 1 rev., 60 mins., 25/- Consumption 24 watts. Size 2 1/2 x 2 1/4. Cash with order. Registered post and packing 1/- extra.

15 Amp. Mercury Switches, enclosed bakelite tubular cases, 2 1/2 x 1 1/2 in., fitted swivel saddle, connector block, etc., 5/6 each.

Wire-wound Non-inductive Resistances, 2 watt. Ideal for Meter Shunts, Resistance Boxes, etc. 21 per cent. accuracy, wound on bakelite bobbins, 1/4 x 1/4 in. One of each of the following ratings, 25, 50, 100, 200, 400, 300, 1,000 and 2,000 ohms, 5/6 per lot, postage paid, quantities available.

Electro Magnets, 200-250 volts A.C. Resistance 320 ohms, 1 1/2 x 1 1/2 in., 3.6 each. Rev. Counters, Ex-Meters, drum type, 10/- Automatic, reset to zero on completion, 3/0 each.

Terms—Cash with Order.
H. FRANKS, SCIENTIFIC STORES, 58, New Oxford Street, W.C.1. Phone: MUSEUM 3534.

Large selection of differential reduction gears, meters, relays, etc., for Callers only.

ANNUAL HOLIDAYS—Our Postal Dept. will be closed from Sept. 3-15. Callers only please observe these dates.

REWINDS and Radio Spares. Armatures, Fields, Transformers, Pickups, Fractional H.P. Motors, Speakers, New Cones and Speech Coils fitted. All work guaranteed and promptly executed. C.O.D. Postal Service. Send S.A.E. for list Valves and Radio Bargains.—D.S. Co., 231/5, Lichenfield Road, Aston, Birmingham 6.

RUSSELLS Radio offer I.F. transformers, 465 kc/s, iron-cored, 16/- pair. Aerial and H.F., 5/- pair. New type suppressor, 6/- O.P. transformer, 8/6. All goods guaranteed. Add 9d. for postage.—Russells, 22A, Paternoster Row, Boscombe, Hants.

PRICE LIST 1/-—Unequalled range. Example values: Vaxley 4 Bank 5 way Macaulay 5/6, 1 Bank 11 way 3/6.—Taylors, Macaulay Street, Huddersfield.

THE SIMPLEX FOUR

Complete constructional data, comprising full-scale layout and wiring diagrams, instructions, etc., for the construction of this 4-valve A.C./D.C. medium wave T.R.F. midset receiver. (Total cost of construction minus cabinet £9.) A proven success. Per copy 4/6.

MIDGET polished wooden cabinet, 35/- **MIDGET** coils, aerial and H.F. medium wave, T.R.F. high gain coils, ideal for the T.R.F. midset, 7/6 pair; ditto, medium and long coils, 10/- pair; midset aerial and oscillator coils, medium wave, for use on I.F. 465 kc/s, pair, 7/6; midset ditto coils, short wave, pair, 5/-; aerial and oscillator, all wave superhet coils for use with I.F. of 465 kc/s, with circuit diagram, 15/- set.

MIDGET I.F. transformers, 1F 465 kc/s, pair, 15/-; standard size transformers, 12/6. **MIDGET "SIMPLEX"** chassis, for the 4-valve midset, all holes drilled, electro zinc finish, a professional job, 11 x 4 1/2 x 2 1/2 in., 6/-

MIDGET superior quality smoothing choke, 260 ohms, 50/60 mA., 8/-; ditto, medium choke, 80 mA., 20 henry, 8/-; heavy duty, 120 mA., 25 henry, 15/-.

MIDGET variable 2-range 0.0095 mfd. condenser, 13/6.

MIDGET speaker transformer, 6/6; medium ditto transformer, tapped, 9/-; ROLA tapped tran. for push-pull, 12/6 each.

MIDGET "CELESTION" 10 watt, 20/1, transformer 8/-

MIDGET dials, medium wave, station names, Home, European, Forces, etc., Ivorine, 4 x 3 1/2 in., 1/6.

MIDGET knobs, black and brown, standard size 9d. each, 8/- doz.; 2 1/2 in. control knob, milled edge, brown, 1/6; black instrument pointer knob, 1/-, 10/- doz.

INTERFERENCE suppressor unit, bakelite case, for A.C. or D.C. mains, 2/6. **WAVELAKE** potentiometer, 1,000 ohms, for meter, zero control, 1/6.

MAINS droppers, mounted on fixing feet, with two variable taps, 0.3 amp., 800 ohms, 5/6; superior quality dropper, the best, 0.3 amp. and 0.2 amp., 800 and 950 ohms, 7/6 each; ditto, superior quality dropper, 0.3 amp., 200 ohms, four taps, for mains and bias control, 3/-.

PUSH BUTTON units, 6-way, with bakelite escutcheon and knobs, each button operates 2 switches, 12 switches in all, 5/6.

MAINS CONNECTOR flush 3-in. brass-able mains plug and socket for all types of mains apparatus, third pin for earth, terminal connections, shockproof, 3/-.

SWITCHES, mains toggle on/off, 2/6; rotary, D.F. on/off; midset wave-change switches, rotary, D.F.D.T., 3/6; S.P.D.T., 3/-.

SPEAKERS, "GOODMANS" auditorium, 12in., P.M. speaker, less transformer, 15 ohms speech coil, 16/15; 8" and A. 6 1/2 in., P.M. speaker, with multi-tapped transformer, 25/-; 8in. speaker, P.M., with trans., 27/6; 10in. ditto, 35/-; R. and A. mains energised, 8in., 1,200 ohms speaker with trans., 35/-.

SCREENED cable, single core, 1/- yard; ditto cable in 8in. lengths, per dozen lengths, 1/-.

VOLUME CONTROLS, long spindle with switch, 3,000, 10,000, 50,000 ohms, and 1, 2 and megohms, 6/- each.

NUTS and screws, 6BA, per gross (2 gross in all), 6/-; ditto, 4BA, per gross, 7/6.

TRIMMERS, T.C.C. air-spaced trimmer, 3.35 mmfd., 9d., 8/- doz.; twin short wave ceramic trimmers, 1/6; 2-bank wave dielectric trimmers, 45 to 50 mmfd., 2/-; 2-bank ditto trimmers, 150 to 400 mmfd., 2/3; 3-bank trimmers, 3.35 mmfd., 1/6; 4-bank trimmers, ditto, 2/-.

VALVE HOLDERS, paxolin chassis mounting, English, 5, 7 and 9 pin, and American international octal, 5, 6 and 9 pin, 9d. each, 8/- doz.; Amphenol international octal, 1/-, 10/- doz.

SLOW motion spring drives, with drum and timing shaft, 2/6.

SHIELD back connection wire, 12 yard, 2/6. **WIRE** wound 10 watt resistances, 24 and 60 ohms, 1/6, vitreous enamelled.

CONDENSERS, tubular wire ends, 0.1 mfd., and 0.01 mfd., 9d., 8/- doz.; electrolytic 25 mfd., 25 V.W., 2/6; 250 mfd., 25 V.W., 4/6. **SLEEVING**, best quality yard lengths, 2 mills, 3d.; 7 mills, 6d.

EXTENSION spindles, for standard 1in. shafts, 1/-.

Comprehensive stocks of all components, sent for monthly or monthly 2d. stamp with all enquiries please, postage on all orders.

O. GREENLICK, 34, Bancroft Road, Cambridge Heath Road, London, E.1.
Stepney Green 1334.

Practical Wireless BLUEPRINT SERVICE

SPECIAL NOTICE

THESE blueprints are drawn full size. The issues containing descriptions of these sets are now out of print, but an asterisk beside the blueprint number denotes that constructional details are available, free with the blueprint.

The index letters which precede the Blueprint Number indicates the periodical in which the description appears: Thus P.W. refers to PRACTICAL WIRELESS, A.W. to Amateur Wireless, W.M. to Wireless Magazine.

Send (preferably) a postal order to cover the cost of the Blueprint (stamps over 6d. unacceptable) to PRACTICAL WIRELESS, Blueprint Dept., George Newnes, Ltd., Tower House, Southampton Street, Strand, W.C.2.

PRACTICAL WIRELESS

CRYSTAL SETS

Blueprints, 6d. each.
1927 Crystal Receiver PW71*
The "Junior" Crystal Set PW94*

STRAIGHT SETS. Battery Operated.

One-Valve: Blueprints, 1s. each.
All-Wave Unipen (Pendole) PW31A*
Belmiers' One-valver PW85*
The "Pyramid" One-valver (HF Pen) PW93*
Two-valve: Blueprint, 1s.
The Signet Two (D & I F) PW76*
Three-valve: Blueprints, 1s. each.
Selectone Battery Three (D, 2LF (Trans)) PW16
Summit Three (HF Pen, D, Pen) All Pendole Three (HF Pen, D (Pen), Pen) PW37*
Hall-Mark Cadet (D.L.F. Pen (RD)) PW39*
F. J. Camm's Silver Souvenir (HF Pen, D (Pen), Pen) (All-Wave Three) PW48*
Cameo Midget Three (D, 2 LF (Trans)) PW49*
1936 Sonotone Three-Four (HF Pen, HF Pen, Westcoater, Pen) Battery All-Wave Three (D, 2 LF (RC)) PW51*
The Monitor (HF Pen, D, Pen) PW53*
The Tutor Three (HF Pen, D, Pen) PW55*
The Centaur Three (SG, D, P) PW61*
The "Cok" All-Wave Three (D, 2 LF (RC & Trans)) PW64*
The "Rapid" Straight 3 (D, 2 LF (RC & Trans)) PW72*
F. J. Camm's Oracle All-Wave Three (HF, Det. Pen) PW82*
1938 "Triand" All-Wave Three (HF, Pen, D, Pen) PW78*
F. J. Camm's "Sprite" Three (HF Pen, D, Pen) PW84*
The "Hurricane" All-Wave Three (SG, D, Pen, Pen) PW87*
F. J. Camm's "Push-Button" Three (HF Pen, D (Pen), Pen) PW89*
Four-valve: Blueprints, 1s. each.
Beta Universal Four (SG, D, LF, C, B) PW92*
Nucleon Class B Four (SG, D, SG, LF, C, B) PW17*
Fury Four Super (SG, SG, D, Pen) Battery Hall-Mark 4 (HF, Pen, D, Push-Pull) PW34B*
"Acme" All-Wave 4 (HF Pen, D (Pen), LF, C, B) PW34C*
The "Admiral" Four (HF Pen, HF Pen, D, Pen (RC)) PW40*
F. J. Camm's "Limit" All-Wave Four (HF Pen, D, LF, P) PW83*
PW90*
PW67*

Mains Operated

Two-valve: Blueprints, 1s. each.
A.C. Twin (D (Pen), Pen) PW18*
Selectone A.C. Radiogram Two (D, P) PW19*
Three-valve: Blueprints, 1s. each.
Double-Diode-Triode Three (HF Pen, DDT, Pen) PW23*
D.C. Ace (SG, D, Pen) PW25*
A.C. Leader (HF Pen, D, P) PW29*
D.C. Premier (HF Pen, D, Pen) PW35B*
Unique (HF Pen, D, Pen), Pen) PW36A*
F. J. Camm's A.C. All-Wave Silver Souvenir Three (HF Pen, D, Pen) "All-Wave" A.C. Three (D, 2 LF (RC)) PW54*
A.C. 1936 Sonotone (HF Pen, HF Pen, Westcoater, Pen) PW58*
Mains Record All-Wave 3 (HF Pen, D, Pen) PW70*
Four-valve: Blueprints, 1s. each.
A.C. Fury Four (SG, SG, D, Pen) A.C. Fury Four Super (SG, SG, D, Pen) PW20*
A.C. Hall-Mark (HF Pen, D, Push-Pull) PW34D
Universal Hall-Mark (HF Pen, D, Push-Pull) PW45*
PW47*

SUPERHETS

Battery Sets: Blueprints, 1s. each.
P5 Superhet (three-valve) PW40
P. J. Camm's 5-valve Superhet PW52*
Mains Sets: Blueprints, 1s. each.
A.C. 25 Superhet (Three-valve) PW43*
D.C. 25 Superhet (Three-valve) PW42*

F. J. Camm's A.C. Superhet 4 PW55*
F. J. Camm's Universal 4 Superhet 4 PW60
"Quione" Universal Four PW73*
Four-valve: Double-Sided Blueprint, 1s. 6d.
Push Button 4, Battery Model} PW95*
Push Button 4, A.C. Mains Model}

SHORT-WAVE SETS. Battery Operated

One-valve: Blueprint, 1s.
Simple S.W. One-valver PW88*
Two-valve: Blueprints, 1s. each.
Midget Short-wave Two (D, Pen) The "Pica" Short-wave Two (D (HF Pen), Pen) PW91*
Three-valve: Blueprints, 1s. each.
Experimenter's Short-wave Three (SG, D, P) PW30A*
The Perfect 3 (D, 2 LF (RC and Trans)) PW63*
The Band-spread S.W. Three (HF Pen, D, Pen), Pen) PW68*

PORTABLES

Three-valve: Blueprints, 1s. each.
F. J. Camm's ELF Three-valve Portable (HF Pen, D, Pen) PW65*
Parvo Flyweight Midget Portable (SG, D, Pen) PW77*
Four-valve: Blueprint, 1s.
"Imp" Portable 4 (D, LF, LF (Pen)) PW80*

MISCELLANEOUS

Blueprint, 1s.
S.W. Converter-Adapter (1 valve) PW48A*

AMATEUR WIRELESS AND WIRELESS MAGAZINE

CRYSTAL SETS

Blueprints, 6d. each.
Four-station Crystal Set AW42*
Lucerne Tuning Coil for A.W. 42* 6d.
1934 Crystal Set AW44
Modern "Crystal" Set AW45*

STRAIGHT SETS. Battery Operated.

One-valve: Blueprint, 1s.
B.B.C. Special One-valver AW38*
Two-valve: Blueprints, 1s. each.
Melody Ranger Two (D, Trans) AW38B*
Full-voltage Two (SG det. Pen) AW39*
A Modern Two-valver WM409*
Three-valve: Blueprints, 1s. each.
45 5a. A.1. 3 (SG, D, Trans) AW41*
Lucerne Ranger (SG, D, Trans) AW42*
45 5a. Three De Luxe Version AW43*
Transportable Three (SG, D, Pen) Simple-Tune Three (SG, D, Pen) Economy Pentode Three (SG, D, Pen) WM327*
"W.M." (1934 Standard Three (SG, D, Pen)) WM337
23 5a. Three (SG, D, Trans) WM351*
1935 20 6a. Battery Three (SG, D, Pen) WM354
PTP Three (Pen, D, Pen) WM371*
Certainty Three (SG, D, Pen) WM389*
Minitube Three (SG, D, Trans) WM393*
All-wave Winning Three (SG, D, Pen) WM400
Four-valve: Blueprints, 1s. 6d. each.
65a. Four (SG, D, RC, Trans) Self-contained Four (SG, D, LF, C, B) AW370
Lucerne Straight Four (SG, D, LF, Trans) WM330
25 5a. Battery Four (HF, D, P) WM350
The H.K. Four (SG, SG, D, Pen) The Auto Straight Four (HF, Pen, HF, Pen, DDT, Pen) WM384
Five-valve: Blueprints, 1s. 6d. each.
Superactively Five (2 HF, D, RC, Trans) WM404*
Class B Quadradynic (2 SG, D, LF, Class B) WM320
New Class B Five (2 SG, D, LF, Class B) WM344
WM340

Mains Operated.

Two-valve: Blueprints, 1s. each.
Conoelectric Two (D, Pen) A.C. Economy A.C. Two (D, Trans) A.C. Three-valve: Blueprints, 1s. each.
Home-Lover's New All-Electric Three (SG, D, Trans A.C. Mantovani A.C. Three (HF, Pen, D, Pen) AW365*
25 15a. 1936 A.C. Radiogram (HF, D, Pen) WM374*
Four-valve: Blueprints, 1s. 6d. each.
All-Metal Four (2 SG, D, Pen) WM401*
Harris Jubilee Radiogram (HF, Pen D, LF, P) WM399
WM386*

SUPERHETS

Battery Sets: Blueprints, 1s. 6d. each.
Variety Four WM395*
The Request All-Waver WM407

Mains Sets: Blueprints, 1s. each.
Hextode Super Three A.C. WM350*

PORTABLES

Four-valve: Blueprints, 1s. 6d. each.
Holiday Portable (SG, D, LF, Class B) AW393*
Family Super-charge (HF, D, RC, Trans) AW447*
Tyers Portable (SG, D, 2 Trans) WM397*

SHORT-WAVE SETS. Battery Operated

One-valve: Blueprints, 1s. each.
S.W. One-valver for America AW425*
Roma Short-Waver AW426*
Two-valve: Blueprints, 1s. each.
Ultra-short Battery Two (SG, det Pen) WM402*
Home-made Coil Two (D, Pen) AW440

Three-valve: Blueprints, 1s. each.
Experimenter's 5-metre Set (D, Trans, Super-regen) AW438
The Carrier Short-waver (SG, D, P) WM390*

Four-valve: Blueprints, 1s. 6d. each.
A.W. Short-wave World-beater (HF, Pen, D, RC, Trans) Standard Four-valver Short-waver (SG, D, LF, P) WM383*
Superhet: Blueprint, 1s. 6d.
Simplified Short-waver Super WM397*

Mains Operated

Two-valve: Blueprints, 1s. each.
Two-valve Mains Short-waver (D, Pen) A.C. AW453*
Three-valve: Blueprints, 1s. each.
Emigrator (SG, D, Pen) A.C. WM352*
Four-valve: Blueprints, 1s. 6d.
Standard Four-valve A.C. Short-waver (SG, D, RC, Trans) WM391*

MISCELLANEOUS

S.W. One-valve Converter (Price 6d.) AW329
Enthusiast's Power Amplifier (1/6) WM387*
Listener's 5-watt A.C. Amplifier (1/6) WM392*
Radio Unit (2v.) for WM392 (1/-) WM398*
Hartz Electrogram battery amplifier (1/-) WM359*
De Luxe Concert A.C. Electrogram (1/-) WM403*
New Style Short-wave Adapter (1/-) WM388
Short-wave Adaptor (1/-) AW456*
B.L.D.L.C. Short-wave Converter (1/-) WM405*
Wilson Tonic Master (1/-) WM406
The W.M. A.C. Short-wave Converter (1/-) WM408*

HINTS COUPON

This coupon is available until September 10th, 1945, and must accompany all Practical Hints.

PRACTICAL WIRELESS, September, 1945.

All applications respecting Advertising in this Publication should be addressed to the ADVERTISER'S DIRECTOR, GEORGE NEWNES, LTD., Tower House, Southampton Street, Strand, London, W.C.2. Telephone: Temple Bar 4363.

CONDITIONS OF SALE AND SUPPLY. This periodical is sold subject to the following conditions, namely, that it shall not, without the written consent of the publishers first given, be lent, re-sold, hired out or otherwise disposed of by way of Trade except at the full retail price of 9d.; and that it shall not be lent, re-sold, hired out or otherwise disposed of in a mutilated condition or in any unauthorised cover by way of Trade; or affixed to or as part of any publication or advertising, literary or pictorial matter, whatsoever.



*When the boys
come home—*

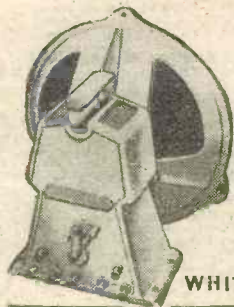
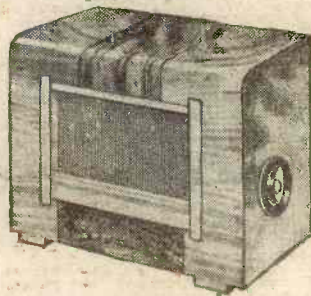

Stentorian

SPEAKERS

WHITELEY ELECTRICAL RADIO CO. LTD., MANSFIELD, NOTTS.



AMBITIOUS ENGINEERS

HAVE YOU HAD YOUR COPY OF "ENGINEERING OPPORTUNITIES"?

Whatever your age or experience—whether you are one of the "old school" or a newcomer to Engineering anxious to hold your position under post-war conditions—you must read this highly informative guide to the best paid Engineering posts.

The Handbook contains among other intensely interesting matter, particulars of B.Sc., A.M.I.C.E., A.M.I.Mech.E., A.M.I.E.E., A.M.I.A.E., A.M.I.P.E., A.M.Brit.I.R.E., CITY & GUILDS, CIVIL SERVICE, and other important Engineering Examinations, outlines courses in all branches of CIVIL, MECHANICAL, ELECTRICAL, AUTOMOBILE, RADIO, TELEVISION, AERONAUTICAL and PRODUCTION ENGINEERING, DRAUGHTSMANSHIP, GOVERNMENT EMPLOYMENT, BUILDING and PLASTICS (the great peacetime careers), MATRICULATION, etc., and explains the unique advantages of our Employment Department.

WE DEFINITELY GUARANTEE 'NO PASS—NO FEE'

If you are earning less than £10 a week you cannot afford to miss reading "ENGINEERING OPPORTUNITIES"; it tells you everything you want to know to *make your future secure* and describes many chances you are now missing. In your own interest we advise you to write for your copy of this enlightening guide to well-paid posts NOW—FREE and without obligation.

BRITISH INSTITUTE OF ENGINEERING TECHNOLOGY

409, SHAKESPEARE HOUSE, 17, 18 & 19, STRATFORD PLACE, LONDON, W.1.

THE B.I.E.T. IS THE LEADING INSTITUTE OF ITS KIND IN THE WORLD

Published on the 7th of each month by GEORGE NEWNES, LIMITED, Tower House, Southampton Street, Strand, London, W.C.2. and printed in England by THE NEWNES & PEARSON PRINTING CO. LTD, Exmoor Street, London, W.10. Sole Agents for Australia and New Zealand: GORDON & GOTCH, LTD. South Africa: CENTRAL NEWS AGENCY, LTD. Subscription rates including postage: Inland 10s. 6d. per annum; Abroad 10s. per annum. Registered at the General Post Office for the Canadian Magazine Post.