

USING OLD COMPONENTS

Practical Wireless

9^D EVERY MONTH

Editor
F. J. CAMM

and PRACTICAL TELEVISION

Vol. 18. No. 430.

NEW SERIES.

APRIL, 1942.

**'Still keep
going
when the
rest have
stopped'**



Exide BATTERIES

• THE CHLORIDE ELECTRICAL STORAGE COMPANY LTD.
Grosvenor Gardens House, Grosvenor Gardens, London,
S.W.1
Telephone: VICTORIA 2299. Grams: Chloridic, Sowest, London

THE SAME ACCURATE FAULT-TRACING for Me, too!



BRITISH
MADE

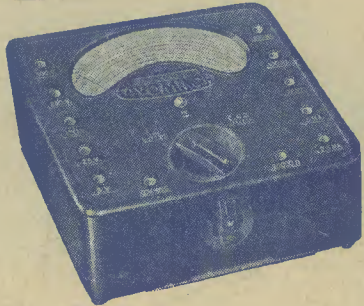

D.C. Volts 0- 75 milli-volts 0- 5 volts 0- 25 " " 0-100 " " 0-250 " " 0-500 " "	A.C. Volts 0- 5 volts 0- 25 " " 0-100 " " 0-250 " " 0-500 " "
D.C. Milliamps 0- 2.5 milliamps. 0- 5 " " 0- 25 " " 0-100 " " 0-500 " "	Resistance 0- 20,000 ohms 0-100,000 ohms 0-500,000 ohms 0- 2 meg-ohms 0- 5 " " 0-10 " "

THE UNIVERSAL AvoMINOR ELECTRICAL MEASURING INSTRUMENT

The Universal AvoMinor provides the serious amateur with testing facilities comparable in accuracy with those of the famous "AvoMeter" on which service engineers and manufacturers rely for precision testing.

Trouble-tracking with the AvoMinor is reduced to its simplest terms, enabling amateur and expert alike to locate faults with ease and rapidity.

Some delay is inevitable in delivery of orders without Priority Numbers, but we shall continue to do our best to fulfil requirements as promptly as possible.

NOTE: The word "AVO" is our Registered Trade Mark.

sole Proprietors & Manufacturers—
Automatic Coil Winder & Electrical Equipment Co., Ltd.
Winder House, Douglas St., London, S.W.1. 'Phone: Victoria 8404/7

PREMIER RADIO

NEW PREMIER S.W. COILS

4- and 6-pin types now have octal pin spacing, and will fit International Octal valve-holders.

4-pin Type			6-pin Type		
Type	Range	Price	Type	Range	Price
0A	9-15 m.	2/6	0B	9-15 m.	2/6
0A4	12-26 m.	2/6	0B4	12-26 m.	2/6
0A8	22-47 m.	2/6	0B8	22-47 m.	2/6
0A4C	41-94 m.	2/6	0B4C	41-94 m.	2/6
0A4D	76-170 m.	2/6	0B4D	76-170 m.	2/6
0A4E	150-350 m.	3/-			
0A4F	255-550 m.	3/-			
0A4G	490-1,000 m.	4/-			
0A4H	1,000-2,000 m.	4/-			

PREMIER 2-GANG S.W. CONDENSER

2 x .00015 mfd. with integral slow motion complete with pointer, knob and scale, 10/6.

SHORT-WAVE CONDENSERS			
Trolitol insulation. Certified superior to ceramic.			
All-brass construction.	Easily ganged.		
15 m.mfd.....	2/4	100 m.mfd.....	3/-
25 m.mfd.....	2/6	160 m.mfd.....	3/7
40 m.mfd.....	2/6	250 m.mfd.....	4/-

Bakelite Dielectric Variable Condensers. 0005 mfd. Suitable Tuning or Reaction, 1/9 each.
S.W. H.F. Chokes. 10-100 m., 10/d. High grade Pie-wound, U.S.A. type. 5-200 m., 2/6 each.

PICK-UPS

Crystal Pick-up, Rothermel Junior model, 31/10.

Rothermel Crystal Pick-up head, will fit any gramophone tone arm, 34/9.

MATCHMAKER UNIVERSAL OUTPUT TRANSFORMERS.

Will match any output valves to any speaker impedance.

11 ratios from 12-1 to 80-1, 5/7 watts, 20/-, 10/15 watts, 28/-, 20-30 watts, 44/6, 50-60 watts, 59/6.

Write for new valve list.

PREMIER MAINS TRANSFORMERS AND SMOOTHING CHOKES AGAIN AVAILABLE.

Write for details.

MOVING COIL SPEAKERS

Celestion 8in. P.M. Speaker, 25/-, Plessey, 8in., 2,000 ohms field speaker, 15/-. Both speakers complete with output transformer.

PREMIER MICROPHONES

Transverse-Current Mike. High grade large output unit. Response 45-7,500 cycles. Low hiss level, 23/-. Moving Coil Mike. Permanent magnet model requiring no energising. Response 90-5,200 cycles. Output .25 v., average. Excellent reproduction of speech and music, 49/-. Crystal Microphone. Rothermel D, 105, 83/-.

PREMIER REPLACEMENT VALVES

4 volt A.C. types, 5-pin. ACHL, ACL, ACSG. All 5/6 each.

"LEARNING MORSE?"

Then purchase one of the new practice Oscillators. Supplied complete with valve, on steel chassis
Practice Key, 3/3; TX Key, 5/9. 27/6
Brown's Headphones 17/6 pair.

PREMIER BATTERY CHARGERS FOR A.C. MAINS

Westinghouse rectification complete and ready for use. To charge 6 volts at 1 amp., 29/6. 12v. 1a. (also tapped for 2 and 6v), 37/6. 6 v. at 2a. (also tapped to charge 2 and 4 volts), 48/-.

ALL ENQUIRIES MUST BE ACCOMPANIED BY 2½d. STAMP. ALL ORDERS LESS THAN 5/- 6d. POST EXTRA.

ALL POST ORDERS to: JUBILEE WORKS, 167, LOWER CLAPTON ROAD, LONDON, E.5. (Amherst 4723)
CALLERS to: Jubilee Works, or 169, Fleet Street, E.C.4. (Central 2833)

Practical Wireless

EVERY MONTH

Vol. XVIII. No. 430. APRIL, 1942.

and PRACTICAL TELEVISION

Editor F. J. CAMM

Staff:
L. O. SPARKS.
FRANK PRESTON.

COMMENTS OF THE MONTH

BY THE EDITOR

Plan to Retain Radio Engineers

THE servicing problem, like the supply of components, including valves, has grown more acute during the past year. Few dealers are now able to undertake servicing at all, for not only is it practically impossible to obtain certain replacement parts, but most of the service engineers have joined the Services. This year the difficulty will increase, because under the new de-reservation scheme the age limit is raised by one year each month. Any scheme, therefore, to lessen the difficulty, and to accelerate the servicing of sets, must take into account not only the supply of man-power but the supply of components. The wireless during a war becomes the official mouthpiece of the Government, and it is the means by which instructions can be given to the population more rapidly and perhaps more effectively than by any other means. It is important, therefore, to the war effort that receivers should be maintained in good working order. The wireless industry is comparatively young, and it was inevitable therefore that most of those engaged in it would be of military age.

A large percentage of them were called up very early in the war without, as we think, due consideration being given to the relative needs of the Services and the civil population.

Trade associations have prepared a plan to retain a sufficient number of radio engineers to ensure adequate servicing of receivers. The Ministry of Labour, at the moment of going to press, has concurred in a temporary suspension of the call-up of service engineers, and they have made provision for applications for deferments of those who have already received de-reservation notices. At this late stage in the war questionnaires are being sent to all firms in the radio industry from which plans for the retention of servicemen will be evolved.

The Radio Manufacturers' Association is acting in concert with several other associations representative of various sections of the radio trade.

Although the scheme is for the purposes of ensuring the retention of "a sufficient number" of skilled men, we quite fail to see how this can be brought about if all of those engaged on service work were retained, since all firms and dealers are taking a considerable number of weeks to effect comparatively simple repairs. A sufficient number could only be obtained by bringing back from the Services some thousands of service men.

Firms are invited to get in touch with Mr. R. P. Browne, R.M.A., 59, Russell Square, London, W.C.1,

who will supply copies of the questionnaire. In order that national representation of views can be presented to the various departments it is essential that a high proportion of firms engaged in radio should complete these forms.

We have not had an opportunity of perusing one of the questionnaires, but we hope that it will include details regarding the supply of spares and the stocks held. We mention this because man-power alone cannot solve the servicing problem, and Sir Andrew Duncan, who was then President of the Board of Trade, recently stated in Parliament that he had nothing further to add to the reply previously given to the question concerning the inadequacy of the supply of valves. It had been stated in Parliament that the supply of valves might shortly improve, but our enquiries to date do not indicate that this is so. Men and material supply the solution to the servicing problem.

The Re-sale Racket

WE are glad that the Board of Trade has made the Price Controlled Goods (Restriction of Re-sale) Order, for this will effectively stop the activities of those commercial cheats who buy and sell goods to one another, adding on a percentage each time, so that when the goods reach the purchaser they are sold at an inflated price. Each member of this disgusting commercial practice has complied with the law by merely adding on the legitimate percentage. These transactions were quite legal, but the new Order makes them illegal. The Order makes it an offence for a retailer to sell at a profit goods which he has purchased at retail prices. The Order, of course, only applies to those goods which are price controlled. This seems to be an argument in favour of the price control of all goods, otherwise these racketeers will merely transfer their activities to a freer market.

"Newnes Engineer's Vest Pocket Book"

"NEWNES Engineer's Vest Pocket Book," containing 600 pages of facts, figures, formulae, tables, and memoranda, is now available at 7s. 6d. (by post 8s.). The book is strongly bound in blue art leather cloth, has round corners, gold lettering and gilt edges, a 32-page index, buyers' guide, and will be found of immense value at the present time to radio engineers, mechanical engineers, aircraft engineers, fitters, draughtsmen, turners, tool makers, in fact to all those engaged in the practical trades.

Editorial and Advertisement Offices:
"Practical Wireless," George Newnes, Ltd.,
Tower House, Southampton Street, Strand,
W.C.2. Phone: Temple Bar 4363.
Telegrams: Newnes, Rand, London.
Registered at the G.P.O. for transmission by
Canadian Magazine Post.

The Editor will be pleased to consider articles of a practical nature suitable for publication in PRACTICAL WIRELESS. Such articles should be written on one side of the paper only, and should contain the name and address of the sender. Whilst the Editor does not hold himself responsible for manuscripts, every effort will be made to return them if a stamped and addressed envelope is enclosed. All correspondence intended for the Editor should be addressed: The Editor, PRACTICAL WIRELESS, George Newnes, Ltd., Tower House, Southampton Street, Strand, W.C.2.

Owing to the rapid progress in the design of wireless apparatus and to our efforts to keep our readers in touch with the latest developments, we give no warranty that apparatus described in our columns is not the subject of letters patent.

Copyright in all drawings, photographs and articles published in PRACTICAL WIRELESS is specifically reserved throughout the countries signatory to the Berne Convention and the U.S.A. Reproductions or imitations of any of these are therefore expressly forbidden. PRACTICAL WIRELESS incorporates "Amateur Wireless."

The fact that goods made of raw materials in short supply owing to war conditions are advertised in this paper should not be taken as an indication that they are necessarily available for export.

ROUND THE WORLD OF WIRELESS

Televising A.R.P.

A RECENT report from America states that the National Broadcasting Company has televised in New York the first of a series of four A.R.P. lessons. It was seen by wardens and others. The 50-minute programme included a motion picture of incendiary bombs falling on London.

Medal for Radio Operator

THE Royal Humane Society's Stanhope Gold Medal for 1941 for the bravest deed of the year has been won by Radio Operator Douglas S. Fairley, Merchant Navy, of Carding Mill, Brae, Oban. When his ship was hit by a bomb and set on fire, Fairley left his place in the lifeboat to save seaman John Miller. Both had broken legs. Fairley managed to get Miller into the water and, finding a lifeboat, held on to it with one hand and supported Miller with the other for 50 minutes till he was picked up.

Enemy Radio Seized

RIO DE JANEIRO police recently seized a short-wave secret radio transmitter installed at the top of the German embassy in that city. This is stated to be the first step in the smashing of a web of secret stations operating throughout Brazil which are in contact with Berlin and with Axis shipping.

More Women Announcers

RAISING of the reserved age for B.B.C. men announcers to 35 will bring more women's voices on the air. First of these announced is that of Mrs. Prudence Avery Neill, Public Relations Officer, A.T.S., who has been "seconded for duty" to the B.B.C. Five more appointments will be made, bringing the total of women announcers to 16.

All-India Radio

IT is reported that although it is difficult for All-India Radio to obtain equipment from Great Britain, the chief engineer has announced that progress is being maintained and new projects planned. Among the projects are a 10-kW medium-wave transmitter for Peshawar, a 5-kW medium-wave station at Patna, and a new centre at Karachi with a 250-watt transmitter.

Secrets Broadcast from Australia

ACCORDING to a recent report from Canberra, a nation-wide spy hunt is being launched, following the startling revelations of leakages in Australian military secrets.

The authorities suspect that portable transmitting stations, possibly described as commercial trucks, are being run into lonely spots in the bush, where broadcasts overseas are made.

U.S. Speaks to Europe

THE voice of America is now heard daily in Europe through B.B.C. facilities. The new service, which is announced as "U.S. Calling Europe," began recently transmissions, each of fifteen minutes duration, in French, German and Italian. The material for the broadcasts is recorded from America by radio-telephone for transcription or reproduction at this end. The times of transmissions are: German, 3.15 p.m.; French, 4.30 p.m.; and Italian, 11.45 p.m.—all B.S.T.

Obituary

MR. A. A. MASCHWITZ, father of Mr. Eric Maschwitz, former B.B.C. variety director, died at Birmingham, aged 81.

Bing Crosby and U.S. Troops

US. soldiers under General MacArthur in the Philippines have sent a radio appeal to Bing Crosby to divert their thoughts from the pressure of battle by broadcasting songs to them.

B.B.C. Records

THE B.B.C. use two methods of recording—one on discs, similar to ordinary gramophone records, and the other on steel tape. The steel tape method is the more durable and records of this kind are made in the same way as the sound track of a film, the "track" being etched on the steel. These recordings store easily in a small space and are indestructible except by fire.

The disc type of recording used by the mobile vans is exactly similar to ordinary gramophone records and the records can be used only a few times.

Australian S.W. Broadcast Schedules

MELBOURNE short-wave stations now use the following wavelengths and call signs: Call signs: 6.30-10.15 a.m., VLR8; 12.0-6.15 p.m., VLR3; 6.30-11.30 p.m., VLR. Wavelengths: 25.51 metres; 25.25 metres; 31.32 metres. Frequencies: 11.760 k/cs; 11.880 k/cs; 9.580 k/cs. Power: 2 kilowatts. Call signs: 6.30 a.m.-3.30 p.m., VLG6; 3.55 p.m.-4.40 p.m., VLG3; 5.00 p.m.-6.45 p.m., VLG6; 7 p.m.-10.0 p.m., VLG5; 10.25 p.m.-11.10 p.m., and 11.15 p.m.-1.0 a.m., VLG2; 1.25 a.m.-2.10 a.m., VLG. Wavelengths: 19.66 metres; 25.62 metres; 19.66 metres; 25.25 metres; 25.27 metres, and 31.32 metres. Power: 10 kilowatts.

Location: Lyndhurst, near Melbourne. The times are Australian Eastern Standard Time.

All mail matter should be addressed to: Australian Broadcasting Commission, Short-wave Section, Box 1686, G.P.O., Melbourne, Australia. Cables and Telegrams, "Abcom," Melbourne.



In a B.B.C. studio during a recent exchange of greetings between R.A.F. personnel training in South Africa, and their relatives in this country.

Frequency Modulation Receivers

A REPORT recently issued by F.M. Broadcasters Inc., states that a total of more than 120,000 frequency-modulation receivers are now in use in American homes.

At the beginning of 1941 there was approximately only 15,000 F.M. sets in use. It is estimated that manufacturers were turning out 1,500 receivers a day at the outbreak of the war in the Pacific.

Mr. Ogilvie Leaves B.B.C.

TO facilitate B.B.C. reorganisation, the Director-General, Mr. F. W. Ogilvie, has resigned.

Sir Cecil Graves, formerly Deputy Director-General, and Mr. Robert Foot, at present B.B.C. General Adviser on war-time organisation, are to be joint Directors-General for duration of war.

Sir Cecil is responsible to the Board of Governors and to the Government for general policy and the production side of all programmes.

Mr. Foot will be responsible to the same authorities for the vast war-time organisation of the B.B.C. and with all administrative and business problems.

R.A.F. Co-operate with Army

THE primary function of the Army Co-operation Command is to organise, experiment and train in all forms of co-operation between the two Services. Squadrons of this Command are under the operational control of the Army and, including those attached to armoured divisions, have a mobile organisation housed in vans which can be moved at short notice. R.A.F. photographers, working in mobile units concealed in a wood or beside a country lane, form the photographic sections of Army Co-operation Command's Squadrons, and do much to keep the Army supplied with a continual flow of important photographs taken from the air. The pilots are all keenly interested in this Army Co-operation work.

In the illustration on this page a wing commander is seen giving instructions to pilots through a microphone from a mobile wireless unit.



Instructions being given to pilots by means of a mobile wireless unit.

Storm Perils of the Air

JANUARY and February are the months when those who are fighting the enemy in the air have to fight the worst weather as well.

Even rainstorms can be alarming as well as uncomfortable. Beaufort crews returned from Norway one day with their flying clothing soaked, in spite of their enclosed cockpit. The force of the wind blew rain through the window frames and other chinks until they were like leaking water-pipes. But the Beauforts flew well, although the crews felt as if the fuselage was straining and protesting against the undue stresses.

The Canadian captain of a Blenheim flew in a cloud-burst which was so violent that the downward air current began to force the aircraft towards the sea. Another aircraft, a Beaufort, was thrown about so much by a squall that the crew became sick, the first time in several hundred hours' operational flying.

A "wall" of cumulus cloud 50 miles long and thousands of feet high met three Beauforts on their way to Norway. "It looked so solid," said one of the pilots, "that we seemed to be going into a massive grey cliff." Thermal currents within the cloud were violent, and the Beauforts had to come out again very soon. One pilot found an electrical storm, and bright blue flashes of static electricity began to appear on all metal parts outside the aircraft, and the wireless set gave a special fireworks display of its own.

B.B.C. Broadcasts to Europe

DURING the moving of the supplementary B.B.C. estimate in the House of Commons recently, Mr. Thurtle (Information) said that there is a mass of

evidence that in spite of severest penalties and jamming by the enemy, British broadcasts were reaching the homes of listeners in all countries of Europe.

Radiolocation in America

ACCORDING to an announcement by the U.S. Navy Department, a new radio device for locating ships and aircraft hidden from sight has been introduced in the United States. It is thought to be similar to British radiolocation. Skilled personnel to operate and maintain the "Radars," as the apparatus is called, must have had experience in the design, construction and operation of U.H.F. transmitting and receiving equipment, or experience with television and cathode-ray apparatus. Accepted applicants will be enlisted in the Naval Reserve.

Mr. R. A. Watson Watt, who was chiefly responsible for radiolocation in this country, has, incidentally, been on a visit to the United States recently.

B.I.R.E. : Paper on Transmitting Valves

AT the February meeting of the British Institution of Radio Engineers, held on February 7th, at the Federation of British Industries, Westminster, S.W.1, L. Grinstead, M.I.E.E., M.Brit.I.R.E.E., of the Mullard Wireless Service Co., Ltd., gave a paper on "Transmitting Valves."

He described the development of transmitting valves, from the first small triode which succeeded the spark system used in early transmitters, to the present large power handling capacity of the valves. He showed how the increased demand for more power led to the development of silica envelopes and water cooling of the anode, and explained how the limitations imposed by electron transit time influenced short-wave design.

Aids to Selectivity

General Practical Considerations on This Important Subject

IN the January issue we published an article dealing with the theoretical considerations involved in obtaining a satisfactory degree of selectivity. The information given was primarily intended to guide those who are constructing their own receivers; therefore, for the benefit of those who are experiencing selectivity troubles with a receiver now in use we give below some practical advice to assist them to obtain better results.

It is not always realised that the aerial-earth system can have a pronounced effect upon the ability of a receiver used with it to eliminate unwanted stations. This is an important point which should receive careful attention when trying out various methods of improving selectivity. The maximum length for an outside aerial permitted by the Post Office authorities is 150ft., and some years ago everyone who erected an aerial felt it his duty to make full use of the maximum length allowed. That was all very well when the greatest possible range was required regardless of sharp tuning (which was not necessary, due to the few stations in operation), but to-day it is scarcely ever wise to attempt to employ an aerial longer than 70ft. or so (this length includes the lead-in), whilst when the receiver itself is not of an inherently selective type the length can generally be cut down to some 30ft. with advantage.

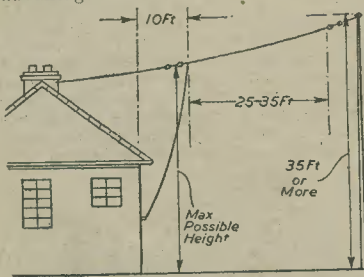

Fig. 1.

Fig. 1.—Showing what might be termed an ideal aerial arrangement for general reception. Fig. 2.—Where length is not possible, a vertical aerial will give very satisfactory results, provided a reasonable height is obtained.

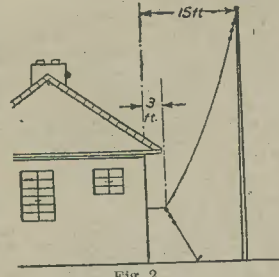

Fig. 2.

Height—Not Length

In any case it is not the length of the aerial wire which is most important, even when the question of selectivity can be ignored, but it is the height which is all-important. Increasing the effective height by 5ft. will nearly always prove considerably more effective than extending the length by so much as 50ft. The aim, therefore, in erecting an aerial should be to obtain the greatest possible height combined with the shortest length with which the necessary "pick-up" required by the particular receiver in use can be secured.

Low Capacity

For an aerial to be selective it must, like all other portions of the receiver tuning circuits, have a low resistance (more correctly, impedance) to the high-frequency currents which flow through it. This does not only mean that the wire itself should be of a fairly heavy gauge and of stranded form, but that it must have a low capacity to earth. The latter requirement is most important, and to comply with it the aerial should always be kept as far away as conveniently possible from roofs and walls of the house, trees, etc. Fig. 1 shows the general arrangement and approximate dimensions of what might be considered

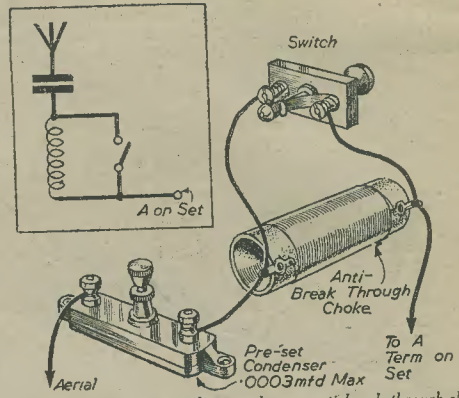

Fig. 4.—An aerial series condenser, plus an anti-break-through choke.

an almost ideal aerial for modern conditions and for use with the average type of receiver. The wire itself is of the so-called 7/22, and it is thoroughly insulated at each end by means of a string of egg insulators. Notice also that the supporting wires at each end of the aerial are "broken" by a couple of insulators so that they do not in themselves act as small aeri-als and "rob" the proper one of some of the H.F. current.

Aerial Direction

The direction in which the aerial "points" can have a fairly pronounced effect, even if not upon the actual selectivity, on the ability of the receiver to eliminate the signals of a powerful local station. All "inverted-L-type" aeri-als are most sensitive to signals coming in a direction in the line of the horizontal span, particularly to those coming towards the lead-in end. Because of this it is often possible entirely to eliminate local interference without altering the set in any way, by merely changing the direction of the aerial. A better way, in

situations where it can be adopted, is to let the aerial consist of a vertical portion only, or, at least, of a nearly vertical stretch, as shown in Fig. 2. The pole or other support should be as high as possible—40ft. or more is excellent—and the wire should, naturally, be kept as far away from the walls of the house as possible. When it is not possible to obtain the height by means of a pole or mast the next best arrangement is to fasten a much shorter and lighter pole to a convenient chimney stack.

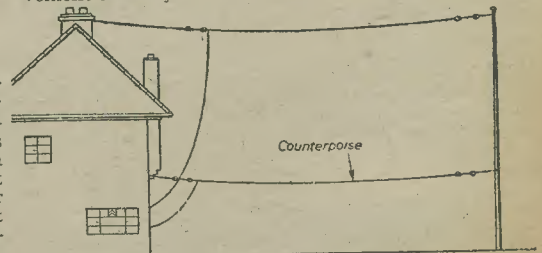

Fig. 3.—This form of counterpoise earth is better than a doubtful connection to earth.

Counterpoise Earths

When a really effective earth connection of one of the types mentioned cannot be obtained, a good substitute can often be found in the form of a sheet of wire-netting or gauze placed under a carpet, and connected by means of a wire to the earth terminal on the set. Yet another excellent form of earth consists of a large metal plate fitted in the bottom of the receiver cabinet. With some receivers an "earth" of this kind gives much sharper tuning than does one of the more orthodox pattern.

A still better "earth" can be obtained by taking a wire about 6ft. above the ground and parallel to the horizontal span of the aerial. This "counterpoise earth," as it is called, must be insulated in just the same

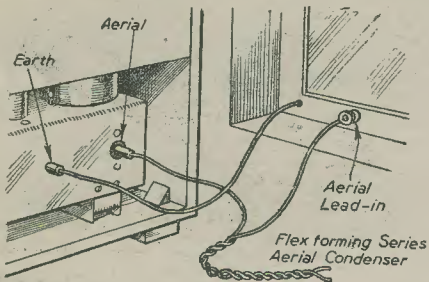

Fig. 5.—A very simple but quite effective form of aerial series condenser.

manner as the aerial and connected to the earth terminal of the set in the usual way (Fig. 3). The only objection to the counterpoise earth is that it increases the directional effect of the aerial; often this can be put to good account, however, by arranging the aerial and earth in a direction which is at right-angles to the line between the local station and the receiver.

Indoor Aerials

Most of the above remarks apply with equal force in cases where an outside aerial is impossible and an indoor one must be used instead. There are a few additional points which should be raised in respect to indoor aerials, but before dealing with them it should be stressed that an outside aerial, if properly arranged, is almost invariably to be preferred to an indoor one, both on the score of selectivity and sensitivity. With an indoor aerial it is usual to take the wire, or one of the special materials sold for the purpose, along the walls of the room. While this is convenient and neat, however, it is not always the best method, since the capacity of the aerial to earth (the walls of the room in this case) is higher than it need be. Because of this, it is better, where conditions allow, to let the aerial consist of a single length of wire going across the centre of an attic or the under-roofing. The wire should be as far away from the walls and the roof as possible, and the same conditions regarding its direction apply as in the case of outdoor aerials. In all probability the lead-in must come down close to the wall, so make it as short as possible.

Frame Aerials

The directional property of an aerial can be put to good use by employing a frame aerial, which can be rotated at will to cut out any unwanted signal. This advantage must be paid for, however, in the way of decreased sensitivity, so that it is not generally successful to attempt to employ a frame with any receiver having less than one efficient S.G. stage. In connecting a frame to an ordinary receiver it is necessary first of all to remove the aerial tuning coil, since the frame serves its purpose besides acting as an aerial. Then the two ends of the

frame aerial are connected in place of the "grid" and "earth" terminals respectively of the tuner so that the frame is tuned by the normal aerial tuning condenser.

Selectivity Devices

Because increased selectivity, or sharpness of tuning, is required, it does not necessarily mean that the receiver must be completely rebuilt or even drastically modified, since there are a number of little devices which may be fitted to produce the desired effect. The simplest of these is the well-known aerial series condenser which is simply joined between the aerial lead-in and the aerial terminal on the receiver as shown in Fig. 4. Small variable condensers are to be obtained in a variety of (maximum) capacities between about .0005 mfd. and .005 mfd., but in the majority of cases a capacity of either .002 mfd. or .003 mfd. will prove most suitable. Once the condenser has been connected in circuit, it must be adjusted to its optimum setting. It will soon be found that if the capacity is made too small signal strength and maximum volume will suffer. On the other hand, if the capacity is too great, the increase in selectivity might be insufficient. It will, therefore, be clearly understood that the best setting should be found by experiment and by carefully checking results at various capacities. On altering the capacity it will at once be found that (with most receivers not provided with a gang condenser) the dial readings for the various stations will be modified, the actual reading being higher when the aerial capacity is reduced, and vice versa.

Series-Aerial Condenser

Quite often it is found with a rather old-fashioned "local station" receiver, that the tuning is not even sufficiently sharp to enable the two nearby transmitters—Home Service and Forces—to be entirely separated. Such a state of affairs definitely points to a most inefficient set, but if the owner has no intention of replacing it by a new one a great improvement can be effected by employing one of the methods just described. An even simpler and less-expensive system can be made use of, however, and the idea is illustrated in Fig. 5. A short length of twin flex acts as a perfectly effective small-capacity pre-set condenser, the end of one strand being

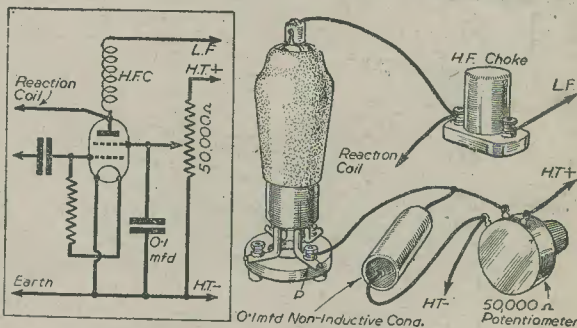

Fig. 6.—Better results are usually obtained when using a S.G. valve in the detector position, the connections being as shown here.

joined to the aerial lead-in, and the end of the other to the aerial terminal. The most suitable length of wire can best be found by trial, starting with a piece about 4ft. long and gradually unwinding it at one end, as shown. When the correct capacity has been found, the wire can be cut off to the correct length. Perhaps it should be mentioned in passing that the ends of the two strands should not normally be allowed to touch each other, or else the device will have no effect. At the same time, if the full sensitivity of the set is ever required for receiving a distant station while one of the locals is closed down, the condenser can easily be put out of circuit by twisting the bared ends of the flexible wires together.

(To be continued)

Telephone-dial Tuning Mechanism

A Novel Arrangement for the Control of Volume and Tone

THE telephone dial mechanism has already been used for remote control of radio receivers. Usually, the impulses transmitted by this mechanism are arranged to operate a ratchet, or other type of step by step motor which causes the switch arm of a rotary switch to select one of a number of contacts appropriate to the number of impulses transmitted. The receiver may be provided with pre-tuned circuits corresponding to the number of stations which it is desired to receive, and the desired station selected by dialling a given number of impulses.

This arrangement is not, however, well suited to the control of volume or tone, or even to the continuous tuning of the receiver, since the act of dialling, for example, volume, should cause the volume to increase steadily until the desired level is attained and then to cease increasing, and this clearly cannot be obtained by means of a selector switch mechanism.

It is, nevertheless, possible to adapt the telephone dial mechanism to the continuous control of volume,

tone, etc., in a simple way by mounting the finger stop so as to be movable. The principle is that the dial mechanism is operated so as to select a particular switch contact which will energise a motor and that the finger stop is then held down so as to maintain the circuit until the motor has moved the volume control or tone control to the desired position, when the motor circuit is broken by releasing the finger stop.

Dial Transmitter

A dial transmitter suitable for this purpose is shown in the accompanying Figs. 1, 2, 3 and 4. Fig. 1 is a front view of the dial with the finger plate 5 and the finger stop 6. Ten finger openings are provided, eight of which can be used for selecting stations and two for controlling the volume, including, if desired, switching the receiver on and off.

Figs. 2, 3 and 4 show parts of the mechanism with the dial plate removed. The finger plate 5 is normally secured to the shaft 7, on which is mounted a plate 8, which carries a pawl 9 engaging a ratchet wheel 10. The ratchet wheel 10 drives the cam 13 through gears 11, 12 and the cam engages switch arm 14 of the switch 15 and is shaped so that it closes and opens switch 15 twice per revolution of the cam. The switch is connected by terminals 16 in a control circuit to the receiver and thus creates two impulses per revolution. Clockwise movement of the dial plate 5 causes pawl 9 to move away from a pawl stopping arm 25 so that it rides over the ratchet wheel 10 and also loads a spring 20 (Fig. 4). When released, the dial plate 5 and pawl 9 are rotated anti-clockwise by the spring 20 and the pawl 9 rotates ratchet wheel 10 and movement is imparted to cam 13. Rotation of the cam 13 causes switch 15 to send out impulses at the rate of two per revolution and it is apparent that the total number of impulses transmitted

Fig. 2.—Parts of the mechanism, with the dial plate removed.

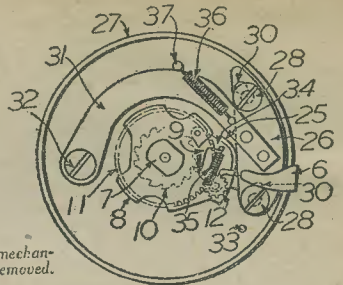

depends upon the initial displacement of the finger plate 5. A friction governor 17, driven from the cam shaft through pinion 18 and worm 19, is provided to ensure uniform motion of the cam 13.

Pawl Stopping Mechanism

The pawl stopping arm 25 and the finger stop 6 are mounted on a plate 26 provided with slots 30 and guide screws 28 which permit limited movement of the plate, and the plate is mounted on the bent arm 31 pivoted at 32. A spring 36 secured to the casing at 37 and to the arm 31 normally holds the arm in the position shown in Fig. 2, but pressure applied to the finger stop 6 causes it to move to the position 6A (Fig. 1) so that arm 31 rotates clockwise until plate 26 engages a stop 33. This movement advances the pawl stopping arm 25 slightly in a clockwise direction, but not sufficiently to cause it to rise over a ratchet tooth. The effect of this is that if after the dial plate 5 has been manipulated and released the manual stop is held down, the pawl will be stopped before it has quite returned to its original position, the cam will be stopped in the position shown in Fig. 3, and the contacts of the switch 15 will remain closed. The last impulse is thus prolonged and current will continue to flow through the switch until the finger stop 6 is released. When this occurs the lever 31 and the pawl stopping arm 25 are restored by spring 35 to their original positions, the spring 20 restores the pawl 9 and shaft 10 to their original positions, and the cam 13 moves back to the position shown in Fig. 4 and opens the contacts of switch 15. Thus, stations may be selected by dialling with the finger stop 6 in the normal position, while for

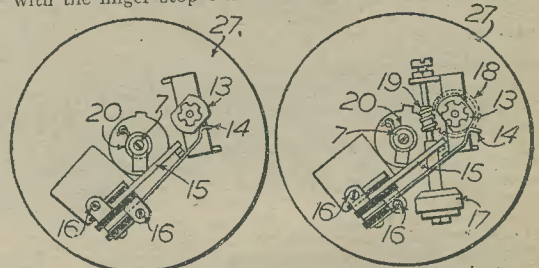

Figs. 3 and 4.—Additional details of the operating dial mechanism.

volume control dialling will take place with the finger stop held in the position 6A (thus prolonging the last impulse) until the required intensity of sound has been attained.

This system has been developed in the laboratories of the Radio Corporation of America.

NEWNES' SHORT-WAVE MANUAL

6/-, or 6/6 by post from
George Newnes, Ltd., Tower House, Southampton St.,
London, W.C.2.

Using Old Components

Some Hints on Suitable Methods of Employing Parts Which May Often be Recovered from the Junk Box

DUE to the difficulty which is now frequently experienced in obtaining new components it is necessary to make full use of those which may be available from old receivers, or which may have been relegated to the spares box. It may not always be possible to find exactly the components required, but makeshift and compromise can often be adopted without marring the results. When it is a question of building a receiver which has been described in these pages, and for which a solus specification has been given, it would not be fair to expect quite the standard of efficiency of the original receiver. At the same time, by careful choice of alternative parts it will generally be possible to build a satisfactory instrument.

Alternative Tuning Coils

For example, the aerial tuning coil specified may be of a type with a loose-coupled aerial winding, while all of those on hand consist of a grid winding only, with aerial tappings. One of these could be used, and if it were found that additional selectivity were required a pre-set condenser could be included in the aerial lead. Alternatively, it is often perfectly satisfactory to use a reaction winding for aerial coupling. The end of this winding intended to be connected to the anode of the detector valve would receive the aerial connection, the other end being earth-connected if not connected to the earth end of the grid winding internally. This improvised aerial winding would probably give insufficient coupling on the long-wave band, but that is not of much consequence nowadays when practically all broadcasting stations work on the medium-wave band.

The above-mentioned arrangement is sometimes "reversible"; that is, an aerial coupling winding may be suitable for reaction. Should the original aerial winding be tapped for medium- and long-wave reception it will generally be best to short-circuit the long-wave portion. This applies whether the set is to cover medium waves only or is for both wavebands.

S.W. Tuning Condensers

A low-capacity tuning condenser may be required for a short-wave receiver. When only one of .0005-mfd. capacity is available it is a simple matter to reduce its effective capacity by connecting a fixed condenser in series with it. For example, the effective maximum capacity of a "composite" condenser consisting of a .0005-mfd. variable and .0005-mfd. fixed condenser in series is .00025 mfd.—just half the capacity of either. A still lower effective capacity can be obtained by wiring a smaller fixed condenser in series. Thus, if the fixed condenser had a capacity of .0003 mfd. the maximum effective capacity would be slightly under .0002 mfd. The above system is equally applicable to a reaction condenser.

Increasing the Working Voltage

When a by-pass condenser of, say, 500 volts working is required, and only condensers of 250 volts working are available a similar arrangement can be employed. Two 250-volt condensers in series are equivalent to one 500-volt condenser, as far as working voltage is concerned. It must, of course, be realised that the overall capacity will be reduced, two 2-mfd. condensers in series providing a working capacity of only 1 mfd., for example. Similarly, two 4-mfd. condensers in series would provide an overall capacity of 2 mfd.

Again, the principle may be reversed. By placing two or more condensers in parallel the overall capacity will be equal to the sum of the individual capacities. In

that case, the working voltage will be that of the condenser of lowest voltage rating. By combining series and parallel connections it is generally an easy matter to provide any required capacity. It should be borne in mind, however, that for other than tuning purposes the condenser value in any circuit is seldom critical. In many cases a 1-mfd. condenser can be used in place of one specified as having a capacity of either .2 mfd. or .5 mfd.

Series and Parallel Resistors

What has been written above with regard to condensers is applicable in modified form to resistors. By connecting two resistors in series it is possible to provide a resistance value equal to the sum of the values of the two components; the same idea applies to any number of resistors in series. The wattage rating of the chain of resistors is equal to that of the lowest rating. For example, if three resistors of 5,000 ohms, 20,000 ohms and 40,000 ohms were wired in series and the first two were rated at 1 watt and the third at .5 watt, the assembly would be equivalent in all respects to a single resistor of 65,000 ohms, .5 watt.

When two resistors are wired in parallel, on the

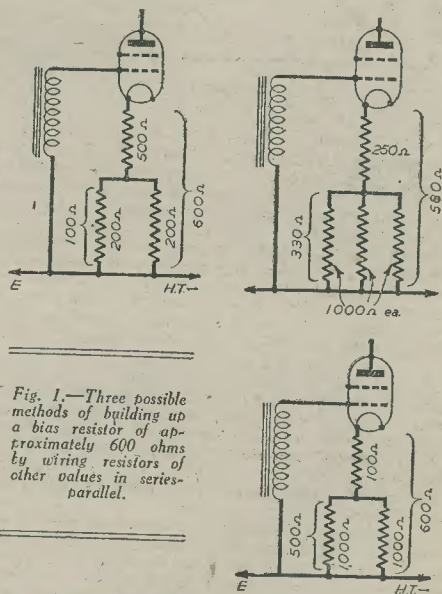

Fig. 1.—Three possible methods of building up a bias resistor of approximately 600 ohms by wiring resistors of other values in series-parallel.

other hand, the combined value is less than that of either component, but the wattage rating is higher. Two 50,000-ohm, 1-watt resistors in parallel are equivalent to a single 25,000-ohm, 2-watt component. The actual effective resistance of two resistors in parallel can be found from the simple formula: $R = \frac{r_1 \times r_2}{r_1 + r_2}$, where R is the total resistance and r1 and r2 are the resistances of the two components.

Bias Resistors

One instance in which it is often necessary to combine two or more resistors is in providing a bias resistor for an indirectly-heated valve. Suppose the value required were 600 ohms; it could be made up by connecting a

100-ohm resistor in series with a pair of 1,000-ohm components in parallel, by wiring a 500-ohm resistor in series with two 200-ohm resistors in parallel or, approximately only, by connecting a 250-ohm resistor in series with three 1,000-ohm ones in parallel. There are various other combinations, the most suitable depending upon the resistors available in any particular case. Fig. 1 illustrates the examples quoted.

Field-coil Resistance

An improvisation which is comparable in many ways with those just described is convenient when it is wished to replace an energised moving-coil speaker by one of the permanent-magnet type. In the original circuit the speaker specified may have a field winding rated at 2,500 ohms. This would serve both for energising and smoothing, and therefore would have to be replaced by a choke. But the choke would probably have a D.C. resistance of only about 200 ohms. In order to

This is not advanced as an ideal solution, because it may impair reproduction to a certain extent, but as a convenient and workable arrangement.

Transformer Repairs

"Burnt-out" L.F. transformers can sometimes be repaired fairly easily if a little care is taken, since the fault may be due to nothing more serious than a fracture in one of the leads from a winding to its terminal. Careful removal of the terminal blocks, or of the transformer from its bakelite case, will permit of an examination being made of the leads; any that are faulty can then be replaced by cleaning the broken end and soldering on a new flexible lead. Sometimes it is necessary to remove the insulation tape from the bobbin to trace a lead right back to the winding. It may then be necessary to unwind a few turns, solder on a 2-in. length of thin,

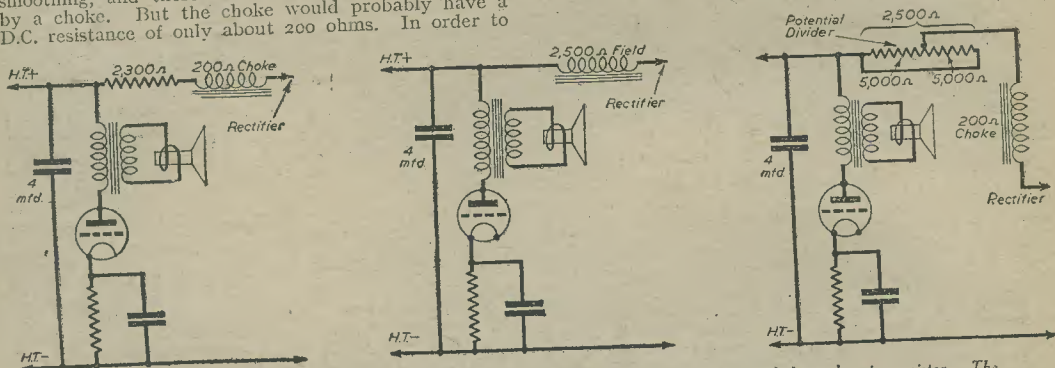

Fig. 2.—Methods of replacing a 2,500-ohm speaker field by a combination of a smoothing choke and series resistor. The original circuit is shown on the left. These methods are explained in the text.

prevent the application of too high a high-tension voltage a fixed resistor would have to be wired in series with the choke, and a value of about 2,300 ohms would be required. A fixed resistor of 2,000 or 2,500 ohms would probably be suitable if one of sufficiently-high wattage dissipation were available. Alternatively, two or more resistors of other values could be wired in series or series-parallel to make up the value.

The necessary wattage rating would require to be watched very closely in a case of this kind because the value would be higher than that of the components most commonly in use. This rating can easily be determined from the formula: $W=I^2R$, where I is the current passed, in amps., and R is the value of the resistor in ohms. Thus, if the current were 50 mA and the resistance 2,500 ohms, the required wattage rating would be .05 times .05 times 2,500, or 6.25 watts.

Two 5,000 ohm 5-watt resistors would be suitable if wired in parallel. Similarly, four 10,000-ohm 2-watt resistors, or eight 20,000-ohm 1-watt resistors could be wired in parallel to serve the purpose. As a simple and very convenient alternative, it would be possible to use a section of an old potential divider if one happened to be lying in the junk box. If the wattage rating were too low—indicated by a marked rise in temperature, two 5,000-ohm sections could be wired in parallel.

The solutions described above are illustrated in Fig. 2.

Old L.F. Transformers

L.F. transformers are other components which are usually in demand. If one of the specified ratio is not available it is seldom that very much harm would come of using one of slightly different ratio. Thus, a 1:3 transformer could well be used where a ratio of 1:2 or 1:5 was specified. But if a ratio of 1:2 were required and the only one available had a ratio of 1:6, it is probable that L.F. instability and poor reproduction would follow from its use in the ordinary way. One method of overcoming the danger of overloading the following valve would be to connect a resistor of between 100,000 and 250,000 ohms in parallel with the secondary.

rubber-covered flex, make one turn with this and then anchor and connect it.

If a repair cannot be effected, remember that the windings of the transformer will often provide a good supply of fine wire for winding H.F. chokes or even midget tuning coils. To obtain the wire first remove the core clamps, when it will be found that the laminations can be removed from alternate ends of the spool. When the core has been removed, take off the insulating tape, after which the winding should be fairly accessible. Be patient in removing the wire to avoid stretching and fracture. The job will probably be simplified if a wooden rod is pushed through the bobbin and mounted so that the whole bobbin can rotate easily.

American Broadcasts of War News

SEVERAL months ago station WLW (Cincinnati) began to prepare for the present situation in order that its listeners might be ensured complete and accurate coverage on all events involving the National Defence effort. The first step in this programme was the assurance of an authoritative staff, competent in reporting and evaluating the importance of news events.

The station was fortunate in possessing such interesting and well-informed news reporters as Peter Grant, H. R. Gross, Elizabeth Bemis, and William Dowell, news editor of WLW. Grant has been recognised nationally for years as one of the premier newscasters of the country, and H. R. Gross came to the Nation's Station after having established himself as the most popular news reporter in the Middle West.

In order to prepare for adequate coverage of the Far Eastern field, WLW contracted for the services of Carroll D. Alcott, for years the most popular newscaster in the Orient. As the voice behind the news broadcasts of a Shanghai radio station, antagonistic to the Japanese, Alcott was a "must" in the daily life of all English-speaking people in the Far East.



ON YOUR WAVELENGTH

By THERMION

The Brine Trust Again

THE Brine Trust has achieved fame by having questions asked about it in the House of Commons. An M.P. said that members of the B.B.C. Brains Trust were paid £20 a session; and Mr. A. Edwards, the Labour Member for Middlesbrough East, asked the Information Minister if he was aware that large sums of public money were being paid by the B.B.C. to radio stars or their agents out of proportion to their real value, and if he would publish examples. Mr. R. Morrison, Member for Tottenham, asked if the Minister was aware that members of the Brains Trust get £20 a session for trying to answer very simple questions? They record two sessions at the same time, and draw £40 each. Did the Minister think that what they give the public is worth it? Mr. Hopkinson asked whether it is not a fact that the Brains Trust is for the innocent amusement of the people. My own opinion is that the Brains Trust is not worth this sum of money, and I have yet to hear one of their sessions which entitles them to the omniscient title of Brains Trust.

Mind you, I agree with the Minister of Information when he said that the fact that they could obtain £20 for one of their sessions indicated that they have brains. I do not blame members of the Brains Trust for earning all they can. If any criticism at all attaches to the money they are paid it attaches to the B.B.C., who seem to assess the value of an item by the number of letters they receive. They do not state what proportion of the letters they receive, however, are adverse criticisms. Apparently, if they receive 1,000 letters of criticism the item is popular, whilst if they receive more than that the item is even more popular.

Assuming, however, that the public does like some such feature, the Brains Trust should be varied from week to week. It is ludicrous to assume that Joad, Huxley, Hogben, Campbell and Co. can answer any questions put to them. If I am wrong about that, and these gentlemen are able to answer questions on every topic under the sun, I am entitled to ask why it is in such times as the present, when brain power is needed more than ever before, that these men are not locked up in a room and confronted with questions of military strategy, aircraft design, naval problems, and so on. They should not be exercising their brains, if any, on entertainment.

I have given many examples of their alleged replies to questions, and one which I briefly dealt with last month was "Why are the Scots better educated than the English?" Now, the obvious answer is that Scots are not better educated than the English, for no census has been taken of the relative educations. There has not been any examination between the two races, and I strongly object to this use of the microphone for what is really a piece of blatant and arrogant Scottish propaganda. But the Brains Trust proceeded to answer the question as though it were a fact that the Scots were better educated. The fact is that there are only about 3,000,000 Scots in Scotland, and the Brains Trust might as a pookish aside have informed listeners that most of the Scots gravitate to England at an early age armed with introductions from their local Meenisters to receive education at the hands of the English! Joad did explode one Scottish myth—that they hold the best positions. They do not, of course. They are usually junior assistants to the English!

This does not indicate any lack of intelligence on the part of the Scots—merely lack of opportunity.

The New B.B.C. Governor

QUESTIONS were also asked in Commons whether Mr. F. W. Ogilvie, ex-Director-General of the B.B.C., resigned voluntarily. Mr. Brendan Bracken said: "I am informed that the B.B.C. Governors have for some time been concerned regarding the executive control, and for this reason they appointed Mr. Robert Foot as General Advisor. Mr. Foot has had important administrative business and organising experience. The Governors decided that the executive control under war-time conditions called for different qualities and experience from those suitable in peace-time. They felt the circumstances of to-day were completely different from those which existed at the time of Mr. Ogilvie's appointment in 1938. Their views were conveyed to Mr. Ogilvie, with the result that he placed his resignation in the hands of the Governors, and it was accepted."

Mr. Robert Foot was general manager of the Gas Light and Coke Company from 1929 until he joined the B.B.C. last November. He may be an extremely able man, and I wish him well in his new task. I do think, however, that we should have been told what particular qualities Mr. Foot possesses which Mr. Ogilvie does not. After all, the qualifications as Director-General of the B.B.C. have always seemed to me to be a combination of the academic and the commercial. It may well be that Mr. Foot possesses both these qualities.

Resale of Goods

THE Price Controlled Goods (Restriction of Resale) Order which was recently made by the Board of Trade is designed to stop a malpractice which has been developing since the war. This practice is the buying and selling amongst dealers of goods, each tacking on a profit so that the consumer is virtually paying the profits of an unnecessarily large number of middlemen. Unfortunately, until this Order was made such practice was quite legal, for each dealer handling the goods would be careful to tack a percentage well within the prescribed limit. This Order lays it down that if a retailer buys price-controlled retail goods from another retailer, and pays retail price for them, he must sell them at that price, and may not add any additional profits.

The Brine Trust

CERTAIN features of the Brine Trust which invoke in us insanity

Are so manifestly foolish and absurd,
That we recognise the symptoms of incipient insanity,

In this really most extraordinary bird.

There's its hegemonic bearing acting on us like a purge,
There's its weird and idiosyncratic grammar,

Whilst its academic arrogance inspires us with the urge

To attack things and to stammer and to yammer.

The dogmatical decisions it delivers in debate

Are masterpieces of inverted logic,

Whilst its ludicrous assumption of an omniscient state

Has imbued it with pretensions pedagogic.

It has other odd obsessions, peccadillos and perversions,

Symptomatical of jibbering debility,

It has follies, fads and fancies, and makes asnerine assertions,

Indicating lack of cerebral agility.

Enough perhaps has now been said—we've been asked to treat

it gently—

To establish something commonly inferred,

That this singular phenomenon is summed up eloquently,

In a single terse B. B. C. syllabic word!—F. J.

(The word is *tripe*).

Practical Output Circuits

Standard Output Arrangements are Analysed, and the Importance of Matching Explained

COMMENCING with the very simplest forms, Fig. 1 shows the arrangement of a simple output stage for a battery receiver, and may be considered as the basic circuit from which all the later circuits are derived. The input to the stage is shown as the secondary winding of an intervalve transformer, but the grid leak winding of an intervalve transformer, or of course, be substituted. It will be seen that the lower end of the input circuit is in each case connected to the appropriate negative grid-bias tapping—and it is important that the correct value of grid bias be applied in accordance with the table supplied by the valve maker. Incorrect bias leads to distortion, and if the biasing voltage is too small the valve will take excessive anode current in addition, thus shortening the life of both the high-tension battery and the valve.

The output valve in this case would be either a power or a super-power triode; the relative merits of each have been discussed in a previous instalment. As such valves take a comparatively small anode current, the output can be taken straight to the loudspeaker, provided that this instrument (together with its transformer, if fitted) represents a "load" of the correct impedance for the valve used.

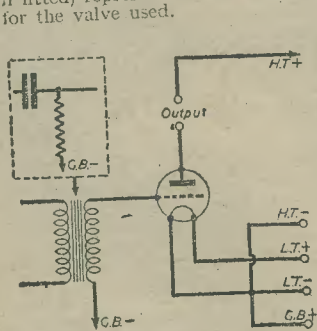

Fig. 1.—The basic output circuit for battery triodes.

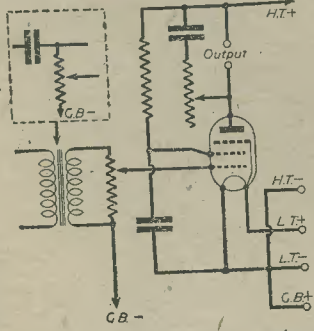

Fig. 2.—The basic output circuit for battery pentodes.

Matching

This matter of matching the speaker impedance to the valve will be referred to later on, but it should be remarked here that a certain valve with a certain input signal will give an output depending upon the impedance of the load, that is, the speaker circuit. It is possible to calculate, and also to measure, the output with different loads. Similarly, the amount of distortion varies with the load impedance. Valve manufacturers now specify in their catalogues the "optimum" or best value of load impedance for each type of output valve, this value being that which gives the largest output for a reasonably small amount of distortion—usually 5 per cent. second harmonic distortion.

The correct matching of the speaker impedance to meet optimum conditions is done usually by selecting the correct ratio for the speaker transformer. Suitable ratios for the ordinary battery triodes and pentodes are standard, and most makes of moving-coil speakers are either obtainable with transformers having one of a number of ratios, or with universal transformers, the tappings of which can be adjusted to give practically

any desired load value. In the diagram shown in Fig. 1, however, it is assumed that a speaker of correct impedance is available.

Using Pentodes

The circuit for an output stage using a battery pentode is shown in Fig. 2. It does not differ very much, basically, from that given in Fig. 1, but two or three points are worthy of note. In the first place, a volume control is shown in the input circuit. This is not essential, but has been included to indicate how such a control should be arranged, if wanted, in order to avoid overloading the more sensitive pentode. The transformer coupled stage has a potentiometer across the secondary for volume control purposes; for the resistance capacity coupling arrangement a potentiometer is substituted for the fixed value grid leak.

The next point for consideration is the decoupling in the auxiliary grid circuit of the pentode. This, again, is not an essential refinement, and normal battery pentodes are so designed that the auxiliary grid may be connected to the same high-tension voltage as the anode supply. Some of the larger mains pentodes, however, require lower auxiliary grid voltages, and the arrangement shown may be employed as a voltage-dropping resistance and decoupling circuit.

Lastly, in this diagram it will be seen that a small condenser and variable resistance in series with it is connected across the output terminals. This should be done always with a pentode stage, and fulfils two functions. In the first place it serves to limit the serious rise in voltage which would occur if the load across output terminals was inadvertently disconnected while the set was switched on. This voltage rise might easily be sufficient to cause a breakdown in the insulation of

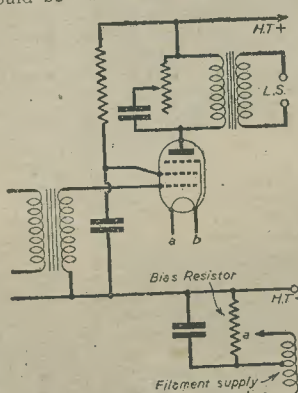

Fig. 4.—Using a directly-heated mains output pentode.

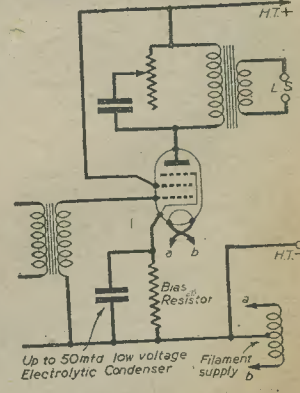

Fig. 5.—The modifications for an indirectly-heated mains pentode.

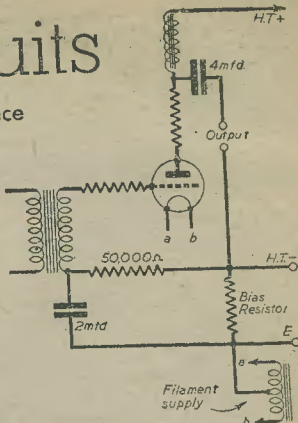

Fig. 3.—An output circuit for a directly-heated mains triode.

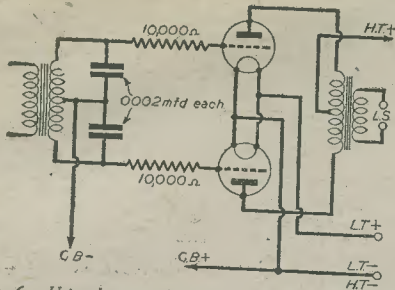

Fig. 6.—Using battery triodes in a push-pull output stage.

the speaker transformer, and might even crack the foot of the valve. Secondly, the condenser and resistance can be used as a form of tone control to reduce the high note response, and give what many listeners feel is a more balanced reproduction. The condenser may be of .01 or mfd., and the resistance should have a maximum value of 50,000 ohms for small battery pentodes or 25,000 ohms for the mains pentodes.

Similarity

We now come to directly-heated A.C. mains output valves, Fig. 3 showing a triode stage and Fig. 4 a

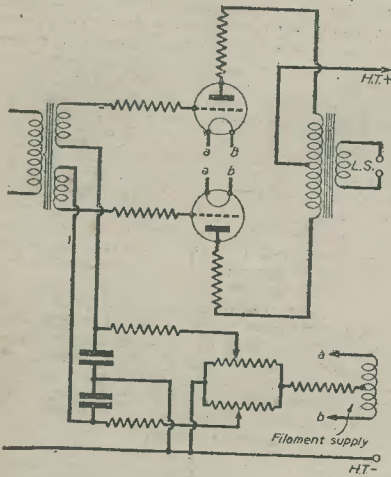
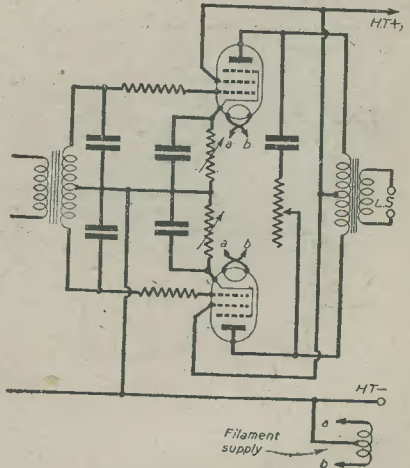

Fig. 7.—(Left) A pair of directly-heated mains triodes in push-pull showing independent variable bias.

Fig. 8.—(Right) Using indirectly-heated pentodes in a push-pull stage.



isolated from the anode supply, and no D.C. component flows through the transformer winding.

Fig. 5 shows an amplifier using an indirectly-heated mains output pentode, and the simpler form of grid bias circuit, namely, a resistance in the cathode lead with large bypass condenser, should be noted. Otherwise, the arrangement is identical with that shown in Fig. 4.

Push-pull Schemes

We now come to ordinary push-pull circuits, and the basic arrangement for two battery valves (triode or pentode) is shown in Fig. 6. The very complete grid oscillation stoppers provided should be noted. They consist of a 10,000-ohm resistance in each grid lead, and a .0002 condenser across each half of the push-pull input transformer. It will be observed that a centre-tapped input transformer is employed, so that the two valves share a common grid-bias tapping. The ideal arrangement is to use a double-secondary transformer so that the two valves may be independently biased and their anode currents adjusted to equality. This type of transformer should certainly be used with mains valves, and Fig. 7 shows the circuit for two directly-heated mains valves in push-pull, and in particular the arrangement for individually adjustable grid bias. The circuit for a pair of indirectly-heated mains pentodes is given in Fig. 8, and here again certain items, such as the auxiliary grid decoupling, are merely refinements.

Finally, there are the various quiescent output schemes.

directly-heated pentode. The main details are similar to those of the corresponding battery stages, and the reader will have little difficulty in identifying those which are merely refinements. Two alternative methods of applying automatic grid bias are shown. That in Fig. 3, with a decoupling resistance, is the ideal case, but in practice the Fig. 4 arrangement, with a large, low voltage electrolytic by-pass condenser, will be found perfectly satisfactory.

The two resistances, one in the grid circuit and one in the anode circuit of the triode version, are of interest. They are high-frequency oscillation stoppers, and should always be used with the larger A.C. mains valves of the 5-watt output class and above, and always in push-pull arrangements. The grid stopper may be of from 5,000 ohms to 10,000 ohms resistance, and the anode stopper (which must be rated to carry the full anode current of the valve and arranged as close to the anode terminal of the valve as possible) should be of 80 to 100 ohms.

In Fig. 3, also, is shown an alternative to the transformer output, namely, a choke-capacity filter feed. This has the advantage that the primary of the output transformer, and also the extension leads, if any, are

A Class "B" arrangement is shown in Fig. 9. The arrangement of two oscillation stoppers in the form of 10,000-ohm resistances connected across the two halves of the Class "B" input transformer should be noted,

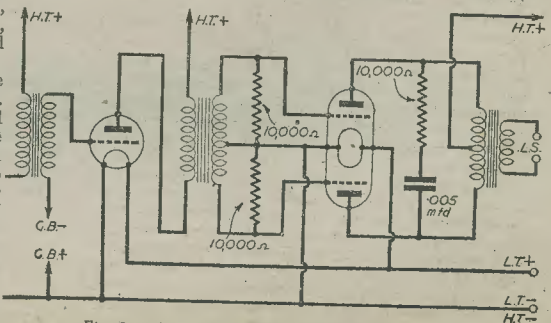

Fig. 9.—A typical Class "B" output circuit.

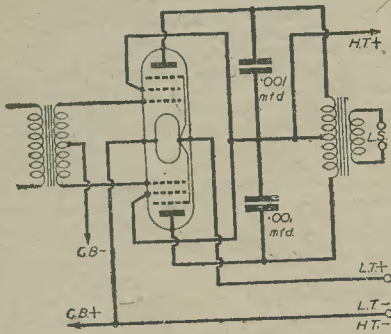

Fig. 10.—The connections for a Q.P.P. output stage.

and also the fact that a suppressor circuit, comprising resistance and condenser in series, is shunted across the primary of the output transformer in the same way as

in the pentode circuit in Fig. 2. As explained in previous articles, the input and output transformers for Class "B" are of special type, the former having a step-down ratio and low resistance secondary (about 400 ohms), and the latter having a primary resistance of not exceeding 1,000 ohms.

Q.P.P. Stage

The last circuit, Fig. 10, is of a Q.P.P. stage, using the double pentode valve. It calls for little comment, most of the features being similar to those already described. The component values given, however, represent normal practice, and the circuit may be followed with confidence.

It should be pointed out that both in this type of circuit, and in the circuit just mentioned, the anode current is continually varying with the signal, and this variation in the load necessitates the use of a special source of H.T. supply in order to take full advantage of the circuit. A good large battery should be employed, or one of the special H.T. units when the mains are available.

Grid-current and Grid-bias

A Brief Explanation of How These Items Affect the Working of a Thermionic Valve

THE simplest type of valve is the diode (two-electrode) and it is shown in diagrammatical form in Fig. 1. It consists of a filament (cathode) and an anode, the latter being above or around the filament. The assembly is enclosed in a glass bulb in which a vacuum exists, and the electrodes are so fixed that no direct electrical connection is made between them.

The material used for the filament consists, like any other substance, of molecules, and these, in turn, depend for their structure on atoms. Now an atom has a nucleus which is considered to consist of tiny particles

When the filament is heated to a certain temperature, by connecting it to a low-tension source of supply of electricity, it will emit a continuous stream of electrons. Many of these will reach the anode, but others will collect in a cloud formation around the filament and produce what is known as the *space charge*.

In magnetism and electricity it is known that like bodies *repel* and *unlike* bodies *attract* each other. Therefore, the space charge existing between the filament and anode tends to repel the electrons leaving the filament, owing to the fact that they are of the same polarity. In Fig. 2 it will be seen that a high-voltage (high-tension) battery and a low-tension accumulator have been connected to the anode and filament circuits respectively. The positive pole of the H.T. is joined to the anode and the negative side of each supply made common. The effect of this is to make the anode positive with respect to the filament, so it now attracts the electrons and causes them to proceed in a continuous stream from the filament to the anode and thence through the external circuit back to the filament. The flow of electrons thus produced creates an electric current; if a suitable meter is connected in the H.T. supply, as shown in the diagram, it will indicate that such a current does exist. To achieve this, it is necessary for the H.T. voltage to be of sufficient value to over-

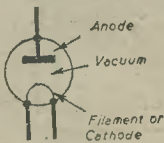

Fig. 1 (left).—The diode valve.

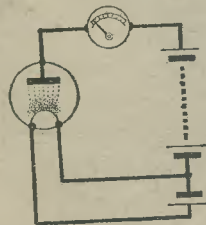

Fig. 2 (right).—The electron flow and space charge.

known as electrons. As these can possess a positive or negative characteristic, it is usual to call the former *protons* and the latter *electrons*. The nucleus of the atom has an excess of protons, therefore it is said to have a *positive* characteristic, but around the nucleus there exists a certain number of *free* electrons. The term "free" is given to these, as they are not closely bound together like the protons and electrons forming the nucleus of the atom.

Under normal conditions, the atom is neutral—in an electrical sense—due to the fact that the *free electrons* balance out or *neutralise* the positive nucleus. If, however, certain conditions are created to upset this balance, it is possible for the free electrons to leave the circle of influence of its parent atom and drift away. Once these tiny negative particles (electrons) are set in motion, they constitute an electric current.

One method of creating conditions which will upset the normal balance of the atom, is to heat the substance in which they exist, and this is what is done in the case of the filament of a valve.

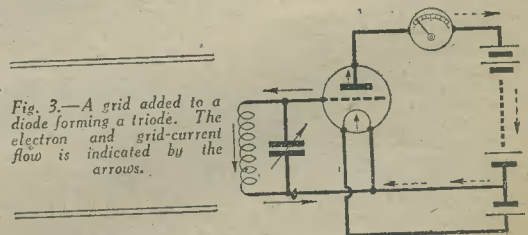

Fig. 3.—A grid added to a diode forming a triode. The electron and grid-current flow is indicated by the arrows.

come the blanketing or retarding effect exerted by the space charge.

It should be noted that for a given filament temperature only a certain number of electrons will be emitted, and any increase in the voltage applied to the anode will not produce a greater emission. It is possible, however, to produce an increase in the anode current by

increasing—up to a certain limit—the anode voltage. These two statements may appear contradictory, but this is not so, as the increase in anode current is due to the gradual neutralisation of the space charge, thus allowing all the emitted electrons to reach the anode. From the above, it is clear that the anode must be made positive to create an anode current flow; if a negative voltage or, taking it a step further, no voltage at all, existed at the anode, then no electron flow would be produced. It is due to this fact that the diode can act as a rectifier, as current can only flow in one direction.

This is clearly illustrated by replacing the H.T. battery by a source of alternating current (signal). Owing to the characteristics of alternating current, the anode would be made alternatively positive and negative; therefore, during the positive half-cycle anode current would flow, and during the negative half-cycle no electrons would be attracted to the anode and no current would be produced. The resultant effect is a *pulsating* direct-current, i.e., half-wave rectification.

Adding the Grid

Fig. 3 shows a triode (three-electrode) valve, the third grid taking the form of a wire grid or mesh which is placed around or above the filament so that it is between the anode and the filament. The object of this additional electrode is to provide another means of controlling the anode current; this it achieves by effecting the space charge. The construction of the grid does not, in itself, offer any obstacle to the electron flow, but if its potential is varied positive or negative, then additional impetus or a repelling effect is produced in the electron flow and, likewise, the anode current is varied. If a negative potential is applied, the electrons are repelled, i.e., the space charge strengthened, and the anode current will decrease. If the potential is changed to one of a positive nature, the grid will attract electrons and help more of them to get through to the anode, thus causing an increase in the anode current. Due to the positive potential, and the attraction of the electrons by the grid, another effect is produced in addition to that mentioned above. There is always the possibility that some of the electrons will be attracted to the grid itself, and, instead of passing on to the anode, will take a short cut back to the filament. This they can do by flowing down through the tuning coil or the grid leak, as indicated in the diagram, and create what is known as *grid current*. The value of this current, so far as the efficiency of the valve is concerned, is a variable quantity, and, without going into technical considerations, it is sufficient to note that in H.F. and L.F. amplifying circuits it is far from being a desirable feature.

If a signal (alternating current) is now applied to the tuned circuit across the grid and filament, the former will have its polarity varied alternatively positive and negative, and the anode current will vary above and below its mean value, but more about that later.

Biasing

To prevent grid current from being developed, it is possible to arrange matters so that the grid is maintained in a negative state. The process is known as biasing (grid-bias), and the diagrams shown in Figs. 4 and 5 will help to make this clear.

The graph, Fig. 4, shows the anode current of a triode valve plotted against its grid voltage, the latter being shown as increasing from a central zero point to values positive and negative. The small curve drawn about the vertical line below the zero bias point is the graphical representation of an alternating current of a simple wave form, in this case serving as the applied signal.

Let us assume that the signal voltage has a total swing of 8 volts, i.e., 4 volts negative to 4 volts positive. Following the vertical lines from these grid voltages upwards, we find that they intersect the anode current/grid voltage curve at A and B. By projecting these points to the right, we can read off the vertical current scale the anode current variation produced above and below the operating point O. The current value at O is 20 mA's; at A it is 10 mA's, and at B 25 mA's or; when the grid is made 4 volts negative the current decreases 10 mA's, and when it is made 4 volts positive it increases by 5 mA's to 25 mA's; thus the signal voltage (total swing) of 8 volts produces an anode current variation of 15 mA's. Note that the changes in anode current above and below the value indicated for zero grid volts (point O) are not equal.

From the above hypothetical case it will be observed that the grid has been allowed to become positive, and that grid current will undoubtedly have been created. As we wish to avoid this, negative bias is applied, which has the effect of moving the operating point O down the curve to the position shown in Fig. 5. If a signal of the same value as that in the previous example is applied, the grid will no longer be driven into a positive state. The negative bias applied is 4 volts, therefore the 4-volt positive half of the signal will simply neutralise the bias and make the grid zero potential, and *not positive*, as when no bias was used. The 4-volt negative half of the

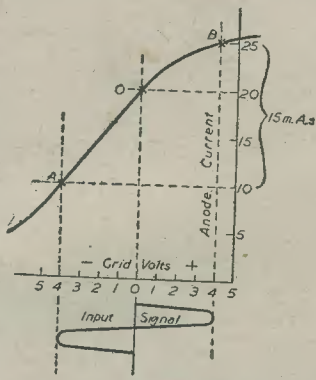

Fig. 4.—The anode current/grid volt curve of a triode when operated without grid bias.

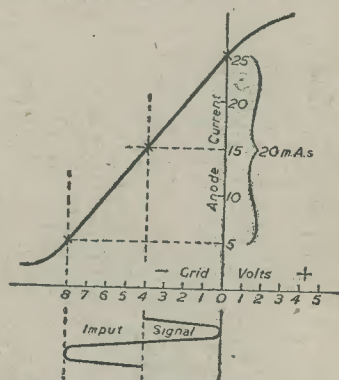

Fig. 5.—Shows the effect of applying grid bias. Note signal is now operating on straight portion of curve.

input will increase the negative state of the grid to 8 volts, thus the two points A and B on Fig. 4 now become those shown on the curve Fig. 5. The new anode current values are now 5 mA's, 15 mA's, and 25 mA's respectively, representing a total variation of 20 mA's against 15 mA's in the case of Fig. 4.

Although this increase means greater output, the chief features to note are that the signal is now operating on the *straight* portion of the curve, and that the variation each side of O is equal and, finally, the grid does not become positive.

To understand the advantages thus gained, the two curves, Figs. 4 and 5, should be compared. Without bias, the anode current at the operating point O was 20 mA's, but when bias is applied (Fig. 5) the current for the same point is only 15 mA's, yet the ultimate output of the valve is greater. By keeping the signal on the straight portion of the curve, an equal increase and decrease in anode current is obtained for the positive and negative half-cycles of the signal. This means that the anode current variations represent *faithfully* the variations in the grid potential, thus ensuring distortionless operation. In the case of Fig. 4 the negative portion of the signal produced a change in anode current of 10 mA's, whilst the positive section yielded only 5 mA's change, indicating that the signal was being distorted, due to incorrect operating conditions of the valve.

A Refresher Course in Mathematics—3

By F. J. CAMM

Cube Root—Continued Fractions—Dydecimals—Logarithms

Extracting Cube Root

DIVIDE the number into periods by marking a dot over every third figure beginning at the units place as for square root (as in the example below). Find the greatest cube root in the figures in the left-hand period, and place this root on the left-hand side of the sum. Subtract the cube of this root from the left-hand period, and bring down the next period to the remainder, using this as a dividend as before. Next, divide this dividend, omitting the last two figures, by three times the square of the root already found and attach this quotient to the root. Next, add together, thus obtaining the final divisor, firstly, this last trial divisor with 00 attached (300), three times the product of the last root figure (2) and the remainder of the root (1) with one cipher attached ($3 \times 2 \times 1$ plus cipher = 60), and the square of the last root figure ($2^2 = 4$). Multiply this final divisor ($300 + 60 + 4 = 364$) by the figure of the root last obtained (2), and subtract the product from the dividend. The simplest method of extracting roots is by means of logarithms, and these will be explained later.

Example: Find the cube root of 1728:—

$$\begin{array}{r} \overset{\cdot}{1} \overset{\cdot}{7} \overset{\cdot}{2} 8 (12 \\ \underline{1} \\ 364 \quad \overset{\cdot}{7} 28 \\ \quad \quad \underline{728} \end{array}$$

The fourth root of a number can be obtained by finding its square root, and then extracting the square root of the answer.

Most engineering pocket books include tables of roots and powers of numbers up to 100 or 200, and the use of these can be extended to apply to larger numbers, by applying the rule that *the square of a composite number (as distinct from a prime number) is equal to the square of its two factors multiplied together*. For example, suppose the table of powers extends only to 100, and it is desired to find the square of 124. Mentally divide 123 by 3; the answer is 41. Find the square of 41 from the table and multiply the answer by the square of 3 = 9. The rule to remember is: *Divide the number to be squared by the smallest number or factor as will bring it within the compass of the table of powers, thus taking advantage of the highest square in relation to the number which the table will yield.*

The same rule applies when extracting roots, for the square root, cube root, or any other root of a number is equal to the root of one of its factors multiplied by the same root of the other factor.

Example: To find the cube root of 512 from a table of roots which does not go beyond 100, divide the number by some smaller cube number to bring it within the compass of the table. In this case we can divide by 8 (2 cubed), the quotient being 64. From the table we note that the cube root of 64 is 4, and multiplying this by the cube root of 8 (2) we obtain $4 \times 2 = 8$ as the cube root of 512.

A quick way of multiplying by 9 is to add a nought to the number to be multiplied and then subtract the number.

Example:

$$321 \times 9 = 3210 - 321 = 2889$$

Similarly, when multiplying by 99, add two noughts and subtract the number; when multiplying by 999 add three noughts, and so on.

Continued Fractions

Quite often in workshop calculations an unwieldy fraction occurs. A fraction having a large denominator consisting of a prime number is reduced to simpler terms by means of continued fractions. In this system of continued fractions unity is used for the numerator and the denominator is an entire number or integer plus a fraction.

Continued fractions, therefore, enable us to find another fraction expressed in smaller numbers which may be sufficiently approximate to another value expressed in large numbers.

Example: What fraction expressed in smaller numbers is nearest to value to $\frac{29}{146}$? Dividing the numerator and denominator by the same number does not change the value of the fraction. Dividing both terms of

$\frac{29}{146}$ by 29, we have $\frac{1}{5\frac{1}{29}}$, or, what is the same thing expressed as a continued fraction, $\frac{1}{5 + \frac{1}{29}}$. The continued fraction $\frac{1}{5 + \frac{1}{29}}$ is exactly equal to $\frac{29}{146}$. If, now,

we reject the $\frac{1}{29}$, the fraction $\frac{1}{5}$ will be larger than $\frac{1}{5 + \frac{1}{29}}$, because the denominator has been diminished 5 being less than $5\frac{1}{29}$. $\frac{1}{5}$ is something near $\frac{29}{146}$ expressed in smaller numbers than 29 for a numerator and 146 for a denominator. Reducing $\frac{1}{5}$ and $\frac{29}{146}$ to a common denominator, we have $\frac{1}{5} = \frac{146}{730}$ and $\frac{29}{146} = \frac{145}{730}$. Subtracting one from the other, we have $\frac{1}{730}$, which is the difference between $\frac{1}{5}$ and $\frac{29}{146}$.

There are fourteen fractions with terms smaller than 29 and 146, which are nearer $\frac{29}{146}$ than $\frac{1}{5}$ is, such as $\frac{15}{76}$, $\frac{16}{81}$ and so on to $\frac{28}{141}$. In this case by continued fractions we obtain one approximation, namely, $\frac{1}{5}$, and any other approximations, such as $\frac{15}{76}$, $\frac{16}{81}$, etc., we find by trial. It will be noted that all these approximations are smaller in value than $\frac{29}{146}$. There are cases, however, in which we can, by continued fractions, obtain approximations both greater and less than the required fraction.

In the French metric system, a millimetre is equal to .03937 inch: What fraction in smaller terms nearly expresses .03937 inch? .03937, in a vulgar fraction, is $\frac{3937}{100000}$. Dividing both numerator and denominator by

3937, we have $\frac{1}{25 + \frac{1575}{3937}}$. Rejecting from the denominator of the new fraction, $\frac{1575}{3937}$, the fraction $\frac{1}{25}$ gives us a

pretty good idea of the value of .03937 inch. If in the

expression $25\frac{1575}{3937}$ we divide both terms of the fraction

$\frac{1575}{3937}$ by 1575, the value will not be changed. Performing the division we have

$$\begin{array}{r} \overset{\cdot}{1} \\ \underline{25 + 1} \\ 2 + 787 \\ \underline{ + 787} \\ 1575. \end{array}$$

We can now divide both terms of $\frac{787}{1575}$ by 787, without changing its value, and then substitute the new fraction for $\frac{787}{1575}$ in the continued fraction.

Dividing again, and substituting, we have:

$$\begin{array}{r} \frac{1}{25+1} \\ \frac{2+1}{2+1} \\ \frac{2+1}{787} \end{array}$$

as the continued fraction that is exactly equal to .03937. In performing the divisions, the work stands thus:

$$\begin{array}{r} 3937 \text{ } 10000(25) \\ \underline{7874} \\ 21260 \\ \underline{19685} \\ 1575)3937(2 \\ \underline{3150} \\ 787)1575(2 \\ \underline{1574} \\ 1)787(787 \\ \underline{787} \\ 0 \end{array}$$

That is, dividing the last divisor by the last remainder, as in finding the greatest common divisor, the quotients become the denominators of the continued fraction, with unity for numerators. The denominators 25, 2, and so on, are called incomplete quotients, since they are only the entire parts of each quotient. The first expression in the continued fraction is $\frac{1}{25}$ or .04—a little larger than .03937. If, now, we take $\frac{1}{25+\frac{1}{2}}$, we shall come still

nearer .03937. The expression $\frac{1}{25+\frac{1}{2}}$ is merely stating that 1 is to be divided by $25\frac{1}{2}$. To divide, we first reduce $25\frac{1}{2}$ to an improper fraction, $\frac{51}{2}$, and the expression becomes $\frac{1}{\frac{51}{2}}$, or one divided $\frac{51}{2}$. To divide by a fraction, invert the divisor, and proceed as in multiplication. We then have $\frac{2}{51}$ as the next nearest fraction .03937. $\frac{2}{51} = .0392+$, which is smaller than .03937. To get still nearer, we take in the next part of the continued fraction, and have:

$$\begin{array}{r} \frac{1}{25+1} \\ \frac{2+1}{2+1} \\ \frac{2}{2} \end{array}$$

We can bring the value of this expression into a fraction, with only one number for its numerator and one number for its denominator, by performing the operations indicated, step by step, commencing at the last part of the continued fraction. Thus, $2+\frac{1}{2}$ or $2\frac{1}{2}$ is equal to $\frac{5}{2}$. Stopping here, the continued fraction would become

$$\begin{array}{r} \frac{1}{25+1} \\ \frac{5}{5} \\ \frac{2}{2} \end{array}$$

Now, $\frac{1}{2}$ equals $\frac{2}{4}$, and we have $\frac{1}{25+\frac{2}{4}}$. $25\frac{2}{4}$ equals

$\frac{127}{5}$; substituting again, we have $\frac{1}{5}$. Dividing 1 by

$\frac{127}{5}$, we have $\frac{5}{127}$. This is the nearest fraction to .03937 unless we reduce the whole continued fraction:

$$\begin{array}{r} \frac{1}{25+1} \\ \frac{2+1}{2+1} \\ \frac{787}{787} \end{array}$$

which would give us back the .03937 itself.

$\frac{5}{127} = .03937007$, which is only $\frac{7}{100000000}$ larger than .03937. It is not often that an approximation will come so near as this.

This ratio, 5 to 127, is used cutting millimetre thread screws. If the leading screw of the lathe is 1 to 127; if the change gears will have the ratio of 5 to 127; if 8 to in., the ratio will be 8 times as large, or 40 to 127; so that with leading screw 8 to inch, and change gears 40 and 127, we can cut millimetre threads sufficiently accurate for practical purposes.

Duodecimals

In calculations involving feet and inches a system of calculation known as duodecimals is used. As calculations in the building trades are almost entirely confined to feet and inches duodecimals are very generally used by surveyors, architects, bricklayers, painters and glaziers.

In the normal system of calculation, in order to multiply feet by inches it is necessary to reduce the feet to inches, and, similarly, if it is desired to multiply, say, 3ft. 6in. by 7ft. 9in., we should proceed to reduce each to inches, multiplying the two quantities together in the ordinary way, and then divide the answer by 144 to obtain the answer in square feet (144 sq. in. equals 1 sq. foot, and 1,728 in. equals 1 cubic foot).

This somewhat cumbersome method is eliminated by the use of duodecimals. In this system the unit is the foot, and this is subdivided into 12 primes (1¹), the primes are subdivided into 12 seconds (1¹¹), and the seconds are divided into 12 thirds (1¹¹¹); the latter are divided into 12 fourths (1¹¹¹¹), etc. In some text books the term parts is used in place of seconds.

Thus, the divisions and sub-divisions of the square foot are termed superficial primes, superficial seconds, superficial thirds, etc. Similarly, in cubic measure the sub-divisions are termed cubic primes, cubic seconds, cubic thirds, etc.

It will thus be seen that when primes are multiplied by feet the answer is in superficial primes, the product of feet times feet being, of course, square feet. Hence, one prime equals $\frac{1}{12}$ sq. feet, and therefore one prime multiplied by one foot equals $\frac{1}{12} \times 1$, which equals one superficial prime. From this it will be seen that by multiplying feet and seconds the product will be termed superficial seconds.

Here is an example:

Multiply 7ft. 6in. by 5ft. 2in.; then multiply the product by 8ft. 2 $\frac{1}{2}$ in.

First write down the two quantities to be multiplied together, putting like quantities immediately beneath each other.

Commence with the number indicating feet in the multiple, and use the lower dimensions as the multiplier, carrying one to the left for each twelve in each product.

Now multiply by the inches, carrying forward the result of the mental division by twelve and setting the result down to the right of the former product. Proceed in this manner if there is a third dimension. Thus:

$$\begin{array}{r} 5\text{ft. } 8^1 \\ \underline{7 \quad 6} \\ 39 \quad 8 \\ \underline{34 \quad 0} \\ 73\text{ft. } 8^1 \quad 0^1 \end{array}$$

In this example $7 \times 8 = 56$. Dividing 56 mentally by 12 we obtain $4 + 8$. Set down the 8 and carry the 4. Now $7 \times 5 = 35$, and $35 + 4 = 39$.

Next we multiply by 6, obtaining $6 \times 8 = 48$, and this divided by 12 = 4. Hence, we put 0 down and carry forward 4. So $6 \times 5 = 30$ and adding the 4 = 34. Adding these together, we obtain as a result 73 sq. ft. + 8 superficial primes. This may be converted into square feet and square inches in the following way:

$$73 \text{ sq. ft.} + 8^i = 73 + \left(\frac{8}{12}\right) \times 144 \text{ sq. in.}$$

$$= 73 + \frac{96}{144} \text{ sq. in.}$$

In multiplying by the third dimension (8ft. 2 1/2 in.) this dimension, in duodecimals, is 8ft. + 2 6/12 in. = 8ft. 2 6/12 in.

Multiply as before:

73ft. 8 ⁱ	0 ⁱⁱ			
8	2	6		
589	4 ⁱ	0 ⁱⁱ		
144	3 ⁱ	4 ⁱⁱ	0 ⁱⁱⁱ	
3	0 ⁱ	10 ⁱⁱ	0 ⁱⁱⁱ	0 ^{iv}
736ft. 8 ⁱ	2 ⁱⁱ	0 ⁱⁱⁱ	0 ^{iv}	

This equals 736 cu. ft. + $\left(\frac{8}{12} + \frac{2}{144}\right) \times 1,728$ cu. in.
 $= 736 + \left(\frac{96}{144} + \frac{2}{144}\right) \times 1,728$
 $= 736$ cu. ft. + 1,776 cu. in.

Another example: Multiply 5ft. 8in. \times 3ft. 4in.

3ft. 4 ⁱ			
5	8		
16ft. 8 ⁱ			
2	2 ⁱ	8 ⁱⁱ	
18ft. 10 ⁱ	8 ⁱⁱ		

Which equals 18 sq. ft. + $\left(\frac{10}{12} + \frac{8}{144}\right) \times 144$

$$= 18 \text{ sq. ft.} + \left(\frac{120}{144} + \frac{8}{144}\right) \times 144$$

$$= 18 \text{ sq. ft.} + 128 \text{ sq. in.}$$

Division is carried out as in this example:

Divide 16 sq. ft. 9 sq. in. by 3ft. 6in.

3ft. 6in.) 16 sq. ft. 9 sq. in.	7 ⁱ	6 ⁱⁱ	4 sq. ft. 9 sq. in.
14 sq. ft. 0 ⁱ			
2	7 ⁱ	6 ⁱⁱ	
2	7 ⁱ	6 ⁱⁱ	

It will be seen that 4 is tried as a multiplier : $4 \times 6 = 24$. Put down 0 and carry 2 ; $4 \times 3 = 12$; add 2 and obtain 14. Subtract, thus getting 2,7 ; bring down 6ⁱⁱ. Try 9 : $9 \times 6 = 54$; put down 6 and carry 4 ; $9 \times 3 = 27$; add 4 and obtain 31 ; $31 = 2.7^i$.

Logarithms

Logarithms are one of the most important of the labour-saving methods of calculation. It is necessary to understand the use of logarithmic tables, for they enable calculations to be made which are quite impossible by any other method. By means of logarithms (logs for short), we are able to carry out the operation of multiplication, division, involution and evolution (not, be it noted, of addition or subtraction). A knowledge of logarithms is quite essential before the slide rule (dealt with later) can be mastered. The slide rule itself considerably augments the facility of rapid calculation which logarithms provide.

I shall deal here first with common logarithms, leaving Napierian logarithms and Hyperbolic logarithms for a later article. (Common logarithms are those calculated to base 10.)

In logarithms, the processes of multiplication and division are converted into those of addition and subtraction. Thus, to multiply numbers together, their logarithms are added, and to divide them their logarithms are subtracted.

Let us first define what a logarithm is, and then obtain an idea of how logarithms are applied.

The logarithm of a number, to a given base, is the index of the power to which the base must be raised to produce the aforesaid number.

Here is a table of the number 3 raised to various powers :

$3^1 = 3$	$3^7 = 2187$
$3^2 = 9$	$3^8 = 6561$
$3^3 = 27$	$3^9 = 10683$
$3^4 = 81$	$3^{10} = 59049$
$3^5 = 243$	$3^{11} = 177147$
$3^6 = 729$	$3^{12} = 531441$

Suppose we wish to multiply 27 by 19683. We can proceed by the lengthy way as follows :

19683
27
137781
393660
531441

By means of the table of logarithms, however, we look up the logarithm of the two numbers, add the two logarithms together, and then consult the table to ascertain what number corresponds to the logarithm so obtained. Thus, from the table we see that—

$$27 = 3^3, \text{ and } 19683 = 3^9.$$

The two logarithms are therefore 3 and 9, which, added together equal 12.

Consulting the table we see that $3^{12} = 531,441$.

Observe that we have not multiplied the quantities to obtain the answer.

The table above is calculated to the base 3. In other words it contains the index of the power (1, 2, 3, 12) to which the base (3) must be raised to produce the numbers (3 to 531,441).

If we wished to divide two of the numbers in the table we should subtract their logarithms. For example $19683 \div 27$. By ordinary methods this is found to be 729.

But the logarithm of 27 (from the table) is seen to be 3, and the logarithm of 19683 is 9. Subtracting the logarithms, $9 - 3 = 6$; the answer therefore to $19683 \div 27$ is $3^6 - 3^3 = 3^9 - 3^3 = 3^6 = 729$, the answer.

These are simple examples of the principle of logarithms.

Common logarithms are, however, calculated to the base 10. It is obvious that in multiplication and division by logarithms the numbers to be multiplied or divided will never be an exact power of 10. If they were logarithms would not be needed, for we should merely add noughts to the multiplicand according to the number of digits in the multiplier. Thus $10,000 \times 100 = 1,000,000$.

So let us make another table of powers of 10.

$1,000,000 = 10^6$
$100,000 = 10^5$
$10,000 = 10^4$
$1,000 = 10^3$
$100 = 10^2$
$10 = 10^1$
$1 = 10^0$

$$1 = \frac{1}{10} = \frac{1}{10^1} = 1^{-1}$$

$$.01 = \frac{1}{100} = \frac{1}{10^2} = 1^{-2}$$

$$.001 = \frac{1}{1,000} = \frac{1}{10^3} = 1^{-3}$$

$$.0001 = \frac{1}{10,000} = \frac{1}{10^4} = 1^{-4}$$

$$.00001 = \frac{1}{100,000} = \frac{1}{10^5} = 1^{-5}$$

$$.000001 = \frac{1}{1,000,000} = \frac{1}{10^6} = 1^{-6}$$

It is obvious that any number between, say, 1,000,000 and 100,000 would have an index or characteristic between 5 and 6, and it is the decimal part of the index for which we require tables of logarithms. This decimal part of the index or characteristic is called the mantissa.

Thus the logarithm of a number consists of two parts—the *index or characteristic*, and the *mantissa*.

Now the characteristic (to "base 10") of any number can quite easily be found by observation.

The characteristic of any number greater than unity is always 1 less than the number of digits in the number.

Thus in the table above:

1,000,000 has 7 digits, and the characteristic is 6				
100,000 has 6	"	"	"	5
10,000 has 5	"	"	"	4
1,000 has 4	"	"	"	3
100 has 3	"	"	"	2
10 has 2	"	"	"	1
1 has 1	"	"	"	0

The characteristic of any number less than unity is greater by one than the number of noughts which follow the decimal point.

The index or characteristic of a number less than unity is negative; this is indicated by placing the negative sign or bar over the figure, as in the table on page 208.

Here are a few examples:

Index or characteristic of	547.062 equals	2
"	47.062	1
"	7.062	0
"	.7062	$\bar{1}$
"	.07062	2
"	.007062	3
"	.0007062	4

The characteristic of 100 is 2, and of .01 is $\bar{2}$. The characteristic of any number over 100 but less than 1,000 will also be 2, plus the mantissa found from a table of logarithms. The characteristics of any decimal from .1 to .9 will always be 1, the characteristic of any decimal from .01 to .09 will be 2, the characteristic of any decimal from .001 to .009 will be 3, and so on.

The numbers, whether whole or decimal, or whether consisting of a whole number and a decimal, are treated as whole numbers for the purpose of extracting the mantissa from the tables.

The Mantissa.

The characteristic of a number which is a decimal only, and has no whole numbers before the decimal point, is always *negative*. The characteristic of a number consisting of whole numbers and a decimal will always be *positive*, and the decimal part in this latter case is ignored when determining the characteristic by inspection. Thus, in the number 4890.375, we ignore the decimal .375, and as the whole number contains 4 digits the characteristic will be 3. We must, however, take into account both the whole number and the decimal when finding the mantissa from the tables. We, in fact, proceed as if the decimal point did not exist.

It is important to remember that the mantissa is always positive; and the mantissa of a number, irrespective of whether it is a decimal, or contains a whole number and a decimal, is the same. For example, the logarithm of 101 is 2.0043; the logarithm of 10.1 is 1.0043, of .101 it is $\bar{1}$.0043, and so on. The logarithm of all numbers from 1 to 9.999 . . . will consist of decimals only. I have not space here to reproduce a complete set of tables of logarithms and antilogarithms, and I would, therefore, recommend the reader to obtain "Workshop Calcula-

tions, Tables and Formulæ" from the publishers of this journal. This volume, now in its seventh edition, contains a clearly printed set of such tables. Some tables of logarithms are calculated to four places of decimals, and these are sufficiently accurate for most purposes. By using such tables we are only able to extract the logarithms of the first four figures of numbers; hence, if we wish to extract the logarithm of 605.125 we must abbreviate the number by the method described in the previous article. In this case we should extract the logarithm of 605.1.

If the number, however, was, say, 605.175 we should (as 7 is more than 5) call it 605.2. Again, if the expression were 605.045 we should write it as 605.1, because by adding 1 to the 4 for the previous figure (5), we obtain 605.05, and again, applying this principle we arrive at 605.1.

Tables.

For the purposes of illustration, I append a small portion of a table of logarithms.

Find the logarithm of 126.5. The characteristic is 2, and we look up the first two figures of the number (12) in the first column of the logarithm. We next run our eye along that line and read beneath the third figure of the number (6), 1004; continuing, under 5 in what is known as the *difference column*, 17. We add 17 to 1004, making 1021, adding the characteristic (2), the log. of 126.5 is 2.1021.

Therefore, 126 equals 10².1021

Find the logarithm of 146.0.	Answer 2.1644,
Find the logarithm of 17.53.	Answer 1.2437.
Find the logarithm of 1.399.	Answer 0.1459.
Find the logarithm of .1621.	Answer $\bar{1}$.2098.
Find the logarithm of .01788.	Answer $\bar{2}$.2524.

The logarithms represent the power to which the base 10 must be raised to produce the number.

This description and these examples are given to indicate how we extract the logarithms of numbers from tables, for the object of carrying out the processes of multiplication, division, involution and evolution, when we have large and unwieldy quantities with which to deal, or when we have a large number of calculations to make. We have seen that in order to multiply in logarithms, we merely add the logarithms.

I will now give some examples: Multiply 165.3 by 144.6.

The logarithm of 165.3 is found to be 2.2183, and the logarithm of 144.6 is 2.1593. Add these together:

2.2183
2.1593
4.3776

We now look up a table of antilogarithms (ignoring the characteristic) and we find that .3776 corresponds to 2385. We now have to fix the position of the decimal point. We have seen that the characteristic is always 1 less than the number of digits. As the characteristic is 4 there will be 5 figures before the decimal point in the answer. Therefore, the answer is 23850.0, which is approximately correct, because if we multiply 165.3 by 144.6 in the ordinary way we shall obtain 23902.38.

(To be continued)

Logarithms

	0	1	2	3	4	5	6	7	8	9	1	2	3	4	5	6	7	8	9
10	0000	0043	0086	0128	0170	0212	0253	0294	0334	0374	4	8	12	17	21	25	29	33	37
11	0414	0453	0492	0531	0569	0607	0645	0682	0719	0755	4	8	11	15	19	23	26	30	34
12	0792	0828	0864	0899	9934	0969	1004	1038	1072	1106	3	7	10	14	17	21	24	28	31
13	1139	1173	1206	1239	1271	1303	1335	1367	1399	1430	3	6	10	13	16	19	23	26	29
14	1461	1492	1523	1553	1584	1614	1644	1673	1703	1732	3	6	9	12	15	18	21	24	27
15	1761	1790	1818	1847	1875	1903	1931	1959	1987	2014	3	6	8	11	14	17	20	22	25
16	2041	2068	2095	2122	2148	2175	2201	2227	2253	2279	3	5	8	11	13	16	18	21	24
17	2304	2330	2355	2380	2405	2430	2455	2480	2504	2529	2	5	7	10	12	15	17	20	22

An Astatic Galvanometer

The Theory of Galvanometers is Discussed in This Article, and Constructional Details are Given of a Cheap but Reliable Instrument

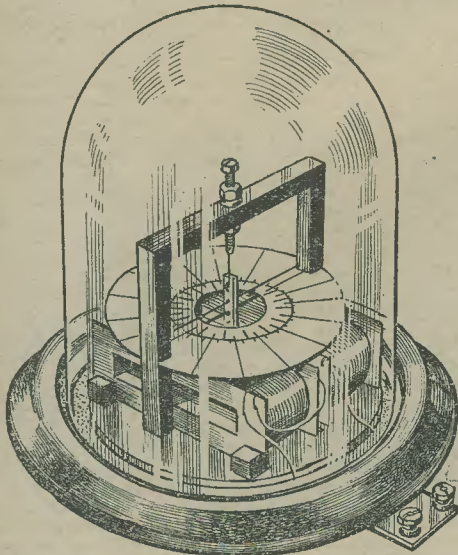

The finished galvanometer.

IN spite of the fact that the galvanometer is still extensively used in numerous branches of electrical engineering, it seems to have been ignored by the average radio enthusiast.

Perhaps this is due to a lack of understanding of the capabilities and numerous uses of this simple instrument, but more probably the real cause is due to a combination of failure to appreciate the galvanometer's usefulness and, shall we say, the lack of constructional details to enable a serviceable instrument to be made at a low cost.

Most good text-books will tell you that "The galvanometer is an instrument by which the presence, direction, and intensity of electrical currents can be determined." The first galvanometer was introduced by a German scientist, named Schweigger, in 1822. Previously, in 1819, a professor of physics, Oersted by name, discovered that electrical currents have a directive action upon the magnetic needle, and that they always tend to set at right angles to their own direction. This statement can

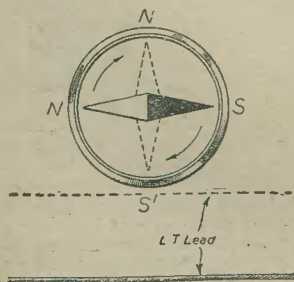

Fig. 1.—Showing how an electric current has a directive effect on a magnetic needle.

be verified in a very simple manner, as shown in Fig. 1. Obtain a small compass and place it near the L.T. battery connected to your receiver, after it is switched on. See that the needle is free to swing in either direction, and then slowly bring one lead from the battery towards the compass, holding the lead parallel to the compass needle. The needle will commence to move as the wire approaches until it is at right angles, although the actual movement will depend on the current flowing and the sensitivity of the compass.

Electro-magnetic Effect

Now see what happens when you bring the other wire over the needle and the first one is taken away. The needle swings in the other direction, which seems to bear out Oersted's claim and, incidentally, reveals an easy method of determining the positive and negative leads. Now place the wire under the compass. It will be found that the deflection is reversed, which tends to prove that the magnetic field produced by the current is round the wire in concentric rings. The whole effect was very nicely summed up by another famous scientist, Amperé, whose statement is to the effect that "in the

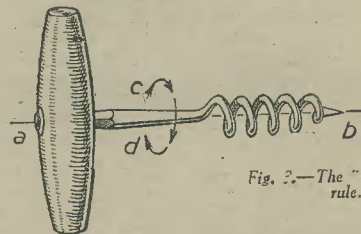

Fig. 2.—The "corkscrew" rule.

directive action of currents on magnets, the north pole is always deflected towards the left of the current."

More comprehensive details of this electro-magnetic effect are obtained from the investigations carried out by Michael Faraday, who determined, by means of iron filings, that the field produced round a straight conductor carrying a current is concentric, as shown by the dotted lines in Fig. 2. It should be noted that paths are complete circles, and can exist without magnetic bodies being present, or, in other words, they are dependent on and accompany a current flowing along a conductor.

It is obvious that this magnetic field thus produced be overlooked, and as practical evidence of this we have only to remember the screening required in certain radio circuits. One other point worth noting is that there is the relation between the direction of the current flow and the direction of the magnetic lines. While these are shown in Fig. 2 by the arrows, it is handy to know some method whereby the relationship is easy to remember. A good example is that known as the "corkscrew" rule.

The Corkscrew Rule

If it is imagined that a line through a right-handed corkscrew, from handle to point, represents the direction of the current, then the direction of rotation of the corkscrew will indicate the direction of the magnetic lines of the field. Fig. 3 shows a right-handed corkscrew. The line a b represents the direction of travel of the current, and the curved line c d the direction of the magnetic lines of force.

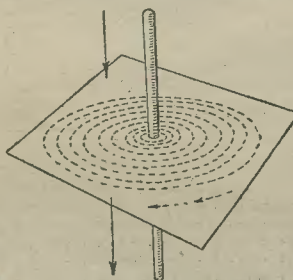

Fig. 2.—Illustrating the lines of force round a current-carrying conductor.

The simple circuit given in Fig. 4 shows a magnetic needle a b suspended by a silken thread c. The path d e f g h represents a single conductor in a vertical plane surrounding a b.

Now if we assume that the current is flowing in the direction of d e f g h, then the magnetic fields produced in each part of the circuit will be such, remembering the corkscrew rule and the compass test, that they all tend to turn the north pole of the needle in the same direction.

If we now replace the single conductor with several turns, insulated from each other, of course, the effective action of the current will be increased or multiplied. In fact, in the early days a galvanometer was often called a multiplier for this reason. This increase will either produce a greater deflection for given current or give the same deflection for a much weaker one.

By virtue of the earth's magnetic effect, the needle is tempted to point along the magnetic meridian, or, in other words, along an imaginary line drawn between the north and south poles. This tendency to point always in one direction is very inconvenient, as it means that the galvo. has to be twisted about each time it is moved, to get the zero mark on the scale to line up with the needle, and, apart from that, it tends to oppose the directive action of the current. This defect has been overcome in many ways.

Counteracting the Earth's Magnetic Effect.

In Fig. 5 it will be seen that two needles are suspended by the thread c, their poles being so arranged that they are opposing each other.

This arrangement is known as an *astatic system*, and it has the effect of reducing the action of the earth's magnetic field. But what happens when the electrical circuit is added?

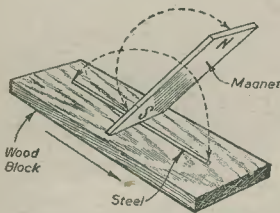

Fig. 6.—The single-stroke method of magnetising a steel needle.

The action on the needle a b will be exactly the same as in the previous case, but the upper needle a' b' will be acted upon by the two contrary currents e f and h g. While the two fields are effective, the nearer one, e f, predominates, and the action is, as follows.

Assume that the circuit tends to turn a b to the west. Well, we know from our compass experiment that a' b', being above the wire e f, should turn in the opposite direction, to the east. That is so, and it would happen, but it must be remembered that the needle a' b' has its poles reversed to those of a b, therefore its movement will be in the same direction.

Construction of an Astatic Galvanometer

It will be advisable to obtain or make the magnetised needles first. These should be 1 1/2 in. in length, and can be made from 1/16 in. wide clock spring, or from 1/16 in. steel rod. A steel darning needle admirably answers the purpose. Make sure that the needle is really made of steel.

Single-stroke Method of Magnetising

The rod, spring strip, or darning needle is laid on a flat wooden surface, and an ordinary bar or

horseshoe magnet, which can be purchased for a few pence, is held in the position shown in Fig. 6.

The magnet is drawn from the centre of the needle to the end, care being taken to remove the magnet at the end of each stroke. Repeat this operation several times in the one direction then, turning the magnet and the needle round, so that the other pole makes contact with the centre of the metal, make the same number of strokes as before.

This will produce a north and south seeking pole at the two ends of the needle, and the effectiveness of the

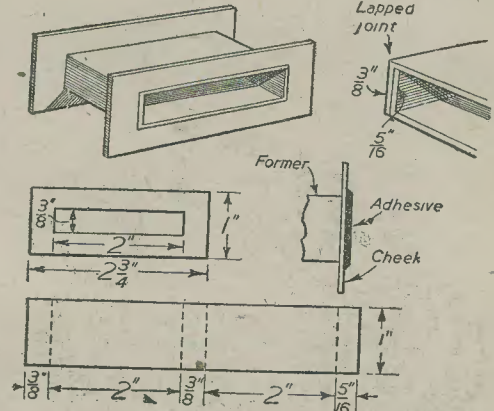

Fig. 7.—Details of the coil formers.

operation can be tested by suspending each needle in turn from a long length of silk thread. If they are magnetised they will, of course, come to rest pointing due north and south, irrespective of how much they are spun.

Coil Formers

The dimensions of these are given in Fig. 7, from which it will be seen that each former consists of three parts—two sides, and a strip for the centre part. The parts are cut from stiff cardboard or, better still, prespahn, about 1/64 in. thick.

Mark out the strip first and, where indicated by the dotted lines, mark the material with a knife, taking care not to cut too deeply. A light cut enables a neat right-angle bend to be obtained, and when the strip has been

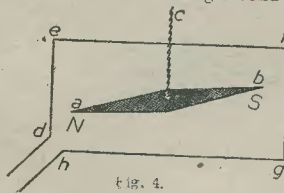

Fig. 4.

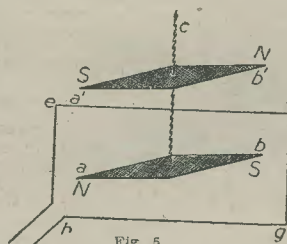

Fig. 5

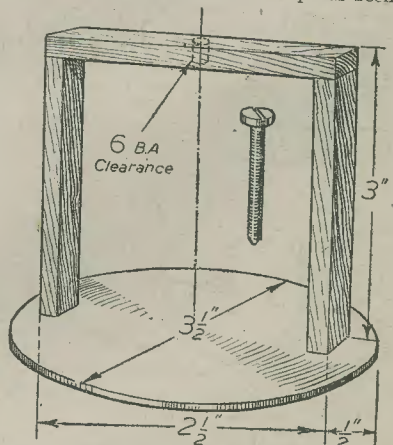

Fig. 8.

Fig. 4.—A magnetic needle suspended in a single coil of wire. Fig. 5.—Two magnetic needles suspended with opposite poles adjacent, and known as the astatic system. Fig. 8.—The galvanometer bridge and base.

folded to the required shape make a good join by coating the overlap with a quick-drying adhesive. While this is setting, cut out the four cheeks or sides, according to the measurements given in the diagram. One point to watch during these operations is when cutting the centre part out cut along the outside of the marked lines, otherwise the formers will not fit.

When the cheeks are ready, the formers can be fitted into the openings; give the edges a thin smear of adhesive, and make sure that the cheeks are square with the former and parallel with the sides. Leave about

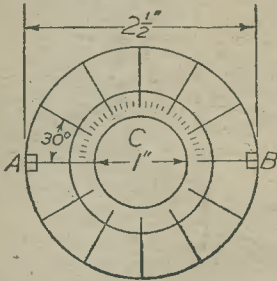

Fig. 9.—How to mark out the scale.

$\frac{1}{32}$ in. of the former projecting through each side, and then run a very small quantity of adhesive right round the narrow ledge, so formed, as shown in diagram. The two formers thus made can now be put to one side to dry and harden, while attention is turned to the needles and their suspension.

Suspending the Needles

The suspension frame is made from $\frac{1}{4}$ in. square beading, and is formed with three pieces cut to the lengths shown in Fig. 8.

See that the ends are square so that a neat flush join is made between the supports and the cross-bar. A hole, large enough to clear a 6 B.A. bolt, is made in the dead centre of the cross-bar. The uprights should be mounted first on the baseboard by means of small panel pins and a touch of adhesive. A small hole must be drilled through each end of the cross-bar to take panel pins for fixing it to the uprights.

The 1-in. 6 B.A. bolt can now be prepared for the suspension adjustment. The end should be filed to form a small hook, as shown in Fig. 8, to enable the silk cord to be held.

The prepared bolt, with a lock-nut fitted, is passed through the hole in the cross-bar, and another nut fitted on the underside.

The pointer should be 2 in. long and as thin and light as possible consistent with the required rigidity. A stiff bristle from a carpet broom answers the purpose very well.

A spot of adhesive should be used to hold the pointer and the needles securely in position once they have been adjusted to secure perfect balance. Remember it is vital that the needles are mounted so that a north and south pole are adjacent, otherwise the benefit of the astatic system will be lost. It will be found that ordinary cotton or silk twist has a marked retarding action on the movement of the magnetic system. The finest thing to use is a human hair, and this is what is employed in the instrument illustrated.

A bakelite or stiff cardboard strip $\frac{1}{4}$ in. wide is the next thing to prepare. The size of the holes will depend on the material used for the needles and the pointer.

The Coils

The actual winding of the coils will depend on the use to which the galvo. is to be put. If it is intended primarily for a voltmeter, the windings will need to be of high resistance, but if, on the other hand, it is to be used as an ammeter or milliammeter, then the windings should be of low resistance. On the coils in question there are wound 2,000 turns of 34 enamelled wire, 1,000 turns on each bobbin.

No special precaution is necessary during the winding, other than keeping the turns on each coil in the same direction and making the layers as even as possible without stretching the wire or letting it get too loose.

Once the bobbins have been wound they can be

mounted on the baseboard, being held in position by a smear of adhesive and tiny wooden blocks fitted to the outside corners.

It is an advantage to have the magnetic system in position before the bobbins are finally secured, as this allows the distance between them to be made as small as possible consistent with free movement of the needle strip.

The end of the winding of one coil can now be connected to the commencement of the other winding, thus leaving two ends which are brought out to two terminals fitted to the end of a suitable terminal strip.

The scale (Fig. 9) can be cut from stiff white cardboard, after it has been marked off in degrees or sections according to requirements. It is mounted on the upper edges of the bobbins, and held in position with a touch of adhesive.

While a galvanometer of this type is primarily intended for comparison readings, it is quite possible to mark off the scale in milliamps. and/or volts, providing some standard is available to enable calibration to be obtained.

With the specified windings, quite a reasonable deflection can be obtained when half a milliamp. is flowing, while a full-scale deflection is given by approximately 6 milliamps. If a low-reading milliammeter is available, this should be connected in series with a 2- or 4-volt battery, a 10,000-ohm variable resistance, and the windings. The resistance should be adjusted until the lowest current is passing which will give a deflection on the galvanometer.

When the needle is perfectly steady the milliammeter reading should be marked on the scale at the point indicated by the pointer. This process is repeated for as many values as possible, and it should be noted that the movement is not directly proportional to the current flowing.

To enable higher readings to be obtained, it must be appreciated that it is not a difficult matter to arrange external resistances so that multiples of the original maximum current can be measured.

Owing to the sensitivity of this instrument it will be found that $1\frac{1}{2}$ volts will give a full scale of deflection, therefore it is not a difficult matter to arrange external resistance in series to enable this to be read as 150 volts.

While the details contained in this article relate to one particular form of galvanometer, which provides a cheap, reliable and useful meter for the radio or electrical enthusiast, it must be appreciated that the fundamental theory can be adapted to suit any specific requirement.

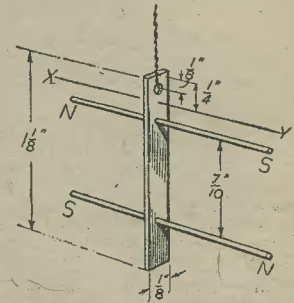

Fig. 10.—Simple suspension frame for the needles and pointer.

MASTERING the MORSE CODE

By the Editor of
PRACTICAL WIRELESS
2nd EDITION

This handbook, written with special regard for service requirements, will enable even the beginner rapidly to become proficient in sending and receiving.

1/-
net

Of all Booksellers, or by post 1/2 from
GEORGE NEWNES, LTD. (Book Dept.),
Tower House, Southampton Street,
London, W.C.2

1/-
net

Planning a Valve Tester

Some Helpful and Practical Advice

By F. PRESTON

IT has become evident from recent correspondence—some of which has been published on the "Open for Discussion" page—that many readers are anxious to make a valve tester. They have asked for constructional details and for general advice on the subject. I do not wish to discourage anyone, but I do feel sure that a large number of the correspondents are not fully aware of the vastness of the task. That is, if the tester is to be a really efficient unit capable of

A Basic Circuit

Fig. 1 shows the basic arrangement, and once this has been grasped it should not be difficult for any reader to plan a test-set suitable for his own needs. The general idea is that provision is made for applying H.T., L.T. and G.B. to a valve, and for measuring the anode current passed by the valve. This is done merely by including a milliammeter in the H.T. positive circuit. The grid bias voltage may be controlled by means of a potentiometer as used for volume control with variable-mu valves. In addition, however, a simple two-way switch is included in the G.B. circuit so that the negative bias can be increased momentarily to the extent of 1.5 volts. By this means some idea of the mutual conductance can be gained very quickly.

Method of Testing

The method of using the arrangement represented by Fig. 1 would be roughly as follows when dealing with, say, a battery L.F. valve. After inserting the valve in the appropriate holder the bias potentiometer would be adjusted to its maximum negative position. Power supplies would then be applied by means of the four-point on-off switch, and the bias potentiometer slowly adjusted until the anode current indicated by the milliammeter was average for the type of valve under test; that would be about 5 mA for the type under discussion. The push-switch would then be depressed so that an extra 1.5 volts bias would be applied. That should result in a reduction of anode current to about 3 mA if the valve is in good condition. The actual reduction to be expected can be obtained very approximately from the makers' data or curves.

The same method would apply when testing any other type of valve, except that the current readings would be different. Thus, in the case of an L.F. pentode as shown in broken lines in Fig. 1, the initial H.T. current could be expected to be in the region of 7.5 mA. The depression of the bias switch would cause the current to fall to about one-half of that figure. It will be understood that accurate figures cannot be given, since they must depend almost entirely on the particular valve under test. In any case they are not very important, since the readings may vary to the extent of 20 per cent. in the case of two valves of the same make

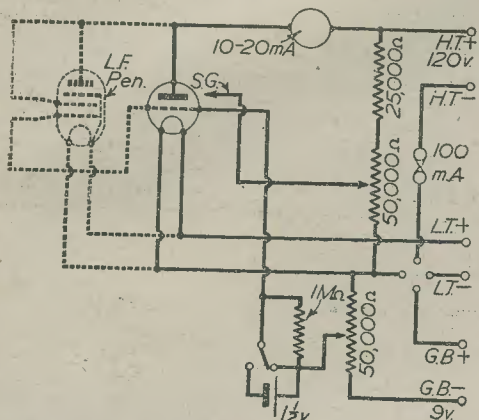

Fig. 1.—Basic circuit for a simple tester for battery valves. Insets A and B show valve-base connections (under side of holder) for a five-pin pentode and a four-pin triode.

dealing with each and every type of valve, and of giving reasonably direct readings of mutual conductance.

Valve Types

Please understand that I am not trying to side-step when not giving all details in this article. A complete tester of the type referred to above would be costly in parts (if all the parts could be obtained) and could not be used to the full by more than a small percentage of readers. It is, therefore, proposed to outline the main requirements of a fairly simple and effective type of instrument, so that individual readers will have sufficient guidance for the design and construction of a unit to suit their own needs. The principle is the same in all cases, but there is not much purpose in fitting the tester with four-pin, five-pin, seven-pin, nine-pin, octal-base, side-contact, American UX four-, five- and six-pin, and octal valve-holders—and possibly many others besides—if it will be required only to deal with about half a dozen types of battery valve.

The experimenter who uses battery receivers working from a 2-volt L.T. supply can do all he needs in the way of valve testing if he makes a unit having about six valve-holders; three of these would be seven-pin types for frequency-changers, class B valves and pentodes, while the other three would be four- or five-pin holders for triodes and five-pin pentodes. It would not be difficult to modify the general arrangement for use with 1.4-volt valves fitted with octal bases, or for use with indirectly-heated valves.

Centre Terminal

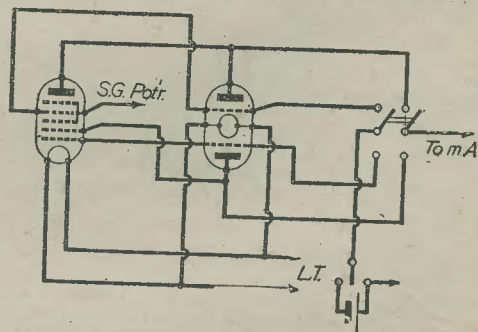
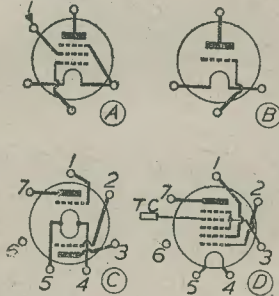

Fig. 2.—Method of providing connections for a pentagrid (or triode hexode) and for a Class B valve. Connections to seven-pin holders are also indicated in the inset diagrams, C and D.

and type, both of which are in good condition. The main point to notice is that if the valve is in normal condition depression of the switch should cause the H.T. current to fall.

If readings were taken when the valves were new, or known to be in good condition, it would be an easy matter to make future checks by noting any falling-off in anode current or any reduction in the difference in

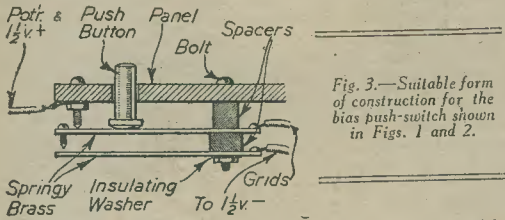

Fig. 3.—Suitable form of construction for the bias push-switch shown in Figs. 1 and 2.

anode current shown in the two positions of the bias push-switch.

Circuit Details

It may be worth while to explain the circuit shown in Fig. 1 in some detail, so that the reader may fully understand the requirements. In the first place, the four-point on-off switch—or a three-point and single-pole switch ganged together—is necessary so that there shall be no drain of H.T. and G.B. through the two potentiometers when the tester is switched off. The purpose of the 1 megohm resistor between two contacts of the bias push-switch may not be clear; it is to prevent the complete breakage of the grid-bias circuit when the moving contact is between its two positions. If the bias circuit were broken there would be a heavy surge of anode current, which would tend to damage the valve.

The 25,000-ohm resistor in series with the screening-grid potentiometer is to prevent the application of an excessive screen voltage, since that would tend to confuse the user as far as the H.T.-current indication is concerned. The holder for a four-pin H.F. pentode or screen-grid valve would be wired in parallel with that for triodes, but of course the main H.T. lead for the anode would be taken to a top-cap connector, while the lead from the potentiometer would be taken to the "anode" socket.

A Suitable Meter

A little difficulty is provided by the milliammeter. For all except fairly large power valves a full-scale reading of 10 milliamps would be adequate. For large power valves, however, it would be necessary for the meter to read up to 15 or 20 milliamps. This problem could be solved by using a meter designed for 10 mA maximum, but with a shunt in series with a switch for doubling the scale readings. It would be better still to have a meter reading up to a maximum of 5 mA, and provided with two switched shunts for doubling and quadrupling the readings. Those who have a multi-range meter can simplify the matter very easily by providing a two-pin socket into which the external meter can be plugged.

Testing "Double" Valves

Fig. 2 shows the method of dealing with frequency-changers and class B valves. In these cases there are, in effect, two valves in each envelope, both of which have to be tested. This question is dealt with by having a two-pole change-over switch. In one position of the switch one triode of the class B valve and the pentode or hexode section of the frequency-changer is tested; in the second position it is the other triode of the class B and the triode section of the frequency-changer which is tested. In making the complete tester all filament, grid, screening-grid and anode connections for all valveholders are wired in parallel, the two sub-circuits of Figs. 1 and 2 being combined. Any additional valveholders required can be added by following the same system.

Two Home-made Components

Now for a few practical details. The push-switch for the bias circuit can be made as shown in Fig. 3. The upper contact tongue is made so that it normally maintains contact with screw fitted through the panel. When the button is depressed this tongue is pressed downward so that the small screw attached to the end makes contact with the lower brass strip. Both brass strips are attached to the panel by means of a long 4 BA. bolt, fitted with wooden or ebonite spacing washers. The holes through the strips should be a good deal larger in diameter than the diameter of the bolt, so that they are not short-circuited by the bolt itself.

The most convenient arrangement for the 1½-volt extra-bias cell is probably that shown in Fig. 4, where an ordinary torch cell is mounted between two springy-brass clips shaped as shown. As an alternative, a small bias battery with wander plugs could be used, but this is wasteful of batteries.

H.T. and G.B. Calibration

It is desirable to make scales for the two potentiometers. These can be formed from cardboard discs, which can be marked off from zero to 10 in ink and then given a coat of shellac varnish. If a high-resistance voltmeter is available it would be better still to mark off the scales in voltages, making sure in the first place that the H.T. and G.B. batteries are up to 120 and 9 volts respectively. The calibration will not be accurate to 100 per cent., but it will be near enough for all practical purposes.

The tester can be made on an ebonite, paxolin or shellaced plywood panel cut to fit any available shallow

Fig. 4.—A simple method of mounting a 1½-volt "extra bias" cell.

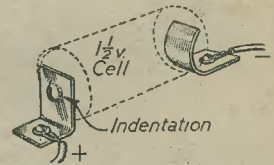

box. It will not be worth while to use special batteries for the tester, so terminals or leads should be fitted for connection to the batteries normally used with the receiver. Before tests are carried out, see that the accumulator is well "up," and if the H.T. voltage is below the rated figure, make the necessary small allowance for this.

Modifications

In making a tester for mains valves the same general principles would apply, but it would generally be considered desirable to include a power pack in the unit, and possibly to use automatic bias. Since the required bias voltage would vary over a wide range it would be best to have a series of fixed resistors, each of which could be brought into the common cathode circuit by means of a rotary switch, and also a variable resistor of about 500 ohms in series with the resistor in use. The rotary switch should be of such a type that the rotary arm may touch two contacts at the same time; this is to ensure that the bias circuit is never broken. As with the battery version, always start with maximum bias and gradually reduce it until a suitable H.T.-current reading is obtained. It would still be desirable to retain the 1½-volt cell and the push-switch.

ELECTRONIC VIEW-FINDER

A NEW American idea for simplifying the job of the television cameraman is an electronic view-finder. This new view-finder replaces the old optical finder, and reproduces exactly the image being picked up by the television camera. The image is supplied by a 5in. cathode-ray tube operated by an independent power supply unit. The image on the screen is shielded from the effects of stray light by means of an eye shield.

Practical Hints

Small Cut-out Switch as "Fuse"

THE accompanying sketches show the construction of a small cut-out switch which I have been using as a "fuse."

When current passes through the coil, it attracts the armature and releases the contacts, thus breaking the circuit. By adjusting the spring, the switch can be made to drop out on any current from about $\frac{1}{2}$ to 5 amps. I find this device is very successful, and it prevents the trouble of replacing fuses, as the switch can be reset by simply pressing the button (made from a piece of ebonite rod). The contacts were taken from an old multiple switch, which I found in my spares box.—E. D. GROOM (Palmer Green).

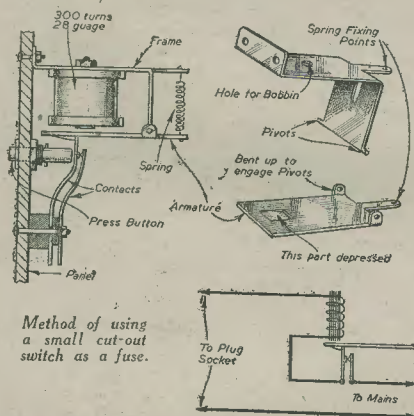

Method of using a small cut-out switch as a fuse.

Improving Faulty Contact

RECENTLY I was called upon to service an A.C. mains receiver which had developed instability. There was loud motor-boating and I subsequently traced this to an electrolytic condenser, the casing of which was not making contact with the metal chassis.

The strange part about it was that the component was perfectly tight, and could not be twisted, although a good pressure on top was sufficient to make contact. The set then became normal. Actually, to effect temporary repair I wedged a piece of lead foil between the bevel of the casing and the chassis, as shown. It has not been possible yet for me to make a thorough inspection, but it seems to me that some corrosion had set in, which whilst effectively fixing the condenser to the chassis it at the same time insulated it.—R. L. GRAPER (Chelmsford).

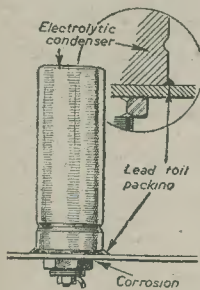

How to obviate faulty connections.

A Simple Potentiometer

OWING to the shortage of components I was unable to obtain a potentiometer for the set I was making at the time, so I made one of a fairly low resistance, which I have used quite successfully.

The main features of it are the ebonite base, the two rigid brackets, and the sliding clip on a strip of pen-

THAT DODGE OF YOURS!

Every Reader of "PRACTICAL WIRELESS" must have originated some little dodge which would interest other readers. Why not pass it on to us? We pay £1-10-0 for the best hint submitted, and for every other item published on this page we will pay half-a-guinea. Turn that idea of yours to account by sending it in to us addressed to the Editor, "PRACTICAL WIRELESS," George Newnes, Ltd., Tower House, Southampton Street, Strand, W.C.2. Put your name and address on every item. Please note that every notion sent in must be original. Mark envelopes "Practical Hints." DO NOT enclose queries with your hints.

SPECIAL NOTICE

All hints must be accompanied by the coupon cut from page 224.

cil lead. It is important that the brackets are tight fitting to ensure good contact on the pencil lead strip, and it is advisable to fit a piece of thin sheet copper to form the sliding clip to avoid scoring the pencil lead. The value of the potentiometer can

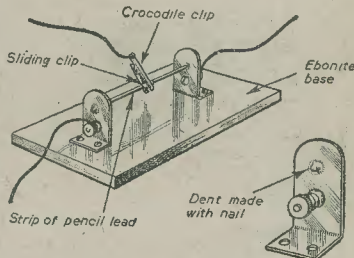

A hook-up which acts as a simple potentiometer.

be altered by using a pencil lead of different thickness.—G. BAGLEY (Ironbridge).

Mounting Small Coils

I RECENTLY built a set incorporating home-made coils, and I used the following method of mounting the coils. Empty glass phials with screw-on caps were used as formers, the caps being pierced and screwed to the baseboard, as shown in the accompanying sketch. A piece of narrow adhesive tape is bound round the starting and finishing ends of the coil to hold the free ends of the wire in place. The idea is also suitable for coils which are to be fitted temporarily.—E. SIMPSON (Wilford).

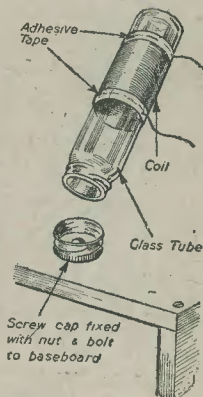

Simple and effective method of mounting a coil.

ITEMS OF INTEREST

The Bomtecta

THE firm of Philco Radio have produced an automatic device for the detection of fire bombs, which they have called the "Bomtecta." It gives immediate warning of an incident in any building wired with the special Detector-Conductor. The warning is caused by the entry of the bomb itself—not by the heat or light subsequently generated; thus, the "Bomtecta" gives the earliest possible alarm. It can be installed by the average handyman, and is so constructed that any defect in the installation is automatically indicated. It is suitable for private houses, shops, factories, office buildings, hotels—in fact, almost every building in areas likely to be subjected to fire raids.

Alvar Lidell Singing It!

ALVAR LIDELL, well known as one of the news announcers on the staff of the B.B.C., recently made his first recording as a singer for His Master's Voice. He has quite a pleasing baritone voice and has recorded "Passing By" and "I'll Walk Beside You." Before he joined the B.B.C., in 1932, he was a schoolmaster and already a good amateur singer. He was born in 1908, educated at Exeter College, Oxford, and speaks both French and Swedish fluently.

THE mains transformer mentioned last month was found to be quite satisfactory when put on test with the Westinghouse H.T.14 and L.T.7 metal rectifiers. The D.C. output was in keeping with the makers' figures; after a hook-up test, the work of assembling the complete pack was started, and although the original idea for the layout had to be modified—owing to the component supply problem—I am well pleased with results.

The basic circuits were taken from the Westinghouse booklet, "The All-metal Way," and Fig. 1 shows the H.T. section as recommended by the makers. The H.T.14 unit is used in a full-wave voltage-doubler arrangement; with an A.C. input of 80 volts and condensers of 4 mfd. capacity, a D.C. output of 120 volts at 20 mA. is obtained. Bearing in mind the estimated use of four valves in the completed Rx, this will be ample for the 2-volt valves selected. Particular attention should be given to the recommended decoupling arrangements, and although those shown are adequate, in fact, generous, for the normal M/L wave receivers, it was in this respect that I decided to make some modifications.

Eliminating Hum

A short-wave receiver is more sensitive (or susceptible) to hum trouble than its M/L wave counterpart, and one cannot be too careful guarding against this annoying form of interference. In many instances, I have found that hum has been introduced into the receiver by radiation from the mains transformer. Placing the offending eliminator in an earthed metal case; keeping it more remote from the receiver—especially the aerial and earth leads—and seeing that the phone or speaker leads do not pass close to mains supply wiring, usually rectifies the trouble. Other S.W. friends of mine who have had their reception spoilt when replacing their H.T. batteries with an A.C. eliminator, have not overcome the trouble so easily; in such cases, it has been a question of adding more smoothing and decoupling circuits, or, as in one particularly stubborn example I came across, tightening up the clamping bolts of the mains transformer and smoothing choke to prevent the laminations from vibrating. The quality of the mains supply varies greatly in different districts; in some areas it is rough and appears to be loaded fully with all forms of interference,

Notes from an Amateur

The Power Pack, Consisting of H.T. Eliminator and L.T. Trickle Charger is Described This Month

(smoothing) condensers of unequal capacity might also be responsible for hum.

The modified eliminator is shown in Fig. 2. The supply for the output stage is taken straight from the set side of the smoothing choke; this is quite satisfactory, as the anode circuit of this valve is provided with its own decoupling by the choke-filter output system, and it seems that the trouble is most likely to manifest itself in those stages having a high gain. The H.F. stage is fed through a resistor of 5,000 ohms which is decoupled

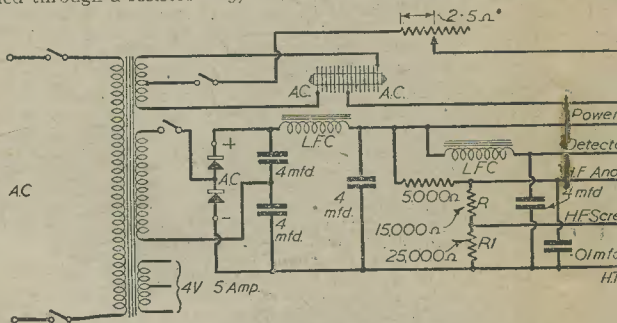

Fig. 3.—The complete circuit of H.T. eliminator and L.T. trickle charger. The switching in the secondaries is optional. The condenser filter across the primary is shown in the wiring plan.

by a 0.01 mfd. condenser. The total H.T. voltage available prevents a resistor of higher value being used; the low value of capacity is quite in order owing to the fact that its reactance is reasonably low at high frequencies. The screen of the valve is fed from the potentiometer formed by the resistors R and R1, the decoupling condenser is not shown on the diagram, as it is incorporated in the H.F. unit.

The potentiometer method is best in this instance, as the current drain is small, and, if an ordinary series resistor had been used, there would be the possibility of large voltage fluctuations as the current is varying almost continuously. Speaking in a general sense, it is not satisfactory to use a potentiometer across the output of the eliminator to obtain two or three different voltages, due to the resistance being common to the supplies, thus increasing the danger of feed-back and instability.

Detector Feed

The anode circuit of this valve includes the load resistor for the resistance-capacity coupling to the next valve, therefore the question of available voltage again arises, although, as it is the detector stage, it is essential to provide adequate decoupling. High value resistors for this purpose are ruled out, so the only alternative was to use an L.F. choke having a high inductance and a low resistance value. I was unable to get a component having a resistance of, say, 400 or 600 ohms, so I have been forced to use one of 1,000 ohms. However, the detector valve in use operates satisfactorily, reaction is smooth and effective on all bands, so I shall let well alone.

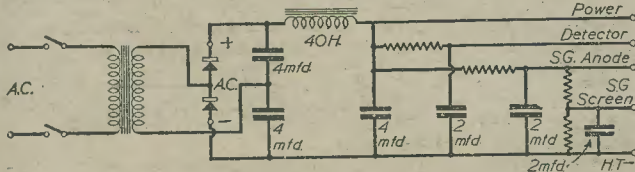

Fig. 1.—The basic eliminator circuit for an average 3-valve set, recommended by the makers of the rectifiers.

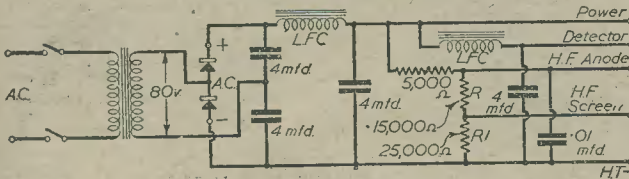

Fig. 2.—After making the modifications mentioned in the text. Note the additional L.F. choke.

whereas in other sections the minimum of smoothing is called for. The use of two fixed condensers—connected in series—across the primary, and having their junction point earthed, as shown in the plan, helps to reduce mains-borne interference. Speaking of condensers, it should be remembered that reservoir

Amateur's Log-book

Eliminator and L.T. Charger, made by 2CHW Completed This Month

The main smoothing is carried out by a large L.F. choke, of unknown make and value, but judging by the size of its core and the gauge of wire used for the winding, I should imagine its inductance to be in the region of 35 to 40 henries and originally designed for a current of something in the neighbourhood of 120 mA.s. The inductance value is required, but its current-carrying capacity is far in excess of that needed for the H.T.14.

The L.T. Charger

The circuit shown in Fig. 3 is that of the complete H.T. and L.T. charger unit, the latter having an output suitable for the charging of a 2-volt cell at 0.5 amps. The A.C. input is 4-0-4 volts, and the secondary which provides this is on the same mains transformer which feeds the H.T.14.

There is little that can be said about this part of the unit, except to stress the need for the resistance in the positive lead. It is possible to see many circuits in which a resistor is not incorporated on the D.C. side, but this does not alter the fact that it is very essential. For example, it provides the means whereby the charging current is controlled; it limits the current in the event of the accumulator being connected the wrong way round, i.e., reversed polarity, and it swamps any current variation which will be produced by any fluctuation in the A.C. voltage.

Switching

In the primary circuit, a double-pole on-off

switch is included, thus making quite sure that the circuit is dead when the switch is off. This may seem a small item, but, personally, after having made so many circuits between one side of the mains and earth with my body, I now take the precaution of cutting both sides of the supply.

A double-throw double-pole is used to break and make the two secondaries. When the H.T. unit is in use it is not likely that the charger will be required, and vice-versa, therefore the switch is so connected that the circuit of the L.T. charger is broken and the secondary of the H.T. section made when the switch is in one position. A flick of the switch and the order is reversed, the H.T. eliminator being put out of circuit and the L.T. charger brought in.

Constructing the Pack

The plan wiring and component layout diagram shows all the connections and how the components are located with respect to each other. This may have to be modified to suit such components, as

are obtained, but if the Westinghouse rectifiers H.T.14 and L.T.7 are used then the wiring should be adhered to. Although I have not yet been able to do it, I intend making a metal cover to fit over the unit. If it is connected to earth (as it should be) it forms a safety cover against electrical shocks, and an effective screen to prevent any A.C. radiation interfering with the receiver.

Had it been possible to obtain one's choice of components, the unit would have been much more compact. For example, the filter smoothing choke is about twice the size of a modern one; the mains transformer is also much larger than the rectifier's requirements necessitate and, finally, had an electrolytic condenser block been used in place of the three 4 mfd. condensers, much space would have been saved and neater wiring would have been possible. Still, we can't worry about little things like these during war-time.

Locating the Unit

To keep the unit away from the set, I made a small wooden shelf which, with the aid of two brackets, was fitted in line with the top of the skirting-board, just inside the rear right leg of the table. This means that the leads to the set are about 3ft. in length; for these I used some heavy flex, which offers no appreciable resistance and, by bunching the H.T. leads together and binding them with a loop of thread every 6ins., made them into a neat supply cord.

The L.T. accumulator stands on the same shelf and its terminals are connected to a rotary double-pole double-throw switch which is fixed to the front edge of the shelf. One side of this switch is connected to the L.T. leads from the set, and the other side is taken to the output from the L.T. charger in the mains unit. This arrangement allows the accumulator to be changed over from set to charger, i.e., when it is not wanted to supply the set it is switched over to the charger for charging. It works out approximately correct to give the same period of time on charge as on discharge.

WIRING DIAGRAM OF COMPLETE UNIT

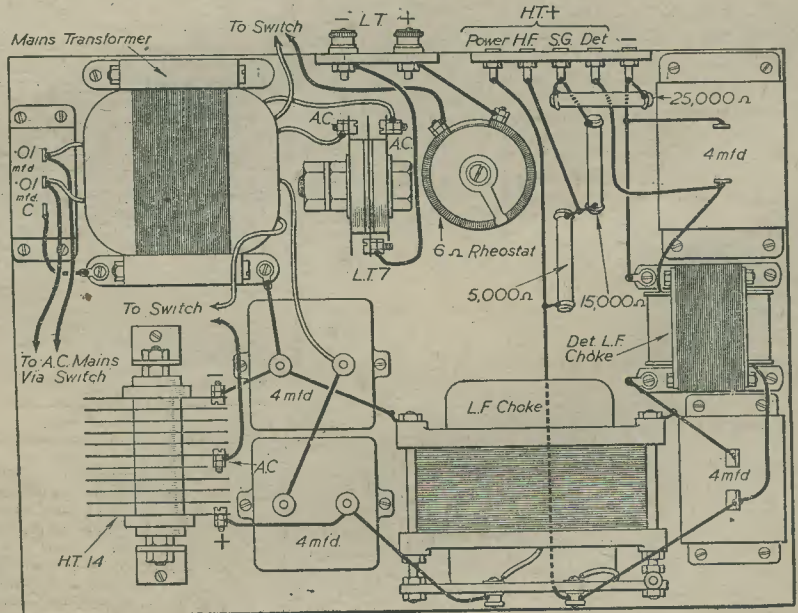

Radio Examination Papers—5

Further Selected Questions, With Answers Supplied by the Experimenters

1.—C.-R. Tuning Indicators

THE usual type of cathode ray tuning indicator, often described as a "magic eye," consists of a miniature form of simplified cathode-ray tube and a triode amplifying valve, the latter having variable-mu characteristics.

From Fig. 1 it may be seen how the electrodes are connected. The grid of the triode amplifier is connected to the A.V.C. line so that it receives the same negative potentials from the diode detector or second detector as do the controlled H.F. stages. A high resistance is included in the anode circuit of the triode, and the anode is internally connected to a control electrode. The target or target anode is connected to the high-potential side of the anode resistance.

The target is coated with fluorescent material, and, therefore, glows when struck by an electron beam. This beam is provided by the cathode, which serves for both sections of the valve. If there were no current flowing through the valve, due to the control grid being very heavily biased, there would be a substantial flow to the target, since the control grid would be at the same potential as the target, due to the fact that there would be no voltage drop across

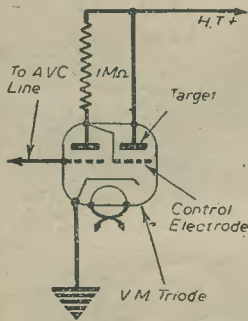

Fig. 1.—Diagrammatic connections of a cathode-ray tuning indicator

increase in signal strength. In practice the control electrode is so constructed that a "shadow" of some convenient shape is cast on the target by the control electrode; the width of this shadow is reduced as the control grid becomes more negative in respect of the target, and, therefore, as the accurate tuning point is reached. Hence, the tuning indicator shows when the set is accurately tuned to a signal, because the "shadow" is of minimum size and the illuminated portion attains a maximum size.

2.—Fading.

There are two components of a radiated signal: one follows the earth's surface and is known as

the ground wave or ray; the other is projected upward into space, and is known as the upward wave or ray. It has been established that there are various layers of ionised gases at varying heights of several miles above the earth's surface, and these have been proved to act as reflectors of radio waves.

On long waves reflection is poor, whilst absorption of the ground wave is comparatively slight. On short waves reflection is good, but the ground wave is rapidly absorbed or lost. Now, the reflecting layers of gases are not smooth like the surface of a mirror, but may be described as wavy. In addition, they are constantly moving. For this reason, reflection of the upward wave or ray is not uniform; it is due to this that fading or constant variation in signal strength is more marked on short waves.

Since long waves are not reflected to any appreciable extent, their transmission is not dependent upon the ionised layers and therefore they remain of sensibly constant strength at any given point.

"Skip-distance effect" is the name given to an effect the result of which is to cause short-wave signals to be practically inaudible a few miles from the transmitter while they can be received at good strength at greater distances. At a few miles from the transmitter the ground wave has been completely absorbed and the reflected wave has not returned to the ground. This is largely due to the fact that waves striking the reflecting layers at an angle greater than a certain critical figure (dependent upon the actual wavelength or frequency

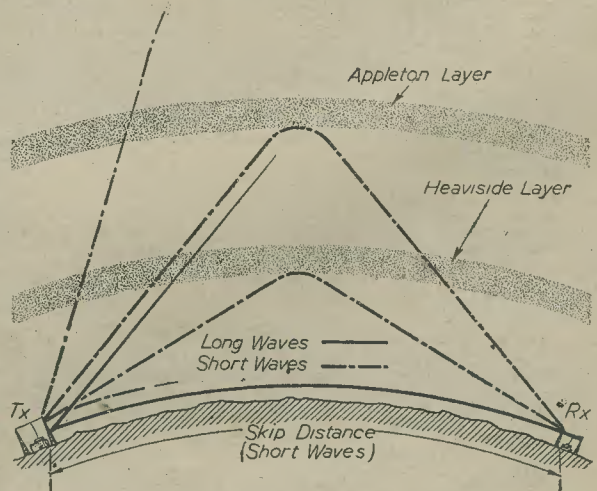

Fig. 2.—This diagram gives an impression of the "routes" taken by the upward and ground rays on short and long waves.

SPE CIMEN QUESTIONS.

- 1.—Explain the operation of a cathode-ray tuning indicator.
- 2.—Why is fading more pronounced on short waves than on long waves; and what is meant by "skip-distance effect"?
- 3.—Briefly describe the action of a lead-acid accumulator during charge and discharge.
- 4.—What is the purpose and principle of operation of a neon stabiliser in a high-tension supply circuit?
- 5.—Describe the difference in construction between an electrolytic and a paper-dielectric condenser.
- 6.—What is meant by the voltage amplification factor, or voltage gain, of an R.C.C. amplifier? Explain how it is determined and find the voltage gain in a stage where the valve has an amplification factor of 30 and an internal resistance of 20,000 ohms when the anode resistor has a value of 30,000 ohms.

employed) are not reflected, but pass through the layers and do not return to the earth's surface. Fig. 2 illustrates the above explanation.

3.—Accumulator Action

Lead-acid accumulators (which are the type most commonly used in radio work) have plates of lead immersed in diluted sulphuric acid. Actually, it is not quite correct to describe the plates as being made of lead, since they are made in the form of lead grids. The holes in the grids are filled with paste; the paste is made from red lead for the positives, and lead monoxide—commonly known as litharge—for the negatives.

In each case the paste is made up by mixing the oxide with sulphuric acid; strong acid is used for the red lead and very dilute acid for the litharge. When the accumulator is given its initial charge the red lead changes to lead peroxide and the litharge to spongy lead.

During discharge the chemical action is such that some of the sulphate from the acid combines with the lead and lead peroxide of the plates to form lead sulphate. At the same time oxygen from the lead peroxide forms a certain amount of water in combination with hydrogen from the acid. Because of this water formation, the acid undergoes dilution.

On subsequent charging, this chemical action is reversed, the positive plate changing back to lead peroxide, and the negative to spongy lead. The water previously formed again breaks up so that the specific gravity of the acid increases to its former value.

It will be clear from the above explanation why the state of charge of an accumulator can be determined by measuring the specific gravity of the electrolyte.

4.—Neon Stabilisers

Neon stabilisers are often used across the output leads from an H.T. eliminator whose voltage should remain constant irrespective of changes of load, or current. Thus a stabiliser of this type is desirable when feeding a receiver having a Class B or Q.P.P. output stage, or when there are two or more variable- μ stages.

The connections for a neon stabiliser are shown diagrammatically in Fig. 3, where it may be seen that the stabiliser is on the "receiver" side of the smoothing choke. A specially designed neon tube is used, and this has the property of failing to "strike" until the voltage between its electrodes reaches a certain critical figure. After it has "struck" the current which it passes increases in proportion to the voltage applied to it. In other words, its resistance falls as the applied voltage is increased.

Because of these properties, the neon tube stabilises the voltage, providing an increased load should the voltage tend to rise, and a reduced load if the voltage should tend to fall. As a result, the voltage is maintained at a reasonably uniform figure.

For correct operation it is necessary that the total D.C. resistance between the rectifier and the neon should be of a particular value. It is for this reason that it is often necessary to include the resistor marked R in Fig. 3. The combined resistance of this and the smoothing choke should be equal to the value required by the stabiliser used; a fairly usual value is 1,800 ohms.

5.—Electrolytic and Paper Condensers

A paper-dielectric condenser consists essentially of two strips of tinfoil with a strip of waxed paper "sandwiched" between them. Leads are taken from the two foils and connected to suitable terminals, after the whole "sandwich" has been rolled up to fit into a suitable insulating case. Sometimes metal is sprayed on to two sides of the waxed paper to replace the foil, so that the condenser may be of more compact form.

In an electrolytic condenser the electrodes consist of thin sheets of aluminium foil, one of which—that connected to the positive point of the circuit—is coated with a very thin film of aluminium oxide. Since it is this insulating oxide which serves as the dielectric, it

will be seen that the plates can be placed considerably closer together than when waxed paper is used. In consequence of this, an electrolytic condenser of any given voltage-rating and capacity is often smaller than a corresponding paper-dielectric condenser. This is especially marked where the condenser is required only for low-voltage working.

The oxide is deposited on the positive electrode by immersing both electrodes in a bath of sodium phosphate or sodium borate and connecting them to a supply voltage. In practice, some of the electrolyte mentioned is often placed in the condenser case, so that the oxide film is always maintained, and so that it may re-form if damaged due to slight overload or temporary reversal of polarity. This type is known as a wet electrolytic, and can usually be recognised by the presence of vent holes, and instructions that it should be mounted vertically. The electrolyte is not in the form of a free liquid, but is absorbed in fabric or prepared paper.

6.—Voltage Amplification Factor

The voltage gain or voltage amplification factor of an amplifier stage is often confused with the amplification factor of the valve used in that stage. It differs from the latter in that the value of the anode load is taken into account. As a result, the V.A.F. must be practised always be less than the valve amplification factor (μ).

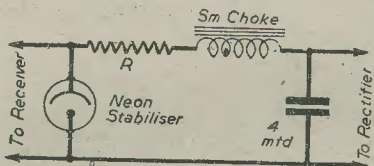

Fig. 3.—Connections for a neon stabiliser used to maintain a constant H.T. voltage over a wide range of current variations.

The voltage gain is found from the formula

$$V.G. = \frac{\mu R}{R + R_a}$$

where R is the impedance in ohms of the anode load and R_a is the internal impedance of the valve.

It should be appreciated that voltage gain is not the same as stage gain, the calculation of which takes into account the efficiency of the form of coupling used between the stage in question and that following it. In the case of an R.C.C. stage losses occur due to the fact that the anode resistor and grid leak together form a potentiometer, whilst the grid condenser offers a certain impedance.

Using the formula given above, we can easily calculate the voltage gain in the valve stage described in the question. We know that μ is 30, that R is 30,000 ohms, and that R_a is 20,000 ohms. Thus,

$$V.G. = \frac{30 \times 30,000}{30,000 + 20,000} = \frac{900,000}{50,000} = \frac{90}{5} = 18$$

This shows that the voltage gain is appreciably less than the amplification factor of the valve, and also that it can be increased by increasing the value of the anode load. In practice it is usual to make the anode load between two and four times the internal impedance of the valve.

TWO NEW VEST-POCKET BOOKS!

WIRE AND WIRE GAUGES

By F. J. CAMM

3/6 or by post 3/9

**NEWNES ENGINEER'S
VEST-POCKET BOOK!**

By F. J. CAMM

7/6 or by post 8/-

Obtainable from all booksellers, or by post from
George Newnes, Ltd. (Book Dept.), Tower
House, Southampton Street, London, W.C.2

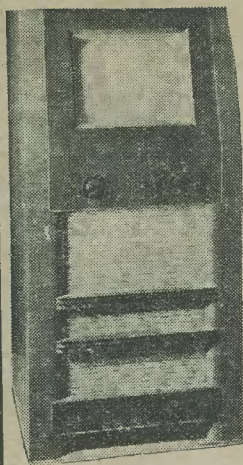

BAIRD MODEL 26 BRAND NEW TELEVISION RECEIVERS

HERE is an excellent war-time opportunity! Invest now for the future. Every receiver is in perfect working order. Cabinet dimensions 3ft. 4in. high, 20in. wide, 17in. deep. Picture screen size 10in. by 8in. Pick-up sockets are fitted enabling it to be used as a Gramophone Amplifier. Extra loudspeaker sockets. 14 valves.

Simple to operate. Only two main controls; one for picture contrast and the other for sound broadcast. The Vision and one V.F. stage with secondary emission valves.

Carriage **£38.10.0** extra.

A few spare Model 26 Cabinets. Brand new **£4.10.0**, carriage extra.

TRANSFORMERS

Made by Standard Telephones. Beautiful job, weight 12lb., 5in. by 4in. 350-0-350 v., 120 m.a. Four tappings giving 4 v., 2 amps., 4 v., 8 amps., 3 v., 8 amps., and 20 v., 1 amp. Brand new, 25/- each, carriage forward. Ex-Television manufacturer. Heavy duty mains transformer. Input 240 v. A.C. Tappings at 5,000 v. 5-8 milliamps. and for supplying filament of Mullard HVR 2 (6.3 v. at 65 amps.). Shrouded in metal box, 10/6 each, carriage forward.

R.A.F. EARPHONES

Single earphones, resistance 750 ohms D.C. approx., 4/- each, ex-Government; low-resistance single earphones, 2/6 each; microphone buttons, well-known make, 2/- each; heavy duty double button carbon microphones, chromium plated case, gold plated electrodes, high output, good quality, with mounting clips and springs, complete with transformer, 23/6.

SLIDING RESISTANCES

Suitable for dimming, etc., carries 600 watts at 230 volts. Size 1 1/2 in. x 4 1/2 in. x 3 1/2 in. Fully enclosed in strong metal ventilated case. Price 50/- each.

SCREENED CABLE

Finest quality, ex important television manufacturer. Brand new, highly insulated single flex, 1.9 yard. Four-way flex 2/3 yard. Minimum, 12 yd. lengths.

PLEASE NOTE

Write your name and address in Block Capitals. You should order only from current advertisement, as many lines soon go out of stock. No orders can be sent C.O.D. Orders cannot be accepted from Eire or Northern Ireland. Postage must be included with all orders.

See also our classified advertisement on page 240.

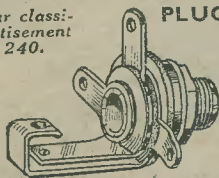

PLUGS AND JACKS

Useful to experimenters. Brand new, exactly as illustrated, 4/- complete. Plugs only, available at 2/- each.

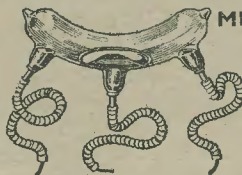
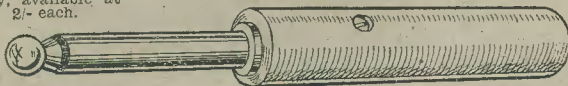

MERCURY SWITCHES

Brand new finest mercury switches. Many hundreds of useful applications. Quick make and break will carry 5 amps. Small quantity to clear at low price of **8/6**.

MOVING COIL MICROPHONES

Heavy nickel plated mics. First quality job—a really high class instrument. Few only to clear. 25 ohms impedance. **£4 5s. 0d.** each.

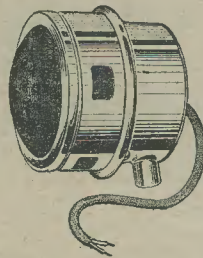

MILNES H.T. UNITS

We have a few of these famous MINOR units to clear at the low price of 45/- each. A sound bargain. Callers only.

WESTINGHOUSE RECTIFIER UNIT

Here is a very fine job. Seldom available. 6-8 v. D.C. output at 32 amps., input 200-250 A.C., 50 cycle, size 22in. x 15in. x 17in. approx., three only. Each **£30**.

ROTARY CONVERTORS

We have been fortunate in obtaining a few brand-new convertors, made by the Carter Motor Company of Chicago. Input D.C. 220 volts 1.8 amps. Speed 1,800 giving 110 volt output, 1.8 amps., 2 KVA. Complete with leads, plugs and sockets. Black crystalline finish on solid base ready for screwing down. Price, **£18 10s. 0d.** each.

D.C./A.C. CONVERTORS

Here is another remarkable offer. First-class convertors 220v. D.C. input, 220 v. A.C. output 100 watts. Enclosed in steel box, complete with suppressors, etc. Few only available, price **£15** each.

BATTERY CHARGERS, 6 VOLT

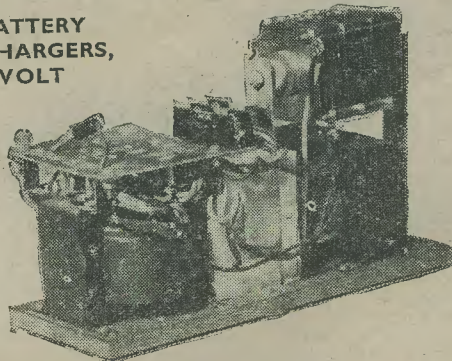

A new delivery of well-made heavy duty battery chargers. First-class components only with metal rectification on solid base board. Will give years of service. Input 200-250 v. A.C. Output 1 1/2 amps. at 6 v. As illustrated. Each **37/6**.

LONDON CENTRAL RADIO STORES
23, LISLE STREET, LONDON, W.C.2
Telephone: Gerrard 2969

P. A. EQUIPMENT-9

Loudspeaker Locations and Power Required. By "SERVICE"

THE actual positioning of loudspeaker units in any particular installation will depend upon the area to be covered and the actual shape of the room or workshop.

For example, four loudspeakers in a cluster in the middle of a square-shaped workshop would be heard quite well over the whole of the area, but a long, narrow room having the same amount of floor space would be better served by four loudspeakers located at intervals along the length of the shop. Another consideration, when deciding upon the number and position of loudspeaker units, is the type of "furnishings" in the workshop and the number of people employed in the shop. More speakers will be required to cover a certain area in a textile factory where there may be large expanses of cloth or stores having a number of shelves filled with soft materials, than would be the case of an installation in a factory workshop in which machinery only was present.

Quite apart from the power required, there is also the tonal value of the reproduction to be considered. In large workshops, loudspeakers should not be placed more than 30ft. to 40ft. apart, otherwise the time lag between the reproduction from each loudspeaker will be too great. For example, a person situated equidistant from two loudspeakers would hear the reproduction from each one at the same time, but another person situated nearer one loudspeaker than the other could still hear the second loudspeaker and the effect would be confusing if the distance between the speakers was very great. The reproduction of the second speaker when not too far away would appear as an echo, but from a more distant position the resultant reproduction might be utter confusion and quite unintelligible.

This trouble can be overcome by using a greater number of speakers, each radiating at a lower power, rather than fewer loudspeakers placed a longer way apart each operating at a high volume level.

Industrial Installations

In industrial installations there is generally no need to conceal or camouflage the loudspeakers, and they may be fixed to the girders supporting the ceiling or to the ceiling itself. As has been previously mentioned in this series of articles, different speakers have various characteristics; low-pitched speakers such as directional baffle, industrial types, etc., are good for workshops where there is a high-pitched background noise, while higher-pitched projector horn-type speakers are more suitable for use where the background consists of heavy rumbling noises.

In a quiet assembly bay, the more normal domestic types of moving-coil cabinet types are very suitable, when arranged on the wall all round the room for general diffusion of sound at a medium or low volume level.

Directional baffle loudspeakers and cabinet types should not be installed with their backs close to a wall, otherwise the quality of reproduction will suffer. These types of loudspeakers have louvres and holes cut in the back of the speaker casing to relieve the back pressure of the air generated by the cone, and if this back pressure is not relieved, the movement of the cone will be restricted and, consequently, distortion will result.

In Lecture Halls

All permanent magnet loudspeakers should be enclosed in a dust bag to prevent any foreign matter entering the speech-coil gap and, in the case of factory installations, to prevent metal filings adhering to the pole pieces.

The arrangement of loudspeakers in a lecture hall or auditorium is naturally governed by the characteristics of the building, but in general it is always advisable to

aim at making the amplified sound of the loudspeaker come from the same direction as the original sound. For example, it is very unnatural for people in the audience to see a man lecturing in front of them but to hear his voice coming from behind them! This will not occur if the loudspeakers are ranged on either side of the dais or stage pointing towards the audience, and of sufficient height to be directed slightly downwards towards the rear of the hall.

Not only is the direction of the sound in a straight line between the listeners and the loudspeakers, but there is less likelihood of trouble arising from the acoustic properties of the hall.

Dead Areas

Wherever possible, loudspeakers should not be so positioned that they face directly on to a hard surface, whether it be straight as in the case of a wall, or curved as in the case of a domed roof. All kinds of unpleasant reflections and, in some cases, almost complete silence,

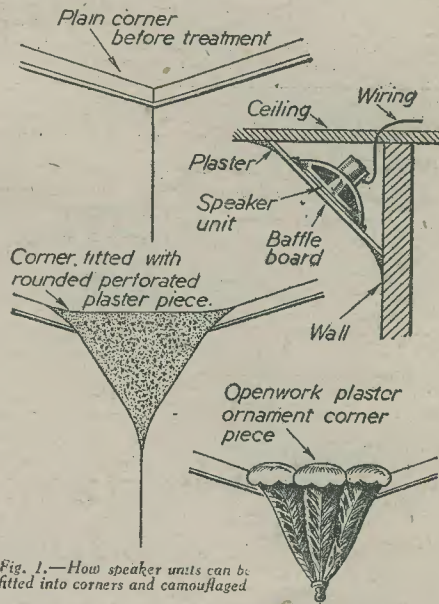

Fig. 1.—How speaker units can be fitted into corners and camouflaged

may be created if care is not taken over this matter. The areas of complete silence are caused by direct sounds from the loudspeakers arriving completely out of phase with the sound of the echo. The waves are then cancelled out and very little, if anything, is heard. Should the distance be such that the two waves arrive at the point at some other phase-difference, the sound may still be quite unintelligible, or have an unpleasant echo.

If, for example, it is desired to "cover" the upper gallery in a theatre, it would be far better to employ loudspeakers high up above the stage, almost at roof level, pointing slightly downwards towards the upper gallery, rather than to use loudspeakers at stage level, pointing upwards.

If matters cannot be arranged as would be desired in this way, the places which receive direct sound waves, and which are reflecting them, must be covered with

soft curtaining, or a soft type of partition boarding so that the sound is absorbed. Sometimes, in the case of old types of cinemas which have been fitted with sound equipment, the straight ceiling must be broken up by suspending lengths of material right across the width of the hall, so as to prevent the sound waves striking the rear part of the ceiling and the rear part of the wall of the building at an intensity which would cause serious reflections and echoes.

Camouflaging Loudspeakers

In installations carried out in municipal buildings, such as town halls, assembly halls, etc., it is often made clear in the installation agreement and specification that the loudspeakers should in no way detract from the beauty of the internal decorative scheme or architecture. Especially is this the case where installations in churches and cathedrals are concerned.

When a building is already erected, and is very bare in its interior scheme, there is little that can be done in the way of camouflage, but even so, there are ways and means if the co-operation of the architect can be obtained.

For example, false corners may be made in which to house the loudspeaker unit, such as shown in Fig. 1, and, in some cases, even false ceilings over lecture platforms can be arranged so that the installation does not exhibit any unsightly equipment in the internal design of the hall.

When the actual loudspeaker unit is fitted into a false wall, corner piece, or ceiling, the camouflage material in front of the loudspeaker unit may be perforated with a number of tiny holes which are hardly visible, but which provide an exit for the sound.

Where there is a ventilation scheme in the room, it is often possible to make up imitation ventilator grilles to match those already in existence, and then to mount the loudspeaker unit behind the grille and insert the whole equipment in a cavity excavated in the wall or ceiling, or sometimes even in the floor. Churches often have heating ducts in the floor covered with a grille at the sides of the aisles.

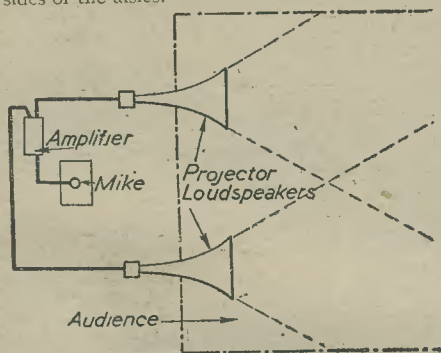

Fig. 2.—A typical arrangement for addressing crowds. Note that the microphone is well behind the loudspeakers to prevent acoustic feedback.

Where there are separate ventilator grilles and it is not possible to fit any false ones, loudspeakers can be mounted behind the actual grille, using a small baffle board which allows a margin of zins. to zins. all round, so that the ventilation is not seriously impaired. The reproduction of the lower frequencies in such cases will probably be attenuated, but this may generally be overcome by tone correction in the amplifier so that the output from the equipment emphasises the bass.

As was mentioned in an earlier article in this series dealing with the wiring of flat installations, it is essential that the civil engineers concerned with the design of the ventilation system, and the architecture, are consulted before any work of the above-mentioned nature is carried out.

Not only is it courteous, but serious trouble may be

prevented due to lack of knowledge, and the architect may often be in a position to advise on a better location for the loudspeakers and be able to design suitable grilles, false plaster decorations, etc., that will fit in with the scheme of the building, and yet give the acoustic results desired.

Covering Power

With regard to the power and the number of loudspeakers required to cover any particular area, it is difficult to give exact figures as there are so many factors which cannot be predicted, and which must be studied.

A bare, empty hall will require far less power to fill it than will one which is panelled in softish wood or has a great amount of cloth material decorations such as curtains, upholstered seats, etc. The audience themselves also provide a considerable amount of damping upon the sound waves. The cinema projectionist knows this well, and has to control the output from his amplifier according to the size of the audience. A volume which is only pleasantly sufficient for a crowded house would be overwhelmingly painful in a half-filled auditorium.

Background Noise

Another consideration is background noise. We have already dealt with this from the factory angle, but for domestic or entertainment installations some idea as to the background conditions should be obtained before deciding upon the power required for the amplifier, and the number of loudspeakers necessary to cover the job.

For example, take the case of restaurants. Higher class establishments will have a far less noisy atmosphere than the more popular type of refreshment place. Quite apart from the fact that in the first type of restaurant the rooms would be more softly furnished, probably with carpets, upholstered chairs, etc., but the staff would move more quietly, and would go about their work unobtrusively compared with the clatter and bustle of a city lunch-house.

However, as a guide, the following notes may be helpful in arriving at a first approximation of the power required, but in all cases it is wise to allow the amplifier to have about 50 per cent. reserve of power to deal with unexpected eventualities such as noisy audiences, extra loudspeakers for overflow crowds, etc.

Straightforward P.A. installations for halls holding up to about 1,000 people can generally be served with a 10-watt amplifier where speech only is required, and a 20-watt amplifier if really good quality reproduction is desired or if the background noise is high, such as in some restaurants as we have just been discussing. Of course, musical interludes between speeches would be fairly satisfactory from a 10-watt equipment, but full-bodied reproduction of music at real quality to an appreciative audience would require double or treble the power required to give satisfactory speech reproduction with its limited range of frequencies.

To prevent too much echo from the rear wall of straightforward rectangular halls used for speeches or lectures, the loudspeakers should be positioned so as to feed diagonally across the hall into the far corners. If, on trial, feedback is troublesome, the rear wall should have curtains, rugs or other material draped over it to absorb the sound waves reaching the wall.

If the room is not rectangular, but has alcoves, balconies, etc., extra loudspeakers of the cabinet or baffle-board type may be required to boost up the sound in dead spots. One or two watts for each of these loudspeakers must be allowed for when deciding upon the power of the amplifier required.

Loudspeakers in alcoves and private dining-rooms in hotels or restaurants should be fitted with their own volume control, so that the reproduction from the speaker may be reduced or completely turned off at the request of the patron. Everybody does not like music with their meals and the discerning "maître d'hôtel" will not wish to lose even one customer if it is possible to cater for his particular likes and dislikes by arranging a table in an alcove which is not supplied with music.



FOR THE RADIO SERVICE MAN, DEALER AND OWNER

The man who enrolls for an I. C. S. Radio Course learns radio thoroughly, completely, practically. When he earns his diploma, he will KNOW radio. We are not content merely to teach the principles of radio, we want to show our students how to apply that training in practical, every-day, radio service work. We train them to be successful!

INTERNATIONAL CORRESPONDENCE SCHOOLS

Dept. 94, International Buildings,
Kingsway, London, W.C.2.

Please explain fully about your instruction in the subject marked X.

Complete Radio Engineering
Radio Service Engineers
Elementary Radio
Television

If you wish to pass a Radio examination, indicate it below.
Institute of Radio Engineers

P.M.G. Certificate for Wireless Operators
Provisional Certificate in Radio Telephony and
Telegraphy for Aircraft
City and Guilds Telecommunications

Name..... Age.....

Address.....



(Use penny stamp on unsealed envelope.)

RELAYS

Ask for Leaflet SPN/PW.

LONDEX LTD.

ANERLEY WORKS,
207, ANERLEY RD.
LONDON, S.E.20.
Phone: SYD. 6258/9

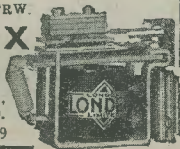

FREE ADVICE BUREAU COUPON

This coupon is available until April 4th, 1942, and must accompany all Queries and Hints.

PRACTICAL WIRELESS, April, 1942.

Outdoor Installations

For conventional P.A. jobs, such as the layout shown in Fig. 2, which is a plan of a typical outdoor assembly or political meeting with an audience of up to about 4,000 persons, an 8- to 10-watt amplifier would suffice for speech reproduction, using two high-efficiency projector-type loudspeakers positioned as shown.

Note that the microphone is well behind the loudspeakers in order to reduce acoustic feedback or howling. The loudspeakers should be as high as possible, preferably on tripods and directed downwards towards the people at the rear half of the crowd.

Should the background noise be high (for example, heavy traffic, trains, etc., passing the area) a 20-watt amplifier may be necessary employing four 5-watt loudspeakers, while, if music is to be reproduced, a 40-watt amplifier should be used with four 10-watt loudspeakers of the directional baffle type.

Outdoor restaurants, tea-gardens, etc., do not require reproduction at such a high level as the music is generally required, only as a background. On the other hand, if a larger number of cabinet or baffle-type loudspeakers are used to diffuse the sound, and as these are far less efficient (acoustic output for electrical watts input) than projector or directional baffle types, a high-powered amplifier may still be necessary, depending, of course, upon the number of loudspeakers being used.

About one watt per loudspeaker may be employed, but a reserve of double the normal power requirements should be provided in case urgent messages, A.R.P. instructions, etc., have to be put out over the system.

Where long, narrow areas have to be served, pairs of loudspeakers, each receiving about 5 watts, are generally used, a distance of 50ft. to 100ft. separating each pair. This arrangement is also useful for serving crowds on all sides of a race track, football ground, etc. The loudspeakers are arranged on tripods (or poles in the case of permanent installations), all round the track or playing area facing the spectators with the loudspeakers pointing towards the back seats or stands.

To cut down losses due to long cables, and to keep the cables as light as possible, high impedance networks are employed with matching transformers for each pair of loudspeakers.

(To be concluded.)

PRIZE PROBLEMS

PROBLEM No. 430.

JONES had made up a two-valve short-wave receiver, and during its initial test he found that the results were most satisfactory as regards sensitivity. Wishing to make it as good as possible, he decided that the condenser controlled reaction circuit was just a shade too fierce. Not wishing to alter the reaction winding, he experimented with fixed condensers in series with the reaction condenser, the latter having a value of 150 m.mfd. Eventually, Jones found that a fixed condenser of .001 mfd. connected in series with the 150 m.mfd. variable condenser produced just the results he desired. What was the resultant maximum capacity?

Three books will be awarded for the first three correct solutions opened. Entries should be addressed to The Editor, PRACTICAL WIRELESS, George Newnes, Ltd., Tower House, Southampton Street, Strand, London, W.C.2. Envelopes must be marked Problem No. 430 in the top left-hand corner, and must be posted to reach this office not later than the first post on Monday, March 16th, 1942.

Solution to Problem No. 429.

Smithers worked out the value of the resistor required to produce a resultant value of 350 ohms, when connected in parallel with the 500 ohm resistor, in the following manner:

$\frac{1}{R} = \frac{1}{R_1} + \frac{1}{R_2}$ But R is the value he wants to produce i.e., 350 ohms, and R_1 is resistor he has, 500 ohms, so inserting these known values and rearranging the formula to allow R_2 to be found, he get

$$\frac{1}{R_2} = \frac{1}{R} - \frac{1}{R_1}$$

$$= \frac{1}{350} - \frac{1}{500} = \frac{10-7}{3500}$$

$$R_2 = \frac{3500}{3} = 1166.66 \text{ ohms.}$$

The following three readers successfully solved Problem No. 428 and books have accordingly been forwarded to them. S. Macadie, 5, Park Drive, Uppingham, Essex; R. F. Poole, 47, Russell Road, Gravesend, Kent; O. R. Hammond, 65, Llantwit Road, Neath, Glam., S. Wales.

Protection Against Lightning

Constructional Details of a Simple but Efficient Lightning Arrester

By "RADIO ENGINEER"

AERIALS have always been considered an additional risk where lightning is concerned, but the possibility of the aerial or house being struck by lightning due to the aerial is, as statistics prove, very minute.

Lightning plays the most freakish tricks, and there is no knowing where it will strike, but there are one or two facts which should not be overlooked. It invariably takes the quickest and least troublesome path to earth and usually strikes the highest point in its striking area.

Knowing these details, it is possible to provide some means whereby, shall we say, the lightning's requirements are fulfilled, and, at the same time, some reasonably secure protection for buildings and other earthed objects.

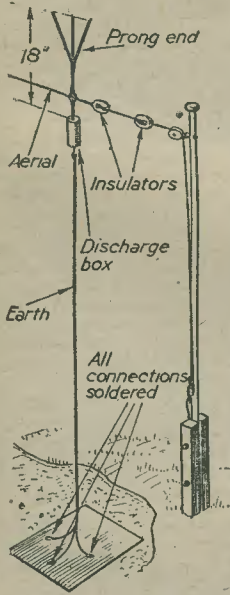

Fig. 1. — Showing the arrester fitted between point of suspension and aerial wire.

It is capable of causing considerable damage to any object it may strike during the course of its travel earthwards.

It also happens, even when no storm is in the vicinity, that the atmosphere reaches a highly-charged state, and while the quantity of electricity may not be sufficient to cause a violent discharge, it is often sufficient to charge up metal bodies to a high potential which is capable of giving an unpleasant shock if taken to earth through one's body.

Lightning Conductors

It is evident, therefore, that some form of protection is desirable, and it is usual to employ "lightning conductors." These consist of a stout metal low-resistance conductor, one end of which terminates in the earth, and the other end in a forked prong which projects above the building or object it has to protect. Good examples can always be seen on high buildings, churches, masts and factory chimney stacks.

Each conductor or arrester, as they are sometimes called, protects a certain area, and it may be stated, approximately, that the effective area is equal to a circular space around it, the radius of which is roughly double the height of the conductor. Bearing these details in mind, it is obvious that if any protection is to be given to an aerial, much will depend on the actual length of the aerial, its height and the surrounding objects.

Aerials and Arresters

We have seen that a discharge of lightning represents a terrific electrical power, and if any resistance is offered to its progress it is highly probable that the resisting body will be completely burnt. It is known that heavy metal objects and lightning conductors have been melted by a lightning discharge; therefore, it hardly seems feasible to think that the small gauge wire usually employed for aerials would stand much hope of remaining intact if struck, especially as it is invariably at right angles to the path of travel.

For this reason, alone, I do not think that an aerial is likely to conduct a destructive charge into or to a house, unless it happens to be in a very high and exposed part, and not surrounded by other earthed objects of a greater height. In the case of ordinary atmospheric discharges, it is possible for the aerial to become highly charged, particularly if it is not earthed either through the set or by a switch, so some means of allowing the charge to escape harmlessly to earth should be provided.

All that is necessary is an efficient spark gap arrangement, the width of the gap being so adjusted that any excessive charge would jump or flash across the gap, one side of which is connected to the aerial, and the other side to earth. Various forms of suitable devices have been produced which can easily be fitted to any existing aerial arrangement.

If anyone has any doubt about these static charges, I would suggest that they watch the spark-gap when a storm is taking place, or summer lightning is in the vicinity. With my own aerial, which happens to be rather high and exposed, I have not only seen quite large flashes, but I have also heard charges crackling off the free lead-in wire, and it was after one or two practical demonstrations of that kind that I decided to design some arrangement to keep the aerial free from such objectionable surprises.

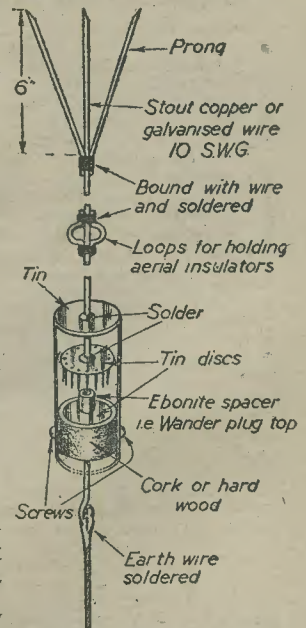

Fig. 2.—The constructional details. The needle points must be kept just clear of the earthed disc by the spacer.

A Simple but Effective Static Arrester

Fig. 1 shows the result of my experiments, and the method of fastening it in the aerial circuit. It will be noted—and this is a very important point—that it is fitted at the highest end, and so arranged that the prongs actually project above the mast, if one is used.

The earth wire which goes straight down to the earthing plate—should be reasonably large; I used 7/22 S.W.G. enamelled wire. The forked prong is provided for the same reason as those fitted to a proper lightning conductor.

Inside the tin case shown in Fig. 2 is housed a very efficient multi-point spark gap, and one side of this is connected to the prong section and the aerial, thus allowing either a heavy discharge to have a straight line to earth or a static charge on the aerial to be attracted to earth.

Through its design and efficiency, a lightning arrester of this kind is really worthy of its name, as it does offer a practical solution to the problem of protecting the aerial and mast, while it also greatly reduces static interference.

As mentioned before, it is fitted at the highest end of

the aerial, therefore it is in a far better position to carry out its work than one, say, fitted at set level and in or near the house. By virtue of its height its effective area is greatly increased, and as it is well protected against atmospheric conditions, it can be fitted and forgotten.

The constructional details are clearly shown in the diagrams, and there is only one point which needs any particular care, that is, soldering the gramophone needles to the tin disc. The tin need not be very stout, and it will be found quite easy to assemble this part if the disc is placed over a cork or a piece of soft wood, and the needles driven through the tin until their flat ends are just projecting above the disc. The centre wire and the needles can then be soldered in position, and when the metal has cooled down, the cork or wood removed.

The ebonite spacer is provided to keep the earth disc one-sixteenth of an inch from the pointed ends of the needles, so this must be adjusted with reasonable care, otherwise too large a gap will be provided, or there will be a possibility of the points and the earth disc shorting.

Small Portable Receiver

Licensing Considerations, and Some Further Notes by the Designer

I TAKE this opportunity to add some "second thoughts" that have occurred to me since my description of a small portable receiver was published in the February issue, particularly as to the legality of its use.

Some of my friends have suggested that it is very daring to be seen about with a portable radio, especially if it is particularly small; others have even gone so far as to say that it would be illegal. "You might be shot by the Home Guard" was a typical observation. Therefore, with these thoughts in mind I decided to enquire further into the position.

The first step was to ascertain exactly what authority is given to a listener under his G.P.O. licence. This was, of course, quite easy, because the conditions are printed on the back. Paragraph 6 of these states:

"This licence will be deemed to permit the occasional use by the Licensee or a member of his household residing with him at the address of the installation of one portable wireless receiving set (i) away from that address (e.g., in the open air), or (ii) at another fixed address at which the Licensee is temporarily resident. . . ."

Now, if you read this very slowly a second time and digest it you will see that what it means is that anybody who holds a licence can take and operate a portable set out in the open, or anywhere where he happens to be living temporarily. There is another condition that if you do this you must carry your licence with you.

Therefore, under this heading there can be no objections to a licensed listener taking a radio wherever he happens to be in order to hear any item of special interest to him, for instance, an announcement of national importance, or his cousin crooning.

This is an ordinary peace-time concession, but to what extent has the war legislation restricted it?

To find the answer was a little more difficult. It involved tracking down and obtaining a copy of an official document with the formidable title of "Defence (General) Regulations, 1939." Going through this you come upon Regulation 8, paragraph (3A) which states, among other things: ". . . no person shall use or have in his possession or under his control any wireless receiving apparatus installed in any road vehicle."

Note particularly that it says road vehicle, because it is this, of course, that prohibits car radio or the carrying of any radio that can be operated in a car, or even an omnibus. That is the point I want to emphasise; if you take a portable or any radio that can be operated on a bus, coach or car you are breaking the law.

On the other hand, it appears that you may take as much radio as you care to carry with you on a train without violating the law, but if, when you leave the railway station, you take the same radio into a bus or car for the purpose of completing your journey, then you break the law.

Incidentally, readers may be interested in my own experience of operating a radio in a train. It was just after the outbreak of war that I had to travel home each evening by train. The carriages were completely blacked out as reading lights had not been fitted. To relieve the monotony of the journey I took a small portable (similar to the one described recently) with me. It was great fun to see the expression on the face of the fellow opposite as he lit up his pipe, and saw me reclining in the corner with the headphones on.

This did not last long, however, because the progressive railway company decided to replace the old wooden coaches with all-steel ones. This screened the set and cut out all signals, unless the set was placed right on the window ledge.

But to get back to the point, so far as I am able to ascertain, there is no reason why you should not take your portable wherever you like so long as you do not take it on "any road vehicle," and you also have with you your licence. What happens if you take it on a tram I cannot pretend to know, because I understand that in law a tramway system has been described as a "light railway."

Reverting to the article in the February issue, there are one or two minor corrections which should be noted.

The first is that the pictorial sketch of the complete receiver shows the position of the plug sockets to be equally centred on the sides. These, I consider, should be farther towards the back (or to the right looking at the sketch), as otherwise the band of the headphones, when packed, might cause a short-circuit between the headphone socket (carrying H.T.) and the L.T. socket. However, the wiring diagram does show the correct position.

Secondly, the capacity of the reaction condenser is .003 mfd. and not .0005 mfd. This, however, is not a very material point.

Thirdly, the illustration of the frame-aerial former is incorrect in that it has 16 slots. There should only be 15, or any odd number, so that each winding threaded in and out of the slots will be on opposite sides of the cardboard to the former turn. This will keep the former rigid and flat, as otherwise the former might buckle.

BRITISH LONG DISTANCE LISTENERS' CLUB

Group Formation

WE still continue to receive letters from all over the British Isles supporting the Group idea, and results tend to point to the idea becoming a practical proposition. The chief difficulty is the scattered membership; a great deal of work has to be undertaken to link up the members in any one area. Although the provisional figure of 24 members for a Group was given, it is now obvious that it will not be possible to hold to that figure. This does not mean that the majority of towns cannot raise this number in normal times, far from it, but under existing conditions, when so many of our members are serving in the Forces and many others are away from their home town on war work, etc., it seems that those remaining will have to get together and form smaller groups with the idea of rapid expansion when peace returns.

Six active members working together is far better than "lone wolf" working. More interest, more progress and greater help for all can only be obtained by co-operating on the best democratic lines. Amateur radio knows no class distinctions where the development and interest of the science is concerned, and it is hoped that no problems of this nature will arise about the suggested formations.

Warning

WE have had many letters from members who wish to launch a group in their area; by this we mean they have asked us to put members in touch with them direct. Such requests are, in all probability, made in good faith and with the desire to help the Club, but it is a practice with which we do not agree. We cannot tolerate any person going around saying that he is forming a B.L.D.L.C. Group and taking up the self-appointed position of secretary or whatever he chooses to name himself. The standing, welfare and integrity of the Club have to be protected, and the interests of all members have to be safeguarded, to prevent unscrupulous persons exploiting the whole idea. It is stressed, once again, that the B.L.D.L.C. is a non-profit-making organisation, and as such it is vital that any of its associated Groups must be the same.

Another item which we feel should now be mentioned is that the recognised headquarters, namely Tower House, is the only source of supply of all B.L.D.L.C. badges and other material.

Each Group will have its own committee, etc., and it will, no doubt, be necessary for the members to make some small contribution from time to time, to cover such expenses which their Group may incur. That will be a matter for the Group members to settle for themselves in open discussion, and they will appoint, at least, two members to act as treasurers.

When the time comes for Groups to be formed, full instructions will be sent from headquarters to all those concerned, advising them of the procedure to adopt, so until such directions are received, it can be assumed that any project put forward has not been sanctioned by headquarters.

Members must appreciate that the above remarks are intended for their protection. We do not wish to convey the idea that we are against members getting together—far from it—provided that they communicate with us and submit such plans and proposals as they may have formulated. In such circumstances, it would be advisable for all members concerned to sign the letter.

Members' Correspondence

HERE is a line from a member in Wellingborough, his number being 8,064.

"I think your idea of forming B.L.D.L.C. groups is very good. We have a club here (we call it the Welling-

borough Amateur Radio Society [W.A.R.S.]), but it only has six members as yet. However, we shall probably be able to form a group here if we get more members.

"I am contacting Member No. 6,897, of Northampton, shortly, having seen your note in the B.L.D.L.C. section of February's PRACTICAL WIRELESS. Please excuse the letter, but I cannot get all I want to on a postcard.

"However, here is what I really wish to tell you about. You will find a photograph of my den in this letter which may be of interest to you, but I don't know whether you think it good enough for PRACTICAL WIRELESS. My Rx is a Graham Farish 'Formo,' r-v-r and the H.T. is supplied by an eliminator. The den is an attic in the top of the house and I use a 6ft. vertical brass aerial.

"My log includes the following stations: WRUL, WNBI, WLWO, WGEA, WRUL, WBOS, WCBX, FZI (R. Brazzaville), TAP, WGEO, R. Ardarra, Moscow, etc. I have never received any Far East stations, but it is probably because I never have done any 'midnight listening.'

"I wonder if any reader could help me in the identification of a station operating on approximately 20 metres on Sunday, December 21st, 1941, at 13.40 B.S.T. A woman's voice said: 'The following is the test transmission by the American Telephone and Telegraph Co. for circuit adjustment purposes.' A man then spoke and they carried on alternatively until 14.15 B.S.T., when there was a news bulletin. The announcer then kept saying, 'Hello London,' and station closed at 14.45 B.S.T.

"I often hear this station at other times, but speech is very blurred."

We regret that the snaps are not satisfactory for reproduction, so perhaps you will let us look at the next lot you take.

Another interesting letter comes from Member 6,947 of Framlingham, Suffolk. In case any other member can help with his query, his address is Longfield Cottage.

"Having been a member of the B.L.D.L.C. for a few months now, I feel I ought to inform you of my activities. My Rxs number three, two short wave and one medium wave. The S.W. Rx which I use most is a r-v-r, but I use a pentode amplifier with it, so it is virtually r-v-2. H.T. is from an H.T. eliminator of my own design and construction, and I have no trouble with mains hum. When pentode amplifier is in use, all reception is on M.C. speaker, but I search the ether with the set as a r-v-r and use 'phones. The aerial in use is an inverted 'L,' 60ft. long, 20ft. high, directed N.E.-S.W.

"Now my log here includes WRUL, WRCA, WGEA, WGEO, WLWO, WBOS, WCBX, HCJB, VUD2/3, which have all been verified. Also I have heard WNBI, WRUW, PMA, Brazzaville, Leopoldville, XGOY, Cairo, TAP, CR7BE, OFE. If any member wants any information re above stations I will be only too pleased to give it.

"Now lately I have heard a station giving 'Sverdlovsk calling.' For its identity, news in English was heard at 12.20 G.M.T. on 20.11 metres. Can any listener give me any more information about it?"

"The only information I can give Mr. R. W. Iball, of Langold, re his query about the Singapore station on 15 m. is that it is *not* Singapore; it is the Dutch transmitter PMA, Batavia, relaying a transmission from Singapore."

Congratulations

To member 8,021 we offer our congratulations for the progress he is making in the A.T.C., and we hope that the experience and training he is receiving will

stand him in good stead when we return to the real amateur conditions once again.

"Firstly, my rig. Two Rxs: (1) 5v. S.H. all-wave mains, (2) 0-v-1 H.F. pentode det., transformer coupled to pentode output. 13-17 metres. Aerial is about 50ft. long, 20ft. high, and pointing due north. Earth lead is, I am afraid, a bit too long, but I am trying to alter position of the Rxs for shorter earth.

"The 0-v-1 I have not had long, but on the S.H. I have Rx'd many DX stations, though having started S.W.L. only recently, I possess only four verification cards, these being from WRCA, WCBX, WRUL and CJCX, though I have a considerable number of reports out. (All these cards were obtained after the ban.)

"I have followed with interest the opinions expressed in the columns of the B.L.D.L.C. page concerning group-working. I (as you no doubt know from my postcard now) am all for it. Unfortunately, I only live in a little village and I'm afraid that the inhabitants of the village care very little about wireless, and so I have to be a sort of 'lone wolf,' relying on PRACTICAL WIRELESS for all the DX news, etc.

"I also agree with the suggestion of member 7,007, who asks for some items on station equipment which, as you say, are of great necessity.

"I have also read the 'controversy' concerning the name of the club. I agree with member 6,628. There is only one B.L.D.L.C. and I think that changing the name

would be, to say the least, confusing, so as 6,628 says, 'Long live the B.L.D.L.C.'

"I am only 16½ years old and in the A.T.C., and have been in it since its formation in February. I am compelled through eyesight to go on the ground staff, and in July, 1941, I obtained my proficiency certificate for 'W/Opr. Ground,' so I am quite pleased about that."

Contacts Required

ROMSEY, Hants.—Member 7,089, 6, Greenhill View.
Newcastle-on-Tyne.—Member 7,112, 145, Fosson Terrace, Heaton.

Lanesfield, Nr. Wolverhampton.—Member 8,122 (age 15), "Beulah," Lane Road.

Ilford, Essex.—Member 8,099 (age 17), 34, Blenheim Avenue.

Norton-on-Tees.—Member 8,026, "Redlands," Weston Crescent.

Walthamstow, London, E.17.—Member 6,736, 15, Borwick Avenue.

Wroxtton, nr. Banbury.—Member 7,049, "The Laurels."

Nr. Horley, Surrey.—Member 7,127, Charlwood Park Cottages.

Arnold, Nottingham.—Member 7,116 (age 14), Beccoh House, Redhill.

Long Eaton, Notts.—Member 6,873, 6, The Nook, off New Tythe Street.

TRADE NOTES

The Ediswan "Ensur-a-lite"

WITH the limited supply of torch and hand-lamp dry batteries, it is interesting to note that the makers of the Ediswan "Ensur-a-lite" accumulator hand-lamp estimate that their product has saved approximately 3,000,000 torch batteries in just over eighteen months. The estimate is based on the assumption

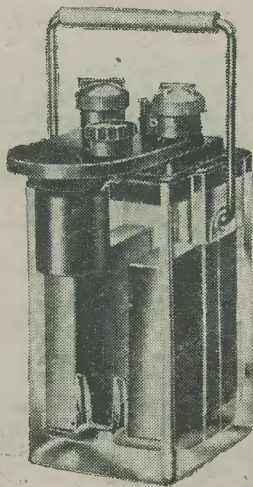

The "Ensur-a-lite" accumulator hand-lamp.

that hand-lamp users renew their batteries at least once a month, and is worked out on the "Ensur-a-lite" sales total of nearly a quarter of a million for that period. Ediswan attributes this fine sales record to the fact that although the "Ensur-a-lite" was designed primarily for A.R.P. purposes, hundreds of other uses have been found by the public for it. This seems to be borne out by the fact that although A.R.P. posts and private shelters have, in the main, long since been wired for lighting, and although the peak period of A.R.P. equipment purchasing has long passed, the sales of the "Ensur-a-lite" have not appreciably dropped.

Its Adaptability

BECAUSE this hand-lamp can be stood in any position (even tilted on to its back or side, if required), and because it is conveniently carried by a top handle, there are literally hundreds of uses for it. Furthermore, due to its simplicity and rugged construction, nothing can go wrong with it—provided it is kept charged it will remain in reliable service for years.

During the summer months many removed the

switch and bulb-holder plate from the top of the cell and used the cell itself as a radio battery, realising that in so doing they were not only getting an additional service from it, but were actually keeping their hand-lamps in trim for the coming black-out.

The points to remember in connection with the "Ensur-a-lite" are that it is filled with jelly acid electrolyte and is therefore safe to tip, even in the house; that the only component apart from the two-volt cell is the switch and bulb-holder plate, which, being made of bakelite, cannot corrode, and that there is no large metal surface of any kind in contact with the electrolyte, eliminating the danger of deterioration however long the lamp stands; that it gives up to 60 hours' light for one charge, costing only a matter of a few coppers; that the light is hooded to comply with A.R.P. outdoor regulations, and that the switch is of the screw-in type for a sustained light when desired.

Webb's Radio

WE are informed that supplies of Webb's Radio Globe have now been exhausted and it is not possible under present circumstances to produce further supplies. Readers may, however, be interested to know that copies of Webb's Radio Map are still available.

Supplies have now arrived in this country of the American Amateur Radio Relay League Handbook for 1942. Supplies of this book should be adequate to meet the demand at least for some months, but preferential treatment will be accorded to members of H.M. Forces and to Government Departments. Private individuals who require the book for purposes other than for work of National importance will be supplied from any surplus available after meeting the aforementioned Priority needs. The price of the book is 9s. 6d. post free.

Change of Address

THE Liverpool Depot of The Edison Swan Electric Co., Ltd., has removed to 23, Stanley Street (Telephone Advance 4944) from the temporary premises recently occupied. The above will be the permanent depot address.

COMMUNICATIONS DEPEND ...

The "Fluxite Quins" at Work

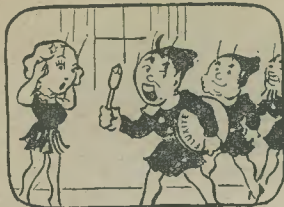

"There's a man shouting awful next door,"
 Cried OO. "Hurry, quick, all you four!"
 "FLUXITE'S needed, I'll bet,
 That's his radio set."
 Chuckled EE. "Here's a job, FLUXITE
 CORPS!"

See that FLUXITE is always by you—in the house—garage—workshop — wherever speedy soldering is needed. Used for 30 years in government works and by leading engineers and manufacturers. Of Ironmongers—in tins, 4d., 8d., 1/4 and 2/8.

Ask to see the FLUXITE SMALL-SPACE SOLDERING SET—compact but substantial—complete with full instructions, 7/6. Write for Free Book on the art of "soft" soldering and ask for Leaflet on CASE-HARDENING STEEL and TEMPERING TOOLS with FLUXITE.

To CYCLISTS! Your wheels will NOT keep round and true unless the spokes are tied with fine wire at the crossings and SOLDERED. This makes a much stronger wheel. It's simple—with —FLUXITE—but IMPORTANT.

THE FLUXITE GUN puts FLUXITE where you want it by a simple pressure. Price 1/6, or filled, 2/6.

FLUXITE LTD. (DEPT. W.P.),
 BERMONDSEY ST., S.E.1.

FLUXITE
 SIMPLIFIES ALL SOLDERING

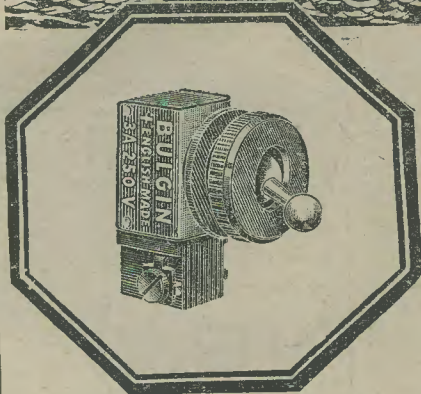

ON SMALL PARTS...

IN countless instances quite intricate pieces of apparatus are wholly dependent on the proved reputation and reliability of their component parts.

All products from the House of Bulgin are pre-eminent for superior design and workmanship, and every article bearing our Trade Mark has to pass exacting and exhaustive tests during the course of its production.

We ask the kind indulgence of the public in delivery until peaceful conditions return.

The Choice of Critics

BULGIN FOR SWITCHES

THE best Radio and small Electrical Switches in the world. Every one is the finest of its class, and the best for any job. Snap-action, low and constant contact resistance, reliable performance for tens of thousands of operations: all these are permanent characteristics.

ALWAYS DEPEND ON

BULGIN

REGISTERED TRADE MARK

A. F. BULGIN & CO., LTD., BY-PASS RD., BARKING, ESSEX
 TEL. RIPPLEWAY 3474 (4 lines).

AUTHORITATIVE ENGINEERING TRAINING

25 FIRST PLACES and Hundreds of Passes were gained by T.I.G.B. students at recent examinations for A.M.Inst.C.E., A.M.I.Mech.E., A.M.I.E.E., A.F.R.Ae.S., C. & G., etc.

Write today for "The Engineer's Guide to Success," containing world's widest choice of home-study engineering courses—Wireless, Television, Electrical, Mechanical, Aeronautical, Automobile, Building, Civil, Chemical, Gas, etc., and which alone gives the Regulations governing admission to the Recognised Engineering Institutions. Mention branch, post or qualification that interests you.

The T.I.G.B. Guarantees training until Successful for the one fee.

The Technological Institute of Gt. Britain, 211, Temple Bar House, London, E.C.4. (Founded 1917. 20,000 Successes.)



RADIO

THE SUPERHETERODYNE RECEIVER

By Alfred T. Witts, A.M.I.E.E. All the information necessary for a complete understanding of the operations and working principles of this type of receiver, including an additional set of notes on the cause and prevention of frequency drift, and an enlargement and revision of the chapter on maintenance. Fifth edition. 5s. net.

THERMIONIC VALVES IN MODERN RADIO RECEIVERS

By Alfred T. Witts, A.M.I.E.E. Second, revised edition of this book includes material on valves introduced since the first edition, together with an entirely new chapter on rectifying valves and circuits and additional information on the aligned grid principles, output tetrodes, negative feed-back and phase splitters circuits and new information on frequency changes. 10s. 6d. net.

SHORT-WAVE RADIO

By J. H. Reyner, B.Sc. (Hons.), A.C.G.I., D.I.C., etc. Deals with the developments and progress in the field of short wave radio telegraphy, giving comprehensive data and practical methods of application. 10s. 6d. net.

39 PARKER ST., KINGSWAY

PITMAN'S

CELESTION

CELESTION-AMPHENOL

valveholders are preferred by radio engineers because of their Strength, Efficiency, Uniform Contact and exceptional Insulation.

All standard British and American types are available.

AMPHENOL

BRITISH MADE

CELESTION LTD.
(Engineers)
KINGSTON-UPON-THAMES, SURREY.
Telephone: KINGston 5656-7-8.

3,000 PAGES OF EXCLUSIVE KNOWLEDGE

An invaluable Electrical Library in 4 Volumes

COMPLETE ELECTRICAL ENGINEERING has been written by over sixty specialists selected for their adequate qualifications, their intimate knowledge of the various branches of electrical work, and their ability to present it in a way which enables it to be readily absorbed by the keen young man. This work offers the latest and best information available on present-day electrical practice at a price which renders it available to all.

Whether you are engaged as an apprentice in an engineering works, in the drawing office, or sales organisation of a firm of electrical manufacturers, or in the electrical contracting industry, you will find in the pages of this work sound, reliable information on every important application of electrical engineering in modern industry.

160 UP-TO-DATE SECTIONS Electrical Power Supply, Switch Controls for Lighting Circuits, Installation of Electric Motors and Control Gear, Talking Picture Equipment, Installing Cables and Wires, Domestic Installation Practice, Electrical Equipment of Aircraft, Alarm and Indicator Circuits, Electrical Timing Instruments, Efficient Earthing, Storage-battery Systems, Lightning Conductors, Electric Meters and Cookers, Power Transformers, Testing Electrical Machinery, Private Automatic and Manual Telephone Systems, Automatic Voltage Regulators, Anodising, Magnetic Chucks, Lifting Magnets, Electric Traction, Workshop Faultfinding and Repair, Lift Operation and Control, Switchboards and Instruments, Television Transmission, etc., etc.

PRESENTED FREE

NEWNES ELECTRICAL POCKET BOOK (sold normally at 5s.). This 300-page Pocket Book supplements the four volumes by giving you just the information you want on the job — something to refer to at once. It deals with A.C. Theory, Chain Drives, Earth Resistance, Generating Plant, Magnetic Circuit, Instruments, Space Heating, Rectifiers, Protective Gear, Remote Lighting, Shunts, Specific Resistances, Welding, Voltage Control, and contains a Profusion of diagrams, sketches, tables and graphs.

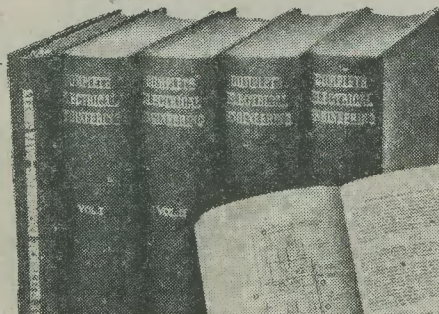

SEND A POSTCARD for special brochure giving full details of this timely work. Address to: THE HOME LIBRARY BOOK CO. (George Neumes, Ltd.), Dept. P.W., Bushey House, Bushey, Watford, Herts. Add your own name, address, occupation and age.

Impressions on the Wax

Review of the Latest Gramophone Records

H.M.V.

AN interesting album consisting of four 12-in. records has been released this month by the H.M.V. Company. It is Moussorgsky's "Pictures at an Exhibition," played by the Leopold Stokowski and the Philadelphia Orchestra—*H.M.V. DB5827-30*. This work, "Pictures at an Exhibition," has an interesting history. Victor Hartmann, a distinguished Russian architect and painter, and intimate friend of Moussorgsky, died in 1873, at the age of 39. Soon after his death an exhibition of his drawings and water-colours was held at the Academy of Arts in St. Petersburg, and Moussorgsky, as a tribute to the memory of his friend, composed a set of ten pianoforte pieces—"Pictures at an Exhibition." Musicians were quick to see the great possibilities that lay in presenting this work in orchestral form, and in 1891 Toushinaloff scored eight of the pieces and they were performed that year in St. Petersburg. Another orchestration of the complete work was made by the pianist composer Leonidas Leonardi, and Sir Henry Wood, too, has made an orchestral version of the work which he has played with success on several occasions in London.

Stokowski and the Philadelphia Orchestra have also made a set of three records called "Carnival of the Animals" on *H.M.V. DB5942-4*.

Among the vocal recordings is a new one by Webster Booth, who has recorded two songs from two famous musical shows. The first is the "Song of the Vagabonds," from the "Vagabond King," and the second "One Alone," from the "Desert Song," on *H.M.V. B9235*. A record I found rather interesting was that made by the Polish Army Choir, who sing a medley of Polish mountaineer songs on *H.M.V. BD970*.

On the lighter side we have Leslie Hutchinson (Hutch) singing two popular songs from the films. They are "Intermezzo" from the film "Escape to Happiness," and "Sand in my Shoes," from the film "Kiss the Boys Goodbye," on *H.M.V. BD992*. Walt Disney's "Dumbo" is featured on a special record by the H.M.V. Company and has a coloured label depicting characters from the film. The two songs on the record—*H.M.V. BD993*—are "Baby Mine" and "When I see an Elephant Fly," and they are both taken from the actual sound track of the film.

Parlophone

THIS month Richard Tauber sings a song which is extremely popular at the moment. It is "Intermezzo" from the film "Escape to Happiness," which he sings in English. The coupling is "Come back my Love," which is also sung in English. The orchestra which accompanies Tauber is conducted by Henry Geelh.

A combination which has made a number of successful records is "The Organ, the Danceband and Me," consisting of H. Robinson Cleaver, Billy Thorburn and a vocalist. Their recording this month is "There's a Land of Begin Again," with Julia Dawn as the vocalist, and "Some Sunny Day," with Cyril Shane as the vocalist, on *Parlophone F1983*. Ivor Moreton and Dave Kaye need no introduction and for their new recording they give their version of "Markin' Time" and "Happy Fingers" on two pianos, accompanied with string bass, drums and guitar—*Parlophone F1880*.

All the latest dance tunes appear in the Parlophone releases. Of these I can recommend Geraldo and His Orchestra playing "Jim" and "Elmers' Tune," on *Parlophone F1888*; Edmundo Ros and his Rumba Band from the "Cocoanut Grove," London, with their rendering of "Quiereme Mucho" and "Congo Boom," on *Parlophone F1892*, and finally Joe Daniels and his Hotshots in his latest "Drumnasticks," "Dancin' for

a Dime" and "Fats in the Fire," on *Parlophone F1891*.

Columbia

NELSON EDDY with his new film partner, Rise Stevens, have made a fine duet recording of two of the songs of their film, "The Chocolate Soldier," on *Columbia DB2069*. They are "My Hero" and "Sympathy." If you like military bands you will enjoy "Irish Fantasy" and "Russian Fantasy," played by the Band of H.M. Life Guards, on *Columbia DB2065*.

I also recommend the recording made by the Leslie Howard String Orchestra of "Serenade in G major" on two 12-in. *Columbia* records *DA1063-4*. The first record introduces 1st Movement—Allegro and 2nd Movement—Romanze—Andante and the other 3rd Movement—Menuetto—Allegretto and 4th Movement—Rondo allegro.

Singers of popular songs are Turner Layton with "He Wants to be a Pilot" and "The World will Sing Again," on *Columbia FB2750*, and Celia Lipton with "Kiss the Boys Goodbye" and "Swing Bugler," on *Columbia FB2752*. If you like dancing, then get the latest recording of Victor Silvester and his Ballroom Orchestra of "That Lovely Week-end" and "Do You Care," on *Columbia FB2755*, which is played in strict dance tempo. My final selection from the dance tunes is "Tropical Magic," played by Carroll Gibbons and his Savoy Hotel Orpheans on *Columbia 2763*. The coupling is "The Man with the Lollypop Song."

Decca

RUSSIAN records recorded in the U.S.S.R., in fact some of them were actually made during the battle for Moscow, are featured in the new Decca releases. First we have two records by the U.S.S.R. Red Banner Ensemble of Red Army songs and dances. They are "Tachanka," "Kalinka," on *Decca F8075* and "Song of the Heroic Airman" and "Through the Moonlit Meadow," on *Decca F8076*. Songs from two Russian operas are featured on the next record, which is *Decca F8077*. The singers are P. T. Kirpichek and P. S. Bellinik, accompanied by the choir and orchestra of The Bolshoi Theatre, Moscow, and the songs are "From Border to Border," from Dzerzhinsky's opera, "Quietly Flows the Don," and "Cossack Song" from Dzerzhinsky's opera "Virgin Soil Uplurned." Ukrainian Folk Songs, "My Husband is a Cossack" and "I Sit Me Down," are sung by M. I. Litvenenko-Volgemut with Symphony Ensemble of Students of Kiev Conservatoire on *Decca F8078*, and the Russian baritone, V. P. Zakharov, has recorded "We Travel the Ocean" and "Death to the Enemies," on *Decca F8079*. Finally two marches, "Under the Soviet Flag," the Red Navy March, and "Anti-Nazi March," are played by The Orchestra of Peoples' Commissariat of Defence of the U.S.S.R. on *Decca F8080*.

Those readers who saw the film "Dangerous Moonlight" will remember "The Warsaw Concerto," which was one of the highlights of the film, and this month Mantovani and his Concert Orchestra have recorded this Concerto, on *Decca F8021*. You should make a point of hearing this record, which I have no hesitation in recommending.

It is hard to make a selection from the vocal recordings as they are all very good, so you can take your choice from the following. "Rose O'Day" (The Pilla-ga-dusha song) and "What More Can I Say," sung by Flanagan and Allen on *Decca F8067*; "Starlight Serenade" and "That Lovely Week-end," by Vera Lynn on *Decca F8081*; "Jealous" and "I'll Guess I'll Have to Dream the Rest," by Tony Martin on *Decca F8071*; and finally Frances Day sings "Daddy" and "I Walked into a Dream Without Knocking," on *Decca F8025*.

Frequency Modulation-1

A Brief Description of the Outstanding Features of This System of Radio Transmission

By L. O. SPARKS

THE radio broadcasting systems with which we are familiar in this country use amplitude modulation (A.M.) to superimpose the matter to be broadcast on the carrier wave. From the average listener's point of view, the method is quite satisfactory, until it is examined in the light of the results obtained with the more recent development of frequency modulation (F.M.) in America. A careful analysis of the two systems reveals the fact that F.M. has much in its favour, but whether the advantages it has to offer would compensate for the difficulties which would be encountered by the B.B.C. in trying to provide a satisfactory service over, say, the British Isles, is a problem which can be settled only by the experts.

Frequency modulation, as the American people know it to-day, is the product of ten years research by that noted American scientist Major Edwin H. Armstrong, who set out to find a transmitting system possessing a characteristic not present in man-made or natural static. After mastering the technical problems involved, several years were then spent in overcoming

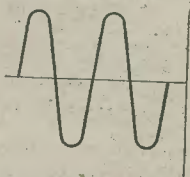

Fig. 1.—Graphical form of the single L.F. note.

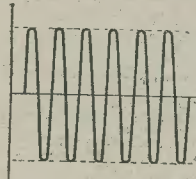

Fig. 2.—Constant amplitude "carrier wave."

industrial snags, and it was not until May, 1940, that the Federal Communications Commission cleared the way for F.M. to proceed with its commercial development.

By October, 1941, there were 30 F.M. transmitting stations in operation, and a further 42 under construction, in the U.S.A., while a considerable number of applications for additional stations were pending. The transmissions are radiated on a frequency band which lies between 42 and 50 megacycles, approximately 6 to 7.2 metres, and the effective service range of each station is in the region of 50 miles.

A.M. or F.M.

The quickest way to appreciate the outstanding features of F.M. is to compare the two systems, but to do this it is necessary to start from the studio of a station and observe the main operational points involved for both A.M. and F.M. In an endeavour to render the comparison and explanation as clear as possible, higher technicalities will be avoided.

In the studio, the sounds to be broadcast are converted into electrical equivalents by means of a microphone, the minute electric currents being amplified through the aid of thermionic valve amplifiers.

The heart of the transmitting station consists of a generator of oscillations having some pre-determined frequency. These oscillations are fed into a suitable aerial system, which allows them to radiate through the ether in the form of electro-magnetic waves. These waves strike or cut the receiving aeriols, and, in those tuned to the same frequency, create minute oscillations having the same characteristics as those transmitted, though, of course, much weaker. To enable the matter to be broadcast to be conveyed from the transmitter to the receiver, it is necessary to superimpose on the

oscillations just mentioned, the electrical output from the microphone system. This process is known as modulation, and the continuous stream of oscillations which convey such modulations is known, quite rightly, as the "carrier wave."

Let the sound produced in the studio be that of a single tone, which can be represented in a graphical manner by the curve shown in Fig. 1. In a similar manner, we can depict the carrier wave, but as its frequency is very much higher it takes the form shown in Fig. 2.

Comparing the Two Systems

We can now start to compare A.M. with F.M., the first step being to modulate the carrier wave by the single tone. The resultant effect for A.M. is the curve of Fig. 3, and for F.M., Fig. 4. Examining amplitude modulation first, it will be seen that the frequency of the carrier has not been affected, i.e., it remains constant. Its amplitude, however, has been altered, it is no longer constant; in fact, it has been increased by twice the amount A.B., and its new outline (modulation envelope) takes the approximate form of the modulating note (Fig. 1). The strips A.B. represent what is known as "side-bands," and they form a band of additional frequencies having a value equal to the sum of the frequency of the carrier and the frequency of the modulation, and equal to the difference between the carrier frequency and the modulation frequency. To simplify this statement, the frequency band-width covered by an amplitude modulated signal is equal to twice the highest frequency of the modulating signal. Supposing a violin in the studio produced a note having a frequency of 4,000 c/s, then the band-width of the radiated signal would have to be 8,000 c/s (8 kc/s) if the note is to be radiated in its true form.

To allow all the various transmitting stations to operate without interfering with each other it has been necessary to limit the frequency band-width of each station. Therefore, if this limit is, say, 10 kc/s, then, with amplitude modulation, according to the above violin example, the highest note which could be broadcast in its true form would be one having a frequency

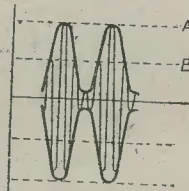

Fig. 3.—The "carrier wave" amplitude modulated.

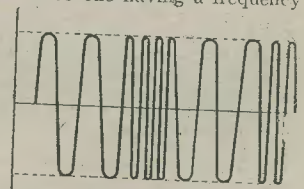

Fig. 4.—The same L.F. note used to frequency modulate the "carrier."

of 5,000 c/s. Musicians and listeners with a keen musical ear will understand the true meaning of this frequency limitation.

Frequency Modulation

Consider now, what happens when F.M. is used. Examination of the curve, Fig. 4, reveals that the amplitude of the modulated carrier remains constant, and that the effect of the modulation has been to vary its frequency. It should be noted that the "side-bands" of amplitude modulation are not present; therefore, the question of limiting the frequency of the modulating signal does not arise. With F.M., the frequency of the modulation is determined by the number of times the frequency of the carrier wave

can be varied per second, which means, virtually, that the limit is governed solely by the ability of the human ear to detect the upper frequencies, and, of course, the response capabilities of the L.F. circuits and the loudspeaker.

Power

With A.M. it is necessary for the transmitting station to be capable of handling four times its rated radiating power, and it is very essential for a continuous check control to be in operation to prevent overloading and the consequent possibilities of damage to the transmitting equipment and distortion. In actual practice, the minimum volume of the modulation has to be such that it is sufficient to overcome a certain noise level, but at the other end of the scale the maximum strength of the modulation often has to be reduced to keep within operating limits. In hard facts, this means that soft passages in an orchestral performance have to be made louder, and loud passages made softer. There is a term for this: it is "compression," and it has formed the subject for controversies since the early days of broadcasting.

The above defects of A.M. are rendered even less agreeable when comparison is made with F.M. With the latter, if a station is rated at 50 kW, then it can be built to have a maximum output of 50 kW, and, what

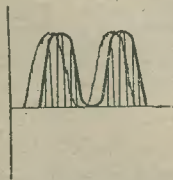

Fig. 5.—The static interference is still present on the amplitude modulated waves after detection.

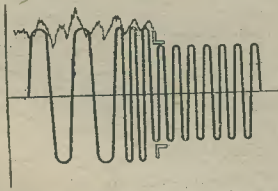

Fig. 6.—Showing how, in the case of frequency modulation, the static is "cut off" the received signal.

is also very important, its cost and upkeep are likewise reduced considerably. The station can, if so desired, be operated full-out all the time; the need for a check control to prevent overload and distortion does not exist, thus the serious drawback of "compression" is eliminated and the full true range of sounds can be transmitted.

Static Interference

The majority of static can be likened to a generator of amplitude modulated oscillations, which, unfortunately, invariably cover such a wide band of frequencies that it is not possible to tune them out.

Many attempts have been made to overcome them, but when receiving A.M. signals, the difficulties encountered have so far allowed little progress to be made. It is in this direction that a true F.M. receiver reveals one of its highlights, as it can and does prevent all the usual types of static, with which we are all only too familiar, from reaching the L.F. stages and the loudspeaker.

It should be understood that this is not due to the failure of static to effect F.M. transmissions and the aerial system of the receiver, but to the design and characteristics of the F.M. receiver. Before giving details of the receiver circuit, the graphical explanations provided by Figs. 5 and 6 should be examined. Fig. 5 shows how the static wave form is superimposed on the carrier-wave of an A.M. transmission. It also shows how, after rectification by the receiver, the unwanted wave form is still present and, therefore, reaches the speaker.

The effect on F.M. is clearly indicated by Fig. 6, where it will be seen that the static imposes itself on the wanted signal just as with A.M., but the diagram on the right shows how, during the passage of the signal through the F.M. receiver, the section of the carrier carrying the static is, so to speak, cut right off. But more about that next month.

YES! BE PREPARED

Times are difficult, but that is no reason why you should not be looking confidently forward to the future. Your future will be what you make it. Use your spare time to increase your earning power, then war or no war your future will be secure.



EARNING POWER IS A SOUND INVESTMENT

DO ANY OF THESE SUBJECTS INTEREST YOU ?

- | | | | | | | | | | | | | | | | | | | | | | | | | | | | | | | | | | | | | | | | | | | | | | | | | | | | | | | | | | | | | | | | | | | | | | | | | | | |
|--------------------------|----------------------------------|-------------|-----------------------------|-------------------|-------------------|-------------------------------|----------------------|-------------------|---------|-------------|---------|---|--------------|---|----------------------|-------------------------------------|-------------------|---------------|-------------------------|----------------|-------------------------|-------------------------------------|------------------|---------------|--|-------------------|-------------------|-------------------------|----------------------|----------------------|-----------|------------|-----------|-------------|---------------|------------|----------------------|--------------------------------|-------------------|-------------|--------------------------------|--------------------|---------------|----------------|--------------|------------------------|------------------------|-----------------|------------------------|-----------------------------|---------------------|---------------------------|------------------------|-----------------------------|------------------------|------------|---------------------------|--------------------|------------------|--------------|----------------------|---------------------|--------------------|------------------------|-----------|-------------------------|--------------------------|------------|------------------------|------------------------------|--------------------------------|---------|-----------------------------------|----------------|
| Accountancy Examinations | Advertising and Sales Management | Agriculture | A.M.I. Fire E. Examinations | Applied Mechanics | Army Certificates | Auctioneers and Estate Agents | Aviation Engineering | Aviation Wireless | Banking | Blue Prints | Bollers | Book-keeping, Accountancy and Modern Business Methods | B.Sc. (Eng.) | Building, Architecture and Clerk of Works | Builders' Quantities | Cambridge Senior School Certificate | Civil Engineering | Civil Service | All Commercial Subjects | Commercial Art | Common Prelim. E.J.E.B. | Concrete and Structural Engineering | Draughtsmanship. | All Branches. | Engineering. All branches, subjects and examinations | General Education | G.P.O. Eng. Dept. | Heating and Ventilating | Industrial Chemistry | Institute of Housing | Insurance | Journalism | Languages | Mathematics | Matriculation | Metallurgy | Mining. All subjects | Mining. Electrical Engineering | Motor Engineering | Motor Trade | Municipal and County Engineers | Naval Architecture | Novel Writing | Pattern Making | Play Writing | Police, Special Course | Preceptors, College of | Press Tool Work | Production Engineering | Pumps and Pumping Machinery | Radio Communication | Radio Service Engineering | R.A.F. Special Courses | Road Making and Maintenance | Salesmanship, I.S.M.A. | Sanitation | School Attendance Officer | Secretarial Exams. | Sheet Metal Work | Shipbuilding | Shorthand (Pitman's) | Short-Story Writing | Speaking in Public | Structural Engineering | Surveying | Teachers of Handicrafts | Telephony and Telegraphy | Television | Transport Inst. Exams. | Viewers, Gaugers, Inspectors | Weights and Measures Inspector | Welding | Wireless Telegraphy and Telephony | Works Managers |
|--------------------------|----------------------------------|-------------|-----------------------------|-------------------|-------------------|-------------------------------|----------------------|-------------------|---------|-------------|---------|---|--------------|---|----------------------|-------------------------------------|-------------------|---------------|-------------------------|----------------|-------------------------|-------------------------------------|------------------|---------------|--|-------------------|-------------------|-------------------------|----------------------|----------------------|-----------|------------|-----------|-------------|---------------|------------|----------------------|--------------------------------|-------------------|-------------|--------------------------------|--------------------|---------------|----------------|--------------|------------------------|------------------------|-----------------|------------------------|-----------------------------|---------------------|---------------------------|------------------------|-----------------------------|------------------------|------------|---------------------------|--------------------|------------------|--------------|----------------------|---------------------|--------------------|------------------------|-----------|-------------------------|--------------------------|------------|------------------------|------------------------------|--------------------------------|---------|-----------------------------------|----------------|

If you do not see your own requirements above, write to us on any subject. Full particulars free.

IF YOU ATTEND TO THIS NOW IT MAY MAKE A WONDERFUL DIFFERENCE TO YOUR FUTURE

COUPON

CUT THIS OUT



To DEPT. 104, THE BENNETT COLLEGE, LTD., SHEFFIELD.

Please send me (free of charge)

Particulars of..... (Cross out line which does not apply.)
Your private advice
about.....

PLEASE WRITE IN BLOCK LETTERS

Name.....

Address.....

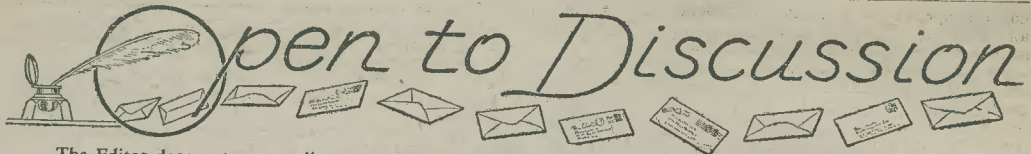

The Editor does not necessarily agree with the opinions expressed by his correspondents. All letters must be accompanied by the name and address of the sender (not necessarily for publication).

More Approval

SIR,—May I express my appreciation of the new series of articles, "Notes from an Amateur's Log," by 2CHW. According to the first article, the course that has been outlined I think is splendid, and the series should be very popular with the vast majority of your readers.

These articles appearing monthly will enable a lot more of us to take part, whereas if weekly, only a few who have a good deal of time on hand could do anything.

After these articles have gone as far as they can without actually covering transmitting, I think it would be very popular if subsidiary apparatus was described for transmitting to enable us to get on the "air" after the war with a really efficient station. I must add that I really think the standard of your journal has risen somewhat since the reduction in size.

I have found such articles as Radio Examination Papers, Analysing a Simple Circuit, Resonant Circuits, and The Importance of Capacity, extremely helpful to me.

Wishing PRACTICAL WIRELESS the continued success it certainly deserves.—G. A. PARRIS (Heathfield).

would not be missed as much as our beloved paper, but please do not go too highbrow.

As regards "Who is the Doyen?" I became interested in wireless in 1910 and obtained an "Experimenter's Licence" in that year and built my first set—a four-valver—everything home-made except valves and terminals. What a game it was, rubbing down spacing washers to get the vanes of the condenser to mesh without touching. Also, when extra 'phones were wanted, rewinding low-resistance type with 48 or 50 gauge d.s.c. wire. When Amplion brought out their first Junior loudspeaker, there was great joy in the household, and earpieces in pudding basins were discarded.

I have taken PRACTICAL WIRELESS from No. 1. I am fifty-eight next month, and am still keen and am always "fiddling" with my set, but regret that since I have retired and left London I cannot walk round the shops and pick up "bits" as I used to, and if one's junk box does not yield a transformer, resistor, or small condenser of the right value required, it is annoying to have to wait for perhaps a week for the post to bring it, but as long as we can get PRACTICAL WIRELESS we get along all right.—HERBERT S. G. BRAY (Sidmouth).

Frequency-changing Circuit

SIR,—I enclose a diagram of a circuit which is particularly suitable for the frequency-changing section of short-wave battery superhets. The oscillator is a simple E.C.O., with the coil split to enable A.V.C. voltages to be fed to the grid of the buffer-amplifier, which effectively isolates the oscillator itself from the associated circuits, and so cuts out pull-in on strong signals, instability with A.V.C. variation, and oscillator shift with tuning of the signal-grid circuit. If A.V.C. is not required, this coil can be connected as is normally done for an E.C.O. The output from the buffer stage is connected via a condenser of about 3 pfd. capacity to the screening-grid of the mixer; a resistance from the H.T. line applies the correct voltage to this electrode. The remainder of the circuit is quite conventional.

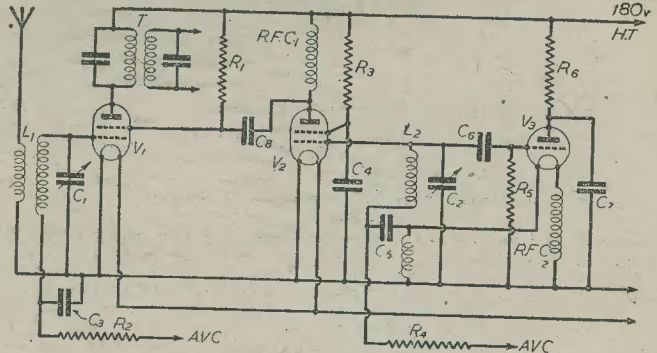

Frequency-changing circuit described by P. J. Waterton.

The "Sprite Three"

SIR,—You may be interested to hear of the performance of one of your circuits after five years of hard wear. The set in question is the "Sprite Three." I have just given it an overhaul for the second time, and I have not had to spend one penny on it.

I am very pleased with the new edition of PRACTICAL WIRELESS as regards its size and quality of contents. I have also three of your manuals, "Sixty Tested Circuits," "Everyman's Wireless," and "P.W. Service Manual," a very clear and helpful book.—A. MILLINGTON (Manor Park).

Battery Economy

SIR,—May I congratulate "Thermon" on his honest and outspoken comment on B.B.C. programmes. I agree with him entirely on the entertainment value of religious services, and I have serious doubts about their moral value. Indeed, when one reflects on what is being done, one can imagine roars of Homeric laughter on Olympus. But one fact should not be forgotten in these days of acute battery scarcity. Frequent religious

Who is the Doyen?

SIR,—I wish to congratulate you on the new-style PRACTICAL WIRELESS. Keep it going, please, whatever the cost. It will be worth it. A few cigarettes

and camouflaged religious, broadcasts effect a considerable economy on the "juice." They are the only programme items about which the family is unanimous.

Talking of battery economy reminds me of a means of cutting down consumption on three- or four-valve sets (if not superhets), especially if the Home or Forces programmes are heard at good volume locally. By taking a lead from the aerial terminal to the anode of the last screen-grid valve through a small condenser (about .001) and making a separate feed from L.T. to the detector valve, which is disconnected from the screen-grid valves, then only the detector and subsequent valves will be operating and consuming current. The output valve can be displaced by one of lower consumption, since the voltage "swing" will be greatly reduced. These adjustments can be made very easily, and if more distant stations are occasionally sought, by the insertion of two switches the L.T. and aerial can be taken back to their original points when in the "on" position.—JOHN F. McNEILL (Lemington).

Small Portable Receiver

SIR,—I have made the "Small Portable Receiver" described in the February issue, and results justify the making of same.

The circuit is exactly as published, with a variation of the case, which measures 8 x 12 x 4 (outside dimen-

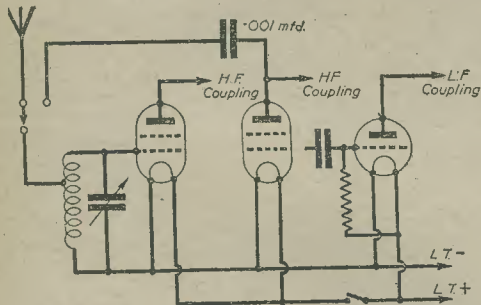

Circuit diagram showing Mr. J. F. McNeill's modification.

sions). The frame slots are cut to 1 1/16 in. as I used 24-gauge D.C.C., which only just sufficed.

H.T.—3 G.B. batteries 9 v. each, and L.T. a partly-used cycle-lamp battery. All components are out of the "junk box," and even the valves are two years old.

Our "dug-out" is situated next to an engine room, wherein is a battery of H.T. converters (A.C. to D.C.) which are running day and night, and underneath the steel girders just above one's head are the mains cables, anything up to 11,000 volts, so, you see, it was a very unfavourable spot to test the portable.

Home Service came in R 9+, and Forces programme faded at times. European News at R 5, and Breslau R.A. The set is critical in tuning and reaction is a little fierce. Valves—HIV L210 and Osram LF 210.—J. W. YOUEL (Handsworth).

Dry Cells for Battery Sets

SIR,—I read with interest, although not in approval of, Mr. D'arcy Ford's comments concerning the use of bell cells in place of accumulators. Being employed in the radio trade, I would like to mention several points gathered from past experience.

Firstly, I query Mr. Ford's extravagant claim of a year's service from a single cell, however lightly the set is used. My opinion here is based on the fact that even with the "all-dry" types of receiver, where the consumption of the filaments is far below that of normal valves, not more than, say, three months' service can be expected from the L.T. section of the composite battery.

The L.T. section invariably consists of six or eight

U.2 unit cells in parallel, and the estimate of three months' life is for only moderate use. I might add that, almost without exception, it is the L.T. which is exhausted first.

Again, at different times I have connected a 1 1/2 volt cell in place of the accumulators to a customer's portable when it was needed urgently and no fresh accumulator was at hand. But, as with all dry cells, the voltage dropped after very little use and results were very inferior, as compared with wet batteries.

Lastly, I expect if the valve manufacturers were consulted, they would strongly deprecate applying anything but the full two volts to the filament pins.—P. P. HORWOOD (Abbey Wood).

Colvern Coils Wanted

T. O. SMITH, of 12, Coplow Avenue, Leicester, is anxious to get in touch with a reader who has a pair of Colvern coils (KTF and KGR) he does not require.

Back Number Wanted

J. HIGHAMS, 216, Broadlands Road, Southampton, Hants, would be glad if any reader who has a spare copy of the December, 1941, issue of PRACTICAL WIRELESS would kindly forward it to above address. Postage will, of course, be refunded.

Valve Supplies

THE question of valve supplies has again been raised in the House of Commons; Mr. J. Dugdale asked the President of the Board of Trade if he had any further statement to make on the subject of radio valves, and Sir Andrew Duncan replied: "No, sir." And referred Mr. Dugdale to the reply given to Sir L. Lyle on December 10th.

This reply was to the effect that the Board of Trade appreciated the importance of keeping the maximum number of wireless sets in commission, subject to the over-riding claims of the Services, and it was hoped to ensure that a sufficient supply of valves would be available.

"The present production of most types of British valves," it was added, "should shortly be sufficient to meet the home maintenance demand, and the possibility of importing any necessary balance of valves of American types is under consideration."

Battery Supplies for Scotland

IN reply to a letter recently sent by Major Duncan McCallum, M.P. for Argyll, to the President of the Board of Trade, concerning the irregularity of supplies of wireless batteries to the county, the President states that the Ever Ready Co., Ltd., have given an assurance that the increased production had been maintained and that supplies to Scotland have been increased by, at least, 50 per cent.

"There seems, however," the President continues, "to be difficulties about distribution. Distribution in Argyllshire is done through wholesalers, and the Ever Ready Co. have, at our request, instructed their depot in Glasgow to investigate."

Taylor's Revised Prices

DUE to the rise in costs of material and higher rates of pay to skilled instrument makers, Messrs. Taylor Electrical Instruments, Ltd., inform us that they have been forced to revise the prices of their products, the new figures being: Model 90, £11 11s.; 95, £9 9s.; 81A, £15 15s.; 81C, £19 19s.; 60A, £14 14s.; 45, £15 15s.; 45P, £17 6s. 6d.; 47, £18 18s.; 47P, £20 9s. 6d.; 30, £26 5s. (Models 60B, 60U and 60L have been temporarily withdrawn.)

In our March issue, the All-wave Signal Generator produced by this firm was stated to cover "6.5 to 300 metres." It should have read, "6.5 to 3,000 metres."

Replies to Queries

Impedance and Optimum Load

"I understand there is a relationship between the impedance of a valve and its optimum load, but I have not been able to find out the exact ratio. As I am now carrying out some tests with L.F. amplifiers, would you be good enough to give me some information on the subject?"—G. Goodenough (Bromley).

WHEN considering triode valves, the optimum load can be taken as 2 to 2.5 times the impedance of the valve, but with L.F. pentodes, this ratio is reduced to 0.1 to 0.25 times. Valve-makers always specify the exact figure for the optimum load, and if such details are to hand, they should be used in preference to the above method.

Ganged Controls

"Is it possible to gang the tuning and reaction controls of a three-valve receiver which incorporates one stage of H.F. amplification?"

"I have been trying to get constant sensitivity over the medium-wave band without touching the reaction control, but when I try to gang it with the tuning condenser, I get violent oscillation at certain points. Can you give me any assistance?"—P. Collinson (Kew).

DESIGNERS have made many attempts to achieve the desired results, and although some ingenious circuits and components were evolved, the ultimate results were not satisfactory in all respects. The chief trouble is that caused by the varying load imposed by the aerial at different frequencies, and the fluctuation of other characteristics. It is, however, possible to get somewhere near the goal if one is prepared to spend some time experimenting with the detector stage, i.e., operating voltage, value of anode by-pass condenser, location and size of reaction coil and the shape of the moving vanes of the reaction condenser. Some amateurs favour "throttle" controlled circuits, while others fancy a S.G. valve as a detector and the use of a screen voltage control.

Distorted Reproduction

"My four valve A.C. receiver (1-v-2), which I constructed about a year ago, and which has been working in a most satisfactory manner, has lately developed distortion on certain notes and loud passages in the reproduction. Having failed to locate the cause of the trouble I shall be pleased if you can suggest possible source."—W. Hicks (R.A.S.C.).

AS no circuit or operating data has been provided we can only assume that operating voltages, etc., were originally in order. As the trouble does not affect all reproduction, we are inclined to suspect the detector and the output valves. If a leaky-grid detector is in use overloading could be responsible, but you can check up on this by inserting a m.A. meter or headphones in its anode circuit, to determine if distortion is present at that point. Falling characteristics, incorrect anode and bias voltages and overloading of the output valve would also produce the effect. Particular attention should be given to these items, and it would be worth while having the valve examined by the makers. If the anode voltage has fallen, due to a reduced output from the rectifier, the bias voltage must be readjusted. If R.C. coupling is used, a high voltage test should be applied to the coupling condenser.

Why Low-reading mA. Meter?

"I have been trying to get hold of the constructional details of a multi-range meter, to enable me to make use of my 0-10 mA. meter, but all the designs I have come across make use of a meter having a maximum scale reading of 0-1 mA. Is there some special reason for this, and does it mean that my meter is not suitable for a multi-range instrument?"—J. W. Short (Birmingham).

IN a multi-range meter, the voltage measurements are obtained by inserting suitable resistors in series with the applied voltage and the mA. meter. In other words, the meter indicates the current produced by the voltage and the resistor. Therefore, if, for example, a voltage of one volt is passed through a resistor of 1,000 ohms, the current would be 1 mA. If it was desired to measure 100 volts, a resistor of 100,000 ohms would have to be used, and for 200 volts a 200,000 ohm resistor, and so forth. This means that for a full-scale reading of the meter, a current of 1 mA. is flowing. If your meter was used a full-scale deflection would represent a current reading of 10 mA.—The resistor values would, of course, be different from those given above—but the very fact that 10 mA. was flowing in the meter circuit would produce misleading readings when voltage measurements were being taken, owing to the current drain imposed on the circuit under consideration, especially if high voltages were being measured.

RULES

We wish to draw the reader's attention to the fact that the Queries Service is intended only for the solution of problems or difficulties arising from the construction of receivers described in our pages, from articles appearing in our pages, or on general wireless matters. We regret that we cannot, for obvious reasons—

- (1) Supply circuit diagrams of complete multi-valve receivers.
- (2) Suggest alterations or modifications of receivers described in our contemporaries.
- (3) Suggest alterations or modifications to commercial receivers.
- (4) Answer queries over the telephone.
- (5) Grant interviews to quierists.

A stamped, addressed envelope must be enclosed for the reply. All sketches and drawings which are sent to us should bear the name and address of the sender.

Requests for Blueprints must not be enclosed with queries, as they are dealt with by a separate department.

Send your queries to the Editor, PRACTICAL WIRELESS, George Newnes, Ltd., Tower House, Southampton Street, Strand, London, W.C.E. The Coupon on page 224 must be enclosed with every query.

Rewinding a Speech Coil

"My moving-coil speaker ceased to function, and examination revealed the fact that the speech coil was broken down. I found this out by applying a continuity test across it after disconnecting the secondary winding of the speaker transformer. After removing the cone I unwound the speech coil and foolishly destroyed the wire before measuring its length or gauge. Can you tell me how much and what gauge wire I shall require to put on a fresh winding?"—H. Thomas (Kettering).

NO, it is impossible for us to give you the information. The length and gauge of wire will depend on the winding space available and the resistance (impedance) required to match up with the speaker transformer. As you have destroyed the wire we can only suggest that you get in touch with the makers of the speaker. If you know the ratio of the speaker transformer and the optimum load of the output valve, you could determine the impedance of the speech coil, then the D.C. resistance is approximately half that value. Therefore, you could calculate the length of a particular gauge of wire to give that resistance.

Eliminators for Q.P.P. or Class B Circuits

"I am using a receiver which has a Class B valve in its output circuit, and I was thinking of making an eliminator to alleviate the battery supply problem. Several of my friends tell me that it is not satisfactory to use a mains unit with Class B output owing to its widely varying current demand. Can you give me any advice on the matter and, if permissible, some hints regarding the construction of a suitable unit?"—P. J. Kerney (Cambridge).

OWING to the operating conditions of a Class B or Q.P.P. stage, its H.T. current consumption depends on the strength of the input signal. It often varies from 5 mA.'s to, say, 30 mA.'s, therefore, if this supply was drawn from an ordinary eliminator it would be found that the H.T. voltage would also vary, thus creating unsatisfactory operating conditions. It is possible, however, to construct an eliminator using a Westinghouse Metal Rectifier, type H.T.17, in a half-wave circuit, and provided that the output valve receives its H.T. direct from the H.T. positive output of the rectifier via a low resistance high inductance L.F. choke, and the other valves are fed through the usual choke-condenser smoothing circuit, also connected to the positive terminal of the rectifier, very satisfactory voltage regulation will be obtained.

REPLIES IN BRIEF

H. K. L. (York).—No, we cannot supply a blueprint of a circuit having the specification mentioned.

R. Y. (Andover).—The coil is satisfactory, provided that the wiring shown on the blueprint is modified to suit. We would advise the use of an H.F.C.

P. F. (Bristol).—See the article in March issue on "Overloading." A vibrator H.T. unit would be quite satisfactory.

C. H. (Bedford).—The trouble might be due to a microphonic valve. The bias should be adjusted according to the valve maker's instructions.

R. T. (Croydon).—Coil winding data is given in our issue of PRACTICAL WIRELESS for December, 1941. We cannot supply constructional details of components to individual requirements.

Tables of Valve Equivalents

3

BATTERY VALVES (British Bases)						
BRIMAR	EVER-READY	FERRANTI	COSSOR	MARCONI-OSRAM	MAZDA	MULLARD
—	—	—	215 S.G.	S.23	S.G.215	P.M.12
5B.1	K.40.B	—	220 S.G.	S.24	S.215A	P.M.12A
—	K.40.N	—	220 V.S.G.	VS.2	S.215.B	P.M.12V
—	K.50M	V.S.2	220 V.S.G.	VS.24	P.M.12M	P.M.12M
—	—	—	210 V.P.A.	W.21	V.P.210	V.P.2
—	—	—	210 S.P.T.	Z.21	SP.210	SP.2
—	—	—	230 L.P.T.	X.22	—	—
—	—	—	220 T.H.	X.24	—	—
—	K.80.A	V.H.T.2A	210 P.G.	X.22	—	—
—	K.80.B	V.H.T.2	210 S.C.G.	—	—	—
—	K.21.B	—	230 D.D.T.	—	HL21/DD	—
—	K.30.A	—	210 D.G.	—	—	—
—	K.30.C	—	210 R.C.	H.210	H.2	P.M.12G
—	K.30.K	—	210 H.L.	H.L.210	H.L.2	P.M.11L
H.L.B.1	K.30.C	—	210 H.L.	H.L.2	H.L.2	P.M.12HL
—	K.30.C	—	210 D.E.T.	L.2	L.2	P.M.12HF
—	K.30.B	—	210 L.F.	L.21	L.21	P.M.12DX
—	K.30.G	—	235 P.	P.215	P.215	P.M.12F
—	—	—	230 P.A.	—	P.220	P.M.2
P.B.1	—	—	230 X.F.	—	P.220.A	P.M.202

A.C. MAINS VALVES (British Bases) (Continued)						
BRIMAR	EVER-READY	FERRANTI	COSSOR	MARCONI-OSRAM	MAZDA	MULLARD
—	A.36.C	—	4 T.H.A. 41 M.H.G.	—	AC/THL	T.H.4B A.C./D.G. 48A.V.
—	A.30.B	—	41 M.H.F.	M.H.41	ACZ/HL	38A.V.
HLA.2	A.30.D	D.4	41 M.H.L.F.	M.H.4	AC/HL	28A.V.
HLA.2	—	—	41 M.L.L.F.	M.H.L.4	—	28A.V.
—	A.20.B	H.4.D.	D.D.4	V.914	—	2D.4A
—	A.23.A	—	D.D.4	AC/HLDD	—	2D.4A
—	—	—	D.D.4	AC/HLDD	—	2D.4A
—	A.70.B	—	41 M.K.X.P.	M.P.T.4	AC/P.	T.T.4
—	—	—	41 M.P.PEN	M.P.T.4	AC/PEN	—
—	A.70.C	—	42 M.P./PEN	M.K.T.4	AC/2/PEN	PEN.4.VA
—	A.70.D	P.T.4	—	N.41	—	—
—	—	—	—	K.T.41	AC6/PEN	PEN.4V.B
—	—	—	—	D.N.41	AC2/PENDD	PEN.4A
—	—	—	—	—	—	T.V.4
—	A.39.A	P.T.4D	—	—	—	AC.043
—	—	—	—	—	—	AC.044
—	S.30.D	L.P.4	—	—	—	P.M.24M
—	S.30.C	—	—	—	—	P.M.24B
—	—	—	—	—	—	—
PEN.A.1	—	—	—	—	—	—
—	—	—	—	—	—	—

4

BATTERY VALVES (British Bases)						
BRIMAR	EVER-READY	FERRANTI	COSSOR	MARCONI-OSRAM	MAZDA	MULLARD
PEN.B.1	K.70.B	P.T.2	220 P.T. 220 P.T.T.	K.T.2 K.T.2	PEN.200.A PEN.220	P.M.20C P.M.22A P.M.22
—	K.33A	—	220 O.T.	K.T.2	—	—
—	—	H.P.2	240 B.	—	P.D.220	P.M.2B
—	—	Q.P.T.2	240 Q.P.	Q.P.21	Q.P.230	Q.P.22B

A.C. MAINS VALVES (British Bases)						
BRIMAR	EVER-READY	FERRANTI	COSSOR	MARCONI-OSRAM	MAZDA	MULLARD
S.G.A.1	—	—	M.S.G./H.A. 41 M.S.G. M.V.S.G.	—	A.C/S2	S.4.V.A. S.4.V.B. M.M.4.V.
—	—	—	—	—	—	—
—	A.40.M	—	—	M.S.4.B M.V.4.B	—	—
8A.1	A.50.A	S.P.T.4A	M.S./PEN	V.M.S.4.B V.M.S.4	—	—
8A.1	A.50.N	V.P.T.4	M.V.S./PEN	V.M.P.4 V.M.P.4G	—	—
—	A.50.M	—	—	—	—	—
—	A.50.P	V.P.T.4B	—	—	—	—
—	A.50.A	—	M.S./PEN-B M.V.S.G.-B	—	—	—
15A.2	—	V.H.T.4	—	—	—	—
20A.1	—	—	—	—	—	—

RECTIFIER VALVES (U.X. and Octal Bases)						
BRIMAR	EVER-READY	FERRANTI	COSSOR	MARCONI-OSRAM	MAZDA	MULLARD
35 RE	—	—	—	—	—	85
25 RE	—	—	—	—	—	25Y5
25Z5	—	—	—	—	—	25Z5
80	—	—	—	—	—	80
84	—	—	—	—	—	84G
5Y4G	—	—	—	—	—	5Y4G

BATTERY VALVES (U.X. and Octal Bases)						
BRIMAR	EVER-READY	FERRANTI	COSSOR	MARCONI-OSRAM	MAZDA	MULLARD
1A7G	1A7G	1A7G	1A7G	X.14	—	1A7G
1N5G	1N5G	1N5G	1N5G	Z.14	—	1N5G
1H5G	1H5G	1H5G	1H5G	HD.14	—	1H5G
1C5G	1C5G	1C5G	1C5G	N.14	—	1C5G
1C6	1C6E	—	1C6E	—	—	1C6
1A4E	1A4E	—	1A4E	—	—	1A4
94E	94E	—	94E	—	—	15
32E	32E	—	32E	—	—	30
2102	2102	—	2102	—	—	2101
2103	2103	—	2103	—	—	2103
19	19	—	19	—	—	19

Classified Advertisements

ADVERTISEMENTS are accepted for these columns at the rate of 2s. per line or part of a line. Minimum charge 4s. All advertisements must be prepaid and addressed to Advertisement Manager, "Practical Wireless," Tower House, Southampton Street, London, W.C.2.

CABINETS

WE regret that, owing to all our employees having joined H.M. forces, we are unable to accept orders for cabinets except to callers. Limited stock only. We have a large stock of radio components.—H. L. Smith & Co., Ltd., 289, Edgware Road, London, W.2. Tel.: Pad. 5891.

LOUDSPEAKER REPAIRS

LOUDSPEAKER repairs, British, American, any make, moderate prices.—Sinclair Speakers, 12, Pembroke Street, Copenhagen Street, N.1.

LITERATURE, MAPS, etc.

AMATEUR Radio Handbook. Second edition now on sale. 328 pages, price 4s.—Radio Society of Great Britain, 16, Ashridge Gardens, London, N.13.

WEBB'S Radio Map of the World. Locates any station heard. Size 40" by 30", 4/6, post 6d. On linen, 10/6, post 6d. **WEBB'S** Radio Globe—12" model.—Radio prefixes, zones, etc., 2/7.6.—Webb's Radio, 14, Soho Street, London, W.1. GERrad 2089.

RADIO SOCIETY OF GREAT BRITAIN invites all keen amateurs to join. Reduced war-time subscriptions. Send 1s. for latest "T. & R. Bulletin" and details.—16, Ashridge Gardens, London, N.13.

TALKIES FOR ALL! "Practical Sound Conversion for Amateurs," shows you how to adapt any silent projector to sound. 5s. 6d. post free from F. G. Benson (PW), 89, Greenfield Avenue, Carpenders Park, Watford, Herts.

DETECTION. New theory, circuits practical experiments. Booklet 2/- post free.—D'Arcy Ford, Gandy Street, Exeter.

MORSE EQUIPMENT

FULL range of Transmitting Keys, practice sets and other equipment for Morse training.—Webb's Radio, 14, Soho Street, London, W.1. 'Phone: GERrad 2089.

NEW LOUDSPEAKERS

3,000 Speakers, P.M. and energised, 4in. to 14in., including several Epoch 18in.—Sinclair Speakers, 12, Pembroke Street, Copenhagen Street, N.1.

RECEIVERS AND COMPONENTS

AMPLIFIERS. All types of portable P.A. amplifiers built to order. First class components used. Specifications submitted for all requirements. Send your enquiries to Gee Electric, 15, Little Newport Street, London, W.C.2. Gerrard 6794.

GOULPHONE Radio, New Longton, Nr. Preston.—Brand new goods only. 8" Plessey and Goodmans P.M. Speakers with transformer, 22/6. Electrolytics, 500 v. 8 mfd., 4/-; 8+8 mfd., 7/9; 50 mfd. 50 v., 3/3. Erie 1 watt resistors, all values, 8d. ea. Tungstram valves, state equipments. S.A.E. for stock list.

COMPONENTS and S.W. Set. Very cheap. S.A.E. for List.—D. Allsop, 340, Lower Hasbury, Halesowen.

YOU CAN BECOME A SKILLED W/T OPERATOR by taking a CANDLER CODE COURSE.

There are opportunities for skilled operators in practically every branch of the Services. Many Candler students now hold Government positions.

LEARN MORSE THE CANDLER WAY

There are courses for the absolute beginner as well as for operators.

JUNIOR Scientific Code Course for beginners. It teaches all the necessary code fundamentals scientifically.

ADVANCED and High-Speed Telegraphing Course for operators who want to increase their w.d.m. speed and improve their technique.

TELEGRAPHY Touch - Typewriting Course for W/T operators who wish to use a typewriter for recording messages. Courses on Cash or Monthly Payment terms.

COUPON

Please send me a Free Copy of Candler "Book of Facts."

NAME

ADDRESS

Post Coupon in 1d. unsealed envelope to
CANDLER SYSTEM CO. (S.L.O.),
 121, Kingsway, London, W.C.2.
 Candler System Co., Denver, Colorado U.S.A.

RECEIVERS AND COMPONENTS

FRED'S RADIO CABIN,
 75, Newington Butts, S.E.11. Rodney 2180.
REMARKABLE PURCHASE ENABLES US TO OFFER THE FOLLOWING GOODS AT LESS THAN PRE-WAR PRICE. BUY NOW BEFORE STOCKS ARE EXHAUSTED.

MORSE KEYS on polished solid oak base, exactly as supplied to the Air Training Corps, etc., 4/6 each.

VALVE-HOLDERS, Clix Chassis mounting, 4-pin, 3d. each, 2/9 dozen. New.

TRIMMERS, 100 m.mfd. small type on paxolin base, 4d. each, 3/9 dozen. New.

PUSH BUTTON, 6-way, complete with knobs—a really fine job. 2/6 each. New.

BULGIN 2-way fuse holders, 8d. New.

T.C.C. Tubular condensers, 5 mfd. 350 v. wkg., 1/2 each. New.

T.C.C. Tubulars, 50 mfd. 12 v. wfg., also 25 mfd. 25 v. wkg. 1/3 each. New.

T.C.C. Tubulars, 25 mfd. 50 v. wkg. 1/6, also T.C.C. 50 mfd. 25 v. wkg., 1/6.

T.C.C. wire-end Tubulars, 0.1 mfd., 7d. each, 6/6 dozen, also .01 mfd. at 6d. each, 5/- dozen.

REACTION Condensers, .00015 mfd., 1/3 each. New.

SPEAKER GRILLES, Chromium frames, 5in. x 5in., 1/- each. New.

TRIMMERS. Set of four—100/400 m.mfd., 6d. set. New.

CRYSTAL Detectors, permanent type, 1/6 each. New.

TUBULARS, .05 mfd., 6d. each. New.

PYE mains dropping resistances, suit any receiver. New. 3/6 each.

MICA CONDENSERS. All useful values, 12 assorted, 2/- dozen.

TRIMMERS, Straight line type, capacity, 3.35 m.mfd., 6d. each.

SPEAKER GRILLES, 7in. x 3 1/2in., Chromium plated, cheap to clear, 1/6 each.

YAXLEY type switches, 3-point, 2-way, 1/- each. New.

CRYSTAL and Catswhisker in metal box. New stock at low price of 6d. each.

TUBULAR CONDENSERS. .25 mfd. 350 volt working, 9d. each. Also .0001, .0002, .0003 and .0005 mfd. 4d. each.

CONDENSERS. 2-gang screened small type, .005 mfd. with slow-motion drive, suitable for all-wave work. 4/6 each.

RESISTANCES. Brand new, 500, 1,200 and 100 ohms. 3/- dozen.

AMERICAN valveholders, 4, 6 and 7-pin, 5d. each.

VARIABLE CONDENSERS, mica dielectric, brand new, 6d. each, 5/- dozen.

MICROPHONES. Complete with transformer. Solid ebony job, full instructions included. 5/6 each.

Postage must be included. No C.O.D.

FRED'S RADIO CABIN FOR BARGAINS,
 75, Newington Butts, S.E.11. Rodney 2180.

New branch at 17, Hamilton Parade, London Road, North Cheam, Surrey.

TAYLOR 38 RANGE UNIVERSAL METER

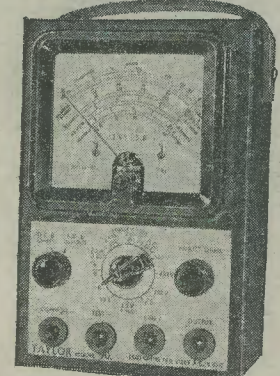

Sensitivity 1,000 ohms per volt A.C. and D.C. A precision instrument for electrical measurements for Radio and General test work.

Complete with leads, test probes and book of operating instructions. Details on request.

MODEL 90
£11-11-0

Write: Inst Sales & Service Dept.
 143a, High Street,
TAYLOR SLOUGH, Bucks.
 Telephone: Slough 21383

GEE GEE GEE GEE GEE GEE
 15, LITTLE NEWPORT STREET, W.C.2.
THE HOUSE FOR QUALITY COMPONENTS AT LOW PRICES

AMERICAN AND B.V.A. VALVES. Many types available. Send lists for quotation.

CONDENSERS. T.C.C., .1 mfd., tubular, 350 v., 7/6 doz. T.C.C. 25 mfd. 25v., brand new, 1/6 each. (Dozens only.)

MAINS DROPPERS. .2 amp, suitable for Lissen Pye, etc. Brand new, 3/9 each.

R.F. TRANSFORMERS. Brand new, 465 K.cyls. Special price to clear, 5/- per pair.

METAL RECTIFIERS. Brand new, 24 volt 6 amps. output. Few only to clear at 45/- each.

STAMPED ENVELOPE must accompany all enquiries.

GEE ELECTRIC, 15, LITTLE NEWPORT STREET, W.C.2. GERRARD 6794.

RECEIVERS AND COMPONENTS

RELIANCE RADIO SERVICE

8, Kennington Park Road, S.E.11.
Phone: REL. 2331.

All the following goods are brand new and unused. Purchase tax has been added where necessary.

MICROPHONES. Table model. Used with set with pick-up sockets. Or with phones and G.B. battery. Complete with transformer and full instructions. 7/6 each.

PUSH BUTTON UNITS. 6-way, complete with buttons. 2/6 each.

TRIMMERS. 4 on a strip. 100/400 mmf. 9d. each.

ADAPTORS. 5-pin, ideal for set testing. 1/- each.

MAZDA octal base valve-holders, ebonite, mounted on bracket, 1/3 each.

PYE CHOKES. 20 Henry, enclosed type. 4/- each.

MAINS TRANSFORMERS. 220 v. input, 4 v. at 1 amp. output. 6/- each.

MORSE KEYS. Fully adjustable. Just the job for beginners. 6/- each.

T.C.C. straight line trimmers. Ebonite base. 3-35 mmf. 9d. each.

REACTION Condensers. In three sizes: .00015 mfd., .0003 mfd., .0005 mfd. 1/3 each.

SPECIAL RESISTANCES. 330 ohm, 3 watt. These, when placed across the filament legs of a valve-holder in a U.S. set (Universal), will enable you to use an English type valve. (It changes the current from .3 amp. to .2 amp.). 2/6 each.

GRID CLIPS. For octal base valves. 2/- doz.

ERIE RESISTANCES. 1 per cent. tolerance. Hundreds in stock. Please send for lists. Standard type, 12,000 ohms, 7,000 ohms, 14 meg., 500 ohms, 100 ohms. All 1 watt. 7d. each.

T.C.C. tubular condensers. .1 mfd. 350 v. working. 8d. each. 7/6 doz. 25 mfd. 50 v. working, 50 mfd. 12 v. working. 2 mfd. 200 v. working, 1/6 each. 50 mfd. 25 v. working, 25 mfd. 50 v. working, 1/9 each.

B.I. tubular condensers. .02 mfd., .001 mfd., .005 mfd., .0001 mfd., .0002 mfd., .0003 mfd., .0005 mfd., all 350 v. working. 6d. each, 5/6 doz. Dubilier tubular, .1 mfd. 6,000 v. working. 3/6 each.

MICA CONDENSERS. Tag end. Dubilier and T.C.C. wire end. .00005 mfd., .0005 mfd., .0006 mfd., .0003 mfd., .002 mfd., also .0005 mfd. 3 per cent. tolerance. 6d. each. 3 per cent. tolerance, 7d. each.

TOGGLE SWITCHES. Double pole on-off type. 1/- each.

VALVE-HOLDERS. U.S. type. 4-, 6-, 7-pin, 6d. each. Octal 7d. each. English type, 5-pin, 4d. each. All are chassis mounting type. 5-pin baseboard mounting type, 3d. each.

T.C.C. Mansbridge type condensers. 1 mfd., 1/- each. .01 mfd., .001, .002, .004, .006, .000005, all 200 v. working, 9d. each.

VALVES. ECH33 equivalent to: 6TH8, 6K5, 6J8, 6J8, 6A8, octal base. EF39 equivalent to: 6U7, 6K7, KTW63, except when used in A.C./D.C. sets. Octal base. All the above valves 15/- each, including post and packing. Also CB131 Universal DD output pen. (octal base), can be used to replace Pen. DD 4020, DDPP39 ECF by changing the base, also as Pen 360 by leaving the diodes disconnected. 17/6 each. 1A7G, 1N5G, 15/- each; 78, 77, 10/- each.

RELIANCE RADIO SERVICE,
8, Kennington Park Road, S.E.11.
Phone: REL. 2331.

YOU MUST KNOW

"MATHS"

WE have already trained hundreds of men for radio duties with the R.A.F. and other vital war-time services. Now, in response to many requests, we have introduced new Mathematical Courses.

If you wish to join the R.A.F., or increase your efficiency in other war-work, you must know Mathematics. By our simplified method of Home Studying, you can at last learn this fascinating subject really thoroughly, in your spare time. Waste no time, but post coupon now for free details of our Home-Study Courses in Mathematics, Radio Calculations, Radio Servicing, Radiolocation, Television and Transmission.

T. & C. RADIO COLLEGE
29, Market Place, READING

(Post in unsealed envelope, 1d. stamp.)

Please send me free details of your Home-Study Mathematics and Radio Course.

NAME

ADDRESS

P.26

GALPINS ELECTRICAL STORES

ELEC. LIGHT CHECK METERS, small, late type, good makers, fine condition, electrically guaranteed, 200/250 volts 50 cv. 1 ph. A.C., 5 amp., 10/-; 10 amp., 12/6, post 1/-.

D.C. ELEC. LIGHT CHECK METERS, 200/250 v., 5 and 10 amps., 7/6, post 1/-.

AUTO. CHARGING CUT OUT AND VOLTAGE REGULATOR, ex-R.A.F., suit any dynamo up to 20 v. at 15 amps., fully adjustable, with wiring instructions, complete in metal case; 3/6, post 9d.

SOLID BRASS LAMPS fitted small B.C. double contact holder and 12-volt bulb, price 3/-, post free.

BLOCK CONDENSER, large size, -1 MF., 4,000 v. working, 15/-, carriage 2/-.

2 kW Transformer, complete with clamps, suitable for rewinding, 25/- each; 1 kW. ditto, 17/- both carriage paid.

DYNAMO for lighting or charging, shunt wound and interpole, output 110 volts 66 amps., price £20, carriage forward.

ZENITH VITREOUS Resistances, assorted, useful sizes, all good, 12/6 per doz., post free.

X-RAY TRANSFORMER, latest type, 110/220 v. to 90,000 v., 60 mA., £25; 110/220 v. to 45,000 v. at 7 mA., £12/10/-.

AUTO TRANSFORMER, tapped at 110, 200, 220 and 240 v., 1,500 watts, 25.

D.O. MOTORS, 110 or 220 v., laminated fields, approx. 1/2 h.p., £1 post free.

AUTO TRANSFORMER, 110 v. to 220 v. or vice versa, 10 kW., £15.

GREAT BARGAINS for visitors.

GALPINS ELECTRICAL STORES, 21, WILLIAM STREET, SLOUGH, BUCKS.

Cash or C.O.D.

Telephone: Slough 20855.

RECEIVERS AND COMPONENTS

F. H. WILSON, 52, Chancery Lane, London, W.C.2. Telephone: HOLborn 4631
B.I. Tubular Condensers. N.I. .0001, .0002, .0003, .0005, .005, .001, .05, .5d. each.

T.C.C. Tubular Condensers. .01, 5d. each; .1, 7d. each.

T.C.C. Tubular Electrolytics. 25 mfd. 25 v., 1/6 each. 50 mfd. 12 v., 1/6 each. 25 mfd. 50 v., 1/9 each. 50 mfd. 25 v., 1/9 each. 2 mfd. 300 v., 1/9 each.

MICA CONDENSERS. .0005 mfd., 6d. each.

VARIABLE CONDENSERS. Two gang, .0005, 2/9 each. Three gang, .0005, 3/11 each.

SPECIAL. All-wave two gang .0005 Variable Condensers. Ceramic Insulation, 4/- each.

PHILIPS Dual range Aerial coils, no reaction, with circuit, 1/6 each.

Also **I.F. TRANSFORMERS,** 180 kc/s, 1/6 each.

STRAIGHT LINE DIALS. 3 waveband, 1/6 each.

VALVE-HOLDERS. Chassis type, 4-pin, 4d. each; 5-pin, 6d. each, 7-pin, 6d. each. American and English-Octal Valve-holders, 6d. each. American 4- and 7-pin Valve-holders, 6d. each.

LOUDSPEAKER or Phone Cords, 4d. each. Battery Leads. Complete with plugs, 5-way. 1/6 each. Single Screened Cable, 9d. yard. Connecting Wire, 10ft. coils, 4d. each.

MAINS TRANSFORMERS. New line, 350-0-350, 4 v. 4 amps., 4 v. 2 amps., 80 milliamps. Brand new, 15/- each.

CHASSIS. Fine cadmium-plated chassis, ex famous manufacturers. Drilled 5 valves, etc. Approx. 10 x 7 x 3. Fine bargain. 1/3 each.

RESISTORS. 1/2 and 1 watt. Brand new. All popular sizes. State requirements. 1/2 watt, 4d. each. 1 watt., 6d. each.

MORSE TAPPERS. Brand new, fully adjustable on solid oak base. 5/- each.

SPECIAL AND INDIVIDUAL ATTENTION TO ALL ORDERS FROM MEMBERS OF H.M. FORCES.

All orders and enquiries must include sufficient postage to cover.

Please write Address in **BLOCK** letters.

F. H. WILSON, 52, Chancery Lane, London, W.C.2. Telephone: HOLborn 4631

SOUTHERN Radio's Wireless Bargains:—

7/6.—Assorted Components contained in attractive permanent box. 9 Assorted Valve Holders, 2 Volume Controls, 12 Assorted Condensers, 6 Resistances, Choke, Wire, Plugs, Circuits, etc. 7/6, postage 7d.

ORMOND Loud Speaker Units, Balanced Armature Types. Small Bakelite, 3/6; unshrouded, 2/6; largest 4-pole type, 6/6.

ACE P.O. Microphones ready for use on any receiver, 6/6. Westectors W2, 2/6.

TELSEN Radio Magazines, complete with 4 circuits, 9d. post free. Wireless Crystals, 6d. each, 5/- per dozen. Permanent Magnet Speakers, 8", complete with multi-ratio transformer, 20/-.

Many other bargains for callers. All goods guaranteed. Please add extra for postage.

SOUTHERN Radio Supply Co., 46, Lisle Street, London, W.C. Gerrard 6653.

PHILCO VALVES

AERIAL, H.F. AND I.F. COILS, VOLUME CONTROLS, ETC.

National Union and Tungram, British and American, Battery, A.C. and Universal Valves

No Lists. Please send stamp and state requirements.

E. H. ROBINS TRADING CO., LTD.

32, City Road, Cardiff.

Practical Wireless BLUEPRINT SERVICE

These Blueprints are drawn full size.
Copies of appropriate issues containing descriptions of these sets can in some cases be supplied at the following prices which are additional to the cost of the Blueprint. A dash before the Blueprint Number indicates that the issue is out of print.
Practical Wireless (issues dated prior to June 1st, 1940) 1d. Post Paid
(Issues dated June 1st to July 27th, 1940) 5d. Post Paid
(Issues dated September, 1940, to November, 1941) 7d. Post Paid
(Issues dated December, 1941, and after) 10d. Post Paid
Amateur Wireless 4d. " " " "
Wireless Magazine 1/4 " " " "
The index letters which precede the Blueprint Number indicate the periodical in which the description appears: Thus P.W. refers to PRACTICAL WIRELESS, A.W. to Amateur Wireless, W.M. to Wireless Magazine.
Send (preferably a postal order to cover the cost of the Blueprint, and the issue (stamps over 6d. unacceptable) to PRACTICAL WIRELESS, Blueprint Dept., George Newnes, Ltd., Tower House, Southampton Street, Strand, W.G.2.

PRACTICAL WIRELESS	No. of Date of Issue, Blueprint.	Universal 45 Superhet (Three-valve)	PW44
CRYSTAL SETS		F. J. Camm's A.C. Superhet 4	PW59
Blueprints, 6d. each.		F. J. Camm's Universal 44 Superhet 4	PW60
1937 Crystal Receiver	PW71	" " Qualitone " Universal Four " "	PW73
The "Pyramid" crystal Set	27.8.38 PW94	Four-valve: Double-sided Blueprint, 1s. 6d.	
STRAIGHT SETS. Battery Operated.		Push Button 4, Battery Model	22.10.38 PW95
One-valve: Blueprints, 1s. each.		Push Button 4, A.C. Mains Model	
All-Wave Unipen (Pentode)	PW31A	SHORT-WAVE SETS. Battery Operated.	
Beginners' One-valver	19.2.38 PW85	One-valve: Blueprint, 1s.	
The "Pyramid" One-valver (HF Pen)	28.8.38 PW93	Simple S.W. One-valver	23-12-39 PW88
Two-valve: Blueprint, 1s.		Two-valve: Blueprints, 1s. each.	
The Signal Two (D & LF)	24.9.38 PW76	Midget Short-wave Two (D, Pen)	PW38A
Three-valve: Blueprints, 1s. each.		The "Fleet" Short-wave Two (D (HF Pen), Pen)	27.8.38 PW91
Selectone Battery Three (D, 2 LF (Trans))	PW10	Three-valve: Blueprints, 1s. each.	
Summit Three (HF Pen, D, Pen)	PW37	Experimenter's Short-wave Three (SG, D, Pow)	PW30A
All Pentode Three (HF Pen, D (Pen), Pen)	PW39	The Prefect 3 (D, 2 LF (RC and Trans))	PW63
Hall-Mark Three (SG, D, Pow)	PW41	The Band-Spread S.W. Three (HF Pen, D (Pen), Pen)	PW68
Hall-Mark Cadet (D, LF, Pen (RC))	PW48		
F. J. Camm's Silver Souvenir (HF Pen, D (Pen), Pen) (All-Wave Three)	PW49	PORTABLES	
Cameo Midget Three (D, 2 LF (Trans))	PW51	Three-valve: Blueprints, 1s. each.	
1938 Sonotone Three-Four (HF Pen, HF Pen, Westecor, Pen)	PW53	F. J. Camm's E.L.F. Three-valve Portable (HF Pen, D, Pen)	PW65
Battery All-Wave Three (D, 2 LF (RC))	PW55	Parvo Flyweight Midget Portable (SG, D, Pen)	3.6.39 PW77
The Monitor (HF Pen, D, Pen)	PW61	Four-valve: Blueprint, 1s.	
Victor Three (HF Pen, D, Pen)	PW62	"Imp" Portable 4 (D, LF, LP (Pen))	PW86
The Centaur Three (SG, D, P)	PW64	MISCELLANEOUS	
F. J. Camm's Record All-Wave Three (HF Pen, D, Pen)	PW69	Blueprint, 1s.	PW45A
The "Colt" All-Wave Three (D, 2 LF (RC & Trans))	18.2.39 PW73	S.W. Converter-Adapter (1 valve)	
The "Rapid" Straight 3 (D, 2 LF (RC & Trans))	PW82	AMATEUR WIRELESS AND WIRELESS MAGAZINE CRYSTAL SETS.	
F. J. Camm's Oracle All-Wave Three (HF, Det, Pen)	PW78	Blueprints, 6d. each.	
1938 "Triband" All-Wave Three (HF Pen, D, Pen)	PW84	Poststation Crystal Set	AW427
F. J. Camm's "Sprite" Three (HF Pen, D, Tet)	26.3.38 PW87	1934 Crystal Set	AW444
The "Hurricane" All-Wave Three (SG, D (Pen), Pen)	PW89	150-mile Crystal Set	AW450
F. J. Camm's "Push-Button" Three (HF Pen, D (Pen), Tet)	3.9.38 PW92	STRAIGHT SETS. Battery Operated.	
Four-valve: Blueprints, 1s. each.		One-valve: Blueprint, 1s.	AW387
Fury Four (2 SG, D, Pen)	PW11	B.B.C. Special One-valver	AW387
Beta Universal Four (SG, D, LF, Cl.B)	PW17	Two-valve: Blueprints, 1s. each.	
Nucleon Class B Four (SG, D (SG), LF, Cl. B)	PW34B	Melody Ranger Two (D, Trans)	AW388
Fury Four Super (SG, SG, D, Pen)	PW34C	Full-volume Two (SG det, Pen)	AW392
Battery Hall-Mark 4 (HF Pen, D, Push-Pull)	PW46	A Modern Two-valver	WM403
F. J. Camm's "Limit" All-Wave Four (HF Pen, D, LF, P)	PW67	Three-valve: Blueprints, 1s. each.	
"Acme" All-Wave 4 (HF Pen, D (Pen), LF, Cl. B)	12.2.38 PW83	25.58 SG 3 (SG, D, Trans)	AW412
The "Admiral" Four (HF Pen, HF Pen, D, Pen (RC))	3.9.38 PW90	Lucerne Ranger (SG, D, Trans)	AW422
Mains Operated		45.58. Three: De Luxe Version (SG, D, Trans)	19.5.34 AW455
Two-valve: Blueprints, 1s. each.		Transportable Three (SG, D, Pen)	WM371
A.C. Twin (D (Pen), Pen)	PW18	Simple-Tune Three (SG, D, Pen)	WM327
A.C. D.C. Two (SG, Pow)	PW31	Economy Pentode Three (SG, D, Pen)	WM337
Selectone A.C. Radiogram Two (D, Pow)	PW19	"W.M." 1934 Standard Three (SG, D, Pen)	WM351
Three-valve: Blueprints, 1s. each.		25.38. Three (SG, D, Trans)	WM354
Double-Diode-Triode Three (HF Pen, DDT, Pen)	PW23	1935 45.6s. Battery Three (SG, D, Pen)	WM371
D.O. Ace (SG, D, Pen)	PW25	PTP Three (Pen, D, Pen)	WM389
A.C. Three (SG, D, Pen)	PW29	Certainty Three (SG, D, Pen)	WM393
A.C. Leader (HF Pen, D, Pow)	7.1.39 PW35C	Mintube Three (SG, D, Trans)	Oct. '35 WM396
D.C. Premier (HF Pen, D, Pen)	PW35B	All-Wave Winning Three (SG, D, Pen)	WM400
Unique (HF Pen, D (Pen), Pen)	PW36A	Four-valve: Blueprints, 1s. 6d. each.	
Armada Mains Three (HF Pen, D (Pen))	PW38	65s. Four (SG, D, RC, Trans)	AW370
F. J. Camm's A.C. All-Wave Silver Souvenir Three (HF Pen, D, Pen)	PW50	Self-contained Four (SG, D, LF, Cl. B)	WM331
"All-Wave" A.C. Three (D, 2 LF (RC))	PW54	Lucerne Straight Four (SG, D, LF, Trans)	WM350
A.C. 1938 Sonotone (HF Pen, HF Pen, Westecor, Pen)	PW56	25.58. Battery Four (HF, D, 2LF)	WM381
Mains Record All-Wave 3 (HF Pen, D, Pen)	PW70	The H.K. Four (SG, SG, D, Pen)	WM384
Four-valve: Blueprints, 1s. each.		The Auto Straight Four (HF, Pen, HF Pen, DDT, Pen)	4pr. '36 WM404
A.C. Fury Four (SG, SG, D, Pen)	PW20	Five-valve: Blueprints, 1s. 6d. each	
A.C. Fury Four Super (SG, SG, D, Pen)	PW34D	Super-quality Five (2 HF, D, RC, Trans)	WM320
A.C. Hall-Mark (HF Pen, D, Push-Pull)	PW45	Class B Quadradyne (2 SG, D, LF Class B)	WM344
Universal Hall-Mark (HF Pen, D, Push-Pull)	PW47	New Class B Five (2 SG, D, LF Class B)	WM340
SUPERHETS.		Mains Operated.	
Battery Sets: Blueprints, 1s. each.		Two-valve: Blueprints, 1s. each	
45 Superhet (Three-valve)	PW40	Consoelectric Two (D, Pen) A.C.	AW403
F. J. Camm's 2-valve Superhet	PW62	Economy A.C. Two (D, Trans) A.C.	WM286
Mains Sets: Blueprints, 1s. each.		Union A.C. D.C. Two (D, Pen) 1	WM394
A.C. 45 Superhet (Three-valve)	PW43	Three-valve: Blueprints, 1s. each.	
A.C. 45 Superhet (Three-valve)	PW42	Home Lover's New All-Electric Three (SG, D, Trans) A.C.	AW388
		Mantovani A.C. Three (HF, Pen, D, Pen)	WM374
		215.15. 1935 A.C. Radiogram (HF, D, Pen)	WM401
		Four-valve: Blueprints, 1s. 6d. each.	
		All Metal Four (2 SG, D, Pen)	WM329
		Harris' Jubilee Radiogram (HF, Pen, D, LF, P)	May '35 WM386
		SUPERHETS.	
		Battery Sets: Blueprints, 1s. 6d. each.	
		"Varsity" Four	Oct. '35 WM395
		The Request All-Waver	WM407

FREE ADVICE BUREAU COUPON
This coupon is available until April 4th, 1942, and must accompany all Queries and Hints.
PRACTICAL WIRELESS, April, 1942.

AMBITIOUS ENGINEERS



HAVE YOU HAD YOUR COPY OF "ENGINEERING OPPORTUNITIES"?

Whatever your age or experience—whether you are one of the "old school," or a new-comer to Engineering anxious to hold your position in peace-time—you must read this highly informative guide to the best paid Engineering posts.

The Handbook contains, among other intensely interesting matter, particulars of **B.Sc., A.M.I.C.E., A.M.I.Mech.E., A.M.I.E.E., A.M.I.A.E., A.M.I.P.E., A.M.Brit.I.R.E., CIVIL SERVICE** and other important Engineering Examinations; outlines courses in all branches of **CIVIL, MECHANICAL, ELECTRICAL, AUTOMOBILE, RADIO, TELEVISION, AERONAUTICAL and PRODUCTION ENGINEERING, GOVERNMENT EMPLOYMENT, BUILDING** (the great after-war career), "**R.A.F. MATHS.**", **MATRICULATION**, etc., and explains the unique advantages of our Employment Department.

WE DEFINITELY GUARANTEE "NO PASS—NO FEE"

If you are earning less than £10 a week, you cannot afford to miss reading "**ENGINEERING OPPORTUNITIES**"; it tells you everything you want to know to *secure your future* and describes many chances you are now missing. In your own interests we advise you to send 2½d. stamp for your copy of this enlightening guide to well-paid posts and subsequent literature **NOW**.

BRITISH INSTITUTE OF ENGINEERING TECHNOLOGY

Principal: Professor A. M. & O. W.
409a, SHAKESPEARE HOUSE,
17, 18 & 19, STRATFORD PLACE, LONDON, W.1

MATRIC

LONDON

MATRICULATION

IS THE KEY TO ALL CAREERS.

FOR DETAILS OF SPECIAL WAR-TIME STUDY SCHEME SEND 2½d. STAMP.

B. I. E. T.
(Dept. B.409a),
17, Stratford Place, W.1.

TEAR OFF HERE

COUPON

British Institute of Engineering Technology,
409a, Shakespeare House,
17-19, Stratford Place, W.1

Please forward your Handbook, "ENGINEERING OPPORTUNITIES," and subsequent literature, for which I enclose 2½d. stamp.

NAME.....

ADDRESS.....

.....

.....

State "Branch" of interest.....

Published on the 7th of each month by GEORGE NEWNES, LIMITED, Tower House, Southampton Street, Strand, London, W.C.2, and printed in England by THE NEWNES & PEARSON PRINTING CO., LTD., Exmoor Street, London, W.1D. Sole Agents for Australia and New Zealand: GORDON & GOTCH, LTD. South Africa: CENTRAL NEWS AGENCY, LTD. Subscription rates including postage: Inland 10s. 6d. per annum; Abroad 10s. per annum. Registered at the General Post Office for the Canadian Magazine Post.