

Greatly Enlarged Xmas Number!

# Practical and Amateur Wireless

**4<sup>D</sup>**  
EVERY  
WEDNESDAY

Edited by F.J. CAMM

a GEORGE  
NEWNES  
Publication

**AND PRACTICAL TELEVISION**

Vol. 11. No. 272. December 4th, 1937.

### MANY GRAND XMAS FEATURES

Including:

- Using Microphones and Pick-ups
- A Radio Play
- Room-to-Room Communication
- Extension Loudspeakers
- Xmas Presents
- Radiograms and Records
- Etc., Etc.



A NEW **Stentorian**

For a **HAPPY RADIO CHRISTMAS!**



# 1947

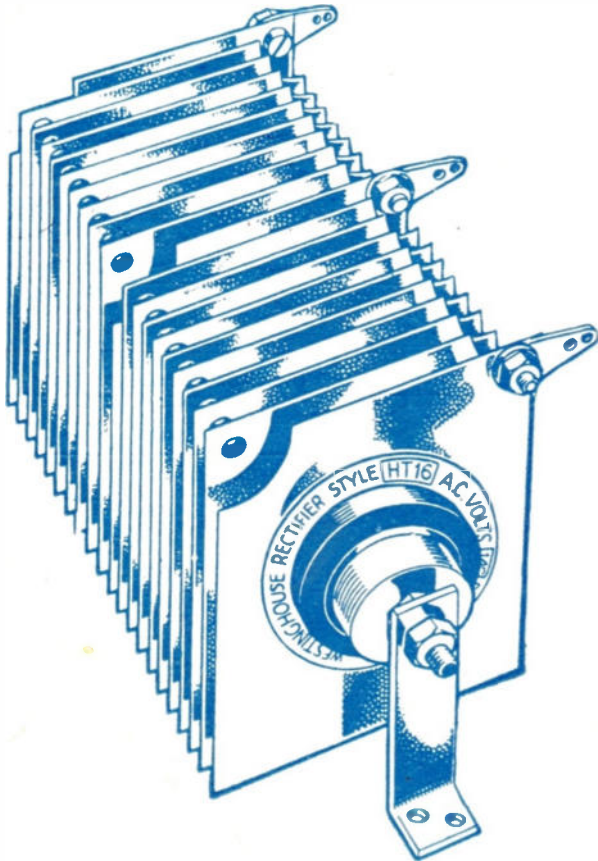

It is significant that Westinghouse Metal Rectifiers are continually used by all Government Departments, where a life of 15-20 years is required of all apparatus installed. Put a metal rectifier in your receiver now, and you may safely expect it to be delivering its rated output in 1947, or even 1957. No other rectifier can in any way approach such a performance for long life and efficiency.

Send 3d. to Dept. PRA. for a copy of "The All Metal Way, 1938"



## METAL RECTIFIERS

*for long life and constant output*

WESTINGHOUSE BRAKE & SIGNAL CO., LTD., 82, York Road, King's Cross, London, N.I.  
 Please send me a copy of "THE ALL-METAL WAY, 1938," for which I enclose 3d. in stamps.

Name .....  
 Address .....

Pract.W.4 12.37.

# BUILD THE D—XMASTER—See Page 319

# Practical and Amateur Wireless

## Round

### Greetings!

IT is the custom for Christmas numbers to be published somewhat in advance of the actual week in which the festival is celebrated, and thus we present this week our greatly enlarged number designed for Christmas consumption. To all our readers we wish to convey the Compliments of the Season and our very best wishes for an enjoyable Christmas. To signalise the event, we present numerous articles of interest, together with a play which may be produced to enliven the proceedings and to make the party spirit all the more enjoyable. In addition, there are full constructional details for two broadcast receivers and a room-to-room communication set which will be found of great interest and value. Among the general articles are those dealing with the use of microphones and pick-ups, Broadcasting Your Own Play, and the usual regular features, such as Wrinkles from Readers, Practical Television, Short-wave Section, and so on. To all those who have been readers from No. 1, as well as to all new readers, we again repeat, a Merry Christmas.

### Police Radio

ANOTHER proof of the value of radio to the police authorities has been given in the London area where a wanted man was reported to own a Rolls-Bentley car, and a police broadcast was made to this effect. Ten minutes later officers in a patrol car saw the car and stopped it. As a result the wanted man was arrested.

### Television by Wire

THE news recently published concerning German wired-television tests has been eclipsed by British engineers. During some recent experiments it was found possible to transmit and receive good pictures over 400 miles of land line, and a much higher definition was employed than in the German system.

### Philips Broadcast, 1938

THIS film which, as has already been mentioned in these pages, has been circulated throughout the country will, when the present series of bookings finishes, be released for retailers who wish to make their own arrangements for having it shown locally. The film is available free, on loan, from December 6th onwards.

### Christmas Packing

IT is announced that the novel Pye Baby Q Portable is now available in a special Christmas packing, with labels

Edited by  
F. J. CAMM

Technical Staff:  
W. J. Deane, H. J. Barton Chapple, Wh.Sch.  
B.Sc., A.M.I.E.E., Frank Preston.  
Vol. XI. No. 272. December 4th, 1937.

## the World of

ready to despatch. A slogan "Here's to a Happy Christmas" is affixed and the general colour scheme of the whole presentation blends easily with the usual holly (green and red) motif of window and other decorations.

### World Radio Convention

A WORLD Radio Convention is to be held in Sydney, N.S.W. from April 4th to 14th, 1938. A cordial invitation

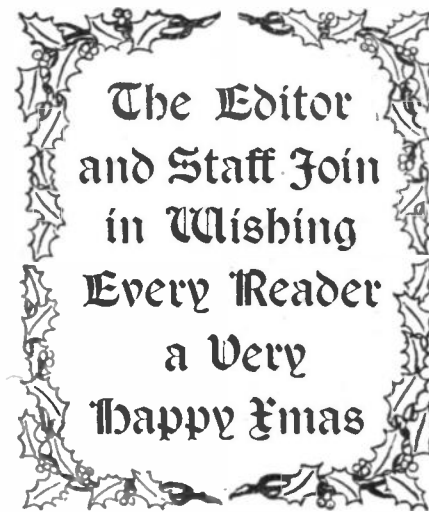

is extended on behalf of the Institution of Radio Engineers to all visitors to Australia during the Celebration period, which commences on January 26th and concludes on April 25th, 1938.

### More Electric Wiring

IT is announced, as a result of a recent survey, that owing to the increasing demand for electric-mains-operated radio receivers, more homes are being wired for the electric supply. There is thus a general improvement in domestic lighting as well as in the use of other useful electrical apparatus, which has resulted from the use of radio equipment.

## Wireless

### Note These Changes

AS a result of the introduction of a new Melnik transmitter to be called Praha 11, the wavelength of Moravska Ostrava will be changed to 249.2 metres—1,204 kc/s, and Praha 11 will transmit on the former wavelength of Moravska Ostrava, namely 269.5 metres—1,113 kc/s. The changes will be made early this month, as soon as the new transmitter is completed.

### Telepathy Tests

TO endeavour to prove whether or not telepathy can be carried out through radio, the National Broadcasting Company of New York recently carried out some tests in conjunction with several of America's leading scientists. A colour selection was employed, and the results given by listeners were stated to be approximately one-third above the mathematical laws of chance in the point of correctness.

### New Variety Feature

A NEW weekly variety feature is to be added to the list of B.B.C. programmes shortly to start. This is to be called "Band Waggon," and will have an experimental run of about six weeks. John Watt, B.B.C. Director of Variety, will then decide whether its success warrants its continuation. The feature is to be based upon the dance band and will be produced by Gordon Crier. Arthur Askey is to be resident comedian. An important feature of this item is that it is hoped to find room in it for artists who have never before had a chance of broadcasting though they have passed a B.B.C. audition. The B.B.C. announce that they hope to use three of such people in each programme, and it will run for 45 minutes.

### Xmas Presents Appeal

ON December 6th, an appeal is to be made in the Midland Children's Hour for presents for Christmas for poor children. The appellant is Binnie Hale, who is to be the principal attraction at Emile Littler's Prince of Wales Theatre pantomime in Birmingham this season.

### Effects of Broadcasting?

THE manufacturers of musical instruments are reporting increasing sales. Does this indicate that the effects of broadcast music are such that more people are now becoming interested in performing on various instruments and are thus taking up a musical profession?

# ROUND the WORLD of WIRELESS (Continued)

## Broadcasts from Cinemas

MANY listeners will welcome an arrangement which has been made between the B.B.C. and cinema managers, as a result of which more variety turns are to be broadcast from cinemas. It means that artistes of the first rank will be heard more often. The first broadcast under the new scheme was given on November 25th from a Clapham cinema, and others will be given on December 14th, and on December 20th. In the New Year relays of variety programmes from cinemas are likely to become a regular feature.

## "Serenade in the Night"

WHILE working in the Mitcham district recently, B.B.C. engineers picked up that haunting melody, "Serenade in the Night." They traced the broadcast to the house of a young amateur who was playing the record on his unlicensed transmitter. The magistrate fined the offender 40s. and told him he must get his licence. The moral is obvious.

## Japan's School Radio

MISS MARY SOMERVILLE, B.B.C. director of school broadcasts, who recently returned from a world tour, was greatly impressed by the general attitude towards children in Japan. According to Miss Somerville, Japan offers children greater educational resources than we do in this country, and she would like to see experiments on Japanese lines of broadcasts to infant schools.

## Red Indians on the Air—

ACCORDING to a recent report, talks by Red Indian chiefs are to be a feature for Canadian radio listeners in the near future.

## Extending Television!

IT was stated recently by the Assistant Postmaster-General that further experience of the working of the London television station will be necessary before the Advisory Committee, presided over by Lord Selsdon, can make definite recommendations for the establishment of other stations for providing a television service in other areas.

## Variety from Carlisle and Leeds

IN the Northern programme on December 8th "Northern Music Hall" will bring a variety relay from Her Majesty's Theatre, Carlisle, and "Northern Concert Party on Tour"—an excerpt from the Arcadian Follies' show at the Grand Theatre, Leeds, a playhouse which has not been on the air for some time. The theatre has indeed a "grand" style—it was constructed in the eighteen-seventies on similar lines to the famous Opera House at Milan. It has twenty-two boxes and altogether can accommodate over 2,000 people. Wilson Barrett was the first lessee.

## INTERESTING and TOPICAL NEWS and NOTES



THE CRAZY GANG from the London Palladium—stars of the recent Command Performance—are all proud owners of Pilot receivers in their homes. Here they are seen in their dressing-room listening intently to a Pilot Model CU-535.

## SOLVE THIS!

### PROBLEM No. 272.

Nicholls constructed an A.C./D.C. set of the H.F. Detector, Pentode type, connecting the valve heaters in series, with the H.F. valve joined to the negative mains lead. Reception could not be obtained until the aerial lead was connected to the cap of the H.F. valve. The H.F. valve was tested and found to be in order; the correct voltage was applied to its anode, but it did not pass any heater current. Where was the fault? Three books will be awarded for the first three correct solutions opened. Solutions should be addressed to The Editor, PRACTICAL AND AMATEUR WIRELESS, George Newnes, Ltd., Tower House, Southampton Street, Strand, W.C.2. Envelopes must be marked Problem No. 272 in the top left-hand corner and must be posted to reach this office not later than the first post on Monday, December 6th, 1937.

### Solution to Problem No. 271.

The dropping resistance had been chosen to pass .1 amp. to suit the original valves. When a .2 amp. pentode was used in the output stage, the current passed through the filament of this valve was too low. The following three readers successfully solved Problem No. 270, and books are accordingly being forwarded to them: R. B. Warr, 342, Yardley Wood Road, Moseley, Birmingham; J. Richards, 25, Kings Place, Buckhurst Hill, Essex; J. Munday, 3, Paston Place, Kempton, Brighton.

## India's New Short-wave Stations

IT is anticipated that the first of the new 10 kW short-wave stations for India, which is to be installed at Delhi, will be operating by the end of the year. The transmitter for the new Bombay station is being installed during the present month. The new equipment, which embodies the latest developments in broadcasting technique, will provide India with the nucleus of a highly efficient broadcasting system.

## In Remembrance of Marconi

IT is reported that at the instigation of Signor Mussolini the Italian Government has made the birthday of the late Marchese Marconi a National Memorial Day.

## Our Village: Getting Ready for Christmas

STANWELLSTEAD folk are going ahead with their Christmas preparations, and on December 2nd listeners will hear about winter flowers, the making of Christmas gifts, lace-making, glove-making, and similar home industries.

## Coast Radio Pioneer

SIR CHARLES BRIGHT, pioneer of coast wireless stations and radio in aircraft, died recently at his home at Bishop's Stortford. He was seventy-three years old.

## Military Band and Vocalist

HAYDN HEARD will conduct the Birmingham Military Band, which he founded about a year ago, in a popular programme on December 8th. The vocalist will be Frances Fox,

the blind soprano from the Black Country; she was first in the Midlands in the Gaumont Golden Voice contest.

## Theme Song

FAMOUS songs from famous films will be presented on December 2nd by the B.B.C. Welsh Orchestra (Variety Section) and a revue chorus conducted by Mansel Thomas. The programme has been devised by Mai Jones, and it will be produced and presented by Glyn Jones, whose programmes, "When Day Is Done" and "By Firelight," have become very popular. The soloists will be Elsie Eaves, Teifion Williams and Morgan Davies.

## Broadcast from a Submarine

IT is reported that voice signals have been successfully broadcast direct from a submerged submarine for the first time by radio engineers in Connecticut, U.S.A. The signals, transmitted from a submarine submerged off Bartlett Reef Light, were picked up ten miles away at the naval submarine base at New London. Hitherto, broadcasts from submarines have been made over a waterproof cable line to a short-wave transmitter on the surface.



# Constructing the D-Xmaster

## A Simple Three-valve Receiver for the Medium and Long-wave Bands Only

OUR recent all-wave designs have aroused tremendous interest amongst home-constructors, but there are still many who do not require short-wave reception. In some cases this is due to a prejudice concerning the results which are obtainable, and in others the listener is already using a standard short-wave receiver. To those in the first category,

may be unable to hear even a trace of the signals.

### The Circuit

The first consideration in designing a receiver for what might be termed "all-round" results, is a good H.F. stage. There are several types of valve available for this type of amplification, and a modern H.F. pentode, using the variable-mu principle will, if incorporated in a suitable circuit, give stable results and the volume may be controlled smoothly over the complete

range, thus enabling a local station to be kept at a suitable level whilst enabling a distant station to be given the maximum amplification before passage to the output stages. A reacting grid-leak detector will provide a further stage in control, the reaction if carefully adjusted giving a very valuable build-up in signal strength. For the output stage a modern tetrode is also

high amplification with a low input voltage requirement. Thus in the receiver now to be described we find this combination of three valves, the coupling between the first two being carried out by means of an H.F. transformer and between the detector and the output stage a good L.F. transformer is employed. For tuning, a modern dual-gang screened coil assembly is utilised, and a standard two-gang condenser is employed in conjunction with them. The remaining incidental details of the circuit may be gathered from the theoretical diagram and wiring diagrams on page 320, show the layout and disposition of the components on the chassis, which is of the ordinary wooden type having a layer of aluminium on the upper surface. This may be obtained from the makers, Messrs. Peto-Scott, with the necessary holes for the valveholders ready drilled.

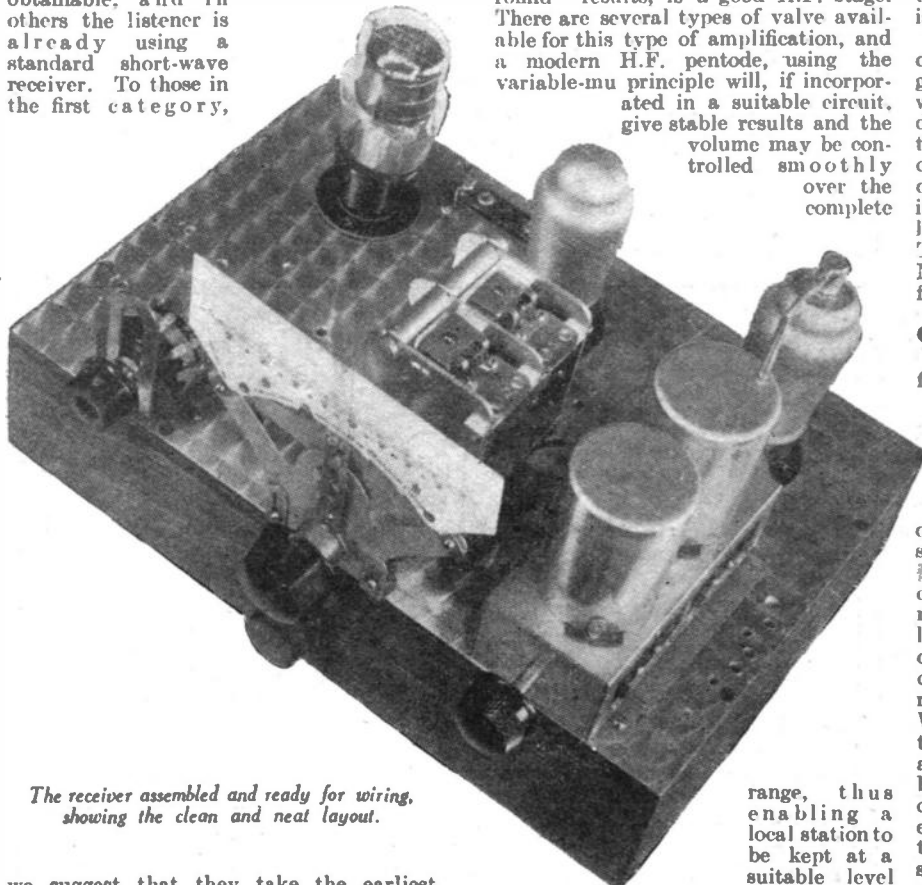

The receiver assembled and ready for wiring, showing the clean and neat layout.

we suggest that they take the earliest opportunity of hearing a really good short-wave or all-wave receiver working under favourable conditions, when we are certain they will find that the short wavebands add a very high standard of entertainment to that which is obtained on the usual broadcast bands. However, the present set has been designed for those who are anxious to have a really high-class broadcast band receiver, which may be relied upon to give a fair number of stations at really good quality, not only from this country but from abroad. It should be borne in mind that it is not essential to use a short-wave receiver in order to hear the American broadcast stations. On the medium-wave band there are several high-powered American stations which may be received during the evening or in the early hours of the morning. As with the short-wave stations, however, it is not possible to give any definite guarantee regarding these stations, and whilst one listener may receive the stations regularly, night after night, it might be found in the same neighbourhood that another listener with the same receiver

range, thus enabling a local station to be kept at a suitable level whilst enabling a distant station to be given the maximum amplification before passage to the output stages. A reacting grid-leak detector will provide a further stage in control, the reaction if carefully adjusted giving a very valuable build-up in signal strength. For the output stage a modern tetrode is also hard to beat, having the advantages of

### Constructional Details

If the chassis is obtained undrilled, the first procedure is to drill the large holes for the valveholders, and these are 1 in. in diameter. An ordinary wood- or centre-bit should be employed for these, and the marker should be allowed to penetrate the aluminium carefully until the wood is reached, when the chassis may be turned over and the hole completed from the underside. In the front runner of the chassis a 3/16 in. hole is drilled for the reaction condenser, but the one-hole mounting bush may be found too short to permit of the lock-nut being given a good grip. Consequently, a good idea is to mark the position of this hole, which is in the centre of the runner, and then to drill a 3/16 in. pilot hole. With a 3/16 in. or 1/8 in. bit drill from the front through about three layers of the plywood, and then complete the hole with the 3/16 in. bit from the back. This will leave a recess on the front in which the lock-nut may be embedded. On the rear runner of the chassis two slots should be made for the terminal socket strips. Alternatively four 3/16 in. holes may be drilled into which the sockets may be passed. Eleven holes will also be needed on the top of the chassis through which connecting leads pass, and these may all be 3/16 in. or 1/8 in. in diameter. When making these holes a very good plan is to drill them first, and then with a large twist bit, say 3/16 in. or 1/8 in., to countersink the aluminium

(Continued on next page)

### COMPONENTS FOR THE D-XMASTER

	s.	d.
One 2-gang coil unit—type BP114 (Varley) .. .. .	13	6
One 2-gang condenser .0005 mfd. (C1, C2)—Bar type (J.B.) .. .. .	12	0
One slow-motion drive—No. 2134 (J.B.) .. .. .	5	9
Five fixed condensers: one 2 mfd. (C8), type BB; one .5 mfd. (C5), one .0005 mfd. (C4), one .0001 mfd. (C6), one .005 mfd. (C7)—type tubular (Dubilier) .. .. .	8	6
Two fixed resistances: one 1 meg. (R2), one 500,000 ohms. (R1)—type F1 (Dubilier) .. .. .	1	0
One volume control, 50,000 ohms with 3-point switch (R3)—type VM60 (Bulgin) .. .. .	5	6
One reaction condenser, .0002 mfd. (C3), No. N23 (Bulgin) .. .. .	3	0
One all-wave H.F. choke—type HF15 (Bulgin) .. .. .	5	0
One L.F. transformer 3/1 (B.T.S.) .. .. .	4	6
One component bracket (Peto-Scott) .. .. .	0	4
Three valveholders: one 5-pin, two 4-pin—chassis mounting type (Clix) .. .. .	2	1
Six plugs: H.T.—, H.T.1, H.T.2, G.B.—1, G.B.—2 (Clix) .. .. .	1	0
Two spades: L.T.—, L.T.—+ (Clix) .. .. .	0	4
One 100 mA fuse with holder (Microfuse) .. .. .	1	6
Two socket strips: A.E. and L.S. (Clix) .. .. .	1	0
One Plymax chassis, 12in. by 8in. by 2 1/2in. (Peto-Scott) .. .. .	6	0
Three valves: VP215, D210, Y220 (Flivac)		
One P.M. speaker—Stentorian Junior (W.B.)		
120 volt H.T. battery (Drydex)		
9 volt G.B. battery (Drydex)		
2 volt L.T. accumulator (Exide)		

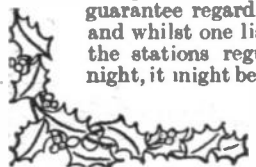

neighbourhood that another listener with the same receiver

THE D-Xmaster

(Continued from previous page.)

so that the metal edge will not be left in a sharp condition to cut through the insulation on the connecting wire and give rise to a short-circuit. A length of systoflex or other insulated sleeving may be slipped over the wire and into the hole to avoid the possibility of such troubles.

Preliminary Tests

Mount the components as shown in the wiring diagram, and if desired the gang condenser may be left until the end. This is often worth watching, as it has been found that some constructors, when turning the set first one way and then the other for wiring, are liable to damage the vanes of the condenser or at least bend them so that the alignment is upset, and when finished it is found impossible accurately to gang the set. Another point which must be stressed is that the mounting bracket for the volume control is in contact with the metal surface of the chassis, and thus it is essential to use the component which we specify. If any alternative is employed, and the spindle should be "live," that is, in contact with the mounting bush and the arm of the control, the control will not function.

The wiring should be carried out with fairly stiff wire, the most suitable being 22 or 24 gauge tinned copper, with insulated sleeving passed over where the leads come into proximity with one another. If you can, employ good soldered connections at all connecting points, and if reliance is placed upon terminal nuts, make quite certain that they are locked tightly, and that the wire ends are firmly held.

A Word of Warning

The points on the wiring diagram marked "M.C." indicate that the connecting leads and components shown connected to these points are in contact with the metal surface of the chassis. It will be noted that on the underside of the chassis condenser C5 and some leads are joined to such a point, and therefore to bring them into contact with the metal surface a bolt will have to be passed through. The head of this bolt is used as the anchoring point for one side of the fuse holder, a short wire being attached to the terminal on the holder and clamped beneath a washer under the bolt head. On the underside a nut should be run on and tightened up and then two large washers in between which the condenser wire end and the remaining two wires should be placed. A further nut will make all secure and will provide a good low-resistance contact. A short wire is

Wiring Diagram of the D-Xmaster

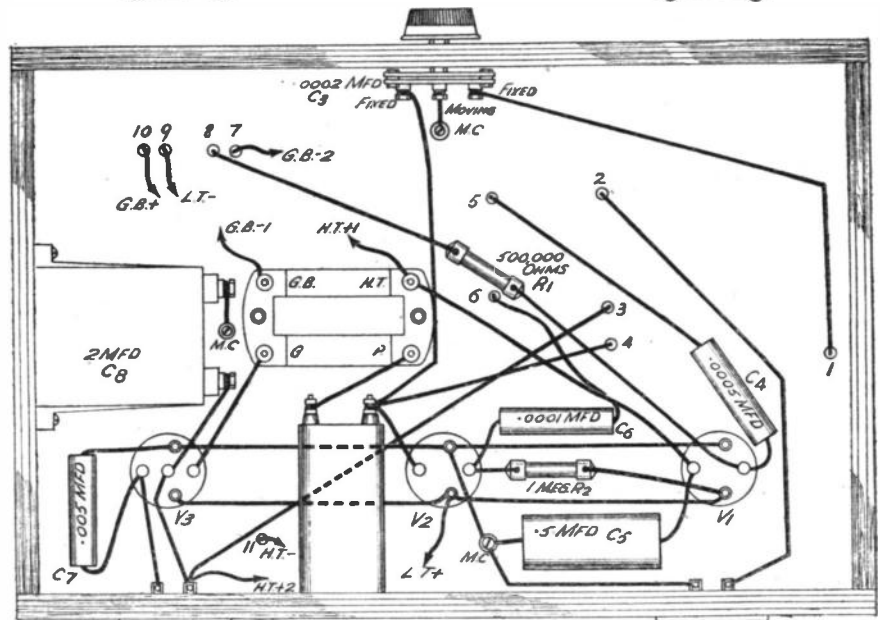
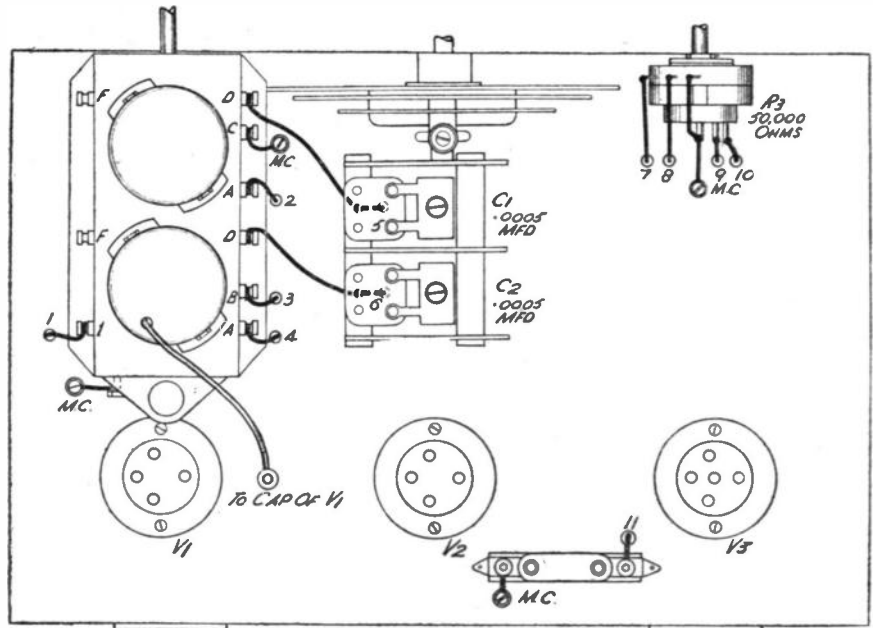

MC CONNECTIONS EARTHED TO CHASSIS

also joined to the earth terminal on the base of the coil mount and connected to a screw on the metal surface to make quite certain that the coil unit is well earthed.

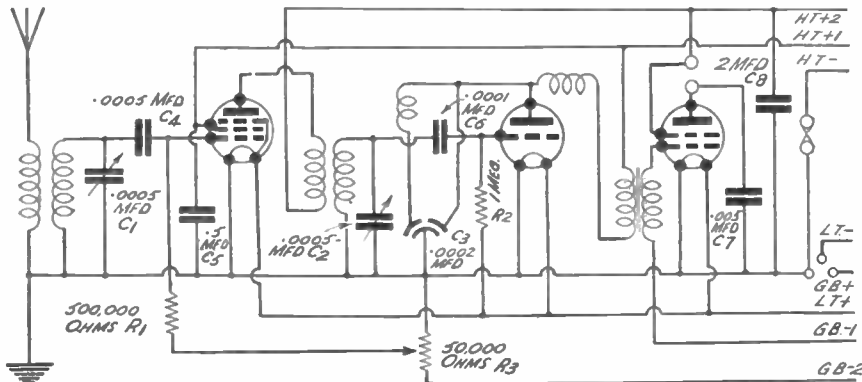

Theoretical Circuit of the D-Xmaster, which may be compared with the practical interpretation shown above.

THE WIRELESS CONSTRUCTOR'S ENCYCLOPEDIA

By F. J. CAMM 4th Edition 5/- net.

(Editor of "Practical and Amateur Wireless") Wireless Construction, Terms, and Definitions explained and illustrated in concise, clear language.

From all Booksellers, or by post 5/6 from George Neumes, Ltd., Tower House, Southampton Street, Strand, London, W.C.2.



# The Amateur Set Designer

The Fundamental Principles of A.V.C. are Dealt With in this Thirteenth Article of the Series

(Continued from page 294, November 27th issue)

THE amateur who has no ganging oscillator should endeavour to enlist the aid of somebody who has got one; otherwise, patience will probably be exhausted before that one and only combination of trimmer and padder settings which will be satisfactory is at last obtained. While on the subject of testing gear it is well to note that a very low reading milliammeter can be used to make a check upon the oscillator's conditions of working.

this minimum will tend to cause overloading and bad distortion. To rely on the manually operated volume control to overcome this trouble is not desirable, particularly in view of the fact that a fast run up and down the scale through a large number of signals is a common event when programme searching is the object. With A.V.C. in action, however, the tendency for overloading can be corrected automatically.

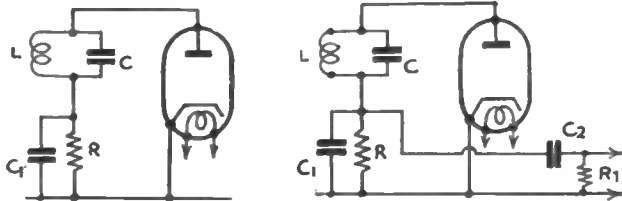

Fig. 61 (left).—Fundamental detector circuit.

Fig. 62 (right).—The same circuit with the addition of L.F. components, C2 and R1.

Referring to Fig. 53, it should be appreciated that if the frequency changer is being used with the correct operating voltages and if the locally generated oscillations have the correct amplitude, then, appropriate to these conditions, there must be a certain particular value of rectified D.C. passing through the oscillator's grid leak. To insert a milliammeter at the lower end of the grid leak will not interfere with the generation of oscillations, and the comparison between the milliammeter reading and the correct current value specified for the valve may be valuable. A sensitive milliammeter is required because the current will be well below 1 mA. Should it be discovered, by any chance, that the oscillating amplitude is considerably greater than optimum it may not be necessary to condemn the oscillator coil assembly, nor to modify its construction. Some trial and error experimenting with resistance shunts across the reaction winding may lead to an improvement.

Where A.V.C. arrangements are concerned the receiver circuit diagram must appear to a beginner to be greatly complicated. Actually the complications are more apparent than real. For the amateur set designer there is one pleasing feature of plain (and delayed) A.V.C. The whole A.V.C. system comprises a valve plus a resistance-capacity network, and the latter lends itself admirably to experimenting with the minimum of inconvenience. The amateur will usually be advised to rely on

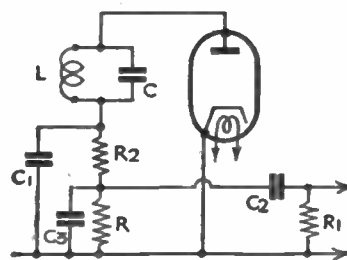

Fig. 63.—In this circuit an H.F. filter has been added.

receiver will increase for weak signals and decrease for strong signals, and it will be obvious that any fluctuation of carrier amplitude will be, at least partly, counteracted by the changes of receiver sensitivity.

The functions of signal detector and A.V.C. detector can be combined in one single diode valve if the A.V.C. system is of the simple non-delayed type, and although this system has a sufficiently bad disadvantage to make it of little interest from the practical utility point of view; nevertheless it is worth consideration as a means of getting clear ideas of the basis of A.V.C. circuit make-up. Figs. 61, 62, 63 and 64 show, progressively, the development of a simple non-delayed A.V.C. system.

Fig. 61 shows the fundamental detection circuit. LC is the tuned input circuit (the last I.F. secondary in the case of a superhet). R is the load resistance and C1 is the H.F. by-pass condenser typical of a detector circuit. The L.F. component of the fluctuation of voltage that takes place across R we need for the operation of the valve that follows the detector and Fig. 62 shows the addition of a connection from the high potential end of R and another condenser and resistance, C2 and R1. The latter form the grid condenser and leak, respectively, of the L.F. valve (not shown in the diagram). If desired, R could be of potentiometer form, with C2 connected to the slider, and this arrangement would very conveniently provide manual volume control.

As Fig. 62 stands there is no special provision for keeping H.F. out of the L.F. section of the receiver. C1 certainly helps, but it will not normally be satisfactory to rely on C1 only. Fig. 63 shows a possible modification of Fig. 62, a resistance-capacity H.F. filter R2C3, being added to the circuit. There are a number of ways, differing in detail, in which H.F. filtering could be provided. A filter of more elaborate type than R2C3 might be used; also the filter components might be shifted to come between R and C2 (Fig. 63) instead of being between the LC circuit and R.

## Automatic Biasing Voltage

Now comes the question of getting hold

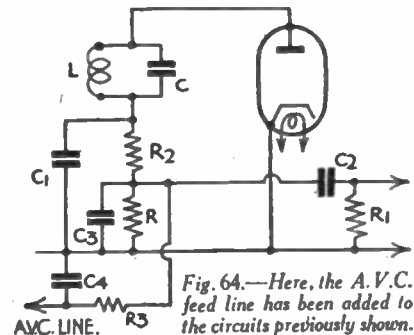

Fig. 64.—Here, the A.V.C. feed line has been added to the circuits previously shown.

## Automatic Volume Control

There are two points of view regarding the usefulness of A.V.C. which does definitely minimise the effects of signal fading, and it is the "no fading" ideal which appeals to the average non-technical person. The latter, however, is rather apt to expect too much from an A.V.C. system, and does not take too kindly to rising background noise, and distortion that may occur during a deep fade.

The set designer will look upon the prevention of overloading of the output stage as being at least of equal importance to that of the minimising of fading. This point merits our consideration. A receiver to be really satisfactory for distant reception must be capable of giving full output from the last stage on other than local signals. To give full output will require a signal input of a certain minimum amplitude so it necessarily follows that signals exceeding

trial results in preference to calculations based (quite possibly) on incomplete data. It is necessary, however, to have a very clear idea of the functions of the various sections of an A.V.C. system

## Fundamental Principles

The fundamental principle of A.V.C. is as follows: A direct voltage is developed by a diode detecting valve, and this voltage is applied as grid bias to one or more of the valves preceding the detector. The A.V.C. valve is, of course, signal operated, and the A.V.C. bias fed back to the earlier valves will be dependent upon the signal amplitude; the stronger the signal the greater will be the bias, the weaker the signal the less will be the bias. Thus the sensitivity of the

of the automatic biasing voltage that we want for the purpose of controlling the earlier valves. A diode detector under the action of modulated H.F. signals passes through the load resistance a direct current the value of which has an L.F. component of variation. This, as we know, we need for the succeeding valves, although we do not want to pass it back to the earlier valves. The mean value of the D.C. in the load resistance will be dependent upon the signal carrier amplitude and corresponding to this mean D.C. value there will be a (direct) voltage drop across the load resistance. It is this particular voltage that constitutes the control bias, a fact which suggests at once that we should take

(Continued on next page)







Battisin Belfry is At Large Again!  
Here are Some More of His  
Rollicking Wrinkles which are  
Guaranteed to Disorganise Your  
Christmas

By ARTHUR ASHDOWN

**B**ATTISIN BELFRY 'phoned me and I shuddered with anticipatory delight. "I would like you," he cooed (with a touch of the iron hand in the velvet glove concealed in his voice), "to come along to my laboratory and inspect some of my Christmas radio inventions on which I have been working during the past year."

When I say that I shuddered at this invitation I mean that I shuddered!

It is not possible to come into contact with this radio prodigy without peculiarly mixed feelings of horror, pleasure and terror—together with a pain in the stomach! The more advanced technicians of the radio world accept this youthful genius and it is only a question of time before he is universally certified. Undaunted by the sneers of derision which have greeted his epic radio inventions (such as the "Santa Trap" and the "Bon-

siren screamed mournfully in the innermost gloom of the building, and the front door swung noiselessly open with a gruff creak. I braced my nerves, injected morphia, and entered.

Enshrouded in gloom I waited for twenty minutes, and eventually the figure of a faithful retainer appeared, neatly encased in a suit of ebonite armour.

"Have you a disappointment?" he asked, with a query in his voice.

"I am a friend of Master Battisin's," I answered with nonchalance, and caught sight of a derisive sneer behind the insulated visor.

"Come that way," he tittered, pointing downwards. Escorting me up the spiral staircase he brought me face to face with an iron-studded door which swung open outwards.

"A visitor to see you, Master Belfry," he announced in a very "B.B.C.-faithful-retainer" voice. The door clanged behind me and I was alone in the presence. Battisin rushed at me with a frenzied charge.

"Come, my friend, make yourself at home," he said, pulling up two deep arm-chairs by the refrigerator and sighing contentedly.

"Thank you very much," I answered, carefully stepping over a retort tube containing white mice.

"And now for my inventions," said Battisin. "You must be all agog!"

"Agog" is the word," I echoed, playing for time.

"I have not been idle during the past year for nothing," he continued. "I have worked without remission of toil and—although I say it myself as shouldn't—I have triumphed!"

His eyes gleamed and glowed, his nostrils quivered and quaked, his ears flipped and flapped as his mouth gibbered and gabbered. For hours he talked of his beloved inventions, whilst I made rapid notes on the front of my dress shirt. As his story of progress developed before my ears, my senses numbed with the overwhelming calamity of the situation. It would be useless for me to try to relate his descriptions as they tormented from his lips, but I can at least try to outline for you a few of his radio activities. I have considered the best way of carrying out this almost

superhuman task, and, after much deliberation, I have decided that the "Becton" method is most suitable.

Recipe No. 1.

First-rate Aid for Carol Singers.

Ingredients: 1 powerful radio receiver, 1 aerial, 1 earth wire, 6 loudspeakers, 1 hand-barrow.

Arrange the receiver on the hand-barrow, connect the aerial, earth and loudspeakers. Camouflage with holly, etc. Push the barrow into the street and group the singers around. Tune in to the station which is broadcasting carols and induce the singers to open and shut their mouths at irregular intervals.

Result: It looks just as if the people are singing the carols.

Recipe No. 2. Carol Singer's First Aid.

Ingredients: 1 powerful amplifier, 7 loud-output speakers, 6 microphones, 1 hand-barrow.

Local inhabitants sometime become annoyed with carol singers. If things become too hot, the singers should switch on the amplifier and bawl, "Help" into the microphones. Result: Police and ambulances arrive.

Recipe No. 3. The Crooner Choke.

Ingredients: 24 chokes, 19 bits of wire, 1 switch, 1 piece of flex, 1 piece of wood.

Fix the chokes to the wood, connect in series and incorporate the switch. This

MAGIC LANTERN OR CINE-PROJECTOR.

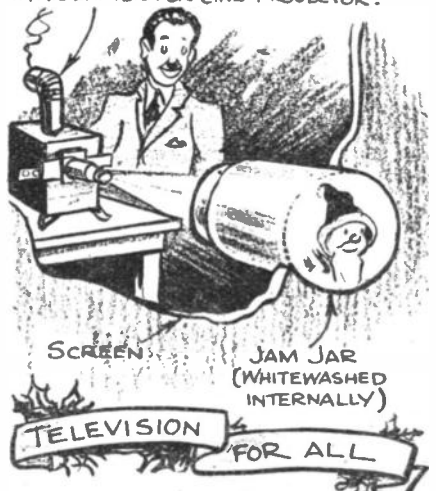

bon Buster"), he ploughs his lonely furrow in the plebeian field of unenlightened radiology. (Given his head he will go far—as I said—"given his head!")

A dreary November wind was swirling the late autumnal fog in and out of the nooks and crannies of the countryside as I drove up to his (private) house on the outskirts of the Peak district. Alighting from the van which had been sent to collect me at the station, I mounted the steps and pulled the bell handle marked "Push." A shrill

choke unit should be wired to the input terminals of the radio receiver. When the dance band programme is in progress and a member of the party says, "I would like to choke that crooner," switch in the unit. Result: The crooner is choked.

Recipe No. 4. The Talking Turkey.

Ingredients: 1 turkey, 1 midget loud-speaker, 1 length of flex.

(Continued overleaf)

(Continued from previous page)

This recipe, although in lighter vein, justifies inclusion through sheer ingenuity. Place the loudspeaker in the turkey and connect to the radio receiver. When the party is assembled around the table, switch on the radio. The programme will be heard coming from the bird. It is much more amusing if the transmission selected is a



Turkish one. Everyone will think that they are suffering from delirium tremens. Result: A great economy in alcoholic drinks.

Recipe No. 5. *World-wide Radio.*

Ingredients: 1 pair of earphones, 1

microphone, 1 amplifier, 1 loudspeaker, 1 screen, 1 interpreter.

When listening to foreign programmes at Christmas, much fun is lost through not being able to understand the language. This will put it right. Place the interpreter behind the screen and allow him to listen, through the earphones, to the programme. He should then translate it into English in front of his microphone.

Result: Laughs from Lithuania, gurgles from Greece, titters from Turkey, and English from U.S.A.

Recipe No. 6. *Television for All.*

Ingredients: 1 magic lantern, 1 large jam jar, 1 gill of whitewash, 1 screen.

Television is very much in the public eye at the moment, but the receivers are somewhat expensive. Here is a method by which you may give your friends the impression that you are terrifically wealthy. Cut a circular hole in the screen, to accommodate the end of the jam-jar. Before placing the jam-jar in position, pour the whitewash into it and then empty it out. This will leave the bottom of the jar white and give the effect of a cathode-ray tube when it appears through the hole in the screen. By projecting pictures from the magic lantern on to the bottom of the jar a very realistic impression of television is obtained. By substituting a cine-projector for the magic lantern moving pictures are obtained.

Result: Your friends will assume that you are very wealthy and try to touch you for money.

\* \* \* \* \*

I have quoted only half a dozen of Battisin's inventions as the remainder which he evolved are somewhat muddled up on my shirt-front. There is, however, one point which must be very clearly understood. It is that all of these whirlwinds of scientific imagination are strictly copyright, and should any person dare to impinge that copyright, they will be hounded down in every court in the world.



Battisin, however, is human enough to relent sufficiently to allow anyone to experiment on these lines on receiving written permission from him. Postcards should be addressed to him personally and marked "Bats" on the top inside corner.

## BOOKS FOR XMAS

ONE of the most useful presents which can be given at Christmastime is a book. If you have any friends who are interested in radio, but who have not yet taken up the hobby, make a gift of one of the various books which we publish on the subject. There is, for instance, the "Wireless Constructor's Encyclopaedia." This explains practically all of the terms mentioned in radio practice and is lavishly illustrated, making it a simple matter for the beginner to become acquainted with modern receiver construction and repair. For those who require something simpler, there is "Everyman's Wireless Book," which may be regarded as a reference book for the listener, the expert and the amateur, and deals with operation, upkeep and overhaul of modern receivers, as well as providing an explanation on the principles of radio telephony. For the more advanced hobbyist you can obtain a book of "Fifty Tested Wireless Circuits," covering all normal requirements from the simple crystal receiver to the superhet. There are diagrams showing the theoretical circuit, explanations regarding the construction, and in many cases detailed wiring diagrams. Notes on the choice of components and operation are also included.

The experimenter who delights in making his own components would be highly delighted with a copy of our latest book on "Coils, Chokes and Transformers." This explains in detail the construction of various types of these components and includes many useful tables of data and reference. It is profusely illustrated.

In addition to the above-mentioned books there are also the various blueprints, which are full-size drawings of the wiring required for receivers which embrace practically every required type of wireless set, from

the humble but efficient crystal set up to the multi-valve mains-operated superheterodyne. A list of these is given in each issue, and in this particular number will be found on page 360, from which any type of set may be chosen. These prints cost 1s. each, and in certain cases it will be



One of the new Philips receivers in charming hands.

found that they give the practical development of receivers which have been described either in these pages or in the book already mentioned—Fifty Tested Wireless Circuits.

Some of these receivers are of interest apart from the actual use of the set, as they show in a practical form the developments which have taken place in the past few years, and thus a receiver constructed to one of the early designs may be built up for experimental purposes and for comparison with the more up-to-date sets.



# The Ideal Christmas Gift!

## TURNS ANY RADIO RECEIVER INTO AN armchair RADIOGRAM



# "The H.M.V." RECORD PLAYER

FOR A.C. MAINS

What a marvellous Christmas present for your friends . . . or the family . . . It plays records with the latest type of High Fidelity pick-up, with all the revealing beauty of modern electrical reproduction through any type of radio receiver. It can be operated from your armchair . . . there is no need to jump up after each record. It has its own volume control. No winding, of course . . . Here's the way really to enjoy hearing records played. Go to your "H.M.V." dealer now and see this wonderful innovation.

**7'6** PER MONTH  
7/6 down and 12 monthly payments of 7/6. OR  
**£3.19.6** CASH

### Hear these Recordings Today

- GIGLI**  
Elegie (Song of Mourning) (Massenet) and  
Plaisir d'Amour (Martini) DB 2530 6/-
- TIBBETT**  
De Glory Road (Film "Metropolitan")  
Edward (Loewe) DB 1684 6/-
- JEANETTE MACDONALD and  
NELSON EDDY**  
Will you remember and Farewell to  
Dreams— DA 1559 4/-
- TOSCANINI** conducting the New York  
Philharmonic - Symphony Orchestra  
Italiana in Algeri—Overture (Rossini)  
DB 2943 6/-
- PAUL ROBESON**  
You didn't oughta do such things  
(Film "Big Fella") and Lazin' B 8607 3/-
- ROY FOX and His Orchestra**  
Afraid to Dream, F.T. (V.R.) (Film  
"You can't have everything")  
Sympathy-Waltz (V.R.) (Film "Firefly")  
BD 5281 2/-
- JACK HARRIS and His Orchestra**  
(Vocalist **ELSIE CARLISLE**)  
Moonlight on the Waterfall, F.T.  
The little boy that Santa Claus forgot,  
F.T. BD 5290 2/-
- MAX MILLER**  
I never thought that she'd do that to  
me and Let's all have a charabanc ride  
BD 458 2/-

★  
To "HIS  
MASTER'S  
VOICE" (The  
Gramophone Co. Ltd.)  
108J CLERKENWELL  
ROAD, LONDON, E.C.1.  
Please send me full details of the  
new "H.M.V." Record Player.

NAME.....  
ADDRESS.....

POST IN 1/4d. STAMP UNSEALED ENVELOPE. (4/12/37)

**ENJOY MODERN ELECTRICAL REPRODUCTION OF YOUR RECORDS**

# POLAR

Specified in the

## RAPIDE STRAIGHT 3

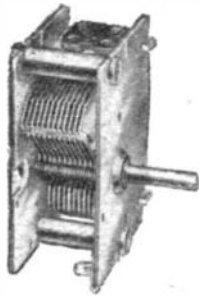

**No. 5 CONDENSER .0005**  
(as illustrated)

Steel frame. Ball bearing spindle. Chassis mounting **4/6**

**'DIFFERENTIAL' CONDENSER**

Solid dielectric. Constructed with insulated spindle. Complete with knob. (.00015 each side) **3/-**

**V.P. HORIZONTAL DRIVE**

Slow motion with vertical moving pointer. Scale calibrated with station names and degrees. Moulded escutcheon. Lamp-holders. Price **6/6**

Send for fully illustrated Catalogue of Polar and Polar N.S.F. Components.

**WINGROVE & ROGERS, LTD.,**

188/189, Strand, London, W.C.2.

Phone: Temple Bar 2244.

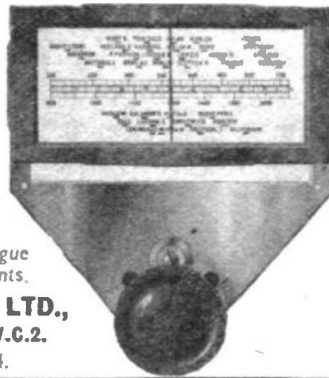

3618

## A new meaning to short-wave listening



To pick up those stations that are out of loudspeaker range you simply must use these supersensitive headphones. Their sensitivity enables you to tune in and listen with comfort to stations which would defeat many other 'phones. Strongly made, they retain their sensitivity and rest very comfortably on the head. And they are perfect in tone.



Three resistances 120,200 and 4,000 ohms. One price **15/-**

**Super-sensitive Telephones.**

At all GOOD dealers or apply direct to:

**ERICSSON TELEPHONES LTD.,**

22, Lincoln's Inn Fields, London, W.C.2. Telephone: HOLborn 6936

## A welcome Xmas Gift

You could not have a better gift than one of these "AVO" precision instruments. They invest you with a qualified engineer's facilities for testing your set and tracing faults. In fact, electrical engineers depend on them. And remember, too, how often you can use an accurate measuring instrument for electrical jobs around the house. Select your Xmas gift from these three suggestions.



British Made

### The D.C. AVOMINOR

13 precision meters in One. This accurate moving-coil instrument has 13 ranges... voltage ranges sufficient for measuring H.T., L.T., Grid Bias, Main and Eliminator voltages; milliamperes for testing all receiving valves and radio apparatus; resistance ranges for all resistance tests. In case, complete with testing prods, crocodile clips, leads and instruction booklet.

**45/-**. Deferred Terms if desired

All good radio dealers sell "AVO" Instruments. Insist on "AVO"—no other instruments offer such a combination of accuracy and usefulness.

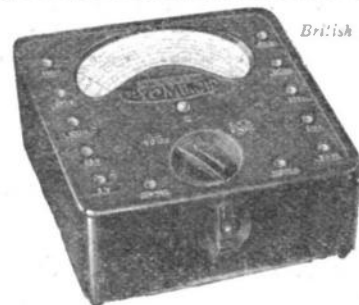

British Made

### The UNIVERSAL AVOMINOR

This compact precision moving-coil instrument covers all A.C. and D.C. testing. It has 22 ranges for measuring A.C. voltage, D.C. voltage, Current and Resistance. All readings are direct. No calculations. The high total resistance of the instrument—200,000 ohms—ensures highly accurate readings. Complete with testing prods, crocodile clips, leads and instruction booklet.

**£5 : 10s.** Deferred Terms if desired  
LEATHER CARRYING CASE, 10/-

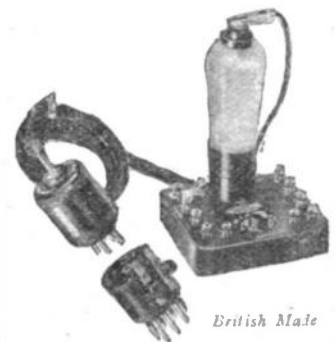

British Made

### The AVODAPTER

Simplifies valve testing. Enables all valves to be tested under actual working conditions. No groping about inside the set. No need to sever connections. Instantly adaptable for 4-pin, 5-pin and 7-pin valves. **27/-**

### The 9-PIN AVOCOUPLER

(Not illustrated) Instantly renders the Avodapter suitable for 9-pin valves. **12/6**

Write for leaflets giving full details of these Instruments.

**THE AUTOMATIC COIL WINDER & ELECTRICAL EQUIPMENT CO. LTD.**

Winder House, Douglas St., London, S.W.1.

Telephone: Victoria 3404/7



# On Your Wavelength

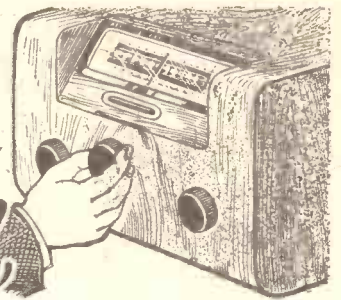

By Thermion

### But Once a Year

THE publication of Christmas Numbers, early though their appearance, is a reminder that the festive season is upon us once more. The journals bedeck themselves with frosty lettering with dripping icicles, sprigs of holly, special features and generally go gay; hence in this Christmas number the age-old custom has been carried out. Although it is early, may I take this opportunity of wishing every one of my readers the merriest of Yules, and the most opulent of New Years. May all your sets work first time; may oodles of aunts and uncles send you presents of the sort you really want; and good listening to you all. I say this with great sincerity, and I extend the sentiments to the fors as well as the againts. I am sorry that I cannot send my thousands of readers personal greetings and I have to use this public platform to make a general declamation. I hope, therefore, that you will take it as particularly applying to you.

### My Quality Set

I HAVE received a batch of letters regarding the recent paragraph about my Quality Set. One reader thinks that the ordinary as apart from the musical listener doesn't pay a great deal of attention to quality provided the reproduction is clear and free from ordinary distortion. The quality-conscious person is above all the constructor. All the time he is listening not to the musical item as a whole but to the quality itself. He thinks the quality fiend is like the prophet without honour except in his own home. His apparatus doesn't look good so it cannot sound good. One day my correspondent threatens to install a detector and L.F. set in a huge bird's-eye maple cabinet, edged with chromium and studded

with gold knobs. His friends will then, he thinks, extol the virtues of the quality.

Concerning my "pardon" and "piano" stories, this correspondent tells me of a particular occasion when he let loose a watt or two more than usual, with the result that some neighbours flocked to their windows to see the local band pass by. I agree with him that it is necessary to listen to a variety of items before assessing the quality value of a set, and comparison with the original is ideal when possible. If we all made such a direct comparison a lot of us would go home and

the history of the paper his name will appear on a constructional article.

I thank H. S. B., of Glamorgan, for writing to me, for it also enables me to answer a letter I have received from E. W. B., of Herne Hill.

### An Opportunity for Someone

ANOTHER letter from a radio and electrical store proprietor invites my assistance in endeavouring to find for him the right type of assistant. This correspondent tells me that he has a flourishing business and he requires a real radio fan and good service man combined who is interested in transmission, P. A. work, etc. For preference, he should be aged from twenty to twenty-six years, willing to work at a moderate wage



The wireless den of the Secretary of the Ealing and District Short-wave Club.

scrap our sets. He thinks that I am not acting in the true Thermion tradition by merely believing that I have made a set that gives reproduction approaching very near to the original. I hope shortly to disgorge my secret, for, as I am reminded, I have no right to withhold from my loyal supporters details of my set. In the very near future, therefore, Thermion will break forth in the technical department and for the first time in

and average hours with exceedingly good prospects and a permanency. His shop is located in a district surrounded by five new estates, and the nearest competitor is almost a mile away. Any reader who thinks he has the necessary qualifications should write to me and I will forward letters on to the dealer concerned. I



believe that this provides a good opportunity for a live wire.

#### A Go-ahead Club

HERE is a letter I have received from W. C., of Ealing. He writes thus: "The Ealing and District DXers Club is now going strong, and has its duly appointed committee, secretary and treasurer. The members all meet on Sunday morning at the shack of 2CKL, and local readers should get into touch with Mr. W. Colclough, 31, Lancaster Gardens, Ealing. They have a chinwag nearly every Monday and Wednesday evening. I reproduce on page 327 a photograph of W. C.'s den.

#### Joke!

H. G., of Walthamstow, tells me that he recently constructed a wireless set (not one of PRACTICAL AND AMATEUR WIRELESS design), the reproduction of which was anything but satisfactory. A friend who is an expert suggested that he should reverse the connections of the L.F. transformer. This was done, and (you will scarcely believe it) the set reproduced the items backwards. So he heard the tail end of the programme first. I don't believe it! Book sent.

#### Radio in School

WHEN I went to school to be taught the rudiments of the three R's, the knowledge was instilled into me by threats of the application of a hefty cane. Nowadays the efforts of the teacher are implemented by radio, and in aiding education to fulfil its purpose of equipping the child for life broadcasting now plays a great part, for it is able to bring many aspects of the world through classroom walls and windows in a way beyond the scope of the teacher within them. The "History in the Making" series is particularly useful, as also are the excerpts from plays, visits to manufacturing centres, such as shipyards; the broadcasting of national events, such as Armistice Day, are all valuable from an educational point of view. The boy of 14 is equivalent in intelligence to the pre-war man of 21.

#### The Club Movement

MY recent comments on club life have called forth a letter from G. C. C., of Newcastle. He thinks that I ought also to tackle the club members for their disturbing habits of arriving late or not at all, irregular payment of subscriptions, and lack of interest in the evening's business.



## Notes from the Test Bench

#### The Corona

A SIMILAR trouble has been reported by some readers who have built the Corona and other receivers in which an H.F. stage is employed in an all-wave receiver. In this case, of course, the trouble will not be due to the aerial-earth system, and in many cases it is found that the receiver is perfectly satisfactory on all wavebands, but the short-waves are not being respected. By this we mean that the user is expecting to tune in signals with the same ease as on the broadcast (medium and long-wave) bands. It must be remembered that a large capacity condenser is being employed for tuning, and in spite of the reduction gear drive used for the tuning control, signals will be extremely sharply tuned. Consequently the control must be turned very slowly, and until one has become used to the tuning it is highly probable that the short waveband will appear entirely blank. Until you have become used to short-wave tuning, adjust the reaction control until the set is almost oscillating, and then when a signal is tuned a whistle will be heard. The reaction may then be slackened off and the signal resolved. The operation is very delicate, however, and some time must be devoted to obtaining the "hang" of tuning on the short waves.

#### Meter Tests

SOME amateurs still find it difficult to remember that a low-priced meter cannot be used for measuring the output from small H.T. battery eliminators. We repeatedly get enquiries from readers who have obtained a mains unit—either second-hand or from some other source, and they endeavour to test it before using it, with an ordinary general-purpose low-priced meter. They naturally find that the socket marked 80, for instance, reads about 40 volts, and wonder if anything is wrong. It must be remembered that this tapping—generally intended for an S.G. or detector valve—is designed to take only 1 mA or so, and the small general-purpose meter will take 30 mA or more. Consequently, as the low voltage is obtained by means of a series resistance a greater voltage drop will be given through the resistance and a false reading will be obtained. When measuring the output from a mains unit of this type, therefore, a high-class meter must be employed. It should preferably be of the type having a resistance of at least 1,000 ohms per volt, and if such a meter is not available, the only other way of ascertaining the voltage output is to connect it to the set, and to measure the anode current flowing and from this calculate the H.T. voltage by means of Ohm's Law.

He gives an example of his own society which decided to give morse practice in the last half-hour, and to show members how they could practice at home. He built an oscillator combined with a simple tester, and it took five meetings to demonstrate to about 20 members owing to lack of attendance. The excuses for non-attendance varied from having a date to "didn't like to come up without the subscription." He reminds me that there are members who could take a hand at teaching beginners, but finding the club has not yet installed a transmitter failed to attend further even after paying their entrance fees. I think this reader is putting the cart before the horse. It is the duty of the officials to solve their own internal problems, and members who will not pay subscriptions should be expelled after the expiration of a reasonable time-limit. I agree that regular attendance of members is necessary, otherwise it disorganises the programme. Unless a rigid control is exercised, and unsatisfactory members immediately expelled, the club is bound to fail. You must not tolerate refractory elements.

#### A Grumble About Dealers

I OUGHT to have said another grumble about dealers. L. E. M., of East Grinstead, has only just begun to experiment with radio. He is a new reader to this journal and approached one of the local dealers with a view to purchasing some second-hand parts as his means are very limited. The dealer invited him into the shop to select some components from the dozens of sets he had scrapped. The dealer required practically new prices and charged him 1/6 each for nuts. Of course, I do not advise my readers to buy their components in this way, for it is very unlikely that parts from commercial receivers are suitable for home-constructed receivers. Apart from this, the components may be faulty; and some of them are bound to be, otherwise the sets would not have been scrapped. There is no guarantee behind second-hand parts, and thus in the long run the reader would find it more expensive than buying new components.

#### NOW READY!

#### WIRELESS COILS, CHOKES AND TRANSFORMERS, AND HOW TO MAKE THEM.

2/6, or 2/10 by post from Geo. Newnes, Ltd., Tower House, Southampton Street, Strand, London, W.C.2.

# Easy Fault Tracing

Some Simple Hints That Might Avoid Reception Troubles During the Festive Season. It is Also Suggested That Fault-tracing Might be Made the Subject of a Radio Game

**R**ECEIVERS are so reliable nowadays, especially home-constructed receivers, that the amateur frequently has little experience of tracing and rectifying faults. The annoying part about it is that any faults that can possibly arise, do so at the most inopportune moment. Just when you have a house full of friends and intend to

*by The Experimenters*

will be assumed that little or no test gear is available, and that you are called upon to make a speedy diagnosis. Cures are generally quite easy to effect once you know what is wrong—but it is not always an easy matter to know just where the "spot of bother" is.

### An Interesting Game

So that we do not bore those of our regular readers who are expert at trouble shooting, as the Yanks call it, we might suggest that some of you might care to make an interesting game of this fault-finding business. For example, a number of enthusiasts might take turns at creating a minor fault such as some of those that will

switch on the set and then switch off again; a click should be heard in the speaker. Do not forget that if it is a mains set it should be left switched on for about a minute to ensure that the valve heaters have become red-hot. An old method of test with a battery set was to remove and replace the negative H.T. wander-plug or to disconnect and reconnect a speaker lead. This method should not be adopted with modern valves, especially when there is a pentode in the output stage, because the voltage surge might cause damage.

If no sound is heard when the test is made it might suggest that the H.T. circuit is broken. Just examine the fuse, if fitted. See that the wander plugs are properly fitted, and that they are clean. In the case of an A.C. set see that the rectifier valve is "alight" if a valve rectifier is in use. If not, try shorting the speaker terminals with a screwdriver blade while holding the insulated handle; this should produce a click unless there is a break in the H.T. or L.T. circuit.

### Grid Tests

Another quick test is to touch the grid terminals of the various valveholders with the moistened tip of the finger. See that you are standing on a mat, and take care that nothing but the grid terminal is touched—especially in the case of a mains set. Start with the output valve and work

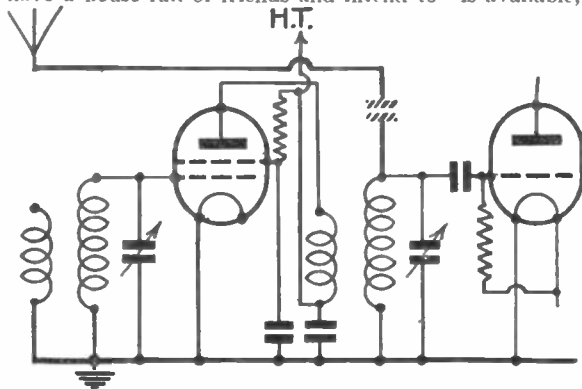

Fig. 1.—Cut out the H.F. stage by transferring the aerial lead as shown here.

listen to a special Christmas broadcast or to a special programme—that is when trouble is most likely to occur.

We are not going to deal with general methods of tracing and remedying faulty operation, but rather with a few quick

be described; the others will then attempt to trace it without the use of any equipment. Another method of playing this game is for each member of the party to go out of the room for a few minutes in turn while the rest "rig" the set so that a small fault known to the rest of the party exists. A time limit of, say, three minutes might be allowed for the member "not in the know" to find what is wrong and to set it right.

### External Connections

However, to get back to the main subject of this article. Suppose in the first place that signals cannot be heard, although the set had previously been working properly. An obvious check is to see that the aerial lead is attached to the aerial terminal, and that the speaker leads are intact. Next

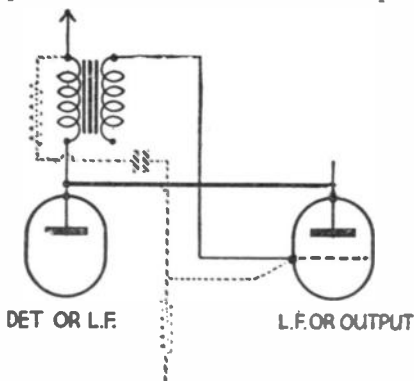

Fig. 2.—The connection shown by a heavy line will enable the L.F. transformer to be tested.

tests that can be made, and with expedients that can be adopted to enable the programme to be enjoyed. For that reason it

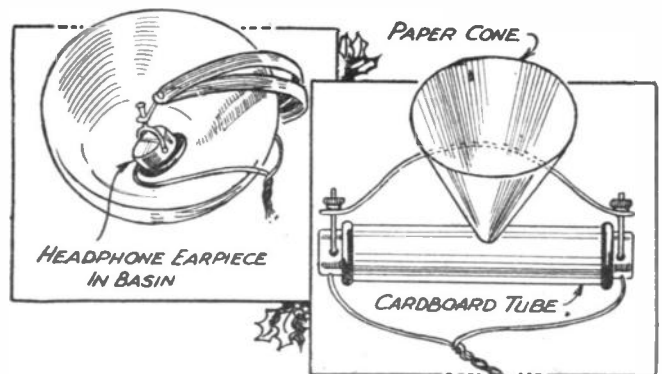

Fig. 3.—An improvised loudspeaker from headphones.

backward toward the first. There should be some kind of noise from the speaker in  
*(Continued overleaf)*

(Continued from previous page)

each case, although it will vary from a very dull "thud" to a howl.

Still silence. Connect one speaker lead to the negative socket of the G.B. battery and touch the other against the 1½-volt socket. A "plop" should be heard as the contact is made and broken; if not, the speaker is probably at fault. In that case, there isn't much to be done unless a pair of 'phones is available. If it is, and provided that the output is not very great and that the H.T. current consumption of the last valve is no more than about 10 mA., the 'phones can be used in place of the speaker if they are placed in a large flower bowl or hung near to the door of a cabinet with plywood panels.

### Mains Valves

Tests of a mains set are not as easy to make, for considerable caution must be taken to avoid receiving a nasty shock.

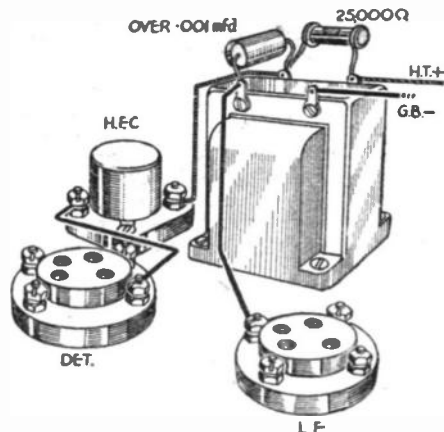

Fig. 4.—If the primary of the L.F. transformer is burnt out a quick makeshift remedy can be effected as shown here.

A rough-and-ready check of the valves can be made after the set has been switched on for some time by touching each valve in turn. All the glass bulbs should be slightly warm, and the output valve will probably be hot. Any valve that is quite cold is probably faulty. A further check is to touch its grid terminal and then to touch that of the following valve. The suspicion will be confirmed if there is no sound in the first place and a "click" in the second.

The on-off switch might be defective. Disconnect the batteries or mains supply, short-circuit the terminals with a short length of wire and reconnect. If the set then works the switch is faulty, and the shorting wire should be left in place until a new switch can be fitted. On the other hand, if the switch is of the open, push-pull type it might be possible to clean the contact faces with a strip of glasspaper.

An apparently faulty valve might be sound but making bad connection with its holder. Remove it, clean the pins with fine glasspaper, open out if of the split type and replace. Take care with pins of the banana type if you propose to open them out, because the lead from the electrode runs down the centre and is easily broken. This also applies to other plug-in components, such as coils, transformer connections and wander plugs.

### Try the Pick-up

When pick-up terminals are provided it is often a good plan to try using these for a pick-up or

microphone (a makeshift alternative is a pair of 'phones) to find whether the fault is before or after this point in the circuit. If before, normal results will be obtained when using the pick-up connections. Should the fault appear to be at a later stage of the circuit than the pick-up terminals, try connecting the speaker leads in the anode circuit—across the transformer primary, choke or resistance—of valves between that to which the pick-up terminals are attached and the output valve. It might even be possible to continue reception by eliminating one or more of the valves in this manner.

If the set appears to be "alive" and yet will not bring in radio signals, although it operates from the pick-up terminals, it might be found that the only fault is that the condenser vanes are not turning with the tuning knob. This will probably mean that the grub screws through the collar fitting on the condenser spindle are loose. On the other hand, it might be found that the lead from one set of fixed vanes has come adrift, so that the condenser is out of circuit.

### Bad H.T. Connections

If the set is not completely "dead," although the reaction control has no effect, it will generally indicate that there is a bad connection in the detector-anode circuit. The H.F. choke, anode resistance, decoupling resistance or transformer primary might be defective. First short-circuit the H.F. choke terminals; if signals can then be received in a practically normal manner the choke should be replaced or left out of circuit. In the case of a suspected resistance, moisten a strip of blotting paper and press that against the two connecting wires. The moisture will carry a certain amount of current, and might permit of the set being used.

When an L.F. transformer is needed the same idea can be tried by connecting a resistance—real or improvised—between the primary terminals and connecting a fixed condenser of any value over .001 mfd. between the anode and grid terminals. This will enable the set to work if the primary winding is burnt out, even though signal strength will not be quite up to par. This test can also be made, with or without the condenser, if there is a persistent crackling noise indicating a bad connection, probably in the H.T. supply.

## Join Newnes' Practical Group!

### PRACTICAL MOTORIST

The owner-driver's journal which tells you how to repair, overhaul and obtain the best performance from your car.

3d.—Every Friday

### PRACTICAL MECHANICS

The only English journal of its type. It deals with every branch of Science, Mechanics, Invention, Model-making, Chemistry, Astronomy, Photography, Television.

6d.—Every Month

### THE CYCLIST

The leading weekly for every Cyclist, Clubman, Utility Cyclist or Tourist. Join "The Cyclist" Road Club and also take advantage of the FREE Insurance.

2d.—Every Wednesday

### Run-down H.T.

Serious distortion with a battery set might show that the H.T. battery is run down, but a cure can often be effected simply by reducing the G.B. voltage. On the other hand, a dry H.T. battery can sometimes be rejuvenated to a certain extent by warming it in front of a low fire or in a not-too-hot oven. If the battery is gently warmed for half an hour or so it will often drive the set again for a few hours.

A run-down L.T. battery—indicated by the fact that signals are fairly normal when the set is first switched on, and then begin to fade out—presents a more difficult problem. With a small set, however, reception can be obtained by using a couple of bell cells or a three-volt cycle-lamp battery in place of the accumulator. The voltage will be slightly too high, but it can be reduced sufficiently by using two 8ft.

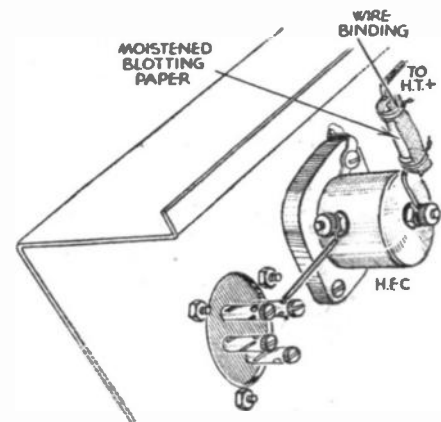

Fig. 5.—Trouble due to a faulty resistor might be overcome by using this simple dodge.

lengths of 24-gauge d.c.c. wire for connecting it to the set. At least, that will do when there are three valves taking about .4-amp. between them. If there are only two valves use leads about 12ft. long; if there is only a single valve it will be safer to employ only one 1½-volt cell connected directly to the normal L.T. leads.

In the case of a receiver taking not more than, say .3 amp. low-tension, reception can be obtained for a short time by using a 3-volt torch or flash-lamp battery for L.T. This can be connected directly to the L.T. leads without much danger of over-running the valve filaments, although to be on the safe side it is better to use long leads until the battery has been used for a short time.

### Microphony

If the set suddenly becomes microphonic, so that a "moan" gradually builds up in the speaker after switching on it means that a valve—probably the detector—is coming to the end of its life. A temporary remedy is to cover the valve with felt or to stick a lump of plasticine on top of the bulb. Another way is to move the speaker away from the set and arrange it so that it points away from the valves. With a built-in speaker, the unit can be taken out and temporarily placed on a table, with three match-boxes between the rim and the table top.

Anyhow, we hope that none of you will need to make use of the above suggestions during Christmas, and take this opportunity of wishing you the compliments of the season. Happy Christmas!





# BROADCAST YOUR OWN PLAY



How to Combine Mike and Pick-up, and Suggestions for Sound Effects, with Especial Reference to the Play Published in This Issue

THE production of sound effects which will come through the loudspeaker in such a manner that they may be recognised, is a difficult matter. There is also some difficulty in so arranging input circuits that it is possible to carry out any desired form of mixing or combining of the outputs of pick-ups and microphones, and this type of experimental work will

put circuit be used for feeding the reproducers.

### Mixing Circuits

The microphones and pick-ups must be joined to the input valve and to avoid unnecessary repetition the reader is referred to the article in this issue on the use of Microphones and Pick-ups for the various incidental details. For the play referred to, the opening consists of a fade-in reproduction of a gramophone record which fades out and a cross-fade of another tune is superimposed. This in turn has to fade out for the announcement. A fader is therefore one essential on the input side. Where expense is of no account it is possible to have a number of separate controls for fading and mixing purposes, but with a little care in arranging switches it is possible to carry out practically any desired fading and mixing with only two controls. The use of a minimum of this type

indicates that the music or speech from the speaker is gradually reduced in strength until it is inaudible. "Mixing" indicates that whilst one item is being reproduced, say speech, music is gradually introduced in the background, being maintained at a low level as a background, or being gradually built up in strength and the speech simultaneously reduced until one

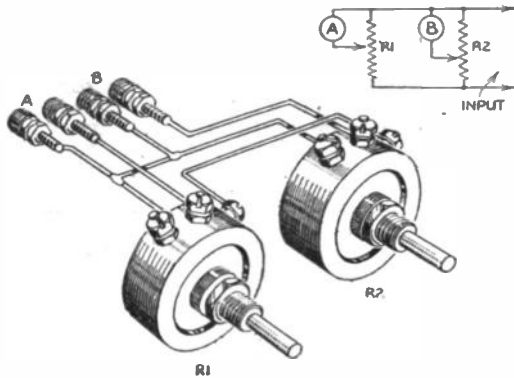

Fig. 1.—How to connect the two controls for perfect mixing on mike and pick-up, etc.

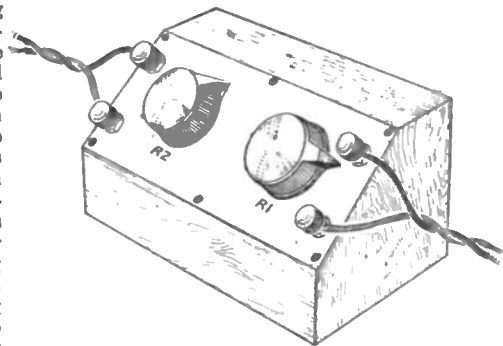

Fig. 3.—How to mount the controls and terminals for ease of handling.

be found of great value to those who are interested in producing plays for reproduction through a loudspeaker. In order to make the various phases of this work clear, it is proposed in this article to show how to carry out the "electrical" side of the work of the play which is given on pages 333 and 334, and therefore the stage or production directions should be followed in conjunction with the details given in this article.

Firstly, there are two ways of reproducing a play of this type. An input circuit (consisting of microphone or microphones and pick-ups) will be needed, and an output circuit consisting of one or more loudspeakers must also be used. As the reproduction must take place in a room distinct from that in which production takes place (so that the only sounds heard by the audience issue from the loudspeaker(s)) this means that either the input or the output leads must be very long. On the input side, it is possible to use long leads, but a 1/1 transformer must then be employed to avoid various types of trouble such as instability, L.F. howling, etc. On the output side, however, an extended lead up to any distance may be used very easily and therefore it is preferable that the amplifier or radio receiver used for amplifying the sounds be situated in the room with the actors, whilst the standard out-

will also prevent difficulties on the input side. If desired, a single component of the "fader" type may, however, be employed, but this will not permit of "mixing." For

takes the place of the other. For mixing, therefore, two separate controls will have to be employed.

In the play in question, it will be possible to carry out all of the necessary production work with two standard volume controls, and these should preferably be of the .25 megohm type. As, however, certain input circuits (depending on the amplifier design) are not standard, it may be desirable before purchasing them to try the effects of different values, and standard fixed resistances may be used for this test. Fig. 1 shows the arrangement of the circuits for the production of "Nightlight Robbery." It will be seen that the input imped-

ance is constant, and consists of the two volume controls in parallel. The two components marked A and B are either microphones or pick-ups, and in order to give all the necessary effects for this play one of these should be the permanent microphone into which the performers speak, whilst the second will have to be changed in turn from pick-up to microphone. In the opening they will both be pick-ups. Thus a double-pole change-over switch will be needed and should be connected as shown in Fig. 2. During the course of the play it will be necessary to make changes to one pair of contacts on the switch and this may be done by disconnecting the unwanted component from a pair of terminals and

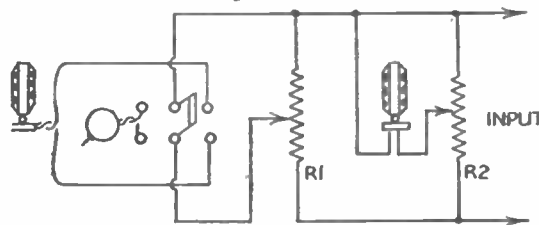

Fig. 2.—By using a change-over switch as shown here you can use mike and pick-up as desired and obtain various mixing effects.

the benefit of those readers who are not familiar with these terms, perhaps it would be as well to explain them before dealing further with the subject. "Fading" simply

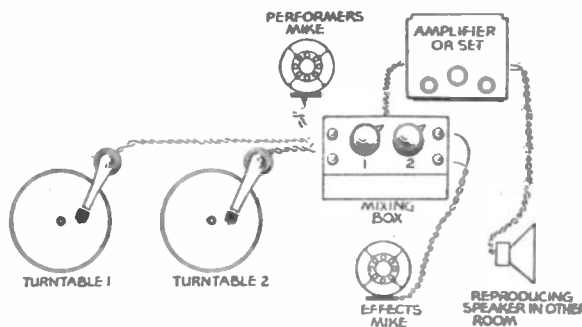

Fig. 4.—The complete lay-out for broadcasting your own play as mentioned in this article.

(Continued on next page)

## BROADCAST YOUR OWN PLAY

*(Continued from previous page)*

connecting the required one. Alternatively plug and jack connections may be adopted.

## Method of Working

Taking our play a microphone will be joined to one pair of the terminals shown in Fig. 3, and a pick-up to the other. The announcer will make the necessary introduction, and then the needle of gramophone pick-up No. 1 will be placed on a record of "Chanson Triste." The volume control for this pick-up will, of course, be set back to minimum. When the announcement is complete the control for the pick-up will be gradually turned up, and during this a second pick-up must be connected to the terminals on the other control in place of the microphone. After a few bars of "Chanson Triste" the second pick-up is placed on the record of "Teddy Bears' Picnic," and the turntable started. The first control is then slowly turned off, and at the same time the control for the new record is slowly turned up. As soon as the control of the first record is right off, the pick-up leads should be disconnected and the leads from the microphone to be used by the performers should be connected in place of them. The play may now commence as the "Teddy Bears' Picnic" is faded out.

During the play incidental noises are required and there may be some difficulty in getting these to "come over" to be

recognisable. The following hints will show the lines upon which the effects may be produced, but they may have to be modified according to the type of L.F. amplifier which is used, and the type of speaker. In the opening scene a grandfather clock is heard ticking. A stick of wood may be used to simulate the ticking, tapping it slowly on a piece of wood. To get the "dull" effect of a real old clock the piece of wood should be thick and placed on a thick piece of cloth. Do not place it too near the effects microphone. The Westminster Chimes and the hour strikes may be produced from a real chiming clock if you have one of this type in the house, but if not, a record in which the sounds occur will have to be employed.

A set of chiming rods for use in a clock may be obtained from a clock-dealer if you think the expense is justified. The 'phone bell may be imitated by an ordinary domestic electric bell, and the receding of the voices may be obtained realistically by the performer walking slowly backwards from the mike. Alternatively, the producer can turn down the volume control when he gets his cue, and turn it up to give the effect of a person entering the room. This method of producing the effect will enable the performers to keep together and devote all their attention to their lines. The smashing of the vase may be produced by dropping a number of pieces of metal on to the table close to the effects mike. Any old pieces of

metal will do, and if you are an old radio experimenter you will find that a handful of discarded condenser vanes dropped on to the table from a height of about 1ft. so that they fall 3 or 4ins. from the mike will give a very realistic effect. The tapping on the window may be best carried out by placing a sheet of tin or other thin metal on the table 4 or 5ins. in front of the mike, and tapping this with the end of a pencil. The breaking of the window and tinkling of the falling glass will be realistically represented by dropping four or five condenser vanes or similar thin pieces of metal on to the metal plate just mentioned. The creaking of the opening window must not be overdone. There are several ways of accomplishing the effect, and the old idea of a wetted cork being drawn along the side of a medicine bottle will be quite as good as any. Light pressure should be used to start with, holding the bottle close up to the mike, and then a heavier pressure to produce the squeak, taking off the pressure to finish with just the faint rubbing sound.

Other ideas will, of course, occur to readers, but the hints given will show how to produce the play, and the diagrammatic layout of Fig. 4 shows how the various accessories for this particular play will be arranged.

## PETO-SCOTT ALL-WAVE KIT

THE accompanying illustration shows the Peto-Scott Battery 1-valve All-wave Kit with a novel Unit method of construction, by means of which amplifying sections may be added. In the illustration the section nearest to the panel is the 1-valve unit, and the rear section is

any time be changed into a more comprehensive receiver, or an experimental circuit may be tried out. Secondly, additional sections may be added so that a two-valve circuit, for instance, may be converted into a three or four valver, and the minimum of constructional work will be involved and there will be no need to scrap one chassis and re-drill another. These kit sets are obtainable complete, or the separate parts may be purchased from time to time. The panel is of steel and has a crackle finish to harmonise with a neat steel cabinet with the same finish, of which the panel forms the entire front. The cabinet has ventilating louvres and a hinged metal lid. The chassis is of stove enamelled steel measuring 10ins. by 4½ins. by 3ins., and is ready drilled with a rubber bush and A.E. and L.S. socket strips bolted in position.

The 1-valve kit consists of a standard circuit with a new All-wave tuner, used in conjunction with a standard .0005 mfd. tuning condenser operated through a special slow-motion dial of the type hav-

ing a small escutcheon window for viewing the dial settings. The tuner is self-contained, that is to say, it incorporates a special low-loss switch for changing from the short-wave to the standard broadcast wavebands. There are only six connections to be made to this tuner. The ranges covered are from 18 to 52, from 200 to 550 and from 900 to 2,000 metres, and the complete Kit for the receiver (exclusive of

valve and cabinet) costs £1 9s. 6d. With valve and cabinet the price is £2 5s. 9d. If the complete receiver is required, ready wired and tested and with the 2-stage amplifier added, the complete cost is £4 10s.

## NEW VARLEY PUSH-PULL TRANSFORMERS

MESSRS. VARLEY announce a new addition to the range of push-pull transformers, in the form of a dual-ratio output transformer. This component is of a similar type to the existing models, having a primary inductance of 48 henries with no D.C. and designed to carry 65 mA through each half. The secondary winding is in two sections, brought out to four separate terminals, and thus it is possible to place the two sections in series or parallel. By this means it is possible to vary the output ratio to obtain a step-down of either 25 to 1 or 50 to 1. This component is, of course, intended for use with low-resistance loudspeakers, and completes the range of double-output push-pull transformers, in which there are now three models.

## Other Models

The two remaining models are similar in construction but provide ratios of 20 to 1, 40 to 1, 34 to 1 and 68 to 1, thus covering practically every requirement for the push-pull feeding of low-resistance speakers. It is, of course, possible to use any of these models to feed a high-resistance speaker by feeding from the two anodes of the push-pull stage through fixed condensers in the usual way.

The transformers are substantially made with sectionalised and interleaved windings, and have an exceptionally good frequency response, giving splendid results with modern high quality speakers and standard power valves. The price of all three models is 18s. and the dimensions are 3½ins. by 3½ins. by 3½ins., whilst the weight is 2½ lb.

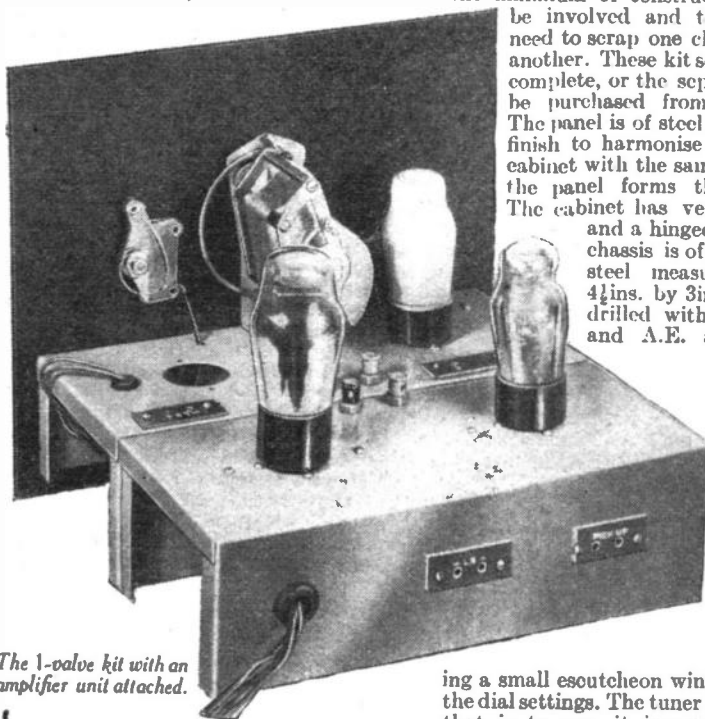

The 1-valve kit with an amplifier unit attached.

a two-stage amplifier, and this scheme has many interesting points of value to the home-constructor.

Firstly, the kit is built on standard chassis units and may thus at



A Comedy-thriller Specially  
Written for Home Broadcasting  
By ARTHUR ASHDOWN

*(Fade in gramophone playing "Chanson Triste" for about thirty seconds. Gradually fade out and fade in record of "The Teddy Bears' Picnic" for about another thirty seconds, and then fade out music whilst Announcer speaks.)*

**ANNOUNCER:** Ladies and Gentlemen, we present "Nightlight Robbery," a comedy-thriller. The characters are: Henry Shannon, Artur Scholer, Steve Smith, and "The Girl."

The action of the play takes place in the library of Scholer's house at Hampstead.

Ladies and Gentlemen—"Nightlight Robbery."

*(Fade in "Chanson Triste" for about fifteen seconds, and fade out into the tick-tock of a clock for about another fifteen seconds. The clock chimes and strikes eleven very slowly. As the clock finishes striking a telephone rings about four times.)*

**SHANNON.**—"Hullo, hullo. . . . You want Mr. Scholer? Who is that speaking? . . . (Pleasantly.) Oh, hullo, Rosa—Nickey this end. I didn't recognise your voice. . . . What's that?—I wasn't meant to? . . . Oh, I see, my dear, you're in disguise. I thought it was Greta Garbo at first. . . . We'll have to get you a radio contract doing impersonations; it would pay as well as this racket, and it would be much more respectable. . . . All right, all right, don't get the wind up. I'm not going to say anything incriminating. In any case, who would be listening in? . . . All right, I'll get Mr. Scholer. (Shouting off.) Fitzey, you're wanted on the 'phone. (Con conversationally into 'phone.) Mr. Scholer will be right along, my dear. By the way, what do you think of the new name, 'Artur Scholer'? Not bad, eh? If you want 'phone me up sometime, to kiss me good-night, don't forget my new name is Henry Shannon. . . . No, not 'Cannon'—'Shannon'—'S' for escalator . . ."

**SCHOLER** (he speaks with a slight guttural accent).—"Come on, Nickey, give me the 'phone."

**SHANNON.**—"Here is Mr. Scholer, Rosa, my dear. We are now taking you over."

**SCHOLER.**—"Hullo, Rosa. Is everything all right? . . . Good! You have the tickets for the boat train? . . . That is good. . . . Yes, I'll send the passports. . . . Yes, that is right. . . . Yes, I have everything worked out and it cannot fail. . . . Listen, Rosa, do not say too much on the 'phone."

We had a crossed line the other night and I heard another conversation. . . . No, I don't think that they heard us. . . . Good-bye, my dear, and—bon voyage. (He chuckles as he replaces the receiver.) That is good. Rosa has everything ready at that end. Now we must make our final plans here. There must be no mistake."

**SHANNON.**—"Do you want Steve?"

**SCHOLER.**—"Yes, call him, please."

**SHANNON** (from a distance).—"Steve! The gov'nor wants you."

**SCHOLER.**—"Is he coming? There is no time to waste."

**SHANNON** (close-up again).—"Yes—oh, here he is."

**STEVE.**—"O.K., gov'nor—all correct and on duty."

**SCHOLER.**—"Good! Now sit down, both of you. We will just go over the plan to make sure that we have forgotten nothing. Remember there must be no single mistake—or else. . . .!"

**STEVE.**—"Oh, gov'nor, don't 'arp on the 'or else' so much. It makes me 'omesick."

**SHANNON.**—"Which home, Steve? Maidstone or Pentonville?"

**SCHOLER.**—"If you slip this time—I'm afraid that it will be Dartmoor. (He chuckles.)"

**STEVE.**—"Go on! Go on! Why not make it the Devil's Punchbowl?"

**SHANNON.**—"You're thinking of 'Devil's Island.' But you have to be French to go there."

**STEVE** (despondently).—"Just my bloomin' luck!—I'm 'alf Continental."

**SHANNON.**—"In that case you'd do ten years home and ten away."

**SCHOLER.**—"Come, now, it is getting late—we will just go over the plan again. The diamonds are in the safe behind that picture. I think, Steve, that you know the combination by now?"

**STEVE.**—"Like the bloomin' h'alphabet, gov'nor."

**SHANNON.**—"There's no 'H' in the combination."

**SCHOLER.**—"When we have finished this little—er—discussion both of you will leave by the back door. The servants are due to return from the dance at 12 o'clock. I shall be in here and will tell Jackson to make sure that the window is shut. Then I will go to bed—and to sleep—as usual. That is my part complete."

**STEVE.**—"Lumme, gov'nor—you do pick the easy bits!"

**SCHOLER** (sternly).—"Don't be a fool, Steve! Do you not forget I have spent months arranging this—er—business? Where would you be, I ask you, without my brain?"

**STEVE.**—"Without your brain, gov'nor—I'd be me—and with your brain, gov'nor—I'd be in bed at ten-past twelve."

**SCHOLER** (heatedly).—"Enough—you little rat! (Almost shrieking.) Do you not think that. . . .?"

**SHANNON** (soothingly).—"Steady, Fitzey. Steady, old man. We'll need all our nerves—later on. Steve didn't mean anything—it's just his sense of humour."

**SCHOLER.**—"Then I am glad that he has at least one sense!"

**SHANNON.**—"Now let's forget it. Where did we get to?"

**STEVE.**—"The Guv'nor's in bed."

**SCHOLER** (with calm determination).—"At two o'clock exactly—you will both return to that window, force it open and enter. Steve will open the safe and take the diamonds. Then you will both get away as quickly as you can and meet Rosa."

**SHANNON.**—"She'll have the car waiting by the cemetery?"

**SCHOLER.**—"Yes."

**STEVE.**—"Ow jolly!"

**SCHOLER.**—"You will drive to Dover and—er—disappear. We shall all meet at Rotterdam—to-morrow week."

**SHANNON.**—"I still don't see why Rosa has to come with us."

**SCHOLER** (quietly and sweetly).—"Rosa is such a careful woman—don't you think? And so capable."

**SHANNON.**—"Look here, Scholer, if you don't trust us—"

**SCHOLER.**—"Of course I trust you, my dear Nickey! Why shouldn't I? After all, I know a lot about you both—yes—such a lot!"

**STEVE.**—"Lumme—don't 'arp about the past! Let's forget it and look to the future."

**SCHOLER.**—"That is right, Steve—the future! It will be bright for all of us."

**SHANNON.**—"All right—let's cut it out and get a move on."

**SCHOLER.**—"Well—that is all! As I say, you will all go to Rotterdam and I will



follow as soon as I have arranged the insurance claim. Are there any questions?"

**SHANNON.**—"You still want me to come back with Steve to-night?"

**SCHOLER.**—"I thought that we had settled all that. If you are disturbed by the servants—it is for you to deal with them—while Steve looks after the diamonds. Are there any more questions?"

**SHANNON.**—"No—it's pretty straight to me."

**STEVE.**—"Yes—dead straight!"

**SCHOLER.**—"Good—then you must go—both of you."

**SHANNON.**—"Come on—let's get going, Steve!"

**SCHOLER.**—"Good-night, my friends—and good luck! . . . Don't forget . . . you are expected at (very slowly) exactly two o'clock!" (Fade in the tick-tock of the clock for about thirty seconds. The clock chimes the hour and slowly strikes two. A gentle tap-tap is heard on the window, followed by the tinkle of falling glass. A creak as the window opens.)

**STEVE.**—"Ere we are Nickey—ome once more. 'Ow the old place 'as changed!"

**SHANNON** (in a hoarse whisper).—"Shut up, you fool—the servants! (more loudly) Oh—damn that chair!"

**STEVE** (mimicking).—"Shut up you fool—the servants!"

**SHANNON.**—"Come on, let's get it over as quickly as possible. Here you are—here's the safe. Get to work!"

**STEVE.**—"Not so much 'urry, Mr. bloomin' Shannon. This is where I get temperamental. This is when the h'artist in me comes h'out!"

**SHANNON.**—"Will you shut up and get on with the job?"

**STEVE.**—"Ain't that a luvly sight. All gleamin' and glistenin'! I can see it's goin' to be a real pleasure to a h'artist like me."

**SHANNON.**—"Come on—come on!"

**STEVE.**—"All right—don't get me flustered. Now then—one, two, three—four, five, six—click! Good! One, two, three—four, five—click! That got you, didn't it? One, two, three—four, five, six, seven. Click!"

**SHANNON.**—"Is that the lot?"

**STEVE.**—"One, two, three—four and five, six—Clickety—clickety—click! Open Sesame!"

**SHANNON.**—"Good! Come on, get the diamonds and let's get away."

**STEVE.**—"Certainly, sir—diamonds I think you said—and diamonds you shall 'ave! There—aren't they beautiful? The Dorit Diamonds to be sure. Will you take them or shall I send them?"

**THE GIRL.**—"I'll take them, please!"

**SHANNON** (surprised).—"Who the devil—!"

**STEVE.**—"Lumme—a ghost!"

**THE GIRL.**—"Quite still, both of you, please. May I have the necklace? Thank you!" (A crash is heard as she smashes a vase.)

**SHANNON.**—"What are you doing—your little fool?"

**THE GIRL.**—"Just giving the alarm. Er—it's quite usual, I believe."

**STEVE.**—"Excuse me, miss, but h'are you a ghost—or—real?"

**THE GIRL.**—"Fairly real, I believe. Anyway, I know the revolver is quite real. Would you both mind standing by the table? A little further—thank you!"

**SCHOLER** (from a distance, and getting nearer).—"What is this? What is happening?"

**THE GIRL.**—"I'm afraid you were being burgled."

**SCHOLER** (stupidly).—"Burgled? Burgled?"

**THE GIRL.**—"A burglar? Oh, no!"

**SCHOLER** (still groping).—"Then—how—how did you know about all this?"

**THE GIRL.**—"Well, you see, it's rather difficult for me. I'm a telephone operator at the local exchange, and some time ago I overheard a conversation about this burglary."

**SCHOLER.**—"Then why did you not tell the police?"

**THE GIRL.**—"As I say, it's rather difficult for me. If I had reported it they would have



"I'm just somebody who happened to know."

**STEVE** (dryly).—"Yes, guv'nor—burgled!"

**SCHOLER.**—"Who are you? Who are you, I say?"

**THE GIRL.**—"I'm just somebody who happened to know."

**SCHOLER.**—"Know what?"

**THE GIRL.**—"I happened to know that you were going to be burgled. But don't worry—I was just in time—here are your diamonds."

**STEVE.**—"Crikey! She is a ghost!"

**SCHOLER.**—"You mean to say that you are not a burglar?"

known that I had been listening-in. I stood a good chance of losing my job."

**SCHOLER.**—"And so you came alone! (Pleasantly.) You were a very brave little girl. I don't know how to thank you."

**STEVE.**—"Give her a kiss, guv'nor!"

**SCHOLER.**—"Silence! I will deal with you presently."

**THE GIRL.**—"Well, I must be going now."

**SCHOLER.**—"If you would keep these men covered, I will go to the safe. Perhaps you will accept a small present from me."

(Continued on page 351)

#### PRODUCTION NOTES

Here are a few points which should be kept in mind by those who are producing their first radio play. The entire action has to be conveyed to the audience by the spoken word. Great care should therefore be taken to rehearse the dialogue very carefully and to put as much meaning as possible into every line. No doubt must be left in the minds of the audience as to which character is speaking. In the case of "Nightlight Robbery," the character parts are typed widely apart. "Scholer" speaks with a slight guttural accent, "Shannon" talks quite naturally, and "Steve" employs the Cockney brogue.

It is helpful for the producer, when rehearsing his cast, to close his eyes. In this way he is able to put himself in the place of the listener. For the final rehearsals he should hear the play in another room, relayed by a loudspeaker.

Elsewhere in this issue will be found an article entitled "Broadcast Your Own Play." This explains how the various effects called for in the script may be produced, and should be carefully studied by the "Effects Manager."

It is suggested that the audience should listen to the play in a darkened room, as this will help to create "atmosphere."

# Using Microphones and Pick-Ups

How to Connect these Components to Standard Apparatus, and Methods of Controlling Volume, Fading, Mixing, etc.

It is possible to use a microphone or a gramophone pick-up with practically any receiver, but in certain commercial sets designed for Universal mains (A.C. or D.C.) operation, the fact that no pick-up sockets or terminals are provided may indicate that it is unsafe to use this type of accessory with that particular receiver. This is because the negative side of the

apparatus, the grid leak will be joined to the cathode, and, therefore, a biasing resistance with by-pass condenser must be inserted in the cathode lead, and the pick-up or mike may then be left permanently connected. Obviously it is desirable to fit a switch so that the radio signals may be cut out, or so that no bad effects will be experienced on radio due to

voltage. Similarly, the ordinary pick-up may need the inclusion of a volume control to prevent the detector valve from being overloaded.

### Volume Control

Some pick-ups are provided with a built-in volume control on the carrier arm, and thus there will be two leads from the component which may be connected as shown in the diagrams already mentioned. If, however, no such control is provided it will be necessary to fit one either on the motor-board close to the pick-up or on the receiver chassis in a convenient position. The value of the control will depend upon the pick-up in use, and it may vary from .25 megohms to 1 megohm. The makers' instructions should therefore be followed when selecting this component. Fig. 3 shows how it is connected in most cases, although it is possible to reverse the connections to the grid and the arm of the control. This is usually only done when two or more pick-ups are employed. If it is desired to mix gramophone records, or fade from one gramophone record into speech or another record, a fader must be used, and this may consist of a centre-tapped volume control or two separate volume controls joined together, as shown in Fig. 4. With this device, however, it is

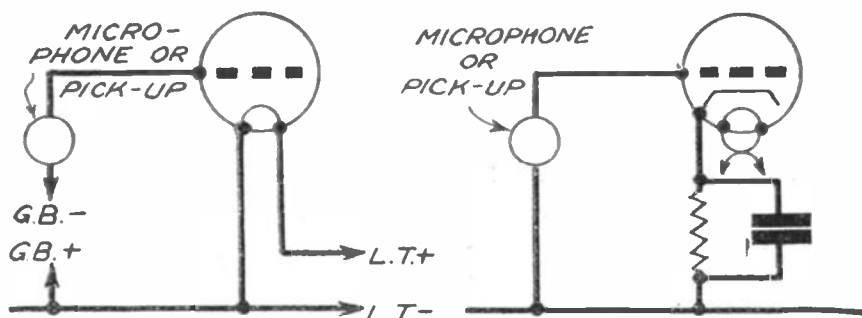

Fig. 1.—Method of connecting mike or pick-up to battery and indirectly-heated valves.

supply is internally connected to the chassis of the receiver, and thus one side of the mike or pick-up may become "live." With an ordinary receiver, however, either battery or A.C. mains operated, the pick-up or microphone is joined between the grid-cathode circuit. If a battery valve is employed, one side of the instrument will be

connected to a tapping on the grid-bias battery at a voltage which is correct for the particular valve in use. The arrangement for both types of valve is shown in Fig. 1, the circle indicating either pick-up or microphone. To obtain maximum amplification from an existing radio receiver the instrument should, of course, be connected as early in the circuit as possible, and one of the best places is in the grid circuit of the detector stage. In the A.C. type of

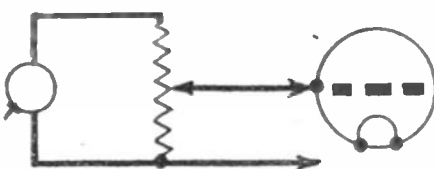
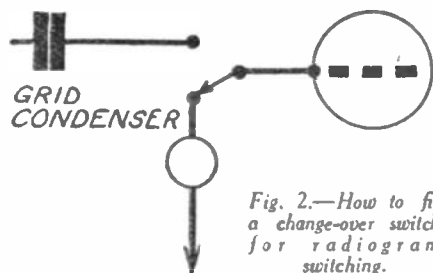

Fig. 2.—How to fit a change-over switch for radiogram switching.



### Connecting the Pick-up

If the receiver is not already fitted with pick-up terminals or sockets, and provided that it is not a Universal mains model, a terminal or socket strip may be mounted on the rear of the chassis and the connections made as shown in Fig. 2. If the grid terminal on the detector valveholder is a long way from the terminal strip it may be found necessary to enclose the lead to the switch in metal screening which should be connected to earth. Failure to do this may result in hum or some form of instability. The pick-up leads may be connected direct to the pick-up terminals, but if a microphone is employed additional precautions are necessary. The ordinary carbon or transverse current type of mike will require a high step-up transformer joined between it and the terminals, and it will also have to be provided with some form of polarising

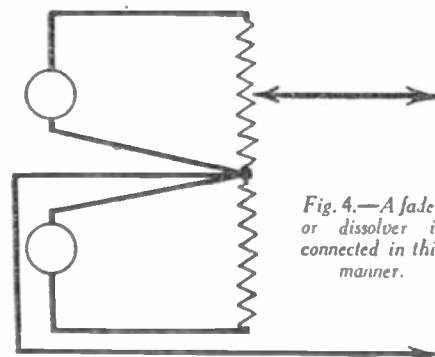

Fig. 4.—A fader or dissolver is connected in this manner.

only possible to decrease the volume from one source until it is at zero, and then build up the signal from a second source. The two cannot be mixed. When one signal has been faded out, the pick-up may be replaced by a microphone if it is desired to introduce speech.

### Microphone Circuits

The standard carbon microphone will be fed from a small voltage, say, about 4.5 volts, and through a

(Continued overleaf)

## Important Broadcasts of the Week

### NATIONAL (261.1 m. and 1,500 m.)

Wednesday, December 1st.—Symphony Concert from the Queen's Hall, London.  
Thursday, December 2nd.—Stanelli's Party.  
Friday, December 3rd.—Memories of St. George's Hall, feature programme.  
Saturday, December 4th.—Music Hall programme.

### REGIONAL (342.1 m.)

Wednesday, December 1st.—A running commentary on the second half of the International Association Football Match, England v. Czechoslovakia, from White Hart Lane, Tottenham.  
Thursday, December 2nd.—Royal Philharmonic Society's Concert from the Queen's Hall, London.  
Friday, December 3rd.—"Il Tabarro," opera by Puccini, from Sadler's Wells.  
Saturday, December 4th.—Brightlight, from the novel by J. B. Priestley, adapted as a radio play.

### MIDLAND (296.2 m.)

Wednesday, December 1st.—Variety from the Grand Theatre, Derby.  
Thursday, December 2nd.—Choral and Orchestral concert from the Albert Hall, Nottingham.

Friday, December 3rd.—Melody and Rhythm, dance band programme.  
Saturday, December 4th.—The Musician at the Gramophone by Sir Ivor Atkins.

### NORTHERN (449.1 m.)

Wednesday, December 1st.—Concert Party programme.  
Thursday, December 2nd.—Madrigal recital.  
Friday, December 3rd.—Port Sights—2, Loading and Unloading.  
Saturday, December 4th.—A running commentary on the second half of the Rugby League match, Barrow v. The Australians, from Craven Park, Barrow-in-Furness.

### WELSH (373.1 m.)

Wednesday, December 1st.—A Recital of Welsh Songs.  
Thursday, December 2nd.—Theme Song: Famous songs from famous films.  
Friday, December 3rd.—Organ recital from the Odeon Theatre, Llandudno.  
Saturday, December 4th.—Benighted, from the novel by J. B. Priestley, adapted as a radio play.

### WEST OF ENGLAND (285.7 m.)

Wednesday, December 1st.—God's Admiral,

Robert Blake, General-at-Sea, a sequence for radio.

Thursday, December 2nd.—Chamber Music concert from the Victoria Rooms, Bristol.  
Friday, December 3rd.—Are you Interested? an informal debate.  
Saturday, December 4th.—Offenbach's Opera, "Tales of Hoffmann," from the Pavilion Theatre, Bournemouth.

### SCOTTISH (391.1 m.)

Wednesday, December 1st.—Choral programme, from the St. Andrew's Hall, Glasgow.  
Thursday, December 2nd.—Reid Orchestral concert from the Usher Hall, Edinburgh.  
Friday, December 3rd.—Per Contra, a study in contrasts.  
Saturday, December 4th.—Scots Songs.

### NORTHERN IRELAND (307.1 m.)

Wednesday, December 1st.—Made in Ulster, Tweeds: A talk.  
Thursday, December 2nd.—Orchestral concert.  
Friday, December 3rd.—Organ recital from the Cathedral Church of St. Patrick, Armagh.  
Saturday, December 4th.—Military Band concert.

### USING MICROPHONES AND PICK-UPS

(Continued from previous page)

transformer as shown in Fig. 5. If, however, a condenser microphone or crystal microphone is employed, it will be essential to use a small amplifier connected close to it in order to avoid loss or hum which would be introduced by long leads. Usually a single stage of amplification is sufficient in the head amplifier, as it is called, and the output will consist of a feed from a fixed condenser joined to the anode, and the H.T. negative lead, thus leaving two leads, as in the previous cases which have been dealt with.

#### Using Microphones

When using a microphone, do not speak directly into it, but slightly to one side and in a natural voice. Much of the disappoint-

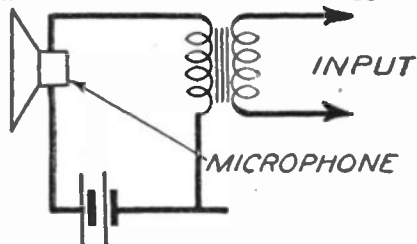

Fig. 5.—When using a microphone an input transformer is connected in this manner.

ment which is experienced by beginners is due to the fact that the voice is raised and this causes blasting. A quiet conversational tone is all that is required, and if this does not give good results additional amplification should be employed in the receiver or amplifier rather than the raising of the voice. The microphone will also have to be placed rather carefully, and if the loudspeaker is to be used in the same room or hall, the two should be placed as far away from each other as possible, to avoid "howl back".

## AN AUTOMATIC TIME SWITCH

A New Accessory which will be Found of Wide Application

FROM the earliest days the design of various types of time switch has intrigued engineers and designers. We have seen clocks designed to switch on the radio at certain times and to switch off after a certain duration. Unfortunately, there are many factors which render such a device of little use—such as the unknown length of a given item, and the over-running of time which is often experienced on B.B.C. programmes. The device is, of course, of great value in countries such

whilst occupied on other work. A new switch is shown in the accompanying illustration, and it will be seen that it is both neat and simple, consisting merely of a standard two-pin plug, two-pin socket, and clockwork mechanism.

This particular device may be used to switch on or off at will, and a small lever—seen on the right of the setting knob, enables the actual operation to be controlled. Indications are engraved on the casing, showing the setting for on or off.

#### Using The Switch

If it is desired to switch the receiver on, it is first necessary to calculate the time which must elapse before the set is required. For instance, if at 5 o'clock one wishes to hear the 9 o'clock news, it is obvious that four hours must elapse. Accordingly the setting lever is set to the "off" position and the control knob is turned until the figure 4 appears in the window at the top of the device. If there is any odd period of minutes, these are indicated round the edge of the setting knob and this will therefore be turned a little further to indicate the number of minutes after the hour. The lever is then set to "On," and at the expiry of four hours (or that to which the control was set), the receiver, will be switched on.

To switch off after a given period of time, the same procedure is followed, the lever being set to "On" whilst the mechanism is wound, and then turned to "Off." The range of time which can be covered by the switch is 11½ hours and the loading of the device is up to 1,000 watts. If desired, of course, the device may be used in conjunction with any electrical apparatus, other than a radio receiver. It is supplied by Messrs. Milnes Bros. and costs 37s. 6d.

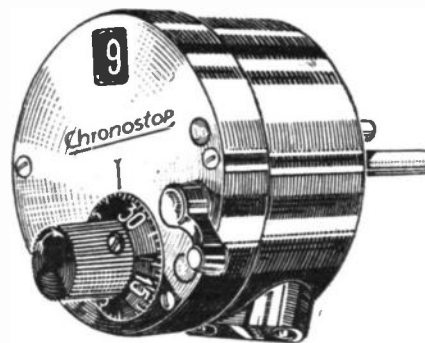

A general view of the Chronostop switch.



# A Radio Robot

Constructional Details of an Amusing Robot that Talks and Sings are Given in this Article. By EVERARD EDMONDS

MAN has created figures in his own image from the very earliest times. One recalls the Colossi of the Ancient World; the marble statuary of Phidias, so perfect that it became imbued with life; the figurehead that, bound to the bow of their ships, brought our Norse forefathers to this England; and, finally, those re-creations of historical characters which have made Mme. Tussaud famous.

speaking doll of a ventriloquist, my excitement knew no bounds, and I sent a shilling off post haste to learn this fascinating art—but, alas! for my ambition, my patience failed to match it, and the power was never acquired.

### Simple Construction

To-day, however, it is possible for almost anyone to construct in relatively little



Fig. 4 (above).—The completed robot ready for work.

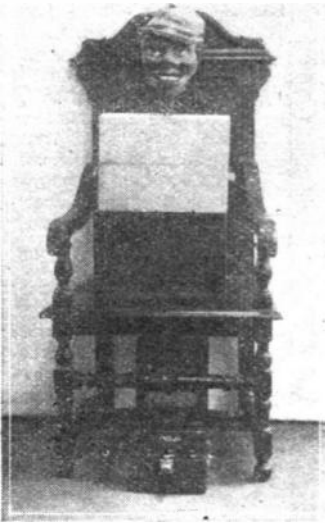

Fig. 1.—The robot mounted on a chair with the portable set underneath.

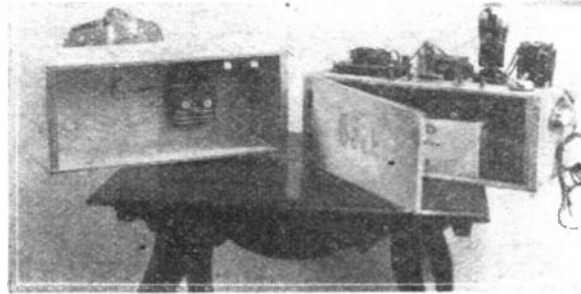

Fig. 3. (left).—The battery and relay sections of the apparatus.

I remember, as a lad, becoming so enchanted with the Sleeping Beauty and her clockwork-heaving breast that I could scarcely be dragged away! And, on another occasion, when I first witnessed the

time, and with inexpensive materials, a most amusing Robot, whose active jaw and dancing eyes as he recites a poem or sings a song will entertain for hours!

First a suitable mask is required—one of those sold for the celebrations of Guy Fawkes Day will do very well. This may be mounted as shown in Fig. 2—the lower jaw having been first cut away. To the latter a T-shaped piece of paper may be glued, so that, when the jaw is fixed in position, the cross of the T stands behind the eyes, and may have drawn upon it two lovely black—er—pupils!

pieces of the magnets, and, in order to prevent sticking, a small square of thin sheet-copper was soldered to the contact face of the armature.

Relay R1 is operated by R2 and a small 4.5 volt flashlight battery. R2 is the sensitive 5mA "Fulton" Relay sold by Electradix, Ltd., and it, in turn, is actuated by a valve. The latter may be any amplifying or power valve, and should have the requisite grid bias battery, as indicated

(Continued on page 349)

On the upright support the magnets and armature of a discarded electric bell. To the armature the lower jaw is now affixed, and we have the simple elements of our Talking Robot.

As the actual operating current will be relatively large, it is necessary to construct the following relay system—a system well worth assembly, as it may be used for wireless control of models, selenium cell operation, etc.

Referring to Fig. 5, the wires leading from the Robot are connected to a relay R1, also made from a discarded bell, which closes the circuit of a two-cell cycle lamp battery (Fig. 6), thus operating the jaw and eyes of the figure. The contacts of this relay are the armature itself, and the pole

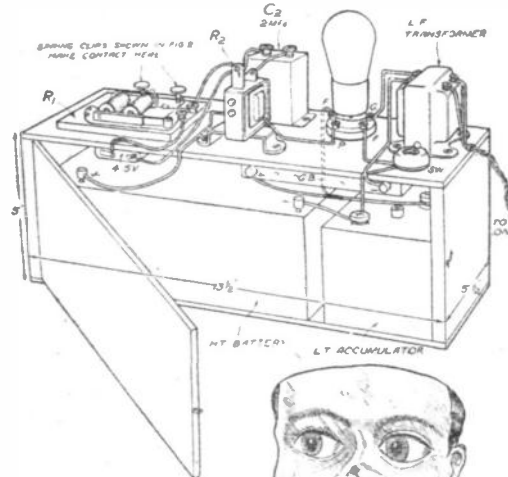

Fig. 5 (above).—The arrangement of batteries, components and connections

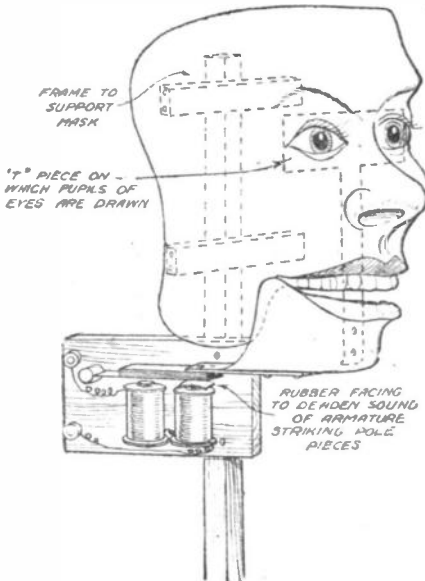

Fig. 2.—Method of mounting the face mask and lower jaw.

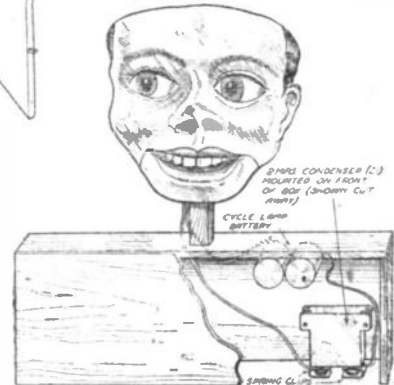

Fig. 6 (right).—How the relays are covered to deaden sound.

# Practical Television

December 4th, 1937. Vol. 3. No. 77.

## The R.C.A. Again

THE Chairman of the Radio Corporation of America has repeatedly made statements about television in an endeavour to prove to the American public that the United States is not lagging behind in the development of this important science. He was recently invited to address the Society of Motion Picture Engineers in New York and give his views on the possibilities and general position of television. During the course of his remarks he laid stress on the relationship between programmes and the number of viewers. He went on to say that if television programmes are to be provided through the medium of commercial sponsored support, on lines similar to those now ruling in the States for aural programmes, then advertisers would quite naturally be justified in asking for sufficient evidence of the extent of viewing public to compensate for any material expenditure. It is the dual problem of simultaneously creating a cause and effect. First of all it was essential to create large audiences in order to give sufficient support to what would admittedly be costly programmes, and on the other hand, it was quite obvious that expensive programmes would have to be organised in order to attract a large or substantial viewing audience.

## Component Parts

In an endeavour to meet this apparent state of impasse the R.C.A. propose to take a lesson from the early days of radio and create an experimental or home-constructor audience. To this end it was stated that component parts will be placed on the market in the New York and Philadelphia areas, where experimental transmissions of high-definition television are undertaken. In this way amateurs will be encouraged to build their own television receiving sets and so extend the field of viewing very materially. No doubt this decision will be watched with interest by manufacturers in this country, for there seems no doubt that home constructors within the present service area of the B.B.C. television signals would wholeheartedly welcome an opportunity of building their own sets, provided parts were available and designs published which would enable sets to be built at a reasonable cost. There are signs already that manufacturers are realising that there is a healthy market in this connection, and any extension by the release of more equipment in part form with adequate design data would be of material benefit to all.

## A Standardisation Plea

Those readers of this journal who were amateur constructors in the early days of radio will remember that valves were available covering a very wide range of filament voltages that included not only the standard 2, 4 and 6 volts, but also several intermediary values which necessitated series resistances, and voltmeters, if the correct working values were to be adhered to. It introduced a measure of confusion that was only removed when an attempt at standardisation of filament voltages was undertaken,

and a reference to any modern valve catalogue will show that all the awkward valve ratings in this connection have disappeared. The increasing importance attached to cathode-ray tubes for television reception purposes is creating a big market for this particular product, but a study of the working data and rating of the different makes and types of tube will show that there is at the moment an apparent complete lack of standardisation. C.R. tube sizes range in screen diameters from 1in. to 15in., while heater volts are from

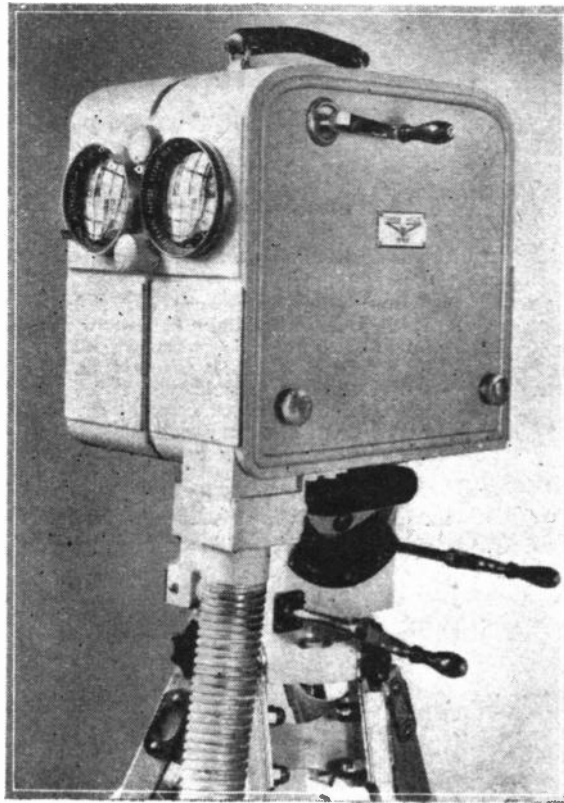

The small German mobile electron camera which has a view finder lens system similar to that used in this country.

0.6 to 6.3, and heater currents from 0.6 to 2.5 amps. While appreciating that one single rating is impossible, and that a range of screen diameters is essential, it would surely help in reducing costs if the variety of working conditions was narrowed very materially. The customer would benefit because his outlay would be reduced and the manufacturers because sales would increase. Most of the cathode-ray tube heaters at the present time derive their cathode-heater power from the mains, and exact ratings of 2, 4 and 6 volts would enable transformers to be simplified in design and be interchangeable for different makes of tube. Anode-voltage problems are certainly a little more complicated owing to the presence of multiple anodes for focusing purposes in the case of electrostatically-operated tubes, while a single anode with a high-voltage potential applied is

required in the case of electro-magnetically operated tubes. Even so, it seems incumbent upon manufacturers to endeavour to arrange for some form of a standard voltage and current supply requirements, as this would undoubtedly simplify somewhat the task of designers and effect economies in receiver costs, whether home constructed or built and sold as complete sets.

## Electron Cameras

Electron cameras seem to have been very much in the news of late. First of all a certain amount of information has become available concerning the new highly sensitive form of Emitron which works on a somewhat different principle to the original type used for some time at Alexandra Palace. These first cameras relied on the direct optical image "excitation" of the mosaic wherein the light and shade of the picture released electrons from the photoelectric surface in direct proportion to the light stimulation received by each isolated element. The electronic charge lost was replaced by electrons in the scanning beam, the restoration of each element to its equilibrium potential giving the picture signal to the first valve of the amplifier associated with the camera. The new camera, however, embodies what at first sight seems an adaptation of part of the original image-dissector tube principle. At the front of the glass cylindrical tube is a semi-transparent photoelectric cathode surface on which the scene to be televised is focused by means of the conventional optical system. The electron image so produced has an electron density at every point equivalent to the light intensity of the image to which it has been exposed. This electron image is then electrically accelerated towards the remote end of the tube and focused on to a plate by means of a solenoid coil mounted external to the cylinder's glass walls. The signal plate is a mosaic made from a secondary emissive material deposited on to the surface of a mica sheet. Owing to the established principles of secondary emission each primary electron impact on the mosaic releases an average of from eight to ten secondary electrons which makes each element acquire a positive charge with reference to the signal plate at the back of the mica sheet. It is seen quite readily, therefore, that the value of each elemental signal is very much greater than that secured by the direct optical image method, and this gives a materially increased sensitivity to the camera as a whole, so much so that reduced illumination is necessary to give a good picture, an extremely important factor where outside television broadcasts are concerned, and the vagaries of the English climate contended with. Each mosaic element's acquired capacity charge due to the secondary electron emission is neutralised by the scanning beam of electrons in the usual manner. These new Emitron cameras mark a material step forward in improvements at the transmitting end.

A PAGE OF PRACTICAL HINTS

SUBMIT YOUR IDEA

READERS WRINKLES

THE HALF-GUINEA PAGE

Pilot Light for a Soldering Iron

THERE are, no doubt, many readers who do not know that an ordinary torch bulb is suitable as a soldering-iron pilot

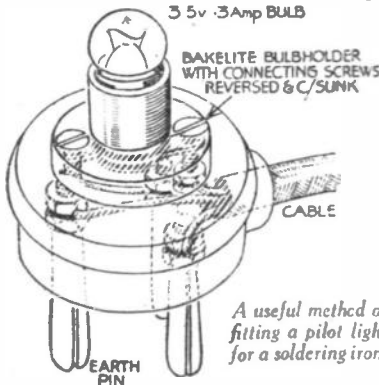

A useful method of fitting a pilot light for a soldering iron.

lamp. The usual electric soldering iron consumes about 50 watts, i.e., .25 amp., therefore, by using a 3.5 v. .3 amp. bulb in series, it will indicate whether the iron is switched on or off, perhaps saving considerable current at times. Readers will, no doubt, have their own ideas of fixing the bulb neatly.

The accompanying sketch shows how the bulb can be fitted to a 3-pin plug.—G. D. MUNDAY (Brighton).

A Midget-valve Tester

THE necessity for a straightforward and quick midget-valve tester prompted me to design the model illustrated in the accompanying sketch, and although two valveholders only are required, five classes of valves may be tested for grid anode curves and mutual conductance.

The only home-constructed parts are the two push-buttons, and the chassis is of the metallised wood type; the front panel is of ebonite, and the meters, toggle switches, 6 terminals, and two wander

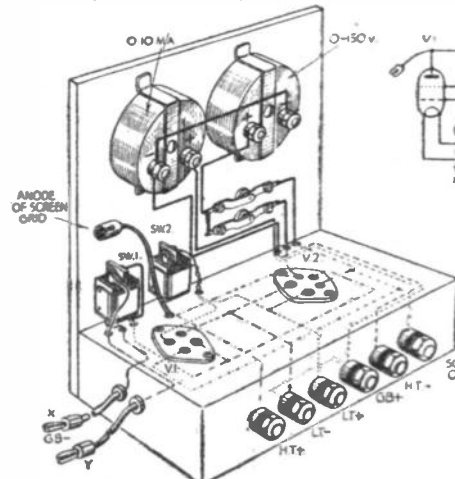

Rear view and circuit diagram of a midget-valve tester.

THAT DODGE OF YOURS!

Every Reader of "PRACTICAL AND AMATEUR WIRELESS" must have originated some little dodge which would interest other readers. Why not pass it on to us? We pay £1-10-0 for the best wrinkle submitted, and for every other item published on this page we will pay half-a-guinea. Turn that idea of yours to account by sending it in to us addressed to the Editor, "PRACTICAL AND AMATEUR WIRELESS," George Newnes, Ltd., Tower House, Southampton Street, Strand, W.C.2. Put your name and address on every item. Please note that every notion sent in must be original. Mark envelopes "Radio Wrinkles." DO NOT enclose Queries with your wrinkles.

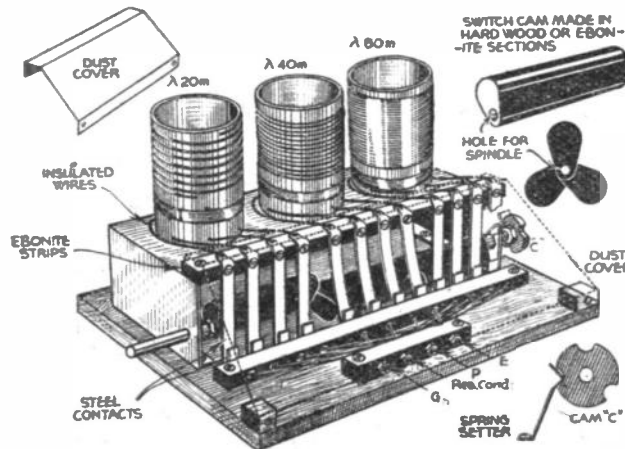

A novel short-wave coil assembly.

plugs and fly leads, constitute the apparatus employed.

One push-button registers the anode voltage for S.G., triode, and pentode, the other registers screen voltages only. The milliammeter is inserted in the H.T. negative side thus giving not only the anode currents, but in the case of the pentode, particularly the anode current + screen-grid current, thus giving a true reading.

The mutual conductance of any of the five valves—XSG, XL, XD, XP and XY can be obtained by operating the switch S1—S2 being the on/off switch.

It will be remembered that a variation of 1 volt in G.B. will register a variation of current on the milliammeter, and the difference between the two figures in mA/V gives the mutual conductance.

The theoretical inset clearly shows the fundamentals of the circuit and its simplicity will be evident. V1 is for the XSG, XD, XL and XP, and the V2 is for the pentode XY.

The fly lead "X" is for the mutual conductance G.B. voltage difference, and "Y" for the normal G.B.—E. A. WITHERINGALE (Bolton).

S.W. Coil Unit

THE accompanying illustrations show a novel short-wave coil assembly I built up from spare parts. The whole job did not cost me 1s. 6d. The contact arms for the switching were made from dismantled radio jacks as these have small silver contacts to improve efficiency. The operating cam is built up from pieces of ebonite or hard wood, assembled on a spindle as shown in the smaller sketches, and a set of home-made coils for the particular bands required will thus provide the listener with a most useful unit which will

be found very serviceable and will not give rise to some of the usual troubles experienced when switching is employed for short-wave sets. To protect the contacts on the switch from the effects of dust a metal cover was made and screwed in place as shown by the dotted lines, and I have had this in use for six months before I took it out to sketch it, and on examining the contacts I found they were perfectly clean—no dust, no damage through arcing.—R. D. PATE (Kirkdale, Liverpool, 4).

A Soldering Tip

WITH modern steel chassis, coated or plated, soldering direct is impossible without first removing this protective

layer. To save disfiguring the chassis by scraping or scratching it, I make a small, shallow depression with a small hand drill, having a rather flat cutting face, which makes a clean and effective soldering point. The accompanying sketch clearly shows the idea.—A. HULME (Runcorn).

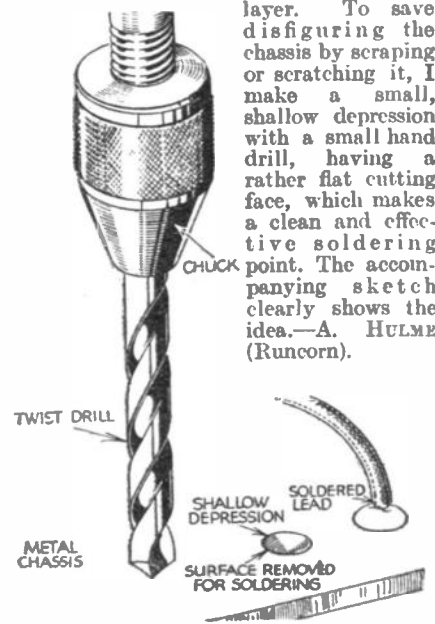

Method of preparing a metal chassis to ensure effective soldered joints.



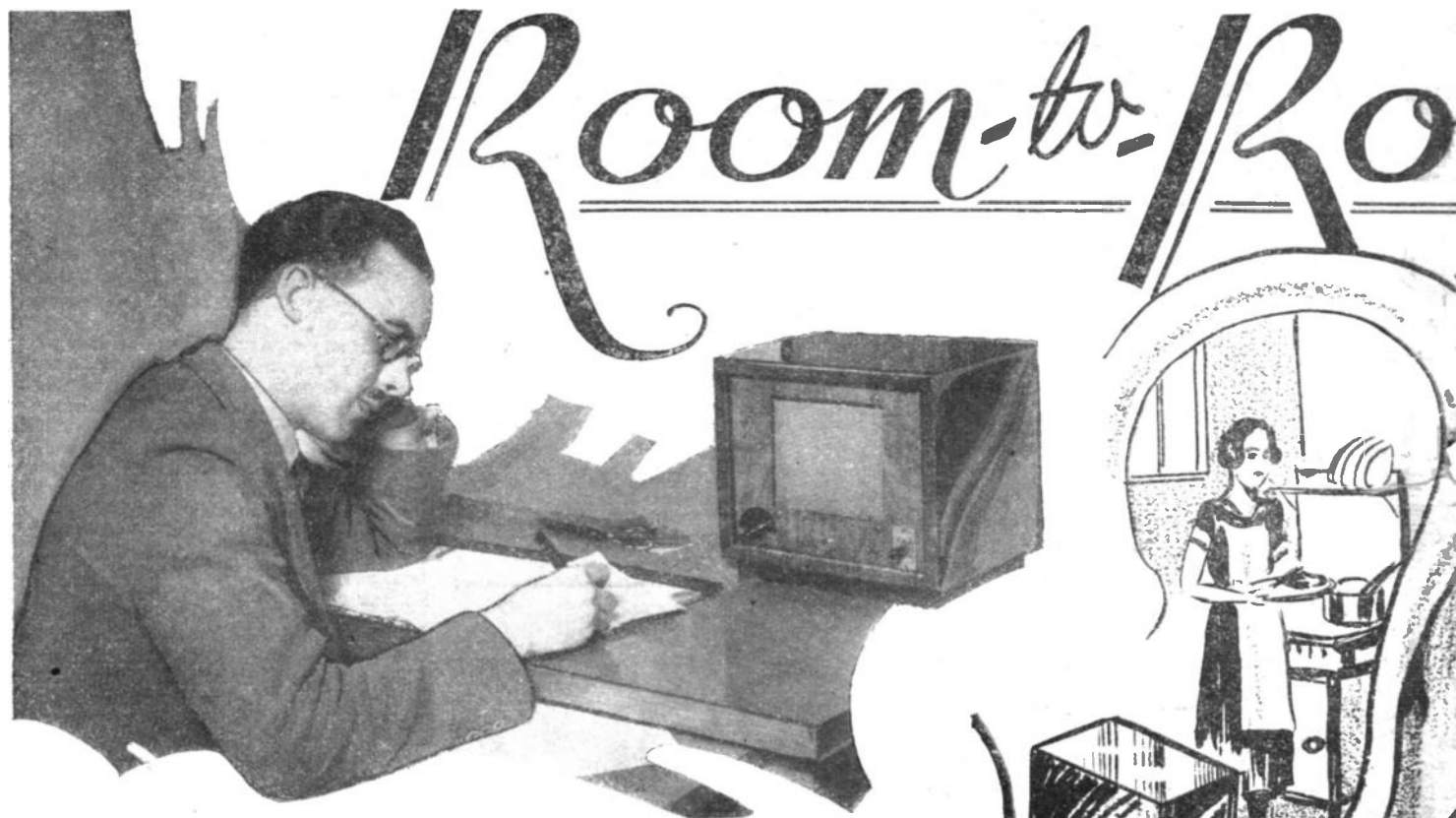

As we have previously pointed out in these pages, it is possible to use an ordinary moving-coil type of loud-speaker both as a microphone and reproducer, and we have also already shown how the speaker may be switched from one position to the other. The unit described in this article utilises this principle and incorporates a two-stage A.C. amplifier, with which it is possible to obtain two-way communication over quite considerable distances and with high input sensitivity. Of course, it is possible to arrange that the speaker acts in the dual capacity without the need for a change-over switch for "Talk" and "Listen" positions, but this

is a more complicated process and will also be more expensive to construct. It is also easy to arrange that any pair of sub-stations can call each other and maintain conversation whilst other lines are in action, without interference. The unit here described, however, is of the simplest type, and will be found ideal for installation in the home so that communication may be established with five different rooms from a central point, and it will also be found of value to a business man who wishes to provide such an installation so that he may be in communication with his various offices or workshops. The illustrations show the general appearance of the finished Master

Unit, from which it will be seen that it is neat and of simple appearance and may take its place on any standard desk without being obtrusive.

**The Circuit**

Fig. 1 shows the circuit employed, from which it will be seen that an input transformer is provided and fed from a five-point selector switch via a special type of change-over switch. The input valve is coupled to the output pentode through a resistance-capacity unit which is incorporated for two reasons. Firstly, it is cheap and avoids troubles which might be introduced owing to the proximity of other transformers in the set, and secondly, the grid leak may be made variable so that a simple but efficient form of volume control may be utilised. The built-in speaker is provided with an output transformer which is also fed to the selector switch through the special change-over switch already mentioned. A standard mains section, consisting of transformer, rectifying valve and smoothing circuit, is fitted, and this has only one difference from the standard devices as used in radio apparatus. This consists of a split negative H.T. feed, the use of which will be explained at a later stage. The wiring diagram shows how the various parts are arranged, and it will be noted that five pairs of terminals are provided for connection to the five sub-stations. It is possible to dispense with five of these terminals by using a common earth return, but there are drawbacks to this arrangement and the saving of expense is very small.

The selector switch is a standard Bulgin

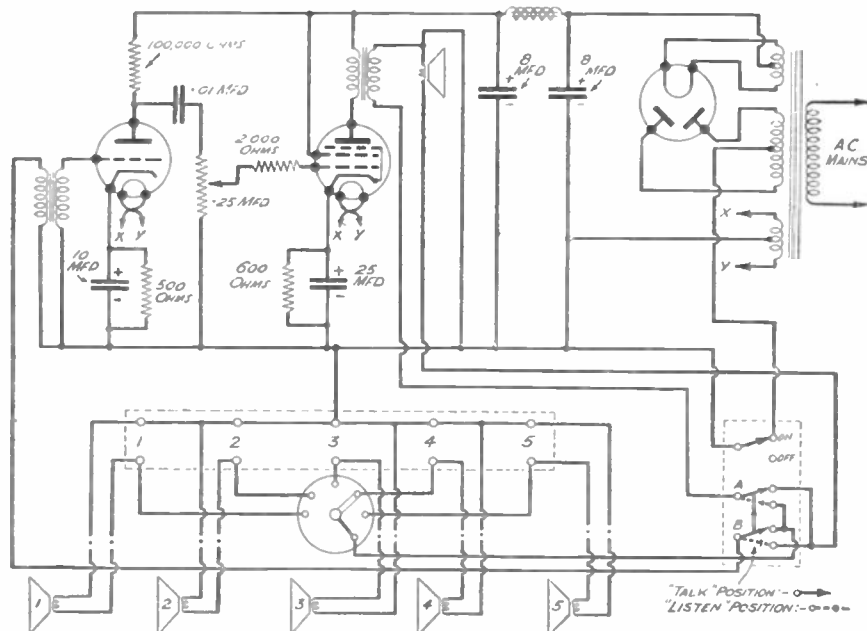

Fig. 1.—This is the theoretical circuit of the Room-to-Room Communicator, showing the switching to the five sub-stations.

# om Communication

*Constructional Details of a Simple Master Unit  
Designed to Operate Five Sub-stations with Two-  
way Communication. By W. J. DELANEY*

transformer. It is possible to use ordinary speakers if you have them handy, but the input transformer should be disconnected and the speech-coil winding only used.

The input transformer is of the microphone type, to give better matching to the input grid circuit and also to provide

the terminals, and a 2in. hole for the Bulgin volume control. A mains connection is shown on the other end of the rear strip, but if desired, a mains on-off switch may be placed here instead and the leads to the nearest mains socket may be permanently attached to the switch and mains transformer. In the design as published the mains must be switched on at the mains plug, but the apparatus may be "disconnected" or rendered inoperative by means of the change-over switch, due to the breaking of the H.T. negative lead previously mentioned.

The panel or cabinet front must be cut to accommodate this change-over switch and two 2in. holes drilled for the 5-point selector switch and the small pilot or signal light. This enables the user to see at a glance whether the unit is switched on, and whilst it is kept in a condition ready for use the light behind this small indicator will glow, although, when the switch is in the "up" position it is impossible to talk or listen on the apparatus. This idea avoids the necessity which would otherwise be introduced of waiting for the valves to heat up and thus the apparatus is ready for immediate use at any time. Wiring should be carried out with heavy wire—say 22 tinned copper, and insulated sleeving should be passed over certain of them to

*(Continued overleaf)*



five-point switch, and is mounted on the left of the panel, and in the illustrations it will be seen that an indicating panel is provided for this. The component which I used was a Bulgin standard dial, but to present a neat appearance this was cut (ordinary scissors will do) to give the shape shown in the illustrations. The change-over switch is a 12-point (four-pole change-over) of the Dewar type, supplied by Electradix. One section of this is not used in this particular design, although if desired it could be used to operate a calling-up buzzer circuit.

**Construction**

A full list of components is included in this article, and it will be seen that the speaker in the Master Unit is a standard W.B. Midget, but the sub-station speakers should be of the same type, without input

a better step-up ratio to overcome the losses which are introduced when very long leads are employed between the master and sub-stations. The chassis should be cut as shown in the wiring diagram, to clear the chassis of the speaker, and holes for the valve-holders and for the passage of connecting leads should then be drilled. On the rear chassis strip ten holes should be drilled for





(Continued from opposite page)  
 into the up, or "off" position. If leads are not connected to the five pairs of terminals, when the right-hand switch is

to the distant point to which he wishes to speak. An ordinary conversational tone may be adopted, and there is no need to raise the voice. When he has spoken

and wishes to hear a reply, the right-hand switch is depressed, and held in position. On this model the switch remains in an "off" or "talk" position only, and thus to hear signals from any of the sub-stations the lever has to be held. If the apparatus is to be used by a business man who is anxious to eavesdrop on his various offices, the inconvenience of holding the switch down to listen may be overcome by changing round the wiring to the two bridged pairs of contacts on the switch, in which case the normal central position will be "Listen" and it will have to be depressed to talk. If, in the case of any special announcement, it is desired to talk to all five sub-stations at once, this may be done by bridging all of the five terminals at the rear by means of a piece of bare wire.

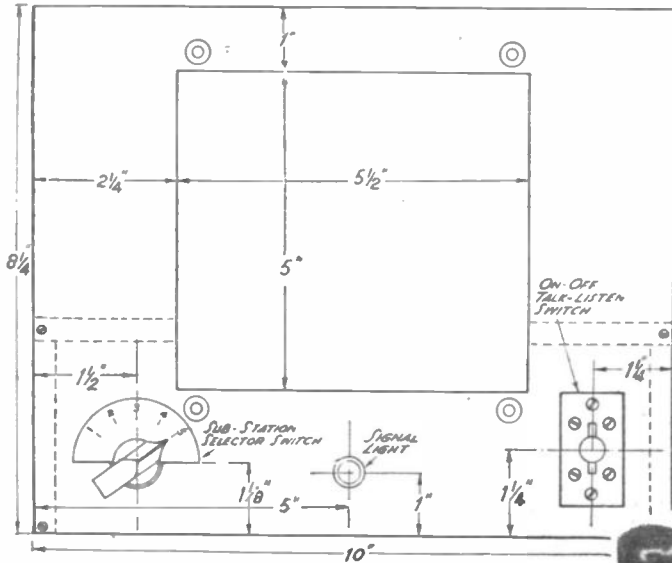
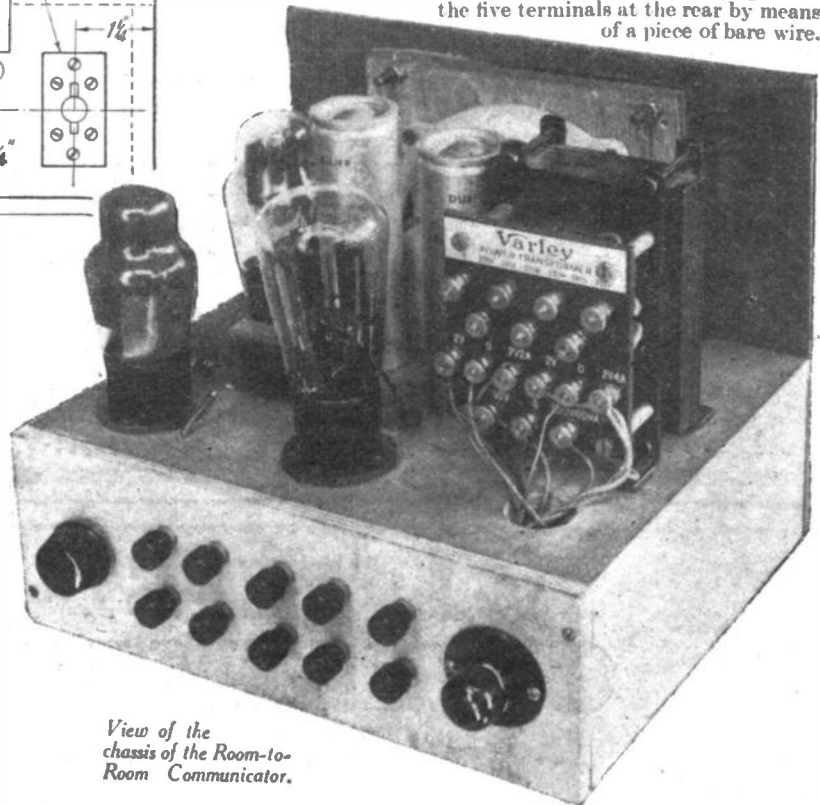

Fig. 3.  
 Panel dimensions for cutting the cabinet front.

pushed down, the speaker on the Master Unit should hum, showing that the switch is operating correctly. The sub-units or stations consist merely of the small speakers and these may be mounted in small cabinets, or simply placed in a convenient position in the room. They need not be placed close to where a person sits, and may be tucked away in any convenient position as they will pick up the normal conversation volume of a person in even a very large room although not pointing at the person. Ordinary twin bell-wire may be used for wiring between master and sub-stations, and if a common earth return is employed the lead to one side of the speech coil on the distant speaker should be connected to the nearest earth point. An earth wire must then be attached to one of the terminals on the rear of the Master Unit which are shown connected together in the wiring diagram.

In use, the user of the Master Unit simply pushes the change-over switch down to a horizontal position and turns the 5-point switch to the number corresponding



View of the chassis of the Room-to-Room Communicator.

## XMAS TELEVISION PROGRAMMES

THE Christmas television programmes, which open on December 20th, will, it is hoped, be representative of the best yet radiated from Alexandra Palace. The season begins with a display of Christmas toys in the afternoon and evening programmes on December 20th. "The Ghost Train," Arnold Ridley's thriller, will be performed on the same afternoon.

The afternoon programme on December 21st will include a star production of "Hundred Per Cent. Broadway," Cecil Madden's all-American cabaret show with David Burns and the Merriell Abbott Girls from the Dorchester. Arthur Marshall, the "school-mistress" broadcasting star, will make his television debut in the afternoon on December 22nd, and the "Picture Page" programmes on that day will have a special Christmas flavour.

"Hansel and Gretel," Humperdinck's fairy-tale opera, will be televised in the evening programme on December 23rd, and the leading parts will be taken by children acting in mime with vocal accompaniment "offstage." The B.B.C. Television Orchestra, conducted by Hyam Greenbaum, will be specially augmented for the occasion. On Christmas Eve, Jack Payne and his Band will appear in both the afternoon and evening shows.

A Christmas edition of "Coffee Stall" will be televised in a snowstorm on the same afternoon.

### Christmas Day

Christmas Day programmes will open with a short address by the Rev. Pat McCormick. Viewers will then be taken into Alexandra Park for a football match between the Alexandra Palace Football Club and a Welsh team. On Christmas evening Harry Pringle will

introduce a Music Hall Cavalcade with old-time artists. The studio will be decked out as an Edwardian music hall and an audience will be present. On Boxing Day Reginald Smith hopes to present a television pantomime.

Mr. Gillie Potter will be among the stars making solo appearances in the Christmas programmes. He will be seen in the evening programme on December 20th and again in the afternoon programme on Christmas Day. Noni, the clown, and his partner, who visited Alexandra Palace in the early days of television, will make a joyful re-appearance in the afternoon programme on December 23rd. It is hoped that Lydia Lopokova, the celebrated ballerina, will appear in the different rôle of story-teller on December 23rd, recounting the adventures of Little Red Shoes in the afternoon programme. In the evening programme on the same day, Marcel Boulestin, the cookery expert, will explain how wine should be served. Irène Prador, the Viennese soubrette, who is one of the first stars created by television, will sing German, French and English songs in the evening programme on December 24th, and again on Christmas night. On Christmas Eve, Nicholas Bentley will draw cartoons.

# TUNGSRAM VALVES

specified for the Practical Wireless "Rapide Straight 3"

In the specifications of the PRACTICAL WIRELESS "Rapide Straight 3," given in this issue, are included two Tungfram L.D. 210 valves, and one L.P. 220.

The former are battery detector valves and the latter a low consumption power valve.

The selection of these valves by PRACTICAL WIRELESS is a striking testimonial to Tungfram's reputation for quality and reliability. They are only two of the exceptional range of Tungfram valves, which includes both British and American types, pin and octal bases.

# TUNGSRAM Barium VALVES

MANUFACTURED AT  
TOTTENHAM, LONDON

"THE VALVE WITH THE NAME BEHIND IT!"

THE TUNGSRAM ELECTRIC LAMP WORKS (GREAT BRITAIN) LTD., 82, THEOBALDS ROAD, LONDON.

PHONE: HOLBORN 3563.

## A FEAST OF CHRISTMAS FUN



Here are the Biggest and Best Christmas Magazines you can buy—packed with Tip-Top Christmas Reading-Stories and articles by famous Writers and Popular Humorists. Laughable Drawings and Cartoons by Leading Artists on practically every page.

+ + +

Capture the Spirit of Christmas with these Special Christmas Numbers.

+ + +

6<sup>D</sup>.  
EACH

Of all Newsagents and Bookstalls.



# Building the "Rapide" Straight 3

An Easy-to-Build Detector-Two-L.F. Receiver which is Especially Suitable for the Beginner. The Performance is Extremely Good Despite the Moderate Cost  
By FRANK PRESTON

THE so-called "straight three," by which is generally meant a detector valve followed by two low-frequency stages, is apparently as popular as ever with home constructors. The first complete receiver that I described in these pages was of this general type and proved to be very satisfactory. This time I am going to deal with a simpler type of set, but nevertheless one that is particularly efficient. It is not supposed to have any revolutionary features; there is no claim that it will receive many hundreds of stations; but it is a completely sound job that can be built and operated successfully by the newest constructor.

### Metallised Baseboard

In order to simplify construction to the greatest possible extent, I have used a flat baseboard, as you can see from the accompanying illustrations. That is not a retrograde step, because the components have been carefully chosen to suit this form of construction. By having a flat baseboard, wiring is simplified, especially for the beginner who has to follow every wire on the wiring plan and strike it through as it is fitted into the set. Further, to enhance simplicity of construction, the baseboard used is fairly large. This makes the complete assembly less compact than it might have been, but at the same time it leaves more room for the wiring and leaves all terminals accessible.

When the receiver was first decided on

it was considered important that cost should be kept down to reasonable limits, but that there should be no "cutting" of components. As a result, the complete kit of specified parts, exclusive of valves, batteries and speaker, costs well under 50s. In spite of the low initial cost, every component is of thoroughly sound design and construction, and every item in the list can be relied upon to give trouble-free service.

### Circuit Details

The two-range screened coil is of modern design, with separate aerial, grid and reaction windings. Additionally, the aerial winding is tapped so that a portion

can be short-circuited to ensure maximum efficiency on the medium-wave band. This inexpensive coil provides a very satisfactory degree of selectivity without efficiency being sacrificed to any noticeable extent. A differential reaction condenser is used to ensure smooth reaction control in conjunction with the detector valve.

Resistance-capacity coupling is used between the detector and the first L.F. valve, and the detector anode circuit is decoupled. The second valve is designated L.D.210, and it makes a very good low-frequency amplifier, as well as being an efficient detector. It gives slightly more amplification than does the average L.F. type of valve, and it has a low anode current consumption. The latter is important, not only because it reduces running costs, but because it permits the effective use of a small and inexpensive L.F. transformer. As the anode current requirement of the L.D.210 is well under 2 mA at 120 volts and appropriate grid bias, there is no danger of the transformer primary winding being overloaded or of the iron core being saturated. This means absence of distortion in the L.F. coupling circuit.

For the last valve an L.P.220 is specified. This is a small-power valve with a fair handling capacity, able to do justice to the full output from the first L.F. stage. It can be operated with 120 volts H.T. and 6 to 7½ volts grid bias to pass only about 5 mA high-tension current. In consequence, the total H.T. current drain can be kept down to between 7 and 8 mA, so that the least expensive dry battery will have a reasonably long life. It is true that rather greater output can be obtained, particularly from the local stations, by using a rather lower G.B. voltage on the output valve, but if that is done a double-capacity type of H.T. battery is to be

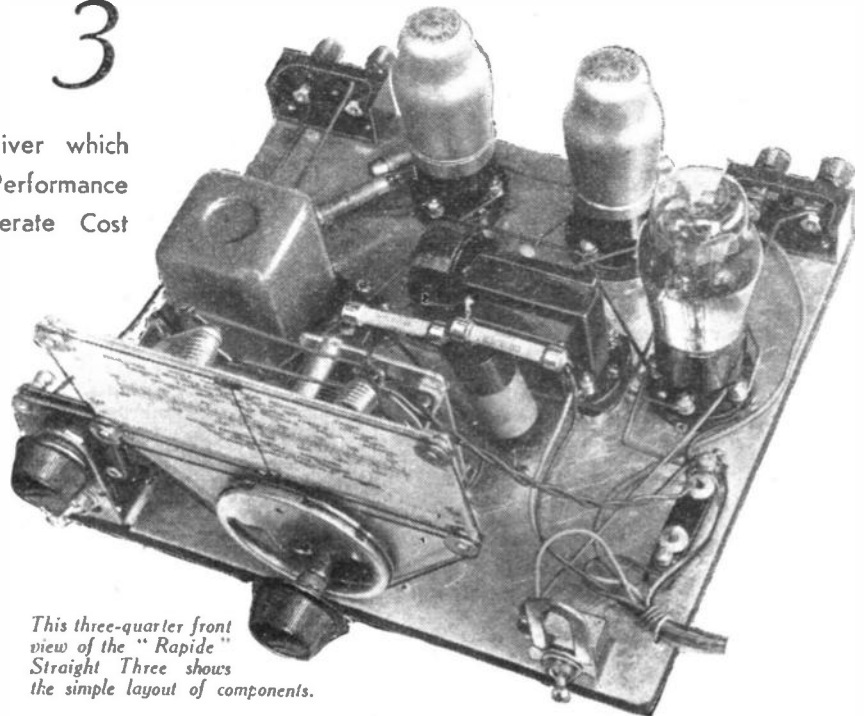

This three-quarter front view of the "Rapide" Straight Three shows the simple layout of components.

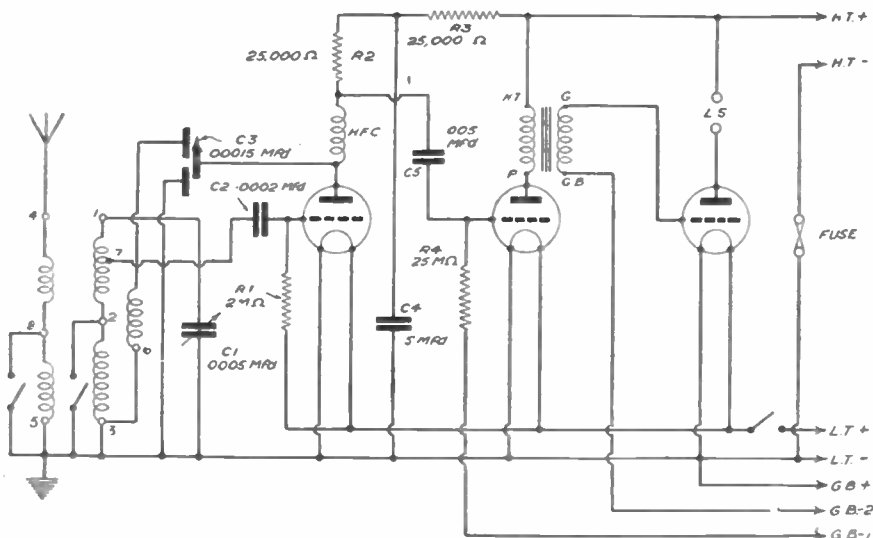

Theoretical circuit diagram of the "Rapide" Straight Three.





# Peto-Scott - for REAL XMAS BARGAINS

**BARGAINS that ARE Bargains**  
Peto-Scott's 20 years' trading is your guarantee of satisfaction!

**6-valve All-Wave A.C. SUPERHET**

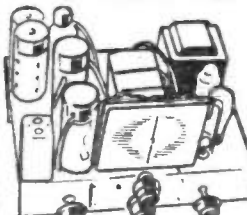

List Value : £9:0:0

**OUR PRICE £7:19:6**

Cash or C.O.D., or 17/6 down and 11 monthly payments of £14/8. 4 wavebands : 10-21, 20-54, 200-550, 900-2,000 metres.

Rationalised tri-mit construction. 6 octal base valves; pre-I.F. Selector, radio frequency amplifier, triode-hexode frequency changer, bandpass I.F. transformer, I.F. amplifier, double-diode triode, phase reversing, output power pentode. With 6 British valves, knobs and escutcheon. For A.C. Mains 200-250 volts, 40-80 cycles.

**17/6 DOWN**

Rationalised tri-mit construction. 6 octal base valves; pre-I.F. Selector, radio frequency amplifier, triode-hexode frequency changer, bandpass I.F. transformer, I.F. amplifier, double-diode triode, phase reversing, output power pentode. With 6 British valves, knobs and escutcheon. For A.C. Mains 200-250 volts, 40-80 cycles.

**9-Valve ALL-WAVE A.C. SUPERHET CHASSIS**



List Value £15:19:6

**OUR PRICE £11:19:6**

Cash or C.O.D., or 27/6 down and 11 monthly payments of £13. 10-21, 20-54, 200-550, 900-2,000 metres. Rationalised tri-mit construction, 9 octal base valves; pre-I.F. selector, radio frequency amplifier, triode-hexode frequency changer, 2 I.F. Amplifiers, bandpass transformer coupled to double-diode triodes providing rectification, automatic volume control and low frequency amplification, followed by phase reversing valve, 2 A.F. power pentodes, 7-watts audio output. With 9 British valves, knobs and escutcheon. For A.C. Mains 200-250 volts, 40-80 cycles.

**27/6 DOWN**

Rationalised tri-mit construction, 9 octal base valves; pre-I.F. selector, radio frequency amplifier, triode-hexode frequency changer, 2 I.F. Amplifiers, bandpass transformer coupled to double-diode triodes providing rectification, automatic volume control and low frequency amplification, followed by phase reversing valve, 2 A.F. power pentodes, 7-watts audio output. With 9 British valves, knobs and escutcheon. For A.C. Mains 200-250 volts, 40-80 cycles.

**EXCEPTIONAL XMAS OFFER - BARGAIN ALL-WAVE FOUR BAND S.G.3**

LIST PRICE £9:15:0 OUR PRICE £6:19:6



14-31, 28-62, 200-550, 900-2,100 metres. Variable-Mu H.F. Pentode Detector, Harmonic Distortionless Output Pentode Valves, 8-1 and 100-1 Slow-motion Drive, Full vision Dial, Beautiful Walnut Veneered Cabinet illustrated.

This Peto-Scott all-wave technical triumph will bring you stations galore from every part of the world. Screened coils. "Tone compensated" moving-coil speaker. Complete with 3 British valves and 18 batteries.

List Price £8:15:0, Bargain £6:19:6 or 5/- down and 18 monthly payments of 8/9.

**5/- DOWN**

**ONLY A FEW AVAILABLE**

**AMAZING BARGAIN - BROADCAST S.G.3 CHASSIS**



With Knobs and escutcheon, less valves. LIST VALUE £2:2:0

**OUR PRICE 21/-**

CASH OR C.O.D.

- S.G.3 Circuit.
- Screened coils.
- Wavelength dial, 200-2,100 metres.
- Wide choice British and Foreign stations.

CHASSIS and VALVES as described and illustrated above but less speaker. List value £4:4:0. Bargain 39/6 or 2/6 down and 11 monthly payments of 3/9.

**21/6 DOWN**

CHASSIS and VALVES as described and illustrated above but less speaker. List value £4:4:0. Bargain 39/6 or 2/6 down and 11 monthly payments of 3/9. CHASSIS, VALVES and SPEAKER, as illustrated above, including splendid P.M. Moving-Coil Speaker. List value £5:7:8. Bargain 55/- or 6/- down and 11 monthly payments of 5/3.

**D-XMASTER KIT "A"** CASH or C.O.D. £3:15:0 or 7/- down

Comprises complete kit of specified parts, ready drilled plymax chassis and including all necessary screws, connecting wire and flex, but less valves. Cash or C.O.D. £3:15:0 or 7/- down and 11 monthly payments of 7/-.

If set of specified valves required add £12/9 to Kit VALVES Price or 2/2 to deposit and each payment. KITBITS Orders value over £1 sent post charges paid.

- 1 B.T.S. I.F. Transformer .. .. . 4/6
- 1 Peto-Scott Plymax Chassis ready-drilled .. .. . 8/6
- 1 Varley 2-band coil unit Type B.P.114 .. .. . 13/6
- 1 J.B. 2-band condenser-Bar Type .. .. . 12/-
- 1 J.B. Slow-motion Drive No. 2134 .. .. . 5/9

**RAPIDE STRAIGHT 3 KIT "A"** CASH or C.O.D. £2:9:6 or 4/6 down

Comprises complete kit of parts as specified with Metaplex base-board and includes all necessary screws, wire flex, etc., but less valves. Cash or C.O.D. £2:9:6 or 4/6 down and 11 monthly payments of 4/8.

If set of specified valves required add 12/3 to Kit VALVES Price or 1/2 to deposit and each weekly payment. KITBITS Orders value over £1 sent post charges paid.

- 1 B.T.S. Type 900 Reaction Choke .. .. . 2/6
- 1 B.T.S. Type I.T. 135 I.F. Transformer .. .. . 4/6
- 1 Peto-Scott Metaplex Baseboard .. .. . 1/6
- 1 Polar No. 5 condenser and V.P. drive .. .. . 11/-

**XMAS BARGAIN KITS - ALL-WAVE BATTERY S.G.3 KIT**

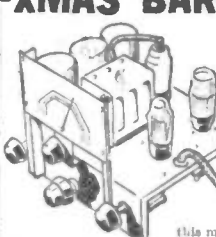

Wavebands 14-31, 28-62, 200-550, 900-2,100 metres. Illustrated on the left is the assembled Peto-Scott All-Wave S.G.3 Kit. Efficiency, economy and simplicity of construction and operation are the keynotes of this modern to-the-minute circuit.

LIST PRICE £4:9:3 OUR PRICE £3:3:0 or 5/- down

**S.W. ADAPTOR CONVERTER KIT**

LIST PRICE £1:14:4 OUR PRICE £1:5:0 or 2/6 down

**"DOUBLE 2" SHORT-WAVE KIT**

LIST PRICE £4:5:4 OUR PRICE £2:19:6 or 5/6 down

**1-VALVE ALL-WAVE KIT**

LIST PRICE £2:0:0 OUR PRICE £1:9:6 or 2/6 down

**BATTERY STRAIGHT 3 ALL-WAVE KIT**

LIST PRICE £3/2/0 OUR PRICE £2:5:0 or 4/- down

All the above mentioned Kit Prices are less valves and are fully described in the Peto-Scott Radio and Television Catalogue sent FREE on request.

**A MERRY XMAS - is yours with this amazing new Peto-Scott HOME BROADCASTER**

GET OVER YOUR "MIKE-FRIGHT!" Croon to your heart's delight... produce at will the Family Ghost... make THIS YEAR'S PARTY the MERRIEST YET! Attach the Peto-Scott "Home Broadcaster" to the pick-up sockets of your existing receiver, whether battery or A.C., and your own broadcasting station is instantly ready to amplify the individual efforts with that professional touch to which we are all accustomed. Everyone hears everything with the aid of the Peto-Scott Home Broadcaster. Running costs are nil and you've nothing more to buy. Supplied to you absolutely complete and ready for immediate use. 2/6 down and 9 monthly payments of 3/-.

CASH OR C.O.D. **21/-**

2/6 down and 9 monthly payments of 3/-

**PETO-SCOTT CROONERS AND DANCE BAND OUTFIT**

For amateur or professional crooners, dance bands, soloists, electricians, and announcements of all kinds. This high grade outfit reproduces speech and music with perfect clarity and is clearly audible up to 500 feet.

This marvellous outfit comprises Peto-Scott professional type transverse current microphone and transformer, 7-watt A.C. Mains High Fidelity Amplifier, Peto-Scott High Fidelity moving-coil speaker, braided microphone lead, and cable for loud-speaker extension (send for leaflet 18/81).

CASH OR C.O.D. Carriage Paid £8:10/-, or £1 down and 11 monthly payments of 15/9.

**1938 STENTORIAN SPEAKERS**



Model 388. Cash or C.O.D., Carr. Pd., £2:2:0, or 2/6 down and 11 monthly payments of 4/-.

Model 387. Cash or C.O.D., Carriage Paid, £1:12/8, or 2/6 down and 11 monthly payments of 3/-.

**21/6 DOWN**

**ORDER NOW FOR XMAS DELIVERY**

**STRAIGHT 3 CHASSIS - LIST PRICE 45/- BARGAIN 29/6**



Amazing Peto-Scott offer! Each chassis tested before dispatch.

**CIRCUIT COMPRISES** detector reaction, followed by R.C.C. and triode super-power output stage. Metal chassis. Slow motion tuning. Dial calibrated degrees. 200-2,000 metres. Low H.T. consumption. Complete with 3 British valves, all knobs and escutcheon. Cash price 29/6 or 2/6 down and 11 monthly payments of 2/9.

**COMPLETE RECEIVER Above chassis 2/6**

in horizontal console cabinet, complete with valves and moving-coil speaker, four batteries. List Price £4:19:6. Bargain, £2:2:0 Cash or C.O.D. or 2/6 down and 11 monthly payments of 4/3.

**2/6 DOWN**

**H.T. for 1d. a Week! - Peto-Scott H.T. ELIMINATORS**

**Model A.C.12 Eliminator.** Suitable for sets operating on an output of up to 12 m.A. A.C. 200-250-v., 40-100 cycles. Output 120-v. at 12 m.A. 4 tappings: 60-v., 75-v., 90-v. and 120-v. Cash or C.O.D. Carr. Pd. **30/-**

Or 2/6 down and 10 monthly payments of 3/-.

**Model MA 10, 30 Eliminator and TRICKLE CHARGER.** £2:19:6, or 5/- down and 11 monthly payments of 5/8.

**Model A.C.25.** Suitable for O.P.P. and Class B operation on outputs up to 25 m.A. H.T. Tappings, Screen Detector and Power Output 25 m.A. at 150v. For A.C. Mains 200-250 volts, 50-100 cycles. Incorporates Westinghouse Rectifier. Cash or C.O.D. Carriage Paid **£2:9:6**

Or 5/- down and 10 monthly payments of 5/-.

Peto-Scott **TRICKLE CHARGER** for 2-watt accumulator at 1 amp. Metal rectifier. Air-cooled transformer. A.C. mains 200-250 volts, 40-100 cycles. Cash or C.O.D. **10/-**.

**ASTOUNDING XMAS BARGAIN - 4-VALVE A.C. ALL-WAVE CHASSIS**



3 WAVEBANDS 18-52, 200-550, 900-2,100 metres

Band-pass tuning; Full-vision illuminated dial (stations and wave-lengths); Slow-motion drive; Rotary low capacity switch.

WITH 4 BRITISH VALVES

LIST VALUE £7:15:0 OUR PRICE **£4:19:6**

**BRIEF SPECIFICATION:** 4 British valves, variable-mu H.F. Pentode, Screened Grid Detector, High Efficiency Output Pentode and Rectifying valves, Steel Chassis, Sensitivity and Volume Control, 3 Watts undistorted output. Gramophone Pick-up Sockets. For A.C. Mains only, 200-250 volts, 40-100 cycles. CASH OR C.O.D. CARRIAGE PAID, £4:19:6, or 7/6 down and 12 monthly payments of 8/6. Or with High Fidelity 2,500 ohms Energised Moving-Coil Speaker, £5:19:6 or 7/6 down and 12 monthly payments of 10:4.

**POST THIS COUPON NOW**

PETO-SCOTT CO. LTD., 77 (Pr.W.14), City Road, London, E.C.1. (City and 9875-97) or 62 (Pr.W.14), High Holborn, London, W.C.1. (Holborn 3248).

Please send me..... for which I enclose £..... Cash/H.P. Deposit.

Please send also the Peto-Scott Radio and Television Catalogue and the Pilot "Short-Wave Experimenter," describing 8 new PILOT Short Wave Kits. I enclose 2d. (stamp) to cover postage.

NAME.....

ADDRESS.....

EST. 1919

All P.O.'s must be crossed and currency registered.

# RADIO CLUB REPORTS

(See also page 358 for further Club Reports.)

## PROPOSED CLUB FOR PORT ISAAC

IT is proposed to form a Radio Club at Port Isaac, Cornwall, and any readers residing in the district, and who are interested in the idea, are invited to get in touch with Mr. J. W. Rowe, 3, Alma Place, Port Isaac, Cornwall.

## NEWCASTLE RADIO SOCIETY

THE above Radio Club was formed on April 18th, 1937, to further the science of radio, to increase the knowledge of members, to cover all aspects of Radio Theory and Construction, and to make wireless construction and listening more interesting, as well as instructive.

The newcomer to Radio will be given tuition in constructional work and theory, while the experienced members find pleasure in teaching, and the advanced

most of them-elves through the facilities of this Society.

Demonstrations, lectures, visits to places of interest are included in the programme, and instruction in Morse code is given in the final half-hour of every meeting. One of the aims of this club is to have a transmitter installed, built by the members as funds allow.

Competitions and co-operation with other clubs throughout the country are other items to add to members' interest. The headquarters have ample accommodation.

The present entrance fee is 1s., and the weekly subscription, 6d.—until sufficient members have enrolled to reduce these fees enabling the club to be self-supporting.

## SHEFFIELD SHORT-WAVE CLUB

THE above club has been re-located in new premises in Ebenezer St., Shalesmoor. Meetings are held every Wednesday at 8 p.m., and special meetings for classes, etc., will be held on other nights. Various pieces of apparatus are being set up for use of the members, including oscillators, receivers, resistance and capacity bridges, etc., and very shortly an artificial aerial transmitter will be installed.

Morse classes are held regularly now, as well as classes for beginners, and for set building. We shall be glad to see any readers of PRACTICAL AND AMATEUR WIRELESS at the meetings, and any further details can be obtained from the Hon. Sec., D. H. Tondia, 32, Moor-side Avenue, Sheffield, 10. Subscriptions are 10s. per year, payable quarterly.

## PARTY LIGHTS

OSRAM "Party Lights" and Christmas Tree outfits can be used very effectively for adding to the Christmas atmosphere.

These "Party Lights" with their coloured shades representing English nursery rhymes are certain to be in wide demand. They are non-inflammable, and translucent, and are supplied in assorted colours, complete with twelve 19-volt 3-watt cone type Osram lamps, one spare, substantial flex (braided in three colours to match the bakelite lampholders) complete with adaptor for attaching to lampholder.

The popular Osram Christmas Tree Outfits consisting of twelve 19-volt 3-watt lamps in assorted colours, and the small illuminated Christmas Trees for use as table centres provide an ideal decorative setting for Yuletide festivities. An illuminated cakestand is an attractive addition to the Osram range. It can be used alternatively as a cakestand or a hanging centre light.

There are also outfits suitable for shop-windows, hotel bars, ballrooms, restaurants, cinemas, and scores of other situations where light and colour contribute materially in creating a cheerful atmosphere—a range of decorative lighting material which should certainly warrant a comprehensive display from now until Christmas, and indeed until well into the New Year.

## A RADIO ROBOT

(Continued from page 337)

in Fig. 5. The plate and H.T.+ terminals go to the relay, and the grid and filament to the secondary of an ordinary intervalve L.F. transformer in the usual way.

A lead from the primary of the transformer is plugged in to the loudspeaker output terminals of a wireless receiving set (a portable receiver makes the whole assembly entirely independent of connecting wires to the mains, etc.) and it is now only necessary to tune in to a broadcast of speech or song when the Talking Robot will tell you all he hears! A microphone connected to the pick-up terminals of the wireless set will enable you to talk through the figure so that, with a friend, you might give a most entertaining dialogue!

The figure may be completed with an overcoat and hat (Fig. 4) or in almost any way the constructor fancies. My own model sits on a chair the portable receiver being arranged underneath (Fig. 1) so that there shall be no interaction between the relay circuits and the aerial of the set. Condensers C1 and C2 have been included for this reason, but, of course, there is still a little interference, which can only be entirely eliminated through the use of separate wireless sets for the sound, and for the operation of the figure—the latter set having the loudspeaker switched off.

FOR ONLY  
3/9

YOU can buy a British Made Super-sensitive, Non-microphonic HIVAC Detector valve.

This simple replacement will add enormously to the performance of your set.

There is also a Complete range of HIVAC Battery, Mains, Special Short-wave, and "Midget" valves, ALL highly recommended by the leading technical experts. HIVAC give you High Quality at Low Price.

Just send us a Postcard with "CHART N" written on it and full details will be sent you.

**HIVAC**  
THE SCIENTIFIC  
VALVE

BRITISH MADE

HIGH VACUUM VALVE CO., LTD., 111-117, FARRINGDON ROAD, LONDON, E.C.1.

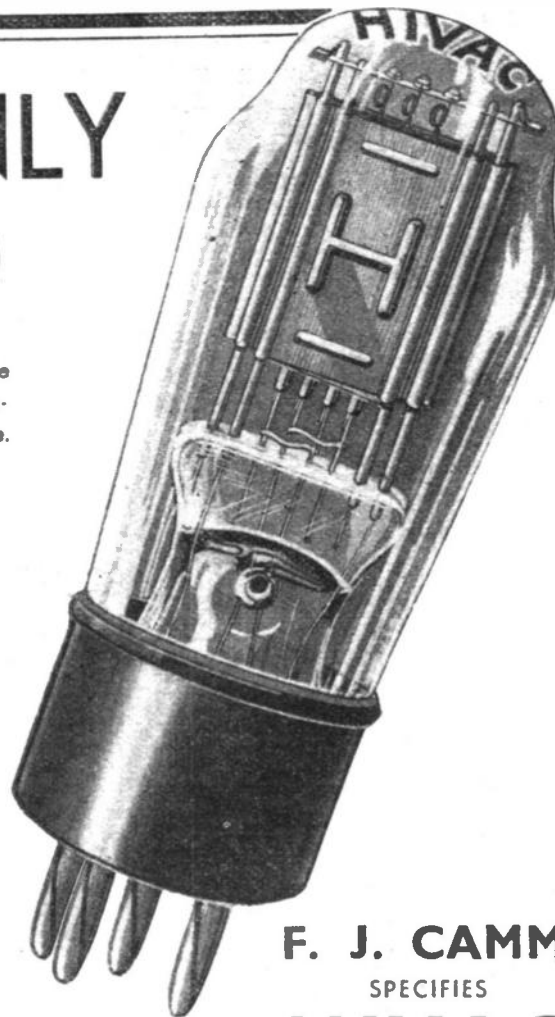

F. J. CAMM

SPECIFIES

**HIVAC**

FOR HIS

**"D-XMASTER"**

SEE DETAILS IN THIS  
ISSUE.



# USING EXTENSION SPEAKERS

Instructions for Wiring Extension Speakers, with Details of the Precautions to be Taken, and the Best Methods of Controlling Volume

It is often desirable, especially during the Christmas holiday period, to have wireless in more than one room. This can be done by having more than one set, of course, but a much cheaper way is to install extension speakers.

## Commercial Receivers

Most of the modern commercial sets are fitted with extension speaker sockets, and therefore it is only necessary to plug the extension speaker leads into these sockets. Care must be taken to choose the correct type of speaker, however, if best results are to be obtained. In some receivers the extension sockets are connected to the speech coil of the internal speaker, whereas in others connection is made to the primary of the internal speaker transformer. When connection is made to the speech coil the extension speaker must be of the low impedance type, or a step-up transformer must be connected between the extension

one of these is used it is only necessary to adjust the controlling switches until best results are obtained. If a special speaker of this type is not readily available the

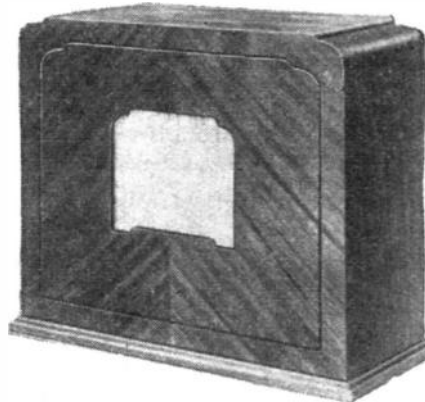

Fig. 2.—Extension speakers are obtainable in various types of cabinet to harmonise with room furnishings.

ordinary type of moving-coil permanent magnet speaker can be wired to suit high or low-impedance sockets. If low-impedance (speech coil connection) sockets are fitted they must be connected direct to

speaker transformer terminals. It should be realised that if the old type cone speaker is used it is essential to use a matching transformer if low impedance sockets are fitted. This type of speaker will, however, give quite satisfactory results with direct connection in most cases where high-impedance sockets are fitted.

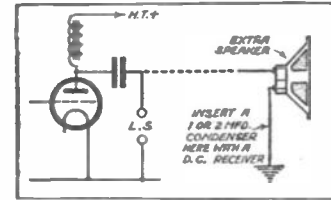

Fig. 5.—It is always desirable to use an output filter circuit for extension speakers.

## Home-constructed Sets

In home-constructed receivers extension speaker sockets are not generally fitted, and, therefore, if an extension is to be installed great care must be taken to wire this correctly. The safest method is to connect one terminal of a 2 mfd. condenser to the anode of the output valve, the other terminal of the condenser to one of the extension speaker leads, and the other extension lead to H.T.—. With this method of connection direct current will not flow through the extension leads, leakage and the possibility of a shock being therefore avoided. A simpler method is to connect the extension leads to the L.S. sockets, either direct or via 2 mfd. condensers—by connecting a condenser in each lead leakage and shock are again avoided.

## Special Output Stages

When a special type of output stage is used care must be taken to wire the extension leads correctly. In the case of push-pull, Class B, and Q.P.P. output stages the method of connection is the same. The internal speaker fitted to sets of this type has three terminal connections, two to the valve anodes, and one to H.T.—. The extension speaker leads should be

(Continued on next page)

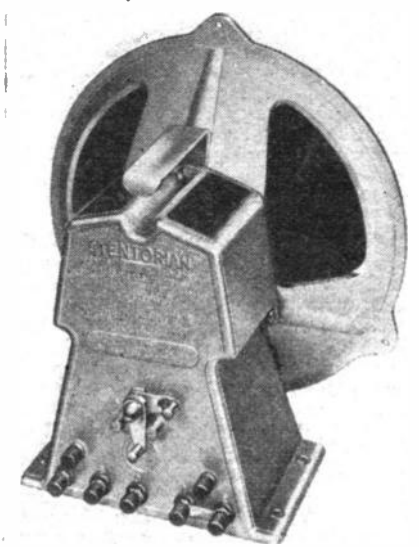

Fig. 1.—This W.B. loudspeaker has a special matching device and is ideal for an extension model.

sockets and the extension leads if the extension speaker is of the high-impedance type—the normal type of speaker transformer may be used with the secondary winding connected to the extension sockets. If an ohmmeter is available it can easily be decided whether a low-impedance speaker should be used, as the difference in the resistance measured across the extension sockets is unmistakable. When the sockets are joined to the speech coil the resistance will be between two and fifteen ohms approximately, but if they are joined to the primary of the internal speaker transformer a resistance of between 200 and 500 ohms approximately should be registered.

## Special Extension Speakers

There are special extension speakers obtainable which are designed to match any type of set and are fitted with a switch for high or low-impedance matching. If

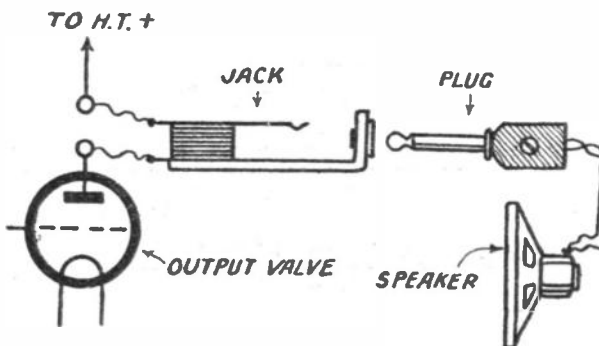

Fig. 3.—A plug and jack method of connection will facilitate changes in speakers.

the speech coil tags on the extension speaker; if these tags cannot be traced an ordinary speaker transformer may be interposed between the sockets and the extension leads, as mentioned above. When high-impedance sockets are fitted, direct connection is made to the extension

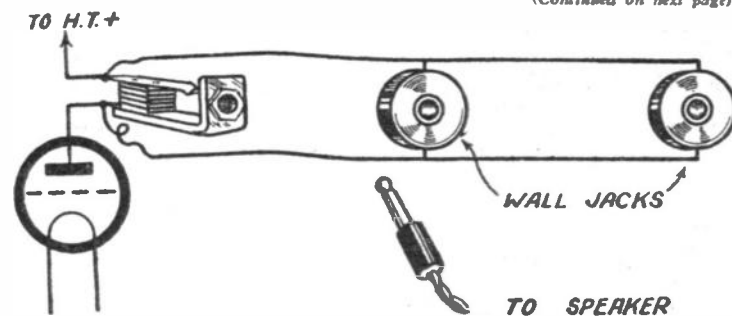

Fig. 4.—Wall sockets may be used for listening at different points as shown here.

**USING EXTENSION SPEAKERS**

*(Continued from previous page)*

connected to the two valve-anode terminals, either direct or via 2 mfd. condensers. It is not necessary for the extension speaker to be of a special push-pull type. If two valves are connected in parallel in the output stage the normal method of connection outlined above for a single valve should be used.

**Switching**

Some readers will probably wish to silence the internal speaker when this is not required. The best method of doing so is by means of a switch connected in the speech coil circuit of the set speaker. If it is only desired to silence one speaker, a two-point switch will be suitable, but by using a three-point change-over type, one or other of the two speakers may be brought into use at will. The switch could

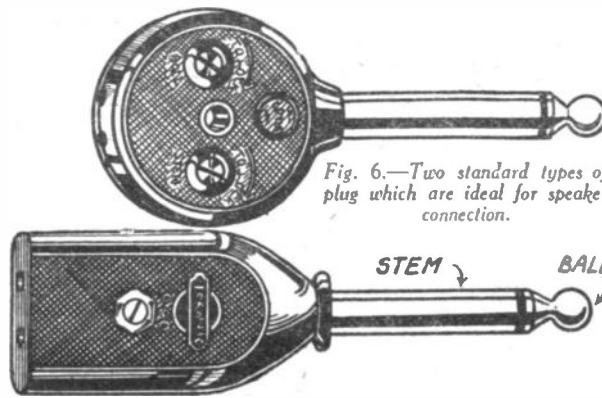

Fig. 6.—Two standard types of plug which are ideal for speaker connection.

be connected in the anode circuit of the output valve but this method of connection is not recommended unless a special type of switch, such as the Clix, is used. With

the normal type of switch the anode circuit of the output valve would be momentarily open during the switching process, and this could possibly cause damage to the valve.

**Controlling Volume**

For smoothest control of volume it is also advisable to use the speech coil circuit in preference to the transformer primary circuit. A variable resistance of approximately 100 ohms is suitable for most speakers. This should be connected

in series with the speech coil of the speaker to be controlled, and may be fitted with an off position if it is desired to silence this speaker. Control of volume can also be effected by connecting a control having a resistance of approximately 50,000 ohms in series with, or across, the extension speaker transformer primary winding, but it is generally found that the speech coil method of connection gives better results.

**Varley AS USUAL!**

for the **D—XMASTER**  
USE

**BP 114 2-Gang Coil Unit and  
BP 21 NICLET Transformer**

**NEW  
PUSH PULL TRANSFORMERS**

- DP 49. Parallel Feed Input. Ratio 1 : 4, 12/6.
- DP 46. Output. Ratios 20 : 1 and 40 : 1, 18/-.
- DP 47. Output. 25 : 1 and 50 : 1, 18/-.
- DP 48. Output. 34 : 1 and 68 : 1, 18/-.

**FREE CIRCUIT DIAGRAMS**

**POST COUPON BELOW TO**

**Varley**

**(OLIVER PELL CONTROL, LTD.),  
Cambridge Place, Burrage Road,  
Woolwich, S.E.18.**

Please send me Free Circuit Diagrams of Push Pull Amplifiers.

Name .....

Address .....

PR.W.4/12

**A TELEVISION CATCH-PHRASE**

No less a person than Sir Noel Ashbridge thought it fit to draw attention to the catch-phrase that people were not buying television receivers now because of the possibility of them becoming obsolete in a few months. He quite wisely pointed out during the course of an address to the Aldwych Club on Armistice Day that no invention could proceed at that enormous rate. If there is any alteration of picture definition standard, present-day sets can be quite readily and simply adapted to meet the case at a small cost. The improvements that are needed are not those linked up with receivers, but with the transmission side, primarily on the extension of the hours of television broadcasting, and the ability of the provinces to have services of their own. As Sir Noel said, this last-named item would be met most economically by signal distribution through the Post Office co-axial cables, linking London with the more important cities. How soon the first of these provincial stations will be put into regular service is still a matter for conjecture, owing to financial reasons, but no doubt early in the New Year, when the Television Advisory Committee have reported, definite plans will materialise.

**"THE WIRELESS TRADER YEAR BOOK," 1938.**

THE new 1938 edition of this handy reference handbook which has just been published has been specially revised and enlarged, at the same time retaining the standard radio features. The main directories include a Buyers' Guide, arranged under some 300 different headings; a directory of radio wholesalers indicating R.W.T.A. members; lists of trade addresses, giving 1,500 entries, and including telephone numbers and telegraphic addresses, and a separate directory of Electrical Wholesalers. There are also detailed specifications of 578 receivers marketed in 1937-38, by forty-nine different manufacturers. Data given includes types of valves fitted, wave ranges, output, intermediate frequencies, extra speaker resistances, and prices.

Amongst the other technical matter included in the Year Book are lists of mains voltages for nearly 1,200 districts; and valve reference tables for about 800 different types and makes.

# NOTES FROM THE TRADE

## Belling-Lee Eliminoise

THE well-known Eliminoise Anti-interference Aerial is now available in a special Christmas packing, consisting of a gilt box with red and green label, and will form an admirable Christmas present to anyone who is experiencing difficulty in obtaining signals free from interference arising from local electrical apparatus. This kit, complete with 50ft. of screened cable, and with aerial and receiver impedance-matching transformers, costs 55s. The aerial is of 7/22 enamelled wire and is 60ft. in length.

## Philco-Ford Car Radio

A special 6-valve receiver has been designed by Philco for use in Ford V8 cars and is now available at 15 gns. It is

of the two-unit type, for medium-wave reception only, and the receiver section is mounted between the steering column and the dashboard, with the speaker concealed behind the top of the windscreen. Separate interference suppressors are stated to be unnecessary.

## Ever-Ready Batteries

Makers of the Ever-Ready H.T. batteries announce that in future these are to be sent out packed in a special type of corrugated cardboard sleeve to ensure that they shall be adequately protected from damage during transit.

## The Hushatone

Messrs. R. A. Rothermel announce that the Hushatone device is now obtainable from them at 35s. This is a small piezo-crystal reproducer, designed for incorpora-

tion in any desired apparatus so that an individual listener may follow a programme or item without annoying other people in the room. It may also be used by the deaf as a bone-conduction hearing aid. It weighs only 4oz. and is supplied complete with a 9ft. moulded rubber cable.

## Tungram 6B8G Valve

The makers of this valve wish to remind set designers that it is of great value in designing a receiver which will bring in weak and distant stations on a satisfactory high volume level, and at the same time give good quality reproduction from the local without overloading the output valve. Ordinary A.V.C. does not permit of this, but with the 6B8G it is possible to employ an A.V.C. controlled L.F. stage and a leaflet showing the arrangement is supplied by Messrs. Tungram. The valve is of the 6.3 volt .3 amp. heater type, and costs 14s.

## NIGHTLIGHT ROBBERY

(Continued from page 334)

**THE GIRL.**—"Oh, no—really—"  
**SCHOLER.**—"There, my dear—just a little token of esteem for a very, very brave little girl."

**THE GIRL.**—"Twenty pounds! Oh, really—"

**SCHOLER.**—"It is a very small return for such a great service."

**THE GIRL.**—"Thank you very much indeed. Do you mind if I go now?"

**STEVE.**—"Oh, won't you stay to breakfast, miss?"

**SCHOLER.**—"Good-bye, my dear—and thank you again."

**THE GIRL.**—"Good-bye—and thank you—ever so much!" (There is a short pause.)

**SCHOLER.**—"Damnation!"

**STEVE.**—"Oh, gov'nor—naughty!"

**SHANNON.**—"Well, what do you know about that?"

**SCHOLER.**—"Ruined—everything ruined. Months of scheming and planning ruined in a second. The interfering little fool!"

**STEVE.**—"Changeable—that's what you are! She was a sweet, brave little girl a minute ago."

**SHANNON.**—"Oh, shut up, Steve! Here, Fitzzy, what about the servants?"

**SCHOLER.**—"They won't disturb us. They had some tea when they came in, and I arranged to dope it for them."

**SHANNON.**—"Why the devil did you have to give the girl twenty pounds, anyway?"

**SCHOLER.**—"Oh, don't be a fool, Nickey. I had to pretend that I was grateful to her. In any case, it was no good to us."

**SHANNON.**—"You mean, dud stuff?"

**SCHOLER.**—"Yes—some of your very worst work."

**STEVE.**—"Cruel—that's what I call it."

**SCHOLER.**—"Anyway, here are the diamonds. We must make a new plan. (Almost shouts.) Look—Nickey—look! The diamonds!"

**SHANNON.**—"Good God! Dud stuff!"

**SCHOLER.**—"The little vixen!"

**SHANNON.**—"She's double-crossed us!"

**STEVE.**—"Lumme—that's what I call nightlight robbery!"

Fade in "The Teddy Bears' Picnic.")

**The CYCLIST - - 2d.**  
Every Wednesday.

## YOU HAVE BEEN WARNED BY RADIO—

Professor Hilton, on November 19th, 1936, from the B.B.C. broadcast a warning. The warning was to the effect that while there are many really good and reliable Colleges teaching by correspondence, there are many others which are colleges by name only. He said some so-called colleges rented a couple of rooms in a large building in a well-known street. Some made great promises which they did not intend to fulfil. Some claimed successes they could not prove. In some cases the names of prominent men were quoted who were in no way connected with the working of the College.

### NOW BE ADVISED BY ME.

The big name of a College is no proof of its national standing. The Bennett College has been established over 30 years and our entire building is devoted to Bennett College work. No other business of any kind is either on or attached to The Bennett College. We have seating accommodation for over 10,000. We have a permanent staff of over 190 people on the College premises. Our Professional Staff have all passed their examinations, and our tutors are all experts in their own specialised work. We do not send out any homework to be corrected by tired, spare-time tutors. All students' homework is corrected on the College premises the same day that it arrives, and is returned by evening post. This College is Technical, Scientific, General and Commercial, thus enabling us to cater for all requirements; this is important to Cost and Works Accountants, and all who have to deal with rate-fixing, machining-allowance, and it is also of great importance in many of the Civil Service Examinations. This is an entirely British College. Most of our textbooks are written on the College premises by our own professional staff, especially for tutorial purposes. Our tutors specialise in teaching students for the examinations they themselves have already passed.

### THERE IS NO OTHER COLLEGE IN THIS KINGDOM THAT CAN CLAIM ALL THE ABOVE ADVANTAGES.

It is not necessary for students to attend the College; we can send exactly the same tuition to you by post for a reasonable fee payable monthly. Anyone who reads the journals knows that there are many things advertised that one can study, and any kind of study is good. It is training for the brain, but the best thing to study, surely, is a course specially prepared to teach you your own vocation, or prepare you for the examination which you have in view. Knowing that you are master of your job gives you self-confidence and personality, but a Diploma from the College is absolute proof of your efficiency. We have agencies in all English-speaking corners of the world. The nature of our business makes us keep in touch with employment requirements in all parts of the world; therefore we specialise in preparing students for the good positions which we know exist, and for all the worth-while examinations.

### THE ABOVE VAST ORGANISATION CAN HAVE BEEN CREATED ONLY BY THE SUCCESS OF OUR STUDENTS.

There is a tide in the affairs of man which, if taken at the flood, leads on to fortune and success. There are three things which come not back: the sped arrow, the spoken word, and the lost opportunity—this is your opportunity. If it is your desire to make progress and establish yourself in a good career, write to us for free particulars on any subject which interests you, or if your career is not decided, write and tell us of your likes and dislikes, and we will give you practical advice as to the possibilities of a vocation and how to succeed in it. You will be under no obligation whatever. It is our pleasure to help. We never take students for courses unless we feel satisfied they are suitable. Do not forget of the brilliant. Our experience will to succeed achieves more than for courses unless we feel satisfied they are suitable. Do not forget of the brilliant. Our experience will to succeed achieves more than



### LET ME BE YOUR FATHER

Let me tell you how to make a success of your career. If your future is undecided or appears unsatisfactory, let us talk it over together. I want to help, and it will cost you nothing to get my help, you will be under no obligation whatsoever.

We are prepared to produce, on demand, over 10,000 unsolicited testimonials from successful students, or in default we will hand over £100 to charity.

**A STAFF OF 197** are in daily attendance at this College at your service.

## YOUNG MEN

Young men physically fit and whose careers are not definitely fixed should join the Police Force. We have Special Courses for Entrance and Promotion. Full particulars Free. Address: POLICE Dept. 104.

**YOUR CHANCE**  
**KEY POSITIONS**

**THE MOST SUCCESSFUL AND MOST PROGRESSIVE COLLEGE IN THE WORLD.**

## ENGINEERS

Engineers, now is your chance to dig yourselves into a Key position and make your future solid. It needs Technical Training: we can give you that by post. Full particulars Free. Dept. 104.

**DEPT. 104, THE BENNETT COLLEGE, LTD., SHEFFIELD**



## THE BRITISH LONG-DISTANCE LISTENERS' CLUB

### Mast Design

**A** MEMBER who lives in a closely populated suburb of London is rather puzzled concerning the design of an aerial mast which he wishes to erect. His garden is very short and his neighbours are not very co-operating. Consequently, the erection of a high flagstaff or scaffold-pole is difficult, as it would have to rest in the neighbouring garden before hoisting in position. He writes to ask what he can do about the matter, as he cannot get to his roof for a pole fitting and later wishes to carry out transmitting tests. In such a case there is nothing to beat the lattice type of mast such as was recently described in these pages. By using thin quartering (say from  $\frac{3}{4}$  in. to  $1\frac{1}{2}$  in. thick) it is possible to build up a most efficient mast which may be erected in stages without trespassing on any other property. The mast should first be planned on paper, then scaled and divided into sections. The length of each section, and the design of taper, will depend upon the overall height of the mast, but even with the highest mast it is possible to erect in a garden each section will be quite manageable.

A hole is not required for this type of mast, as it may be stood flat on the ground, as shown in one of the accompanying illustrations. Of course, it will have to be guyed satisfactorily, and this may be carried out at each section. The top section should be made first, and sufficient length of guy rope or wire attached for subsequent anchoring. If wire is employed, of course, insulators should be inserted at intervals to avoid losses.

### Erecting the Aerial

When all the sections are completed, they should be placed handy, and an assistant will be needed to help in hoisting. The top section should be stood upright, and the guy ropes passed through rings attached to posts driven in the ground or attached to the garden wall (if of brick). By paying out the guys equally all round, the section may then be lifted vertically without fear of tipping. Alternatively, if the sections are very long, a pole may be used with a pulley tackle for hoisting, but the same vertical lift

may be obtained. When high enough the next section may be placed in position, the two bolted together, both lifted, and so on. A ladder may be needed for assisting in the bolting process, although if well made it should be possible to climb up the cross-pieces, additional strength being given to the complete mast by means of cross-bracing wires of light steel. Obviously, a pulley should be attached to the top of the upper section with a long cord through it for the subsequent erection of an aerial, and

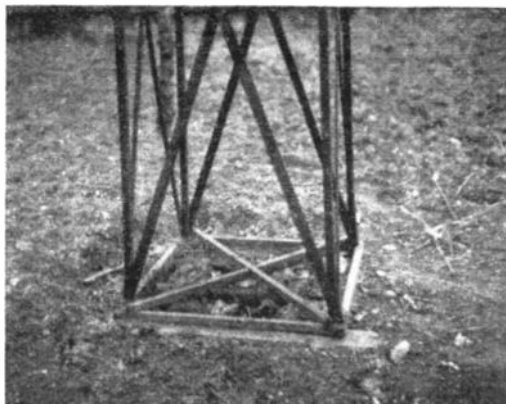

How the base of the mast rests on the ground.

a mast of this type not only proves very efficient, but greatly adds to the appearance of a wireless installation and is much less unsightly than a bending or swaying pole made up of odd lengths of quartering.

### The B.E.R.U. 56 mc. Contest

The Radio Society of Great Britain announce an international contest on 56 mc/s commencing on January 1st next. The following are the main rules, which should be noted by all transmitting members of the B.L.D.L.C.:

1. The contest will commence on January 1st, 1938, and conclude on December 31st, 1938.

2. The contest will be open to any radio amateur who is licensed to operate his station in the 56 mc/s band.

3. The winner of the contest will be the operator of the station scoring the most points based on the following system:

- 1 point for each contact over a distance between 200 and 1,000 miles.
  - 5 points between 1,001 and 2,000 miles.
  - 10 points between 2,001 and 3,000 miles.
  - 15 points between 3,001 and 4,000 miles.
  - 20 points between 4,001 and 5,000 miles,
- and so on, at the rate of five extra points for each additional 1,000 miles or part thereof.

All distances to be calculated by Great Circle.

To count for points the readability, strength and tone (both incoming and outgoing), must be logged, together with date, time and call-sign.

4. In addition, and in order to collect current data, each contestant must send to the Radio Society of Great Britain a monthly report of stations heard and/or worked, together with notes concerning conditions, power used for contacts, etc.

5. The Radio Society of Great Britain will present a suitable trophy to the winner of the contest, whilst certificates of merit will be awarded to the leading station or stations in each country.

6. No entrant may employ interrupted continuous waves, modulated continuous waves, telephony, or any other form of modulated carrier, for contacts claimed in this contest.

7. At the time of a contact both stations must be operating on 56 mc/s from their fixed station addresses.

8. Only one contact with a specific station may count for points in any 7 Day period.

9. Entrants must adhere to the terms of their licence.

10. Final entries must be received by R.S.G.B., 53, Victoria Street, S.W.1, not later than February 28th, 1939.

11. The decision of the Council of the R.S.G.B. shall be final in all matters relating to the contest.

*Note:* In the above rules the term 56 mc/s refers to the amateur frequency band, 56 to 60 mc/s. For the purpose of this contest a non-transmitter shall be regarded as a person who did not hold a radiating permit on January 1st, 1938. For further details members who desire to take part in this contest should write to the Radio Society of Great Britain at the address given above.

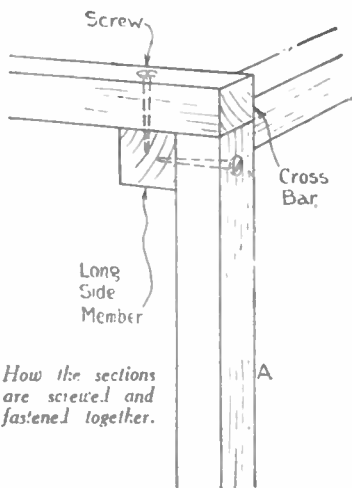

How the sections are screwed and fastened together.

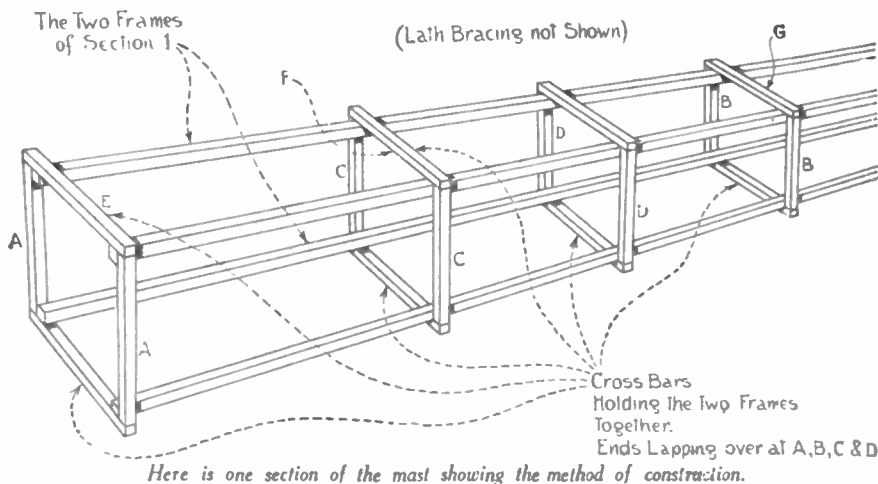

Here is one section of the mast showing the method of construction.

# MORE N.T.S. XMAS BARGAINS

## STRAIGHT 3 RECEIVER

Complete with 3 valves. Speaker. Walnut Cabinet.

LIST PRICE £4:19:6 **BARGAIN**  
**£2:10:0**



- New type highly selective Straight Battery 3 circuit.
- Slow-motion illuminated dial.
- Pick-up sockets.
- Metal Chassis.
- Low H.T. consumption.

Wavelength: 200-2,000 metres.

Complete with 3 British Valves and Moving-Coil Speaker in the handsome horizontal-type walnut-veneered table cabinet illustrated. Less batteries only. Cash or C.O.D. £2 10 0, or 5/- down and 12 monthly payments of 4/3.

**5/-**  
**DOWN**

## SCREENED GRID 3

Amazing S.G. H.F. Detector and Pentode output circuit. Only 9 m.a. consumption. Moving coil speaker fitted housed in cabinet illustrated. Less batteries. **BARGAIN** or 5/- down and 12 monthly payments of 5/-. **£2:19:6**

**POSITIVELY YOUR LAST CHANCE TO SECURE THIS WONDERFUL BARGAIN**

## A.C. BANDPASS S.G.4

LIST PRICE £8:8:0 **BARGAIN** **£4:19:6**

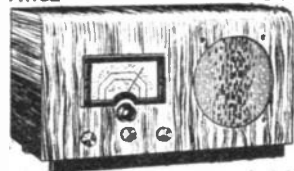

With 4 Valves. CELESTION Field-Ener-gised Moving-Coil SPEAKER and Walnut-Veneered CABINET READY TO PLAY.

Wonderful selectivity and sensitivity. 4 matched British valves. Screened Band-pass Coils. Slow motion Tuning. Illuminated station name dial. Gramo pick-up sockets. 3 watts output. Wavelength 200-550, 1,000-2,000 metres. For A.C. Mains ONLY. 200-250 volts. 40/80 Cycles. Complete with beautiful walnut-veneered cabinet with silk fret illustrated and Celestion Field-Energised Moving Coil Speaker. READY TO PLAY. Cash or C.O.D. £4 19 6. Or 5/- down and 12 monthly payments of 7/3.

**5/-**  
**DOWN**

## DX SHORT WAVE KITS

THE IDEAL XMAS GIFT for YOUNG and OLD.

**"3-in-1" SHORT-WAVE KIT** RECEIVER—ADAPTOR—CONVERTER

List Value 37/6 **BARGAIN** **25/-**

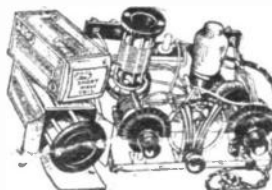

12-94 metres. ADAPTS or CONVERTS your battery set for short-wave reception. It may be used as one-valve Short-Wave Receiver. Slow-motion handspread tuning SIMPLIFIES WORLD RECEPTION. Air-spaced handspread and tank condensers. SPECIAL ANTI-BLIND SPOT CONDENSER. 3 scales calibrated in degrees.

**KIT "1"** comprises every part for assembling, including 3 4-pin coils, wiring and assembly instructions, less valve only. Cash or C.O.D. Carr. Pk. 25/-, or 2/6 down and 10 monthly payments 2/6.  
**KIT "2"** With 2-volt valve £1 8 9, or 2/6 down and 11 monthly payments 2/9.

**2/6**  
**DOWN**

**3-VALVE BANDSPREAD S W KIT** 12-94 metres. Will bring a lifetime of fascinating short wave entertainment. Kit 1 including all coils but less valves. List value £3 0 0. **BARGAIN CASH OR C.O.D. 37/6**, or 2/6 down and 11 monthly payments of 3/6. Kit "2" With matched valves £2 15 0, or 5/- down and 11 monthly payments of 3/5.

**4-VALVE A.C. BANDSPREAD KIT** 12-94 metres. Entirely new design. Guaranteed world wide reception. Kit "1" Complete with all coils. List value £5 10 0. **BARGAIN** 188 18 0, or 3/4 down and 11 monthly payments of 7/5. Kit "2" matched valves required 2/6 to deposit and 3/6 to each monthly payment.

## SAVE £1 ON YOUR CORONA ALL-WAVE 4

EVERY PART GUARANTEED MATCHED—PROVED—TESTED  
**KIT "1" CASH OR C.O.D. 67/6**

Comprising all parts for Receiver, including Exclusively Specimen WEARLE TRIOGEN COILS, POLAR V.P. DRIVE with station names, CLIX Valveholders, BELLING-LIE Terminal Strip, FITO-SCOTT FLYMAX Chassis and mounting brackets. Less valves, cabinet and speaker.

**5/-**  
**DOWN**

Balance in 12 monthly payments of 5/6  
**KIT "2"** as Kit "1" but with 4 Specimen Valves, less Cabinet and Speaker, Cash or C.O.D. Carr. Pk. £4: 14: 0, or 7/6 down and 12 monthly payments of 8/-.

## FURTHER PURCHASE OF

## K.B. RECEIVERS

OFFERED AT ONE-THIRD LIST PRICES. LIMITED STOCK ONLY. ORDER IMMEDIATELY. Shipped only, these sets are offered in thorough working order and ready for immediate use. All models are housed in beautiful upright walnut cabinets and represent unique value for money which will be instantly appreciated by callers. The ideal set for everyday use or in that spare room. Order with confidence.

**K.B. MODEL 429**  
Efficient circuit utilises H.F. Amplifier, detector and output pentode valves. K.B. "Foto-tune" dial Wave-range, 200-2,000 metres. Highflux moving-coil speaker. Wonderful volume and selectivity. Provision for pick-up. Less batteries. Housed in walnut cabinet. Overall dimensions, 17 1/2" high, 13 1/2" wide, 9 1/2" deep.

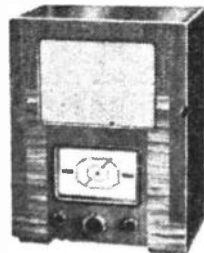

LIST PRICE £8: 18: 6 **BARGAIN** **£2: 19: 6**

Cash or C.O.D.

or 5/- down and 12 monthly payments of 5/9

**K.B. MODEL 437.** Battery Screened Grid 3. Similar to Model 429 but with Triode Power Output. Moving coil speaker. Wave-range, 200-2,000 metres. Special features provide excellent reception of many British and Continental stations. Beautiful walnut cabinet. Less batteries.

LIST PRICE £8: 8: 0 **BARGAIN** **£2: 17: 6**

Cash or C.O.D.

or 5/- down and 12 monthly payments of 5/7

## SPECIAL OFFERS

**HEADPHONES.** Super-sensitive type recommended for short wave work and testing. 3 6 (postage 6d.); 3 pairs 10/- (post paid).  
**VALVES.** Give your set a tonic and fit new valves. Huge purchases enable us to supply at greatly reduced prices. Long and efficient service guaranteed. Battery, Det., I.F. and H.F. 2 9; S.O., V.M., Class "B" H.F., and L.F. Pentodes, 6/-.  
**Mains Types, A.C., H.T., 5/-.** All A.C. S.G., V.S., Pentodes and H.F. Pentodes, 7/2. Grids and Heaters, 9/2. Dearth heated P.W. rectifiers, 5/6 each. 120 ma., 5/-, postage extra.

## S.G. BATTERY 3

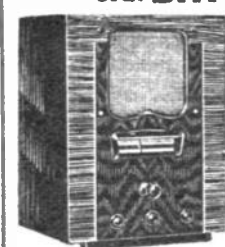

● Wavelength 200-2,100 metres. ● Conceit-Grand Moving-coil Speaker. ● New-type No-trouble Switch. ● Complete with Valves, less Battery and Accumulator. ● READY TO PLAY.

Will bring you British and Foreign programmes with remarkable clarity and volume. A British Valve of guaranteed life; new screened-grid high-frequency, high-efficiency detector, and Pentode output. Latest improved components. Steel Chassis. Slow motion tuning. Illuminated wavelength scale. Beautiful walnut-veneered cabinet, 19 1/2" high, 14" wide, 10" deep.

LIST PRICE £6: 6: 0 **BARGAIN** **67/6**

**5/-**  
**DOWN**

or 5/- down and 12 monthly payments of 5/9

## BELMONT 6-VALVE ALL-WAVE SUPERHET

(18-2,000 Metres)

GENEROUS ALLOWANCE MADE FOR YOUR OLD SET IN PART EXCHANGE.

### MODEL 600.

A receiver of out-standing world-wide performance and quality at a remarkably moderate price. Model 600 is a 6-valve all-wave superhet with a high gain circuit of extreme sensitivity. It incorporates all the modern improvements — A.V.C., provision for extension speaker, latest Octal Type Valves and 6-in. Moving Coil Speaker. The oval dial is calibrated in metres and station names, with a different colour for each wave-band. Output is 3 watts undistorted. Cabinet is of modernistic lines of beautifully figured walnut. Overall size is 20 in. high, 15 1/2 in. wide, and 8 1/2 in. deep. Cash or C.O.D. £10: 10: 0, or 10/6 Deposit and 18 monthly payments of 13/-. **10/6**  
**DOWN**



## B.T.S. ADABAND

★ AMAZING BARGAIN! ★

List Price **£5: 5: 0**  
**BARGAIN**  
**£3: 3: 0**



● Your Set rests on top of the ADABAND. ● BRINGS AMERICA and War News to your present set! Stand your receiver on this amazing unit and hear the whole world! Walnut figured cabinet. Single tuning control. One-touch without disconnecting. Wavelength 13-74 metres.

**BATTERY MODEL.** List Price, £5/5/0. **Battery Model.** £3/3/0. Or 5/- down and 12 monthly payments of 5/6.

**5/-**  
**DOWN**

## B.T.S. SHORT-WAVE ADAPTOR

LIST PRICE £2:12:6 **BARGAIN**

Brand New and Ready for Instant Use. Nothing to Assemble **39/6**

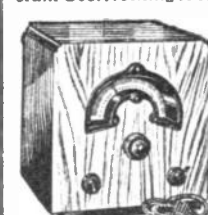

America Direct on your Present Receiver! This amazing unit simply plugs into your battery or A.C. Mains set. No alterations necessary. 100-1 ratio aerial tuning and slow-motion reaction; for use either as Plug-in or Superhet Adaptor. Walnut finished Cabinet (11 1/2" x 12 1/2" x 2 1/2" deep). Ready assembled. Yours for 2/6 down and 10 monthly payments of 4/2.

**2/6**  
**DOWN**

## New Times Sales Co.

56 (Pr. W. 43), Ludgate Hill, London, E.C.4

Please send me..... Cash H.P. Deposit. For which I enclose..... Please send also your Free Booklet describing in detail 5 new Short Wave Kits, and General Bargain Catalogue of Components, Valves, Receivers, etc., etc.

NAME..... ADDRESS.....

Please cross all P.O.'s and register numbers. Orders must be accompanied by full cash and appropriate postage.

# Buy Yourself a Radio Present

**AND EARN THE APPRECIATION OF ALL THE FAMILY!** Now is the time to think about your Christmas Radio—to make sure of getting the best out of the wonderful Xmas fare offered by the B.B.C. and the other stations of the World, but be sure to order at once.

**CASH or C.O.D.** Orders despatched by return.

Any of these lines will help to give you a **HAPPIER RADIO XMAS.**

## McCARTHY ALL WAVE CHASSIS

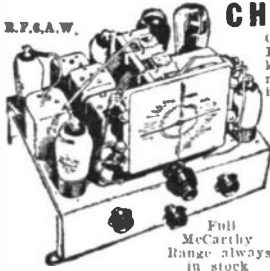

Complete with B.V.A. Valves, knobs, leads, etc., ready for fitting into any cabinet. **R.F.S.A.W.**  
**17/6 WITH ORDER** and 12 monthly Payments of 14/9. Cash price **£9.17.6.** S.S. A.W.  
**14/6 WITH ORDER** and 12 monthly Payments of 11/5. Cash Price **£6.17.6.** Full McCarthy Range always in stock

## The W.B. SENIOR STENTORIAN



Still the finest Permanent Magnet Unit on the market. A model of unusually high performance. Ideal as principal or extension speaker for any set. Other W.B. Models a similar term.  
**2/6** with order and 11 monthly payments of 4/- Cash price **42/-**

## GARRARD A.C.6 Radiogram UNIT



Comprising all essential running, enclosed, economical Induction motor for A.C. 100-250 volts, 50-60 cycles. Unit plate with pick-up, needle cups, etc.  
**5/6** WITH ORDER and 11 monthly payments of 7/- Cash price **75/-**

## GARRARD A.C.6 MOTOR only

Similar to above but with fully automatic start and stop, and without pick-up, needle cups, etc. Complete with 12in. push-covered turntable.  
**4/-** WITH ORDER and 10 monthly payments of 4/3. Cash price **42/6**

## AVOMINOR TEST METER

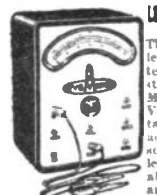

The equivalent of thirteen testing instruments in one. Measures Current, Voltage and Resistance with ease and accuracy. Its handy use with leads, interchangeable crocodile clips and testing probe.  
**5/-** with order and 10 monthly payments of 4/6. Cash price **45/-**

## ROTHERMEL PIEZO PICK-UP

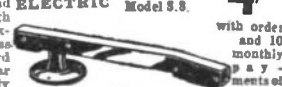

Unsurpassed for wide frequency response and amazingly high output. Extreme lightness reduces record wear and tear to practically nil.  
**4/-** with order and 10 monthly payments of 4/3. Cash price **£2-2-0**

Whatever your needs let us quote **EASY TERMS.**

EVERY offer carrying this symbol is:

- Fully Guaranteed.
- Post Carriage Paid.
- Available for immediate Delivery.
- On the Best and Lowest Terms.

**LONDON RADIO SUPPLY COMPANY** ESTD. 1925  
11, OAT LANE, NOBLE ST. LONDON, E.C.2.  
Phone: NATIONAL 6828-9

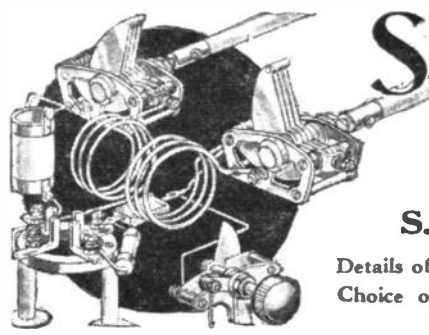

# Short Wave Section

## S.W. COIL DESIGN

Details of the Main Considerations Underlying the Choice of Coils for Simple Short-wave Receivers.

**M**ANY beginners are confused when they come to select the tuning coil for use in a simple short-wave receiver. A glance through radio component catalogues shows many different types, and in the plug-in variety there are 4- and 6-pin components. It is about these that this article is principally written, as many amateurs seem to be unable to make a selection regarding the type of base to adopt. The accompanying illustration shows a standard 4-pin plug-in coil, whilst the theoretical circuit indicates a simple detector stage utilising one of these coils. It will be seen that there are two windings only, and in the circuit shown these are employed for the grid and for the reaction windings. If, however, the coil is required for use in an H.F. stage, it would be possible to use the smaller winding (L2) for an aerial coupling coil, in which case L1 would remain across the grid-filament circuit, but the aerial would be joined to one end of L2 and the other end of this would be joined to earth. What are the advantages and disadvantages, therefore, of this type of coil compared with the 6-pin component? The difference in construction is that the 6-pin coil has a further winding, joined across the two additional pins, and this is employed as an aerial coil in the manner just mentioned, thus leaving a winding for reaction purposes. It will be obvious, therefore, that in a simple detector stage such as that shown, the 6-pin coil will provide an additional winding which may be used or omitted as desired. Thus for experimental purposes alone, this type of coil is to be preferred.

variable type. This may then be adjusted to provide the required degree of damping, or, in other words, to remove damping so that the valve will oscillate.

If a separate coil is coupled to the L1 coil, and this additional coil is joined between aerial and earth, it will not only remove the damping effect but will also be found to provide better selectivity,

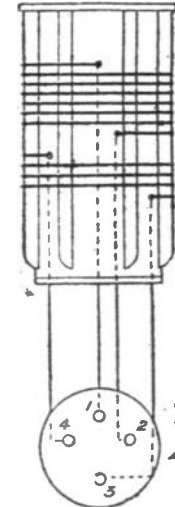
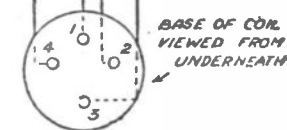

Fig. 1.—The method of building a 4-pin short-wave coil, showing the connections to the pins.



BASE OF COIL VIEWED FROM UNDERNEATH

although it is important to see that the coil is carefully chosen, both as regards the number of turns and their relation to the grid coil. If a commercial coil is obtained, the coil may be relied upon to provide the correct degree of coupling, but when a home-made coil is used it may be found desirable to experiment and carry out some tests with a view to finding the best coupling and the best position for the coil.

### Aerial Damping

If the aerial is joined direct to coil L1 in the theoretical circuit shown, it will be

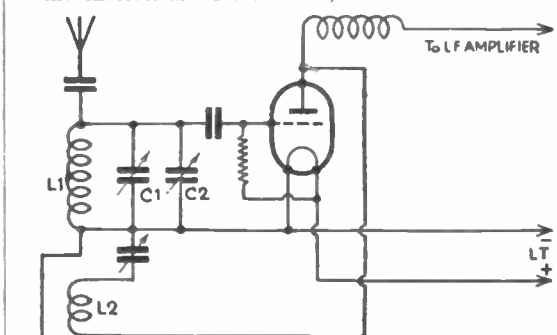

Fig. 2.—Standard circuit for a single-valve or detector stage using a 4-pin type of coil.

found in most cases that reaction will be difficult to obtain. This is because the aerial and earth leads, when connected to the coil have the effect of what is known as "damping" the circuit. That is to say, they "load" the circuit and prevent the valve from oscillating easily. To remove the damping effect the aerial is therefore connected to the coil through a small condenser, which may be fixed or of the semi-

Naturally, one is able with this type of coil to ignore the aerial coupling winding and use the standard connections shown in the theoretical diagram herewith.

### H.F. Coils

When, however, he wishes to use a receiver in which an H.F. stage is employed it will be found that the three windings are needed, the first (corresponding to the aerial coil already mentioned) being joined between the anode of the H.F. valve and the H.T. positive line, and the grid coil and reaction winding being used in the ordinary way in the detector stage. Such an arrangement will provide better stability and greater magnification than a plain tuned-anode circuit. It will be seen, therefore, that the choice of the type of coil must rest with the individual, and will depend not only on the circuit to be used, but also the experiments which it is wished to carry out.

Would get it **QUICKER** and on **BETTER TERMS** from **L.R.S.**

## Leaves from a Short-wave Log

### That Obstinate Carillon

**N**OTWITHSTANDING the fact that the majority of buildings in the centre of Madrid have been destroyed in the course of the Civil War, the Chimes installed in the tower of the Home Office in the *Puerta del Sol* Square have escaped damage, and are nightly relayed to all Government transmitters, including short-wave stations.

### Change of Call-sign

CT1AA, Lisbon (Portugal), on 31.09 m., (9.65 mc/s), should now be entered in your log under the new call-sign CS2WA, and Radio Catolica (*Radio Renascenca*), also in the Portuguese capital, as (S2WD). The latter station works on 50.25 m. (5.977 mc/s).

### New Moroccan Station Testing

Listeners report hearing test broadcasts from a French station on 48.88 m. (6.1375 mc/s). This would appear to be CNR2, the new 2 kilowatt transmitter installed in the vicinity of Rabat (Morocco). The station has been heard working towards G.M.T. 20.15.

### La Voz Del Pueblo

On 49.42 m. (6.07 mc/s) HP5H, situated at Colon (Republic of Panama), has now been logged almost nightly towards midnight. The slogan adopted by the studio is given out after the full call, namely *La Voz del Pueblo* (The Voice of the People).

### The Other Georgetown Station

VP3MR is not the only station operating at Georgetown (British Guiana); it possesses a competitor, VPP3BG, which is now transmitting regularly on 48.9 m. (6.135 mc/s). Reception reports should be addressed to: J. La Motte Kerr, 1 Wellington Street, Georgetown (British Guiana).

### New West African Short-wave Station

French listeners report hearing broadcasts from a short-wave transmitter installed at Duala (Cameroons-French Mandated Territory); the wavelength advertised is 23.66 m. (12.68 mc/s).

### Rotating Aerials

According to the *Nieuwe Rotterdamse Courant*, one of the leading Dutch newspapers, so far, wireless transmitters desiring to beam their broadcasts on different quarters of the globe have been compelled to erect a series of aerials for the various directions required. The report states that at Huizen (Holland), Philips Radio have installed a new system of rotating aerials. Two pylons mounted on a moveable platform in some ways similar to an engine turntable, and worked by electric motors, are fitted with eight vertical aerials, each consisting of three insulated sections, constituting in this manner, twenty-four dipole aerials. It is further stated that each supporting pylon weighs eighteen tons. By means of the motors the platform is made to turn in order to beam the respective aerials on the required area overseas to which it is desired to beam the broadcast.

# Make this a Memorable Christmas!

A sense of achievement—the thrill of enjoying, and giving your family, a brand new comfort—what else could so positively ensure an even happier "Happy Christmas" than usual?

Think of the real pleasure which any of this up-to-date WB apparatus can bring into your home—the comfort of an extension speaker in that other room, the novelty and convenience of a Long Arm remote control, or the added zest which realistic modern reproduction can give to your radio programmes!

This Christmas, fit a new Stentorian in place of your old speaker. Or rig up a new extension, with remote control. Not only will you enjoy doing the job; you will be able to look forward to years of extra pleasure as a result of it.

Your dealer has stocks.  
Let him show you—to-day!



## Stentorian

QUALITY REPRODUCTION APPARATUS

WHITELEY ELECTRICAL RADIO CO., LTD.  
(technical dept.), MANSFIELD, NOTTS.

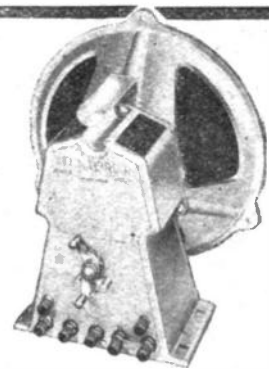

1938 Stentorian chassis, for better Christmas radio. Wider response—less colouration—greater realism. Matches to any set. Prices from 23/6 upwards.

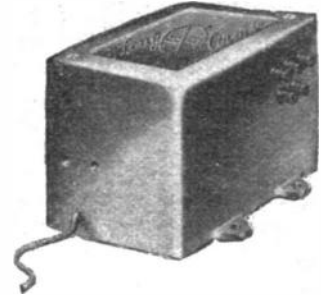

"Long Arm" remote control for switching the set on or off from any extension point. One "Long Arm" serves any number of 1938 Stentorian extension speakers. Price 15/6.

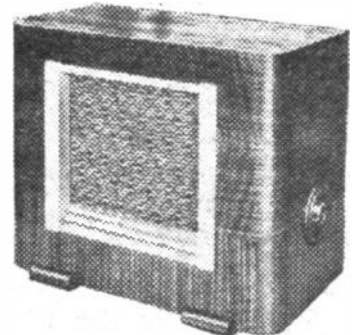

1938 Stentorian cabinet model. All models except the "Baby" (29/6) incorporate volume control type R.C. Prices 29/6, 39/6, 49/6, 63/-.



Especially useful at Christmas is the Stentorian junior portable receiver, with self-contained aerial and full-size batteries. Price £6-6-0, or 11/- down and 12-monthly payments of 1/14.





Here  
Familiarity  
Breeds *Respect!*

Setmakers and designers must know condensers... know that they will work as "per specification"... will stand up to dozen or more exacting conditions. Only through years of continuous contact with these condensers... being really familiar with their performance can the designer make sure. For over 30 years, T.C.C. Condensers have been the almost invariable choice of they who know. T.C.C. have earned their respect.

**T.C.C.**  
ALL-BRITISH  
**CONDENSERS**

The Telegraph Condenser Co. Ltd., Wales Farm Road,  
N. Acton, W.3.

# LETTERS FROM READERS

The Editor does not necessarily agree with the opinions expressed by his correspondents. All letters must be accompanied by the name and address of the sender (not necessarily for publication).

### Our 12-watt Amplifier

SIR,—I have completed the 12-watt amplifier recently described in PRACTICAL AND AMATEUR WIRELESS, and it is really a joy to listen to.—H. COTTON (Grays, Essex).

### A Good Log from Ealing

SIR,—I have not seen a log of stations from my district, so I thought mine would interest other readers. All stations were received between October 1st and October 22nd.

On the 20-metre band: ON4UF, G8SB, G15KE, G5NW, WIADF, WIADM, W1CRW, W1DLO, W1HED, W2IFL, W4CYU, W8KA, PY2AJ (Brazil), S3EQ.

On the 40-metre band: G8IO, G6XJ, G6ZK, G2XG, G8GM, G5CJ, G5SO, G15MZ, G2SQ, GM2SE, GHKB, G2SU, G2NL, G2UQ, G8IO, G5ZN, G8KP, G2RW, G2KP, G5BP, G2NP, G15MZ, G6SW, G8TY, G18J, G8CB, G2RW, G6CO, G8JE, G8IG, G5NW.

Among the commercial stations I have received are: HAS3, DJR, W2XAD, GSP, DJQ, W2XE, GSI, W1XAL, PC5, W8XF, DJB, GSO, GSF, HVJ, DJL, RKI, LZA, SPW, RNE, TPA3, W8XK, GSE, DJB, GSN, 12R04, DJD, GSD, PHI, TPA4, SPB, ORK, PMN, CSW, EAQ1, CTIAA, HBL, BCJ, W3XAU, GSC, DJA, DJN, W2XAF, OZF, GSB, HJU, EAQ2, COCH, HAT4, HBP, GSL, W3XAL, W9XAA, OER2, SBO, W3XAU, W8XAL, GSA, W1XAL, DJC, HJ3, ABH, COCO, HVJ, XGOX, JZJ, JZK, XEUF.—I. A. WALKER (Ealing, London, W.5.)

### More Prizewinners' Thanks

SIR,—I have received the W.B. Stenorian Junior Loudspeaker which I won in your recent Radiolympia contest. It is a marvellous speaker, and I wish to thank you very much for it.

Wishing your paper every success in the future.—A. S. WOODLEY (High Wycombe).

SIR,—I have now received the "Stenorian Speaker" awarded me in your recent competition and for which I thank you. I always read what you have had to say about these speakers—your praises of them—and you have certainly not exaggerated their high quality.

I am tremendously pleased with the speaker and, incidentally, it has proved to me how much I need a new set!—C. RAINES (Whitstable).

### VP3MR (British Guiana)

SIR,—In the November 20th issue of PRACTICAL AND AMATEUR WIRELESS, on the "Leaves from a Short-wave Log" page, there is a statement: "Do not apply to VP3MR, Georgetown (British Guiana), for a 'veri' as they do not reply by post." This station comes in here R8 at present, and the announcer mentions that "Q.S.L.

cards will only be sent to those sending International or Imperial reply coupons," as the case may be. All who do not send coupons will only be answered over the air."

I have just received their Q.S.L. card for a report I sent on the 28th September. Their schedule, as shown on the Q.S.L. card, is: "The Voice of Guiana," Monday to Saturday, 5.30-9.30 p.m. (B.G. time). Sundays, 9.00 a.m.-12.00 p.m. (B.G. time). British Guiana time is three and three-quarter hours behind G.M.T. and one and a quarter hours ahead of E.S.T.—E. BRIAN (South Croydon).

### Our Free Service

SIR,—I feel I ought to thank you for your letter and the very helpful information it contained. I can now carry on with confidence the construction of the £5 Superhet, whereas without your valuable help I should not have tackled it.

Home constructors must be very grateful to you for your unstinted free advice—I'm afraid I should have given up making sets but for your help. I don't mind the expense—I very much enjoy the hobby—providing the results of my labours and financial outlay are successful.

The very fine set I am using at the present time—the "A.C. Leader"—was unsatisfactory when I first tried it out, owing to

CUT THIS OUT EACH WEEK.

## Do you know

—THAT an A.V.C. circuit may be tested by using a short length of aerial lead and moving this about. No variation in signal strength should be noticed.

—THAT signal strength may be measured visually by suspending a mirror in front of the speaker and focusing a spot of light on the wall.

—THAT an ordinary pocket compass may be used for various forms of testing in H.F. and L.F. circuits.

—THAT the capacity of a condenser connected in the earth lead of a D.C. set will govern the severity of shocks which may be experienced when touching certain "live" parts in the set.

—THAT aerial insulators should not be greased when erecting an aerial as the grease will attract carbon deposits from the air and provide a leakage path. Rain should keep ordinary insulators clean.

The Editor will be pleased to consider articles of a practical nature suitable for publication in PRACTICAL AND AMATEUR WIRELESS. Such articles should be written on one side of the paper only, and should contain the name and address of the sender. Whilst the Editor does not hold himself responsible for manuscripts, every effort will be made to return them if a stamped and addressed envelope is enclosed. All correspondence intended for the Editor should be addressed: The Editor, PRACTICAL AND AMATEUR WIRELESS, George Newman Ltd., Tower House, Southampton Street, Strand, W.C.2.

Owing to the rapid progress in the design of wireless apparatus and to our efforts to keep our readers in touch with the latest developments, we give no warranty that apparatus described in our columns is not the subject of letters patent.

the very disturbing hum which quite ruined all programmes. Nothing I did had the least effect. Eventually I did what I ought to have done earlier—I asked for your advice. By return of post came the very simple remedy. I say simple, because it was accomplished in about two minutes. Just a matter of rotating the I.F. transformer about 30 degrees relative to the smoothing choke, and behold, the hum faded out!

It must take a lot of your valuable time dealing with the troubles of your readers, but you can be happy in the knowledge that you are keeping home construction very much alive.—C. E. HOLT (Stechford, Birmingham).

**Heard at Guildford**

SIR,—I have been a reader of your excellent paper for some years, and having seen many logs submitted from various parts, I enclose mine from Guildford. The receiver used is a 2-valve detector-L.F., as described in PRACTICAL AND AMATEUR WIRELESS dated July 18th, 1936, with a 60 ft. "L" type aerial. W1XAL, W3XAL, W2XAD, W2XAF, W3XAU, W8XK, W9XF, CJRX, VP3MR, COCM, VK3LR, ZBW3, JVN, VE9HX, RAN, RNE, DJJ, DJC, CT1AA, OLR3A, OLR4A, OLR4C, IUC, I2R03, EAJ28, RR6VS, EAR, EA4TSD, ERGU, OER2, PCJ, HBO, SU'ICH, TPA3, HAT4, and W2XE.

Also, the following amateurs were received: ON4US, ON4UF, ON4CC, ON4LO, ON4BG, CT1ZZ, CT1JW, F3HM, F3DI, F5BD, SP1CC, LX1TW, HB9BI, E16J, E18J, E14L, W1BAL, and 160 G stations.—M. CANAGHER (Guildford).

**From a Scottish Reader**

SIR,—I have not seen a 20-metre log published in PRACTICAL AND AMATEUR WIRELESS from my district, so I send mine. All stations were received during the last four weeks and I only listen a short time each day—about two hours.

My set is a home-made o-v-2 transformer coupled L.F. and P, but the same detector stage as described in PRACTICAL AND AMATEUR WIRELESS for December 12th, 1936. The coil I am using is a six-pin type and I find it very good indeed. It was the one-valve circuit mentioned above that set me on the track of short waves, and like many other young beginners I owe all my thanks to PRACTICAL AND AMATEUR WIRELESS.—T. J. MILLER (Airdrie, Lanarkshire).

[We were greatly interested in your log, but unfortunately it was too long for publication.—ED.]

**NOW READY!**

**WIRELESS COILS,  
CHOKES AND  
TRANSFORMERS,  
AND HOW TO  
MAKE THEM**

2/6, or 2/10 by post from Geo. Neufnes, Ltd., Tower House, Southampton Street, Strand, London, W.C.2.

**CLIX "MASTER" PLUGS—**  
Spade Terminals—Socket Strips and  
Standard Valveholders are all Specified  
FOR THE "D-XMASTER"



(V.1)

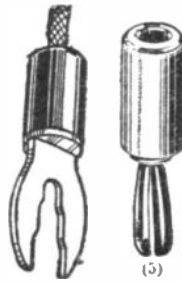

(14)

(5)

For Folders  
Write Dept. G.

Mr. F. J. CAMM, like all experienced designers of receivers, fully realises the importance of perfect contact for each and every component, large or small, which goes to make the perfect all-wave receiver. He knows, also, that he can rely on CLIX.

(V.1) VALVEHOLDERS. Standard types V.1 and V.2. 4-pin 8d., 5-pin 9d., 7-pin, 1/-

(14) SPADE TERMINALS. Engraved L.T. +. L.T.-. (Large) 2d. (Small) 1½d.

(5) MASTER PLUGS. Long or Short types for H.T. and G.B. .. .. . 1½d.

(A) TWO-SOCKET STRIP. Engraved A.E. or L.S. or Pick-up. .. .. . 6d.

(35) PLUG SOCKET. A dual-purpose master plug .. .. . 2½d.

(32) CROCODILE CLIP. For short-wave and service work .. .. . 4½d.

CLIX STOCKED BY ALL GOOD DEALERS

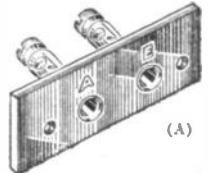

(A)



(35)



(32)

BRITISH MECHANICAL PRODUCTIONS LIMITED  
79<sup>a</sup> ROCHESTER ROW LONDON S.W.1



**CHOSEN BY MR. F. J. CAMM**  
for his "D-XMASTER"

Receiver because the necessity for low losses and low minimum capacity in All-wave Receivers forms the basic design of the specified J.B. Condenser. Widely spaced heavy gauge aluminium vanes, together with the overall rigidity in construction makes this model, therefore, particularly suitable for Short-wave work; vane resonance—through close association with a powerful loudspeaker—is obviated.

Ball-bearing rotor is employed and electrical continuity is maintained throughout.

**J. B. STRAIGHT LINE DRIVE**  
Also Specified by Mr. F. J. CAMM

A Friction Disc Drive, single ratio 8 to 1. No backlash, thus resulting in immediate and exact readings. Rigid construction, full vision scale, Hair line cursor with travelling illumination which gives maximum intensity at any setting.

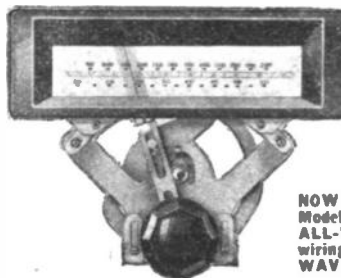

TYPE S.L.4

**5/9**

Escutcheon available in Black or Brown Bakelite.

NOW READY.—The BATTERY Model of the NEW J.B. LINACORE ALL-WAVE TUNER. Full size wiring plan, all details for ALL-WAVE "VIVID" 4 Receiver, 3d. post free.

**J. B. BAR TYPE CONDENSER**

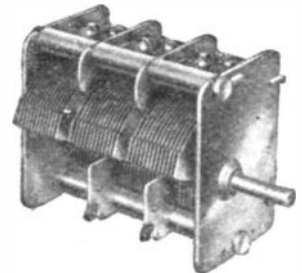

?-Gang as illustrated **17/6**

2-Gang (As specified) **12/-**

**JACKSON BROS. (LONDON) LTD., 72, ST. THOMAS STREET, LONDON, S.E.1.**

# BULGIN

QUALITY COMPONENTS

**AERIAL FITTINGS.** Moulded cowl insulators on screws or brackets. Fine weather-proof jobs, vertical or right-angle stand-off types, 1/9. With fuse and spark gap, 4/-. Wall fixing bracket type, 2/-.  
**DOUBLET AND U.S.W. AERIAL KITS,** including Transposition Blocks (2/3 per box of 6), all insulators, twin feeder cable, etc., etc., 7/6 to 30/- (super television type).  
**L.F. CHOKES.** 100 h. at 10 ma., 12/-; 15 h. at 100 ma., 15/-. Others from 6/6. Tapped output chokes, 16/-; Q.P.P. output, 15/-.

**COILS, ALL-WAVE, STRAIGHT AND SUPERHET TYPES.** Dual wave in square or round cans, 5/-, and (for Osc.), 7/6; 3-range types, aerial, 9/6; Osc., 15/6; 4-range, 10/6; 5-range, aerial, 21/-. Osc., 30/-. All precision wound, standard inductances. **I.F. TRANSFORMERS,** general purpose in square cans, 6/-; var. selectivity, 9/6, 15/6; super type, 20/-. Marvellous choice of first-class coils for all types of receivers. (N.B. I.F. formers 465 kc/s only.)  
**TRIMMER CONDENSERS.** High-class low-loss trimmers, mica-dielectric, "Microloss" base, one-hole fixing, from .00016 uF to .003 uF max., 2/- to 2/9; **TRIMMER STRIPS,** with 30 uF mica-dielectrics, 2-mounts, 1/3; 6-mounts, 2/9. **AIR DIELECTRIC TYPES,** panel or baseboard, 5/- to 7/6, "Microloss" base.

**NEON LINES, I.F. AND R.F.,** Generate 465 and 110 kc/s I.F.s and accurately fixed R.F. signals. Invaluable for lining up and ganging modern superhets. Write for full details. Price 15/- each.  
**MAINS CONNECTORS AND FUSE-HOLDERS.** Wide variety of types for all domestic apparatus. Bulgin "Fuseplug," complete with fuses, 2/-; panel-mount single fuse type, 1/9; baseboard types, twin and single, 6d. to 2/6.  
**OUTPUT METER.** Indicates signal strength by glow in neon lamp. Simply connect across output stage. No external power, no moving parts. Ideal for lining up. List No. V.T.19, 20/-.

**KNOBS.** A superb range to match all sets. Large octagon shape, 8d.; small ditto, 4d. Instrument type, 6d. American types, 6d. Many others.  
**PRECISION RESISTORS.** For meters, shunts, lab. work, etc. Standard accurate to 2 per cent. Special types to order. 6/- for 0.1Ω, and 12/6 for 0.1 MΩ.  
**SWITCHES, WAVE-CHANGE, MAINS, etc.** Numerous choice. Famous 5-way rotary for all-wave selection, gangable, 2/3 per unit. Toggle mains types, average 25,000 operations, on-off type, 1/6; D.P.D.T., 3/6; 4-point, 2/-; change-over type, 2/6.  
**TRANSFORMERS, MIDGET MIKE, L.F.,** Q.P.P., etc., with high mu cores. Midget type L.F.48, 1" x 1 1/4" x 1 1/4", marvellously compact, 3/6; mike type, same size, L.F.49, 3/6.  
**VIBRATOR H.T. UNITS,** 4, 6 and 12v. inputs for H.T. outputs up to 250 v. at 60 ma. smoothed D.C.; self-rectifying, 20/- each. Write for folder.

**ALL THE ABOVE ARE NEW, TESTED AND FULLY GUARANTEED GOODS. WRITE FOR 120 PAGE CATALOGUE**

## COUPON

To Messrs. A. F. BULGIN & Co., Ltd.,  
 Abbey Road, Barking, Essex.

Please send, post free, a copy of your new 120 Page Catalogue for which I enclose 3d. stamps.

NAME .....

ADDRESS .....

P. R.

1

Block Letters, Please

Send this Coupon Now

# RADIO CLUBS & SOCIETIES

Club Reports should not exceed 200 words in length and should be received First Post each Monday morning for publication in the following week's issue.

## ILFORD AND DISTRICT RADIO SOCIETY

ON Friday, November 12th, a representative number of our members visited the Southend Society at their headquarters at Leigh Technical College, where a lecture on Modern High-definition Television was given by Mr. Watson, of E.M.I. The lecturer gave a most interesting talk, and went very fully into his subject from most points of view. The proceedings terminated with many questions, especially in regard to the Emitron camera, which was shown to the meeting.

Visitors are welcome at all meetings, and prospective members are asked to come along at any time.—Hon. Secretary, C. E. Lagen, 44, Trelawney Road, Barking-side, Ilford.

## THE EAST DORSET AND WEST HANTS RADIO CLUB

IT is proposed to form a club in the Bournemouth-Poole area, under the above title, meeting monthly. The co-operation of G5OH has been obtained, and others in the district are being approached. The proposed annual subscription is 5s. per annum. Inquiries will be welcomed from anyone in the district interested in the formation of this club, and these should be addressed to the undersigned at the address given.—David M. Williams, "Amberley," Cornwell Road, Poole.

## LINCOLN SHORT-WAVE CLUB

THE headquarters of this club are now at 30, Tentercroft Street, Lincoln, where meetings will be held every Tuesday at 7.30 p.m. Constructional work on the club's own receiver is now in hand. All applications for membership should be addressed to Mr. Babbs (G5IG), 203, Wragby Road, Lincoln.

## BIDEFORD AND DISTRICT SHORT-WAVE SOCIETY

ON Wednesday, November 3rd, this society held its second Annual Dinner, and were honoured with the presence of G6GM, Holeworthy; also Mr. A. Cornish (Torrington Radio Society), and members. Others present were G6FQ, Appledore, G8US, Bideford, and 2ADJ, Northam.

On Monday, November 8th, at the club rooms, tests were carried out on Messrs. Whiteley's "Stentorian" Speaker. This was voted a fine instrument, and the club decided to procure one for its own use.

Anyone interested in membership should apply to the Hon. Sec., W. G. Couch, Hillside, Glen Gardens, Bideford.

## THE CROYDON RADIO SOCIETY

THERE was another popular loudspeaker night on Tuesday, November 16th, for the Croydon Radio Society's meeting in St. Peter's Hall, South Croydon. The Technical Adviser was in charge, and, indeed, he revelled in experiments on the various loudspeakers, each one having to pass stern tests before he was satisfied. It was very interesting to note that nearly all models had some special means of increasing the high-note response, and it could not be denied that such combinations had definite advantages over single-diaphragm units. Nor were the B.B.C. programmes neglected, as a sharp recital was particularly helpful in judging "attack" or "transient" response. Then Mr. Ménage's variable frequency oscillator did good work in finding flaws, as it uttered frequencies up to 15,000 cycles and hence many a loudspeaker fell by the wayside. Eventually, the choice was narrowed down to four models, and finally, one of the comparatively cheap models became the winner. Perhaps its secret of success was in its cone, designed so that the apex was made of harder material than the outside. On Tuesday, December 7th, there will be a lecture entitled "Searchlight on the B.B.C.," and PRACTICAL AND AMATEUR WIRELESS readers are invited to come to what is expected to be a novel evening.  
 Hon. pub. sec.: E. L. Cumbers, Maycourt, Campden Road, South Croydon.

## KETTERING RADIO AND PHYSICAL SOCIETY

IN spite of the counter attraction of the Royal Command Performance on the radio, there was a fair attendance of members at the Kettering Radio and Physical Society's meeting on Monday, November 18th, to hear Mr. F. K. Webb, of Pye Radio, Ltd., lecture on "The Problems of Short-wave Reception."

Mr. Webb, who prefaced his remarks with a survey of what actually comprised the short-wave bands, proceeded to acquaint his audience with the effects of the Heaviside and Appleton Layers on short waves, and pointed out that it was through the reflecting properties of these layers that signals from the other side of the world were receivable by us here in England. These layers were constantly shifting, he said, and this accounted for the effect known as fading, and mentioned that several American amateurs used two

aerials for reception, so that one, placed some distance from the other, received the full signal at its peak, whilst the other aerial was under the effect of the fade, and the two were mixed just before entering the receiver, with the result that a comparatively steady signal was received.

This system was used very successfully by the B.B.C. in their efforts to relay American programmes, although the stations in this case were separated by several miles.

After the interval, the lecturer proceeded to discuss aerials for short-wave reception and demonstrated the Pye Anti-Static Aerial. He also demonstrated the Pye QAC5 all-wave receiver.

Secretary-treasurer: Irving L. Holmes (2ANF), "Miami," The Close, Headlands, Kettering.

Headquarters: Ivy Cafe, Gold Street, Kettering.

Permanent Club-room: Pollard Street.

Meetings: Weekly, Monday evening, 7.30 p.m.

Short-wave section and Morse class: Tuesday evenings, 7.30 p.m.

Photographic section: Wednesday evenings, 7.30 p.m.

## SOUTHALL RADIO SOCIETY

ON November 16th, the lecturer at Southall was Mr. H. A. M. Clarke, G6OT, who talked on "Transmitter Design." His very lucid lecture was greatly appreciated by the audience, who asked a number of questions at the end of the evening.

Future meetings to be held this month are as follows: December 14th: "Suppression of Electrical Interference," by H. J. Walters. This talk is arranged in co-operation with Messrs. Belling and Lee, Ltd. Mr. Walters is a member of their technical staff and an authority on the subject.

December 21st: Discussion—"The Future of Amateur Radio." This will be on the lines of the very successful "Television" discussion held recently, and it is hoped that members will keep things moving again on this occasion.

Headquarters: Southall Library, Osterley Park Road, Southall. Meetings: Tuesdays at 8.15 p.m. Visitors are welcome. Hon. sec.: H. F. Reeve, 26, Green Drive, Southall.

## SLOUGH AND DISTRICT SHORT-WAVE CLUB

NOW that the winter radio season is in full swing the attendance at meetings is increasing, and with increased revenue our programmes can become more ambitious. At the last meeting a junk sale was held, and a great deal of gear was bought and sold by auction. A further listening contest, a very popular feature, was arranged, and score sheets of the last one were compared. Mr. Bramhill, 2BM, then demonstrated the operation of a T.N.T. oscillator, and explained its working. The meeting concluded with the usual Morse practice.

At the next meeting a further junk sale will be held, and G6PIL will lecture on receiving aerials. There will also be a display of members' apparatus. Further particulars of this club may be obtained from the Hon. Sec., J. H. White, 20, Chalvey Road, East Slough, Bucks.

## WEYMOUTH AND DISTRICT SHORT-WAVE CLUB

THE above club (G8WQ) held their weekly meeting at the headquarters, 15A, Hope Street, on Wednesday, October 17th. The meeting was well attended. Owing to the lack of A.C. supply at the headquarters the members were invited to the chairman's home to hear a demonstration by two welcome visitors, G5OH and G8KX, of the Halliarafter's 1928 receiver, Super Skyriter. The club's own receiver has been constructed and their transmitter is in course of construction. New members are wanted, and will be welcomed on applying to the Sec., W. Bartlett, 15B, Franchise Street, Weymouth.

## BRENTWOOD AMATEUR RADIO SOCIETY

A recent meeting of the above society, Mr. C. V. Jarvis gave a very interesting lecture on "Transformers." He dealt fully with both the technical and practical side of transformer design, and covered all types from mains to microphone transformers. Mr. Jarvis illustrated his talk with several home-made and commercial transformers, and also materials used in their manufacture.

Due to unforeseen circumstances the date of the lecture on "Valves," by Mr. W. G. J. Nixon, has been altered from December 3rd to December 17th. The open evening for the comparison of members' short-wave receivers will be held on December 3rd.

Meetings are held on alternate Friday evenings, and interested readers are invited to communicate with the Hon. Sec., N. K. Road (2BNK), "Netherton," Herington Grove, Hutton Mount, Brentwood, Essex.

## THE EXETER AND DISTRICT WIRELESS SOCIETY

AT the last meeting of the Exeter and District Wireless Society, a lecture was given by Mr. V. Searle, M.Sc., of the University College of the South-West. He took for his subject, "Atoms, Electrons, and Ions." The lecture was fully illustrated with some excellent slides, and as usual, Mr. Searle put his talk over with great clarity, so that even such a difficult subject as he chose was made not only interesting but extremely instructive.

Mr. Searle showed how everything in the whole world was composed from only ninety-two elements, and this evoked some rather interesting discussions. At question time the lecturer was assailed from all sides, but each query was answered completely to the questioner's satisfaction.

Meetings are held each Monday at No. 3, Dix's Field, Exeter, at 8 p.m., and all those interested should get in touch with the secretary, Mr. W. Ching, 9, Sivel Place, Heavitree, Exeter.

**REPLIES IN BRIEF**

*The following replies to queries are given in abbreviated form either because of non-compliance with our rules, or because the point raised is not of general interest.*

**S. W. (Hull).**—All of the sets indicated by you are rather out of date for modern conditions, and we recommend one of our more modern sets. If you can give any definite indication of the type of set, we may be able to recommend a suitable blueprint.

**S. H. (Salford).**—The consumption is certainly on the high side, but could be due to the use of certain types of valve. We advise a systematic test, with the valves in and with the valves out. There should be no current in the latter condition unless a potentiometer is joined across the H.T. supply, and in that case a switch should be fitted to break the potentiometer circuit when the set is switched off. So far as we can trace the firm is no longer in business.

**A. G. S. (Edinburgh).**—We cannot solve your problem without a circuit diagram. There may be no provision for a doublet connection.

**I. B. (Southsea).**—There is no other way of eliminating the effect you mention than by the use of the special valve.

**T. W. D. (Fulford).**—The voltage on the valves will be low with the arrangement shown and thus efficiency will also be low. You could utilise a voltage doubler circuit and obtain an increased output, but another transformer would be required.

**M. G. T. (Cambridge).**—The Wireless Constructor's Encyclopedia, and some other of our books would be of use to you. Read these in conjunction with the various articles designed for the beginner which appear in our pages.

**W. W. (Croy).**—A leaflet showing connections and suitable receiver circuits may be obtained from Messrs. Varley.

**J. A. (Dublin).**—We are sorry that we cannot assist you from the details given. Can you send us a sketch of the circuit so that we can follow the details more clearly.

**F. J. H. (Crouch End).**—The 12-watt amplifier recently described or the Enthusiast's Amplifier should be quite suitable. You do not state, however, whether you require it for battery or mains operation and we cannot therefore make a definite recommendation.

**M. M. (Cawthorne).**—Excessive voltage on the detector valve can cause the trouble, or the wrong value of reaction condenser. Try reducing the H.T. voltage first, and if this is unsatisfactory, use a smaller capacity reaction condenser.

**S. E. P. (St. Leonards-on-Sea).**—The trouble is only apparent because you are getting good top-note response, and is a transmitting fault. It should only be noticed with certain types of speaker or announcer, and is due to the closeness of the artist to the mike.

**A DIFFICULT POINT**

**PUBLIC** exhibitions of television are becoming more and more popular and quite frequently the point has been raised as to whether any organiser of such a function is entitled to make a charge for admission. There is no doubt that if this were done questions of copyright would arise owing to the rules governing programmes for paying audiences at entertainments. For example, in the case of those films now being hired and used as part of the daily B.B.C. programme matter, for private reception purposes, all is plain sailing, but if anyone paid for admission to a television exhibition then it would add one more problem to those which already seem to beset the path of progress of this new science. The rights of performers would also have to be considered, and this is one of the factors which must be settled before any of the B.B.C. transmissions can be shown to a public theatre or cinema audience, as has been promised so often within the last few months. The possible development of special television theatres seems to presage the time when there will be one or more established transmitting stations erected for the sole use of the theatres or entertainment industry. How the different film circuits will, for example, co-operate for this particular purpose is a matter which needs careful and delicate negotiation, but it is certain that that section of the industry can no longer regard television as a form of scientific novelty capable of being exploited in one form or another for showmanship purposes.

**A GOOD JOB IN RADIO FOR YOU**

The Radio Industry is short of trained men. You may still be an untrained assistant in a wireless shop, or doing a dead-end job on the bench, yet you have a grand opportunity to get a progressive, highly paid post—if you equip yourself for it by spare-time study.

Whatever branch of the Industry appeals most strongly to you, the International Correspondence Schools have a Course to fit your needs. Under I.C.S. direction, you study when and where you like. You are guided throughout by highly qualified instructors, whose advice and assistance is yours just as often as you care to ask for it. Nearly half a century of unrivalled experience is at the back of this work.

*I.C.S. Courses cost no more than those of other reputable schools teaching by post. All instruction books and special textbooks are supplied without extra charge. The students of many postal concerns have to buy the books required, this often involving an additional expenditure of several pounds.*

Write for our free "Radio" booklet, stating your subject—or use the coupon below if you wish.

**THE ADVISORY DEPARTMENT  
INTERNATIONAL CORRESPONDENCE SCHOOLS Ltd.**

94, INTERNATIONAL BUILDINGS, KINGSWAY, LONDON, W.C.2.

- Radio Engineering.
- Complete Radio.
- Radio Servicemen's
- Elementary Radio.
- Radio Service and Sales.
- Television.
- I.E.E. Grad. Exam.
- I.W.T. Exam.
- C. & G. in Radio Com. Exam.
- P.M.G. Certif.
- Air Ministry Prov. Certif.

Mark X in front of Courses in which you are interested.

Name.....Age.....

Address.....

The I.C.S. are the creative pioneers of vocational training by the postal method, and by far the largest, greatest, and most successful correspondence institution in the World.

**PRACTICAL PRANKS for the PARTY**

**Funny Jokes to Play on your Friends this Christmas — if you dare!**

*Also*

**CHRISTMASTIME CONJURING  
MAKING A BAGATELLE TABLE  
CHEMICAL AMUSEMENTS  
FOR CHRISTMAS**

*In The Christmas*

**PRACTICAL MECHANICS**

The Magazine of Modern Marvels

On Sale at all Newsagents & Bookstalls

**6D.**

**ARMSTRONG**

6-Valve All-wave Superheterodyne Radiogram Chassis, complete with British Valves and 8" Moving Coil Speaker. **£7-10-0**  
Model 3BE/3. (Ready to switch on.) **PLEASE**

This chassis, one of the most popular of our 1936 range, incorporates many refinements, including iron-cored coils, iron-cored intermediate transformers, latest Yanley type switching, latest British Octal base Valves, etc. The circuit also is particularly up-to-date, whilst the short-wave band has been especially studied and American stations are readily obtainable. All the best British components are used throughout. Armstrong chassis are sent on 7 days' approval, packing and carriage free. All Armstrong chassis carry twelve months' guarantee.

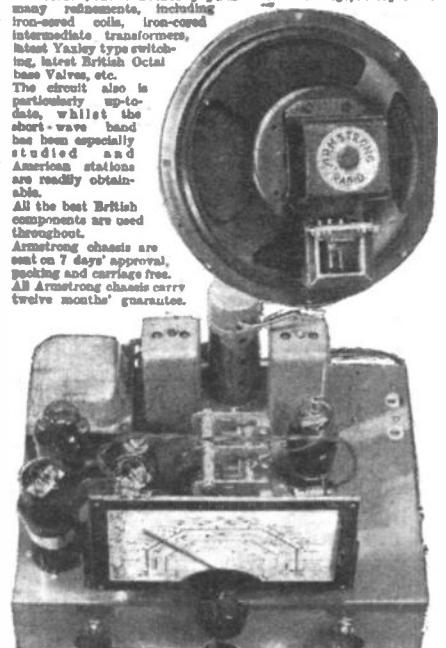

Armstrong Company has published a new illustrated catalogue, fully describing Model 3BE/3, together with many other chassis of equal interest. A copy will gladly be sent on application. It is called 'Armstrong Technical Catalogue No. 12.'

**ARMSTRONG MANUFACTURING Co.**  
100, KING'S ROAD, GARDEN TOWN, LONDON, N.W.1  
Phone: GULLier 3105.



# Practical and Amateur Wireless BLUEPRINT SERVICE

**PRACTICAL WIRELESS** No. of  
Date of Issue. Blueprint.

## CRYSTAL SETS

**Blueprint, 6d.**

1937 Crystal Receiver .. 9.1.37 PW71

## STRAIGHT SETS. Battery Operated.

**One-valve: Blueprint, 1s.**

All-wave Unipen (Pentode) .. — PW31A

**Two-valve: Blueprints, 1s. each.**

Four-range Super Mag Two (D, Pen) .. 11.8.34 PW36B

The Signet Two .. 29.8.36 PW76

**Three-valve: Blueprints, 1s. each.**

The Long-range Express Three (SG, D, Pen) .. 24.4.37 PW2

Selectone Battery Three (D, 2 LF (Trans)) .. — PW10

Sixty Shilling Three (D, 2 LF (RC & Trans)) .. — PW34A

Leader Three (SG, D, Pow) .. 22.5.37 PW35

Summit Three (HF Pen, D, Pen) .. 8.8.34 PW37

All Pentode Three (HF Pen, D, (Pen), Pen) .. 29.5.37 PW30

Hall-mark Three (SG, D, Pow) .. 12.6.37 PW41

Hall-mark Cadet (D, LF, Pen (RC)) .. 16.3.35 PW48

F. J. Camm's Silver Souvenir (HF Pen, D (Pen), Pen) (All-wave Three) .. 13.4.35 PW49

Genet Midget (D, 2 LF (Trans)) .. June '35 PM1

Cameo Midget Three (D, 2 LF (Trans)) .. 8.6.35 PW51

1936 Sonotone Three-Four (HF Pen, HF Pen, Westector, Pen) .. 17.8.35 PW53

Battery All-Wave Three (D, 2 LF (RC)) .. — PW55

The Monitor (HF Pen, D, Pen) .. PW61

The Tutor Three (HF Pen, D, Pen) .. PW62

The Centaur Three (SG, D, P) .. 14.8.37 PW64

The Gladiator All-Wave Three (HF Pen, D (Pen), Pen) .. 29.8.36 PW66

F. J. Camm's Record All-Wave Three (HF Pen, D, Pen) .. 31.10.36 PW69

The "Colt" All-Wave Three (D, 2 LF (RC & Trans)) .. 5.12.36 PW72

**Four-valve: Blueprints, 1s. each.**

Sonotone Four (SG, D, LF, P) .. 1.5.37 PW4

Fury Four (2SG, D, Pen) .. 8.5.37 PW11

Beta Universal Four (SG, D, LF, Cl. B) .. — PW17

Nucleon Class B Four (SG, D (SG), LF, Cl. B) .. 6.1.34 PW34B

Fury Four Super (SG, SG, D, Pen) .. PW34C

Battery Hall-Mark 4 (HF, Pen, D, Push-Pull) .. — PW46

F. J. Camm's "Limit" All-Wave Four (HF Pen, D, LF, P) .. 26.9.36 PW67

All-Wave "Corona" 4 (HF Pen, D, LF, Pow) .. 9.10.37 PW79

## Mains Operated

**Two-valve: Blueprints, 1s. each.**

A.C. Twin (D (Pen), Pen) .. — PW18

A.C.-D.C. Two (SG, Pow) .. — PW31

Selectone A.C. Radiogram Two (D, Pow) .. — PW19

**Three-valve: Blueprints, 1s. each.**

Double-Diode-Triode Three (HF Pen, DDT, Pen) .. — PW23

D.C. Ace (SG, D, Pen) .. — PW25

A.C. Three (SG, D, Pen) .. — PW29

A.C. Leader (HF Pen, D, Pow) .. 7.4.34 PW35A

D.C. Premier (HF Pen, D, Pen) .. 31.3.34 PW35B

Ubique (HF Pen, D (Pen), Pen) .. 28.7.34 PW36A

Armada Mains Three (HF Pen, D, Pen) .. — PW38

F. J. Camm's A.C. All-Wave Silver Souvenir Three (HF Pen, D, Pen) .. 11.5.35 PW50

"All-Wave" A.C. Three (D, 2LF (RC)) .. 17.9.35 PW54

A.C. 1936 Sonotone (HF Pen, HF Pen, Westector, Pen) .. — PW56

Mains Record All-Wave 3 (HF Pen, D, Pen) .. 5.12.36 PW70

All-World Ace (HF Pen, D, Pen) .. 29.8.37 PW80

**Four-valve: Blueprints, 1s. each.**

A.C. Fury Four (SG, SG, D, Pen) .. — PW20

A.C. Fury Four Super (SG, SG, D, Pen) .. — PW34D

A.C. Hall-Mark (HF Pen, D, Push-Pull) .. 24.7.37 PW45

Universal Hall-Mark (HF Pen, D, Push-Pull) .. 9.2.35 PW47

## SUPERNETS.

**Battery Sets: Blueprints, 1s. each.**

£5 Superhet (Three-valve) .. 5.8.37 PW40

F. J. Camm's 2-valve Superhet .. 13.7.35 PW52

F. J. Camm's £4 Superhet .. — PW58

F. J. Camm's "Titese" All-Wave (5-valver) .. 27.2.37 PW75

**Mains Sets: Blueprints, 1s. each.**

A.C. £5 Superhet (Three-valve) .. — PW43

D.C. £5 Superhet (Three-valve) .. 1.12.34 PW42

Universal £5 Superhet (Three-valve) .. — PW44

F. J. Camm's A.C. £4 Superhet 4 .. 31.7.37 PW59

F. J. Camm's Universal £4 Superhet 4 .. — PW60

"Qualitone" Universal Four .. 16.1.37 PW73

## SHORT-WAVE SETS.

**Two-valve: Blueprint, 1s.**

Midget Short-wave Two (D, Pen) .. — PW38A

**Three-valve: Blueprints, 1s. each.**

Experimenter's Short-Wave Three (SG, D, Pow) .. — PW30A

The Prefect 3 (D, 2LF (RC and Trans)) .. 7.8.37 PW63

The Bandspeed S.W. Three (HF Pen, D (Pen), Pen) .. 29.8.36 PW68

F. J. Camm's Oracle All-wave Three (HF, Det, Pen) .. 28.8.37 PW78

## PORTABLES.

**Three-valve: Blueprints, 1s. each.**

F. J. Camm's ELF Three-valve Portable (HF Pen, D, Pen) .. — PW65

Parvo Flyweight Midget Portable (SG, D, Pen) .. 19.6.37 PW77

**Four-valve: Blueprint, 1s.**

Featherweight Portable Four (SG, D, LF, Cl.B) .. 15.5.37 PW12

## MISCELLANEOUS.

S.W. Converter-Adapter (1 valve) .. — PW48A

## AMATEUR WIRELESS AND WIRELESS MAGAZINE CRYSTAL SETS.

**Blueprints, 6d. each.**

Four-station Crystal Set .. 12.12.36 AW427

1934 Crystal Set .. — AW444

130-mile Crystal Set .. — AW450

## STRAIGHT SETS. Battery Operated.

**One-valve: Blueprints, 1s. each.**

B.B.C. Special One-valver .. — AW387

Twenty-station Loudspeaker One-valver (Class B) .. — AW449

**Two-valve: Blueprints, 1s. each.**

Melody Ranger Two (D, Trans) .. — AW388

Full-volume Two (SG det., Pen) .. — AW392

B.H.C. National Two with Lucerne Coil (D, Trans) .. — AW377A

Big-power Melody Two with Lucerne Coil (SG, Trans) .. — AW388A

Lucerne Minor (D, Pen) .. — AW426

A Modern Two-valver .. — WM409

**Three-valve: Blueprints, 1s. each.**

Class B Three (D, Trans, Class B) .. — AW386

New Britain's Favourite Three (D, Trans, Class B) .. 15.7.33 AW394

Homo-build Coll Three (SG, D, Trans) .. — AW404

Fan and Family Three (D, Trans, Class B) .. 25.11.33 AW410

£5 5s. S.G.3 (SG, D, Trans) .. 2.12.33 AW412

1934 Ether Searcher; Baseboard Model (SG, D, Pen) .. — AW417

1934 Ether Searcher; Chassis Model (SG, D, Pen) .. — AW419

Lucerne Ranger (SG, D, Trans) .. — AW422

Cosor Melody Maker with Lucerne Coils .. — AW423

Mullard Master Three with Lucerne Coils .. — AW424

£5 5s. Three: De Luxe Version (SG, D, Trans) .. 19.5.34 AW433

Lucerne Straight Three (D, RC, Trans) .. — AW437

All-Britain Three (HF Pen, D, Pen) "Wireless League" Three (HF Pen, D, Pen) .. 3.11.34 AW451

Transportable Three (SG, D, Pen) .. — WM271

£6 6s. Radiogram (D, RC, Trans) .. — WM318

Simple-tune Three (SG, D, Pen) .. June '33 WM327

Economy-Pentode Three (SG, D, Pen) .. Oct. '33 WM337

"W.M." 1934 Standard Three (SG, D, Pen) .. — WM351

£3 3s. Three (SG, D, Trans) .. Mar. '34 WM354

Iron-core Band-pass Three (SG, D, QP21) .. — WM362

1935 £6 6s. Battery Three (SG, D, Pen) .. — WM371

PTP Three (Pen, D, Pen) .. June '35 WM380

"Certainty Three (SG, D, Pen) .. — WM393

Minutube Three (SG, D, Trans) .. Oct. '35 WM400

All-wave Winning Three (SG, D, Pen) .. Dec. '35 WM396

**Four-valve: Blueprints, 1s. 6d. each.**

£5s. Four (SG, D, RC, Trans) .. — AW370

"A.W." Ideal Four (2SG, D, Pen) .. 16.9.33 AW402

2HF Four (2 SG, D, Pen) .. — AW421

Crusader's A.V.C.4 (2 HF, D, QP21) (Pentode and Class B Outputs for above: Blueprints, 6d. each) .. 18.8.34 AW445

Self-contained Four (SG, D, LF, Class B) .. 25.8.34 AW445A

Lucerne Straight Four (SG, D, LF, Trans) .. Aug. '33 WM331

£5 5s. Battery Four (HF, D, 2LF) .. — WM350

The H.K. Four (SG, SG, D, Pen) .. Feb. '35 WM381

The Auto Straight Four (HF Pen, HF Pen, DDT, Pen) .. Mar. '35 WM384

.. April '36 WM404

**Five-valve: Blueprints, 1s. 6d. each.**

Super-quality Five (2HF, D, RC, Trans) .. May '33 WM320

Class B Quadradyne (2 SG, D, LF, Class B) .. Dec. '33 WM344

New Class-B Five (2 SG, D, LF, Class B) .. Nov. '33 WM340

## Mains Operated.

**Two-valve: Blueprints, 1s. each.**

Consoelectric Two (D, Pen) A.C. .. — AW403

These Blueprints are drawn full size. Copies of appropriate issues containing descriptions of these sets can in some cases be supplied at the following prices, which are additional to the cost of the Blueprint. A dash before the Blueprint Number indicates that the issue is out of print.

Issues of Practical Wireless	.. 4d.	Post Paid.
Amateur Wireless	.. 6d.	.. ..
Practical Mechanics	.. 7d.	.. ..
Wireless Magazine	.. 1/6	.. ..

The index letters which precede the Blueprint Number indicate the periodical in which the description appears: thus PW refers to PRACTICAL WIRELESS, AW to Amateur Wireless, PM to Practical Mechanics, WM to Wireless Magazine.

Send (preferably) a postal order to cover the cost of the blueprint and the issue (stamps over 6d. unacceptable), to PRACTICAL AND AMATEUR WIRELESS, Blueprint Dept., George Newnes, 14d., Tower House, Southampton Street, Strand, W.C.2.

Economy A.C. Two (D, Trans) A.C. .. — WM290

Unicorn A.C.-D.C. Two (D, Pen) .. — WM394

**Three-valve: Blueprints, 1s. each.**

Home-Lover's New All-electric Three (SG, D, Trans) A.C. .. — AW283

S.G. Three (SG, D, Pen) A.C. .. — AW390

A.C. Triodyne (SG, D, Pen) A.C. .. 19.8.33 AW399

A.C. Pentaquester (HF Pen, D, Pen) .. 23.6.34 AW489

Mahtovani A.C. Three (HF Pen, D, Pen) .. — WM374

£15 15s. 1936 A.C. Radiogram (HF, D, Pen) .. Jan. '36 WM401

**Four-valve: Blueprints, 1s. 6d. each.**

All-Metal Four (2 SG, D, Pen) .. July '33 WM356

Harris Jubilee Radiogram (HF Pen, D, LF, P) .. May '35 WM386

## SUPERNETS.

**Battery Sets: Blueprints, 1s. 6d. each.**

Modern Super Scaler .. — WM375

Varsity Four .. Oct. '35 WM395

The Request All-Waver .. June '36 WM407

1935 Super Five Battery (Super-let) .. — WM379

**Mains Sets: Blueprints, 1s. 6d. each.**

1934 A.C. Century Super A.C. .. — AW425

Heptode Super Three A.C. .. May '34 WM369

"W.M." Radiogram Super A.C. .. — WM306

1935 A.C. Stenode .. Apl. '35 WM385

## PORTABLES.

**Four-valve: Blueprints, 1s. 6d. each.**

Midget Class B Portable (SG, D, LF, Class B) .. 20.5.33 AW382

Holiday Portable (SG, D, LF, Class B) .. 1.7.33 AW393

Family Portable (HF, D, RC, Trans) .. 22.9.34 AW447

Two H.F. Portable (2 SG, D, QP21) .. June '34 WM363

Tyers Portable (SG, D, 2 Trans) .. — WM367

**SHORT-WAVE SETS—Battery Operated.**

**One-valve: Blueprint, 1s. each.**

S.W. One-valve converter (Price 6d.) .. — AW329

S.W. One-valve for America .. 23.1.37 AW429

Home Short-Waver .. — AW452

**Two-valve: Blueprints, 1s. each.**

Ultra-short Battery Two (SG det., Pen) .. Feb. '36 WM402

Home-made Coil Two (D, Pen) .. — AW440

**Three-valve: Blueprints, 1s. each.**

World-ranger Short-wave 3 (D, RC, Trans) .. — AW255

Experimenter's 5-metre Set (D, Trans, Super-regen) .. 30.6.34 AW438

Experimenter's Short-waver (SG, D, Pen) .. — AW453

The Carrier Short-waver (SG, D, P) .. July '35 WM390

**Four-valve: Blueprints, 1s. 6d. each.**

A.W. Short-wave World-Beater (HF Pen, D, RC, Trans) .. — AW436

Empire Short-Waver (SG, D, RC, Trans) .. — WM318

Standard Four-valver Short-waver (SG, D, LF, P) .. Mar. '35 WM383

Superhet: Blueprint, 1s. 6d. Simplified Short-waver Super .. Nov. '35 WM397

## Mains Operated.

**Two-valve: Blueprints, 1s. each.**

Two-valve Mains short-waver (D, Pen) A.C. .. — AW453W

"W.M." Band-spread Short-waver (D, Pen) A.C.-D.C. .. — WM368

"W.M." Long-wave Converter .. — WM380

**Three-valve: Blueprint, 1s.**

Kaigrator (SG, D, Pen) A.C. .. — WM352

**Four-valve: Blueprint, 1s. 6d.**

Standard Four-valve A.C. Short-waver (SG, D, RC, Trans) .. Aug. '35 WM391

## MISCELLANEOUS.

Enthusiast's Power Amplifier (1/6) .. June '35 WM337

Listeners' 5-watt A.C. Amplifier (1/6) .. — WM392



# QUERIES and ENQUIRIES

cannot tune down to Radio-Lyons and as I particularly want to hear this station I should like to know the best way of modifying the circuit to bring in this station. The London National comes in at 3 on the dial, which is standard and tunes a Polar condenser."—G. E. (Bow).

AS the coil is home-made we presume that there are rather too many turns on the grid winding. Strip off two or three, and then try the set. A few experiments should enable you to find the number of turns to remove in order to permit the set to tune in the station you require.

### Energising a Speaker

"I have a mains-energised type of speaker, but am uncertain regarding the best way of energising the field winding. I am told that it may be used for bias and also for smoothing the H.T., but I do not want to make any drastic alterations to my set to include this if I can avoid doing so."—G. L. (York).

THE most important factor is the resistance of the field winding. Upon this will depend the position at which it is included. You can use it as a bias resistance or in the H.T. positive lead, but if you do not want to interfere with the circuit you can build a separate mains unit to energise it. This will make it entirely self-contained and for further details we suggest you refer to the article in our September 25th issue in which the problem was fully covered.

### Coil Connections

"I built one of your midget portables some time ago, and dismantled this to use the parts in a different set. Unfortunately, some time has now elapsed and I am unable to locate the connections for the coil. This is non-screened and has a small angle bracket for mounting purposes. The leads are soldered to tags and are coloured. Is there any code for these or is it a special component? If so, could you give me the connections for it, please?"—N. P. S. (Brockley).

WE presume that it is a B.T.S. coil such as we have employed on several sets and in that case the leads are coded as follows: White is the top of the grid coil (grid connection); yellow is the tapping to which the wave-change switch is connected; green is the earth end of the reaction winding; blue is the anode end of this winding, and red is the H.T. end of the primary winding (or earth if this winding is used as an aerial coupling coil). The top of the coil has a single lead which is joined to anode or aerial, whilst the earth end of the grid winding is connected to the mounting bracket which must, therefore, be mounted direct on the metal surface of a chassis or connected to the earth terminal if a wooden chassis is employed. An ordinary two-point (on-off) switch is used for wave-changing.

**FREE ADVICE BUREAU  
COUPON**

This coupon is available until December 11th 1937, and must be attached to all letters containing queries.

PRACTICAL AND AMATEUR WIRELESS,  
4/12/37.

bracket. Alternatively, if a metal chassis is employed a wooden or other insulated bracket could be used.

### D.C. Mains Polarity

"I am going to charge my own accumulators from the D.C. mains, and in order to make the board I want to find the polarity of the mains sockets. I have been told by one friend that this may be done by putting

### Obtaining Transmitting Licence

"I should be glad if you could give me any information as to how to set about getting an amateur transmitting licence."—T. H. P. (Litherland).

THE first step is to obtain an artificial aerial licence, and a form must be obtained from the postal authorities upon which you enter the lines of experiment you wish to take up. Write to the Engineer in Chief, Radio Section, G.P.O., Armour House, London, E.C., for the necessary form and further particulars. Details were given in our issue dated November 28th last.

### Biasing Output Valves

"I am going to build the 12-watt amplifier, but the mains transformer which I have got only has one L.T. winding—4 volts at 5 amps. What is the best way of providing bias for the P.X.25A's in this case?"—J. K. (Tonbridge).

AS the remaining valves in the amplifier are indirectly heated, the cathodes may be returned to H.T.—through biasing resistors, and it is therefore in order to include the bias resistor for the output valves in the centre tap of the heater winding. The total anode current will, of course, pass through the resistance, and thus careful calculation will be required to arrive at the correct value, and the arrangement is not very desirable. A better plan would be to obtain a small mains transformer having two 4 volt 2 amp. windings and to use this for the output valves. Such a component would not be very expensive and would provide much better results.

### Volume Controls

"I enclose a diagram of my set in which I find that the volume control does not have any effect at all. I can turn it from one end to the other and it does not make the slightest difference. I changed it twice and I am told that the previous samples were in perfect working order. Can you help me by telling me the most likely cause of the trouble?"—F. D. P. (Barnsley).

THE theoretical diagram is correct and so is the actual wiring on the diagram which you sent. We assume, however, that you are using a metal or metallised chassis and that the volume control is mounted on a metal bracket. In this case the spindle of the control will be in contact with the chassis if certain makes of component are employed and this will result in the control being short-circuited. Some makes of volume control have the spindle in direct metallic contact with the moving arm of the control and in such a case the bush must be fitted with insulating washers, or the metal surface of the chassis must be scraped away to accommodate the mounting

**RULES**

We wish to draw the reader's attention to the fact that the Queries Service is intended only for the solution of problems or difficulties arising from the construction of receivers described in our pages, from articles appearing in our pages, or on general wireless matters. We regret that we cannot, for obvious reasons—

- (1) Supply circuit diagrams of complete multi-valve receivers.
- (2) Suggest alterations or modifications of receivers described in our contemporaries.
- (3) Suggest alterations or modifications to commercial receivers.
- (4) Answer queries over the telephone.
- (5) Grant interviews to questers.

A stamped addressed envelope must be enclosed for the reply. All sketches and drawings which are sent to us should bear the name and address of the sender. Requests for Blueprints must not be enclosed with queries as they are dealt with by a separate department.

Send your queries to the Editor, PRACTICAL AND AMATEUR WIRELESS, George Nowes, Ltd., Tower House, Southampton Street, Strand, London, W.C.2. The Coupon must be enclosed with every query.

the leads in salt water, but someone else has told me that this is dangerous. I should like to know what is the correct way of finding the positive and negative leads."—M. A. (Aldershot).

THE use of pole-finding paper is the most practical way of finding the polarity of the mains leads, but you can adopt the water scheme with safety if you include a lamp in series with one lead. The lamp

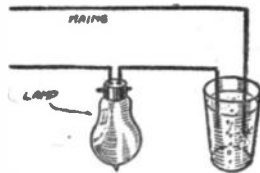

The safe way of testing D.C. Mains polarity when using a saline solution.

should be mounted in a holder and the two ends of the wires inserted into the glass of salt water. Make quite certain before switching on that the wires are well separated and will not move. When switched on a profuse stream of bubbles will rise from the negative lead and your mains socket may be marked accordingly. The accompanying diagram should make the idea quite clear.

### Aerial Coil Modification

"I have a home-made set in which a home-made coil is employed. I find that I

**THE ONE AERIAL FOR THE MODERN SET**

**PIX INVISIBLE AERIAL**

PIX LONDON, S.E.1

Highly efficient, self adhesive aluminium strip—gives wonderful pick-up clear of interference—fixed in a jiffy without tools—just press it and it sticks.

2/-  
3/6  
Double Length

**Miscellaneous Advertisements**

Advertisements are accepted for these columns at the rate of 3d. per word. Words in black face and/or capitals are charged double this rate (minimum charge 3/- per paragraph). Display lines are charged at 6/- per line. All advertisements must be prepaid. All communications should be addressed to the Advertisement Manager, "Practical and Amateur Wireless," Tower House, Southampton Street, Strand, London, W.C.2.

**RECEIVERS, COMPONENTS AND ACCESSORIES**  
Surplus, Clearance or Secondhand, etc.

**RADIO CLEARANCE**

63, HIGH HOLBORN, W.C.1. Holborn 4631. SPECIAL BARGAINS FOR THE HOME CONSTRUCTOR. Offers that cannot be repeated.  
5/6 per gross, NON-INDUCTANCE MIXED RESISTANCES, all well-known makes, Philips, Eerie, Sator, all 1 watt and standard sizes, no duds.  
1/- for 4, 0003 BAKELITE REACTION CONDENSERS, good make, brand new.  
6d. each, 6in. TURN-TABLES for Portable Receivers.  
3d. each, ALUMINIUM COIL CANS, 3 1/2 in. high, 2 1/2 in. in diameter.  
4d. each, ALUMINIUM COIL CANS, 5in. high, 2 1/2 in. in diameter.  
1/3, ALUMINIUM FACED PLY, size approximately 10ins. by 10ins.  
3/6, PLESSEY 2-GANG STRAIGHT CONDENSERS, .0005 sections, Top Trimmers Fully Screened.  
3/-, PLESSEY 3-GANG MIDGET CONDENSER, size approximately 2 1/2 in. by 2 1/2 in., precision built, each section .0005, Semi Screened.  
4/6 dozen, T.C.C., .25 mfd., 250 volt working, Metal-cased Condenser. Upright type.  
5/6 dozen, STANDARD 1 mfd., 250 volt working, Metal-cased Condensers. Upright type.  
8d. per package, BRASS RIVETS, approximately 5,000.  
3/-, LISSEN GENERAL PURPOSE IRON-CORED COIL for Aerial and H.F., complete with Reaction, list price 8/6, without Switch.  
8/11, LISSEN SET OF 3 IRON-CORED BAND-PASS COILS, complete with Switching, Circuit, list price 37/0.  
8/-, SPECIAL CLEARANCE OF BRYCE TRANSFORMERS, ex. large manufacturer's order, 300-0-300, 80 m.a., 4 volt, 4 amp., C/T, 4 volt 2 amp. Mains input 200-250 volts adjustable.  
1/- for 3, LISSEN R.C.C. UNITS, complete with resistance, etc. Boxed.  
5d. LISSEN H.F. BY PASS UNITS, comprising 2 Mains-bridge type Condensers, Moulded Bakelite case. All orders 5/- or over Post Free; orders under 5/- must be accompanied by a reasonable amount for postage; C.O.D. orders under 5/- cannot be accepted.  
RADIO CLEARANCE, 63, High Holborn, W.C.1. Holborn 4631.

VAUXHALL. Polar Midget condensers, 2-gang, .06. 8d.; 3-gang, 8s. 9d.; 4-gang, 13s. 6d. Polar full vision horizontal drives, 5s.  
VAUXHALL. Hivac valves, entire range, full discounts. Polar station-named scales for horizontal drives, 1s.  
VAUXHALL. T.C.C. electrolytic condensers, 8 mfd. and 4 mfd. 500 volt, 2s. 6d.; 50 mfd. 50 volt, 1s. 6d.  
VAUXHALL. Iron-cored coils, 3-gang, on base, with circuit, 17s. J.B. drives with station-named scale, 5s. 6d.  
VAUXHALL. Magnavox and Rola P.M. speakers, 7in. cone, 16s. 6d.; 10in. cone, 22s. Energised models, 2,500 field coils, 7in., 12s. 6d.; 10in., 17s. 6d.  
VAUXHALL UTILITIES, 163a, Strand, W.C.2. Temple Bar 9338. Send postcard for free list. Post paid, 2s. 6d. and over, or C.O.D.

CONVERSION UNITS for operating D.C. Receivers from A.C. Mains, improved type, 120 watt output at £2/10/0. Send for our comprehensive list of speakers, resistances and other components.  
WARD, 46, Farringdon Street, London, E.C.4. Telephone: Holborn 9703.

THE largest stock of components in England, over 500 lines, new catalogue now ready 1/4d.—J. Bearfield, 105, Upper Street, London, N.1.

HEADPHONES.—Brown, Ericsson, G.E.C., B.T.H., Standard Telephones, Nesper, Western Electric, Sterling, etc., 2,000 ohms, 2s. 6d.; 4,000, 5s. Postage 6d.  
SPECIAL. Ericsson, 4,000 ohms, as new, 7s. 6d. Telefunken, lightweight, adjustable, 7s. 6d.  
CRYSTAL SETS. Burne-Jones. Complete, Guaranteed, 5s. 6d. Ditto, double circuit, 8s. Sensitive permanent detectors, 1s. 6d. Crystal Detectors, complete, 1s. Crystals with silver cat's-whisker, 6d. Postage 1/4d.—Post Radio, 2, Copenhagen Street, London, N.1.

SHORT WAVE on a crystal set. Full building instruction and crystal 1/2 post paid.—Radlo-mall, Tanworth-in-Arden, Warwickshire.

**VALVES**

AMERICAN Valves in sealed cartons, all types 6s. 6d. post paid.—Valves, 661-3, Harrow Road, N.W.10.

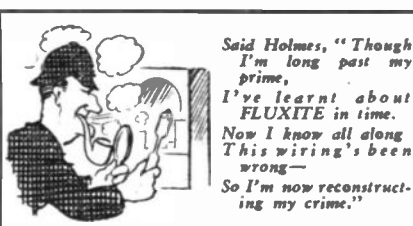

Said Holmes, "Though I'm long past my prime, I've learnt about FLUXITE in time. Now I know all along This wiring's been wrong— So I'm now reconstructing my crime."

See that FLUXITE is always by you—in the house—garage—workshop—wherever speedy soldering is needed. Used for 30 years in government works and by leading engineers and manufacturers. Of Ironmongers—in tins, 4d., 6d., 1/4 and 2/8. Ask to see the FLUXITE SMALL-SPACE SOLDERING SET—compact but substantial—complete with full instructions, 7/6. Write for Free Book on the art of "soft" soldering and ask for Leaflet on CASE-HARDENING STEEL and TEMPERING TOOLS with FLUXITE.

TO CYCLISTS! Your wheels will NOT keep round and true, unless the spokes are tied with the fine wire at the crossings AND SOLDERED. This makes a much stronger wheel. It's simple—with FLUXITE—but IMPORTANT.

**THE FLUXITE GUN**

is always ready to put Fluxite on the soldering job instantly. A little pressure places the right quantity on the right spot and one charging lasts for ages. Price 1/6.



ALL MECHANICS WILL HAVE

**FLUXITE**

IT SIMPLIFIES ALL SOLDERING

FLUXITE LTD. (Dept. W.P.) DRAGON WORKS, BELMONDSEY STREET, S.E.1.



**Get the new Kit in the Golden Box**

The remarkably efficient "Eliminoise" (Trade Mark) Anti-interference aerial, wired with 60 ft. aerial and 50 ft. "Eliminoise" screened cable. An ideal gift. The better the Set, the greater the need.

POST THE COUPON **BELLING-LEE SUPPRESSION SERVICE**

BELLING & LEE, Ltd., Cambridge Arterial Road, Enfield, Middx.

Please send free booklet—"Wireless Without Crackling." (P261 H)

Name.....  
Address.....  
Pr. W. 4.12.37 .....

**PREMIER SUPPLY STORES**

**POST ORDERS**  
Jubilee Works,  
167, Lower Clapton Rd., London, E.5.  
Amherst 4723

**CALLERS**  
165 & 165a, Fleet Street, E.C.4 Central 2333  
50, High Street, Clapham, S.W.4. Macaulay 2381

3-VALVE SHORT-WAVE KIT. S.G., H.F.; Det. and Pentode. Covers 14-170 metres, with 4 pairs interchangeable 4-pin coils. Complete kit of parts, with metal chassis and set of 3 matched 2-volt valves, 42/-; suitable metal cabinet 7/6 extra.  
NEW 1-VALVE SHORT-WAVE RECEIVER OR ADAPTOR KIT. 13 to 86 metres without coil changing. Complete Kit and Circuit, 12/6. VALVE GIVEN FREE!  
DE LUXE MODEL, 14 to 170 metres, complete Kit with Chassis, 4 Coils and all parts, 17/6.  
SUPERHET CONVERTER KIT, 15/- De Luxe Model, 20/-.  
S.W. SUPERHET CONVERTER KIT, for A.C. Mains Receivers, 22/6. A.C. Valve given FREE!  
NEW 2-VALVE S.W. KIT, 13 to 86 metres without coil changing. Complete Kit and Circuit, 19/6. VALVES GIVEN FREE!  
DE LUXE MODEL, 14 to 150 metres, complete Kit and Circuit, 4 Coils and all parts, 25/- VALVES GIVEN FREE.  
ALL-WAVE AERIAL KITS, 1.5-2,000 metres, complete with matching transformer, 15/-.  
PREMIER "TROLITUL" Short Wave CONDENSERS, Certified superior to Ceramic. All-brass Construction, 15 mmd., 1/6; 40 mmd., 1/7; 100 mmd., 1/10; 160 mmd., 250 mmd., 2/4; Double Spaced 15 mmd., 2/9; 40 mmd., 3/6. S.W.H.F. Chokes, 9d.; screened, 1/8. All-Brass S.W. Condensers with integral slotted-tuning, .00015 Tuning, 4/3; .00015 Reaction, 3/8. UTILITY 4" MICRO-CURSOR DIALS. Direct and 100:1 ratio, 3/9 each.  
LISSEN HYPERNIK Q.P.P. TRANSFORMERS, 3/8.  
LIGHTWEIGHT HEADPHONES, 3/9 pair.  
RELIABLE SOLDERING IRONS, A.C. or D.C., 1/6 each.  
JUBILEE SUPER SOLDERING IRONS, 4/6 each.

Now Ready. Our New 1938 Enlarged Illustrated Catalogue, Handbook and Valve Manual. Price 6d. Send 6d. in Stamps for 90 Pages of Radio Interest!

SHORT-WAVE COILS, 4- and 6-pin types, 13-28, 22-47, 41-94, 78-170 metres, 1/9 each, with circuit. Special set of S.W. Coils, 14-150 metres 4/- set with circuit. Premier 3-band S.W. Coil, 11-25, 18-43, 38-86 metres. Simplifies S.W. receiver construction, suitable any type circuit, 2/6.  
COIL FORMERS, 4- or 6-pin low-loss, 1/- each.  
Famous EUROPA MAINS VALVES, 4v. A.C. and 20v. .18 Universal. All standard types, 4/6. I.H. Pentodes and F.W. Rectifiers 5/8.  
BATTERY VALVES, 2 volts, H.F., L.F., 2/3. Power, Super-Power, 2/9. Var-Mu-S.G., 4- or 5-pin Pentodes, H.F. Pens., V-mu-H.F. Pens., 5/- Class B, 5/-.  
AMERICAN VALVES. Genuine American MYTRON and TRIAD, first-grade Valves, 3 months' guarantee. All types in stock, 5/6 each. 210 and 250, 8/6 each. New Metal-Glass Valves, all types, 5/6 each. Genuine American DOUTRON Valves, all types, 3/6 each. Valve holders for all above types, 6d. each. OSTAL bases, 9d. each.  
COSMOCORD PICK-UPS, with tonearm and volume control, 10/6 each. PICK-UP HEADS only, 4/6 each.  
PREMIER MAINS TRANSFORMERS, all types still available.  
TELSEN IRON-CORED BAND-PASS COILS, 180-2,000 metres. Integral switching, 12/6 set.  
PREMIER H.T. POWER PACKS. Ready for use. 120 v. 20 ma., 25/- with 1/2 amp. charger, 33/-; 150 v. 30 ma., 27/6; with 1/2 amp. charger, 35/4; 250 v. 60 ma. 4 v. 3-5 a., 33/-; 150 v. 30 ma. valve rectifier (replacements only 2/-), 17/6.  
MAGNAVOX MOVING COILS. Mains energised. "154" 7in. cone, 2,500 ohms, 18/-; "152" 9in. cone, 2,500 ohms, 19/6. "152" Magna. 9in. cone, 2,500 ohms, 37/6. Magnavox P.M.'s—"254", 7in. cone, 18/6; "252" 9in. cone, 22/6. Latest type 6in. P.M.'s, 15/-. Celestion Standard, 19/6.

# ELECTRADIX

Exceptional Bargains in Transformers

**L.P. TRANSFORMERS.** Fine lot of Ferranti shrouded and B.T.H. Bakelite for coupling and outputs. Ferranti A.36, A.F.3 and 4, B.D.23, 3-1, etc. 5/6. B.T.H. 4-1 at 5/- each. Ferranti O.F.S., B. & D. for output to speaker, 8/- 4/6. Push Pull, 6/- 0.F.M. 3 ratio output, 8/6. Large B.A.F. 100-watt amplifier output Transformers for 6 speakers, 20/6.



**MAINS TRANSFORMERS.** H.M.V., all mains to 200-0-250, 60 m.a., 4 v. 1 amp. and 4 v. 2amps., 8/6. Extra large H.T. to 4,000 volts for television or transmit. 4,000 volts, 200 m.a., 60/6.

**CHOKES.** L.P. Smoothing, 1 amp., Browns, 5/6. **FABTS.** Experimenters often want to wind their own transformers. We have a quantity of oil intervals, mains chokes, etc., unmarked, at bargain prices. Sizes: 3 watt, 1/8; 10 watt, 2/-; 15 watt, 2/6; 20 watt, 3/-; Postage, 6d. You get a set of stamping, hobbin and wire cheap this way.

**CONSTRUCTORS.** Our hand-gear 2in. drill at 1/6 in a vice makes a good coil winder. Rectifiers, metal, for H.T. direct on A.C. mains, give 180 v. 30 m.A. D.C., 5/6. Short-wave stand-off insulators, 6d. Lightning arrestors, vacuum type, 1/6.

**CONDENSERS.** Fixed 8,000 volts, test, 1 mfd., 15/-; 1 mfd., 250 volts, 4 for 1/-; 2 mfd., 3 for 1/6. Post extra.

## MIKES AND SPEAKERS FOR XMAS



**MICROPHONES.** Table Model "H.W.11." For home broadcasting. Bakelite square body on bronze base, containing transformer, switch and plug, is a marvellous production at a low price. Worth 2 guineas. Only 15/- Leadix No. 10B Pedestal, 10in. high, 12/6. Leadix Superior No. 12BB Ring, 14in. pedestal, 12/6. Hand mikes in 2in. case, No. 11 at 5/6. Superior type, No. 11a, 7/6. Home microphone No. 11 is a solo general-purpose robust mike, with solid bakelite body, back terminals, front metal grille, hand or sling design, 5/6.

Ameters and Relays.

**SPEAKER BARGAINS.** Moving-coil, energised 1 1/2 in. cone, soiled but good, famous makers, 4/6 only. New Speakers, R. & A., 6in. cone, 2,300 ohms and trans., 7/6. Macnavox Type 144, 6in. cone, 2,500 ohms, 12/6. A.C. mains energised speakers, with rectifiers, 100/250 v., 11in. cone, with transformer, 30/6. Jensen 220 v., A.C. 8in. cone and transformer, 25/6. Battery Energised Speakers, K.B. 6 v., 7in. cone, 8/6. P.M. Epoch in polished cabinet, 10in. x 7in. x 10in. high, 17/6.



**DEWAR Type 81 SWITCH** as specified for the Home Inter-communication unit, 3/6.

**THE DIX-MIPANTA.** Prompt delivery can now be given. This is a wonderfully versatile, high-grade moving-iron multi-range meter for service on A.C. or D.C. jobs. No projecting terminals. THREE ranges of volts, 0-7.5, 0-150, 0-900. Used for MILLIAMPS, reads 12 1/2 m.a. and 75 m.a. in black bakelite case. Only 2 1/2in. by 2 1/2in., 19/6.



**MORSE AND SIGNAL KEYS.** Royal Air Force model, balanced action, all solid brass bar, tungoil contacts, indicator lamp. Type K185L, a guinea key for 7/6. Other keys from 2/6 to 30/6.

**BATTERIES.** 1/6, 3/6 and 5/-.

**SOUNDERS.** 7/6 and 10/-.

**MORSE PRACTICE SETS COMPLETE.** 4/6.

**BELLS.** circular Desk, vibrator in case, 2/6. Wall Bell Pushes, Porcelain, 2 1/2in., 6d. or 8/- 4/6. Brass Pushes, 6d., 3/6 and 2/6. Pendant Pushes, 6d.

**A.C. ELECTRO-MAGNETS** for 250 volts 30 m.A. holds 14 oz., 2/6.

**SOLENOIDS** for remote work or relay, 4 and 6 volts, 1 in. stroke and 1 oz. pull, silk covered coil, metal frame, 3/6. Transmitters, magnetic key, 10 amp. contacts 6-v. coil, 15/6. Magnet Selector, 6 gangs of 25 contacts, each 10/6. Magnetic clip or overcoil switches, 1 to 10 amps., any voltage, 7/6. Auto-Out and Cut-in battery switches, 15/6. Max. and min. circuit breakers, battery autos, pump float switches, extra high voltage switches, all in stock. Specify your wants.

**MODEL BOAT CONTROL.** Short-wave Transmitters, 6 volt, 21/-.

**Coberrers,** 8/-.

**Relays,** 10/-.

**Light Ray Cells,** selenium, 5/-, 7/6 and 10/-.

## MAKE YOUR OWN RECORDS ON DISC

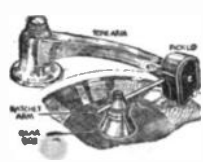

The FEIGH RECORDER fits any Radiogram and is positive driven by worn rear and rack. Complete and ready for use, only 37/6. Less Pick-up and Tone Arm, 21/6. Either 4 - doz. metal blanks can be used or the glass coated simpels, 10in., 3/- each. Pre-amplifiers for Recording Mike, 1 valve Battery Model in cabinet, 25/6. A.C. Mains pre-amplifiers, with valve rectifier, steel-cased model, 60/6.

**GRAMO-MOTORS** for recording, Universal Model, 25/10/-.

**GRAMO-MOTORS.** Garrard Universal A.C./D.C. with turntable and auto switch, 23/10/-.

**B.T.H. Universal model YM,** turntable and autostop, 25/6.

**A.C. Gramo Motors and turntable,** H.M.V. 110 volts, 25/6.

**250 volts, 27/6.** Motor only, 30/6.

**B.T.H. Golden Disc,** 37/6.

**PROJECTION LANTERNS,** on Stand, 250-watt, 25/6. Arc lamps, slide lanterns, film projectors, and sound heads, cheap.

1,000 other Bargains in New Sale List "N" Post Free.

# ELECTRADIX RADIOS

218, Upper Thames Street, London, E.C.4

Telephone: Central 4611

## RECEIVERS, COMPONENTS AND ACCESSORIES

Surplus, Clearance or Secondhand, etc.

# RADIOMART SHORT-WAVE MANUAL

Packed with short-wave information and circuits of mains and battery receivers, including straight, superhet and 5-metre transmitters, modulators, etc. Information on transmitting licences, aerials, Class B amplifications, neutralizations, superhet alignment, etc. The most comprehensive manual published free, written by practical engineers, price 6d., post free, 7 1/2 including catalogue.

1037 Short-wave Catalogue only (3 times enlarged) price 1 1/2d., post free.

## 44, HOLLOWAY HEAD, BIRMINGHAM 1

**COMMUNICATION** Receivers, transmitting gear, amplifiers, valves, transformers. Distributors for Hallicrafter, Taylor, Hammarlund, Raytheon, Eimac, Radiographic, Ltd., 66, Osborne Street, Glasgow, C.1.

**SOUTHERN RADIO'S** Guaranteed Wireless Bargains; post paid.

**PLESSEY 3-valve Battery Sets,** complete in sealed cartons with three Mazda valves, moving coil speaker, Pertrix batteries and accumulator, in exquisite walnut cabinet; 57/6 (limited quantity only).

**GARRARD Record Changers,** A.C. 200-250 volts, changes eight 10- or 12-inch records; £6 (complete sealed cartons); universal A.C./D.C. model, £7/10.

**GARRARD A.C. Radiogram Units,** with pick-up and all accessories, in sealed cartons; 42/6.

**COLLARO Single Spring Motors** for Gramophones or battery radio; 10/-, complete with turntable and all accessories.

**TENSEN (1937-38) Components:** iron-core coils W.349 (Midget size), 3/6; W.477 (triple ganged, for band-pass or straight circuits), 14/6; W.476 (triple ganged superhet), 14/6; W.478 (twin ganged), 9/-; all ganged coils complete on bases, with switch; I.F. transformer coils, 4/6; dual range coils, 2/0; with aerial series condenser, W.76, 3/0.

**TENSEN A.C./D.C. Multimeters,** 5-range (tests anything radio or electrical), 8/6; loud speaker units, 2/6; Ace (P.O.) microphones, complete with transformer, ready for use with any receiver, 4/6; headphones, 4,000 ohms, 3/- pair.

**VALVES.**—Full range for American receivers, 6/- each.

**MORSE Tappers,** complete radio-telegraph set (basher, buzzer and tapper), with batteries, bulb, code, 3/6.

**BARGAIN Parcels of Assorted Components,** including coils, resistances, condensers, chokes, wire, circuits, etc., value 21/-; 5/- per parcel.

**SOUTHERN RADIO, 323, Euston Rd., London, S.W.1;** and 46, Lisle St., London, W.C.1. All mail orders to SOUTHERN RADIO, 323, Euston Rd., London, S.W.1 (near Warren St./Tube). Phone: Euston 3775.

FOR all components at right price, write Radiographic, state your requirements: quotations per return. Radiographic, Ltd., 66, Osborne Street, Glasgow, C.1.

**BANKRUPT Bargains.** List free. All new goods. Decca 6v. 1937 A.C. superhets, 5 gns. Decca 18 gn. 1937 6v. A.C. radiograms, 10 gns. Truphonic (coronation models, 5v. all-wave superhets, list 12 gns. for 6/10/0. Lotus 4v. A.C./D.C. consolettes, 67/6. Decca 3-pentode battery sets, £6/15/0, list 1937, 77/6. Decca 5v. 9 gn. battery 1937 superhets, 92/6. Plessey 5v. A.C./D.C. superhet chassis with Mullards and speaker, 90/-.

Ditto 4v. battery type, complete, 67/6. Celestion 65/- type cabinet M.C. speakers, 30/-.

Ditto 45/- type, 17/6. M.C. chassis only. Celestion Soundex 9/6 PPM/W, 13/6. Battery 3v. consolettes with valves and M.C., 27/6. Vidor A.C./D.C. 4v. 8gn. models, £3/17/6. Burgoyne 5v. A.C. superhet table radiogram, £8. Altham 3v. H.F. pen., detector and pentode sets all-wave, 67/6. All sets with valves and M.C. speakers. Large stock replacement valves. Most makes of sets supplied. Get my part-exchange offer first. Second-hand as new Vidor 1937 midget battery portable. Cost £5/19/6, 50/-.

Advertiser since 1929.—Butlin, 6, Stanford Avenue, Brighton, Sussex. Preston 4030.

"ST900" "Camm's Corona" battery and all-mains versions, specified and competitive kits. Best value receivers, valves, etc. Pick-ups, 4/-.

H.M.V. Auto-Record Changers. Bankrupt surplus stocks, etc. Lists free.—"Ford Radio" Service, Queens Place, Hove.



# MCCARTHY

High Efficiency plus Economy!

## 5-VALVE ALL-WAVE SUPERHET

Price £6.17.6

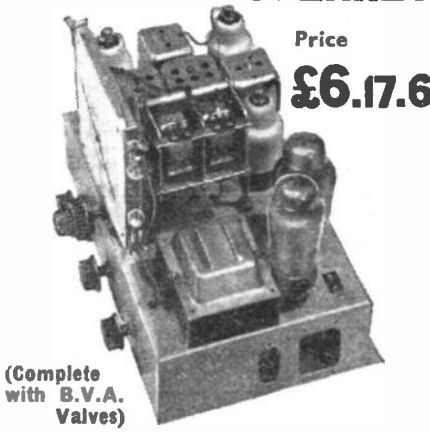

(Complete with B.V.A. Valves)

This moderately-priced 7-stage 5-valve all-wave receiver utilizes a remarkably efficient superheterodyne circuit which provides exceptional sensitivity on all three wavebands—18-50, 200-350, 1,000-2,000 metres.

Circuit includes: Latest type triode-hexode frequency changer, vari-mu pentode I.F. amplifier, double diode-triode operating as diode detector and I.F. amplifier, and providing full A.V.C. High-slope 3 watts output pentode. Wave-change and gram. switch. As illustrated, but with new type dial with principal station names.

## 6-valve all-wave Superhet with Radio Frequency Stage

8 Stages  
8 tuned circuits  
3 wavebands



Price (Complete with 8 B.V.A. Valves) £8.17.6

Performance (made possible by use of multi-electrode valves) equal to that of many receivers employing 8 valves or more. Brief specification includes: Large "Airplane" dial with different coloured lights automatically switched on for each wave-range. Micro-windler 3-speed drive, 4-point wave-change and gramophone switch. Volume control and variable tone control also operative on gramophone. Reinforced heavy-gauge steel chassis. Covers 19-2,000 metres.

Circuit comprises: Presetector circuit, radio frequency amplifier (operative on all 3 wavebands), triode-hexode frequency changer, double band-pass I.F.T. coupled I.F. amplifier, double diode-triode detector and I.F. amplifier. D.A.V.C. applied to 3 preceding valves. 3-watt pentode output.

All McCarthy receivers supplied complete with valves, knobs, pilot lamps, leads, mains cable and plug. 12 months' guarantee.

Deferred terms on application, or through our city agents, London Radio Supply Co., 11, Oat Lane, E.C.2. Demonstrations Daily.

Cash with order on 7 days' approval. Also write for illustrated catalogue of complete range of all McCarthy receivers.

# MCCARTHY RADIO LTD.

44a, Westbourne Grove, London, W.2. Telephone: Bayswater 320112.



**MISCELLANEOUS**

**RADIO-TURNED RADIOGRAM.** Electric motors, 25/-; Pick-ups, 9/6; Heads, 4/3; Pedestal Anexagrams, £5.5/-; Tablegrams, £4/3/-; Portables A.C./mains, £3/10/-; Battery, £2/10/-; Automatic record-changers, £6. Acoustic gramophones. Portable, pedestals, spring motors, turntables, tonearms, sound-boxes, horns, cabinets, fittings, spring, wheels, musical instruments. Cheapest. Unique assortment. List Free. Gilt alarm clocks, 8/6. Approval—"Regentam," 120, Old Street, London, E.C.1. Telephone: CLE. 5770. Est. 34 years.

**WANTED** Immediately 3 dozen detachable sponge rubber headphone ear-piece caps, similar to those used in Crystal Receiver days. Must be unused. Apply to Hancock House, 17, Fleet St., Dublin.

**REPAIRS** to any kind of Loudspeakers, 4/-. L.F. and Speech Transformers, 4/-; Phones, 3/-. Moving Coils and Mains Trans., Chokes and Resistances, Quoted For. Trade discount. Quick Service.—E. Mason, 44, East Rd., City Rd., N.1. Clerk 3339.

**MOVIES** at Home. How to make your own Cinema Projector. Particulars free.—Movie-scope (L), Pear Tree Green, Dodinghurst, Essex.

**OUR 1937-8 Catalogue** contains much information on Transformer Design. Post Free.—Lunnon Electric Coy., 14, Searisbrick Avenue, Liverpool, 21.

**BATTERY CHARGING PLANT**

**12-VOLT** Car Battery Model CG/122, 30/-; 6-volt, 25/-; 2-volt, 18/6. All 2 amps. 6v, 1a, 15/-; **2-VOLT** 1 amp, 8/6; 1 amp, 12/6. All chargers complete with metal rectifiers, steel cases; just plug-in, fit spades, switch-on.  
**DELIVERY CERTAIN** if ordered at once; send now, stating Mains voltage.—Brighton Radio Service, 34, Middle Street, Brighton.

**TUITION**

**MAKE YOUR HOBBY** your career or increase its interest tenfold. Britain's Best College, approved by the Inst. Rad. Eng. and leading Radio firms, provides complete training in Radio Engineering by post or day classes. Full details from: "P.R.W.," LONDON RADIO COLLEGE, Grove Park Rd., London, W.4 (Chiswick 3244).

**FOYLES**  
Booksellers to the World.  
Special department for Wireless Books.  
119-125, CHARING CROSS RD., LONDON, W.C.2  
Telephone: Gerrard 5660 (12 lines).

**MICROFU GOLD FILM FUSES**

**20 Stock Rotings**  
Type F.2, suitable for Battery sets. 150 mA blows at 300 m/A. Resistance 7½ ohms. Voltage 200 Volts D.C.  
Type F.2, suitable for Mains sets. 500mA blows at 1 amp. Resistance 1½ ohms 280 Volts D.C. Now available 2 m/A, 4/-, 1 m/A, 4/6.  
**FUSES 6d. HOLDERS 6d.**  
You need one Type F.2. 100 m/A Fuse and Holder.

**MICROFUSES Ltd., 4, Charterhouse Bldgs.,**  
Goswell Rd., London, E.C.1. Phone: CLR 4049.

**ENGINEERING OPPORTUNITIES**  
*Free!*  
This unique Handbook shows the easy way to secure **A.M.I.C.E., A.M.I.E.E., A.M.I.A.E., A.M.I.W.T., A.M.I.E.E.,** and similar qualifications. **WE GUARANTEE—NO PASS—NO FEE.** Details are given of over 150 Diploma Courses in all branches of Civil, Mech., Elec., Motor, Aero, Radio and Television Engineering, Building, Government Employment, etc. Write for this enlightening Handbook to-day **FREE** and post free.  
**British Institute of Engineering Technology,**  
409, Shakespeare House, 17, 18, 19, Stratford Pl. W.1

**LOUDSPEAKER REPAIRS**

**LOUDSPEAKER** repairs, British, American, any make, 24-hour service; moderate prices.—Sinclair Speakers, Alma Grove, Copenhagen Street, London, N.1.

**REPAIRS** to Moving Coil Speakers, Cones and Coils, fitted or rewound. Fields altered. Prices Quoted including Eliminators, Loudspeakers, Repaired, 4/-. L.F. and Speech Transformers, 4/- post free. Trade invited. Guaranteed. Satisfaction. Prompt Service, Estimates Free.—L.S. Repair Service, 5, Balham Grove, London, S.W.12. Battersea 1321.

**ADVERTISEMENT INDEX**

Aircraft Products, Ltd.	364
Armstrong Manufacturing Co.	359
Automatic Coil Winder and Electrical Equipment Co., Ltd.	326
Belling and Lee, Ltd.	362
Bennett College, Ltd.	351
British Institute of Engineering Technology	364
British Mechanical Productions, Ltd.	357
Bulgin, A. F., and Co., Ltd.	358
Electradix Radios, Ltd.	363
Ericason Telephones, Ltd.	362
Fluxite, Ltd.	362
Foyles	364
General Electric, Co., Ltd.	Back Cover
H.M.V.	325
High Vacuum Valve Co., Ltd.	348
International Correspondence Schools, Ltd.	359
Jackson Bros., Ltd.	357
London Radio Supply Co.	354 and 364
Makers Agents, Ltd.	364
McCarthy Radio, Ltd.	363
Microfuses, Ltd.	364
New Times Sales Co.	353
Peto-Scott Co., Ltd.	347
Pix	361
Premier Supply Stores	362 and 364
Telegraph Condenser Co., Ltd.	356
Tungram, Ltd.	344
Universal Radio	364
Varley	350
Westinghouse Brake and Signal Co., Ltd.	Inside Front Cover
Whiteley Electrical Radio Co., Ltd.	Front Cover and 355
Wingrove and Rogers, Ltd.	326

**CHRISTMAS BARGAINS BY POST**

**WONDERFUL NEW PIANO ACCORDION**  
**BARGAIN**  
24 ONLY SHOP-SOILED 4-GUINEA MODELS  
To Clear at **35/-** Part at 3/- Carr. 1/-

Only 24 to offer at this price—only slightly shop-soiled. We guarantee these accordions to be our regular £44.0 models. Please note specification—No. 2025/12/2. 25 piano keys, 12 bass, 2 years. Reeds on separate plates give rich tone. Easy to play. Strong carrying case FREE. 24 only at 35/- (Cash only), so order at once—Money refunded in full if too late to secure.

The L. R. Supply Co., Ltd., 11, Otat Lane, London, E.C.2

**400 ONLY JAZZ TO CLEAR DRUM SETS**  
Having purchased an entire factory stock of musical instruments, we are able to make this truly amazing offer of complete drum sets, comprising large bass drum, brass cymbal, snare drum, and seven adjusters, strong automatic fly-back footbeater, real skin side drum, hardwood tap box, brass cymbal, triangle and cowbell, also pair well-balanced drum sticks. The whole outfit comes to you complete in strong box at the incredible clearance price of 8/6 only, postage 1/-. No party or amateur band is complete without this wonderful outfit, so send P.O. 9/6 at once to:—**AIRCRAFT PRODUCTS LTD.,** (Dept. P.W.J.S.1), 91, New Oxford Street, London, W.C.1. Phone: TEM 6559.

**YOUR CAR WILL ALWAYS START!**  
With a **PREMIER** Battery Charger for Home or Garage.  
Westinghouse Rectification. Complete Ready for use.  
To charge 2 volts at 1/2 amp. 10/-  
" 6 " 1/2 " 16/6.  
" 6 " 1 " 19/6.  
" 12 " 1 " 21/-  
" 6 " 2 " 32/6.  
TWO NEW MODELS, completely enclosed.  
To charge 6 volts at 4 amps. £3/19/6.  
" 6 or 12 volts at 2 amps. £3/19/6

**SPECIAL OFFER**  
Cosmocord Playing Desk for 100-250 v. A.C. mains. Converts your Radio into a Radio-gram. Stand your Radio on top of this unit and connect pick-up lead to your set. Beautifully finished Satin Walnut Cabinet fitted with Motor and Pick-up. Our price, £3/10/0.  
Desk Microphones. P.O. Carbon Types, An efficient carbon instrument for general use. In all colours. 4/-. Post Paid.  
**PREMIER SUPPLY STORES,**  
167, LOWER CLAPTON RD., LONDON, E.5.  
AMHerst 4723.  
165, FLEET ST., LONDON, E.C.4. CENTRAL 2833.  
50, HIGH ST., CLAPHAM, S.W.4. MACaulay 2381.

**EXCEPTIONAL RADIO BARGAINS**

"REES-MAK" 3 Valve Portable	40/-
"PHILLIPS" 3 Valve D.C.	35/-
"AMPLION" 4 Valve A.C.	55/-
"MAJESTIC" 5 Valve Superhet A.C.	55/-
"PHILLIPS" 5 Valve A.C.	55/-
"EKO" 3 Valve D.C.	35/-
"H.M.V." 3 Valve D.C.	50/-
"ULTRA" Tiger 3 Valves D.C.	50/-
"ULTRA" All-wave 6 Valve D.C./A.C.	£7/10/-
"COLUMBIA" 2 Valve A.C.	25/-
"TELER" 3 Valve A.C.	40/-
"ULTRA" 2 Valve D.C.	35/-
"K.B." 3 Valve A.C.	45/-
"AMPLION" 6 Valve A.C.	60/-
"PYE" 2 Valve A.C.	35/-
"EKO" 3 Valve D.C.	42/6
"COSSOR" Battery Receiver, Complete Kit 2/6, complete with 3 Valves	40/-
Mains Unit D.C. 4 Tappings	20/-
	7/6

**UNIVERSAL RADIO,**  
221, City Rd., London, E.C.1.

**TORTOISE LAMP-LITA**  
For lighting 2½v. or 3½v. lamps, i.e. 80 lamps at 0.16 amperes, 25 lamps at 0.26 amperes. Useful for lighting model stages, doll houses, Xmas trees, shop windows, moving signs, displays, etc. For use on 200/250v. A.C. mains.  
Bakelite Case. Price **15/6** post free.

**TORTOISE HOME CHARGER**  
For charging 2v. accumulators at 1/2 amp. or 4v. accumulators at 1 amp. 200/250v. A.C. mains. Westinghouse Rect.  
Bakelite Case. Price **12/6** post free.

**MAKERS AGENTS LIMITED,**  
HIGH HOLBORN HOUSE, LONDON, W.C.1.

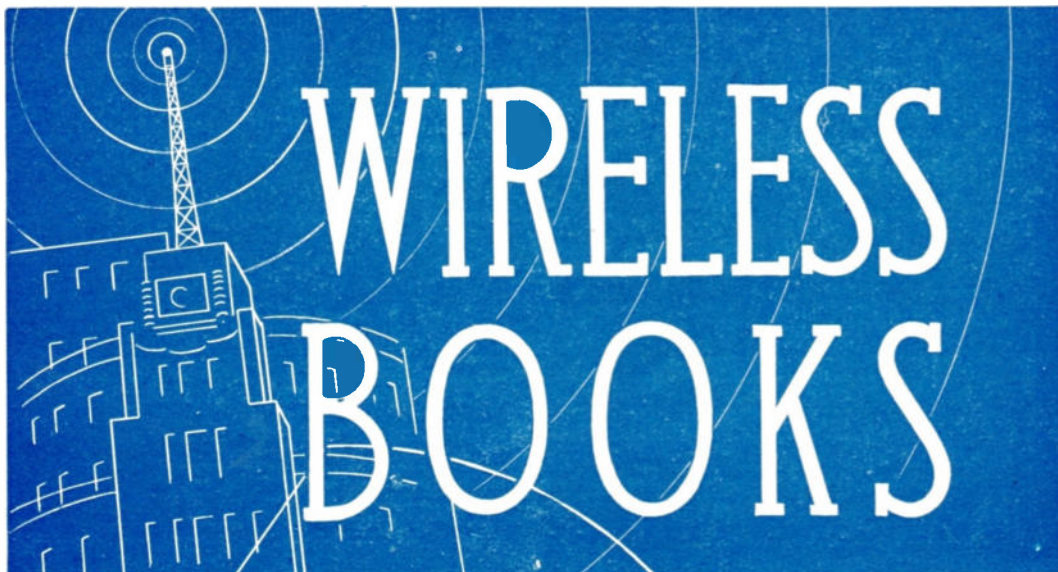

### THE OUTLINE OF WIRELESS

By RALPH STRANGER

8 6 net (9/-)

A book which covers the theory and practice of Reception from A to Z.

### WIRELESS CONSTRUCTOR'S ENCYCLOPÆDIA

By F. J. CAMM

5 - net (5'3)

The whole field of wireless construction is covered, in description and diagram, in this book.

### THE MATHEMATICS OF WIRELESS

By RALPH STRANGER

5 - net (5 5)

A simple introduction to arithmetic, algebra, geometry, trigonometry and calculus as they affect wireless calculations. 256 pages. *Fully Illustrated.*

### NEWNES TELEVISION AND SHORT-WAVE HANDBOOK

By F. J. CAMM

3/6 net (4/-)

The first really complete and authoritative work on this subject.

### EVERYMAN'S WIRELESS BOOK

By F. J. CAMM

3 6 net (4/-)

**JUST OUT:**

### WIRELESS COILS, CHOKES AND TRANSFORMERS : AND HOW TO MAKE THEM.

By F. J. CAMM

2 6 net (2 10)

An important new Handbook for every home constructor and anyone interested in radio. With Special Chapters on Selectivity, Break-through, Coil Winders, Coil Troubles and their Remedies. 180 pages, cloth bound, with 126 easy-to-follow illustrations.

### FIFTY TESTED WIRELESS CIRCUITS

By F. J. CAMM

2 6 net (2/10)

### DICTIONARY OF WIRELESS TERMS

By RALPH STRANGER

2'6 net (2/10)

A valuable synopsis of technical terms that everybody can understand.

Obtainable from all booksellers or send a P.O. for the amount indicated in brackets after each price and the book will be delivered to you post free . . . . write to Wireless Book Department, George Newnes, Ltd., Tower House, Southampton Street, Strand, London, W.C.2.



**THE NEW OSRAM "INTERNATIONAL" RANGE OF VALVES**

**POINTS OF  
TECHNICAL  
IMPORTANCE**

**POINT 2.**



The International Range includes valves of most modern design

**NEW RELEASE**

★ **OSRAM X65 TRIODE HEXODE**

The OSRAM X65 is designed as an electron coupled Frequency Changer in superheterodyne circuits which include short wave reception. It has the great advantage of a higher input impedance at ultra-high frequencies than ever previously achieved in valves of this class and, due to the electrode design, the drawbacks of other frequency changers operating at the short wavelengths are almost non-existent. High stage gain is obtainable even down to the shortest wavelengths.

Due to the use of a 6.3 volt 0.3 amp. Indirectly Heated Cathode, the OSRAM X65 is equally suitable for both A.C. Mains and D.C.-A.C. Mains sets.

it is recommended that the X65 is used in conjunction with a stage of H.F. Amplification, such as the OSRAM W63 or (KTW63) to ensure maximum efficiency and highest signal to noise ratio

**PRICE EACH 15/-**

**CHARACTERISTICS OF OSRAM VALVE X65**

Heater Volts	6.3
Heater Current	0.3 amp.
Anode Voltage	250 max.
Screen Voltage	100 max.
Control Grid Voltage	-3
Oscillator Voltage	10v. peak.
Conversion Conductance at Eg-3	225 micro amps. Volt.

*The self-locating "International" Octal base is fitted.*

★ **LOOK FOR FURTHER "POINTS OF TECHNICAL IMPORTANCE" IN FUTURE ANNOUNCEMENTS.**  
Write for Osram Valve Guide.

**Osram Valves**

**MADE IN ENGLAND**

*Sold by all Radio Dealers*

**OSRAM VALVES · DESIGNED TO ASSIST THE DESIGNER**

*Advt. of The General Electric Co. Ltd., Magnet House, Kingsway, London, W.C.2*



# ADJUSTING AND OPERATING THE D-XMASTER— See page 367.

# Practical and Amateur Wireless

3<sup>d</sup>  
EVERY  
WEDNESDAY

Edited by F.J. CAMM

a GEORGE  
NEWNES  
Publication

Vol. 11. No. 273.  
December 11th, 1937.

AND PRACTICAL TELEVISION



*Inter-Room  
Communication*

**JUST OUT!**  
**WIRELESS COILS, CHOKES AND TRANSFORMERS:** **AND HOW TO MAKE THEM.**

By F. J. CAMM.

An important new Handbook for every home constructor and anyone interested in radio. With Special Chapters on Selectivity, Break-through, Coil Winders, Coil Troubles and their Remedies. 180 pages, cloth bound, with 126 easy-to-follow illustrations.

2/6 By post 2/10.

GEORGE NEWNES, LTD., Tower House, Southampton Street, Strand, LONDON, W.C.2.





WILL'S  
**GOLD  
 FLAKE**  
 CIGARETTES

*Specially packed in attractive  
 'Christmas Greetings' Cartons,  
 without extra charge*

Flat 50 (Card Box) 2/5 . Flat 50 (Tin) 2/6  
 100 (Card Box) 4/8 . 100 (Tin) 4/10

PLAIN OR CORK TIPPED

G.F.B. 320



SHERLOCK HOLMES SAYS . . .

*It isn't just for Radio — but  
 for testing everything electrical*

A fuse may have gone in the lighting circuit; the door-bell may have ceased to function; the radio, perhaps, is not up to standard; the vacuum cleaner, usually so reliable, has definitely "given up the ghost," faults . . . faults . . . faults . . . all equally perplexing . . . but they're all the same to the Pifco Rotameter . . . just another job, in fact. This precision-built instrument reduces electrical fault-finding to a mere bagatelle; saves hours of wasted time, money too; yet its price is only a modest 42s. Has it occurred to you how useful this Rotameter could be in your own home, workshop or garage?

The PIFCO RADIOMETER. The only instrument of its kind in the world for making both A.C. and D.C. tests.

**RANGES:**  
 0-6 volts. 0-240 volts. 0-30 mA.  
 Filament and Resistance Test. 8,000  
 ohms Resistance.  
 Complete with two 15-inch flex cables  
 and engraved terminals. Fitted with  
 Dry Cell No. 495, and socket and plug-  
 in test for valves.

**RANGES:**  
 1—0.5 volts. 5—0-10 mA.  
 2—0-20 volts. 6—0-50 mA.  
 3—0-100 volts. 7—0-250 mA.  
 4—0-400 volts. 8—Resist/valve test.  
 9—Plug-in test for  
 valves.

Complete in velvet-lined case with testing leads.

Your regular dealer can supply you, or write:  
**PIFCO LTD., Watling Street, Manchester.**  
 London Office: 58, City Road, E.C.1.

12/6

42/-

PIFCO  
**ROTAMETER**



# MAKING AN I.F. AMPLIFIER— See page 383.

# Practical and Amateur Wireless

## Round

### Room-to-Room Communication

ALTHOUGH not strictly radio, the apparatus which is described in this issue and which is employed for room-to-room communication, follows strictly on the same lines as is used in the low-frequency section of standard broadcast apparatus. It is an interesting side-line to radio, and such apparatus which is supplied commercially is a side-line of many well-known radio firms. The majority of experimenters will no doubt have sufficient apparatus in the junk box or the spare parts box to enable a simple unit to be rigged up on the lines indicated and the house may then be wired so that a really effective house telephone system is introduced. The uses of this apparatus are legion, and one interesting use to which it may be put is in the nursery, where it will be possible for the parents in another part of the house to hear at intervals whether baby is awake—the sound from the radio normally drowning external sounds and thus rendering it necessary to pay repeated visits to the nursery, or to switch off the wireless and listen for cries. It may even be found that this apparatus will enable a mother to quieten a baby without visiting the nursery, simply by talking through the equipment. If the radio is in the same room as the master unit, it may even be possible to allow a little quiet music to be broadcast to the nursery to quieten the baby.

### Radio Replaces School

THE Cincinnati schools are closing a week earlier than usual this Christmas—owing to lack of school funds. To fill in during the extra week's vacation, the "Nation's School of the Air" broadcast from station WLW will provide instruction. The broadcasts take place daily from 2 to 3 p.m. (Eastern Standard Time) every day except Saturday and Sunday, and on Friday the classes are devoted to music study.

### Valve Factory Extensions

THE Brimar valve factory of Standard Telephones and Cables, Ltd., at Foots Cray, is being extended by a new building which will provide a 60 per cent. increase over the present available space. The new building will enable a big increase in production to take place in the new year.

Lord Hirst Succeeds Lord Gainford

UPON the retirement of Lord Gainford

Edited by

F. J. CAMM

Technical Staff:

W. J. Delaney, H. J. Barton Chapple, Wh.Sch. B.Sc., A.M.I.E.E., Frank Preston.

Vol. XI. No. 273. December 11th, 1937.

## the World of

from the office of president of the Radio Manufacturers Association, the Rt. Hon. Lord Hirst of Witton has been appointed to succeed him.

### American Valve Guarantee

THE distributors of National Union Valves announced that as a result of investigation it has been found that

## GIVE BOOKS THIS CHRISTMAS!

The following Standard Works make ideal Christmas presents. They are all suitable for beginner and expert, lavishly illustrated, well bound, and written by F. J. Camm.

**WIRELESS CONSTRUCTOR'S ENCYCLOPEDIA.** 4th Edition, 392 pages, 490 illustrations, 5/-, or by post 5/6.

**EVERYMAN'S WIRELESS BOOK.** 2nd Edition, 288 pages, 243 illustrations, 3/6, or by post 3/10.

**TELEVISION AND SHORT-WAVE HANDBOOK.** 2nd Edition, 288 pages, 230 illustrations, 3/6, or by post 3/10.

**HOME MECHANIC ENCYCLOPEDIA.** 2nd Edition, 392 pages, 627 illustrations, 3/6, or by post 3/10.

**WIRELESS COILS, CHOKES & TRANSFORMERS, and How to Make Them,** 180 pages, 126 illustrations, 2/6, or by post 2/10.

returns over a period of years have been less than 1 per cent., and as a result these valves will in future carry a guarantee of 365 days in place of the former 90 days.

### "Master" Lough Again

SOME years ago great interest was aroused when a gramophone record was broadcast by the B.B.C., featuring a Temple choirboy known as Master Ernest Lough—the record being of "Hear my Prayer." Nothing has been heard of this wonderful voice for some time and in spite of various rumours it is now announced

## Wireless

that the reason has been that his voice broke and he has been resting. He is now appearing as a fully fledged baritone and H.M.V. have recorded him in "Holy Child" and Schubert's "Serenade" on B8672.

### Radio-minded City

WHICH is the most radio-minded town or city in the British Isles. Cardiff makes first claim to the distinction, where it is stated that there are 72 radio shops. With a population of approximately 220,000 people, this means that there is a radio shop to every 3,050 persons, which worked out still further on the census figures means that for every 611 households there is a radio store.

### Cossor Portable

IT is announced that Messrs. A. C. Cossor are to produce a portable receiver, the first time in history that a receiver of this type has been made in the Cossor works. It is to be a battery-operated model selling at £6 19s. with batteries.

### Splitting the Atom

THE Western Research Laboratories in America are to make yet another attempt to split the atom. They have installed for the purpose a D.C. supply greater than five million volts. It is assumed that they will have some method of boosting this to a much greater figure. Many previous attempts have been made to split the atom without success and without proving that the atom is divisible, while the latest theory that matter is slowed-down radiation would mean, if true, that the atom did not exist.

### Special Belgrade Broadcast

THE Belgrade S.W. Station will broadcast its eighteenth transatlantic transmission on December 15th from 1 to 2.15 a.m., (Central European Time) on a wavelength of 49.18 metres. The same programme will be relayed by DJP, Berlin, on 25.43 metres, beamed to New York, and by DZC, Berlin, on 20.15 metres, beamed to Buenos Ayres.

### Nanking Station Destroyed

DURING the recent bombing of Nanking, the 75 kW. station of the Central Committee of the Kuomintang was completely destroyed. Several stations of smaller power in Shanghai and the surrounding district have also been destroyed.



# ROUND the WORLD of WIRELESS (Continued)

## A King Buys a Portable

THE number of notable personages using McMichael receivers has been increased by the addition of King Boris of Bulgaria, who recently bought a model 367 lightweight portable.

## Air-raid Sound Beacon

EXPERIMENTS are being carried out at Leicester by Parmeko, Ltd., with a sound beacon which is intended to act as a warning throughout the city in the event of an air raid. During recent experiments the sound, at only half-volume, was clearly heard all over the city.

## Two-way Television

TELEVISION history was made a few days ago when "viewers," for the first time, watched a two-way vision and sound conversation between the Alexandra Palace and the Elstree studios. This remarkable experiment showed in a striking manner the future possibilities of television in this country. Mr. Gerald Cock, the television director at the Alexandra Palace, was talking to Mr. Walter Mycroft, who was at Elstree.

## Radio Telephone in Mid Pacific

IT is reported that wireless communications of the Pacific Ocean have been strengthened by improved radio telephone facilities at Ocean Island and at Nauru. The new equipment, which was provided by the British Phosphate Commission, includes special types of voice-operated relays, by means of which the transmitter is brought into action immediately one commences to speak into the telephone. The wavelength change at Ocean Island is effected by press-button control, the aerial system being 800 yards from the transmitter. On the medium wavelength, vocal communication of good quality has been held for distances of over 1,000 miles, and with short-wave telephony, this range has been considerably increased.



Before taking the ice, the Brighton Tigers Ice Hockey Team take a short world tour with a Pye QAC5 receiver, which has recently been installed in their dressing room.

## New Station for Bessarabia

IT is reported that the Romanian Broadcasting Company intend to erect a transmitter at Chisinau (Kishenev), the capital of Bessarabia, to counteract broadcast propaganda from abroad. The new station is to be named "Radio Bessara-

## INTERESTING and TOPICAL NEWS and NOTES

bia," and it will operate on a wavelength of 201.2 metres.

## Radio Equipment for Australian Steamer

THE new passenger motor ship *Koolama*, now being constructed on the Clyde for the Western Australian State Shipping Service, is to be fitted with a comprehensive Australian-made radio installation. The equipment includes a standard 750-watt radio telegraphic transmitter and emergency equipment, an auto-alarm receiver, a



Max Miller, well known on the stage, screen and radio, is here seen expressing his appreciation of his Pilot receiver, model U-357.

direction finder, and a music amplifying equipment. There are also a number of receivers covering the wavebands of 15 to 2,000 metres.

## An Interesting Broadcast

BEHIND the programme entitled "Night Shift," which will be broadcast from the locomotive depot at King's Cross on December 20th, is the idea of giving National listeners an impression of how one of the large Northern express engines is "put to bed" for the night. Mr. T. Woodrooffe and Mr. F. H. Grisewood, of the B.B.C. Outside Broadcasts Department, will describe the activities which surround such an engine from the time it enters the depot, following the completion of a run from the North, until it puffs away to its shed all prepared for the

next day's work. The depot itself is a mass of railway lines, sheds, wagons and engines from the oldest to the most modern type, with an atmosphere of coal dust and steam.

## Christmas in Bethlehem

WE understand that arrangements have been made with the Palestine broadcasting service to relay from Bethlehem, Palestine, on Sunday, December 26th, part of the annual religious Nativity ceremonies. The Bells of Bethlehem will open the programme and, in addition to the broadcast of the Christmas Service at the Church of the Nativity, famed for its choir, a visit will subsequently be made to the environs of this famous building, a relic of the Emperor Constantine's Basilica, built over the Grotto of the Nativity. The commentator in describing the scene is expected to include the neighbouring Convents of the Greek, Latin and Armenian Churches, the Altar of the Innocents, and the Tomb of St. Jerome.

It is hoped in this programme to reflect the atmosphere of Christmas as observed in Bethlehem.

## SOLVE THIS!

### PROBLEM No. 273.

Hestler built a three-valve broadcast receiver, and after some time decided to convert it to an all-waver. He accordingly took out the broadcast coils and replaced them by all-wave components. When tried out, he found that the medium and long-wave results were just as good as formerly, but he could obtain no stations on the short-wave band. He returned the coils to the makers, but they were sent back O.K. What was his trouble? Three books will be awarded for the first three correct solutions opened. Address your solutions to The Editor, PRACTICAL AND AMATEUR WIRELESS, George Newnes, Ltd., Tower House, Southampton Street, Strand, W.C.2. Envelopes must be marked Problem No. 273 in the top left-hand corner, and must be posted to reach this office not later than the first post on Monday, December 13th, 1937.

### Solution to Problem No. 272.

In mounting the valveholders in his receiver, Nicholls had inadvertently allowed one of the heater sockets on his H.F. valveholder to come into contact with the metallised surface of his chassis, with the result that this valve heater was short-circuited.

The following three readers successfully solved Problem No. 271, and books have accordingly been forwarded to them: J. Garlick, 84, Kingswood Chase, Leigh-on-Sea, Essex; W. J. Thomas, 61, Mornington Road, Leytonstone, E.11; G. Moran, 13, Portsdown, Station Road, Edgware.

# COMPLETING AND OPERATING THE D-XMASTER

Some Further Notes Regarding the Construction of this Simple Three-valver, with Operating and Adjusting Details



Here is the receiver ready for the valves to be inserted.

right up to this clip so that there will be no risk of the bared wire coming into contact with the metallised surface on top of the valve.

### Pick-up Connections

Before completing the receiver you may desire to fit gramophone pick-up terminals, and the connections for these were given in the article on "Microphones and Pick-ups" in last week's issue. In this particular receiver, two pick-up sockets (or a Clix connecting strip) are mounted on the rear chassis runner, and the leads taken to the grid socket of the centre valveholder. The socket strip will thus come in the centre of

In last week's issue we gave the main constructional details for this receiver, and there are very few points remaining which will cause difficulty in building this neat three-valve broadcast receiver. It will be noted that the tuning dial is provided with an adjustable foot, and, therefore, before you can screw this in position on the top of the chassis, the two screws on the adjustable foot will have to be loosened and the dial raised the merest fraction of an inch. The bush on the drive may then be slipped over the condenser spindle, and the positions of the holding-down screws for the dial mount marked on the chassis. The dial is then removed and small holes drilled in the metal surface for the screws. When replaced, the screws should be driven home and the two locking screws on the adjustable mount are then tightened. Push the vanes of the tuning condenser to the "all in" or maximum position, and turn the tuning knob until the pointer is at the end of the tuning dial. Then lock the small grub screw on the bush of the dial, to enable the condenser to be adjusted for the preliminary tests. At a later stage this screw will have to be loosened so that the pointer on the dial may be set to the exact wavelength reading of a station.

For connection to the top of the first

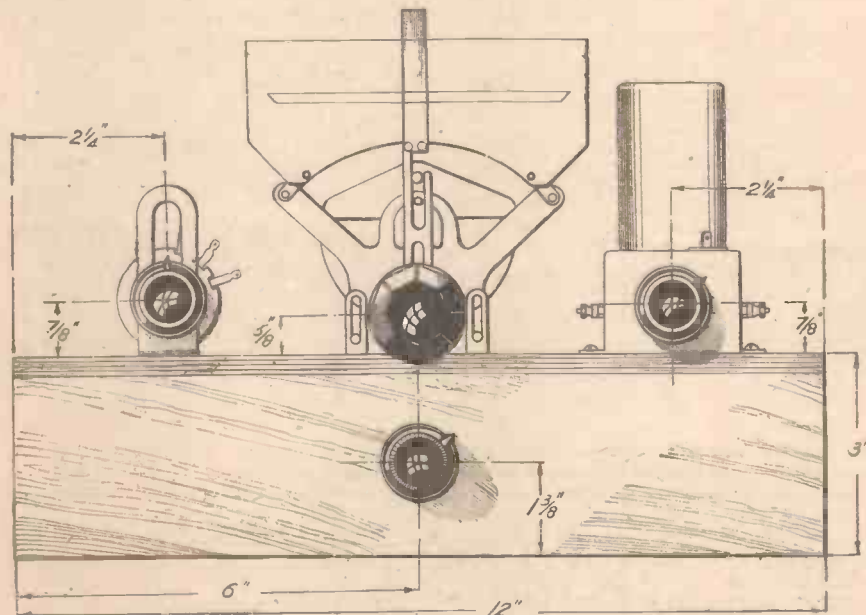

Dimensioned drawing for drilling the panel or cabinet front.

valve a small clip must be soldered to the end of the lead projecting from the top of the rear coil, and a length of insulated sleeving should be pushed over the wire

the runner and will balance the two strips already mounted. The wire to the grid socket in question, and also the lead from the remaining pick-up socket to the grid-bias battery, should preferably be covered with the metallic-screening lead which is sold for screening purposes, although for preliminary tests you may omit this. It is not always found essential to adopt screening of these leads, but in some cases instability arises if the pick-up is left connected.

### Ganging

The receiver is now ready for the preliminary tests, and the wiring should be very carefully checked before any battery connections are made. The VP215 valve should be placed in the first valveholder (immediately behind the coils), the D210 in the centre holder, and the Y220 in the remaining holder. The L.T. negative and positive spades should be placed under the

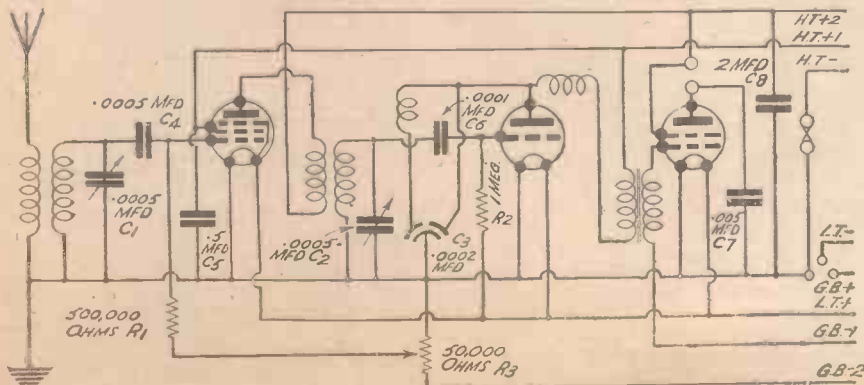

Theoretical circuit of the D-Xmaster.



terminals on the 2-volt accumulator and the H.T.— plug inserted into the negative socket on the H.T. battery. G.B.+ plug should be inserted into the positive socket and the G.B.—2 plug inserted into the 9-volt socket on this battery. G.B.—1 should be inserted into the —3-volt socket. The plug H.T.2 should be inserted into the 120-volt socket on the H.T. battery, and for the first tests H.T.1 should be placed into the 60- or 66-volt socket. During subsequent tests you may find that this voltage may be modified to obtain better results. Switch on by turning the left-hand switch in a clockwise direction, when the switch will be heard to snap over, and the volume control should then commence to work. It should be at minimum as soon as the set is switched on, and further movement of the control should build up signal strength. Turn the tuning dial to the approximate wavelength of your local station and rock it backwards and forwards over a few degrees. You should hear the local, although it may be very weak until the set is trimmed. This is carried out by adjusting the two screws on top of the tuning condenser, rocking the tuning pointer slowly backwards and forwards in order to ascertain the improvement which is made as the trimmers are adjusted. When satisfactory results have been obtained, turn to the other end of the dial and use the volume control, and react if necessary, in order to locate

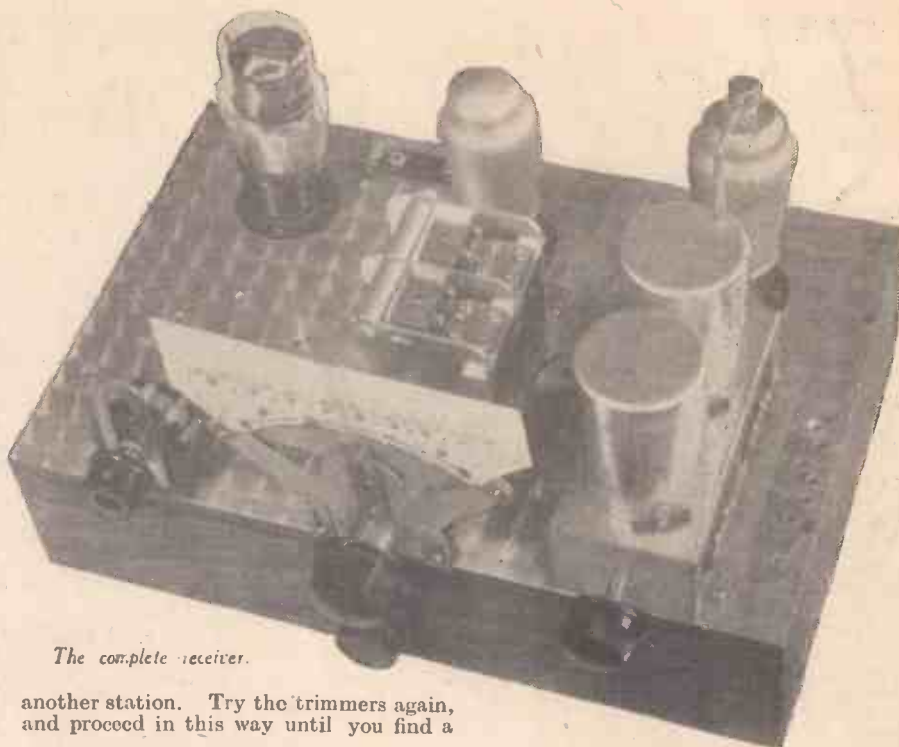

The complete receiver.

another station. Try the trimmers again, and proceed in this way until you find a

COMPONENTS FOR THE D—XMASTER

	s.	d.
One 2-gang coil unit—type BP114 (Varley) .. .. .	13	6
One 2-gang condenser .0005 mfd. (C1, C2)—Bar type (J.B.) .. .. .	12	0
One slow-motion drive—No. 2134 (J.B.) .. .. .	5	9
Five fixed condensers: one 2 mfd. (C8), type BB; one .5 mfd. (C5), one .0005 mfd. (C4), one .0001 mfd. (C6), one .005 mfd. (C7)—type tubular (Dubilier) .. .. .	8	6
Two fixed resistances: one 1 meg. (R2), one 500,000 ohms. (R1)—type E3 (Dubilier) .. .. .	1	0
One volume control, 50,000 ohms with 3-point switch (R3)—type VM60 (Bulgin) .. .. .	5	6
One reaction condenser, .0002 mfd. (C3), No. N23 (Bulgin) .. .. .	3	0
One all-wave H.F. choke—type HF15 (Bulgin) .. .. .	5	0
One L.F. transformer 3/1 (B.T.S.) .. .. .	4	6
One component bracket (Peto-Scott) .. .. .	0	4
Three valveholders: one 5-pin, two 4-pin—chassis mounting type (Clix) .. .. .	2	1
Six plugs: H.T.—, H.T.1, H.T.2, G.B.—, G.B.—1, G.B.—2 (Clix) .. .. .	1	0
Two spades: L.T.—, L.T.—+ (Clix) .. .. .	0	4
One 100 mA fuse with holder (Microfuse) .. .. .	1	6
Two socket strips: A.E. and L.S. (Clix) .. .. .	1	0
One Plymax chassis, 12in. by 8in. by 2½in. (Peto-Scott) .. .. .	6	6
Three valves: VP215, D210, Y220 (Hivac)		
One P.M. speaker—Stentorian Junior (W.B.)		
120 volt H.T. battery (Drydex)		
9 volt G.B. battery (Drydex)		
2 volt L.T. accumulator (Exide)		

setting which holds at both ends of the dial. No further adjustment should be required for the long waves, and when the best setting has been located the local should be tuned in, and the locking screw on the dial loosened whilst the pointer is adjusted to give the correct wavelength indication. Make certain that the condenser vanes do not move whilst this is being done. The receiver should now be accurately adjusted, and it should be found possible to tune in any desired station on medium or long waves merely by setting the pointer to the required wavelength, and turning up volume and reaction controls. Oscillation, produced when the volume control is turned up, will probably indicate that the voltage at H.T.1 is too high, and accordingly it should be reduced.

## Important Broadcasts of the Week

**NATIONAL (261.1 m. and 1,500 m.)**

Wednesday, December 8th.—Symphony Concert from the Queen's Hall, London.  
 Thursday, December 9th.—Variety from the New Hippodrome, Coventry.  
 Friday, December 10th.—Ghosts, by Henrik Ibsen, a play.  
 Saturday, December 11th.—Palace of Varieties programme.

**REGIONAL (342.1 m.)**

Wednesday, December 8th.—Military Band programme.  
 Thursday, December 9th.—Ghosts, by Henrik Ibsen, a play.  
 Friday, December 10th.—Buerger Potpourri: Orchestral programme.  
 Saturday, December 11th.—Military Band and choral programme.

**MIDLAND (296.2 m.)**

Wednesday, December 8th.—Military Band concert.  
 Thursday, December 9th.—Children's Hour talk by Eleanor Farjeon.  
 Friday, December 10th.—How to get your

money's worth—9, When Buying Boots and Shoes—a discussion.  
 Saturday, December 11th.—Part songs by Victorian composers.

**WEST OF ENGLAND (285.7 m.)**

Wednesday, December 8th.—Variety from the Palace Theatre, Plymouth.  
 Thursday, December 9th.—Choral programme, from the Foresters' Hall, Barnstaple.  
 Friday, December 10th.—Countess of Pembroke's Arcadia—a Picture of Wilton House, in Wiltshire.  
 Saturday, December 11th.—Orchestral programme, from the Colston Hall, Bristol.

**WELSH (373.1 m.)**

Wednesday, December 8th.—Choral concert from the Olympia, Tredegar.  
 Thursday, December 9th.—A Welsh variety programme.  
 Friday, December 10th.—Tristram, a dramatic programme.  
 Saturday, December 11th.—Vocal recital.

**NORTHERN (449.1 m.)**

Wednesday, December 8th.—Variety from Her Majesty's Theatre, Carlisle, and Concert Party programme from the Grand Theatre, Leeds.  
 Friday, December 10th.—Variety from the Winter Gardens, Morecambe.  
 Saturday, December 11th.—Northern Philharmonic Concert from the Town Hall, Leeds.

**SCOTTISH (391.1 m.)**

Wednesday, December 8th.—Gaelic choral programme.  
 Thursday, December 9th.—Instrumental recital.  
 Friday, December 10th.—Choral-Orchestral concert.  
 Saturday, December 11th.—The Clocks were Slower Then, December in Scotland thirty years ago.

**NORTHERN IRELAND (307.1 m.)**

Saturday, December 11th.—Trial of the Witches: a reconstruction of the last trial for witchcraft in Ireland.

# The Amateur Set Designer

Further Notes on Automatic Volume Control are Given in this Fourteenth Article of the Series

(Continued from page 322, December 4th issue)

FIG. 65 illustrates part of a mains receiver. We want the A.V.C. diode to be biased negatively with reference to the cathode, and this will come about if we give the cathode a potential which is positive with reference to the A.V.C. anode. With a double-diode valve of the type shown in the diagram, it will not be possible to obtain the necessary bias by a cathode resistance carrying the diode current only, so the problem comes to that of looking round for some point which is at a suitable positive potential, and of connecting the cathode to that point. The A.V.C. load resistance will be connected to the earth line

The bias resistance of the valve following the double-diode will very probably provide a total bias voltage sufficient for, or possibly in excess of, the required delay voltage, so one scheme to consider is that of connecting the cathode of the double diode to some point on the bias resistance of the next valve. In Fig. 65 this method of obtaining delay is shown, and the case illustrated is one in which the bias of the L.F. valve is greater than the required delay voltage; hence the detector cathode is connected to a point coming between the ends of the L.F. valve's bias resistance. The higher the tapping point the greater, of course, is the delay voltage. In practice, if the total L.F. bias exceeds the required delay it will usually be most convenient to make up the total value of bias resistance for the L.F. valve with two resistances in series, and to pick up the delay voltage by a connection to the junction.

## Bias Voltage

Suppose the total bias voltage provided by the L.F. valve turns out to be insufficient for the particular delay requirements. One way out of this difficulty would be to connect the cathode of the double-diode valve to the cathode of the L.F. valve (so as to bring the whole of the latter's bias into use for delay), take the lower end of the A.V.C. load resistance to negative H.T. and insert a resistance between negative H.T. and the earth line. The detector cathode will now be positive to the earth line by the amount of the L.F. valve's bias, and the A.V.C. diode anode will be negative to the earth line by the voltage drop across the resistance in the negative H.T. lead. The latter voltage has therefore been added to the delay.

An alternative way of biasing the A.V.C. detector is that of using a potentiometer resistance (or series of resistances), between positive H.T. and the earth line, and to connect the detector cathode to some point on this potentiometer. There will be no difficulty here in getting sufficient delay.

It should be appreciated that the net A.V.C. bias available with a delayed system is not the total value of the rectified

voltage in the A.V.C. detector circuit, but is this voltage less the amount of the delay voltage.

So far, we have been confining our attention to the mains-operated receiver. As regards the battery receiver it must first be pointed out that indirectly-heated double-diode valves are available for battery sets, and that with one of these it is possible to get the delay by connecting the cathode to a suitable point on an H.T. potentiometer, as just mentioned.

A simple method of getting the delay is, of course, that of running the lower end of the A.V.C. load resistance to a grid bias battery. A more elaborate arrangement is to use a grid bias potentiometer. Another method is that of developing the delay voltage across a resistance connected in the negative H.T. lead.

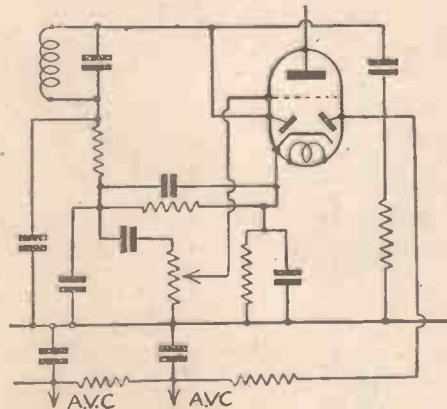

Fig. 66.—When the A.V.C. is fed to more than one valve, decoupling must be introduced as shown here.

## I.F. Filtering

As we have already seen, the signal detector circuit should contain some form of "stopper," or filter, to keep H.F. away from the grid of the L.F. valve. In Fig. 65 it is done by R3, which could be a resistance of about 100,000 ohms. Alternatively, a resistance-capacity filter could be inserted at the point marked X in Fig. 65. A filter suitable for I.F. values could be made of a 100,000 ohms resistance with two .0001 mfd. condensers connected in series across the resistance with the junction of the condensers run to earth.

## The A.V.C. Line

In Fig. 65 a lead is taken from the top of the A.V.C. diode load resistance, R2, to form the A.V.C. line feeding the auto bias to the controlled valves. It will be understood that the grid return connections of the latter will be taken to the A.V.C. line, instead of to the earth line. R4 and C2

provide the decoupling and filtering for the A.V.C. line.

There is a complication which crops up here which the amateur designer will do well to keep in mind. From the filtering point of view a large product of resistance and capacity values is desirable, but there is another consideration which places a limit upon the maximum RC product that will be satisfactory. Ability to cope with a rapid signal fade is usually expected of any A.V.C. system, and this point becomes of considerable importance in connection with short-wave reception. Referring again to Fig. 65, it is quite legitimate to regard the voltage across C2 as forming the actual auto bias voltage operating on the controlled valves. A rapid signal fluctuation demands a quick change of bias. This implies a quick automatic adjustment of the charge in C2. The larger the capacity of C2, or the larger the resistance of R4, the more "sluggish" will be the action of C2 in changing its charge. Thus the requirement of quick acting A.V.C. necessitates a restriction of capacity, and resistance values for C2 and R4, respectively. Capacities 0.1 mfd. for C2, and 1 meg. for R4 represent useful values with which to make a start if the receiver is to receive medium and long waves. For an "all-wave," or a short-wave receiver, the designer must be prepared to have to use smaller values.

## Decoupling Combination

In the interests of stability it may be necessary to have more than one decoupling combination, and Fig. 66 will be found to contain an example involving A.V.C. feed (through one line) to two controlled valves.

As already mentioned, it may be necessary to give the valve immediately preceding the detector less A.V.C. bias than the other controlled valve, or valves. This is easy to arrange, for it simply means taking a second A.V.C. feed line from some point on R2 (Fig. 65) which will give the required smaller A.V.C. bias. In other words, make R2 act as a potentiometer. Needless to say it is advisable to filter the additional A.V.C. line, although sometimes a condenser only will prove to be sufficient.

## Delayed A.V.C. with the Double-diode-triode

The double-diode-triode valve is one of the most useful valves, and used on the lines illustrated in Fig. 66 it provides diode signal detection, delayed A.V.C., and also L.F. amplification (the triode section acting as the first L.F. valve of the receiver). The valve shown in Fig. 66 is of the indirectly-heated mains type, and the triode section is biased by a resistance connected between cathode and the earth line. For the first trial the amateur designer will be advised to make this same bias resistance provide the A.V.C. delay voltage also, as in Fig. 66.

Since the (single) double-diode-triode valve of Fig. 66 is really equivalent to the separate double-diode and triode valves of Fig. 65 (assuming that the latter is an L.F. voltage amplifier) we need not say any more about the double-diode-triode and delayed A.V.C. This rather short dismissal of the double-diode-triode must not be taken, however, as indicating any lack of importance of the valve.

(To be continued.)

## NEWNES' TELEVISION AND SHORT-WAVE HANDBOOK

3/6, or 4/- by post from  
GEORGE NEWNES, Ltd., Tower House,  
Southampton Street, Strand, London, W.C.2.



# SOME XMAS PRESENTS

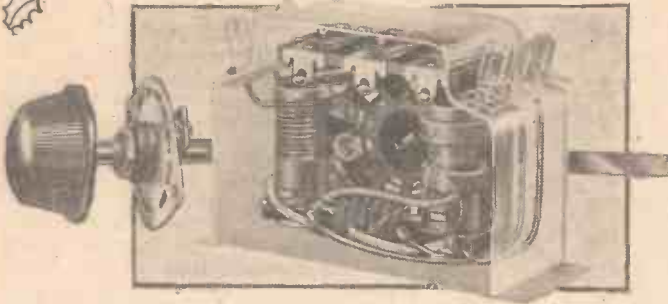

Here is one of the latest all-wave tuners—made by Wearite. This is a “straight” coil and may be used in combination for practically any type of straight receiver. This unit is complete with multi-point switch and a self-locating plate for the different settings.

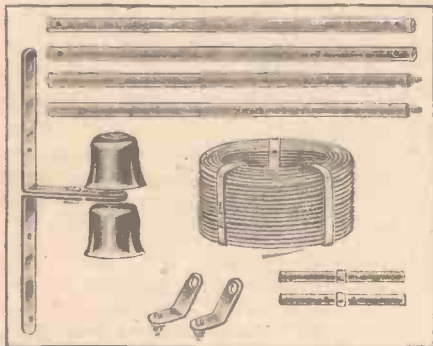

For improved results on short waves, a special dipole aerial system is to be recommended. Above is shown the special dipole aerial kit obtainable from Messrs. Bulgin. As may be seen, this includes all the essential parts, and it is a simple matter to erect this type of aerial which gives better signal/noise ratio than the standard type of equipment.

If you are asked to select a radio component as an Xmas present, there are now many interesting items which can be chosen. A few suggestions are given on this page, but the selection is not, of course, complete. All-wave coils, modern tuning condensers, station-calibrated tuning scales, meters, pick-ups, and similar items may be chosen to incorporate in an existing receiver or for use in constructing a new set. More details will be found on other pages.

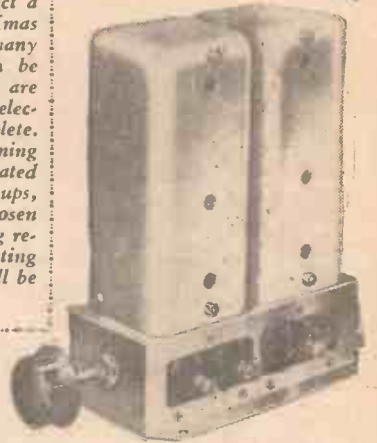

Here is another all-wave coil unit, this time a Varley component. This particular model is designed for use in a superhet circuit and includes an aerial coil and an oscillator coil, ganged together with a self-contained switch. This unit may be used with a “straight” type of two-gang condenser and it incorporates special padders to provide the correct frequency difference when this type of condenser is used.



A new accumulator will prove of great value in several ways. For instance, a model such as the Exide cell shown here includes a novel indicator which shows exactly when the battery needs re-charging, and thus a longer life will be obtained and all doubts as to whether the battery will last through a programme are removed.



Improve your entertainment by including gramophone record reproduction. A good pick-up, such as the Cosmocord component here illustrated, may be used with practically any receiver, as explained

fully in last week's issue, and will double your enjoyment.



Avoid constant visits to the charging station and the trouble of carrying your accumulator backwards and forwards by charging it yourself at home. A small trickle charger such as the Heayberd Tom-thumb unit illustrated above will enable you to keep your battery right up to standard and will cost very little to maintain.



For the keen experimenter a good meter is indispensable. But the ordinary amateur will also find that the acquisition of such a meter will enable him quickly to trace faults, and an all-purpose meter such as the Avo instrument shown above will prove a most acceptable gift.



Even if you now possess a good speaker, a modern W.B. Stentorian may be chosen as a valuable gift to use as an extension listening point. If your present speaker is of an old pattern, do not hesitate to choose one of these up-to-date models and hear the difference it will make to the reproduction from your set.



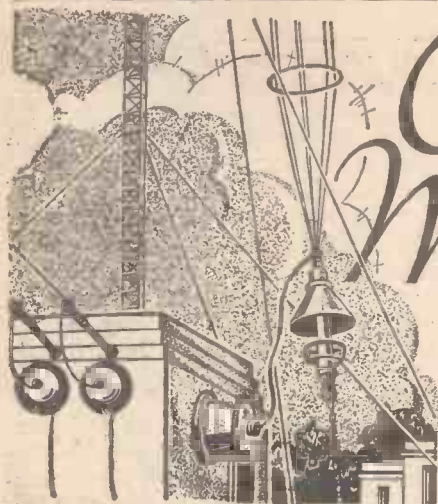

# On Your Wavelength

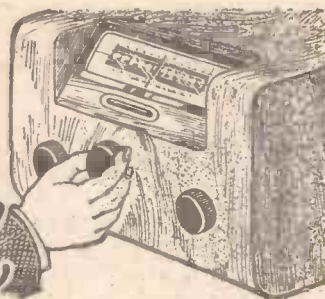

By Thermion

## The Danger of Centralisation

HAVE you noticed how the world is tending to centralise everything? Have you observed that whereas a few years ago a vast number of separate and individual companies were responsible for our electricity, our entertainment, our power, our thoughts, our education, our food, nowadays the large number of small bodies is being swallowed up by a small number of large monopolies which tend to control us in every way?

We now draw our entertainment from the B.B.C., or we largely do. It has become a powerful competitor of the theatrical and musical professions. Now that television is being developed broadcasting will become an even more potent competitor of the theatre. Formerly, we relied upon school teachers to teach the young. Nowadays broadcasting is penetrating even the walls and windows of the schools, and largely usurping the functions of school teachers. Thus, we shall tend to have in the very near future mass-produced minds from which all trace of individualism has been exorcised by the mass-produced idea. Do you realise that the Grid System is another move towards centralisation, where by means of a flick of the switch you can draw the power which formerly you obtained from a gas engine, or a steam engine, or from a local electrical undertaking? Do you appreciate that milk and vegetables, market produce, and meat are all controlled by marketing boards? Shortly our mines will come under Government control. The Post Office, the telephone, are Government bodies which stifle competition. We may shortly

be compelled to draw our power from the air. We are doing so even now with our wireless sets. Everything is being centralised.

Our houses are chiefly built according to

the dictates of the Ministry of Health. We may shortly all wear a national dress decided by the Government. Even the time has been centralised, and electricity has practically killed the spring and weight driven clock industry. Where will it all end? Shall we all become soulless robots? Have we not too much government? Has radio really exerted a beneficent influence on civilisation? These are pertinent questions to ask, for once a government has complete control of our thoughts and our habits we are as but clay upon the potter's wheel. Broadcasting was originally considered as a form of entertainment. It is now a most powerful propaganda machine, and instead of being used to combat the heritage of the Tower of Babel and ensuring that nation speaks peace unto nation, dangerous propaganda is being radiated and inspiring repartee from other nations in the form of even more dangerous propaganda. The more you consider

certain amount of government and control is essential, but when Government decides upon a policy of suppression and repression of the views of the populace there is bound to be an outcry. Individual competition is good, and must inevitably react to the benefit of the population. Bureaucracy never did anything really good as history proves. We do not need Cromwells and Judge Jeffreys' in broadcasting, and it is my view that programmes should be rigidly confined to entertainment, and not used for political propaganda of any sort. I have no particular political leanings, and do not subscribe to the party-right-or-wrong principle. I use my judgment on a particular problem, and having made up my mind as to what is right, having heard all sides of the question, I plump for the particular party which holds my views. At times, therefore, I support every party, and at others, oppose them.

If this centralisation system continues as it is now continuing, individual incentive will go, because eventually you will find that you are only dealing with one boss, and if he does not approve there is no one else whom you can approach. I raise these points because they are worth thinking about. The best brains of the country are never cornered by a Government. Excellent though the Grid Scheme may be, this country

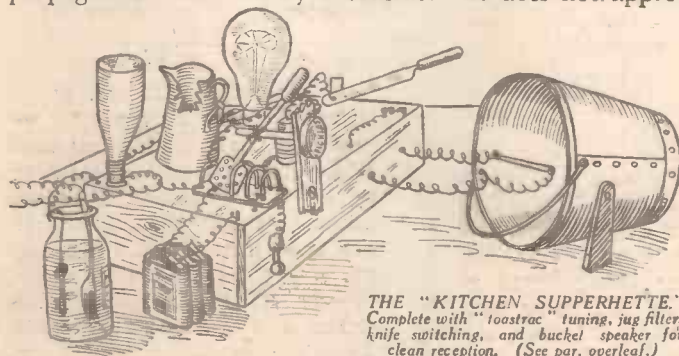

THE "KITCHEN SUPPERHETTE."  
Complete with "toastrac" tuning, jug filter, knife switching, and bucket speaker for clean reception. (See par. overleaf.)

this centralisation idea, the more you unearth the multifarious inroads it is making on us. Soon the individual will have no effective reply, even to despotism. As soon as a new industry springs up which seems likely to be useful to the Government they promptly control it. You all know what has happened to television, because private enterprise has been stifled. It is not sufficiently useful yet. When it is you may rest assured that entertainment alone will not be the main plank in its platform. A

could be blotted out in time of war by three or four hostile aeroplanes. The system offers severe risks to the development of civil aviation, and broadcasting, if used for educational purposes, can in a veiled way mould the opinions of our youths in a particular direction desired by the Government. We must preserve at all costs the individual point of view, and encourage the development



of individual egos. We do not all wish to think alike, to act alike, to wear the same clothes, to listen to the same sort of programme, nor to go to the same places, nor to eat the same food. Think it over!

#### Joke

HERE is another joke, this time from Mr. E. B. Lister, of Normanton. He says: "I built a two-valve wireless set for a friend of mine, but on seeing that it had earphones (it was a short-wave model) he refused to try it, saying that the magnets in the 'phones drew the sweat out of his ears. I can assure you that this is perfectly true, strange as it sounds."

It is certainly a new one on me. A book has been sent.

#### The Overseas Market

MR. H. R. WATSON, of Hampstead, contributes the following letter to this discussion:

"I cannot let this opportunity pass without a little constructive criticism re your Overseas Market par., Nov. 27, 1937.

"Whoever your correspondent, he knows what he is talking about. I have lived in the Dominions for the past 15 years and I can assure you that the Americans have supplied, and are supplying, the Dominions and Colonies with what they want and ask for—and this in a competitive market, against a preferential tariff, and without ballyhoo.

"They have got the car market, and are likely to keep it, despite what a leading manufacturer says. Do a three or four thousand miles trip in a Yank car, and then in an English car, break a part of an English car and then look at your bank balance! The same applies to radio.

"Who pioneered the first A.C. sets, short-wave sets, components, circuits, etc.? The Yanks, the Dutch, and the Germans. Who did the first Empire short-wave experiments and hook-ups? The Yanks and the Dutch. Who were being heard at full strength whilst Daventry was learning to walk? The Yanks, the Dutch, the Germans, the French, and even Moscow!

"If the Yank sets and circuits are sold by bluff and ballyhoo, why, over the last ten years or so, haven't the English sent out sets to beat them, instead of sending out a few valves to fit U.X. sockets? Why do the Dominion manufacturers make their sets along Yankee lines, with Yankee circuits?

"All over the Dominions, Yankee sets, circuits, components, etc., are marked in plain figures, sold with as much ballyhoo as one sees in



## Notes from the Test Bench

#### The Trident

SOME readers have complained that they cannot get satisfactory short-wave reception from the Trident, the simple all-wave three-valver described in the Radiolympia number. Lack of signals on the short-wave band is generally due to absence of reaction, and this, in turn, is commonly due to the use of a long aerial-earth system. The earth lead should be kept as short as possible, and if the aerial is long a .0001 mfd. variable condenser should be connected between the aerial lead and the aerial socket of the set.

If these alterations fail to enable short-wave signals to be obtained, the voltage on the detector valve should be carefully checked. Remember that an anode-bypass condenser is not used in the detector circuit on short waves.

#### Using American Valves

THE main type of American valve has a heater rated at 6.3 volts and the Osram International range has a similar rating. Some readers have expressed a wish to use these valves but have ordinary mains transformers in their possession in which the heater windings are at 4 volts. Their problem is how to obtain the necessary 6.3 volts without going to the trouble of buying a new mains transformer for the purpose. It is possible to obtain just over 6 volts by using one heater winding, plus one half of another winding, and as the 6.3 type heater takes a much lower current, it is possible in many cases that one winding alone on the mains transformer will be sufficient to run all of the valves, thus leaving one heater winding spare. By connecting one of the end terminals on the winding to be used to the centre terminal of the spare winding, and then employing one of the end terminals on this winding and the remaining terminal on the full winding as the heater supply, the full 6 volts will be obtained—subject to one proviso. The two separate windings must be connected in phase. The correct relationship may be measured by using a meter, or the old dodge of connecting a small pocket-lamp bulb and gauging the brilliancy may be tried. The latter is not so reliable, but it is possible to identify the difference in brilliance when the windings are wrongly connected and when they are correctly wired.

## Practical Mechanics Big Xmas Number

NOW ON SALE—6d.

English radio ads., and do the job they were made to do. Valve for valve, shilling for shilling, the Yank job holds its own, and is, in most cases, in front, to say nothing of a very certain pleasing line they attain with their products.

"As for their publications, for every English job in the Dominions there must be six Yanks.

"I'll say no more for the moment, as I think this is quite long enough for a Christmas party piece! 73's."

#### Another Joke

MR. F. E. NEWELL, of Peckham, writes: "I have an accumulator charging station, and a customer regularly brings a small celluloid accumulator for charging. This has a celluloid screw-in stopper with a short tube attached to render it unspillable. On one occasion I mislaid this stopper, and put in an odd one which lacked a tube. The customer was emphatic that his set was not nearly so loud at it was when the stopper with the 'sounding tube' was in the accumulator. He insisted that the set worked on it. I found the original stopper and the set has now recovered its lost power!"

#### A Non-wave Set

MR. S. T. O'MARA, of Camberwell, sends me the sketch on page 371 of his latest in non-wave sets. The people who have seen it so far think that he ought to put it in a safe place, and he hopes that I will give him my opinion of it before I send the cops. I will give him my opinion of it. I have played over a suitable tattoo on that musical instrument known as the kazoo, and the office boy is suitably amused. I believe that the noise is popularly referred to as a raspberry, but although something of a scholar this piece of terminology had not yet reached my vocabulary.

#### The Blyth and District Radio Club

MR. G. PURVIS, of 18, Chamberlain Street, Blyth, Northumberland, says that a dozen keen enthusiasts of the town have formed the above club, and they appeal to me to appeal to you local readers of Blyth to rally round the banner of the old school tie, and all that. While they are all very much interested in short waves, and intend to build and operate a transmitter as soon as possible, they also intend to disseminate knowledge of all branches of radio among the members. Shall it be said that my oodles of readers in Blyth could not support their own club? A nosand times thou!

THE SUM TOTAL OF A GOOD CIGARETTE



HCC408 E. PLAYERS NAVY CUT CIGARETTES 'MEDIUM' OR 'MILD' 10 FOR 6<sup>0</sup> 20 FOR 11<sup>5</sup> 9

# The Ideal Gift

## For a Radio Man

The truest test of a gift is the thoughtfulness that inspires its choice. The AvoMinor will be appreciated for many, many years because, for all that time, it will ensure trouble-free radio and will invest its fortunate owner with the testing facilities and the confidence of the expert radio engineer. The AvoMinor is the ideal gift, both to give and to receive. See that you get an AvoMinor this Christmas.



BRITISH MADE

If any difficulty in obtaining locally, send direct or write for fully descriptive folder.

Automatic Coil Winder & Electrical Equipment Co., Ltd.,  
Winder House, Douglas Street, London, S.W.1.  
Phone: Victoria 3404/7.

The D.C. **AVOMINOR**  
REGD. TRADE MARK

45/-

Deferred Terms if desired.

CURRENT	
0.6 m/amps.	
0.30 "	
0.120 "	
VOLTAGE	
v.t.s.	v.t.s.
0.6	0.12
0.120	0.240
0.300	0.600
RESISTANCE	
0.10,000	ohms
0.60,000	"
0.1,200,000	"
0.6	megohms.

# Varley AS USUAL

for the **"D-XMASTER"**

USE

## BP 114 2-Gang Coil Unit

for Medium and Long Waves. Comprises high selectivity aerial and intervalve coil with wave-change switch and provision for fitting ON-OFF switch 13/6

## DP 21 NICLET Transformer

Ratio 1—3.5 can be used directly coupled or parallel-fed 7/6



## BP 120 THREE-BAND SUPERHET UNIT

The BP 120 is the most simple superhet coil unit available to the home constructor. It is supplied complete with all trimmers and padding condensers, which are all adjusted before the unit leaves our factory. Used in conjunction with our new skeleton type, 465 KC I.F. transformers, no constructor need be afraid that the trimming will be too difficult, in most cases none will be needed.

## THE BP 120 BLUEPRINT Price 6<sup>0</sup>

gives full instructions for building an all-wave A.C. mains-operated superhet.

INEXPENSIVE TO BUY. EASY TO BUILD.

EFFICIENT IN PERFORMANCE

THE COMPLETE KIT MAKES AN IDEAL XMAS GIFT FOR A KEEN HOME CONSTRUCTOR.

VARLEY (OLIVER PELL CONTROL, LTD.,)  
CAMBRIDGE PLACE, WOOLWICH,  
S.E.18.

# Varley

Please send me Blue Print BP 120 and full constructional details of the new receiver. I enclose 6d. in stamps.

Name .....

Address .....

Pr.W. 11/12/37.



# Practical Television

December 11th, 1937. Vol. 3. No. 78.

## Beating a Record

THE transmission of television pictures over long lengths of land line is an extremely important section of development in connection with the provision of additional television stations, and the distribution of programme material. With the earlier type of low-definition signals the record distance was from London to Glasgow, established by Baird in 1927. For this experiment ordinary Post Office telephone lines were employed, the characteristics of the trunk lines being of such a character that the relatively low band width of the picture signal could be accommodated comfortably without excessive distortion. As readers know, the advent of high-definition television presented an entirely new and highly complicated problem in line distribution over long distances, one which necessitated considerable research before a special type of co-axial cable could be produced capable of handling the enormous frequencies involved in present-day television pictures. Quite recently, however, the Germans showed how television pictures could be transmitted to a distance of over 300 miles when viewers in Berlin watched what was happening before the transmitting scanner in Nuremburg. Now comes the news that British experts have topped this achievement, for it has been shown that clear, high-definition television pictures of the present standard of line dissection can be sent over 400 miles of cable. This work promises to simplify programme distribution problems very materially, and may alter the whole scheme for providing television in the provinces. It is felt that any premature building of high-powered television transmitting stations may prove wasteful if a method is found for linking up a series of relay stations deriving their programmes from one or more central studios. No doubt the promised pronouncement of the Television Advisory Committee will throw some light on this aspect of television early in the New Year.

## An Excellent Scheme

A recent scheme which has borne fruit has much to commend it, and is one which no doubt will be taken up in many quarters. A dealer who gave demonstrations daily on television receivers in his shop conceived the idea of having available a collecting box labelled "Hospital Television Installation." Those members of the public who were entertained by the demonstrations were invited to place small contributions in the box so that a sufficient sum could be collected for the purpose of purchasing a television set to be given to the local hospital. Messrs. Harrops Radio, of Brentwood, were the instigators, and so successful were the results shown that in a relatively short time a large enough sum was forthcoming. The installation was effected before the Coronation, and the set has proved a source of delight and comfort to the patients who, lying on a bed of sickness, were deprived of enjoying normal pleasures through no fault of their own. To complete matters, the ceremony of officially handing over the set was

carried out a few days ago, and Mr. Baird, in one of the hospital wards, made the presentation, pointing out that this was the first effort of its kind to be undertaken in this way anywhere in this country. The receiver, a standard Baird model, can be moved from ward to ward as required, as Harrops Radio are wiring up a complete local distribution scheme for this purpose. The idea is an excellent one for the cost is met by public generosity in a simple and straightforward manner, and during the ceremony, hope was expressed that a similar idea would be adopted by other

television purposes. It is agreed that the electron camera with its mobility and absence of mechanical moving parts is the ideal solution for direct studio or outside broadcasts, but in the case of films, which need special treatment, there are many experts who still regard the mechanical scanner as the best form for this work. In Germany this argument has been met by providing two forms of scanner. The Fernseh Company, for example, have undertaken careful and prolonged development to produce an extremely high degree of accuracy in apertured scanning discs. This has been combined with the use of a new optical correcting system, and the employment of incandescent lamps of high wattage in lieu of arc lamps. The result of this work was demonstrated recently using the German standard of 441 lines, interlaced, fifty frames per second, and the sharp clear pictures coupled with the absence of flares during sudden changes of light on the film were the subject of very favourable comment.

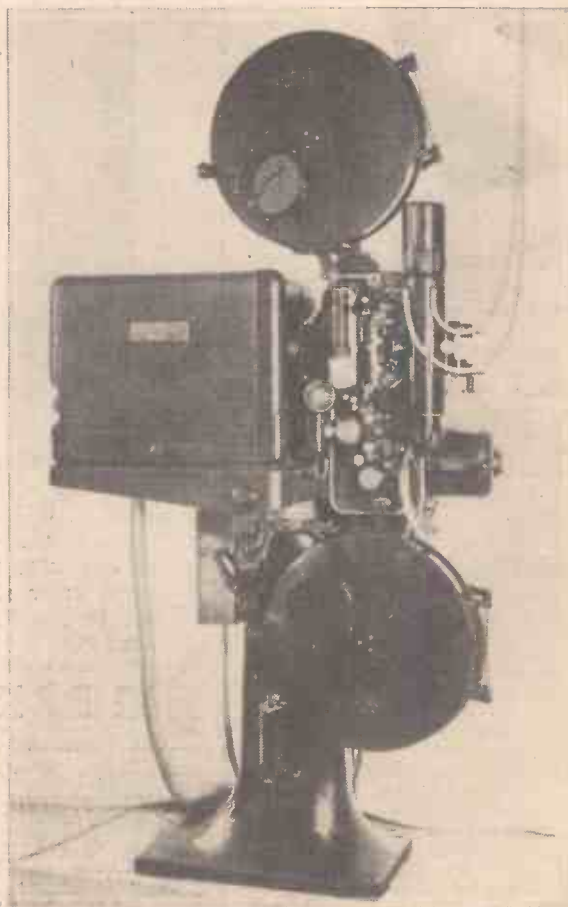

An example of a portable type of electron telecine scanner suitable for high-definition television.

On the other hand, it was felt that certain installations of a less permanent character will experience a measure of inconvenience, and difficulty, with mechanical scanners, which obviously need very careful setting up on the site to ensure accuracy in scanning, together with the correct operation of the multiplier type photo-electric cell used for providing the signal output. To meet these cases, therefore, a second type of film scanner has been developed, one form of which is shown in the accompanying illustration. It consists of a modified film projector with an incandescent lamp replacing the arc lamp, as shown on the right. Picture dissection and television signal generation are provided by an image dissector type in conjunction with an electron multiplier integral with the whole instrument. This is enclosed in the screened metal box shown on the left, and the whole equipment built up in this way makes a very compact installation suitable for those cases where a measure of portability is desirable, or alternatively where the scanner is to be employed for a series of demonstrations and is not to be a permanent feature.

## French Transmissions

In an effort to secure as much useful data as possible concerning the French television transmissions, the authorities in that country are now undertaking tests on a regular experimental schedule. Vision signals are being radiated in a carrier frequency of 46 megacycles (6.52 metres) with a peak power of 15 kilowatts, while the sound is being transmitted on 42 megacycles (7.15 metres); the power in this case being rated at 6 kilowatts. According to report the standard of definition used is 441 lines, interlaced, with 50 frames per second, but no final decision has been reached in this matter for the scheme to be adopted when the regular service is inaugurated.

dealers and stores, and so give pleasure to the suffering.

## A Sound Argument

The transmission of talking films will always form an important part of the usual type of programme matter featured in the television service. Just as gramophone records or other types of recorded items are dovetailed successfully into the ordinary aural broadcast programme, so news reels, short films, and even longer feature items are used to lend variety to the fare provided for those looking-in. A good deal of controversy still exists, however, as to the best type of scanner which can be employed for



# The "Rapide" Straight 3

## Further Constructional Details for this Easily-made Receiver

*Continued from Last Week, this Article Explains the Method of Wiring, Connecting the Dial Lights and Operating the Simple Detector-Two L.F. Set.* By FRANK PRESTON.

**L**AST week I explained the main features of this receiver and concluded by giving some details of construction. It is now possible to give additional constructional particulars. The first step is to prepare the condenser and drive for attachment to the baseboard.

To attach the drive, set the pointer to the left-hand end of the scale and move the vanes to the full-out position. Slacken the grub screws in the collar of the drive and press this over the condenser spindle. There is a metal bridge fitted to the drive and this can be affixed to the end-plate of the condenser by means of two screws supplied with the drive. Access to the screws is gained through two holes in the drum round which the cord runs.

The valveholders when bought will probably have the terminal heads on the underside as they are used when mounting the holder on a chassis. If this is the case, they must be taken out and reversed. Mounting of the other parts is straightforward. They should be attached to the baseboard by means of  $\frac{1}{2}$  in. round-head brass screws. It will be clear that the fixed resistors and the tubular .5 mfd. condenser are not fixed to the baseboard, but are held in place by means of the connecting wires with which they are provided. Mount the condenser and drive first, then the coil, terminal mounts, valveholders, L.F. transformer, component brackets and switches, in that order.

### The Wiring

Little need be said about connecting up, except that all wires should be kept as short and direct as possible. They can be fitted by baring the ends for about  $\frac{1}{4}$  in. and forming loops that fit the terminal shanks. Screw the terminal nuts tightly to ensure good and permanent contact. A soldered joint is desirable between the wire-end connectors of the two 25,000-ohm resistors and the .5 mfd. condenser, although it is possible to obtain a fairly satisfactory joint by tightly twisting the three wires together with a pair of pliers. It should be emphasised that this is only a poor substitute for soldering, and also that they should be similarly twisted even if the joint is to be soldered.

Lengths of single flex are used for the battery connections, although a seven-way battery cord could be used instead if preferred. If the batteries are to be housed in the same cabinet as the set, and this is generally to be preferred, the flexible leads can be kept quite short. Take care that the proper wander plugs and spade terminals are attached to the seven wires, because a mistake here might result in the fuse blowing or of the output valve being insufficiently biased.

### Dial Lights

It will be seen from the photographs and wiring plan that there are two dial lights attached to the condenser drive. These are wired as shown, the connecting

wires being soldered to the tags provided on the bulb-holders. If it is not required to illuminate the scale these connections can be omitted. The lights are worth while, especially if the receiver is to be used in a rather dark corner, but it must be remembered that the bulbs consume a certain amount of L.T. current. This objection can be overcome by employing only one bulb—which will give fair illumination of the whole scale—or by using low-consumption bulbs of the type specially designed for dial lights in battery sets.

Suitable bulbs are the Bulgin B.206, which cost 9d. each and consume only .06 amp. Even a single one of these is sufficient to make the station names visible in a darkened room. It is important that ordinary flash-lamp bulbs are not used, since a pair of these might well take more current than the three valve filaments, so making it necessary to have the accumulator charged at frequent intervals.

A point that calls for some explanation is the use of a double-pole on-off switch for wave-changing. As used, this only serves the same purpose as a three-point shorting switch, which costs a few pence less. The switch specified, however, can be used if and when it is proposed to employ a doublet or similar type of aerial. In that case the shorting wire between the two left-hand tags of the switch should be removed. The wire from terminal 5 on

the coil to the earthed metal baseboard should also be removed and replaced by another going to the switch tag that is then "empty."

The method of securing the flexible battery leads might be of interest. All leads are neatly grouped together, after which they are bound round with a short length of connecting wire. The bunch is then attached to the baseboard by means of a staple, which prevents the leads from being pulled adrift and adds to the neatness of the complete set.

### Battery Voltages

For the valves specified the H.T.+wander plug should be inserted in the 120-volt battery socket, plug G.B.—1 should be inserted into the 3-volt or  $4\frac{1}{2}$ -volt socket of the 9-volt G.B. battery and plug G.B.—2 should receive 6 volts bias for the initial tests. It might afterwards be found that slightly better results are obtained by reducing the voltage of G.B.—2 to  $4\frac{1}{2}$ , but that will entail a slight increase in H.T. current. If a 150-volt eliminator is used 9 volts G.B. should be applied to the small-power valve and  $4\frac{1}{2}$  volts to the second valve.

When using a very long aerial it might be found that selectivity is not quite as good as is required—although it is very satisfactory with a normal, modern aerial. In that case, the inclusion of a .0001 mfd. fixed condenser or a .0002 mfd. pre-set

(Continued overleaf)

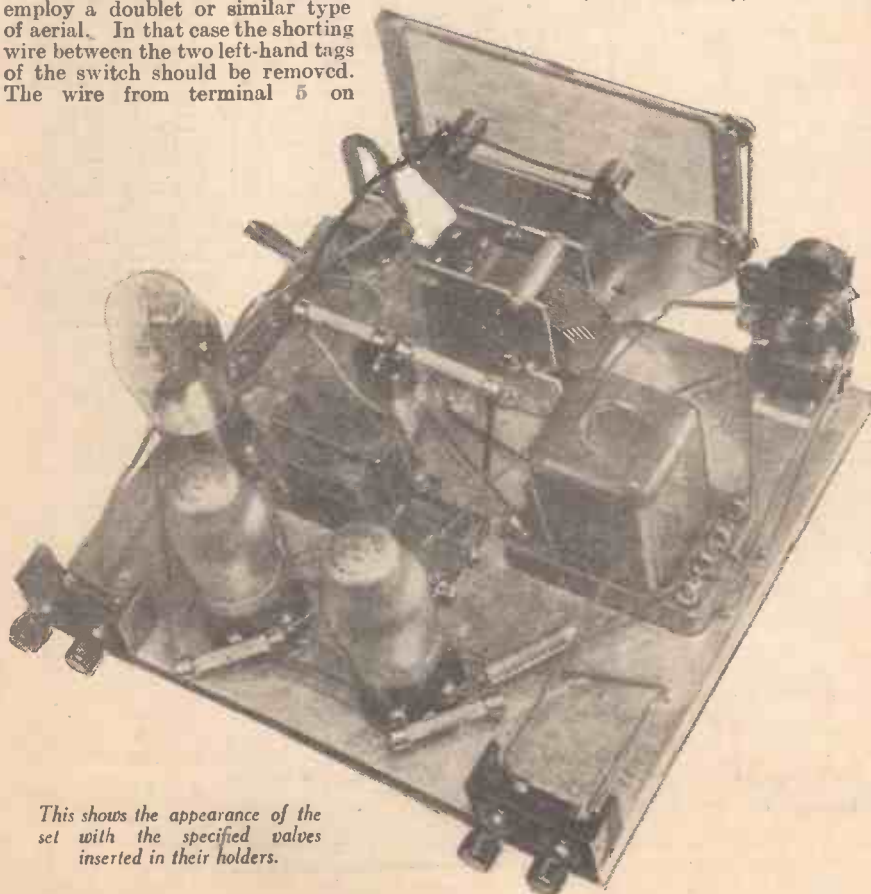

This shows the appearance of the set with the specified valves inserted in their holders.



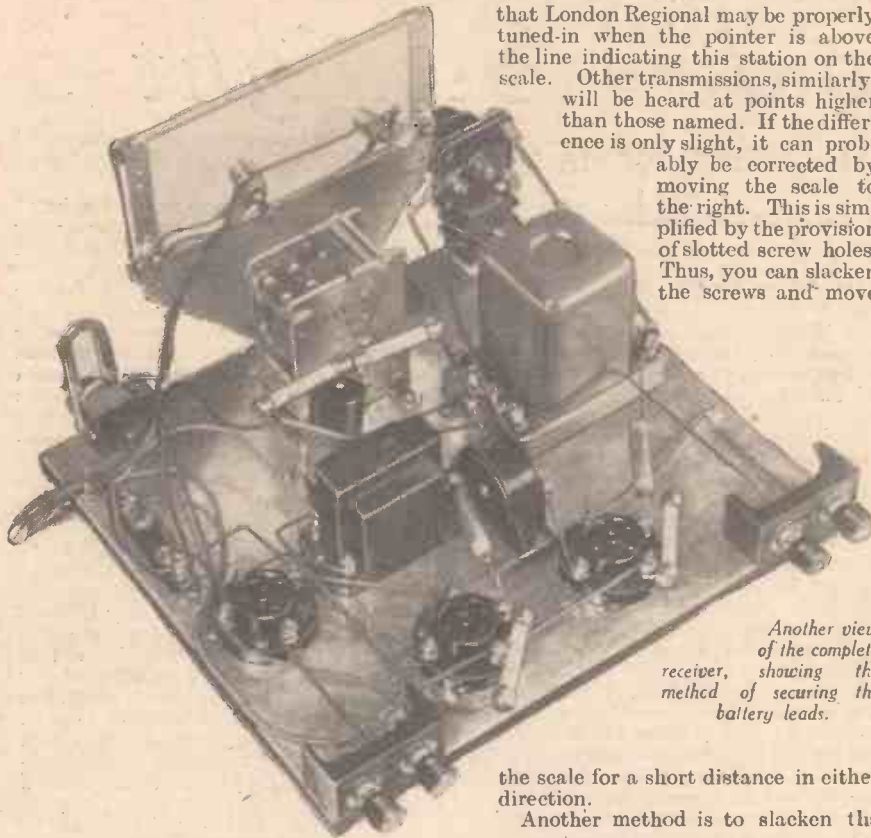

that London Regional may be properly tuned-in when the pointer is above the line indicating this station on the scale. Other transmissions, similarly, will be heard at points higher than those named. If the difference is only slight, it can probably be corrected by moving the scale to the right. This is simplified by the provision of slotted screw holes. Thus, you can slacken the screws and move

grub screws in the collar of the drive after tuning to a known station. Then hold the condenser vanes while the pointer is moved to correspond with the marking on the scale. When that has been done, the grub screws should be tightened, and all stations will then be received at approximately the correct points.

It is worth remembering that the condenser drive specified can be obtained with wavelength-only or degrees-only celluloid scales if preferred. In most instances this is an advantage only with a very sensitive receiver capable of bringing in a large number of transmissions.

### GERMAN TELEVISION RECEIVERS

IT is known that in Germany intensive research is being undertaken by the authorities concerned with the development of high grade electron cameras. Evidence of this was forthcoming at the demonstration given recently in Berlin. Electron cameras working on the storage principle of the Zworykin Iconoscope were well in evidence, and it is interesting to note that two forms were exhibited. One example was illustrated in our issue dated November 27th last. The larger camera used for the 441 line picture standard was designed for use more particularly with "close-up" pictures where mobility was not a material consideration. Lightness, ease of transport and mobility were the prime considerations of the smaller camera, however, so that it could be used in large

Another view of the complete receiver, showing the method of securing the battery leads.

the scale for a short distance in either direction. Another method is to slacken the

(Continued from previous page)

condenser between the aerial lead-in and the aerial terminal is justified.

On the other hand, when using an unusually short aerial, or when the set is installed at a fair distance from the nearest broadcasting station, it will generally be possible to sacrifice a certain amount of selectivity in order to obtain greater signal strength from more-distant transmitters. This can be done very simply, by transferring the wire-end connection of the .0002-mfd. tubular grid condenser from terminal seven to terminal eight on the coil. This slightly increases the damping effect of the valve on the tuned circuit, but allows a rather higher signal input to the detector.

After trying out the receiver it might be found that stations are not received exactly at the points indicated by the names on the tuning scale. It is possible, for example,

#### LIST OF COMPONENTS—"RAPIDE" STRAIGHT THREE

	No.	d.
1 Metallised baseboard, 10in. by 9in.—Peto-Scott	1	6
1 "Unigen" coil—Wearite	5	0
1 .0005-mfd. baseboard mounting condenser—Polar No. 5	4	6
1 Condenser drive with station names—Polar V.P. horizontal	6	6
1 .00015 mfd. differential condenser—Polar	3	0
3 baseboard mounting valveholders—W.B. rigid	2	0
1 H.F. choke—British Television Supplies: type 600	2	6
1 3/1 L.F. transformer—British Television Supplies	4	6
2 Component mounting brackets—Peto-Scott	0	8
1 On-off switch—Bulgin S.80.T.	1	6
1 Double-pole on-off switch—Bulgin S.123	2	6
4 Fixed resistors—2 meg.; .25 meg.; and two 25,000 ohm.—Dubilier 1 watt	4	0
3 Fixed tubular condensers—.0002 mfd.; .005 mfd. (type 300), and .5 mfd. (type 250)—T.C.C.	3	0
2 Terminal mounts—Belling-Lee	1	0
4 Terminals marked A, B, L.S., L.S.—Belling-Lee	1	2
5 Wander plugs marked H.T., H.T., G.B., G.B.,—1, G.B.—2—Belling-Lee	0	10
2 Spade terminals marked L.T.— and L.T.—Belling-Lee	0	4
1 fuse and holder, 100 mA.—Microfuse	1	6
Connecting wire, screws, flex, etc.	2	6
2 L.D.210 metallised valves—Tungsram	7	6
1 L.P.220 valve—Tungsram	4	9
1 120-volt H.T. battery—Drydex		
1 9-volt G.B. battery—Drydex		
1 2-volt accumulator—Evide		

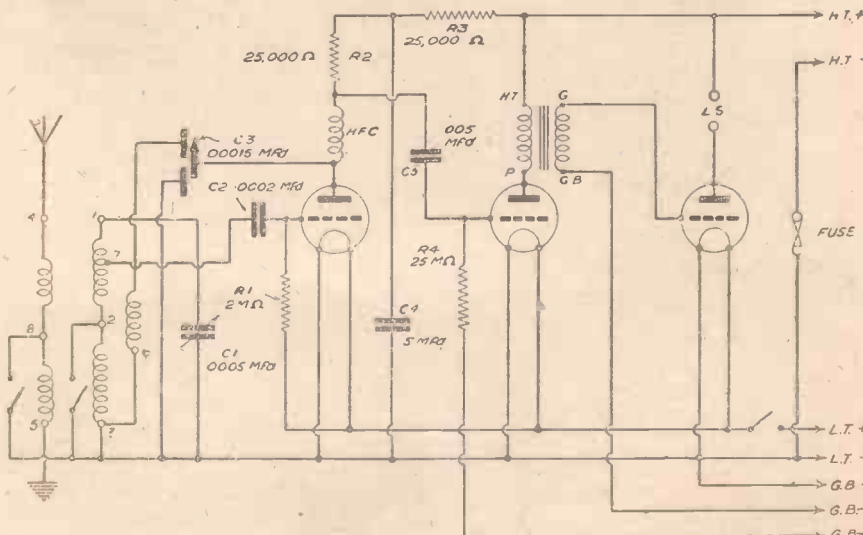

Theoretical circuit diagram of the "Rapide" Straight 3.

studios or for outdoor transmissions, which are generally regarded in Germany as television reporting. Mounted on a tripod stand or dolly truck, the camera has a pair of lenses completely hooded, the whole assembly being rather tall and robust. With the smaller camera, however, the optical view-finder scheme has been simplified very considerably to enable the operator to keep in correct focus any form of activity which is in evidence in the scene he is transmitting, say, for example, the rapid movement of players in a football match. The view-finder lens has exactly the same focus as the camera lens, the two being mounted side by side, as shown. Any adjustment made to the former is conveyed simultaneously to the latter. The view-finder lens to which reference is always made by the operator gives a sharp, clear and bright picture on a translucent screen about 3½ in. by 2 in., and everything seen on the screen is, of course, focused on to the signal plate of the camera. The adjustment of the camera is therefore simple and as convenient as that of the mirror reflex type of photographic camera.

A PAGE OF PRACTICAL HINTS

SUBMIT YOUR IDEA

READERS WRINKLES

THE HALF-GUINEA PAGE

**A Use For Old Condenser Plates**  
 THE accompanying sketches show a novel use for old condenser plates. The corners are bent, as shown, to form

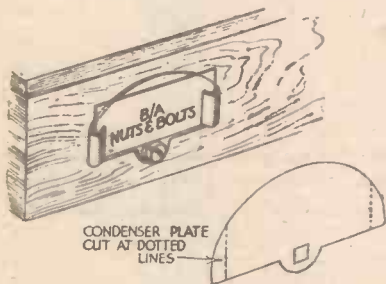

holders in which a card is placed, designating the contents of a drawer, or other container. I have fixed them on the front of all my drawers, cupboards, and sliding boxes, and I find the idea saves much time when looking for different small parts.—ANTHONY JOHNSTONE (Sheffield).

**Uses for Disused Fountain Pens**

A NEAT H.F. choke for short-wave work can easily be made from an old propelling pencil as follows: Take out the spiral from inside the body of the pen and with a hack saw cut off a suitable length of the tube, measuring from the end nearest the screw end cap (Fig. 3). Wind the wire as shown, leaving a space of 1/4 in. to 3/8 in. between the coils to reduce self-inductance. I used 36 gauge wire, shellac-varnished, and wound five coils of 40 turns each. The ends should be secured as shown,

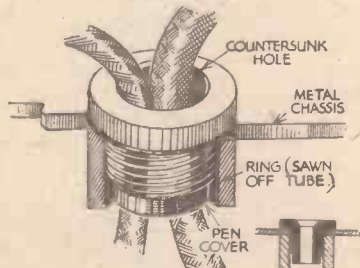

Fig. 1.—A simple "grummet."

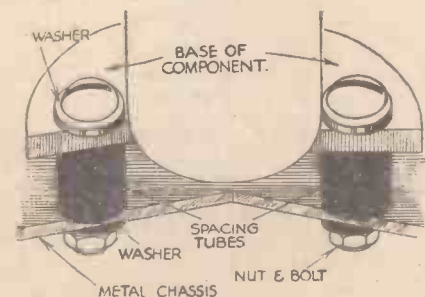

Fig. 2.—Insulating spacers made from short pieces of fountain-pen tubes.

**THAT DODGE OF YOURS!**

Every Reader of "PRACTICAL AND AMATEUR WIRELESS" must have originated some little dodge which would interest other readers. Why not pass it on to us? We pay £1-10-0 for the best wrinkle submitted, and for every other item published on this page we will pay half-a-guinea. Turn that idea of yours to account by sending it in to us addressed to the Editor, "PRACTICAL AND AMATEUR WIRELESS," George Newnes, Ltd., Tower House, Southampton Street, Strand, W.C.2. Put your name and address on every item. Please note that every notion sent in must be original. Mark envelopes "Radio Wrinkles." DO NOT enclose Queries with your wrinkles.

and the whole is screwed down to the base-board by drilling a small hole and screwing in the end cap from the underside. This type of choke is best suited for a metal chassis, as it gives a low-loss effect and is efficiently insulated.

Pieces of fountain-pen tube of convenient length can be used to space valveholders, chokes, etc., from a metal chassis (Fig. 2).

A greater efficiency and saving of wire will result if, instead of passing a wire, or bunch of wires, through a metal chassis by means of an ordinary hole, a "grummet"

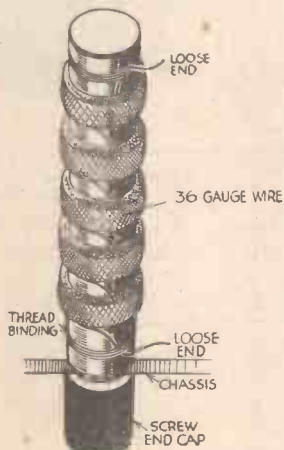

Fig. 3.—A neat short-wave choke.

is used, as shown in Fig. 1. By sawing off the top of an old fountain-pen sheath about 1/4 in. below the screw top, and drilling a hole through the screw top, a neat grummet is formed, if one half is passed through a hole in the chassis and the ring be screwed down on it.—J. L. N. BARKER, Junr. (Redcar).

**A Reaction Improvement**

ON those sets which employ reaction one has to have a nice sense of touch to apply it to the best advantage. One method which I have used successfully to lessen this disadvantage is shown in the sketch. I fitted a toothed wheel from an old clock to the spindle of the reaction condenser, and arranged for a spring to engage in the teeth of the wheel so that it gave a definite click every time it passed over a tooth.

The method of working is very simple.

One can keep one, two, or more "clicks" away from the oscillation point; or, again, one can start from zero and advance the

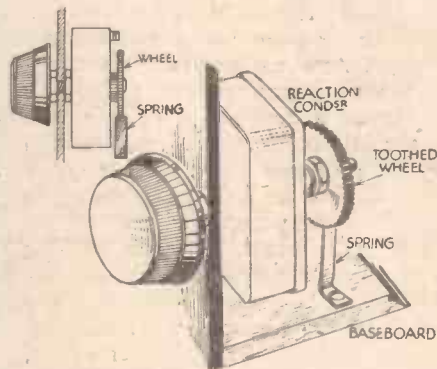

An efficient method of improving reaction control.

condenser the requisite number of clicks, according to the strength of the station. This method is not suitable for short-wave sets.—WM. NIMMONS (Belfast).

**An Aerial Coupling Unit**

THE accompanying sketch shows a neat aerial coupling unit which I made from an old coil assembly. It is for use with four-pin "plug-in" coils in short-wave sets, and greatly facilitates coil changing. I have had this unit in use in my short-wave converter for some time, and find it very efficient, even on 10 metres. I think the sketch is self-explanatory.

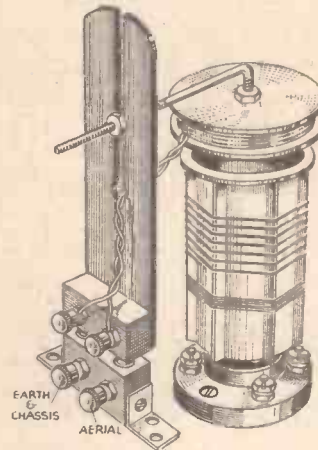

A plug-in aerial coupling unit.

The number of turns on the coil will have to be found by experiment, but I have found that three turns are sufficient. If the old coil assembly is not to be found in the "junk box" it can easily be made from a few pieces of ebonite.—WALTER F. HART (Trowbridge).

**The CYCLIST - - 2d.**  
 Every Wednesday.



# Room-to-Room

ALL the necessary constructional details were given in our pages last week, and thus there remains only the best method of wiring this unit, and suggested modifications which may be required for special circumstances. As the sub-stations all consist of low-resistance speaker units, it is important to keep down the resistance of the interconnecting wires, although up to a certain point there is not a great deal to be lost by this owing to the high step-up employed in the microphone transformer. However, nothing finer than ordinary bell-wire should be employed, and this will generally be found to be about 22 or 24 d.c.c. It is obtainable in single strand coils, or in twin patterns, the latter also being sold in two separate types—flat or twisted. The flat variety is generally provided with a single cotton covering overall and thus may be laid neatly along the wall and will not be obtrusive—even being dropped into a picture rail if the apparatus is being used in the home.

The wire is wound with two-colour



The finished master unit.

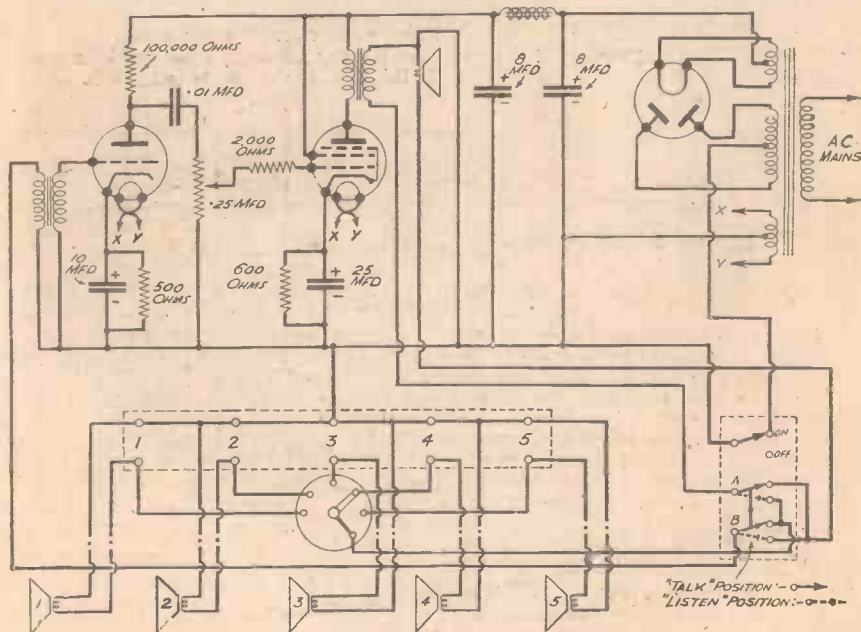

Theoretical circuit of the master unit.

cotton and thus it is possible to identify any particular lead if it is desired to carry out experiments with return earths as mentioned last

week. In the ordinary way, of course, it is not necessary to adhere to any special connections to the sub-stations, and there is no right and wrong way round for the connecting leads, unless a common earth return is used.

### Return Earths

One length of wiring may sometimes be saved by using a common earth, but there is a risk of overhearing when this is employed, as well as a reduction in efficiency, but for those who wish to try the arrangement, the lower terminals on the rear of the chassis (which are joined together with a single length of bare wire), should be earthed by means of a length of ordinary flex run from this set of terminals to the nearest sound earth connection—the earthing pin on the three-wire electric plug would be ideal. At the sub-stations a wire will then be joined from one terminal on the loudspeaker to the

### LIST OF COMPONENTS FOR ROOM-TO-ROOM COMMUNICATIONS

- Two 8 mfd. electrolytic condensers, type 502 (T.C.C.).
- One 10 mfd. electrolytic condenser, type 521 (T.C.C.).
- One 25 mfd. electrolytic condenser, type 511 (T.C.C.).
- One .01 mfd. fixed condenser, type 300 (T.C.C.).
- One 100,000 ohm 1 watt resistor (Dubilier).
- One 2,000 ohm 1 watt resistor (Dubilier).
- One 500 ohm 1 watt resistor (Dubilier).
- One 600 ohm 1 watt resistor (Dubilier).
- One L.F. smoothing choke (B.T.S.).
- One volume control .25 megohm, type V.C.62 (Bulgin).
- One mains connector, type P.20 (Bulgin).
- One 5-way rotary switch, type S.119 (Bulgin).
- One signal light, type D.19 (Bulgin).
- One mains transformer, type E.P. 20 (Varley).
- One microphone transformer (Bulgin).

# Communication

Further Notes on the 5-Way Communicator, and Some Suggested Modifications for Special Requirements By W. J. DELANEY

nearest earth point—again using the earth of the electric mains if possible. As, however, the earth will be common, and in some cases a shorter earth will exist between two sub-stations than from a sub-station to the master, it may be found that leakage of signals will occur, and a faint signal may be heard from another station. The twin-wire method of connections is therefore advised and the additional expense is very small.

### Alternative Output

In the published design provision is made for feeding five sub-stations, but it is possible to modify this arrangement so that from 3 to 10 stations may be used, the only alterations for this purpose consisting of the substitution of an alternative switch and the necessary change in the terminals on the rear of the chassis. Messrs. Bulgin sell a three- and a four-point switch of similar design to the five-point component recommended, and these may be used in its place. The terminals will be adjusted accord-

ingly. Alternatively, one of the 10-point switches, type S.160, may be used, and if it is not desired to use all

10 points at the present time, only those points needed may be wired up and the remainder left blank.

### Modifications

The apparatus so far described may form the basis for numerous experiments, and the lines upon which these may be based are as follows. Firstly, it may be found worth while to incorporate a buzzer circuit so that when the user of the master unit wishes to speak to a sub-station he may first call by means of the buzzer. By running additional wires between master and sub-station this buzzer circuit may be operated by a push-button on the sub-station and this will enable the master to be called. Unless it were desired to keep all sub-stations connected at one time, a signal indicator would have to be used with this arrangement to enable the master, after being called, to select the appropriate station.

By providing a further ampli-

station, utilising the same form of selector switch, and making each sub-station more or less a replica of the master. It is, of course, possible to carry out any desired two-way communication without such elaborate schemes, but the wiring between units becomes more complicated, and relays have to be employed.

An interesting series of experiments may be carried out by those who are interested in avoiding the change-over switch for talk and listen. It is possible to include the speaker in the grid circuit and at the same time to leave it in the anode circuit of the output valve, so that it is possible to talk into the master and whilst addressing a distant listener the latter can answer back, thus causing the master speaker to act both as mike and speaker at one and the same time. The main difficulty with this scheme is to prevent a howl from being set up, similar to that which occurs when a microphone and speaker are placed close to each other. Such a scheme improves the value of the apparatus.



View of the chassis which is employed in the master unit.

### COMPONENTS.

#### COMMUNICATOR (5-WAY).

- 10 terminals (5 red, 5 black) (Clix).
- One four-pole Dewar switch, type 81 (Electradix).
- One chassis, 10in. by 8in., metallised surface (Peto-Scott).
- One cabinet (Peto-Scott).
- One 41 MHL valve
- One MP/pen valve } (Cossor).
- One 506 BU valve }
- One Midget Stentorian speaker, type 37M. (W.B.).

#### SUB-STATIONS

- One Midget loudspeaker, type 37M. without transformer (W.B.).
- (One for each sub-station).
- Cabinet to suit above, and to harmonise with room furnishings (Peto-Scott).

fier in each sub-station, designed on the lines of the master circuit, it is possible, with additional wiring, for any sub-station to call the master or a separate





# NEW TIMES SALES S.G.3

Full Details and Test Report of a Neat and Low-priced Three Valver Supplied by New Times Sales Company

THE accompanying illustration shows a neat and efficient three-valve receiver which is obtainable from the New Times Sales Company for £3 7s. 6d. The general appearance of the receiver will be seen to be extremely neat and simple, providing not only a tidy appearance in keeping with any ordinary type of furnishing, but also possessing a simple layout of controls which will be found most effective in using the receiver. The circuit is the well-tried and tested H.F.-detector-L.F. combination, which is, of course,

number of station names found on some dials results in confusion and difficulty in finding a given station setting. The inside of the cabinet is divided into two sections, the upper being reserved for the speaker and batteries. The speaker which is supplied is of the 8in. cone type—permanent magnet—and is provided with a matching transformer to provide a suitable and correct load for the output valve employed in the set.

The chassis is provided with a multi-lead battery cord, and this has two H.T. positive plugs. In use it will be found that a critical value is required on one of these plugs, as will be mentioned in the test report to follow. An interesting point in the general design of the receiver is in the type of material which is employed for the loudspeaker opening. In place of the usual silk or gauze which is so often utilised, in this receiver the makers have employed a woven covering carried out in two-tone material resembling ordinary string. This is called by the makers "synthetic mache," and the method of plaiting, and the combination of the two colours lends a novel and pleasing appearance which is quite a change from the usual type of covering, employed for speaker openings.

The tuning scale is provided with a lamp connected to a bracket which moves with the transparent pointer, and thus it is very easy to obtain an accurate wavelength setting. On the receiver which we had for test the wavelength settings were substantially correct, only the long-wave section being slightly out. It was found that the two circuits were accurately aligned and no re-trimming was necessary whilst the wave-change switch operated efficiently and noiselessly. This would appear to be one of the strong points of the receiver, as the wave-change switch is one of the components which gives rise to most trouble, either due to noisiness arising from the fact that the contacts become dirty, or because the movement does not provide a cleaning action. The weakening of springs is also a fruitful source of trouble, but the switch on this receiver would appear to be of a type which will not give rise to any of these troubles. The measured H.T. consumption is only 9mA and the L.T. consumption is not excessive, although a saving may be obtained by fitting an on/off switch in the dial-light circuit so that this may be switched off after a station has been located. The majority of the English B.B.C. stations were received at good volume, whilst the main Continental stations also provided good loudspeaker signals. On the score of selectivity, it was not found possible to obtain Fécamp free from the National, but by the judicious use of reaction and the H.F. volume control, it was possible to listen to the former station with only a very slight background from the National. The Midland was clear of interference from both of the Nationals. On the long waves Luxembourg was just about the same as Fécamp so far as concerned the background from Droitwich, but in other respects this band was well up to the standard of an S.G. three of standard design. The tone was pleasing and well balanced, without undue trace of cabinet resonance, and the receiver should thus be found quite suitable for all normal purposes where a simple straight type of circuit is required for home reception.



A general view of the receiver in domestic surroundings.

available in several different forms. In this receiver the H.F. stage is occupied by a variable- $\mu$  S.G. valve, the detector stage by a triode, and the output stage by a standard pentode. Thus, one might expect maximum amplification and selectivity, with good control of selectivity and volume—an expectation which is fully borne out on test. The coils are of the screened type and are spaced on either side of the two-gang condenser, not only to simplify the wiring, but also to provide adequate screening between leads and other parts. The valves are symmetrically disposed at the rear of the chassis, and a fuse is included on the chassis to afford protection from accidental short circuits.

## The Controls

In addition to the main tuning control seen in the centre of the panel, the remaining controls are for wave-change and on/off switching, reaction and volume, the latter two controls providing best results when used in conjunction with each other. The tuning scale is of the full-vision type and is calibrated in wavelengths, although no station names are marked thereon. Rather than this proving a disadvantage, many listeners prefer a plain dial as the large

## Test Report

The receiver was tested on our standard aerial system, and proved fully up to our expectations. The wavelength covered on the two-range coils was from just below 200 metres to a point slightly above 550 metres and from 900 to 2,100 metres. In each case it was found that the type of aerial and earth connection had a very small effect upon the wave-band covered, but it only amounted to a few degrees.

## SPECIFICATION

RECEIVER: S.G.3.

MAKERS: New Times Sales Co.

CIRCUIT: S.G. H.F. stage (variable- $\mu$  volume control), triode detector, with pentode output stage. Two tuned circuits, tuned with a two-gang condenser, wave-wound air-core coils used, and individually screened. Permanent magnet moving-coil loudspeaker with provision for external speaker. Tuning range 200 to 550 and 900 to 2,100 metres.

GENERAL REMARKS: Substantial construction on pressed steel enamelled chassis. Cabinet work neat and in keeping with modern design.

PRICE: £3 7s. 6d. Overall dimensions 19½in. high, 14in. wide, and 10in. deep.

## AN ALL-STAR CONCERT

ON Sunday next, December 12th, readers will obtain a splendid opportunity of seeing their favourite radio stars in person at a Gala Concert to be held at the London Palladium. This concert, organised by Felix Mendelssohn and Edward P. Genn in aid of the Centenary Rebuilding Appeal for the School of the Blind at Swiss Cottage, is claimed to be the greatest constellation of stars ever assembled in one programme. Such eminent artists as Larry Adler, Afrique, Les Allen, Arthur Askey, Max Miller, Navarre, Clarkson Rose, Revnell and West, Muriel George and Ernest Butcher, Bransby Williams, Dorothy Dickson, Elsie Carlisle, and dozens of other radio stars, together with combinations such as Joe Loss and his Band, Mantovani and his famous Orchestra, have promised to appear, and the Compères will include Sutherland Felce, Eddie Pola, Hugh E. Wright, Gordon Harker and Michael Carr. Prices of admission range from 2s. (all seats bookable), and the concert is timed to commence at 7.15 p.m. Doors open at 6.45 p.m.



### ATTRACTIVE CHRISTMAS GIFTS

THE pleasure which a gift brings is so much greater when the present is one that is really acceptable, and a little extra care and thought in selecting gifts will ensure that there are no disappointments. For instance, Cigarettes cannot fail to be appreciated, and the extensive and attractive range of packings containing their famous brands introduced by Messrs. W. D. & H. O. Wills are certain to be in great demand. The beautiful Oak Cabinets which have made such a wide appeal in previous years are again available in the following sizes to contain either "Gold Flake" Special or "Capstan" Special Cigarettes:—

Oak Cabinet containing 50 Cigarettes at 3s. 10d.; Oak Cabinet containing 100 Cigarettes at 6s. 6d.; Oak Cabinet containing 150 Cigarettes at 9s. 6d.

The 100's Oak Cabinet is also supplied containing "Three Castles" Cigarettes at the price of 8s.

The ever popular "Gold Flake" and "Capstan" Cigarettes (50's and 100's boxes and tins), and "Three Castles" Cigarettes (50's and 100's boxes), are enclosed in handsome Christmas cartons at no extra charge.

The 150's tins containing "Gold Flake" or "Capstan" Cigarettes at the price of 7/3, are lines of special interest.

The world-famous "Woodbine," and "Star" (Plain and Cork Tipped) Cigarettes are also put up in attractive Greetings cartons containing four 15's, at a cost of 2/-.

In Cigars Messrs. Wills offer a selection which should make a wide appeal. The range includes such well known names as "Embassy," "Legation," "Rajah," "Ivanhoe" and "Wills's Whiffs," the 12's tin and the 25's box of the last named being enclosed in special Christmas cartons.

### NEW SERIES OF TALKS

THE B.B.C. announces that during the Christmas holidays a series of talks which are likely to be of interest and value to school children will be broadcast. The talks will be given bi-weekly at two o'clock on Tuesdays and Fridays from the Regional and National transmitters respectively. The scope of the talks will be very varied. They will range from straight talks to dramatic features, book talks, and so on.

The two opening broadcasts, on Tuesday, December 14th, and Friday, December 17th, respectively, are entitled "Climbing in the Rockies" and "Singing Carols." The first of these will be by Kitty Trevelyan, and the second by Dr. Thalben-Ball, Organist of the Temple Church, and six Temple choirboys.

It should be emphasised that while these talks are designed with the general listening public in view, they will be of unquestionable value to school children who may care to listen to them at home, or be given the chance to do so at school should the term still be in session.

### NEWNES' TELEVISION AND SHORT-WAVE HANDBOOK

2nd Edition

By F. J. CAMM

Price 3/6 or 4/- by post from the Publishing Dept., George Newnes, Ltd., Tower House, Southampton Street, Strand, London, W.C.2.

# PETO-SCOTT EVERYTHING ALL-WAVE

## D-MASTER

**KIT "A" CASH or £3:15:0** 7/- down C.O.D.  
Comprises complete kit of specified parts, but less valves. Cash or C.O.D. £2/9/6 or 7/- down and 11 monthly payments of 7/-.  
**VALVES** If set of specified valves required add £1/2/3 to Kit Price or 2/2 to deposit and each payment.

## =RAPIDE STRAIGHT 3=

**KIT "A" CASH or £2:9:6** or 4/6 down C.O.D.  
Comprises complete kit of parts as specified, but less valves. Cash or C.O.D. £2/9/6 or 4/6 down and 11 monthly payments of 4/8.  
**VALVES** If set of specified valves required add 12/3 to Kit Price or 1/2 to deposit and each monthly payment.

## XMAS RADIO DE-LUXE

**5-valve ALL-WAVE A.C. SUPERHET RADIO/GRAM CHASSIS** with 5 British Valves and Moving-Coil Speaker  
**LIST VALUE £10:0:0**

**OUR PRICE £6:6:0**

- 3 Wavebands -18-50, 200-550, 900-2,000 metres.
- Automatic volume control on two stages.
- Bandpass on all stages.
- Mains input filter.

5 British Valves: Hexode as Detector and oscillator, Variable-mu H.F. Pentode as I.F. amplifier, Double diode-triode for second detection, A.V.C. and 1st L.F. amplification. High slope output pentode, 3 position wavechange switch for 3 bands and gram. Each band separately dial lighted. Provision for extension speaker. Combined on-off switch and volume control. Separate tone control. A.C. Mains, 200-260 volts, 50-100 cycles. Output 5 watts. Complete with Valves and High-Fidelity Field-Energised 8" cone Moving-coil Speaker illustrated. Cash or C.O.D. £6/6/0, or 7/6 down and 15 monthly payments of 7/11.

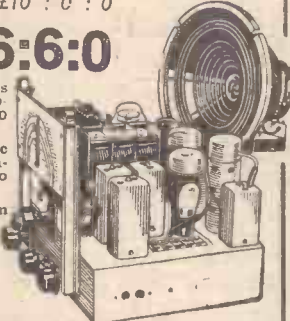

7/6 DOWN

## BUY YOURSELF A NEW SPEAKER FOR XMAS

**MODEL 38S** (illustrated). Further improvement on the famous W.B. Senior 378. New higher flux density and increased sensitivity. Microdiode device for matching any receiver. Cash or C.O.D., Carr. Pd. £2/2/0, or 2/6 down and 11 monthly payments of 4/-.  
**MIDGET MODEL 38M.** A new thoroughly efficient permanent magnet moving-coil speaker in extremely compact form. Complete with 3-ratio transformer. Cash or C.O.D. Carr. Pd. 17/6, or 2/6 down and 7 monthly payments of 2/6.

**W.B. "ELLIPSIS" MODEL.** With elliptical cone for receivers where height of speaker opening restricted. Nipernag magnet. Whiteley speech coil. Microdiode universal matching device. Cash or C.O.D. Carr. Pd. £2/2/0, or 2/6 down and 11 monthly payments of 4/-. All the new W.B. Chassis Pedestal and Cabinet models on similar Easy Terms.



2/6 DOWN

## AN IDEAL XMAS GIFT

**PILOT 8-IN-1 EXPERIMENTERS KIT**  
Buy this new Kit for Xmas and you can build 8 short-wave sets one after another. Never before has the constructor been given such a wonderful opportunity for experimenting.

**Every Circuit a Winner 8-in-1 KIT**  
Comprises all highest grade components, ready drilled chassis, panel, and crinkle finished steel cabinet. 8 coils and 16 working drawings to build 8 sets. Cash or C.O.D., £4/8/0, or 7/6 deposit and 11 monthly payments of 7/6 8/- Down  
Set of 4 Valves, £1/7/6, or add 2/9 to deposit and 2/6 to each monthly payment.

ORDER NOW FOR XMAS

## 1-valve ALL-WAVE KIT

See page 382 of this issue.

## BATTERY RECEIVER

## WORLD-WIDE RECEPTION!

**List Value £2:0:10**  
**OUR PRICE 29/6**

Cash or C.O.D. Carr. Pd. or 2/6 down and 11 monthly payments of 2/8. A unique All-Wave single-valve combining simplicity of assembly with extraordinary efficiency and low cost. Ready assembled tuning unit incorporates all windings and need only six simple connections for incorporation in the circuit. KIT "A" comprises all parts including ready drilled steel panel and chassis, drawings and instructions, less valve and cabinet.  
● Waveranges 18-52, 200-550, 900-2,000 metres. ● A unique All-Wave single-valve combining extraordinary efficiency with low cost. ● Ideal for the experienced DX Fan and novice alike. ● Stove enamelled steel chassis. ● Slow motion tuning. ● Air-spaced Tuning Condenser.

## 2-valve L.F. AMPLIFIER KIT

(Battery Operated). Audio Amplifier Kit, for connecting to the 1-valve All-Wave Kit (above) to boost up signal strength to enable speaker to be used instead of headphones. Equally suitable for almost any 1-valve or crystal set. KIT "A" comprises all parts including drawings and instructions less valves. List Value 19/9  
Peto-Scott's Price, Cash or C.O.D. **15/-**

## COMPLETE 3-valve ALL-WAVE KIT

Comprises Complete Kit of parts for constructing 1-valve All-Wave Receiver and 2-valve Amplifier, and Metal Cabinet illustrated, including all drawings and set of 3 valves. List Value, £410.7. Peto-Scott's Price, Cash or C.O.D. £31/6, or 5/- down and 11 monthly payments of 7/3.

## ★ YOU NEED THIS! FREE SEND NOW!

Peto-Scott RADIO and TELEVISION CATALOGUE.—No matter whether you require a small condenser or a 9-valve All-Wave Superhet Receiver, Peto-Scott will supply you by post, either for Cash, C.O.D., or on Easy Terms, at astonishingly low prices, made possible only by our direct-to-customer method of trading. Every item in the new Peto-Scott range of quality Radio apparatus is described and illustrated in a coloured art catalogue sent free to all for 14d. stamp.

## WONDERFUL CASH OFFER

## of PETO-SCOTT ELIMINATORS

### MODEL A.C.12 CASH or 25/- C.O.D.

This efficient model is suitable for sets operating on output of up to 12 m/a. For A.C. Mains 200/250v., 40 to 100 cycles. Output 120 v. at 12 m/a. 4 tapping: 60v., 75v., 90v., and 120v. Or 2/6 down and 10 monthly payments of 3/-.

### MODEL M.A.10/30 CASH or 39/6 C.O.D.

A super model that is justly famed as one of the best on the market, this outstanding unit incorporates a Trickle Charger, which re-charges a 2-volt L.T. accumulator at 0.5 amp. For A.C. Mains 200/250v., 50/100 cycles. Wathtight Metal Rectifier. Four H.F. tappings: Screen, Detector, Medium Power, High Power Output 20 m/a. at 120 volts. Or 5/- down and 11 monthly payments of 5/8.

## Ensure Good Xmas Listening With a Peto-Scott

## ALL-WAVE AERIAL

Increases signal strength on all bands. Improves selectivity. Waterproof and Weather-proof. Two transformers. Outfit comprises Duplex lacquered aerials, insulators, waterproof "lead-in" wire, aerial and set transformers, with instructions for erection. Cash or C.O.D. 17/6, or 8 monthly payments of 2/6.

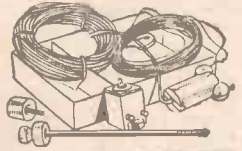

2/6 DOWN

## POST THIS COUPON NOW

PETO-SCOTT CO., LTD. 77 (Pr.W.15), City Road, London, E.C.1. or 62 (Pr.W.15), High Holborn, London, W.C.1.

Please send me..... for which I enclose £ : : Cash/H.P. Deposit. Also please send me gratis the Peto-Scott Radio and Television Catalogue and the Pilot "Short-Wave Experimenter." I enclose 2d. (stamps) to cover postage.

NAME .....  
ADDRESS .....

All P.O.'s must be crossed and currency registered.



# PETO-SCOTT UNIT SET

AS mentioned last week some interesting Unit sets are now available from Messrs. Peto-Scott and form admirable Christmas presents which may be improved from time to time by simple modifications. The 1-valve All-wave Kit is an admirable gift for anyone who is just starting radio construction, and as is shown by the wiring diagram which is given on

## Wiring Details

This drive is mounted on the chassis by means of two bolts, and the condenser is held in position on the drive by its own one-hole fixing bush. The majority of the wiring may be carried out without soldering—there being only two or three points where the manufacturers have not provided terminal connection points. There are very

few wires needed to connect up this one-valve unit and it may be employed as it is, with headphones, or may be coupled to the special 2-valve amplifier kit which is made on similar lines. It will be seen from the wiring diagrams that the two output terminals are situated in the centre of the rear edge of the chassis, and the input terminals for the amplifier are similarly disposed. Thus the two units, which are built on similar chassis, may be coupled together in the very simplest way by short lengths of flex between the adjacent terminals, or by using plug-and-

tail much additional wiring, and very few additional parts, although the chassis could also be utilised to convert the 1-valver into a detector-L.F. set. This type of kit apparatus, designed on the Unit system, will no doubt be found of great value to those who are interested in experimenting with the minimum of trouble, and the chassis, being made from steel, are robust enough to stand up to any amount of handling and need not be scrapped after each change. The price of the kit for the 1-valve set is £1 9s. 6d., which actually represents a saving over the price of the individual components, which come to over £2. The kit is obtainable on easy payment terms of 2s. 6d. down and 11 monthly payments of 2s. 9d. The 2-valve amplifier kit costs £2 4s. 6d. (actual list price of the individual parts £3 0s. 7d.), and this also may be obtained on easy terms—2s. 6d. deposit and 11 monthly payments of 4s. 3d. Further details of these two units may be obtained direct from Messrs. Peto-Scott, by writing for leaflets 18/71 and 18/72.

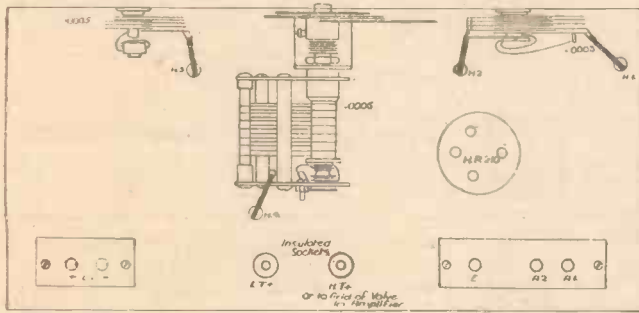
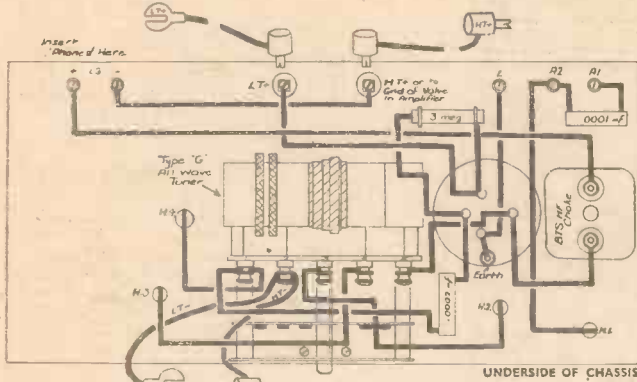

Wiring diagram of the 1-valve All-wave Set.

this page, the constructional work is very small indeed. The metal chassis is ready drilled with all the necessary holes, and the coil unit is ready mounted on the special selector switch with which it is used. This all-wave tuning unit is of novel design, and incorporates a standard dual-range coil wound on a 1in. paxolin former, with the addition of a special short-wave coil, the two separate units being mounted at right-angles on a rectangular paxolin plate. A low-loss multi-contact switch is mounted on the same plate, distance pillars being used in all cases to provide the necessary spacing, and a special locating plate is provided which has a one-hole fixing bush of standard design. Thus the entire unit—coil, wave-change switch and locator plate—is mounted at one and the same time by a simple one-nut fixing, and there are only five connections to be made to the supporting plate. It may thus be said that the construction of this particular all-wave receiver is no more difficult than the building of a simple one-valver.

The tuning is carried out by means of a standard .0005 mfd. condenser, and this is also a simple matter to mount, as it is employed in conjunction with the chassis-mounting disc drive.

socket connections. The 1-valver will then operate a loudspeaker without difficulty, and should it be necessary at any time to economise or remove the amplifier, the phones may be joined to the 1-valve chassis so that reception may still be obtained.

It will also be noted that the chassis which is supplied with the 1-valve kit has a hole drilled to match that used for the detector valve-holder, and thus it is possible to modify the circuit, should it at any time be found desirable to do so, and a periodic H.F. stage, for instance, could be added to increase the range of the set. This would not en-

**A FINE BOOK FOR THE BEGINNER!**  
 AND A USEFUL PRESENT  
**EVERYMAN'S WIRELESS BOOK**  
 (2nd Edition)  
 By F. J. CAMM  
 3/6 or 4/- by post from George Newnes, Ltd., Tower House, Southampton Street, Strand, London, W.C.2.

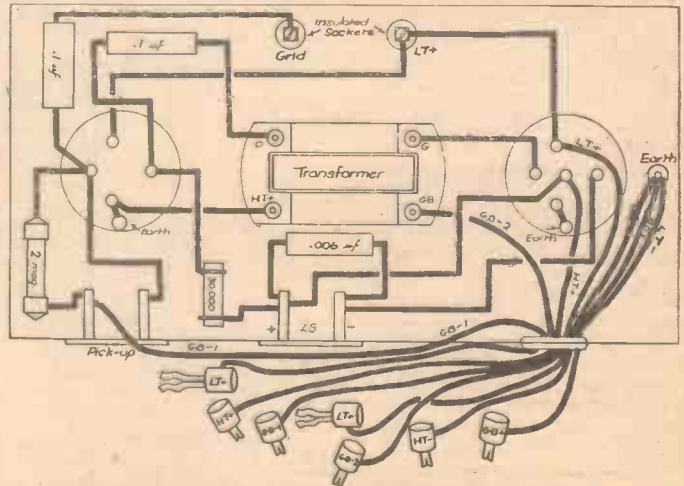
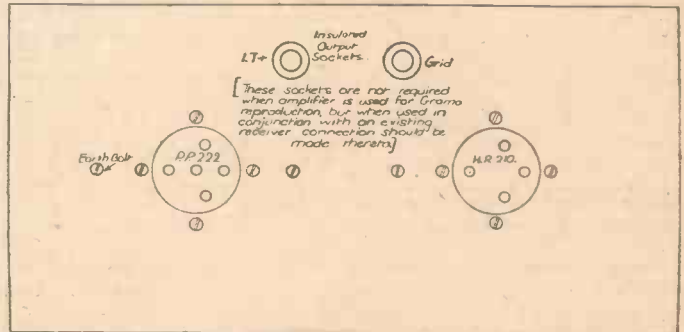

Wiring diagram of the 2-stage L.F. Amplifier Unit.





**SHORT-WAVE SECTION**

(Continued from previous page)

tuning-condenser connections should be broken, so that one lead from the output terminals goes to the grid condenser and the other to the earth line.

With these connections an existing three-valve det.-L.F. receiver becomes a five-valve short-wave superhet of fairly efficient type. It should have a long range and will easily operate a speaker on most signals. Speaker operation will still be possible if the receiver is only a two-valver, but 'phone reception will be better for real "DX stuff."

**Transformer Trimming**

Having connected up the three parts of the complete receiver, it will be worth while to spend a little time making careful adjustment of the I.F. transformer trimmers. First turn the adjusting screw of the trimmer operating on the primary of the first transformer (this will be nearest to the primary terminals). Turn the screw fully down and then right up, to ascertain the range of

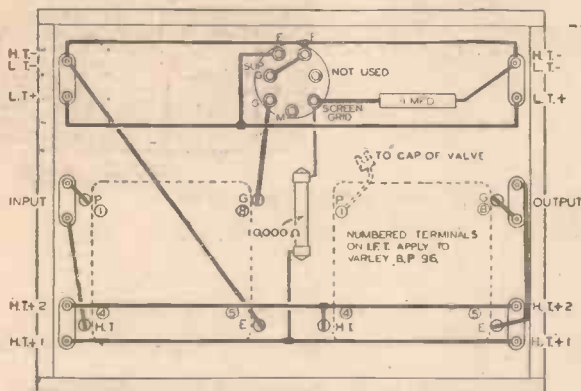

Fig. 4.—Wiring of the unit. Connections are shown for both four- and seven-pin valves. With some metallised seven-pin valves, the terminal marked M should be connected to H.T.—.

movement, and then set it to its midway position. Tune in a fairly weak signal that is not subject to noticeable fading. You can then set each of the other trimmers in turn until adjustments are found at which signal strength is at its maximum. Once proper adjustments have been made the trimmers should be left entirely alone.

If a receiver is not available for connection to the two units you might care to use a crystal detector in conjunction with a pair of 'phones and a .001 mfd. by-pass condenser connected as shown in Fig. 5. It will be seen in that diagram that the earth terminal of the I.F. transformer is connected to the earth line through the 'phone connections. This crystal detector arrangement will permit of good 'phone

reception, although the use of a speaker will, naturally, be precluded.

In a later article of this series we will describe the construction of a valve-detector unit suitable for direct connection to the two units already made. That will be followed by details of a low-frequency amplifier for connection after the detector.

**Mains-set Connections**

We must now devote a little space to a few of the interesting letters that have been received during the past week. All of those calling for reply have been answered through the post, but some of them were simply in the form of constructive criticism or helpful suggestions. One is from A. G. Stirling, of Edinburgh, and it refers to this

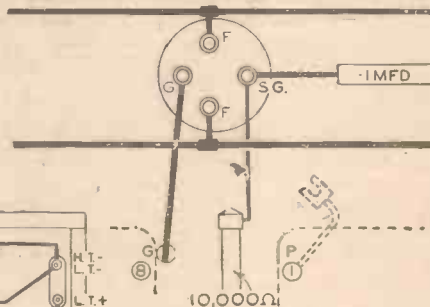

printed on page 277 of the issue dated November 20th, and suggests that the trouble experienced is due to the reaction winding "taking charge" of the tuning,

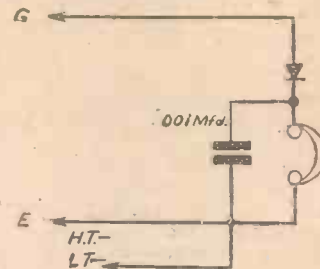

Fig. 5.—A simple crystal detector unit for use as second detector.

with the result that, "as reaction drops, signal strength drops too." He also sends the circuit of his short-wave converter, which apparently gives good results. It will no doubt be of interest to many readers, so we show it in Fig. 6.

Another of our correspondents asks: "What is the difference between a pentagrid and a heptode?" The answer is that there is no difference. A pentagrid has five grids (penta=five) plus the anode and cathode; a heptode has seven electrodes (hept=seven), these being five grids, plus anode and cathode.

**More Letters**

L. R. Hale, of Staple Hill, near Bristol, wants still more "Q" articles and asks: "What about giving us "Q" men the low-down on building a four-valve "straight" set to work from a 6 or 12-volt car battery?" What do others think?

Mr. G. S. Deadman sends us a long and interesting letter thanking us for our "quality" articles and encloses a very

series of articles. This correspondent writes: "I am very interested in your new series... but why must you always honour the battery user? If you could only put in the mains connections in broken lines I am sure a large number of readers would appreciate it." Later he states that he now always uses mains valves "as they are more efficient and cheaper in the long run."

Now we agree with his last remark, but we have to attempt to please the majority of readers. And most of those who have been good enough to write have been in favour of battery operation. Perhaps some of those who agree with Mr. Stirling's ideas will write and say so. We want to please everybody, despite the difficulty of the task. We are afraid, however, that our correspondent's first suggestion is not practicable. You cannot design one and the same set for battery and mains operation; each must be considered separately. This is largely because of the extra decoupling and additional wiring required in a mains set.

**Reaction "Taking Charge"**

Reader J. Douglas, of Shantallow, Londonderry, writes about the circuit

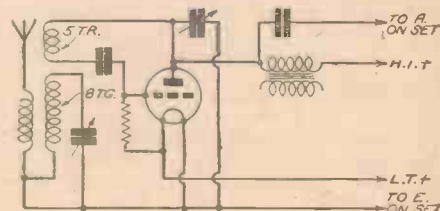

Fig. 6.—A reader's circuit suggestion.

neat circuit diagram of his own four-five valve receiver. He also gives full details of it. Unfortunately, the space placed at our disposal is already exhausted, so we propose to pass the letter over to the Editor, who might see fit to publish it in the "Letters" page. Cheerio and 73's.

**The Moscow Chimes**

TO commemorate the twentieth anniversary of the Lenin Revolution the sixteenth-century clock installed in the St. Saviour's Tower, Moscow, has been specially repaired. Originally crudely constructed of cast and wrought iron components, the clock has not been working regularly for the last 60 years. The chimes will now be broadcast through all long, medium, and short-wave transmitters, and the carillon will play the opening bars of the *Internationale*.

**The Chilean Short-wavers**

CB1190, Valdivia, now reported on 24.93 m., 12.01 mc/s (a correspondent informs

**LEAVES FROM A SHORT-WAVE LOG**

us that he has logged this station on 25.18 m.—and CB1170, Santiago, on a channel varying between 25.51 m. (11.76 mc/s) and 25.64 m. (11.7 mc/s), are both being well heard in the later evening hours. The call of *Valdivia* preceding a broadcast was recently logged as early as G.M.T. 22.00. CB1170, relaying the medium-wave station CB89, Santiago (Chile), has an Anglo-American Hour between G.M.T. 23.00-23.45 daily. It closes down with the playing of the "Stars and Stripes for Ever."

**War News from China**

During the past fortnight several radio transmitters previously used for commercial traffic only have undertaken broadcasting duties. XGOX, Nanking, working on 30.61 m. (9.8 mc/s), and 43.8 m. (6.85 mc/s), gives out a news bulletin in the English language daily from G.M.T. 13.20-14.00. JDY, Dairen (Manchukuo), on 30.33 m. (9.89 mc/s), also broadcasts in English at the same time. There would also appear to be another station in the Shanghai area operated by the Japanese, as transmissions have been logged on 28.79 m. (10.42 mc/s), a channel previously used by XGW, Shanghai. The call-sign, however, which the writer was unable to pick up distinctly, starts with the letters JS.



**Altered Wavelength**

Possibly, in view of interference or deliberate jamming, EAQL, Madrid-Aranjuez (Spain) has changed its wavelength to 30.52 m. (9.83 mc/s) or slightly above COCM, Havana (Cuba). It is on the air nightly from G.M.T. 21.00 to midnight.

**Martinique Again Logged**

FZF6, Fort-de-France, on 30.98 m. (9.685 mc/s), calling: *Radio Martinique*, has again been logged between G.M.T. 23.30-00.45. The station usually works until G.M.T. 01.45 or 02.00. Identification is facilitated by the fact that 6 or 7 chimes are struck between items in the programme, and announcements are made alternately by a man and a woman. the former in French and Spanish, and the latter in English and German.

**Bucaramanga on New Channel**

HJ2ABD, Bucaramanga (Colombia), has forsaken the 50 m. band, and may now be found on most nights on 31.17 m. (9.62 mc/s). The daily schedule is: G.M.T. 16.30-17.30; 22.30-23.30 and 00.30-03.30. The full call is *Emisora HJ2ABD, Bucaramanga, Colombia en America del Sud*, but is usually abbreviated to a curt: *Radio Bucaramanga*.

**Vatican City on High Power**

It is stated in Rome that HVJ, Vatican City, in order to extend the sphere of its daily broadcasts, will shortly be endowed with a 50-kilowatt transmitter, and may also, for its daylight transmissions, use a lower channel than the one hitherto adopted.

**Poland's New Interval Signal**

The two Warsaw short-wave stations, SPW, on 22 m. (13.635 mc/s), and SPD, 23.01 m. (11.535 mc/s), have adopted a special interval signal in order that their transmissions may be readily recognised. It consists of a few bars taken from the carillon theme in Moniuszko's opera *The Haunted Castle*, and is a very distinctive melody. The times of the broadcasts are now definitely fixed as follows: On Saturdays and Sundays, from G.M.T. 23.00-02.00, and on other days from G.M.T. 23.00-01.00.

**Nairobi Reappears in the Log**

Providing atmospheric conditions are fairly favourable, you should experience no difficulty in hearing VQ7LO, Nairobi (Kenya Colony), on 49.31 m. (6.083 mc/s). The schedule is a regular daily one as under: G.M.T. 11.00-11.30, and 16.45-19.45, with an extra broadcast on Tuesdays and Thursdays from G.M.T. 13.45-14.45. As an interval signal the station still uses the roar of a lion, which was an easy sound to record in view of the relatively close proximity of the town to the Wild Game preserve.

**A New Station ?**

We are informed by a reader that he has picked up on 49.36 m. (6.007 mc/s) a test broadcast of a new station in British India. The call was thought to be VUM, Madras, and the transmission was heard between G.M.T. 14.40-15.00.



**Stentorian**

**EXTENSION SPEAKERS**  
from 23/6



**PORTABLE RECEIVERS**  
from 6-6-0



for a  
**HAPPY RADIO CHRISTMAS!**

WHITELEY ELECTRICAL RADIO CO., LTD. (technical dept.), MANSFIELD, NOTTS.

**CLIX**

Specified for the Home Intercommunication Unit

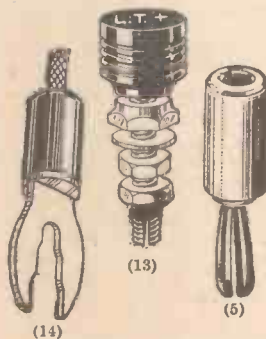

**CLIX VALVEHOLDERS.**  
Standard type V.1, 4-pin 8d., 5-pin 9d.

**CLIX TERMINALS**  
(13) These Panel terminal: have Hexagonal shoulders to facilitate mounting. Red or Black insulators. Type B .. .. . 4d.

(14) **SPADE TERMINALS.** Engraved L.T. +, L.T. - (Large) 2d. (Small) 1½d.

(5) **MASTER PLUGS.** Long or Short types for H.T. and G.B. .. .. . 1½d.

(35) **PLUG SOCKET.** A dual-purpose master plug .. .. . 2½d.

(32) **CROCODILE CLIP.** For short-wave and service work .. .. . 4½d.

(A) **TWO-SOCKET STRIP.** Engraved A.E. or L.S. or Pick-up .. .. . 6d.

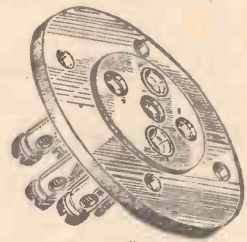

(V.1)

**CLIX Contact**  
Components were also specified for the **"D-XMASTER THREE"**  
Fully described in last week's special **XMAS NUMBER**

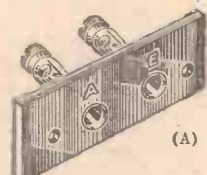
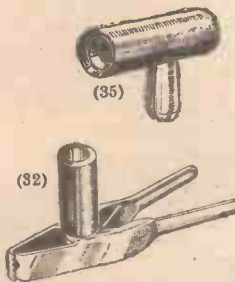

CLIX STOCKED BY ALL GOOD DEALERS

For Folders Write Dept. G.

**BRITISH MECHANICAL PRODUCTIONS LIMITED**  
79<sup>a</sup> ROCHESTER ROW LONDON S.W.1

**THE WIRELESS CONSTRUCTOR'S ENCYCLOPÆDIA**

By F. J. CANN 4th Edition 5/- net

Wireless Construction, Terms, and Definitions explained and illustrated in concise, clear language.

From all Booksellers, or by post 5/6 from George Newnes, Ltd., Tower House, Southampton Street, Strand, London, W.C.2.



## RADIO CLUBS AND SOCIETIES

Club Reports should not exceed 200 words in length and should be received First Post each Monday morning for publication in the following week's issue.

### SMETHWICK WIRELESS SOCIETY

ON November 20th a party of members paid a visit to the B.B.C. Transmitting Station at Droitwich. Thanks to the courtesy and able explanation of Mr. Barker, who conducted the party round the station, a very interesting and pleasant time was spent. The members concluded their visit with an enjoyable tea at the Crown Hotel, Wychbold.

The society is at present engaged in experiments in transmission and reception on the five-metre band, and would offer a cordial welcome at their meetings to anyone interested in such experiments. Hon. Sec., Mr. E. Fisher, M.A., 33, Freeth Street, Oldbury.

### WELLINGBOROUGH AND DISTRICT RADIO AND TELEVISION SOCIETY

THE fortnightly meeting of the above society was held at the Exchange Hotel, Wellingborough, on Wednesday, November 24th, when a talk was given by Mr. Webb, of Messrs. Pye Radio (Cambridge), on the transmission and reception of television signals from the Alexandra Palace.

Mr. Webb prefaced his talk with a brief review of the behaviour of signals transmitted upon the television sound and vision wavelengths, and mentioned that for some considerable time before it was generally known that these signals were being heard well outside the estimated service area, the Pye research engineers at Cambridge had been utilising the television signals for the experimental design and construction of television receivers, the distance being roughly 45 miles. It was also a proved fact, he stated, that the signals had been picked up quite regularly in America and South Africa, but despite these freak results, the service area inside which a television receiver could be expected to produce good pictures was not much more than had been anticipated by the designers of the Alexandra Palace station.

One important factor that had been noticed at Cambridge was that the television signals varied considerably from daylight reception to that in darkness, and it was discovered that signal strength in the evening programme was considerably better than that which was obtained during the afternoon transmission.

Mr. Webb then demonstrated and described a special aerial that had been designed for reception of the television signals, and which had a total length of just over eleven feet. A special bracket was supplied with the aerial so that the whole system could be erected in a vertical position by fixing the bracket either to the chimney stack of a house or to the top of a mast. Height of the aerial was of considerable importance, and if the aerial could be erected well up in the air, it was quite probable that good strong signals from the television transmitter at Alexandra Palace, would be received in Wellingborough. A great aid to reception on these ultra-short wavelengths was to use a reflector spaced a small distance behind the receiving aerial, and of equal dimensions, and with this array it was possible to increase the strength of the received signals to double that which was obtainable with the usual type of aerial. Hon. Sec., J. K. Parker, 22, Second Avenue, Wellingborough, Northants.

### THE CROYDON RADIO SOCIETY

QUESTION nights of the Croydon Radio Society have a special appeal, and such an occasion was on Tuesday, November 23rd, in St. Peter's Hall, Ledbury Road, S. Croydon. The first topic was prompted by a letter from Mr. A. Whittaker, of Hull, who sought advice on the choice of a loudspeaker as he considered that the society was expert on this problem. Naturally, a very thorough discussion followed, and many models suggested, but it had to be borne in mind that Mr. Whittaker was using a PX4 output valve. Mention of loudspeakers was quite enough to start the Technical Adviser on a discourse on his recent experiments on them, and he gave particular attention to the design of a twin cone, and how the smaller one vibrated independently of the larger one surrounding it. From this the society led rather naturally to sound reproduction, with comments on Mr. W. J. Bird's recent lecture on sound-film technique. Then the Vice-Chairman spent an interesting time in talking about cabinet design, and the problem of a self-contained or separate loudspeaker. A controversial discussion centred on the public's toleration of "mellow" or "booming" reproduction, and other topics like the effect of studio echo, room resonance, design of pick-ups, the use of heterodyne whistle filters, all ensured a very engrossing meeting. On Tuesday, December 14th, the Vice-Chairman, Mr. G. A. Hoskins, is presenting a musical programme on records with his quality reproducer, and PRACTICAL AND AMATEUR WIRELESS readers who want reproduction a little better than ordinary are invited to come as guests on this evening. Hon. Pub. Sec., E. L. Gumbers, Maycourt, Campden Road, South Croydon.

### EALING AND DISTRICT SHORT-WAVE CLUB

THE above club met recently at the Anchor Public House, West Ealing, but unfortunately several members could not attend and the appointment of an executive committee was not proceeded with. It is hoped that the committee will be appointed

at the next meeting, but in the meantime, Mr. W. Colclough will act as secretary, and all communications should be made to him at 31, Lancaster Gardens, Ealing, W.13.

The rest of the time at the meeting was taken up by a general discussion on circuits, etc., but it was agreed that the committee should consider:—

(a) regular morse practice on a valve oscillator and, (b) arrangements for lectures by various firms and persons on equipment, operation, circuits, etc.

Two members hope to be in possession of Artificial Aerial Licences in the very near future so that those interested in transmission and transmitter circuits will be well provided for.

Anyone interested in short-wave DX work (transmission and reception) is invited to get in touch with Mr. Colclough at the above address.

### BRADFORD SHORT-WAVE CLUB

THE above club have just completed a series of weekly lectures. On Friday, November 10th, Mr. E. Chotot, of Messrs. Lissen, came to the club and gave an interesting demonstration of the Company's short-wave products. His lecture was absorbing, and his stock of anecdotes is apparently inexhaustible.

The following week, November 20th, Mr. S. A. Stevens, A.M.I.E.E., of the Westinghouse Brake and Signal Company, Limited, delivered a lantern lecture before the club. The members were very interested in the theory of rectification as explained by Mr. Stevens.

Enthusiasts in the district should write to the hon. secretary for details of future lectures.

Hon. Sec., S. Fischer, Edenbank, 10, Highfield Avenue, Idle, Bradford, Yorks.

### SWINDON AND DISTRICT SHORT-WAVE SOCIETY

A VISIT was paid by the members of the above club to the local automatic telephone exchange on November 25th. The party was conducted by Mr. Griffiths of the Post Office staff. The meetings are held fortnightly. The club's transmitter is to be rebuilt and also the receiver. Greater interest is being taken in CW with the view of obtaining a full call. There are now eight A.A. holders, and W. C. Barnes (2BWR) has now been granted permission to use the 5- and 10-metre wavebands. Mr. R. A. Hiscocks (G6LM) takes a big interest in this society, and G8VP has had some FB QSO's on 160 metres using 2 watts, 'phone and CW. A. Wheeler is the operator and the QRA is Faringdon, Berks. D. T. Roffin (2CVA) is about to apply for a full ticket. E. J. Rose (2CTG) is experimenting with doubling stages. The junior section are interested in the design, etc., of short-wave receivers.

Hon. Sec., W. C. Barnes (2BWR), 7, Surrey Road, Swindon.

### WIRRAL AMATEUR TRANSMITTING AND SHORT-WAVE CLUB

AN interesting talk on the theories of DX in wireless wave propagation was given by Mr. Norman Campbell Hobbs (G8AA) to the members of the above club at their last meeting on November 24th. Mr. Hobbs, explaining the various theories that have been evolved to account for the passage of radio signals to the other side of the globe, stated that, so far, actual proof of only one reflection of radio waves had been obtained. The talk provoked a keen discussion on angles of radiation. The next meeting will be held on December 8th at the club headquarters, Beechcroft Settlement, Whetstone Lane, Birkenhead. The club secretary, Mr. J. R. Williamson, announced that the arrangements for the forthcoming club receiving contest were well in hand.

Hon. Sec., J. R. Williamson, 49, Neville Road, Bromborough, Birkenhead.

### DOLLIS HILL RADIO COMMUNICATION SOCIETY

THE following talks have been arranged for the present month—December 14th.—A talk on 10-metre transmission and reception by Mr. H. Wilkins (G6WN). December 21st.—A talk on simple mathematics and Ohm's Law. Both talks to take place in the Brantford Schools, Warren Road, N.W.2. at 8 p.m. Hon. Sec., Mr. J. R. Hodgkins (2CQF), 102, Crest Road, Cricklewood, N.W.2.

### Christmas is Coming

THE last of the term's Friday feature programmes will be heard on December 10th (National), and, like a good deal of school broadcasts at this period, it will be "Christmasy" in character. Listeners in British schools will hear from the mouths of boys and girls in various parts of the world what Christmas is like in their homes.

### Western Cabaret

A POPULAR cabaret programme from the Royal Bath Hotel, Bournemouth, on December 15th, will include: Murray and Mooney "In more funny business"; Ann Penn, "The Popular Impressionist"; Mario de Pietro "and his Mandolin"; and dancing to Billy Bissett and his Canadians, with the Canadian Capers and Alice Mann.

## THE BRITISH LONG-DISTANCE LISTENERS' CLUB

### How Many QSL Cards?

IT would be interesting to know what member holds the record for the number of QSL cards which have been obtained as a result of the sending of a verification report to a distant transmitter. We have had letters from readers who have had more than 200 in a year, but so far no member has stated the total number of cards in his possession, and we believe that other members would be interested to know to what extent the collection of cards can go. It is obvious that the majority of listeners pin the cards up or otherwise attach them to the walls of their shack or den, but when a certain time has elapsed the walls or the available space must become filled, and filing systems have to be started. We should be glad, therefore, to hear from members who have more than 300 cards in their possession, so that we can offer an incentive to other members to indulge in serious listening with a view to obtaining cards themselves. As we have pointed out before, the acquisition of these cards is not only a proof of the efficiency of a receiver, but is a permanent record of the results of hours of patient and systematic listening.

### Amateur Bands

We are frequently asked to supply data for building coils and circuits for use on the amateur bands, and this is a subject which often gives rise to difficulty. If you have tables showing how to wind coils to a given inductance, it is a simple matter to work out the required inductance and parallel capacity required to tune to any given frequency (or wavelength). The three amateur bands (14 mc, 23 mc and 56 mc) may each be covered by using inductances of 11.25, 5.63 and 2.82  $\mu\text{H}$ , and capacities of 11.25, 5.63 and 2.82  $\mu\text{f}$ . A practical interpretation of these figures is required to be able to tune the inductance values given, but those who are interested in the mathematical side and who prefer to make their own components will no doubt find these figures of value to them.

### Fitting Fuses

A Devon member has had an expensive breakdown in his receiver, and to avoid a repetition of the trouble has asked for some advice regarding fuses. The fitting of fuses can definitely be overdone in a receiver, and it must be remembered that should a fuse be blown it will not only be necessary to find the cause of the trouble but also to locate the blown fuse. In a simple battery receiver, the main protection may be afforded by a fuse in the H.T. negative lead. But if high values of a grid bias are employed, it may also be worth while including a fuse in the G.B. positive lead. In a mains receiver there are several precautions which may be taken. Firstly, a fuse should be included between the receiver and the mains socket, or, preferably, a fuse in each of the mains leads. This will protect the mains leads or the mains fuse, but will not save the rectifying valve from being burnt out should a mains choke or smoothing condenser fail. For this purpose, a fuse should be included between the H.T. negative lead from the mains transformer and the earth line, and then, should the rectifier fail, or a short-circuit develop on that side of the mains transformer, the latter will be prevented from damage.



## NEW BULGIN TELEVISION H.F. TRANSFORMER

ONE of the new television components introduced by Messrs. Bulgin is illustrated below, and consists of a special H.F. transformer for use in "straight" television circuits. As we have already pointed out it is not essential to use the superhet principle, although the majority of commercial sets do employ this arrangement. The straight circuit has much to recommend it if it can be

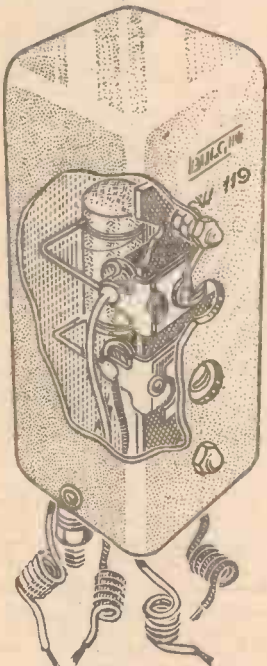

View of the Bulgin television H.F. transformer—showing method of construction.

stabilised and designed on sound lines. The coupling between the H.F. stages may be either choke or transformer, some designers preferring the former and some the latter. In the Bulgin component two coils are tuned by two pre-set condensers, and the windings are damped by resistors placed across them. This ensures that the tuning will be sufficiently broad to enable the full frequency range of the picture signal to be obtained, and with a suitable type of valve a high-stage gain should be obtained. The components are mounted on a paxolin insulating strip supported inside a metal can measuring slightly under 1 1/2 in. square and 3 1/4 in. high, with the usual two bolts at the foot for attachment to a metal chassis. These bolts are not sufficiently long to enable it to be mounted on a standard wooden chassis unless the underside is first drilled or countersunk to enable the lock-nuts to be sunk low enough to enable sufficient thread to be gripped to form an efficient anchorage, but in view of the high screening efficiency which is required in television apparatus it is not advised that a wooden chassis be employed. It may be found desirable when using this type of coil to complete the individual screening by a small metal plate bolted to the component, and then to support it slightly above the chassis surface. This does in some cases assist in preventing the metal chassis from forming a connecting link through which interaction can take place due to the surface of the chassis becoming dirty. The price of this component is five shillings.

# BARGAINS FOR XMAS.

## N.T.S. BATTERY S.G.3



Reviewed on page 380.  
LIST VALUE £6 : 6 : 0  
**BARGAIN**  
CASH or **52/6**  
or 5/- down and 12 monthly payments of 5/-.

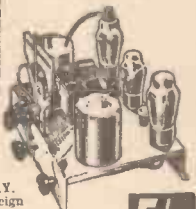

Waverange 200-2,100 metres. ● Concert-Grand Moving-coil Speaker. ● New-type No-trouble Switch. ● Complete with Valves less Batteries. **READY TO PLAY.** Will bring you British and Foreign programmes with remarkable fidelity and volume. New screened-grid high-frequency, high-efficiency detector, and Pentode output. Only 9 m.a. H.T. consumption. Latest improved components. Steel chassis. Slow-motion tuning. Illuminated wavelength scale. Beautiful walnut-veneered cabinet, 19 1/2" high, 14" wide, 10" deep. **CHASSIS ONLY**, as employed in the above complete receiver. Ready for fixing in your own cabinet. Dimensions 10" wide, 7 1/2" deep, 8" high to top of scale, 19/6. **GR COMPLETE** with 3 matched valves. CASH OR C.O.D. £22/2/0, or 2/6 down and 11 monthly payments of 4/-.

**5/-**  
DOWN

**HEADPHONES.** New lightweight, super quality, ideal for short-wave work and testing, 3/6. Post 6d.

Something Everyone Needs!

### AVOMINOR TESTMETER



Universal A.C./D.C. Model (illustrated), 22 ranges. In bakelite case on rubber feet, with clips and testing prods. Cash or C.O.D. 25/10/0, or 10/- down and 11 monthly payments of 10/-. D.C. Main and Battery Model (10 ranges), 22/5/0, or 2/6 down and 11 monthly payments of 4/4.

**2/6**  
DOWN

**FREE** N.T.S. General Bargain Catalogue.  
N.T.S. Short-Wave Bargain Catalogue.  
Please cross all P.O.'s and register currency.

## SPECIAL CASH OFFER



**N.T.S. MAINS UNITS**  
You will need a Mains Unit some time or other. You **MUST** buy **NOW**, however, to obtain these efficient units as we cannot repeat at the price.

**A.C. MODEL.** Output 120v. at 25 m/A : 4 tapings 60v., 75v., 90v., 120v. For A.C. Mains 200/250v. 40/80 cycles. Cash or C.O.D. 32/6.  
**D.C. MODEL.** Tapped for screen. Def. and Power. Output 25 m/A at 150v. for D.C. Mains 200/250v. Cash or C.O.D. 19/6.

## HALCYON AUTODYNE SHORT-WAVE CONVERTER

Instantly attached to your present A.C. Mains set and makes it an efficient All-Wave Receiver

**LIST PRICE £3 : 3 : 0 BARGAIN**

**29/6**



With Mullard 85V Valves.

Stand your set on this amazing unit and hear the whole world through your present (a m 11) a r receiver. Only from N.T.S. is this famous converter obtainable at this astounding bargain price. Secure yours now!

**FOR A.C. MAINS SETS ONLY**  
● 14-60 metres. ● No alterations to your set.  
● Simply attach, and your set is an all-waver, a special switch enabling short-wave or broadcast reception to be enjoyed at will. ● Tuning and Sensitivity controls. ● Dial calibrated degrees. ● Walnut finished cabinet. Complete with plug-in adaptor and instructions. ● For A.C. mains sets only. 2/6 down secures; balance in 10 monthly payments of 3/-.

**New Times Sales Co.**  
56 (Pr. W 44), Ludgate Hill, London. E.C.4.

# ENJOY SHORTWAVES at CHRISTMAS

You can get first-class headphones reception of World-wide short-wave broadcast and experimental amateur transmissions with this Eddystone battery-operated "All-World Two." It will consistently receive many American, European, Australian, and other long distance short-wave broadcast and amateur stations at good volume and quality. It is fitted with special "Eddystone" band-spread tuning. Wave range 15 to 52 metres. Price with valves and coils, guaranteed aerial tested and ready for immediate use.

**£3.17.6**  
SEND FOR FULL DETAILS



## EDDYSTONE ALL WORLD TWO

STRATTON & CO., LTD., Eddystone Works, Bromsgrove Street, Birmingham  
London Service: WEBB'S RADIO, 14, Soho Street, Oxford Street, W.1



### ELECTRADIX BARGAINS

**DEWAR Type 81 SWITCH** as specified for the Home Inter-communication unit, **3/6** **WIND GENERATORS.** Slow speed enclosed. 6v. to 12v. 10 amps. enclosed, ball bearing, for windmills, 35/- **A BARGAIN IN DYNAMOS.** Type "C." Our latest for Bungalow, Yacht, or Cell Charging, 140 watts. Enclosed Dynamo, 120 v. 12 amps. Ball Bearings, Yec Pulley, 25/- **Marine Type Switchboard** with Ammeter, maximum and minimum Auto Cutout Mains Switch and Fuses, Field Regulator, 25/- **CRYSTAL SETS.** Buy the boy one, they cost nothing to run. No battery or valves wanted. Quiet and efficient reception. 500 shop-sold sets cheap. Enclosed type, 5/6 and 7/6 each. Battery portables, 30/-.

**HEADPHONES.** Light weight, 2,000 ohms, 4/8. Single-high res. carpenter's, 2/6. Sullivan 120 ohm W.D. model. Aluminium body and headbands. Maker's price to-day 15/-. Our price 2/9 per pair, 2d. postage. Pocket Headphones all leather headband and cords, 2/9 pair.

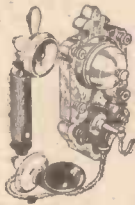

**TELEPHONES** for all purposes. Home, Office, Garage and Field Sports. Wall type, as illustrated, 15/-. Other Wall and Table models cheap. Send for lists. **SPARK COILS.** 1in., 1 1/2in. and 1in. gap, with condensers, 10/6. Large 7in. coils in mahogany case, 25/10/6. Short wave spark transmitters for boat model control, 17/- **Relays** 10/-, Coherers 5/- **SELECTOR RELAY SWITCHES,** 25 ways, magnet operated, 8/6. **SOLENOIDS,** 6-volt, for model work or distance switch, core travel 1/2in. pull 1 oz., 3/6. A.C. Magnets, 230 volts, 30 mfa., 14 oz., lift, 2/6. **FLEX CORDS.** 3-way 6ft. long, 6d. 4-way, 12ft., 1/-.

4-way 6ft. with plug and socket, 1/6. Govt. 6ft. headpiece cords, with plug, 1/- **X-RAY TUBES.** Grand new W.O. Hoopital Surplus. 7in. dia. bulb big tungsten electrodes. Full emission. Cost £5. Sale 15/- **Packings,** 2/6.

**METERS.** Genuine Weston model 354. Central zero 1 to 15 amps, pol. mag. dead beat. Flush panel, 2 1/2in. dial, nickel or black. Sale price 7/6. Mounted in solid mahog., 3in. sq., 9/- **Moyle C22** mov. coil milliammeters, 25-0-25 m.a., 10/- **Weston** 5, 30 and 50 m.a. mov. coil milliammeters, 17/6. 0-100 m.a., 17/6. Switchboard Meters all sizes.



**MICRO-AMMETERS** for Valve Voltmeters, etc., 0 to 50 microamps, full scale, 50 mV. moving coil, 1,000 ohms, flush panel, 2 1/2in. dial, 40/-, 2,000 Meters. All sizes. **FERRANTI TRANSFORMERS,** intertensive and Push-pull, 6/6. B.T.H. 4 to 1 ratio, 5/-.

**ELECTRIC HOME RECORDERS.** Our prices are unbeatable, as factory cost was twice our sale price. **THE FEIGH RECORDER** fits any Radiogram and is positive drive by worm gear and rack. Only 37/6. **ELECTRIC GRAMO MOTORS,** 25/-, 37/6, 45/- and 70/-.

**MIRRORS.** 5 1/2in. dia., Helle or Television, 1/8. Parabolic Concave, 10in., 20/-, 20in., 25/-, 24in., 30/-. Carr. fed. Neon Lamps, 2/6 and 3/- each, with holder. Miniature Neons, 2/6. **LIGHT BAY CELLS.** LESDIX CELLS are light sensitive, with gold grids, moisture proof, 5/-. Mounted in Bakelite Case, 7/6. Super-model in oxy-brass body, with window, 10/-. Complete Burglar Alarm Sets, £3 10s.

**FUN ON YOUR RADIO.** Lesdix Microphones reproduce your voice as heard from your radio set to loud speaker **SOLO BUTTON MICROPHONES** 1/- **A New Practical Solo Microphone** for broadcasting at home. It is a general purpose, robust mike, with solid Bakelite Body, back terminals, front metal grille. **No. 11.** New design, finely finished, 5/6. **No. 11A.** Special, in solid brass body unequalled at the price on speech and music, 7/6.



**No. "NW" 11 Table Mike.** This is a splendid microphone for speech and music. The bakelite case, containing a 2in. mike and transformer, is on a bronze pedestal. Switch and plug sockets are fitted on the case. It stands unrivalled for quality and price, 15/-.

**TRANSmitters, MORSE AND SIGNAL KEYS.** Royal Air Force model, balanced action, solid brass bar, tungsten contacts, indicator lamp. Type KBSL, a guinea key for 7/6. Other keys from 4/6 to 30/-. Learner's outfit complete, 4/8. Ask for special illustrated Key List "K.N."

List "N" of a 1,000 Bargains. 11d. stamp.

**ELECTRADIX RADIOS**  
218, UPPER THAMES STREET, LONDON, E.C.4  
Telephone: Central 4611

218, UPPER THAMES STREET, LONDON, E.C.4  
Telephone: Central 4611

**THE AIRMAN'S DIARY, 1938**

A useful source of knowledge and includes the following:

- Aerodromes in Great Britain. Aeronautical terms explained. Controls, Flying Clubs and Schools. Manufacturers. Notable flights and world records. Air squadrons, etc.

There are thirty-two illustrations showing the development of aircraft from the beginning right up to the powerful machines which now cover the world.

In each opening of the diary there is an illustration with descriptive matter covering a wide field of aeronautical subjects.

1s. 6d. ... .. Rexine Binding, with pencil  
2s. 6d. ... .. Leather Binding, with pencil

*These diaries are on sale at all stationers and bookstalls.*

**GEORGE NEWNES, LTD., TOWER HOUSE, SOUTHAMPTON ST., STRAND, LONDON, W.C.2.**

### REPLIES IN BRIEF

The following replies to queries are given in abbreviated form either because of non-compliance with our rules, or because the point raised is not of general interest.

**A. F. (Antrim).** We cannot trace any manufacturer who produces a set of the type outlined in your letter. We have published constructional details of a 3-valve S.W. set which could be modified to agree with your specification, and the blueprint number is P.W.03. We cannot advise modification to our published designs, but you should not find it difficult to eliminate the last stage and made the other changes.

**J. F. (Law).** You can substitute a pentode, and the only modification is to connect the additional terminal to H.T. positive maximum. Your speaker must, of course, be chosen to match the pentode and you will probably find it necessary to use a tone-corrector across the speaker terminals. The usual 10,000 ohms resistance in series with a .01 mfd. condenser should be satisfactory. Your mains unit should prove quite satisfactory.

**R. C. H. (Gravesend).** We are checking up the call-letters of other countries, and further details will be given in a subsequent issue.

**F. B. (Twickenham).** We have published a three-valve of the type you mention—the Prefect S.W. Three, blueprint P.W.63. You could omit the last stage if you only need two valves. Standard 6-pin plug in coils are employed.

**I. J. C. (Dublin).** There is no alternative all-wave coil unit, but you could, of course, replace it by any standard broadcast coil unit and use the set as an ordinary broadcast receiver. The two L.S. 1 leads must be joined together and to one side of the speaker.

**C. M. (Galne).** The issues you mention are still available. We have no details of your circuit, which was published in a contemporary and therefore cannot advise regarding additions to it.

**A. M. (E.I.).** The chokes you used were unsuitable. Ordinary H.F. chokes have too much wire on them, and incidentally the wire is very thin and you were lucky not to have burnt them out and shorted the mains. You must use special chokes for the purpose, consisting of a comparatively few turns of heavy gauge wire. 100 turns of 22 D.C.C. on a 2in. diameter paxolin former may be employed if you wish to wind the chokes yourself.

**F. J. W. (Gillingham).** The Super is a later design and employs variable-mu H.F. stages. We have not published a more modern design on similar lines.

**A. W. R. (Mortlake).** The Listeners' 5-watt A.C. Amplifier meets your specification. Blueprint No. W.M.302 is available, price 1s. 6d. and the unit could be modified to incorporate any desired mixing circuit for radio, pick-up or mike.

**H. B. (Edgbaston).** You could add an amplifier, but this would only add to the apparent lack of selectivity as it would increase volume and thus produce more of a background from weak stations. An H.F. amplifier would improve selectivity and give a slight increase in volume, but we cannot recommend a design in view of the lack of details regarding the type of set.

**T. W. H. (Hednestord).** Simply send a remittance to our Back Number Department at Tower House, Southampton Street, Strand, W.C.2.

**E. G. (Huntingdon).** We regret that we could not advise any of our blueprints which would enable you to reassemble the commercial set. Apart from the fact that many of the odd parts may be unsuitable they may also be damaged, and thus you would be introducing trouble from the start. We only guarantee our sets when built from the parts which we specify.

**W. P. (Liverpool).** It is only necessary to observe filament polarity (or order of wiring) in battery, D.C. and Universal receiver. In an A.C. set there is no filament polarity. The choke in question is of the split type, having an inductance (with no D.C.) of 680 henries when the windings are in series and 25 henries when in parallel. The D.C. resistance is 680 ohms in series, and 170 ohms in parallel and the current which may be carried is 70 mA. in series and 140 mA. in parallel.

**G. M. (Bromyard).** We regret that the receiver was not described by us and we therefore have no details of it. We are, consequently, unable to recommend modifications for modernising the set.

## ARMSTRONG

6-Valve All-wave Superheterodyne Radiogram Chassis, complete with British Valves and 8" Moving Coil Speaker. Model 3BE/8. (Ready to switch on.) **PRICE £7-10-0**

This chassis, one of the most popular of our 1938 range, incorporates many refinements, including iron-cored coils, iron-cored intermediate transformers, latest Vaxley type switching, latest British Octal base Valves, etc. The circuit also is particularly up-to-date, whilst the short-wave band has been especially studied and American stations are readily obtainable. All the best British components are used throughout. Armstrong chassis are sent on 7 days' approval packing and carriage free. All Armstrong chassis carry twelve months' guarantee.

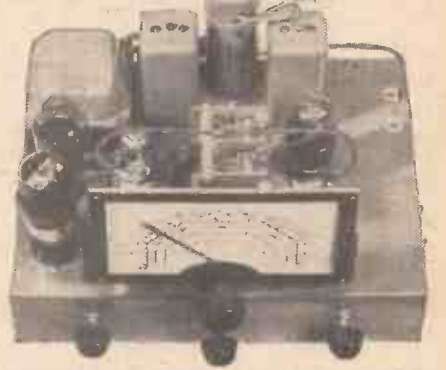

Armstrong Company has published a new illustrated catalogue, fully describing model 3BE/8, together with many other chassis of equal interest. A copy will gladly be sent on application. It is called 'Armstrong Technical Catalogue No. 12.'

**ARMSTRONG MANUFACTURING CO.**  
100, KING'S ROAD, CAMDEN TOWN, LONDON, N.W.1  
'Phone: GULLIVER 3105.

### YOU CAN GET IT AT ONCE FROM L.R.S.!

**CASH OR C.O.D.** Orders despatched BY RETURN.

**L.R.S. McCARTHY ALL WAVE CHASSIS**

R.F. 6, A.W. 17/6 WITH ORDER	S.S. A.W. 14/6 WITH ORDER	Complete with B.V.A. Valves, knobs, leads, etc., ready for fitting into any cabinet.
and 12 month- price 14.9.	and 12 month- price 11.5.	Payments by Cash Demonstrations Free.

Full McCarthy Range always in Stock.

**L.R.S. GARRARD A.C.6. RADIOGRAM UNIT**

Induction motor for A.C. 100/250 volts, 50/60 cycles, Unit plate with pick-up, needle cups, etc.

**5/6** WITH ORDER and 11 monthly payments of 7/-.

**L.R.S. GARRARD A.C.6. Motor only**

As above but with fully automatic start and stop, etc. Complete with 12in. turntable.

**4/-** WITH ORDER and 10 monthly payments of 4/3.

**L.R.S. Rothermel PIEZO ELECTRIC PICK-UP**

wide frequency response and amazingly high output.

**3/6** WITH ORDER and 8 monthly payments of 4/-.

Also supplied on best possible EASY TERMS. Electric Vacuum Cleaners; Sun-Ray Health Lamps; Electric Clocks; Model Electric Train Sets; Electric Fires

**What ever your needs let us quote EASY TERMS.**

**LONDON RADIO SUPPLY COMPANY** ESTD. 1925

11, OAT LANE, NOBLE ST. LONDON, E.C.2.

Phone: NATIONAL 6828-9

**Join Newnes' Practical Group!**

**PRACTICAL MOTORIST**  
The owner-driver's journal which tells you how to repair, overhaul, and obtain the best performance from your car.  
3d.—every Friday.

**PRACTICAL MECHANICS**  
The only English journal of its type. It deals with every branch of Science, Mechanics, Invention, Model-Making, Chemistry, Astronomy, Photography, Television.  
6d.—Every Month.

**THE CYCLIST**  
The leading weekly for every Cyclist, Clubman, Utility Cyclist, or Tourist.  
Join "The Cyclist" Road Club and also take advantage of the FREE Insurance offered.  
2d.—Every Wednesday.

Will get it QUICKER and on BETTER TERMS from L.R.S.





# LETTERS FROM READERS

The Editor does not necessarily agree with the opinions expressed by his correspondents. All letters must be accompanied by the name and address of the sender (not necessarily for publication).

### Experimenting in Australia

**SIR,**—For the past fourteen years my listening and experimenting has been done in the Dominions—Australia and New Zealand, and for the past four or five years have been using the circuit almost identical to that of Mr. Daker, of Brighton, my first valve being an ordinary S.G. H.F. During this time I have tried almost every known refinement and dodge—from the aerial to the speaker. I am back now to where I started, minus refinements, although the last improvement I got was when I made a simple wave-trap, the type we used in grandma's day, sixty turns on a cardboard former, etc. With this I used a hand-drawn copper wire aerial (ex. P.M.G. telephone wire), joined in half a dozen places (no soldering), slung across the lawn, 10ft. high and a lead in of ordinary flex. With this I used to pull in many of the amateurs in Perth, Western Australia, on the broadcast band, whilst I was in Melbourne, about 2,000 miles away.

Did you know our radio sets are true weather prophets down under? Well we know it should a storm be approaching from the East (Sydney) whilst a few metres away listening West (Adelaide) there isn't a bit of static to be heard, and vice versa. Static is usually a curse on the medium band, whilst on the 80-metre band life is just not worth living. Also, on the short-wave band, when the Europeans are at their best, all the valves in the country will not pull the Yanks in, and vice versa. That has been my experience, anyway.

To get back to the circuit, I have had the same experience as Mr. Daker—no oscillation when a choke has been inserted in the plate lead of the H.F. valve—the reason why is beyond me. I have just reassembled my set, and the circuit, as I have it now, is:—

H.F. 32 (American)	Det. Philips' A630 6 volt. 20,000 ohms imp. 10 meg. G.L. (Dutch)	L.F. Mullard PM. 5X 0.50,000 variable res. across sec. of tran. varying G.B. (Good volume con- trol)	Output 45 Push-pull (American)
--------------------------	---	---	---

Ferranti transformers are used. I still prefer 6 volt battery valves to 2 volt ones, as I find they are more stable and robust.  
—H. R. WATSON (Hampstead).

### A Young Reader's Appreciation

**SIR,**—I would like to take this opportunity of congratulating you on your fine magazine, and to thank you for the large amount of information I have received from it.

I am fifteen years of age, and I have built several sets. My present one is a two-valve short-wave, and I got the circuit and wiring diagram from your paper. I have logged several continents, although it is not long since I built it.—J. V. S. DUNCAN (Portobello).

### Some Suggestions

**SIR,**—I was very pleased to learn that I had successfully solved Problem No. 270, and thank you for the fine book you have sent me, which will be very helpful.

I have been a reader of PRACTICAL AND AMATEUR WIRELESS for some time, and have found the articles published very instructive. In fact, practically all the knowledge that I possess on wireless matters has been gained from your valuable publication.

May the articles that are now running, "The Amateur Set Designer," lead up to the building of a superhet receiver, with and without automatic volume control, and using a triode output valve such as the PX4 or equivalent in one of the other makes.

Also, I would like to see an article giving full instructions for the building of a test oscillator at a reasonable cost, and more details on the servicing of sets, particularly mains receivers.—J. RICHARDS (Buckhurst Hill).

### A Five-valve S.W. Superhet!

**SIR,**—I would like to suggest a circuit, which I think would prove very popular not only with English readers but

CUT THIS OUT EACH WEEK.

## Do you know

—THAT all H.F. conducting surfaces should be highly polished and free from pitting, as H.F. currents travel on the surface.

—THAT when using a stranded aerial wire the efficiency is increased if each separate strand is enamelled before the material is twisted.

—THAT when hum is found to be difficult to eradicate the question of induction between mains components and L.F. coupling components should be borne in mind.

—THAT in the above connection it is often necessary to place an L.F. transformer or choke at an angle to remove all traces of hum or induction.

—THAT instability may be introduced due to an earth wire breaking away from the plate or body to which it is attached underground.

—THAT a short-wave adapter may be used with any receiver, whilst a short-wave converter can only be used with a set employing H.F. amplification.

—THAT in the above connection a superhet may be considered as employing H.F. amplification, even although no H.F. stage is employed.

The Editor will be pleased to consider articles of a practical nature suitable for publication in PRACTICAL AND AMATEUR WIRELESS. Such articles should be written on one side of the paper only, and should contain the name and address of the sender. Whilst the Editor does not hold himself responsible for manuscripts, every effort will be made to return them if a stamped and addressed envelope is enclosed. All correspondence intended for the Editor should be addressed: The Editor, PRACTICAL AND AMATEUR WIRELESS, George Neumes, Ltd., Tower House, Southampton Street, Strand, W.C.2

Owing to the rapid progress in the design of wireless apparatus and to our efforts to keep our readers in touch with the latest developments, we give no warranty that apparatus described in our columns is not the subject of letters patent.

also with your readers overseas. So far you have designed only T.R.F. receivers for S.W. reception, with the exception of the "Vitesse," which was a three-wave band superhet.

The suggestion I have in mind is for a simple four- or five-valve S.W. superhet. This would have an H.F. stage (in the case of the five-valve set), a frequency-changer, one stage of I.F. with switch for beat oscillator, 2nd detector and A.V.C. (with switch for cut-out), and output pentode. The wavebands would be from 9 to 170 metres, or using the new Wearite coils with switching to 750 metres. This type of circuit, I am certain, would not be too complicated for the average constructor, and not only that, it would fill the long wanted need for a real all-wave receiver. In addition, the overseas readers would benefit by getting a set that will cover the bands they want. As far as I can see, a set designed on these lines would be the ideal receiver.—D. R. HOOPER (London, S.W.).

### "Veris" from VP3MR

**SIR,**—In your issue of November 20th, under the heading of "Leaves from a Short-wave Log," your contributor advises listeners not to write to VP3MR, Georgetown, British Guiana, for a "veri," as they always acknowledge reports over the air, and do not reply by post. It may interest readers to know that I have just received a QSL card from this station acknowledging a report which I sent in October.—P. BOYLAN (Dublin).

### Battery-operated versus All-mains Sets

**SIR,**—I was most interested to read the letter published under the title "Battery-operated versus All-mains Sets." I am also very musical, and before the days of broadcasting went to all the concerts I could afford. Even now I prefer the actual concert as there are certain tones and harmonics of sounds that are not caught up satisfactorily by any receiver that I have heard. But for actual purity of tone and music value, I back the set operated by the humble battery valve, of which relatively few now appear on the valve makers' lists. It is now four years since I made my own—H.F.-det.-L.F.-P. I get H.T. from mains, and trickle-charge for L.T. It is important to have 150 volts for H.T. and to use a super power triode valve about 500 m.w. The L.S. is a W.B. of 1933 vintage, and was carefully baffled in an open-backed case which stands across a corner of the room.

Of course, the one disadvantage is that it all wants looking after, to make sure that accumulators are O.K., etc., and I suppose most people will not be bothered when they can get commercial sets that work as easy as running water from a tap. It seems to me that excessive output as much advertised, defeats its own object, as the sound output is much too loud for the average house. Then, what loud sets I hear pick up too much mush and all are either shrill and tinny, or else tone controlled until they get woolly.

This refers to sets for the average man, as I realise that the expensive set with triode or tetrode push-pull overcomes the faults mentioned, and also the magnificent P.A. installations that are obtainable. But I do hope that more interest will be taken in the humble battery set and in home-constructed sets generally, and that we shall not see so many of them in second-hand junk shops.

May your paper ever exert its good influence.—E. W. KIRBY (Wanstead).



# Practical and Amateur Wireless BLUEPRINT SERVICE

PRACTICAL WIRELESS		No. of	Three-valve : Blueprints, 1s. each.	
CRYSTAL SETS		Date of Issue.	Blueprint.	
Blueprint, 6d.				
1937 Crystal Receiver	9.1.37	PW71	Experimenter's Short-Wave Three (SG, D, Pow)	PW30A
<b>STRAIGHT SETS. Battery Operated.</b>				
One-valve : Blueprint, 1s.			The Prefect 3 (D, 2LF (RC and Trans))	7.8.37 PW63
All-wave Unipen (Pentode)		PW31A	The Bandsread S.W. Threo (HF Pen, D (Pen), Pen)	20.8.36 PW63
Two-valve : Blueprints, 1s. each.			F. J. Camm's Oracle All-wave Threo (HF, Det, Pen)	28.8.37 PW78
Four-range Super Mag Two (D, Pen)	11.8.34	PW36B	<b>PORTABLES.</b>	
The Signet Two	29.8.36	PW76	Three-valve : Blueprints, 1s. each.	
Three-valve : Blueprints, 1s. each.			F. J. Camm's ELF Three-valve Portable (H.F. Pen, D, Pen)	PW65
The Long-range Express Threo (SG, D, Pen)	24.4.37	PW2	Parvo Flywight Midget Portable (SG, D, Pen)	19.6.37 PW77
Selectone Battery Threo (D, 2 LF (Trans))		PW10	Four-valve : Blueprint, 1s.	
Sixty Shilling Threo (D, 2 LF (RC & Trans))		PW34A	Leatherweight Portable Four (SG, D, LF, Cl.B)	15.5.37 PW12
Leader Threo (SG, D, Pow)	22.5.37	PW35	<b>MISCELLANEOUS.</b>	
Summit Threo (HF Pen, D, Pen)	18.8.34	PW37	S.W. Converter-Adapter (1 valve)	PW48A
All Pentode Threo (HF Pen, D, Pen), Pen)	29.5.37	PW39	<b>AMATEUR WIRELESS AND WIRELESS MAGAZINE</b>	
Hall-mark Threo (SG, D, Pow)	12.6.37	PW41	<b>CRYSTAL SETS.</b>	
Hall-mark Cadet (D, LF, Pen (RC))	16.3.35	PW48	Blueprints, 6d. each.	
F. J. Camm's Silver Souvenir (HF Pen, D (Pen), Pen) (All-wave Threo)	13.4.35	PW49	Four-station Crystal Set	12.12.36 AW427
Genet Midget (D, 2 LF (Trans))	June '35	PM1	1934 Crystal Set	AW444
Cameo Midget Threo (D, 2 LF (Trans))	8.6.35	PW51	150-mile Crystal Set	AW450
1936 Sonotone Threo-Four (HF Pen, HF Pen, Westector, Pen)	17.8.35	PW53	<b>STRAIGHT SETS. Battery Operated.</b>	
Battery All-Wave Threo (D, 2 LF (RC))		PW55	One-valve : Blueprints, 1s. each.	
The Monitor (HF Pen, D, Pen)		PW61	B.B.C. Special One-valver	AW397
The Tutor Threo (HF Pen, D, Pen)	21.3.36	PW62	Twenty-station Loudspeaker	AW440
The Centaur Threo (SG, D, P)	14.8.37	PW64	One-valver (Class B)	AW440
The Gladiator All-Wave Threo (HF Pen, D (Pen), Pen)	29.8.36	PW66	Two-valve : Blueprints, 1s. each.	
F. J. Camm's Record All-Wave Threo (HF Pen, D, Pen)	31.10.36	PW69	Melody Ranger Two (D, Trans)	AW388
The "Colt" All-Wave Threo (D, 2 LF (RC & Trans))	5.12.36	PW72	Full-volume Two (SG det., Pen)	AW392
Four-valve : Blueprints, 1s. each.			B.C. National Two with Lucerne Coll (D, Trans)	AW377A
Sonotone Four (SG, D, LF, P)	1.5.37	PW4	Big-power Melody Two with Lucerne Coll (SG, Trans)	AW338A
Fury Four (2SG, D, Pen)	8.5.37	PW11	Lucerne Minor (D, Pen)	AW426
Beta Universal Four (SG, D, LF, Cl. B)		PW17	A Modern Two-valver	WM409
Nucleon Class B Four (SG, D (SG), LF, Cl. B)	6.1.34	PW34B	Three-valve : Blueprints, 1s. each.	
Fury Four Super (SG, SG, D, Pen)		PW34C	Class B Threo (D, Trans, Class B)	AW386
Battery Hall-Mark 4 (HF, Pen, D, Push-Pull)		PW46	New Britain's Favourite Threo (D, Trans, Class B)	15.7.33 AW394
F. J. Camm's "Limit" All-Wave Four (HF Pen, D, LF, P)	26.9.36	PW67	Home-bull Coll Threo (SG, D, Trans)	AW404
All-Wave "Corona" 4 (HF Pen, D, LF, Pow)	9.10.37	PW79	Fan and Family Threo (D, Trans, Class B)	25.11.33 AW410
<b>Mains Operated</b>				
Two-valve : Blueprints, 1s. each.			£5 5s. S.G. 3 (SG, D, Trans)	2.12.33 AW412
A.C. Twin (D (Pen), Pen)		PW18	1934 Ether Searcher; Baseboard Model (SG, D, Pen)	AW417
A.C. D.C. Two (SG, Pow)		PW31	1934 Ether Searcher; Chassis Model (SG, D, Pen)	AW410
Selectone A.C. Radiogram Two (D, Pow)		PW10	Lucerne Ranger (SG, D, Trans)	AW422
Three-valve : Blueprints, 1s. each.			Cosor Melody Maker with Lucerne Coils	AW423
Double-Diode-Triode Threo (HF Pen, DDT, Pen)		PW23	Mullard Master Threo with Lucerne Coils	AW424
D.C. Ace (SG, D, Pen)		PW25	£5 5s. Threo: De Luxe Version (SG, D, Trans)	10.5.34 AW435
A.C. Threo (SG, D, Pen)		PW29	Lucerne Straight Threo (D, RC, Trans)	AW437
A.C. Leader (HF Pen, D, Pow)	7.4.34	PW35C	All-Britain Threo (HF Pen, D, Pen)	AW448
D.C. Premier (HF Pen, D, Pen)	31.3.34	PW85B	"Wireless League" Threo (HF Pen, D, Pen)	3.11.34 AW451
Ubique (HF Pen, D (Pen), Pen)	28.7.34	PW36A	Transportable Threo (SG, D, Pen)	WM271
Armada Mains Threo (HF Pen, D, Pen)		PW33	£6 6s. Radiogram (D, RC, Trans)	WM318
F. J. Camm's A.C. All-Wave Silver Souvenir Threo (HF Pen, D, Pen)	11.5.35	PW59	Simple-tune Threo (SG, D, Pen)	June '33 WM327
"All-Wave" A.C. Threo (D, 2LF (RC))	17.8.35	PW54	Economy-Pentode Threo (SG, D, Pen)	Oct. '33 WM337
A.C. 1936 Sonotone (HF Pen, HF Pen, Westector, Pen)		PW56	"W.M." 1934 Standard Threo (SG, D, Pen)	WM351
Mains Record All-Wave 3 (HF Pen, D, Pen)	5.12.36	PW70	£3 3s. Threo (SG, D, Trans)	Mar. '34 WM354
All-World Ace (HF Pen, D, Pen)	28.8.37	PW80	Iron-core Band-pass Threo (SG, D, QP21)	WM362
Four-valve : Blueprints, 1s. each.			1935 £6 6s. Battery Threo (SG, D, Pen)	WM371
A.C. Fury Four (SG, SG, D, Pen)		PW20	PTP Threo (Pen, D, Pen)	June '35 WM389
A.C. Fury Four Super (SG, SG, D, Pen)		PW34D	Certainty Threo (SG, D, Pen)	WM393
A.C. Hall-Mark (HF Pen, D, Push-Pull)	24.7.37	PW45	Minute Threo (SG, D, Trans)	Oct. '35 WM400
Universal Hall-Mark (HF Pen, D, Push-Pull)	9.2.35	PW47	All-wave Winning Threo (SG, D, Pen)	Dec. '35 WM396
<b>SUPERHETS.</b>				
Battery Sets : Blueprints, 1s. each.			Four-valve : Blueprints, 1s. 6d. each.	
£5 Superhet (Three-valve)	5.6.37	PW40	65a. Four (SG, D, RC, Trans)	AW370
F. J. Camm's 2-valve Superhet	13.7.35	PW52	"A.W." Ideal Four (2SG, D, Pen)	16.9.33 AW402
F. J. Camm's £4 Superhet		PW58	2HF Four (2 SG, D, Pen)	AW421
F. J. Camm's "Vitesse" All-Wave (5-valver)	27.2.37	PW75	Crusader's A.V.C.4 (2 HF, D, QP21) (Pentode and Class B Outputs for above: Blueprints, 6d. each)	18.8.34 AW445
Mains Sets : Blueprints, 1s. each.			Self-contained Four (SG, D, LF, Class B)	25.8.34 AW445A
A.C. £5 Superhet (Three-valve)		PW43	Lucerne Straight Four (SG, D, LF, Trans)	Aug. '33 WM331
D.C. £5 Superhet (Three-valve)	1.12.34	PW42	£5 5s. Battery Four (HF, D, 2LF)	Feb. '35 WM381
Universal £5 Superhet (Three-valve)		PW44	The H.K. Four (SG, SG, D, Pen)	Mar. '35 WM384
F. J. Camm's A.C. £4 Superhet 4	31.7.37	PW59	The Auto Straight Four (HF Pen, HF Pen, DDT, Pen)	April '36 WM404
F. J. Camm's Universal £4 Superhet 4		PW60	Five-valve : Blueprints, 1s. 6d. each.	
"Qualitone" Universal Four	16.1.37	PW73	Super-quality Five (2HF, D, RC, Trans)	May '33 WM320
<b>SHORT-WAVE SETS.</b>				
Two-valve : Blueprint, 1s.			Class B Quadradyne (2 SG, D, LF, Class B)	Dec. '33 WM344
Midget Short-wave Two (D, Pen)		PW38A	New Class-B Five (2 SG, D, LF, Class B)	Nov. '33 WM340

These Blueprints are drawn full size. Copies of appropriate issues containing descriptions of these sets can in some cases be supplied at the following prices, which are additional to the cost of the Blueprint. A dash before the Blueprint Number indicates that the issue is out of print.

Issues of Practical Wireless	.. 4d.	Post Paid.
Amateur Wireless	.. 4d.	.. ..
Practical Mechanics	.. 7d.	.. ..
Wireless Magazine	.. 1/3	.. ..

The index letters which precede the Blueprint Number indicate the periodical in which the description appears: thus PW refers to PRACTICAL WIRELESS, AW to Amateur Wireless, PM to Practical Mechanics, WM to Wireless Magazine.

Send (preferably) a postal order to cover the cost of the blueprint and the issue (stamps over 6d. unacceptable), to PRACTICAL AND AMATEUR WIRELESS Blueprint Dept., George Newnes, Ltd., Tower House, Southampton Street, Strand, W.C.2.

Economy A.C. Two (D, Trans) A.C.		WM286
Unicorn A.C.-D.C. Two (D, Pen)		WM304
Three-valve : Blueprints, 1s. each.		
Home-Lover's New All-electric Threo (SG, D, Trans) A.C.		AW383
S.G. Threo (SG, D, Pen) A.C.		AW390
A.C. Triodyne (SG, D, Pen) A.C.	19.8.33	AW399
A.C. Pentaquester (HF Pen, D, Pen)	23.6.34	AW439
Mantovan A.C. Threo (HF Pen, D, Pen)		WM374
£15, 15s. 1936 A.C. Radiogram (HF, D, Pen)	Jan. '36	WM401
Four-valve : Blueprints, 1s. 6d. each.		
All-Metal Four (2 SG, D, Pen)	July '33	WM326
Harris Jubilee Radiogram (HF Pen, D, LF, P)	May '35	WM386

SUPERHETS.		
Battery Sets : Blueprints, 1s. 6d. each.		
Modern Super Senior		WM375
Varsity Four	Oct. '35	WM395
The Request All-Waver	June '36	WM407
1935 Super Five Battery (Superhet)		WM379
Mains Sets : Blueprints, 1s. 6d. each.		
1934 A.C. Century Super A.C.		AW425
Heptode Super Three A.C.	May '34	WM359
"W.M." Radiogram Super A.C.		WM366
1935 A.C. Stenode	Apr. '35	WM385

PORTABLES.		
Four-valve : Blueprints, 1s. 6d. each.		
Midget Class B Portable (SG, D, LF, Class B)	20.5.33	AW389
Holiday Portable (SG, D, LF, Class B)	1.7.33	AW393
Family Portable (HF, D, RC, Trans)	22.9.34	AW447
Two H.F. Portable (2 SG, D, QP21)	June '34	WM363
Tyers Portable (SG, D, 2 Trans)		WM367

SHORT-WAVE SETS—Battery Operated.		
One-valve : Blueprints, 1s. each.		
S.W. One-valve converter (Price 6d.)		AW329
S.W. One-valve for America	23.1.37	AW429
Rome Short-Waver		AW452
Two-valve : Blueprints, 1s. each.		
Ultra-short Battery Two (SG det., Pen)	Feb. '36	WM402
Home-made Coll Two (D, Pen)		AW440
Three-valve : Blueprints, 1s. each.		
World-ranger Short-wave 3 (D, RC, Trans)		AW355
Experimenter's 5-metre Set (D, Trans, Super-regen)	30.6.34	AW438
Experimenter's Short-waver (SG, D, Pen)	Jan. 19, '35	AW463
The Carrier Short-waver (SG, D, P) July '35		WM390
Four-valve : Blueprints, 1s. 6d. each.		
A.W. Short-wave World-Beater (HF Pen, D, RC, Trans)		AW436
Empire Short-Waver (SG, D, RC, Trans)		WM313
Standard Four-valver Short-waver (SG, D, LF, P)	Mar. '35	WM388
Superhet: Blueprint, 1s. 6d.		WM397
Simplified Short-waver Super	Nov. '35	WM397

Mains Operated.		
Two-valve : Blueprints, 1s. each.		
Two-valve Mains short-waver (D, Pen), A.C.		AW453W
"W.M." Band-spread Short-waver (D, Pen) A.C.-D.C.		WM368
"W.M." Long-wave Converter		WM380
Three-valve : Blueprint, 1s.		
Emigrator (SG, D, Pen) A.C.		WM352
Four-valve : Blueprint, 1s. 6d.		
Standard Four-valve A.C. Short-waver (SG, D, RC, Trans)	Aug. '35	WM391

MISCELLANEOUS.		
Enthusiast's Power Amplifier (1/8) June '35		WM387
Listeners' 5-watt A.C. Amplifier (1/8)		WM392
Radio Unit (2v) for WM392	Nov. '35	WM398
Harris Electrogram (battery amplifier) (1/-)	Dec. '35	WM399
De-Luxe Concert A.C. Electrogram	Mar. '36	WM403
New Style Short-Wave Adapter (1/-)	June '35	WM388
Trickle Charger (6d.)	Jan. 5, '35	AW462
Short-Wave Adapter (1/-)	Dec. 1, '34	AW456
Superhet Converter (1/-)	Dec. 1, '34	AW457
B.L.D.L.C. Short-wave Converter (1/-)	May '36	WM405
Wilson Tone Master (1/-)	June '36	WM406
The W.M. A.C. Short-Wave Converter (1/-)		WM403



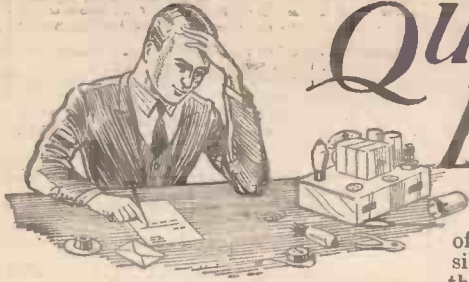

# QUERIES and ENQUIRIES

surplus. Unfortunately, there is no standardisation regarding the colours of leads to such coils, and it is not possible from a sketch to ascertain whether they are straight broadcast coils, all-wave units, or superhet coils. We regret, therefore, that we cannot give connections, and you must first ascertain the windings which are employed. If you have had no experience with modern coils, your best plan would be to take them to a good local dealer who may recognise the make and thus enable you to get into touch with the makers with a view to finding the particular type.

## Frame Aerial Connections

"To use with a small portable set I propose to make a frame aerial winding, to go round the set case. I am not clear concerning the method of winding, although I remember your rule-of-thumb details, 75ft. for medium waves and 250ft. for long waves. What gauge of wire is best and what is the method of winding?"—B. F. (Cardiff).

THE windings are all in the same direction and the total length may be wound as one continuous winding, with a tapping taken at the end of the 75ft. length. The best scheme is to use a good Litz wire for the shorter length (used for medium-wave tuning) and an ordinary cotton-covered wire (gauge 28 or so) for the remainder of the winding. By separating the two sections slightly it is sometimes possible to obtain improved results. If a reaction winding is needed on the frame it should be placed between the two sections, closer to the long-wave section so that the effects on both wavebands are equal without switching the reaction winding. Generally about 30ft. of wire will be found suitable for this winding.

## Three-valver for Beginner

"I am just taking up wireless and should be glad if you could recommend a suitable set for me. I have not built a receiver before and am impressed with the designs published by you. I do not want all of the world to start with, but something which will repay me for the trouble of making it and assist in obtaining an understanding of radio receiver construction. What do you recommend?"—F. H. (York).

A BEGINNER would find it preferable to start with a simple broadcast receiver, and although chassis construction is desirable, a plain baseboard arrangement will be found simpler at the start. By using modern coils you can simplify construction, and to enable a fair selection of stations to be received an H.F. stage is desirable but not essential. The Centaur Three (Blueprint PW64) is a baseboard three-valver with an H.F. stage and two separate screened coils, while the Rapide receiver, described in this issue and also in last week's issue, is a simple detector-two L.F. receiver. Either of these will be found satisfactory for your purposes, the latter for a few stations at good volume, and the former for good DX work (long distance reception).

## Coil Connections

"I have obtained two screened coils as per diagram attached, and there are several coloured leads projecting from the bottoms of these. Can you please give me the connections so that I can fit these in a simple three-valver I am making up."—H. W. (Boston).

THE coils do not appear to be standard home-constructor components, and have probably been dismantled from a commercial receiver, or are manufacturer's

some care is required in choosing a battery capable of delivering the current required by the receiver. However, to check the consumption, connect a good milliammeter in the H.T. negative lead and switch on. This will give you the total current taken by the set. If it is excessive for the valves in use, remove the valves one at a time, and the difference in current will show what each takes. When all the valves are out of the set there should be no current flowing. If, however, a potentiometer is connected across the H.T. supply a current might flow through this, and in that case a switch should be included in the potentiometer circuit to break it when the set is switched off. Otherwise, there will be a continual drain through it and this may be the cause of your trouble. If there is no potentiometer, and current is still shown with all valves out, disconnect various components one at a time until the current drops to zero, and you will thus ascertain which component is causing the trouble.

## Speaker Distortion.

"I have a shop-built set which has now given rise to some form of distortion which I have been unable to trace out. It is in the form of a buzzing on the higher notes, and I have tried an external speaker on which it does not occur, and have taken out the built-in speaker and it does not occur on that. Can you give any clue as to what may be causing this noise as it is very distressing when listening to a good musical programme?"—D. S. F. (Barnsley).

THERE are many things which can cause a trouble of the type mentioned, and these include a loose or split lamination in a plywood cabinet; loose silk covering the speaker opening; or even vibration of some metallic fitting on the cabinet. It should not be overlooked that the silk or similar material which is fitted across the speaker grille can, if it becomes loose, vibrate with the sound waves caused by the movement of the cone and set up a noise which is quite audible—although it is only made of silk. If the cabinet is made from ordinary plywood and has been kept in a changing atmosphere, the layers of wood can separate and vibrate, giving rise to the noise.

## Automatic Volume Control.

"I should like to prevent fading on my three-valver and have been told that one can convert an old circuit to employ a modern device known as automatic fading or volume control. I am rather out of touch with radio matters, but should like to know how to incorporate this scheme in my set, a diagram of which I enclose."—Q. E. (Petworth).

THE arrangement you refer to operates on valves of the variable- $\mu$  type, in which a variation of the grid-bias controls the amplification of the valve. Consequently, the first requirement for fitting A.V.C. is that the receiver utilises H.F. amplification. In a simple set such as yours, with only one H.F. stage, there would be insufficient H.F. to control the valves—the H.F. currents being rectified and fed back to the H.F. stage in the form of bias. Generally, this arrangement is only effective where two or more H.F. stages are employed, or where the circuit is of the superhet type, and thus the I.F. stages, as well as the frequency-changer (or signal H.F.) stage may be controlled.

## RULES

We wish to draw the reader's attention to the fact that the Queries Service is intended only for the solution of problems or difficulties arising from the construction of receivers described in our pages, from articles appearing in our pages, or on general wireless matters. We regret that we cannot, for obvious reasons—

- (1) Supply circuit diagrams of complete multi-valve receivers.
- (2) Suggest alterations or modifications of receivers described in our contemporaries.
- (3) Suggest alterations or modifications to commercial receivers.
- (4) Answer queries over the telephone.
- (5) Grant interviews to querists.

A stamped addressed envelope must be enclosed for the reply. All sketches and drawings which are sent to us should bear the name and address of the sender. Requests for Blueprints must not be enclosed with queries as they are dealt with by a separate department.

Send your queries to the Editor, PRACTICAL AND AMATEUR WIRELESS, George Newnes, Ltd., Tower House, Southampton Street, Strand, London, W.C.E. The coupon must be enclosed with every query.

## Best One-valver!

"Can you tell me which would give the better results—the B.B.C. One-valver or the Twenty Station One-valver?"—D. R. (Nairn).

THE first-mentioned set is a simple one-valver, but the second employs a special Class B valve used in a novel circuit. The Class B valve, as you probably know, consists of two triode assemblies in a single glass envelope, and in the Twenty-Station set, the special valve used is of the type having also the driver (triode) electrode assembly included. In this receiver, this driver section is employed as the reacting detector, and the output is fed to the two Class B sections through a push-pull transformer of the standard Class B type. Thus, the receiver is, in effect, a two-valver giving a very large output and is likely to give much better results than the single straight one-valver. Obviously, we cannot give definite indications of the stations you will hear as this depends upon your particular local conditions.

## H.T. Consumption

"I recently built a receiver but find that my H.T. battery only lasts two weeks. I have looked over the set but cannot find anything wrong. Can you tell me where to look for the trouble?"—W. K. (Reading).

WITHOUT details of the circuit and the type of H.T. battery you are using, we cannot advise definitely. It is useless trying to use a Class B valve, for instance, with a cheap 100 volt battery, and thus

The coupon on page iii of cover must be attached to every query.



## Miscellaneous Advertisements

Advertisements are accepted for these columns at the rate of 3d. per word. Words in black face and/or capitals are charged double this rate (minimum charge 3/- per paragraph). Display lines are charged at 6/- per line. All advertisements must be prepaid. All communications should be addressed to the Advertisement Manager, "Practical and Amateur Wireless," Tower House, Southampton Street, Strand, London. W.C.2.

## RECEIVERS, COMPONENTS AND ACCESSORIES

Surplus, Clearance or Secondhand, etc.

# RADIOMART

## SHORT-WAVE MANUAL

Packed with short-wave information and circuits of mains and battery receivers, including straight, superhet and 5-metre transmitters, modulators, etc. Information on transmitting licences, aerials, Class B amplifications, neutralizations, superhet alignment, etc. The most comprehensive manual published, written by practical engineers, price 6d., post free, 7/d. including catalogue.

1937 Short-wave Catalogue only (3 times enlarged) price 1/d., post free.

**44, HOLLOWAY HEAD, BIRMINGHAM 1**

**S**OUTHERN RADIO'S Guaranteed Wireless Bargains; post paid.

**P**LESSEY 3-valve Battery Sets, complete in sealed cartons with three Mazda valves, moving coil speaker, Pertrix batteries and accumulator, in exclusive walnut cabinet; 57/6 (limited quantity only).

**G**ARRARD Record Changers, A.C. 200-250 volts, changes eight 10- or 12-inch records; £6 (complete sealed cartons); universal A.C./D.C. model, 27/10.

**G**ARRARD A.C. Radiogram Units, with pick-up and all accessories, in sealed cartons; 42/-. COLLARO Single Spring Motors for Gramophones or battery radio; 10/-, complete with turntable and all accessories.

**T**EISEN (1937-38) Components: iron-core coils W.349 (Midget size), 3/6; W.477 (triple ganged, for band-pass or straight circuits), 14/6; W.476 (triple ganged superhet), 14/6; W.478 (twin ganged), 9/-; all ganged coils complete on bases, with switch; I.F. transformer coils, 4/6; dual range coils, 2/9; with aerial series condenser, W.76, 3/9.

**T**EISEN A.C./D.C. Multimeters, 5-range (tests anything radio or electrical), 8/6; loudspeaker units, 2/6; Ace (P.O.) microphones, complete with transformer, ready for use with any receiver, 4/6; headphones, 4,000 ohms, 3/- pair.

**V**ALVES.—Full range for American receivers, 6/- each.

**M**ORSE Tappers, complete radio-telegraph set (flasher, buzzer and tapper), with batteries, bulb, code, 3/-.

**B**ARGAIN Parcels of Assorted Components, including coils, resistances, condensers, chokes, wire, circuits, etc., value 21/-; 5/- per parcel.

**S**OUTHERN RADIO, 323, Euston Rd., London, N.W.1; and 48, Lisie St., London, W.C.1. All mail orders to

**S**OUTHERN RADIO, 323, Euston Rd., London, N.W.1 (near Warren St. Tube). Phone: Euston 3775.

**C**ONVERSION UNITS for operating D.C. Receivers from A.C. Mains, improved type, 120 watt output at £2/10/0. Send for our comprehensive list of speakers, resistances and other components.

**W**ARD, 46, Farringdon Street, London, E.C.4. Telephone: Holborn 9703.

**T**HE largest stock of components in England, over 500 lines, new catalogue now ready 1/d.—J. Bearfield, 105, Upper Street, London, N.1.

**H**EARPHONES.—Brown, Ericsson, G.E.O., B.T.H., Standard Telephones, Nesper, Western Electric, Sterling, etc., 2,000 ohms, 2s. 6d.; 4,000, 5s. Postage 6d. SPECIAL. Ericsson, 4,000 ohms, as new, 7s. 6d. Telefunken, lightweight, adjustable, 7s. 6d. CRYSTAL SETS. Burne-Jones. Complete, Guaranteed, 5s. 6d. Ditto, double circuit, 8s. Sensitive permanent detectors, 1s. 6d. Crystal Detectors, complete, 1s. Crystals with silver cat's-whisker, 6d. Postage 1/d.—Post Radio, 2, Copenhagen Street, London, N.1.

**C**OMMUNICATION Receivers, transmitting gear, amplifiers, valves, transformers. Distributors for Hallicrafter, Taylor, Hammarlund, Raytheon, Eimac.

Radiographic, Ltd., 66, Osborne Street, Glasgow, C.1.

# PREMIER SUPPLY STORES

## POST ORDERS

Jubilee Works,  
167, Lower  
Clapton Rd.,  
London, E.5.  
Amherst 4723

## CALLERS

165 & 165a,  
Fleet Street, E.C.4  
Central 2833  
50, High Street,  
Clapham, S.W.4.  
Macauley 2381

**3-VALVE SHORT-WAVE KIT.** S.G., H.F.; Det. and Pentode. Covers 14-170 metres, with 4 pairs interchangeable 4-pin coils. Complete kit of parts, with metal chassis and set of 3 matched 2-volt valves, 42/-; suitable metal cabinet 7/6 extra.

**NEW 1-VALVE SHORT-WAVE RECEIVER OR ADAPTOR KIT.** 13 to 86 metres without coil changing. Complete Kit and Circuit, 12/6. VALVE GIVEN FREE!

**DE LUXE MODEL, 14 to 170 metres,** complete Kit with Chassis, 4 Coils and all parts, 17/6.

**SUPERHET CONVERTER KIT, 15/-.** De Luxe Model, 20/-.

**S.W. SUPERHET CONVERTER KIT,** for A.C. Mains Receivers, 22/6. A.C. Valve given FREE!

**NEW 2-VALVE S.W. KIT, 13 to 86 metres** without coil changing. Complete Kit and Circuit, 19/6. VALVES GIVEN FREE!

**DE LUXE MODEL, 14 to 150 metres,** complete Kit and Circuit, 4 Coils and all parts, 25/-. VALVES GIVEN FREE.

**PREMIER "TROLITUL" Short Wave CONDENSERS,** Certified superior to Ceramic. All-brass Construction, 15 mmfd., 1/6; 40 mmfd., 1/7; 100 mmfd., 1/10; 160 mmfd., 2/0 mmfd., 2/6; Double Spaced 15 mmfd., 2/9; 40 mmfd., 3/6. S.W.H.F. Chokes, 9d.; screened, 1/6. All-Brass S.W. Condensers with integral slow-motion, .00015 Tuning, 4/3; .00015 Reaction, 3/9. UTILITY 4" MICRO-CURSOR DIALS. Direct and 100:1 ratio, 3/9 each.

## PREMIER MAINS TRANSFORMERS

Screened Primary Wire-end Type

250+250 or 300+300V. 60 m.a., 4v. 1-2a., 4v. 2-3a., 4v. 4v. 3-4a., all C.T. H.T. 8 & 9, 4v. 1a., 4v. 4a., all C.T. 10/- each. 350+350V. 120 m.a. 4v. 1-2a., 4v. 2-3a., 4v. 3-4a., all C.T., 11/6. 500+500V. 150 m.a., 4v. 2-3a., 4v. 2-3a., 4v. 2-3a., 4v. 3-4a., all C.T., 21/-. 100-watt auto transformers. 100-110v. to 200-240v. 10/-, terminal type. Terminal Types 1/6 extra.

**Now ready. Our New 1938 Enlarged Illustrated Catalogue, Handbook and Valve Manual. Price 6d. Send 6d. in Stamps for 90 Pages of Radio Interest!**

**Premier Battery Chargers.** Westinghouse Rectification. Complete Ready for use.

To charge 2 volts at 1 amp. 10/-
" 6 " " 1 " 16/6.
" 6 " " 1 " 19/6.
" 12 " " 1 " 21/-
" 6 " " 2 " 32/6.

**TWO NEW MODELS,** completely enclosed. To charge 6 volts at 4 amps. £3/19/6.

" 6 or 12 volts at 2 amps. £3/19/6.

**SHORT-WAVE COILS,** 4- and 6-pin types, 13-26, 22-47, 41-94, 78-170 metres, 1/9 each, with circuit. Special set of S.W. Coils, 14-150 metres, 4/- set with circuit. Premier 3-band S.W. Coil, 11-25, 10-43, 38-86 metres. Simplifies S.W. receiver construction, suitable any type circuit, 2/6.

**COIL FORMERS,** 4- or 6-pin low-loss, 1/- each.

**MAINS VALVES.** Replacement for all types in stock from 4/6 each.

**BATTERY VALVES,** 2 volts, H.F., L.F., 2/3. Power, Super-Power, 2/3. Var-Mu-S.G., 4- or 5-pin Pentodes, H.F. Pens. V-mu-H.F. Pens/5/- Class B, 5/-.

**AMERICAN VALVES.** Genuine American HYTRON and TRIAD, first-grade Valves, 3 months' guarantee. All types in stock, 5/6 each. 210 and 250, 8/6 each. New Metal-Glass Valves, all types, 6/6 each. Valve holders for all above types, 6d. each. OCTAL bases, 9d. each.

**COSMOCORD PICK-UPS,** with tonearm and volume control, 10/6 each. PICK-UP HEADS only, 4/6 each.

**PREMIER H.T. POWER PACKS.** Ready for use. 120 v. 20 m.a., 25/-, with 1/2 amp. charger, 33/-; 150 v. 30 m.a., 27/6; with 1/2 amp. charger, 35/-; 250v. 60 m.a. 4 v. 3-5 a., 33/-; 150 v. 30 m.a. valve rectifier (replacements only 2/-), 17/6.

## RADIO CLEARANCE

**63, HIGH HOLBORN, W.C.1. Holborn 4631. SPECIAL BARGAINS FOR THE HOME CONSTRUCTOR.** Offers that cannot be repeated.

5/6 per gross, **NON-INDUCTANCE MIXED RESISTANCES,** all well-known makes, Philips, Erie, Sator all 1 watt and standard sizes, no duds.

1/- for 4, **0003 BAKELITE REACTION CONDENSERS,** good make, brand new.

8d. each, **6in. TURN-TABLES** for Portable Receivers. 3d. each, **ALUMINIUM COIL CANS,** 3 1/2 ins. high, 2 1/2 ins. in diameter.

4d. each, **ALUMINIUM COIL CANS,** 5in. high, 2 1/2 ins. in diameter.

1/3, **ALUMINIUM FACED PLY,** size approximately 16ins. by 10ins.

3/6, **PLESSEY 2-GANG STRAIGHT CONDENSERS,** .0005 sections, Top Trimmers Fully Screened.

3/-, **PLESSEY 3-GANG MIDGET CONDENSER,** size approximately 2 1/2 ins. by 2 1/2 ins., precision built, each section .0005, Semi Screened.

4/6 dozen, **T.C.C., .25 mfd., 250 volt working,** Metal-cased Condenser. Upright type.

5/6 dozen, **STANDARD 1 mfd., 250 volt working,** Metal-cased Condensers. Upright type.

8d. per package, **BRASS RIVETS,** approximately 5,000.

3/-, **LISSEN GENERAL PURPOSE IRON-CORED COIL** for Aerial and H.F., complete with Reaction, list price 8/6, without Switch.

8/11, **LISSEN SET OF 3 IRON-CORED BAND-PASS COILS,** complete with Switching, Circuit, list price 37/6.

6/-, **SPECIAL CLEARANCE OF BRYCE TRANSFORMERS,** ex. large manufacturer's order, 300-0-300, 80 m.a., 4 volt, 4 amp., C/T, 4 volt 2 amp. Mains input. 200-250 volts adjustable.

1/- for 3, **LISSEN R.C.C. UNITS,** complete with resistance, etc. Boxed.

5d. **LISSEN H.F. BY PASS UNITS,** comprising 2 Mains-bridge type Condensers, Moulded Bakelite case.

All orders 5/- or over Post Free; orders under 5/- must be accompanied by a reasonable amount for postage; C.O.D. orders under 5/- cannot be accepted. **RADIO CLEARANCE, 63, High Holborn, W.C.1. Holborn 4631.**

**A**LL goods previously advertised are standard lines, still available. Post card for list free. **V**AUXILIARY UTILITIES, 163a, Strand, W.C.2. Over Denny's the Booksellers, Temple Bar 9338.

**A**LCO Eliminators and Chargers. 4 H.T. taps, Standard outputs, 18/-; with 1/2 amp. charger, 25/-. Charger, 7/6; 1/2 amp., 11/- Year's guarantee. Details free.—P. & D. Radio, 1, Gooding Road, N.7.

**B**ANKRUPT Bargains. List free. Large stock of B mains and battery sets, components, valves, speakers, and all radio goods. All brand new. Whatever you require write for a quotation. Part exchange. Easily the cheapest.—Butlin, 6, Stanford Avenue, Brighton. Phone: Preston 4030.

**F**OR all components at right price, write Radiographic, state your requirements: quotations per return. Radiographic, Ltd., 66, Osborne Street, Glasgow, C.1.

"Camm's Corona" battery and all-mains versions, specified and competitive kits. Best value receivers, valves, etc. Pick-ups, 4/- H.M.V. Auto-Record Changers. Bankrupt surplus stocks, etc. Lists free.—"Ford Radio" Service, Queens Place, Hove.

## LOUDSPEAKER REPAIRS

**L**OUNDSPEAKER repairs, British, American, any make, 24-hour service; moderate prices.—Sinclair Speakers, Alma Grove, Copenhagen Street, London, N.1.

**R**EPAIRS to Moving Coil Speakers, Cones and Coils, fitted or rewound. Fields altered. Prices Quoted including Eliminators, Loudspeakers, Repaired, 4/- L.F. and Speech Transformers, 4/- post free. Trade invited. Guaranteed Satisfaction. Prompt Service, Estimates Free.—L.S. Repair Service, 5, Balham Grove, London, S.W.12. Battersea 1321.

## VALVES

**BUY VALVES DIRECT.**—Fully guaranteed. 2-volt, H2, L2, 2s. 3d.; Power, 3s.; Screen-grids, 4s. 9d.; Pentodes, 5s. 6d. Mains, General Purpose, 4s. 6d.; Power, 6s.; Screen-grids and Pentodes, 6s. 6d.; Rectifiers, 4s. 6d. Over 150 types available—Battery, A.C. and A.C./D.C. Mains, and American. Postage 3d. one valve, 4d. two, 6d. three and over. Cash with order.—Luminous Electric Appliances Ltd. (Dept. 9), Phenix Works, Tyburn Road, Birmingham.

## TUITION

**MAKE YOUR HOBBY your career or increase its interest tenfold.** Britain's Best College, approved by the Inst. Rad. Eng. and leading Radio firms, provides complete training in Radio Engineering by post or day classes. Full details from: "P.R.W." LONDON RADIO COLLEGE, Grove Park Rd., London, W.4 (Chiswick 3244).



MISCELLANEOUS

ALL kinds of woodwork made to order.—Chipper, 63, Birnam Road, N.A.

HOBBY MONEY. Experienced amateur urgently required to assemble and install one special Gramo Amplifier. Phone Langham 1162.

OUR 1937-8 Catalogue contains much information on Transformer Design. Post Free.—Lumen Electric Coy., 1A, Scarisbrick Avenue, Liverpool, 21.

RUN YOUR ELECTRIC BELL from HOUSE MAINS



SPECIAL OFFER OF TRANSFORMERS USUAL PRICE 10/6

3/11 Converts 200v. — 250v. A.C. to 2v., 5v., or 8v. Post 6d.

Ideal for Bells, Cine Projector, Pilot Lights, Pin Tables, Testing, etc., with fuse. Fitted in 2 minutes. Just fit it and forget it. You'll never be let down through dead batteries. For A.C. only.

BARNES STORES (Pth.), Ltd. (Dpt. P.W.), 78, New Oxford Street, London, W.C.1 (And at 48, Kingston Rd., Portsmouth).

ENGINEERING OPPORTUNITIES FREE!



This unique Hand-book shows the easy way to secure A.M.I.C.E., A.M.I.Mech.E., A.M.I.E.E., A.M.I.A.E., A.M.I.W.T., A.M.I.R.E., and similar qualifications. WE GUARANTEE—“NO PASS—NO FEE.” Details are given of over 150 Diploma Courses in all branches of Civil, Mech., Elec., Navors, Aero, Radio and Television Engineering, Building, Government Employment, etc.

Write for this enlightening Hand-book to-day FREE and post free. British Institute of Engineering Technology, 409, Shakespeare House, 17, 18, 19, Stratford Place, W.1.

When writing to Advertisers please mention "Practical and Amateur Wireless"

FREE ADVICE BUREAU COUPON

This coupon is available until December 18th, 1937, and must be attached to all letters containing queries. PRACTICAL AND AMATEUR WIRELESS, 11/12/37.

ADVERTISEMENT INDEX

	Page
Armstrong Manufacturing Co.	388
Automatic Coil Winder and Electrical Equipment Co., Ltd.	373
Barnes	Cover iii
British Institute of Engineering Technology	Cover iii
British Mechanical Productions, Ltd.	385
Electradix Radios	388
Exide	Cover iv
London Radio Supply Co.	388
McCarthy Radio, Ltd.	Cover iii
New Times Sales Co.	387
Peto Scott Co., Ltd.	381
Pifco, Ltd.	Cover ii
Player's Navy Cut	373
Premier Supply Stores	392
Stratton & Co.	387
Varley	373
Whiteley Electrical Radio Co.	385
Wills' Gold Flake Cigarettes	Cover ii

PRESENTS FOR BOYS

SPEED 3/6 net.

Edited by CAPT. EYSTON, "The Fastest Man on Earth."

A lavishly produced new volume with hundreds of dramatic photographs. Captain Eyston has collected fascinating articles on man's quest for speed from simple athletics to thousand-horse-power flying machines.

\* \* \*

MODEL AIRCRAFT BOOK

3/6 net.

By F. J. CAMM. The author of Power-Driven Model Aircraft has here produced an expert's book for boys containing very latest model planes, with hundreds of helpful diagrams.

\* \* \*

MARVELS OF THE AIR 3/6 net.

Edited by T. STANHOPE SPRIGG. Another de luxe volume; lavishly illustrated, compiled by the Editor of Air Stories. Informative and stimulating articles for the air-minded youngster.

\* \* \*

HOBBIES NEW ANNUAL 3/6 net.

By F. J. CAMM. Each year Mr. Camm becomes more ingenious and interesting in his choice of models to make. Here the modern boy will find scores of fascinating articles, with hundreds of diagrams and sketches, enabling him to make experiments in present-day engineering with the simplest of materials.

George Newnes, Ltd., Tower House, Southampton St., London, W.C.2.



MCCARTHY

High Efficiency plus Economy! 5-VALVE ALL-WAVE SUPERHET

Price £6.17.6



(Complete with B.V.A. Valves)

This moderately-priced 7-stage 5-valve all-wave receiver utilizes a remarkably efficient superheterodyne circuit which provides exceptional sensitivity on all three wavebands—18-50, 200-550, 1,000-2,000 metres.

Circuit includes: Latest type triode-hexode frequency changer, vari-mu pentode I.F. amplifier, double diode-triode operating as diode detector and I.F. amplifier, and providing full A.V.C. High-slope 3 watts output pentode. Wave-change and gram. switch. As illustrated, but with new type dial with principal station names.

6-valve all-wave Superhet with Radio Frequency Stage

8 Stages  
8 tuned circuits  
3 wavebands

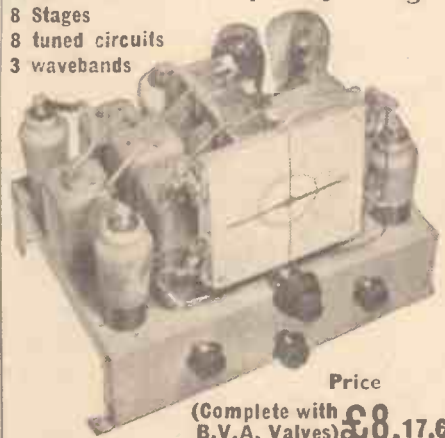

Price (Complete with B.V.A. Valves) £8.17.6

Performance made possible by use of multi-electrode valves equal to that of many receivers employing 8 valves or more. Brief specification includes: Large "Airplane" dial, with different coloured lights automatically switched on for each wave-range. Micro-vernier 2-speed drive. 4-point wave-change and gramophone switch. Volume control and variable tone control also operative on gramophone. Reinforced heavy-gauge steel chassis. Covers 19-2,000 metres.

Circuit comprises: Preselector circuit, radio frequency amplifier (operative on all 3 wavebands), triode-hexode frequency changer, double band-pass I.F.T. coupled I.F. amplifier, double diode-triode detector and L.F. amplifier. D.A.V.C. applied to 3 preceding valves. 3-watt pentode output.

All McCarthy receivers supplied complete with valves, knobs, pilot lamps, leads, mains cable and plug. 12 months' guarantee.

Deferred terms on application, or through our city agents, London Radio Supply Co., 11, Oat Lane, E.C.2. Demonstrations Daily.

Cash with order on 7 days' approval. Also write for illustrated catalogue of complete range of all McCarthy receivers.

MCCARTHY RADIO LTD. 44a, Westbourne Grove, London, W.2.

Telephone: Bayswater 3201/2.

That's  
got you  
keyed up!

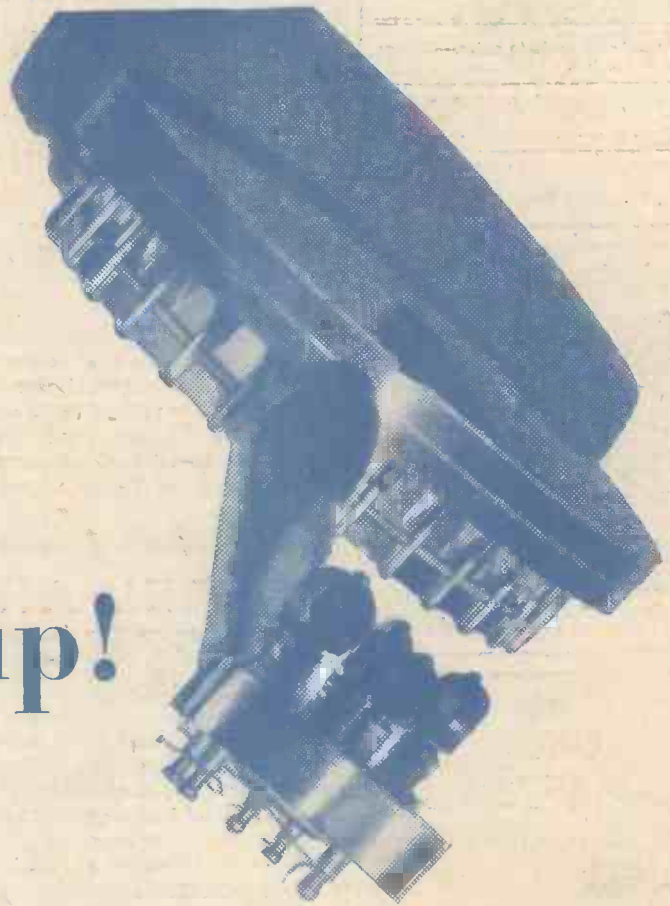

*This is a banjo! If a banjo sounds as topsy-turvy on your radio as it looks in this picture, there's something you can do at once. Get an Exide.*



R21

*From reputable dealers and Exide Service Stations. Exide Service Stations give service on every make of battery Exide Batteries, Exide Works, Clifton Junction, near Manchester. Also at London, Manchester, Birmingham, Bristol, Glasgow, Dublin and Belfast.*

# Exide

## BATTERIES FOR RADIO

*'Still keep going when the rest have stopped'*

**EXIDE 'HYCAP' BATTERY (High Capacity L.T. Battery)**

For modern multi-valve sets—lasts longer on one charge. For small sets use the Exide 'D' Type. Both have the Exide Charge Indicator. Your dealer will tell you which to use. For High Tension use Drydex.



# VARIABLE SELECTIVITY CIRCUITS — See page 395.

# Practical and Amateur Wireless

**3<sup>D</sup>**  
EVERY  
WEDNESDAY

Edited by F.J. CAMM

A GEORGE  
NEWNES  
Publication

Vol. 11. No. 274.  
December 18th, 1937.

AND PRACTICAL TELEVISION



**JUST OUT!**

## **WIRELESS COILS, CHOKES AND TRANSFORMERS: AND HOW TO MAKE THEM.**

By F. J. CAMM.

An important new Handbook for every home constructor and anyone interested in radio. With Special Chapters on Selectivity, Break-through, Coil Winders, Coil Troubles and their Remedies. 180 pages, cloth bound, with 126 easy-to-follow illustrations.

2/6 By post 2/10.

GEORGE NEWNES, LTD., Tower House, Southampton Street, Strand, LONDON, W.C.2.

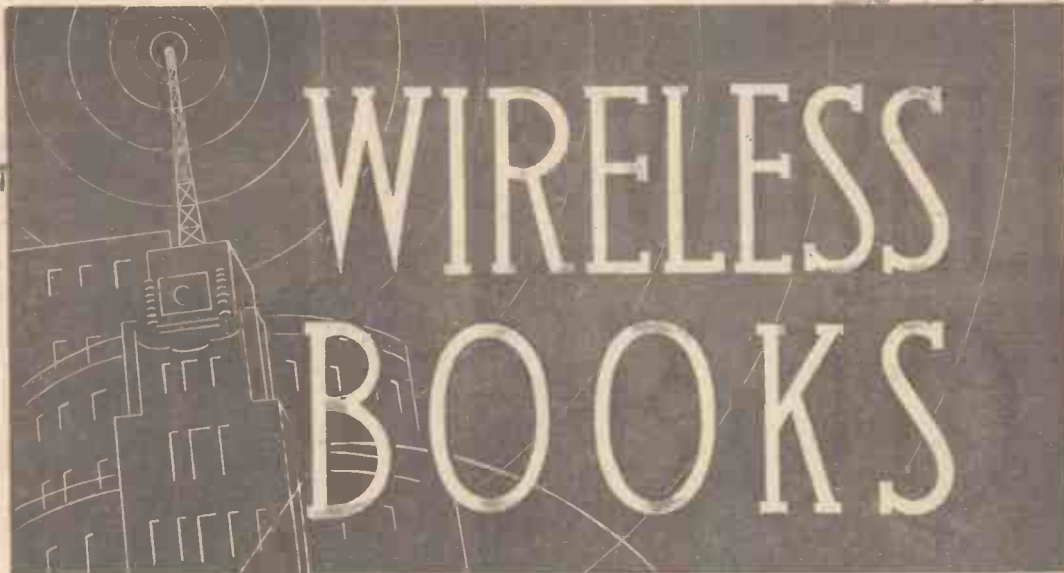

### THE OUTLINE OF WIRELESS

By RALPH STRANGER

8/6 net (9/-)

A book which covers the theory and practice of Reception from A to Z.

### WIRELESS CONSTRUCTOR'S ENCYCLOPÆDIA

By F. J. CAMM

5/- net (5/3)

The whole field of wireless construction is covered, in description and diagram in this book.

### THE MATHEMATICS OF WIRELESS

By RALPH STRANGER

5/- net (5/5)

A simple introduction to arithmetic, algebra, geometry, trigonometry and calculus as they affect wireless calculations. 256 pages. *Fully Illustrated.*

### NEWNES TELEVISION AND SHORT-WAVE HANDBOOK

By F. J. CAMM

3/6 net (4/-)

The first really complete and authoritative work on this subject.

### EVERYMAN'S WIRELESS BOOK

By F. J. CAMM

3/6 net (4/-)

**JUST OUT!**

### WIRELESS COILS, CHOKES AND TRANSFORMERS: AND HOW TO MAKE THEM

By F. J. CAMM

2/6 net (2/10)

An important new Handbook for every home constructor and anyone interested in radio. With Special Chapters on Selectivity, Break-through, Coil Winders, Coil Troubles and their Remedies. 180 pages, cloth bound, with 126 easy-to-follow illustrations.

### FIFTY TESTED WIRELESS CIRCUITS

By F. J. CAMM

2/6 net (2/10)

### DICTIONARY OF WIRELESS TERMS

By RALPH STRANGER

2/6 net (2/10)

A valuable synopsis of technical terms that everybody can understand.

Obtainable from all booksellers or send a P.O. for the amount indicated in brackets after each price and the book will be delivered to you post free . . . write to Wireless Book Department, George Newnes, Ltd., Tower House, Southampton Street, Strand, London, W.C.2.





# MODERNISING A SHORT-WAVE RECEIVER.—See page 401.

# Practical and Amateur Wireless

## Round

### Variable Selectivity

ALTHOUGH the superhet is such a useful circuit to employ where maximum selectivity is required, it is often found that the quality on the local stations does not come up to that provided by a "straight" circuit on account of the degree of cut-off which is provided by the sharply-tuned circuits. However, some listeners require to have the selectivity for distant listening, and the quality for local listening, and it is possible to obtain both without recourse to two separate receivers. There are several schemes which may be employed for the purpose—either changing the circuit by means of switches for local and distant work, or by some modification to the circuit arrangement employed in the superhet. Of these, the easiest and most practicable is the inclusion of what is now known as variable selectivity. In most cases this will consist of some means of adjusting the I.F. transformers so that by a simple switch or control knob it is instantly possible to change from one system to the other. On page 395 will be found details of the most practicable of these schemes, with diagrams showing how the various additional components are incorporated.

### Italian Morse Practice

UNDER the control of the Italian Ministry of War some slow-morse signals are being broadcast from a number of Italian stations from 3 to 3.30 p.m. on Mondays, Tuesdays, Wednesdays and Thursdays. The stations in question are Rome I, Milan I, Turin II, Genoa II, Florence II, Naples II and Bari II. The course is stated to cover the entire field of sending and receiving.

### Colour Television

IT is announced that the Baird Television Company has succeeded in radiating a picture in colour, using an analysing system based on the primary colours. A public demonstration is to be held in the near future, and it is claimed that it is capable of incorporation in the modern high-definition transmissions.

### Quality Receiver

IT is announced that a special high-quality receiver is now available in the Keates-Hacker range. It is an all-wave set, designed for very high quality and including fifteen valves, two rectifiers and two cathode-ray tuning indicators. The price, which includes an 18in. loudspeaker, but less cabinet, is £135.

Edited by  
F. J. CANN

Technical Staff:  
W. J. Delaney, H. J. Barton Chaapple, Wh.Sch.,  
B.Sc., A.M.I.E.E., Frank Preston.

Vol. XI. No. 274. December 18th, 1937.

## Wireless

## the World of

### Undersea Broadcast

IT is stated that some radio engineers of New London (Connecticut) have succeeded in broadcasting voice signals from a submerged submarine for the first time. The submarine was submerged off Bartlett Reef Light, and the signals were picked up ten miles away at the New London submarine base.

### Gaumont State Cinema, Kilburn

ON December 20th this new cinema will open its doors and a special broadcast will take place in the Regional programme. The variety to be broadcast will include Gracie Fields, Henry Hall and his Orchestra, George Formby, Larry Adler, Carroll Levis, Vic Oliver, Stone and Lee, and Alfred Van Dam and his State Orchestra. Sidney Torch will be at the organ and the broadcast will last three-quarters of an hour. The B.B.C. has

arranged to place microphones throughout the cinema to pick up both the stage performance and the atmosphere of the house.

### Carols

IN the National programme on December 24th a broadcast will take place as in previous years by the King's College Chapel Choir. Included in this broadcast is what is regarded as the most beautiful carol service in the United Kingdom—the traditional name being "The Festival of Nine Lessons and Carols." It is claimed that King's College Chapel has perfect acoustics and is possibly the church best suited to broadcasting in this country. From St. Mary's, Whitechapel, on the same day there will also be a broadcast of modern waits. The B.B.C. singers, augmented by members of the Military Band, have, with the Vicar, sung carols to the world since 1922. Leslie Woodgate will conduct the combined choir.

### From Abroad

DURING Christmas week some interesting broadcasts will take place, from foreign studios, through the B.B.C. network. On December 21st the light orchestra of the Amsterdam broadcasting station will play teatime music. The following day a relay of French poetry will be broadcast from P.T.T. From the Prague National Theatre the third act of "The Bartered Bride" is to be related on Christmas Day, and a programme entitled "Bagpipe Music" will also come from Czecho-Slovakia during this week.

### What Christmas Means to Me

THIS is the title of a special broadcast of talks to be given to Northern listeners on December 20th by (amongst others) a postman, a children's hospital nurse, a poulterer, a girl assistant in a big store, and even by Father Christmas himself.

### Hungarian Gypsy Party

ON Tuesday of Christmas week the microphone will visit the Hungaria Restaurant for the Hungarian Gypsy Party. This is a gay inconsequential affair, produced by Mike Meelan of "In Town To-night," with popular Hungarian dances and a first-rate Tzigane orchestra. The Gypsy Orchestra will congregate round the microphone and, with various artists, will stage a party reminiscent of a Budapest cabaret.

## GIVE BOOKS THIS CHRISTMAS!

The following Standard Works make ideal Christmas presents. They are all suitable for beginner and expert, lavishly illustrated, well bound, and written by F. J. Cann.

**WIRELESS CONSTRUCTOR'S ENCYCLOPEDIA.** 4th Edition, 392 pages, 490 illustrations, 5/- or by post 5/6.

**EVERYMAN'S WIRELESS BOOK.** 2nd Edition, 288 pages, 243 illustrations, 3/6, or by post 3/10.

**TELEVISION AND SHORT-WAVE HANDBOOK.** 2nd Edition, 288 pages, 230 illustrations, 3/6, or by post 3/10.

**HOME MECHANIC ENCYCLOPEDIA.** 2nd Edition, 392 pages, 627 illustrations, 3/6, or by post 3/10.

**WIRELESS COILS, CHOKES & TRANSFORMERS,** and How to Make Them, 180 pages, 126 illustrations, 2/6, or by post 2/10.



# ROUND the WORLD of WIRELESS (Continued)

## Television Announcer's New Appointment

MR. LESLIE MITCHELL, the first male television announcer, has resigned from the B.B.C. in order to accept an appointment with a news reel company. His resignation will take effect towards the end of February, until when he will continue to appear regularly in the television programmes. Mr. Mitchell joined the B.B.C. as an announcer in 1934.

## The News Commentator's Cat

AN amusing incident occurred recently when Paul Sullivan, the news commentator of station WLW, Cincinnati, Ohio, startled his neighbours by opening his back door and calling, "Here, Thirty, Thirty, Thirty!"

"Poor boy—overwork, I guess," Sullivan heard a friend remark, but attention was soon drawn to a white Persian cat. Sullivan then explained.

"We named the cat Thirty," he commented, as he placed a saucer of milk on the floor.

## Variety from Blackpool

THE Northern microphone has by no means deserted the great entertainment field of Blackpool now that summer has passed, and a Northern Music Hall programme from the famous resort will be included in the evening programmes of December 15th, when listeners to the main Regional and the Northern programmes may hear some of the variety fare from the Palace Theatre.

## Stradivari

TWO hundred years ago, Antonio Stradivari, the great maker of violins, died at Cremona, and on December 18th—the day of his death—the bicentenary of his death will be celebrated by a special recital to be given by Arthur Catterall playing on his famous "Strad." The recital will be introduced by a talk by Alfred Hill, the well-known expert on old violins, and the programme will consist of the Chaconne by Giovanni Batista Vitali, the Italian composer who was born in the same year as his great compatriot, Stradivari.

## Short Radius—Long Range

THE General Electric Company, have received from a listener in Phoenix, Arizona, 2,000 miles away, the first letter reporting reception of their new ultra-short-wave transmitter, W2XOY, which is installed on top of the State Office Building, Albany, New York. The

## INTERESTING and TOPICAL NEWS and NOTES

new transmitter operates on a wavelength of 7 m. with a power of 150 watts, and is designed primarily for transmitting signals within a 20-mile radius.



Unusual method of transport for a Philips Radio through the mountain passes in Albania.

## Italian Foreign Broadcasts

A LARGE increase in foreign language talks are arranged in the official handbook of the Rome short-wave station (2RO), which has just been published. Broadcasts in Arabic will now become a daily feature from both 2RO and the Bari medium-wave station, instead of once or twice weekly, as in the past. News in Hindustani will also be broadcast every Saturday; and there will also be news transmitted in Greek, Serbian, Chinese, Japanese, Portuguese, Turkish, Albanian and Romanian, as well as the principal European languages.

## B.B.C. Symphony Orchestra's Visit to Newcastle

WE are informed that the B.B.C. Symphony Orchestra, under the direction of Sir Adrian Boult, will give a concert in the City Hall, Newcastle-upon-Tyne, on January 12th, at 8 p.m.

The programme will consist of the following works: Introduction and Allegro for String Quartet and String Orchestra (Elgar); Symphony No. 7, in A (Beethoven); Symphonic Dances (1937)—first concert performance (Hindemith); and Bolero (Ravel). Tickets and all information can be obtained from the sole agents, Messrs. J. G. Windows, Ltd., 4-7, Central Arcade, Newcastle-upon-Tyne.

## A Vatican Concert

IT is hoped that the new 50-kW short-wave Vatican station will be opened in time for transmitting the special Christmas Eve

concert of sacred music, in which the famous tenor, Beniamino Gigli, and the singers of the Sistine Chapel choir, will take part. Arrangements are being made for a series of international relays.

## New Greek Radio Headquarters

THE construction of the new Broadcasting House at Athens is making good progress, and it is officially announced that it will be opened early in the new year. Radio-Athens, which will have a power of 15 kW, will use the wavelength allotted to it by the Lucerne Conference—499.2 m. (601 kc/s).

## Poldhu Radio Station Memorial

A STRIKING memorial, consisting of a granite column with inscribed plaques on the sides, erected by the Marconi Company to commemorate the site of the former Poldhu wireless station, was inaugurated on the cliffs at Poldhu Cove, Cornwall, recently. The unveiling ceremony was performed by Mr. R. N. Vyvyan, the former Chief Engineer of the Marconi Company.

## SOLVE THIS!

### PROBLEM No. 274.

Jackson built a superhet, using all standard components. When tested out he found that it was necessary to trim the various circuits, but noted that adjustment of the I.F. transformer trimmers produced a whistle. He accordingly set these trimmers so that the whistle was not audible, but found it impossible to obtain signals throughout the tuning range, although one or two stations at one end of the dial were quite clear and strong. What was his trouble? Three books will be awarded for the first three correct solutions opened. Address your solutions to the Editor, PRACTICAL AND AMATEUR WIRELESS, Geo. Newnes, Ltd., Tower House, Southampton Street, Strand, W.C.2. Envelopes must be marked Problem No. 274 in the top left-hand corner, and must be posted to reach this office not later than the first post on Monday, December 20th, 1937.

### Solution to Problem No. 273.

The trouble with Hestler's set was that it had been built for broadcast reception and thus no attention had been paid to losses. Consequently these were so high on the short-wave band that the all-wave coil failed to give results except on the medium and long-wave bands.

The following three readers successfully solved Problem No. 272, and books have accordingly been forwarded to them: T. A. Thomas, 6, Pen-y-Wern, Wern Las, Rhos, Nr. Wrexham; D. Robertson, Aukengill, Wick, Caithness, Scotland; G. Barrow, 9, Meadow Lane, Long Eaton, Nr. Notts.



# Variable Selectivity Circuits

A Few Notes on this Important Subject, with Particular Reference to the Superhet, are Given in This Article  
by W. A. FLINT

THE most popular receiver to-day is undoubtedly the superhet, because of its great range and selectivity. Nevertheless, because of the latter, it suffers from a rather serious snag—that of “cutting” top notes.

Since the superheterodyne receiver depends for its selectivity on the use of fixed I.F. circuits tuned to a given frequency, it is obvious that any attempt to improve the high-note response of such a receiver is most easily and best carried out in the I.F. circuits themselves.

It is, of course, obvious that by the use of tight coupling between the primary and

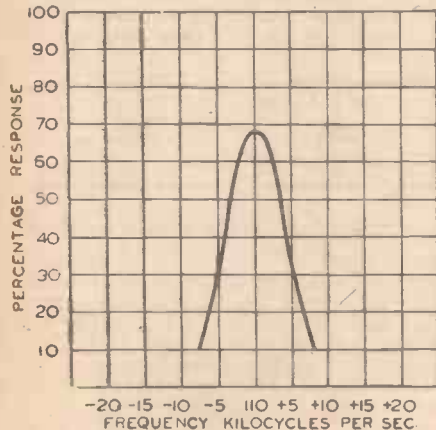

Fig. 1.—Single peak giving high selectivity and severe cut off.

secondary coils of an I.F. transformer the frequency response will be good, and the selectivity poor. With loose coupling the reverse occurs, and we have high selectivity and an attendant loss of high notes.

What is wanted, therefore, is an I.F. circuit which is adjustable for both high quality from the local station and, at the same time, possesses the ability to receive a very distant station, even though it may be on an adjacent waveband to the local, to the exclusion of all other stations. This is most easily achieved by varying the coupling between the two coils of the I.F. transformer.

## Resonance Curves

By the use of band-pass filters in the I.F. amplifier circuits and variable coupling, either electrical or mechanical, both high quality and selectivity can be obtained. In Fig. 1 is shown the response curve of an I.F. amplifier with the coupling at minimum. It will be noted that the resonance curve has a single peak, corresponding to a high degree of selectivity. Fig. 1 is not an actual resonance curve obtained by measurements, but is arbitrary, and intended to show only the selectivity of a loosely coupled I.F. transformer. The height of the curve is an indication of signal strength, and it will be noted that on either side of the resonant point there is a falling-off of

amplification of the frequencies. Since the signal received consists not only of the carrier-wave frequency, but of the carrier wave and side-band frequencies of approximately plus and minus 10,000 cycles above and below the frequency of the carrier, it is apparent that this selective circuit will respond only to the carrier wave and frequencies one or two thousand above and below it, resulting in a severe loss of the higher notes.

As the coupling between the two coils is increased, two peaks occur with a trough between them, as shown in Fig. 2, and further increase in coupling causes the peaks to move farther apart. The resonant curve now has a broad peak at the top and steeply sloping sides, the centre of the trough corresponds to the resonant point of the original single peak, and the two peaks are equally spaced on either side of the original resonant point. The circuit will now respond to frequencies 5,000 cycles above and below the original resonant point, while other frequencies will produce little or no result. This

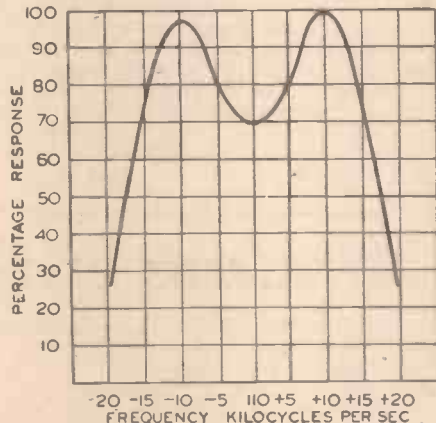

Fig. 2.—Band-pass effect giving improved frequency response.

gives very much improved high-note response but has not lowered the selectivity to the extent of introducing sidebands from adjacent unwanted stations.

If the two peaks are made excessively sharp with a large dip in between them, the ideal aimed at will not be achieved, but the result will be shrill and distorted reproduction.

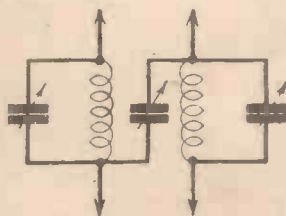

Fig. 4.—A variable condenser to control selectivity is used in this circuit.

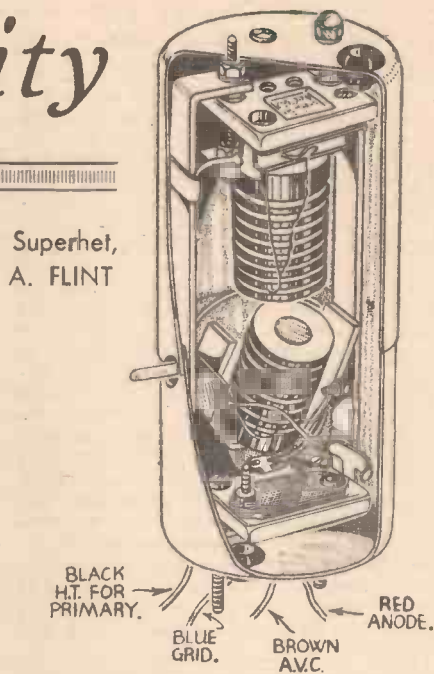

Fig. 3.—A variable-selectivity I.F. transformer having mechanical control of the coupling.

## External Control

The variation of coupling may be achieved either electrically or mechanically, and one obvious method is to adjust the distance between the two coils mechanically by means of an external control. The closer the coils are together, the tighter the coupling and the better the quality of reproduction.

An easier method, however, than varying the distance between the primary and secondary windings of an I.F. transformer is to fix one winding and rotate the other. This system is similar to the old “variometer” type of aperiodic aerial coupling, in which the aerial coupling coil was mounted within the tuning coil and rotated on its axis to give the required degree of selectivity. When the coupling coil was at right-angles to the tuning coil the coupling was at minimum and selectivity at its greatest.

In the case of the I.F. transformer, the two windings are mounted one above the other with their horizontal axes at right-angles to the side of the screen. The external controlling rod rotates the lower coil about its vertical axis, and thus varies the coupling between the two windings, and controls the degree of selectivity and high-note response. This method has the advantage of producing symmetrical double peaked curves with little change in the single peak resonant frequency. A typical variable-selectivity I.F. transformer of this type is shown in Fig. 3.]

Another method, which is carried out electrically, consists of mounting the two coils comprising the band-pass arrangement for the I.F. transformer the correct distance apart so as to give a single-peaked reson-

(Continued overleaf)

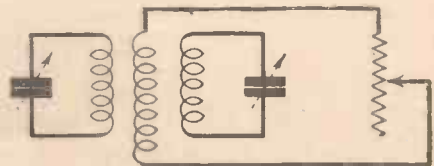

Fig. 5.—A tertiary winding shunted by a variable resistance may be used to control selectivity.

## VARIABLE SELECTIVITY CIRCUITS

(Continued from previous page)

ance curve, and to control their coupling by means of a small variable condenser across the high potential ends, as shown in Fig. 4. The currents in the primary winding pass through this coupling condenser and will energise the secondary winding. The larger the capacity of the coupling condenser, the weaker will be the potentials established across it, and therefore the coupling effect will be reduced. This is equivalent to moving the coils farther apart, and gives maximum selectivity. On the other hand, if the coupling condenser is reduced in value, the potentials established across it will be greater at all frequencies, and the coupling will be increased giving greater and wider frequency response. The coupling condenser is usually of the pre-set variety, and when screwed right up gives a peak separation of about 6 kc/s. This method has the advantage that the coils are fixed relative to the screen, and their inductance and tuning are not, therefore, affected by adjustment of the coupling. The obvious disadvantage is the method of controlling the pre-set condenser externally, as neither plate is "earthed," and the

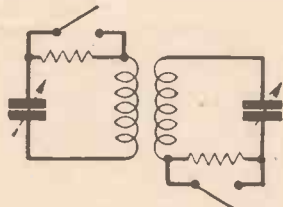

Fig. 7.—Damping resistances added in series to broaden tuning.

addition of a long controlling rod will add unwanted capacity.

## Tertiary Winding

There is another electrical method of controlling coupling, which is now being more widely used. This consists of a third

or tertiary winding acting as a coupling between the two coils comprising the I.F. transformer. This tertiary winding is shunted with a variable resistance as shown in Fig. 5. The degree of coupling depends on the inductance of the third winding and its associated resistance, which helps to communicate the potentials established across the primary winding to the secondary winding. The degree of coupling depends upon the value of the resistance. The greater the value of the latter, the less will

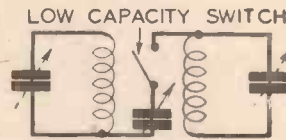

Fig. 6.—Method of adding variable selectivity to an ordinary I.F. transformer.

be the coupling and the more selective the circuit. As the value of the resistance is decreased, so the inductance of the circuit is increased, and the coupling between the windings becomes tighter.

A modification of this arrangement is to dispense with the variable resistance, and allow the auxiliary coupling winding to be controlled for single-peak selectivity or double-peaked quality by means of a single-pole double-throw switch.

These are the methods of controlling I.F. selectivity in general use to-day, but there are two or three methods which, while not being very popular, are at least worth consideration.

## Alternative Methods

The first is a modification of Fig. 4, in which an external condenser is added to a normal I.F. transformer, and controlled by a low-capacity switch as shown in Fig. 6. The disadvantages of this arrangement are the capacity of the switch and its external control, hand-capacity effects, and the fact that a condenser of very low value is necessary. The exact value of the condenser is a matter of trial and error, and is

the cause of much experiment on the part of a constructor. However, quite good results have been obtained by the author using a .00001 mfd. fixed condenser.

When both windings of an I.F. transformer are accurately tuned to the frequency of the local oscillator, high selectivity results. Two methods of "damping" the windings and thus broadening the tuning are resistances in series or in parallel, as shown in Figs. 7 and 8. In each case the gain is reduced, and the high-note response improved. When the series method is used, resistances with a value of 500-1,000 ohms will generally be found suitable, while shunts of 50,000 ohms will usually give good results. In either case, the resistance of the coil windings, the I.F. frequency, etc., have to be taken into consideration, but the values given make a good starting point for experimental work.

The resonant frequency of an oscillatory circuit depends, among other things, upon the capacity in the circuit. Providing the remaining components making up the circuit remain constant, it follows that any alteration in the capacity will affect the resonant frequency to a given degree. The smaller the ratio of the capacity to the inductance in the circuit, the sharper will be the resonance curve. It follows, therefore, that by increasing the capacity

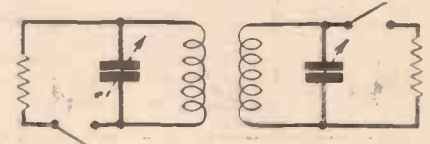

Fig. 8.—Damping resistances added in parallel to broaden tuning.

across the windings of an I.F. transformer, we shall extend the frequency response. This method has been tried out by the author, but has been found to give unsymmetrical peaks, and to introduce distortion, unless the values of the condensers are accurately adjusted for value and equality.

## Important Broadcasts of the Week

### NATIONAL (261.1 m. and 1,500 m.)

Wednesday, December 15th.—Russian Revolution: feature programme by Professor Temperley.

Thursday, December 16th.—Playing the Game, a musical play.

Friday, December 17th.—Finnish European Concert, from Helsingfors.

Saturday, December 18th.—Music Hall programme.

### REGIONAL (342.1 m.)

Wednesday, December 15th.—Midland Parliament: Should Men and Women get Equal Pay? A discussion.

Thursday, December 16th.—The Messiah: Choral and Orchestral programme, from the Victoria Hall, Hanley.

Friday, December 17th.—Snooker: A commentary during play between H. Lindrum and T. Newman in the Handicap Competition, from Thurston's Hall.

Saturday, December 18th.—Scrapbook for 1913, feature programme by Leslie Bailey and Charles Brewer.

### MIDLAND (296.2 m.)

Wednesday, December 15th.—Midland Parliament: Should Men and Women get Equal Pay? A discussion.

Thursday, December 16th.—The Messiah: Choral and Orchestral programme, from the Victoria Hall, Hanley.

Friday, December 17th.—Songs by Cyril Christopher: vocal recital.

Saturday, December 18th.—Orchestral programme.

### WELSH (373.1 m.)

Wednesday, December 15th.—Variety from the New Theatre, Cardiff.

Thursday, December 16th.—Orchestral concert.

Friday, December 17th.—At Random: Rural Crafts, a talk.

Saturday, December 18th.—Vocal recital.

### WEST OF ENGLAND (285.7 m.)

Wednesday, December 15th.—Western Cabaret, from the Royal Bath Hotel, Bournemouth.

Thursday, December 16th.—The Elephant, an anthology.

Friday, December 17th.—Organ recital from the Regent Cinema, Bournemouth.

Saturday, December 18th.—Crimes, a traditional Dorset play, by the Evershot Mummings.

### NORTHERN (449.1 m.)

Wednesday, December 15th.—Variety from the Palace Theatre, Blackpool.

Thursday, December 16th.—Port Sights—3, Cargo—a short outside broadcast cameo.

Friday, December 17th.—Variety from the Palace Theatre, Halifax.

Saturday, December 18th.—Brass Band and choral concert.

### SCOTTISH (391.1 m.)

Wednesday, December 15th.—Orchestral programme.

Thursday, December 16th.—Orchestral concert from the Caird Hall, Dundee.

Friday, December 17th.—Choral programme.

Saturday, December 18th.—Holly Follies (1937 edition), variety programme.

### NORTHERN IRELAND (307.1 m.)

Wednesday, December 15th.—Stop Dancing, a programme of very light music.

Thursday, December 16th.—Orchestral concert.

Friday, December 17th.—Belfast Philharmonic Society's Concert from the Ulster Hall.

Saturday, December 18th.—The Birth of a Giant, feature programme.



# Converting Battery to Mains Circuits

The Experimenters Discuss Some of the Problems that Arise and Show that there is More in the Matter than a Mere Exchange of Valves and Cathode Connections

IN a recent article we pointed out that a reader had suggested that we gave too much attention to battery-set users, to the detriment of those who prefer mains operation. Since writing that, we have had a few similar letters, as well as several from readers who suggest that we should give both mains and battery "versions" of all the circuits that we describe. Perhaps that would be a method of satisfying everybody, but you must remember that the whole issue cannot be placed at our disposal. If every circuit had to be duplicated

is certainly not our wish to slight the beginner—we have all to pass through the novitiate stage at some time and we are as

*by The Experimenters*

anxious as anybody could be to assist beginners to graduate to the state of experimenters or experienced constructors. At the same time, we find that the

wished to build a set to follow a complete design published in other parts of this journal. However, do not let us labour this point. We hope that we have made the matter clear and that we shall be able to write the kind of material that appeals to the majority of our readers. We are always pleased to receive suggestions, and where these are endorsed by a number of readers, to act upon them.

### Changing to A.C.

But let us return to the subject that forms the title of this article. If we show the principal differences between battery and mains circuits, our future references to various types of circuit will perhaps be better appreciated. Fundamentally, there is no difference between a circuit for a battery set and one for operation from the mains supply; in practice there can be a vast difference.

Probably the most important point to be remembered is that mains valves are more efficient than their battery counterparts. This does not necessarily mean that you can take a battery circuit, put in mains valves—after modifying the H.T. and L.T. connections—and obtain better results than could be provided by the battery set. Increased efficiency also results in increased probability of instability unless precautions are taken to ensure more thorough decoupling and better screening.

Take the three-valve circuit shown in Fig. 1. This is for battery operation. Now look at Fig. 2, which shows a similar circuit for mains operation, using 4-volt A.C. valves. You can see that, instead of one side of the filaments being joined to the earth line, the cathode completes the earth-return circuit. You can also see that instead of using a separate H.T. positive tapping for the screening-grid of the

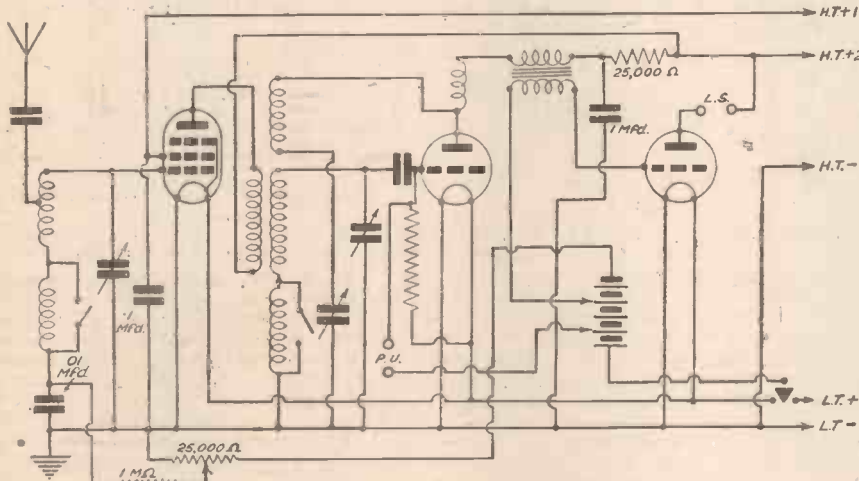

Fig. 1.—A typical three-valve circuit for battery operation.

there would be very little space left for the article itself—and that would never do.

### Skeleton Diagrams

There is, another important aspect of this question. Many of the circuits dealt with are used to illustrate principles and general circuit arrangements; they are similarly applicable to both battery and mains operation. In such cases, those constructors who always operate their receivers from the mains should not find very much difficulty in completing the skeleton diagrams that are given. These incomplete circuits are often more valuable than if they showed every component and every wire in the set. That is because they should clearly show the main items in such a way that the underlying idea can be grasped immediately.

In any case, circuits of this kind are given only in articles intended to appeal more to the experienced constructor. When we write for the beginner we do not rely on theoretical diagrams but give wiring plans or pictorial illustrations as well. Let us be quite frank. When we give a circuit that some readers cannot understand it can be taken for granted that the reader concerned probably lacks the necessary experience to use it satisfactorily. It

majority of our regular readers have a very sound knowledge of the fundamentals of the subject, and are anxious to have articles of a slightly more advanced nature. This is another reason why we have recommended a few of our correspondents who

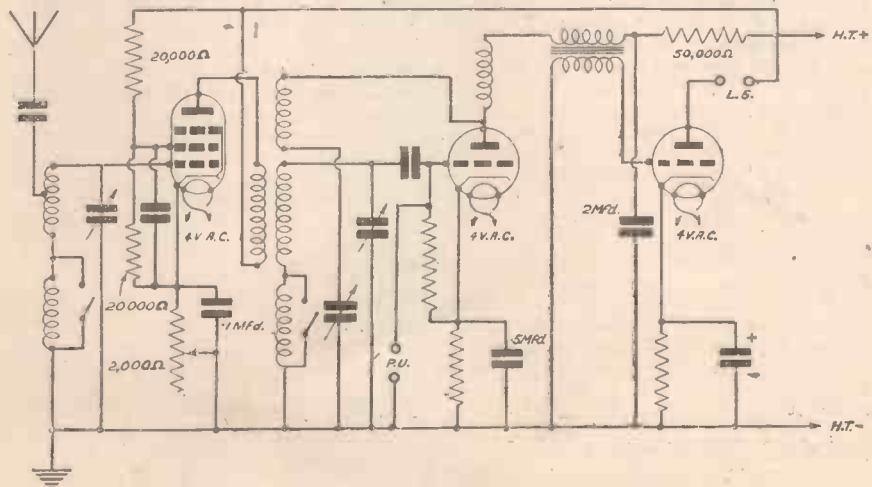

Fig. 2.—Similar in principle to Fig. 1, this circuit is for A.C. operation. The power-supply section is omitted for simplicity.

H.F. pentode, this electrode is supplied from a fixed potentiometer connected across the H.T. supply. The variable- $\mu$  control by means of a battery and potentiometer is replaced by a variable resistance in the cathode lead of the first valve.

### Detector and L.F. Circuits

The detector circuit, also, is different, for the grid-leak is connected to the cathode instead of to L.T.+, and the grid bias for use in connection with the pick-up terminals is developed across a fixed resistance, shunted by a by-pass condenser, in the cathode circuit of the detector valve. Additionally, the decoupling resistor in the detector anode circuit is of higher value in the mains circuit.

Turning to the output valve, it can be seen that bias is derived from the voltage drop across the cathode-to-earth bias resistor.

The above are just the elementary points that have to be considered. In addition to these, it is found in practice that the components have to be arranged with rather more care, and that the L.F. transformer has to be kept as far away from the mains transformer and smoothing choke as possible; it should also be at right-angles to these components if mains hum is to be avoided. In some cases it might be found that a decoupling resistor must be included in the anode circuit of the H.F. pentode to prevent uncontrollable oscillation. It might even be found that the H.F. transformer between the first two valves should be replaced by tuned-grid coupling if the set is not to get "out of hand."

### H.T. Voltage

Some of these things cannot always be foreseen, and the constructor has, therefore, to understand the symptoms which point to their necessity. Another very important point is that the receiver circuit has to be designed in conjunction with the power-supply portion of the complete set. Thus, if the resistance values are chosen to suit an H.T. voltage of 250, they might have to be modified should the voltage applied be, say, 350. Then again, the actual voltage that will be developed can be determined only when the designer has a knowledge of the current consumption of the various valves, and of the rectifier output under certain conditions of load.

The latter point will be more easily understood when it is pointed out that a metal rectifier having a nominal output of 250 volts at 60 mA. will give about 330 volts if the current drain is reduced to 30 mA. And then suppose that a rectifier giving 60 mA. at 250 volts is used in conjunction with a receiver circuit requiring 60 mA. A smoothing choke must be included in the H.T. circuit, and one constructor might choose one with a D.C. resistance of 300 ohms, whereas another constructor would use one with a resistance of 750 ohms. The first would cause a voltage-drop of 18 and the second of 45; in calculating the values of coupling and decoupling resistors the difference might be important.

Please do not think that we are trying to make the subject appear very difficult. We are not, but in fairness to readers we must show what points should be given careful consideration if trouble is to be avoided.

### A.C./D.C. Modifications

If we consider an A.C./D.C. circuit, such as that shown in Fig. 3, we find still more considerations that must be observed.

This circuit is identical in principle and form with those in Figs. 1 and 2, but it differs from both. The cathode connections are practically the same as those shown in Fig. 2, but the heater circuit is entirely different. In this case, all the heaters are connected in series, that of the detector being at the negative end of the chain, and that of the rectifier being at the positive end.

In addition, there is the barretter which is included in series with all the heaters to limit the voltage supplied to them to the correct figure regardless of the voltage of the mains supply (within normal limits). In this case, care has to be taken that all of the valves in the set have heaters taking the same current, whilst the total

words, it would require to have a "voltage range" of 75 to 165 volts. Lists would have to be consulted to find the most suitable type.

We think that you will see from the brief details of the question that we have given that there are many items that have to be borne in mind. The design of a suitable circuit is not difficult, but you cannot just take a battery arrangement and use it for mains-feed simply by changing the valves.

As far as we are concerned, we would rather give mains circuits than battery circuits, because we prefer to use mains-operated valves. But our correspondence has shown that by far the largest proportion of our readers do not agree on this point; they prefer to carry out their

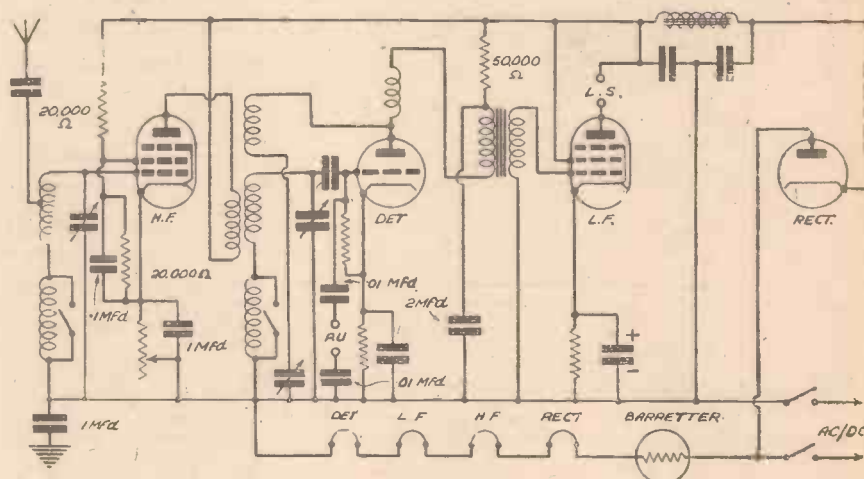

Fig. 3.—This circuit is of the "Universal" type. Note the isolation from earth of the aerial, earth and pick-up terminals.

voltage required by them has to be subtracted away from the mains voltage to find the correct value of the voltage-dropping resistance—actually the barretter, for it serves that purpose. For example, if the heaters required 78 volts altogether and the set was to be used with mains supplies with voltages between 150 and 240 volts, the barretter would have to "drop" about 75 to 165 volts. In other

experiments with battery-fed circuits. Nevertheless, we shall be glad to hear from readers who are in favour of mains working—as well as from those who prefer that we should continue to devote the greater portion of our space to battery sets—so that we can be of greatest use to the majority. Even so, we do not intend to forget the minority. That's all this time. Cherio.

## XMAS TELEVISION PROGRAMMES

TWO interesting television broadcasts take place this week: "The Ghost Train" and "Cavalcade of Music-Hall." In the first item, to be broadcast on December 20th and 28th, film flashes and tricks of the television cameras will both play a large part in creating that scene of ghastly desolation in the small general waiting-room at Fal Vale on the South Cornwall Joint Railway. The part of Miss Bourne, the elderly lady with the parrot cage, will be played by Laura Smithson, who has appeared in thousands of stage performances of the play, including a tour of Australia and New Zealand. Hugh Dempster will be seen as Richard Winthrop, Daphne Riggs as Elsie his wife, and the honey moon couple will be played by John Counsel and Joan Lawson.

### A Transformation

The television studios will be transformed into an old-time theatre with stage, boxes and auditorium when Harry Pringle's "Cavalcade of Music-Hall" is presented on Christmas Night. Among the stars of the

past and present who have promised to appear are George Mozart, the famous comedian; Tom Leamore, the original "Percy from Pimlico"; Walter Williams, who scored that War-time hit "K-K-Katie"; and Charlie Lee, aged seventy-two, who is still a champion high kicker; the popular Daisy Dormer, in "I Wouldn't Leave my Little Wooden Hut for You"; Lizzie Collins, granddaughter of the famous Lottie, who will sing "Ta-ra-ra-boom-de-ay"; Sable Fern; and Marie Kendall; Talbot O'Farrell, the ever popular singer of "That Old-fashioned Mother of Mine"; and Emile Boreo. The whole programme will conjure up the memories of an old couple at the fireside who cast their minds back to the good old days, and as their visions take shape on the television screen they will recall many of the happy evenings they have spent up to the present time. The old couple will be played by Fewlass Llewellyn and Una Venning.

During the show the cameras will be focussed at intervals on the audience, and viewers will easily be able to imagine themselves in the theatre.





# On Your Wavelength

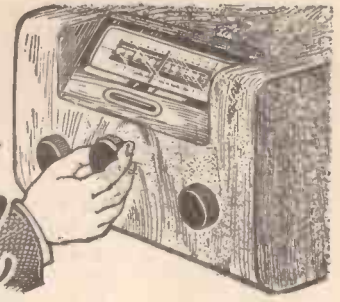

By *Thermion*

Shakespeare's plays, and I prefer to believe that it was some individual of that name.

## More Jokes

HEREWITH a collection of some jokes sent in by readers. A reader lives in a lonely place in the Wicklow Mountains, and some years ago brought the first wireless set to the district—an old-fashioned affair in a large box and equipped with bright emitting valves. He erected a huge aerial, the lead-in was hanging through the window, and when boring a hole with a brace in the window sash, to pass the wire through, an old man was heard to exclaim: "Won't you be tired turning the handle?"—W. S. (Kilkenny).

\* \* \*

"A friend of mine who knows nothing about wireless recently constructed a simple three-valve set. He complained that the signals were exceptionally weak and asked me to go round and have a look at it for him. This I did, and was surprised to see that several wires ran from the set out of the window. When asked why this was so, he pointed out to me that several wires were shown connected to earth on the theoretical circuit, and he thought the most positive method of getting a good connection to each was to run them all to earth separately."—E. C. (Crowborough).

\* \* \*

"A friend of mine came up to me the other day and asked me, 'Why did the anode bend?' I naturally replied that if no one had bent it I did not know. 'Well,' said he, 'it's because it saw the grid leak.'"—P. B. (London).

\* \* \*

This letter was addressed to Master Battisn Belfry, whose screamingly funny jokes and inventions enliven the pages of our Christmas Numbers:

"I bin reeding of your marvelous invenshuns in P. & A.W.—witch i

does evry Xmas number, an i bin thinkin, as ow i wud like to ave the squire on at our Christmas Dinner wi yore wunderful Recipe No. 6—The Television for all.

"As i be only the swineherd on is farm e will wont to now were I be gettin all the dough from to ave a television set, specially in Ashby.

"Well as you sez in your piece that they is copyw(right)? will you pleeze send your agreementt per return of post,? cos i dont wont two be hounded out of every court in England.

"Will you pleeze send me a serkit of a 'Squire Choke' cos i don't think the 'Crooner Choke' will be strong enuff to polish the owd man off.

i bee

one of your Fan(s)?

E. BEADFORD.

"P.S. Bee you any relative to the Bats in our belfry?"

## The British Sound Recording Association

I HAVE received a copy of the first issue of The Journal of the British Recording Association. I learn that the membership of this Association is rapidly increasing, and they now have many overseas members. The journal is neatly produced from duplicated typewritten matter, and contains a number of articles, such as the manufacture of gramophone records, practical hints for cutting blanks, sound recording on cine film, etc., etc. The price is 1s.

## A Lost Policeman

MESSRS. E. K. COLE, LTD., send me the following story:

One January night in 1901, a young policeman, Arthur John Cole, just transferred from Chelmsford, went out on his first night duty at Southend-on-Sea.

At 4 a.m. he went off duty, and set out to go home. The streets were still unfamiliar. The street-lamps were out. He lost his way.

Early milkmen saw him approach, turn away and walk on. He was in uniform. He walked until daylight, and only then picked up his sense of direction.

## Pioneers and Plodders

YOU can broadly classify people into two groups—the pioneers and the plodders, and it is the duty of the plodders to go out and attack the pioneers. This thought assails me because so many people nowadays exist for no other purpose than to prove that someone didn't do something, or that they did do it.

There are many people who think that Lodge did not invent the tuning circuit, that Fleming did not invent the valve, and that Marconi had little to do with wireless. These critics would assign the tuning circuit to Galileo or Faraday, the valve to Edison, and wireless to all of the earlier experimenters. It doesn't matter really who invented it as long as we have it. Now many books have been written to prove that Bacon was Shakespeare, or that Shakespeare was Bacon, or that Shakespeare was neither Bacon nor Shakespeare, or that there were no such persons as Bacon and/or Shakespeare. I do hope that my permutations of the possibilities are correct. I am reminded of this for two reasons, firstly, that I happened to be listening in to some Shakespearian broadcasts, and secondly, because I have received a postcard inviting me to buy a book which sets forth to expose Shakespeare's vital secret. This book, I am told, shows that the attribution of the plays to the Patron of W. Shakespeare is confirmed by the evidence of several contemporaries. The book explains the difficulties connected with the authorship, and also deals with the nick-name Shakespeare when the real name was Shakspere. I shall not buy this book for the simple reason I do not care one atom of a hoot who wrote it; the man is dead anyway, and rest his soul for providing the world with the finest literature the world has ever seen. Nothing conclusive can ever be proved about the authorship of

"I must have walked the length and breadth of every street in Southend," said Mr. Cole. "They still rag me about it when I see my old colleagues."

Mr. Cole retired from the police force in 1930. Now he is retiring altogether from active service. For the past six years he has been employed by E. K. Cole, Ltd., the Southend-on-Sea radio manufacturers. He began his career in the police force in 1900, and recalls the days when Southend, now a thriving borough, was little more than half its present size. Practically all the

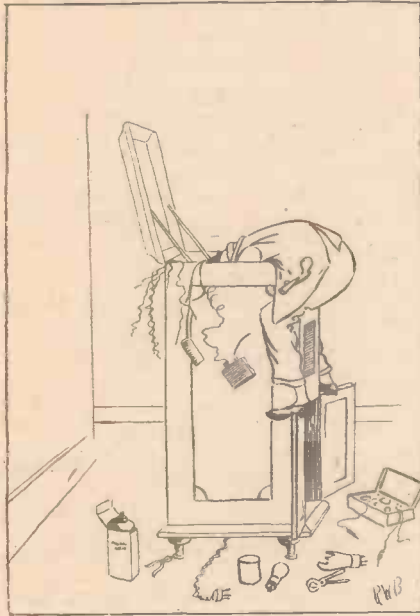

Inter-action.

trippers to Southend came by train, the only vehicular traffic, apart from horse carriages, being the trams. The main road from London, now seething with traffic at week-ends, was as quiet as a country lane. Mr. Cole was stationed at Purfleet for a few years. In those days Purfleet Fair was held annually in the streets.

"Some rowdies started a pitched battle, and I was hit over the head with an axe when I tried to make peace," said Mr. Cole. "That cost me four months on the sick list."

The Fair was abolished as a result of this incident.

#### Poor Service Again

H. W. B., of Thurgarton, Notts, complains of poor service he has received from a component manufacturer. He ordered the parts through a dealer first of all, but after 14 days nothing had happened, so he wrote to the firm direct. They replied that they had received no order, so H. W. B. sent another letter ordering the parts. The firm again

replied that they had received no order, and the reader was present when the dealer 'phoned, and the components arrived 5 days later. When the kit was erected, a succession of troubles due to faulty components followed. He is still waiting for the replacement parts.

#### Our New Laboratories

EIGHT to eleven, Southampton Street, Strand, has been an historic spot in the Strand, and famous in the annals of journalism throughout the world as the centre from which the world-renowned firm of George Newnes, Ltd., operates. For more than fifty years this firm has been famous as publishers of high-class periodicals and books. Many thousands of people eminent in literature, politics, art, commerce and industry have been associated with its staff and its productions, and there is not a country in the world which does not regularly absorb many millions of periodicals, magazines, and books, each day of the year. Publications bearing the famous imprint of the House of Newnes reach the remotest shacks of the world, and we regularly receive letters from every quarter of the globe from readers who regard our publications as their only link with the Mother Country. There is hardly a home in the British Isles which does not take one or more of the numerous George Newnes publications.

Southampton Street has been the scene of intense activity and enterprise for fifty years, and a reputation unexcelled in any country in the world has been built up around that famous name. Success, industry, and enterprise connote rapid expansion, and that expansion has been steadily going on until, enormous as were the existing establishments, it has tended like a mighty stream to burst its banks.

So, in the course of progress, the famous site in Southampton Street was passed over to the hands of builders who ingeniously contrived to erect a new building whilst the old was demolished. In part of it are housed the commodious and well-equipped new PRACTICAL AND AMATEUR WIRELESS laboratories. It is now common knowledge among wireless constructors, and in Fleet Street, that PRACTICAL AND AMATEUR WIRELESS is the Leading Weekly for home constructors, and these new laboratories have been rendered necessary purely by virtue of the remarkable success of this journal.

Success begets success! In these new laboratories, situated on the top floor of the new building, you may

view St. Paul's Cathedral, the Crystal Palace, and other eminences.

Even the late Sir George Newnes, with that perspicacity and genius for which he was noted, could not have envisaged the enormous growth of the firm he founded when, in 1884, he started the new era in journalism with the publication of that national family journal *Tit-Bits*, rapidly followed by that magazine which is a national institution — *The Strand Magazine*. In those days wireless was unheard of. Illustrations in periodicals were from wood-cuts. Photography, the gramophone, the bicycle, were but at the beginning of their careers. The motor-car was a curiosity only occasionally to be seen; aeroplanes were still the dream of scientific cranks. Within those fifty years the House of Newnes has marched with the times. It has dealt with changing fashions in public taste, with industries, new sciences, and new hobbies. Its journals are served by the best authors and the leading authorities.

Fifty years is but 600 months, and life is indeed short; but in that comparatively short space of time the publishing achievements of the House



A short-wave fan's nightmare.

of Newnes are every bit as miraculous as those in the fields of aeronautics, radio, and other sciences introduced during that collateral period; 1936 saw the birth of the new television service, and this journal, worthily upholding the traditions of the House which sponsors it, has guided its readers in the new science since the service started. Perhaps at the end of the next fifty years we shall be building some new PRACTICAL AND AMATEUR WIRELESS laboratories!



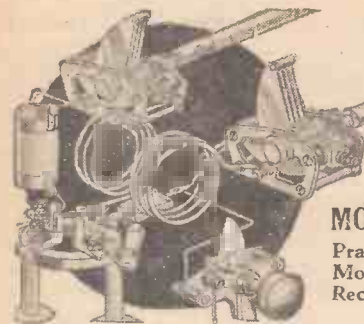

# Short Wave Section

## MODERNISING A SHORT-WAVE RECEIVER

Practical Information and Ideas for Rebuilding and Modernising an Obsolete Four-valve Short-wave Receiver are Given in This Article by A. W. MANN.

WHILST the specially designed communication type receiver is regarded as the DX enthusiast's ideal, it is but few who can afford to indulge in such a luxury. It is not a question of buying the best receiver available, but of selecting one which falls within the limits of one's purse. These remarks, of course, apply to commercial products and price is more or less a useful guide to performance. The field of home construction, however,

### Modernising a Four-valver

The practical information given in this article may be used as a basis of experiment and design, when the rebuilding of an obsolete four-valve short-wave receiver to meet modern requirements, is under consideration. Before going further, however, it must be understood that rush tactics, and hook up constructional methods, will not do. Everything should be carefully studied and worked out to the last detail.

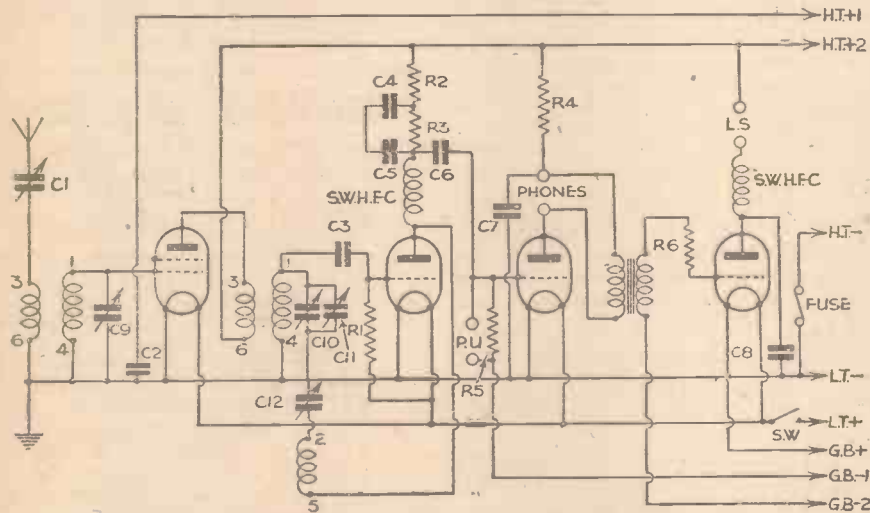

Fig. 1.—Theoretical circuit diagram of the 4-valve short-wave receiver referred to in this article. C1, .0001 mfd.; C2, .04 mfd.; C3, .0001 mfd.; C4, 2 mfd.; C5, .0003 mfd.; C6, .02 mfd.; C7, 2 mfd.; C8, .001 mfd.; C9, .00016 mfd.; C10, .00015 mfd.; C11, 15 mmfd.; C12, .0002 mfd.; R1, 3 megohms; R2, 60,000 ohms; R3, 40,000 ohms; R4, 30,000 ohms; R5, 500,000 ohms; R6, 10,000 ohms.

offers wider scope, and whilst there are definite standards of excellence, and price is a ruling factor when performance is taken into account, it does not follow that because a receiver is comparatively cheap to build, that its performance is, when measured in terms of results, inferior.

The various logs published in this journal from time to time, definitely prove that it is possible to obtain amazing results with simple apparatus for a comparatively small outlay, and in doing so enjoy the additional advantage of being able to rebuild, and bring up to date existing apparatus as the need arises, using many of the original components over again.

### The T.R.F. Receiver

Before the advent of the modern super-heterodyne, short-wave enthusiasts who desired loudspeaker reception of the world's most popular short-wave transmissions, regarded the four-valve tuned radio frequency receiver as most suitable to their requirements, and there is, no doubt, still a large number of this type in use capable of providing, in some measure, satisfactory results within limits.

Generally, however, their design and construction leave much to be desired, when taking into account present-day requirements.

Pre-determined planning, patience, and sound workmanship are most desirable, and necessary.

Briefly, the constructor should know definitely what he requires, and what in his own mind is the ideal to be achieved, and set to work methodically. Progress may be slow, but it is results which count.

Choice of circuit is the first consideration. As it is desired to employ four valves, including an H.F. stage ahead of the detector, it is as well to choose a circuit which includes a stage of tuned high

frequency, in order to assure maximum gain and improved selectivity, as compared with an untuned stage.

Next for consideration is tuning. The easier the tuning of the receiver, the greater its adaptability and flexibility. Bandspread tuning is, therefore, an essential and most desirable feature.

### Circuit Considerations

Fig. 1 shows a suitable circuit which in addition to the above features, includes inductive coupling between the H.F. and detector stages, decoupling and voltage dropping arrangements, together with two stages of L.F. amplification, the first being resistance-capacity coupled, and the output stage transformer coupled. A fuse, which is a wise precaution, is also shown.

Having decided as to the circuit and electrical requirements, we must next consider the mechanical details, requirements and constructional features. Before doing so, however, it is as well to bear in mind that careful study, and a series of cut and try experiments, are essential so that decisions may be made once, and strictly adhered to in every way, otherwise changes and mistakes may eventually prove costly.

The essential requirements are stability, maximum selectivity, maximum range, volume and flexibility, within the defined limits of the chosen circuit.

The modern commercial receiver, due to efficient design, possesses as a rule all the features outlined above; therefore, to adapt commercial practice to meet amateur requirements will undoubtedly be a step in the right direction.

### Screening Details

In the interests of stability, and in order to avoid magnetic coupling and interlocking between the individual stages of the receiver, we must not only take precautions in the electrical sense, but also in the mechanical sense, and to this end thorough and efficient screening is most desirable.

With commercial practice in mind, metal chassis construction, a metal panel, and complete shielding of the high frequency, detector and low frequency stages is, undoubtedly the ideal specification. There are various methods which may be adopted in order to build up a sound job in both the mechanical and electrical senses.

Fig. 2, for example, shows a very efficient arrangement which consists of a metal chassis and panel, together with three screening boxes; the first housing the H.F. stage, the second the detector stage, and the third the two-stage L.F. amplifier.

Choice between the use of aluminium or cadmium plated steel in the construction of chassis panel, and screening boxes, is left to the constructor. Aluminium, whilst perhaps a little more expensive, is the most efficient from the short-wave point of view, taking into consideration hysteresis losses. Copper is, of course, by far the best, but more expensive.

### Chassis Assembly

There are various other considerations which the writer proposes to deal with, collectively, later in this article. In the meantime, let us pass to Fig. 3. This shows a plan view of the chassis assembly shown in Fig. 2.

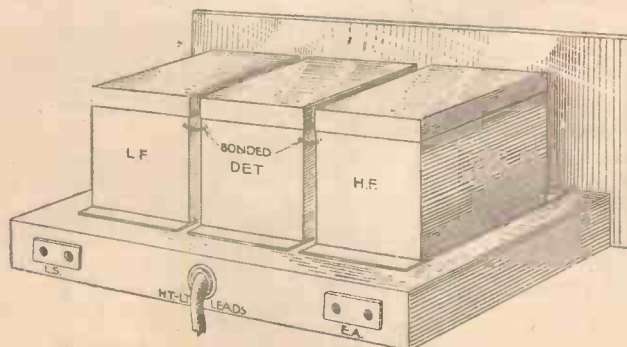

Fig. 2.—A metal chassis and panel with screened components.

(Continued on next page)



**SHORT-WAVE SECTION**

(Continued from previous page)

It will be noticed that separate tuning condensers are used in the H.F. and detector stages respectively, and that band-spread tuning is only applied to the detector. The reason for this is that owing to the comparatively broad tuning of the H.F. stage, the additional capacity increase across the detector stage tuned circuit is not sufficient as to affect the tracking of the two circuits to any serious extent.

Fig. 4 shows a more simple yet efficient arrangement. In this the tuned H.F. stage is contained in a suitable screening box on

tuning coils as far away as possible from metal screens, in order to avoid excessive damping.

With reference to screening, it will be appreciated that the largest high-frequency current will be in the tuning coils and leads between them, and the tuning condensers i.e., the tuned circuits.

Screening incorrectly applied, is worse than useless, and will accentuate instability rather than prevent it; therefore, to be effective, the screens must carry current and form a closed circuit, the screening current flowing in a direction opposed to the coil current.

Another point is that if we screen the tuning coils too closely their capacity increases, and inductance decreases.

There is another mistake which should at all costs be avoided in T.R.F. designs, and especially in the case of intermediate-frequency transformer mounting, when building superheterodyne receivers on steel chassis. It is to fit coil-screens directly on to the steel chassis. In all instances, a screening base should be mounted on the chassis instead of using the chassis face as the can bottom. To ignore this rule will result in increased losses,

as contributory factors towards overall efficiency.

A correctly built chassis receiver should be absolutely free from hand capacity and metallic crackling. The relative positions of the reaction condenser and its associated coil will, in some instances, according to design, be located some distance apart.

In such instances it is advisable to screen the reaction to anode lead. In doing so it is also advisable to use fine wire for this lead in preference to the gauge commonly used for set wiring purposes. Incidentally, the writer has found that in short-wave receivers, employing two H.F. stages and an S.G. detector, the difference between a 30-gauge and 18-gauge lead is sometimes the difference between dead spots and freedom from dead spots in tuning.

In conclusion, whilst the circuit shown in Fig. 1 is given as a basis on experiment, there is no reason why the experimenter of experience should not modify or further improve upon it. The modernising and rebuilding of an existing receiver following the principles outlined, will, on test, prove to more than justify the time, care and patience devoted to its re-design and construction.

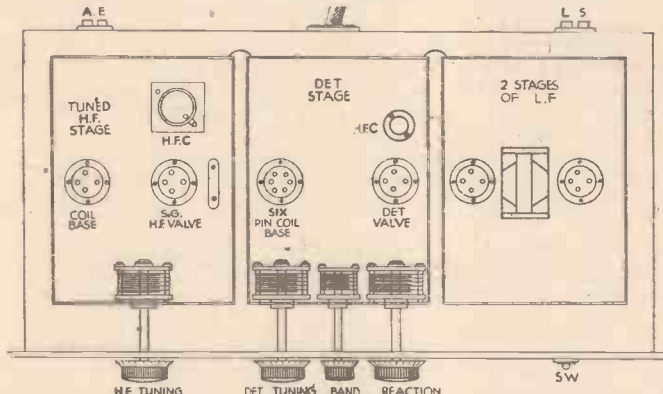

Fig. 3.—A plan of the chassis assembly shown in Fig. 2 with the screen covers removed.

the left-hand side of the chassis, and the detector stage on the right-hand side, the two-stage L.F. amplifier and coupling components, etc., being arranged at the back of the chassis.

**Band-spreading Arrangements**

In this instance, band-spreading is applied to both tuned circuits, the tank or band-setting condensers being mounted underneath the chassis, and the ganged band spreading condensers mounted on brackets and coupled via an extension rod to the slow-motion tuning dial.

A similar arrangement is employed in the case of the reaction control shown on the right. The general arrangement indicated has much to recommend it, especially when ten-step Eddystone band setting condensers are used.

Passing to Fig. 5, we have the most simple form of chassis assembly, with inter-stage screening, and one which is well within the constructional abilities of the average experimenter.

A metal chassis, panel and vertical screens are used. The band-spread condensers are drum-drive controlled, the band-setters are of the ten-step type, and the reaction condenser incorporates a slow-motion reduction gear.

The L.F. output choke shown in Fig. 4 and Fig. 5 is optional, and although not shown in the theoretical diagram, it is a refinement worthy of consideration.

**General Considerations**

There are various points relative to the construction of chassis assemblies as outlined which must be taken into consideration. First, the dimensions of the chassis panel and screening boxes.

These will be governed by the physical dimensions of the individual components to be incorporated in the receiver, and it is advisable to get out the drawing-board, lay out the various stages and arrange the dimensions of panel, chassis and screening boxes, according to requirements, keeping

and reduce the overall efficiency of the screening.

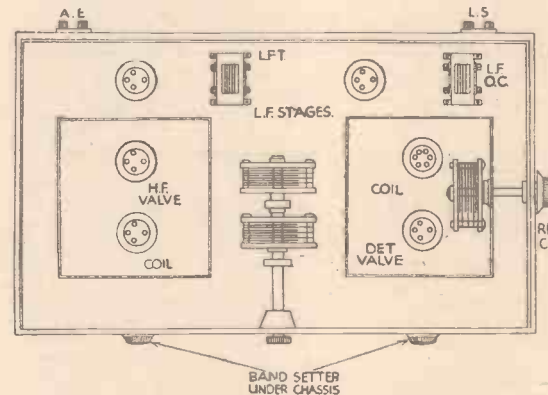

Fig. 4.—An alternative layout of components.

and reduce the overall efficiency of the screening.

**Screening Leads**

When H.F. stages are incorporated in a design, it is necessary to screen the leads between coils and condensers. Braided cable may be used, but solid conduit is far more satisfactory in instances where it is possible to use it.

The use of stout gauge material for chassis and screening, rigid mechanical construction and assembly, the efficient bonding of all metal at earth potential, are also of vital importance

vision transmitter is employed so that the quality of the sound should be most satisfactory. In the meantime, French manufacturers are awaiting news of the picture standard before producing sets.

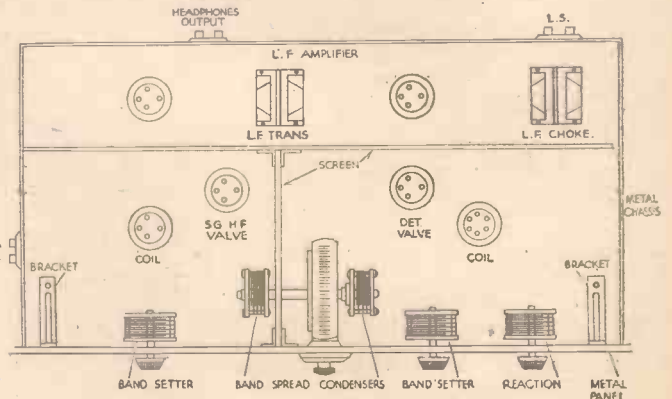

Fig. 5.—A simple form of chassis assembly with inter-stage screening.



A PAGE OF PRACTICAL HINTS

SUBMIT YOUR IDEA

READERS WRINKLES

THE HALF-GUINEA PAGE

An S.P.D.T. Push-button for Remote Control.

A PUSH-BUTTON having other than the normal make-break action is difficult to obtain, and usually expensive, consequently I set about making a few of the type shown in the attached sketch.

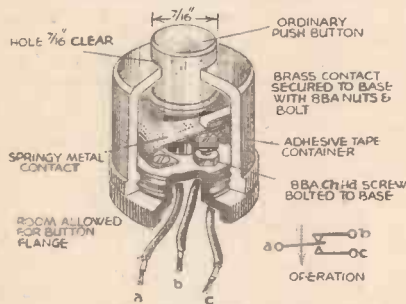

An efficient "S.P.D.T." push-button control.

Having purchased some adhesive tape containers from well-known chemists, and obtained the ordinary buttons from cheap bell pushes, the assembly was the matter of a few minutes for each unit, as I first of all drilled the holes to take the fixing screws, and a 1/8 in. clearance hole in the lids of the containers for the push-buttons. The top contact (b) is fixed to the base, as is the other spring contact (a), whilst a 6BA screw with lock-nuts (permitting gap adjustment) constitutes the bottom contact. The wire connections in each case are soldered to the fixing nuts underneath, and small slots in the base flange permit the unit to "sit evenly on a baseboard, etc." Fixing the unit may be accomplished in many ways; for example, by small screws through the base, or again, with small brass clips, thus allowing it to be easily and quickly removed.—T. C. BEAKE, (Darlington).

A Pick-up Needle "Thimble"

IT is fairly well known that the length of needle used in a pick-up is usually critical. With fibre needles which are shortened every time they are sharpened, and with steel needles which, I think, are very often too short for the best results,

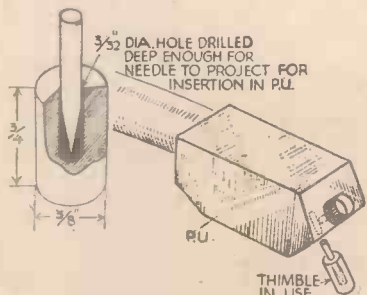

A handy "thimble" device for use with pick-up needles.

THAT DODGE OF YOURS!

Every Reader of "PRACTICAL AND AMATEUR WIRELESS" must have originated some little dodge which would interest other readers. Why not pass it on to us? We pay £1-10-0 for the best wrinkle submitted, and for every other item published on this page we will pay half-a-guinea. Turn that idea of yours to account by sending it in to us addressed to the Editor, "PRACTICAL AND AMATEUR WIRELESS," George Newnes, Ltd., Tower House, Southampton Street, Strand, W.C.2. Put your name and address on every item. Please note that every notion sent in must be original. Mark envelopes "Radio Wrinkles." DO NOT enclose Queries with your wrinkles.

it is difficult to ensure that always only the "optimum" length of needle projects from the socket.

The enclosed illustration is of a simple "thimble" I have made, to ensure that every needle placed in the pick-up socket projects exactly a predetermined amount. It consists of a short length of brass rod, about 3/16 in. diameter, drilled out to a depth equal to the length of needle it is decided to have projecting from the pick-up. The needle to be used is first placed point first in the thimble by means of which the needle is pushed home until the thimble touches the casing. The needle is then secured by the socket screw, and the thimble removed, leaving exactly the correct length of needle projecting from the pick-up. After much experimenting, the writer has greatly improved reproduction and minimised record wear by paying attention to needle length, and has found the thimble both simple to use, and effective.—E. R. J. ROBBINS (Hounslow).

Increasing a Dial-pointer Movement

THE accompanying sketch shows a simple method of increasing the normal 180° movement of a tuning dial pointer to approx. 250°. It will be seen that

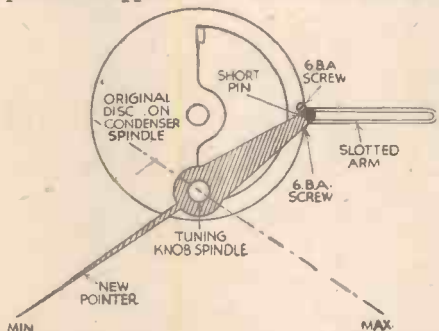

A method of increasing the normal movement of a dial pointer.

a slotted arm is fixed to the edge of the driving disc on the condenser spindle at the centre of the cut-out portion (in my case this arm was made from 18 G. iron wire).

Practical Mechanics Big Xmas Number NOW ON SALE—6d.

The new pointer has its centre on the tuning knob spindle and has an extended arm as shown, at the end of which is fixed a short pin engaging the slotted arm. In the sketch the pointer is shown at the zero position, the dotted line showing the maximum setting.

The slotted arm must, of course, be long enough to enable the pointer to attain the vertical position, and should grip the short pin just tightly enough to prevent any "play" or rattle. I have found the increased traverse very useful when trying to separate crowded stations, and the device would be very useful with a short-wave or all-wave dial. Also, any dial mechanism of the friction-drive type shown can be converted to give the extra movement.—S. C. BLACKSHAW (Wolverhampton).

A Novel "Kick" Meter

A NOVEL form of "kick" meter may easily be constructed from the parts of an old shadow tuning indicator, and I have included on my test panel one such unit which gives surprisingly good results.

As will be seen on referring to the accompanying sketches, the whole action is mounted on a piece of bakelite supported away from the main front panel by long screws and spacer washers—of the type to

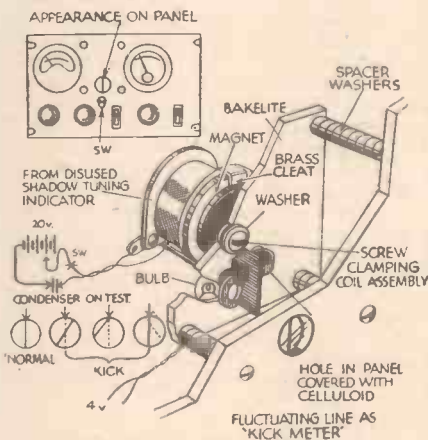

A novel "kick" meter made from odd parts.

be found in some condenser designs. A hole is drilled in the bakelite, and immediately behind this is centred the 3.5 volt torch bulb; in front of the hole is centred the original shadow tuning "fin" assembly, but the point to remember here is that the bakelite mounting panel should not be too thick, otherwise the coil's magnetic influence will not be strong enough to effect a satisfactory response in the fin. Condensers of from approx .5 mfd. upwards may be tested; also resistances, etc. The delicate nature of the design necessitates careful construction and use, and the best e.m.f. to use for the majority of tests is in the neighbourhood of 20 volts.—A. F. ANORVE (Lewes).



At this time of the year many parties are held, and it often becomes difficult to think of something new to do. Many of the old party games are played out, and anything new is not only greeted with enthusiasm but will also give the host a name for introducing originality into his parties. The radio apparatus will no doubt be pressed into use to provide normal musical entertainment, either from the variety programmes, or by means of records reproduced through a gramophone pick-up, but there are many other interesting and amusing games which may be made up by employing either the

EARS PRESSED TOGETHER WITH BROWN PAPER BETWEEN

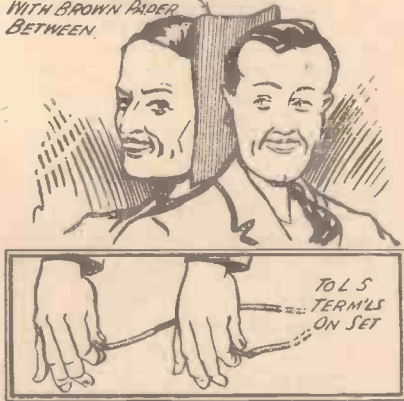

Fig. 1.—Hearing the music without phones or loudspeaker.

radio receiver itself, the gramophone section, or the loudspeaker, and some hints are now given in this direction. It must be emphasised that the details given do not call for any interference with the normal working of the set, and will not entail any risk, either of damage or shock, even when an A.C. mains set is utilised. If the receiver is not fitted with pick-up terminals, these should be arranged for, and details for doing this were given in our issue dated December 4th last. Similarly, an output filter circuit should be used, and in a commercial receiver this may be done by connecting the extension speaker to the sockets marked for this purpose and silencing the built-in speaker—if a switch for the purpose is provided. (Fig. 4.) If it is not, then the existing speaker should be removed, and a good iron-core choke connected in its place. Terminals should be fitted and connected to earth and to the anode of the output valve through a 2 mfd. condenser as shown in Fig. 4.

**For Present Distribution**

If a microphone is now connected to the pick-up terminals as mentioned in previous articles (see page 335, December 4th last), it will be possible to place a loudspeaker in one room and talk to your guests from another room. This alone provides endless scope for amusement at a party. For instance, there is certain to be a distribution of presents during the party—either to the children or the other guests. For the children, a Christmas tree will undoubtedly take a place in the decorations and the various gifts may be hung thereon, each wrapped and carrying a large number or some other indicating device

# Xmas Fun With

## The Standard Wireless Receiver may be Made to Play Programmes. Some Suggestions for Doing This

which is easily observed. A list of these gifts and the numbers or devices which they carry should be prepared, and supplied to an "operator" in the room where the microphone is fitted, whilst a loudspeaker should be concealed beneath the tree, preferably placed close to the pot in which it is placed and the whole covered with fancy paper in keeping with the remaining decorations. When the time for distribution arrives the children are marshalled and after suitable announcements regarding the "magic" tree, a voice will emanate from it announcing that "Peggy" should step forward and detach the parcel bearing the number 1, or whatever gift is intended for her. In this way the pleasure of receiving the gifts will be greatly enhanced and the idea will be greeted with enthusiasm. But it need not be reserved for children only. If the older guests are to receive gifts, why not arrange for a similar type of distribution based on the "Spot Waltz." By playing records of a suitable waltz tune, the guests may take part in the dance, and the announcer should be placed in a position where he is able to see the Christmas tree. He should also control the music from the pick-up. When a couple are close to the tree, he stops the music, the guests halt in their stride, and the voice from the tree tells the nearest couple to take so many steps forward to the tree, stretch out the right hand, and take the parcel immediately on their right—or wherever it is. It will be seen that this idea alone is capable of endless variation.

**Musical Problems**

Much amusement may be obtained from competitions in which the players have to

numbers DB. 4033-7, price 6s. each). If your gramophone motor is provided with a speed regulator having sufficiently wide control you can also try the effect of running records extremely slow or fast and see who can recognise the tune or artist. Only popular items should be used for this, as it is not a simple task. You can even run a record backwards (Fig. 5) or eccentrically

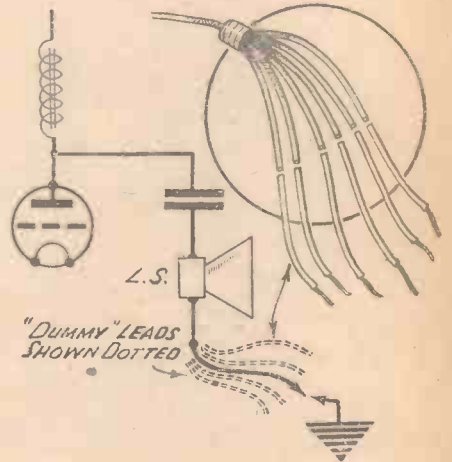

Fig. 3.—Arranging an output filter circuit so that various games are possible.

to provide a similar competition (Fig. 6). The easiest way of running it backwards is to support a record on a pencil or spindle held in the hand, and rest the edge against the edge of the ordinary turntable. To

produce the requisite friction, a length of insulation tape of the ordinary adhesive variety should be stuck round the edge of the turntable. If there is room on your motor board a spindle may be mounted firmly there. To run the record eccentrically, a hole should be drilled about 1/4 in. from the standard hole, but if this is done, the needle must be placed on the first groove of the sound track before the turntable is started, as it will otherwise be impossible to place the needle down without damaging the record (Fig. 6). With care, you can burn the second hole through with an ordinary cigarette.

**Games**

If lengths of wire are attached to the output terminals you can invent any number of games in which the junction

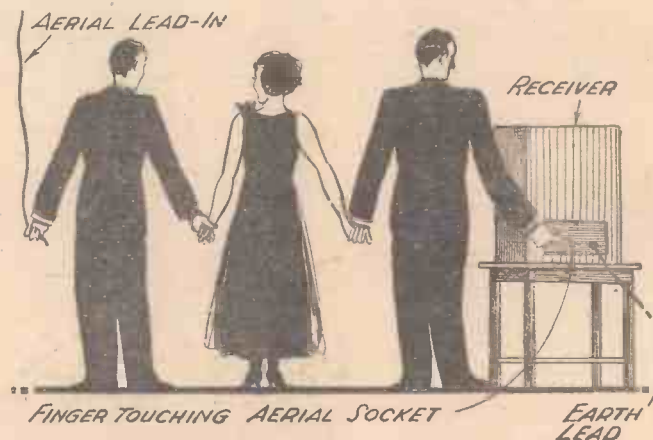

Fig. 2.—The human aerial.

guess various things. For instance, with a microphone in another room, various sound effects may be made by the operator and the players can be awarded points for the correctness of their solutions as to the source of the noises. If you doubt your ability to produce suitable sounds, you can obtain records of various noises from your local gramophone store (H.M.V.



# th Your Radio

Provide Entertainment apart from Reproducing Radio  
 e Given in this Article - - By W. J. DELANEY

of two wires completes the output circuit and thus joins up the loudspeaker (Fig. 3). For instance, the extension wires may all be bunched, and only one of the speaker leads included—the remainder being “dummies” not joined at the set end. Thus, one player may take an earth wire and the remaining players each take one of the remaining wires, and the object of the game is for the

set, and give the lead to one person to hold (the bared end, of course). Now take his free hand in one of yours and with your other hand touch the aerial terminal or socket. The music or broadcast programme will again be heard, the two bodies acting as a complete aerial (Fig. 2). Similarly, a number of people may hold hands, and may even pick-up the local station without touching the aerial lead.

It is also possible to hear the broadcast programmes without ‘phones or loudspeaker—in the following way. Two wires are attached to the output terminals, and two people each take a wire in their hands. A sheet of dry brown paper is now held between the heads of these two people, and they press their heads together so that the paper comes between the right ear of one and the left ear of another (Fig. 1). It will be found that the programme is immediately audible due to the capacity effect of the two bodies and in some cases quite loud signals will be obtained. It is not safe to try this idea with a D.C. or Universal mains type of receiver unless good fixed condensers are already included in the output circuit. Even with a crystal receiver quite good signals may be obtained in this way.

To complete this subject it should not be forgotten that many of the old and popular types of game and character playing may be employed with improved results via the radio. As an instance there are charades, and it needs little imagination to see that with a judicious use of the microphone and players who understand the game, this may be made a most interesting subject. Whereas in the ordinary playing of charades, one has to act and accomplish many effects in mime, through the microphone sound effects of all kinds may be introduced in addition to the spoken word and thus provide endless variety to the game. The radio may also be used as an embellishment in

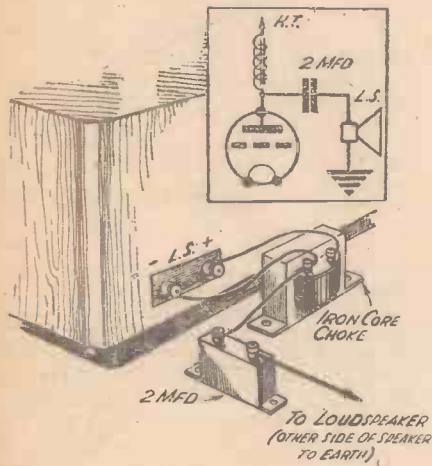

Fig. 4.—Method of fitting an output filter if one is not already in existence.

individual player to find the “live” return lead in the quickest time. By extending this you can introduce all kinds of games. The wires may be joined to metal studs (drawing-pins) on a board and they may be placed at such a distance apart that a standard coin (one penny, for instance) will link up adjacent studs. By making some “dead” and some “live” studs points may be awarded or prizes paid when the return circuit is completed. If a record is played, or a programme tuned in, the speaker will be silent, of course, until the points are linked, and thus it is immediately obvious when a player succeeds, and to add to the fun the sudden ejaculation from the speaker will, in many cases, cause more laughter than the fun of success. This is especially so if a talk is being received, as the disjointed words which are heard appear very funny when disconnected from the remainder of the sentence.

For those who are not versed in the wonders of radio there are some interesting experiments which may be carried out to the mystification of the uninitiated. For instance, disconnect the aerial lead from

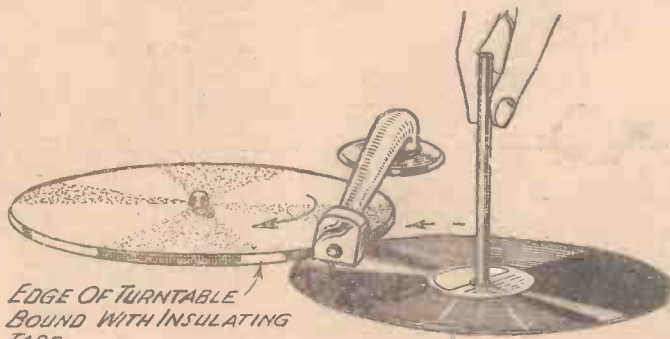

Fig. 5.—Playing a gramophone record backwards.

certain games—for instance, in the popular “Murder” game, the loudspeaker may be employed with a microphone circuit to broadcast a description of the victim and other incidental effects wherein the operator acts as a police chief.

Although some fun may be obtained by giving “Microphone tests” to the stage-struck, it is possible to make this an even

more interesting pastime if a home-recording outfit is available. Your guests may then be permitted to make a record of themselves to take away as a souvenir, or during the festivities you can surreptitiously switch in a concealed microphone and make a record of the gaiety and incidental noises, which, played back later in the evening, may cause considerable amusement.

### For Radio Students

Finally, where a number of radio fans or students are gathered together—such as at a radio club or some similar place—it must not be forgotten that there are many

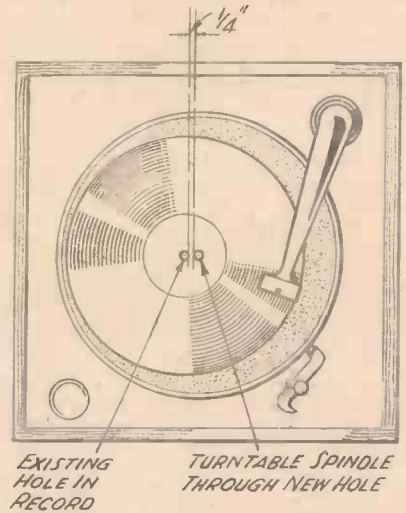

Fig. 6.—A great deal of fun may be obtained by playing a record from an eccentric hole.

interesting schemes which may be employed to provide a party spirit and at the same time to provide interest and knowledge. For instance, a number of spare parts could be supplied by each member, and the complete collection pooled. The secretary or M.C. could then sort these out into groups of parts depending upon the number taking part. These could be wrapped and numbered and the members would then be called into the room and each select a parcel. At the word of command they will untie the parcel and decide upon the best method of utilising all of the parts in their collection, the winner being the one who first makes a decision. The apparatus could, if desired, be built up. Similarly, an old set could be used, and various breakdowns and faults introduced and prizes awarded for the member who succeeds in locating the fault in the shortest time—with or without instruments.

### Join Hewnes' Practical Group!

**PRACTICAL MOTORIST**  
 The owner-driver's journal which tells you how to repair, overhaul, and obtain the best performance from your car.  
 3d.—every Friday.

**PRACTICAL MECHANICS**  
 The only English journal of its type. It deals with every branch of Science, Mechanics, Invention, Model-Making, Chemistry, Astronomy, Photography, Television.  
 6d.—Every Month.

**THE CYCLIST**  
 The leading weekly for every Cyclist, Clubman, Utility Cyclist, or Tourist.  
 Join “The Cyclist” Road Club and also take advantage of the FREE Insurance offered.  
 2d.—Every Wednesday.

# The Amateur Set Designer

Amongst Subjects Dealt With in this Fifteenth Article of the Series are H.T. Feed Voltage, the Rectifier Valve, and Mains Transformers

(Continued from page 369, December 11th issue.)

**I**N connection with the designing of an A.C. mains receiver of either straight or superhet type, the designer must necessarily leave the question of H.T. and L.T. supplies until he has definitely decided upon the valve combination for the receiver.

After the valve combination has been settled the valve manufacturer's data should be consulted, and provisional values taken for the anode and screen voltages and currents.

The major problem is now that of choosing a suitable rectifier and mains transformer, the problem being complicated by the necessity of having to allow for the voltage drops across decoupling and coupling resistances. Moreover, assuming that the conventional arrangement of speaker field in series with the H.T. feed line will be used, it will, at the same time, be necessary to consider the question of adequate field excitation, and also to allow for the voltage drop across the field winding.

We have on a number of occasions in this series of articles pointed out that the amateur can get round certain problems of design by a certain amount of experimenting on trial-and-error lines. Where mains transformers, rectifiers, and speaker fields are concerned, however, it is advisable for the amateur designer to figure things out on paper as closely as he can, in order that any necessary trial-and-error practical work may be reduced to a minimum.

## H.T. Feed Voltage

A useful plan upon which to work is to assume, at first, that the wanted anode and screen voltages and currents will actually be obtainable, and to proceed to calculate the necessary voltage required between the (smoothed) H.T. positive feed line and negative H.T. This work may make it obvious that it will be desirable to alter some of the first provisional voltage and current values. Once a figure is obtained for the H.T. feed voltage the speaker field problem can be tackled. The voltage drop across the field winding should be worked out, which will now make it possible to arrive at a figure for the rectifier output voltage. With reasonably "safe" figures for the rectifier output voltage and current it becomes easy to choose a suitable type of rectifier. Then, at last, the requirements for the mains transformer can be worked out.

Once the rectifier and mains transformer types have been chosen, matters can be looked at from a different angle. It will not be a difficult job to work back (rectifier and transformer having been settled upon) to see whether anode and screen voltages and currents are likely now to come out according to plan, or whether any voltage-dropping resistance readjustments will be required.

Let us assume that the valve combination

has been chosen, the valve data has been consulted, and provisional values have been chosen for the various anode and screen voltages and currents. (The voltages had better be considered with reference to cathodes.)

The immediate object must be to work out a suitable value for the voltage between the (smoothed) H.T. feed line and negative H.T. Referring to Fig. 67, what is wanted is the voltage between A and B. The highest anode voltage should be looked for among the notes that have been made from the valve data, and the particular anode concerned taken as the "jumping-off point." If this particular valve has no considerable resistance between anode and positive H.T., or between cathode and negative H.T., then its anode voltage gives a first estimate for the (smoothed) H.T. supply volts. Suppose, for instance, that in Fig. 67 V1 is a heptode with only an I.F. transformer primary in its anode circuit, and with no cathode biasing resistance, then, obviously, the voltage

the question arises as to whether such a feed voltage will be suitable for the other valves (still considering anodes only): If the output valve is not the one that has been under investigation it will be advisable to consider it next. It is unlikely that the output valve's anode circuit will contain any more series resistance than that of an output transformer or choke. Allowing for the voltage across this plus any bias voltage operating between cathode and negative H.T., a check should be made to see if the originally estimated feed voltage will give the anode voltage and current that were expected at the output valve. If it appears that the anode voltage of the output valve is going to be lower than what is wanted, then it will be advisable to consider either working with a higher feed voltage and letting the first valve considered have more volts or, alternatively, working with a higher feed voltage and adding some extra resistance to the circuit of the first valve considered. If the anode voltage of the output valve comes out higher than what was anticipated, then there are the alternatives either of allowing the output valve to work at a higher rating, or of reducing the figure for the feed voltage, and correspondingly revising ideas about the first valve that was considered.

By now a reasonably useful figure for the AB voltage (Fig. 67) should become evident.

As soon as an H.T. feed voltage value is provisionally decided upon it becomes possible to work out first estimates of all the values for the various anodes and screen decoupling or voltage-dropping resistances. Referring to Fig. 67, suppose the H.T. feed voltage has been worked out to 265 volts, and that 240 volts, 10 mA, is wanted at the anode of V2.

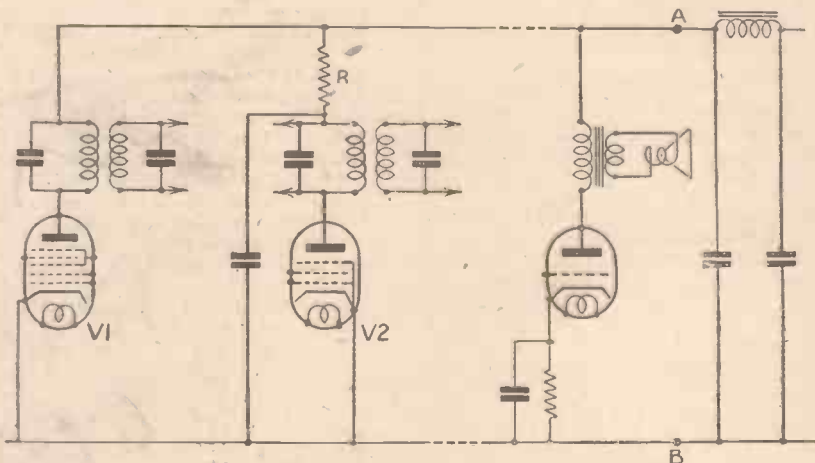

Fig. 67.—Diagram explaining the theory underlying the choice of H.T. supply as mentioned on this page.

between anode and cathode of V1 is a reasonably close approximation for the voltage between A and B. If the valve with the highest anode voltage is to have any anode decoupling resistance, then it will be necessary to fix upon a value for the latter, and to add its voltage drop to the anode/cathode voltage. (Multiply the chosen resistance value, in ohms, by the anticipated anode current, in mA, and divide by 1,000.) Correspondingly, if there is any cathode biasing resistance the drop across this should be allowed for. Whatever the circuit arrangements are, it should not, however, be difficult to arrive at a figure for the H.T. feed volts.

Once a value for this voltage is obtained

$$R \text{ will then be } \frac{25 \times 1000}{10} = 2500 \text{ ohms.}$$

If R is intended more for voltage dropping than for decoupling purposes this resistance value can be taken as probably satisfactory. If, however, looking at the matter from the point of view of decoupling, the designer would like to see R of a higher value, then he must face the alternatives either of lowering the anode voltage and current at V2, or of starting all over again with the object of getting a higher feed voltage. As soon as all the series resistances have been considered the potential divider, if any, should be looked into. Potential dividers merit a paragraph to themselves and details are given later.





## Notes from the Test Bench

### Defective By-pass Condensers

A POINT which is often overlooked by amateurs, and one which should be self-evident, is the breaking-down of by-pass condensers. A typical instance is in the decoupling component employed in the anode circuit of a valve. It is sometimes found that the decoupling resistance begins to smoke or otherwise heat up, and eventually breaks down. We have often had queries from readers mentioning this fact and asking the reason. A moment's thought will indicate that an excessive current has been passed through the resistance, and as it is joined at one end to the H.T. positive line, and at the other end to the decoupling condenser (which is, in turn, joined to H.T. negative), the most probable cause is a break-down or short-circuit in that condenser. Very often the voltage rating of this type of condenser is wrongly estimated. It is important to remember the surge which may take place when the set is switched on and off, and attention to this small point may result in a saving of expense as it will not then be necessary to replace anode resistors and condensers.

### Earth Returns

AN interesting point is raised by a reader who built a superhet and used a three-gang condenser with a tracked oscillator section. He points out that the makers of the condenser had provided lugs projecting across the dividing plates between each section, and that these lugs were in contact with the spindle. He asks whether they should be used for any connections. The answer is that, strictly speaking, they should be employed for earth connections. The spindle is common to all three sections of the condenser and thus there is a possibility in some circuits that instability would arise. By taking a lead from each of the projecting lugs mentioned, and connecting these leads direct to the chassis upon which the set is built, the circuits are more certain of isolation, and better results may be obtained in some sets. Theoretically, of course, the condenser chassis, which is built in the form of a screen between each section, should be adequate, but unfortunately it is sometimes found that theory and practice do not agree, and it is thus worth while earthing these lugs as mentioned.

### NEWNES' TELEVISION AND SHORT-WAVE HANDBOOK

3/6, or 4/- by post from  
GEORGE NEWNES, Ltd., Tower House,  
Southampton Street, Strand, London, W.C.2.

## THE B.B.C. CHRISTMAS PARTY

LISTENERS, sitting by the fireside in their homes on Christmas night, will be able to join in a comic "murder hunt." They will actually hear the "crime" committed on the darkened stage of St. George's Hall during Archie Campbell's production of the B.B.C.'s two-hour Christmas Party. Plenty of comedy will be in evidence over the way in which everyone at the festivities is questioned till the culprit is caught.

But the "crime" contains an ingenious plot as well, and listeners hearing the interrogation will be able to allocate guilt and check their verdict with that announced

later in the Party. As in past years the Party will include charades, musical chairs, crackers, mottoes, riddles, and all the merriment of a Christmas family gathering—and a number of surprises, too.

Artists already booked to take part in the broadcast are: Billy Bennett ("Almost a Gentleman"), Elsie and Doris Waters (radio's Gert and Daisy), Tommy Handley, Stainless Stephen, and the Two Leslies (Holmes and Sarony). Charles Shadwell will conduct the B.B.C. Variety Orchestra, and Reginald Foort will be at the B.B.C. Theatre Organ.

**'BETTER BUY  
CAPSTAN**  
they're blended better

and they  
make an ideal  
present



50's FLAT BOX (as illustrated) 2/5.

100's BOX 4/8. 50's FLAT TIN 2/6. 100's TIN 4/10.

All supplied in these Christmas cartons.

*W. D. & H. O. Wills.*

Branch of The Imperial Tobacco Co. (of Great Britain and Ireland), Ltd. C. G. 589D

# Practical Television

December 18th, 1937. Vol. 3. No. 79.

## Long-distance Working

ALL the hitherto accepted theories concerning the propagation characteristics of ultra-short waves are being partially, and in some cases wholly, destroyed by the feats of reception which keep being reported in connection with London's own television station. Prior to the advent of high-definition television, with its stringent frequency modulation requirements, ultra-short waves were, of course, being used, but the modulation range seldom exceeded ten kilocycles, and

has also heard the television sound, and a television receiver is now on its way to that city for an attempt at resolving the picture signal. The latest information is from radio engineers at Delhi, about 6,000 miles away, who say that the television sound has been heard quite clearly. These extra long distances are additional to the feats of television reception undertaken in this country, and well outside the original estimated service area. In Leicester the signals are watched quite regularly, although this same result was undertaken

during the course of a Baird demonstration at a British Association meeting a few years ago. The same story comes from Manchester, Ipswich, Brighton, Eastbourne, Cambridge, etc., and show that for the future there are two great fundamental needs in research. These are the production of very high-powered ultra-short-wave transmitters, and the fullest investigations of the conditions under which these waves are reflected or extend their horizon limit.

The question of fading, degree of signal-strength reduction, screening by hills or large buildings, etc., should all come within the scope of the investigation, for a great deal of importance will be attached to the results found because of its bearing on the extension of any television service, and the establishment of commercial communication on very high carrier frequencies.

## Receiver Design

Research into television receiver design is

now being carried out in the laboratories of all the leading radio-manufacturers. Apart from the all-important vision chassis with its superhet or T.R.F. circuit, and minor points concerning the sound receiver, power units, etc., the work centres round the cathode-ray tube and its associated equipment for giving the scanning field, focusing and modulation. In some of the earlier designs the tube itself was looked upon as a separate unit having connecting plugs linking it up to the various receiver sections for operational purposes. Many designers now favour the scheme of making the C.R. tube more or less integral with the time-base generator unit. This not only shortens connecting leads, but lends itself to a very compact layout. The actual size will depend very materially upon whether the tube is made to function by electrostatic or electromagnetic means, and a Baird version of the latter is shown in the accompanying illustration, Fig. 1. A twelve-inch tube is employed in this case, a combined helical spring and rubber support holding the tube face to the mask which prescribes the available picture limits in height and breadth. The line and frame scanning gear, together with the focusing coil surrounding the tube neck, bring about a neat assembly which has the advantage of easy adjustment on site during installation when the set is lined up for home use. The current pulse generator assembly is accommodated on a metal chassis with the pre-set controls at the rear for adjustment by the engineer before incorporation in the receiver cabinet proper. The advance which has been made in the reliability of television sets now makes it possible to eliminate most of the controls for the viewer's use, and apart from occasional brightness and contrast adjustments, the user just switches on and watches a transmission right through.

## Control and Mixing

The methods adopted by different countries for handling the televising signals prior to passing them on as a modulation for the ultra-short-wave radio transmitter differ in many respects. As a rule, with the B.B.C. service the producer undertakes the various fades from one camera to another so as to bring about the various effects and shots which he thinks are essential to give pictorial and entertainment value to the programme, item being radiated. The illustration, Fig. 2, shows a German version for a similar sort of scheme. After suitable amplification from the direct or telecine scanners, the signals pass to this mixing desk, which is of horseshoe shape and has arranged in the centre section two monitoring

installations. Each of these consists of a 12in. diameter cathode-ray tube for showing the picture itself, together with a smaller type tube on which is built up an oscillogram of the picture signal, complete with vision modulation and synchronising pulses. One section is intended for the supervision of the outgoing signal which is being radiated, while the second monitor serves for observing the image from the camera which is to be next faded into circuit.



Fig. 1.—A 12in. Baird cathode-ray tube mounted with time-base generator chassis prior to incorporation in a complete receiver.

the power of individual radio transmitters was quite small. On the results achieved with this equipment were based many theories that seemed justified, by practical experiment. One of the first "blows" was the discovery by the Department of Scientific and Industrial Research, under Mr. Watson Watt, of a series of extra reflecting layers varying in height between 4 and 37 miles. The Heaviside layer did not reflect ultra-short waves, but these new layers did, and the discovery was hailed as a triumph of obstinate optimism. A parallel case was that of Marconi's, who at the time he was sending wireless signals 3,000 miles across the Atlantic Ocean in 1901, found that distinguished mathematicians were proving that communication on the wavelength he was employing was limited to approximately 100 miles. Another factor which brought new light on to the problems attached to what had hitherto been regarded as quasi-optical waves was the high peak powers used for television. Alexandra Palace is rated at 17 kilowatts peak, and the Eiffel Tower is designed for nearly double this figure.

## Are they Freak Results?

Reports of reception of the B.B.C. vision and sound signals have already come from scattered spots on the Continent, while the United States made a record of the received sound, and sent it to the B.B.C. for confirmation. Johannesburg



Fig. 2.—A German version of a mixing and control desk suitable for monitoring high-definition television signals.



# THE BRITISH LONG-DISTANCE LISTENERS' CLUB

## Renovating Old Parts

SOME interesting points were raised in a recent letter from a member who had been spending his time cleaning up an old set for a friend. He went over the set thoroughly and took the majority of the parts to pieces in order to re-solder joints and otherwise make things sparkle. The idea is a very good one, but, unfortunately, there are one or two snags, and he seemed to have found them. One of these relates to the volume control, and as this worked stiffly, he had carefully cleaned it and, when reassembling it, had put a nice film of vaseline over the element and the moving arm. This seems quite a sound idea and no doubt would function with some components, but it must be remembered that this material is an insulator, and thus instead of improving things, it might easily make them worse, due to the fact that it would reduce the contact between the arm and the element. In the case of a wire-wound component it might be quite a good plan to use such a material to reduce friction, as the actual contact surface would soon be cleaned off, but some discrimination should be used when using any lubricant in moving parts of radio apparatus, as these all may be used as conducting surfaces and thus no insulation can be employed.

For such components as condensers, where a definite connection is made to the spindle, it would be permissible to place oil or other lubricant in the bush through which the spindle turns, or to the ball-races if such are fitted. Colloidal graphite

plug-and-socket combination was split and into it a parallel-sided plug was inserted. Some makes of socket now available are parallel-sided and the plug itself is split. Consequently, if a parallel-sided plug is inserted into a parallel-sided socket a poor contact will be effected, and at least one of the sections should be of the spring or split type to prevent movement and to ensure good contact. The modern split plug may be opened to provide better contact when it has become worn by

The popular Clix plug and socket, which explains the points mentioned in the accompanying notes.



inserting a penknife blade between the sections and squeezing the ends with a pair of pliers. Care should be taken with split sockets, however, as they may be broken if squeezed too hard.

## A Trimming Problem

A difficulty which often appears to arise when trimming a set of the superhet type, where tuning is very sharp, is in obtaining an exact setting. A member complains that as soon as he removes his screwdriver the setting goes and he cannot obtain the exact resonant point. He asks for a cure for this trouble. The first thing is to use an insulated implement for adjustment—not an ordinary metal screwdriver. The hand-capacity effect produced on the primary side of the transformer especially by this type of instrument will make it difficult to get an exact setting. But it is also necessary in some components to refrain from pressure when the adjustment is made. The screw which carries out the adjustment in some trimming condensers may be pushed downwards and is held in position by a spring washer underneath the condenser. Thus, if you push on it you will compress the plates forming the condenser and vary the capacity, and this may lead you to think that you have adjusted it to that setting, whereas on releasing pressure the springy top plate will lift the trimming screw and upset the adjustment made. A final point to be remembered in connection with such trimmers is that they should not be turned backwards and forwards indiscriminately time after time, as this will take out the springiness of the plate and it will be found difficult to obtain a smooth variation in capacity.

It has sometimes been advised to drop sealing wax on the trimming screw after the adjustment has been made, but this is not always a sound piece of advice. The heat of the wax may easily result in sufficient expansion of the metal to modify the setting, and may also upset the adjustment due to the wax running down between the plates of the trimming condenser.

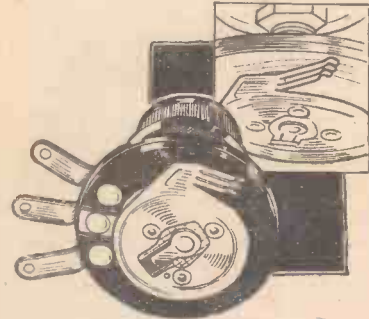

A typical volume control from the Dubilier range.

might also be used under certain circumstances, but before any application of these materials is made the component should be carefully studied so that the full purpose of the movement is understood, and the properties of it should be retained.

## Socket Troubles

During the renovation referred to an interesting point arose relating to ordinary plugs and sockets. It appears that there were several of these in the receiver (which was of old vintage) and the member in question went out and bought some new plugs. These appeared to give worse results, from the point of view of the fit between plug and socket, than the old parts and he wonders why. The reason is probably to be found in the fact that the components are of different make, and this, coupled with the difference in age, would account for the trouble in the following way. Some time ago the socket part of a

# PETO-SCOTT ALL-WAVE S.G.3 CHASSIS

Battery Operated.  
List Value £5 : 19 : 6  
BARGAIN  
£3 : 19 : 6  
Wave-ranges: 5 18-52 metres; 200-550 metres; 900-2,100 metres.



S.G. Detector and Pentode Circuit. Variable Selectivity Tappings. Stove enamelled pressed steel chassis. 2 gang air spaced condenser. Peto-Scott Duplex Epicyclic full vision dial provides double ratio slow motion drive. New triple-banked Rotary switch, with silver-plated contacts. Air-cored wave-wound Broadcast and Electrostatically screened Short-Wave Coils. CHASSIS ONLY. Complete with 3 British valves. Cash or C.O.D. Carriage Paid £3 : 19 : 6 or 1/- Deposit and 11 monthly payments of 7/6. CHASSIS and SPEAKER. As above but with Peto-Scott Permanent Magnet "tone-compensated" speaker. Cash or C.O.D. Carriage Paid £4 : 19 : 6 or 7/6 Deposit and 11 monthly payments of 9/6.

## HOME BROADCASTER'S 6-7 watt AMPLIFIER

A powerful, compact unit, suitable for any medium-sized hall for public speeches or small dances. A super-efficient general purpose amplifier to earn you extra money. 4 valves. Triode, Resistance Transformer-coupled to 2 triple Grid Power Amplifier Valves, in Push-Pull. Full Wave Rectifier. Tapped and Screened Mains Transformer. Electrolytic condensers. Volume Control. Mains consumption approx. 60 watts. Tapped for A.C. Mains 200-250 volts, 40/100 cycles. Output 6-7 watts undistorted. Complete with Valves. Ready to connect to microphone or pick-up. Cash £3.10.0 LIST VALUE £6 10/0, or C.O.D. Or 5/- down and 11 monthly payments of 6/9.

77 (Pr.W.16) City Road, LONDON, E.C.1. 62 (Pr.W.16) HIGH HOLBORN LONDON, W.C.1. Holborn 3248

## MAKE SURE OF EXCELLENT XMAS RADIO

Don't be let down—last-minute orders dispatched immediately. Now is the time to replace worn valves. Any make supplied by RETURN POST for cash or C.O.D.  
LRS → McCarthy ALL WAVE Chassis  
Complete with B.V.A. R.F. 8, A.W. 8.5, A.W. Valves, knobs, leads, etc., ready for fitting into any cabinet. 17/6 WITH ORDER and 12 monthly payments of 14/6 WITH ORDER. Demonstrations Free. 12 monthly payments of 11/8. Cash price £3.17.6. 11/8. Cash price £3.17.6.

LRS → GARRARD A.C.6. RADIOGRAM UNIT  
Induction motor for A.C. 100/250 volts, 50/60 cycles. Unit plate with pick-up, needle amps, etc. 5/6 WITH ORDER and 11 monthly payments of 7/- Cash price 75/-

LRS → GARRARD A.C.6. Motor only  
As above but with fully automatic start and stop, and without pick-up, etc. Complete with 12in. turntable. 4/- WITH ORDER and 10 monthly payments of 4/6. Cash price 42/6.

LRS → Rothermel PIEZO ELECTRIC PICK-UP  
wide frequency response and amazingly high output. 3/6 WITH ORDER and 8 monthly payments of 4/- Cash price 32/6.

Also supplied on best possible EASY TERMS: Electric Vacuum Cleaners; Sun-Ray Health Lamps; Electric Clocks; Model Electric Train Sets; Electric Fires. Whatever your needs let us quote EASY TERMS.

EVERY offer carrying this symbol is: Fully Guaranteed. Sent Carriage Paid. Available for Immediate Delivery. On the Best and Lowest Terms. CASH or C.O.D. Orders dispatched BY RETURN.

5 MINUTES FROM ST PAULS

# LONDON RADIO SUPPLY ESTD COMPANY 1925

11, OAT LANE, NOBLE ST. LONDON, E.C.2. Phone: NATIONAL 6828-9

You'll get it QUICKER and on BETTER TERMS from LRS



*Dependability*

doesn't 'just happen'

for 30 years it has been built into

**T.C.C.**  
ALL-BRITISH  
**CONDENSERS**



The Telegraph Condenser Co. Ltd., Wales Farm Road, N. Acton, W.3.

3635

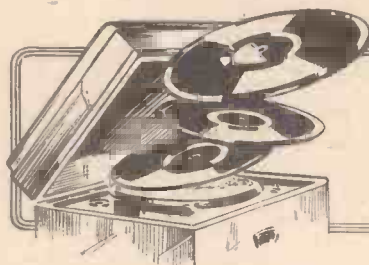

# Impressions on the Wax

## Decca

THE Decca Gramophone Company have just issued a forty-page catalogue of "Permanent Music" which displays the wide field of music covered by them. If readers are interested, a copy of this interesting booklet will be sent to them upon application to the above company.

Bruckner's Overture in G Minor is the latest addition to this series, and appears on Decca X 192-X 193. This Overture was left incomplete by Bruckner and was finished by a friend. This is a bright piece of music of which Sir Henry Wood and the Queen's Hall Orchestra give a first-rate performance. Also in this series is the Dylan Prelude on Decca X 194-X 195. On the reverse of the latter record is recorded Ships movement from the Third Symphony.

## Christmas Entertainment

THE imposing list of new records by the Street Singer, there are five of them, almost makes a Christmas home entertainment in themselves. "Tavern Ditties" on Decca F 6538 is an ideal record for a party as everybody can join in the choruses. For his other records he has chosen four tunes from his new film "Command Performance"—Decca F 6525-6—and "The Little Boy that Santa Claus Forgot," coupled with "Moonlight on the Waterfall"—Decca F 6539—also "Old Pal of Mine" and "Little Old Lady"—Decca F 6541.

Jessie Matthews has made two new discs this month on which she sings four of the songs from her new film "Gangway." They are Decca F 6470-1.

I draw special attention to Decca K 870, which is a splendid souvenir of all the popular artists who adorn Decca records. The title is "Presenting All Stars" and you should certainly hear it. "Round the Shows with Charlie Kunz," on Decca F 6510, is a finely conceived sample of what is showing at the London theatres at this very moment.

## Brunswick

FOUR "hit" tunes from the new Bing Crosby film "Double or Nothing," appear on Brunswick 02498-9. This film was a big success at its London pre-release exhibition and very shortly it will be on show generally. Crosby at his best.

Known as "the miracle voice of the screen," Deanna Durbin has recorded on Brunswick 02486 numbers from her new film "Hundred Men and a Girl."

Very shortly we shall be able to see "Broadway Melody of 1938," and we shall discover that Judy Garland is the outstanding artist of this welcome annual film revue. The song, "Dear Mr. Gable," is one of the best numbers in the film and you should hear it sung by Judy Garland on Brunswick 02488.

Records by Bing Crosby and Connie Boswell are generally sought after, but now it will be possible to get both these famous

artists on the same record. They have made a duet of "Basin Street Blues" and "Bob White" (Whotcha gonna swing to-night) on Brunswick 02492.

## Rex

THE millions of people who listened to the Royal Command Variety Performance will remember Gracie Fields singing "Little Old Lady." She has now recorded this tune on Rex 9166. On the reverse side she sings "The First Time I Saw You." She has also recorded "The Organ, the Monkey and Me" and "Gipsy Lullaby" on Rex 9161.

Within a few hours of the Singing Bricklayer appearing in the Carol Levis broadcast hour, Rex had secured this new artist for recording. His first disc is therefore released this month on which he sings "The Greatest Mistake of My Life" and "Let Us Be Sweethearts Over Again" on Rex 9174.

Bob Mallin, the popular radio star who appears with Henry Hall and his Band, sings the comedy tune of the moment, "Oh! They're Tough, Mighty Tough in the West," on Rex 9093. He has also chosen another popular tune for the reverse side—"A Sailboat in the Moonlight."

"Rex Cavalcade of 1937" on Rex 9159 introduces eight famous stars on one record. They are Gracie Fields, Sandy Powell, Billy Cotton, Brian Lawrence, Ralph Silvester, Primo Scala, Reginald Dixon and Jay Wilbur. It is extremely good, and Gracie Fields and Sandy Powell lead these artists in hilarious jollity and with a mixture of past and present successes give us a record which will prove an outstanding success with everyone.

## Vocalion

ARTIE SHAW and his Orchestra have recorded that old favourite, "It's a Long, Long Way to Tipperary" and "Shoot the Likker to Me, John, Boy," on Vocalion-S 120. "Tipperary" in swing style, featuring the brilliant clarinet playing of Artie Shaw, is a most pleasing novelty, while the coupling has some amusing singing in the "instrumental imitation" style by Leo Watson.

Benny Carter and his Orchestra with Coleman Hawkins as the guest star have made a recording of "Lazy Afternoon" and "My Buddy" on Vocalion S 118. In similar style to his famous "Nightfall," Benny Carter's new composition, "Lazy Afternoon," features him on the trumpet and alto saxophone.

## THE WIRELESS CONSTRUCTOR'S ENCYCLOPÆDIA

By F. J. CAMM 4th Edition 5/- net  
(Editor of "Practical and Amateur Wireless")

Wireless Construction, Terms, and Definitions explained and illustrated in concise, clear language.

From all Booksellers, or by post 5/6 from George Newnes, Ltd., Tower House, Southampton Street, Strand, London, W.C.2.



## Leaves from a Short-wave Log

### Rome's Wave Turntable

THE six new short-wave transmitters which are under construction at Prato Smeraldo and Monte Mario, respectively, and of which two will be of 100 kilowatts, three of 50 kilowatts and one of two kilowatts, are being rapidly completed in order to bring them into service early in 1938. An ultra-modern system of beam aerials supplied by an affiliated company of the International Telephone and Telegraph Company, of New York, will comprise a revolving turntable on which are to be installed all the components of the transmitter which must be brought into action when a change of wavelength is needed. By a simple revolution of this turntable it is possible to switch in the apparatus necessitated by the various frequencies required for satisfactory broadcasts to all quarters of the globe at different times of the day and night.

### South Africa Calling

The South African Broadcasting Corporation is still pursuing its experimental transmissions through the Klipheuevel stations in order to find a suitable frequency for the Johannesburg, Cape Town, and Pretoria programmes. Transmissions have been made on 33.77 m. (8.883 mc/s); 31.22 m. (9.61 mc/s) and are now being carried out on 31.5 m. (9.523 mc/s). The best time to pick up these signals is between G.M.T. 17.00-19.00. Reports of reception should be addressed to Chief Engineer, G.P.O. The South African Broadcasting Corporation and Overseas Communication, Ltd., Pretoria (Union of South Africa).

### Another Armenia Overseas

A condenser setting of a fraction of a degree below that required for tuning in GSB, Daventry Empire, namely, 31.51 m. (9.52 mc/s), will bring you on most nights a clear broadcast from HJ4ABH, Armenia, Caldas, in the Republic of Colombia. The announcer regularly puts out the call-sign in Spanish and follows it up with the station's slogan: *La Voz de Armenia*, then a full announcement in the English language: *This is short-wave station HJ4ABH in the City of Armenia, Caldas, Colombia.* Two strokes on a gong follow all announcements, the interval signal consisting of five or more musical chimes. The station closes down at about G.M.T. 02.45 with the well-known *Indian Love Call*.

### La Voz De Carabobo

Such is the call heard every fifteen minutes from YV4RB (late YV6RV), Valencia (Venezuela), on 46.01 m. (6.52 mc/s). It is preceded by two notes struck on a heavy gong, and the announcements are followed by a series of four chimes. Frequent references are made to "General Electric" in the sponsored programmes. The broadcasts usually conclude with one of Sousa's popular marches.

This station should not be confused with YV6RB (late YV11RB), situated at Ciudad Bolivar (Venezuela) and operating on 45.84 m. (6.545 mc/s). Although this studio also uses three bell chimes the call is always coupled with the slogan: *Ecos del Orinoco, Emisora Ciudad Bolivar.*

# A GOOD JOB IN RADIO FOR YOU

The Radio Industry is short of trained men. You may still be an untrained assistant in a wireless shop, or doing a dead-end job on the bench, yet you have a grand opportunity to get a progressive, highly paid post—if you equip yourself for it by spare-time study.

Whatever branch of the Industry appeals most strongly to you, the International Correspondence Schools have a Course to fit your needs. Under I.C.S. direction, you study when and where you like. You are guided throughout by highly qualified instructors, whose advice and assistance is yours just as often as you care to ask for it. Nearly half a century of unrivalled experience is at the back of this work.

I.C.S. Courses cost no more than those of other reputable schools teaching by post. All instruction books and special textbooks are supplied without extra charge. The students of many postal concerns have to buy the books required, this often involving an additional expenditure of several pounds.

Write for our free "Radio" booklet, stating your subject—or use the coupon below if you wish.

## THE ADVISORY DEPARTMENT INTERNATIONAL CORRESPONDENCE SCHOOLS Ltd.

94, INTERNATIONAL BUILDINGS, KINGSWAY, LONDON, W.C.2.

Radio Engineering.	I.E.E. Grad. Exam.
Complete Radio.	I.W.T. Exam.
Radio Servicemen's	C. & G. in Radio Com. Exam.
Elementary Radio.	P.M.G. Certif.
Radio Service and Sales.	Air Ministry Prov. Certif.
Television.	

Mark X in front of Courses in which you are interested.

Name.....Age.....

Address.....

The I.C.S. are the creative pioneers of vocational training by the postal method, and by far the largest, greatest, and most successful correspondence institution in the World.

## ARMSTRONG

6-Valve All-wave Superheterodyne Radiogram Chassis, complete with British Valves and 8" Moving Coil Speaker. **£7-10-0**  
Model 3BF/8. (Ready to switch on.) PRICE

This chassis, one of the most popular of our 1938 range, incorporates many refinements, including iron-cored coils, iron-cored intermediate transformers, latest Vaxley type switching, latest British Octal Base Valves, etc.

The circuit also is particularly up-to-date, whilst the short-wave band has been especially studied and American stations are readily obtainable.

All the best British components are used throughout.

Armstrong chassis are sent on 7 days' approval, packing and carriage free. All Armstrong chassis carry twelve months' guarantee.



Armstrong Company has published a new illustrated catalogue, fully describing model 3BF/8, together with many other chassis of equal interest. A copy will gladly be sent on application. It is called "Armstrong Technical Catalogue No. 12."

**ARMSTRONG MANUFACTURING Co.**  
100, KING'S ROAD, CAMDEN TOWN, LONDON, N.W.1  
Phone: GULlier 3105.

## ELECTRADIX BARGAINS

### For Xmas and New Year Gifts

#### MAKE YOUR OWN RECORDS ON DISC

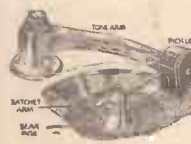

The FEIGH RECORDER fits any Radiogram and is positive drive by worm gear and rack. Complete and ready for use, only 37/6. Less Pick-up and Tone Arm, 21/-. Either 4 doz. metal blanks can be used or the glass coated simpels, 10in. 3/- each. Pre-amplifiers for Recording Mikes, 1-valve Battery Model in cabinet, 25/-. A.C. Mains pre-amplifiers, with valve rectifier, steel-cased model, 80/-.

GRAMO-MOTORS for recording. Universal Model, 55/10/-, GRAMO-MOTORS. Garrard Universal A.C./D.C. with turntable and auto switch, 23/10/-. B.T.H. Universal model YM, turntable and autostop, 45/-. A.C. Gramo Motors and turntable, H.M.V. 110 volts, 25/-, 230 volts, 37/6. Motor only, 30/-. B.T.H. Golden Disc, 37/6.

MICROPHONES. Table Model "N.W.11" For home broadcasting. Bakelite square body on bronze base, containing transformer, switch and plugs, is a marvellous production at a low price. Worth 2 guineas. Only 15/-. Leedix No. 10B Pedestal, 10in. high, 12/6. Leedix Superior No. 12BB Rim, 14in. pedestal, 18/6. Hand mikes in 2in. case, No. 11 at 5/6. Superior type, No. 11a, 7/6. Home microphone No. 11 is a solo general-purpose robust mike, with solid bakelite body, lock terminals, front metal grille, hand- or sling design, 5/6.

MIKE AMPLIFIERS. First stage Battery model. Oak case, 25/-, A.C. Mains model, steel case, 60/-.

L.F. TRANSFORMERS. Fine lot of Ferranti shrouded and B.T.H. Bakelite for coupling and outputs. Ferranti A.36, A.P.3 and 4, R.D.354, 3-1, etc., 8/6. B.T.H. 4-1 at 8/- each. Ferranti O.P.S., B. & D., for output to speaker, 6/-, 46A Push Pull, 6/6. O.P.M. 3 ratio output, 6/6. Large B.A.F. 100-watt amplifier output Transformers for 6 speakers; 52/6.

Transformers for working models, 200/250 A.C. to 10 volts 5 amp. 15/-.

CRYSTAL SETS. Buy the boy one, they cost nothing to run. No battery or valves wanted. Quiet and efficient reception. 500 shop-soiled sets cheap. Enclosed type, 5/8 and 7/6 each. Battery portables, 30/-.

HEADPHONES. Light weight, 2,000 ohms, 4/6. Single high res. earpiece, 2/8. Sullivan 129 ohm W.D. model. Aluminium body and headbands. Maker's price to-day 15/-. Our price 2/8 per pair, 3d. postage. Pocket Headphones all leather-headband and cords, 2/8 pair.

TELEPHONES for all purposes. Home, Office, Garage and Field Sports. Wall type, 15/-. Other Wall and Table models cheap. Send for lists.

1,000 other Bargains in New Sale List "N" Post Free.

## ELECTRADIX RADIOS

218, Upper Thames Street, London, E.C.4.

Telephone: Central 4611



# RADIO CLUBS & SOCIETIES

Club Reports should not exceed 200 words in length and should be received First Post each Monday morning for publication in the following week's issue.

## INTERNATIONAL D'XERS' ALLIANCE.

SHORT-WAVE listeners may be interested to know that VO6D (14,280 kc/s) will broadcast from North West River, Labrador, special programmes for the International D'xers' Alliance on December 17th at 24.30 G.M.T. and December 26th at 11.00 G.M.T.

Reports should be sent to W21XY, who will read them over the air to VO6D on their schedule at 21.30 G.M.T. Mondays and Thursdays. A. Anderson, 45, Shawburn Road, Selkirk.

## THE CROYDON RADIO SOCIETY

THE Croydon Radio Society's meeting on Tuesday, November 30th, in St. Peter's Hall, Ledbury Road, S. Croydon, was devoted to a talk on "Avo Measuring Instruments and Radio Servicing," by Mr. Wilkins, and the vice-chairman, Mr. G. A. Hoskins, presided. The lecturer, in discussing scale ranges, had much to say on the reasons for a low ohms-per-voltage reading, which assisted in the British Standard first grade specification being followed. Such problems as the coil's D.C. resistance and field strength necessary proved very absorbing. Mr. Wilkins then passed on to the consideration of safeguarding devices against overload. Some of those discussed had certain disadvantages, and at length he came to a purely mechanical safety device. It incorporated a moving ratchet, and the whole movement was made quite clear. In practice, he said, 100 volts overload had been tried, and the user had been pleased to say that the instrument had survived!

An interesting time was also spent in explaining the uses of a valve tester: with a valve what was wanted was the change of current in the anode circuit per change in grid volts. Nor did the Avo oscillator escape notice. It uses a Colpitz R.F. circuit, and the account of its uses was only shortened by need for a reasonable period for questions. Hon. pub. sec.: E. L. Cumbers, Maycourt, Campden Road, S. Croydon.

## WOLVERHAMPTON SHORT-WAVE RADIO SOCIETY

THE above society held a meeting at the Molneaux Hotel on Tuesday, November 30th, and heard an interesting talk by Mr. Cholot, of Lissen's, on H.I-Q components and receivers. The club have recently acquired a club room, and hope to be on the air at an early date. Prospective members are heartily welcomed. Will persons interested please communicate with the secretary, V. C. Hague, 76, Darlington Street, Wolverhampton?

## GLACKMANNANSHIRE SHORT-WAVE CLUB

THE above club, during the month of November, has been under the chairmanship of Mr. J. Ferguson (2AGF), who received his AA call during the close season. Mr. J. D. McGirr, another member, has now his AA call (2AJX). Mr. J. Innes, who won the "20-metre fone" DX contest for 1937, hopes to have his AA call shortly. Through the kindness of Whitely Bros., of Mansfield, a "WB" Senior model speaker has been tested by the members, who had nothing but praise for its performance. On November 14th a test was made of a six-valve A.C. G.E.C. receiver brought to the club through the kindness of a local radio store. Using an indoor antenna, this receiver brought in "local" and foreign amateurs at full loudspeaker strength. A paper kindly sent from WFSRA (London HQ) by G6AQ (Mr. A. H. Bird) on "Interplanetary Communication," which has been completed from notes taken from experiments dating from 1921, will be given this month. We wish to appeal to amateurs who read this notice, and who could possibly come along and assist, to write to the secretary, Mr. D. McIntosh, 10, Coblerook Gardens, Alva. Meetings are held every Sunday, from 2.30 p.m. till 4.30 p.m., in the Drill Hall, Alva.

## THE PORTSMOUTH AND DISTRICT WIRELESS AND TELEVISION SOCIETY

AT the meeting of the above club, Mr. Bott continued his lecture on "Wireless Step by Step," and dealt with valves and high frequency amplification. After the lecture, work was started on the transmitter, as the Society now holds a transmitting licence. The call sign is G6II, and useful reports will be appreciated. CW will be used for a while on the m/c band (7,100 kc/s) and later 'phone on all bands. Chairman: Harold Leigh, 20, King Street, Southsea.

## KETERING RADIO AND PHYSICAL SOCIETY

THE working of the Milnes H.T. Battery formed the subject of a lecture by Mr. F. G. Glanfield, to the members of the above Society on Monday, November 29th. Mr. Milnes's early experiments with the nickel-

cadmium type of battery were touched upon, and also his discovery that a 6-volt accumulator would level-up the voltage of banks of 4 cells of these nickel-cadmium batteries—which led to the patenting of the Milnes H.T. Unit. The various experiments to obtain a switch to put all the banks of cells in parallel with the accumulator were dealt with, and Mr. Glanfield related some amusing incidents regarding these experiments and the early models of the unit.

An interesting discussion took place after the meeting, and great interest was displayed in the units on view.

On January 10th the lecturer will be Mr. J. S. Blair, of the Research Dept. of Stewarts and Lloyds Steel-works, Corby, on "Uses of Electronic Devices in Industry," and an illustrated lecture by the courtesy of the G.E.C. on "Distortion in Valve Amplifiers."

Further lectures are being arranged, and the secretary would be pleased to hear from anyone who would give a talk, especially on amateur radio subjects. Secretary: Irving L. Holmes (2AXF), "Miami," The Close, Headlands, Kettering, Northants.

## EDGWARE SHORT-WAVE SOCIETY

THE above society has applied to the G.P.O. for a transmitting licence, and Morse lessons are being held every week. A jumble sale was held at our headquarters on Sunday, December 5th, and our vice-president demonstrated his all-wave receiver. Particulars of membership may be obtained from the hon. sec., Mr. G. Yale, 40, Raeburu Road, Edgware.

## SOUTHALL RADIO SOCIETY

AT the meeting on November 23rd, Mr. W. G. Pyke (G6PK) was the speaker, his subject being "The Practical Side of Five Metres." Various pieces of apparatus were described by the lecturer, and he appealed for a greater number of stations to use the 56 mc/s band. A number of members of the Thames Valley Society attended this meeting, repaying the visit Southall members made to their headquarters in the spring.

On November 30th, Southall had a distinguished visitor in Mr. W. Nixon, of the Osram Valve Technical Department, and it was unfortunate that the bad weather kept the attendance down to the very low figure of thirty. Mr. Nixon, in a most interesting talk, illustrated by films, gave details of manufacturing processes used by the G.E.C.

Will readers please note that there will be no meetings on December 23rd and January 4th. The 1938 session starts on January 11th. Visitors are, of course, welcome at all meetings. Programmes can be obtained from the secretary, H. F. Reeve, 26, Green Drive, Southall.

# The Ideal Gift

For a Radio Man



The truest test of a gift is the thoughtfulness that inspires its choice. The AvoMinor will be appreciated for many, many years because, for all that time, it will ensure trouble-free radio and will invest its fortunate owner with the testing facilities and the confidence of the expert radio engineer. The AvoMinor is the ideal gift, both to give and to receive. See that you get an AvoMinor this Christmas.

45/-

Deferred Terms if desired.

BRITISH MADE

If any difficulty in obtaining locally, send direct or write for fully descriptive folder.

Automatic Coil Winder & Electrical Equipment Co., Ltd., Winder House, Douglas Street, London, S.W.1. Phone: Victoria 3404/7.

The D.C. **AVOMINOR** REGD. TRADE MARK

CURRENT	
C-0	m/amps.
C-30	"
C-120	"
VOLTAGE	
C-5	volts. 0-12
C-120	" 0-240
C-300	" 0-600
RESISTANCE	
C-10,000	ohms
C-60,000	"
C-1,200,000	"
C-3	megohms.

## The HOME MECHANIC SERIES

Each 1/- net Illustrated. These Inexpensive Books will help you . . .

**THE HOME WOODWORKER.** The various examples of woodwork described in this handbook have been designed by practical craftsmen. They are modern in style, and their construction is well within the powers of the average home-worker who follows the instructions given.

**THE HANDYMAN'S ENQUIRE WITHIN.** Hundreds of practical ideas and hints—many not hitherto published. Classified according to the subjects dealt with, an index being provided to facilitate speedy reference.

**POWER DRIVEN MODEL AIRCRAFT.** All about petrol, compressed-air and steam engines, wheels, carburettors, ignition systems, rotary engines, etc., with special constructor's chapters, ranging from compressed-air models for beginners to advanced petrol-engined planes. With 130 sketches, diagrams, and photographs.

**MODEL AIRSHIPS AND AEROPLANES.** This handbook is intended as a guide to the beginner in model aeronautics. It presents in clear language the first principles of aviation and incorporates these in various forms of simple flying models. Profusely illustrated.

**ACCUMULATORS.** An accumulator (whether for wireless or the car), if properly used and cared for, is an extremely reliable piece of apparatus. Proper care and proper use can only follow a possession of the knowledge which study of this book will impart.

**SIMPLE ELECTRICAL APPARATUS.** Interesting and useful apparatus, easily constructed, with which the student is enabled to test for himself the theory and practice of electricity as laid down in the text-books. 138 illustrations.

All fully illustrated.

1/2 each post free, from the Publishers:

**GEORGE NEWNES, LTD.,**  
Tower House, Southampton Street,  
Strand, London, W.C.2







# Practical and Amateur Wireless BLUEPRINT SERVICE

Practical Wireless.	No. of Date of Issue. Blueprint.	Three-valve : Blueprints, 1s. each.	
<b>CRYSTAL SETS.</b>			
Blueprint, 6d.		Experimenter's Short-Wave Three (SG, D, Pow)	PW30A
1937 Crystal Receiver	9.1.37 PW71	The Perfect 3 (D, 2LF (RC and Trans))	7.8.37 PW68
<b>STRAIGHT SETS. Battery Operated.</b>			
One-valve : Blueprint, 1s.		The Bandsread S.W. Three (HF Pen, D (Pen), Pen)	29.8.36 PW68
All-wave Unipen (Pentode)	PW31A	F. J. Camm's Oracle All-wave Three (HF, Det, Pen)	28.8.37 PW78
Two-valve : Blueprints, 1s. each.		<b>PORTABLES.</b>	
Four-range Super Mag Two (D, Pen)	11.8.34 PW36B	Three-valve : Blueprints, 1s. each.	
The Signet Two	29.8.36 PW76	F. J. Camm's ELF Three-valve Portable (HF Pen, D, Pen)	PW65
Three-valve : Blueprints, 1s. each		Parvo Flyweight Midget Portable (SG, D, Pen)	19.6.37 PW77
The Long-range Express Three (SG, D, Pen)	24.4.37 PW2	Four-valve : Blueprints, 1s.	
Selectone Battery Three (D, 2 LF (Trans))	PW10	Featherweight Portable Four (SG, D, LF, Cl.B)	15.5.37 PW12
Sixty Shilling Three (D, 2 LF (RC & Trans))	PW34A	<b>MISCELLANEOUS.</b>	
Leader Three (SG, D, Pow)	PW35	S.W. Converter-Adapter (1 valve)	PW48A
Summit Three (HF Pen, D, Pen)	PW37	<b>AMATEUR WIRELESS AND WIRELESS MAGAZINE</b>	
All Pentode Three (HF Pen, D, Pen, Pen)	PW39	<b>CRYSTAL SETS.</b>	
Hall-mark Three (SG, D, Pow)	PW41	Blueprints, 6d. each.	
Hall-mark Cadet (D, LF, Pen, RC)	PW48	Four-station Crystal Set	12.12.36 AW427
F. J. Camm's Silver Souvenir (HF Pen, D (Pen), Pen) (All-wave Three)	13.4.35 PW40	1934 Crystal Set	AW444
Genet Midget (D, 2 LF (Trans))	June '35 PM1	150-mile Crystal Set	AW450
Cameo Midget Three (D, 2 LF (Trans))	8.6.35 PW51	<b>STRAIGHT SETS. Battery Operated.</b>	
1936 Sonotone Three-Four (HF Pen, HF Pen, Westector, Pen)	17.8.35 PW53	One-valve : Blueprints, 1s. each.	
Battery All-Wave Three (D, 2 LF (RC))	PW65	R.B.C. Special One-valver	AW387
The Monitor (HF Pen, D, Pen)	PW61	Twenty - station Loudspeaker One-valver (Class B)	AW440
The Tutor Three (HF Pen, D, Pen)	PW62	Two-valve : Blueprints, 1s. each.	
The Centaur Three (SG, D, P)	PW64	Melody Ranger Two (D, Trans)	AW388
The Gladiator All-Wave Three (HF Pen, D (Pen), Pen)	29.8.36 PW66	Full-volume Two (SG det., Pen)	AW392
F. J. Camm's Record All-Wave Three (HF Pen, D, Pen)	31.10.36 PW60	B.B.C. National Two with Lucerne Coil (D, Trans)	AW377A
The "Golt" All-Wave Three (D, 2 LF (RC & Trans))	5.12.36 PW72	Big-power Melody Two with Lucerne Coil (SG, Trans)	AW338A
Four-valve : Blueprints, 1s. each.		Lucerne Minor (D, Pen)	AW426
Sonotone Four (SG, D, LF, P)	1.5.37 PW4	A Modern Two-valver	WM409
Fury Four (2SG, D, Pen)	8.5.37 PW11	Three-valve : Blueprints, 1s. each.	
Beta Universal Four (SG, D, LF, Cl. B)	PW17	Class B Three (D, Trans, Class B)	AW386
Nucleon Class B Four (SG, D (SG), LF, Cl. B)	6.1.34 PW34B	New Britain's Favourite Three (D, Trans, Class B)	15.7.33 AW394
Fury Four Super (SG, SG, D, Pen)	PW34C	Home-built Coil Three (SG, D, Trans)	AW404
Battery Hall-mark 4 (HF, Pen, D, Push-Pull)	PW46	Fan and Family Three (D, Trans, Class B)	25.11.33 AW410
F. J. Camm's "Limit" All-Wave Four (HF Pen, D, LF, P)	PW67	£5 5s. S.G.3 (SG, D, Trans)	2.12.33 AW412
All-Wave "Corona" 4 (HF Pen, D, LF, Pow)	9.10.37 PW70	1934 Ether Searcher; Baseboard Model (SG, D, Pen)	AW417
<b>Mains Operated.</b>			
Two-valve : Blueprints, 1s. each.		1934 Ether Searcher; Chassis Model (SG, D, Pen)	AW419
A.C. Twin (D (Pen), Pen)	PW18	Lucerne Ranger (SG, D, Trans)	AW422
A.C.-D.C. Two (SG, Pow)	PW31	Coscor Melody Maker with Lucerne Coils	AW423
Selectone A.C. Radiogram Two (D, Pow)	PW19	Mullard Master Three with Lucerne Coils	AW424
Three-valve : Blueprints, 1s. each.		£5 5s. Three: De Luxe Version (SG, D, Trans)	19.5.34 AW485
Double-Diode-Triode Three (HF Pen, DDT, Pen)	PW23	Lucerne Straight Three (D, RC, Trans)	AW437
D.C. Ace (SG, D, Pen)	PW25	All-Britain Three (HF Pen, D, Pen)	AW448
A.C. Three (SG, D, Pen)	PW29	"Wireless League" Three (HF Pen, D, Pen)	3.11.34 AW451
A.C. Leader (HF Pen, D, Pow)	7.4.34 PW35C	Transportable Three (SG, D, Pen)	WM271
D.C. Premier (HF Pen, D, Pen)	31.3.34 PW35B	£6 6s. Radiogram (D, RC, Trans)	WM318
Ubique (HF Pen, D (Pen), Pen)	28.7.34 PW36A	Simple-tune Three (SG, D, Pen)	June '33 WM327
Arnuda Mains Three (HF Pen, D, Pen)	PW38	Economy-Pentode Three (SG, D, Pen)	Oct. '33 WM337
F. J. Camm's A.C. All-Wave Silver Souvenir Three (HF Pen, D, Pen)	11.5.35 PW50	"W.M." 1934 Standard Three (SG, D, Pen)	WM351
"All-Wave" A.C. Three (D, 2LF (RC))	17.8.35 PW54	£3 3s. Three (SG, D, Trans)	Mar. '34 WM354
A.C. 1936 Sonotone (HF Pen, HF Pen, Westector, Pen)	PW56	Leon-core Band-pass Three (SG, D, QP21)	WM362
Mains Record All-Wave 3 (HF Pen, D, Pen)	5.12.36 PW70	1935 £6 6s. Battery Three (SG, D, Pen)	WM371
All-World Ace (HF Pen, D, Pen)	28.8.37 PW80	PTP Three (Pen, D, Pen)	June '35 WM389
Four-valve : Blueprints, 1s. each.		Certainty Three (SG, D, Pen)	WM393
A.C. Fury Four (SG, SG, D, Pen)	PW20	Minutube Three (SG, D, Trans)	Oct. '35 WM400
A.C. Fury Four Super (SG, SG, D, Pen)	PW34D	All-wave Winning Three (SG, D, Pen)	Dec. '35 WM396
A.C. Hall-Mark (HF Pen, D, Push-Pull)	24.7.37 PW45	Four-valve : Blueprints, 1s. 6d. each.	
Universal Hall-Mark (HF Pen, D, Push-Pull)	9.2.35 PW47	65s. Four (SG, D, RC, Trans)	AW370
A.C. All-Wave Corona Four	6.11.37 PW81	"A.W." Ideal Four (2 SG, D, Pen)	10.9.33 AW402
<b>SUPERHETS.</b>			
Battery Sets : Blueprints, 1s. each.		2HF Four (2 SG, D, Pen)	AW421
£5 Superhet (Three-valve)	5.6.37 PW40	Crusader's A.V.C.4 (2 HF, D, QP21)	18.8.34 AW445
E. J. Camm's 2-valve Superhet	13.7.35 PW52	(Pentode and Class B Outputs for above : Blueprints, 6d. each)	25.8.34 AW445A
F. J. Camm's EM Superhet	PW58	Self-contained Four (SG, D, LF, Class B)	Aug. '33 WM331
F. J. Camm's "Vitesse" All-Waver (5-valver)	27.2.37 PW75	Lucerne Straight Four (SG, D, LF, Trans)	WM350
Mains Sets : Blueprints, 1s. each.		£5 5s. Battery Four (HF, D, 2LF)	Feb. '35 WM381
A.C. £5 Superhet (Three-valve)	PW43	The H.K. Four (SG, SG, D, Pen)	Mar. '35 WM384
D.C. £5 Superhet (Three-valve)	PW42	The Auto Straight Four (HF Pen, HF Pen, DDT, Pen)	April '36 WM404
Universal £5 Superhet (Three-valve)	PW44	Five-valve : Blueprints, 1s. 6d. each.	
F. J. Camm's A.C. £4 Superhet 4	31.7.37 PW59	Super-quality Five (2HF, D, RC, Trans)	May '33 WM320
F. J. Camm's Universal £4 Superhet 4	PW60	Class B Quadradyne (2 SG, D, LF, Class B)	Dec. '33 WM344
"Qualitone" Universal Four	16.1.37 PW73	New Class-B Five (2 SG, D, LF, Class B)	Nov. '33 WM340
<b>SHORT-WAVE SETS.</b>			
Two-valve : Blueprint, 1s.		<b>Mains Operated.</b>	
Midget Short-wave Two (D, Pen)	PW38A	Two-valve : Blueprints, 1s. each.	

These Blueprints are drawn full size. Copies of appropriate issues containing descriptions of these sets can in some cases be supplied at the following prices which are additional to the cost of the Blueprint. A dash before the Blueprint Number indicates that the issue is out of print.

Issues of Practical Wireless .. 4d. Post Paid.  
Amateur Wireless .. 4d. " "  
Practical Mechanics .. 7d. " "  
Wireless Magazine .. 1/3 " "

The index letters which precede the Blueprint Number indicate the periodical in which the description appears: thus PW refers to Practical Wireless, AW to Amateur Wireless, PM to Practical Mechanics, WM to Wireless Magazine.

Send (preferably) a postal order to cover the cost of the blueprint and the issue (stamps over 6d. unacceptable), to PRACTICAL AND AMATEUR WIRELESS, Blueprint Dept., George Newnes, Ltd., Tower House, Southampton Street, Strand, W.C.2.

Economy A.C. Two (D, Trans) A.C.	—	WM286
Unicorn A.C.-D.C. Two (D, Pen)	—	WM394
<b>Three-valve : Blueprints, 1s. each.</b>		
Home-Lover's New All-electric Three (SG, D, Trans) A.C.	—	AW383
S.G. Three (SG, D, Pen) A.C.	—	AW390
A.C. Triodyne (SG, D, Pen) A.C.	19.3.33	AW399
A.C. Pentaquester (HF Pen, D, Pen)	23.6.34	AW439
Mantovani A.C. Three (HF Pen, D, Pen)	—	WM374
£15 15s. 1936 A.C. Radiogram (HF, D, Pen)	Jan. '36	WM401
<b>Four-valve : Blueprints, 1s. 6d. each.</b>		
All-Metal Four (2 SG, D, Pen)	July '33	WM326
Harris Jubilee Radiogram (HF Pen, D, LF, P)	May '35	WM386
<b>SUPERHETS.</b>		
Battery Sets : Blueprints, 1s. 6d. each.		
Modern Super Senior	—	WM375
Varsity Four	Oct. '35	WM395
The Request All-Waver	June '36	WM407
1935 Super Five Battery (Superhet)	—	WM379
<b>Mains Sets : Blueprints, 1s. 6d. each.</b>		
1934 A.C. Century Super A.C.	—	AW425
Heptode Super Three A.C.	May '34	WM359
"W.M." Radiogram Super A.C.	—	WM366
1935 A.C. Stenode	Apr. '35	WM385
<b>PORTABLES.</b>		
Four-valve : Blueprints, 1s. 6d. each.		
Midget Class B Portable (SG, D, LF, Class B)	20.5.33	AW380
Holiday Portable (SG, D, LF, Class B)	1.7.33	AW393
Family Portable (HF, D, RC, Trans)	22.9.34	AW447
Two H.F. Portable (2 SG, D, QP21)	June '34	WM363
Tyers Portable (SG, D, 2 Trans)	—	WM367
<b>SHORT-WAVE SETS—Battery Operated.</b>		
One-valve : Blueprints, 1s. each.		
S.W. One-valve converter (Ericc 6d.)	—	AW329
S.W. One-valve for America	23.1.37	AW429
Rome Short-Waver	—	AW452
Two-valve : Blueprints, 1s. each.		
Ultra-short Battery Two (SG det., Pen)	Feb. '36	WM402
Home-made Coil Two (D, Pen)	—	AW440
Three-valve : Blueprints, 1s. each.		
World-ranger Short-wave 3 (D, RC, Trans)	—	AW355
Experimenter's 5-metre Set (D, Trans, Super-regen)	30.6.34	AW438
Experimenter's Short-waver (SG, D, Pen)	Jan. 19. '35	AW463
The Carrier Short-waver (SG, D, P)	July '35	WM390
<b>Four-valve : Blueprints, 1s. 6d. each.</b>		
A.W. Short-wave World-Beater (HF Pen, D, RC, Trans)	—	AW436
Empire Short-Waver (SG, D, RC, Trans)	—	WM313
Standard Four-valver Short-waver (SG, D, LF, P)	Mar. '33	WM383
Superhet : Blueprint, 1s. 6d.	—	WM397
Simplified Short-waver Super	Nov. '35	WM397
<b>Mains Operated.</b>		
Two-valve : Blueprints, 1s. each.		
Two-valve Mains short-waver (D, Pen), A.C.	—	AW453W
"W.M." Band-spread Short-waver (D, Pen) A.C.-D.C.	—	WM368
"W.M." Long-wave Converter	—	WM380
Three-valve : Blueprint, 1s.		
Emigrator (SG, D, Pen) A.C.	—	WM352
Four-valve : Blueprint, 1s. 6d.		
Standard Four-valve A.C. Short-waver (SG, D, RC, Trans)	Aug. '35	WM391
<b>MISCELLANEOUS.</b>		
Enthusiast's Power Amplifier (1/8)	June '35	WM387
Listeners' 5-watt A.C. Amplifier (1/6)	—	WM392
Radio Unit (2v) for WM392	Nov. '35	WM398
Harris Electrogram (battery amplifier) (1/-)	Dec. '35	WM399
De-Luxe Concert A.C. Electrogram	Mar. '36	WM403
New Style Short-Wave Adapter (1/-)	June '35	WM388
Tackle Charger (6d.)	Jan. 5, '35	AW462
Short-Wave Adapter (1/-)	Dec. 1, '34	AW456
Superhet Converter (1/-)	Dec. 1, '34	AW457
B.L.D.L.C. Short-wave Converter (1/-)	May '36	WM405
Wilson Tone Master (1/-)	June '36	WM406
The W.M. A.C. Short-Wave Converter (1/-)	—	WM408





# QUERIES and ENQUIRIES

## Designing a Set

"I am only a beginner and have gathered all my knowledge from reading your pages through the past few months. I have been using for some time a two-valve which was given to me, and I am now anxious to try my hand at construction, and have designed a four-valve set. My knowledge may not yet be O.K., but the circuit I intend to use looks quite satisfactory, and I should like to have your O.K. before proceeding to buy

## Advantages of A.C. Sets

"Is it a fact that an A.C./D.C. set cannot possibly come up to the performance of a set designed solely for A.C. or D.C. operation?"—F. A. F. (Naphill).

A SET designed for A.C./D.C. operation may be considered along with a D.C. set. That is, it is designed for a maximum input of 250 volts and there is no transformer on the input side. Consequently, the highest H.T. voltage available is less than 250 volts (after smoothing) and thus the valves which may be used are restricted. On the other hand, an A.C. set will have an input transformer with which the A.C. mains voltage may be stepped up to any desired level. Thus it is possible to use H.T. voltages of 500 or more and the very much more efficient and powerful A.C. valves.

## Using a Microphone

"I have a commercial A.C. mains four-valver and wish to use a microphone. When this is connected to the pick-up terminals volume is insufficient. Do you think a single-stage battery-operated amplifier could be joined between the mike and the receiver to give improved results?"—J. D. (Sunderland).

IT is quite possible that the addition of an amplifier will prove all that is needed. You could, of course, use a mains-operated amplifier and probably derive the necessary voltages from your set, but the battery arrangement would be simpler. Incidentally, we presume that the microphone is employed in conjunction with a suitable transformer to match the impedance of the grid circuit of your receiver.

## American Valves

"I attach a circuit of an amplifier I am anxious to try out, and should be glad if you would give me details of the various components which I have marked."—L. C. (Moldgreen).

THE circuit shows three American-type valves, and it is important to bear in mind that these are not so efficient as the standard English valves. Consequently, it is always risky to build up an American circuit and to substitute English valves. If possible, the receiver should be used with American components for which the circuit was designed, and if English valves are substituted, then it may be necessary to experiment to find suitable alternative values for the various components.

**RULES**

We wish to draw the reader's attention to the fact that the Queries Service is intended only for the solution of problems or difficulties arising from the construction of receivers described in our pages, from articles appearing in our pages, or on general wireless matters. We regret that we cannot, for obvious reasons—

- (1) Supply circuit diagrams of complete multi-valve receivers.
- (2) Suggest alterations or modifications of receivers described in our contemporaries.
- (3) Suggest alterations or modifications to commercial receivers.
- (4) Answer queries over the telephone.
- (5) Grant interviews to querists.

A stamped addressed envelope must be enclosed for the reply. All sketches and drawings which are sent to us should bear the name and address of the sender.

Requests for Blueprints must not be enclosed with queries as they are dealt with by a separate department.

Send your queries to the Editor, PRACTICAL AND AMATEUR WIRELESS, George Newnes, Ltd., Tower House, Southampton Street, Strand, London, W.C.2. The Coupon must be enclosed with every query.

the parts and start to build the set. If there is anything wrong perhaps you will tell me."—H. D. U. (Blackpool).

THE circuit itself is quite in order, and all values are standard. So far as the theoretical considerations are concerned, therefore, there is nothing wrong with your idea. We must remind you, however, that drawing out a circuit on paper and building a set to embrace that circuit satisfactorily are two different things, and you may find, especially as there are two H.F. stages, that some experiment will be required in order to find a suitable stable layout.

## Using a Converter

"I have a one-valve converter, and this does not give very good results with my set. Would it be possible to use this converter as a single-valve set, and if so, what alterations must I make to it?"—A. V. (Ossett).

A STANDARD S.W. converter may be used as a one-valve set simply by joining a pair of headphones between the choke and H.T. positive. If, of course, the converter is provided with a multi-plug device, and thus takes its voltages from a

receiver with which it is used, it will be necessary to connect the L.T. and H.T. leads to the converter in the usual way.

## Field Strength Meter

"In connection with some tests by our local club I have been asked to plot some diagrams of field strengths from a local transmitter, and should like to know the best form of apparatus to make to measure the field strength. I understand the plotting of a polar diagram and similar things, but am uncertain regarding the best measuring device for our purpose."—G. R. (Hove).

THE simplest field-strength meter is a single-valve set with milliammeter in the anode circuit. You can, of course, use a two-stage meter if the conditions warrant it. The set should preferably be enclosed in a metal case, with a pick-up coil mounted outside the case, and some form of zero setter should be included. This may be a filament rheostat, a potentiometer controlling screen-grid current in an S.G. valve, or a bias resistor of the variable type in the cathode circuit of an indirectly-heated valve of the 6.3-volt type operated from a car accumulator.

## Quality Receivers

"I am anxious to build a set for really high quality on the main high-powered stations, and am uncertain regarding the best circuit to adopt. I have read through many specifications of commercial receivers, and there are so many various circuit refinements, such as A.V.C., delayed and amplified A.V.C., noise suppressors, T.R.F.'s and so on, that I am a little bewildered as to which to adopt. Perhaps you can assist me in deciding on a circuit for my purpose."—G. R. (Finchley).

IF your main requirement is really quality, then all of the refinements you mention should be eliminated from your final design. Various forms of distortion, from frequency distortion to harmonic distortion are introduced by such things as A.V.C. noise suppression, and so on. For real quality, you will not beat the straight circuit without frills, utilising, say, two H.F. stages, followed by a diode rectifier feeding two L.F. stages in which a single high-powered output valve or a push-pull stage is employed. The H.F. stages must, however, be stabilised, and thus the gain should be kept down. If you are satisfied with three or four stations, and obtain a really good loudspeaker, this combination should be all that you desire. If, however, your quality requirements are not of the highest, a good superhet with A.V.C. to counteract fading, and with variable selectivity to account for variations and different listening requirements, will give quite good results.

The coupon on page 416 must be attached to every query.



## Build the ALL-WAVE A.C. MAINS SUPERHET RECEIVER (465 K.C.)

Three wave bands, Short, Medium and Long. Write for Blue Print BP120 (price 6d.) and full constructional details of the new receiver. Easy to build and inexpensive to buy.

VARLEY (OLIVER PELL CONTROL LTD.), CAMBRIDGE PLACE, WOOLWICH, S.E.18. TEL. WOOLWICH 1422



Miscellaneous Advertisements

Advertisements are accepted for these columns at the rate of 3d. per word. Words in black face and/or capitals are charged double this rate (minimum charge 3/- per paragraph). Display lines are charged at 6/- per line. All advertisements must be prepaid. All communications should be addressed to the Advertisement Manager, "Practical and Amateur Wireless," Tower House, Southampton Street, Strand, London, W.C.2.

RECEIVERS, COMPONENTS AND ACCESSORIES Surplus, Clearance or Secondhand, etc.

RADIOMART SHORT-WAVE MANUAL

Packed with short-wave information and circuits of mains and battery receivers, including straight, superhet and 5-metre transmitters, modulators, etc. Information on transmitting licences, aerials, Class B amplifications, neutralizations, superhet alignment, etc. The most comprehensive manual published, written by practical engineers, price 6d., post free, 7/6. including catalogue.

1937 Short-wave Catalogue only (3 times enlarged) price 1/6d., post free.

44, HOLLOWAY HEAD, BIRMINGHAM 1

SOUTHERN RADIO'S Guaranteed Wireless Bargains; post paid.

PLESSEY 3-valve Battery Sets, complete in sealed cartons with three Mazda valves, moving coil speaker, Pertrix batteries and accumulator, in exquisite walnut cabinet; 57/6 (limited quantity only).

GARRARD Record Changers, A.C. 200-250 volts, changes eight 10- or 12-inch records; £6 (complete sealed cartons); universal A.C./D.C. model, £7/10.

GARRARD A.C. Radiogram Units, with pick-up and all accessories, in sealed cartons; 42/-. COLLARO Single Spring Motors for Gramophones or battery radio; 10/-, complete with turntable and all accessories.

TILSEN (1937-38) Components; iron-core coils W.349 (Midget size), 3/6; W.477 (triple ganged, for band-pass or straight circuits), 14/6; W.476 (triple ganged superhet), 14/6; W.478 (twin ganged), 9/-; all ganged coils complete on bases, with switch; I.F. transformer coils, 4/6; dual range coils, 2/9; with aerial series condenser, W.76, 3/0.

TILSEN A.C./D.C. Multimeters, 5-range (tests anything radio or electrical), 8/6; loudspeaker units, 2/6; Ace (P.O.) microphones, complete with transformer, ready for use with any receiver, 4/6; headphones, 4,000 ohms, 3/- pair.

VALVES.—Full range for American receivers, 6/- each.

MORSE Tappers, complete radio-telegraph set (flasher, buzzer and tapper), with batteries, bulb, code 3/-.

BARGAIN Parcels of Assorted Components, including coils, resistances, condensers, chokes, wire, circuits, etc., value 21/-, 5/- per parcel.

SOUTHERN RADIO, 323, Euston Rd., London, S.W.1; and 46, Lisie St., London, W.C.1. All mails orders to

SOUTHERN RADIO, 323, Euston Rd., London, S.W.1 (near Warren St. Tube). Phone: Euston 3776.

CONVERSION UNITS for operating D.C. Receivers from A.C. Mains, improved type, 120 watt output at £2/10/0. Send for our comprehensive list of speakers, resistances and other components.

WARD, 46, Farringdon Street, London, E.C.4. Telephone: Holborn 9703.

THE largest stock of components in England, over 500 lines, new catalogue now ready 1/6d.—J. Bearfield, 105, Upper Street, London, N.1.

CONDENSERS.—British manufacture, fixed paper in metal containers. 800 volt Wkg., 4 mfd., 3/9; 2 mfd., 2/3; 1 mfd., 1/6. 500 volt Wkg., 4 mfd., 2/6; 2 mfd., 1/6; 1 mfd., 1/-. 400 volt Wkg., 4 mfd., 1/6; 2 mfd., 1/-; 1 mfd., 8d., and ELECTROLYTICS, Dry 500 p.p.v. 4 mfd., 1/6; 8mfd., 1/9; 8 + 4mfd., 2/6; 8 + 8mfd., 3/-; 16mfd., 3/-; 32mfd., 5/-, postage 6d. or C.O.D.—Mentone Radio Stores, 304, Fulham Road, London, S.W.10.

BANKRUPT Bargains. List free. Large stock of receivers, battery, mains, all-wave, at keenest prices. Replacement valves nearly all types. Components, speakers, all radio goods. All brand new. State your requirements, please. Quotations per return. Part exchange.—Butlin, 6, Stanford Avenue, Brighton. Phone: Preston 4030.

PREMIER SUPPLY STORES

POST ORDERS

Jubilee Works, 167, Lower Clapton Rd., London, E.5. Amherst 4723

CALLERS

165 & 165a Fleet Street, E.C.4 Central 2833 50, High Street, Clapham, S.W.4 Macaulay 2381

3-VALVE SHORT-WAVE KIT.—S.G., H.F.: Det. and Pentode. Covers 14-170 metres, with 4 pairs interchangeable 4-pin coils. Complete kit of parts, with metal chassis and set of 3 matched 2-volt valves, 42/-; suitable metal cabinet, 7/6 extra.

NEW 1-VALVE SHORT-WAVE RECEIVER OR ADAPTOR KIT. 13 to 86 metres without coil changing. Complete Kit and Circuit, 12/6. VALVE GIVEN FREE!

DE LUXE MODEL, 14 to 170 metres, complete Kit with Chassis, 4 Coils and all parts, 17/6.

SUPERHET CONVERTER KIT, 15/- De Luxe Model, 20/-.

S.W. SUPERHET CONVERTER KIT, for A.C. Mains Receivers, 22/6. A.C. Valve given FREE!

NEW 2-VALVE S.W. KIT, 13 to 86 metres without coil changing. Complete Kit and Circuit, 19/6. VALVES GIVEN FREE!

DE LUXE MODEL, 14 to 150 metres, complete Kit and Circuit, 4 Coils and all parts, 25/- VALVES GIVEN FREE.

PREMIER "TROLITUL" Short-Wave CONDENSERS, Certified superior to Ceramic. All-brass construction, 15 mmd., 1/6; 40 mmd., 1/7; 100 mmd., 1/10; 160 mmd., 2/50 mmd., 2/6; Double Spaced 15 mmd., 2/9; 40 mmd., 3/6. S.W.H.F. Chokes, 9d.; screened, 1/6. All-Brass S.W. Condensers with integral slow-motion, .00015 Tuning, 4/3; .00015, Reaction, 3/9. UTILITY 4" MICRO-CURSOR DIALS. Direct and 100:1 ratio, 3/9 each.

PREMIER MAINS TRANSFORMERS Screened Primary Wire-end Type

250+250 or 300+300v. 60 m.a., 4v. 1-2a., 4. 2-3a., 4v. 3-4a., all C.T. H.T. 8 & 0, 4v. 1a., 4v. 4a., all C.T. 10/- each. 350+350v. 120 m.a. 4v. 1-2a., 4v. 2-3a., 4v. 3-4a., all C.T. 11/6. 500+500v. 150 m.a., 4v. 2-3a., 4v. 2-3a., 4v. 2-3a., 4v. 3-4a., all C.T., 21/- 100-watt auto transformers, 100-110v. to 200-240v. 10/-, terminal type. Terminal Types 1/6 extra.

Now ready. Our New 1938 Enlarged Illustrated Catalogue, Handbook and Valve Manual. Price 6d. Send 6d. in Stamps for 90 Pages of Radio Interest!

Premier Battery Chargers. Westinghouse Rectification. Complete. Ready for use.

To charge 2 volts at 1 amp. 10/-

" 6 " 1 " 16/6.

" 12 " 1 " 21/-.

" 6 " 2 " 32/6.

TWO NEW MODELS, completely enclosed.

To charge 6 volts at 4 amps. £3/19/6.

6 or 12 volts at 2 amps. £3/19/6.

SHORT-WAVE COILS, 4- and 6-pin types, 13-26, 24-47, 41-94, 73-170 metres, 1/9 each, with circuit. Special set of S.W. Coils, 14-150 metres, 4/- set with circuit. Premier 3-band S.W. Coil. 11-25, 19-43, 38-86 metres. Simplifies S.W. receiver construction, suitable any type circuit, 2/6.

COIL FORMERS, 4- or 6-pin low-loss, 1/- each. A.C. and A.C./D.C. MAINS VALVES. Replacement for all types in stock from 4/6 each.

BATTERY VALVES, 2 volts H.F. L.F. 2/3. Power, Super-Power, 2/9. Var-Mu-S.G., 4- or 5-pin Pentodes, H.F. Pens., V-mu-H.F. Pens. 5/- Class B, 5/-.

AMERICAN VALVES. Genuine American HYTRON and TRIAD, first-grade Valves, 3 months guarantee. All types in stock, 5/6 each. 210 and 250, 8/6 each. New Metal-Glass Valves, all types, 6/6 each. Valve holders for all above types, 6d. each. OCTAL bases, 9d. each.

COSMOCORD PICK-UPS, with tonearm and volume control, 10/6. each. PICK-UP HEADS, only, 4/6 each.

PREMIER HIGH FIDELITY P.A. AMPLIFIERS.—3 watt A.C. or A.C./D.C. Complete Kit with Valves, 40/- Wired and Tested, 55/- 8 watt A.C./D.C. Complete Kit with Valves, £4/4. Wired and Tested, £5/5. 12 watt A.C. Complete Kit with Valves, £5/5. Wired and Tested, £7/7.

RECEIVERS, COMPONENTS AND ACCESSORIES Surplus, Clearance or Secondhand, etc.

V A UXHALL.—Polar Midget condensers, 2-gang, 0s. 8d.; 3-gang, 8s. 9d.; 4-gang, 13s. 6d. Polar full vision horizontal drives, 5s.

V A UXHALL. Hivac valves, entire range, full discounts. Polar station-named scales for horizontal drives, 1s.

V A UXHALL T.C.C. electrolytic condensers, 8 mfd. and 4 mfd. 500 volt, 2s. 6d.; 50 mfd. 50 volt, 1s. 6d.

V A UXHALL. Iron-cored coils, 3-gang, on base, with circuit, 17s. J.D. drives with station-named scale, 5s. 6d.

V A UXHALL. Magnavox and Rola P.M. speakers, 7in. cone, 10s. 6d.; 10in. cone, 22s. Energised models, 2,500 field coils, 7in., 12s. 6d.; 10in., 17s. 6d.

V A UXHALL UTILITIES, 163a, Strand, W.C.2. Temple Bar 9338. Send postcard for free list. Post paid, 2s. 6d. and over, or C.O.D.

A LL lines previously advertised still available.—Radio Clearance, 63, High Holborn, W.C.1. Telephone: Hol. 4631.

FERRANTI. A.F.5., A.F.4.C., P.P.O.P. 25-1, 10/- each. A.F.4, 5/-—Austin, 33, Fitzroy Road, Whitstable.

HEADPHONES.—Brown, Ericsson, G.E.C., B.T.H., Standard Telephones, Nesper, Western Electric, Sterling, etc., 2,000 ohms, 2s. 6d.; 4,000, 5s. Postage 6d. SPECIAL. Ericsson, 4,000 ohms, as new, 7s. 6d. Telefunken, lightweight, adjustable, 7s. 6d. CRYSTAL SETS. Burne-Jones, Complete, Guaranteed, 5s. 6d. Ditto double circuit, 8s. Sensitive permanent detectors, 1s. 6d. Crystal Detectors, complete, 1s. Crystals with silver cat's-whisker, 6d. Postage 1/6.—Post Radio, 2, Copenhagen Street, London, N.1.

"CAMN'S Corona" battery and all-mains versions, specified and competitive kits. Best value receivers, valves, etc. Pick-ups, 4/- H.M.V. Auto-Record Changers. Bankrupt surplus stocks, etc. Lists free.—"Ford Radio" Service, Queens Place, Rove.

O LIVERS offer. Rola G.12. Speakers, £2/19/0 transformer, push-pull, triode, pentode. 2,500 ohms and 1,250 ohms. P.M. Model, £3/12/6. Speaker Transformers, Brand New, Guaranteed. Power Pen; Push-pull, Class "B" and Q.P.P. 3/3 each. L.F. 3/0.

Centralab Volume Controls, with Switch, 2/-. Chassis Mounting Valve Holders, 5-pin 2/6d.; 7-pin 3/6d. Octal and Americans 6d. each. Aluminium chassis, 10" x 10" x 3", 18 gauge, undrilled, 5/3. Any size constructed to order, prices pro rata. Write for quotations.

We can supply a replacement for every valve, Longest Guarantees with highest discounts. American Valves, 3 months' guarantee, all types. Examples: 2A5, 5Y9, 6A7, 3/11; 6D6, 4/- Erie 1-watt colour coded resistances, all values, 3/6d. each, 3/- dozen, 2/6 dozen in 3-dozen lots. T.C.C., B.I., HUNT'S, Cardboard Case Electrolytics, 4mfd. 1/6, 8mfd. 1/9, 50mfd. 50v. 1/9, 25mfd. 25v. 1/-, 50mfd. 12v. 1/3, 8mfd. [plus 4mfd. 2/5, 8mfd. plus 8mfd. 2/9. Ollivers, 676, Christchurch Road, Boscombe, Hants. Orders under 5/6 postage extra; C.O.D. extra. Lists and enquiries free.

FREE ADVICE BUREAU COUPON This coupon is available until December 25th, 1937, and must be attached to all letters containing queries. PRACTICAL AND AMATEUR WIRELESS. 18/12/37.

ADVERTISEMENT INDEX Page Armstrong Manufacturing Co. 411 Automatic Coil Winder and Electrical Equipment Co., Ltd. 412 British Institute of Engineering Technology Cover iii British Mechanical Productions, Ltd. Cover iii Electradix Radios 411 Fluxite, Ltd. Cover iii International Correspondence Schools, Ltd. 411 London Radio Supply Co. 409 McCarthy Radio, Ltd. Cover iii Peto-Scott, Ltd. 409 Premier Supply Stores 416 Shaftesbury Supplies Cover iii Telegraph Condenser Co., Ltd. 410 Varley 415 Wills, W. D. and H.O. 407



## NO XMAS PARTY is complete without a HOME BROADCASTER MIKE

For the sixth year in succession we make a special seasonal offer in microphones. Bargains this year without precedent. Just connect to your set. Ideal for crooning and Christmas Games!

- (1) Fine carbon Mike with built-in Trans., 6/6.
- (2) Carbon suspended mike on 13in. crystaline black table stand, trans. in base, 12/6.
- (3) DOUBLE "3" Mike. New this year. Very superior instrument on new principle. Chr. Table stand and Trans., 16/6.

**BARGAIN OFFERS (unrepeatable)**

- 21/- Model Table Elec. Clock, 10/6.
- 30/- Model Wall Elec. Clock, 12/6.
- Christmas Tree light sets, 13 lamps, 1/9. 18 lamps 2/6.
- Chinese Lantern Set, 18 lamps, 5/6.
- Speaker O.P. trans. pent., 2/11.

Ex. - Government Hand telephones, complete, transmit and receive. Phenomenal Bargain, only 3/6 each.

Everything car. paid. C.O.D. or with order.  
London's Leading Mail Order Store.  
**SHAFTESBURY SUPPLIES,**  
224, Shaftesbury Avenue, London, W.C.2. Tembar 4175.

## POSITIVE CONTACT

The Clix range of contact components includes over 40 lines and one or more of them are incorporated in 90% of Home Constructed and Commercial receivers, etc. Bring your set up to 100% contact efficiency by replacing all faulty contacts components with **CLIX Perfect Contact Components.**

**CLIX for CONTACT**

Send for Free Folders "N."

**CONSISTENTLY SPECIFIED**

For apparatus described in "Practical Wireless"

**BRITISH MECHANICAL PRODUCTIONS LTD.,**

79a, ROCHESTER ROW, LONDON, S.W.1

## ENGINEERING OPPORTUNITIES

**Free!**

268 PAGES

This unique Handbook shows the easy way to secure **A.M.I.C.E., A.M.I.Mech.E., A.M.I.E.E., A.M.I.A.E., A.M.I.W.T., A.M.I.R.E.,** and similar qualifications. **WE GUARANTEE—NO PASS—NO FEE.** Details are given of over 150 Diploma Courses in all branches of Civil, Mech., Elec., Motor, Aero, Radio and Television Engineering, Building, Government Employment, etc. Write for this enlightening Handbook to-day FREE and post free.

British Institute of Engineering Technology, 409, Shakespeare House, 17, 18, 19, Stratford Pl., W.1

When writing to Advertisers please mention "Practical and Amateur Wireless"



Said Holmes, "Though I'm long past my prime,  
I've learnt about FLUXITE in time.  
Now I know all along This wiring's been wrong—  
So I'm now reconstructing my crime."

See that FLUXITE is always by you—in the house—garage—workshop—wherever speedy soldering is needed. Used for 30 years in government works and by leading engineers and manufacturers. Of Ironmongers—in tins, 4d., 8d., 1/4 and 2/8.

Ask to see the FLUXITE SMALL-SPACE SOLDERING SET—compact but substantial—complete with full instructions, 7/6. Write for Free Book on the art of "soft" soldering and ask for Leaflet on CASE-HARDENING STEEL and TEMPERING TOOLS with FLUXITE.

**TO CYCLISTS!** Your wheels will NOT keep round and true, unless the spokes are tied with the fine wire at the crossings AND SOLDERED. This makes a much stronger wheel. It's simple—with FLUXITE—but IMPORTANT.

## THE FLUXITE GUN

is always ready to put Fluxite on the soldering job instantly. A little pressure places the right quantity on the right spot and one charging lasts for ages. Price 1/6.



ALL MECHANICS WILL HAVE

## FLUXITE

IT SIMPLIFIES ALL SOLDERING

FLUXITE LTD. (Dept. W.P.) DRAGON WORKS, BERMONDSEY STREET, S.E.1.

## RECEIVERS, COMPONENTS AND ACCESSORIES

Surplus, Clearance or Secondhand, etc.

21 5010 Metre Transceivers, Complete, Special low price. Write for Lists and Prices.  
£17/10/0, Brand New Haynes Quality Receivers, List £36/10/0.  
£11/0/0, 8 valves, all-wave, 4 bands, 12/2000 Metres, 8 watts output, A.C.  
£8/10/0, 7 valves, all-wave console, 3 bands.  
£6/15/0, 6 valves, all-wave Super, A.C./D.C., 3 bands.  
£5/5/0, 7 valves, all-wave, A.C.  
£3, A.C./D.C. Midget, MC. Speaker. Write for Special Book Offer.  
Radiographic, Ltd., 66, Osborne Street, Glasgow, C.1.

## LOUDSPEAKER REPAIRS

LOUDSPEAKER repairs, British, American, any make, 24-hour service; moderate prices.—Sinclair Speakers, Alma Grove, Copenhagen Street, London, N.1.

REPAIRS to Moving Coil Speakers, Cones and Coils, fitted or rewound. Fields altered. Prices Quoted including Eliminators. Loudspeakers, Repaired, 4/-. L.F. and Speech Transformers, 4/- post free. Trade invited. Guaranteed. Satisfaction. Prompt Service, Estimates Free.—E.S. Repair Service, 5, Ballham Grove, London, S.W.12. Battersea 1321.

## MISCELLANEOUS

OUR 1937-8 Catalogue contains much information on Transformer Design. Post Free.—Lumen Electric Coy., 1A, Scarisbrick Avenue, Liverpool, 21.

## TUITION

MAKE YOUR HOBBY your career or increase its interest tenfold. Britain's Best College, approved by the Inst. Rad. Eng. and leading Radio firms, provides complete training in Radio Engineering by post or day classes. Full details from: "P.R.W.", LONDON RADIO COLLEGE, Grove Park Rd., London, W.4 (Chiswick 3244).



## MCCARTHY

### High Efficiency plus Economy! 5-VALVE ALL-WAVE SUPERHET

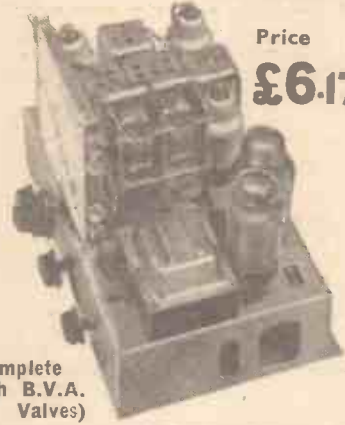

Price  
**£6.17.6**

(Complete with B.V.A. Valves)

This moderately-priced 7-stage 5-valve all-wave receiver utilises a remarkably efficient superheterodyne circuit which provides exceptional sensitivity on all three wavebands—18-50, 200-500, 1,000-2,000 metres.

Circuit includes: Latest type triode-hexode frequency changer—vari-mu pentode I.F. amplifier, double diode-triode operating as diode detector and I.F. amplifier, and providing full A.V.C. High-slope 3 watts output pentode. Wave-change and gram. switch. As illustrated, but with new type dial with principal station names.

### 6-valve all-wave Superhet with Radio Frequency Stage

8 Stages  
8 tuned circuits  
3 wavebands



Price  
(Complete with B.V.A. Valves) **£8.17.6**

Performance (made possible by use of multi-electrode valves) equal to that of many receivers employing 8 valves or more. Brief specification includes: Large "Airplane" dial, with different coloured lights automatically switched on for each wave-range. Micro-vernier 2-speed drive. 4-point wave-change and gramophone switch. Volume control and variable tone control also operative on gramophone. Reinforced heavy-gauge steel chassis. Covers 19-2,000 metres.

Circuit comprises: Presetselector circuit, radio frequency amplifier (operative on all 3 wavebands), triode-hexode frequency changer, double band-pass I.F.T. coupled I.F. amplifier, double diode-triode detector and L.F. amplifier. D.A.V.C. applied to 3 preceding valves. 3-watt pentode output.

All McCarthy receivers supplied complete with valves, knobs, pilot lamps, leads, mains cable and plug. 12 months' guarantee.

Deferred terms on application or through our city agents, London Radio Supply Co., 11, Oat Lane, E.C.2. Demonstrations Daily.

Cash with order on 7 days' approval. Complete illustrated catalogue, with technical data and circuit diagrams, on receipt of 3d. in stamps, or abridged list of McCarthy chassis types free of charge.

## MCCARTHY RADIO LTD.

44a, Westbourne Grove, London, W.2.

Telephone: Bayswater 3201/2.



# PRESENTS FOR BOYS

## SPEED!

3/6 net (4/- post free)

Edited by CAPT. EYSTON (*The Fastest Man on Earth!*). A lavishly produced new volume with hundreds of dramatic photographs. Captain Eyston has collected fascinating articles on man's quest for speed from simple athletics to thousand-horse-power flying machines.



## MODEL AIRCRAFT BOOK 3/6 net (4/- post free)

By F. J. CAMM. The author of *Power-Driven Model Aircraft* and Editor of *Practical Mechanics* has here produced an expert's book for boys containing descriptions for constructing the very latest model planes, with hundreds of helpful diagrams.



## MARVELS OF THE AIR 3/6 net (4/- post free)

Edited by T. STANHOPE SPRIGG. Another de luxe volume; lavishly illustrated, compiled by the Editor of *Air Stories*. Informative and stimulating articles for the air-minded youngster.

## HOBBIES NEW ANNUAL 3/6 net (post free 4/-)

By F. J. CAMM. Each year Mr. Camm becomes more ingenious and interesting in his choice of models to make. Here the modern boy will find scores of fascinating articles, with hundreds of diagrams and sketches, enabling him to make experiments in present-day engineering with the simplest of materials.

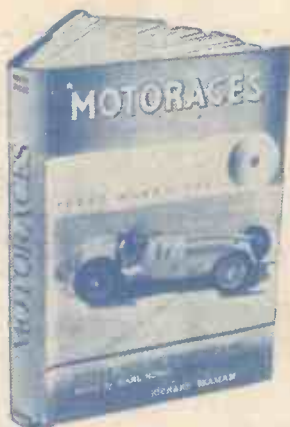
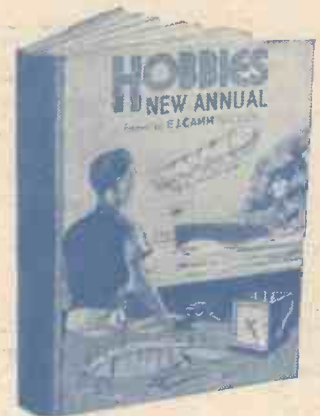

## MOTORACES

By GEORGE MONKHOUSE.

"It contains the finest and in some ways the most representative collection of photographs which has ever been got together in order to illustrate motor road-racing as it exists to-day," says Earl Howe.

"The photography is simply marvellous, and I congratulate you on having produced a most original and excellent work."—Sir Malcolm Campbell in a letter to the author.

"Nothing better or even approaching this has ever been done."—*Motor*.

7/6 net (8/- post free)

## GEORGE NEWNES LIMITED

Tower House, Southampton Street, Strand, London, W.C.2



**NEW VALVES FOR XMAS** — See page 421.

# Practical and Amateur Wireless

**3<sup>D</sup>**  
EVERY  
WEDNESDAY

Edited by F. J. CAMM

a GEORGE  
NEWNES  
Publication

Vol. 11. No. 275.  
December 25th, 1937.

**AND PRACTICAL TELEVISION**

*Making*  
**D**ISTANT  
*Reception*  
**X**TRA  
*Efficient*

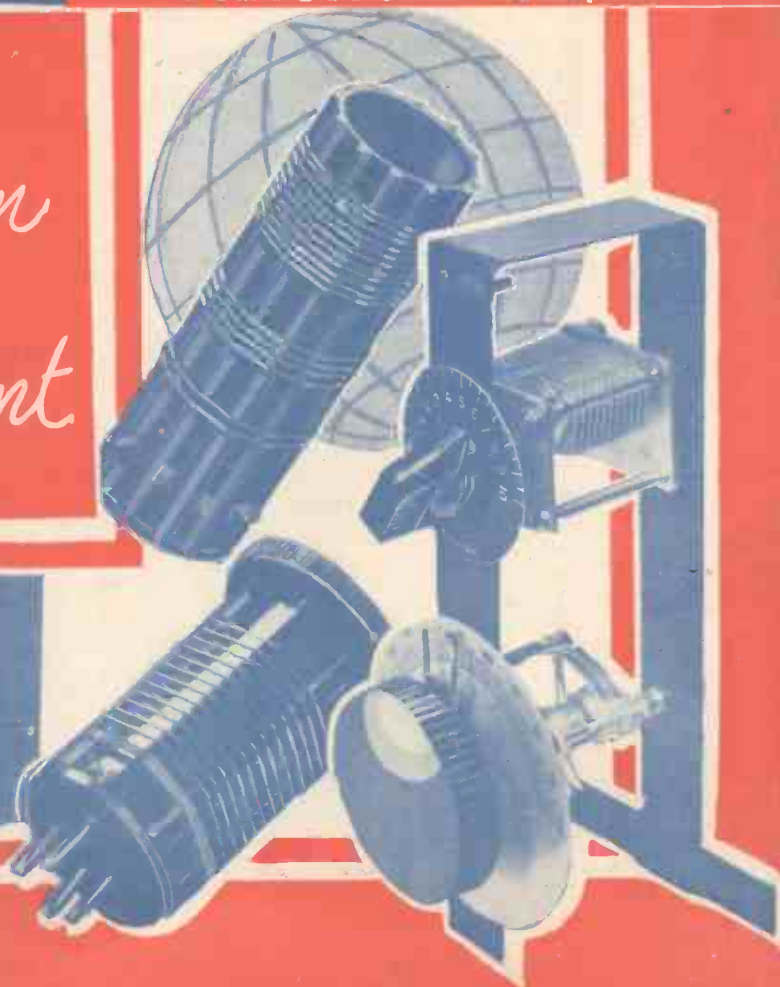

**JUST OUT!**

**WIRELESS COILS, CHOKES AND TRANSFORMERS: AND HOW TO MAKE THEM.**

By F. J. CAMM.

An important new Handbook for every home constructor and anyone interested in radio. With Special Chapters on Selectivity, Break-through, Coil Winders, Coil Troubles and their Remedies. 180 pages, cloth bound, with 126 easy-to-follow illustrations.

2/6 By post 2/10.

GEORGE NEWNES, LTD., Tower House, Southampton Street, Strand, LONDON, W.C.2.



# A Feast of Xmas Fun!



Here are the Biggest and Best Christmas Magazines you can buy—packed with Tip-Top Christmas Reading, Stories and articles by famous Writers and Popular Humorists. Laughable Drawings and Cartoons by Leading Artists on practically every page.

+ + +  
Capture the Spirit of Christmas with these Special Christmas Numbers.

+ + +  
TIT-BITS CHRISTMAS EXTRA 6d.  
HAPPY MAGAZINE CHRISTMAS NUMBER 7d.  
HUMORIST CHRISTMAS NUMBER 6d.  
CHRISTMAS HOLIDAY COMIC 2d.

Of all Newsagents and Bookstalls.

You mustn't forget the children! Here's their CHRISTMAS COMIC, packed with good things!





# The Second-Detector Unit See Page 429

## Practical and Amateur Wireless

### Round

#### Long-Distance Listening

THERE are thrills in plenty to be obtained in short-wave listening, and the feeling of satisfaction which one obtains when an American station is logged on a one-valve set with an indoor aerial must be experienced to be believed. But such reception is in the nature of a freak, and will only be experienced when conditions are just right. With two valves it is possible, with judicious handling of the controls, to log some really long-distance low-powered transmitters, but the keen experimenter will require something more certain than this. When a notice appears that a certain transmission is to take place from a station at the other side of the world it is very useful to be able to sit down at your receiver and tune to the required point and at the appointed hour pick up that transmission. But this can only be done when the receiver has been soundly built and is handled properly. What are the various features which go to make a set as reliable as this? Efficient wiring, reliable tuning, efficient aerial and earth system, and calibrated scales are a few, and on page 419 this week we give some further details which will assist you in obtaining results of this type. But remember that long-distance reception is governed by the peculiarities of the atmosphere, and the weather conditions, as well as the position of the sun, planets and other stellar bodies, all have their effects—many of which are not yet fully understood. But with a reliable receiver it is a simple matter to know whether conditions are right and thus you will not waste time trying to pick up stations which are inaudible.

#### Television Demonstrations

TO add to the list of firms who are demonstrating television, London Associated Electricity Undertakings, at 254, Earl's Court Road, S.W.5, are now fitting out a special showroom for the purpose of introducing to the public the B.B.C. vision programmes. This undertaking controls a number of West End supply companies.

#### Scotland B.B.C. Protest

A JOINT protest has been initiated by the Dundee retailers and public against the reception conditions of the Scottish National programmes in Dundee, Angus and Fife. After many complaints by listeners, it has been found that the receivers are not to blame, and this protest is accordingly being forwarded to the B.B.C.

Edited by

F. J. CAMM

Technical Staff:

W. J. Delaney, H. J. Barton Chapple, Wh.Sch.,  
B.Sc., A.M.I.E.E., Frank Preston,

Vol. XI. No. 275. December 25th, 1937.

### Wireless

## the World of

#### Amateur Call Signs

AN interesting feature is to be noted in the call signs allotted to amateurs in Tanganyika. Here each call sign is an abbreviation of the station owner's name.

#### Statistics

FOR those amateurs who are interested in collecting statistics, the following will, no doubt, be of value. The wavelength

### GIVE BOOKS THIS CHRISTMAS!

The following Standard Works make ideal Christmas presents. They are all suitable for beginner and expert, lavishly illustrated, well bound, and written by F. J. Camm.

**WIRELESS CONSTRUCTOR'S ENCYCLOPEDIA.** 4th Edition, 392 pages, 490 illustrations, 5/-, or by post 5/6.

**EVERYMAN'S WIRELESS BOOK.** 2nd Edition, 288 pages, 243 illustrations, 3/6, or by post 3/10.

**TELEVISION AND SHORT-WAVE HANDBOOK.** 2nd Edition, 288 pages, 230 illustrations, 3/6, or by post 3/10.

**HOME MECHANIC ENCYCLOPEDIA.** 2nd Edition, 392 pages, 627 illustrations, 3/6, or by post 3/10.

**WIRELESS COILS, CHOKES & TRANSFORMERS,** and How to Make Them, 180 pages, 126 illustrations, 2/6, or by post 2/10.

of the shortest known cosmic ray is 600 trillion times shorter than the longest assigned radio wavelength.

#### Non-vocal Dance Programmes

THE B.B.C. Director of Variety, Mr. John Watt, believes that there is a real demand for non-vocal dance programmes, and accordingly is continuing them in the New Year. All late night programmes will come from an outside broadcast point and not from the studios.

#### "The Fortnight's Films"

AS a result of the listeners' Cinema Talks Panel, it has been arranged that F. Andrew Rice will speak for twenty minutes on alternate Sundays from January 9th to March 20th on the above subject. According to the communications from the listeners' panel about half a dozen films likely to be seen in the immediate future was thought to be the right number for discussion, and the type of film and some outline of the plot should be given.

#### Afternoon Variety

IT has been decided in the New Year to give many more afternoon variety programmes—in which gramophone programmes, carefully compiled will be used to augment the variety and give more "life" to the programmes in general.

#### Cinderella

ON December 28th the Welsh Regional is repeating a pantomime from the studio which was first presented a year ago. This was so well received that it has been decided to re-broadcast it in the children's hour and also in the evening programme on December 30th. The programme will include the B.B.C. Welsh Orchestra, led by Frank Thomas and conducted by Idris Lewis.

#### Christmas Variety

LESLIE'S PAVILION, at Rusholme, will have the privilege unique, at any rate in Manchester, of being the only theatre running a variety show—all the other theatres staging pantomime. The North Regional station is planning to broadcast an excerpt from the programme on December 30th, and it is stated that this particular event is original and absolutely new, and may be described as a "Super" Concert Party.

#### Doubting Thomas at the Pantomime: December 27th

DID the Sleeping Beauty make a perfect wife? Did Dick Whittington's cat, surfeited with cream in the household of the Lord Mayor of London, ever sigh for the old adventurous days? What of Ali Baba, Jack and Jill, Little Red Riding Hood, and the rest—did they live happily ever after, or had the Demon King the last laugh? These awkward questions will be answered in "Per-adventures in Panto-Land," a series of sequels to some of the famous stories, to be heard on December 27th.



# ROUND the WORLD of WIRELESS (Continued)

## The King's Christmas Broadcast

**H**IS Majesty the King will broadcast a message to the Empire during the afternoon of Christmas Day. He will broadcast from Sandringham House, where he will be with the Queen and other members of the Royal Family. It will be remembered that the King's father, the late King George the Fifth, broadcast several Christmas Day messages to the Empire and the world from Sandringham House.

## Christmas Carols

**O**N Christmas Eve Midland listeners will hear a programme of carols sung by the Choir of Peterborough Cathedral. The choir consists of sixteen boys and twelve men, and Dr. Henry Coleman, the Cathedral organist, is the choir-master.

## Pantomime Broadcast

**"PANTOMIME PREVIEW,"** which will be broadcast in the Western programme on December 23rd, will allow listeners to take a peep behind the scenes of some West Country pantomimes during the final rehearsals. Visits will be paid to "Cinderella" at both the Prince's Theatre, Bristol, and the Pavilion, Bournemouth, and to "Aladdin" at the Palace Theatre, Plymouth.

## German Wireless Licences

**A**CCORDING to a recent statement by the German Post Office authorities, there were 8,595,121 licensed listeners in the country on November 1st. A push is being made to reach the nine-million mark by January 1st, 1938.

## Radio Aids Farm Workers

**A**CCORDING to a recent report from Kansas, U.S.A., the tractors used on some of the farms are being equipped with receiving sets. We can imagine the farm hands out West ploughing the lonely furrows to the soothing strains of "The Long, Long Trail," and similar melodies.

## Opera from Vienna

**L**ISTENERS who are followers of international opera will welcome the news that they will be able to hear Act 4 of Bizet's "Carmen," sung by the Viennese State Opera Company, from the State Opera House, Vienna, on December 27th. This broadcast will be given in the Regional programme.

## West of England Variety

**T**HE artists in a variety programme from the Colston Hall, Bristol, on December 29th, will include Stanford and McNaughton, "The Wise Jesters"; Stan and Jan, "The Two Devonshire Rustics," and Henry Hall and his Orchestra.

## Radio for Police Patrolmen

**F**OLLOWING a number of experiments the police authorities of the District of Columbia have decided to equip the

## INTERESTING and TOPICAL NEWS and NOTES

entire patrol of fifty motor-cycles attached to the Metropolitan Police Force with



*His Majesty the King at the microphone when he broadcast his historic message from Buckingham Palace on Coronation Day.*

radio receivers. The equipment will consist of a superhet receiver and power-supply unit—operated from the motor-cycle accumulator. The two units are rubber mounted in waterproof steel boxes carried astride the rear wheel of the cycle. The loudspeaker is fitted upon the handlebars of the machine and is arranged so that the sound is projected towards the rider.

## An Electro-camera for Photographing Sound

**A**FTER several months of research work Mr. Don Winget and Mr. Arthur Young, of the Crossley Radio Corporation, U.S.A., have succeeded in producing an electric camera by means of which the sound of gunfire can be photographed, thus enabling a "natural" gunshot to be reproduced over the air with the reverberation sounds unimpaired. It is stated that the new camera operates on a voltage of 11,000.

## Old-time Dancing

**B**ILLY MERRIN and his Commanders will be heard by Midland listeners on December 30th in a programme which will recall old-time dancing.

## Boxing Day Sport

**I**CE hockey features in the broadcast programmes twice on Boxing Day. In the afternoon listeners will hear Stewart MacPherson describing the last period of the National League Ice Hockey match between the Rangers and Racers at the Empress Hall, Earl's Court.

The Greyhounds and Tigers, meanwhile, will be in action in the evening at Harringay arena. Stewart MacPherson will journey there to give listeners a description of the last period of this National League match.

## Leslie Howard as Hamlet

**W**E are informed that Leslie Howard, who recently made a successful debut in radio-drama as Peter Standish in "Berkeley Square," will be heard on January 2nd as Hamlet, in a broadcast version of the play. Mr. Howard portrayed this character with great success in New York, but he has not as yet attempted the role in this country. The broadcast version, which will be the fourth in the "Worth Theatre" series, will be prepared by Barbara Burnham, who will also be the producer. It is hoped, if their engagements permit, to secure the services of Hermione Hannen as Ophelia and A. Bromley Davenport as Polonius.

## Variety from Aston

**T**HEATRE variety on December 23rd will come from the Hippodrome Theatre, Aston. Artists in the bill there during the week include Linga Singh, Tom Hughes, Joe King, and Samme Dunne and his Urchins.

## SOLVE THIS!

### PROBLEM No. 275.

Hoskins had a three-valve set of the S.G. Detector and L.F. type. As the receiver had been in use for some time he thought results might be improved by renewing the valves, and accordingly started by getting a new H.F. valve. When he selected this he was careful to obtain one with practically the same characteristics, but when inserted in the receiver he failed to obtain any signals. He returned it to his dealer, who tested it and pronounced it O.K. It still failed to work in Hoskins's receiver. Why was this? Three books will be awarded for the first three correct solutions opened. Address your envelopes to The Editor, PRACTICAL AND AMATEUR WIRELESS, Geo. Newnes, Ltd., Tower House, Southampton Street, Strand, London, W.C.2. Envelopes should be marked Problem No. 275 in the top left-hand corner and should be posted to reach this office not later than the first post on Tuesday, December 28th, 1937.

### Solution to Problem No. 274.

Jackson's receiver was unstable, and when the circuits were brought into tune oscillation occurred. By setting the trimmers so that the set was stabilised the circuits were not correctly balanced and thus stations were only heard at odd points where the signals were loud enough to be heard, in spite of the fact that the tuning was not exact.

Only one reader successfully solved problem and a book is accordingly being forwarded to N. Wilkinson, Holly Well Cottage, Faddiley, Nantwich, Cheshire.



# Making Long-distance Listening Extra Efficient

Suggestions for Improving Existing Receivers, and for Designing New Ones so that the Maximum Results May be Obtained from Long-distance Stations.  
By W. J. DELANEY.

**A**LTHOUGH it is possible to receive very long distance signals on a simple, roughly-built one-valver, there is a considerable difference between the results which are thereby obtained and those which may be expected from a receiver which has been built solely for long-distance reception. There are two main requirements for reliable reception of this type. The haphazard picking-up of a station from the other side of the world when conditions are favourable, and the tuning-in of a pre-

important part in building up the strength of a weak station, and, therefore, this control should be provided with a calibrated dial of some type or another so that pre-arranged settings may be duplicated. Similarly, the tuning control should be of the type having a substantial gear reduction so that very small adjustments may be made with ease. If the receiver is used on the short waves (upon which most of the really long-distance reception will take place) then the circuit should be fitted with a band-spread condenser. The well-known Eddystone component will be found invaluable for really good work as the tank or band-setting condenser is provided with a good calibrated dial, and the band-spreader is also driven through a good reduction drive. The band-setter is of the type having ten separate settings and with the pointer and numbered dial provided it is a simple matter to set this at any given point. As the band-spreader has a moving cursor it will be obvious that very accurate repetitions of tuning points may instantly be found, and if the reaction condenser also has a good type of dial it should be found very simple indeed to obtain a station after it has once been located.

## Wavemeters

Obviously, when a receiver is first put into use a lot of searching will have to be carried out unless the receiver can be calibrated in wavelengths in metres or frequencies in kilocycles or megacycles. If, therefore, you wish to avoid much waste of time in searching the first requirement is a good wavemeter. This may be purchased or made up, but in the latter case it will have to be calibrated unless you are prepared to tune in known stations and draw up your own calibration curves. This will take as long as it would to calibrate the dials direct from stations, and, therefore, it should be calibrated by a good radio dealer who is provided with suitable instruments. It will then be a simple matter to set your tuning controls to any given wavelength in order to locate a station, and a systematic logging search may then take place. The various notes given in these pages each week, especially in the Short-wave Log, will enable you to see what new stations are on the air and at what times, and you will thus be able to set your controls to the correct point in advance, and if the station is not heard after it has been on the air for some minutes you will know that



Fig. 1.—This is the band-spread combination supplied by the Eddystone people.

selected programme from that same station at a given hour are vastly different, and although some phenomenal logs are often submitted by amateurs with small receivers it would be found in the majority of cases that they could not pick up again one of those stations when asked—unless it was obtained after a lot of tricky adjustments and patient searching. If, therefore, you are anxious to obtain worth-while results in this direction you must attend rigidly to two things—reliability of tuning and high efficiency of receiver and aerial system. The former term will govern not only the choice of the tuning components, but the method of arranging and using them, whilst the latter term will apply to the initial work which is put into the installation.

## The Tuning Circuits

In order to be able to locate a known station accurately when desired, it is imperative that the tuned circuits shall be calibrated, and that a really reliable tuner shall be employed. Reaction will no doubt play an

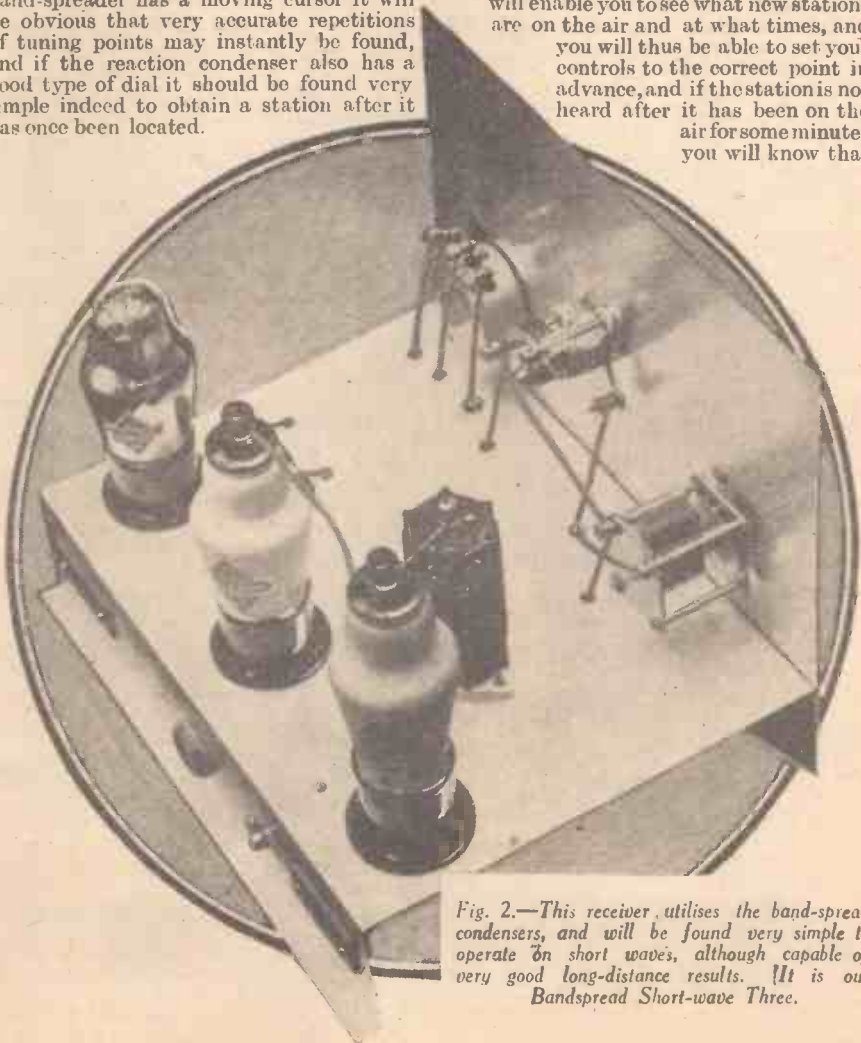

Fig. 2.—This receiver utilises the band-spread condensers, and will be found very simple to operate on short waves, although capable of very good long-distance results. [It is our Bandsread Short-wave Three.

## MAKING LONG-DISTANCE LISTENING EXTRA EFFICIENT

(Continued from previous page)

it is either out of range of your receiver or that conditions are not favourable. It will be seen that without the wavemeter many minutes, or even half an hour or so, may be wasted in an endeavour to pick up the station.

### Aerial Systems

When a receiver has been designed as above described and it has been found that certain stations are not easily received, then it is time to turn to the aerial system and to endeavour to improve things there. It may, for instance, be noticed that stations in a certain direction are more easily received than those in another direction, or that some continent is not heard at all. The obvious solution in such a case is that the aerial is screened or is erected so that it is very directional. If a horizontal wire is employed it may, therefore, be worth while trying a different direction for it to bring in stations in the direction which is not so efficient. Alternatively, a vertical aerial may be erected so that the directional effects are avoided, and more or less regular reception obtained from all directions. Similarly, it may be found that certain wavebands are more or less dead which again may be due to the particular charac-

teristics of the aerial system. In such a case, or where a particular waveband is required for consistent reception, it should not be forgotten that a dipole aerial will give maximum results on a wavelength equal to twice the overall length of the aerial.

Obviously, where long-distance reception is required it is imperative to pay the closest attention to losses as the energy picked up is bound to be very small. The aerial should therefore be provided with good insulators, and a chain of such accessories should be arranged at each end of the aerial. By using the modern "glass" or "trollite" insulators one is assured of a clean surface which will not attract soot and dirt, and thus provide a leakage path. Similarly, the earth connection should be of as low a resistance as possible. This means that a really substantial earth plate should be buried, or one of the modern chemical earths employed. The lead to this buried earth should be of heavy gauge covered wire, and care should be taken to prevent it from coming into touch with any earthed body until it actually meets the buried earth plate or chemical. It is a mistake to assume that as the aerial coil may be of fine wire the earth wire may also be fine. Remember that the point to aim at is low resistance, and if a water pipe is employed for earthing purposes, make certain that it is a main water pipe and not

one which comes from a tank situated in the roof. Furthermore, if you can obtain access to any joints which occur in the pipe before it enters the ground, bridge such joints with bare copper wire to overcome any risk of loss due to paint in the joint—unless, of course, a wiped joint is employed.

### Good Contacts

Finally, remember that all contacts in the receiver must be clean and effective as otherwise background noises may be introduced which will drown a very weak signal. Keep all moving contacts well cleaned and free from dust, and make a periodic inspection of the receiver, valves, etc., to ensure that no troubles can arise from this source. If a battery receiver is in use, keep the battery leads clean and the wander plugs opened so that they fit tightly into the H.T. battery sockets, and the L.T. spades greased to prevent corrosion due to acid spray or fumes. As the batteries are at earth potential, do not place them close to the aerial side of the receiver, but keep them on the loudspeaker side, and, if possible, on the floor or well below the receiver provided that the accumulator fumes cannot come into contact with any copper or other soft metal in the receiver.

# WHAT IS A TETRODE?

The Characteristics of this Useful Addition to the Range of Modern Valves are Briefly Explained in this Article by PERCY RAY.

THE tetrode is undoubtedly a useful contribution to the range of valve types available, but it is, after all, a modified pentode, and it is doubtful if its advantages and limitations are really understood by the average constructor; furthermore there is a surprising amount of confusion over the word "tetrode" in the minds of those people who follow the science in a casual way.

The word "tetrode" unquestionably means four electrodes, and therefore must include the screen-grid H.F. valve, the four-electrode intermediate L.F. amplifier (a type more or less unknown in this country), the bi-grid valve used some ten years ago as a mixer in super-heterodynes, the space charge valve—which was a triode with an extra grid positively charged to enable it to work on an H.T. voltage of 10 volts or so—and the modern output valve. Although the derivation of the word "tetrode" must include the types mentioned above, in practice it is intended to convey two types only—the ordinary screen-grid H.F. amplifier, and the modern output tetrode. It is curious that a valve should date back so far, fall into disuse, and then reappear for a purpose so utterly different from that which it originally served.

### The Screen-Grid Valve

The H.F. tetrode, or as it is colloquially called, the screen-grid valve, was introduced because of the shortcomings of the triode, and when news of its existence became generally known, it was thought to be a valve that would cure all existing ills. Its greatest snag, however, was the nasty dip in its characteristic curve (as seen in the accompanying illustra-

tion) which made it impossible for the valve to handle any considerable H.F. swing, and in the fullness of time, therefore, the additional grid was introduced between the screening-grid and the anode, which effectively prevented secondary emissions

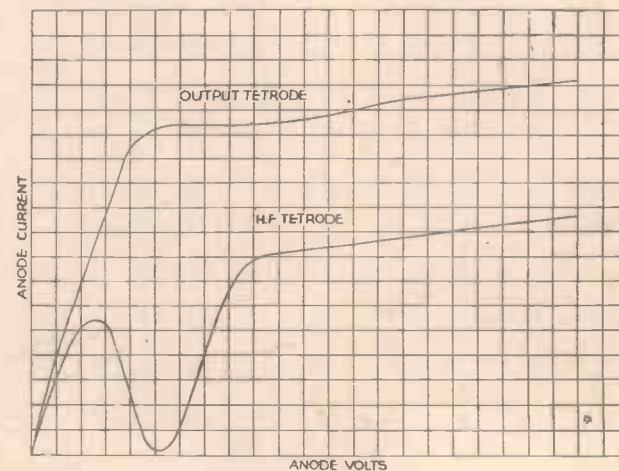

The characteristic curve of an H.F. tetrode, compared with that of an output tetrode.

from the anode from passing to the screen, the cause of the dip in its characteristic curve, and the H.F. pentode came into existence. The tetrode then passed into disuse.

Comparatively recently an effort was made to get rid of the extra grid in the output pentode, as the presence of this grid brought about two undesirable features. Firstly, the close proximity of the extra grid to the anode resulted in relatively high anode to cathode capacity, which tends to

clip very high notes, and secondly the somewhat high impedance of the valve, which tended to produce a certain amount of base resonance. The removal of this additional grid would, therefore, produce a valve with certain desirable characteristics, but it was known that an output tetrode as a pentode would be, without the third grid, at the disadvantage of non-linearity referred to earlier in this article. It was found, however, that by suitably designing the tetrode, and providing the anode with projections, and placing the latter at a safe distance from the other electrodes, a tetrode

of sensibly linear characteristics could be produced, as shown graphically by the lower curve in the accompanying illustration. The large spacing between the anode and nearest electrode is important, resulting in lower capacity between anode and all other electrodes, as already described.

### Third Harmonic Distortion

Tetrodes may be considered as similar to equivalent pentodes, inasmuch as their order of sensitivity is the same, and anode load similar, and the H.T. consumption and grid-bias in many cases identical. These facts make tetrodes and pentodes interchangeable, and permit of direct comparison by the experimenter. Like the pentode, the tetrode is troubled more with third harmonic than second harmonic distortion, and when used with the correct anode load the second harmonic distortion is sensibly absent in some types now available, whereas neither has any great advantage over the other from the point of view of third harmonic distortion, although the tetrode is more tolerant towards an incorrect load than the average pentode.



# NEW VALVES FOR XMAS

THE title on this page might sound rather like an advertising slogan.

It is not. On the contrary, it is intended as a reminder to you that your set might not give of its best during the festive season if some of the valves are suffering from "senile decay" or other pernicious disease. Consequently, if you want to buy a Christmas present for yourself or your best friend, you might find that valves are very appropriate.

Most people, when they build a set, buy the required kit of valves and continue to use them until one is accidentally dropped. That is the evil of the longevity of present-day valves; they are, unfortunately, in the same class as "old soldiers." The filaments and heaters rarely burn out,

If There is Any Doubt About the Efficiency of the Valves in Your Set, it will be Worth While to Test Them Now so that Any Defective Ones can be Replaced Before Christmas

By FRANK PRESTON

be found that there is a pronounced increase in volume as the bias voltage is cut down.

In a similar manner, a detector valve that is "going off" might be shown by the fact that the reaction condenser has to be turned to a much higher setting than before in order to produce oscillation. A faulty H.F. valve will generally give little indication of its weakness except, perhaps, by the greater difficulty experienced in bringing in the more distant stations.

### Anode Current Measurements

The most reliable method of home-testing valves is by measuring the anode current passed when certain H.T. and G.B. voltages are applied. You can make the test in the receiver by using a split-anode adapter, as shown in Fig. 1. To ensure that the anode voltage is the same as the applied H.T. voltage, it is best to short-circuit the anode circuit components, as shown by a broken line in the inset circuit of Fig. 1.

If the valve being tested is an L.F. amplifier, carefully adjust the G.B. voltage to a known figure.

You can then compare the current indicated by the milliammeter with that shown as average on the makers' instruction sheet or characteristic curve. Should the current be more than, say, 30 per cent. less than the average figure, it can be taken as fairly certain that the valve is in need of replacement. In cases where the current is only slightly lower than average it might be desirable at least to try the effect of a replacement.

### Old and New Types

When the valves are of a fairly old type a good deal of care must be exercised when choosing replacements. In many cases manufacturers issue lists which show the modern equivalents of out-of-date patterns. If not, their Service Departments are always ready to supply the information. Alternatively, the Advice Bureau of PRACTICAL AND AMATEUR WIRELESS is at your service. In replacing four-pin H.F. pentodes it will be worth while to use seven-pin types, fitting a new valveholder at the same time. This is because seven-pin valves are being standardised and often give better service.

In the same way, you might think it better to replace a triode detector by an H.F. pentode, which will probably give better results, particularly if resistance-coupling is used, the anode resistor being of not less than 50,000 ohms. The modified connections are shown in Fig. 2, from which it will be seen that the alteration is not of a difficult nature. Fig. 2 also gives the valveholder connections for a seven-pin pentode of the kind advised for H.F.-stage replacement.

When you come to the L.F. stage, remember that the modern tetrodes are generally more efficient than the previous pentodes. They provide at least as much amplification, with less distortion, and can be fitted without any change of connections, assuming that the pentode was of the five-pin-base type. In replacing a pentode with side-terminal contact, a five-pin holder is needed, the centre socket receiving the H.T. + connection previously taken to the side terminal. Be particularly careful that the G.B. voltage is correctly adjusted for the new valve before the valve is inserted in its holder; the correct voltage might be quite different from that used before, probably lower.

### The Dealer's Test Meter

Those who do not possess a milliammeter and who wish to have the valves tested accurately should take them along to a reputable dealer who is equipped with an up-to-date valve tester. Do not accept any tests that are not clearly demonstrated and explained, and do not accept a test made by putting your valve into another set. All good-class service men now have a tester which shows clearly either the anode current for a known H.T. voltage and G.B. voltage, or which measures mutual conductance. Most of those which measure mutual conductance are

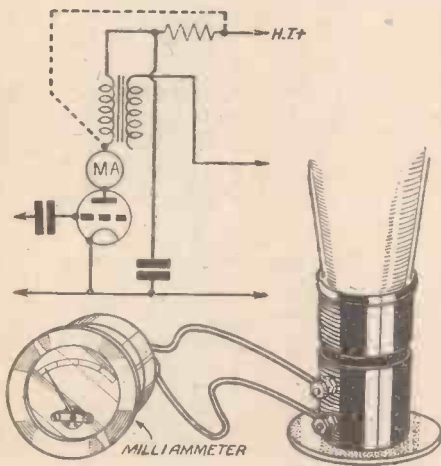

Fig. 1.—Using a split-anode adapter for testing the anode current of a valve.

but they do lose their emission however carefully they are used. That is why periodic testing is always recommended. I have often heard people boast about having the valves in use that were bought six years ago; they ought not to boast, but be summoned for causing cruelty to a radio receiver.

### Replacement Tests

One of the difficulties about valves is that it is not always an easy matter to make a reliable test with simple equipment. It is all very well for well-equipped experimenters to measure mutual conductance, but the average reader simply could not do it. The simplest procedure for him is to ask the local dealer to demonstrate the difference in performance when a new set of valves is fitted. But don't allow him to take out the old valves and put in new; have each valve changed in turn. There might be only one that is "below par." The output valve is generally the first to lose efficiency, since it has the highest anode-current consumption.

With a battery set, a defective output valve can often be recognised without actual test, by the fact that distortion can be avoided only when the grid-bias voltage is lower than that advised on the instruction sheet. This indication is a true one only when it is known that the H.T. voltage is correct. Even if distortion is not noticed, it might

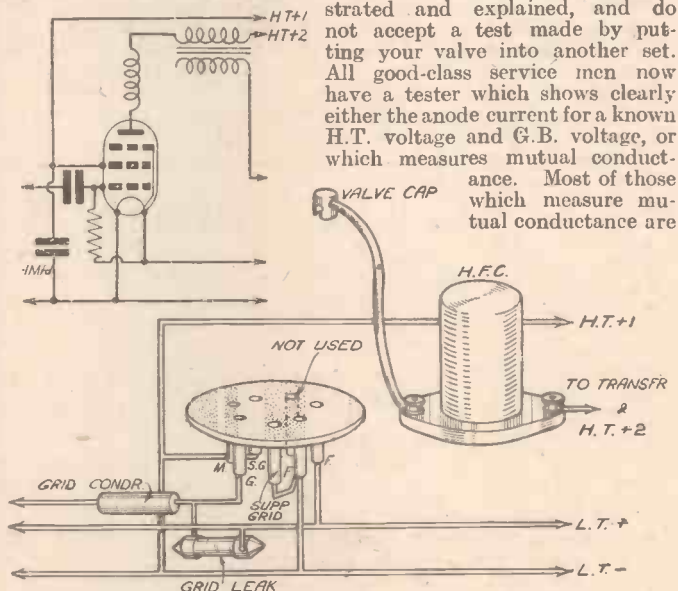

Fig. 2.—Theoretical and pictorial diagrams showing the modified valveholder connections for a seven-pin pentode.

fitted with a scale that reads: good, bad or poor, or words of similar meaning. If the dealer is not known to you as thoroughly reliable, insist on a replacement valve being inserted into the tester immediately after your own, and without any adjustments being made.

This is not intended as a reflection on service engineers as a whole—but there are a few whose business methods are open to criticism, and it is therefore just as well to take precautions.

# THAT MAINS LEAD

A GREAT deal has been written from time to time about refrigerators and vacuum cleaners in connection with the screening of down leads, and various other matters relative to the cause and cure of interference. Noisy mains are frequently discussed, but the few feet of flex that connects the receiver with the wall plug is invariably overlooked. This may be due to the inherent secretive nature of such pieces of flex, which usually reside in a tangled heap between the wall and the back of the cabinet. A house lighting installation that is even moderately up-to-date will have the electric light cables run in metal conduit, duly earthed, and although neither the metal conduit nor the earth is ideal for the purpose of preventing the radiation of interference, it is nevertheless reasonably efficient, but the six feet or so of mains lead is not only unscreened but runs close to the receiver. A highly efficient superbet using five or six valves is quite capable of receiving a Regional transmitter at a distance of 25 miles with an aerial consisting of 6in. of wire.

It does not require any great imagination to realise that a set of such sensitivity can pick up quite a lot of noise radiated by its own mains lead. At this juncture it may be as well to interpose a remark for the benefit of those people who are well primed with elementary principles, for fear that somebody should write to us and point out that as the leads are twisted, they have no field. This theory would hold good if the noise were borne along one wire and back down the other. Actually, it may well be borne in the same direction on both wires, the circuit being completed by the earth on the receiver, or alternatively the balance may be upset by the earthing of one of the mains by the Electric Lighting Company.

## Eliminating Interference

To revert to the question of the mains lead, three possibilities present themselves for eliminating trouble in this direction. In the first place if the receiver stands close to the wall point, the lead can usually be very considerably shortened, or if this is objected to for any reason, the slack may be wound into a small coil, half the surplus length being wound in one direction,

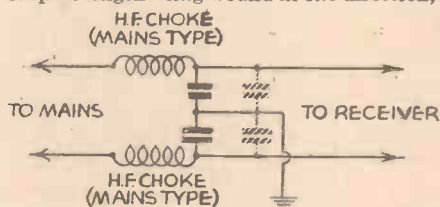

A simple mains filter circuit.

and the other half in the opposite direction. The second suggestion is metal sleeving slipped over the mains lead (which should preferably be shortened as already described), which must be duly earthed, although for some reason or other this procedure is not always as effective as might be supposed. By far the most efficient method is the use of chokes in the mains leads, which, if placed immediately by the wall point, serve the dual purpose of preventing noise reaching the power supply of the receiver, and also preventing the mains lead from acting as the source of interference to the transmitter. The accompanying illustration shows the usual circuit adopted. It is desirable that the few components involved should be mounted in a metal box duly earthed to prevent the chokes themselves from giving the very trouble that it is desired to avoid.

# Flashes Round the Globe

## Proposed New Egyptian Short-wave Station

It is reported that the Rector of the El Azhar University at Cairo has been approached by the Moslem Community in the United States of America with the request that a special transmitter be erected in Egypt to enable Moslems all over the world to listen to daily readings of the Koran. The matter, it is stated, is being considered by the Egyptian Government.

## Modern Wireless Appeal

On the report that an American volunteer was captured by the Spanish Nationalists, according to a New York journal, the man's sister residing in the United States sent to General Franco the following eable: "I beg of you to listen at 15.00 hours, Eastern Standard Time, on October 24th, to W2XAD, on 19.56 m. My mother is dying of a broken heart." In pathetic terms the sender of the cable implored the Spanish Generalissimo to release her brother. It is not stated whether any Nationalist official listened to the appeal, and the result is not stated.

## Another Arctic Expedition

K7GJ is the call-sign of an American Expedition now located at King Island (off Alaska). The station operates both telephony and telegraphy transmitters daily between G.M.T. 22.30-06.00, on one of the following channels: Telephony and telegraphy, 159 m. (1,885 kc/s); 157.4 m. (1,906 kc/s) and 28.7 mc/s in the 10-metre amateur band; in telegraphy only, on 82.19 m. (3,650 kc/s); 41.18 m. (7,285 kc/s); 38.89 m. (7,715 kc/s) and 20.92 m. (14.35 mc/s).

# Christmas Week Broadcasts

## NATIONAL (261.1 m. and 1,500 m.)

Wednesday, December 22nd.—Folly and Mistletoe Revue.  
Thursday, December 23rd.—Jack Payne's Party.  
Friday, December 24th.—A Sad Tale's Best for Winter, a sombre anthology for the Eve of Christmas.  
Saturday, December 25th.—Christmas Party.

## REGIONAL (342.1 m.)

Wednesday, December 22nd.—Variety, from the Argyle Theatre, Birkenhead.  
Thursday, December 23rd.—Concert of Christmas Music.  
Friday, December 24th.—A Carol Service, from St. Mary's, Whitechapel.  
Saturday, December 25th.—The Bartered Bride (Smetana), Act III, from Prague.

## MIDLAND (296.2 m.)

Wednesday, December 22nd.—Songs from the Midland Pantomimes.  
Thursday, December 23rd.—Concert of Christmas Music.  
Friday, December 24th.—Carols, from the Cathedral, Peterborough.  
Saturday, December 25th.—Instrumental programme.

## WEST OF ENGLAND (285.7 m.)

Wednesday, December 22nd.—Great British Organ Music—6 (1880-1910), from St. Mary's, Southampton.  
Thursday, December 23rd.—Pantomime preview: a peep behind the scenes during the final rehearsals of "Cinderella," from the Prince's Theatre, Bristol; "Aladdin" from the Palace Theatre, Plymouth; and "Cinderella," from the Pavilion, Bournemouth.  
Friday, December 24th.—Cabaret, from the Headland Hotel, Newquay.  
Saturday, December 25th.—Anything to Oblige; account of a party to celebrate the festive season of 1902.

## WELSH (373.1 m.)

Wednesday, December 22nd.—A vocal recital.  
Thursday, December 23rd.—Butties, a Christmas feature by Jack Jones.  
Friday, December 24th.—Going Home; Plantation Melodies and Negro spirituals.  
Saturday, December 25th.—Nos Nadolig 1937 (Christmas Night, 1937).

## NORTHERN (449.1 m.)

Wednesday, December 22nd.—Variety, from the Argyle Theatre, Birkenhead.

Thursday, December 23rd.—A commentary on the Darts Match, from the Royal Hotel, Fagley, Bradford.  
Friday, December 24th.—Carol programme.  
Saturday, December 25th.—Christmas Party, from London.

## SCOTTISH (391.1 m.)

Wednesday, December 22nd.—Scottish Dance Music.  
Thursday, December 23rd.—Whuppity-stoorie, an ancient Scots fairy tale, dramatised, with music.  
Friday, December 24th.—An excerpt from the pantomime "Dick Whittington," from the Empire Theatre, Glasgow.  
Saturday, December 25th.—Christmas on the "Vital Spark," by Neil Munro.

## NORTHERN IRELAND (307.1 m.)

Wednesday, December 22nd.—A Tale of Two Cities: Dublin-Belfast, feature programme.  
Thursday, December 23rd.—Christmas Carols, from St. Anne's Cathedral, Belfast.  
Friday, December 24th.—Orchestral programme.  
Saturday, December 25th.—Christmas Party, from London.



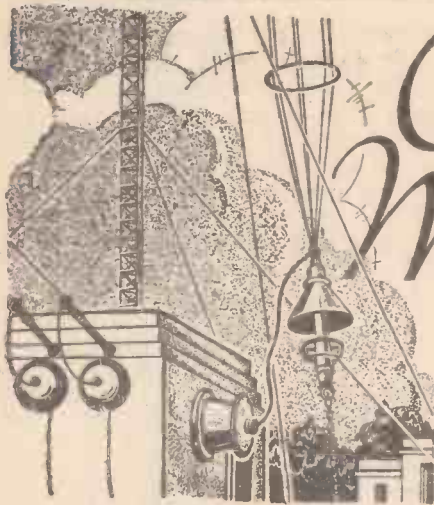

# On Your Wavelength

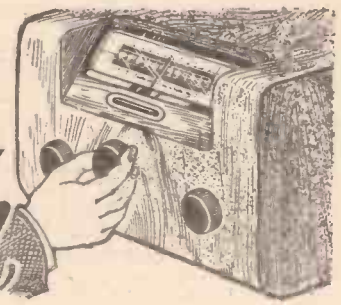

By Thermion

## 8,000,000 Listeners Need Organisation

ANY particular organisation which has a monopoly can do exactly as it likes, knowing that the users have to put up with it whether they like it or not. This is bad from every point of view, for, as the tendency of human nature is to follow the line of least resistance, progress is bound to be slow, if at all. Competition keeps people on their toes, seeking fresh

of it is insulting to the intelligence of the merest schoolboy. Instead of regarding its job as one of entertainment it seems to think that it is a heaven sent organisation for the uplift and education of a community of nitwits. It is true that there are bright spots in a few programmes at lengthy intervals. If 8,000,000 listeners could be organised into some vast organisation like the Automobile Association, with local centres having power to pass a resolution to head office, the latter could force the B.B.C. to obey the dictates of the people it exists to serve. It is a pity that this organisation was not founded in the early days of wireless. Had it been, our programmes to-day would be vastly different. Who will start such an organisation?



Big Chief Thermion has spoken!

ideas, testing new inventions, introducing the right people for the right job, and generally seeing that their organisation and their product are ahead of those of their competitors. With the B.B.C. there is no opposition, in spite of the fact that it serves 8,000,000 British listeners. This vast number of users of the B.B.C. product are helpless, and the time has come when every listener should be organised to ensure that the B.B.C. carries out the reasonable commands of the majority of listeners. The B.B.C. is, after all, a custodian of £4,000,000 of public money. It has not the right to spend it on programmes which people do not want. I can tell the B.B.C. that 60 per cent. of its programme material is waste of time and waste of money, and at least 30 per cent.

## The Ace of Hates

I WENT to a luncheon the other day and was greeted by one of the few people who know my identity as the Ace of Hates. He was referring, I presume, to my ill-disguised contempt for that lounge-lizard collection of diseased-voiced, alleged entertainers with sobs in their voices and who are known as crooners. The only thing, I fear, is that my hatred may cause me to develop the hobby of biting crooners' throats.

## Baird Takes my Tip

YOU will remember that a few weeks ago I penned a few notes on the backwardness of television, due to the throttling effect of the monopoly granted by the Government to the B.B.C., and which has been renewed for a further period of years. I advised the television people to broad-

cast their own programmes without a licence from the Postmaster-General as a protest against the present tendency to keep television in the background. I am delighted to learn that the Baird Company have taken my advice and propose to transmit some protest transmissions on their own account. I had a word from the officials of the Baird Company thanking me for my article. I am glad that they have noted and acted upon it. And if they would like friend Thermion to appear in the television studio for the delectation of his millions of readers looking at the end of a cathode-ray tube, I shall be delighted to do so, upon payment, of course, of the lashings of guineas which such an important broadcast would warrant!

## No More Singing in the Bath

FRIEND Taylor, of W.B. Speaker fame, tells me that Radio in Every Room has become the fashion [this Christmas. The trade has been dealing with exceptional orders for extension speakers; even the kitchen and bathroom have not been overlooked. An extension to the kitchen goes a long way towards keeping maids contented—a step forward in the solution of the servant problem. Mr. Whiteley, of the Stentorian Company, tells me that extensions for bathrooms are similar to those used in the tropics. All the vital parts are impregnated with water-proofing compound, and other parts are steeped in wax under a vacuum. People are no longer satisfied to cluster round the set in one room, any



"So you won't talk, huh!"



more than they will cluster round a single fire. They want their wireless sets laid on like central heating so that they can listen-in in all parts of the house. Considerable developments have been taking place in the design of extension speakers, which are being made in various styles and colours to blend with all interior schemes and decorations. At the same time there have been technical improvements, especially in the direction of remote control, making it possible to turn off the main set from an extension in any part of the house. You can now go to bed early, listen-in until Big Ben strikes, and turn off the set from your bedside extension.

#### Still More Jokes

**T**HIS one from W. H. S., of Kingsbridge: "A friend built a double band-pass ultra-everything set, and assured me that, regarding a certain male quartet whose leading tenor I considered nasal in a particular broadcast, it didn't bother him as he was able to tune that particular vocalist out and reduce the item to a trio." Sez W. H. S.

And D. P., of Glasgow: "I was fitting up a radio for my grandfather who is bedridden, and was having some difficulty in getting results, when I heard the old man say: 'Do you think they know you are listening-in, Willie?'"

And now, R. W., of York:

"In the course of my work I visit a certain house each week, and a week ago noticed a radio set had been installed. When I called again today the conversation drifted to wireless matters and the man of the house asked me a few questions. Just as I was about to leave he said: 'How do you switch this d— set off?' I thought he was trying to catch me at it, when to my great amusement the lady of the house said she was tired of climbing (she was a short person) on a chair to disconnect the set by taking out the connector from the adapter on the light. The person that called to fix the set did not know which was the switch and had told them to do as I have related above. The set had two knobs on the front and one at either end; I caused the wife some merriment by showing the husband how to do it. Turning the tone control with my left hand I slyly switched off with my right hand. The man tried a few times to switch off with the tone control after each of my demonstrations until I let him into the secret that the man who installed the set did not know."

#### An Aerial on Wheels

**O**NE of the most remarkable experiments ever undertaken in short-wave transmission is now nearing completion at P.C.J., the Philips short-wave transmitter known to thousands of listeners throughout the world as the "Happy Station." Recently it raised its power to 60 kW, and its next step is to overcome in a novel manner the one big disadvantage of the "Beam" system—that of requiring a separate set of masts and aerials for each direction of the beam.

The scheme which has been worked out in the Philips laboratories is nothing less than a revolving aerial system. Here are some details of its construction. Briefly, the new aerial comprises two wooden lattice masts, 195 ft. high, which rest on a massive steel girder bridge mounted on a centre pivot and eight heavy wheel trucks. The whole system turns on a circular steel track, the circle of the outer rail being 145 ft. in diameter, and the inner circle about 40 ft. The massive centre pivot is carried by a solid block of some 25 cubic yards of concrete. The weight of each mast is 18 tons, and that of the steel bridge on which they rest is 95 tons.

Due to the careful design of this unique aerial system, it can be revolved in any desired direction, either by electric motor or hand winch, and a somewhat amusing feature is a number of signposts around the circular track, bearing such indications as "Africa," "Argentina," "Brazil," and so on. Careful allowance had to be made for wind pressure, which in normal conditions is of the order of 4½ tons on each limb, but during storms may rise to as high a figure as 48 tons. Each of the eight wheel-bogies is therefore provided with heavy steel claws, which can be

screwed up tightly on to the rails when necessity arises.

The aerial system proper consists of 12 vertical dipole aerials on each mast—24 in all, each aerial being fed separately. With an input of 60 kW, the effect of the special construction of the system is that the energy radiated in the direction of the beam is 24 times that of the radiation of an ordinary dipole aerial, or, in other words, equivalent to the radiation from a dipole aerial of a 2,000 kW transmitter.

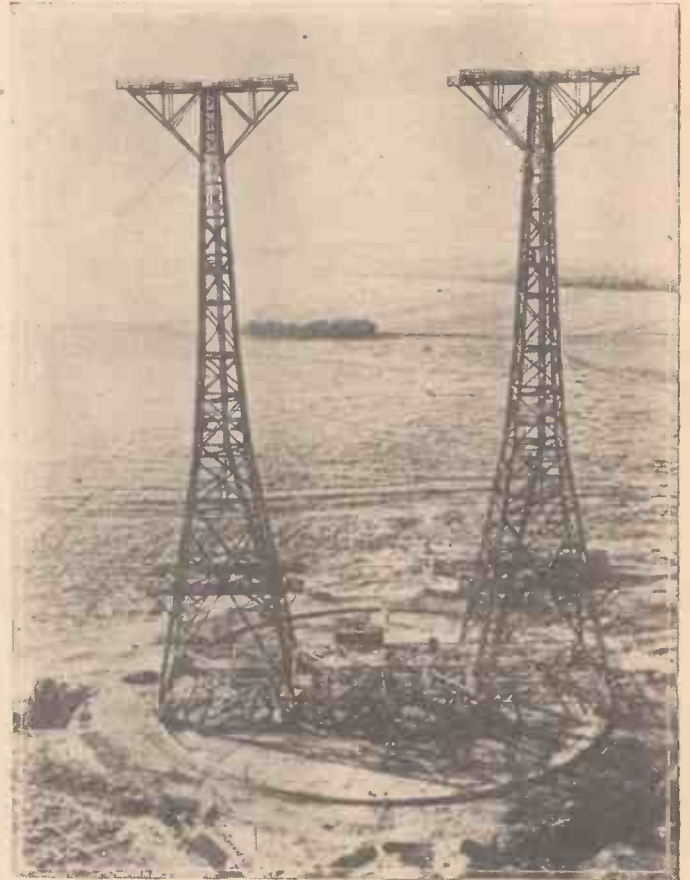

The remarkable short-wave aerial system at P.C.J. referred to on this page. The illustration shows clearly the steel girder bridge carrying the two 195 ft. masts, and the circular rail track on which the whole system turns.

For the time being, this new aerial system will be used only on the 31-metre band, but if it proves as successful as is expected it is probable that an identical system will be constructed for other wavebands.

#### The Clackmannanshire Short-wave Club

**M**R. DAVID MACINTOSH, the secretary of the above club, sends me cordial greetings and solicitations, and a couple of veri's in token thereof. The club certainly seems to be alive and doing well.

An Ideal Book for the Beginner!  
Everyman's Wireless Book  
By F. J. CAMM

3/6. or 4/- by post from George Newnes, Ltd., Tower House, Southampton St., Strand, London, W.C.2.



# The Amateur Set Designer

The Subjects Dealt With in this Sixteenth Article of the Series Include Further Notes on Rectifier Valves, the Mains Transformer, and the H.T. Potential Divider

(Continued from page 406, December 18th issue).

It will now be possible to get an idea of the current passing through the field winding into the H.T. feed line. This current can be taken as the sum of all the anode currents, plus all the screen currents, plus any potential divider "bleed" current. It should be noted that where any valves are going to have variable bias, the maximum current values should be taken.

## The Speaker Field Winding

Assuming that the speaker field winding is going to be used as the smoothing choke there are two considerations to go into: (1) The current passing through the winding must provide adequate field excitation, and (2) the voltage drop across the winding must be allowed for in working out the rectifier output voltage.

As regards the question as to whether the current will be sufficient for satisfactory field excitation, speaker specifications may be consulted, although, for the type of speaker used in the average domestic table model radio, it may be taken that the wattage dissipation in the field winding should not be less than 5 watts and that something between 5 and 10 watts should be aimed at. The accompanying table shows approximate current values for 5, 7 and 10 watts, respectively, for the commonly used field resistances of 2,500, 2,000 and 1,500 ohms. The table also shows the corresponding voltage drops across the windings.

The voltage estimated for the H.T. (smoothed) supply line plus the drop across the field winding will give the rectified output voltage required.

## The Rectifier Valve

Assuming that a rectifier valve is to be used it will now be possible to choose the type.

Full-wave rectifier valves suitable for average radio purposes fall into three ratings, sometimes referred to as A, B and C, respectively. These ratings are:—

A.—Maximum anode volts, 250; R.M.S. maximum rectified current, 60 mA.

B.—Maximum anode volts, 350; R.M.S. maximum rectified current, 120 mA.

C.—Maximum anode volts, 500; R.M.S. maximum rectified current, 120 mA.

The output D.C. voltage delivered by any rectifier valve will, for a given input A.C. voltage, be dependent upon the value of the output current. The valve manufacturers provide characteristic curves which it is most advisable to consult. As an estimate has now been made of the output voltage and current required, it is possible to select a suitable rectifier and also to determine (from the rectifier characteristics) the H.T. transformer secondary voltage required.

It will probably happen that the estimated rectified output voltage and current prove,

upon inspection of the rectifier valve data, to be appropriate to some H.T. secondary voltage which is not standard for the types of transformer which are readily obtainable. In such case it is best to settle on the standard secondary voltage nearest above the non-standard value. This means, of course, that the first estimates of current and voltage values will have to be revised, but the work done has not been wasted. Once the rectifier and mains transformer are definitely settled upon the work is simplified, and it will not be a long job to work back

Field Resistance	5 Watts		7 Watts		10 Watts	
	Current	Voltage Drop.	Current	Voltage Drop.	Current	Voltage Drop.
2,500 ohms	45 mA	112 volts	53 mA	133 volts	63 mA	158 volts
2,000 "	50 "	100 "	59 "	118 "	71 "	142 "
1,500 "	58 "	87 "	68 "	102 "	82 "	123 "

Table of current values for various speaker field windings.

and make any corrections that may obviously be necessary in respect of voltage-dropping values. Possibly it may happen that no change may be considered necessary.

## The Mains Transformer

The H.T. secondary voltage and current requirements are now known, and the valve heater requirements are, of course, very easy to work out.

The question as to whether all the valves (excluding rectifier) are to be heated from one winding should be gone into. It will also be necessary to decide whether or not any heater winding centre taps are required. Care should be taken that each heater winding is of adequate current rating.

As regards H.T. secondary voltages, 250, 300, 325, 350 and 500 (all R.M.S.) are values to be found among the ratings of transformers that are on the market.

A typical transformer specification reads: H.T. secondary, 350-0-350 volts, 120 mA.; L.T. secondary, 2-0-2 volts, 2.5 amps.; L.T. secondary, 2-0-2 volts, 6 amps.; L.T. secondary, 2-0-2 volts, 1 amp.

The rating of 350-0-350 shows that the secondary is centre-tapped and gives 350 volts R.M.S. in each half. This transformer is obviously not suitable for an A rectifier, but can be used with B or C types. Each of the L.T. windings is obviously centre-tapped. The 2.5 amp. winding will be satisfactory for the heating of a B or C rectifier. The 6-amp. winding will handle the heaters of up to six valves of the 4-volt 1-amp. type. The additional 1-amp. heater winding will prove useful if it is desired to use separate heating for an output valve with a 4-volt 1-amp. heater.

## Rating of Smoothing Condensers

As soon as the H.T. secondary voltage is known it is possible to decide upon a safe voltage rating for the smoothing condensers. It is advisable that the latter

should be rated at sufficient dielectric strength to be able to stand up continuously to a voltage at least equal to the peak value of the H.T. transformer secondary voltage, i.e., 1.414 times the R.M.S. rectifier anode voltage.

## The H.T. Potential Divider

It is not difficult to work out values for a potential divider, once the H.T. (smoothed) voltage is known.

Referring to Fig. 68, suppose a valve screen is to be fed from point A. The current flowing through R2 is known as the "waste" or "bleed" current, and it is advisable to allot a value for this. The value of screen voltage at A (with reference to negative H.T.) gives the voltage across R2, so

$$R2 = \frac{\text{Screen voltage}}{\text{Bleed current}} = \text{ohms}$$

the bleed current being expressed in amps.

The current flowing through R1 is the sum of the screen and bleed currents, while the voltage across R1 can be obtained by subtracting the screen voltage from the H.T. voltage across the whole divider. From these values the resistance of R1 can be worked out.

By regarding the bleed current as a matter of choice, the way is open to make this choice rather a useful let out if any trouble is experienced due to the total rectifier output current not being quite the value the designer would like to see. Of course, change of bleed current value will alter the other H.T. values, but the idea may be worth noting.

## The "Universal" A.C./D.C. Receiver

The fact that an A.C./D.C. receiver must be capable of working off D.C. mains implies that there can be no mains transformer. Thus, the H.T. and L.T. supplies must be drawn direct from the mains, and this feature has important bearings upon design with which the amateur designer should make himself familiar.

### Safety First

If, as is usual, a metal chassis is used, and negative H.T. is connected to the chassis, it follows that the latter is in direct connection with one of the supply mains. Under no circumstances, therefore, must an earth connection be taken to the chassis. The unearthed chassis becomes dangerous from the point of view of risk of shocks (taking all possible mains cases into consideration), and it is consequently necessary for the designer to take precautions that the completed receiver will provide adequate protection to any person using it. No metal parts in contact with chassis should be exposed, and this rule should be carried even so far as making certain that the grub-screws of the knobs are well sunk below the surfaces of the knobs.

From the radio reception point of view, it is necessary to have an earth connection, and this problem is met by providing an earth terminal, not connected direct to chassis, but via a condenser. The latter should be of high voltage type, and a capacity of about 0.1 mfd., will be suitable.

(Continued overleaf.)

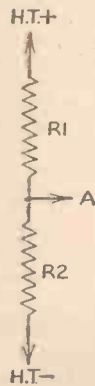

Fig. 68.—Diagram of an H.T. potential divider.







A PAGE OF PRACTICAL HINTS

SUBMIT YOUR IDEA

READERS WRINKLES

THE HALF-GUINEA PAGE

Positioning Rotary Movements

THE occasion often arises when a locator action for such as switching, volume and tone control, etc., is required, and I have many times resorted to the method illustrated in the accompanying sketch.

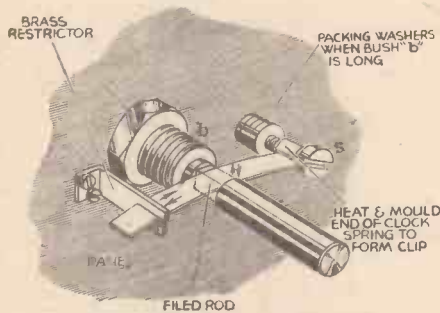

A simple but effective method of positioning rotary movements of control spindles.

The advantage of this arrangement lies in the compactness of the whole assembly, whilst adequate tension is afforded in the use of a wide clock spring. Sufficient length of spring should be made for overlap when fitted through the brass restrictor piece, as shown and, by carefully predetermining the positions for the screw "S" and the restrictor, varying degrees of spring tension may be obtained.—R. T. COLTRIDE (Colchester).

A Variable I.F. Transformer

THE following dodge may be useful to other readers desiring better quality from their all-wave superhets, or greater sensitivity. My aim was better quality, and the accompanying sketch clearly explains the idea. Most fixed I.F. transformers can be converted, and if the can is not long enough it is a simple matter to make a longer one with square corners, the same width as the diameter of the

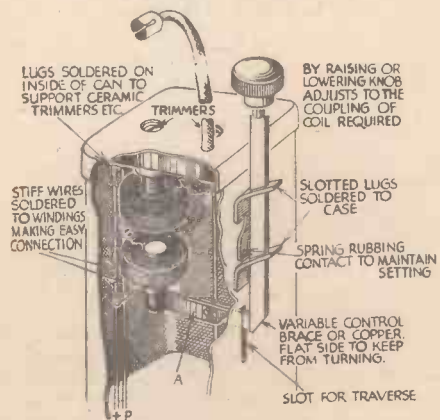

A method of arranging variable coupling in an I.F. transformer.

THAT DODGE OF YOURS!

Every Reader of "PRACTICAL AND AMATEUR WIRELESS" must have originated some little dodge which would interest other readers. Why not pass it on to us? We pay £1-10-0 for the best wrinkle submitted, and for every other item published on this page we will pay half-a-guinea. Turn that idea of yours to account by sending it in to us addressed to the Editor, "PRACTICAL AND AMATEUR WIRELESS," George Newnes, Ltd., Tower House, Southampton Street, Strand, W.C.2. Put your name and address on every item. Please note that every notion sent in must be original. Mark envelopes "Radio Wrinkles." DO NOT enclose Queries with your wrinkles.

original. I made fresh cans out of copper, which operate very satisfactorily and are a great improvement. The strip (A) is a piece of paxolin riveted to the brass control brace.—H. W. KIRK (Liverpool).

An Illuminated Joint Abac Calculator

WHEN referring to the well-known Abac system it occurred to me that by combining the scales of a number of the most used laws—in my case—I could, by expending a little patience and time, evolve a ready reference in the form of a single unit, thus eventually saving time and affording a novel addition to my equipment. The accompanying drawings illustrate the results of my efforts in this direction.

The box measures 8ins. by 9ins. by 3ins., and is constructed of oak for rigidity and appearance. The glass plate I purchased, and it will be noticed that a slight overlap is allowed for the engagement of the home-constructed brass sliders. An old clock spring, heated and straightened, forms the cursor, and a "hair line" reading can be obtained in this manner. Three push-pull switches, wired in accordance with the inset circuit to the bulbs and battery, constitute the simple lighting equipment.

Partitioning was done with 3-ply wood strips let into the box in the desired positions and glued; a back strip was drilled to accommodate the bulbs, and the contacts "C" were made out of old condenser vanes which prove very satisfactory.

The scales were worked from a table

to twice size and drawn in pencil first, then indian ink, on to a sheet of medium thickness paper which was then glued with transparent mucilage to the glass sheet.

The scales should be worked out independently, space being allowed between each vertical line, thus permitting room to be made for the slots and, of course, the lines of bulbs in the partitioned spaces.

The scales I have illustrated are as follows:—

- (1) Ohm's law—volts, ohms, mA.
  - (2) Watts dissipation—volts, ohms, mA, watts.
  - (3) Decibel equivalents—power ratio/decibels voltage or current ratio/decibels.
- Coloured cellophane strips may be glued over the various slots so that for O.L. (Ohm's law) green, red, yellow scales

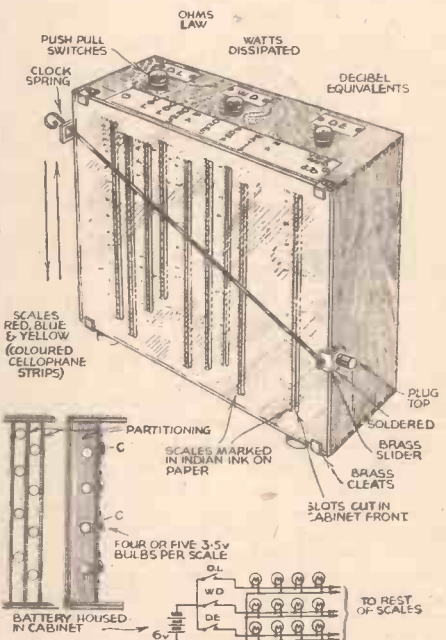

A novel Abac calculator unit.

appear; whilst for watts dissipation green, red, yellow and blue could be used. The model illustrated can, of course, be modified to suit one's own requirements.—W. R. HUNT (Chingford).

Join Newnes' Practical Group!

**PRACTICAL MOTORIST**  
The owner-driver's journal which tells you how to repair, overhaul, and obtain the best performance from your car.  
3d.—every Friday.

**PRACTICAL MECHANICS**  
The only English journal of its type. It deals with every branch of Science, Mechanics, Invention, Model-Making, Chemistry, Astronomy, Photography, Television.  
6d.—Every Month.

**THE CYCLIST**  
The leading weekly for every Cyclist, Clubman, Utility Cyclist, or Tourist.  
Join "The Cyclist" Road Club and also take advantage of the FREE Insurance offered.  
2d.—Every Wednesday.

Drilling Glass

SOME constructors may like to employ a glass panel or even a glass cabinet for their well-built receiver, and it should be remembered that glass may be drilled just as easily as ebonite, provided the right drill and lubricant is employed. The broken-off point of a triangular file makes a very good drill, and it should be turned slowly, without undue pressure, and at the same time lubricated with copious supplies of ordinary turpentine. When through, turn the glass over and finish from the opposite side.—D. WATTS (Hendon).

# VOLTAGE DOUBLING

The Principle of Voltage Doubling with the Metal Rectifier is Well Known, but the Possibility of Voltage Doubling with a Valve is Comparatively New, and a Few Notes on the Subject are Given in this Short Article.

THE fundamental idea underlying the use of the voltage-doubling circuit is to produce a D.C. voltage which can be considerably more than double that of the maximum A.C. output of the transformer. For example, with the circuit shown in Fig. 1, it is possible to develop a voltage of 2,000 volts when using a transformer with an output of only 750 volts R.M.S. The valve used is the Cossor 225 D.U., which is, in effect, a full-wave rectifier, with the exception that the two filaments instead of being internally connected, are led out to separate pins. Each

positive or negative lead, whichever is convenient, together with the usual smoothing condensers. The condensers C1 and C2 contribute to the smoothing, but it must be remembered that neither of these condensers may be of the electrolytic type, as they are subjected to A.C. voltages, and, furthermore, the value of C2 must necessarily be such that it will pass the necessary A.C. current to anode "B" of the voltage-doubling valve.

The Cossor Voltage-Doubler Valve  
The Cossor 225 D.U. voltage-doubler

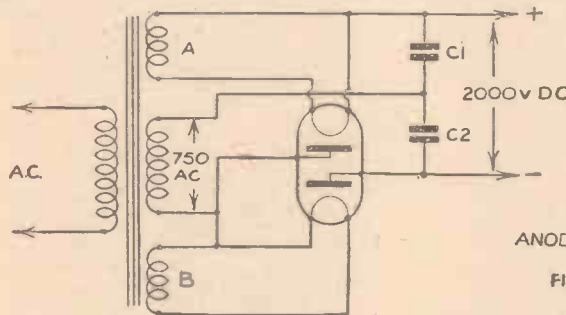

Fig. 1 (above).—A voltage-doubling circuit which delivers a very high output.

filament is intended to operate at 2 volts, and consumes half an ampere, and with a maximum input of 750 volts R.M.S., using the circuit shown, an output of 2,000 volts 20 milliamps is obtainable. If one half of the valve is considered separately, it is noted that the application of 750 volts will produce a D.C. output of 1,000 volts, so that in order to get double this figure it is necessary that the D.C. output of one half should be in series with the D.C. output of the other half. Reference to Fig. 1 will show that the two heaters are fed by two separate windings, the winding marked, "B" being floating from the output point of view, but connected to the anode of that half of the valve that receives its filament current from winding "A." It is possible to trace the path of the current through this valve in the following sequence. It will be observed that H.T. positive is connected to filament "A," and that the anode associated with this filament is fed from a transformer secondary with an A.C. voltage of 750. It will be seen that the D.C. output of this anode, being, of course, unable to flow through the condensers C1 and C2, has passed to filament "B," the anode of which is held at a voltage of 750 A.C. fed to it through the condenser C2. In this way the 1,000 volts developed by section "B" is in series with the output of section "A," consequently the potential developed between filament "A" and anode "B" attains the figure of 2,000 volts.

## Smoothing

Smoothing is carried out in the ordinary way, the usual choke being placed in the

Fig. 2 (below).—This diagram shows the pin connections of the Cossor 225 D.U. valve.

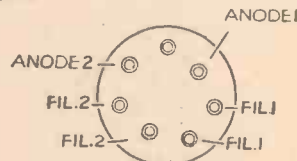

valve is fitted with a 7-pin base, the connections of which are shown in Fig. 2. It can, of course, be used as an ordinary rectifier, by getting the filaments in series or parallel, whichever is the more convenient, and used in this way may have a maximum applied A.C. voltage not exceeding 1500-0-1500, in which condition it will produce a voltage of the same order as that available when used as a voltage-doubler, but with the disadvantage that a transformer must be employed capable of delivering 3,000 volts across the secondary, whereas when used in a voltage-doubler

circuit a comparatively simple transformer may be employed, as it is only required to develop 750 volts across the secondary.

There are, of course, many other instances in which the principle of voltage doubling will be needed, and we hope to give some circuits at a later date.



Fig. 3.—A typical Cossor voltage-doubler valve.

## NEWS FROM ALL QUARTERS

### Trujillo City Heard Again

HI4V, at Ciudad Trujillo, capital of the Dominican Republic, working on 46.51 m. (6.45 mc/s), was twice logged during the past week. The call in Spanish reads phonetically: *Ah-hay ee koo-at-tro vey, La Voz de la Marina*, and is given by a lady announcer. The *Stein Song* was heard at the close of the broadcast, G.M.T. 01.30. Address: Apartado Postal, 771, Trujillo City, Dominican Republic.

### Tokio Brings in JZI

JZI, the 50-kilowatt station at Tokio-Nazaki operating on 31.46 m. (9.535 mc/s), has now been brought into operation for the broadcasting of war news bulletins, and will be found on the air at the same time as JZJ, (25.42 m.-11.8 mc/s) and JZK (19.79 m.-15.16 mc/s). The stations

continue to close down with the announcement: *This is the Voice of Tokio, City of the 1940 Olympics and Metropolis of the Far East*, followed by a fanfare of trumpets and the Japanese National Anthem.

### The German Mystery Station

Towards G.M.T. 21.00, on 29.81 m. (10.065 mc/s), broadcasts have been carried out nightly by an unauthorised German station styling itself the German Liberty transmitter. The full call is: *Hier der Deutsche Freiheits sender auf Welle 29.81 metre*. It recently gave out its location as Breslau, but other cities have been mentioned from time to time. A recent law in Germany makes the user of an illicit broadcasting station liable to penal servitude, and to the death sentence if the broadcasts are of a subversive character!



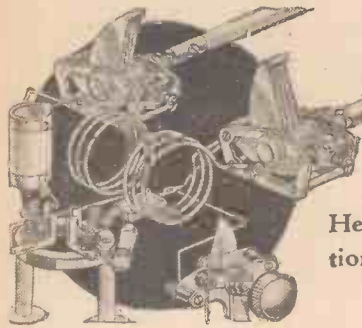

# Short Wave Section

Here "The Experimenters" Give Constructional Details for the Third Unit of Their Complete Short-wave Superhet.

**A**FTER the intermediate-frequency amplifier comes the second detector. The purpose of this is to "separate" the I.F. currents from the audio-frequency or sound portion of the signal. There is no material difference between the principle of the second detector and that of a normal detector stage in a "straight" circuit; what difference there is is confined to the frequency of the signals handled. These are all at the intermediate frequency of 465 kc/s.

We do not require any additional tuning circuit for the unit under discussion,

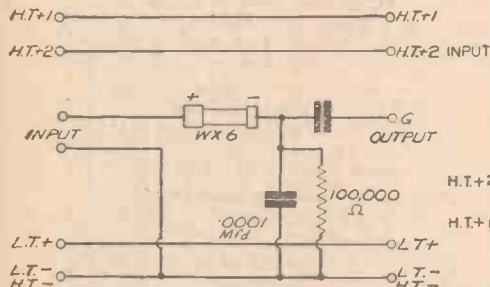

Fig. 1.—Circuit of the "Westector" second-detector unit.

because the I.F. transformer which feeds it was included in the section described a fortnight ago. There are several possible alternative arrangements for the second-detector unit, for we might use a "Westector" metal-oxide rectifier, a triode or pentode in a leaky-grid circuit, or a double-diode triode. As our main object throughout this unit-type receiver has been to maintain simplicity and ease of construction, we propose to deal with the first two systems only. Some of you might at first object to this, pointing out that the double-diode rectifier provides an excellent means of obtaining A.V.C.

### A.V.C.—Or Not?

Our contention—and it is based on a good deal of experiment—is that A.V.C. is not usually of great value on short waves. The fading that is experienced is generally of a "high-speed" kind, and we have found that in most instances it cannot be overcome by employing normal systems of A.V.C. No doubt some of you will write and tell us that we are quite wrong about this; we hope you will if you have found any effective method of preventing changes of volume level in short-wave reception.

In any case, if you consider that A.V.C. is worth while in the receiver we are describing it will not be difficult to add it at a later stage, particularly if you propose to use the "Westector" for the second-detector unit. This rectifier can be employed very easily indeed, as you can see from Fig. 1, which shows the circuit. There is nothing in it beyond the rectifier

*by The Experimenters*

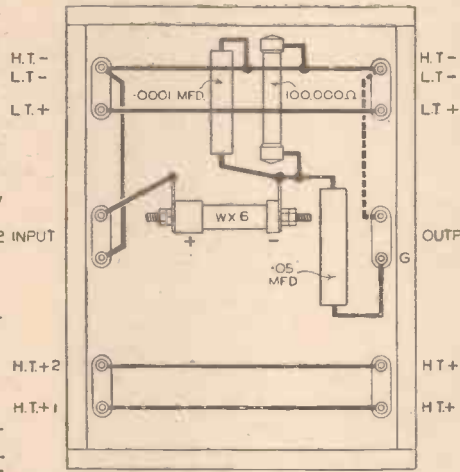

Fig. 2.—Wiring plan (underside of chassis) corresponding to the circuit in Fig. 1.

itself, a couple of fixed condensers and a fixed resistor.

### Wiring

In consequence, the chassis can be very small indeed, although it must be the same depth (front to back) as the other two in order to have the terminal strips in line. The few components are all mounted under the chassis, so there is no need to give a general view of this. Instead, we show the wiring in Fig. 2. Notice that the two sockets marked input are in line with those marked output on the I.F. amplifier, and that only one output socket is used on the present unit. The reason for this is that

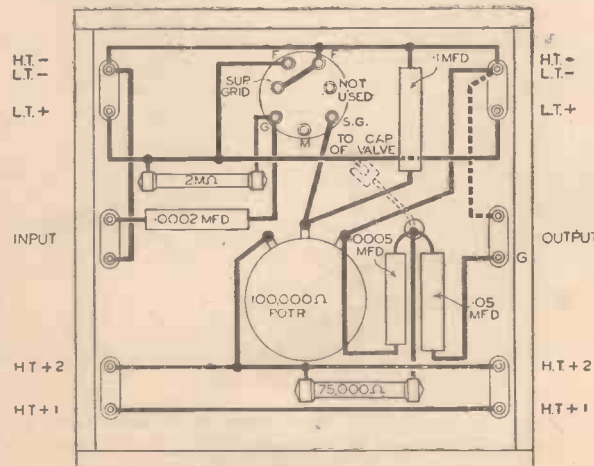

Fig. 4.—Practical wiring plan for a second-detector unit with H.F. pentode valve. Inset are shown connections for a four-pin pentode.

the other output connection is the "earth line" or H.T. and L.T. negative.

The output socket is marked G, since it will be connected to the grid of the following L.F. valve. If you wish to use 'phones before the L.F. amplifier is made, you can do so by connecting them between the output terminal and earth. We need make no further reference to this "Westector" unit, except that the rectifier should be a type W.X.6; do not obtain the W.6 by mistake, because this is intended for use only when the intermediate frequency is below 200 kc/s.

### H.F. Pen. Second Detector

Fig. 3 gives the circuit for a second-detector unit employing an H.F. pentode, grid condenser and leak. The circuit will be recognised easily enough, for it is quite standard in form. A .0002-mfd. grid condenser is used, along with a 2-megohm leak, whilst the screening-grid voltage is made variable by the inclusion of a 100,000-ohm potentiometer. Notice also the .0005-mfd. anode by-pass condenser, which is practically essential if L.F. stability is to be ensured. We do not show an H.F. choke in the detector anode circuit, for we have not found this to be necessary in this circuit when not using reaction.

You will see in both this circuit and that dealt with above that a number of connections are shown as going right across the diagram and not connected to anything. These are H.T. and L.T. leads. In the first circuit, neither of these supplies is required for the "Westector," but the "through" connections must be made to feed the preceding valves. In the second circuit the same applies to the H.T.+2 lead. If desired, this could be used by cutting out the potentiometer and connecting the screening grid of the pentode

(Continued overleaf)

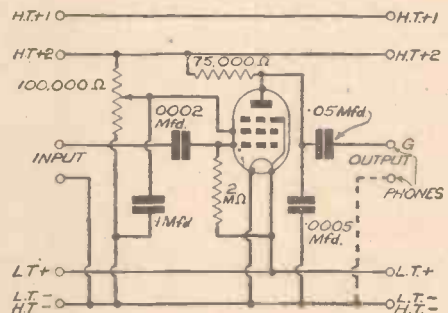

Fig. 3.—A second-detector unit using an H.F. pentode with leaky-grid connections.





# Practical Television

December 25th, 1937. Vol. 3. No. 80.

## The Scophony System

Now that the B.B.C. have redesigned their time-base equipment, the Scophony apparatus can be made to function in a satisfactory manner, and we recently had the pleasure of seeing a demonstration of both the home receiver and the large cinema screen—upon both of which a standard B.B.C. programme from the Alexandra Palace was received in West London. The picture was perfectly steady and very brilliant and could have been witnessed by a crowd of 600 people or more in a suitable hall. The home model gave one of the best pictures which we have yet seen on a domestic

screens and a mercury lamp for the domestic model, the light from these being directed through a condenser and lens assembly on to a quartz crystal D. The crystal is situated at the foot of a container which is filled with a liquid, and it is found that when a radio-frequency supply is fed to the crystal waves are set up in the liquid. The frequency of the waves is dependent upon the liquid, and in the Scophony apparatus has been chosen to give a wave form suitable for the present broadcast service.

## Scanning

Situated between the light source and the crystal is a bar which, when no R.F. is applied to the quartz, blocks out the light which would otherwise be directed on to a further lens situated just in front of the motor E. As soon as the R.F. is applied, however, the refraction of light caused by the waves through the liquid causes the light to "spread over" and thus reach the

in accordance with the television signal. Mounted on the spindle of the motor E is a stainless steel polygon scanning element which is kept exactly in step with the oscillations through the liquid and it therefore follows these faithfully. The motor E is synchronously controlled by the line frequency broadcast by the B.B.C. and the light which impinges on the multi-surfaced scanner is directed upwards through lens F on to the scanning drum B, which is also controlled by a special synchronous motor A. This drum provides the picture repetition frequency.

The relationship between the speed of the two motors A and E and the number of mirrors on the drum B and surfaces on the scanner at E ensure perfect interlacing and synchronism with the transmission. The mirrors on the drum B direct the picture forwards on to the rear of the screen, which is of ground glass or oiled silk or any similiar material. All the usual controls, focusing, brilliance and so on, are provided and the apparatus is almost fool-proof. The large cinema model may be operated by any ordinary cinema engineer and does not require to be handled by a television expert. In the home receiver the maximum voltage which is available at any one point is only 350 volts, so that it is no more risky to handle than a standard A.C. mains set. The screen in the provisional domestic models is made to draw out when required for use, and to push back into the cabinet when only radio is being received. Prices have not yet been definitely fixed, but it is hoped to place the receivers on the market in the New Year at a price in the neighbourhood of £70 or £80.

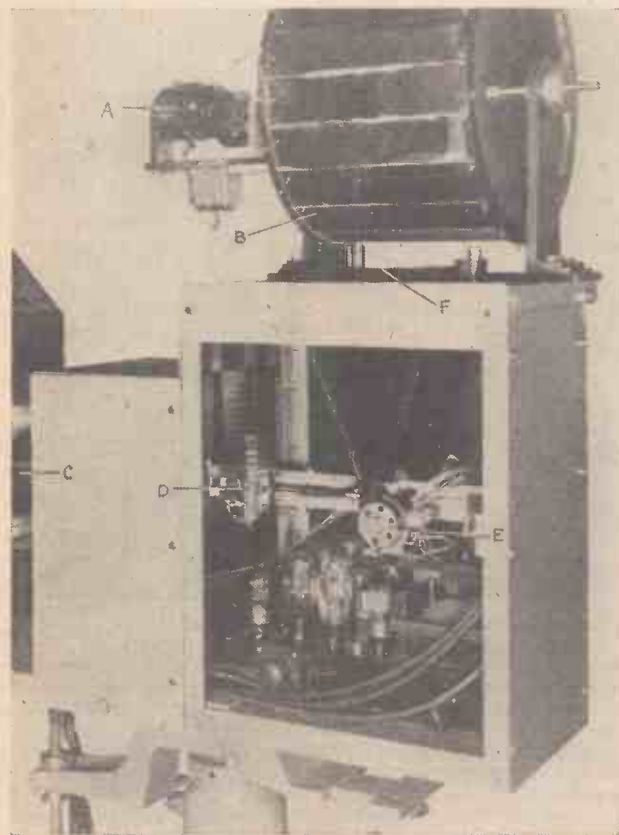

Interior view of the Scophony public hall projector which gives pictures approximating cinema standards of brightness up to 6ft. in size. The illustration shows the amplifier which drives the light control, and above the amplifier is seen the high-speed synchronous motor.

receiver, the size being 24ins. by 22ins., and the brilliancy and steadiness of the image being far in excess of that seen on the earlier models of large screen television. For the benefit of those readers who are not familiar with the Scophony process the following details will no doubt be of interest. The illustrations show the large screen model and a view of the interior. Unlike the present apparatus which is available, this system makes use of a mechanical arrangement by means of which the picture is projected on to a screen. The light source is a standard 100 amp. arc for large

second lens. It is obvious, therefore, that if a modulated R.F. is applied to the quartz the amount of light passed on will vary in intensity and time in accordance with the modulation of the R.F. The television signal is therefore applied to this quartz control and thus gives rise to a variation in the light

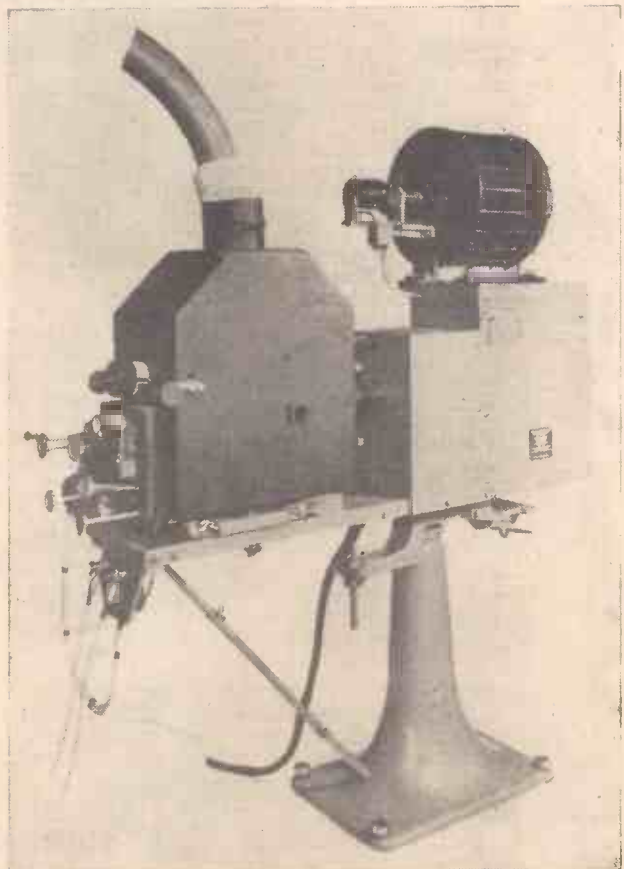

The Scophony television projector, for use in public halls. This model is for pictures 6ft. by 5ft.

## TELEVIEWS

### Very Necessary

THE recent remarks of Mr. Gerald Cock, the B.B.C. director of television, shows that he is fully alive to the necessity of improved facilities of viewing. An extension in programme hours is now under very careful consideration, but Mr. Cock has made it clear that if the present two hours per day was doubled (ignoring the morning film transmission, which is primarily for set manufacturers and dealers' demonstrations), then not only would a large increase in staff be necessary, but twice the studio space and equipment would be essential. The promised increased use of the mobile television unit would ease the studio situation, but there is no doubt that decisions on this point will hinge on the extent of the B.B.C.'s extra New Year grant. On the other hand, with Sunday, which is the day when most people are keen to put their television receivers into commission, programmes could be arranged, according to Mr. Cock, with existing equipment and but little addition to the staff. If this latter course was adopted, it is certain that television's popularity would increase enormously, for, generally speaking, this is the one day of the week when every member of the family circle is in a position to enjoy the transmissions. With manufacturers and dealers decrying the present lack of programme time it would be a good gesture on the part of the B.B.C. to meet the situation if Sunday transmissions were started straight away.

### Colour Television Again

ALTHOUGH the main body of television research is directed towards the successful transmission and reception of monochromatic television pictures, the subject of colour images makes an ever recurring appearance. At the receiving end the cathode-ray tube is being subjected to various forms of adaptation so that advantage can be taken of the varying colours of fluorescence which it is possible to reproduce according to the chemical content of the fine powder sprayed and bound on the tube face. Pictures of any single colour are, of course, an easy matter, the difficulty is in securing a correct blending of the primary colours so that the final image presented to the eye is a close approximation to the natural ones existing in the original scene or object transmitted. According to the latest reports, Mr. Baird has succeeded in achieving colour television pictures, thus recalling his efforts in 1928 when crude low-definition television images were shown by him by mixing the primary colours of red, blue and green. According to this same report the results of the work are to be featured on the large screen at the Dominion Theatre, London, for this is the only cinema at the moment which has a permanent television installation of this nature, one that is regarded as a television public address system.

### A Mechanical Scanner

THAT the Germans still have a measure of faith in mechanical scanners for television is borne out by the equipment made for Telefunken by Mechau. A lens drum replaces the apertured disc, and this is made up with three rows of lenses so that the top one can be employed for the scanning of continuously moving film. The other two rows function in conjunction with a spirally-rotated shutter in order to produce direct

scanning for scenes or objects of small compass, the actual signals being derived from the light-spot reflection on to banks of photo-electric cells. An arc lamp of very low amperage is used as the light source, while incorporated in the same equipment is the synchronising impulse generator. This is a disc, light source and photo-electric cell, both line and frame pulses of the usual rectangular shape and correct amplitude being provided for injecting the signals into the vision modulation at the proper intervals. Good results are claimed for this equipment, but the standard of definition employed is, at the moment, less than that used in Germany for the experimental service working.

### Demonstrations in America

THE Society of Motion Picture Engineers in America were recently given a demonstration of television by the Radio Corporation of America. For this purpose a total of twenty receivers were used, each giving a picture 9in. by 7in., in what was termed a neutral colouring. Transmission and reception occurred in the same building, although the signals were sent by cable to

### Flat Distribution

ALTHOUGH several alternative schemes have been suggested, the idea which seems to be favoured most at the moment for television signal distribution in flats is that in which the set receives a signal exactly similar to that obtained from a normal ultra-short-wave aerial, while the set itself functions as if it was fed from a separate aerial. In one arrangement a number of main cables pass from the distribution amplifier, these cables being laid along separate sections of the flat building with individual tappings taken through junction points to each suite of rooms where the amenities of television reception is to be provided. The amplifier itself has to be of a special design capable of maintaining sufficient overall gain at the carrier frequencies of 45 and 41.5 megacycles. Up to as many as one hundred sets can be furnished with adequate signals from one compact amplifier, but steps have to be taken to ensure that the A.C. mains do not vary more than a predetermined margin. The amplifier is, as a rule, situated close to the aerial, this last-named being on



"Cooking" Machines at the G.E.C. Factories at Witton.

the radio transmitter a few hundred yards away, and radiated back again. In addition, large pictures, about 4ft. by 3ft., were shown on a screen using cathode-ray tube projection, and in both cases the results were claimed to be satisfactory. David Sarnoff pointed out subsequently that in his opinion it was essential for members of the film industry to pay increasing attention to television developments. In the States it is also reported that the Bell Telephone Laboratories are carrying out experiments by sending a complete film as a television signal over cable. As there is likely to be a measure of difficulty in linking up cinemas by radio, the use of suitable cable connections is being put forward as a substitute, and any developments that arise from work of this nature are therefore likely to assume a high degree of importance as time goes on.

the roof, so orientated that the resulting signal has the maximum possible signal to noise ratio. Furthermore, the amplifier is controlled through the medium of a time switch to ensure that it is operative only during those periods that the B.B.C. television signals are being radiated. Interaction between neighbouring receivers is prevented by maintaining an attenuation of from 40 to 50 decibels between them by means of a resistance network. Another interesting suggestion for flat working is to simulate the methods of a radio relay service where a subscriber merely pays a hire fee for the use of a loud-speaker. With the television proposal a subscriber would purchase or hire a cathode-ray tube to act as the picture reproducer and a loud-speaker. The scanning, focusing, modulation and power feeds are passed through a special type of cable so that the initial costs to the user should be reduced. On the other hand, a cable capable of handling all the signals necessary for the successful operation of this scheme is most intricate and expensive, and at the moment has not materialised beyond the experimental stage.

### NEWNES' TELEVISION AND SHORT-WAVE HANDBOOK

3/6, or 4/- by post from  
GEORGE NEWNES, Ltd., Tower House,  
Southampton Street, Strand, London, W.C.2.



# The Art of S.-W. Listening

This Article, and Accompanying Tables, are Intended as a Guide to the Best Periods of the Day for Listening on Particular Wavebands

**L**ISTENERS below 100 metres are well aware of the almost fantastic inconsistency of the majority of the ultra-short-wave stations. The station that may be received on Tuesday at almost embarrassing loudness may be impossible to tune in on Wednesday; alternatively, stations which are received strongly at seven o'clock may disappear entirely at eight o'clock, while stations that are more or less generally receivable in the autumn may be hard to get in the spring.

An investigation the writer has carried out with a hundred fortunate possessors of all-wave receivers, showed that about three of them were capable of getting the best, twenty-four were capable of getting pleasing results, while seventy-three had reached various stages of bitter disappointment because they were unable to get anything worth while.

Assuming that the set is all that it should be, and the aerial system is suitable, there are three factors which govern success and failure:—

(1) Patience—a virtue which is outside the scope of this article; (2) Carefulness of touch—the necessity for which on ultra-short waves is generally appreciated; (3) The proper appreciation of time and waveband. Time and waveband interconnect, and it is the purpose of this article and the accompanying tables to indicate what times are appropriate for various wavebands. Table 1 is intended for use at those times of the day when the path between transmitter and receiver is in daylight, and table 2 when the path between transmitter and receiver is in darkness.

## Reception Conditions

These tables are intended to be a guide when reception conditions are normal, and are necessarily of an approximate nature; take an example from table 1. It will be seen that the 75-metre band in daylight may be expected to bring in those stations up to 400 miles only, whereas the 16-metre band will bring in those stations between 600 miles and 7,000 miles. On the other

hand, the 16-metre band during darkness, see table 2, will bring in nothing at all, whereas the 50-metre band will bring in stations at all distances up to nearly 7,000 miles. A glance at the appropriate table will clearly show which wavebands are most likely to prove profitable.

There are, of course, various combinations of light and darkness, but to produce a table which brought in this very variable factor would be complicated to the point of uselessness. These tables, therefore, while being helpful when total daylight or total darkness is met with at the particular time, do not give information appropriate when the sunset is between transmitter and receiver (the transmitter path is therefore part daylight and part darkness), but the tables serve a very useful purpose in indicating the manner in which the correct waveband varies as the clock goes round. Even if they do no more than illustrate the uselessness of listening on certain wavebands at some hours of the day, they are well worth the serious attention of ultra-short-wave listeners.

In order to make these notes helpful, and as complete as possible, one or two rules regarding the choice of wavelengths will be found of assistance, and their intelligent use will make ultra-short-wave listening a revelation to those who are in the habit of tuning blindly over the whole dial. On the ultra-short-wave band the most rough and ready rule for English listeners is "the later the hour the longer the wavelength."

## Reception Outside Europe

In the morning and afternoon 13- and 16-metre wavebands will be found most profitable for long-range reception; in fact, for reception outside Europe they will almost invariably be found the only wavebands that will yield anything at all. For example, when American music is required at tea time, the 16-metre band is usually the one to use. As the day wears on and twilight approaches, reception on the 16-metre band will fall off, while the 19-metre band will become alive and will hold good until darkness has nearly set in when attention may be turned to the 25-metre band, and then to the 31-metre band. Eleven months in the year satisfactory reception on the 25-metre band is usually of such short duration that many experienced listeners move straight from the 19- to the 31-metre band without bothering about the 25-metre band, unless, of course, there is some desired station working on the 25-metre band that does not transmit on either of the other two. Later on, ten, eleven or 12 o'clock at night,

the 49-metre (sometimes called the 50-metre band) will prove not only the most profitable band but also the most pleasing to the average listener who requires entertainment, as by this time the Americans, who are, of course, five hours behind us, are just warming up to their evening programmes.



Complaints of interference in reception by radio users, which are especially noticeable on short waves, are investigated and tracked down by special G.P.O. radio detectives armed with apparatus which has proved very successful.

It should be fully understood that the time of day is not the ruling factor, but the hour of sunset; consequently, the 19-metre band will be suitable for reception in December at 5 o'clock, but it would not be suitable for reception in June until much later. Similarly, while the 15-metre band at this time of the year will prove useful from ten o'clock onwards, it is usually quite different as far as the American stations are concerned until around midnight in midsummer.

Those who care to go to the trouble of starting in the afternoon and listening continually, passing from one waveband to the one above systematically, will find that the broadcasting stations which have transmitters in each group, take over transmitting progressively, in the same way that a relay runner takes over the baton from his colleague who has traversed the preceding lap. All this may sound very complicated, but the principle is obvious, namely, searching should be confined to one or two suitable wavebands, if short-wave listening is to be quickly mastered. The little time thus spent will be rewarded many times over with more stations, and the programmes giving real service.

TABLE No. 1.

Applicable when the path between transmitter and receiver is wholly in daylight.

Waveband	Zone of Reception
13 metres	800-8,500
16 "	600-7,000
19 "	475-4,750
25 "	325-1,900*
31 "	260-1,400
49 "	50-600
75 "	0-400

While the above figures are necessarily of an approximate nature, the figure marked\* is liable to particularly wide variation.

TABLE No. 2.

Applicable when the path between transmitter and receiver is wholly in darkness.

Waveband	Zone of reception
13 metres	nil
16 "	nil
19 "	2,000*
25 "	1,000-10,000
31 "	600-9,000
49 "	100-7,000
75 "	0-5,500

\* Reception sometimes possible at a critical distance of approximately this figure.



# THE BRITISH LONG-DISTANCE LISTENERS' CLUB

## Insulated Ganging

IN the course of experimental work it is often found necessary or desirable to insulate certain components although they need to be ganged together. An instance is in the case of two condensers of the short-wave type which may be used, one in the aerial circuit and the other in the anode circuit. Obviously, separate components will have to be used, but the operating spindles must be kept electrically separate. A very good method of doing this is to use the insulated couplers which are now available from several sources. The accompanying illustrations show two types which are supplied by Messrs. Bulgin, and with this it is possible to make various

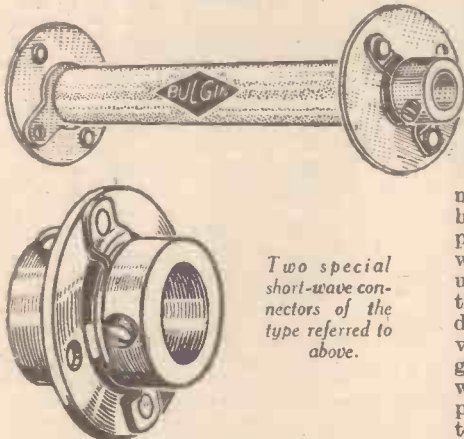

Two special short-wave connectors of the type referred to above.

types of apparatus. The smaller coupler, for instance, could be used where two ganged condensers are employed and the spacing must be kept down in order to reduce the length of wiring, whilst the long model could be used if it were desired to control a component at a distance. The material fitted to these components is of the special type designed for use on very high voltages and this will ensure good insulation on short-wave equipment. It is, of course, possible to use a number of these ganging controls in series, or to couple together more than two items, and the method of attaching the locking collar to them overcomes any difficulty in rotation which might arise if the components are not mounted in true relationship.

## The Super-regenerative Set

A new member has written to ask what is the most important feature of the super-reg. receiver, and why it is not popular in these days. Actually, of course, in the early days of broadcasting it was commonly used by amateurs, but it died out when valves became cheaper. It is, however, a very popular circuit amongst short-wave enthusiasts, and is the type of circuit which is now employed in many of the small Police radio outfits and similar types of equipment. This is because it is found that it gives its best results on the ultra-short wavelengths and is much more efficient down there than on the broadcast wavebands. It is actually an improved reacting detector circuit, where the constants are so arranged that a separate frequency is generated and this frequency is above audibility. The effect of this oscillation

is to quench the valve and thus when a signal is received the oscillations are constantly stopped and started, with the result that the signal can build up to a very high value before the valve "spills over." In the ordinary reacting detector, of course, the limit is reached long before maximum signal strength is obtained as the valve "bursts into oscillation." Those members who are anxious to try out a good ultra-short-wave battery set, therefore, should not overlook the possibilities of this type of receiver, and the necessary quench coils which are used for the circuit may be obtained from any good radio dealer or direct from Messrs. Stratton, makers of the popular Eddystone components. It has been found possible to get quite good signals with this type of receiver right down to 1 metre.

## Television Reception

Some members are still trying to obtain successful pictures from the television transmission by means of disc receivers. Although it is quite interesting to try and make apparatus for this purpose it must be borne in mind that the high-definition pictures are exceedingly difficult to deal with, and the fact that the picture is built up of two sets of lines interlaced renders the task even more difficult. The scanning disc would have to be perforated with a very large number of holes, and this would greatly reduce the amount of light which would pass, and therefore a very dull picture would be seen, even if you managed to obtain a satisfactory system. So far as we are aware, however, it would be impossible to make a receiver of this type—although it is always risky to make definite statements in connection with new sciences. There is, of course, one satisfactory mechanical system for receiving the present transmissions and this is described on another page in this issue. It does not utilise a scanning disc, however, but is a combination of a mirror-drum and an oscillating prism. Of course, if any member does succeed in building up a mechanical receiver with satisfactory results we should be pleased to receive details, and we are sure that the scheme would be of great interest to other readers of this paper.

## THE WIRELESS CONSTRUCTOR'S ENCYCLOPÆDIA

By F. J. CAMM 4th Edition 5/- net.  
(Editor of "Practical and Amateur Wireless")

Wireless Construction, Terms, and Definitions explained and illustrated in concise, clear language.

From all Booksellers, or by post 5/6 from George Newnes, Ltd., Tower House, Southampton Street, Strand, London, W.C.2.

## REPLIES IN BRIEF

The following replies to queries are given in abbreviated form either because of non-compliance with our rules, or because the point raised is not of general interest.

**W. MacL. (Glasgow, W.3).** The blueprint should be suitable and may be obtained for 1s. The coils should be obtained in your district, but in the event of any difficulty we suggest you write direct to the makers, Messrs. Wright and Wearie, 740, High Road, Tottenham, N.

**T. O. (File).** The circuit as drawn by you is perfectly correct, and therefore failure to get signals must be due to a faulty component or wrong wiring. Although the coil may have been tested, is it connected correctly?

**A. H. (Leicester).** The voltage used for the valve may be too high. Is the valve of the indirectly-heated type? If not, you will find it difficult, if not impossible, to obtain satisfaction from the ordinary type of valve.

**H. J. W. (Dagenham).** We cannot supply a blueprint for a car radio receiver. The only details available are those included in the article on car radio in our issue dated November 20th last.

**J. W. N. (Queensbury).** The transformer may be obtained from Messrs. Heayberd. We regret that we are not familiar with the H.F. unit mentioned.

**F. G. (Rugby).** Messrs. Peto-Scott, or E. Parousi, of Featherstone Buildings, London, W.C., can supply the required chassis. We do not advise more than 3ft. for the leads in question.

**D. M. S. (Low Fell).** We regret that we cannot supply a diagram or blueprint for your particular requirements. You will find it difficult to obtain the desired results from a battery-fed amplifier.

**A. D. (Lr. Edmonton).** The article which appeared in our issue dated December 4th on using a pick-up will probably enable you to overcome your difficulties.

**G. H. (Camborne).** We regret that the blueprint of the only receiver in which the tuning unit was employed has now been withdrawn and no further copies are available.

**H. A. B. (Weston-Super-Mare).** We refer you to our issue dated November 20th last. No blueprints are available.

**J. M. (Laurencekirk).** We can supply blueprints of simple receivers, and issues are available in most cases in which the instructions for building will be found. For a beginner, we suggest the Centaur Three.

**F. T. (Thornaby-on-Tees).** The rated output of the amplifier in question is slightly above 1 watt.

**J. S. E. (Orpington).** So far as we can trace the makers are no longer in business. A good dealer should be able to trace out the connections for you.

**E. J. B. (Nuneaton).** The Benjamin Transfeeda could be used, or any standard L.F. transformer plus a resistor and fixed condenser. The component you refer to is simply a parallel-fed L.F. transformer.

**F. P. (Middlesboro').** An aerial as mentioned would no doubt be an improvement, but it is always worth while experimenting in order to find the best arrangement especially as your set includes short waves.

**C. B. (Bristol, 2).** The counter is a standard Veeder product and should be obtainable at your local cycle or car store.

**W. S. S. (Wembley).** Between 1 and 3 the aerial coil is joined and therefore failure to obtain a reading indicates that the coil is broken or disconnected.

**W. D. C. (Blackburn).** The device in question is not suitable for a crystal set and we refer you to our 1937 crystal receiver in which we utilised a permanent type of crystal detector.

**T. M. (Darlington).** We regret that we cannot supply components for our receivers, but these may be obtained from Messrs. Peto-Scott or the firms whose products we utilise.

**W. A. A. (Truro).** Coil No. 8 is for a superhet and thus you would have to utilise this type of receiver. We have not used the combination mentioned for some considerable time and cannot supply you with a blueprint or circuit for the purpose.

**L. R. (Southgate).** You could use the pentagrid (or an octode) but it would be desirable to retain the triode-hexode valve specified.

**W. R. J. (Bromley).** As recently mentioned in these pages, you should ascertain from the makers that the receiver is suitable for use with a pick-up. Our Christmas number gave details for connecting a pick-up to a standard receiver.

**J. O'B. (Dublin).** The coil was not used in any of our receivers, and we believe it was designed by a contemporary. We are, consequently, unable to help you regarding the connections.

**E. M. R. (Rotherham).** The trouble is due to interference on the carrier wave and you cannot remedy it. We have no details of the horn motor and therefore cannot advise you concerning its use.

**J. W. (Earlestown).** You will find all the details you require in our latest book, "Coils, Chokes and Transformers." We could not give details for all the coils you require in the form of a reply.

**B. M. (Newport, Mon.).** Messrs. Philco market a special indoor aerial which will suit your requirements. Alternatively, you could use a Pix or a wire suspended round the walls of the room.

**R. R. G. (Glasgow).** We regret that we could not give full coil winding details for the set you mention in the form of a reply. We suggest you obtain a copy of our latest book, "Coils, Chokes and Transformers," in which the information will be found.



# RADIO CLUBS & SOCIETIES

Club Reports should not exceed 200 words in length and should be received First Post each Monday morning for publication in the following week's issue.

## THE CROYDON RADIO SOCIETY

THE Press had its say for the Croydon Radio Society's meeting on Tuesday, December 7th, in St. Peter's Hall, S. Croydon, when the lecturer was Mr. Garry Allighan, who spoke on: "Searchlight on the B.B.C." He considered the B.B.C. approached programmes with the view that it had a mission to educate and uplift the public. It was useless to try and make the whole country University- or Mayfair-minded, as the working class was not unduly interested in Bach or Swedish drama. What such a section, at least, wanted was a type of light entertainment easy to assimilate, but this, Mr. Allighan insisted, was provided in only a very small amount. He went on to doubt if many people were at the moment really listening to B.B.C. programmes, but rather to foreign ones.

Mr. C. L. Amos, hon. treasurer, took the lecturer to task for believing that listeners did prefer sponsored foreign broadcast matter. The majority he regretted, only listened semi-consciously, and more discriminating listeners would surely help towards a cure. Mr. Fletcher also hoped profoundly that the B.B.C. would never descend to the low programme level achieved by certain continental advertising stations.

Finally, it was agreed by all that our annual ten-shilling licence was cheap at the price, considering what we got for it. The society would like to wish the Editor and Staff of PRACTICAL AND AMATEUR WIRELESS a very happy Christmas and prosperous New Year. Hon. pub. sec., E. L. Cumbers, Maycourt, Campden Road, S. Croydon.

## BRADFORD SHORT-WAVE CLUB

ON Friday, December 10th, the Bradford Short-wave Club held their usual meeting at Bradford Moor Council Schools. Mr. Simpson (2BX5) brought with him his 'phone transmitter, and a number of experiments were carried out on the premises. The club holds an A.A. licence, of course, with the call-sign 2BWC.

There will be no meeting on Friday, December 24th, Christmas Eve, but the club meets as usual on December 31st. Anyone requiring any details of the club should write to the secretary, S. Fischer, Edenbank, 10, Highfield Avenue, Idle, Bradford, Yorks.

## KIDDERMINSTER AND DISTRICT RADIO CLUB

THIS club is now nearing its first anniversary and the membership is now 20. We first started on Morse, and now we are on constructional work, which adds to the interest on club nights. The club hopes to be transmitting early in the New Year. We meet twice monthly at the Clubroom, Railway House, Prospect Hill, at 8 p.m., on Monday nights. Readers residing in the Kidderminster district who are interested please write to the secretary, Harold A. Brown, 12, Stourport Road, Kidderminster.

## TOTTENHAM SHORT-WAVE CLUB

IN common with other clubs, we are arranging many talks and debates during the winter months, and these were opened by the hon. sec. on the 6th of this month with an interesting talk on factory production.

The club has commenced a competition among the members to find the member who can log the largest number of short-wave stations between December 1st and March 31st, 1938. A prize will be subscribed for and presented to the winning member. Owing to the tremendous success of the last Visitors' Evenings, it has been agreed that the club will endeavour to repeat these during the month of January, 1938. Full particulars of the club will be forwarded on receipt of a postcard to the hon. sec., Edwin Jones, 60, Walmer Terrace, Firs Lane, Palmers Green, N.13.

## MAIDSTONE AMATEUR RADIO SOCIETY

THE above society, which has been in existence since August, 1937, is now flourishing, having a membership of twenty-two, including five holders of A.A. licences, Radios 2BFW, 2BMP, 2BT1, 2BXW, and 2DBA, and one full call holder, 68UC.

The large clubroom, which has now been fitted with heating, can be opened on request on almost every evening, Wednesday and Saturday afternoons, and Sundays, in addition to meeting nights, so that members have plenty of opportunities of carrying out any experiments or work on the large work bench, especially now that a high aerial has been installed.

At recent meetings, the provisional code of rules was revised, retabulated, and augmented, being divided into two sections, general society rules, and clubroom rules.

Mr. Harold Goldsmith, a very well-known figure in Maidstone radio circles, has recently consented to become the president of the society, and has received a hearty welcome by the members. The library, under the direction of Mr. W. J. Gribbin, is progressing very well, now embracing nearly 400 radio magazines.

The subscription is a nominal entrance fee of 6d., followed by a weekly subscription of 3d. Meetings are held in the clubroom, 244, Upper Fant Road, Maidstone, at 7.45 p.m., every Tuesday evening, during which many interesting lectures and code practice will be given.

Anybody interested in radio matters in general, short waves, or transmitting, with a technical knowledge, however slight (one of the objects of the society is to help beginners who really want to learn), will be heartily welcomed into the society, and is invited to come along to the meetings, or, if they require further information first, to get in touch with Mr. P. M. S. Hedgeland (2DBA), honorary secretary, 8, Hayle Road, Maidstone.

## THE EXETER AND DISTRICT WIRELESS SOCIETY

AT the meeting of the Exeter and District Wireless Society held on Monday, November 29th, members were taken over the electricity generating station by Mr. Cornish, of the electrical branch, and members were very interested in the automatic stoking, turbo-generators, and control room. The room containing the switchboard was particularly interesting, and the system of control from Bristol by the Central Electricity Board was explained.

At the meeting of the club held on Monday, December 6th, a lecture was given by Mr. Cornish, of the General Electric Company, on short-wave reception. He traced its growth from its inception to the present day, but the most interesting part of his talk was on the various types of aerial which can be used to give best results on the short and ultra-short waves. Directional and reflective aerial systems were described in detail, and in particular the Bruce aerial came in for quite a lot of comment from the members. It would seem, however, that most of the members present showed preference for the inverted-V aerial for most consistent results.

Meetings are held each Monday at 3, Dix's Field, Exeter, at 8 p.m., and all those interested should get in touch with the secretary, Mr. W. Ching, 9, Sivel Place, Heavitree, Exeter.

## SWINDON AND DISTRICT SHORT-WAVE SOCIETY

AT the meeting held on December 9th, the chairman, Mr. E. W. Mortimer (2BMM), demonstrated various makes of moving-coil loudspeaker, including the new WB Stentorian. The chairman's paraphrase amplifier, and frequency response records were used for this interesting demonstration. The next meeting is on January 6th.—Hon. sec., W. C. Barnes (2BWB), 7, Surrey Road, Swindon.

## THE SLOUGH AND DISTRICT SHORT-WAVE CLUB

AT the December 7th meeting of this club another of our very popular junk sales was held, and Mr. Paine (G6PR) gave a most interesting and instructive talk on aerials, and answered many questions on the subject. The question of club notepaper was discussed further, and it was decided to begin a publicity drive to increase the membership. Even the veriest tyro is welcome, and for the benefit of beginners a series of lectures on "the fundamentals of radio" will be given by Mr. K. Sly, the first of which is to be given at the next meeting, on December 24th, and the construction of a simple short-wave receiver, which will also be commenced at the next meeting, will provide practical instruction. Anyone interested will be heartily welcomed at our fortnightly meetings, whether they are newcomers to radio or veterans. Further particulars may be obtained from the secretary, J. H. White (2DAJ), 20, Chalney Road East, Slough, Bucks.

## OUR FREE CATALOGUE SERVICE

To save readers trouble, we undertake to send on catalogues of any of our advertisers. Merely state, on a postcard, the names of the firms from whom you require catalogues, and address it to "Catalogue," PRACTICAL AND AMATEUR WIRELESS, Geo. Neuge, Ltd., Toner House, Southampton St., Strand, London, W.C.2. Where advertisers make a charge, or require postage, this should be enclosed with applications for catalogues. No other correspondence whatsoever should be enclosed.

## RADIO LABORATORY INSTRUMENTS

IN a new 80-page catalogue just issued by Claude Lyons, Ltd., 40, Buckingham Gate, London, S.W.1, a comprehensive range of semi-laboratory precision instruments and components are listed. The apparatus is intended for use in the small electrical and radio laboratory, as well as by advanced experimental workers, and technical colleges. Radio servicemen will also find several pieces of test-apparatus of particular use to them for critical and accurate work. Amongst the instruments listed are signal generators and oscillators, wavemeters, output-power meters, vacuum-tube and zero-current voltmeters, "Roto-Ranger" volt-ohm-milliammeters, and oscillographs and their accessories. Vacuum tubes, photo-electric cells, bridges, calibrated volume controls, rheostat-potentiometers, variable condensers, "instrument" type dials and "Raytheon" voltage regulators are also listed. Readers interested in any of the high-class instruments catalogued can see them at the forthcoming Annual Exhibition of the Physical Society, to be held at the Imperial College of Science, South Kensington, London, S.W.7, on January 4-6, 1938. The catalogue, which is well illustrated, is priced at 1s.

## THE POPULARITY OF SCHOOL BROADCASTING

ACCORDING to a recent announcement by the B.B.C., the closing down of School Broadcasting for the Christmas holidays marks the end of a record term. There are over 7,000 schools on the official register, as compared with 5,645 last year. In certain cases as many as 4,000 schools have been listening to a single series.

During the term just ended, schools have heard straight talks on travel and current affairs; dramatic episodes from British and world history; talks on nature study and gardening; feature programmes bringing the world to the classroom; music; modern languages; and a brand new course entitled "Our Village."

Travel Talks have again proved the most popular items in the school programme, with 4,402 schools listening to them. Hard on their heels in order of popularity came Nature Study with 4,072 schools, Regional Geography with 3,307, and World History with 3,188. Miss Ann Driver's Music and Movement broadcasts for very young children, and rather older ones, have broken all their previous records.

Over a hundred adults have written expressing their praise or criticism of the School Broadcasting service, and well over 300 children have written to broadcasters and producers with, in many cases, pertinent comments.

Most brutal of these, maybe, was the child who wrote from Lancashire to say what he thought about a talk dealing with drought in Egypt. "It were all about drought," he said, "and it were dry." A valuable appreciation of broadcasting quality was unconsciously made by another child who wrote to praise a certain broadcaster, saying that owing to her "childlike way of speaking" she was readily understood.

## BOOK RECEIVED

A NEW issue of the B.B.C. Music Programmes booklet contains details of music programmes and other general information concerning music to be broadcast during the first quarter of 1938. The booklet includes details of the B.B.C. Symphony Concerts at Queen's Hall, the Sunday Orchestral Concerts, and the most important outside broadcasts, such as those of the Royal Philharmonic Society, the City of Birmingham, the Scottish and Reid Orchestras, and the Hallé Society. It also contains details of the new Music Productions Unit (Studio Opera) and of the main musical fixtures in the Regions. An index of composers whose works will be broadcast during the quarter is again a feature of the present issue.

"B.B.C. Music Programmes, January to March, 1938," may be obtained free and post free, on application by post to the B.B.C. Publications Department, 35, High Street, Marylebone, London, W.1, or on personal application to Broadcasting House, Portland Place, London, W.1. The pamphlet may also be obtained from any B.B.C. Regional office. Envelopes and postcards should be marked "Pamphlets" in the top left-hand corner.

**Practical Mechanics**  
**Big Xmas Number**  
NOW ON SALE—6d.





## Impressions on the Wax

**T**AUBER turns to the films this month for his latest recording on Parlophone RO 20367. "Sympathy," from the film "Firefly," is on one side, whilst on the reverse is "Can I forget You," from "High, Wide and Handsome."

In the Parlophone Company's historical series of voices from the past they present this month "La Sonnambula" (Act 1, Amina's Aria, part 1), "Come per me sereno," sung in Italian with piano accompaniment by Maria Barrientos. It was acoustically recorded in 1906.

In the classic series Parlophone R 2452 is an operetta in brief. It features Margarete Slezak, soprano, and Erich Zimmermann, tenor, in "Die Fledermaus," supported by a chorus and orchestra from the State Opera, Berlin. Other interesting records in this series are "Famous Operettas Potpourri," by the Grand Symphony Orchestra, on Parlophone R 2442, "Farewell to the Volga" and "Two Peasants in Petrograd," by the Russian Choir; "Boyar," conducted by Dr. Eugen Swerkoff, on Parlophone R 2441, and "Chopin Melodies" and "By the Fireside" on Parlophone R 2443, played by Frederic Hippmann and his Orchestra.

### Light Records

**R**ONALD FRANKAU, the popular radio comedian, has made an amusing record on Parlophone R 2451 which should be popular at Christmas parties. "Freddie's Got a Lot to Learn" and "It's an Overrated Pastime after all" are the titles, and he is accompanied by Monte Crick at the piano.

Harry Roy and his Orchestra have made three new records introducing a number of popular tunes, and Harry Roy's Tiger Ragamuffins have recorded "You Made Me Love You" and "Where did Robinson Crusoe go with Friday on Saturday Night" on Parlophone F 936.

Leslie A. Hutchinson, better known as "Hutch," sings one of the most popular tunes of the moment, "Little Old Lady," on Parlophone F 946, coupled with "If it's the Last Thing I do."

An ideal record for Christmas is a Paul Jones in strict dance tempo on Parlophone E 11339.

Still keeping up the Christmas spirit, we have "Christmas Medley" on Parlophone F 954, played by H. Robinson Cleaver at the organ of the Union Cinemas' "Regal," at Bexley Heath. Such old-time favourites as "Little Brown Jug," "Tavern in the Town," "Drink to Me Only," etc., are included. Whilst on medleys there is "Popular Hits Medley," on Parlophone F 960, played by The Kerbside Crusaders.

The kiddies have not been forgotten, as the Parlophone Company have recorded twelve of the best-known children's songs on six 10-in. double-sided records complete in a portfolio for 12s. complete. Single records may be obtained separately for 2s.

### H.M.V.

**A** REMARKABLE record produced by the H.M.V. Company this month is the re-creation of one of Caruso's records, in which a new full orchestral accompaniment is superimposed over the old one. The effect is that of a modern recording of the famous tenor singing Tosti's "Addio" (Good-bye) and "Parted." The number of the record is H.M.V. DB 3327. Of living tenors, Gigli gives a fine rendering of "Celeste Aida" and a duet, "O Soave Fanciulla" (O Lovely Maiden), from "La Bohème," with Maria Caniglia, on H.M.V. DB 3225.

The new Scandinavian tenor Jussi Bjorling, who appeared in London with great success, has a voice similar to Caruso. For recording purposes it is ideal and his latest disc, H.M.V. DA 1582, gives "O sole mio" and Tosti's "Ideale," both exacting tests.

Schubert, surely one of the most recorded of composers, is yet again represented by one of his longer songs, "Der Hirt auf dem Telsen," sung by Elisabeth Schumann with piano and clarinet accompaniment on H.M.V. DB 3361.

### The Royal Variety Performance

**T**HERE are new records by several of the artists who appeared at the Royal Variety Performance. Max Miller is heard in "The Christmas Dinner," in which he is very funny, and in an almost straight song, "Just Another Sally," on H.M.V. BD 475. Cicely Courtneidge sings two of the new numbers from the new show "Hide and Seek," in which she is now playing, "May belle" and "Follow the Bride," which latter is a variant on the theme "Always a Bridesmaid, never a Bride,"—H.M.V. BD 674. Ethel Revnell and Gracie West, who have never recorded previously, give a humorous impression of two cockney children describing "The Steamboat Trip," coupled with one of their grown-up numbers, "We're Still Single To-day," on H.M.V. BD 473.

Other light vocal numbers include Nelson Eddy of film fame in two simple ballads, "Smilin' Through" and "A Dream," on H.M.V. DA 1590. Louise Browne and Roy Royston in duets, "A Little Co-operation From You," and "The Sheep were in the Meadow," both from the film "Going Greek."

### A Medley Selection

**O**F medleys and vocal selections there is plenty to choose in the following: Ivor Novello presents a number of popular vocalists including Olive Groves and Patrick Waddington in "My Earlier Songs," on H.M.V. C 2965 and Dorothy Dickson sings many of her successes on H.M.V. C 2946. Elsie Carlisle also revives memories in her medley on H.M.V. BD 476, and Denis Noble has a fine selection entitled "Famous Ballads by Frederick Weatherly," on H.M.V. C 2958. They include such old favourites as "Midshipmite" and "The Deathless Army."

## LEAVES FROM A SHORT-WAVE LOG

### More Short-wave Broadcasts from Brazil

**N**IGHTLY between G.M.T. 00.00 and 02.00, a programme from PRF4, a medium-wave transmitter at Rio de Janeiro may be picked up through PSH, Marapicu (Brazil) on 29.35 m. (10.22 mc/s). PRF5, Rio de Janeiro, on 31.58 m. (9.501 mc/s), the short-wave station of the Brazilian Government, broadcasts daily between G.M.T. 21.15-23.00 in the Portuguese language followed by a transmission in English, Esperanto, German, Spanish or French, according to a weekly rota. This foreign talk is styled: *The Brazilian Hour*. PRA8, Pernambuco (Brazil) on 49.76 m. (6.028 mc/s) is reported to have closed down.

### And from the Argentine

From Buenos Aires two programmes can be regularly captured, namely from LR3, *Radio Belgrano*, via LSK3, Hurlingham, on 29.27 m. (10.25 mc/s) and from LR1, *Radio el Mundo*, via LRU, on 19.62 m. (15.29 mc/s) and LRX, on 31.06 m. (9.66 mc/s). Special programmes in English are broadcast every Monday and Friday between G.M.T. 22.00-23.00. In the ordinary way, LRX is on the air daily from G.M.T. 14.30-04.30.

### Japan's December Schedule

Two 50-kilowatt transmitters are being used during December and January for the broadcast of the Tokio news and war bulletins. They are JZJ, Nazaki, 25.42 m. (11.8 mc/s), and JZI, 31.46 m. (9.53 mc/s). Simultaneous transmissions through both stations are carried out from G.M.T. 20.00-21.00 for European listeners; from 21.30-22.30 for dwellers on the Atlantic seaboard of the United States and South America; from G.M.T. 05.30-06.30 for the Pacific Coast, Canada, Hawaii, etc., JZI, alone broadcasts between G.M.T. 13.00-14.00 for listeners in Oceania.

### Prague's New Time Table

OLR5A, on 19.69 m. (15.23 mc/s) and OLR3A, on 31.41 m. (9.55 mc/s), both situated at Podebrady, near the Czechoslovakian capital, are now responsible for all short-wave broadcasts from Prague. The new time table is as follows: G.M.T. 11.30-12.30 (OLR5A); 15.10-16.00 and 17.55-21.15 (OLR3A). The Radio Journal or News Bulletin is transmitted daily at G.M.T. 21.30.

### The Argentine via Uruguay

Should you tune in CXA8, Montevideo (Uruguay) now operating on 31.12 m. (9.641 mc/s) you may chance to hear the call of LR3, *Radio Belgrano*, Buenos Aires (Argentine Republic) as the Uruguayan frequently takes his programmes from this source. The station has been heard working until G.M.T. 06.30, and, in addition to its call-sign, announces itself as *Radio Colonia*.

### Amateur Club on 30-Metre Band

The Radio Club of Zurich (Switzerland) under the call-sign HB9D broadcasts twice weekly on 31.46 m. (9.535 mc/s); the times are G.M.T. 14.00-16.00 on Sundays, and on Thursdays from G.M.T. 18.00-20.00. Reports of reception—with full details if verification is desired—should be sent to Radio Club, Zurich (Switzerland).





# LETTERS FROM READERS

The Editor does not necessarily agree with the opinions expressed by his correspondents. All letters must be accompanied by the name and address of the sender (not necessarily for publication).

### Station HJ7ABD

SIR,—In the "Leaves from a Short-Wave Log" column in your issue of December 11th, you give the call-sign of Radio Bucaramanga as HJ2ABD. Some time ago I received a station on 31.17 metres, approximately, which was announcing itself as "Emisora HJ7ABD, Bucaramanga, Colombia, en America del Sud." I am certain of this because I was using a 5-valve superhet at the time, and HJ7ABD was coming over at a good R8 on the loud-speaker. The call-sign, wavelength and location, etc., were given frequently in English. I took particular notice of this station because I had previously thought that Colombia was divided into five districts and that the highest was HJ5. I have sent for a QSL which I am expecting in the near future, and as soon as I get it I will forward it to you.

Wishing yourself and staff a Merry Christmas and a Prosperous New Year and looking forward to many more issues of your excellent journal.—W. PEARSON (Ulverston, Lancs).

### The "Simplest" Two Valver Aboard Ship at Athens

SIR,—Let me fall into the ranks of the many admirers of your "Simplest" Short-wave Two, and hand you a "bouquet" for a really efficient little set.

It was very easy to build, and what's more it works seemingly under adverse conditions. We have eight receivers in the ship ranging from American multi-valvers to my little two-valver, but the former haven't a chance. As I am writing the announcer at Dav. is literally jumping out of my 'phones at good R8 strength, as clear as a bell.

My aerial is 50ft. long, absolutely vertical over the set. Some of the stations I've received are: W1XK, 8XK, 2XAD, 2XAF; PCJ, DJN, DAF, and several amateurs. The former stations were at good R6-7 strength.

Wishing your paper, PRACTICAL AND AMATEUR WIRELESS, every success.—J. W. BRETT (H.M.S. Garland, Athens).

### A Reader Wins a U.S.A. Silver Trophy

SIR,—Having been a reader of your magazine for a considerable time I feel that I am doing right in writing this, my first letter to you. I read the short-wave section very carefully, and should like to take this opportunity of informing you of something that I have accomplished. Being a short-wave "fan" and experimenter, I naturally obtain all the "dope" I can about short waves and this forces me around after books, etc., and amongst my magazines is one from U.S.A. The short-wave contest which this magazine runs fascinated me so much that I resolved to win it if possible. This you will agree was a pretty stiff task to perform consider-

ing that my receiver consisted of only two valves. No allowance whatever was made for the type of set used, and it is common knowledge that the "Yanks" use multi-tube sets. It gives me much pleasure to inform you that a two-valver designed and constructed by myself has broken records all round and I have won the silver trophy offered by the magazine. I am the first person outside the continent of America to win this coveted prize.—FRED LANAWAY (London, W.9.)

### A Battery Radio-gram!

SIR,—I am taking this opportunity to express my appreciation of your excellent journal, and at the same time to make an appeal to you to publish details for a battery radio-gram using standard components. I should imagine that such a set would be popular with constructors like myself who are without mains facilities and want a radio-gram. My specification would be this—straight 3 or 4-valve circuit, medium and long wavebands, and a table model cabinet, using a separate cabinet for the speaker.

And now another appreciation, overdue it is true, but better late than never. About a year ago I built your one-valve short-waver and adapter with plug-in coils and low-loss S.W. components, and since then I have logged the five continents on it, using it as an adapter in conjunction with a veteran 3-valve detector, L.F. and power

receiver. I consider this to be an excellent performance for an adapter.—E. Cox (Bishopstoke).

### A Good Log from Plumstead

SIR,—I have been a reader of your fine publication for just on three years, and as I have not seen a log of stations from my district, I submit the following, all of which were heard between November 1st and December 1st, 1937, on a three-valve battery set with 25ft. indoor aerial.

COMMERCIAL.—W2XAD, DJN, JZK, W2XE, DJA, I2R04, GSC, JSJ, W1XAL, PHI, DJE, W8XK, YV5RC, EAQ2, CSW, RNE, GSP, DZG, DJQ, I2R03, JZI, DJR, W3XAL, PCJ, RW59, GSD, GSI, W3XAU, OLR2A, and IRLKI.

AMATEUR.—W8MPX, C2IPM, EI8J, F300, EI3J, OZ5BW, SV1AK, LA1F, GI2CC, OZ9B, FAQD, and 86 G-stations.

I hope this log will be of interest to other readers.—CYRIL R. BURGESS (Plumstead Common).

### Delhi Experimental Short-wave Station

SIR,—Although I have been a reader of your paper since it was first published, this is the first occasion on which I have written to you.

In the issue dated December 11th I saw with great interest a report in the "Leaves from a Short-Wave Log," of a reception of an Indian station on 49.36 m. whose call was thought to be VUM.

I beg to inform you that on Friday, December 3rd, I picked up what I thought to be VQ7LO, Nairobi, but I heard the announcements, "This is Delhi Experimental Short-wave Station operating on 49.3 m." The time of reception was between 19.45-20.45 G.M.T. Subsequently I heard the announcement again at 20.15 and 20.30 and 20.45 (approx.) when the local time was given as 02.15. No call was given. The reception was clear and steady at R6. The programme consisted of gramophone records of popular dance tunes and some Oriental music very similar to that radiated from HS8PJ, Bangkok, Siam.—N. KALYA (Liverpool).

CUT THIS OUT EACH WEEK.

## Do you know

—THAT a noise-silencer circuit may be fitted to most superhet receivers to prevent background and inter-station noises.

—THAT super-power receiving valves often make very good transmitting valves.

—THAT when a valve base becomes loose care must be taken not to twist it, as the internal wires may be short-circuited.

—THAT aluminium paint and similar metallic paints are not suitable for screening radio components, valves or chassis.

—THAT for a similar reason it is not practicable to stick strips of aluminium foil or silver paper round components for screening purposes.

—THAT a by-pass condenser from the output anode to earth is often found very desirable in a short-wave receiver.

The Editor will be pleased to consider articles of a practical nature suitable for publication in PRACTICAL AND AMATEUR WIRELESS. Such articles should be written on one side of the paper only, and should contain the name and address of the sender. Whilst the Editor does not hold himself responsible for manuscripts, every effort will be made to return them if a stamped and addressed envelope is enclosed. All correspondence intended for the Editor should be addressed: The Editor, PRACTICAL AND AMATEUR WIRELESS, George Newnes, Ltd., Tower House, Southampton Street, Strand, W.C.2

Owing to the rapid progress in the design of wireless apparatus and to our efforts to keep our readers in touch with the latest developments, we give no warranty that apparatus described in our columns is not the subject of letters patent.

### A Short-wave Log from Belfast

SIR,—I have read with interest the logs submitted by many readers, and so far I have not seen any from this district. I have much pleasure, therefore, in submitting my own log which may be of interest to other readers.

On the 20-metre band:—F8DU, F8UE, ON4AM, ON4SS, OZ5BW, I1MK, I1MG, SV1KE, SV1MK, W1APA, W1BLO, W2HS, W2AZ, W2ZC, W2IXY, W3MD, W3FIH, W4DSY, W4CYU, W4DLH, SU1CH, SU1SG, EA9AH, K4SA, HA8N, PAMD.

On the 40-metre band:—HB9D, EAJS, EA7DB, ON4BG, ON4SS, G2HF, G2PL, G2PV, G5CJ, G5KN, G6OS, G6BW, GW5PH, GW5KJ, GM6WD, GM2MP, EI8J, EI6F, EI6B, EI9G, GI5ZY, GI5DX, G3AD, etc.—W. E. CAUGHEY (Belfast).

## Now Ready!

WIRELESS COILS, CHOKES AND TRANSFORMERS, AND HOW TO MAKE THEM.

2/6. or 2/10 by post from Geo. Newnes, Ltd., Tower House, Southampton Street, Strand, London, W.C.2.



# Practical and Amateur Wireless BLUEPRINT SERVICE

PRACTICAL WIRELESS.		No. of		
CRYSTAL SETS.		Date of Issue.	Blueprint.	
Blueprint, 6d.				
1937 Crystal Receiver	9.1.37	PW71		
<b>STRAIGHT SETS. Battery Operated.</b>				
One-valve : Blueprint, 1s.				
All-wave Unipen (Pentode)		PW31A		
Two-valve : Blueprints, 1s. each.				
Four-range Super Mag Two (D, Pen)	11.8.34	PW36B		
The Signet Two	20.8.36	PW76		
Three-valve : Blueprints, 1s. each				
The Long-range Express Three (SG, D, Pen)	24.4.37	PW2		
Selectone Battery Three (D, 2 LF (Trans))		PW10		
Sixty Shilling Three (D, 2 LF (RC & Trans))		PW34A		
Leader Three (SG, D, Pow)	22.5.37	PW35		
Summit Three (HF Pen, D, Pen)	18.8.34	PW37		
All Pentode Three (HF Pen, D, Pen)	20.5.37	PW39		
Hall-mark Three (SG, D, Pow)	12.6.37	PW41		
Hall-mark Cadet (D, LF, Pen (RC))	10.3.35	PW48		
F. J. Camm's Silver Souvenir (HF Pen, D (Pen), Pen) (All-wave Three)	13.4.35	PW49		
Genet Midget (D, 2 LF (Trans))	June '35	PM1		
Cameo Midget Three (D, 2 LF (Trans))	8.9.35	PW51		
1936 Sonotone Three-Four (HF Pen, HF Pen, Westector, Pen)	17.8.35	PW53		
Battery All-Wave Three (D, 2 LF (RC))		PW55		
The Monitor (HF Pen, D, Pen)		PW61		
The Tutor Three (HF Pen, D, Pen)	21.3.36	PW62		
The Centaur Three (SG, D, P)	14.3.37	PW04		
The Gladiator All-Wave Three (HF Pen, D (Pen), Pen)	29.8.36	PW66		
F. J. Camm's Record All-Wave Three (HF Pen, D, Pen)	31.10.36	PW69		
The "Colt" All-Wave Three (D, 2 LF (RC & Trans))	5.12.36	PW72		
Four-valve : Blueprints, 1s. each.				
Sonotone Four (SG, D, LF, P)	1.5.37	PW4		
Fury Four (2SG, D, Pen)	8.5.37	PW11		
Beta Universal Four (SG, D, LF, Cl. B)		PW17		
Nucleon Class B Four (SG, D (SG), LF, Cl. B)	6.1.34	PW34B		
Fury Four Super (SG, SG, D, Pen)		PW34C		
Battery Hall-mark 4 (HF, Pen, D, Push-Pull)		PW46		
F. J. Camm's "Limit" All-Wave Four (HF Pen, D, LF, P)	26.9.36	PW67		
All-Wave "Corona" 4 (HF Pen, D, LF, Pow)	0.10.37	PW79		
<b>Mains Operated.</b>				
Two-valve : Blueprints, 1s. each.				
A.C. Twin (D, Pen)		PW18		
A.C.-D.C. Two (SG, Pow)		PW31		
Selectone A.C. Radiogram Two (D, Pow)		PW19		
Three-valve : Blueprints, 1s. each.				
Double-Diode-Triode Three (HF Pen, DDT, Pen)		PW23		
D.C. Ace (SG, D, Pen)		PW25		
A.C. Three (SG, D, Pen)		PW29		
A.C. Leader (HF Pen, D, Pow)	7.4.34	PW35C		
D.C. Premier (HF Pen, D, Pen)	31.3.34	PW35B		
Ubique (HF Pen, D (Pen), Pen)	28.7.34	PW36A		
Arnica Mains Three (HF Pen, D, Pen)		PW38		
F. J. Camm's A.C. All-Wave Silver Souvenir Three (HF Pen, D, Pen)	11.5.35	PW50		
"All-Wave" A.C. Three (D, 2LF (RC))	17.8.35	PW51		
A.C. 1936 Sonotone (HF Pen, HF Pen, Westector, Pen)		PW56		
Mains Record All-Wave 3 (HF Pen, D, Pen)	5.12.36	PW70		
All-World Ace (HF Pen, D, Pen)	28.8.37	PW80		
Four-valve : Blueprints, 1s. each.				
A.C. Fury Four (SG, SG, D, Pen)		PW20		
A.C. Fury Four Super (SG, SG, D, Pen)		PW34D		
A.C. Hall-Mark (HF Pen, D, Push-Pull)	24.7.37	PW45		
Universal Hall-Mark (HF Pen, D, Push-Pull)	9.2.35	PW47		
A.C. All-Wave Corona Four	6.11.37	PW51		
<b>SUPERHETS.</b>				
Battery Sets : Blueprints, 1s. each.				
£5 Superhet (Three-valve)	5.6.37	PW40		
F. J. Camm's 2-valve Superhet	13.7.35	PW52		
F. J. Camm's £4 Superhet		PW53		
F. J. Camm's "Vitesse" All-Waver (5-valver)	27.2.37	PW75		
Mains Sets : Blueprints, 1s. each.				
A.C. £6 Superhet (Three-valve)		PW43		
D.C. £5 Superhet (Three-valve)	1.12.34	PW42		
Universal £5 Superhet (Three-valve)		PW44		
F. J. Camm's A.C. £4 Superhet 4	31.7.37	PW59		
F. J. Camm's Universal £4 Superhet 4		PW60		
"Qualitone" Universal Four	16.1.37	PW73		
<b>SHORT-WAVE SETS.</b>				
Two-valve : Blueprint, 1s.				
Midget Short-wave Two (D, Pen)		PW38A		
Three-valve : Blueprints, 1s. each.				
Experimenter's Short-Wave Three (SG, D, Pow)		PW30A		
The Perfect 3 (D, 2LF (RC and Trans))	7.8.37	PW63		
The Bandsread S.W. Three (HF Pen, D (Pen), Pen)	29.8.36	PW68		
F. J. Camm's Oracle All-wave Three (HF, Det, Pen)	28.8.37	PW78		
<b>PORTABLES.</b>				
Three-valve : Blueprints, 1s. each.				
F. J. Camm's ELF Three-valve Portable (HF Pen, D, Pen)		PW65		
Parvo Plyweight Midget Portable (SG, D, Pen)	19.6.37	PW77		
Four-valve : Blueprints, 1s.				
Featherweight Portable Four (SG, D, LF, Cl. B)	15.5.37	PW12		
<b>MISCELLANEOUS.</b>				
S.W. Converter-Adapter (1 valve)		PW48A		
<b>AMATEUR WIRELESS AND WIRELESS MAGAZINE CRYSTAL SETS.</b>				
Blueprints, 6d. each.				
Four-station Crystal Set	12.12.36	AW427		
1934 Crystal Set		AW444		
150-mile Crystal Set		AW450		
<b>STRAIGHT SETS. Battery Operated.</b>				
One-valve : Blueprints, 1s. each.				
B.B.C. Special One-valver		AW387		
Twenty-station Loudspeaker One-valver (Class B)		AW440		
Two-valve : Blueprints, 1s. each.				
Melody Ranger Two (D, Trans)		AW388		
Full-volume Two (SG det., Pen)		AW392		
B.B.C. National Two with Lucerne Coil (D, Trans)		AW377A		
Big-power Melody Two with Lucerne Coil (SG, Trans)		AW388A		
Lucerne Minor (D, Pen)		AW426		
A Modern Two-valver		AW409		
Three-valve : Blueprints, 1s. each.				
Class B Three (D, Trans, Class B)		AW386		
New Britain's Favourite Three (D, Trans, Class B)	15.7.33	AW394		
Home-built Coil Three (SG, D, Trans)		AW404		
Fan and Family Three (D, Trans, Class B)	25.11.33	AW410		
£5 5s. S.G.3 (SG, D, Trans)	2.12.33	AW412		
1934 Ether Searcher : Baseboard Model (SG, D, Pen)		AW417		
1934 Ether Searcher : Chassis Model (SG, D, Pen)		AW419		
Lucerne Ranger (SG, D, Trans)		AW422		
Cosor Melody Maker with Lucerne Coils		AW423		
Mullard Master Three with Lucerne Coils		AW424		
£5 5s. Three: De Luxe Version (SG, D, Trans)	19.5.34	AW435		
Lucerne Straight Three (D, RC, Trans)		AW437		
All-Britain Three (HF Pen, D, Pen)		AW448		
"Wireless League" Three (HF Pen, D, Pen)	3.11.34	AW451		
Transportable Three (SG, D, Pen)		WM271		
£6 6s. Radiogram (D, RC, Trans)		WM318		
Simple-tune Three (SG, D, Pen)	June '33	WM327		
Economy-Pentode Three (SG, D, Pen)	Oct. '33	WM337		
"W.M." 1934 Standard Three (SG, D, Pen)		WM351		
£3 3s. Three (SG, D, Trans)	Mar. '34	WM354		
Iron-core Band-pass Three (SG, D, QP21)		WM362		
1935 £6 6s. Battery Three (SG, D, Pen)		WM371		
PTP Three (Pen, D, Pen)	June '35	WM389		
Certainty Three (SG, D, Pen)		WM393		
Minutube Three (SG, D, Trans)	Oct. '35	WM400		
All-wave Winaing Three (SG, D, Pen)	Dec. '35	WM396		
Four-valve : Blueprints, 1s. 6d. each.				
95s. Four (SG, D, RC, Trans)		AW370		
"A.W." Ideal Four (2 SG, D, Pen)	16.9.33	AW402		
2HF Four (2 SG, D, Pen)		AW421		
Crusador's A.V.C.4 (2 HF, D, QP21)	18.8.34	AW445		
(Pentode and Class B Outputs for above : Blueprints, 6d. each)	25.8.34	AW445A		
Self-contained Four (SG, D, LF, Class B)	Aug. '33	WM331		
Lucerne Straight Four (SG, D, LF, Trans)		WM350		
£5 5s. Battery Four (HF, D, 2LF)	Feb. '35	WM381		
The H.K. Four (SG, SG, D, Pen)	Mar. '35	WM384		
The Auto Straight Four (HF Pen, HF Pen, DDT, Pen)	April '36	WM404		
Five-valve : Blueprints, 1s. 6d. each.				
Super-quality Five (2HF, D, RC, Trans)	May '33	WM320		
Class B Quadradyne (2 SG, D, LF, Class B)	Dec. '33	WM344		
New Class-B Five (2 SG, D, LF, Class B)	Nov. '33	WM340		
<b>Mains Operated.</b>				
Two-valve : Blueprints, 1s. each.				
Consoclectric Two (D, Pen) A.C.		AW403		

These Blueprints are drawn full size. Copies of appropriate issues containing descriptions of these sets can in some cases be supplied at the following prices, which are additional to the cost of the Blueprint. A dash before the Blueprint Number indicates that the issue is out of print.

Issues of Practical Wireless .. 4d. Post Paid.  
Amateur Wireless .. 4d. " "  
Practical Mechanics .. 7d. " "  
Wireless Magazine .. 1/3 " "

The Index letters which precede the Blueprint Number indicate the periodical in which the description appears: thus PW refers to PRACTICAL WIRELESS, AW to Amateur Wireless, PM to Practical Mechanics, WM to Wireless Magazine.

Send (preferably) a postal order to cover the cost of the blueprint and the issue (stamps order 6d. unacceptable), to PRACTICAL AND AMATEUR WIRELESS Blueprint Dept., George Newnes, Ltd., Tower House, Southampton Street, Strand, W.C.2.

Economy A.C. Two (D, Trans) A.C.		WM286
Unicorn A.C.-D.C. Two (D, Pen)		WM394
Three-valve : Blueprints, 1s. each.		
Home-Lover's New All-electric Three (SG, D, Trans) A.C.		AW383
S.G. Three (SG, D, Pen) A.C.		AW390
A.C. Triodyne (SG, D, Pen) A.C.	19.8.33	AW399
A.C. Pentaquester (HF Pen, D, Pen)	23.6.34	AW439
Mantovani A.C. Three (HF Pen, D, Pen)		WM374
£15 15s. 1936 A.C. Radiogram (HF, D, Pen)	Jan. '36	WM401
Four-valve : Blueprints, 1s. 6d. each.		
All-Metal Four (2 SG, D, Pen)	July '33	WM326
Harris Jubilee Radiogram (HF Pen, D, LF, P)	May '35	WM386
<b>SUPERHETS.</b>		
Battery Sets : Blueprints, 1s. 6d. each.		
Modern Super Senior		WM375
Varsity Four	Oct. '35	WM395
The Request All-Waver	June '36	WM407
1935 Super Five Battery (Superhet)		WM379
Mains Sets : Blueprints, 1s. 6d. each.		
1934 A.C. Century Super A.C.		AW425
Heptode Super Three A.C.	May '34	WM359
"W.M." Radiogram Super A.C.		WM366
1935 A.C. Stenode	Apr. '35	WM385
<b>PORTABLES.</b>		
Four-valve : Blueprints, 1s. 6d. each.		
Midget Class B Portable (SG, D, LF, Class B)	20.5.33	AW389
Holiday Portable (SG, D, LF, Class B)	1.7.33	AW393
Family Portable (HF, D, RC, Trans)	22.9.34	AW447
Two H.F. Portable (2 SG, D, QP21)	June '34	WM369
Tyers Portable (SG, D, 2 Trans)		WM367
<b>SHORT-WAVE SETS—Battery Operated.</b>		
One-valve : Blueprints, 1s. each.		
S.W. One-valve converter (Price 6d.)		AW329
S.W. One-valve for America	23.1.37	AW429
Rome Short-Waver		AW452
Two-valve : Blueprints, 1s. each.		
Ultra-short Battery Two (SG det., Pen)	Feb. '36	WM402
Home-made Coil Two (D, Pen)		AW440
Three-valve : Blueprints, 1s. each.		
World-ranger Short-wave 3 (D, RC, Trans)		AW355
Experimenter's 5-metre Set (D, Trans, Super-regen)	30.6.34	AW438
Experimenter's Short-waver (SG, D, Pen)	Jan. 19, '35	AW463
The Carrier Short-waver (SG, D, P)	July '35	WM390
Four-valve : Blueprints, 1s. 6d. each.		
A.W. Short-wave World-beater (HF Pen, D, RC, Trans)		AW436
Empire Short-Waver (SG, D, RC, Trans)		WM313
Standard Four-valver Short-waver (SG, D, LF, P)	Mar. '35	WM383
Superhet : Blueprint, 1s. 6d.		
Simplified Short-wave Super	Nov. '35	WM397
<b>Mains Operated.</b>		
Two-valve : Blueprints, 1s. each.		
Two-valve Mains short-waver (D, Pen) A.C.		AW453IV
"W.M." Band-spread Short-waver (D, Pen) A.C.-D.C.		WM368
"W.M." Long-wave Converter		WM380
Three-valve : Blueprint, 1s.		
Emigrator (SG, D, Pen) A.C.		WM352
Four-valve : Blueprint, 1s. 6d.		
Standard Four-valve A.C. Short-waver (SG, D, RC, Trans)	Aug. '35	WM391
<b>MISCELLANEOUS.</b>		
Enthusiast's Power Amplifier (1/6)	June '35	WM387
Listeners' 5-watt A.C. Amplifier (1/6)		WM392
Radio Unit (2v) for WM392	Nov. '35	WM398
Harris Electrogram (battery amplifier) (1/-)	Dec. '35	WM399
De-Luxe Concert A.C. Electrogram	Mar. '36	WM403
New Style Short-Wave Adapter (1/-)	June '35	WM388
Trickle Charger (6d.)	Jan. 5, '35	AW462
Short-Wave Adapter (1/-)	Dec. 1, '34	AW456
Superhet Converter (1/-)	Dec. 1, '34	AW457
B.L.D.L.C. Short-wave Converter (1/-)	May '36	WM405
Wilson Tone Master (1/-)	June '36	WM406
The W.M. A.C. Short-wave Converter (1/-)		WM408





# QUERIES and ENQUIRIES

## Grid Leak

"I recently built a one-valver in order to try out various experiments and noticed a peculiar thing. I always understood that the grid condenser and leak were essential for the proper rectification of signals, and yet in my set, when changing the leak to see the effects of different values, I found that the set worked just as well without the leak. When I disconnected it there was no drop in volume and no other effect whatsoever. Can you explain this?"—F. L. O. (Highbury).

THERE may be several explanations for the effect you mention. Firstly, there may have been a leakage across the valveholder you were using, the resistance between the grid and filament pins being of the order of 1 or 2 megohms. Secondly, there may even have been such a leakage inside the valve or on the valve base. Again, the valves may have been of such a type that, if you connected L.T. negative to the earth line, the valve acted as an anode bend rectifier and thus gave signals. Theoretically, when the leak is removed, the valve should gradually choke and signals should cease. This is an ideal condition, but can be realised in practice.

## L.T. Short Circuit

"I have built a three-valve set, but cannot get a sound from it. I took out all the valves and with a meter tested the voltages at each anode and these were O.K. The L.T. also read 2 volts at each socket, but when I put the valves in and test the accumulator it reads nothing. Can you explain why this is?"—T. A. T. (Walney).

THERE are two possibilities in this particular case. As there is a voltage at the sockets before the valves are placed in, there may be a short circuit in one of the valves, due to the filament having broken or the leading in wires coming into contact owing to the glass bulb having become loose. Alternatively, your accumulator is in a bad condition and as soon as the valves are inserted the load causes the voltage to drop to zero. We suggest you have both valves and accumulator tested by your local radio dealer.

## Avoiding Hand Capacity

"I have a short-wave set but find that tuning is impossible owing to terrific hand-capacity effects. I have tried the old dodge of connecting a wire to a tin and putting this under the cushion on my chair, but I

still cannot tune easily owing to the trouble. What can you suggest?"—J. W. (Camborne).

AS your body is at earth potential it is necessary to make certain that the controls which you handle are also at the same potential. In the case of the tuning condenser the moving plates (control spindle) should be joined to earth, and the reaction condenser should also be connected in the same way. A really good earth should be used with the set. It is also worth while placing a metal panel behind the present panel and connecting this to earth. Alter-

## RULES

We wish to draw the reader's attention to the fact that the Queries Service is intended only for the solution of problems or difficulties arising from the construction of receivers described in our pages, from articles appearing in our pages, or on general wireless matters. We regret that we cannot, for obvious reasons—

- (1) Supply circuit diagrams of complete multi-valve receivers.
- (2) Suggest alterations or modifications of receivers described in our contemporaries.
- (3) Suggest alterations or modifications to commercial receivers.
- (4) Answer queries over the telephone.
- (5) Grant interviews to questists.

A stamped addressed envelope must be enclosed for the reply. All sketches and drawings which are sent to us should bear the name and address of the sender.

Requests for Blueprints must not be enclosed with queries as they are dealt with by a separate department.

Send your queries to the Editor, PRACTICAL AND AMATEUR WIRELESS, George Newnes, Ltd., Tower House, Southampton Street, Strand, London, W.C.2. The Coupon must be enclosed with every query.

natively you can have an aluminium panel drilled and placed over your present panel, and the control knobs only will have to be removed to enable this to be done. The panel should, of course, be joined to earth.

## The Record All-wave 3

"I am building the Record Three and should like to know how to connect the speaker, aerial, and earth wires. I cannot quite follow the wiring diagram in this respect."—R. A. B. (Leamington Spa).

IT will be noted in the blueprint that there are two leads each of which is marked L.S.1. These two leads are joined together to one terminal on the loudspeaker. The lead marked L.S.2 is joined to the other loudspeaker terminal. The aerial and earth sockets are on the back of the coil unit, the earth socket being marked "E" and the aerial sockets "A 1," "A 2." You should plug the aerial lead into either of these sockets, trying them both to find the one which gives best results in your particular set of conditions.

## Short-wave Coil Connections

"I have a number of 4-pin short-wave coils and should like to build up a short-wave three, but note that the 6-pin coil is usually used. I wonder if you could tell me how to use the 4-pin type of coil in the detector type of receiver I wish to build."—A. W. (Wilmorton).

THE 6-pin coil has a grid winding, reaction winding, and an aerial winding, and it is this latter which will be missing in a 4-pin coil. Consequently, you will have to join the aerial direct to the grid coil (or connect it through a small condenser), and it will be found slightly more difficult to remove the damping effect of the aerial-earth system. You could, of course, overwind a small coil on the 4-pin unit and connect this to aerial and earth, but you may find that a pre-set or small variable condenser in the aerial lead will be capable of adjustment to give you the required results.

## Using a Microphone

"Can you tell me whether the cheap, home-type microphone will work when connected up in series with a pair of headphones and a battery. The instrument has four terminals, two of which are joined to a battery and I joined the other two to headphones, but could not get any signals. The headphones, battery and flex were tested and are all in working order."—F. P. (Woodingdean).

THE small carbon microphone, presumably of the type you have obtained, does not give a very high output and thus when used as you indicate would, no doubt, be insufficient to give good results. You can connect a small H.F. battery in series with the 'phones to improve matters, but it would probably prove advantageous to build a small amplifier which will then give you the desired results. If a battery is used you should take the usual precautions to avoid an overload and damage to the 'phones.

## Choosing a Speaker

"I have built a set and anticipate purchasing a Stentorian speaker, but I am unable to decide between a Junior or a Senior model, having regard to the volume of the set I have at present, which is a Det. and 2 L.F. Can you give me an idea which would be better?"—W. E. A. (Eastleigh).

THE Senior model will handle more than the Junior, and will prove more sensitive. Consequently, it would be an investment to obtain the larger model as, should you modify your set at any future date, the speaker will not have to be replaced. The additional sensitivity of a larger model may also enable you to obtain even more volume from your present set.

The coupon on page 440 must be attached to every query.

# Greetings! Peto-Scott

PETO-SCOTT CO. LTD., 77, City Road, London, E.C.1.

personally extends the  
**SEASON'S GREETINGS**  
to his thousands of customers at home, abroad and on the High Seas.



## Miscellaneous Advertisements

Advertisements are accepted for these columns at the rate of 3d. per word. Words in black face and/or capitals are charged double this rate (minimum charge 3/- per paragraph). Display lines are charged at 6/- per line. All advertisements must be prepaid. All communications should be addressed to the Advertisement Manager, "Practical and Amateur Wireless," Tower House, Southampton Street, Strand, London, W.C.2.

## RECEIVERS, COMPONENTS AND ACCESSORIES

Surplus, Clearance or Secondhand, etc.

# RADIOMART

## SHORT-WAVE MANUAL

Packed with short-wave information and circuits of mains and battery receivers, including straight, superhet and 5-metre transmitters, modulators, etc. Information on transmitting licences, aeriels, Class B amplifications, neutralizations, superhet alignment, etc. The most comprehensive manual published, written by practical engineers, price 6d., post free, 7½d. including catalogue.

1937 Short-wave Catalogue only (3 times enlarged) price 1½d., post free.

**44, HOLLOWAY HEAD, BIRMINGHAM 1**

**CONVERSION UNITS** for operating D.C. Receivers from A.C. Mains, improved type, 120 watt output at £2/10/0. Send for our comprehensive list of speakers, resistances and other components. **WARD, 46, Farringdon Street, London, E.C.4.** Telephone: Holborn 9703.

**THE largest stock of components in England, over 500 lines, new catalogue now ready 1½d.—J. Bearfield, 105, Upper Street, London, N.1.**

**HEADPHONES.**—Brown, Ericsson, G.E.C., B.T.H., Standard Telephones, Nesper, Western Electric, Sterling, etc., 2,000 ohms, 2s. 6d.; 4,000, 5s. Postage 6d. **SPECIAL** Ericsson, 4,000 ohms, as new, 7s. 6d. Telefunken, lightweight, adjustable, 7s. 6d. **CRYSTAL SETS.** Burne-Jones. Complete, Guaranteed, 5s. 6d. Ditto, double circuit, 8s. Sensitive permanent detectors, 1s. 6d. Crystal Detectors, complete, 1s. Crystals with silver cat's-whisker, 6d. Postage 1½d.—Post Radio, 2, Copenhagen Street, London, N.1.

**SOUTHERN RADIO'S** Guaranteed Wireless Bargains; post paid.

**PLESSEY** 3-valve Battery Sets, complete in sealed cartons with three Mazda valves, moving coil speaker, Pertrix batteries and accumulator, in exquisite walnut cabinet; 57/6 (limited quantity only).

**GARRARD** Record Changers, A.C. 200-250 volts, changes eight 10- or 12-inch records; £6 (complete sealed cartons); universal A.C./D.C. model, £7/10.

**GARRARD A.C. Radiogram** Units, with pick-up and all accessories, in sealed cartons; 42/-. **COLLARO** Single Spring Motors for Gramophones or battery radio; 10/-, complete with turntable and all accessories.

**TELSEN (1937-38)** Components; iron-core coils W.349 (Midget size), 3/6; W.477 (triple ganged, for band-pass or straight circuits), 14/6; W.476 (triple ganged superhet), 14/6; W.478 (twin ganged), 9/-; all ganged coils complete on bases, with switch; I.F. transformer coils, 4/6; dual range coils, 2/9; with aerial series condenser, W.76, 3/9.

**TELSEN A.C./D.C. Multimeters**, 5-range (tests anything radio or electrical), 8/6; loudspeaker units, 2/6; Ace (P.O.) microphones, complete with transformer, ready for use with any receiver, 4/0; headphones, 4,000 ohms, 3/- pair.

**VALVES.**—Full range for American receivers, 6/- each.

**MORSE** Tappers, complete radio-telegraph set (flasher, buzzer and tapper), with batteries, bulb, code, 3/-.

**BARGAIN** Parcels of Assorted Components, including coils, resistances, condensers, chokes, wire, circuits, etc., value 21/-; 5/- per parcel.

**SOUTHERN RADIO, 323, Euston Rd., London, N.W.1;** and 40, Lisle St., London, W.C.1. All mails orders to

**SOUTHERN RADIO, 323, Euston Rd., London, N.W.1** (near Warren St. Tube). Phone: Euston 3775.

**BANKRUPT** Bargains. All new goods. All other lines as advertised, also Decca 1938 A.C./D.C. 8½gn. portables for 5gn. Decca 1938 9½gn. all-wave 5v. superhets £5/10/0. Decca 1937 6v A.C. superhets £5. Lotus 4v. A.C./D.C. console £3. Plessey 4v. battery chassis, Mullards and M.C. speaker 65/-. Many others. Valves all types and components. State requirements.—Butlin, 6, Stanford Avenue, Brighton.

# PREMIER SUPPLY STORES

## POST ORDERS

Jubilee Works,  
167, Lower  
Clapton Rd.,  
London, E.5.  
Amherst 4723

## CALLERS

165 & 165a  
Fleet Street, E.C.4  
Central 2833  
50, High Street,  
Clapham, S.W.4  
Macaulay 2381

Premier Battery Chargers. Westinghouse Rectification Complete, Ready for use.

To charge 2 volts at 1 amp.	10/-
" 6 " 1 "	16/6
" 6 " 1 "	19/6
" 12 " 1 "	21/-
" 6 " 2 "	32/6

**TWO NEW MODELS**, completely enclosed.

To charge 6 volts at 4 amps. £3/19/6.  
6 or 12 volts at 2 amps. £3/19/6.

**3-VALVE SHORT-WAVE KIT.**—S.G., H.F.; Det. and Pentode. Covers 14-170 metres, with 4 pairs interchangeable 4-pin coils. Complete kit of parts, with metal chassis and set of 3 matched 2-volt valves, 42/-; suitable metal cabinet, 7/6 extra.

**NEW 1-VALVE SHORT-WAVE RECEIVER OR ADAPTOR KIT.** 13 to 86 metres without coil changing. Complete Kit and Circuit, 12/6. **VALVE GIVEN FREE!**

**DE LUXE MODEL**, 14 to 170 metres, complete Kit with Chassis, 4 Coils and all parts, 17/6.

**SUPERHET CONVERTER KIT**, 15/-. **De Luxe Model**, 20/-.

**S.W. SUPERHET CONVERTER KIT**, for A.C. Mains Receivers, 22/6. **A.C. Valve given FREE!**

**NEW 2-VALVE S.W. KIT**, 13 to 86 metres without coil changing. Complete Kit and Circuit, 19/6. **VALVES GIVEN FREE!**

**DE LUXE MODEL**, 14 to 150 metres, complete Kit and Circuit, 4 Coils and all parts, 25/-. **VALVES GIVEN FREE.**

**PREMIER "TROLITUL" Short-Wave CONDENSERS**, Certified superior to Ceramic. All-brass Construction, 15 mmfd., 1/6; 40 mmfd., 1/7; 100 mmfd., 1/10; 160 mmfd., 250 mmfd., 2/6; Double Spaced 15 mmfd., 2/9; 40 mmfd., 3/6. S.W.H.F. Chokes, 9d.; screened 1/6. All-Brass S.W. Condensers with integral slow-motion, .00015 Tuning, 4/3; .00015, Reaction, 3/9. **UTILITY 4" MICRO-CURSOR DIALS.** Direct and 100:1 ratio, 3/9 each.

**PREMIER MAINS TRANSFORMERS ALL TYPES STILL AVAILABLE.**

**Now ready. Our New 1938 Enlarged Illustrated Catalogue, Handbook and Valve Manual. Price 6d. 90 Pages of Radio Interest!**

**U.S.A. GEN. E. MOTORS** step-up 12 volts D.C. to 285v. at .06 amps. D.C. output. Complete in metal case 6" x 5" x 3", 25/-.

**SHORT-WAVE COILS**, 4- and 6-pin types, 13-20, 24-47, 41-94, 78-170 metres, 1/9 each, with circuit. Special set of S.W. Coils, 14-150 metres, 4/- set with circuit. Premier 3-band S.W. Coil. 11-25, 19-43, 38-86 metres. Simplifies S.W. receiver construction, suitable any type circuit, 2/6.

**COIL FORMERS**, 4- or 6-pin low-loss, 1/- each. **A.C. and A.C./D.C. MAINS VALVES.** Replacement for all types in stock from 4/6 each.

**BATTERY VALVES**, 2 volts H.F. L.F. 2/3. Power, Super-Power, 2/9. Var-Mu-S.G., 4- or 5-pin Pentodes, H.F. Pens., V-mu-H.F. Pens. 5/- Class B, 5/-.

**AMERICAN VALVES.** Genuine American HYTRON and TRIAD, first-grade Valves, 3 months' guarantee. All types in stock, 5/6 each. 210 and 250, 8/6 each. New Metal-Glass Valves, all types, 6/6 each. Valve holders for all above types, 6d. each. **OCTAL** bases, 9d. each.

**PREMIER HIGH FIDELITY P.A. AMPLIFIERS.**—3 watt A.C. or A.C./D.C. Complete Kit with Valves, 40/-. Wired and Tested, 55/-. 8 watt A.C./D.C. Complete Kit with Valves, £3/4. Wired and Tested, £5/5. 12 watt A.C. Complete Kit with Valves, £5/5. Wired and Tested, £7/7.

**PREMIER TRANSVERSE CURRENT (Reisz Pattern) MICROPHONE.** High-grade, large output unit with fine frequency response, 20/- Microphone Transformer to match, 5/-.

**PREMIER MOVING COIL MIKE**, no energising current required. Real quality instrument, 42/-.

**MOVING IRON METERS.** Any range between 10 and 500 m/a. Also 1.3 or 5 amps. Read A.C. or D.C. Flush Bakelite case, 2½in. diam. B.E.S.A. standard specification 89. 5/9 each.

**MOVING COIL METERS.** 0.1 m/a. 100 ohms resistance. Diameter 3½in., 22/6. Flush mounting. Bakelite case. B.E.S.A., first-grade accuracy. Multipliers for above, 1/- each.

## RECEIVERS, COMPONENTS AND ACCESSORIES

Surplus, Clearance or Secondhand, etc.

## RADIO CLEARANCE

63, HIGH HOLBORN, W.C.1.

**SPECIAL OFFER.** Huge purchase 7-Valve Universal All-Wave Superhet Chassis, covering 4 Wave Bands, 2 Short, Medium and Long; total range 15 to 2,000 metres covered by the 4 Bands. Fitted 7 Mullard Valves, Pre-H.F. stage, etc., Pentode Output. Chassis complete with Valves, less Speaker, £3 17s. 6d. each. **AERODYNE 5-VALVE BATTERY SUPERHET**, fitted in magnificent Walnut Cabinet, Upright Design, Brand New in sealed cartons as from the makers. Listed 8½ gns, our price £5 2s. 6d., with Valves, less Batteries.

Ideal Christmas Gift, **ELECTRIC TROUSER PRESSES**, made for a Pall Mall firm to sell at 3 gns. Brand New, Boxed. The Press that steams and presses your trousers in one operation, price 12/11d., plus 1/0 carriage.

**BRUCE MAINS TRANSFORMERS**, standard for the season. These transformers are British made and are fully guaranteed for 6 months.

350-0-350, 120 m.a., 2-0-2 volts, 2.5 amp, 2-0-2 volts, 4 amp, 10/6d.

350-0-350, 150 m.a., 2-0-2 volts, 2.5 amp, 2-0-2 volts, 4 amp, 2-0-2 volts, 2 amp, 11/6d.

500-0-500, 150 m.a., 2-0-2 volts, 2.5 amp, 2-0-2 volts, 6 amp, 2-0-2 volts, 2 amp, 2-0-2 volts, 2 amp, 17/6.

Huge Purchase of **WET ELECTROLYTIC CONDENSERS**, by well-known manufacturer. Following types available:

8 mid., Metal Case, Single-hole fixing, Wet Electrolytic, complete with Locking Nut, 450 volt working, 2/- each. 16 plus 16 ditto, 2/3d. each.

16 Mid., 320 volt working, ditto, 1/10d. each.

25 Mid., 320 volt working, ditto, 1/10d. each.

32 Mid., 320 volt working, ditto, 2/3d. each.

50 Mid., 35 volt working, one-hole fixing, metal can, 1/6 each.

All Orders 5/- or over, post free. Orders under 5/- must be accompanied by a reasonable amount for postage. C.O.D. orders under 5/- cannot be accepted.

**RADIO CLEARANCE, 63, High Holborn, W.C.1. Holborn 4631.**

All goods previously advertised are standard lines, still available. Post card for list free. **VAUXHALL UTILITIES, 168a, Strand, W.C.2.** Over Denny's the Booksellers, Temple Bar 9338.

## LOUDSPEAKER REPAIRS

**LOUDSPEAKER** repairs, British, American, any make, 24-hour service; moderate prices.—Sinclair Speakers, Alma Grove, Copenhagen Street, London, N.1.

**REPAIRS** to Moving Coil Speakers, Cones and Coils, fitted or rewound. Fields altered. Prices Quoted including Eliminators. Loudspeakers, Repaired, 4/-. L.F. and Speech Transformers, 4/- post free. Trade invited. Guaranteed. Satisfaction. Prompt Service, Estimates Free.—L.S. Repair Service, 5, Balham Grove, London, S.W.12. Battersea 1321.

## TUITION

**MAKE YOUR HOBBY** your career or increase its interest tenfold. Britain's Best College, approved by the Inst. Rad. Eng. and leading Radio firms, provides complete training in Radio Engineering by post or day classes. Full details from: "P.R.W." **LONDON RADIO COLLEGE, Grove Park Rd., London, W.4** (Chiswick 3244).

## MISCELLANEOUS

**OUR 1937-8 Catalogue** contains much information on Transformer Design. Post Free.—Lumen Electric Coy., 1A, Scarisbrick Avenue, Liverpool, 21.

**MOVIES** at Home. How to make your own Cinema Projector. Particulars free.—Movie-scope (L), Pear Tree Green, Dodinghurst, Essex.

## FREE ADVICE BUREAU COUPON

This coupon is available until January 1st, 1938, and must be attached to all letters containing queries.

**PRACTICAL AND AMATEUR WIRELESS, 25/12/37.**



# The MYSTERY REGION

By W. J. BRANDS

Hunted through dense jungle by savage dogs set upon him by an unscrupulous Filipino timber-“poacher,” the narrator of this thrilling true-life adventure twice narrowly escaped a violent death. Pygmy forest-dwellers were the writer's strange allies in the struggle which followed his discovery of the Filipino's depredations.

*Other Special Features:*

**MY CYCLE-TRIP TO SPAIN**

The writer describes his varied experiences whilst making a cycle-trip across France to “gate-crash” the forbidden Spanish Frontier.

**FIVE MEETINGS**

A remarkable story told by an oilfield engineer. Five times his path crossed that of a ruffianly teamster—always in most dramatic circumstances—until stark tragedy severed the connection.

**TYPHOON**

A vivid account of a sailor's experiences on board a tramp steamer during one of the most devastating typhoons ever loosed upon the Pacific.

IN THE JANUARY

# WIDE WORLD MAGAZINE

Of all Newsagents and Bookstalls, or by post 1s. 2hd. from the Publisher, George Newnes, Ltd., Tower House, Southampton St., Strand, W.C.2.

1/-

## ELECTRADIX RADIOS

Sends Xmas Greetings to all Readers

**MORSE AND SIGNAL KEYS.**



**BARGAINS FOR ALL**  
Royal Air Force model, balanced action, all solid brass bar, tungsten contacts, indicator lamp. Type K88L, 2s. galvanic key for 7/6. Other keys from 3/- to 30/-.  
**BUZZERS,** 1/6, 2/6 and 5/-.  
**SOUNDERS,** 7/6 and 10/-.  
**MORSE PRACTICE SETS,** 4/5.  
**SWITCHES.** For all purposes, 5 amp. Edison mains tumbler, 5/6 doz. Samples 6d., post 2d.

Double pole, linked on wood Dewar base, on-off or C.O., 2/- . Panel inter-comm. switches, 3/6. Wave-change switches, stud switches, float switches, Relay switches (from micro-amps. to mains), Contactor switches, Magnetic switches, and many others, cheap.  
**Solenoids** 3/6. A.C. mains magnets, 2/6.  
**METAL CABINETS.** 42" x 24" x 16", with front hinged door, 57/6. Smaller size, 18" x 18" x 11", with side door, 30/- . Finished any colour.

**TRANSFORMERS.** L.F. for up to 50 watts inter-valve or output to speakers. Ferranti, 5/-, 6/- and 6/6. B.T.H. 4 to 1 at 5/- each. Mains transformers, all sizes, from 5/6.

**CRYSTAL SETS.** Need no battery, work on mattress aerial. 5/6 and 7/6. Headphones, lightweight, 4/6. Single earphone and cord, 2/6. Sullivan 120 ohms W.D., 2/9 pair. Pocket type leather bands, 2/3, or 2/9 with cords. House 'phones, table and wall, 15/-.  
**Bells.** Desk type with movement in cone, 2/6. Wall bells, 3/- . Large size, 7/6. Large ironclad, single stroke, 15/- . Mains outdoor fire alarm bells, 10". 17/6. Bell Pushes, 6d. Heavy brass, 1/- . Bell Wire, Twin, 3/- 100 yds.

**SPEAKER BARGAINS.** Moving Coil. Mains energised, perm. magnet and piezo. Public Address and Cinema speakers. All cheap.  
**HOME RECORDERS.** Pelic, 37/6. Bradford, 45/- . Blauks, 4/- doz. Gramo Motors, A.C. mains, with turntable, 25/-, 37/6, 45/- and 23/10/- . Microphones. Table Model with transf. and switch, 15/- . No. 11 Hand Mike, 5/6. Transverse mikes, 30/- and 55/- . Table Stands, adjustable, 5/-, 7/6 and 10/- . Floor Stands, 15/-, 17/6, and 25/6.

*Latest Bargain List "N" Free on request.*

## ELECTRADIX RADIOS

218, Upper Thames Street, London, E.C.4.

Telephone: Central 4611

### MISCELLANEOUS

**"NEWNES TOURIST ATLAS** of Great Britain and "Route Guide." Edited by John Bartholomew & Son, Ltd., 120 pages of fully-coloured contour maps for the whole of England, Scotland, Ireland and Channel Islands, with Index to the principal Motoring and Cycling centres and distances, 2s. 6d. from all Booksellers.—George Newnes, Ltd., Tower House, Southampton Street, Strand, London, W.C.2.

**"THE OUTLINE OF WIRELESS,"** by Ralph Stranger. Fifth Edition, 8s. 6d. net.—This book, which covers the subject from A to Z, is to be recommended to all who desire to master the theory of Modern Wireless. At all Booksellers and Newsagents.—George Newnes, Ltd., Tower House, Southampton Street, Strand, London, W.C.2.

**A DICTIONARY OF WIRELESS TERMS,** by Ralph Stranger. A Wireless Work of Reference that should be on the bookshelf of every keen amateur. Compiled by a master of lucidity, it gives the meanings of all Technical terms in general use. Price 2s. 6d. from all Booksellers and Newsagents.—George Newnes, Ltd., Tower House, Southampton Street, Strand, London, W.C.2.

**FIFTY TESTED WIRELESS CIRCUITS,** by F. J. Camm, 2s. 6d.—This handbook contains every modern circuit complete with instructions for assembling, component values, and notes on operation. Obtainable at all Booksellers and Newsagents.—George Newnes, Ltd., Tower House, Southampton Street, Strand, London, W.C.2.

**PERPLEXITIES and TANTALISERS.**—"The Strand Problem Book" is the finest collection of puzzles of all kinds ever assembled, mathematical, geographical, literary—acrostics and codes, by W. T. Williams (Tantalus) and G. H. Savage. Only 2s. 6d. net from all Booksellers.—George Newnes, Ltd., Tower House, Southampton Street, Strand, London, W.C.2.

**EVERYMAN'S WIRELESS BOOK,** by F. J. Camm, 3s. 6d. net. An invaluable book of reference, explaining the operation, upkeep and overhaul of all types of wireless receiver. 200 illustrations. From all Booksellers and Newsagents.—George Newnes, Ltd., Tower House, Southampton Street, Strand, London, W.C.2.

**TELEVISION.**—Newnes Television and Short-wave Handbook, by F. J. Camm, deals authoritatively with Scanning Systems (Drums, Mirror Screws, Discs, etc.), Neon Lamps, The Cathode-Ray, Oscillograph. How to build Short-wave and Ultra-short-wave Receivers. Fully illustrated, 3s. 6d. net. From your bookseller.—George Newnes, Ltd., Tower House, Southampton Street, Strand, London, W.C.2.

**THE PRACTICAL MOTORIST'S ENCYCLOPEDIA,** by F. J. Camm, 3s. 6d. net. A lucid exposition of the principles, upkeep and repair of every part of the car. 442 illustrations. From book-sellers everywhere.—George Newnes, Ltd., Tower House, Southampton Street, Strand, London, W.C.2.



# MCCARTHY

High Efficiency plus Economy!  
**5-VALVE ALL-WAVE SUPERHET**



Price  
**£6.17.6**

(Complete with B.V.A. Valves)

This moderately-priced 7-stage 5-valve all-wave receiver utilises a remarkably efficient superheterodyne circuit which provides exceptional sensitivity on all three wavebands—18-50, 200-550, 1,000-2,000 metres.

Circuit includes: Latest type triode-hexode frequency changer, vari-mu pentode I.F. amplifier, double diode-triode operating as diode detector and I.F. amplifier, and providing full A.V.C. High-slope 3 watts output pentode. Wave-change and gram. switch. As illustrated, but with new type dial with principal station names.

**6-valve all-wave Superhet with Radio Frequency Stage**

8 Stages  
8 tuned circuits  
3 wavebands



Price  
(Complete with B.V.A. Valves) **£8.17.6**

Performance (made possible by use of multi-electrode valves) equal to that of many receivers employing 8 valves or more. Brief specification includes: Large "Airplane" dial, with different coloured lights automatically switched on for each wave-range. Micro-vernier 2-speed drive. 4-point wave-change and gramophone switch. Volume control and variable tone control also operative on gramophone. Reinforced heavy-gauge steel chassis. Covers 19-2,000 metres.

Circuit comprises: Preselector circuit, radio frequency amplifier (operative on all 3 wavebands), triode-hexode frequency changer, double band-pass I.F.T. coupled I.F. amplifier, double diode-triode detector and L.F. amplifier. D.A.V.C. applied to 3 preceding valves. 3-watt pentode output.

All McCarthy receivers supplied complete with valves, knobs, pilot lamps, leads, mains cable and plug. 12 months' guarantee.

Deferred terms on application or through our city agents, London Radio Supply Co., 11, Oat Lane, E.C.2. Demonstrations Daily.

Cash with order on 7 days' approval. Complete illustrated catalogue, with technical data and circuit diagrams, on receipt of 3d. in stamps, or abridged list of McCarthy chassis types free of charge.

## MCCARTHY RADIO LTD.

44a, Westbourne Grove, London, W.2.

Telephone: Bayswater 3201/2.

# STANDARD WIRELESS BOOKS

## THE OUTLINE OF WIRELESS

By **RALPH STRANGER** 8/6 net (9/-)

A book which covers the theory and practice of Reception from A to Z.

## WIRELESS CONSTRUCTOR'S ENCYCLOPÆDIA

By **F. J. CAMM** 5/- net (5/3)

The whole field of wireless construction is covered, in description and diagram in this book.

## THE MATHEMATICS OF WIRELESS

By **RALPH STRANGER** 5/- net (5/5)

A simple introduction to arithmetic, algebra, geometry, trigonometry and calculus as they affect wireless calculations. 256 pages. *Fully Illustrated.*

## NEWNES TELEVISION AND SHORT-WAVE HANDBOOK

By **F. J. CAMM** 3/6 net (4/-)

The first really complete and authoritative work on this subject.

## EVERYMAN'S WIRELESS BOOK

By **F. J. CAMM** 3/6 net (4/-)

**JUST OUT!**

## WIRELESS COILS, CHOKES AND TRANSFORMERS: AND HOW TO MAKE THEM

By **F. J. CAMM** 2/6 net (2/10)

An important new Handbook for every home constructor and anyone interested in radio. With Special Chapters on Selectivity, Break-through, Coil Winders, Coil Troubles and their Remedies. 180 pages, cloth bound, with 126 easy-to-follow illustrations.

## FIFTY TESTED WIRELESS CIRCUITS

By **F. J. CAMM** 2/6 net (2/10)

## DICTIONARY OF WIRELESS TERMS

By **RALPH STRANGER** 2/6 net (2/10)

A valuable synopsis of technical terms that everybody can understand.

Obtainable from all booksellers, or send a P.O. for the amount indicated in brackets after each price and the book will be delivered to you post free—write to Wireless Book Department—

**GEORGE NEWNES, LIMITED,**  
Tower House, Southampton Street, Strand,  
London, W.C.2.

*High Performance  
German Bomber*



# MILITARY AVIATION IN GERMANY

A SPECIAL ARTICLE ILLUSTRATED  
WITH NEW PHOTOGRAPHS OF  
GERMANY'S MODERN AIR FLEET

*Other Contents of the January "POPULAR  
FLYING" include:*

**WINGS OVER SPAIN**

*Flying Lessons from the War Areas.*

**FLYING TEN MILES HIGH**

*Stratospheric Experiments.*

**WAR FLYING EXPERIENCES**

**BEST TOPICAL AND HISTORICAL  
AIR PICTURES**

# POPULAR FLYING

THE NATIONAL AVIATION MAGAZINE

*Of all Newsagents and Bookstalls, or by post  
8d. from the Publisher, C. Arthur Pearson,  
Ltd., Tower House, Southampton Street,  
Strand, London, W.C.2.*

**6<sup>D</sup>**  
JANUARY

*C. Arthur Pearson, Ltd.*