

ALL ABOUT MICROPHONES—See Page 313

Practical and Amateur Wireless

3^d
EVERY
WEDNESDAY

Edited by F.J. CAMM

a GEORGE
NEWNES
Publication

Vol. 8. No. 194.
June 6th, 1936.

AND PRACTICAL TELEVISION

H.T. Battery



ECONOMY



WIRELESS WORLD

Can there be a better speaker? asks Mr. Camm

ADVT.

FOR EVERY CYCLIST, MOTORIST AND HIKER

Get one

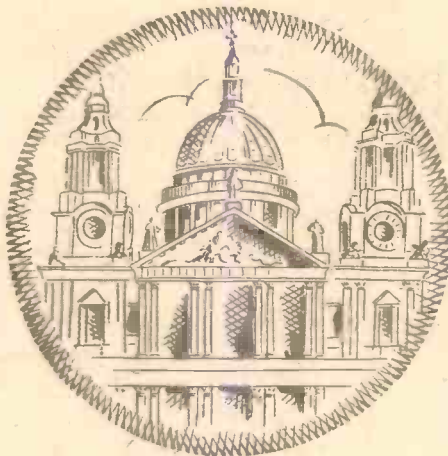

Today!

NEWNES

ROAD MAP of LONDON

and

SURROUNDING COUNTRY

Every hiker, cyclist, and motorist and all people who get their pleasure from going "Places" knows that a good map is almost as essential as fine weather.

Since we cannot make the weather for you we can merely wish you the best of the sunshine, and offer you the best of maps. A good map is always a fascinating possession. To study the way you will go is almost as pleasant as going.

TWO HANDY MAPS IN ONE:

1. Six hundred square miles of the London area, showing the principal thoroughfares and new arterial and by-pass roads, with explanatory list of map references to the chief places of interest, golf courses and other sports centres. Scale: 1 mile to 1 inch.
2. Map of the country surrounding London from Colchester to the South Coast. Scale: 4 miles to 1 inch.

Special Features: Printed in four colours on specially reinforced "canvas paper." Landmarks and points of interest clearly shown, as well as adjacent railways and stations. Types of road clearly differentiated in colour. The entire map calibrated in three-inch squares for easy scale reading. Folded to pocket size.

Only
2/6 net.

From All
Booksellers.

Order
Yours
Now . . .

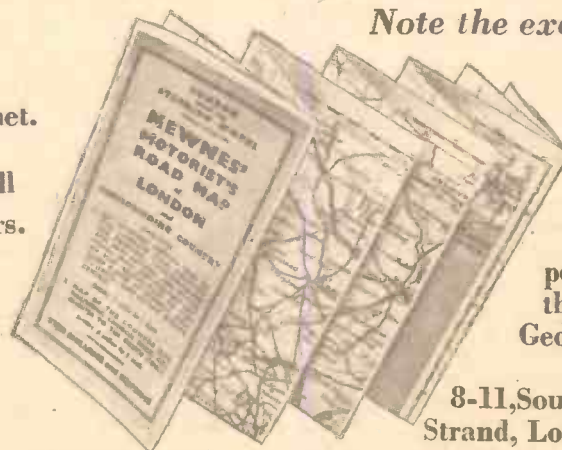

Note the exceptionally
large
scale!

2/9
post free from
the publishers
George Newnes,
Ltd.,

8-11, Southampton St.
Strand, London, W.C.2.

NEWNES: LONDON

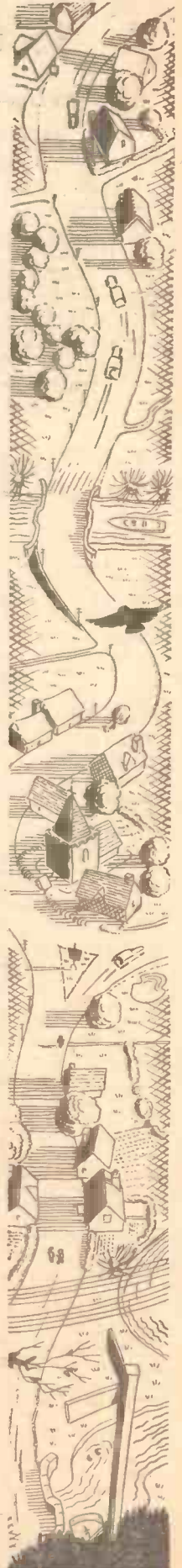
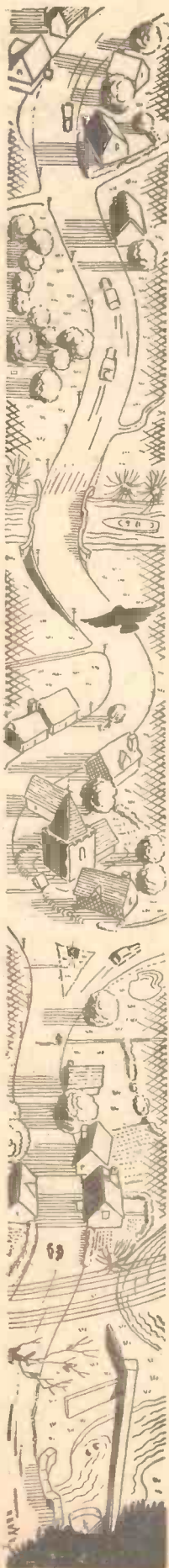

A SEASONAL SPRING CLEAN—Page 320



Practical and Amateur Wireless

Edited by **F. J. CAMM**

Technical Staff
W. J. Delaney, H. J. Barton Chapple, Wh.Sch.,
B.Sc., A.M.I.E.E., Frank Preston.

VOL. VIII. No. 194. June 6th, 1936.

ROUND *the* WORLD of WIRELESS

Binding Cases and Indexes for Volume VII.

BINDING cases and indexes for Volume VII of "Practical and Amateur Wireless" are now available. The binding case, complete with title page and index, costs 3s. 6d., and the index alone 7d. by post from Geo. Newnes, Ltd., 8-11, Southampton Street, London, W.C.2.

Centenary of a Physicist

JEAN-MARIE AMPERE, the French scientist to whom, amongst other things, we owe the word "amps," died at Marseilles on June 10th, 1836. The centenary of his death is to be commemorated by a series of special broadcasts in July from most of the French P.T.T. stations. In his native land it is contended that, in effect, Ampere was the originator of the conception of electric telegraphy.

The N.B.C. Chimes

LISTENERS to the U.S.A. broadcasting studios are often puzzled by the three notes which are heard at the end of every transmission. They represent the initials of the General Electric Company (G.E.C.) which, amongst other stations, runs WGY, Schenectady, and its short-wave outlets.

Runner-up in Europe's Radio Stakes

ON May 1st last Germany possessed 7,599,525 registered licence holders, of which 579,153 were allotted free by the authorities. It is anticipated that the general interest in the forthcoming Olympic Games at Berlin will still further increase the number.

New Transmitters for Jugo-Slavia

BOTH the Marconi Wireless Company of London and the Telefunken Company of Berlin are tendering for the construction of the four radio stations which the Belgrade broadcasting organisation proposes to add to its network. The plan includes a 100-kilowatt transmitter for the capital, a 25-kilowatt station at Zagreb, one of 10 kilowatt at Skoplje, and a smaller plant to be installed at Spalato (Split). When the high-power station is completed in the neighbourhood of Belgrade the present station will be dismantled and re-erected at Serajevo.

Extension of Broadcasting House

THERE is every possibility that in the near future the size of the B.B.C. Headquarters in Portland Place, London,

will be doubled in view of the Corporation's recent acquisition of adjoining property. It is also more than likely that the building will be mainly used for administration purposes, as provision for extra studios has been made at Maida Vale, St. George's Hall, and elsewhere.

Open Day and Night

VK2UW, one of the principal Sydney (N.S.W.) broadcasting stations, operates a twenty-four-hour service, and during the night hours provides entertainment for listeners who suffer from insomnia. At various intervals items of immediate interest are broadcast; they are strictly topical,

ON OTHER PAGES.

	Page.
H. T. Economy	311
All About Microphones	313
Readers' Wrinkles	314
Interference Suppression	315
On Your Wavelength	317
Practical Television	319
A Seasonal Spring Clean	320
Beginners' Supplement	321
Listening in Comfort	322
Data Sheet (The "Elf")	324
Short-wave Section	325
Practical Letters	328
Queries and Enquiries	331

and may include SOS messages or other happenings of major importance.

One Way of Hearing Clients' Opinions

AT one of the main Vienna stores a microphone has been cunningly hidden in one of the shop show-windows. By this means a shorthand-typist, equipped with headphones, may overhear and transcribe useful observations and criticisms made by passers-by respecting the prices of goods placed on display. The notes are later passed on to the management for due consideration.

Rediffusion Service in West Africa

AS Lagos possesses no wireless broadcasting station, the authorities have established a rediffusion system which brings to the population most of the benefits of an up-to-date studio. News

bulletins, weather forecasts, shipping news, concerts, talks, and the playing of gramophone records with, as a special feature, a relay of the Daventry Empire programme, are regular features of the entertainment.

German Television-Telephone

By next year Germany hopes to have a telephone-television cable extending 620 miles. The experiments carried out on the Berlin-Leipzig line were so satisfactory that they are now to be made between the capital and Hamburg, and on a line installed between Leipzig and Munich.

These Polyglot Studios

ONCE upon a time it was possible to identify a broadcast by the language heard, and state definitely that it emanated from a certain country. To-day, in view of the fact that some studios put on news bulletins and propaganda talks in a number of European tongues, the matter has become more difficult. Just below Leipzig, on Tuesdays and Saturdays, you may pick up a French news bulletin; log it as from Barcelona (EAJ1) on 377.4 m. (795 kc/s).

Why the Set was Switched Off

ON several occasions one of the announcers at the Hilversum studio received anonymous letters threatening him with a sudden and sticky death. These, curiously enough, were ultimately traced to a young school-girl in North Holland, on whose nerves, it was stated, the voice grated. The announcer was later informed that her father, for the time being, at least, had disconnected the wireless receiver!

Marseilles P.T.T.

SINCE May 14th, following vigorous protests received from listeners against the undue delay in bringing the new station into operation, the authorities have arranged to broadcast all the Marseilles programmes from the 120-kilowatt transmitter from B.S.T. 18.30 nightly until the studio signs off for the day.

Opening of the Masaryk Station

THE 30-kilowatt transmitter which the Czechs have installed at Leskomer Hill, some five miles distant from Banská-Bystrica, was formally inaugurated on May 17th. *Radio Masaryk*, as the station is called in honour of the first president of the Czech Republic, works on 765 m. (392 kc/s), with full power during the day, and on 15 kilowatts after sunset, in accordance with the Lucerne Plan.

THE PICK of the PROGRAMMES

Besses o' the Barn Band

THIS famous Lancashire Band which, conducted by W. Wood, will broadcast from the Manchester studios on June 7, dates back to 1828. The original members paid a penny a week "for the support of the society in books and candles," and fines were imposed for non-attendance and other delinquencies. The band takes its name from a little Lancashire village halfway between Manchester and Bury. In its time the band has been one of the most successful in the country, and is still perhaps the most famous in Lancashire. It has toured the world and won innumerable prizes.

"Tale Twisting"

THE third edition of "Tale Twisting" will be broadcast in the Regional programme on June 11th and in the Western programme on June 12th. The sketches and music are written by West Country authors and composers. As in the earlier editions, John Plym the sailor man will tell stories, including one about his shipmate being swallowed by a whale. The broadcast will also provide the "true" reason why Cabot went to America and the "true" story of Cæsar's conquest of England. Alice is also a regular visitor, and she always has some trouble to tell about, usually heart trouble. Listeners will also hear about Prehistoric Percy, a Day in Sollywood, and The New Pupil.

Symphony Concert

H. FOSTER CLARK will conduct the B.B.C. Midland Orchestra in Schubert's seventh Symphony and Wagner's "Siegfried's Journey to the Rhine," on June 12th. The leader of the orchestra is Alfred Cave.

Anne Ziegler

THIS popular Liverpool musical comedy and pantomime star will be "Up North" again on June 7th, and she is to broadcast a programme of popular songs from the Pavilion Gardens, Buxton. She will be accompanied by the Buxton Spa Orchestra, under the direction of Maurice Miles.

"Eight Bells"

THE many letters and messages of congratulation received by Mungo Dewar after his recent production of "Eight Bells" bear eloquent testimony to the interest aroused by this nautical programme. Despite the predominantly naval atmosphere of the show, and the nautical nature of some of the slang and cross-talk, appreciation of it was by no means confined to past or present members of the Navy, though many ex-naval men of all ranks wrote to say how much they enjoyed the authentic atmosphere of the programme. A second edition of "Eight Bells," with entirely new songs and dialogue, will be broadcast on the National wavelength on June 6th. The cast will include Arthur Prince and Jim, Harry Hudson, Denis O'Neil, and George Baker.

Country Songs

WALTER PITCHFORD, of Lamport, Northamptonshire, has arranged a programme of Country Songs for the B.B.C. Midland Singers. Mr. Pitchford is

MAKE THESE DATES WITH YOUR RADIO

keenly interested in music and has collected tunes and songs in the Nene Valley and in Norfolk. Two of his earliest Midland

IN A MODERN RADIO FACTORY



A girl worker testing volume controls in the Ferranti works at Moston.

broadcasts were devoted to what he called "Great-grandfather's Song Book." The Singers will be conducted by Edgar Morgan, and accompanied by a Salon Orchestra led by Norris Stanley. This broadcast will be given in the Midland programme on June 10th.

SOLVE THIS!

PROBLEM No. 194.

After Edwards had completed the construction of his new three valver he connected up the aerial and earth leads and switched on, but was disappointed to find that only one weak transmission could be heard. This station was heard at all points of the tuning scale at equal volume. What was the trouble? Three books will be awarded for the first three correct solutions opened. Address your letters to the Editor, PRACTICAL AND AMATEUR WIRELESS, George Newnes, Ltd., 8-11, Southampton St., Strand, London, W.C.2. Envelopes must be marked Problem No. 194 in the left-hand corner and must be posted to reach this office not later than the first post Monday, June 8th, 1936.

Solution to Problem No. 193.

The fault in Brandon's receiver was an open-circuited bias resistance in the cathode circuit of the output valve.

Only one reader successfully solved Problem No. 192, and a book is accordingly being forwarded to him: D. F. Eadle, 15, The Loaming, Whitecraigs, Renfrewshire.

Promenade Concerts, 1936

THE B.B.C. announces that the forty-second summer season of Promenade Concerts will be given in the Queen's Hall from Saturday, August 8th, to Saturday, October 3rd. Sir Henry J. Wood will again conduct the B.B.C. Symphony Orchestra throughout the season.

Follies from Blackpool

TOM VERNON'S "Royal Follies" will broadcast from the Central Pier, Blackpool, on June 10th. This popular concert party includes Phil Strickland (comedian), John Wright (tenor), Howell Glynn (bass), and Evelyn Bury (soprano).

Travellers at Ease

THE microphone will visit Ludlow Youth Hostel on June 13th, in order to give a sound picture of life here on a Saturday night in the summer, when walkers and cyclists exchange experiences in the Common Room in the hour before lights out. There will be several continental visitors, so possibly the Englishman's aversion from singing will be overcome for the occasion. Ludlow is one of five Shropshire hostels organised by the Birmingham regional group of the Y.H.A., and members obtain a bed at a cost of a shilling a night, but it is a strict condition that they must travel under their own power. This programme, which will be given from the Midland Regional on June 13th, has been arranged and will be produced by David Gretton.

Variety of Instruments

JACK HYND'S Banjoliers will contribute to the "Variety of Instruments" programme on June 11th. This combination is composed of clerks, bricklayers, jewellers, joiners, hairdressers, shopfitters, and engineers. The club was formed in Glasgow about eleven years ago and has been managed by Jack Hynd since then. It consists of forty-three members, but only a number of these will broadcast on this occasion. Leslie Lewis (xylophone) and Richmond McKinnon (accordion) will also be heard.

Concert from Barrfields Pavilion

SUMMER shows are again the order of the day, and on June 9th the first excerpt from Harry Kemp's summer show will be broadcast from the Barrfields Pavilion, Largs. Talented artists are Dave Bruce, Elsie Prince, Sylvia Cecil, Percy Manchester, Jack E. Raymond, Ann Doel, the Saxon Girls, and Harry Carmichael and his Band. The producer will be Jack E. Raymond.

The Plymouth Orpheus Society

THE Plymouth Orpheus Society, conducted by David Parkes, will give a concert from the Abbey Hall, Plymouth, on June 6th; Margaret Fairless (violin) will be the artist. The Society was founded by its present conductor in 1906 and many world-famous instrumentalists have appeared at its concerts. It sometimes happened that important singers were stationed at Plymouth garrison during the war, and they took part in the Society's concerts which were devoted towards charities.

High Tension Current Economy



A Drydex standard 120-volts H.T. battery.

THE cost of high-tension current is generally the most important item in the running expenses of the average battery receiver, especially when dry batteries are used. For this reason, if for no other, it is worth while to consider possible means of reducing the current as much as possible without impairing results to any marked extent. One factor which tends towards excessive cost of dry-battery replacements is that so few wireless-set users appreciate the saving which can be effected by using double- or triple-capacity batteries; that, however, is a

The Effects of G.B. and H.T. Voltage Variations: Automatic Grid Bias: Economiser Arrangements: Cutting Out One Valve: H.F. Valve Bias

By FRANK PRESTON



A Telsen 3-range test meter.

higher the grid-bias voltage which is applied to this valve, the lower the H.T. consumption becomes. There is a limit, of course, because if the bias is increased too much, distortion results, whilst the output volume is curtailed. In very many instances, though, the total available grid swing of the valve is not required, due to the fact that the input to the valve is insufficient to

tapping, but it is certainly worth while to try a lower voltage by adding an extra tapping, as shown in Fig. 1, or by including a 2,000-ohm fixed resistance, with a 1-mfd. by-pass condenser, as shown in Fig. 2.

In the case of a single L.F.-stage receiver having a small power valve, or even a super-power valve in the last stage, it is frequently possible to reduce the H.T. current by replacing this by a pentode. The reason is that a modern high-efficiency pentode, such as the Cossor 220 H.P.T., actually takes less current than the triode, despite the greater degree of amplification which is afforded. As a matter of fact, the pentode mentioned will operate very satisfactorily in most simple sets with a total H.T. consumption — both anode and

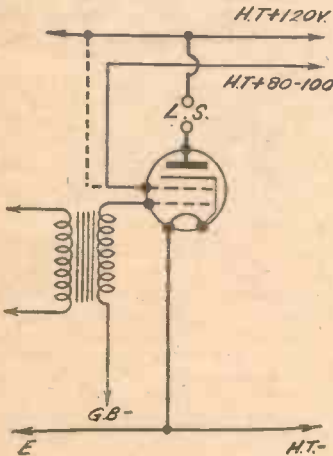

Fig. 1.—An economy in H.T. can often be effected by using a separate H.T. + lead for the pentode auxiliary grid, instead of the direct lead shown by a broken line.

point which was dealt with at length in two articles entitled "Running Costs" which appeared in the issues of this journal dated February 1st and 8th, 1936, and therefore the matter will not be further considered here.

The H.T. Battery

There are many instances where a large-capacity battery cannot satisfactorily be employed, especially in portable sets or in others with self-contained batteries, which must be accommodated in a rather limited space. It is in such cases that the current question must be studied still more closely. For the normal type of three-valve set having H.F., detector and L.F. valves it is nearly always possible to bring the total current consumed down to 10 mA or less without sacrificing either sensitivity or quality, but in order to ensure this, care must be taken in every stage of the set. It is the output valve which is responsible for the major portion of the current load, and it should be remembered that the

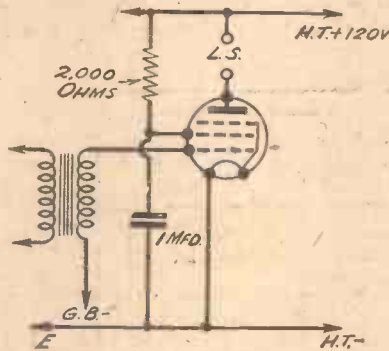

Fig. 2.—An alternative arrangement to that shown in Fig. 1, where a voltage-dropping and decoupling system is used.

warrant it. There is then every justification for using a G.B. voltage appreciably higher than the average figure quoted by the makers.

Alternative Valves

When a pentode valve is used in the output stage the voltage applied to the auxiliary grid also has a profound influence on the H.T. current consumption. For simplicity it is common to connect the auxiliary grid direct to the maximum-voltage H.T.

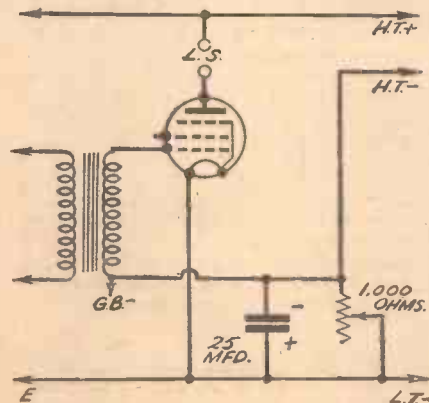

Fig. 3.—When using a high G.B. voltage for the output valve it is preferable to obtain the bias automatically as shown.

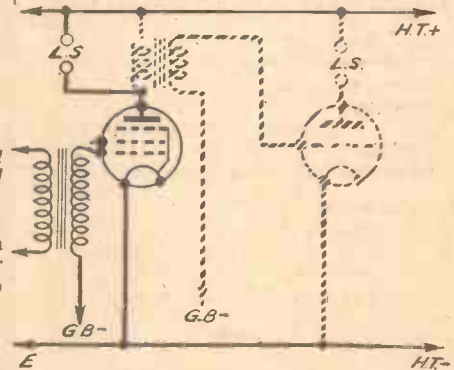

Fig. 4.—Replacing two triodes by a single pentode to reduce H.T. current without loss of volume.

auxiliary grid—of slightly more than 6 mA. This is when using the circuit shown in Fig. 2, applying 120 volts to the anode, and using a G.B. voltage of 6. With this arrangement, however, it might be found that a certain amount of distortion occurs when the H.T. battery begins to run down, but this can be rectified by reducing the G.B. voltage accordingly; the current can still be kept at about the figure mentioned. A still better method is to use automatic grid bias, for then the G.B. voltage is regulated automatically according to the H.T. voltage actually applied to the valve. The circuit for this is given in Fig. 3, where a 1,000-ohm variable bias resistance is indicated, this being by-passed by means of a 25-mfd. electrolytic condenser. The setting of the resistance depends upon the total current taken by all of the valves together, but the highest resistance which provides satisfactory quality should be employed. Once the resistance has been adjusted in this manner it can be left entirely alone.

(Continued overleaf)

(Continued from previous page)

One Pentode for Two Triodes

When two L.F. valves are employed it is frequently possible to replace both of these by a single pentode, when the saving in current is still more noticeable, although the output may remain practically unchanged. All that is necessary is to remove the second transformer and replace the four-pin valve-holder used for the first L.F. stage by a five-pin one, of which the fifth pin is joined to a tapping on the H.T. battery. This is shown in Fig. 4, where the parts to be removed are indicated by broken lines. In some cases it might be better to use an L.F. transformer providing a slightly higher step-up ratio. On the other hand, if resistance-capacity coupling were used for the first stage, the transformer no longer required can be added to this, as shown in Fig. 5. In that illustration it will be seen that the transformer is wired to provide a step-up ratio greater than that at which the transformer is nominally rated. If the transformer were rated at 1.3 the ratio provided would be 1:4.

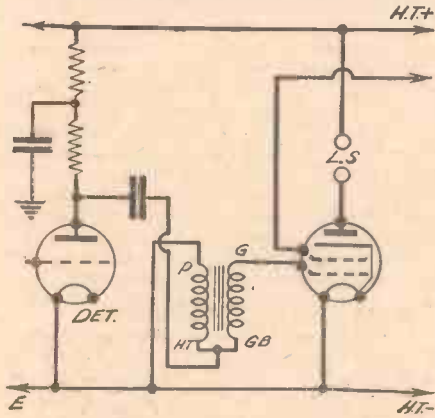

Fig. 5.—When using the arrangement shown in Fig. 4 it is often preferable to increase the step-up ratio between the detector and output valve. One method is indicated here.

The Economiser Circuit

When an output of 500 milliwatts or more is required it becomes necessary to employ a super-power pentode, and this naturally passes a fairly high H.T. current—probably in the region of 15 mA at 120 volts. But this current can be reduced to an appreciable extent by employing an economiser device comprising a WX "Westector," a couple of fixed condensers and three fixed resistances, wired as shown in Fig. 6. In this case it is also necessary to

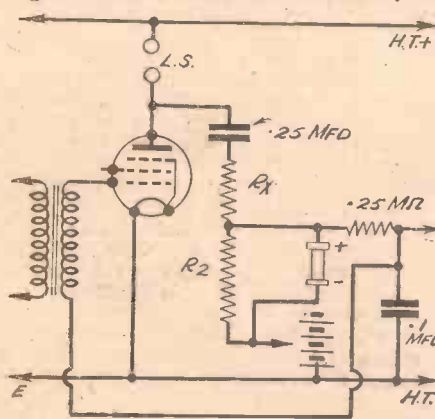

Fig. 6.—Connections for a "Westector" used as a current economiser. The G.B. voltage should be almost double the usual value, and resistance R_x must be chosen according to the particular valve employed.

use a separate G.B. battery for the output valve if bias is also applied to the H.F. valve. Altogether, the initial cost of the modification is fairly high, but it serves to reduce the H.T. current passed to a marked extent by increasing the grid-bias voltage when the valve is handling quiet passages, and thus the expense is soon saved. Values are given for all except one of the resistances, and this is governed by the particular output valve employed. For the Cossor 220 P.T. the Mazda Pen 220A and similar pentodes, the value of R_x should be 100,000 ohms, whilst for the 220 H.P.T. the appropriate resistance is 150,000 ohms. The system can also be used in conjunction with triode power valves, when suitable values for the resistance are 20,000 ohms for the Osram P.2, or 60,000 ohms for the Cossor 220 P.A. The G.B. voltage used should be about twice the ordinary value.

Switching Out One Valve

Another method of reducing the H.T. current when using two L.F. valves is to arrange a method of switching the second valve out of circuit when only a modest volume is required. One simple method of doing this is indicated in Fig. 7, where a two-pole change-over switch is used to transfer the speaker to the first L.F. valve, and at the same time to break the filament circuit of the last valve; by doing this a

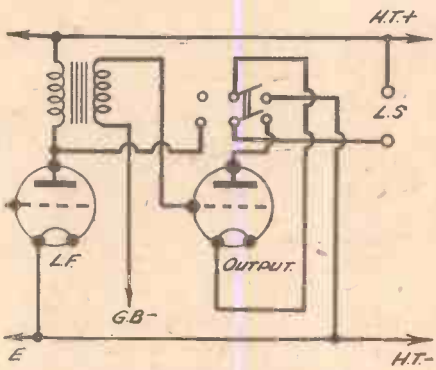

Fig. 7.—One way of switching out the last valve and transferring the speaker to that preceding it.

saving of L.T. current is also obtained. An ordinary Q.M.B. switch can be used, and the alteration is perfectly simple. It is most satisfactory when the L.F. transformer between the last two valves has a high primary impedance, because this is left in parallel with the speaker transformer and tends to reduce the volume by acting as a by-pass. For this reason, a better arrangement is to use a plug and jack for the speaker, this being wired as shown in Fig. 8. A simple two-point jack is used in the anode circuit of the last valve, but the other one is of the three-point make-and-break type, and is wired so that the speaker is parallel-fed, and also so that the filament circuit of the last valve is broken when the speaker is joined to that preceding it.

Biasing the H.F. Valve

Although the output valve consumes the greater part of the total anode current, it is worth while considering means of reducing the consumption of the others in the receiver. With the variable-mu H.F. valve this is easy, for it simply means that the volume control must be turned towards its minimum-volume position. It is obvious that a loss of sensitivity must accrue from this, but for the local stations, at any rate, this will be unimportant if a decent aerial system is employed, and if full use is made of reaction. It is possible to arrange a switch to cut out the H.F. valve, but this

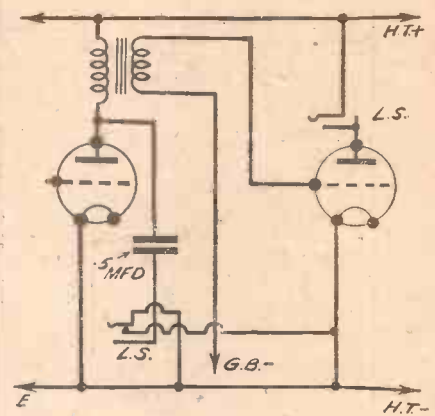

Fig. 8.—A better method of transferring the speaker—using a pair of jacks.

is not advised, because it might introduce losses when the valve is in use.

When the H.F. valve is not of the variable-mu type it is worth while to connect it as such so that the bias applied to the grid can be increased when full sensitivity is not required. As an alternative a switch could be provided for applying bias to the grid when amplification of the valve is unnecessary, as in Fig. 9.

In nearly every case the anode-current consumption of the detector valve is very small compared with that of the other valves in the set, but it might still be worth while to experiment with methods of reducing it still further. One simple arrangement is to increase the value of the decoupling resistance—and this might improve results rather than the reverse. Another method is to replace the special detector or L.F. type of valve, when used, by one of the H.F. type, which operates more efficiently with a lower-anode voltage, besides having

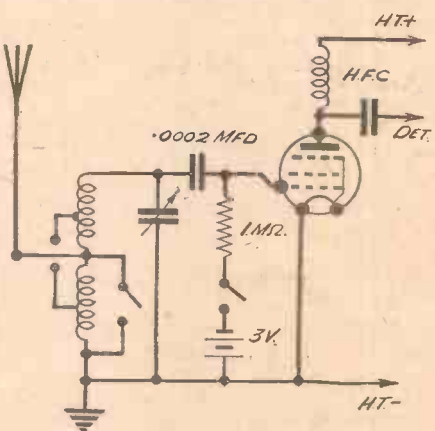

Fig. 9.—Showing how the H.F. valve can be biased when high sensitivity is not required.

a greater impedance and thus passing a smaller amount of current.

Current Measurements

All of the above modifications can be made simply by trial and without actually measuring the current consumption, but it is a good plan, when a milliammeter is available, to take readings with this in order to verify the results. In most instances it will be sufficient merely to join the meter between the H.T. negative lead from the battery and the corresponding terminal of the set. So that the resistance of the meter will not cause instability, a 2-mfd. condenser should be connected directly between its two terminals, to act as a by-pass.

All About Microphones-1

A Simple and Brief Explanation of the Various Types of Microphone which may be Used and Constructed by the Average Amateur.

By W. J. DELANEY

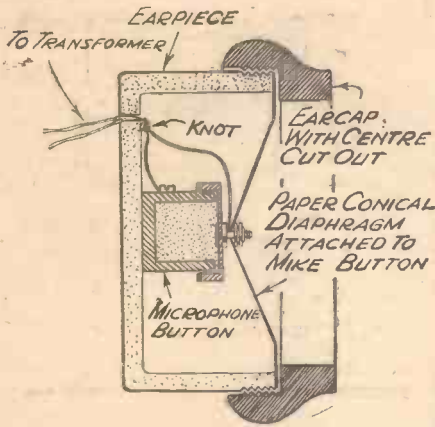

Fig. 2.—A good microphone may be built up in the manner shown here, with the aid of a microphone button.

MANY amateurs to-day are interested in the use of their radio apparatus for gramophone record amplification and desire to carry this stage even further by making use of a microphone. In many cases, too, readers are connected with dance bands and wish to make use of an L.F. amplifier in conjunction with a microphone to relay vocal effects. Some confusion seems to exist, however, with regard to the various types of microphone which are now seen in the illustrations of public-address and broadcasting apparatus and it is proposed to cover the subject in this article.

How the Mike Works

The microphone, no matter what type is considered, functions in a similar manner to the loud-speaker, but in the opposite direction. That is to say, the sound waves, either from the announcer or from some musical instrument, are permitted to impinge upon the microphone, whereupon they are converted into some form of electrical energy. This energy is imparted to the grid circuit of a valve amplifier and thereby produces a change in anode current which may be subsequently further amplified. The differences in the various types of microphone are found in the method of converting the sound waves into electrical energy, and it is obviously here that the essential features will be found.

Types of Microphone

The majority, if not all, of the "cheap" (by which I refer to low-priced) microphones on the market are of the carbon type. This is the simplest arrangement, but it may be made up in dozens of different patterns, and in most designs the modifications are carried out in an endeavour to remove the various background noises which may be introduced by this type of instrument.

The remaining popular types of instrument are the moving-coil microphone, the condenser microphone, and the ribbon or velocity microphone. The piezo-crystal instrument is also available in this country, but does not seem to be so popular as it should be amongst amateurs, and this is probably due to its high cost. However, we will now consider these various instruments in order.

The Carbon Microphone

This particular instrument is the cheapest, and may now be obtained for as low as 1s., in which form, of course, it is at its simplest. A small brass box is packed with very fine carbon granules, and the front of the box is closed by means of a thin disc

of flexible material upon which the sound waves impinge. Carbon is a conductor, and thus if the granules are permitted to complete an electrical circuit there will be a definite resistance depending upon the degree of "packing" of the granules. As the diaphragm vibrates the pressure on the granules is varied, and thus the resistance, thereby producing the necessary electrical change to operate the valve to which it is connected. To improve upon the simple instrument just described the diaphragm may be increased in size, thickness, weight, shape, and method of attachment, and all of these variations are found in the various commercial microphones now on the market.

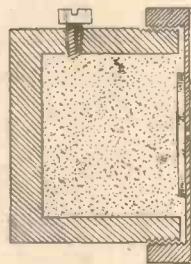

Fig. 1.—Sectional drawing showing the principle of construction of the popular type of microphone button.

A large disc may be attached to the centre screw of the instrument to increase the movement created by the sound waves, and this disc may be constructed from dozens of different materials in order to vary the particular resonance point of the instrument. A different type of reproduction will be found with practically every different diaphragm which is employed, and best results are generally obtained when a conical diaphragm of the lightest possible construction is fitted. Fig. 1 shows the original simple 1s. microphone, and a suggested modification is shown in Fig. 2. A thin conical diaphragm is constructed from stout drawing-paper (two-sheet Bristol Board) and this is mounted in an old telephone earpiece, with the microphone button attached to the rear of the instrument. Other ideas may be developed from this brief suggestion, but whatever system is adopted the instrument must be so mounted that no vibrations can be transmitted to it other than through the air. Thus the usual

scheme is to fit ordinary screw-eyes to the outside of the instrument and then suspend it in a metal ring by means of rubber or elastic bands.

Matching the Input

It is necessary to match the impedance of the microphone to the grid circuit of the valve, and thus a transformer must be employed with this type of microphone. The usual step-up which is required is about 100 to 1, but by obtaining a tapped transformer the best ratio may be ascertained upon test. The circuit which is adopted is shown in Fig. 3, where it will be seen that the current required for the energisation of the microphone is passed through the primary of the transformer, and it is necessary to select a suitable voltage to avoid noise and also to prevent damage to the transformer primary. Suitable microphone transformers may be obtained at various prices from 3s. 6d. upwards.

The Moving-coil Microphone

The moving-coil microphone is exactly similar to the moving-coil loud-speaker, and consists in its essentials of a small coil of wire suspended in a magnetic field. The coil is made to move under the influence of the sound waves and thus varies the magnetic flux (again it will be seen that this is just the opposite effect of the moving-coil loud-speaker). The essential requirements of this type of instrument are a very light coil, a strong magnetic field, and the avoidance of resonance in the coil and its mounting. A diaphragm is, of course, attached to the coil in order to concentrate the effect of the sound waves, and this will have to be designed, as in the previous instrument, to be light in weight, free to move under the weakest impulse, and yet to be sufficiently robust to avoid blasting. A small moving-coil loud-speaker may be used for the purpose, but should be mounted in a small box so as to pick up

(Continued on page 327)

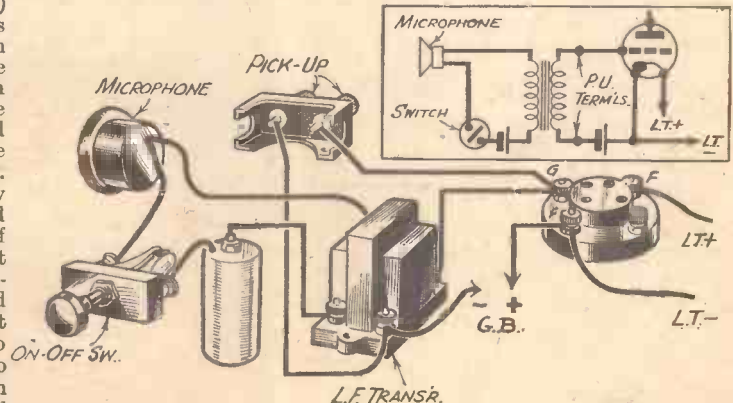

Fig. 3.—The general method of connecting a microphone to a valve amplifier. The air switch must be included to prevent discharge of the battery when the amplifier is not in use.

A PAGE OF PRACTICAL HINTS

**SUBMIT
YOUR
IDEA**

READERS WRINKLES

**THE
HALF-
GUINEA
PAGE**

A Simple Volume Control

THIS volume control, which has no moving contacts, can easily be made with a few odds and ends usually found in the scrap box. The moving arm, which is made of stout brass, presses on to a

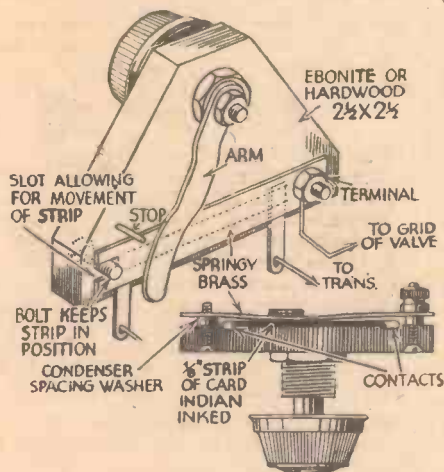

A simple volume control without moving contacts.

strip of thin sheet brass which makes contact at any required point with an inked strip of card immediately below it. A line 1/4 in. wide is made on the card with Indian ink. Other details of construction are shown in the accompanying sketch. This volume control is silent in action as the grid connection is taken from the terminal on the end of the contact strip and not from the moving arm.—E. NORWOOD (Margate).

A Thimble-cap Alteration

NO doubt many readers have been faced with the problem of making contact to the anode of the older type of screen-grid valve which has a screw-on terminal, in a set having the more modern type of anode

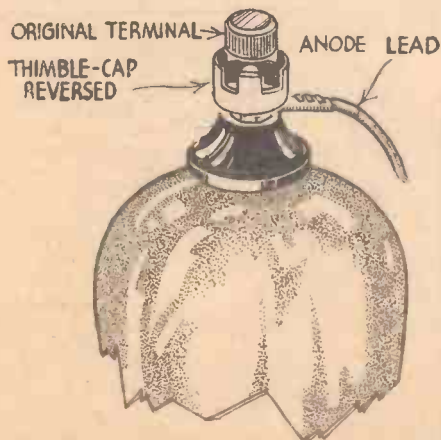

A modified thimble-cap connection for the anode of a screen-grid valve.

THAT DODGE OF YOURS!

Every Reader of "PRACTICAL AND AMATEUR WIRELESS" must have originated some little dodge which would interest other readers. Why not pass it on to us? We pay £1-10-0 for the best wrinkle submitted, and for every other item published on this page we will pay half-a-guinea. Turn that idea of yours to account by sending it in to us addressed to the Editor, "PRACTICAL AND AMATEUR WIRELESS," George Newnes, Ltd., 8-11, Southampton Street, Strand, W.C.2. Put your name and address on every item. Please note that every notion sent in must be original. Mark envelopes "Radio Wrinkles." Do NOT enclose Queries with your Wrinkle.

connection provided with a thimble cap at the end. To make the cap suitable for the valve on a recent occasion, I simply drilled a hole in the top of the cap, reversed it and forced it on the threaded part of the anode terminal, as shown in the sketch. With some caps it might be possible to screw on the terminal inside, so as to hold it securely; but if made a tight fit there is no necessity for this.—WM. NIMMONS (Belfast).

Incorporating a Switch in Aerial Tuning Condensers

THIS device was attached to an aerial tuner to facilitate short-circuiting the condenser itself (at the maximum position) or cutting it out to switch in an alternative tuning circuit. The fixing nut of the moving vanes was replaced by two lock-nuts which hold in position a circular brass cam (.048in. thick).

A strip of insulating material was secured between the existing condenser terminals to

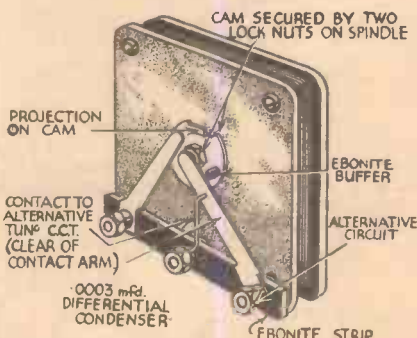

A method of incorporating a switch with an aerial tuning condenser.

enable three contact arms and terminals to be mounted, as shown in the diagram.

One of these arms (.032in. brass strip) bears upon the spindle to connect the moving vanes, whilst a similar arm is secured below a terminal to the fixed vanes and extends to a position above the cam. A centre arm (.064in. brass rod) is secured by an additional terminal so as to be just clear of the contact to the moving vanes. The circular cam carries an ebonite buffer and a raised metal projection located approximately 45 degrees apart; the cam is rotated by the spindle, so that when the

moving vanes are in their maximum position the metal projection makes upon the contact secured to the fixed vanes, thereby shorting the condenser for a straight-through connection.

At the minimum setting the ebonite cam lifts the contact clear of the main spindle and causes it to make upon the contact rod above it, so the condenser is disconnected and the lead transferred to the alternative circuit. Thus the multiplicity of controls can be avoided and all switching carried out at the extreme positions of the associated condenser.—WM. A. HARRISON (Aintree).

A Full-vision Dial Arrangement

THE full-vision dial with vertical pointer, shown in the accompanying sketch, can be easily and cheaply made by utilising

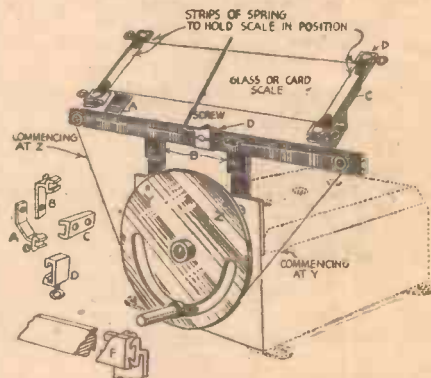

Constructional details of a full-vision dial arrangement with vertical pointer.

the various parts of a well-known make of curtain rail and fittings, obtainable from any of the cheap stores.

The greater part of the assembly consists of fitting the "jaws" of the small brackets, etc., on to the centre rib of the main bar, as shown. Three pieces of this bar are required, one for the traveller holding the pointer to move along, which piece also forms the main support of the whole dial. Two shorter lengths are required to fit at the ends of the main bar and support the glass for the dial, or if it is not required to have the dial illuminated then cardboard, or even thin plywood, will do.

If glass is used, the dial can be marked out on thin paper and clipped on to the glass at each end by a piece of spring held at either end under the small brass tabs that are shown soldered to the four "end stops" marked "D".

A piece of strip lead about 1/4 in. or 3/8 in. wide is soldered all round to the edge of drive disc, and two shallow grooves about 1/8 in. deep are cut close together all round this on the outside with a file, to carry the driving thread and ensure its running clear.

The two small "pulleys" at each end of the main bar are simply the special running pulleys supplied with the rail.—J. H. GIDDY (Folkestone).

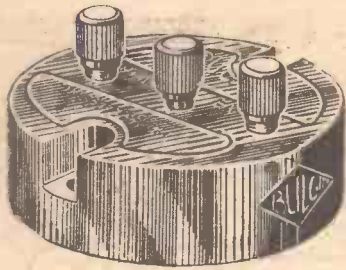

The Bulgín interference suppressor, consisting of two .1mf. condensers in series—rated at 250 volts.

SO far we have only considered the interference which arises from electrical apparatus situated either in the actual house or at least within the near vicinity. There are, however, several other sources of crackles or clicks which can mar the received programme, and the commonest of these is a poor-fitting connector. This may be of any form, and does not necessarily refer to a plug or socket. It was stated in the opening paragraphs of the article last week that when a current was interrupted a spark took place, and that

this gave rise to a radiation and thereby caused a noise in the receiver. This type of radiation is untuned—that is to say, owing to



The Clix patented plug which avoids all troubles arising from crackles due to poor contact.

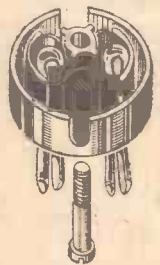

the absence of a resonance circuit, there is no exact frequency upon which the noise will be heard. Owing to this, it matters not what wavelength the receiver is tuned to, the noise will be heard as

a background. In the average home there are many sources of supply in which continuity of contact has to be relied upon for the function of some appliance or apparatus, and it is here that an intermittent current or supply can give rise to the noises already mentioned. For instance, the ordinary mains plug and socket consists of two brass sockets into which two brass pins are forced. To ensure a firm contact the usual procedure is to slot the pins and open them slightly, so that the overall diameter is slightly greater than the internal diameter of the socket. When the pins are pushed into the socket they are closed together, but owing to the natural springiness of the metal the sides make good contact with the sides of the socket and thus no trouble should be experienced.

Worn Contacts

It is often found, however, that after some period of use the natural springiness of the metal is lost and one of the pins makes a poor contact in the socket, or only touches at one point. Vibration, due either to passing traffic in the street, or to the weight of a person walking across the floor, will cause the plug to shake in the socket and the contact is then made and broken erratically, with the result that arcing takes place and the crackles and other noises are heard through the wireless receiver. The remedy is obviously to make quite certain that the contact is firm and reliable, and in this connection the novel Clix plug which

is shown on this page may be recommended. Instead of a slotted brass pin the insulated plug head carries two cotter

Continuing the Article which was Given Last Week, We Deal Here with Some Further Causes of Interference and the Methods of Overcoming the Difficulties

pins, and the wire leads are passed through the looped heads of these and when the two parts of the head are fitted together the wires are rigidly held whilst the cotter unit makes perfect permanent contact in the usual type of socket.

An ordinary electric lamp can also give

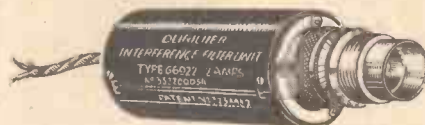

A filter unit made by Dubilier.

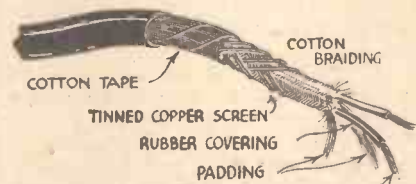

The method of building up a screened cable for interference elimination.

rise to crackles and interference in a similar manner. The base of an ordinary electric lamp is provided with two soldered connections, the solder being usually left in a "rounded" condition, so that it may

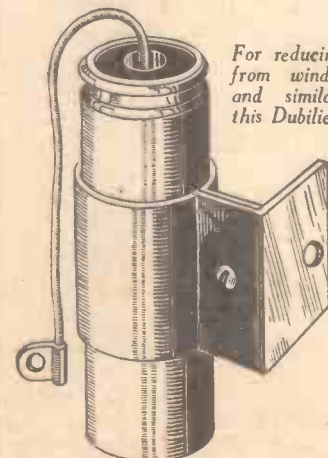

For reducing interference from windscreen wipers and similar apparatus this Dubilier unit is ideal.

bear against the small spring pins in the lamp-holder.

It may be found in certain cases (especially with cheap or foreign lamps) that the solder is insufficient to enable the contact to be firmly made when the lamp is in its final position in the holder, and this can give rise to crackles as already mentioned. The remedy is to run some

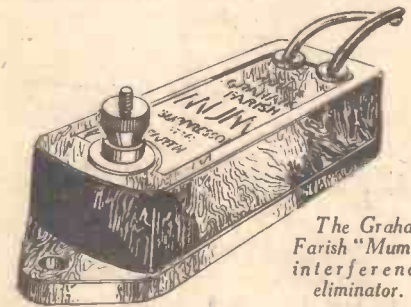

The Graham Farish "Mum" interference eliminator.

more solder on the contacts, and also to inspect the spring plungers in the holder and make quite certain that they return to their "full out" position after being depressed. (Any test at this point should, of course, only be made with the mains 'off'.)

Car Interference

When listening on the short-waves interference may easily be experienced from passing cars. The ignition system gives rise to quite a powerful radiation, and when a car radio is being employed the trouble is, of course, increased. Special interference suppressors may, however, now be obtained for the sparking plugs (which provide sparks from the interrupted current already referred to), and for the magneto, and these may be obtained from Messrs. Belling-Lee or Dubilier.

Similarly, in the car any motor-driven apparatus must be considered as mentioned in the first article, if a car radio is being used. The wind-screen wiper, for instance, may be of the motor-operated type and the commutator will give rise to noises unless a suppressor is employed. A small unit suitable for the purpose is shown on this page and is a Dubilier product.

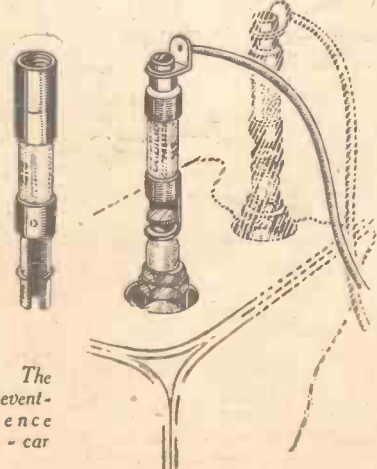

On the right. The method of preventing interference from motor-car plugs.

TESTS OF STANDARD RECEIVERS

ON OUR
AERIAL

REVIEWS OF LATEST RECEIVERS

The Aerodyne All-wave Snipe

THIS receiver has been designed for the battery user and is intended to bring to the listener who has no mains facilities all the advantages of all-wave reception. The receiver is designed to cover the short-wave band from 18 to 50 metres, in addition to the normal broadcast bands from 200 to 550 and from 800 to 2,000 metres. The medium band is covered by means of an iron-cored coil of standard design, tuned by means of a standard two-gang condenser. For the short-wave band special short-wave coils are mounted beneath the chassis and are brought

The Circuit

The aerial may be joined to the tuned circuit through either of a pair of fixed condensers to vary the selectivity, and the short-wave coil is joined in series with the broadcast coil. The grid of the H.F. valve is joined to one contact on the multi-point switch so that either the secondary of the broadcast coil or the secondary of the short-wave coil may be brought into circuit as desired. Coupling between the

smooth and adequate control on all wavebands.

A parallel-fed L.F. transformer coupling is adopted on the L.F. side, and it will be seen that the usual procedure of arranging two chokes in series is adopted. An anti-parasitic oscillation stopper is included in the grid circuit to the output valve, whilst a condenser is connected across the speaker transformer primary for tone-control purposes. Extension speaker sockets are provided.

Test Results

It will be noticed that the standard condenser is employed for tuning on the short-waves, but the slow-motion drive is sufficiently sensitive to enable tuning to be carried out without difficulty. Tests showed also that the controls all functioned in a very satisfactory manner, and the wave-change switch will be very unlikely to develop faults after repeated use, as it employs the now popular square section rod with contacts riveted into position. Under normal conditions selectivity was adequate for the reception of the principal medium and long-wave broadcast stations. Quality was clear and moderately brilliant, the tone control condenser serving to remove the "edge" from speech and music without providing a deep boomy tone. In fact, in this respect the tone from the pentode valve which was fitted was better than some receivers we have heard. Even when pushed to the limit there was no undue cabinet resonance, but volume is adequate for all normal requirements without using excessive reaction.

On the short waves there was sufficient material available for the average listener,

(Continued on page 327)



The Aerodyne Snipe in the neat walnut cabinet, showing the large tuning scale which is fitted.

into operation by means of the multi-contact switch.

The circuit employed is of the H.F. detector and output type, in which pentodes are employed in the first and last stages. The detector stage utilises a triode valve and the normal reaction circuit is included. The H.F. valve is of the variable- μ type and volume control is carried out by means of a potentiometer control across the G.B. battery, fed to the lower end of the grid coil in the usual manner.

H.F. and detector stages is carried out by means of tuned-anode coupling, and here the coils are switched when changing wavelength, whilst the reaction circuit is left unaltered. It will be seen from the circuit diagram below that the short-wave reaction winding is joined in series with a low value resistance and the broadcast reaction winding, and upon test this proves to be quite effective in giving

SPECIFICATION

Receiver.—All-wave Battery Three (The Snipe).

Circuit.—H.F., detector, and pentode. H.F. transformer in the aerial circuit, with short-wave transformer in series, and tuned-anode coupling between H.F. and detector stage. Parallel-fed L.F. transformer coupling. Capacity-controlled reaction, without switching. Gramophone pick-up and external speaker sockets. Partial tone-correction by means of capacity shunt on speaker transformer primary.

Valve Combination.—Variable- μ H.F. pentode, triode, and economy L.F. pentode.

Controls.—Reaction; tuning; wave-change; and combined volume control and on-off switch.

Remarks.—Good selectivity on all bands, with smooth reaction control throughout the entire range. Good quality and clear tuning indication due to the large tuning dial which is fitted.

Price.—£7 7s. with valves, but less batteries. Makers.—Aerodyne Radio Ltd., Aerodyne Works, Tottenham, London, N.17.

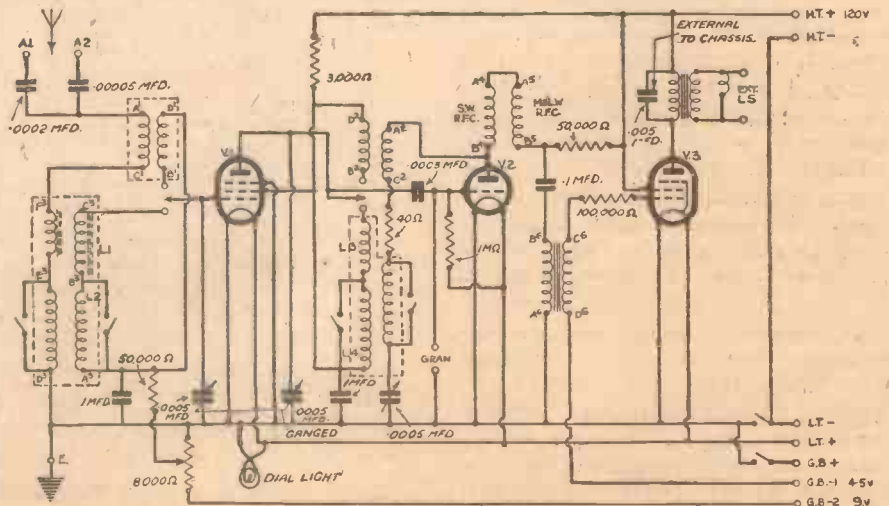

Theoretical circuit of the Snipe.

On Your Wavelength

That Standard Receiver

I AM surprised at the little notice which has been accorded the recommendation in the report of the Broadcasting Committee that the B.B.C. and the Wireless Trade should jointly sponsor a standard receiver. I do not quite know what this recommendation means, but if it is a suggestion that only sets should be marketed which are approved by the B.B.C., then I am all against it. We know what has happened in Germany with the standard receiver which Hitler introduced. We know that such a receiver would be incapable of receiving certain programmes, for apparently the German idea was that true Aryans should only listen to the words of the Führer and not endeavour to broaden their outlook by listening to foreign programmes. Such a system is a most

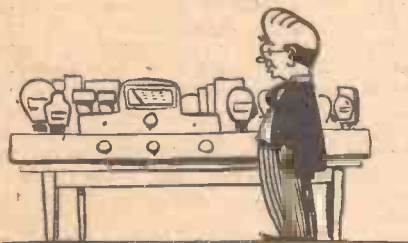

If valves were cheaper.

effective way of muzzling public opinion and preventing foreign propaganda from interfering with internal politics.

In any case, the B.B.C. is not the body to decide what a standard receiver should be. For one thing any changes in transmitting systems would place at a severe disadvantage any owner of such a standard receiver, and certainly the commercial receiver would decline in popularity. The net result would be that everyone would again turn to home construction and build receivers of the sort which manufacturers under a standard system would be precluded from supplying. It is certain that radio technique will undergo severe and rapid changes within the next twelve months, for the very good reason that television will change it. Ultra-short-wave transmission and reception is a vastly different science from the normal technique, and a standard system at this juncture would be most undesirable

By Thermion

as a direct interference with the listener's liberty. You may argue that you can only listen to one telephone subscriber at once, and that no listener should want to listen to more than one programme; but with the telephone you can get any number, and with a wireless receiver you should have the largest measure of freedom to listen to what programme you choose. In this supposedly free land of ours, where everyone works 20 per cent. of the year for the country, and where few liberties are left, we should be permitted to use our radio according to our own likes and dislikes.

The B.B.C. has a monopoly and monopolies have a nasty way of being operated against general interests. Let us hope that the B.B.C. does not go that way, for abuse of monopoly can cause an enormous public outcry and the collapse of the monopoly.

My Thoughts

JUST a word about the conduct of this feature. Lots of readers write to me when I deal with Dickens or crooners, telling me to stick to wireless, and they write to the Editor in similar strain. Whilst I am conducting this feature I shall write of what I see and think and hear without let or hindrance. You build a wireless receiver so that you can listen to music, to talks, to the news, to variety. This feature is not intended to be a technical one, and all of the subjects upon which I write are related in some way to radio.

I refuse to play to the gallery. It would be as sensible to argue that the B.B.C. programme should consist entirely of technical discourses on wireless; and if you do not like my feature, you need not read it. Lots of readers do like it, and it is impossible to design every feature of a paper to appeal to every reader. Savvy?

Are Valves Too Dear?

I HAVE received a few letters from readers who think that valves are still too dear, and that if valves

were cheaper they would build six- and seven-valve sets, instead of the modest threes they construct now. I don't agree at all. The valve is a modern marvel. It is trouble-free and lasts for at least 1,000 working hours. What other commodities can you name which give such faithful service for such a small outlay?

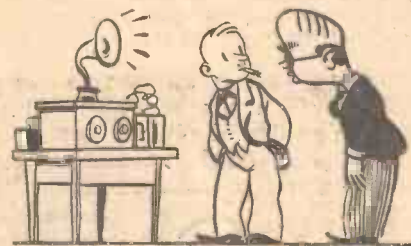

He's waiting for television.

Compare the price of the modern valve with the frightful things which were sold only ten years ago.

Poem!

THE Editor has passed along, from a reader who desires to remain anonymous, the following poem:—

To Thermion, whose noble scrawl
Makes innocent and guilty bawl
In endless provocation;
Although you write with verve and
class
I can't allow the whole to pass
Without interrogation.

This fleeting shaft, earth's life, I
mean,
Is far too short to make unclean
With warblings from crooners;
We'll banish them to desert land
To mix their sentiments with sand
And other brainless mooners.

"Oh, would some power"—you
know the rest,
Which comes from Burns—the
truest jest:

He never saw his image;
Nor should his doggerel disgrace
The ethics of our moral race
In microphonic scrimmage.

Of Stevenson and Scott and such,
Like you, I really don't think much;
Nor Dickens with his capers
Could e'er have hoped to earn my
praise;

I go berserk when'er I gaze
Upon his "Pickwick Papers."

But one more breath, majestic
scribe,
Ride gently ere you turn the jibe
To B.B.C. officials.
If you denounce the voice and
style,
The angel may think it worth while
To cancel your initials.

H'm!

When Television is Here

I SAW a set the other day which had been in use for the last ten years. I asked the owner why he did not have a better and more modern set (he could easily afford it), and he told me that he will—when television arrives. He argued "Why have a set which will be out of date next month?" This is all due to the publicity which the television hostesses are getting. I did my best to explain that it would be considerably more than a few weeks before real



During the heat wave.

television was "here," especially as he lives at Guildford. But he is one of those people who keep waiting, and when television does come he will go on waiting until colour television arrives.

Silly Newspaper Stunts

OPEN any picture paper to-day and you will find somewhere a photograph showing a group of girls with very little on listening in to a portable wireless set. Of course, the photographer was prowling around and stumbled on the group. The photograph was not posed in any way! So before the summer is very old my artist thinks it desirable to show you a picture of Thermion adding to the gaiety of nations. Even at the seaside I continue my experiments; and what, may I ask, is there funny in that? If the girls can show their legs, why can't I?

Murder in the Air

A NEIGHBOUR called on me late the other evening with a shotgun. He knew that I was a wireless fan and blamed me for the nocturnal-



Notes from the Best Bench

Band Spreading

UNLESS a high ratio slow-motion condenser drive is used, tuning below 50 metres is very difficult, and care must be taken to avoid missing stations when touring the scale. Another method of easy tuning which is becoming increasingly popular is the band-spread method. The ordinary type of .0002 or .00015 mfd. tuning condenser is used, and a lower capacity condenser is connected across it, the latter being used for final tuning. Slow-motion drives, although desirable, are by no means essential with this method, but one difficulty presents itself—the exact tuning position of stations cannot easily be logged. To overcome this, special twin condenser assemblies are now available, the larger of the two condensers having ten predetermined settings, final tuning being effected by a continuously variable condenser having a slow-motion drive and a capacity of about 25 m.mfd.

Speaker Energising

WE often receive inquiries from readers who wish to use energised moving-coil speakers in conjunction with battery-operated receivers. The current taken by battery valves is insufficient to energise the speaker field winding, and therefore a separate energising source must be used. If D.C. mains are available a speaker having a field winding resistance of approximately 6,500 ohms may be employed with the winding connected directly across the supply leads. If the mains are A.C., however, a rectifier will be necessary in order to convert the A.C. to D.C. A transformer is not essential, it being permissible to connect one of the mains leads direct to the terminal of a metal rectifier. The + terminal of this should then be connected to one end of the speaker field winding and the other end of the winding to the other mains lead, a 4-mfd. condenser being connected across the winding for smoothing purposes. If the speaker field winding has a resistance of less than 4,000 ohms and the mains supply is between 220 and 250 volts, an HT8 rectifier may be used, and if the winding resistance is between 4,000 and 7,000 ohms the HT12 type is suitable. The wattage dissipation will be approximately 7 watts when these rectifiers and the series method of connection are used.

Resistance Wattage Rating

WHEN choosing resistances it is necessary to calculate the necessary wattage rating as well as the correct value in ohms. This is a point which is often overlooked by home-constructors. If the wattage dissipation in the resistance is higher than the wattage rating the resistance will get too hot and will eventually break down. The wattage dissipated can easily be found by multiplying the voltage drop across the resistance by the current passing through it. For example, if a current of 10 m.a. passes through a 10,000 ohms resistance the voltage drop will be 100 volts and the wattage dissipation will be 1 watt.

loudspeaker-with-the-windows-open which has been keeping us awake for the past week now that the warm weather is here (or has it gone before this appears in print?). I hastily convinced him that I was not the culprit, but it was a near thing.

A Readers' League

ONE or two readers are making suggestions that this journal should sponsor a League of Readers so that by some suitable badge they may recognise one another. I think there is a lot in this idea, for when in strange places it is nice to know that a badge will effect an introduction to someone with mutual interests. Lasting friendships can be created in this way, but I do not know why my readers should think that I am the best person to form such a League. Perhaps it is some part of a dark scheme to assassinate me, readers hoping to recognise me by means of the special gold badge which they presume my highly paid status warrants. Perish the thought! I should imagine that it would be easier to form a league of anti-Thermionites, if I am to be guided by some correspondents.

All the same, I welcome your letters whether they are for me or against me. Perhaps my views become a trifle jaundiced in the passage of the years. Any schoolboy editor knows how difficult it is to



I can explain everything.

continue to write with the regularity of clockwork whether you like it or not, whether you feel fit or well. That is the position, however, of the regular writer; he must deliver his copy to time, and die afterwards. It is a crime to die before. The paper must be served. The readers expect their weekly pabulum, so when you violently disagree with me remember that writing is not all beer and skittles. I am not yet approaching that age when I should retire, but you would hasten my decision by letting me know whether you are in favour of it.

All those who have written to me in support of crooners I will conclude now would be amongst the ayes.

Practical Television

June 6th, 1936. Vol. 3. No. 5.

At School

COMMENTING on the "attractions" which are used during the course of educating the young mind at school, a writer recently made reference to the epidiascope, the film slide lantern, radio receivers, and the work now being undertaken with a view to fitting up schools with complete talking film projectors using the 16 mm. film. In some cases the gramophone is used, and it will not be long before television will serve as an aid to the spoken word. When all these devices are available the prime difficulty will not be to make children stay at school, but rather to persuade them that their schooling days are over, and they must enter the commercial market.

Using Films

The B.B.C. have confirmed that they intend to make rather an extensive use of films in connection with their television programmes. It is not proposed to make or use films of long length comparable with the features now shown at cinemas, but one important use will be in connection with film criticism. In order to illustrate his remarks the critic will be able to fade into the vision screen excerpts in the form of a trailer, and if this is undertaken with the B.B.C.'s usual impartiality, it is certain to meet with the whole-hearted approval of the film industry, as it will furnish an excellent advertisement. Added to that there will be a news reel service, while a film library is to be formed on somewhat similar lines to the gramophone record library. Then it is stated that technical talks will be illustrated by special technical films, which will include charts and diagrams portrayed in a pictorial fashion so as to emphasise the speaker's remarks and ensure that the interest of those looking on will be maintained. This subtle form of education is much to be preferred to the ordinary broadcast talks where the mind of the listener can so easily be distracted owing to the "dry" nature of the sound which is radiated. It is the B.B.C.'s hope that the public's whole attitude to talks will be altered owing to the greatly increased interest which can be stimulated by the dual appeal to eye and ear.

Is Germany Marking Time?

Since the television telephone experiments carried out in Germany in connection with the Leipzig Fair, where those using the apparatus could both see and hear one another for quite a nominal charge, there has been a marked cessation of news concerning television developments in that country. This is no doubt due partly to the control vested in the Air Ministry. The authorities in Germany are of the opinion that electronic scanning and such allied television subjects as directional micro-waves and noctovision have considerable potential military value, and they are therefore very reticent in disclosing what progress has been made, even for the purpose of maintaining their prestige in the world of television. Since the introduction of regular experimental high-definition television transmissions in Berlin in January last, on a basis of 180-line picture

dissection, consecutive scanning with 25 frames per second, there has been a quiet but nevertheless intensive investigation going on both from the point of view of programmes and technical efficiency. The higher the standard of picture definition the better are the results seen, but the difficulties of transmission and reception increase in a much greater proportion than the percentage increase in the degree of definition. This fact has even been put forward as a possible reason for the delay in the inauguration of the B.B.C. service, it being felt that a 180-line standard would have been satisfactory for a start with a promise of improvement as knowledge of transmission and reception technique was acquired. With the large number of viewing rooms scattered round Berlin, observers are noting the reactions of the public visitors to the programmes in order to

acquire data for future programme building. It is confidently anticipated that the present definition standard of 180 lines which has been in use for so long will be increased, but whether a drastic change to nearly double the lines, or a more gradual step by step improvement is to take place, is largely a matter of speculation.

Still Growing

Now that the B.B.C. have acquired most of the property in the immediate vicinity of Broadcasting House, it is certain that plans will soon be drawn up for approximately doubling the size of the B.B.C.'s headquarters. With the co-axial cable laid between Alexandra Palace and Portland Place it is safe to assume that some provision will have to be made for television studios. This will enable programme items to be carried out at Broadcasting House without the necessity for the participants to proceed to Alexandra Palace. This procedure will only be followed in special circumstances where time is a big factor, but even so the claims of television will have to be met when the reorganisation and new building plans are made.

Alexandra Palace.

At the Royal Institution recently, the lecturer gave an interesting discourse on scientific reminiscences. On Faraday's original and famous lecture table was arranged television equipment which showed very clearly how the pictures were built up from disintegrated electrical signals. It was pointed out how Campbell Swinton suggested in a letter to "Nature" in 1908 how cathode-ray tubes could be used for this purpose, and the equipment worked on these principles propounded twenty-eight years ago. Little did Faraday think, when he designed his lecture table, that in the famous lecture room would be shown "sight at a distance using electrical methods of communication," and the audience must have been impressed with the whole significance of the situation, made possible by Faraday's work.

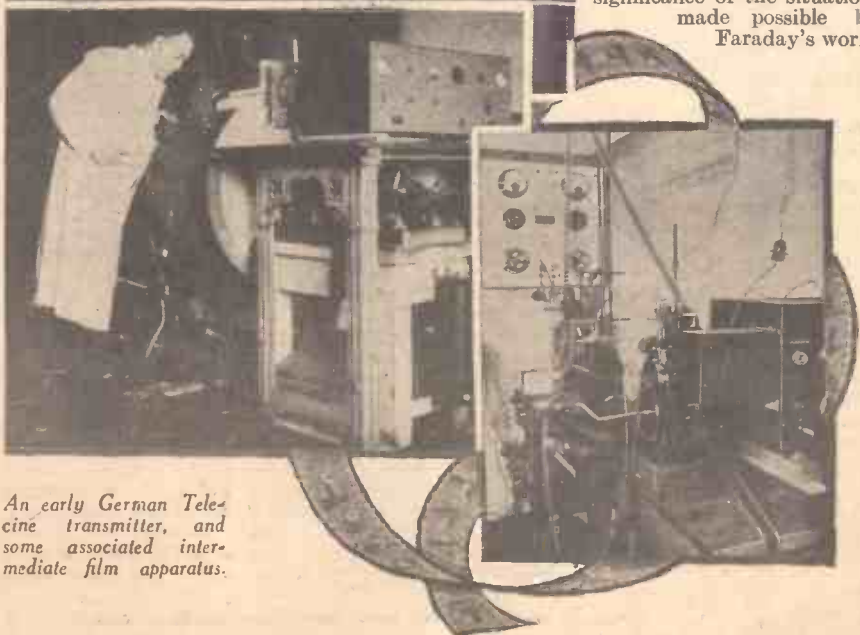
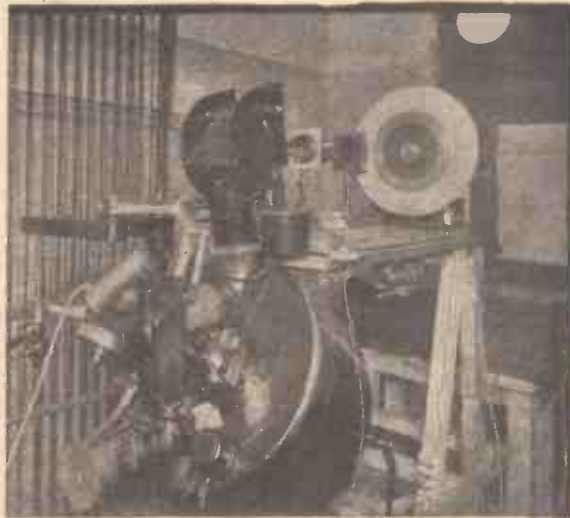

An early German Television transmitter, and some associated intermediate film apparatus.

A Seasonal Spring Clean—1

A Systematic Overhaul of Your Aerial and Earth Equipment will Ensure Maximum Results.

By L. ORMOND SPARKS

MANY of us, unfortunately, do not seem to notice a few layers of dust, or think of the effect of the atmosphere on the innards of our receivers which gradually become more or less buried, while the aerial and earth arrangements are simply left to fade away through senile decay.

Of course, as long as results are satisfactory one doesn't think of these things, neither does one appreciate how detrimental they are until such lax habits are recorded in black and white.

Tackle It Right Away

There are numerous reasons why the spring-clean should be carried out without further delay, and not left until later on in the season.

During the winter months, it is true, we devote most time to radio, so it is hardly policy to think of turning the set inside out when it is wanted for listening purposes. Then again, the weather conditions are hardly suitable for attending to the aerial or earth equipment, while the hours of daylight are too short to allow much to be done in that direction.

It does not matter on which part of the installation you commence your activities, and if some settled procedure is adopted there is less likelihood of any one part being overlooked.

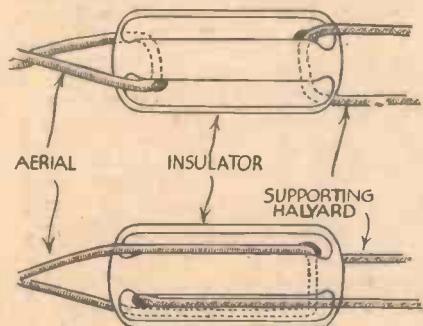

Figs. 1 and 2.—The incorrect and correct methods of connecting aerial and halyard to an insulator.

The Aerial

Commencing with the aerial, this should be lowered at each end so that every part is available for inspection, but before doing this, pay particular attention to the wire, rope or cord used for hoisting and lowering. Do not let any of it pass through your hands until you are satisfied that there are no frayed, kinked or rotten parts, otherwise, when you come to hoist the aerial again, there is every possibility that it will snap. When the aerial has been lowered, make sure that the ends of the halyard are made secure; they have a nasty habit of pulling right through the pulley block.

It is a good plan to erect a temporary aerial while carrying out the inspection, as this removes any necessity to hurry or skimp the work, and allows the receiver to still be used. Examine all insulators and their fastenings and, if possible, remove the

insulators, and give them a good scrub in hot soda water. In any case, see that all deposits are removed, and that no cracks or other flaws are present. Insulators are very cheap, so don't be afraid of using two or three at each end or replacing doubtful ones, as they play a very important part towards efficient reception.

Next, examine all lashings or fastenings, and look out for frayed strands, parts that are showing signs of rotting, and loose knots or bindings. Don't hesitate to replace all such parts with new wire or rope, as any attempt to "make do" is very foolish economy. While on this part of the work, see that the insulators are properly connected.

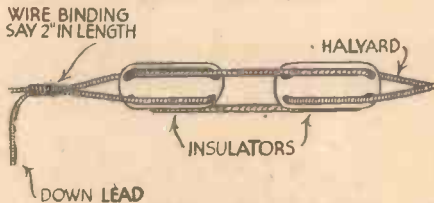

Fig. 3.—How to arrange the aerial and lead-in in one piece.

When fastened in the manner shown in Fig. 1, which is the wrong method, it will be seen that if the insulator cracks through excessive heat or frost there is nothing to prevent the aerial wire coming down; in addition the insulator is subjected to unnecessary strains. Fig. 2 shows the correct method, where it will be seen that the aerial wire and the supporting wire are actually looped round each other, the body of the insulator providing the required insulation.

Aerial Wire and Lead-in

Nothing much can happen to the aerial wire except corrosion and broken strands, but these two items can produce sufficient ill-effects to render a careful examination advisable. Once again, don't try to patch it up, but get a fresh coil of wire; it is quite possible that the old aerial has been in service for several years. The actual lead-in end certainly calls for more consideration. If the aerial proper and the lead-in are not formed by one length (which is advisable) look out for faulty and corroded joints. Should any joints be of the twisted variety, cut them out and make soldered connections, binding afterwards with insulation tape, and coating the job with grease.

Where the lead-in branches off from the aerial, see that it is arranged in the manner shown by Fig. 3, as it is quite unnecessary and less efficient to make numerous twists and turns.

If trees are near the aerial, make sure that their foliage—when out—will not be too close to the wire; also make sure that the aerial cannot sway in a violent manner.

While it is more usual, nowadays, to take the lead-in into the house by passing it through a stout insulating tube, there are

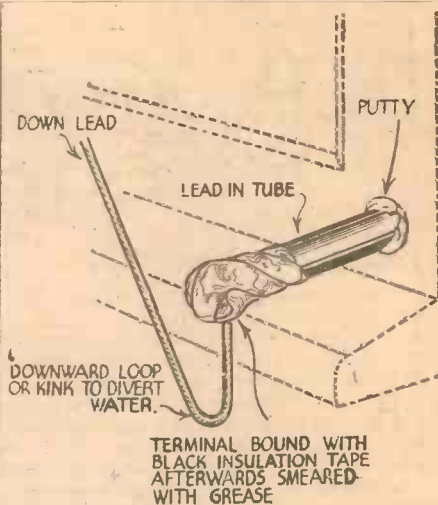

Fig. 4.—An efficient waterproof lead-in arrangement can be arranged as shown.

still many of the older types of lead-in tubes—fitted with terminals—in use. With these, particular attention should be given to the terminal surfaces and the wire. Corrosion will no doubt be found; therefore, clean all parts until all traces are removed, and then make a really tight connection, binding the terminal with insulating tape and greasing as before. Fig. 4 shows how the job should be done, and how a loop should be formed to prevent water running down to the tube.

Earthing Switches

Where earthing or lightning switches are in use, they will require a certain amount of attention, as they are usually sadly neglected, and often cause weird crackles, and loss of signal strength. See that all terminals and contacts are clean and firm, and also that the leads are sound and not fractured. Clean the insulating material, and if the arrangement is fitted outside the house it is a good plan to provide a cover to protect it from the weather. A suitable arrangement is shown in Fig. 5. To complete this part of the spring-clean, it only remains to examine the aerial lead from the set to the lead-in. If spade-ends or plugs are fitted, see that they are still good, and that the wire is not dirty, fractured, or the insulation perished.

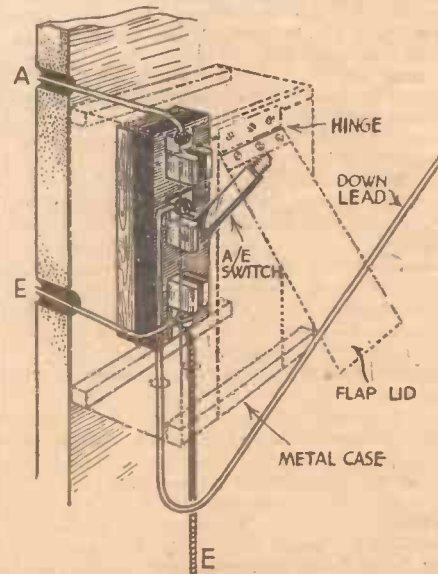

Fig. 5.—It is a good plan to provide a weather-proof casing for the aerial-earthing switch.



SPEAKER TYPES AND CONNECTIONS

Useful Data Concerning Speakers and their Use in Conjunction with Different Valve Types. By IDRIS EVANS

BEARING in mind that the speaker is one of the most important links in the receiving chain, it is surprising that this component is chosen haphazardly by the average constructor. He builds a good receiver from a modern design and then spoils results by using the speaker from his old set—perhaps a horn model which has been in use for

Permanent Magnet Speakers

Permanent magnet moving-coil (dynamic) speakers have become very popular during the last three or four years. This type is suitable for use with battery pentodes or super-power valves, and also with mains operated valves. Unlike the cone type, the dynamic type has a very low impedance, and must be matched to the output valve by means of a high-ratio transformer. This transformer is attached to the speaker in most cases, and often has several tapings so that different valve types can be matched; a good example of this type of instrument is shown in Fig. 2.

The finding of the correct tapping is not such a critical operation that special instructions are required in this connec-

tion. A direct method of connection may be used if the consumption of the output valve is below this value. Some of the super-power mains valves consume more than 60 mA., however, and therefore when such valves are employed a filter output circuit as shown in Fig. 1 should be fitted, using a suitable choke.

Energised Speakers

The energised speaker works on the same principle as the permanent magnet moving-coil type, but employs an electromagnet instead of the permanent type. The anode current consumed by the valves in a mains operated receiver is generally used for energising the speaker, the field winding being connected either in the H.T.+ or the H.T.— lead. When replacing a speaker of this type two important points besides matching to the output valve must be watched; the field winding must have the correct resistance, and it must be designed to carry the current passing.

It is permissible to use a permanent magnet speaker as a replacement for the energised type, but a choke having the same resistance and current carrying capacity as the field winding of the original speaker must be connected in place of the field winding of the latter. If, on the other hand, it is desired to use an energised speaker in place of a permanent magnet type it will be necessary to energise the new speaker from an external source (mains or battery) unless there is an excessive voltage in the rectifier output circuit—it must always be borne in mind that the connection of the field winding to the H.T.+ or H.T.— circuit reduces the voltages applied to the valve anodes. The current consumed by the average battery receiver valves is insufficient for speaker energising, and therefore a permanent magnet type of speaker should be used with these.

Dual Speakers

It is now customary to use two speakers when high quality of reproduction is desired. High note reproducers have been designed for connection across the normal speaker in order to improve the top-note response: a circuit diagram indicating the method of connection of the extra speaker is shown in Fig. 3. An ordinary speaker which is known to have a good high-note response could be used in place of the special tweeter if desired, but in some cases it will then be found advantageous to reduce the value of one of the 1-mfd. condensers shown in the diagram to .01 or .02 mfd. in order to prevent the lower frequencies from reaching the extra speaker.

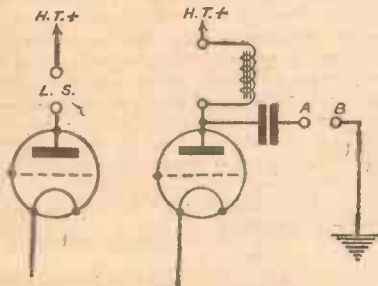

Fig. 1.—The circuit on the left shows the direct method of speaker connection, and on the right is shown a choke filter output circuit.

twelve years. If best results are to be obtained the speaker should be carefully chosen to suit the receiver as a whole, and especially to match the output valve.

There are three commonly used speaker types nowadays—the magnetic type (generally called cone speakers), the permanent magnet moving coil type, and the energised moving coil type. The horn type, popular when broadcasting commenced, is now practically obsolete.

Battery Set Speaker

Some battery-operated receivers have a small power valve in the output stage, having an undistorted output rating of approximately 150 watts. In most cases it is found that best quality of reproduction is obtained with one of these valves in use when a cone (magnetic) speaker is employed. A reliable balanced armature cone unit attached to a large cone, and mounted on a large baffle board, can be relied upon to give reasonably good quality when used in conjunction with a small power valve. The current consumption of such valves is only about 5 mA., and therefore the speaker may be connected directly between the valve anode and the H.T.+ line. When a higher undistorted output is desired the power valve may be replaced by a super-power type without changing the speaker, but it will then be advisable to use a choke filter output circuit as shown in Fig. 1, otherwise the high current passed by the valve may possibly damage the speaker winding. The choke should have a current carrying capacity of 25 mA., or higher, and an inductance of 30 to 50 henries, and the condenser should have a capacity of approximately 2 mfd.



Fig. 2.—A permanent magnet speaker with adjustable ratios.

tion, and in most cases the tapings are clearly marked. If no markings are provided it is only necessary to try each tapping in turn until the best quality is obtained. It is advisable to switch the valves off when transferring from one tapping to another, however, as the anode circuit of the output valve will be momentarily broken if the taps are attached to the primary winding of the speaker transformer. The transformer primary winding is designed to carry at least 60 mA. in most speakers and therefore the

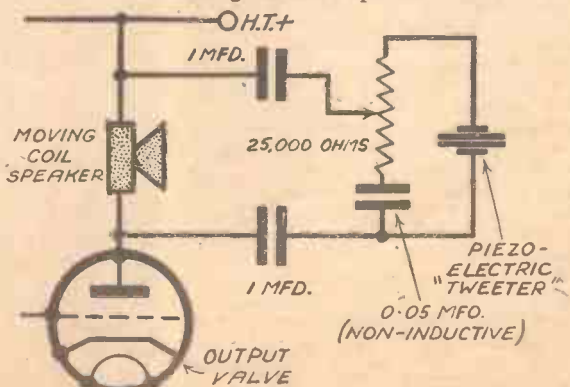

Fig. 3.—A method of connecting a tweeter across the speaker

Listening in Comfort

BROADCASTING is intended for entertainment, amusement, instruction, and recreation, and although no doubt the bulk of the readers of this journal find their chief delight in designing, constructing, and experimenting, there are periods when it is desired to listen to the radiated programmes in complete comfort. Given a reasonably good receiver, the enjoyment is easy enough to achieve, but in a large number of domestic installations, including many belonging to the more technically-minded class of listeners, much of the enjoyment is seriously discounted by the number of adjustments, handling of controls, etc., which make it difficult to sit down and listen for a few hours in complete comfort. Many of these inconveniences can be avoided by the exercise of a little thought and ingenuity, and most of the others are not above solution.

First Considerations

The first point for consideration is the receiver itself. Naturally, if a factory-made set is employed, very little can be done to modify it in order to make it more convenient to use, but here it should be re-

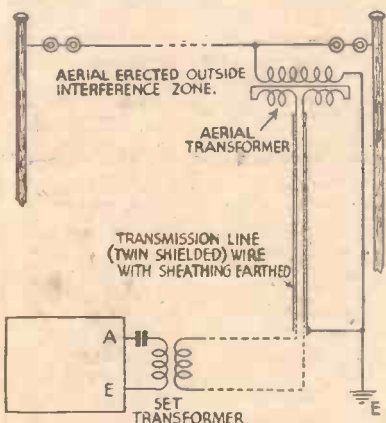

Fig. 1.—The basic diagram of aerial transformer and transmission line equipment which permits the set to be installed in any position, and avoids man-made static.

marked that most modern factory-built receivers are fitted with controls which have already been reduced to the simplest form. Existing sets of commercial make, therefore, will not be discussed, but if a new set is to be purchased it is as well to consider what the listener desires to hear, and to obtain a set which best caters for his particular needs. Thus, if local programme reception is chiefly wanted, with an occasional good-class foreigner, a straight three—H.F., detector, and output—may be chosen, but where considerable continental listening is to be indulged in, a superhet is almost essential. The choice will also be affected by such questions as the "goodness" of the available aerial, the location of the listener's home with respect to the local and interfering stations, and so forth. Again, if a superhet is necessary, and the highest quality reproduction consistent with local conditions is required, a more complex set with additional controls, such as variable selectivity and tone correction, will be required, and this means added complications in adjustment.

But assuming that the final choice of the receiver results in more than the simple single-knob tuner and volume control, the number of adjustments can be minimised by a few evenings' intensive study and experiment with the set to know the best settings of the various controls for different stations and classes of programme.

The Comfortable Enjoyment of Programme Fare is a Matter Often Overlooked, so Study the Suggestions Made in this Article

By H. J. BARTON CHAPPLE,
B.Sc., A.M.I.E.E.

so that when serious listening is contemplated the receiver may be quickly and easily adjusted for optimum results, and need not be touched throughout the programme.

In designing a home-built set for comfortable listening it is suggested that simplicity of operation be given a place of prime importance in the design. For normal family listening, a set giving a very restricted number of stations usually suffices, and no difficulty should be met in designing a receiver capable of achieving these results with the controls reduced to a simple on/off switch, tuner, and volume control; all other adjustments being fixed and incorporated in the design of the receiver. Indeed, as will be shown later, a set of this type may be made practically, if not entirely, automatic.

Positioning the Set

The next point for consideration is the position of the set, for even if the controls are reduced to a minimum it is a nuisance

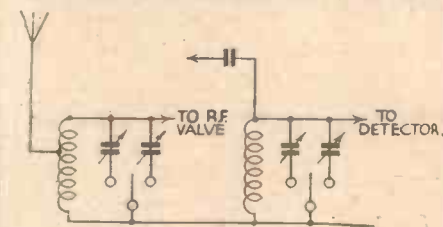

Fig. 2.—Tuning system for a two-station pre-tuned straight set. The two wave-change switches may be ganged for manual operation, or operated by relays from a distant push-button.

to have to make continuous journeys to the corner where the receiver is situated in order to make adjustments of volume or to tune in another station. The most convenient place for the set from this point of view is by the side of the listener's chair. There are two objections. First, this position is not generally the best from the point of view of the aerial and earth connection, a site near the window being usually the best technically. This difficulty can, however, be overcome easily by the simple expedient of connecting the set to the aerial by a pair of transformers and a transmission line. Suitable transformers are now obtainable, the circuit being given in Fig. 1, where the transmission line is a twin lead-covered cable. This device may be said to add to

the comfort of listening in two ways, for not only does it permit the set to be located anywhere in the house, but also, provided the aerial is erected out of the field of electrical interference, supplies a better background than is experienced when the set is joined to an aerial by an unscreened lead passing through the interference field.

The second objection to placing the set close to the listener's chair is that the built-in speaker is then too near for comfort. This is clearly an argument for making the speaker an independent adjunct and not a self-contained component, and for the home-built "comfort" set a separate speaker should always be used, mounted on a baffle or in a cabinet carefully designed to combine good technical performance and artistic appearance. The speaker, then, should be located in the spot where, by experiment, the best acoustic results are obtained. Another advantage in this connection is that, as the speaker is not in the set cabinet, it need not be of microscopic dimensions and a good large instrument may be used.

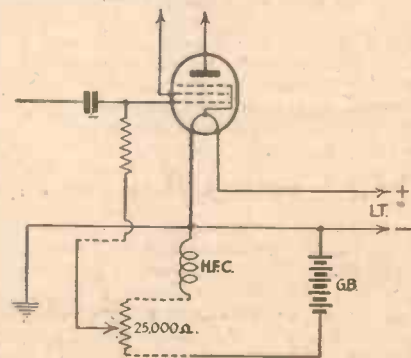

Fig. 3.—Showing how the volume control leads may be extended for remote operation.

Alternatives

Here, then, is one main scheme for comfortable listening—a radio unit which may be considered as just a control box, located conveniently to the hand, and operating a speaker at the spot in the room where the best acoustic results are obtained. If, however, this is not approved or impracticable in any particular case, there are several other alternatives. For example, there are commercial sets on the market fitted with remote control for both tuning and volume. In one case the set is provided with a duplicate of the tuning, wave-change, and volume controls mounted in a small metal box connected to the receiver by a long cable. By means of this control box the distant set can be switched on and off, tuned to any station, and the volume controlled, without the listener moving from his chair, the device including a motor drive for the tuning condenser, and special means for stopping the motor immediately the incoming station is dead in tune.

Relay Switches

A scheme of this kind is, perhaps, beyond the capabilities of the average home constructor, but he can go at least part of the way. There are several good relays on the market for switching battery or mains sets on and off at a distance, and it is

not a difficult matter to construct such a relay personally. Although the distant control of tuning may not be an easy matter, distant volume control is not difficult to achieve. Of the many possible ways, variable- μ bias control is, perhaps, the easiest. It must be remembered that the grid-bias circuit of a variable- μ valve is not a signal circuit, and no harm can be done by prolonging the grid-bias leads to any reasonable length. Taking a typical circuit, therefore, such as that shown in Fig. 3, the leads may be extended as indicated by dotted lines, to permit the volume control to be installed quite close to the fireside, or elsewhere. This distant control can be combined with the distant switch on one panel, and readers may like to try their skill in endeavouring to work out the minimum number of wires required for these two controls.

Automatic Tuning

It has been said that a complete automatic-tuning set may not be a proposition which the home constructor would care to tackle, but, provided only two or three stations are required, it is not difficult to design a pre-tuned set which can be switched over from one station to another. A set having only two tuned circuits (aerial and H.F. coupling) should be chosen, and each circuit should be tuned by pre-set condensers, one condenser for each station wanted, with an arrangement of relays to switch into circuit the condensers corresponding to the station required at the moment. A skeleton circuit for the tuning system of a two-station set is given in

Fig. 2, and the only practical difficulties are the initial adjustment of the condensers and the design of the relay system. The ingenious amateur, however, will either construct his own relays or adapt some of the excellent gear which can often be picked up quite cheaply from dealers' shops.

While on the subject of distant switching a word must be said about extension speakers. The practice of listening in bed is quite a sound one in times of good health, and is invaluable in the convalescent stage after illness. Individual control of each extension speaker, both as regards volume and for switching on and off are, however, essential to comfort and can be easily arranged, most extension speakers being fitted with volume controls or provided with terminals for connecting a control. A switch on each speaker is also arranged easily, and this should be combined with a switch for disconnecting the set when the last speaker is switched off. Commercial apparatus for such an arrangement is available, and it can also be designed and made at home. Here, then, is something more for the technical amateur to puzzle out for himself.

Finally, one point which certainly affects listening comfort must be mentioned, namely, in the case of a mains set, the provision of a proper plug point from which it can be supplied, and located quite close to the receiver itself. It is very annoying if, when requiring to listen to a programme, one has to endeavour to fit a plug into an almost inaccessible socket, and worse still if one has to remove the lamp bulb in order to plug in the set.

"H.M.V." "QUEEN MARY" COMPETITION

FOUR hundred thousand school-children in Great Britain have entered the R.M.S. *Queen Mary* competition organised by "His Master's Voice" in connection with the liner's maiden voyage. So considerable was the interest being taken, not only by children, but by their parents and teachers, that "H.M.V." has had to detail a special staff to deal exclusively with the scheme, which has proved even more successful than was anticipated.

The initial order for brochures was 150,000, but so great was the response on the day after the scheme had been announced, that a repeat order was put in immediately. Five hundred "His Master's Voice" accredited dealers co-operated and already one hundred "H.M.V." instruments have been sold as the result of direct contact.

In every school throughout the country, children were seeking the co-operation of their teachers in an effort to determine the duration of the maiden voyage of the *Queen Mary*. In addition, 120,000 adults have received a brochure describing the broadcast arrangements in connection with the liner, and giving details of the "H.M.V." range of instruments.

The illustration on this page shows the attractive cover of the brochure, giving

particulars of the competition, and which includes the complete entry form, illustrations of the prizes and other details.

A novel
Competition
for
Children

HIS MASTER'S VOICE

OVER
300
PRIZES

WHAT DO YOU KNOW ABOUT THE QUEEN MARY?

PETO-SCOTT

We can supply PILOT AUTHOR KITS of any set featured in this journal during the past three years. Miscellaneous Components, Kits, Finished Receivers or Accessories for Cash or C.O.D. or on our own system of Easy Payments.

ELF PORTABLE KIT "A" CASH or C.O.D. 35/-
CARRIAGE PAID 35/-

or 5/- down and 6 monthly payments of 5/6
Author's Kit of first specified parts less valves, batteries, speaker and earphones.
If required with set of 3 specified valves, Cash or C.O.D. Carriage Paid, £3/16/6 or 12 monthly payments of 7/-.

Peto-Scott 1936 UP-TO-DATE SENSITIVE S.G.3 KIT

- 2-gang Air Dielectric Tuning Condenser.
- Automatic Grid Bias.
- Full Vision Slow-motion Tuning.
- Detector, S.G., Pentode Output Valves.
- Modern Air-spaced Coils.

KIT "A" 35/-

Cash or C.O.D. Carriage Paid. All necessary parts less valves and cabinet, for 2/6 down and 9 monthly payments of 4/-.

Send for Full Details of valves and Peto-Scott cabinets and Free Blueprint.



G.E.C. Home Broadcaster MICRO-PHONE. With Volume Control, self-contained transformer, and 25ft. screened cable. Cash or C.O.D. Carriage Paid, £1/1/0. only Balance in 8 monthly payments of 2/6.

W.B. Stentorian SPEAKER, Model 36S. Send 2/6 For any output. Incorporates improved Microphone Device. Cash or C.O.D. Carriage Paid, £2/2/0. only Balance in 11 monthly payments of 4/-.

PETO-SCOTT Co., Ltd., 77 (Pr.W.6), City Road, London, E.C.1. Telephone: Clerkenwell 9406/7. West End: 62 (Pr.W.6), High Holborn London, W.C.1. EST. 1919

A Listener named Timothy Tell Said "FLUXITE'S the thing for your set; Since I used it I've found My connections all sound, So I'll 'long wave' its banner, you bet!"



See that FLUXITE is always by you—in the house—garage—workshop—wherever speedy soldering is needed. Used for 30 years in government works and by leading engineers and manufacturers. Of Ironmongers—in tins, 4d., 8d., 1/4 and 2/8.

Ask to see the FLUXITE SMALL-SPACE SOLDERING SET—compact but substantial—complete with full instructions, 7/6.

Write for Free Book on the art of "soft" soldering and ask for Leaflet on CASE-HARDENING STEEL and TEMPERING TOOLS with FLUXITE.

TO CYCLISTS! Your wheels will NOT keep round and true, unless the spokes are tied with fine wire at the crossings AND SOLDERED. This makes a much stronger wheel. It's simple—with FLUXITE—but IMPORTANT.

THE FLUXITE GUN

is always ready to put Fluxite on the soldering job instantly. A little pressure places the right quantity on the right spot and one charging lasts for ages. Price 1/6.



ALL MECHANICS WILL HAVE

FLUXITE

IT SIMPLIFIES ALL SOLDERING

FLUXITE LTD. (Dept. W.P.) DRAGON WORKS, BERNONSEY STREET, S.E.1.

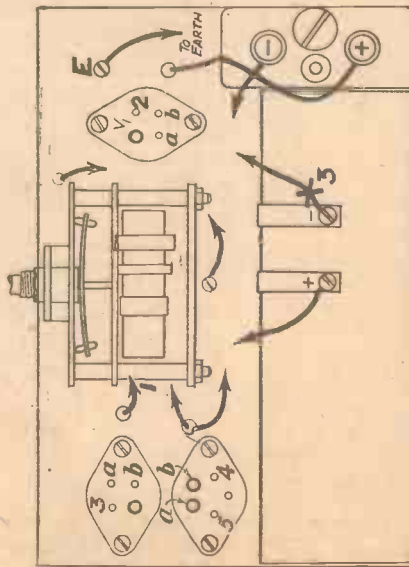
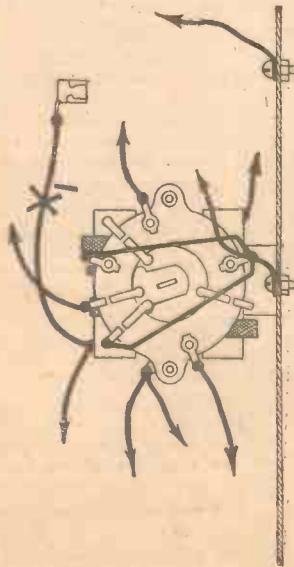

Top of Chassis View

Approximate Voltage Readings

Voltmeter — connected to E.	" 1 = 60 volts.
" "	" 2 = 45 volts.
" "	" 3 = 40 volts.
" "	" 4 = 55 volts.
" "	" 5 = 60 volts.
" "	across a and b = 2 volts.

DATA SHEETS ALREADY PUBLISHED.

1—£5 3-valve Battery Superhet	14th September, 1935
2—A.C. £5 Superhet Three	21st September, 1935
3—Universal Three-valve Superhet	28th September, 1935
4—Hall-Mark Three	5th October, 1935
5—Battery Hall-Mark Four	12th October, 1935
6—A.C. Leader	19th October, 1935
7—Universal Hall-Mark Four	26th October, 1935
8—Summit Three	2nd November, 1935
9—Hall-Mark Cadet	8th November, 1935
10—A.C. Silver Souvenir	23rd November, 1935
11—Battery Silver Souvenir	30th November, 1935
12—1936 Sonotone Three-four	14th December, 1935
13—Cameo Midget Three	21st December, 1935
14—A.C. Hall-Mark	28th December, 1935
15—Mr. F. J. Camm's Superformer	11th January, 1936
16—A.C. 1936 Sonotone	18th January, 1936
17—All-wave Three	15th February, 1936
18—The Monitor Three	22nd February, 1936
19—£4 Superhet Four	4th April, 1936
20—F. J. Camm's Tutor Three	25th April, 1936
21—A.C. £4 Superhet Four	16th May, 1936

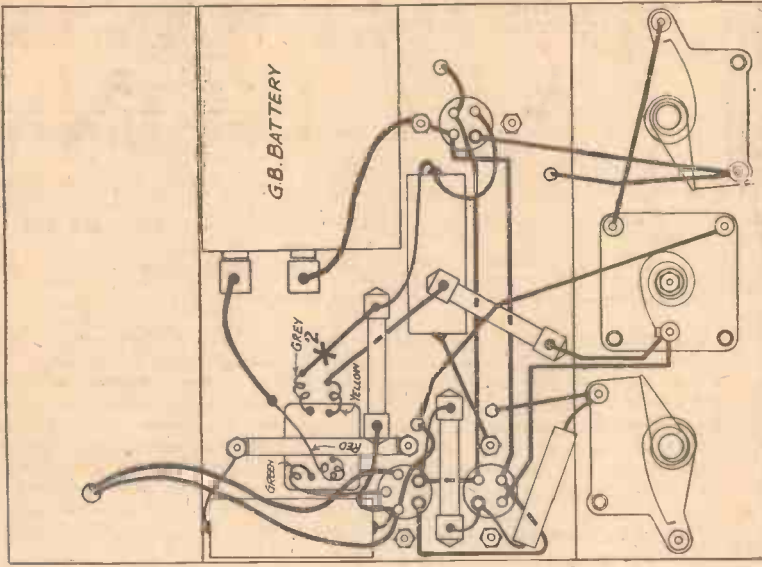

Underside of Chassis

Approximate Resistance Readings

L.F. Transformer.	Ohmmeter connected across	Green and Red = 2,500 ohms.
	Ohmmeter connected across	Grey and Yellow = 900 ohms.

Approximate Current Readings

Milliammeter connected at X1 = 1 mA.	" "	" X2 = .75 mA.
" "	" "	" X3 = 5 mA.

SHORT WAVE SECTION

SMALL PORTABLES FOR S.-W. RECEPTION

Brief General Details are Given for Making a Portable Short-wave Set Using Midget Valves and Components



It is generally known that short-wave reception is often better in summer than in winter, this being the opposite of the case where medium and long waves are concerned. Because of this, summer is the ideal time for long-distance S.W. work, and the experimenter will often find more to interest him than he does during the dark season. The chief objection to wireless in all forms during summer is that it keeps one indoors; but there is no reason why it should, since a reliable portable can easily be made. In many respects, conditions for short-wave reception with a portable receiver are better than those which apply to normal broadcast reception, because the shortest of aerials is adequate, and because 'phones are often used as a matter of course.

Detector-Power Circuit

It would be by no means a difficult matter to construct a midget short-wave portable on similar lines to the "Elf," which has been fully described in recent issues. But when 'phones are to be used an even simpler instrument than this will often suffice, especially for experimental purposes. A really pocket-size portable can be made by using a couple of the Hivac midget valves—preferably those with low-loss "Frequentite" bases, specially designed for short-wave use. The first of these can be a triode type XD (detector), the second being a type XP small economy power valve. This combination makes for simplicity and efficiency, and at the same time simplifies the task of keeping down the dimensions of the complete set. The two valves can be operated satisfactorily from the Drydex X418 60-volt H.T. battery and the B.T.S. M.7 2-volt unspillable accumulator, whilst the Drydex X89 4½-volt battery is suitable for G.B. supply.

Home-made Coils

The suggested circuit is given in Fig. 1, where it can be seen that the general arrangement is perfectly conventional.

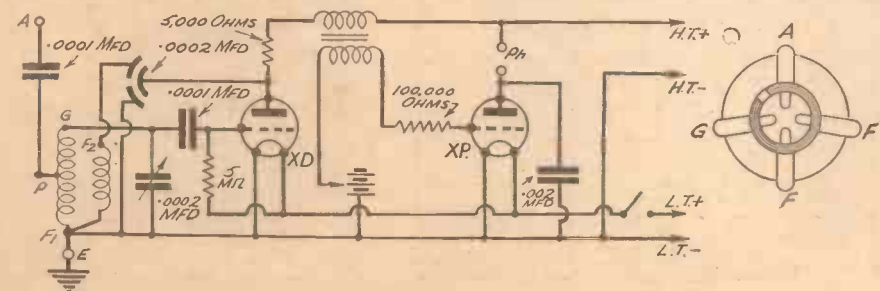

Fig. 1.—Circuit of the detector-power valve short-wave portable. Coil connections correspond to those shown in Fig. 2. Inset are shown valve-holder connections.

except that the usual "reaction" choke is replaced by a 5,000-ohm fixed resistor, which can be of the midget ½-watt pattern. A simple 4-pin coil is indicated, but standard 6-pin types can be used if desired, although these are rather on the large size for a pocket receiver. By making use of the

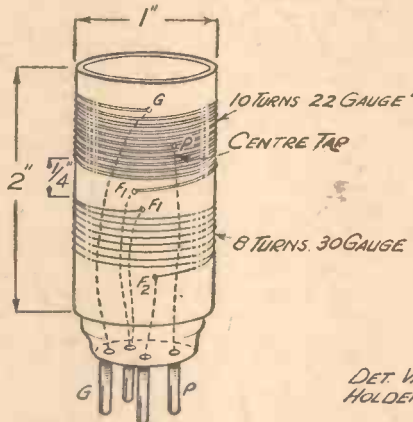

Fig. 2 (above).—Details of a plug-in coil built on an old valve base or 4-pin adapter.

enamelled wire, 30-gauge enamelled wire being used for reaction. This comparatively thin wire does not make for maximum efficiency, but is good enough for present requirements. For the benefit of those who are not in possession of an old valve of which the base can be used it might be mentioned that an adaptor plug or 4-pin valve-type connector can be used equally well.

Components

A .0002-mfd. differential condenser is used for reaction, but it is desirable to use a condenser of the air-dielectric type for tuning, and a suitable component is the Eddystone S.M. reaction condenser; this has a capacity of .0002 mfd., and is provided with a built-in slow-motion drive and with a circular scale and pointer. The

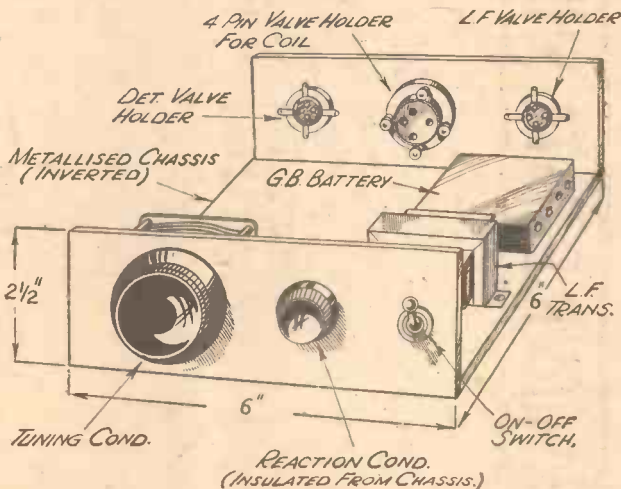

Fig. 3 (on right).—A suitable arrangement of the principal components.

base of an old valve and a length of shellacked cardboard or paxolin tube, a few plug-in coils can easily be made to cover various wavelength ranges. A suitable form of construction is indicated in Fig. 2, where the numbers of turns suggested are those required for the 30-metre band. The tuned winding consists of 22-gauge

reduction ratio is about 10 to 1, which is just sufficient if the knob is turned very slowly. It is rather better, however, to replace the knob by a larger one so that somewhat better control is possible.

Chassis Construction

The few components can be assembled on a "reversed" metallised chassis, the front edge of which is used for mounting the controls, and the rear edge for the valve- and coil-holders. Valve-holders of the baseboard-mounting type are recommended, the valves being of the type with "base-pip" connectors (bayonet cap). By following this arrangement the capacity between the electrodes is reduced to a minimum, and construction is made rather easier. Fig. 3 indicates a layout which can be followed, although the arrangement can be modified as desired according to particular requirements. An L.F. transformer of the Bulgin L.F.33 midget pattern is suitable, but there are one or two possible

alternatives. The few remaining parts can be of any standard type, preferably midgets of well-known make which can be relied upon to be efficient. It will be seen that the complete set can be made very compact by omitting the H.T. and L.T. batteries; these can be placed in a separate container suitable for carrying in another pocket. Alternatively, the complete outfit could be accommodated in one carrying case built up from three-ply board.

When using separate compartments for the receiver and batteries, terminal-socket strips can be mounted on the set and also on the battery case so that the two items can be connected together by means of lengths of flex fitted with wander plugs.

The set briefly described is intended for use with a "throw-out" aerial consisting

of a 12ft. length of flex which can easily be thrown over the branch of a tree or laid along the top of a wall or fence. Rather more difficulty is presented by the earth connection, because it is important that this should be efficient. One idea is to carry a metal spike which can be pressed into the ground, whilst another—not quite as good—is to use a second length of flex similar to that used as the aerial, and to lay this along the ground beneath the aerial wire to form a counterpoise earth.

Aerial and Earth

Accommodation for a pair of 'phones can usually be provided in the battery compartment, or this item can simply be carried in the pocket. In either case a pair of sockets should be fitted to the set for easy connection. Those who wish to

make the outfit in rather more "finished" style might use the special carrying case designed for the "Elf" midget broadcast set, because this can readily be bought ready-made from Peto-Scott, the price complete with carrying handle being 12s. 6d. It is not proposed to give any definite details of the method of arranging the various parts, however, since the experimenter will probably have his own ideas on the subject and might wish to utilise a case or light box which is on hand.

One of the main points to observe in wiring the receiver is that the metallised outer surface of the chassis should be joined to the earth line; this can be done most easily by passing a bolt through the plywood, and joining the inner end of this to low-tension negative.

THE owner of a short-wave receiver has an advantage over his colleague who only owns a set capable of receiving broadcasts on the medium or long-wave bands, inasmuch as if he is interested in news he can pick up quite a large number of bulletins in the English language broadcast by four of the principal European States, namely, Great Britain, Germany, France, and Italy, in the course of twenty-four hours. Although the B.B.C. is only responsible for seven of these daily transmissions, they are sent out on two or more channels. Paris-Colonial gives nine, Rome three, and Berlin-Zeesen six every day. It is, therefore, possible to assert that if he so desires the short-wave listener may pick up twenty-one editions of a radio news bulletin daily throughout the year.

Iceland and U.S.S.R.

I must draw your attention to a European short-waver of whom little is mentioned, although the broadcasts are now coming through well. It is TFJ, Reykjavik (Iceland), on 24.52 m. (12,235 kc/s). The call: *Ríkisutvarp Island* is given out by a woman announcer, and the broadcasts are preceded by the conventional tuning note. The best time to tune in is at B.S.T. 19.40 on Sundays, when a special talk for English listeners is transmitted. The station closes down with the playing of a gramophone record of a choir singing, I believe, an Icelandic hymn. The address for reports is: *Icelandic State Broadcasting Service, P.O. Box 547, Reykjavik (Iceland)*. Another station which should prove a worth-while catch is RV15, Khabarovsk (U.S.S.R.) on 70.2 m. (4,273 kc/s) and which broadcasts in English at B.S.T. 05.15 on every even day of the month. Here again the studio employs a woman announcer.

Canadian papers advertise the resumption of broadcasts from an old-timer VE9DR, Montreal, on 49.96 m. (6,005 kc/s). The schedule, at present, reads: B.S.T. 13.00-06.00 (Mon., Tues., Wed., Thurs., and Fri.); 13.00-03.45 (Sat.), and 14.00-04.15 (Sun.).

Alterations in wavelengths and advices of new arrivals on the air continue to reach me, and in view of the increasing activity of short-wave transmitters during the summer months it is wise to add them to your list for future eventualities.

HS8PJ, Bangkok (Siam), recently reported in these notes as working on 27.32 m. (10,980 kc/s) appears to have increased its wavelength to 29.5 m. (10,165 kc/s) and its power is said to exceed 5 kilowatts. Daily: B.S.T. 14.00-16.00. HIT, Trujillo City (Dominican Republic), on 45.25 m. (6,630 kc/s), 200 watts has been logged

Leaves from a Short-wave Log

twice during the past week. The call is: *La Voz de la R.C.A. Victor, Ciudad Trujillo*, and the broadcasts open with the well-known "Barcarolle" from the "Tales of Hoffmann." The times now advertised are: Daily: B.S.T. 18.30-19.00; 00.00-03.00 and B.S.T. 04.00-06.00 (Sundays). Reports of reception should be sent to Senor F.A. Sanabria, Estación HIT, Apartado 1,105, Trujillo City (Dominican Republic).

Panama

A new short-waver has cropped up at Colon (Republic of Panama) and is given by a French correspondent as HP5K, operating on 50 m. (6,000 kc/s). Another and more important broadcaster is YNLAT, Granada (Nicaragua), *La Voz de Mombacho*, on 39.98 m. (7,500 kc/s). Power is 150 watts. The station is owned by an experimental amateur YNILT, who, when communicating with other fans, uses the channel 42.25 m. (7,100 kc/s). Address: Sr. Leonidas A. Tenorio, Apartado 17, Granada (Republic of Nicaragua).

XEFT, Vera Cruz, Mexico, on 49.02 m. (6,120 kc/s) has somewhat altered its schedule for the coming months. The times of broadcast advised are now: B.S.T. 18.00-23.00; 02.30-07.00 on week-days, with the early transmission beginning at 00.30 on Sundays. You may send reception reports to: Estación XEFT, *La Voz de Veracruz*, Avenida Independencia, 28, Vera Cruz (Mexico).

Further, to come nearer home, has anybody picked up a series of tests consisting of relays of a programme from the Lisbon National medium-wave transmitter? The call-letters heard were CSW and the wavelength 31.98 m. or 9,380 kc/s. It is possible that a new channel is being tried out as the call was given in Portuguese, Spanish, French, and English.

VUB, Bombay, only a degree or so above HP5J or 31.36 m. (9,565 kc/s), has also been well received lately and, according to its call, the station is now broadcasting

simultaneously on 350.9 m. (855 kc/s), 31.36 m., and 5 metres. As an interval signal the studio uses a bell. The new timings are: Sundays, B.S.T. 07.00-08.30; Tuesdays, 17.00-18.30, and Saturdays, 17.30-18.30, with an occasional transmission on Mondays. It is interesting to know that although the studio is at Bombay, the actual transmitter is at Kirkec (near Poona), some 120 miles away.

Pernambuco

PRA8, Pernambuco (Brazil), hitherto operating on 49.67 m. (6,040 kc/s), the channel used by two U.S.A. short-wavers, has now moved to 49.76 m. (6,028 kc/s) in order to avoid interference. It is now in the immediate vicinity of DJC (Zeesen). A new interval signal has been introduced; it is one stroke of a gong after all numbers in the programme.

Now is the time to search for Japanese broadcasts as they have been very well heard during the past week. JVN, Nazaki, on 28.14 m. (10,660 kc/s), relays most of its material from JOAK, Tokyo. As a rule the broadcasts open with chimes and the man and woman announcers give out a greeting in Japanese, French and English (*Good evening, neighbours!*).

Try for this station between B.S.T. 11.00-13.40 or for the special overseas hour on Mondays and Thursdays between B.S.T. 22.00-23.00. JVN is also on the air between B.S.T. 23.50-00.10 with physical jerks given by a Japanese instructor. The call when closing down is frequently made in English: *This is the Tokyo Central Broadcasting station JOAK*, and in Japanese: *Kochira wa Tokyo chuo hosokiyoku de arimasu*. Another station to try for is JVT, which has been taking portions of the same programme on 44.44 m. (6,750 kc/s); although no interval signal appears to have been adopted, at B.S.T. 13.30, you may hear a time signal. It consists of three deep note gongs, and one of a higher pitch.

JVM, Nazaki, on 27.93 m. (10,740 kc/s), is also largely used for programmes destined for the United States of America and for Europe. For the latter a special broadcast is made every Tuesday and Friday between B.S.T. 20.00-21.00. To make the call perfectly clear the woman announcer spells it out as *J for Japan, V as in violet*, and so on.

Recently on several mornings I have picked up unscrambled telephony between Moscow and Paris. The U.S.S.R. transmitter used for the purpose is RNE, on 24.99 m. (12,005 kc/s), which is often, at other periods of the day, busy with broadcasts; its opposite number in France is FTH, Ste Assise (Paris), on 27.42 m. (10,940 kc/s), which formerly worked South America.

LATHE WORK FOR AMATEURS

By F. J. CAMM.

1/- or 1/2 by post from

GEORGE NEWNES, LTD., 8/11, Southampton St., Strand, W.C.2.

RADIO CLUBS AND SOCIETIES

Club Reports should not exceed 200 words in length and should be received First Post each Monday morning for publication in the following week's issue.

THE RADIO PHYSICAL AND TELEVISION SOCIETY
 THE attendance registered at the last meeting clearly showed that the amateur's interest is not waning as the summer approaches, as was the case in past years, and the full attendance of members was fully justified by an interesting lecture entitled, "High Voltage Discharges," by our President, Dr. G. G. Lemon.

The spark coil, the most useful apparatus for high-voltage production, was explained. The lecturer had on view a coil about 5 feet long and capable of producing about a quarter of a million volts. During the demonstration a discharge of 100,000 volts was produced, the artificial thunder being of a very deafening nature. Using a special 2½ kW. valve the lecturer produced 2½ kW. of RF energy at 5 metres, illustrating the very great heating effect of high power at these high frequencies.

We welcome all readers of PRACTICAL AND AMATEUR WIRELESS to any of our meetings held on Fridays at 8 p.m., our headquarters being at 72a, North End Road (off Talgarth Road), West Kensington, while the Hon. Sec. is Mr. M. E. Arnold, 12, Nassau Road, Barnes, S.W.13.

THE WEST CORNWALL SHORT-WAVE CLUB
 AT the second meeting, held on May 17th, it was decided to give to the club the above name—by which it will be known on all future occasions. It was also decided to invite all persons interested in short-wave work in Cornwall to join the club; and if they happen to reside at some distance from the meeting-place they can be put on the mailing list of the letter budget which is rapidly becoming popular. The club leader holds an A.A. licence as do four other members of the club, all of whom hope to be issued with Call Signs soon. Will all persons interested please write to the Club Secretary—J. H. Phillips, "Villandruca," Stithians, Truro, Cornwall? Monthly meetings are held at the Lanner Inn, Lanner, Redruth, on the third Sunday in each month.

CARDIFF AND DISTRICT SHORT-WAVE CLUB
 THIS club has now taken over a clubroom in City Road, Cardiff, and the annual subscription has been fixed at 6s., payable 1s. 3d. quarterly. Meetings are now held weekly, on Thursday evenings at 8 p.m., as before.

Within the next few weeks a demonstration and lecture on the cathode-ray oscillograph will probably be given, and arrangements are also being made for a five-metre field day to be held at midsummer.

Further information as to the club's activities, membership, etc., will be given if those interested will write to the Honorary Secretary, Mr. H. H. Phillips, 2BQB, 132, Clare Road, Cardiff.

WELLINGBOROUGH AND DISTRICT RADIO AND TELEVISION SOCIETY

THE above society held a well-attended meeting at the Midland Hotel, Wellingborough, on Monday, May 18th, when a talk was given by the Secretary, Mr. I. F. Parker (G5LP), on "Hotting up your Short-wave Receiver." Mr. Parker gave an outline of the troubles most commonly encountered by the beginner when constructing his first short-wave receiver and, with the help of explanatory diagrams, outlined the various methods of curing these faults. He advised the beginner to commence with a published design, such as the PRACTICAL AND AMATEUR WIRELESS receiver, the Prefect, and, after experience with this type of set had been gained, to attempt to hot it up by means of various devices designed to get the last ounce out of the simple type of receiver.

Arrangements are being made to hold a series of lectures dealing with the fundamental principles of radio, electricity and magnetism, and the chemical side of wireless, and a noted speaker has promised his services to take over the lectures. All PRACTICAL AND AMATEUR WIRELESS readers in the district who are interested in these lectures should get in touch with the Hon. Sec., L. F. Parker, 127, Jubilee Crescent, Wellingborough, who will forward particulars on how to join the society.

WEST LONDON RADIO SOCIETY

THE above club is holding a 5-metre day on the river on the second Sunday in June. A transmitter will be operative throughout the day, and conditions will be studied from every angle. The expenses of the day, including punts and tea, will be 3s. 10d. All are welcome with or without receivers. Full particulars can be obtained from the Secretary, H. A. Williamson, 22, Camborne Avenue, Ealing, W.13.

CATALOGUES RECEIVED

CLIX CONNECTORS

THE latest Clix lists give full particulars of various small items which are indispensable to the wireless constructor. There are, for instance, in addition to the well-known valve-holders of the chassis-mounting type, such small parts as aerial and earth socket strips; pick-up and loud-speaker socket strips; mains selector plates; plugs and sockets of various types (which, incidentally, may be obtained plain or with various markings engraved thereon). These lists may be obtained on application to Lectrolinx, Ltd., of 79a, Rochester Row, London, S.W.1.

"GOLSTONE" COMPONENTS

THE latest list of the well-known "Golstone" radio components comprises fifty-six well-illustrated pages, and will be found extremely useful to all radio enthusiasts. Nearly 300 items are enumerated in the index, which gives some idea of the comprehensive range covered. Practically all the lines listed are made in England, the few that are not being clearly design-

nated foreign. Devices for the suppression of man-made static have been given much space, notably patent air-spaced metal-screened down-leads as recommended by the Post Office authorities and installed by both the B.B.C. and Home and Dominion Governments. The list also includes a wide range of iron-cored tuning-coils, chokes, fixed condensers, switches, and general electrical accessories, including meters of various types. This comprehensive list is issued by Ward and Goldstone, Ltd., Frederick Road, Pendleton, Manchester.

ROLA SPEAKERS

THE remarkable fidelity of reproduction for which these popular speakers are noted is the result of several years of research work. Particulars of a complete range of these speakers are given in an attractive folder issued by The British Rola Co., Ltd., Minerva Road, Park Royal, London, N.W.10. Included in the range are various permanent-magnet and field-excited models, ranging in price from 25s. to 35s.; a Class B speaker amplifier unit; universal extension speakers, and the new Rola High Fidelity Speaker, G.12, which is specially designed for greater power-handling capacity, and is intended for use in theatre and public-address systems. Several new and important features are embodied in this instrument, which is available for either D.C. or A.C. working.

ALL ABOUT MICROPHONES

(Continued from page 313)

only the sound waves issuing from the front.

An old speaker may be dismantled and a new diaphragm and coil made up by the constructor, preferably using a self-supporting coil made rigid by a brushing of cellulose or colloidal dope, and attached to a paper diaphragm.

In a modern commercial instrument of this type the speech coil is constructed from oxidised aluminium wire cemented to a tissue paper mount, and this is kept in place by cotton wool packed round it in the magnet gap. The packing is carefully carried out to avoid restriction of movement, but is essential to avoid distortion due to the air compression in the gap causing the light coil to carry out additional movements. This type of instrument has a very low impedance and is extremely sensitive. Again a transformer must be used between it and the grid circuit of the valve.

THE AERODYNE ALL-WAVE SNIPE

(Continued from page 316)

although it could not be expected with such an arrangement that stations could be heard from all parts of the globe. Several of the better-known short-wave transmissions were picked up during our daylight test and the difficulties which we anticipated in tuning were found to be non-existent. The large tuning dial, coupled with the pointer which travels at the rear, and is fitted with a travelling dial-light, gives a clear indication of the wave-range in use and of the frequency to which the set is adjusted. British station names are engraved in red, whilst medium-wave foreign station names are engraved in green. For the long waves black is employed to mark the principal nine stations. The outer—and consequently the larger—scale is employed for the short waves. This is altogether a very fine example of a low-priced all-wave battery receiver, and represents very good value at the price of £7 7s. (less batteries).

Let Us Send You This 40-Page Booklet—Free



It gives full information regarding various I.C.S. Courses of Instruction in Radio work.

The Radio industry is progressing with amazing rapidity. Only by knowing thoroughly the basic principles can pace be kept with it. I.C.S. Instruction includes American broadcasting as well as British wireless practice. It is a modern education, covering every department of the industry.

OUR COURSES

Included in the I.C.S. range are Courses dealing with the installing of radio sets and, in particular, with their Servicing, which to-day intimately concerns every wireless dealer and his employees. The Equipment Course gives sound instruction in radio principles and practice.

There is also a Course for the Wireless Salesman. This, in addition to inculcating the art of salesmanship, provides that knowledge which enables the salesman to hold his own with the most technical of his customers.

Then there are the Preparatory Courses for the City and Guilds and I.W.T. Exams.

We will be pleased to send you details and free advice on any or all of these subjects. Just fill in, and post the coupon, or write in any other way.

International Correspondence Schools, Ltd.,
 Dept. 94, International Buildings,
 Kingsway, London, W.C.2.

Without cost, or obligation, please send me your "Radio" booklet of information about the Courses I have marked X

- COMPLETE RADIO
- RADIO SERVICING
- RADIO EQUIPMENT
- RADIO SERVICING AND SALESMANSHIP
- WIRELESS ENGINEERING
- EXAMINATION (state which)

Name.....Age.....
 Address

LETTERS FROM READERS

The Editor does not necessarily agree with opinions expressed by his correspondents.



All letters must be accompanied by the name and address of the sender (not necessarily for publication).

Variable Directional Aerials

SIR.—With reference to the article dealing with the Variable Directional Aerial, of which I am the inventor and patentee, batches of inquiries have been received. Some misunderstanding has arisen re the tuner unit. This letter will, it is hoped, make matters clear. This aerial system can be used, and will function satisfactorily in every way, without the tuner on any type or make of receiver excluding those using Eddystone and B.T.S. plug-in coils. The tuner enables advantage to be taken of tuning in harmonic relation, and enables signals to be received at good volume under adverse conditions and as an aid to obtaining a high signal-to-noise ratio.

Short-wave signals are known to take a reverse path at certain periods of the year. It may interest readers to know that it is possible to check such reversals with the variable directional aerial.

Reverting to the tuner, an extra blueprint containing coil and circuit data is included in every kit, and components on hand may be used in its construction. Prices include postage and packing. Amateur radio enthusiasts may be interested to know, especially if users of straight regenerative receivers, that it is possible to peak amateur C.W. and 'phone signals under average conditions using this aerial system.—A. W. MANN (Middlesbrough).

Transmissions from the Queen Mary

SIR.—In reply to Mr. L. Gist's letter, published in the May 23rd issue, the wavelength of the transmission he heard was 62 metres. GBT was very loud and clear, also the Queen Mary's operator, but New York was wobbly, and after the tests, which were very clear, GBT asked New York if he would take the broadcast from the Queen Mary, but he replied it was not desired. GBT repeated to GBTT, who replied all right and closed down. All stations were speaking on the same wavelength. I also received the Berlin operator calling airship Hindenburg, Bremen, and New York on 25 metres. All operators were heard on 25 metres. Berlin clear; Bremen medium, Hindenburg loud, and New York clear. These transmissions were in English and were received on the night the Hindenburg gave the broadcast over the Atlantic.

I usually stand by on 62 metres till he calls, then search for the airship, which may be on one of five different wavelengths. My receiver is an untuned H.F., Det., and transformer L.F. set.—JOHN R. LAMMING (Andover).

SIR.—I have just completed my first short waver, which I am using as an adapter to an ordinary broadcast receiver. On a Thursday evening recently I picked up the Queen Mary testing. The station calling her was the B.B.C. in London. The liner's call was GBTT and came through at good strength. The time was about 21.00 to 22.00 G.M.T.—S. FISHER (Billericay).

Mullard Booklet Required

SIR.—I shall be greatly obliged if any reader would loan me a copy of the Mullard Booklet, containing a description

of 1931 Orgola Four. Alternatively, I would be pleased to give in exchange a large number of your P.W.s., including blueprints.—R. CARLISLE (Cork).

[Any reader interested is invited to write to Mr. Carlisle, c/o, the Editor.—ED.]

A Good Log from Northern Ireland

SIR.—As a reader of PRACTICAL AND AMATEUR WIRELESS for at least eighteen months I have not seen any letters published in the paper from Northern Ireland, so I enclose a log of amateurs received on 20 metres on a recent Sunday evening between 23.30 B.S.T. and 01.30 B.S.T. All stations were received on 'phones.

W4CFO, EA5BC, W1IFD, VP1I, W4BSD, W3MB, CO2KY, ON4AA, VP9R, W1BTL, VP3BG, EA5BE, CO7CX, W1CJC, T12FG, W1ARC, T12RC, PY2CK, W9HX, PY2DA, F8LG, W1HAV, W8CNA, W3EZY, W3APO, W8KQQ, W8IMF, W6KSE, and CO2HY. My receiver is a 1-v-2 with untuned H.F. stage. The aerial is 96ft. long.—WILSON GAMBLE (Magherafelt, N. Ireland).

An American Log

SIR.—I have noticed lately that several readers have sent in details of their reception, at various times, of American amateurs. I think that it would be a very good idea to have a separate section dealing with this subject. As a matter of interest, I have received thirty-one American and Canadian amateurs between 11.30 p.m. and 1.0 a.m. on Monday morning, April 6th.

I often get the experimental broadcasts between America and London and various other countries, on the 20-metre band.—ERIC B. JONES (Merton Park).

CUT THIS OUT EACH WEEK.

Do you know

- THAT the capacity of a variable condenser may be increased by cementing paper to the vanes.
- THAT for laboratory use and constancy a variable condenser may be immersed in oil.
- THAT the use of a capacity buried in the earth will often prove of value as an aerial when static interference is very bad.
- THAT it is useless taking precautions to avoid losses in a short-wave set if ordinary components are used in the input circuit.
- THAT a small moving-coil loud-speaker may be employed as a moving-coil microphone.
- THAT any number of wave-traps may be connected in the aerial circuit of a receiver for selectivity purposes.
- THAT Class B and Q.P.P. are only modifications of the standard push-pull circuit.

The Editor will be pleased to consider articles of a practical nature suitable for publication in PRACTICAL AND AMATEUR WIRELESS. Such articles should be written on one side of the paper only, and should contain the name and address of the sender. Whilst the Editor does not hold himself responsible for manuscripts, every effort will be made to return them if a stamped and addressed envelope is enclosed. All correspondence intended for the Editor should be addressed: The Editor, PRACTICAL AND AMATEUR WIRELESS, Geo. Newnes, Ltd., 8-11, Southampton Street, Strand, W.C.2.

Owing to the rapid progress in the design of wireless apparatus and to our efforts to keep our readers in touch with the latest developments, we give no warranty that apparatus described in our columns is not the subject of letters patent.

REPLIES IN BRIEF

The following replies to queries are given in abbreviated form either because of non-compliance with our rules, or because the point raised is not of general interest.

A. C. J. (Skegness). In an aerial circuit the aerial is joined to terminal No. 6 and the earth to No. 5. The grid is connected to terminal No. 1 and No. 3 is joined to earth. The on-off (wave-change) switch is joined across terminals 2 and 3. In an H.F. circuit the anode takes the place of the aerial and the H.T. lead is joined to No. 5. The reaction condenser is joined between the anode of the detector valve and terminal No. 4. The coils were employed in the A.C. Three. We do not recommend the use of the ganged condenser in the receiver you refer to.

J. D. (Denny). We can answer any query you raise concerning the set referred to. If you will enclose a stamped addressed envelope and enumerate your difficulties we will assist you in obtaining satisfaction.

Dr. J. A. Lopes (Lisbon). The unit is for a superhet receiver, but is no longer on the English market. The intermediate-frequency is 110 kc/s and any modern standard coil designed for this frequency could be used. The Westector should take the place of the detector stage and type W.6 should be used.

J. D. (Thomondgate). We regret that we have no details of the speaker. It may have been designed especially for some commercial set maker and therefore you should communicate with the makers of the speaker (The Benjamin Electric Company) with a view to ascertaining the correct connections. You may destroy the speech coil if you connect the speaker wrongly and interchange this with the field coil. The meter should have a resistance of 1,000 ohms per volt and that referred to by you is too low to be of any use for service with your eliminator. Your dealer has given you the correct information regarding this point.

H. T. (Chipping Norton). The crystal may be obtained from Electradix Radios, of Upper Thames Street, London, E.C.

H. N. (Hornsey). There is a possibility that your H.T. unit is not suitable for this particular receiver without alteration of the H.T. feeds. We therefore suggest that you try out the receiver with a dry battery before making any alterations to the components or circuit.

J. F. (Hull). The old Hobbies Three employed a British General tuner, but you give no indication of the particular model which you have and we cannot therefore say whether this is suitable for this receiver. A blueprint is available, price 1s.

T. B. H. (Kent). The headphones should have a resistance of 2,000 or 4,000 ohms.

W. H. J. (Bettws-y-Coed). The instrument was used in the construction of a Service Engineer's Test Outfit which was described in a series of articles in our issues commencing December 28th last. Back numbers may be obtained from this office.

D. F. (Shirley). The trouble is probably due to the fact that you are using the same components. One of these may be defective and thus you are merely transferring the trouble from one set to another. If the receiver is built with new components or parts which are tested and found in order you will not experience the trouble referred to.

P. W. (Abingdon). We have no details of the coils in question and suggest you communicate with the makers, Messrs. Graham Farish.

D. D. (High Wycombe). From your remarks we certainly think the set could be used with a S.W. detector stage for a converter. The S.W. detector stage should, of course, be arranged to act as an autodyne converter and two chokes must be included in the anode circuit.

J. M. (Inverurie). The choke may be of any well-known make, but it may be as well to have the coil tested by the makers to confirm that it is not defective.

A. E. B. (Brighton). The exact amount is 1s. 4d. and a fraction, and the figure of 1s. 6d. is the nearest even amount. In any case the slight difference is of no moment.

G. N. M. (Wolverhampton). The circuit would be quite standard and you could follow the arrangement from any of our published designs.

N. B. W. (Grantham). The two condensers on the diagrams you enclosed could certainly be ganged, but to enable accurate tuning to be carried out on every station a panel trimmer should be employed in conjunction with one of them. Special ganged condensers with a panel (concentric) trimmer arc obtainable.

G. V. H. (Old Trafford). We cannot give full windiz details in this section of the paper nor in the form of a reply. We publish articles on the subject from time to time.

A. W. M. (Wroxham). The point in the circuit referred to is H.T. positive, whereas the centre-tap of the anode winding is H.T. positive. The circuit is completed by the filament stream in the actual rectifying valve.

A. H. (Ashburton). The trouble is no doubt due to L.F. instability and may be cured by reversing the connections to the secondary of the L.F. transformer that is, the leads joined to G. and G.B.).

Facts and Figures

COMPONENTS TESTED IN OUR NEW LABORATORY

New B.T.S. Components

A NUMBER of new components has been submitted for test by British Television Supplies, and in addition to multi-switches, short-wave coils, etc., the all-wave screened H.F. choke is a most interesting item. This is mounted in a square metal box, with terminal on the upper surface. This has been designed for operation on all wavelengths from 15 to 2,000 metres, and consists of a sectional winding on a rigid paxolin former. Five sections are employed and a central spindle carries a paxolin plate to which the terminals are mounted and which are connected to the ends of the choke winding by means of soldering lugs direct, no wire connections being relied upon. By this means there is no risk of the ends of the leads coming adrift through the turning of the screw if undue force is employed when tightening the terminals. This particular point has occurred on a number of occasions in receivers which we have serviced, and we are pleased to note this departure in the method of connection. The rigidity of the connection also prevents troubles from noises even if the screw should become loose. Short ebonite pillars are mounted on the terminals so that they project through the metal casing when the choke is enclosed and these prevent the risk of short circuits. Mounting lugs are eyeletted to the base of the choke, and to ensure complete screening it should be mounted on a metal or metallised chassis as the bottom of the choke is not enclosed by any metal surface. The makers announce that a second model will shortly be produced and that a flexible screened lead will be attached for connection to a valve cap. The price of the present model, type AWC1, is 4s. 6d.

New Lissen All-wave Receiver

MESSRS. LISSSEN announce a new all-wave Universal receiver, Model 8130. This covers the three ranges from 18.5 to 54 metres, from 202 to 560 metres, and from 900 to 2,000 metres, and employs four valves. These are variable-mu H.F. pentode, triode detector, output pentode, and valve rectifier. A full-vision tuning dial is fitted, and the controls include a two-position tone control. A moving-coil loud-speaker is fitted, together with provision for using an external speaker. A

high degree of selectivity is obtained by the use of Litz wound coils, and the receiver may be used with any type of mains rated at 200 to 250 volts. The price is 9 guineas.

New Mullard Valve

THE importance of the superheterodyne circuit has led Messrs. Mullard to introduce yet another valve for frequency-changing purposes. This is to take the form of a triode-hexode and will be suitable for use in A.C. mains receivers. The only details so far issued are that the reference number is to be TH.4 and that it is of the indirectly-heated type. Further particulars will be announced when they are received by us.

Goltone All-wave Aerial Kit

FROM Messrs. Ward and Goldstone we have received details of a new "Overseas" aerial kit, designed for use on wavelengths from 15 to 2,100 metres. The kit includes two 30ft. horizontal aerial wires with a 50ft. length of twin-feeder downlead cable. Two special toughened glass insulators and a glazed porcelain aerial separator are included, and for the downlead two stand-off insulators are included. To complete the kit there is a packet of insulated staples together with the necessary receiver coupler and a detailed instruction book giving full information on the erection and use of the kit. The price is 17s. 6d.

Elex Universal Converter

IN addition to the A.C. mains version of the short-wave converter mentioned in last week's issue, we now understand that Messrs. Eastick are also introducing a model designed for universal mains (A.C. or D.C.) operation. This model will be known as the U2 and will sell at the same price as the A.C. model, namely £4 14s. 6d. The extra coil unit designed for the band from 50 to 100 metres will cost 5s.

NEWNES' TELEVISION AND SHORT - WAVE HANDBOOK

3/6 or 3/10 by post from
GEO. NEWNES, Ltd., 8-11, Southampton St., Strand, W.C.2



Each 1/- net
Illustrated

These Inexpensive Books will help you . . .

THE HOME WOODWORKER. The various examples of woodwork described in this handbook have been designed by practical craftsmen. They are modern in style, and their construction is well within the powers of the average home-worker who follows the instructions given.

THE HANDYMAN'S ENQUIRE WITHIN. Hundreds of practical ideas and hints—many not hitherto published. Classified according to the subjects dealt with, an index being provided to facilitate speedy reference.

POWER-DRIVEN MODEL AIRCRAFT. All about petrol, compressed-air and steam engines, wheels, carburettors, ignition systems, rotary engines, etc., with special constructor's chapters, ranging from compressed-air models for beginners to advanced petrol-engined planes. With 130 sketches, diagrams, and photographs.

MODEL AIRSHIPS AND AEROPLANES. This handbook is intended as a guide to the beginner in model aeronautics. It presents in clear language the first principles of aviation and incorporates these in various forms of simple flying models. Profusely illustrated.

ACCUMULATORS. An accumulator (whether for wireless or the car), if properly used and cared for, is an extremely reliable piece of apparatus. Proper care and proper use can only follow a possession of the knowledge which study of this book will impart.

SIMPLE ELECTRICAL APPARATUS. Interesting and useful apparatus, easily constructed, with which the student is enabled to test for himself the theory and practice of electricity as laid down in the text-books. 138 illustrations.

All fully illustrated.

1/2 each post free, from the Publishers:

GEORGE NEWNES, LIMITED,
8-11, Southampton St.,
Strand, London, W.C.2

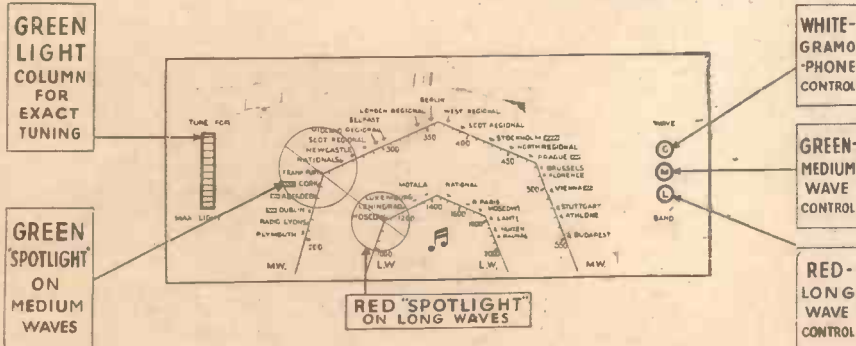

This diagram shows the principal features of the Columbia Tuning Dial, which, in addition to an indication of tuning and the waveband which has been selected, shows the actual tuning point by means of a coloured spot of light.

Practical and Amateur Wireless BLUEPRINT SERVICE

PRACTICAL WIRELESS STRAIGHT SETS. Battery Operated. One-valve : Blueprints, 1s. each.

Date of Issue.	No of Blueprint
—	PW31A

All-Wave Unipen (pentode) ..	—	PW31A
Two-valve : Blueprints, 1s. each.		
Four-range Super Mag Two (D, Pen)	11.8.34	PW36B
Three-valve : Blueprints, 1s. each.		
Selectone Battery Three (D, 2 LF (trans.))	—	PW10
Sixty-Shilling Three (D, 2 LF (R.C. & trans.))	2.12.33	PW34A
Leader Three (SG, D, Pow.)	—	PW35
Summit Three (HF Pen, D, Pen)	18.8.34	PW37
All-Pentode Three (HF Pen, D (pen.), Pen)	22.9.34	PW39
Hall-Mark Three (SG, D, Pow.)	—	PW41
Hall-Mark Cadet (D, L.F. Pen (R.C.))	10.3.35	PW48
F. J. Camm's Silver Souvenir (HF Pen, D (pen), Pen) (All-Wave Three)	13.4.35	PW49
Genet Midget (D, 2 LF (trans.))	June '35	PM2
Camco Midget Three (D, 2 LF (trans.))	8.0.35	PW51
1936 Sonotone Three-Four (HF Pen, HF Pen, Westector, Pen)	17.8.35	PW53
Battery All-Wave Three (D, 2 LF (R.C.))	31.8.35	PW55
The Moulter (HF Pen, D, Pen)	8.2.36	PW61
The Tutor Three (HF Pen, D, Pen)	21.3.36	PW62
The Centaur Three (SG, D, P)	7.12.35	PW64

Four-valve : Blueprints, 1s. each.		
Fury Four (2 SG, D, Pen)	—	PW11
Beta Universal Four (SG, D, LF, Cl B)	15.4.33	PW17
Nucleon Class B Four (SG, D (SG), LF, Cl B)	6.1.34	PW34B
Fury Four Super (SG, SG, D, Pen)	—	PW34C
Battery Hall-Mark 4 (HF Pen, D, Push-Pull)	—	PW46
F. J. Camm's Superformer (SG, SG, D, Pen.)	12.10.35	PW57

Mains Operated.

Two-valve : Blueprints, 1s. each.		
A.C. Twin (D (pen), Pen)	—	PW18
A.C.-D.C. Two (SG, Power)	7.10.33	PW31
Selectone A.C. Radiogram Two (D, Pow.)	—	PW19

Three-valve : Blueprints, 1s. each.		
Double-Diode-Triode Three (HF Pen, D.D.T. Pen)	10.0.33	PW23
D.C. Ace (SG, D, Pen)	15.7.33	PW25
A.C. Three (SG, D, Pen)	—	PW29
A.C. Leader (HF Pen, D, Power)	7.4.34	PW35C
D.C. Premier (HF, Pen, D, Pen)	31.3.34	PW35B
Ubique (HF Pen, D (Pen), Pen)	28.7.34	PW36A
Armada Mains Three (HF Pen, D, Pen)	18.8.34	PW38
F. J. Camm's A.C. All-Wave Silver Souvenir Three (HF Pen, D, Pen)	11.5.35	PW50
"Allwave" A.C. Three (D, 2LF (R.C.))	17.8.35	PW54
A.C. 1936 Sonotone (HF Pen, HF Pen, Westector, Pen)	31.8.35	PW56

Four-valve : Blueprints, 1s. each.		
A.C. Fury Four (SG, SG, D, Pen)	—	PW20
A.C. Fury Four Super (SG, SG, D, Pen)	—	PW34D
A.C. Hall-Mark (HF Pen, D, Push-Pull)	—	PW45
Universal Hall-Mark (HF Pen, D, Push-Pull)	0.2.35	PW47

SUPERHETS

Battery Sets : Blueprints, 1s. each.		
£5 Superhet (Three valve)	—	PW40
F. J. Camm's 2-valve Superhet (two-valve)	—	PW58
F. J. Camm's £4 Superhet	13.7.35	PW52
Mains Sets : Blueprints, 1s. each.		
A.C. £5 Superhet (three valve)	—	PW43
D.C. £5 Superhet (three valve)	1.12.34	PW42
Universal £5 Superhet (three valve)	—	PW44
F. J. Camm's A.C. £4 Superhet 4	7.12.35	PW59
F. J. Camm's Universal £4 Superhet 4	11.1.36	PW60

SHORT-WAVE SETS.

Two-valve : Blueprints, 1s. each.		
Midget Short-Wave Two (D, Pen)	15.9.34	PW38A
Three-valve : Blueprints, 1s. each.		
Experimenter's Short-wave Three (SG, D, Power)	—	PW30A
The Prefect 3 (D, 2 LF, RC and Trans.)	8.2.36	PW63

PORTABLES.		
Three-valve : Blueprints, 1s. each.		
F. J. Camm's ELF Three-valve Portable.	16.5.36	PW65

Four-valve : Blueprints, 1s. each.		
Featherweight Portable Four (SG, D, LF, Cl. B.)	—	PW12

MISCELLANEOUS.		
S. W. Converter-Adapter (1 valve)	23.2.35	PW48A

AMATEUR WIRELESS AND WIRELESS MAGAZINE CRYSTAL SETS.

Blueprints, 6d. each.		
Four-station Crystal Set	—	AW427
1934 Crystal Set	—	AW444
150-mile Crystal Set	—	AW450

STRAIGHT SETS, Battery Operated.

One-valve : Blueprints, 1s. each.		
B.B.C. Special One-valver	—	AW387
Twenty-station Loud-speaker One-valver (Class B)	—	AW449

Two-valve : Blueprints, 1s. each.		
Melody Ranger Two (D, Trans.)	—	AW388
Full-volume Two (SG, Det., Pen)	—	AW392
Iron-core Two (D, Trans)	—	AW395
Iron-core Two (D, Q.P.P.)	12.8.33	AW396

B.B.C. National Two with Lucerne		
Coll (D, Trans.)	—	AW377A
Blg-power Melody Two with Lucerne Coll (SG, Trans)	—	AW388A
Lucerne Minor (D, Pen)	—	AW426

Three-valve : Blueprints 1s. each.		
Class-B Three (D, Trans, Class B)	22.4.33	AW386
New Britain's Favourite Three (D, Trans, Class B)	15.7.33	AW394
Home-Built Coll Three (SG, D, Trans)	—	AW404
Fan and Family Three (D, Trans, Class B)	25.11.33	AW410
£5 5s. S.G.3 (SG, D, Trans)	2.12.33	AW412
1934 Ether Searcher : Baseboard Model (SG, D, Pen)	20.1.34	AW417
1934 Ether Searcher : Chassis Model (SG, D, Pen)	—	AW419
Lucerne Ranger (SG, D, Trans)	—	AW422
Cosor Melody Maker with Lucerne Coils	—	AW423

P.W.H. Mascot with Lucerne Coils		
(D, RC, Trans)	—	AW377A
Mullard Master Three with Lucerne Coils	—	AW424

£5 5s. Three : De Luxe Version		
(SG, D, Trans)	10.5.34	AW435
Lucerne Straight Three (D, RC, Trans)	—	AW437
All Britain Three (HF Pen, D, Pen)	—	AW448

"Wireless League" Three (HF Pen, D, Pen)		
3.11.34	AW451	
Transportable Three (SG, D, Pen)	—	WM271
£4 6s. Radiogram (D, RC, Trans)	—	WM318
Simple tune Three (SG, D, Pen)	June '33	WM327

Economy-pentode Three (SG, D, Pen)		
Oct. '33	WM337	
"W.M." 1934 Standard Three (SG, D, Pen)	—	WM351
£3 3s. Three (SG, D, Trans)	Mar. '34	WM354

Iron-core Band-pass Three (SG, D, QP21)		
June '34	WM362	
1935 £6 6s. Battery Three (SG, D, Pen)	—	WM371

Graduating to a Low-frequency Stage (D, 2LF)		
June '35	WM878	
P.T.P. Three (Pen, D, Pen)	Sept. '35	WM389
Certainty Three (SG, D, Pen)	Oct. '35	WM393
Minutube Three (SG, D, Trans)	—	WM396

All-wave Winning Three (SG, D, Pen)		
Dec. '35	WM400	
Four-valve : Blueprints, 1s. 6d. each.		
55/- Four (SG, D, RC, Trans)	—	AW370
A.W.' Ideal Four (2SG, D, Pen)	16.9.33	AW402
2 H.F. Four (2SG, D, Pen)	—	AW421

Crusaders' A.V.C. 4 (2HF D, QP21)		
18.8.34	AW445	
(Pentode and Class-B Outputs for above : blueprints 6d. each)	25.8.34	AW445A
Self-contained Four (SG, D, LF, Class B)	Aug. '33	WM331

Lucerne Straight Four (SG, D, LF, Trans)		
—	—	WM350
£5 5s. Battery Four (HF, D, 2LF)	Feb. '35	WM381
The H.K. Four	Mar. '35	WM384

Five-valve : Blueprints, 1s. 6d. each.		
Super-quality Five (2HF, D, RC, Trans)	May '33	WM320
New Class-B Five (2SG, D, LF, Class B)	Nov. '33	WM340
Class-B Quadradync (2SG, D, LF, Class B)	Dec. '33	WM344
1935 Super Five (Battery Superhet)	—	WM379

These blueprints are full size. Copies of appropriate issues containing descriptions of these sets can in most cases be obtained as follows: "Practical Wireless" at 4d., "Amateur Wireless" at 4d., "Practical Mechanics" at 7d., and "Wireless Magazine" at 1/3d., post paid. Index letters "P.W." refer to "Practical Wireless" sets, "P.M." to "Practical Mechanics" sets, "A.W." refer to "Amateur Wireless" sets, and "W.M." refer to "Wireless Magazine" sets. Send (preferably) a postal order (stamps ever sixpence unacceptible) to "Practical and Amateur Wireless" Blueprint Dept., Geo. G. Newnes, Ltd., 8-11, Southampton Street, Strand, W.C.2.

Mains Operated.		
Two-valve : Blueprints, 1s. each.		
Consoelectric Two (D, Pen) A.C.	23.9.33	AW403
Economy A.C. Two (D, Trans) A.C.	—	WM286
Unicorn A.C./D.C. Two (D, Pen)	Sept. '35	WM394

Three-valve : Blueprints, 1s. each.		
Home-lover's New All-electric Three (SG, D, Trans) A.C.	—	AW383
S.G. Three (SG, D, Pen) A.C.	—	AW390
A.C. Triodyne (SG, D, Pen) A.C.	19.8.33	AW399
A.C. Pentaquester (HF, Pen, D, Pen) A.C.	23.6.34	AW439
Mantovani A.C. Three (HF, Pen, D, Pen) A.C.	—	WM374
£15 15s. 1936 A.C. Radiogram (HF, D, Pen)	Jan. '36	WM401

Four-valve : Blueprints, 1s. 6d. each.		
All Metal Four (2 SG, D, Pen)	July '33	WM329
Harris Jubilee Radiogram	May '35	WM386

SUPERHETS.

Battery Sets : Blueprints, 1s. 6d. each.		
Modern Super Senior	—	WM375
Varsity Four	Oct. '35	WM395
Mains Sets : Blueprints, 1s. 6d. each.		
1934 A.C. Century Super A.C.	10.3.34	AW425
Heptode Super Three A.C.	May '34	WM359
"W.M." Radiogram Super A.C.	—	WM366
1935 A.C. Stenode	Apl. '35	WM385

PORTABLES.

Four-valve : Blueprints, 1s. 6d. each.		
Midget Class-B Portable (SG, D, LF, Class B)	20.5.33	AW638
Holiday Portable (SG, D, LF, Class B)	17.3.33	AW393
Family Portable (HF, D, RC, Trans)	22.9.34	AW447
Two H.F. Portable (2 SG, D, QP21)	June '34	WM363
Tyers Portable (SG, D, 2 Trans)	Aug. '34	WM367

SHORT-WAVERS—Battery Operated.

One-valve : Blueprints, 1s. each.		
S.W. One-valve converter (price 6d.)	—	AW329
S.W. One-valve for America	—	AW429
Roma Short-waver	—	AW452

Two-valve : Blueprints, 1s. each.		
Ultra-short Battery Two (SG det., Pen)	Feb. '36	WM402
Home-made Coil Two (D, Pen)	—	AW440

Three-valve : Blueprints, 1s. each.		
World-ranger Short-wave 3 (D, RC, Trans)	—	AW355
Experimenter's 5-metre Set (D, Trans, Super-regen)	30.6.34	AW438
Experimenter's Short-waver	Jan. 19, '35	AW463
The Carrier Short-waver	July '35	WM390

Four-valve : Blueprints, 1s. 6d. each.		
A.W. Short-wave World Beater (HF Pen, D, RC, Trans)	—	AW436
Empire Short-waver (SG, D, RC, Trans)	—	WM313
Standard Four-valve Short-waver	Mar. '35	WM383
Superhet : Blueprint, 1s. 6d.	—	—
Simplified Short-wave Super	Nov. '35	WM397

Mains Operated.

Two-valve : Blueprints, 1s. each.		
Two-valve Mains Short-waver (D, Pen) A.C.	—	AW453
"W.M." Band-spread Short-waver (D, Pen) A.C./D.C.	Aug. '34	WM368
"W.M." Long-wave Converter	—	WM380

Three-valve : Blueprint, 1s.		
Enigrator (SG, D, Pen) A.C.	—	WM352
Four-valve : Blueprint, 1s. 6d.		
Standard Four-valve A.C. Short-waver (SG, D, RC, Trans)	Aug. '35	WM391

MISCELLANEOUS.

Enthusiast's Power Amplifier (1/6)	June '35	WM387
Listener's 5-watt A.C. Amplifier (1/6)	Sept. '35	WM392
Radio Unit (2v.) for WM392 (1s.)	Nov. '35	WM398
Harris Electrogram (battery amplifier)	Dec. '35	WM399
De-Luxe Concert A.C. Electrogram	Mar. '36	WM403
New style Short-wave Adapter (1s.)	June '35	WM388
Trickle Charger (6d.)	Jan. 5, '35	AW462
Short-wave Adapter	Dec. 1, '34	AW456
Superhet Converter	Dec. 1, '34	AW457



QUERIES and ENQUIRIES

Overcoming Battery Problems

"I am an inexperienced experimenter and am continually building and taking down receivers and find the cost of upkeep of H.T. and L.T. rather expensive—the latter rather more than the former. I wonder if you could advise me as to what means of supply I could use without changing my present battery valves for mains. My mains are A.C. 200-250, 50 cycles. Could you also please let me know about what price this is going to cost?"—A. H. B. (Godalming).

THE obvious solution is to use mains valves, and no doubt these will prove cheapest in the long run. This statement is not based upon the actual cost of the valves, but upon the associated equipment, as the greater efficiency of mains valves will enable better results to be obtained with fewer valves. However, by charging your own accumulators you will be able to effect some saving and for this purpose will require a mains transformer and rectifier. The former would also be required for A.C. valves, but the rectifier would not then be needed. A mains transformer for the rectifier would cost about 17s. 6d., whilst the rectifier would cost 11s. or 13s.

Visual Tuning Indicator

"In your issue of May 2nd, 1936, page 185, I cannot quite follow your diagram, Fig. 2. Would you kindly have a look at it and, if you would be so good, inform me whether I might still follow it with confidence?"—G. J. B. (Bexley Heath).

THE diagram illustrates the connections required to include a visual tuning indicator of simple type in the £4 Superhet. This indicator consists simply of a milliammeter in the anode circuit of the second detector stage and is therefore joined on the "earth" side of the anode circuit component—namely, between the H.T. terminal on the L.F. transformer and the H.T. tapping. The wire originally joined from the H.T. terminal to the flexible lead (which is also joined to the screening grid of the I.F. valve and to a fixed condenser joined to M.B.) is removed and the meter then joined to these two points. As the receiver is tuned the anode current of the second detector will vary and thus the meter will give an indication when the set is accurately tuned, or in other words, when maximum volume is obtained at this stage. The set is tuned for maximum deflection on each station.

Quality Reception

"Can you recommend one of your superhets for perfect quality reception, together with a speaker suitable? I have become tired of the usual broadcast reception and now want to launch out for real quality stuff, and I shall only be satisfied with the best. I do not want to use more than six valves and shall be satisfied with about twenty stations at perfect quality."—B. R. (Gloucester).

WE have not yet designed a set to suit the requirements outlined by you, and do not think that anyone else has. If you require perfect quality, then you must be satisfied with the nearest B.B.C. station; if you require the very highest quality, you cannot employ a superhet; and so one could go on with comparisons and criticisms to show that that at which you aim is impossible. However, if you cannot now be satisfied with anything but the best quality of reproduction, you must confine your broadcast reception to the local B.B.C. station, and then a good mains-operated push-pull amplifier (such as the Paraphrase amplifier recently described by us) will meet your needs, when fed from a radio section consisting of a good H.F. stage followed by a diode detector and no reaction arrangements. A moving-coil energised speaker must be employed and no doubt a considerable amount of experimentation will be needed to find a model to suit your room acoustics, together with the best

RULES

We wish to draw the reader's attention to the fact that the Queries Service is intended only for the solution of problems or difficulties arising from the construction of receivers described in our pages, from articles appearing in our pages, or on general wireless matters. We regret that we cannot, for obvious reasons—

- (1) Supply circuit diagrams of complete multi-valve receivers.
- (2) Suggest alterations or modifications of receivers described in our contemporaries.
- (3) Suggest alterations or modifications to commercial receivers.
- (4) Answer queries over the telephone.
- (5) Grant interviews to querists.

Please note also, that queries must be limited to two per reader, and all sketches and drawings which are sent to us should bear the name and address of the sender.

If a postal reply is desired, a stamped addressed envelope must be enclosed. Send your queries to the Editor, PRACTICAL AND AMATEUR WIRELESS, Geo. Newnes, Ltd., 8-11, Southampton Street, Strand, London, W.2.

position in the room you intend to use. On the other hand, if you use two good H.F. stages and a double-diode-triode to feed an amplifier of the type mentioned, you could receive a number of stations with very good quality, but it would be a long way short of perfection.

Technical Symbols

"I have just obtained a new valve and there was a paper in the box with some figures on it. Some of these I cannot understand as it says Ia and Eg before them. Can you tell me what these letters mean? Is there some standard of these references and do they mean anything?"—B. R. (Stockport).

THE letters are standard electrical symbols and we published a full table in an early issue, and also in the Wireless Constructors' Encyclopaedia. The letter I stands for current and the letter E for voltage (or electro-motive force). The smaller letters denote the parts of the valve, thus 'a' represents anode and 'g' the grid. Ia therefore stands for anode current, and Eg for grid voltage. Some valve manufacturers adopt the letter V (which really means Volt) for the voltage and thus would indicate anode voltage by the letters Va and grid voltage by Vg.

Making a Microphone

"I belong to a dance band and have tried a number of different commercial types of microphone without great success. I should therefore like to make up a mike to experiment with and should be glad if you could give me some details concerning the various types and which is the best to make."—D. T. A. (Finchley).

THE difficulty may be due to your amplifier or to the method of use, as we have seen many microphone amplifiers built up by amateurs with even cheap mikes which give remarkable results. The amplifier may, of course, be tested on radio or gramophone records in order to make certain that it is good from the quality point of view.

Energised Speaker

"I have a mains energised speaker, rated at 200-250 volts, 2,000 ohms field, 25 watts. I should be glad to know what current is necessary to feed this. Further, I have spare 400 volts 60 milliamps. Can I utilise this for the purpose?"—H. C. (Grays).

THE rating of the speaker is 25 watts, and therefore the current to obtain this wattage at 200 to 250 volts would be in the neighbourhood of 125 milliamps. Thus to include the field in the H.T. positive feed to your set it would be necessary for the total anode current of all the valves to be 125 milliamps for maximum field strength. To obtain maximum efficiency, therefore, we suggest that you consider the construction of a unit embodying a Westinghouse Metal Rectifier, entirely for the energisation of the speaker field.

Microphone Types

"I have been offered a microphone for a birthday present, but do not know which type to choose. Expense is no object, but I want good quality. What types do you suggest from which to choose? I think an article on the subject would be welcomed by many readers. Could you explain the function of the various types and the results to be expected?"—G. B. U. O. (Hove).

WE are commencing a short series on the subject of microphones in this issue, but in the meantime suggest that you obtain various catalogues giving details of the instruments. The highest quality would be obtained with the crystal or velocity types of instrument, whilst the lowest priced is the carbon microphone. Full details of the function, etc., will be given in the articles which commence on page 313 of this issue.

Adapter to Converter

"I have been using a short-wave three-valve set for some months, and recently cut out the two L.F. stages and used the detector stage alone with the L.F. side of my new commercial mains four. What alterations must I now make so as to use the detector stage as a short-wave converter and so use the H.F. side of my mains set?"—B. W. (Cardiff).

THE only modification which should be necessary is the inclusion of a broadcast choke in series with the present short-wave H.F. choke. The apparatus would then, of course, be joined through a fixed condenser connected between the two chokes to the aerial terminal of your mains set.

The coupon on cover iii must be attached to every query.

Miscellaneous Advertisements

Advertisements are accepted for these columns at the rate of 3d. per word. Words in black face and/or capitals are charged double this rate (minimum charge 3/- per paragraph). Display lines are charged at 6/- per line. All advertisements must be prepaid. All communications should be addressed to the Advertisement Manager, "Practical and Amateur Wireless," 8, Southampton Street, Strand, London.

RADIO CLEARANCE

63, HIGH HOLBORN, W.C.1

TEL.: HOLBORN 4631.

END OF SEASON SALE SUPER BARGAINS FOR ALL

52/- LISSAN SCREEN GRID, DETECTOR, PEM-TODE, SET. Handsome Ebony finish cabinet, Chromium fittings, Moving Coil Speaker. Complete with Valves, BRAND NEW.

67/6 BUSH 3 VALVE BATTERY SUPERHET. Modern cabinet, Moving Coil Speaker, Multi Valves, A.V.C., etc.

5/6 TRIAD VALVES. 01-A, 21A, 27, 30, 31, 32, 33, 35, 37, 38, 39, 41, 42, 43, 45, 46, 47, 53, 55, 56, 57, 58, 59, 71A, 75, 78, 80, GA6, 1C6, 6F7, 2A3, 5Z3, 12A7, 6A6, 6A7, 6D6, 12Z3, 25Z5.

3/6 SPECIAL OFFER AMERICAN VALVES, type 12Z3, 5Z3, 25Z5, 6B7, 6A7, 6FY, 45.

3/6 LISSAN 2 VOLT CLASS B VALVES. Type BB.220 A. Brand new, boxed.

8/6 COMPLETE LISSAN SUPERHET ASSEMBLY. Comprising 3 Gang Superhet Condenser, 126 kc/s Oscillator Section. Set of Ganged Superhet Coils with Switch and two 126 kc/s I.F. Transformers. A Wonderful Bargain.

2/11 LISSAN INTERMEDIATE FREQUENCY TRANSFORMERS, 126 kc/s. Brand new, boxed. List price, 8/6.

BRYCE MAINS TRANSFORMERS.

8/6 250-0-250, 80 m.a. 2-0-2 volts, 2.5 amps., 2-0-2 volts, 4 amps. Shrouded.

10/6 350-0-350 volts, 120 m.a., 2-0-2 volts, 2.5 amps., 2-0-2 volts, 4 amps. Shrouded.

12/6 350-0-350 volts, 150 m.a., 2-0-2 volts, 2.5 amps., 2-0-2 volts, 4 amps., 2-0-2 volts, 2 amps. Shrouded.

17/6 500-0-500 volts, 150 m.a., 2-0-2 volts, 2.5 amps., 2-0-2 volts, 6 amps., 2-0-2 volts, 2 amps., 2-0-2 volts, 2 amps. Shrouded.

8/6 H.T.S. TRANSFORMERS. 250 volts, 60 m.a., 2-0-2 volts, 4 amps.

17/6 DITTO. With H.T.S. Metal Rectifier.

ALL THE ABOVE TRANSFORMERS ARE OF FIRST CLASS MANUFACTURE, BRAND NEW AND CARRY MAKERS' GUARANTEE

2/6 8 mfd. and 4 mfd. DRY ELECTROLYTIC CONDENSERS. By well-known manufacturer. 450 volt working, 500 volt peak. Brand new.

HIVAC VALVES. Complete range in stock, send for lists.

2/- G.E.C. 110 kc/s INTERMEDIATE FREQUENCY COILS. Complete with two trimmers.

1/3 G.E.C. 500,000 ohms VOLUME CONTROLS. With Switch.

9d. LISSAN R.C. UNIT. Brand new, boxed, list price, 3/6.

1/11 LISSAN STRAIGHT LINE DIALS with Escutcheon.

2/11 LISSAN IRON CORED AERIAL COILS with Reaction.

7/11 LISSAN SET OF 3 IRON CORED BAND PASS COILS with circuit.

HUGE PURCHASE of Weston and Jewel Metros. Various types. Call and inspect competitive prices.

SPECIAL

Available shortly, one, two and three valve Short Wave Kits, Battery and A.C./D.C. types. At competitive prices. Apply for details.

WRITE FOR CATALOGUE.

ALL ORDERS OVER 5/- POST FREE.

RADIO CLEARANCE

63, HIGH HOLBORN, W.C.1

TEL.: HOLBORN 4631.

PREMIER SUPPLY STORES

IMPORTANT NOTICE! As our Mail Order Dept. again requires larger premises, we are removing same to our new factory. All POST ORDERS should be addressed to—

JUBILEE WORKS, 167, LOWER CLAPTON RD., LONDON, E.5.

*Phone Amhurst 2833 (Private Branch Exchange.)

Callers, as usual, to 20-22, HIGH ST., CLAPHAM, S.W.4. (Macaulay 2381).

and 165 and 165a, Fleet St., E.C.4 (next to Andertons Hotel). (Central 2833).

NOW READY! Send 4d. in stamps for NEW ILLUSTRATED GIANT CATALOGUE AND VALVE LIST.

SHORT WAVES.

SHORT-WAVE COILS 4 or 6-pin types. 13-26. 22-47, 41-94, 78-170 metres, 1/9 each with circuit. Special set of 3 S.W. Coils, 14-150 metres. 4/-, with circuit. Premier 3-band S.W. Coil, 11-25, 19-43, 38-86 metres. Simplifies S.W. receiver construction, suitable any type circuit, 2/-.

COIL FORMERS, in finest plastic materials, 1 1/2 in. low-loss ribbed 4- or 6-pin, 1/- each.

CONDENSERS, super ceramic S.L.F. .00016, .0001, 2/9 each; double-spaced .000015, .000025, .00005, 3/- each. All brass with integral slow-motion .00015 tuning, 3/9; .00015 reaction, 2/9.

SHORT-WAVE KIT for 1 valve receiver or adaptor, complete with chassis, 3 coils 14-150 metres. Condensers, circuit, and all parts, 12/6. VALVE GIVEN FREE.

BAND-PASS KIT, 14/6 the lot. Lissen 3-gang coil unit. Utility 3-gang condenser and disc drive, 4 valve-holders, chassis and blueprint.

MAINS TRANSFORMERS. Premier wire-end type with screened primaries.

H.T.8 & 9 or H.T.10 with 4v. 4a. C.T. and 4v. 1a. C.T., 8/6.

250-250v. 60 ma., 4v. 1 a. 4v. 2a. and 4v. 4a., all C.T., 8/6.

350-350v. 120 ma., 4v. 1a., 4v. 2a. and 4v. 4a., all C.T., 10/6.

500-500v. 150 ma., 4v. 2-3a., 4v. 2-3a., 4v. 2-3a., all C.T., 19/6.

Any of these transformers with engraved panel and N.P. terminals 1/6 extra.

AUTO TRANSFORMERS, step up or down, 60 watts, 7/6, 100 watts, 10/-.

MAINS VALVES, famous Europa 4v. A.C. types, 4/6 each. H.L., L., S.G., Var-Mu-S.G., H.F. Pens., Var-Mu-H.F. Pens., 1, 3, and 4-watt A.C. directly-heated output Pentodes.

Full-wave rectifiers, 250 v. 60 ma. Frequency Changers. Octodes and Heptodes. A.6/D.6 types, 20-volt 18 amp. S.G., Var-Mu-S.G., H., H.L., Power and Pentodes.

Following Types all 5 1/2 each. Full-wave rectifiers 350 v. 120 ma. and 500 v. 120 ma. 2 1/2 watt indirectly heated Pentodes. 2 1/2 watt indirectly-heated Power.

BATTERY VALVES. 2-volts. H.F., L.F., 2/3. Power, Super-Power, 2/9. S.G., Var-Mu-S.G., 4 or 5-pin Pentodes, H.F. Pens., V-Mu-H.F. Pens., 5/-.

AMERICAN VALVES. Genuine American

A DUOTRON, all types, 3/6 each. Hytron super quality, 3 months' guarantee, all types, 5/6.

MILLIAMMETERS, moving-iron flush 2 1/2", all ranges from 0-10 5/9. Visual tuning, 6 or 12 m.a., 5/-. Moving coil meters, 2 1/2" 0-1 m.a. 18/6; 3 1/2" 0-1 m.a. 22/6. Multipliers 1/- each. Westinghouse metal rectifiers, 17/6 each.

ELECTROLYTICS. U.S.A. 4, 8 or 12 mfd. 530 v. peak, 1/9 each. Dubilier, 4 or 8 mfd. 509 v., 3/-; 50 mfd. 50 v.-1/9; 12 mfd. 20 v. 6d.; 25 mfd. 25 v. 1/-.

T.C.C. 4 or 8 mfd. 650 v. 4/-; 15 mfd. 50 or 100 v. 1/-; 50 mfd. 12 v. 1/-.

Paper Condensers. W.E., 250 v. working 4 mfd., 2/-; 2 mfd. 1/-; 1 mfd. 6d.; 350 v. working 4 mfd. 2/6; 2 mfd. 1/6, Dubilier 500 v. working 4 mfd. 4/-; 800 v. 4 mfd. 6/-; 2 mfd. 750 v. 3/-.

Wego 450 v. working 1 mfd. 1/-; 2 mfd. 1/9, 4 mfd. 3/-; 700 v. working 2 mfd. 2/-; 4 mfd. 3/6; 1,650 v. working 1 mfd. 3/6, 2 mfd. 5/6.

TRANSFORMERS, latest type Telsen R.G.4 (list 12/6), 2/9. Lissen Hypernik Q.P.P. (list 12/6), 3/6.

ELIMINATOR KITS for A.C. mains. 120 v. 20 m.a., 8/6; 150 v. 25 m.a., 10/-, tapped S.G. det. and output. Complete Kit with long-life valve rectifier (replacement cost only 2/-).

G.E.C. A.C./D.C. All-Mains Three. Ready to plug in, sealed cartons with maker's guarantee (listed, £7/15/0), 75/-.

LISSAN All-Electric A.C.4. complete with valves and M.C. Speaker, list 9 gns., 65/-.

2-VALVE Battery receivers in bakelite cabinet, complete with speaker and 2 Mullard valves (less batteries), 25/-.

Potentiometers by well-known makers. All values up to 1 meg. 2/-; with switch 2/6.

RECEIVERS, COMPONENTS AND ACCESSORIES Surplus, Clearance, or Secondhand, etc:

RADIOMART (G5NI) SHORT-WAVE SPECIALISTS

Everything a constructor requires. Lowest prices. No junk. Catalogue 1 1/2 d. shows thousands of bargains. During Summer, few only shown below.

RADIOMART. Utility 2-gang unknob and dial, 3/11, 1,500 vt. Tubular condensers, 6d.; Helsby electrolytics 8mf. 500, 2/11, 4 x 4 mf., 1/6; 25mf., 25v., 1/-, etc.

RADIOMART. Smoothing chokes, 20 by., 120 ma., 3/11; 100 ma., 2/11; 40 ma., 1/11. Telsen Ace transformers, 1/11. Radiogrand, RG48, 2/9. BTH speaker, 2/11.

RADIOMART. Varley iron-cored, 10/6. Bifocal dual-range coils. Very selective, 2/11; matched pair, 5/3.

RADIOMART. Pushback wire 6 yds. 6d, heavy 9d.; 2 gross solder tags, 6d. Resincoated solder, 9ft., 6d.

RADIOMART. Centralab pots, all sizes, 1/6; switched 2/-.

RADIOMART. Igranid midget jacks, 3d. Milliameters, 25 ma. upwards, 5/9; super, 6/9.

RADIOMART. Telsen H.F. chokes, 1/11; screened 1/11. Utility 1936 S.L. wavelength dials, 3/11.

RADIOMART. Lissen 3-gang superhet kit coils, two I.F.'s ganged condenser, ditto Bandpass, ditto 2-gang all-wave, 10/- kit.

RADIOMART. Traders' monster bargain parcels, value £4/10/0 for 10/- also 5/- parcels.

RADIOMART. Famous continental A.C. valves, 4/6. American Duotron, etc. All types, 3/6. Battery from 2/3.

RADIOMART. Utility 8/6, microdisc dials, 3/11. Radiophone .00016 short-wave condensers, 3/6. Series gap twin, 3/9.

RADIOMART. Ceramic all brass microvariables, 15 mmd., 1/4. 40 mmd., 1/7. 100 mmd., 1/10. Short-wave HFC, 9d.

RADIOMART. Orders 5/- post free. Get our bargain catalogues. General 1 1/2 d. Short-wave, 1 1/2 d. 44, Holloway Head, Birmingham. Tel.: MID 3254.

THE following unused set manufacturers' Surplus; all goods guaranteed perfect; immediate delivery.

MAGNAVOX speakers complete with hum-bucking coil, output transformers, etc. DC152 (9in. cone), 22/0. DC154 (7in. cone), 10/-.

All with 2,500 or 6,500 ohms fields.

REGENTONE transformers for HT8 or HT9, with 4v. 4 amp. L.T. winding, 7/-.

Eliminators, first-class make. Outputs 150v. 25ma. S.G. and Detector. A.C. type with Westinghouse rectifier, 25/-.

A.C. type with 5 amp. trickle charger, 30/-.

D.C. type, 12/6.

HELSEBY dry electrolytic condensers 8 mfd. or 4 mfd., 500v. working, 50 mfd., 50v., 200 mfd., 10v., 3/3; 50 mfd., 15v., and 15 mfd., 100v., 2/3; 50 mfd., 12v., 2/-.

TCC type "M" condensers, any value up to .001 mfd., 6d. Erie resistances, 1 watt type, 7d., 2 watt, 1/2; 3 watt, 1/9. Send for comprehensive list.

CONVERSION Units for converting D.C. Receivers to A.C. Mains operations up to 100 watts, £2 each.

WARD, 46, Farringdon Street, London, E.C.4. Telephone: Holborn, 9703.

ALL goods previously advertised are standard lines, still available. Post card for lists free.

VAUXHALL UTILITIES, 163a, Strand, W.C.2. Over Denny's the Booksellers, Temple Bar 9338.

SOUTHERN RADIO'S WIRELESS BARGAINS. Thousands of Bargains at our Various Branches. ALL Goods advertised in previous issues of "Practical Wireless" can be supplied. All Goods Guaranteed and sent Post Paid.

See next week's "Practical Wireless" for full range of goods at specially reduced Summer Prices.

SOUTHERN RADIO, 323, Euston Road, London, N.W.1. (Near Warren St. Tube.) 'Phone Museum 6324.

BANKRUPT Bargains. List free. Alba S.G. 3v. B complete, 67/6. Lotus A.C. 4v. £4. Telsen 8v. A.C. superhets, £5/17/6. Corsor 3v S.G.-D.C., £4. Ampilion superhet radiograms, £13/10/0. Truphonic, Pilot, Ferguson allwave sets. Large stock valves, components. All goods new.—Butlin, 6, Stanford Avenue, Brighton.

WANTED, good modern radio sets, parts, etc.—spot cash paid; exchanges; bring or send.—University Radio, Ltd., 142, Drummond Street, Euston, London, N.W.1.

MISCELLANEOUS

5000 spring-motors, 6/-; Gramophones, 15/-; electric Pickup-motors, 38/-; for radiogram, plusgramms, pedestal anaxgramms, £5; sound-boxes, horns, tone-arms, cabinets, accessories, repairs, needles, cheapest, wholesale-retail. Catalogues free.—Regentam, 120, Old Street, London, E.C.1.

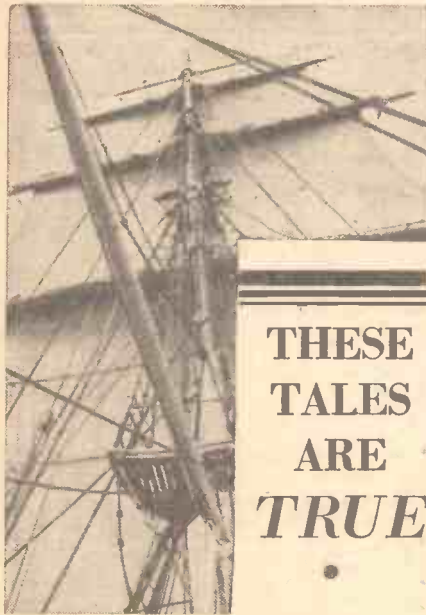

THESE
TALES
ARE
TRUE

Newnes
**WIDE WORLD
LIBRARY**

HERE is the most popular series of true-life travel and adventure books in existence, all classics of their type, now attractively published at a price within the reach of all. These tales are every bit as thrilling as the most ingenious fiction, and pulsing with drama on every page.

WIDE SEAS AND MANY LANDS

By ARTHUR MASON. A beautifully written tale of a rolling stone, who ran away from home, went to sea, and wandered the globe.

BLUE WATER

By A. S. HILDEBRAND. The experience of two men sailing around the world in a small cutter. A Classic of its type.

IM ALONE

By JACK RANDALL. Jack Randall, the skipper of the rum-runner, *I'm Alone*, which was sunk by a United States revenue cutter, describes his "rough-diamond" career.

MY TROPIC ISLE

By E. J. BANFIELD. A modern Robinson Crusoe, Banfield turned his back on civilisation, bought a "desert island" and settled down.

HORIZON

By KEN ATTWILL. Life in the fore-castle of a windjammer. **LAGOONED IN THE VIRGIN ISLANDS**

By H. B. EADIE. Adventures on a treasure island of buccaneer fame in a shark-infested Caribbean.

HARPOON

By HENRY FERGUSON. A first-hand narrative of a whaling expedition in the Antarctic.

A NORTH SEA DIARY, 1914-1918

By STEPHEN KING-HALL. A stirring and graphic account of the Navy in the Great War.

LOG OF A SHELLBACK

By H. F. FARMER. A thrilling tale of the Clipper Ships.

Each
2/6
net



Make
"Wide
World"
books a
reading
habit

From all Libraries and Bookshops
NEWNES

**NEW RECEIVERS, COMPONENTS
AND ACCESSORIES**

VALVES. By well-known manufacturer. Complete range of Battery, A.C. Mains, Rectifiers, Brand new stock with six months' guarantee. 2 volt Detector 2/3, Power 2/9, Screen Grid, Pentode, H.F. Pentode 5/-. The following American type valves, fully guaranteed, at 5/6 each: No. 80, 42, 43, 57, 58, 77, 78, 6C6, 6D6, 25Y5, 25Z5. Write for other prices to: Dulc Electrical Co., Ltd., 7, Lizard Street, London, E.C.1.

HULBERT for Quality Surplus Speakers. All Music Lovers should write for List of amazing bargains. Prices from 8/6 brand new. Made by best known British maker.—Hulbert, 6, Conduit Street, W.1.

CLARION VALVES.—All brand new; battery types 2-volt, H.2, H.L.2. L.P.2, 1/9; super power, P.2, 2/6; screens and L.F. pentodes, 3/9; A.C. mains, 4-volt, 1-amp., general purpose, 3/8; power 4/-; screens and L.F. pentodes, 4/6; full wave rectifiers, 3/6; postage paid, cash with order, or C.O.D. over 10/-.—Clarion Valves, Dept. 2, 885, Tyburn Road, Erdington, Birmingham.

MISCELLANEOUS

REPAIRS to Moving Coil Speakers, Cones and Coils fitted or rewound. Fields altered. Prices Quoted including Eliminators. Loud-speakers Repaired, 4/-. L.F. and Speech Transformers, 4/- Post Free. Trade invited. Guaranteed. Satisfaction. Prompt Service. Estimates Free. L.S. Repair Service, 5, Balham Grove, London, S.W.12. Battersea 1321.

RADIO AND ENGINEERING SUPPLIES.

SPECIAL OFFER OF SHORTWAVE components for 2 weeks only.

SHORTWAVE condensers 0.0001, 0.00015, 0.0002, 0.00025, 0.0003, 0.0005 with slow and fast drive, 2/-; 2-piece dial, 6d. As above, all brass, with knob and pointer 0001, 00015, 2/8; 0002, 00025, 3/3.

ULTRA Shortwave Condensers, stealan end plates, silver coated brass vanes, .00015 to .00016, 2/6.

SHORTWAVE coils, 13/22 metres, 20/44 metres, 40/90, 4-pin or 6-pin type, 2/- each. Set of three, 5/9.

CHOKES Shortwave H.F. Superior low-loss 10-100 metres, 5d.

VALVE HOLDERS, Clix Chassis mounting, 4-5 pin, 3d.; 7-pin, 4d.

ERIE resistances, 1 watt type, all values, 4d.

Postage extra on all the above.

RADIO AND ENGINEERING SUPPLIES, 88, Edgware Road, London. Phone: Pad. 6652.

EASY TERMS

EVERYTHING RADIO supplied on the lowest terms. Send list of requirements for quotation by return. Prompt delivery. Cash and C.O.D. Orders Despatched by Return.

W.B. STENTORIAN UNITS

36.S Cash Price £2/2/0, or 2/6 WITH ORDER and 11 monthly payments of 4/-.

36.J Cash Price £1/12/6, or 2/6 WITH ORDER and 11 monthly payments of 3/-.

VALVES

MULLARD, COSSOR OR MARCONI S.G., DET. AND POWER

Cash Price £1/5/0, or 5/- with order and 5 monthly payments of 4/6. All Types Supplied. ALL CARRIAGE PAID.

Est. 1925 THE NATIONAL 1977

LONDON RADIO SUPPLY COMPANY

11 OAT LANE NOBLE STREET LONDON E.C.2

EASY PAYMENTS

"THERE'S NO PLACE LIKE HOLMES."

	Deposit	Monthly Payments.
W.B. SENIOR	42/-	4/7 9 of 4/7
W.B. JUNIOR	32/6	4/5 7 of 4/5
BLUE SPOT SENIOR	29/6	4/- 7 of 4/1
ROLA F.720	35/-	3/10 9 of 3/10

Any make of speaker supplied.

GRAHAM-FARISH SENSITY

SUPER 50/- 4/7 11 of 4/7

GRAHAM - FARISH ALL WAVE KITS .. 57/6 5/3 11 of 5/3

SPECIAL.—G.E.C. universal mains A.C. or D.C. with M.C. Speaker, complete with valves in cabinet. List price, £6 10s. Our price, 2/8 deposit and 11 payments of 7/8.

PARTS FOR ANY SET. ANY MAKE OF SPEAKER. New goods obtained for every order.

Send us a list of parts or valves you require or any speaker or set you may select and we will forward you a definite quotation. Ten years' advertiser in the Wireless Press. Thousands of satisfied customers.

H. W. HOLMES,
New Address:—333, EUSTON ROAD, LONDON, N.W.1.
Phone: Museum 1414.

ELECTRADIX

Your voice amplified from your radio set to loudspeaker.



5/- BUTTON MICROPHONES for all purposes. Usually sold at 3/6. Our price has always been 1/-! We have supplied thousands.

***N.W.' NO. 11 TABLE MIKE.** This is a splendid Microphone for speech and music. The bakelite case, containing a 2in. mike and transformer, is on a bronze pedestal, detachable for sling. Switch and plug fitted. Unrivalled for quality and price, 15/-.

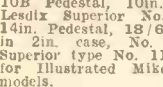

Other types: Lesdix No. 10B Pedestal, 10in. high, 12/6; Lesdix Superior No. 12BB Ring, 14in. Pedestal, 18/6. Hand Mikes in 2in. case, No. 11 at 5/6; Superior type No. 11A, 7/6. Ask for Illustrated Mike List of 25 models.

Our Public Address Eisels-Reiss Transverse Current Microphones are far superior, and all the best judges use them. Only 55/-.

High-grade Stand, as illustrated, 15/- extra.

HEADPHONES for short-wave work, 2,000 or 4,000 ohms, 4/6.

WESTON TABLE TEST SETS in unused condition, Model 301, M.C. Weston Voltmeter, 0-30, flush ebonite panel on table brackets, five terminals and test key. Great Bargain at 18/6 to clear; limited number.



FORMO .0005 Varia. Condensers, 3 for 4/6.

A BARGAIN IN DYNAMOS. Type "C." Our latest for Bungalow, Yacht or Cell Charging, 140-watt Enclosed Dynamo, 12/20 v., 12 amps. Ball Bearings, Vee Pulley, 25/-.

Machine Type Switchboard with Ammeter, maximum and minimum Auto Cutout Mains Switch and Fuses, Field Regulator, 25/- or 47/6 the pair (as illustrated).

Do write for our Free Illustrated Green Bargain List "N." It will save you a lot of money.

47/6 (as illus.)

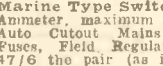

ELECTRADIX RADIOS

218, UPPER THAMES ST., LONDON, E.C.4
Telephone: Central 4611

Add 50/- WEEKLY to your earnings

Charge accumulators in your spare time. Complete Charger, incorporating Westinghouse Metal Rectifiers. Will charge 84 accumulators weekly. Price £4 : 4 : 0 or 8/- monthly. Send for full particulars. M.P.R. ELECTRICAL CO., 252, Victoria Rd., Romford, Essex.



ENGINEERS! ARE YOU EARNING LESS THAN £10 PER WEEK?

If so, you cannot afford to carry on without reading our 268-page Handbook. The book explains clearly and definitely many ways of carving out a successful career. Among other things it explains the Services of our unique Appointments Department, outlines Home-study Courses in all branches of Civil, Mechanical, Electrical, Motor, Aero, Wireless, "Talkie," Engineering, Building, Govt. Employment, etc., and gives details of B.Sc., A.M.I.C.E., A.M.I.E.E., A.M.I.Mech.E., A.M.I.A.E., A.M.I.W.T., A.M.I.R.E., G.P.O., MATRIC., and all Exams. We Guarantee—"NO PASS—NO FEE." Whether you be an old hand or a budding apprentice, get this book to-day—FREE and POST FREE. BRITISH INSTITUTE OF ENGINEERING TECHNOLOGY. 409, Shakespeare House, 17/19, Stratford Place, London, W.1.



FREE ADVICE BUREAU COUPON

This coupon is available until June 13, 1936, and must be attached to all letters containing queries. PRACTICAL AND AMATEUR WIRELESS, 6/8/36.



The HINDENBURG'S TRANS-ATLANTIC FLIGHT

COME aboard the *Hindenburg*—the giant Zeppelin that has made such quick work of the Trans-atlantic crossing. Be with the engineers, the crew, and the passengers in the monster airship as it traverses the space between Europe and America. The secrets of the vessel are laid bare in a special article in this month's "PRACTICAL MECHANICS," the Magazine of Modern Marvels.

Other Contents of the June "PRACTICAL MECHANICS"

A Petrol-driven Low-wing Monoplane.

How the Suez Canal was Built.

Working Model Steam Engines.

The Post Office Speaking Clock.

Model Aero Topics.

The Mystery of Egypt's Mighty Monuments.

The Latest in Railway Modelling.

The "Easy to Build Three" Receiver.

Constructional Details of the £20 Car, etc.

THE JUNE

PRACTICAL MECHANICS

Now On Sale at All Newsagents and Bookstalls

George Newnes, Ltd.

CAMERA 5
P. Wireless

Published every Wednesday by GEORGE NEWNES, LTD., 8-11, Southampton Street, Strand, London, W.C.2. and Printed in Great Britain by NEWNES & PEARSON PRINTING CO., LTD., Exmoor Street, London, W.10. Sole agents for Australia and New Zealand: GORDON & GOTCH, LTD. South Africa: CENTRAL NEWS AGENCY, LTD. *Practical and Amateur Wireless* can be sent to any part of the world, post free, for 17s. 8d. per annum: six months, 8s. 10d. Registered at the General Post Office as a newspaper and for the Canadian Magazine Post.