

Weeks

A NEW DIAL LIGHTING METHOD — See Page 207

Practical and Amateur Wireless

3rd
EVERY
WEDNESDAY

Edited by F.J. CAMM

"GEORGE
NEWNES
Publication

Vol. 8, No. 190,
May 9th, 1936.

AND PRACTICAL TELEVISION

*Still
Smaller*
PORTABLES



1936 SUPER-TERRITORIAN

Can there be a better speaker? asks Mr. Camm

ADVT.

Half Price!

GREAT CAMERA OFFER *Only 2/10* AND TWO COUPONS

Takes Pictures 3 1/2" x 2 1/2". The most popular size.



Spool of Film FREE

Here is a splendid Presentation Camera for you **AT LESS THAN HALF ITS REAL VALUE**, and a roll of film, **ABSOLUTELY FREE!**

The offer is open to all Readers and members of their families. The Camera has been specially made in Great Britain, and is *definitely guaranteed to produce Splendid Pictures*. It is fitted with an Instantaneous Shutter to give snapshots, also a Special Attachment for making Time Exposures. So simple is the Camera to operate that a child can take successful photos.

The Camera is covered with black leatherette. It has a real leather handle, two brilliant view finders, nickel-plated silent winder, and British-made Meniscus lens.

Post the form to-day, and you will have this wonderful Camera and free roll of film in your possession before Whitsun—sure of a happy, picture-making holiday!

GIVE YOUR CHILD THIS CAMERA —LET HIM SNAP THE FAMILY

HOW TO SECURE YOUR CAMERA AND FREE ROLL FILM

Fill up the Reservation Form on left and post at once to the address given on it.

When we receive the Reservation Form from you we will immediately reserve in your name one Camera and Free Spool of Film, and a Special Instruction Booklet.

On the back cover at foot of this number of "Practical and Amateur Wireless" you will find a Gift Token marked "Camera I." Cut this out and keep it by you until next week, when No. 2 will appear.

To claim your reserved Camera and Free Roll Film, and Instruction Booklet, you send these two Gift Tokens, together with your postal order for only 2s. 10d. The price includes packing, carriage, and delivery.

Your Camera, etc., will then be despatched, and should be in your hands within ten days of receipt of your postal order.

This offer applies to persons residing in Great Britain and Northern Ireland: Readers in the Irish Free State must pay any duty imposed.

Post this Reservation Form **IMMEDIATELY** to:
PRACTICAL AND AMATEUR WIRELESS
 (CAMERA DEPT.), 8/11, Southampton Street, Strand, London, W.C.2

In accordance with the conditions of your special Half-Price Offer, please reserve a Camera and Free Roll of Film in my name. (Please write in Block Letters.)

Reader's Name.....

Full Address.....

Leave Blank

Post this form in an unsealed envelope (4d. stamp only required).

ROUND the WORLD of WIRELESS (Contd.)

For Amusement Only

JOHN LAMPSON has prepared a programme entitled "For Amusement Only," which he will present from West Regional on May 14th, with Lillian Keyes (soprano), the West Country Chorus, and the Clifton Light Orchestra (conducted by J. Leslie Bridgmont) as the artists. The programme will be divided into three sections, each consisting of a game. The first is described as "An Enigmatical Essay," the second is a crossword puzzle and the third a pot-pourri of songs from films and musical comedies in which listeners will be invited to guess the show from which the numbers are taken.

A Futurist Band

"**WESTERN Cabaret**" No. 7 will come from the Grand Atlantic Hotel, Weston-super-Mare, on May 16th, when listeners will hear Reginald Williams' Futurists Band.

North Stars Shine Again

IF the B.B.C.'s postbag may be relied upon to indicate the tastes of listeners, there is not the slightest doubt that Violet Davidson and her Concert Party have provided acceptable entertainment. On May 16th she will present in the Northern programme a programme of "Further Reminiscences of the Old Beach Pavilion, Aberdeen," now so happily presided over by Harry Gordon.

A Burlesque in Rhyme: Midland Programme on May 13th

MARTYN WEBSTER is to produce another of Moore Raymond's burlesques in rhyme in the Midland programme on May 13th. The first one was "The Marmalade Mystery." An explorer, named Plantagenet McFortescue, is the hero of the new one, "The Belle of Boopadoo." He was disappointed with the jungle domain, which he had hoped to civilise, for did not the King Umbopo answer his salutation with the words "Nerts! and the same to you!" However, he solaced himself by falling in love with the King's ex-governess, Maisie Smith, of Golder's Green. By way of interlude, there is a capital scene between Umbopo and a hat salesman. John Morley has written the music, and he and Valerie Larg will take the parts of the two narrators. Reginald Burston is to conduct the Revue Orchestra and B.B.C. Midland Chorus.

Fishing Talks

FROM time to time it is hoped to include "Fishing Talks" in the Welsh summer programmes. The first one comes on May 6th, when D. O. Thomas will speak about "Fishing on the Towy." D. O. Thomas is a member of the Board of Conservators for the Towy Fisheries District, and he will give a graphic description of hooking and playing a salmon. From source to mouth the Towy is a succession of pools and shallows which contain coarse fish—trout, sewin and salmon. Its course lies through the most beautiful country, and the well-wooded

INTERESTING and TOPICAL PARAGRAPHS

banks and the numerous castles, some in a fair state of preservation, add to the delight of the anglers.

A CHASSIS-STAMPING MACHINE

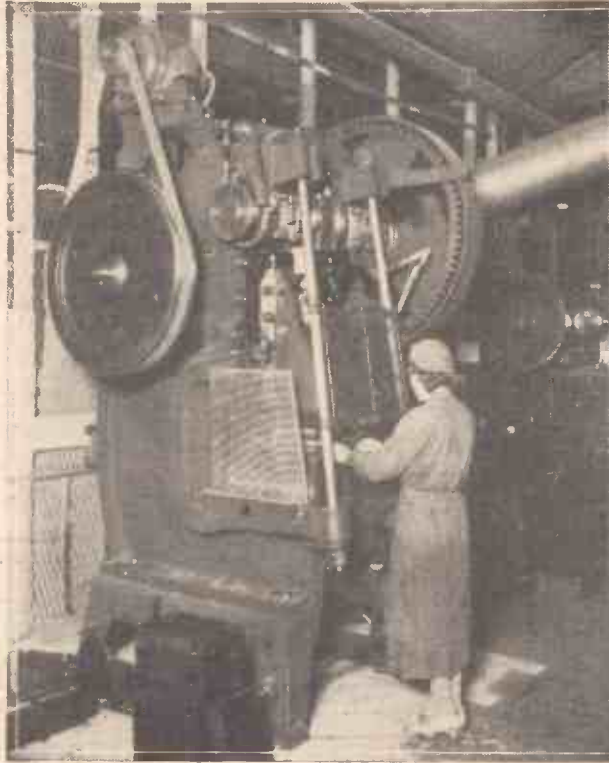

This powerful press transforms sheets of metal into chassis at one blow. It is installed at the Southend works of Messrs. E. K. Cole Ltd.

SOLVE THIS!

Problem No. 190

Robinson had an A.C./D.C. receiver supplied from A.C. mains which hummed excessively. He was told that this could be remedied by connecting a fixed condenser across the heater circuit. He obtained a 4 mf. condenser and connected it between the heater end of the heater dropping resistance and H.T.—This certainly reduced the hum, but also caused a reduction of signal strength and after a while the heater dropping resistance became overheated. He removed the condenser and tested it, but found it to be in order. What was the reason for the overheating and loss of volume? Three books will be awarded for the first three correct solutions opened. Address your letters to the Editor, PRACTICAL AND AMATEUR WIRELESS, George Newnes, Ltd., 8-11, Southampton St., Strand, London, W.C.2. Envelopes must be marked Problem No. 190 in the left-hand corner, and must be posted to reach this office not later than the first post Monday, May 11th, 1936.

Solution to Problem No. 189.

H.F. oscillation was occurring in Ellis's receiver owing to inadequate screening of the H.F. components. It is difficult to provide sufficiently effective screening when an efficient H.F. pentode is used, however, and the best remedy is to provide a grid bias volume control so that the efficiency of the first valve can be controlled. The following three readers successfully solved Problem No. 188, and books are accordingly being forwarded to them:—H. G. Trimble, Church Hill, Holywood, Belfast; S. P. Hill, 35, Bewardly Rd., Stourport-in-Severn, Worcs.; W. E. Birmingham, 53, Queens Rd., Wimbledon, S.W.19.

Edinburgh Trades Silver Band

SEVEN years ago two trades band enthusiasts, J. Fairley and Mark Ormiston, set about the raising of a band in the Canongate, Edinburgh. They got the men they wanted, but how could they raise funds to buy instruments? They heard that a complete set belonging to a band which had ceased to exist could be had and a business man in the Canongate agreed to advance a loan. A hall was secured and practice began in good earnest. The Edinburgh Trades Band needed a considerable amount of practice, but hard work and able supervision worked wonders. In their spare moments the bandmen transformed an old, uninhabitable place into suitable and even beautiful premises. The band possesses three trophies, won at the Border League Contests, and is confident of adding to the number in the near future. They will be heard on May 9th from the Scottish transmitter.

A Baseball Commentary

FOR the first time on record a commentary on a baseball match will be given to British listeners from the National transmitters on May 23rd. The match is between White City and West Ham, and will be played at the White City. Mr. Robert Bowman, who will be remembered for his vivid description of an ice hockey match at Garmisch during the Olympic Winter Games, will be the commentator. Baseball is becoming increasingly popular in this country, and there is now a big baseball league in existence in the London district. Most of the players are Canadians or Americans temporarily resident in England, but the crowds who flock to watch them are English. On the Saturday before the match, May 16th, the sports talk in the National programme will be devoted to baseball, which will provide listeners who know nothing of the game with the opportunity of repairing this gap in their athletic education in time to take an intelligent interest in what is certain to be a brilliantly swift and "racy" commentary. It looks as if the days are numbered when baseball will be described by people in this country as a "kind of rounders."

Vauxhall Gardens

VAUXHALL in the days of the two-horse carriage and the sedan chair was one of London's most fashionable quarters. The lovely houses still remain, now peopled by thousands of South Londoners. The B.B.C. Variety Director has decided to make Vauxhall Gardens the setting of a story and bring to life the atmosphere and tempo of that more spacious age, when silks and satins, conveyed by sedan chairs to the lovely gardens of Vauxhall, gave life and gaiety and a charming atmosphere to that romantic neighbourhood. Such a background offers to broadcasting a rich environment, for there is available both prose and poetry. With the B.B.C. Theatre Orchestra and many artists suited to this theme, Vauxhall Gardens will live again during the summer programmes.

The "Elf" Midget Portable Three

FREE BLUEPRINT NEXT WEEK!

EACH year since this journal commenced publication I have produced a portable receiver and issued a Free Gift Blueprint of it. You will notice that each of these receivers is smaller than the one which preceded it, and each of them has become lighter, cheaper to make, simpler to build, and yet has maintained a high standard of performance. Outstanding portables in this series have been the Featherweight, the Atom, and the Cameo. Next week I shall introduce you to my "Elf," which name is intended to convey some idea of its Lilliputian proportions and low weight. A few years ago the term "portable" was a decided misnomer, for you needed to be something of a Hercules in order to yank them even a few inches, and their size was truly Brobdingnagian. They were not even transportable. Manufacturers were chiefly to blame for this, since for many years they refused to make small components. It was chiefly due to the lead I took on this question that eventually we were supplied with small valveholders, small tuning coils, small variable condensers and valves, transformers, resistances, and so on. There is no particular merit about size, and the public have long ceased to be deluded by the big-bag-of-sweets-for-a-penny idea. You could not charge 16s. 6d. a few years ago for, say, a transformer unless you gave a man a handful of transformer. Actually there is no need for him to have more than a waistcoat-pocketful.

Since I produced my last portable, interest in portable radio has grown, commensurately with the increase in hiking, cycling, motor-cycling, camping and caravanning. Weight is an important factor. A cyclist, for example, likes to expend his ergs in propelling his vehicle, and likes as little bicycle as possible. He does not want to perspire by carrying a heavy wireless case in his saddle-bag. He wants a receiver which will work with a most inefficient aerial and earth, and which will give him a fair number of stations on medium and long-wave bands. He does not expect to get Timbuctoo or any other of the remoter transmissions. If he does the Elf is not for him. So many constructors expect too much from a portable. You do not select an Austin Seven in order to beat Sir Malcolm Campbell's *Bluebird*. The former is intended for general utility, whilst the latter is specially constructed purely for the purposes of speed. The Elf is a special-purpose receiver

made specially light so that even a hiker would scarcely notice that he was carrying it. It is small in size and conveniently carried by the cyclist. It will tuck into a corner of your suitcase and help you to wile away the lazy hours at the seaside, and to enjoy the programmes in the room of your hotel. Its batteries are midget but adequate for the receiver. Its cheapness will be apparent from the advertisements in the next issue, whilst an inspection of the blueprint next week will indicate that a school-boy could make it.

Notwithstanding its small size, it yet acquits itself well on the score of efficiency and the number of stations received. About a dozen stations are easily receivable on the medium-wave band, and three on the long-wave band. The reception is such that it will easily operate a small moving-coil loud-speaker, although for some purposes readers may elect to use headphones.

By F. J. CAMM



Here are previous portables from our laboratories. On the right is the Atom—How will the Elf compare with these?

The Circuit

And now, for those fans who must indeed know the very intimate details of the make-up of a receiver, some facts on the circuit will not be out of place. There is nothing unusual in the general arrangement, and, as I have repeatedly pointed out, the old and trusty three-valve combination of H.F., detector and output stage wants a great deal of beating. It may be regarded as the keystone upon which all receivers are fashioned, and although it cannot be claimed that it is the last word in either sensitivity or selectivity, it does give a remarkably good performance and speaks well for itself under practically all conditions. Two tuned circuits can be used with this arrangement, and in this new portable I have employed two newly-designed coils which are extremely small and are mounted on a switch assembly, the complete coil-switch arrangement then being smaller than a standard single screened tuning coil.

In spite of the fact that size and weight had to be kept well down, I have been enabled to employ transformer coupling between the detector and output stages, a miniature component designed by Messrs. Bulgin being employed for the purpose. It may be taken as a matter of course that I should use the Midget valves which have been produced by Hivac, and these small valves and components are adequately backed up by a miniature accumulator, H.T. and G.B. battery from the Exide range. Full constructional details and the Free Blue Print will be given next week.

COMPONENT LIST FOR THE "ELF"

Special Coil Assembly	B.T.S.
Two .0005 mfd. condensers, type Compax	Polar
One .0003 mfd. condenser, type Differential	Polar
Three fixed condensers, type Tubular—two .1 mfd., one .0001 mfd.	T.M.C.
Three fixed resistances—one 1 meg., one 15,000 ohms, one 5,000 ohms (1 watt rating)	Dublrier
One L.F. transformer, type L.F.33	Bulgin
Three valve-holders, type Midget—one 5-pin, two 4-pin	Clix
Two plugs—G.B., G.B.—	Belling Lee
One component bracket	Peto-Scott
One special chassis	Peto-Scott
Three valves—One XSG, one XL, one XY	Hivac
One 60-volt battery, type X418	Drydex
One 4½-volt battery, type X89	Drydex
One 2-volt accumulator, type Gel-Cel PRP3	Exide
One speaker	W.B.
One pair headphones	Eriesson

Points About Condenser Calculations

By the Use of the Tables Compiled in this Article many Tedious Condenser Calculations will be Avoided ——— By H. BEAT HEAVYCHURCH

CHOICE of the capacity of fixed condensers in a wireless circuit, though usually not very critical, has to be made with due regard to the function which each condenser has to perform and to the values of the other components with which it is associated. This usually means a small amount of calculation—not of a very elaborate nature—since some very useful rules of thumb have been evolved to simplify these calculations to the lowest terms.

Before dealing with some of these simple rules there are one or two types of calculation which every constructor has to perform on occasion, and which can be further simplified for him in ways to be described. For example, having ascertained that a fixed condenser of a particular capacity is required in a certain position, the constructor may find that he has not just the right size in his possession. If, however, he happens to have a selection of other sizes at hand, it is quite possible that he may be able to make up the required capacity by using two or more condensers of smaller or even larger value.

Combinations

In the case where the condensers available are smaller than the required capacity, all that is necessary is to select two or more condensers whose combined capacities when added together make up the total required, and to connect them all in parallel. For example, a 2 mfd. bypass condenser could be made up of two 1 mfd. condensers in parallel.

But supposing all the condensers available are larger than the desired value—how can a smaller capacity be made up? The answer is, by connecting two or more condensers in series, and it is here that the first small calculations are necessary. The actual formula for finding the capacity of two condensers in series is to multiply the two values together and to divide the result by their sum, and for three condensers the calculation, though no more difficult, is a little more complicated. Moreover, since in order to obtain the desired value it may be necessary to work out the capacities of several different combinations and select the nearest to the required value, the process becomes a little more tedious.

CAPACITY (mfd.)	REACTANCE (ohms) (approx.)	
	at 50 cycles.	at 100 cycles.
.25	13,000	6,500
.5	6,500	3,250
1.0	3,250	1,600
2.0	1,600	800
4.0	800	400
8.0	400	200
12.0	250	120
25.0	120	60
60.0	50	25

A Helpful Table

The attached Table (1), however, reduces the amount of calculation very considerably. It consists of two columns, the first of which is headed "Capacity in mfd." and the second "Reciprocal." To find the capacity of any combination of condensers in series it is first of all necessary to write down the

CAPACITY IN MFD.	RECIPROCAL.
.001	10,000
.0015	6,666
.002	5,000
.0025	4,000
.003	3,333
.004	2,500
.005	2,000
.006	1,666
.01	1,000
.015	666
.02	500
.025	400
.03	333
.04	250
.05	200
.06	166
.1	100
.2	50
.5	20
1	10
2	5
25	4
5	2

number in the "Reciprocal" column corresponding to each of the condensers. These numbers must then be added together, after which the combined capacity will be found in the first column opposite the number in the "Reciprocal" column corresponding to the sum of the reciprocals already obtained.

For example, suppose that two condensers, each of .01 mfd., are connected in series.

GRID LEAK (megohms)	COUPLING CONDENSER (mfd.)
1.0	.006
0.5	.012
0.25	.024
0.1	.06

The reciprocal of .01 from the Table is 100, and as there are two such condensers we must add another 100, giving a total of 200. The capacity in Column 1 corresponding to 200 in the "Reciprocal" column is .005 mfd.

It will probably happen that when the sum of the reciprocals has been obtained it will be found that there is no number in the "Reciprocal" column exactly corresponding to this figure, but in these circumstances the nearest figure must be taken. This does not very much matter for, as already explained, the values of fixed condensers in wireless circuits are seldom very critical. For example, a .01 and a .02 mfd. condenser in series correspond to reciprocals of 100 and 50 respectively; these two numbers added together give 150. The nearest to this in Column 2 is 166, and this

CAPACITY (mfd.)	REACTANCE (ohms) (approx.)	
	at 50 cycles.	at 1,000 cycles.
.001	3,250,000	160,000
.002	1,600,000	80,000
.003	1,100,000	50,000
.004	800,000	40,000
.005	650,000	32,500
.006	500,000	25,000
.01	325,000	16,000
.02	160,000	8,000
.05	65,000	3,250
.1	32,500	1,600

corresponds with a condenser of .006. Therefore, a condenser of .01 mfd. in series with a condenser of .02 mfd. can be considered as approximately the equivalent of a .006 mfd. condenser, although, if the value were worked out mathematically, their actual capacity would be .0066. The error is only about 10 per cent., which is of the same order as the manufacturing tolerance of these small condensers.

Coupling Condensers

We now come to cases in which a little calculation is required to arrive at the best value for a fixed condenser. This usually occurs in connection with the coupling condenser in a resistance-capacity amplifier. A full discussion of the factors governing the design of such couplings is outside the scope of the present article, and in any case they have been dealt with before in these columns, and it must suffice to remark that the liability to pass the lower audio-frequencies without serious bass attenuation suggests a fairly large capacity, while an upper limit is set by the necessity of avoiding choking the grid circuit due to the inability of the grid leak to discharge the coupling condenser rapidly enough.

There is a fairly generally accepted rule of thumb governing the size of such a condenser. Briefly stated, it is that the capacity of the coupling condenser in microfarads, multiplied by the resistance of the grid leak in megohms, should not be less than .006, and it may also be added that the grid leak should not be less than four times the value of the anode load of the preceding valve and not greater than .5 megohm, or such lower value as may be recommended by the valve-maker. (See Table 2.)

According to this formula, therefore, the correct size of condenser for use with a .25 megohm grid leak would be .024 mfd. as a minimum, but in actual practice a rather larger value would be chosen, such as the standard .05 mfd. component.

Bypass Condensers

The next case is that of the bypass condensers in smoothing and decoupling circuits and for automatic grid-bias arrangements. The requirement is that the condensers shall have a low reactance to the frequencies it is desired to bypass, compared with the impedance to those frequencies offered by the smoothing choke or decoupling resis-

(Concluded on page 215).

CAPACITY (mfd.)	REACTANCE (ohms)	
	at 1,000 kc.	at 200 kc.
.0001	1,600	8,000
.0002	800	4,000
.0003	500	2,500
.0004	400	2,000
.0005	300	1,500
.001	160	800
.002	80	400
.003	50	250
.004	40	200
.005	30	150
.01	16	80

Short-Wave Coil Data

Winding Details and Standard Pin Connections for Short-Wave Coils for Use in Standard Circuits.
By W. J. DELANEY

WE have now studied the requirements of the ordinary type of short-wave coil, and it will have been apparent that where a receiver is intended to cover a number of wave-bands it is preferable to utilise plug-in coils. This does not indicate that the multi-range coil is inefficient, but merely that its purpose is limited and obviously for those to whom it is not so important to have every conceivable waveband available, a multi-range coil will suffice. However, the experimenter prefers to be able to adapt the receiver as he desires and thus will use a coil which may be changed at will, and for the constructor who does not want too much complication in the actual building of the receiver, the same type of coil will appeal on account of the omission of switching arrangements. The more standard plug-in coils which are now in use employ either 4 or 6 pins on the base.

of two windings only, and these may be employed as grid and reaction, or as an H.F. transformer. The remaining type of coil utilises three windings and these provide the same arrangement as in the 4-pin coil, with the addition of a winding which may serve as primary or reaction as desired. The circuit was given last week, and the standard pin connections are shown in Figs. 1 and 2.

Winding Your Own Coils!

For those who wish to wind their own coils one of the plain coil formers should be obtained from B.T.S., Eddystone, or

as there are considerable modifications due to stray capacities. Furthermore, the minimum wavelength of a given coil will be governed by the minimum capacity of the tuning condenser, and thus the better the condenser the lower will be the minimum wavelength. The three coils may be wound to cover from 11 to 25 metres, from 22 to 47 metres and from 45 to 100 metres. A slight overlap on each coil will ensure that the total range is covered without any dead areas, and the following table gives the number of turns for these three coils, for both primary and secondary. The coil formers are, of course, fitted with 4 pins, and the type which is provided with threaded ribs should be selected in order that the turns of wire may be spaced and kept firmly in position.

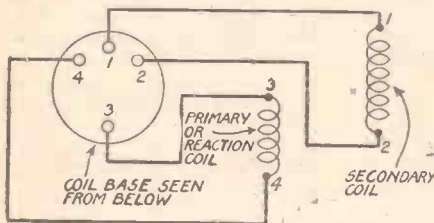

Fig. 1.—The connections for the standard 4-pin coil.

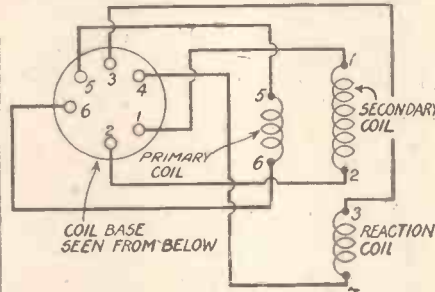

Fig. 2.—Connections for the standard 6-pin coil.

In some cases a 7-pin base is adopted, but only 6 pins are connected. The latter type of coil may be plugged into a standard 7-pin valveholder, whilst the 4-pin coil may be used in conjunction with a 4-pin valveholder. The 6-pin coil requires a special 6-pin coil base, and these are obtainable from B.T.S., Eddystone, and other makers of short-wave apparatus. The 4-pin type of coil generally consists

Raymart, and these will be found to have an overall diameter (over the ribs) of approximately 1 1/2 ins. The most useful short-wave ranges may be said to extend from 10 to 100 metres, and this range may be covered by means of a short-wave tuning condenser having a maximum capacity of .00015 or .00016 mfd. and a set of three coils. It must be emphasised that wavelengths can only be given approximately

Four-pin Coils

	Secondary	Primary
Coil 1 ..	4 turns	2 turns
Coil 2 ..	8 turns	5 turns
Coil 3 ..	25 turns	9 turns

The wire used for Coils 1 and 2 and for the secondary of Coil 3 should be 22 gauge, either tinned or enamelled. In order to accommodate the total winding for Coil 3, the primary may be wound with a much finer gauge, and a slot should be cut at the lower end of the former into which the turns are wound. In each case the

(Continued overleaf)

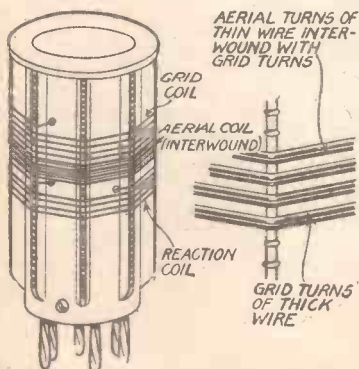

Fig. 3.—Diagrams showing how the ends of the coils are passed through for anchoring and how the aerial coil is interwound.

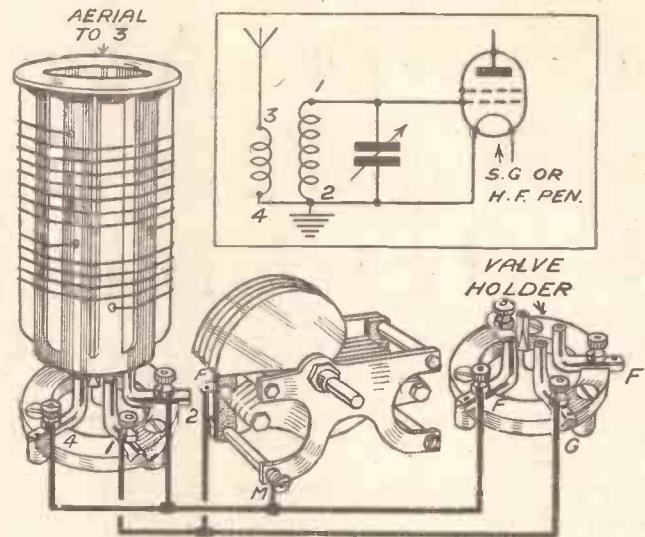

Fig. 4.—Arrangement of the 4-pin coil in the aerial circuit.

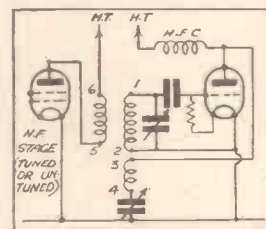

Fig. 5.—A 6-pin coil used as an H.F. transformer with reaction.

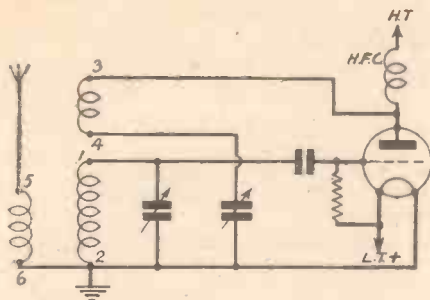

Fig. 5.—The 6-pin coil used in a simple detector stage, with reaction.

(Continued from previous page)

earthed end of the secondary is nearest the pins, and the primary is not joined to the secondary at all. By this means it may be employed with a reaction condenser earthed direct, or may be used for an aerial coupling coil or as the primary in an H.F. valve anode circuit, without difficulty.

Seven-pin Coils

To accommodate a further winding in order that a complete H.F. transformer with reaction may be employed, a fine gauge covered wire will have to be obtained, and No. 28 should prove quite suitable. This should be interwound with the lower turns of the secondary winding and should normally be employed as the primary, with the reaction winding as given for the 4-pin coils. Exactly the same number of turns may be employed. It is, however, quite possible to interchange these two windings, and experiments may be conducted with each receiver to find the most suitable combination.

	Secondary	Primary	Reaction
Coil 1	4 turns	2 turns	2 turns
Coil 2	8 turns	5 turns	5 turns
Coil 3	25 turns	9 turns	9 turns

The standard connections are given in Figs. 3, 4, 5 and 6, which show the use of the 4 and of the 7-pin coils in the most common types of circuit.

The ends of each winding should be passed through a small hole drilled in the former and then threaded down through the pins, which are hollow and are provided with a hole at the extremity. If enamelled wire is used, the enamel should be scraped off and the wire then soldered neatly on the

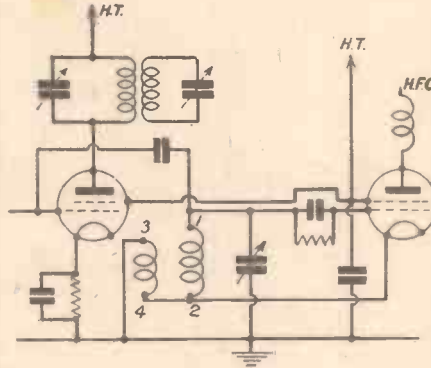

Fig. 6.—The 4-pin coil used in an electron-coupled oscillator circuit.

point of the pin. The surplus is then cut off. Between the two windings a small space should be left, and in most cases it will be found that one space as indicated by the grooves on the ribs will be found most suitable. It will often pay the experimenter, however, to carry out a few tests with a view to finding the best arrangement for his individual circuit and his aerial-earth system. The same thing applies to the actual size of the primary (or coupling) winding. When used in the aerial circuit, for instance, it may often prove worth while to ignore this winding and to connect the aerial through a fixed or pre-set condenser to the "top" of the secondary winding, but by making the coils as here described more or less

standard components will be obtained which will form the basis for experiment and the design of a good short-wave receiver.

Marking the Coils

The coils should, of course, be identified so that they may be readily selected when a change in wavelength is required, and if the numbers 1, 2 and 3 above given are kept in mind it will suffice to scratch or paint these numbers on the top of the coil former. If, however, the Raymatt coil formers are obtained it will be found that there is a groove or recess in the top of the former and a disc of cardboard may be cut to fit into this groove. This may then be marked with the actual wavelengths which the coil is found to cover after it has been tested, and it will form a permanent record. The disc should be 1 1/8 in. in diameter.

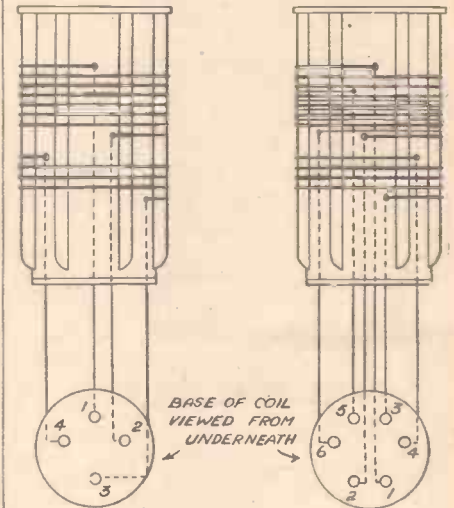

Fig. 7.—Diagram showing connections and coil arrangement of the 4- and 6-pin coils.

PROGRAMME NOTES

A Cycling Tour

WILLIAM OAKLEY, a Councillor of the C.T.C. and cycling correspondent of two evening papers in the Midlands, is to give a series of weekly talks entitled "New Country," commencing from the Midland station on May 6th. He will describe some adventurous Midland routes. In the first, "Cycling Across the Berwyns," the track from Llanarmon to the Bala Valley is for some miles between 1,000 and 2,000 feet above sea level. Mr. Oakley has ridden in Normandy, Belgium, and the Black Forest, as well as during the War in Italy, Corfu, and Macedonia. His favourite British county for cycling is Shropshire. He took a leading part in the post-War expansion of the C.T.C. in Birmingham and district.

A Midland Composer

FROM the same station and also on May 6th, the fourteenth Midland Chamber Concert will be given. This programme will consist of the works of William Alwyn. He was born in Northampton, and had his early musical studies there, receiving great help from the late Mr. Charles J. King, who did a great deal for Northampton musical life. He went to the Royal Academy of Music with a scholarship for flute-playing,



This illustration shows transformers in a rotary turntable, which is used for putting them through their many tests at the Ferranti works at Moston, Manchester.

studied composition under Sir John McEwen (now Principal), and later became Professor of Composition there. His work includes twelve quartets, five preludes for orchestra, a piano concerto and overture, and a number of songs. The preludes have been played at Proms, and the concerto and overture were recently broadcast from London. Birmingham Ladies' String Quartet will play his Quartet No. 10, *En Voyage*. It was written on a voyage from Auckland, New Zealand, via Panama, and is dedicated to "The Ship." Eveline Stevenson, the Birmingham soprano, will sing two groups of his songs.

Sydney Howard

THIS famous stage and screen comedian had decided to give listeners during the early part of May the benefit of his long experience, or rather thorough Lancashire upbringing, in the form of a series of household hints. The B.B.C. has for years struggled to inculcate better house-keeping. Unfortunately, Sydney Howard's witticisms or *bon mots* have caused engine trouble to the ship on which he is "cruising," forcing it to enter Capetown for repairs. He has wired the B.B.C. stating that Howard's contributions to domestic economy must necessarily be postponed, and that it is with his utter Lancashire regret that he will be unable to broadcast until the last week in May. Nevertheless, Sydney Howard's household talks should not be missed by the keen morning listeners.

A NEW SCALE LIGHTING METHOD

Some Details of a Novel Method of Employing a Dial Light to Provide Station Names in Relief

WE are all familiar with the attractive luminous effect of lift and other similar signs. By a cunning device the lettering is rendered so brilliantly illuminated compared with the background that it appears to glow of its own accord. Such an effect is very attractive when adapted to radio wavelength scales, but for several reasons it has not been practicable in the past. The original arrangement has certain disadvantages which render it unsuitable for large quantity production of radio sets, but a number of

change of speed, then there is no refraction of the light, so, providing the two materials are the same colour or colourless, they will appear as one, that is, homogeneous. This can be verified simply by observing a tumbler of water. The air-glass and the air-water surfaces are very apparent because of the large changes in light speed (33½ per cent. and 25 per cent. respectively). But the water-glass surface is only just apparent, for the change of speed of light passing from water to glass is only 11 per cent.

There is yet another effect to be noticed, which will be best understood by reference to Fig. 1. AD is the boundary between a block of glass and air. S is a source of light within the glass block. Rays of light emerge from S in all directions, of which four are shown. The first, SA, is perpendicular to the surface, and so passes out into the air undeflected. The second, SB, strikes the surface at an angle, and emerges into the air at a smaller angle to the surface. (Note that a ray of light can always be reversed in direction; so a ray EB will be bent when entering the glass to BS, which agrees with a statement made in a previous paragraph.)

As the angle between ray and surface is decreased, the point C will be reached at an angle of 48 degrees, such that, the emergent

etched deeply into the back surface. The etched letters may, if required, be filled with a coloured paint. The light source S is disposed along one edge and is shrouded as illustrated. The light from S enters the sheet of glass by the edge and will in all cases be nearly perpendicular to this edge. This is a limitation imposed by the relative dimensions of the lamp and thickness of the glass, which limitation means that but a small "pencil" of light is collected by the glass. Since the light enters the glass at nearly 90 degrees to the surface it will suffer but little refraction, and so will strike the back and front surfaces at a small angle, well below the critical angle of 48 degrees. Reflection, therefore, takes place at both these surfaces. Furthermore, since the two surfaces are parallel to one another, the reflected ray from the back surface, say, passes through the glass and strikes the front surface at the same angle and, therefore, suffers a second reflection. Hence the light travels to and fro throughout the length of the glass, as SMN. Where the back surface is etched, however, the light is dispersed in such a direction that it passes out of the upper surface. Deep etching is necessary to catch as much light as possible, since the light is passing through the glass at small angles to the surfaces. It is also advantageous for the surface of the lettering to be slightly rough, as this diffuses the reflected light, rendering the lettering equally well illuminated at whatever angle the plate is viewed.

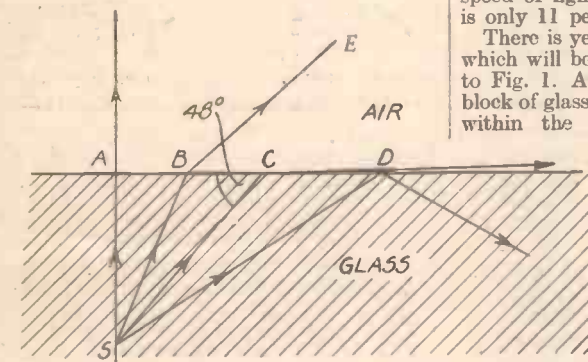

Fig 1.—Showing how the rays of light are bent in passing through the glass.

patents have been taken out covering modified arrangements which are simpler and cheaper, and the purpose of this article is to describe a new form which achieves the result with the minimum of expense.

This new arrangement will be better appreciated if the fundamental principles underlying this and the original arrangement are described.

The Original Scheme

It is well known that light travels in straight lines. This means that a ray of light in air will continue to travel along the same straight path, until some material other than air obstructs it. Suppose that a piece of glass is interposed in its path: then the light will enter it and will continue to travel in a straight line, but two changes will take place. Firstly, it will travel more slowly by 33½ per cent. Secondly, because of the change in speed, its path will, in general, be deflected from its original course. This bending will occur in a definite manner, such that the path in the glass is nearer perpendicularity with the surface, than the path in the air. It will be evident, then, that if the air-path is already perpendicular to the surface there will be no change of direction, but only change of speed.

Now the amount of bending that takes place depends on the difference in the speeds of light in the two media. If light passes then from air to diamond it will be bent more than light passing from air to water, for the speed of light in diamond is only two-fifths, and in water three-quarters that in air. But suppose two materials are in contact, in each of which the speed of light is the same; what happens then? If there is no

ray just grazes along the surface. Rays of angles smaller than 48 degrees cannot emerge into the air, and instead they are reflected into the glass again, such as SD. Above the point S, then, there is a circle of radius AC through which light can pass, while the rest of the surface acts, so far as S is concerned, as a perfect mirror. The various schemes for luminous signs are based on this effect, so we can now study the arrangements.

The Effect of Etching

The arrangement which we can consider as the basic scheme, consists of a piece of plate glass A (Fig 2) having the lettering L (to be illuminated)

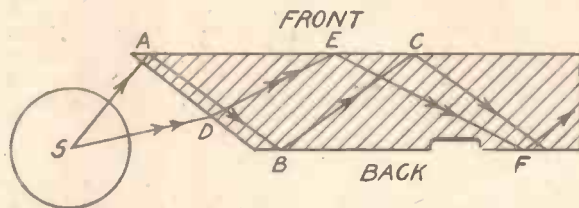

Fig 3.—An improvement on Fig. 2, in which more angles are obtained by suitably positioning the light.

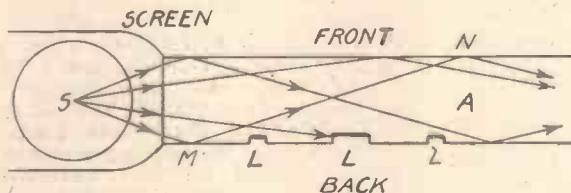

Fig. 2.—Another arrangement showing the illumination of etched characters in an illuminated glass block.

There is a patented improvement on this arrangement which permits of greater illumination with the same relative dimensions. Instead of presenting the source of light to a straight cut edge of the glass, it is presented to a bevelled

edge. The significance of this is that not only is a larger area presented to the source, but by a suitable disposition of the lamp and angle of bevel, light may travel through the glass at all angles to the surface, from a grazing angle to the critical angle. This will be appreciated

(Continued overleaf)

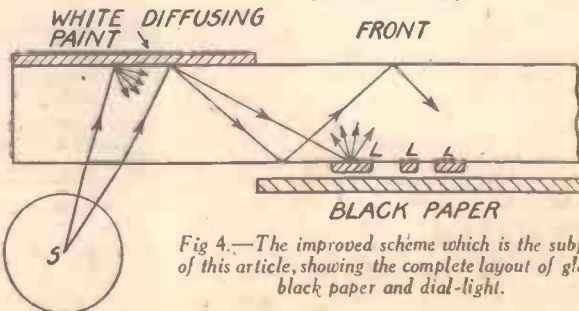

Fig 4.—The improved scheme which is the subject of this article, showing the complete layout of glass, black paper and dial-light.

(Continued from previous page)

by reference to Fig. 3, where SABC strikes the back and front surfaces at the critical angle, and SDEF is at a smaller angle.

An Improved Scheme

Both these arrangements are, however, costly and unsuitable for radio scales. With the first arrangement etching is essential, and this is not only costly, but can only be used for large lettering; it is impossible to etch station names in the small type used on radio scales. With the second arrangement, etching is not necessarily essential (as will be seen later); but bevelled edging is too expensive. The arrangement to be described now embodies the advantages of the latter arrangement with the added advantage of simplicity.

The arrangement is shown in Fig. 4. The lettering L is printed on the back surface of the glass, and printed backwards so that it is correct for viewing through the glass. The border of the front surface opposite to the illuminating lamps is painted with a white diffusing paint, which reflects and diffuses the light from S. Now in the absence of this white paint, all the light from S which enters the glass passes out again through the upper surface. This is because all the refracted rays in

the glass strike the upper surface at an angle greater than the critical angle, since both surfaces are parallel. If a mirror surface were substituted for the paint, the same would be true, except that all rays reflected by the mirror would emerge from the lower surface. But contrary to the mirror surface, the white paint diffuses the light, so that a single ray gives rise not to one reflected ray but to a great number at various angles. For every incident ray, then, there will be a pencil of rays, weaker in intensity, which will strike the back surface below the critical angle. So, as in the second arrangement, light transmission takes place in the glass at all angles from the critical angle down to zero. Because of this, it is not essential to etch the lettering, though the effect would be enhanced if it were.

Improving the Illumination

In order to improve the lighting effect of the printing, a piece of black paper is held close to it. It is important that the air space between the two be not obliterated either by pressing the paper in too close contact with the glass, or by substituting a black spray for the paper. The reason

is evident, for the velocity of light in paper or paint is not very different from that in glass, so little bending occurs as light passes from one to the other. Hence the critical angle at which reflection takes place is greatly reduced, so that much light will escape from the glass to the paint, where it is absorbed.

A few other considerations affect the uniformity of illumination, and the distance the light travels along the glass. Naturally, the more lamps used the brighter, and the more pleasing, is the result. But for a given means of illumination and a given scale size, the thickness and quality of the glass play their part. At every reflection there is a loss of intensity in the reflected ray, so it is advantageous for the light to suffer as few reflections as possible before reaching the furthest point to be illuminated. It is therefore better to use thick glass, and, of course, one that is clear in colour. Plate glass, which has polished and truly parallel surfaces, yields better results than sheet glass, but over small areas the difference is not very marked.

By this simple arrangement it is possible to illuminate a scale 6in. long on glass one-eighth of an inch thick with but two small lamps situated one at each end.

TELEVISION NOTES

Television and Secondary Emission

THE question of secondary emission keeps cropping up in connection with television problems. For example, the ordinary principle of gas ionisation which operates in gas-filled cathode-ray tubes, while increasing the number of electrons in the cathode-ray beam, brings about phase, frequency, and amplitude distortion, which limit very considerably their utility for television picture reproduction, particularly in high-definition work. On the other hand, under proper control, secondary emission is of vital importance, one striking example of this being in connection with photo-electric cells. Some time ago it was found that when a metal plate is bombarded with electrons in order to produce secondary emission and then illuminated, the number of secondary electrons so produced is increased when compared with the normal photo-electric emission produced by the illumination alone. Secondary emission photo-electric cells have therefore assumed a degree of importance, and when fully developed will find diverse applications of interest. Of late, however, the question of secondary emission has been brought more into the limelight of scientific progress by the production of multipliers, or what the lay press is pleased to term "cold valves."

Zworykin Multipliers

With multipliers of the successive type the greatest success seems to have been achieved by Zworykin. In this case instead of the electrons reciprocating between the same two surfaces, they are made to fall on successive secondary emitting surfaces in the form of a zigzag path. A potential gradient between the surfaces provides the "motive force" for bringing about the successive impacts, while "focusing" fields ensure that the electrons keep to their pre-determined path and do not diffuse and so reduce the degree of amplification. In a single tube working on this principle

the inventor has claimed to achieve a degree of amplification up to and even exceeding one million, while the "noise level" is much less than for the same degree of gain when using thermionic valves. Bearing in mind the extremely small currents and voltages which are generated at the transmitting end by television equipment, especially those employing electronic scanning, it is easy to see how important these multipliers will become, at least in the initial stages, after the photo-electric conversion of the transmitted scene has taken place.

Poly. Television Lectures

A NEW Special Course of four lectures on Television is to commence at the Polytechnic, Regent Street, London, W.1, on May 18th next. The lecturer is Mr. H. J. Barton-Chapple, the well-known authority on television, and the syllabus is as follows:

Lecture I (May 18th)—Introduction. Electrical and mechanical methods of scanning. Details of equipment employed at transmitting end.

Lecture II (May 25th)—Nature of generated television signal. Signal transfer by line and radio. Ultra-short waves. Directional micro-waves. Types of modulation.

Lecture III (June 8th)—Cathode-ray tubes and auxiliary equipment. Light modulation. Mechanical and electrical television receivers. Synchronising.

Lecture IV (June 15th)—Video frequency amplification. Correcting devices. Details of new high-definition television service equipment. Electron multipliers. Big screen developments.

The course is intended for those who have attained a reasonable standard in electrical and high-frequency technology, and who desire to become acquainted with the principles of television, including the latest developments in high-definition transmission and reception. The lectures will be illustrated by experiments, lantern slides,

and demonstrations on modern television receiving equipment.

The fee for the complete course is 6s.

Mechanical and Electrical

While it is conceded generally that up to the present the best high-definition television pictures have been seen with the greatest consistency through the medium of wholly electrical methods of operation at the receiving end, that is *via* the cathode-ray tube, it is an open secret that certain firms are concentrating on mechanical methods. The mirror screw is one device which is quite promising, although the minimum definition of 240 lines in the received picture in this country has added very materially to the difficulties associated with this device. When shown in Germany in connection with 180-line pictures it was felt that this method of portraying television images had nearly reached the economical limit. Since then, however, the long delay in starting a service in this country has, no doubt, enabled those workers who pin their faith in this type of scanner to effect improvements and solve many of their difficulties. Then it is known that an echelon of mirrors or prisms in conjunction with a rotating mirror drum of the low-definition type is capable of multiplying the drum's primary scan to one of high-definition standard. Optical losses and complications, together with a form of keystone distortion, are factors of no mean difficulty to be met here, however, and the comparison between the "rival" systems of reception is going to prove of extreme interest. One thing which has made matters worse as far as mechanical receiving systems are concerned, is the use of two quite different standards for the B.B.C.'s radiated pictures. The Television Advisory Committee were very severely criticised for adopting this plan, but they stated that the two systems chosen, namely Baird and E.M.I., should be given an opportunity of demonstrating the respective merits of their systems under practical conditions of service. The value of this plan will only manifest itself after several months of test, and the final results after careful consideration will be of great importance in planning subsequent stations for working in different parts of the country.

On Your Wavelength

Bats in My Belfry, or Rats in this Reader's?

MY recent remarks about Dickens, the vain old man of literature, have called forth a great deal of praise and a mild amount of comment. What I write in this feature, of course, represents my opinion, and I am as much entitled to express it as any other citizen. I do not object to criticism, and I have often quoted letters which have slated me. I cannot be fairer than that. If, therefore, I am sincere in my opinion that the radio ought not to be used to perpetuate the memories of Grub Street collectors of miscellaneous guineas, such as Dickens undoubtedly was, I am entitled to say so. I do not ask you to agree with me. It is just as well for you to know what sort of a fellow I am, and if I fed you with the treachery and sycophantic adulation which people of low intelligence usually bestow on others who merely have normal brains, you would be misled. I do not, cannot, and certainly shall not subscribe to the doctrine of the perfect world, and of the hypocritical modern tendencies to puff and praise unworthy products and unworthy viewpoints. You know my views on crooners and jazz. I stand by them and am prepared to support them. I also mentioned in connection with my criticism of Dickens, the doggerel poet Burrerruns (Ramsay

By *Jhermion*

and biographers seem agreed that he was something of a cheat, like Watt, the swindler who claimed to have invented the steam engine, and filched the designs of Hornblower and others. All of these things are supportable by documents; and yet, because I justly tell you what are proven facts those who merely have silly views imparted by their school teachers (who still perpetuate ludicrous tales about Bruce and the Spider, King Alfred and his Cakes, and Watt and the Steam Engine) take up their pens, plunge them in vitriol and dash off a screed to the editor asking for me to be sacked.

I can understand certain Scots feeling cross because I attack their national heroes, but nevertheless it must be remembered that the truth is always unpopular. I am, I would repeat, entitled to my views, and I am employed to write them because it is presumed that I know what I am talking about. Journalists do not get jobs, nor are they allowed to express their opinions in print, unless they have some particular standing, knowledge, and experience. Personally, I do not care two hoots whether I ever write another line for the Press, and I have no doubt that when my sphere of utility is ended your shrew-like Editor will be the first to sack me. Until that time, if I have a particular viewpoint and feel strongly about a particular matter, you may rest assured that I shall not hesitate to express my opinion. I have always been a fearless journalist, and refuse to write popular trash merely in order to play to the gallery. And that's that!

thought artists just wasted their time in Paris, excusing their innate laziness on the score of their "temperament"), how fishermen live in a Brixham trawler, how university students live at Oxford (it will always be my contention that they merely waste their time there; certainly the few of the post-war generation whom I know have a lower standard of intelligence than a secondary schoolboy), and finally, how a lighthouse attendant lives. In this connection there was a model of the Eddystone Lighthouse and the wireless set intrigued me. It was a two-valve set working a baby curved-horn loud-speaker made by Browns about ten years ago. I should have thought that men who live in lighthouses in a time when the risks of the sea are not so great would have required an up-to-date set. I expect, however, that they find any sort of a receiver a real blessing.

Jazz Note

A PRACTICAL hint for a change. Don't trim your set whilst receiving jazz music—it seems to vary so much in tempo and quality that it is almost impossible to tell if the various stages are out of step or if the trumpets have been muted or covered with a gold-painted bowler hat, after the style of those who earn a thousand a year for making nigger

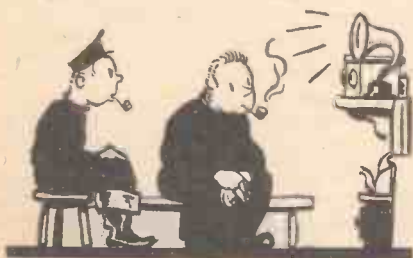

A poor set in a lighthouse.

Mac is supposed to be a good Scot, and he says wurrrrrrrruld, so I suppose I am correct in pronouncing the "poet's" name that way), Scott and Stevenson. I am sincere when I say that they, too, have enjoyed spurious reputations which the radio has tended to enhance. Scott's history in connection with the firm with which he was associated does not exactly appeal to me, nor to others,

The Other Half

I WENT along to an exhibition the other day, which included an exhibit entitled "How the Other Half Lives." My knowledge was enriched by seeing how sailors lived in a submarine (Why call them sailors? People who go to sea nowadays know very little about sailing. Many of them cannot even swim!), how artists live in Paris (I



Don't try to trim to jazz.

noises and presuming that it is music. How I wish that all jazz music were abolished, or at least limited in proportion to those who listen to it. I have never seen anyone dancing to it. And that reminds me! When are they going to stop this nonsense of the signature tune? I thought advertising was not allowed on the wireless?

(Continued overleaf)

(Continued from previous page)

Sight and Hearing

HAVE you ever been affected as I have recently been when searching for a particularly faint and elusive short-wave station? My eyes smart, and I suppose that sight and hearing must be in some way connected, and the straining of the ears imposes a sympathetic strain on the eyes also. Motor-cyclists often find when wearing goggles that they cannot hear so well. I shall be glad to hear from correspondents on this point, since it is one on which they can write sensibly to me and even append the names and addresses which some of them conveniently omit when they want to write my family history. Aren't some critics bold?

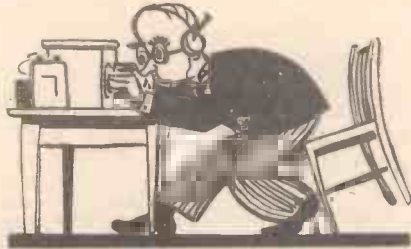

Eye strain through listening to faint stations.

Radio Critics

AS a critic myself I am still envious of those whose easy job it is to criticise yesterday's broadcast. Strikes me as being utterly useless, since it is the past event and cannot be recalled. Theatre criticism is in a different category, for the very good reason that the play is expected to last for a few months, and well-directed criticism might possibly improve the piece. All the radio critic has to do is to plant his feet on the mantelpiece, choose one or two items from *The Radio Times*, listen for a few minutes, and then 'phone to the editor of the particular paper a few hundred words asking what the B.B.C. is going to do about it.

Words of Wisdom from Glasgow

HERE is the type of letter to which I have referred in a previous paragraph. I won't give the reader's name and address, for I am sure that he is ashamed of it when he sees it in cold print. I would merely say that he resides somewhere in Glasgow. For all this reader knows I may be a personal friend of his thoroughly enjoying the leg-pull. In any case, the joke is on him! Here is his screed: "Who is this wizard—this lion of journalism? Let this sniper stand out from behind the shelter of the pen-name 'Thermion,' give us his honest-to-goodness name that we may really know to whom we are

**H.T. Battery Leakage**

THE on-off switches fitted to battery type receivers break the L.T. supply circuit, and in some cases the G.B. battery circuit, but no provision is made for breaking the H.T. circuit. The H.T. circuit becomes automatically broken when the filament circuit is opened at the L.T. on-off switch, because no current passes through the valves when their filaments are cold. There is always the possibility of a leakage occurring, however, and therefore a periodical current test should be taken in order to ascertain that no current flows from the H.T. battery when the on-off switch is in the off position. A continuous leakage of even $\frac{1}{2}$ m.A will considerably shorten the life of an H.T. battery, and it is often found that a leakage of this amount takes place across a decoupling or by-pass condenser without materially affecting the reception.

Current Test

THE current test should be made by connecting a milliammeter between the H.T.—lead and the H.T.—socket of the battery. When the on-off switch is in the off position no reading should be registered on the meter. If a reading, however small, is registered it will indicate that there is a leakage, or that the receiver is badly designed. If the meter indicates that a current is passing after the filaments have been switched off, and the receiver is known to be of reliable design, the S.G. valve screen by-pass condenser, detector decoupling condenser, or any other condenser connected across the H.T.+ and H.T.—circuit should be suspected. If the receiver is of doubtful design, the circuit should be checked, as in some receivers a potentiometer is used for supplying the screen of the S.G. valve, and a steady leakage may occur across this after the set has been switched off.

Band-pass Coupling

THERE are several methods of coupling the tuned circuits of a band-pass unit, the most common being the bottom capacity method. In this type of unit the earth ends of the two coils are joined together, and the junction is connected to the junction of the moving vane terminals of the two associated tuning condensers by means of a condenser having a capacity of approximately .02 mfl. This method of coupling the two circuits is quite satisfactory in practice, but unless a special precaution is taken the coupling condenser can prevent exact matching of the band-pass unit circuits and the inter-valve tuned circuit. The coupling condenser is in series with the tuning condensers of the band-pass circuits and therefore the effective capacity of these tuning condensers is slightly reduced, and is less than the effective capacity of the tuning condenser connected across the inter-valve coil. This error cannot be effectively corrected by means of the trimmer condensers, and the correct procedure is to connect the earth end of the inter-valve coil to the moving vanes of its tuning condenser via a condenser of the same size as the band-pass coupling condenser.

indebted for correcting our stupid notions and ideas. Let me suggest that when the time comes for the publication of a new wireless circuit, you then offer the alternative of the blue print for it or a picture of 'Thermion.' Invite your readers to let you know which they would prefer." Very nice indeed of this reader to flatter me in this way, but my style and my pen-name must identify me. You remember the story of the man who had been travelling so long on a particular branch-line that he took umbrage when the ticket collector asked him for his ticket. "My face is my ticket," he said. "I am instructed to punch all tickets," replied the ticket collector. If this reader ever visits London, I hope he will call



How nice to be a radio critic.

upon me, when I shall have much pleasure in posing in profile and full face and demonstrating to him my manly physique and muscular development

Mobile Radio

I WAS talking to an official of the police force radio section the other day and he gave me some interesting sidelights on the problem of mobile radio. Every motorist who has tried to use an ordinary set in a car knows the peculiar effects of bridges, high buildings, etc, and in view of the prominence which has been given to the police radio tests at Brighton many members of the public are inclined to criticise the London police force for not similarly equipping their members with these portable sets. The fact of the matter is that the sets have been tried, but they are of little use in our streets owing to the screening effects of the big buildings, and to the interference from our heavy traffic. Here is a chance for a budding inventor to design a set which will fit in a policeman's helmet and which will employ full A.V.C. or its equivalent and which will operate from a very light-weight battery. Although only headphone signals are needed, it has to be a very efficient receiver indeed, and exhaustive tests are necessary under London conditions to ensure that it will actually work.

A PAGE OF PRACTICAL HINTS

SUBMIT YOUR IDEA

READERS WRINKLES

THE HALF-GUINEA PAGE

Improved Feet for Cabinets

HERE is a simple method of making feet for cabinets from old picture frames. The four corners of a frame are cut away, as indicated in the sketch, and screwed on underneath the cabinet, at the

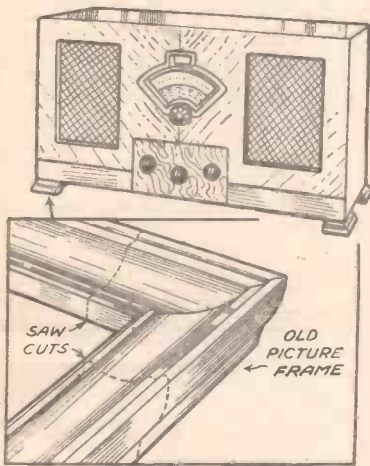

A novel method of making cabinet feet from an old picture frame.

corners, as shown. This is a very good time-saving dodge for constructors who are not used to cutting mitres. If the corner pieces are well cleaned they can then be stained and polished to match the cabinet. —C. M. MASON (Hampstead).

A Short-wave S.G. Improvement

THE lead to the anode of the S.G. valve in my short-wave receiver was of flexible wire. I found that when this lead was disturbed in any way (as, for example, when the valve was removed from its holder temporarily) it upset the ganging

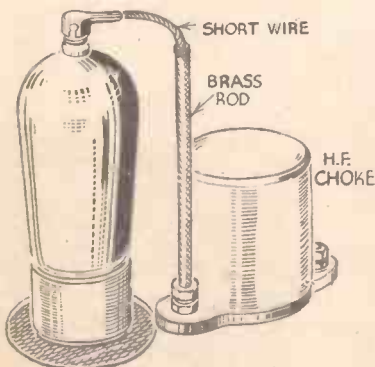

An improved method of connecting the anode lead to an S.G. valve.

of the set. To overcome this I fitted a short length of rod to the H.F. choke, and soldered a short length of flexible wire to the end of this. —WM. NIMMONS (Belfast).

THAT DODGE OF YOURS!

Every Reader of "PRACTICAL AND AMATEUR WIRELESS" must have originated some little dodge which would interest other readers. Why not pass it on to us? We pay £1-10-0 for the best wrinkle submitted, and for every other item published on this page we will pay half-a-guinea. Turn that idea of yours to account by sending it in to us addressed to the Editor, "PRACTICAL AND AMATEUR WIRELESS," George Newnes, Ltd., 8-11, Southampton Street, Strand, W.C.2. Put your name and address on every item. Please note that every notion sent in must be original. Mark envelopes "Radio Wrinkles." Do NOT enclose Queries with your Wrinkle.

An Efficient Dual Wave-trap

MOST devices for increasing the selectivity of a wireless set also to a large extent reduce its all-round sensitivity. In London, the chief need for selectivity is to stop interference on foreign stations by the Regional and National programmes, and this simple wave-trap device was designed to cut these stations out almost

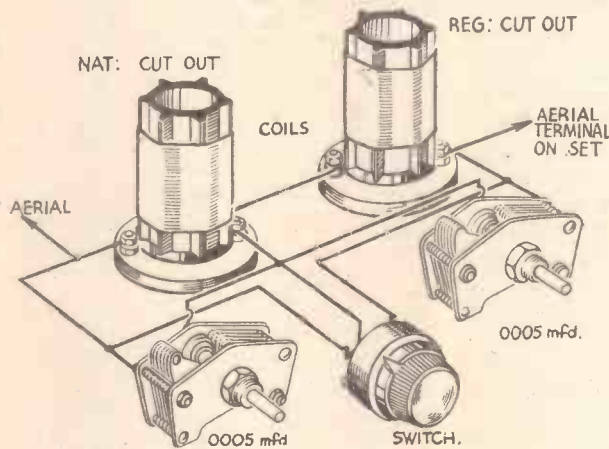

An efficient wave-trap for suppressing local high-power stations.

entirely without affecting foreign stations. By its use a straight, single H.F. stage set can be made as selective as a band-pass tuned or multi-H.F. stage set.

Instead of the usual .0001 μ F series condenser in the aerial lead (which always reduces the all-round volume), two tuned circuits are placed between the aerial and the set. Each circuit consists in my case of an old coil of the type shown in series with the aerial, with a .0005 tuning condenser having a slow motion dial, placed across each coil. Of course, any efficient medium wave coil can be used, or a long-wave coil, if Droitwich is to be suppressed.

The National is first tuned right in, and then the first tuned circuit is tuned until it is cut down as low as possible. The same is then done with the other circuit

for the Regional. It is usually found that these stations can still be got as loudly as required, and the foreigners quite close on the dial can be brought in at full strength.

Once the wave-trap is set it is unnecessary to touch it again, and it can be placed out of the way. By means of a switch, short-circuiting either one or other of the two circuits, three positions of it may be arranged so that either Regional, National or foreign stations may best be obtained. —J. M. IAGO (Harrow).

A Combination Tool

A USEFUL combination tool, suitable for the experimenter, is shown in the accompanying sketch. Two pieces of flat steel 5in. long, by 1/2in. wide, by 1/16in. thick are required. These are marked, and filed as in Fig. 1. Holes are drilled, and slots for 3/16in. or 1/4in. screws are worked in the centres. Fasten the pieces together, and

slightly bend the points at one end (Fig. 2). The other points require hardening. Each part should be polished with fine emery cloth.

It will be seen, by reference to Fig. 3, that by inserting a screw and knurled nut in the slots that it is possible to use the tool in several ways, such as outside calipers, inside calipers, jennies or odd legs, dividers, or each point may be used as a scriber. Various adjustments may be made for small or larger work, and it will be found that a similar tool is useful on every work-bench, and will have many uses in

radio construction jobs. —J. STOBBS (Keighley).

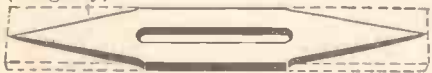

FIG. 1



FIG. 2

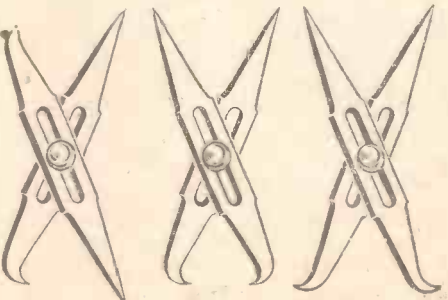

FIG. 3

A useful combination tool.

An Ideal Book for the Beginner! Everyman's Wireless Book

By F. J. CAMM

3/6 or 3/9 by post from Geo. Newnes, Ltd., 8-11, Southampton Street, Strand, W.C.2.

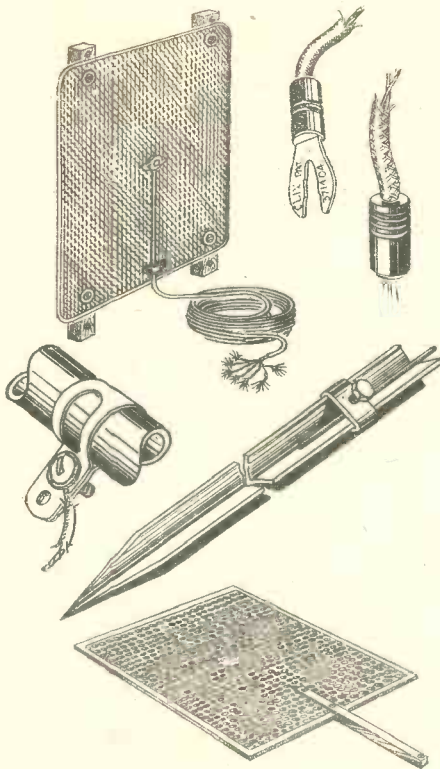

Fig. 1.—In this group is seen a Goltone aerial plate and earthing mat, an Anacos copper earthing rod and clip, and the Clix heavy duty plug and spade terminals which are ideal for making aerial and earth connections.

IN the first days of wireless every listener endeavoured to erect the aerial as high as possible and with the greatest possible length. This was no doubt due, in a large measure, to the fact that the post office licence mentioned the fact that the permissible aerial could not exceed 100ft. in length, and it became the custom to regard this maximum as essential for good results. Radio receivers were, of course, very inefficient at this time, whilst the service area of a transmitting station was also on the small side. Naturally, one had to rely upon a sensitive aerial-earth system in order to obtain a worth-while signal, but as conditions improved there should have been a corresponding improvement in the listener's aerial and earth system. Instead, many listeners even to-day are content merely to erect a tall pole (or even

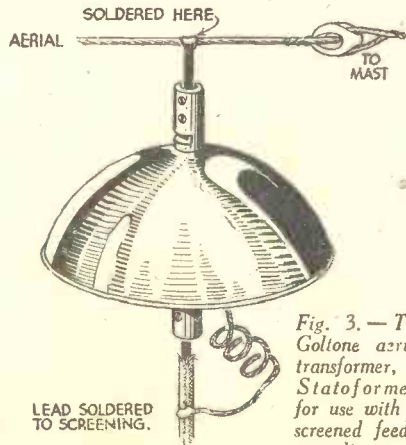

Fig. 3.—The Goltone aerial transformer, or Statoformer, for use with a screened feeder line.

a haphazard collection of odd lengths of timber) at one end of a garden and sling a length of wire from this pole to the house, paying very little attention to insulation, gauge of wire, lead-in efficiency and other important details. They feel that such attention is unnecessary as they can hear nearly every country in the world on their three- or four-valve set. It is true that the greater efficiency of both transmitters and receivers enables us to do with inefficient receiving aeri-als, but by a careful attention to details in this part of our receiving equipment we can do very much towards improving reception, not only from the point of view of selectivity, but also with regard to quality.

Aerial Efficiency

First of all it must not be considered that by an efficient aerial we to-day refer to a high and long wire. In the case of one

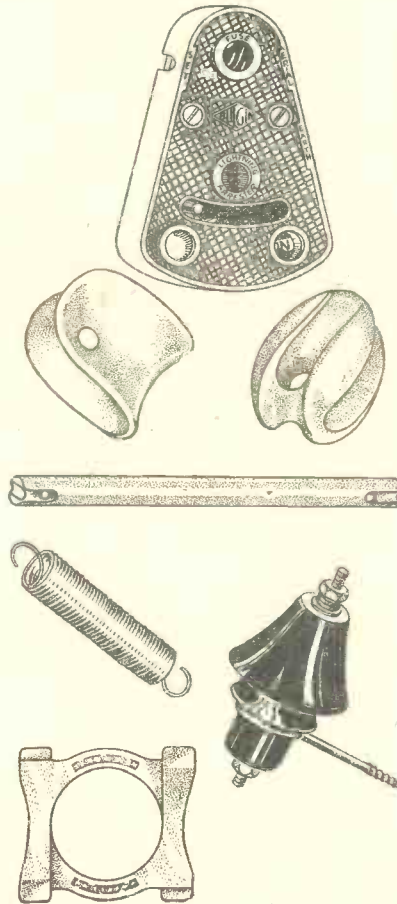
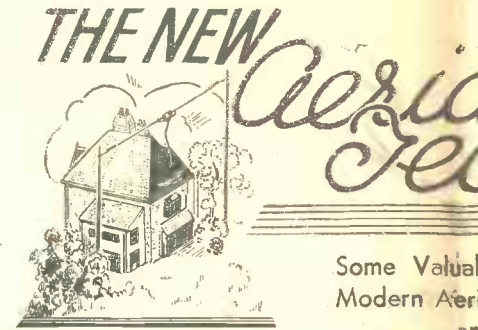

Fig. 2.—At the top of this group is the Bulgin lightning arrester, and the remaining items are Streamline space insulators and lightning arrester, a B.T.S. aerial strainer spring, an Eddystone cross-feeder block and standard egg and shell insulators.

listener, for instance, it may be found that a local station swamps all signals over a wide band on that particular listener's receiver. Without going to the trouble of rebuilding the receiver it may be possible to redesign the aerial so that not only is the local restricted to a narrow band, but that distant stations which were hitherto very weak may be received with increased volume. There are many types of aerial from which to select, and two forms are shown at the foot of these pages, whilst some others



of a more ambitious pattern will be given next week.

Dealing first with the actual aerial wire, it must be remembered that the wireless signal consists of a high-frequency oscillation, and that high-frequencies travel on the surface. Therefore, the largest possible surface should be aimed at on the signal collector, or aerial, and in this connection it must be borne in mind that stranded wire only gives a greater surface area than its equivalent thickness of solid wire when each strand is individually insulated, either by enamel or some other covering. Where, however, it is impossible to erect any aerial wire (such as in a restricted area such as a flat-dweller might encounter) a flat plate of metal erected outside a window or against a chimney stack will prove very effective. The direction in which it faces may influence reception results and therefore it should be attached temporarily in various positions until the best one for the particular locality is ascertained.



Fig. 4.—The complete aerial kit sold by Streamline.

An aerial of this type is shown on the left of this page and is selected from the Goltone range of products. It consists of a perforated plate mounted on stout wooden battens and is treated to resist corrosion. A 50ft. length of leading-in wire is attached and it costs 21s.

A Wall Aerial

Also for use in areas where a large or ordinary type of wire may not be employed is the "Wallaerial" manufactured by Messrs. Bulgin. This is a complete equipment having cowl-type insulators mounted on stout metal brackets for attachment at the top and bottom of a wall, and a six-wire aerial with circular spacers totalling 15ft. in length. This may, of course, be cut down

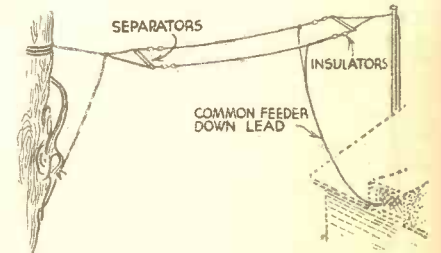

Fig. 5.—Where space is not readily available a twin-wire aerial of this type may be employed.

Technique

able and Complete References to the
ial and Earth Components, Accessories
nd Methods of Construction

to suit individual requirements, and a
lead-in is attached to the lower end to be
brought to the receiver in the normal man-
ner. The complete equipment costs 7s. 6d.

The frame-aerial is now very little used,
but a typical specimen is shown in the
lower right-hand corner of this page, and
it possesses the advantage that it may be
rotated to provide maximum signal strength
from any station. Signals are at maximum
when the frame is turned in the plane of the
incoming signals, and thus it is possible to

use this as an addi-
tional control, although
in view of the weak-
ness of the received
impulses a fairly
powerful receiver is
required with it.

Aerial Insulation

We now come to the
orthodox aerial erec-
tions which consist of
a wire or wires
supported between the
house and a pole
in the garden, or
between two poles
situated some distance

Pilot dipole balanced
line Radio.

apart. It is obvious first of all, apart
from any consideration of length or
type, that the wire or wires which are
employed must be effectively insulated if all
the energy which is picked up is to be trans-
ferred to the receiver. As before mentioned,
the signals consist of high-frequency
oscillations and these take the most direct
path to earth. A wet wooden pole will
provide a good path to earth, and this
may easily prove of lower resistance than
the actual receiver with the result that
any leakage at this end of the aerial will
permit the signals or a good deal of them to
pass to earth down the pole and this will
result in a loss of signal strength in the
receiver. Therefore insulation must be the
first consideration and whereas in the early
days there was only the round china
insulator to use, there are now many
different types made from china, porcelain,

glass, pyrex, bakelite and other materials.
Some different patterns are shown on this
page, and may be obtained from Messrs.
Bulgin, Eddystone, B.T.S., Ward and Gold-
stone and others. The corrugated type
offers a long leakage path without unduly
increasing the length of the insulator,
whereas the cowl type not only offers the
advantage of a long path, but also provides
a protector for the end of the wire against
wet during rain. It is, of course, appre-
ciated that if the insulator is covered with
water a good conducting path is automati-
cally provided and will result in losses. A
highly-glazed surface prevents the accumu-
lation of dust or dirt which will provide a
conducting surface and the action of the
rain will be to clean off any slight accumu-
lation of this nature.

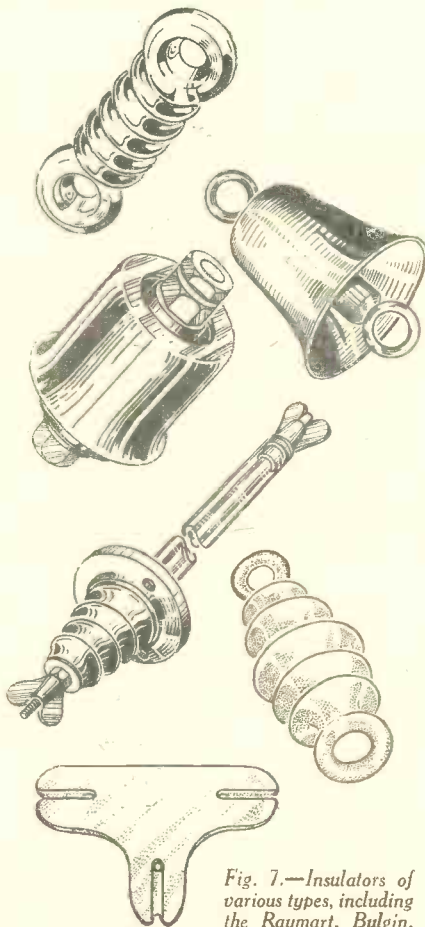

Fig. 7.—Insulators of various types, including the Raymart, Bulgin, Eddystone and B.T.S., together with the Graham Farish Gard lightning arrester.

After insulation we must consider the
question of the tension of the wire. Although
the aerial could be drawn taut when
erected, there would be a risk of guy ropes
snapping when shrunk under the action of
moisture, and if left slack the aerial may
sway with the wind and result in a form of
fading as it approaches and recedes from
any earthed body, such as a house wall.
A tensioning spring may therefore form
part of the suspension system.

The Lead-in or Feeder

To connect the aerial to the receiver we
must take a feeder wire or lead-in, and this
may take several forms, dependent upon the
type of aerial which is erected. Thus a single
wire may be led straight to the set, or twin

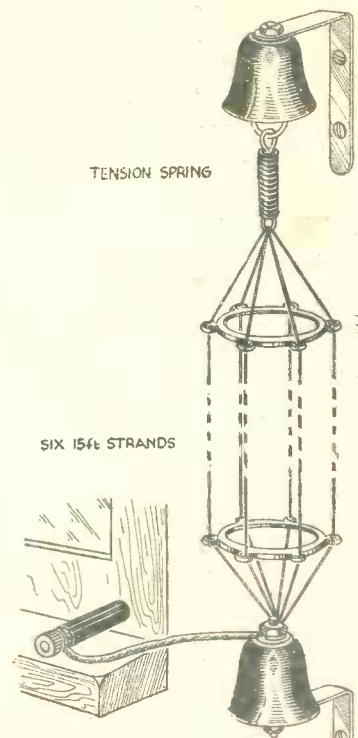

Fig. 8.—The "Wallaerial" supplied by Messrs. Bulgin. This can be erected to any desired length and is supplied with 15ft. strands and 10 ring spacers.

leads may be used, and these, in turn, may
be crossed at intervals (transposed) or kept
parallel throughout their length. These, and
further details of aerial systems, will be dealt
with next week.

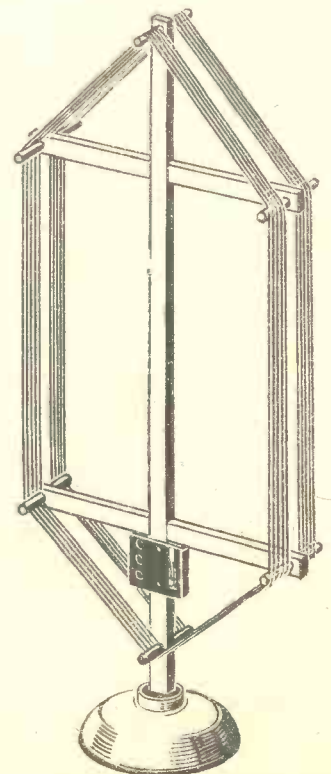

Fig. 9.—The frame aerial gives control over selectivity owing to its directional property. It should be used with a powerful type of receiver.

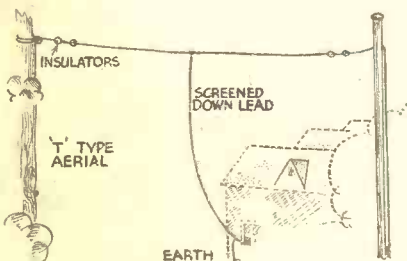

Fig. 6.—A single "T" aerial to which a screened down-lead is attached by means of the Statoformer shown in Fig. 3.



GETTING THE BEST FROM YOUR FIRST SET

Useful Hints Concerning the Choice of Receiver and Accessories. By IDRIS EVANS

WHEN the beginner decides to construct a receiver he should take great care in the choice of design. If he is not accustomed to soldering, a receiver design employing terminal components should be chosen, and if the main requirement is quality reception of the local stations a straight two or three-valve receiver should be built. If, on the other hand, reliable distant station reception is desired, it will be necessary to construct a receiver having a high degree of sensitivity and selectivity—sensitivity is the term applied to the ability of the receiver to pick up a large number of stations, and a set is said to be selective if stations can easily be separated. The four-valve superhet

50ft. long may be used. This should be placed as high as possible and clear of trees and walls. The earth lead in this case should be as short as possible and should be joined to a copper earthing tube buried in moist earth. In town the aerial installation presents greater difficulty than in country districts, as in some cases tenants are not allowed to fit outside aerials and in other cases there is insufficient available space for this type of aerial.

Very satisfactory reception can be obtained from indoor aerials nowadays, however, and the would-be constructor need not despair if he has not the facilities for fitting a long outdoor aerial. The attic type is probably the most efficient of the indoor aerials. This consists of a length of insulated copper wire slung across the rafters in the attic, with an insulated down lead passed under the eaves of the roof, and through the window frame; if the down lead cannot be taken outside it may be passed through the ceiling. If a good outside earth connection cannot easily be found, the earth wire may be joined to the water main pipe, or to the gas pipe, and if neither of these pipes can be used a large piece of metal such as a bed frame or spring mattress will prove satisfactory.

Batteries versus Eliminators

If a mains supply is available, but the beginner does not feel sufficiently confident to attempt the construction of an all-mains set, an H.T. unit, or battery eliminator may be used for supplying H.T., and an accumulator for L.T. supply. A reliable eliminator of the correct type is generally more satisfactory than dry batteries, as the voltage of the latter gradually drops with use and therefore the efficiency of the receiver is also lowered. When an

eliminator is used the voltage supplied to the valve anodes remains constant, and if the accumulator and receiver are kept in good order the quality of reproduction and sensitivity does not deteriorate as in the case of the battery-operated set. The eliminator has the disadvantage of being more noisy than the battery, however, and unless it is of reliable design excessive mains hum is likely to be experienced. When choosing an eliminator great care should be taken to obtain one having a current rating slightly in excess of the normal H.T. current consumption of the valves, and if a tapping is not provided for supplying H.T. to the screen of the H.F. pentode valve the method shown in Fig. 1 may be adopted. The third method of supplying H.T. to battery type valves is from a wet battery. This is probably the most satisfactory method as it provides the advantages of the other two, namely, constant voltage supply and a hum-free reception. This type of battery requires recharging periodically, of course, and is therefore not so popular amongst constructors as the dry type.

Choosing the Speaker

Two speaker types are commonly used nowadays, the moving-coil type and the balanced-armature type. The latter is gradually losing its popularity owing to the advent of the cheap type of permanent magnet moving-coil instrument. If a low output valve of the power type is used, however, the balanced-armature speaker generally gives better reproduction than the cheap moving-coil type. It is also a well-known fact that the moving-coil instrument tends to show up the deficiencies of a low output battery receiver. The best rule is to use a cone speaker if the output valve has an undistorted output of less than ½ watt, and a

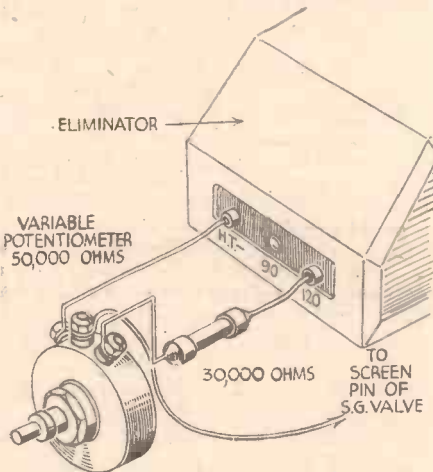

Fig. 1.—Showing method of supplying H.T. to an H.F. valve screen.

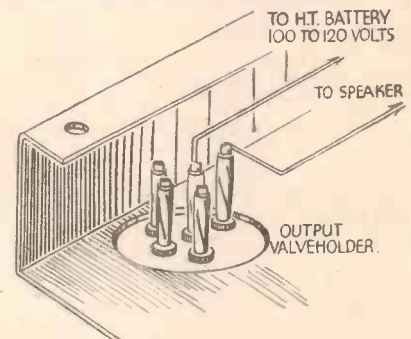

Fig. 2.—Five-pin valve-holder wired for battery pentode.

meets with these requirements, but as it is more difficult to adjust than the straight set, the beginner is advised to build the latter type, contenting himself with the reception of local stations and a few of the more powerful continentals.

A simple two-valve set of the detector-power or the detector-pentode type will prove sufficiently sensitive if the listener is situated within approximately thirty miles of the local stations, but if the distance is greater than this a three-valve should be built. This should preferably be of the H.F. pentode (or S.G.)-detector-pentode type, and should have two or three tuned circuits; the Hallmark Three and the Tutor Three of the PRACTICAL AND AMATEUR WIRELESS designs are of this type.

Aerial-Earth System

After the construction of the receiver has been completed, attention should be paid to the aerial-earth system. If the listener is situated in the country an efficient outside aerial can be fitted, and a stranded copper wire approximately

moving-coil type having a matched transformer attached if the valve has an output of ½ watt or higher. This does not mean that moving-coil speakers as a class will not work satisfactorily in conjunction with low output valves—many of the reliable makes do—but many of the cheap types on the market give inferior results to the old cone type in such cases.

Valves

The best circuit arrangement for the beginner's set uses an S.G. or H.F. pentode H. F. valve, followed by a detector and an L. F. valve of the power or pentode type. The pentode will give slightly more volume than the power type and therefore if greater volume is desired from a receiver designed for a power valve, a pentode may be substituted provided that a five-pin holder is fitted as shown in Fig. 2.

WINSTON CHURCHILL

writes on

"R.M.S. QUEEN MARY"

IN a magnificent article, "Queen of the Seas," exclusively written for the May STRAND MAGAZINE, Mr. Winston Churchill describes the true significance of this great triumph of British shipbuilding, and its world-wide effect on British prestige. On a special visit to the "Queen Mary" he saw all the marvels of the great ship, and in his inimitable style gives his impressions.

In the MAY

STRAND
MAGAZINE

OUT NOW - - - 1/-

RADIO CLUBS AND SOCIETIES

Club Reports should not exceed 200 words in length and should be received First Post each Monday morning for publication in the following week's issue.

THE RADIO, PHYSICAL AND TELEVISION SOCIETY

WITH the approach of the summer months considerable interest is being aroused among members of this society in 5-metre work. In view of this, a lecture on this subject was given by our president, Dr. C. G. Lemon, on Friday, April 24th, and it was entitled "5-Metre Technique." Various transmitting circuits were illustrated, and their working explained. After spending some minutes in examining the possibilities of a new 5-metre directional antenna, details of which had only just come to hand, Dr. Lemon then went on to talk about receivers. Needless to say, the super-regenerative claimed most of his attention and various circuits of this type were drawn on the board. The self-quenching super-regenerative set using no quench coils and only one valve seemed to be the general favourite among members, owing to its simplicity in construction and operation. The straight detector, the lecturer said, was of little use at high frequencies owing to its extremely sharp tuning and instability, whereas the super-regenerative set has a very wide band width which serves the double purpose of simplifying tuning and accommodating fatly tuned carriers.

The society is holding a 5-metre field day on Wimbledon Common and district on Sunday, May 10th. Several aerial systems are to be used, among them being a directional system which has not yet been widely used and which is claimed to have a uni-directional radiation of a very high order. We welcome reports from PRACTICAL AND AMATEUR WIRELESS readers on transmissions which will be made during the afternoon under the call of G5NR on phone and I.C.W.

In order to satisfy a growing demand, a correspondence section of the society has been started, which will enable country and overseas members to participate to some extent in the activities of the society.

A meeting of the society will be held on Friday, May 8th, at 8 p.m., at 72A, North End Road, West Kensington. All readers of PRACTICAL AND AMATEUR WIRELESS are welcome, and further details of the society's activities may be obtained from the Hon. Sec., M. E. Arnold, 12, Nassau Road, Barnes, S.W.13.

THE WHITLEY AND MONKSEATON RADIO CLUB
TWO interesting and well-attended meetings of the above club were held during the past month, at each of which informal talks on features of interest to all radio enthusiasts were given. Owing to the large demand for Morse classes, we have made the necessary arrangements and these will be given by an expert before each meeting.

Our meetings are of interest to all, not only to short-wave enthusiasts, but to anyone whose interest in wireless extends further than mere "knob-twiddling." Entrance to the club is only 1s., and the subscription every two weeks is 6d.—D. Brewer, Secretary, 60, Marine Avenue, Monkseaton, Northumberland.

POINTS ABOUT CONDENSER CALCULATIONS (Continued from page 204)

tance. Now the reactance, or opposition offered by a condenser to an alternating current, varies with the frequency, being less at high frequencies than at low frequencies. It is very desirable, therefore, to be able to calculate the reactance of a condenser at any particular frequency. This can be done by multiplying together the capacity of the condenser in mfd., the frequency in question in cycles per second, and the number 6.28, and dividing the result into 1,000,000. The answer will be the reactance of the condenser at that particular frequency expressed in ohms.

It is true that this calculation involves only simple arithmetic, but in order to reduce the necessity for such calculations as much as possible, a further group of tables have been prepared giving the reactances of commonly used sizes of condenser at frequencies with which they are usually expected to deal. Table 3 gives the reactance of the larger bypass condensers from .25 mfd. upwards at 50 and 100 cycles. Table 4 gives the reactances of smaller coupling and bypass condensers at 50 and 1,000 cycles, the latter being an average kind of audio-frequency, while Table 5 gives the reactances of condensers between .0001 and .01 mfd. at 1,000 kc/s (400 metres) and 200 kc/s (1,500 metres).

WIRRAL AMATEUR TRANSMITTING AND SHORT-WAVE CLUB

THE second meeting of this club was held on April 22nd, in Heswall. After the preliminary business had been attended to, members exchanged their experiences in applying for both artificial aerial and full transmitting licences.

Following this, Mr. Leo (G6GL) delivered an extremely interesting talk on 56 mc. transmission and reception, and his experiences of it in conjunction with Mr. Cross (G2FZ). Meetings will continue to be held on the fourth Wednesday in each month. For particulars apply to the Hon. Sec., B. O'Brien (2BON), "Caldy," Irby Road, Heswall, Wirral.

BELLINGHAM AND DISTRICT RADIO CLUB

THIS society is one of the activities of the Downham Men's (L.C.C.) Evening Institute, and meets every Tuesday evening from 8 to 10 at the Elfrida School, Bellingham Estate. Lectures on wireless and popular science topics are given by a highly qualified and experienced wireless specialist, and part of the time is given to practical work.

Wireless enthusiasts, either experts or novices, are cordially invited to join this society. The fee for membership is 1s. 3d. for a term of roughly three months. New members may enrol at the Men's Evening Institute, Durham Hill School, Downham Estate, on any evening from 7 to 10, or may see the club secretary, Mr. W. Thomas, at the Elfrida School, Bellingham, on Tuesday evenings.

SOUTHEND AND DISTRICT RADIO AND SCIENTIFIC SOCIETY

THE Annual Supper and Ladies' Night of this society was held at the London Hotel, Southend-on-Sea, on Saturday, April 18th. Fifty-four members and ladies had a thoroughly enjoyable evening, and were entertained at the conclusion of the dinner by Mr. Frank Loud (baritone), Miss Eileen Merrie (entertainer), and Miss Chris Hall (accompanist).

The Mayor of Southend was present, and in his speech thanked the society for the valuable work they had done in the borough, with particular reference to the charitable side of its activities. He mentioned the fact that members maintained free of charge suitable receivers in the homes of fifty-six blind persons in addition to the huge installation which the society presented to the local General Hospital at a total cost of nearly £700. Other members undertook the servicing of installations provided by the society at the Crowstone Home for the Blind, and the Stamford Hill Cripples' Home.

At the conclusion of his speech the Mayor (Councillor A. H. White) presented the society's Silver Challenge Trophy to two members who exhibited the most meritorious workmanship at the society's annual exhibition of home-constructed apparatus which took place recently.

Field days are also being planned and those interested are invited to apply to the Hon. Secretary for particulars. The address is: "Chippenham," Eastern Avenue, Southend-on-Sea.

PETO-SCOTT RADIO—CASH C.O.D. or EASY TERMS

IMPORTANT Miscellaneous Components, Parts, Kits, Finished Receivers or Accessories for Cash or C.O.D. or on our own system of Easy Payments. Send us a list of your wants. We will quote you by return. C.O.D. orders value over 10/- sent carriage and post charges paid (GREAT BRITAIN ONLY). Hire purchase terms are NOT available to Irish and Overseas Customers.

AMERICA DIRECT

ON YOUR PRESENT BATTERY OR A.C./D.C. MAINS SET WITH THE **B.T.S. ADABAND** and no alterations!

WHY GO TO THE EXPENSE OF AN ALL-WAVE RECEIVER? The Adaband fits perfectly beneath and gives your present, familiar set a world-wide range!

Suitable for almost any set. Single Tuning Control. 13-74 metres. Walnut veneered cabinet. Long and medium-wave reception of present set continued without disconnecting.

BATTERY MODEL £5:5:0 Cash or C.O.D. Carriage Paid, or 8/- down and 14 monthly payments of 8/-.

A.C. MAINS MODEL £6:12:6 Cash or C.O.D. Carriage Paid, or 10/- down and 14 monthly payments of 10/-.



PILOT AUTHOR KITS

TUTOR KIT "A" £4

Cash or C.O.D. Carriage Paid, or 7/6 down and 11 monthly payments of 7/3.

If required with set of 3 specified valves, add 32/6 to Cash or C.O.D. price or 3/- to deposit and to each monthly payment.

B.T.S. Tutor Coil Unit as specified 19/8.

MONITOR 3 (2nd VERSION)

Complete Kit of Components to build the second version of the Monitor 3, including all additional components with 2-gang straight type condenser, less valves. Cash or C.O.D. Carriage Paid, £3/17/6, or 10/- deposit and 10 monthly payments of 7/6. As above, but with 3-gang-straight or superhet type condenser, instead of 2-gang. Cash or C.O.D. Carriage Paid, £4/3/0. Or 12/6 deposit and 7 monthly payments of 11/-.

1936 RADIO ACCESSORIES 1936

- REGENTONE W.I.A. ELIMINATOR** with output regulator. A.C. Mains. 7 voltage tappings. Output 150 v. at 30 m/A. Cash or C.O.D. Carriage Paid, £3/7/6. Send only 5/-; balance in 11 monthly payments of 6/3.
- GARRARD A.C.6 Induction ELECTRIC MOTOR.** Complete with 12in. turntable, 12in. Unit Plate and fully automatic Switch. For A.C. mains only. Cash or C.O.D. Carriage Paid, £2/2/6. Send only 2/6; balance in 11 monthly payments of 4/-.
- GARRARD No. 30 Double Spring MOTOR.** Complete with 12in. Plush-covered Turntable, Brake, Speed Indicator, Patent Winding Crank. Will play 2 sides of a 12in. record at one wind. Cash or C.O.D. Carriage Paid, £1/5/0. Send only 2/6; balance in 10 monthly payments of 2/6.
- PIFCO DeLuxe Moving Coil RADIO-METER.** Battery or Mains Test meter. Tests everything. Cash or C.O.D. Carriage Paid, £2/2/0. Send only 2/6; balance in 11 monthly payments of 4/-.
- BLUE SPOT POPULAR P.M. SPEAKER.** Universal Matching Transformer. Cash or C.O.D. Carriage Paid, 19/6. Send only 2/6; balance in 8 monthly payments of 2/6.
- ROLA F 514 P.M.T. SPEAKER.** Suitable for all outputs and fitted with universal transformer. Cash or C.O.D. Carriage Paid, £1/3/6. Send only 2/6; balance in 10 monthly payments of 2/6.

B.T.S. INTERNATIONAL SHORT-WAVE 2 KIT

A different 2-valve short-waver—the number of stations obtainable on this remarkable set will amaze you!

KIT "A" £2:12:6 Cash or C.O.D. Carriage Paid, Or 5/- down and 11 monthly payments of 5/-.

Contains every part for building, including 2 coils, 13-52 m., wiring, assembling and operating instructions and full-size blueprint, less valves. Set of 2 RIVAC valves, 9/3 extra. This two valve has a range never before accredited to this number of valves.

5/- DOWN

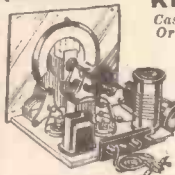

B.T.S. Short-Wave AERIAL KIT

As reviewed on page 213.

A specially designed aerial, incorporating all the features necessary for short and ultra-short-wave work. Essential to perfect reception, it is supplied absolutely complete with coupling unit and instructions. Current Feed or Voltage Feed type (state which).

Cash or C.O.D. Carriage Paid, **21/-** Or 2/6 down and 8 monthly payments of 2/6.

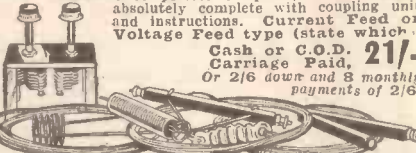

Peto-Scott 1936 CLASS "B" 4

KIT "A" comprising all parts for building, including ready-drilled Metaplex chassis, and full-size Blueprint, less Valves, Cabinet, and Speaker. **7/-**

Cash or C.O.D. Carriage Paid, £4, or 7/- down and 11 monthly payments of 7/6. **DOWN**

Send Coupon for Free Blueprint.

SEND YOUR ORDER NOW! FULL DETAILS OF ANYTHING RADIO SENT ON REQUEST

PETO-SCOTT CO., LTD., 77 (Pr.W.2), City Road, London, E.C.1. Tel.: Clerkenwell, 3406/7. West End Showrooms: 62 (Pr.W.2), High Holborn, London, W.C.1.

Please send me CASH/C.O.D./H.P.

NAME

ADDRESS

..... Est. 1919.

I am interested in
Please send me full details without obligation.

THE MULTIWAVE THREE

A New Short-wave and Broadcast-band Receiver from the Graham-Farish Laboratories

SOME time ago we reviewed an interesting three-valve receiver designed by the Graham-Farish laboratories and intended for the short waves primarily, but which could be used for long waves by plugging in suitable coils. The latest receiver designed by them is intended for all-wave use and is an improvement on the Discovery Three. The illustrations show the general appearance of the finished receiver and also give a very good idea of the internal arrangement of the components and wiring; the receiver is sold in kit form, but the absence of soldered connections will enable anyone to build the receiver as neatly as that shown in the illustrations. As is usual with this type of kit set, only a screwdriver and a pair of pliers are required, and in an extremity the former could be dispensed with and the various components held down by adjusting the screws with a penknife.

The Circuit

In this particular receiver the tried and proved detector and two L.F. circuit is adopted, with all resistance coupling. In the aerial circuit a three-coil tuner is employed, one winding serving as aerial coupling coil, one as the tuned grid winding, and the third for reaction. If desired, a pre-set condenser may be included in the aerial lead, but this is not provided with the kit. The main tuning condenser has a maximum capacity of .0005 mfd. and connected in series with it is a fixed condenser across which an on/off switch is joined so that the condenser may be shorted out on the broadcast band and left in series on the short waves. Two H.F. chokes in series are connected in the detector anode circuit, the first a highly-efficient short-wave component and the second a standard broadcast choke, and in addition to the coupling resistance there is also a decoupling resistance. A parasitic oscillation stopper is joined in the grid circuit of the L.F. and the output valve, and in the loud-speaker leads two S.W. H.F. chokes are connected, and these may clearly be seen in the illustration joined to the two spring contacts to which the speaker has to be connected.

The Layout

The layout of the components is extremely clear and no difficulty should be experienced by even the beginner when he has the full size wiring diagram before him. On this all the components are clearly indicated and the coil mount is the only component likely to occasion trouble, but even this may be overcome by carefully examining it and studying the diagram. Furthermore, the instructions supplied with the kit will greatly assist in obtaining a ready-wired set in the

The Multiwave Three in a Laurence cabinet showing the single all-wave tuning dial.



shortest possible time, and the maker's instructions regarding the mounting of the condenser should be faithfully followed in order not to damage the component.

The panel is extremely neat, and as will be seen there is only a single control knob. This is of the now familiar snail-drive type and operates a pointer travelling over a scale which is divided into seven separate bands, ranging from 8 to 2,000 metres. Six separate coils are required for this receiver, and these are rated for the following wavebands: 12 to 25, 21 to 50, 38 to 102, 90 to 320, 200 to 650 and 650

Results

The results to be obtained will vary in different parts of the country and under different aerial conditions. A good aerial is essential in order to take maximum advantage of all the wavebands, and a good earth is equally essential. The size of the aerial may be adjusted after the receiver has been tested, as it may be found that a long aerial will result in poor selectivity on the broadcast wavebands, whilst on the short waves a reduction in size will not result in loss of signal strength until a certain minimum has been reached. Our experience is that 30ft. of wire erected as high as possible (preferably vertical) will give as good results as a larger horizontal wire, but the makers of the receiver suggest about 40ft. If maximum results are desired on the short waves perhaps it will be found desirable to use a special short-wave aerial system, but obviously greatest advantage will be taken of the all-wave tuning capabilities of the set if a compromise is effected and what may be termed a "general purpose" aerial is installed. In such a case it will be possible to hear the various amateur transmitters, the police transmissions, aircraft, special trawler broadcasts, as well as the more familiar entertainment broadcasts on the standard wavebands, and the receiver should prove very popular indeed. At our own test some very interesting broadcasts were received and the receiver gave a most impressive performance, during which a number of aeriels were employed with perfect satisfaction during the hours of daylight.

The kit costs only 57s. 6d., and is complete down to the last screw. The three valves are obtainable for 24s. 6d., and a suitable speaker may be purchased for 22s. 6d. The cabinet shown in the illustration is of the latest Laurence design, finished in grey or green leatherette, and costs 14s. 6d. For those listeners who wish to take advantage of this novel receiver but do not wish to carry out the constructional work, the Graham-Farish engineers will assemble and wire the kit at a purely nominal charge of 10s. per receiver.



A view of the receiver on its chassis showing the compact layout.

to 2,000 metres. Thus it will be seen that the entire band from 12 to 2,000 metres may be covered without any gaps, and although only two coils can be used at a time a much wider band is covered than is usual in a multi-range receiver of this type.

The Controls

Apart from the main tuning control just referred to, there is a combined switch on the left and the reaction control on the right. The combined switch has four positions. The first position is "Off," the second switches out the fixed condenser, which is in series with the tuning condensers, the third position brings into action one coil, and the next position brings into action the second coil.

THE FIRST COMPLETE VOLUME
TELEVISION & SHORT-WAVE
HANDBOOK 2nd EDITION

3/6, or 3/10 by post from George Newnes, Ltd.
811, Southampton Street, Strand, W.C.2.

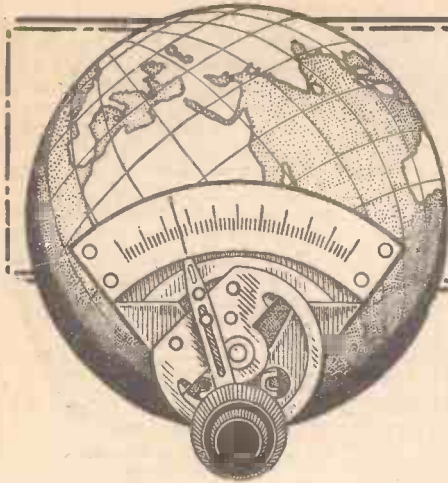

SHORT WAVE SECTION

TRY SHORT WAVES THIS SUMMER

Short-wave Receivers Are of Especial Interest and Value in Summer, for They Enable You to Obtain Long-distance Reception Which Might Be Impossible with a Broadcast Set. By FRANK PRESTON

IN spite of all that has been written in these pages concerning the advantages peculiar to short-wave reception, it is still found that there are many readers who have not yet taken up this side of radio. Those who have not cannot choose a better time to do so than during the spring and summer months, for the simple reason that short-wave reception is better than the reception of the normal broadcast transmissions during the lighter weather. Most readers will already have found that long-distance stations on the medium waves which could be heard perfectly well during the winter have now become almost inaudible; this is quite normal, due to the fact that conditions for such reception are far worse in spring and summer than in autumn and winter. In contrast to this, the short waves generally "come over" better during the lighter months of the year, reception being more consistent.

Time and—Wavelength

The fact is that signals of different wavelength travel better during certain parts of the day. In winter it is often found that signals on wavelengths between, say, 19 and 30 metres cannot be received at all well except during the morning and afternoon, but in summer signals on these waves are available throughout the greater part of the day and evening on even simple types of receiver. Moreover, world-wide reception can be expected on these wavelengths. Thus, although the fascination of long-distance reception is lost in summer to those who use only the so-called broadcast bands, it is available all the year

round on short waves. This is because in winter wavelengths between approximately 25 and 50 metres are particularly good during the evenings, whilst lower wavelengths down to 10 or so provide excellent long-distance results during other parts of the day. In addition to the advantages which have been claimed for short waves in the foregoing remarks, signals on these wavelengths are more satisfactory for DX reception at any time. As an example of this it can be stated without contradiction that short-wave American signals which are transmitted on very low power can be received at loud-speaker strength with a three-valve set, whilst signals on wavelengths over 200 metres cannot be heard at all well when using a multi-valve superhet.

Fascination of Uncertainty

It must not be forgotten that reception on any short-wave band cannot generally be relied on at any one time. This might

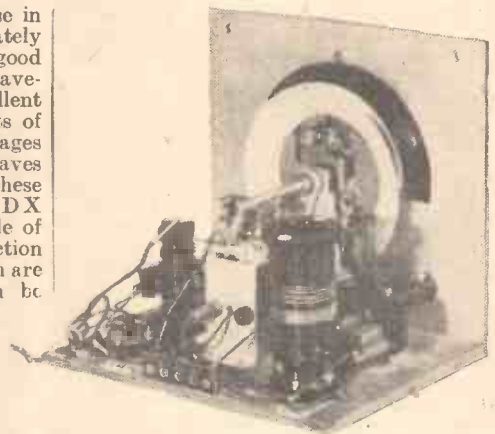

Rear view of a short-wave converter-adaptor which can be used with either a battery or mains-operated receiver.

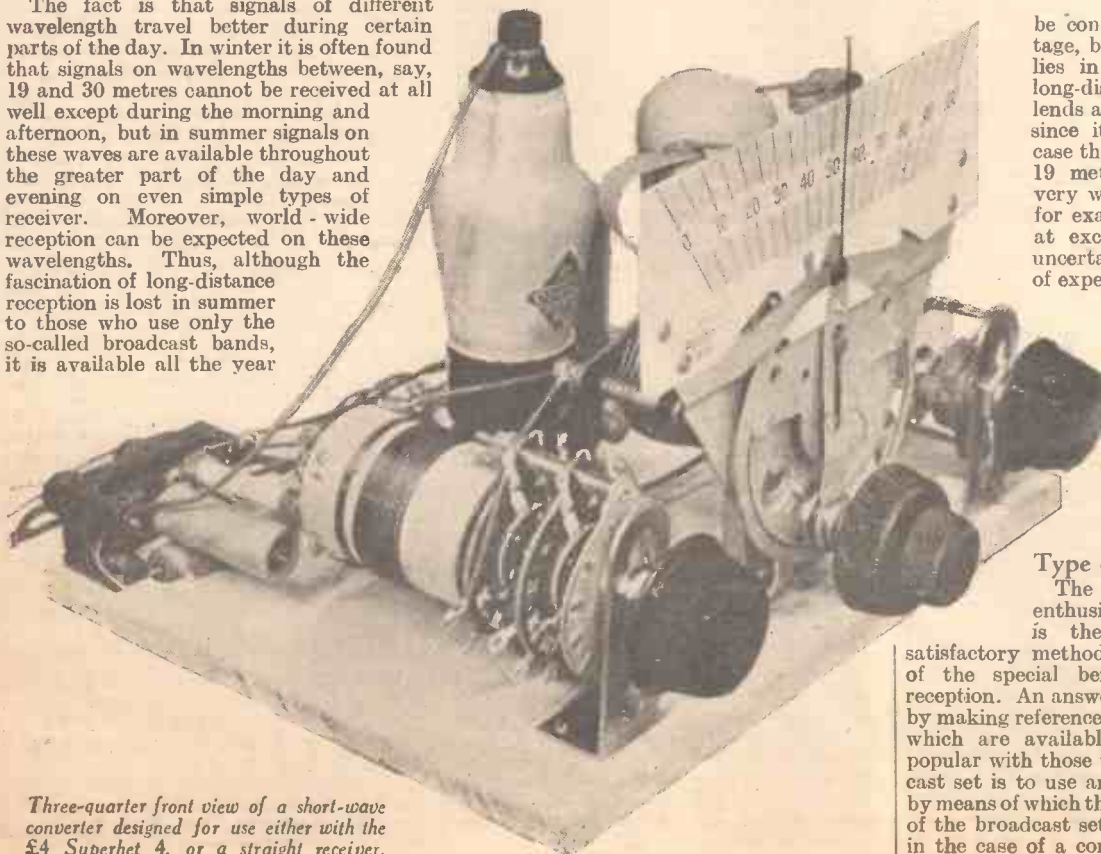

Three-quarter front view of a short-wave converter designed for use either with the £4 Superhet 4, or a straight receiver.

be considered as a disadvantage, but those whose interest lies in experimenting and in long-distance work find that it lends added interest, especially since it is nearly always the case that when signals on, say, 19 metres are not coming in very well, those on 30 metres, for example, can be received at excellent strength. This uncertainty adds to the interest of experimenting and provides ample scope for valuable research work. And, since many stations send out the same programme on two or three short-wave bands, it is possible at most times of the day to obtain satisfactory reception of that programme.

Type of Short-waver

The prospective short-wave enthusiast might well ask what is the simplest and most satisfactory method of taking advantage of the special benefits of short-wave reception. An answer can be provided only by making reference to the various methods which are available. One of the most popular with those who own a good broadcast set is to use an adaptor or converter, by means of which the low-frequency portion of the broadcast set, or the whole receiver in the case of a converter, can be used in

conjunction with an inexpensive unit. Many designs for adapters and converters have been given in these pages, and one which can be recommended is the "Short-wave Converter for the £4 Superhet" described in the issue dated January 18th, 1936. This is shown on page 217 and is designed for use in conjunction with a receiver having an H.F. stage; by its use a three-valve "straight" receiver can be used as an efficient four-valve superhet on the short waves, and all of the important short-wave stations in all parts of the world can be

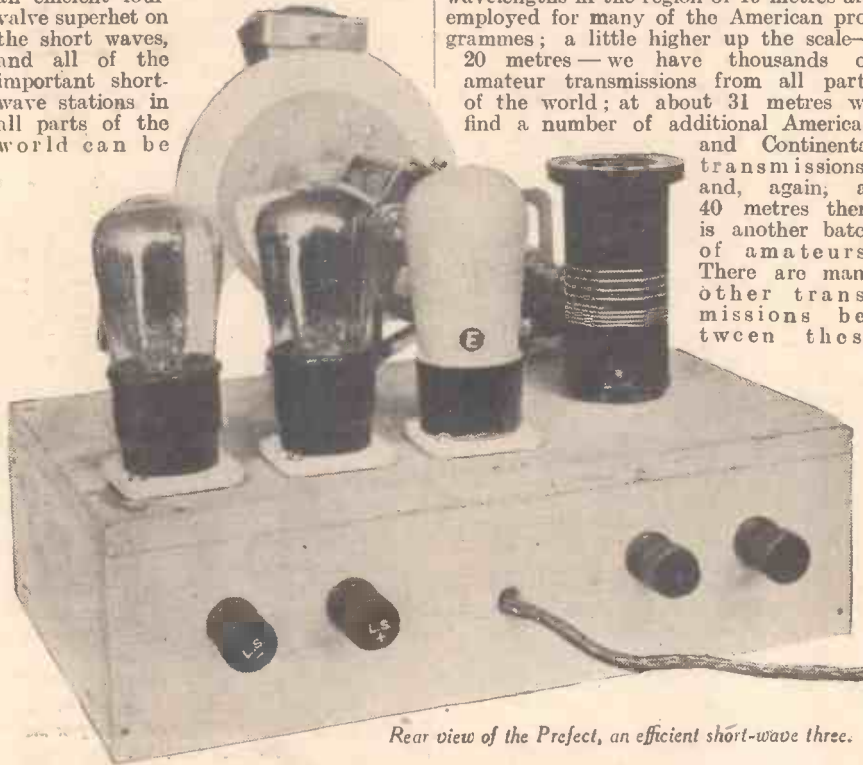

Rear view of the Prefect, an efficient short-wave three.

heard. It is not necessary to modify the broadcast set in any way, and it can always be used for normal, medium- and long-wave reception when desired.

A Converter-Adapter

Another convenient unit which can be employed as either a converter or an adapter, with either a battery- or mains-operated receiver, is the "Short-wave Converter-Adapter" which was fully de-

scribed in our issue dated February 23rd, 1935 (which is now out of print), and which is the subject of Blueprint PW48A. This has interchangeable coils, and can thus be used on any short wavelength from 10 metres upward. It is worth mentioning in passing, however, that most short-wave transmissions are confined to a number of comparatively narrow bands, which simplifies matters for the beginner. For example, wavelengths in the region of 19 metres are employed for many of the American programmes; a little higher up the scale—20 metres—we have thousands of amateur transmissions from all parts of the world; at about 31 metres we find a number of additional American

and Continental transmissions; and, again, at 40 metres there is another batch of amateurs. There are many other transmissions between these

which has proved immensely popular with hundreds of readers was described in the issue dated September 14th, 1935, and a three-valver capable of remarkably good results (the now well-known "Prefect") was fully described and illustrated in the issues dated February 8th, 1936, and February 15th, 1936. There are many advantages in using a separate short-wave receiver, not least of which is that short-wave reception can be carried out by the experimenter at the same time as the rest of the family is listening to normal broadcasts. Use can be made of either the same aerial or of a separate short indoor one placed near the short-wave set.

All-wave Reception

Still another method of enjoying short-wave reception is by making a single all-wave receiver, and this arrangement can be recommended when the construction of a new broadcast instrument is contemplated. An all-wave set which has been made in large numbers, and which has given a considerable degree of satisfaction, is the "All-wave Three," and constructional details of this were given in the issue dated August 31st, 1935. This receiver has three valves which function as detector with two low-frequency amplifying stages, the first of which is resistance-capacity coupled, a transformer being used between the second and third valves. A complete multiple-range tuning coil is employed, by means of which wavelengths between 13.5 and 40 metres, 260 and 520 metres, and 1,100 to 1,900 metres can be covered by means of the single tuning condenser, and by the operation of a rotary switch.

Free Advice

Numerous other types of receiver, adapter and converter have been dealt with in PRACTICAL AND AMATEUR WIRELESS, and any reader who is in doubt concerning the most satisfactory system to adopt in his own case should write to our Free Advice Bureau setting out his requirements and mentioning the type of receiver now in use. He will be informed as to what system will best meet his particular requirements.

But, whatever kind of receiver you are using, you should certainly give short waves a trial. The small amount of trouble and expense involved will be fully justified, and the latter can be suited to the depth of purse of the individual constructor.

bands, of course, but they are easily found after logging a few transmissions on one of the extensively-used ranges.

Separate Short-wave Set

Many of those who contemplate short-wave reception will prefer to build a special and separate receiver for the purpose. This can be made as simple or as complicated as desired, and thus as cheaply as may be wished. A very inexpensive single-valver

REPORTS of good reception of two new European short wavers are now more frequent as the stations appear to have adopted a fairly regular schedule. They are, Radio-Beograd (Belgrade), on 49.18 metres (6,100 kc/s) which already promises in the near future an increase in power to 2.5 kilowatts and LZA, Sofia, on 20.04 metres (14,970 kc/s) operated by the *Direction Générale des Postes, Télégraphes et Téléphones* in the Bulgarian capital. So far, the broadcasts, which are still in an experimental stage, have been limited to two sessions, from B.S.T. 06.30-14.00 and again from 16.00-22.30, on Sundays only. I am now informed that the schedule is to be extended to weekdays when the station will be on the air from B.S.T. 10.30-11.30 and from 18.00-22.00. The call and details of the items transmitted are given out by a woman announcer.

Relays from Buenos Aires

Another alteration to be noted is the new channel to which YV8RB, Barquisimeto, Venezuela, has moved. You will hear the call: *Radiodifusora La Voz de Lara*, on 50.90 metres (5,892.5 kc/s) or

Leaves from a Short-wave Log

on a reading just above that of the more powerful Moscow transmitter (RW 59). You will not have to wait long to identify the station as the call is punctually given every fifteen minutes. Times of broadcast: B.S.T. 18.00-19.00 and from midnight to 05.00 daily. On 19.62 metres (15,290 kc/s), LRU has been logged several times during the past week with an excellent relay of LRI, Radio el Mundo, Buenos Aires, and tests have also been picked up of similar broadcasts carried out through another channel, namely, LRX, 31.32 metres (9,580 kc/s) in the early morning hours (between 05.00-06.00). Should you hear either or both of these there is a *veri* to be obtained by giving details of reception to Radio el Mundo (LRI), Calle Maipu 555, Buenos Aires, Argentine Republic.

From the Dominican Republic

Finally, in the Dominican Republic new stations are springing up overnight. Here are a few of which more details would be welcome. At Santiago de los Caballeros, *La Voz de Comercio*, with the doubtful call-letters HIAU—the third letter should be a numeral—on 47.07 metres (6,383 kc/s) has been reported by a French listener; also HI7P or HI7G, located at Trujillo City and with a somewhat similar slogan: *Emisora de Comercio*, on 44.12 metres (6,800 kc/s). A British "fan" also adds to our list the following stations situated in the same island: HI3C, *La Voz de Rio Dulce*, La Romana, on 42.92 metres (6,990 kc/s), HI5E, *Radiodifusora Ozama*, at Trujillo City, on 43.48 metres (6,900 kc/s) and HI5N, Santiago de los Caballeros, on 4.633 metres (6,473 kc/s), *La Voz del Almacén Dominicana*. Radiodifusora HIL, Trujillo City (in Spanish, phonetically: *Cee-oo-dad day True-heel-lo*) appears to have settled down on 46.13 metres (6,503 kc/s). It has been well heard during the last ten days between midnight and 02.00. The address is Apartado (Post-box) 623, Trujillo City, Dominican Republic.

Facts and Figures

COMPONENTS TESTED IN OUR NEW LABORATORY

New K.B. Receiver

AN interesting new mains receiver is announced by Messrs. Kolster Brandes. This is of the straight type, employing H.F., detector, and output stages, with pentodes in the first and last stages, and a triode in the detector stage. A full-wave A.C. rectifier is employed with an 8in. diameter energised loud-speaker, and the complete receiver sells for 8½ guineas. The tuning dial is calibrated with station names and wavelengths in metres, and an indicator is fitted to show to which wave-range the set is adjusted. There are only three controls, tuning (with wave-change combined), reaction, and volume.

Mazda Valve Base Chart

THE Edison Swan Electric Company have just issued an interesting chart showing the base connections and references for all the principal types of Mazda valves. These are, of course, built to the Radio Valve Manufacturers' Association standards, and consequently are of universal application. The chart measures 14½ins. wide by 22in. in length and is stiffened at top and bottom by brass strips. A hanger is fitted and the chart should be in every service-engineer's workshop. They may be obtained free on application to the above company at 155, Charing Cross Road, London, W.C.2.

New Mullard Transmitting Valve

TRANSMITTING valves of the S.G. or tetrode type have been available for some years, and have, in fact, been adopted with every success for certain specific duties. Now comes the news that, just as the screened pentode is rapidly replacing the screened tetrode in reception practice, so are transmitting pentodes becoming available as a further advance on the transmitting screen-grid valve. Details are to hand concerning the first of a series of Mullard pentode transmitting valves—a low-power valve rated for a maximum continuous anode dissipation of 35 watts and for a maximum anode voltage of 1,000 volts. It is understood that this valve will be rapidly followed by a smaller type, rated at 15 watts dissipation and an anode voltage of 500 V., while other valves are also projected.

The advantages of the transmitting pentode are, in the main, identical with those of the H.F. receiving pentode. For example, the very low anode-control grid capacity (0.06 µµF. for the Mullard PZ1-35) renders neutralising quite unnecessary. Next, secondary emission effects, which limit the performance of screened tetrodes, are also avoided in the transmitting pentode by the use of the third grid. High output and good efficiency are thus obtained without critical adjustment of operating conditions.

The high sensitivity which characterises all valves of the pentode family, permits the full output of the valve to be secured for a very small expenditure of H.F. excitation power, resulting in economy in the number and size of previous amplifying stages.

The points already mentioned are all counterparts of the benefits which screened pentodes have brought to radio reception. For transmission, however, the valves have

another and very important advantage, namely, the ease with which modulation can be effected by means of the third grid, and the low modulating power required. For the 35-watt valve referred to above, good quality modulation to a depth of 90 to 95 per cent. is possible with a carrier output power of 12 watts, the mean negative third-grid voltage being approximately 90 volts.

For telegraphy service an output of 50 watts can be obtained down to 50 metres when the valve is operated at an anode voltage of 1,000 V., of 20/25 watts at 500 volts anode supply. For lower wavelengths the anode voltage must be reduced, with a limit of 800 volts at 14 metres, while the combined anode and second-grid currents must in no case be allowed to exceed 110 mA.

Complete data sheets concerning this valve are available from the Mullard Transmitting Division.

Bulgin Neon Test Prod

EVERY good testing device should be provided with insulated test prods as these enable various otherwise inaccessible points to be reached, and at the same time prevent the fingers from coming into contact with high-voltage points, or otherwise giving the operator making the tests a severe shock. When ascertaining the live main of a supply; when ascertaining whether a supply is A.C. or D.C.; when making continuity tests, and for other types of wireless circuit servicing it is necessary to take especial precautions unless one adopts a specialised type of tester. Such an instrument is the Neon prod illustrated on this page. It is of orthodox pattern, but incorporates a special neon lamp which glows at a very minute current. The lamp is provided with a cathode and an anode, and when fed from an A.C. supply both electrodes will glow. When only one electrode glows, the indication is that the supply is of the D.C. type, and this greatly simplifies tests where the type of supply is unknown. To ascertain which of a pair of main leads is "live," the prod is simply touched against the main leads, and due to the capacity of the body to earth the lamp will light on the live main. Should the body be very effectively



The Bulgin Neon Test Prod.

insulated from earth, owing to very dry flooring or other particular circumstance, a lead

may be made to the terminal on the cap of the prod. The tester will indicate continuity by a glow dependent upon the current passed, and it may be used in conjunction with a battery of 180 volts or more, or may even be used in conjunction with a tapping on a mains transformer.

HEAVY DUTY

Spade Terminals and "Master" Plugs for A or E Contacts.

These "Clix" Heavy Duty models are intended for bringing aerial or earth leads direct to set without having to make breaks or joins. Lead-in hole in insulators allows leads up to 3/8 in. diameter to be used without stripping insulation tape from wires.



CLIX "MASTER" PLUGS

The most important feature in these is the efficiency of the pin, which is non-collapsible and is so constructed that it will give perfect contact with the varying sizes of sockets. These Clix plugs give full surface contact.

3d. each

CLIX SPADE TERMINALS

An important feature embodied in all models of Clix Spade terminals is the metal shoulder piece which prevents acid creeping up to the leads. The wiring contact is positive metal-to-metal and the jaw in all models is designed to give full surface contact.

3d. each



The Plug and Spade Terminal illustrated are exceptionally efficient for aerial or earth connections.

Folder "N" Free.

LECTRO LINX LTD.

79a, Rochester Row London, S.W. 1

CLIX

IT PAYS TO BUY THE BEST



INTERCHANGEABLE COILS.

New low loss formers of DL-9 high frequency insulation. Rigidly made and each coil matched. First-class results assured. 4-pin coils have two windings, 6-pin three windings. No. 959 6-pin Set of 4 12-170 metres Price 16/- No. 932 4-pin " " " " Price 14/-

Universal S.W. Valve-holder



A low loss holder for above or below base-board use. The valve enters the contacts from either side. There is no measurable increase of self capacity to that already in the valve base. DL-9 H.F. dielectric, one piece noiseless contacts. No. 1015 4-pin 1/3d. No. 1016 5-pin 1/5d. No. 1024 7-pin 1/8d.

STRATTON & CO., LTD. Bromsgrove Street, BIRMINGHAM. London Service Depot: Webb's Radio Stores, 14, Soho Street, Oxford Street, W.1.

EDDYSTONE

SHORT WAVE COMPONENTS

LETTERS FROM READERS

The Editor does not necessarily agree with opinions expressed by his correspondents.



All letters must be accompanied by the name and address of the sender (not necessarily for publication).

S.W. Reception in Scotland

SIR,—I observed in a recent issue that a correspondent, F. W. Moore, of Exeter, described the 13-metre waveband as hopeless. It may be so in Devon, but here W8XK on 13.93 metres is to be found regularly between 1 and 2 a.m. at a strength varying from R3 to R6 on loud-speaker, though inclined to swing a little.

W2XE, on the same waveband, was received on the 29th ult., but not so loud as W8XK, the power being only 1 kW, as against 40 kW of Pittsburgh. It apparently does not close down till 4 a.m.

American amateurs on 10 metres are also heard on the loud-speaker, and I have listened to W2XEN, the New Jersey police transmitter, on 9 metres, at a strength rivalling the usual American broadcast stations. I use a home-made short-wave converter of my own design on a five-valve mains superhet, and both a di-pole and inverted-L aerials.—GEORGE PROCTOR (Dunfermline).

S.W. Correspondent Wanted

SIR,—I should be very glad to get in touch with someone interested in short-wave work with regard to constructing both receivers and transmitters when a licence is obtained. I have heard W2BSD quite often on 14 mes, but it seems of late that conditions on this band are dropping off a little.—PAUL STEIN (4, Hodford Road, Golders Green, N.W.11).

A Good Log on 10 and 20 Metres

SIR,—I read with interest E. A. Monk's letter in your issue for March 28th, as on that particular date I also received many of the stations mentioned. Conditions were particularly good on 20 metres during that week, but my best night was March 2nd.

Conditions seem to have deteriorated lately so far as North American 'phones are concerned, but South Americans are coming through at good strength, and the high spot of the month has been the daily reception of Australian 'phones recently at 07.00-08.00 G.M.T.

Below is a list of the more interesting stations heard during March. The receiver is a home-made 0-v-2, all-mains, with outside aerial. All stations received on loud-speaker:

20 m. ('phone): VE1CX, VE1DC, VE1DQ, VE1CN, VE1EX, VE2BG, VE2BQ, VE2XY, VE3AAQ, VE3BD, VE3EO, VE3JV, VE3QS, VE4CW, VK2AP, VK2BQ, VK2BW, VK2TI, VK2YW, VK3OC, VP2CD, VP6YB, VP9R, PY2BA, PY2DC, PY2DN, CO2HY, CO2RA, CO2WC, CO6OM, TI2RC, TI3AV, LU1EX, LU8DR, VOII, HI5X.

20 m. (C.W.): VK's, 2AP, 2QU, 2SQ, 2ZR, 2MW, 3CX, 3JX, 4HR, 4US, 6FO, 7BJ. ZL's: 2KD, 2NN, 3JR, 3DJ, 3JT.

10 m. ('phone): W's: 1HAQ, 2EUG, 3AUC, 3AIR, 3CIJ, 3CRG, 3DRA, 8XWJ, 9XAD, K4DDH.

10 m. (C.W.): W's: 1DZE, 1BXC, 1JLE, 1EWD, 1APQ, 1DUK, 1HQN, 2ECO, 2TP, 2DVV, 2GJB, 2AIW, 2DIJ, 2AFV, 2ICQ, 2IOL, 5EHM, 5AFX, 6GUQ, 8BTK, 8CKY, 9DCB, 9DXX, VE3ER, VE3TY, VE3KF, OA4J, LU9AX.—W. H. DYSON (Burnley).

Polishing Cabinets

SIR,—Concerning "Hints on Polishing," in your issue of March 14th, 1936, I notice that the most important part has been omitted, i.e., the cleaning of oil from

Back Numbers from Readers.

We have published several requests recently from readers for back issues, and in some cases have also published letters from readers who are willing to supply such back issues. The following letter has been received from Mr. S. M. Mosley, of Manchester, and we wish to draw the attention of readers to the criticism raised therein:

SIR,—I was interested to note Mr. Webster's remarks in this week's "Letters From Readers."

My experience has been a little less fortunate than his, as during the last few weeks I have sent about fifteen back numbers of PRACTICAL AND AMATEUR WIRELESS in response to requests in your columns from readers, and up to date I have not had one reply from the people I helped out.

While I do not expect them to refund the postage, I do think that they might have had the courtesy to acknowledge the safe receipt of the paper.

This sort of reward for your trouble rather daunts one from acting the Good Samaritan in future.—S. M. MOSLEY (Manchester).

It is only common courtesy that when a reader is kind enough to oblige another in this manner an acknowledgment should be made. We hope that in future cases other readers will take note of this point.—ED.

the surface of the job. It is well known that to successfully polish any article, enough oil must be used to allow the rubber (pad) to work easily over the surface without pulling the polish; it must be clearly understood, however, that for an amateur the smaller the amount of oil he uses the better will be the finished article. Your article finished by recommending working up and down the grain in small circles, but this is not the end as the most difficult part is to follow; perhaps this is your reason for not including this in your article, but I think it ought to be given for the benefit of amateurs who, like myself, like tackling all difficult problems. The finishing part is to clear the oil from the polish, for if this was not done the job after a time is liable to become misty; this is called "sweating," due to the oil (which you have used in the process of polishing) rising to the surface.

Eventually, dust sticks to the oil, giving a rough coat to the polish and making it look misty. Particular care must be taken

when tackling this part of the job as methylated spirits is used on a pad and then gently and very lightly drawn over the surface; if by any accident the pad presses too hard on the surface, the spirits will burn the polish. This process should be carried on until no flashes are noticed.

I always use "spirit stains" for my jobs, as this mixes with polish, which consists of methylated spirits.—ARTHUR CHILVERS (King's Lynn).

Back Numbers Available and Wanted

SIR,—I have a large number of copies of PRACTICAL WIRELESS and PRACTICAL AND AMATEUR WIRELESS extending, with a few exceptions, over the last three years 1933-4-5. If any reader would like them he is welcome on payment of carriage.—A. H. SELICK.

[If any reader cares to forward the cost of carriage to us, the first letter received will be forwarded to Mr. Selick.—ED.]

SIR,—I have PRACTICAL AND AMATEUR WIRELESS from No. 1. I will loan any reader same on condition they are returned in a week and in good condition, post paid by the borrower. I have built your Prefect Shortwave 3, and I think it a fine little set and cheap to build.—S. SMITH (78, Manor Road, Itchen, Southampton).

SIR,—If any readers of PRACTICAL AND AMATEUR WIRELESS require any back numbers since 1933 they can have same by sending postage to this address.—H. W. WRIGHT (Address on application).

SIR,—I should be very pleased to buy, if possible, a copy of PRACTICAL WIRELESS dated May 6th, 1933, No. 569.—E. POACH (468, Shirley Road, Hall Green, Birmingham).

CUT THIS OUT EACH WEEK.

Do you know

—THAT to ensure good reception without undue sideband interference a band width of about 5 kc. is necessary.

—THAT under the above conditions good quality cannot be obtained, and this is one of the reasons for building a local station quality receiver.

—THAT a standard L.F. transformer may be used in a push-pull circuit by connecting two resistances across the secondary, with the junction earthed or returned to G.B.

—THAT the selection of anti-parasitic oscillation stoppers in the grid circuits of highly-efficient power valves should be made with great care.

—THAT a flash-lamp bulb connected to a loop of wire forms a good indicating device for oscillation in an inductive circuit.

—THAT some types of "screened" tuning coil are not completely screened unless mounted on a metal plate or its equivalent.

—THAT in some cases of instability the above point should be the first to receive attention, unless the coils are totally enclosed in a metal can.

The Editor will be pleased to consider articles of a practical nature suitable for publication in PRACTICAL AND AMATEUR WIRELESS. Such articles should be written on one side of the paper only, and should contain the name and address of the sender. Whilst the Editor does not hold himself responsible for manuscripts, every effort will be made to return them if a stamped and addressed envelope is enclosed. All correspondence intended for the Editor should be addressed: The Editor, PRACTICAL AND AMATEUR WIRELESS, Geo. Neumes, Ltd., 8-11, Southampton Street, Strand, W.C.2.

Owing to the rapid progress in the design of wireless apparatus and to our efforts to keep our readers in touch with the latest developments, we give no warranty that apparatus described in our columns is not the subject of letters patent.



**"PILOT"
ALL-WAVE
AERIAL KIT**

This "Pilot" Di-pole Balanced aerial will definitely improve the performance of your receiver, and, furthermore, it is essential if you want to get the best from your set, particularly on the "short" waves. Modern radio requires this modern aerial kit.

All radio energy reaching the "Pilot" Aerial is passed to the set without appreciable loss of power.

The "Pilot" Transformer included in the equipment still further "boosts" incoming signals and increases sensitivity and selectivity.

A switch gives change-over from normal to ultra-short or short-wave reception.

The "Pilot" low-impedance Down-Lead greatly reduces effects of Man-made or Etherial statics.

Set is fully protected by two "Pilot" lightning arresters. Simple installation instructions with every kit.

THIS PILOT KIT IS SHOWN ON PAGES 212 & 213

De Luxe Model 27/6 Post Paid

or obtainable through your local radio dealer.

If interested in All-wave developments, register your name on our mailing list "N."

Trade enquiries to:

STREAMLINE RADIO LTD.
146, THEOBALDS ROAD, LONDON, W.C.1

**ELECTRADIX
PUBLIC ADDRESS SPEAKERS**

with Tone Correct Horn and 8 Ohms. New Emerson Per. Mag. M.C. 15 watts without distortion. 24in. Flare, 40in. long, £8/8s. Marconiphones. P.M. Short Horn. Model P.A., 12-15 watts, as new. Cheap. Vitavox M.C. Units 10 watt size for outdoor horns, 30/-; Various High Power P.M. Speakers on baffles and in cabinet.

AMPLIFIERS. We can supply from stock 3, 6 or 10 watt Mains or Battery Amplifiers in portable or chassis form at lowest prices. Special Public Address or Dance Band Portable with mike and speaker, £12. Phillips 2 watt 110/230 v. small A.C. Mains Amplifier, £4/10/-; 10 watt A.C. Mains Amplifier, 200/250 v., now, with valves, steel case, £10 etc. etc.

Recording Gramo type ditto, with turntable, pick-up and mike, £15. Large Set for 16 watts output, with 4 speakers, £25. Amplifying Valves, Large, 100 watt Osram T3, T2A and a DET. 1/8W; all 65 valves at 45/- each. 300 watt AB500 Mullard and T7A Osram, 85/-.

DIG TRANSFORMERS. 5 K.W. Foster, 415 v. 50 cycle to 500 v., 1,000 v. and 2,000 v. £5 4 0
31 K.W. 230 v. 50 cycle to 130/150 v., 4 taps, 25 amps. £3 10 0
1 K.W. G.E.C. Heavy L.T. for Spot Welding, etc., 230 v. 50 cycles to 14/17 volts, 4 taps, 70/100 amps. 50/-
400 WATT BAYLISS 110/420 v. 50 cycle, 26 output taps for 100/400 volts.

New Radiogram 90 watt Converters D.C. to A.C. in Silence Cabinet £7. Large Rotaries, 150 to 500 watts from £3/17/8. Engine Alternators for field work. 50/-
500 WATT WESTON 100 v. 50 cycles to 500 volts. 40/-
Ditto 250 watts 230 volt to 50 volt 5 amps 35/-

ROTARY CONVERTERS AND ALTERNATORS, as new, for 220 v. D.C. or drive 150 and 200 watts. £3/17/8. 400 watts in Silence Cabinet, £16. Also 50 and 90 watt sets cheap.

HOME RECORDER UNIT. Engineer made, machine out gear tracker arm pick-up, cutter head, diamond needle. Ready attachment to gram. or diogram, 27/8.

Learn Morse at home. Cheap Home Learner's set, complete with battery and buzzer, on walnut base, 4/6.
1,000 other Bargains in New Sale List "N" Post Free.

ELECTRADIX RADIOS
218, UPPER THAMES ST., LONDON, E.C.4
Telephone: Central 4611

**Add 50/- WEEKLY
to your earnings**

Charge accumulators in your spare time

Complete Charger, incorporating Westinghouse Metal Rectifiers. Will charge 84 accumulators weekly.

Price £4.4.0 or 8/- monthly.

Send for full particulars.

M.P.R. ELECTRICAL CO., 252 Victoria Rd., Romford, Essex.



REPLIES IN BRIEF

The following replies to queries are given in abbreviated form either because of non-compliance with our rules, or because the point raised is not of general interest.

J. L. S. (Islington). The term resistor is actually more correct, but the component is the same thing as a resistance. Resistance is, of course, a property and is thus wrongly employed as a noun. However, it is a generally used term, and like many other radio terms is a misnomer. We cannot advise regarding the automatic bias without further details.

T. K. (Chilten). There are ways and means of using the set with a standard eliminator, but there are also eliminators with a number ofappings to suit a multiple H.T. supply. You cannot, however, have two H.T.—appings, and therefore have been misinformed or the plugs are wrongly marked.

L. D. D. (Nasrapur). We do not think it would be feasible to fit A.V.C. to the circuit in question. There are various schemes for obtaining this feature, but they would entail such drastic modifications to the set that you would probably find that the H.F. stages would need to be re-designed.

L. H. (Southend-on-Sea). The International Correspondence Schools would no doubt be able to supply you with information on the subject, although we do not think that Servicing forms the subject of a complete course. It would probably be only a part of the complete Wireless Course.

P. J. B. (Hammersmith). Can you give any further details of the set? We cannot agree to service it until you have made some efforts to obtain satisfactory working, as in such a case we should be inundated with receivers which failed to work immediately on switching on. We shall be pleased to assist you by answering queries if you will enclose a stamped and addressed envelope.

F. B. (Tonbridge). We suggest that you communicate with H.M.S. President, Victoria Embankment, E.C.4.

B. A. S. (N.4). You have the crystal connected across the tuning coil. It should, of course, be in series with the phones, the two then being connected in parallel with the coil. The variable condenser remains as now shown. Write to the Hon. Sec., T. Battersby, Southgate Television Society, 20, Palmerston Crescent, Palmers Green, N.13.

R. P. S. (Haddington). The gang condenser may be of the "straight" type. Alternatively, the oscillator may be adjusted to the wrong frequency. We advise more careful adjustment of this section after checking that the condenser is of the superhet type.

R. T. W. (Sheffield). The coils may not be sufficiently well matched to warrant a ganged tuning circuit. We suggest that you obtain modern coils which are designed for a ganged condenser when you should experience no difficulty in converting the set.

F. N. (Wealdstone). We regret that we no longer include station identification in our queries service.

F. M. (New Beckton). We cannot supply blueprints of commercial receivers and we have no data regarding your particular set.

P. F. (Worcester Park). The oscillation may be due to the layout, caused by interaction between components or even between the wiring. Without details, and as the set is not one of our designs, we cannot assist you. The noise may be local interference or simply the normal background noises usual with a powerful set of the type you have built.

G. N. (Liverpool). We have no details of your receiver and cannot trace the name in our records of commercial receivers.

S. M. (Muswell Hill). There should be no noises of the type mentioned with this particular receiver. There may be a faulty valve, or the set may simply be unstable due to bad wiring or a defective component.

S.S. (Leicester). We can only recommend our blueprints when it is desired to build the set with the specified parts. You could, of course, substitute your own parts, but we could not then guarantee results. As the present parts have been dismantled from an old set which presumably failed to give satisfaction, there is a possibility that this was due to faulty components and if you build a new set with these parts you will simply be transferring the trouble to the new set.

A. J. (Kenton). The wire should be 22 gauge D.C.C. for medium waves and 28 D.S.C. for the long waves. We do not think very good results could be expected from the two-valve with a frame aerial and you would certainly not load the loud-speaker.

J. H. T. (Kirkdale). We recommend blueprint WM.392. This is the largest type of amplifier we have designed.

HOME CHARGING!

You can build your own low-tension battery charger, from a HEAYBERD Kit of Parts, in 30 minutes.

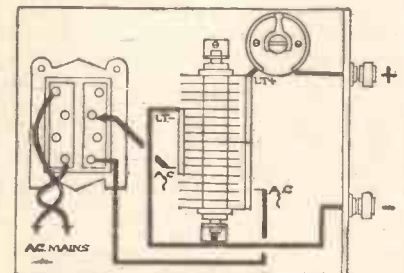

Home Battery charging is CHEAPER, it SAVES TIME, and it ensures that the accumulator is always WELL UP. These HEAYBERD chargers incorporate METAL RECTIFIERS.

Set	Charges	Price
L.T.2	2, 4 or 6 volts at 1/2 amp.	30/6
L.T.4	2, 4 or 6 volts at 1 amp.	32/6
L.T.5	6, 10 or 12 volts at 1 amp.	41/-
L.T.6	2, 4 or 6 volts at 2 amps.	54/6

SEND NOW for the New Heayberd
List No. 983, describing complete Battery Chargers and Kits of Parts.

Mr.
Address

F. C. HEAYBERD & Co. 10, FINSBURY STREET, LONDON, E.C.2.

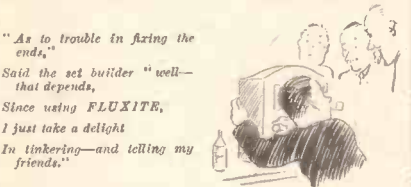

See that FLUXITE is always by you—in the house—garage—workshop—wherever speedy soldering is needed. Used for 30 years in government works and by leading engineers and manufacturers. Of Ironmongers—in tins, 4d., 8d., 1/4 and 2/8.

Ask to see the FLUXITE SMALL-SPACE SOLDERING SET—compact but substantial—complete with full instructions, 7/6.

Write for Free Book on the art of "soft" soldering and ask for Leaflet on CASE-HARDENING STEEL and TEMPERING TOOLS with FLUXITE.

TO CYCLISTS! Your wheels will NOT keep round and true unless the spokes are tied with fine wire at the crossings AND SOLDERED. This makes a much stronger wheel. It's simple—with FLUXITE—but IMPORTANT.

THE FLUXITE GUN

is always ready to put Fluxite on the soldering job instantly. A little pressure places the right quantity on the right spot and one charging lasts for ages.
Price 1/6.



ALL MECHANICS WILL HAVE

FLUXITE

IT SIMPLIFIES ALL SOLDERING

FLUXITE LTD. (Dept. W.P.) DRAGON WORKS, BERMONDSEY STREET, S.E.1.

**FREE ADVICE BUREAU
COUPON**

This coupon is available until May 16, 1936, and must be attached to all letters containing queries.
PRACTICAL AND AMATEUR WIRELESS,
9/5/36.

Practical and Amateur Wireless BLUEPRINT SERVICE

PRACTICAL WIRELESS STRAIGHT SETS. Battery Operated.		
One-valve: Blueprints, 1s. each.	Date of Issue.	No. of Blueprint
All-Wave Unipeu (pentode) ..	—	PW31A
Two-valve: Blueprints, 1s. each.		
Four-range Super Mag Two (D, Pen)	11.8.34	PW36B
Three-valve: Blueprints, 1s. each.		
Selectone Battery Three (D, 2 LF (trans.)) ..	—	PW10
Sixty-Shilling Three (D, 2 LF (R.C. & trans.)) ..	2.12.33	PW34A
Leader Three (SG, D, Pow.) ..	—	PW35
Summit Three (HF Pen, D, Pen)	18.8.34	PW37
All-Pentode Three (HF Pen, D (pen), Pen)	22.0.34	PW39
Hall-Mark Three (SG, D, Pow.) ..	—	PW41
Hall-Mark Cadet (D, L.F. Pen (R.C.)) ..	16.3.35	PW48
F. J. Camm's Silver Souvenir (HF Pen, D (pen), Pen) (All-Wave Three)	13.4.35	PW49
Genet Midget (D, 2 LF (trans.)) ..	June '35	PM2
Cameo Midget Three (D, 2 LF (trans.)) ..	8.6.35	PW51
1936 Sonotone Three-Four (HF Pen, HF Pen, Westector, Pen)	17.8.35	PW53
Battery All-Wave Three (D, 2 LF (R.C.)) ..	31.8.35	PW55
The Monitor (HF Pen, D, Pen)	8.2.36	PW01
The Tutor Three (HF Pen, D, Pen)	21.3.36	PW02
The Centaur Three (SG, D, P)	7.12.35	PW04
Four-valve: Blueprints, 1s. each.		
Fury Four (2 SG, D, Pen)	—	PW11
Beta, Universal Four (SG, D, LF, Cl. B)	15.4.33	PW17
Nucleon Class B Four (SG, D (SG), LF, Cl. B)	6.1.34	PW34B
Fury Four Super (SG, SG, D, Pen)	—	PW34C
Battery Hall-Mark 4 (HF Pen, D, Push-Pull)	—	PW46
F. J. Camm's Performer (SG, SG, D, Pen.) ..	12.10.35	PW57
Mains Operated.		
Two-valve: Blueprints, 1s. each.		
A.C. Twin (D (pen), Pen)	—	PW18
A.C.-D.C. Two (SG, Power)	7.10.33	PW31
Selectone A.C. Radiogram Two (D, Pow.) ..	—	PW19
Three-valve: Blueprints, 1s. each.		
Double-Diode-Triode Three (HF Pen, D, D.T., Pen)	10.6.33	PW23
D.C. Ace (SG, D, Pen)	15.7.33	PW25
A.C. Three (SG, D, Pen)	—	PW29
A.C. Leader (HF Pen, D, Power)	7.4.34	PW35C
D.C. Premier (HF, Pen, D, Pen)	31.3.34	PW35D
Ubique (HF Pen, D (Pen), Pen)	28.7.34	PW36A
Armada Mains Three (HF Pen, D, Pen)	18.8.34	PW38
F. J. Camm's A.C. All-Wave Silver Souvenir Three (HF Pen, D, Pen)	11.5.35	PW50
"Allwave" A.C. Three (D, 2LF (R.C.)) ..	17.8.35	PW54
A.C. 1936 Sonotone (HF Pen, HF Pen, Westector, Pen)	31.8.35	PW56
Four-valve: Blueprints, 1s. each.		
A.C. Fury Four (SG, SG, D, Pen)	—	PW20
A.C. Fury Four Super (SG, SG, D, Pen)	—	PW34D
A.C. Hall-Mark (HF Pen, D, Push-Pull)	—	PW46
Universal Hall-Mark (HF Pen, D, Push-Pull)	9.2.35	PW47
SUPERHETS.		
Battery Sets: Blueprints, 1s. each.		
£5 Superhet (Three valve)	—	PW40
F. J. Camm's 2-valve superhet (two valve)	13.7.35	PW52
F. J. Camm's £4 Superhet 4	—	PW58

Mains Sets: Blueprints, 1s. each.		
A.C. £5 Superhet (three valve) ..	1.12.34	PW43
D.C. £5 Superhet (three valve) ..	—	PW42
Universal £5 Superhet (three valve)	—	PW44
F. J. Camm's A.C. £4 Superhet 4	7.12.35	PW50
F. J. Camm's Universal £4 Superhet 4	11.1.36	PW60
Two-valve: Blueprints, 1s. each.		
Midget Short-Wave Two (D, Pen)	15.9.34	PW38A
Three-valve: Blueprints, 1s. each.		
Experimenter's Short-wave Three (SG, D, Power)	—	PW30A
The Prefect 3 (D, 2 LF, RC and Trans.) ..	8.2.36	PW63
Four-valve: Blueprints, 1s. each.		
Featherweight Portable Four (SG, D, LF, Cl. B)	—	PW12
MISCELLANEOUS.		
S.W. Converter-Adapter (1 valve)	23.2.35	PW48A
AMATEUR WIRELESS AND WIRELESS MAGAZINE CRYSTAL SETS.		
Blueprints, 6d. each.		
Four-station Crystal Set ..	—	AW427
1934 Crystal Set ..	—	AW444
150-mile Crystal Set ..	—	AW450
One-valve: Blueprints, 1s. each.		
R.B.C. Special One-valver ..	—	AW387
Twenty-station Loud-speaker One-valver (Class B) ..	—	AW449
Two-valve: Blueprints, 1s. each.		
Melody Ranger Two (D, Trans) ..	—	AW388
Full-volume Two (SG, Det, Pen)	—	AW392
Iron-core Two (D, Trans) ..	—	AW395
Iron-core Two (D, Q.P.P.) ..	12.8.33	AW396
B.B.C. National Two with Lucerne Coil (D, Trans) ..	—	AW377A
Big-power Melody Two with Lucerne Coil (SG, Trans) ..	—	AW398A
Lucerne Minor (D, Pen) ..	—	AW426
Three-valve: Blueprints, 1s. each.		
Class-B Three (D, Trans, Class B)	22.4.33	AW386
New Britain's Favourite Three (D, Trans, Class B) ..	15.7.33	AW394
Home-Built Coil Three (SG, D, Trans)	—	AW404
Fan and Family Three (D, Trans, Class B) ..	25.11.33	AW410
£5 5s. S.G.3 (SG, D, Trans)	2.12.33	AW412
1934 Ether Searcher: Baseboard Model (SG, D, Pen)	20.1.34	AW417
1934 Ether Searcher: Chassis Model (SG, D, Pen) ..	—	AW419
Lucerne Ranger (SG, D, Trans) ..	—	AW422
Cosmor Melody Maker with Lucerne Coils ..	—	AW423
P.W.H. Mascot with Lucerne Coils (D, RC, Trans) ..	—	AW337A
Mullard Master Three with Lucerne Coils ..	—	AW424
£5 5s. Three: De Luxe Version (SG, D, Trans)	10.5.34	AW435
Lucerne Straight Three (D, RC, Trans)	—	AW437
All Britain Three (HF Pen, D, Pen)	—	AW448
"Wireless League" Three (HF Pen, D, Pen)	3.11.34	AW451
Transportable Three (SG, D, Pen)	—	WM271
£6 6s. Radiogram (D, RC, Trans)	—	WM318
Simple tune Three (SG, D, Pen)	June '33	WM327
Economy-pentode Three (SG, D, Pen)	—	WM337
"W.M." 1934 Standard Three (SG, D, Pen)	Oct. '33	WM337
£3 3s. Three (SG, D, Trans)	Mar. '34	WM351
Iron-core Band-pass Three (SG, D, QP21)	June '34	WM362
1935 £6 6s. Battery Three (SG, D, Pen)	—	WM371
Graduating to a Low-frequency Stage (D, 2LF) ..	—	WM378

These blueprints are full size. Copies of appropriate issues containing descriptions of these sets can in most cases be obtained as follows:—
 "Practical Wireless" at 4d., "Amateur Wireless" at 4d., "Practical Mechanics" at 7d., and "Wireless Magazine" at 1/3d., post paid. Index letters "P.W." refer to "Practical Wireless" sets, "P.M." to "Practical Mechanics" sets, "A.W." refer to "Amateur Wireless" sets, and "W.M." to "Wireless Magazine" sets. Send (preferably) a postal order (stamps over sixpence unacceptable) to "Practical and Amateur Wireless" Blueprint Dept., Geo. Newnes, Ltd., 8-11, Southampton Street, Strand, W.C.2.

P.T.P. Three (Pen, D, Pen)	June '35	WM389
Certainty Three (SG, D, Pen)	Sept. '35	WM393
Minutube Three (SG, D, Trans)	Oct. '35	WM396
All-wave Winning Three (SG, D, Pen)	Dec. '35	WM400
Four-valve: Blueprints, 1s. 6d. each.		
65/- Four (SG, D, RC, Trans)	—	AW370
"A.W." Ideal four (2SG, D, Pen)	16.9.33	AW402
2 H.F. Four (2SG, D, Pen)	—	AW421
Crusaders' A.V.C. 4 (2HF, D, QP21)	18.8.34	AW445
(Pentode and Class-B Outputs for above: blueprints (6d. each) ..	25.8.34	AW445A
Self-contained Four (SG, D, LF, Class B) ..	Aug. '33	WM331
Lucerne Straight Four (SG, D, LF, Trans)	—	WM350
£5 5s. Battery Four (HF, D, 2LF)	Feb. '35	WM381
The H.K. Four ..	Mar. '35	WM384
Five-valve: Blueprints, 1s. 6d. each.		
Super-quality Five (2HF, D, RC, Trans)	May '33	WM320
New Class-B Five (2SG, D, LF, Class B) ..	Nov. '33	WM340
Class-B Quadradyne (2SG, D, LF, Class B) ..	Dec. '33	WM344
1935 Super Five (Battery Superhet)	—	WM379
Mains Operated.		
Two-valve: Blueprints, 1s. each.		
Conoselectric Two (D, Pen) A.C. ..	23.9.33	AW403
Economy A.C. Two (D, Trans) A.C.	—	WM286
Unicorn A.C./D.C. Two (D, Pen) ..	Sept. '35	WM394
Three-valve: Blueprints, 1s. each.		
Home-lover's New All-electric Three (SG, D, Trans) A.C. ..	—	AW382
S.G. Three (SG, D, Pen) A.C. ..	—	AW390
A.C. Triodyne (SG, D, Pen) A.C.	19.8.33	AW399
A.C. Pentaquester (HF, Pen; D, Pen) A.C.	23.6.34	AW439
Mantovani A.C. Three (HF, Pen, D, Pen) A.C.	—	WM374
£15 15s. 1936 A.C. Radiogram (HF, D, Pen) ..	Jan. '36	WM401
Four-valve: Blueprints, 1s. 6d. each.		
All Metal Four (2 SG, D, Pen)	July '33	WM329
Harris Jubilee Radiogram ..	May '35	WM386
SUPERHETS.		
Battery Sets: Blueprints, 1s. 6d. each.		
Modern Super Senior ..	—	WM375
Varsity Four ..	Oct. '35	WM395
Mains Sets: Blueprints, 1s. 6d. each.		
1934 A.C. Century Super A.C. ..	10.3.34	AW425
Heptode Super Three A.C. ..	May '34	WM359
"W.M." Radiogram Super A.C.	—	WM366
1935 A.C. Stenode ..	Apr. '35	WM385
PORTABLES.		
Four-valve: Blueprints, 1s. 6d. each.		
Midget Class-B Portable (SG, D, LF, Class B)	20.5.33	AW638
Holiday Portable (SG, D, LF, Class B) ..	17.5.33	AW393
Family Portable (HF, D, RC, Trans)	22.9.34	AW447
Two H.F. Portable (2 SG, D, QP21)	June '34	WM363
Tyers Portable (SG, D, 2 Trans)	Aug. '34	WM367
SHORT-WAVES—Battery Operated.		
One-valve: Blueprints, 1s. each.		
S.W. One-valve converter (price 6d.) ..	—	AW329
S.W. One-valve for America ..	—	AW429
Roma Short-waver ..	—	AW452
Two-valve: Blueprints, 1s. each.		
Ultra-short Battery Two (SG det, Pen)	Feb. '36	WM402
Home-made Coil Two (D, Pen) ..	—	AW440

THE ONE AERIAL FOR THE MODERN SET

PIX INVISIBLE AERIAL

PIX, LONDON, S.E.1.

Neat
Efficient
Blends with furnishings
Self-Adhesive

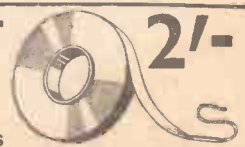

Double Length 3/6

2/-



QUERIES and ENQUIRIES

The coupon on page 221 must be attached to every query.

A Chassis Precaution

"I transferred a reasonably good S.-W. three-valve battery set from a baseboard to an aluminium chassis. The operation of the reaction condenser became erratic, and I could tune stations in and out. Also there was a very bad hum. I then built a standard broadcast set with only one valve, and exactly the same thing occurred. Negative leads and earth are connected to the chassis. How can I cure it by using the chassis?"—C. M. B. (Patcham).

It is probable that you have overlooked the fact that the reaction condenser has a "live" spindle. That is to say, the spindle is in contact with the fixing bush and thus when this is mounted on a metal bracket which is in turn mounted on the chassis the spindle of the reaction condenser is automatically earthed. If the reaction coil is connected on the earth side of the reaction condenser it would be short-circuited by the above method of mounting unless an insulating bush were used on the mount. Alternatively, the reaction coil must be joined between the anode of the valve and the fixed plates of the reaction condenser, when the spindle of this component may be earthed without difficulty. Some makes of coil, unfortunately, prevent this connection from being employed as the reaction coil is connected to the earthed end of the grid winding in the coil itself.

The Simplest Short-waver

"In your issue dated March 21st last you published a diagram of a single-valve S.-W. set or adapter. You did not mention the values of the reaction or tuning condensers, nor did you give the diameter of the coil-former nor the gauge of wire used to wind it. I would also like to know what commercial makes of component you suggest."—K. H. (Ballymena).

THE illustration was of a receiver which was fully described in our issue dated September 14th last, wherein all details will be found. However, the tuning condenser was a standard .0005 mfd. component with a .0003 mfd. fixed condenser connected in series to reduce its overall capacity. The reaction condenser has a maximum capacity of .0003 mfd. The coil former has a diameter of 2in., and the grid coil is wound with 20-gauge enamelled wire. The remaining windings are wound with 26-gauge enamelled wire. Commercial substitutes may be obtained from Eddystone, Raymart, B.T.S. and other firms specialising in short-wave components, and the tuning condenser may be a standard short-wave component with a maximum capacity of .00016 mfd., in which case the .0003 mfd. fixed condenser would be omitted.

What is Squelch?

"What is a squelch valve and its purpose? Also, where a piezo electric pick-up requiring a volume control of 500,000

RULES

We wish to draw the reader's attention to the fact that the Queries Service is intended only for the solution of problems or difficulties arising from the construction of receivers described in our pages, or on general wireless matters. We regret that we cannot, for obvious reasons—

- (1) Supply circuit diagrams of complete multi-valve receivers.
- (2) Suggest alterations or modifications of receivers described in our contemporaries.
- (3) Suggest alterations or modifications to commercial receivers.
- (4) Answer queries over the telephone.
- (5) Grant interviews to quicists.

Please note also, that queries must be limited to two per reader, and all sketches and drawings which are sent to us should bear the name and address of the sender.

If a postal reply is desired, a stamped addressed envelope must be enclosed. Send your queries to the Editor, PRACTICAL AND AMATEUR WIRELESS, Geo. Newnes, Ltd., 8-11, Southampton Street, Strand, London, W.C.2.

ohms is to be used on a set fitted with A.V.C., the volume control (50,000 ohms) controlling both radio and gramophone, would this have to be replaced by a volume control of 500,000 to enable the crystal pick-up to work satisfactorily, and, if so, would this alteration affect the working of the set on radio?"—G. D. H. (Hounslow).

IN a receiver fitted with A.V.C. it is found that the control is at maximum, and thus the H.F. amplification at minimum, when a powerful signal is received. Consequently, when tuned to a point on the dial where no transmission is heard, the A.V.C. action is at a minimum and H.F. amplification at maximum, with the result that all the various atmospheric crackles and noises, as well as inter-valve hiss, etc., are reproduced at full strength. Thus the operation of tuning such a receiver is distressing, due to the terrible noise directly a station is tuned out. One way of overcoming this is to fit a manual volume control and a visual indicator, setting the control to the point of minimum volume and then turning the tuning control until the indicator shows that a worth-while station is tuned, when the manual volume control may be turned up to the desired level. Alternatively, a valve may be fitted and connected in such a manner that when no worth-while signal is tuned in the L.F. valves are "squelched" (or paralysed, or any other term you wish); in other words, the L.F. amplification is only effective and the loud-speaker only reproduces signals of good volume. It may be so arranged that only the one or two signals which are at worth-while strength will be heard and all weaker signals will be suppressed. There are other ways of obtaining the same end without the use of a special squelch valve. It may prove desirable to modify your circuit to use the pick-up, although the present volume-control may be capable of modification without seriously affecting its effect on radio. We cannot give any more definite information in the absence of full circuit details.

THE BULGIN WALLERIAL

MODERN RADIO conditions demand modern equipment. Aerials are particularly important: be up-to-date!

The Bulgin Wallerial is a scientific equipment providing an Aerial to suit any requirements and all conveniences. Its scope is unlimited. Complete equipment: 2 Insulators, 100ft. wire, 10 spacers, and spring.

List No. L.8 . 7/6 Complete Kit.
BULGIN AERIAL SWITCH.
This guaranteed switch gives complete protection at low cost. It provides: a spark-gap, a fuse, and an earthing Switch. Snap-action and position-indicators. £100 guarantee of safety from storms.
List No. S.99 . 2/6 each.
BULGIN AERIAL INSULATOR.
A strong moulded Suspension type Aerial Insulator which provides a long dry insulation path under all weather conditions. Years of service are assured, and no losses are introduced.
List No. L.3 1/6 each.

BULGIN

To Messrs. A. F. Bulgin & Co. Ltd.,
Abbey Road, Barking, Essex.

Please send me post-free your Complete 100-page Catalogue No. 155 "N." I enclose 3d. stamps.

Name
Address

(please use BLOCK letters)

A. F. BULGIN & CO. LTD., ABBEY RD., BARKING.
Tel. RIPPLEWAY 3474 (3 lines.)

THE POLYTECHNIC REGENT STREET, LONDON, W.1.

A Special Course of Four Lectures on
TELEVISION

will be given by
H. J. BARTON-CHAPPLE, Wh.Sch., B.Sc., A.C.G.I.
A.M.I.E.E.,
on Monday evenings, 6.30-8.0, beginning
18th May, 1936.

The lectures will be illustrated by experiments, lantern slides, and demonstrations on modern television receiving equipment.

FEE FOR THE COURSE—6/-.

Syllabus on application to the Director of Education.

EASY TERMS

EVERYTHING RADIO supplied on the lowest terms. Send list of requirements for quotation by return. Prompt delivery. Cash and C.O.D. Orders Despatched by Return.

W.B. STENTORIAN UNITS

36.S Cash Price £2/2/0, or 2/6 WITH ORDER and 11 monthly payments of 4/-.
36.J Cash Price £1/12/6, or 2/6 WITH ORDER and 11 monthly payments of 3/-.
ROLA L.S. UNITS SUPPLIED ON SIMILAR TERMS.
ALL CARRIAGE PAID.

Estd. 1925 THE **PHONE NATIONAL 1977**

LONDON RADIO SUPPLY COMPANY

11, OAT LANE, NOBLE STREET, LONDON, E.C.2

Miscellaneous Advertisements

Advertisements are accepted for these columns at the rate of 3d. per word. Words in black face and/or capitals are charged double this rate (minimum charge 3/- per paragraph). Display lines are charged at 6/- per line. All advertisements must be prepaid. All communications should be addressed to the Advertisement Manager, "Practical and Amateur Wireless," 8, Southampton Street, Strand, London.

RECEIVERS, COMPONENTS AND ACCESSORIES

Surplus, Clearance or Secondhand, etc.

PREMIER SUPPLY STORES

OFFER the Following Manufacturers' Brand New Surplus Goods at a Fraction of the Original Cost. All Goods guaranteed perfect. Carriage paid over 5/-; under 5/-, postage 6d. extra; I.F.S. and abroad, carriage extra. Orders under 5/- cannot be sent C.O.D.

WORLD-FAMOUS Continental Mains Valves, 4/6 each. HL., L., S.G., Var.-Mu-S.G., H.F.-Pens., Var.-Mu-H.F. Pens. 1, 3 and 4-watt A.C. directly-heated output Pentodes. Full-wave rectifiers, 250 v. 60 m.a. Frequency Changers, Octodes and Heptodes. A.C./D.C. types. 20-volt 18 amp. S.G., Var.-Mu-S.G. H., HL., Power and Pentodes.

Following Types all 5/6 each. Full-wave rectifiers 350 v. 120 m.a. and 500 v. 120 m.a. 2 1/2 watt indirectly-heated Pentodes. 2 1/2 watt indirectly-heated Power. 2v. Battery Types. H.F., L.F. 2/3. Power, Economy Power, Super-Power 2/9. S.G., Var.-Mu-S.G., 4 or 5-pin Pentodes, H.F. Pens., V.-Mu-H.F. Pens. 5/-. Class B 3/6.

American HYTRON valves, all types with 3 months' Guarantee, 5/6.

SHORT WAVES! SHORT WAVES!! SHORT WAVES!!!

PREMIER S.W. Tuning Condensers (S.L.F.), complete ceramic insulation; silver-sprayed brass vanes, noiseless pitfall. .00015; .00016; .0001 2/9 each. Double-spaced .00005; .000015; .000025 3/- each. Brass S.W. Reaction Condensers. .00015, integral slow-motion 2/9; mica condensers, .000025, .00005, 6d. Premier S.W. Coils with circuit. Set of 4, 13-170 metres, 7/- set. 4 or 6-pin. Reliable S.W. Coils, 4-pin, 14-150 metres. 4/- set of 3 with circuit.

Lowloss ribbed Formers, 4 and 6-pin, 1 1/2" diameter, 1/- S.W. Steatite valve-holders. Chassis 4, 5 or 7-pin 6d. Baseboard 8d.

Premier all-brass S.W. condensers. .00015 with integral slow-motion 3/9.

Ormond condensers. O.K. for short waves. Marvellous value! .00025 1/8; with slow-motion 2/-; all-brass slow-motion .00025 2/6.

Premier S.W. H.F. chokes, 10-200 metres, 9d.; Screened S.W. H.F. chokes 1/6.

Reliable Morse Keys with code engraved on Bakelite base 2/-; Buzzers 1/6; enclosed type 2/6.

Potentiometers by well-known makers. All up to 1 meg. 2/-; with switch 2/6.

Lissen 3-gang Band-Pass Screened Coils, with switching and blueprint, 6/11.

Special Offer. Band-Pass Kit, 14/6 the lot. Lissen 3-gang Coil unit. Utility 3-gang condenser and Disc Drive, 4 valve-holders, Chassis and Blueprint.

Lissen All-wave 2-gang screened Coils with switching, 12-2,000 metres. 12/6.

Iron-cored coils with circuit 2/11 each. Clarion moving-light slow-motion dial, 2" knob, 2/-.

Premier dual-ratio full-vision drive, ratios 10-1 and 150-1. Perfect for short waves. 6/6.

SPECIAL Offer. H.T. Elliminator Kits for A.C. mains. 120 v. 20 m.a. 8/6; 150 v. 25 m.a. 10/-, tapped S.G., Detector and Output. Complete Kit with long-life valve rectifier (replacement cost only 2/-).

Milliammeters, moving-iron, flush 2 1/2", all ranges from 0-10 5/9. Visual tuning, 6 or 12 m.a., 5/-. Moving-coil meters, 2 1/2" 0-1 m.a. 18/6; 3 1/2" 0-1 m.a. 22/6.

Multipliers 1/- each. Westinghouse meter rectifiers 17/6 each.

MAGNAVOX SPEAKERS. Mains energised. '154', 7" cone, 2,500 ohms 4 watts, 12/6. '154 Magna', 5 watts, 25/-; '152', 9" cone, 2,500 ohms, 17/6; '152 Magna', 9" cone, 2,500 ohms, 6 watts, 37/6.

Magnavox P.M.s.—'254', 7" cone, 16/6; '252', 9" cone, 22/6. Reliable P.M.'s 10/6; Cossor P.M.'s 13/6; Blue Spot 29 P.M. 15/-.

BALANCED armature speaker units 3/6 each.

PREMIER L.T. Charger Kits with Westinghouse Rectifiers. 2 to 6 volt 1 amp. 14/6; 2 to 6 volt 1 amp 17/6; 2 to 6 volt 2 amp. 27/6; 30 volts 1 amp. 37/6.

ELECTROLYTICS. U.S.A. 4, 8 or 12 mfd. 530 v. peak, 1/9 each. Dubilier, 4 or 8 mfd. 500 v., 3/-; 50 mfd. 50 v. 1/9; 12 mfd. 20 v. 6d.; 25 mfd. 25 v. 1/-; T.C.C. 4 or 8 mfd. 650 v. 4/-; 15 mfd. 50 or 100 v. 1/-; 50 mfd. 12 v. 1/-.

Paper Condensers. W.E., 250 v. working 4 mf. 2/-, 2 mf. 1/-, 1 mf. 6d.; 350 v. working 4 mf. 2/6, 2 mf. 1/6, Dubilier 500 v. working 4 mf. 4/-; 800 v. 4 mf. 5/-; 2 mf. 750 v. 3/-.

Wego 450 v. working 1 mf. 1/-, 2 mf. 1/9, 4 mf. 3/-; 700 v. working 2 mf. 2/-, 4 mf. 3/6; 1,650 v. working 1 mf. 3/6, 2 mf. 5/6.

PREMIER Screened H.F. chokes, 100-2,000 metres, 1/6.

Premier Mains HFC, carry 1 amp. 1/6.

(Continued at top of column three)

PREMIER SUPPLY STORES

have pleasure in announcing the issue of their

NEW ILLUSTRATED GIANT CATALOGUE AND VALVE LIST

Crammed with hundreds of Radio Bargains that will amaze and delight every Radio enthusiast. Send 4d. in stamps for the Wonder-List, produced by the

LARGEST SURPLUS-RADIO MAIL-ORDER HOUSE IN THE WORLD!!

Here are a few of our many Snips: Another wonderful 'PREMIER' purchase. 50,000 Genuine AMERICAN 'DUOTRON' VALVES. Every type you can possibly want. We offer these at the unheard-of price of 3/6 each.

PREMIER SHORT-WAVE KIT for 1 Valve Receiver or Adaptor, complete with Chassis, 3 Coils, 15-170 metres. Condensers, Circuit and all parts.

VALVE GIVEN FREE!! 12/6

PREMIER MAINS TRANSFORMERS (Wire-end type).

250 + 250 or 300 + 300 v. 60 ma. 4v. 1-2a., 4v. 2-3a., 4v. 3-4a., all C.T. H.T. 8 & 9, 4v. 1a, 4v. 4a., all C.T. H.T. 10, 4v. 1a., 4v. 8/6 each. 4a., all C.T.

350 + 350 v. 120 m.a. 4v. 1-2a., 4v. 2-3a., 4v. 3-4a., all C.T. 10/6

500 + 500 v. 150 m.a., 4v. 2-3a., 4v. 2-3a., 4v. 2-3a., 4v.3-4a., all C.T. 19/6

5,000 TELSEN RG4. L.F. TRANSFORMERS

latest type Super L.F. All brand new and boxed (Listed 12/6) 2/9

COSMOCORD GRAMO UNIT, comprising A.C. Motor 100/250v. and Super-Sensitive Pick-up, Unit Plate and Vol. Control. (Listed 55/-) Our price 35/9

PREMIER SUPPLY STORES

20-22, HIGH STREET, CLAPHAM, S.W.4.

Macauley 2381.

165 & 165a, FLEET STREET, E.C.4.

Central 2833

(Next door to Anderton's Hotel)

See also Classified Advt.

(Continued from foot of column one)

Premier Smoothing Chokes. 25 m.a. 20 henries 2/9; 40 m.a. 30 henries 4/-; 60 m.a. 40 henries 5/6; 150 m.a. 40 henries 10/-; 60 m.a. 80 henries 2,500 ohms for speaker replacement 5/6.

G.E.C. A.C./D.C. All-Mains Three-Valve receivers complete in handsome cabinet with Moving-coil Speaker and G.E.C. Valves. Ready to plug in. In original sealed cartons with maker's guarantee (Listed £7/15/0, 75/-).

2-VALVE Battery receivers in bakelite cabinet, complete with speaker and 2 Mullard valves (less batteries), 25/-.

PREMIER SUPPLY STORES.

20-22, High Street, Clapham, S.W.4. Open till 9 p.m. Saturdays. Wednesday 1 p.m. Macauley 2381. 165 and 165a, Fleet Street, E.C.4 (next door to Anderton's Hotel). Early closing, Saturday 1.30 p.m. Central 2833. All post orders to Clapham.

RADIO CLEARANCE

63, HIGH HOLBORN, W.C.1

TEL.: HOLBORN 4631.

70/- LISSEN BAND PASS 3 BATTERY SETS. Complete in handsome Walnut cabinets, Iron Cored Coils, Band Pass tuned, P.M. Moving Coil Speaker and Valves. Brand new. List £8 10s.

5/- TRIAD VALVES. 01-A, 24A, 27, 30, 31, 32, 33, 35, 37, 38, 39, 41, 42, 43, 45, 46, 47, 53, 55, 56, 57, 58, 59, 71A, 75, 78, 80, 6A6, 10C, 6F7, 2A3, 5Z3, 12A7, 6A7, 6C6, 6D6, 12Z3, 25Z5.

3/6 LISSEN 2 VOLT CLASS B VALVES. Type BB.220 A. Brand new, boxed.

8/6 COMPLETE LISSEN SUPERHET ASSEMBLY. Comprising 3 Gang Superhet Condenser. 126 kc/s Oscillator Section. Set of Ganged Superhet Coils with Switch and two 126 kc/s I.F. Transformers. A Wonderful Bargain.

2/11 LISSEN INTERMEDIATE FREQUENCY TRANSFORMERS. 126 kc/s Brand new, boxed. List price, 8/6.

8/11 BRYCE MAINS TRANSFORMERS. 250-0-250, 80 m.a. 2-0-2 volts, 2.5 amps., 2-0-2 volts, 4 amps. Shrouded.

9/6 350-0-350 volts, 120 m.a., 2-0-2 volts, 2.5 amps., 2-0-2 volts, 4 amps. Shrouded.

11/6 350-0-350 volts, 150 m.a., 2-0-2 volts, 2.5 amps., 2-0-2 volts, 4 amps., 2-0-2 volts, 2 amps. Shrouded.

17/6 500-0-500 volts, 150 m.a., 2-0-2 volts, 2.5 amps., 2-0-2 volts, 6 amps., 2-0-2 volts, 2 amps. Shrouded.

8/11 H.T.S. TRANSFORMERS. 250 volts, 60 m.a., 2-0-2 volts, 4 amps.

17/6 DITTO. With H.T.S Metal Rectifier.

ALL THE ABOVE TRANSFORMERS ARE OF FIRST CLASS MANUFACTURE, BRAND NEW AND CARRY MAKERS' GUARANTEE.

2/6 8 mfd. and 4 mfd. DRY ELECTROLYTIC CONDENSERS. By well-known manufacturer. 450 volt working, 500 volt peak. Brand new.

HIVAC VALVES. Complete range in stock, send for lists.

2/- G.E.C. 110 kc/s INTERMEDIATE FREQUENCY COILS. Complete with two trimmers.

1/3 G.E.C. 500,000 ohms VOLUME CONTROLS. With Switch.

9d. LISSEN R.C. UNIT. Brand new, boxed, list price, 3/6.

ALL ORDERS VALUE 10/- OR OVER, CARRIAGE PAID IN UNITED KINGDOM.

ORDERS UNDER 10/- MUST BE ACCOMPANIED BY A REASONABLE AMOUNT OF POSTAGE. NO ORDERS UNDER 10/- WILL BE DEALT WITH UNLESS POSTAGE IS INCLUDED.

RADIO CLEARANCE

63, HIGH HOLBORN, W.C.1

TEL.: HOLBORN 4631.

ALL goods previously advertised are standard lines, still available. Post card for lists free.

VAUXHALL UTILITIES, 163a, Strand, W.C.2. Over Denny's the Booksellers. Temple Bar 9338.

BANKRUPT Bargains. List free. All new goods.

BAlba 3v S.G. Pentode receivers, MC speaker and batteries. BVA valves, 67/6. Amplion 5v. A.C. superhets, £7/10/0. Ditto radiograms, £13. £5 on your old set against new 12 gn. Mullard 6v. A.C./D.C. superhets. Mullard MB3 Battery set, £4/15/0. Burgoyne Fury 4v. A.C./D.C., £4/17/6. Burgoyne A.C./D.C. 4v. radiogram, £10. Ferguson and Truphonic all-wave sets. Large stock valves and components.—Butlin, 6, Stanford Avenue, Brighton.

NEW RECEIVERS, COMPONENTS AND ACCESSORIES

TRY THE STANDARD WET H.T. BATTERY and banish for ever the troubles of Dry Batteries. No. 4 size 30 milli-amps, 120 volts, £37/10 complete. Ditto No. 3 size 15 milli-amps, £2/12/6. Standard Batteries wonderfully improve reception and cost much less to maintain than Dry Batteries. Send for particulars. Immediate delivery.—Wet H.T. Battery Co., 95, Dean Street, London, W. Gerrard 6121.

RECEIVERS, COMPONENTS AND ACCESSORIES

Surplus, Clearance or Secondhand, etc.

SOUTHERN RADIO'S Wireless Bargains; all goods guaranteed and sent post paid. SPEAKERS, Celestion, Soundex permanent magnet, 11/-; Telsen latest type permanent magnet, with ten ratio transformer for use with any receiver including Class B and Q.P.P., 14/6 each; Telsen loud-speaker units, 2/9 each; all new and boxed.

E.C.A.C. D.C. Mains 3-valve Sets, complete with 3 Osram valves in exquisite Bakelite cabinet, with Osram M.C. speaker, ready to plug in to any mains universal voltage, new, in sealed cartons, fully guaranteed: £3/19/6 (list £7/15).

ELIMINATORS.—Regentone, latest type, A.C. mains, 200-250 volts, type W.5a, complete with trickle charger, 39/6; W.1a, less trickle charger, 30 millamps, 38/-; all new and boxed.

CONDENSERS.—Lotus 0.0005, fully screened, dials, escutcheon, etc., 3-gang, 11/-; 2-gang, 7/3; Dyklock single, 0.0005, complete, 4/-.

COILS.—Varley square peak coils B.P.5, complete, 2/3 each; Telsen latest type iron cored coils, type W.349, midjet size, 4/6; type W.478 (twin), 9/- pair; type W.477 (triple), 16/- set; type W.476 (triple, superhet, selector and oscillator), 16/-; all ganged coils are mounted complete with switch; I.F. transformer coil, type W.482, 5/6; all new and boxed.

POTENTIAL Dividers, Lissen, wire wound 3-section 60 watt, 4,500, 3,000, 2,000 ohms, 2/- each; 3-section, 60 watt, 8,000, 12,000 and 15,000 ohms, 2/- each; 2-section, 60 watt, 2,500 and 500 ohms, 1/9 each; 2-section, 5-watt, 50,000 and 30,000 ohms, 1/6 each; all new and guaranteed.

TELSEN A.C. D.C. Multimeter (latest type), 5-range for every conceivable test for radio and domestic electrical appliances, 9/6 each; boxed and new.

MICROPHONES.—Ace, P.O. microphones, complete with transformer, can be used in any set; 5/- each.

AMERICAN Valves.—A full range of valves for all American receivers at 7/- each valve.

SOUTHERN RADIO Branches at 271-275, High Rd., Willesden Green, N.W.10; 46, Lisle St., W.C.2. All mail orders to 323, Euston Road, London, N.W.1. SOUTHERN RADIO, 323, Euston Road, London, N.W.1 (near Warren Street Tube). Phone: Museum 6324.

"UNIVERSAL" RADIO BARGAINS.—ORMOND AC/DC Mains Sets (List £7/10/10). OUR PRICE 75/-. Ditto AC/DC 3 Pentode (List £9/15/0). OUR PRICE £5/15/0. Ferranti NOVA AC/DC (List £12/1/6). Clearing at £8/2/6. Ferranti UNA AC/DC (List £8/18/6). Clearing at £6. Sonocorde Energised Moving Coils, 2000 ohms, 8/11. Eliminators 0/6. Above all brand new in original cartons. Thousands of other bargains. Stamp for lists.—"Universal," 94, Grove Vale, E. Dulwich, S.E.22.

THE following unused set manufacturers' Surplus; all goods guaranteed perfect; immediate delivery.

MAGNAVOX speakers complete with hum-bucking coil, output transformers, etc. DC152 (9in. cone), 22/6. DC154 (7in. cone), 16/-. All with 2,500 or 6,500 ohms fields.

REGENTONE transformers for HT8 or HT9, with 4v. 4 amp. L.T. winding, 7/-. Eliminators, first-class make. Outputs 150v. 25 ma. S.G. and Detector. A.C. type with Westinghouse rectifier, 25/-. A.C. type with 5 amp. trickle charger, 30/-. D.C. type, 12/6.

HELSEBY dry electrolytic condensers 8 mfd. or 4 mfd., 500v. working, 60 mfd., 50v., 200 mfd., 10v., 3/3, 50 mfd., 15v., and 15 mfd., 100v., 2/3. 50 mfd., 12v., 2/-. TCC type "M" condensers, any value up to .001 mfd., 6d. Erie resistances, 1 watt type, 7d., 2 watt, 1/2, 3 watt, 1/9. Send for comprehensive list.

CONVERSION Units for converting D.C. Receivers to A.C. Mains operations up to 100 watts, £2 each, ARD, 46, Farringdon Street, London, E.C.4. Telephone: Holborn, 9703.

MISCELLANEOUS

F. J. CAMM'S "Superformer" Peto-Scott Kit, £2/5/0. S.T. 600 £3, S.T. 500 £2/2/6, S.T. 1.5 £2/2/6, with valves. Send for bargain list of speakers, valves, eliminators, etc.—R. Wigfield, Furlong Road, Goldthorpe, Yorks.

ALCO ELIMINATORS AND CHARGERS.—4 H.T. taps. 120V/150V. 20/30 m.a. 18/- with 1/2 amp charger 25/-. Charger alone 7/6. 1/2 amp. 11/-. Year's guarantee. Details free.—P. and D. Radio, 1, Gooding Road, N.7.

REPAIRS to Moving Coil Speakers, Cones and Coils fitted or rewound. Fields altered. Prices Quoted including Eliminators. Loud-speakers Re-paired, 4/-. L.F. and Speech Transformers, 4/- Post Free. Trade invited. Guaranteed. Satisfaction. Prompt Service. Estimates Free. L.S. Repair Service, 5, Balham Grove, London, S.W.12. Battersea 1321.

G.P.O. Surplus Condensers. 2 mfd. 800v. wkg., 2/3; 4 mfd. ditto, 3/9; 2 mfd. 1,000v. wkg., 3/3; 4 mfd. ditto, 4/9. Postage 4d. or C.O.D.—De-Ware, 304, Fulham Road, S.W.10.

WANTED, good modern radio sets, parts, etc., spot cash paid; exchanges; bring or send. University Radio, Ltd. 142, Drummond Street, Euston, London, N.W.1.

NEW RECEIVERS, COMPONENTS, AND ACCESSORIES

HULBERT for Quality Surplus Speakers. All Music Lovers should write for List of amazing bargains. Prices from 8/6 brand new. Made by best known British maker.—Hulbert, 6, Conduit Street, W.1.

VALVES. By well-known manufacturer. Complete range of Battery, A.C. Mains, Rectifiers. Brand new stock with six months' guarantee, 2 volt; Detector 2/3, Power 2/9, Screen Grid, Pentode, H.F. Pentode, 5/-. Write for other prices to: Dulci Electrical Co., Ltd., 7, Lizard Street, London, E.C.1.

CLARION VALVES.—All brand new; battery types 2-volt, H.2, H.L.2, L.P.2, 1/9; super power, P.2, 2/6; screens and L.F. pentodes, 3/9; A.C. mains, 4-volt, 1-amp., general purpose, 3/3; power, 4/-; screens and L.F. pentodes, 4/6; full-wave rectifiers, 3/6; postage paid, cash with order, or C.O.D. over 10/-.—Clarion Valves, Dept. 2, 885, Tyburn Road, Erdington, Birmingham.

MISCELLANEOUS

ELIMINATORS, Regentone, new and boxed, latest type, A.C. 200/250 Volts, 32/-; With Trickle Charger, 38/6 (List £3/15/-).

SPEAKERS, Telsen latest type permanent magnet with ten ratio transformer suitable for any receiver including Class B and Q.P.P., 13/6.

MULTIMETER, Telsen A.C., D.C., latest type, volts and milliamps 5-range, for every test Radio and Domestic, Boxed and Guaranteed, 9/-.

MICROPHONES, Ace, complete with transformer for use on any set, 4/6.

ERIE Resistances, 1-watt type, all values, 6d.

VALVE Holders, Clix chassis mounting, 4/5 pin, 3d.; 7-pin, 4d.

LISSEN Screened Intermediate Band-Pass Transformers, 126 kc., 2/11.

AMERICAN Valves, normal types, 4/6. All Guaranteed.

TRADE Enquiries, Send stamp and Trade Heading for latest lists.

RADIO AND ENGINEERING SUPPLIES, 83, Edgware Road, London. Phone: Pad. 6652.

YOU CAN USE YOUR SPARE TIME to Start a Mail Order Business that quickly brings you a full time income. Follow the lead of others who are averaging £12 per week net profits. Get away from a drudging routine job—join the big-money class. No previous experience necessary. Few pounds capital only needed. No samples or outfits to buy; no rent, rates or canvassing. New method makes success certain. Write to-day for FREE BOOKLET to Business Service Institute (Dept. 755c), 6, Carmelite Street, London, E.C.4.

EASY PAYMENTS

"THERE'S NO PLACE LIKE HOLMES."

Table with columns: Name, Deposit, Monthly Payments. Includes W.B. SENIOR, W.B. JUNIOR, BLUE SPOT SENIOR, GRAHAM-F.720.

ANY make of speaker supplied. GRAHAM-FARISH SENSITY SUPER. GRAHAM-FARISH ALL. WAVE KITS. SPECIAL—G.E.C. universal mains A.C. or D.C., with M.C. Speaker, complete with valves in cabinet. List price, £6 10s.

Our price, 7/8 deposit and 11 payments of 7/8. PARTS FOR ANY SET. ANY MAKE OF SPEAKER. New goods obtained for every order. Send us a list of parts or valves you require or any speaker or set you may select and we will forward you a definite quotation. Ten years' advertiser in the Wireless Press. Thousands of satisfied customers.

H. W. HOLMES: New Address — 333, EUSTON ROAD, LONDON, N.W.1. Phone: Museum 1414.

"ENGINEERING OPPORTUNITIES FREE!" Advertisement for Engineering Opportunities, featuring a book cover and text about securing qualifications and employment.

BIRMINGHAM RADIOMART SHORT-WAVE SPECIALISTS

Proprietor, G5NI. Manager, G2AK. Staffed by experienced transmitting amateurs. Obviously we can serve you better.

AERIAL EQUIPMENT

Raymart dipole kit comprising aerial wire, transposed line, screened transformer, Flintglass insulators junction T-piece, 10/6.

AERIAL INSULATORS. Raymart Flintglass, A 3in. ribbed 4d, 12in. porcelain locapacity, 1/6. Dipole T-Piece, 1/-.

RAYMART MICROVARIABLES. All brass construction finest ceramic insulation, electrically shorted ballraces 15mmfd., 1/4; 40mmfd., 1/7; 100mmfd., 1/10. Extension bracket, 3d.

SHORTWAVE CHOKES. Raymart CHP, 0d. American National pattern pie wound on Isolantite, 2/-. Screened HFC, 1/11.

RAYMART COILS. Wound on RD4 Formers; set three, cover 15-100 metres, 7/9. Separately, 2/9.

RAYMART COILFORMS. RD4 Dielectric 4-pin, 1/6. 6-pin standard, 1/9. 6-pin to fit 7-pin valveholder, 1/9. 7-pin, 1/10. Machine threaded (not cut), 2d. extra.

NOTE.—Above coils all moulded in RD4. Resilient, hollow pins. Identifying disc in top. Quality—not junk.

UTILITY 8/6 microdisc dials, fitted famous micro-high reduction, only perfect short-wave dial, 3/11.

RADIOPHONE super ceramic insulated short-wave condensers, .00016, 3/6; series gap, 3/9; 465 kc/s litz wound I.F.'s, 5/6.

CONTINENTAL A.C. valves, 4/6, VMPT, HPT, VMSG, ACSG, ACH, ACHL, PT4. Most American types, A.O.Pen., 5/6.

2V. types, I.F. detector, L.F., 2/3; LP2, P2, 2/9; Supower, 3/3; VMPT, HPT, 5/6; Class B, 4/6; S.G., VMSG, 5/-.

AMERICAN TYPES, practically all types, 4/6. Stocks of over 15,000 tubes.

BARGAIN parcel value, 30/-, containing binocular HFC, 4 750 v. test condensers, 6 resistances, 4 valveholders, .0003, .0005 variable, electrolytic condenser, etc., 5/-.

Traders' parcel, £4/10/0 value, 10/-.

SPECIAL. Set Lissen 3-gang superhet coils, two Lissen I.F.'s, 3-gang superhet condenser; value, 63/- for 10/-.

CABINETS. Climax horizontal set and speaker cabinets, 2/11. Vertical, 3/9. Part postage 6d. extra.

TELSEN, 7/6, Ace transformers made for leading company, boxed, 1/11. Radiogrand, 2/9.

NON-INDUCTIVE condensers by leading makers, T.C.C., Dubilier, etc., 0.5, 0.25, 0.1, 0.02, 0.005, 3d.

ASTOUNDING offer electrolytic condensers, 4+4 mfd. (separate) 500 v., working, 1/6. 8+8 mfd., 3/6; 8+16 mfd., 3/11.

GENUINE 15/6 Frost potentiometers, wire-wound, tapered, 10,000 ganged to 50,000 ohms, 1/6.

LISSEN 2-gang coils, 12-2,000 metres, switched and screened, nothing else required to convert SG3 to all-wave, 12/6.

LISSEN BANDPASS, 3-gang coils, Utility 3-gang Condenser, fully screened Kit, 10/-.

LAMPLION, 3/6; screened H.F. choke, 1/11; Iron-cored binocular, screened, 2/3. Climax binocular, 1/3. Telsen, 1/11.

UTILITY 2-gang .005 Uniknob with large disc drive, 3/11. Ditto, single, with disc, 2/3.

LISSEN; 20hy., 100 ma. chokes, 2/11. Lissen eliminator chokes, 1/3. 8ft. Resin-cored solder, 6d.

GRANIC tapered potentiometers 3-meg., 1-meg. with 3-point switch, 2/-. Centralab 1/2-meg., 1-meg. PUSHBACK connecting wire, ready tinned and sleeved, 6yds., 6d. Heavy, for heaters, 9d.

SCREENED iron-cored selective dual-range coils, with reaction; circuit diagrams, 2/11.

NON-INDUCTIVE tubulars, 1,500 v., 0.01, 0.02, 0.04, 0.05, 0.1, 6d.; 0.2, 0.25, 8d.; 0.5, 9d.

TRANSFORMERS B.T.H. speaker; suit all moving coils, 2/11. Manufacturers push-pull, 1/11.

FUSES, Telsen 1/2-amp., 1-amp., 3-amp., 2d. Telsen, 100 ma., 2d.

TELSEN latest differentials, .003, 1/3; .00015, 1/-, 2 gross solder tags, 6d.

SPECIAL. Four assorted Telsen grid-leaks, 5d.; twelve various wire-ended resistances, 2/6.

MILLIAMMETERS; flush 2 1/2in., 5/9; 2 1/2in., 6/9; all ranges above 25 m.a., visual tuning, 6/9.

T.C.C. etc., bias electrolytics, 50 mfd., 50 v., 1/9; 25 mfd., 25 v., 1/3; 15 mfd., 100 v., 1/-; 6 mfd., 50 v., 6d.

RADIOMART

Order over 6/- post free. Enquirers must enclose stamp.

Catalogues; general catalogue gives hundreds of bargains; short-wave illustrated catalogue also gives diagram of efficient transmitter and receiver; each 1 1/2d. Pair 3d., post free.

THE SQUARE DEALERS

19, John Bright St., 22, Summer Row; mail-orders: 44, Holloway Head, Birmingham. Telephone: Midland 3254

£5.5.0
For You!

If you can take good photographs you should be able to win one of the special cash prizes offered every month in "HOME PHOTOGRAPHER'S" interesting contests. A First Prize of £5.5.0 is waiting for someone this month. Be sure to get your copy to-day.

*Special Contents of the May
HOME PHOTOGRAPHER.*

TWELVE POPULAR SUBJECTS AND HOW TO TAKE THEM. By the Editor.

WITH A CAMERA IN NORMANDY.
By John Lea.

PICTURE CRITICISM. By the Old Hand.
WHERE PANCHROMATIC EMULSIONS
SCORE. By L. Archer.

SPECIAL PHOTOGRAVURE SECTION—
Including a Section of Prize-Winning
Photographs.

THE MAY
**HOME
PHOTOGRAPHER**

On Sale at all Newsagents
and Bookstalls

6^D



**40-Page
ROAD ROUTE GUIDE
OF GREAT BRITAIN**

EVERY MOTORIST will want it—this book of the Principal Road Routes in England, Scotland and Wales. It enables you to find your way from London to the Highlands, to Lakeland, from Land's End to Blackpool, from place to place all over the country.

You are given Ministry of Transport Road Numbers, too, so that it is impossible to miss your road, while mileages between towns on the route are included so that you can time any journey you are undertaking.

This most useful FREE GIFT for motorists, motor-cyclists and cyclists—in fact all road users—is presented with every copy of this week's PRACTICAL MOTORIST, the helpful motoring weekly that saves you pounds.



Free With Every Copy of

THE
**PRACTICAL
MOTORIST**

3^D

On Sale
Friday,
May 8th.

George Newnes, Ltd.

CAMERA
P. Wireless **1**

Published every Wednesday by GEORGE NEWNES, LIMITED, 8-11, Southampton Street, Strand, London, W.C.2, and Printed in Great Britain by THE NEWNES & PEARSON PRINTING CO., LTD., Exmoor Street, London, W.10. Sole Agents for Australia and New Zealand: GORDON & GOTCH, LTD. South Africa: CENTRAL NEWS AGENCY, LTD. *Practical and Amateur Wireless* can be sent to any part of the world, post free, for 17s. 8d. per annum; six months, 8s. 10d. Registered at the General Post Office as a newspaper and for the Canadian Magazine Post.