

Practical TELEVISION

AUGUST 1965

2/-



**Valves and
their habits**

IMPROVED

Modern styling in light grey with legible black engraving.

Constructed to withstand adverse climatic conditions.

Ever ready case including leads, prods and clips.

Improved internal assemblies.

Re-styled scale plate for easy rapid reading. 2 basic scales each 2.5 inches in length.

New standards of accuracy using an individual calibrated scale plate. d.c. ranges 2.25% f.s.d. a.c. ranges 2.75% f.s.d.

Available accessories include a 2500V d.c. multiplier and 5, 10 and 25A shunts for d.c. current measurement.

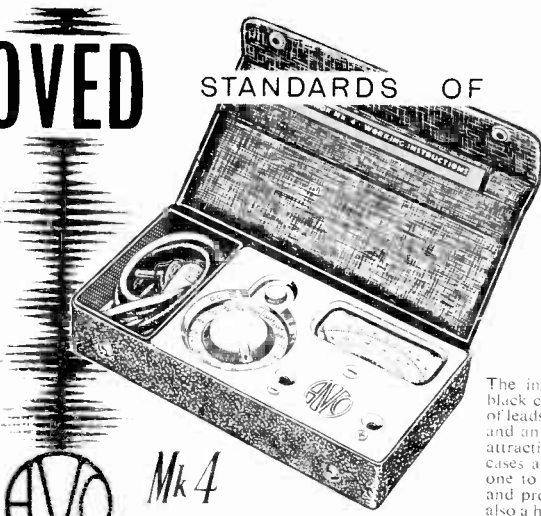

Mk 4

MULTIMINOR

ACCURACY AND RELIABILITY

The Mk 4 MULTIMINOR is an entirely new version of the famous Avo instrument and supersedes all previous models. It is styled on modern lines, with new high standards of accuracy, improved internal assemblies, and incorporating panelmatic properties.

The instrument is supplied in an attractive black carrying case, which also houses a pair of leads with interchangeable prods and clips, and an instruction booklet. It is packed in an attractive display carton. Robust real leather cases are available, if required, in two sizes, one to take the instrument with leads, clips and prods, and the other to house these and also a high voltage multiplier and a d.c. shunt.

D.C. Current: 100µA f.s.d. — 1A f.s.d. in 5 ranges Resistance: 0-2MΩ in 2 ranges using 1.5V cell.
 A.C. Voltage: 10V f.s.d. — 1,000 f.s.d. in 5 ranges Sensitivity: 10,000Ω/V on d.c. Voltage ranges.
 D.C. Voltage: 2.5V f.s.d. — 1,000 f.s.d. in 6 ranges 1,000Ω/V on a.c. Voltage ranges.
 D.C. Millivolt range: 0 — 100mV f.s.d.

● For full details of this great new pocket size instrument, write for descriptive leaflet.



AVOCET HOUSE - 92-96 VAUXHALL BRIDGE ROAD - LONDON S.W.1 - VICtoria 3404 (12 lines)



MM17

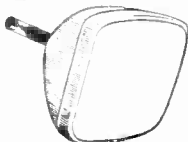

“SABRINA”
STILL WELL IN
FRONT

STOP FIDDLING WITH KNOBS . . . ABSOLUTELY UNNECESSARY . . . Our Automatic Regulator ensures constant voltage on TV, even with Mains of 180-265 v. YES, we know it's wonderful. "Have a heart for your Valves and Tube."

S.A.E. details. *Conditional Free Trial.*

COMPLETELY REBUILT C.R. TUBES ALL TYPES

12" now	£5. 0.0	} For Single Tubes
14" to 17" now	£5.10.0	
21" now	£8. 0.0	

ALL C.W.O.—TRADE SUPPLIED

Special Bonus Scheme for Service Engineers—Reducing to:

12"—87/6; 14" 17"—97/6; 21"—147/6

FREE Pass. transit & Ins. anywhere in British Isles or N. Ireland (12 months' guarantee).

ALSO FULL RANGE OF VALVES
(Guaranteed 12 months)

SABRINA C.R. TUBE CO.
Electron Works, North Bar
BANBURY, OXON
Telephone 2390

ADCOLA
(Regd. Trade Mark)

SOLDERING EQUIPMENT

DESIGNED FOR ALL RADIO ENGINEERS

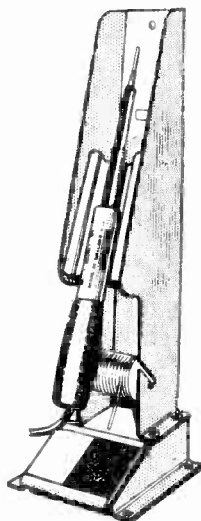

APPLY CATALOGUES:—
ADCOLA PRODUCTS LTD.
ADCOLA HOUSE,
GAUDEN ROAD,
LONDON, S.W.4.
TELEPHONE: MACAULAY 4272 & 3101
TELEGRAMS: SOLJOINT, LONDON, S.W.4.

D. & B. TELEVISION (WIMBLEDON) LTD.

131 KINGSTON ROAD, SOUTH WIMBLEDON,
LONDON, S.W.19. Phone: CHerrywood 3955 and 3513

EKCO/FERRANTI L.O.P.T. HOUSINGS. Top half only
Brand new. Bulk purchase offer ONLY 4/6 each P.P.
P.L. With instructions.

REBUILT C.R. TUBES. All makes All with 12 mths' guarantee.
To the highest possible standards. 12", £2.10, 14", £3, 17",
£3.15, 19", £4.10. Carr. & Ins. 12/6. No C.O.D. C.W.O. only.
This includes 70°, 90°, 110° types.

ALBA									
T641	T644	T724FM	T744FM						at 62/-
T655	T809	T717							at 50/-
BEEHOVEN									
R106	B109	208							at 50/-
BUSH									
TV53	TV56	TV57	TUG58	M59	TUG59	TV82	TV63	TV66	
TV67	TUG68	M69	TUG69.						These are supplied as inserts only
									at 30/-
COSSOR									
R17A	930	931	933	934	935	937	938	938A	9391A
940	942	942A	943	944	946				
949	945B	945							
									at 52/-
									at 52/6
									at 60/-
DECCA									
DM1	DM2/C	DM3/DM4	DM4/C	DM5	DM14	DM17	444	555	at 68/-
DM35	DM45	DM55	DM50						at 58/6
DM21C	DMG21								at 70/-
DM22C	DM19	SRGTV777	SRGTV666						at 79/6
DYNATRON									
TV30	TV35								at 48/-
EKCO									
TC208	TU209	T26911	T221	T231	T231F	T249	TC269		
TC26711	T283	T284	T293	T311	T310	TCC316	T326	T327	
T330	T330F	T331							at 48/-
TM1872	T344	T344F	T348	T348F	T356	TC312	T313	T313F	
T335									at 65/-
EMERSON									
E700	E701	E704	E708	Port-O-Rama	E707				at 48/-
E709	E710	E711.							These are supplied as an exchange unit. Please send old transformer
									at 48/-
FERGUSON									
43T	454T								at 65/-
103T	105T	113T	135T	142T	143T	145T	990T	991T	992T
993T	994T	995T	996T	997T	998T	999T			at 27/6
205T	204T	205T	206T	214T	235T	236T	244T	245T	
									Used only when available
									at 30/-
									at 65/-
									at 45/-
									at 50/-
									at 65/-

FERRANTI									
14T2	14T3	14T3P	14T4	14T4P	14T5	14T6	17K3	17K3F	17T3
17T3P	17K4	17K4P	17K5	178K3	178K4	178K4F	17K6	178K6	
178K6	17T4	17T4P	17T5	17T6.					These are supplied as inserts only
T1001	T1002	T1002/I	T1004	T1005	T1011				at 30/-
T1012	T1023	T1024	T1027						at 48/-
									at 65/-
H.M.V.									
1865	1869								at 48/-
1870	1871.	1872.	1873.	1874.	1875.	1876			at 50/-
MARCONI									
VT155.	VT156								at 48/6
MURPHY									
V240-250									at 72/-
V270-280									at 90/-
V310-320, 330, 350									at 72/-
410-420									at 90/-
470-540									at 80/-
650-730									at 72/-
PETO SCOTT									
148A.	TR16.	178A.	TV1416.	T1418.	T1419.	TV1716.	TV1719.		
TV1720									at 80/-
									These are supplied as inserts only.
PHILCO									
1000.	1010								at 72/-
1019									at 75/-
1021.	1023								at 72/6
REGENTONE									
TR4.	10-6.	10-4.	10-17.	Insert only					at 30/-
ULTRA									
1433.	V114-53.	V15-60.	V1750.	V1752	V1753.	V1760			at 42/6
V1762.									at 42/6
WR1763.	V1763.	V1764.	V21-50.	V21-52.	V2160				at 60/-
V17-70.	V17-71.	V17-72.	V17-73.	V17-74.	V17-75				at 52/6
V1780.	V17-81.	V17-82.	V1783						at 42/6
V19-80.	V19-84.	V19-85							at 80/-
V23-80.	V23-84.								at 65/-

WE HAVE MANY THOUSANDS MORE L.O.P.T.S. AND S/COILS NEW AND USED. PLEASE SEND S.A.E. FOR QUOTATION

TELEVISIONS—EX-RENTAL. All B.B.C./I.T.V. 14in. from £4.10.0. 17in. from £7.10.0. 21in. from £12.10.0. All with written 12 months' GUARANTEE on Cathode Ray Tubes. GENUINE BARGAINS, CALL OR WRITE TODAY.

VALVE LISTS—NEW VALVES. ALL CHECKED ON MULLARD HIGH SPEED TESTER, AND GUARANTEED 3 MONTHS. POSTAGE AND PACKING VALVES 6d. EACH.

5U4/G	5/6	DAF91	6/-	ECH21	9/-	PABC80	5/-	PY800	6/-
5Z3	5/3	DAF96	6/-	ECH42	7/6	PCC84	7/6	PZ30	6/-
6B8G/G	6/3	DF91	7/-	ECH81	6/6	PCC89	6/6	U24	10/-
6SN7GT	3/-	DF96	8/-	ECL80	5/-	PCF80	6/6	U25	10/-
6V6	5/6	DH77	4/9	ECL82	7/-	PCF82	6/6	U26	10/-
10C1	7/6	DK91	7/-	ECL83	7/6	PCF86	6/6	U191	9/6
10C2	10/-	DK96	8/-	ECL86	8/6	PCL82	7/-	U301	9/6
10F1	2/6	DL92	5/-	EF41	6/3	PCL83	7/6	U801	15/-
10P13	6/-	DL94	8/-	EF80	2/6	PCL84	7/6	UABC80	5/-
10P14	9/6	DL96	8/-	EF85	4/6	PCL85	7/6	UAF42	4/6
19B8G/G	6/-	DY86	5/-	EF86	6/6	PL33	7/-	UBF80	6/6
20D1	4/6	EABC80	6/6	EF89	7/6	PL36	6/6	UBF89	7/6
20F2	4/6	EB91	2/-	EF91	2/-	PL38	10/-	UCC84	7/-
20L1	10/-	EBC41	5/6	EF92	3/6	PL81	7/-	UCC85	7/-
20P1	7/6	EBF80	5/-	EF41	7/6	PL82	3/6	UCH87	7/-
20P3	6/-	EBF89	5/-	EL84	6/6	PL83	4/6	UCH80	7/-
20P4	10/-	ECC81	4/-	EM34	7/-	PL84	6/6	UCH42	6/6
275U	10/6	ECC82	4/-	EM81	5/-	PY31	4/6	UCH81	8/-
30C15	7/6	ECC83	4/6	EY51	5/-	PY32	8/-	UCL83	9/6
30P4	7/6	ECC84	5/6	EY86	6/-	PY33	10/-	UL84	6/6
30P12	5/6	ECC85	5/6	EZ40-41	5/6	PY80	3/6	U08	9/6
30PL1	6/6	ECF80	5/-	EZ80-81	5/6	PY81	4/6	UY41	5/-
30PL13	7/6	ECF82	5/6	GZ34	8/6	PY82	3/6	UY85	6/-

We are open 9 a.m. to 6 p.m. Monday, Tuesday, Thursday & Saturday-9 a.m. to 7 p.m. Friday-Closed all day Wednesday
Send S.A.E. for free list of valves.

TERMS: C.W.O. or C.O.D., Postage on all L.O.P.T.S. and S/Coils, 3/-. C.O.D. 5/-.
SERVICE SHEETS. TELEVISION !! ALL MAKES AND MODELS 4/-. P.P. 3d.

BENTLEY ACOUSTIC CORPORATION LTD.

THE NEW VALVE SPECIALISTS
38 CHALCOT RD., LONDON, N.W.1
 EXPRESS SERVICE!
 C.O.D. ORDERS RECEIVED BY 3.30 P.M. EITHER BY LETTER, PHONE OR WIRE. DESPATCHED SAME AFTERNOON

Nearest tube		All goods advertised are in stock		Primrose 9090		MULLARD BY100 MIDGET SILICON RECTIFIERS																
Chalk	Farm					Output: 250v. at amp.	No larger than a shirt button 6/6 each															
0A2	4/8 6CW4	24/-	10P13	8/3	35C5	8/3	DM70	5/-	ECH83	8/6	EM71	15/6	MHLD612/8	PL83	6/-	U28	7/6	UF89	5/6	OA81	3/	
0B2	6/-	6D8	9/6	10P14	11/6	36L8GT	6/-	DM71	9/9	ECH84	8/6	EM80	6/3	MU12/14	4/6	PL84	6/3	U31	7/6	OA2	2/9	
0ZGT	4/3	6F1	8/6	12AC6	8/6	36W4	4/6	DX76	6/8	ECL80	5/6	EM81	7/-	N3	10/6	PL90	15/9	U38	13/6	UL44	23/6	
1D6	9/6	6F13	3/9	12AD6	9/6	35Z3	16/2	DX77	7/6	ECL82	6/6	EM84	6/6	N78	20/-	PM84	9/3	U35	16/8	L46	8/6	
1R9	4/-	6E22	8/3	12AE6	8/-	35Z4GT	4/6	EB01	24/-	ECL83	8/9	EM85	8/9	N109	26/2	PX1	9/-	U37	29/-	UL84	5/6	
1S9	3/3	6E24	10/6	12AH7	5/-	35Z5GT	5/9	EP37	24/-	ECL86	8/-	EM87	7/6	P2	10/0	PX3	8/9	U43	15/6	UM4	15/2	
1T4	2/3	6K7G	4/6	12AH8	10/9	50B5	6/6	EB80C	10/-	EP22	6/6	EN31	10/-	PA30	6/9	PY32	8/9	U76	4/6	UM4	16/10	
2D21	5/-	8J7G	1/3	12AT6	4/6	50C5	6/6	EB80F	19/6	EF27A	7/6	EV51	5/6	P61	2/6	PY33	8/9	U91	9/6	UM80	8/3	
2X2	3/-	8K83G	3/3	12AU6	5/9	50L8GT	8/3	EA30	1/6	EF40	8/9	EV81	7/3	PC86	9/9	PY80	4/9	U91	9/6	UM80	8/3	
2A5	6/9	8K83GT	6/8	12AV6	5/9	72	6/6	EA30C	8/9	EP41	8/6	EV83	9/3	PC88	9/-	PY81	5/-	U92	12/3	UM8	11/6	
3Q9GT	6/9	8K85	24/-	12BA6	5/3	65A2	6/6	EA42	7/9	EP42	3/9	EV84	9/6	PC89	6/9	PY82	4/9	U91	11/6	UM10	10/3	
3S4	4/9	6L11	10/-	12BB6	4/9	90AG	6/7	EB34	1/-	EP60	2/6	EV86	5/6	PC97	6/9	PY88	5/6	U404	6/-	UM21	7/8	
3V4	5/-	6L6GT	7/3	12BH7	6/-	90AV	6/7	EB41	4/9	EP80	4/-	EV88	8/9	PC88A	5/6	PY88	5/6	U401	15/-	UM41	5/-	
4R4GY	8/6	8L7GT	5/6	12K5	10/-	90C1	16/-	EB91	2/3	EP83	9/6	EV91	3/-	PC88B	5/6	PY80	3/9	U4020	6/6	UM85	4/9	
4U4G	4/6	6L18	10/-	12AQ5	7/3	90C3	42/-	EB93	3/-	EP85	4/6	EV40	6/3	PC88	10/6	PY81	7/6	U4030	5/-	UM4	14/8	
5V4G	8/-	6LD20	5/6	19H1	6/-	90CV	42/-	EB41	7/-	EP98	6/6	EV41	6/3	PC89	8/6	PZ30	9/6	U4F42	8/9	VP4B	12/-	
5Y3GT	4/9	6P28	11/6	2001	10/-	150B2	16/6	EB81	5/9	EP89	4/-	EV80	3/9	PC189	10/-	QV03/10	UB41	10/6	VR105	5/6		
5Z3	6/6	6Q7G	4/-	20F2	11/6	185B7	34/11	EB180	5/9	EP91	3/-	EV21	4/3	PCF80	6/6	35/-	UB41	10/6	VR150	4/9		
6Z4G	7/6	6H7G	5/3	20H1	12/6	5765	7/6	EB183	7/3	EP92	2/6	EV23	17/8	PCF82	6/6	QV04/7	7/-	UBC81	6/3	W107	10/6	
6A3	5/9	6H7GT	5/3	20H2	12/6	7476	2/6	EB189	6/-	EP95	4/9	EV24	10/-	PCF84	6/6	R10	15/-	UBP80	5/6	W29	17/8	
6AC7	3/-	6S8GT	20/3	20H3	12/-	AC6PFN	4/9	EB121	10/3	EP97	10/-	EV27	14/8	PCF86	6/6	R17	17/8	UBF89	6/6	X41	10/-	
6AG7	5/9	6U4GT	8/6	20P4	13/3	A231	6/6	EC55	12/6	EP98	9/6	EV80	9/3	PCF80	10/-	R18	9/6	UB121	10/9	X66	7/3	
6AQ5	5/9	6V6G	3/6	20P6	13/3	A241	6/6	EC70	4/9	EP183	7/3	EV183	7/3	PCF802	10/-	R19	6/9	UC92	6/8	X78	27/-	
6AT6	3/9	6X4	3/9	25L6	4/9	B36	4/9	EC92	6/6	EP184	6/6	EV184	6/6	PCF905	8/9	RP41	2/-	UC84	8/-	X63	5/-	
6AU6	5/9	6X5GT	5/3	25Z4C	6/6	CL38	11/6	EC331	7/3	F804	20/5	HL42D	12/6	PCF806	12/9	SP81	2/-	UC85	6/8	Z88	7/3	
6AV8	5/6	6Y6GT	12/6	25Z6GT	8/-	CV31	5/9	EC40	7/-	EP190	9/6	6/6	6/6	PC82	8/6	SH25	27/2	UCF80	8/3	Transistors	OC81D	
6BA8	4/6	7B6	12/6	27R0	23/3	DA96	6/-	EC81	3/6	EK32	3/6	HN309	25/-	PC183	9/6	T41	9/-	UCH21	8/-	and diodes	OC92	
6BB6	4/3	7B7	8/6	30C15	9/3	DD41	10/6	EC82	4/6	EL38	6/6	HVR2	8/3	PUL34	7/8	TH41	10/-	UCH42	8/-	AP102	27/6	
6BB6	5/3	7C5	8/-	30C18	8/9	DP66	15/-	EC83	4/6	EL34	9/9	HVR2A	8/9	PUL35	8/6	TH23	8/9	UCH81	8/6	AP114	11/-	
6B36	5/6	7G6	6/9	30F5	7/3	DP96	8/6	EC84	5/6	EL36	8/9	KT39C	8/-	PCL86	8/9	TH66F	11/8	UC182	7/3	AP115	10/6	
6B47A	7/8	7H7	5/6	30P11	9/3	DP87	10/-	EC85	5/9	EL41	7/-	KT39	28/1	PCN43	7/-	U19	9/-	UC183	9/3	AP116	10/-	
6BB7	8/3	7K7	12/6	30L5	8/6	DH101	25/-	EC88	8/9	EL42	7/9	KT41	6/6	PCN45D	U12/14	7/8	UF41	9/9	AP117	5/6		
6BR8	8/-	7X4	5/-	30P4	12/-	DH107	16/11	EC91	3/-	EL81	8/3	KT44	5/-	12/-	16/-	UP42	4/9	AP127	9/9	MAT100	7/9	
6EW6	7/6	9BW6	6/6	30P12	7/6	DK92	8/-	EC91B	11/6	EL83	6/9	KT61	6/9	PEN46	4/-	U18/20	6/6	UF80	6/3	OA70	3/-	
6BW7	5/-	10C1	9/6	30P13	7/6	DK96	8/6	ECF89	7/8	EL84	4/6	KT63	3/9	PEN38310/3	U22	5/6	UF85	8/9	OA73	3/-		
6C9	10/9	10C2	12/-	30P14	9/3	DL68	15/-	ECF82	8/3	EL85	7/6	KT66	25/1	PL3	8/-	U25	6/6	UF86	9/-	OA79	3/-	
6CD6G	18/-	10P11	10/-	30PL13	10/6	DL72	15/-	ECF86	11/6	EL86	7/3	KT68	25/1	PL33	8/-							
6C16	5/-	10D11	9/6	30PL14	11/3	DL96	6/-	ECN21	9/-	EL91	2/6	KTW61	4/9	PL36	9/-							
								ECH35	6/-	EL95	5/6	KTW62	5/6	PL38	16/-							
								ECF42	8/-	EL180	13/6	KTW63	5/6	PL41	8/9							
								ECN21	5/9	EM34	11/6	MHD4	7/6	PL52	5/-							

Terms of business:—Cash with order or C.O.D. only. Postage/Packing 6d. per item. Orders over £5 post free. C.O.D. 3/6 extra. Any parcel insured against damage in transit for only 6d. extra. All orders despatched on day of receipt. Callers welcome Mon.—Fri. 9-5.30. Sat. 9-1 p.m.

We require for prompt cash settlement all types of valves, loose or boxed, but MUST be new. Offers made by return.

DUKE & CO. (LONDON) LTD.
 621/3 Romford Road, Manor Park, E.12
 Liverpool St.—Manor Pk.—10 mins.
 Phone: ILFord 6001/2/3. Stamp for Free List

VALVES 9d. each. 1,000's available. Send for List.
 CONDENSERS 100—10/-. New. Assorted Electricities and P.F. P. & H. 2/6.
 V/CONTROLS. 20—10/-. A selection of types and sizes. P. & P. 2/6.
 SPEAKERS. 7/9. 6in., 8in., 7 x 4in. and 8 x 3in. Ex. mid. Salvage. P. & P. 2/3.
 RESISTANCES. 10/- per 100. Brand new, mostly High Stable. Assorted parcels. P. & P. 2/6.

TELEPHONE HANDSET

15/6

pair

G.P.O. pattern, House to Workshop, Garage, Inter-Office, etc. Works off any small battery. P. & P. 4/8.

Now in its 11th Revised edition . . .

ELECTRICAL ENGINEER'S REFERENCE BOOK

EX-PARENTAL TELEVISIONS

14 in. £7.10.0
 17 in. £11.10.0

Coloured FREE LIST
 Demonstration daily from our large selection

12 months' written guarantee
 Channels for all areas.

Personal collection advised, or Insured Carr., 14in. 20/-; 17in. 30/-.

AERIALS. BBC/ITA combined Loft and room aerials—from 25/-.
 BBC2/UHF and colour aerials—from 29/6. SEND FOR FREE LIST.

ONE YEAR GUARANTEED TUBES

100% Regunned
 Add 10/- of old tube.
 All 110°—99/6 + 30/- refundable on OLD TUBE. Carr. 10/6.

14", Slimline 17 and 19 inch.
 Export Postage 30/-.

21 in. 99/6
 17 in. 79/6
 15, 14
 12 in. 59/6

EX-MAINTENANCE TESTED TUBES
 17in.—35/- Most makes and types available. 14in.—15/- Guaranteed good picture. Carriage 5/- extra.

A revised edition of this comprehensive thirty-three section standard reference work covering all branches of electrical engineering. New and thoroughly revised sections include materials; cables and wires; wiring and installation; applied electronics; instruments and measurements, etc. References are also made to many new aspects including germanium and silicon; printed circuits; transformer windings and design; electronic motor control; cold-cathode lighting, etc. The "Progress" section is again entirely new and includes an authoritative survey of recent extensions to power-station generating plant.

2,212 pages, 2,096 diagrams, over 300 photographs, 76 specialist contributors, 73 sections, 11th Edition. 120s.

FROM ALL BOOKSELLERS

... or in case of difficulty 120s. post free from GEORGE NEWNES LTD., TOWER HOUSE, SOUTHAMPTON STREET, LONDON, W.C.2

NEWNES

Practical Television

AUGUST 1965

WAIT FOR IT

VOL. 15 No. 179

Our Olympic II television receiver has, predictably, created a considerable stir among television enthusiasts. From the large correspondence it is quite clear that many readers have been stirred to plug in the soldering iron and start practical work on building this receiver.

Although it is not a project for the novice with meagre theoretical and practical knowledge, it certainly presents an interesting and somewhat unusual proposition for the more experienced reader.

In presenting this series of articles, we realised at the outset that for every enthusiast deciding to build the set there would be hundreds who did not. Even so, we have devoted unstinted space to the coverage of this project, justifiably since the material is quite as valuable for those who only want to read the articles.

Transistor TV circuitry is relatively new. But novelty will soon be overtaken by events. In the USA there are already at least 14 transistor TV portables on the market. In the UK, hybrid receivers and all-transistor models are beginning to appear. It will not be too long before most makers will have something on these lines in their ranges. From small-screen sets to standard models with full transistor complements is but a matter of degree.

Readers, particularly those reared on valves, must not become ostrich-like and hope that if they ignore transistors they will conveniently disappear. Particularly service engineers, who will before very long be faced with transistor TV sets sitting on the workbench awaiting treatment.

It behoves us all, then, to begin reorientating our thinking in terms of semiconductor circuitry, and the Olympic II articles will prove a useful introduction to some of the circuits we will all begin to encounter in everyday TV work. In the meantime, we must be practical and realise that for many years old-fashioned sets using thermionic valves will continue to lay ailing on the workbench awaiting resuscitation.

The revised and up-to-date version of "Valves and their Habits" appearing by popular request in this issue, should tide us over until it becomes necessary for contributor H. Peters to start work on "Transistors and Their Habits!"

THIS MONTH

Teletopics	484
The Olympic II Transistor TV— Part 5 Line Timebase Tests and Field Scan Circuit <i>by D. R. Bowman, B.Sc.</i>	486
A Mutual and Self-inductance Bridge <i>by C. J. St. Clair</i>	493
DX-TV <i>by Charles Rafarel</i>	497
30 Years Back	498
A Transistorised E.H.T. Voltmeter <i>by D. R. Bowman, B.Sc.</i>	499
Underneath the Dipole <i>by Iconos</i>	502
Valves and their Habits <i>by H. Peters</i>	504
Audio Amp from TV Chassis <i>by T. D. Williams</i>	508
Letters to the Editor	513
Servicing Television Receivers— Pye, Pam. Invicta, Ekco, Fer- ranti and Dynatron Switchable Models <i>by L. Lawry-Johns</i>	514
Trade News	517
The Cathode Ray Tube and its Circuits—Part 3 <i>by J. McCarthy</i>	518
Your Problems Solved	521
Test Case—33	524

**OUR NEXT ISSUE DATED SEPTEMBER
WILL BE PUBLISHED ON AUGUST 19th**

TELETOPICS

Colour TV via Russian Satellite

EARLIER this year a Russian communications satellite—Molniya-1—was launched successfully and since then a number of colour television test transmissions have been made between Moscow and a receiving station some 1,500 kilometres away, via the satellite. These transmissions have been made using the French SECAM and American NTSC systems, and also a Soviet adaptation of SECAM.

The Molniya satellite carries six panels of solar batteries which are constantly turned towards the Sun, and two parabolic antennae, one of which is directed toward the Earth with a high degree of accuracy.

Colour signals transmitted from Moscow were amplified by Molniya and relayed back to a ground communication centre where the signals were again amplified and transmitted to the capital by radio-relay line. The total path covered by the colour signals equalled some 80,000 kilometres. Picture quality at the end of this path was reported as good and giving practically no sign of static.

In the Moscow studios two pictures were seen on two TV screens: one showing the picture transmitted directly from the studio and the other the one through space. A delay of approximately 0.3 seconds was noticeable between the two pictures received, indicating the enormous distance covered by the signal.

CCTV FOR DRIVE-IN BUILDING SOCIETY

CLOSED circuit television will enable members of a Northampton building society to transact their business without leaving their cars.

In a drive-in forecourt a Beulah monitor receiver shows the customer the cashier sitting in an office in the main building. The cashier in turn can see the customer, via a Beulah camera, on a monitor in his office. Microphones permit two-way conversation, and a system of air-blown tubes completes the arrangement by carrying home safes, cash pass books, etc., back and forth.

POLICE INSTALL CCTV TO FIGHT CRIME

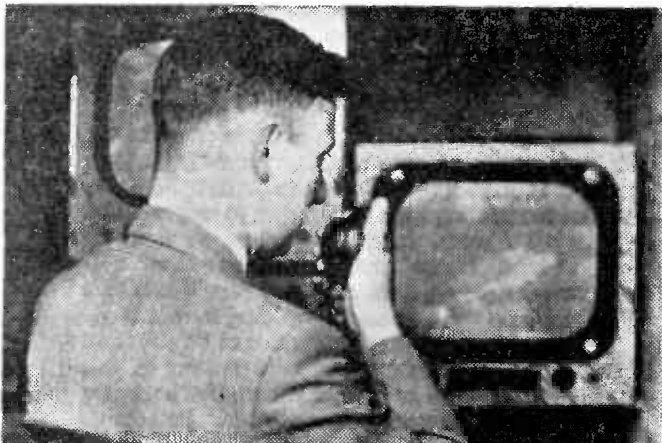

AFTER successful experiments using closed circuit television in crime detection and prevention, the Liverpool City Police have placed an order for a further

four television channels with EMI Electronics Ltd.

The cameras will be installed (above left) overlooking unattended car parks, storage areas, etc.

—places where crime is likely to occur—and from these points will relay pictures to a control room where a detective will watch on a monitor (above right).

SOVIET SCIENTISTS INTRODUCE 3-D TELEVISION

THREE dimensional optical television has been developed at the Leningrad Institute of Electrical Engineering. Important uses in medicine, electrical and radio measurement, computer engineering, etc., have been suggested for this new Russian development.

It is the electron-ray tube in the equipment which is the essential innovation, differing in form from the conventional TV c.r.t., being cylindrical instead of "flattened-out". A light-sensitive screen which is mounted inside the cylinder can rotate about its diameter and is, in fact, revolved at a speed of up to 20-25r.p.sec. Both sides of this screen are covered by a semi-transparent layer of luminophores of varying luminescence. The usual scanning with an electron beam is made on the revolving screen, this producing a yellow image followed by a green image (depending on the colour of the luminophore) as each side of the screen alternately faces at and away from the projector.

With the screen revolving at this speed, the eye only sees a light haze inside the cylinder and the luminescent image becomes three-dimensional. The process of reproducing the image consists in the scintillation in every position on the screen of precisely those spots which correspond to the configuration of the object itself in a given plane.

Service Begins from ITA's Most Northerly TV Mast

THE ITA's most northerly station in the UK began regular service in June at Rumster Forest in Caithness. Twelve and a half miles south-west of Wick, this station is an unmanned, remotely controlled satellite of Mouteagle station, Inverness.

The Rumster Forest station receives Grampian TV programmes from Mouteagle on channel 12 and re-transmits them on channel 8, vertically polarized. Its 750ft. mast which was erected by British Insulated Callender's Construction Co. Ltd., is shown on the right.

Satisfactory reception from the new station should be possible in the majority of towns in Orkney and all the coastal towns between Berriedale, Wick, Duncansby Head, Thurso and Dounreay.

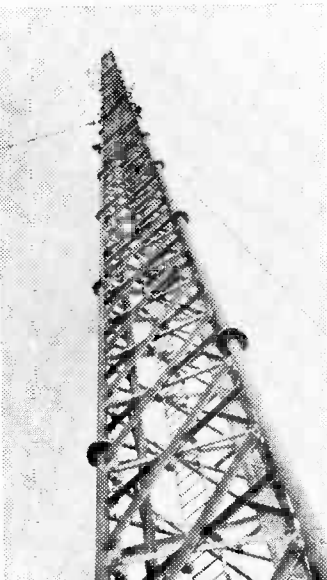

The ITA's new 750ft lattice television mast in Caithness.

New Chairman for the Television Society

THE Council of the Television Society has announced that Mr Thomas Kilvington, B.Sc., has been elected Chairman of Council for 1965-66. At present Mr. Kilvington is head of radio planning and provision (internal) branch of the Post Office Engineering Department and is a fellow of the Society.

TV 'STILLS' FROM RECORDS

EQUIPMENT that permits still pictures for display on a television screen to be picked up from a 12in. gramophone record, has been developed in America by Westinghouse Electric Corporation.

This equipment has been called Phonovid, and voice and music accompaniment are also recorded on the same disc. Up to 400 pictures and 40 minutes of sound can be stored on the two sides of the 33½ rev./min. recording. Pictures can be line drawings, charts, printed text or photographs.

The record is played on an ordinary turntable and any conventional television receiver can be used to display picture and sound. The key component, however, which links the two and makes possible the television display, consists of what Westinghouse call a scan converter. Information coming from the gramophone record is stored in the scan converter's special electronic storage tubes. These tubes build up and display a complete TV picture every six seconds. One picture is read out repeatedly and displayed during the time that the next one is being formed from the video information in the grooves of the recording.

Changes in PAL Transmissions

SINCE 21st June, the BBC experimental colour transmissions using the PAL system (as reported in the July issue) have conformed to new specifications agreed upon at a recent meeting of representatives of the European Broadcasting Union. Modifications to the coding equipment were necessary to bring it in line with the meeting's recommendations, which have entailed revising the characteristics of the German colour system.

New BBC Relay Station for Wales

SOME 2,000 people in the Machynlleth area of Montgomeryshire are now within the service area of a new relay station transmitting BBC Wales Television.

The station came into service on 28th June. The television transmissions are on channel 5 with horizontal polarization.

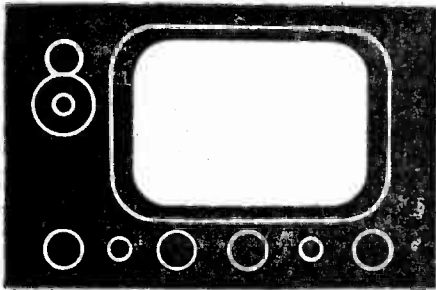

THE OLYMPIC II Transistor TV

by D. R. Bowman

Part Five Line Scan Tests and Field Scan Circuit

WHEN the wiring of the line timebase has been completed, and a check made to see that all is well, it will be necessary to ensure that T5 and T6 are connected the right way round. The following is an effective method of setting-up the circuit.

- (a) Disconnect T6 primary from the —ve supply rail, disconnect R74 (0.5Ω) from the base of Tr18, and disconnect R72 (22Ω).
- (b) Attach battery —ve (12V) lead to the —ve rail on the oscillator side of R72, the disconnected 22Ω resistor, via a 0-100mA meter and a 120Ω resistor (in series).
- (c) Short-circuit L25.
- (d) Note the milliammeter reading:
 - (i) if over 100mA, reverse T5 secondary connection and try again.
 - (ii) if 50mA or under (probably much under) the stage should be oscillating.
- (e) Check by attaching 'phones across R69, the 390Ω resistor in Tr16 collector circuit. A whistle should be heard, adjustable by varying the $10k\Omega$ variable resistor.
- (f) Remove the short-circuit from L25, remove the 120Ω resistor in series with the milliammeter, unscrew the core of L25 completely. Note the milliammeter reading; it should be under 40mA but over 20mA. Adjust the core of L25 until a reading of 40mA is obtained. If the core is screwed too far in there may be a sudden increase to well over 100mA; this condition must be avoided.
- (g) Reconnect T6 primary to the B- rail.
- (h) Connect R74 through a 0-3A thermocouple meter and reconnect to base of Tr18. Switch on B- supply. Note the milliammeter reading; it should be 80-100mA.
- (i) Note the thermocouple meter reading; it should be about 0.5A at least.
- (j) If an oscilloscope is available, attach across the thermocouple meter—observe the waveform. It should be as shown in Fig. 27a, not the other way up. If not, reverse T6 secondary connection.
- (k) If no oscilloscope is available, connect the ammeter in series with R74, the 0.5Ω resistor and the base of Tr18. Switch on B- supply. If a small reading only, or none, reverse the connection of T6 secondary. The reading should be about 0.5 amp, perhaps more.
- (l) With the circuit unscreened, switch on the domestic TV receiver and if possible use a wire as aerial to obtain a synchronised raster. Vary the speed of the time base by adjusting VR4, the $10k\Omega$ speed control, and observe the

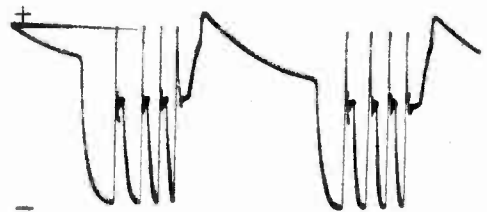

Fig. 27 (a)—Waveform at secondary of T6 (transformer side of R74).

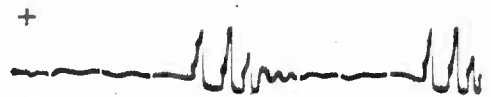

Fig. 27 (b)—Waveform at base of Tr17.

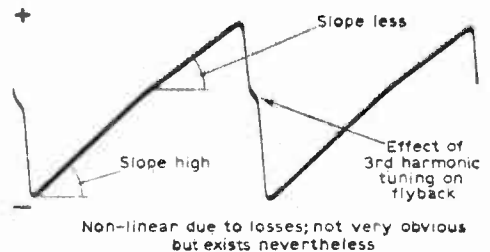

Fig. 27 (c)—Waveform of current in line scan coils.

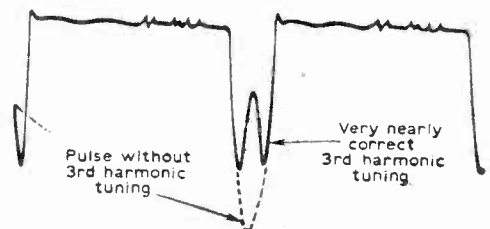

Fig. 27 (d)—Line output stage—collector flyback pulse showing third harmonic tuning.

picture. A pattern of bright dots should be seen, coming into sync when the speed control is right to give three or perhaps four vertical lines on the tube face as shown in Fig. 28.

- (m) Check the current taken by oscillator and driver, and adjust L25 until correct. It should be noted that if L25 core is adjusted carelessly quite heavy currents may be taken by the transistors. Normally this will do no harm, but if the total current goes above 300mA, switch off very quickly!
- (n) Ensure that the e.h.t. lead is clear of any objects; insert the DY86 rectifier, connect up the output stage base and solder the scan coils across the leads. Replace R72, the 22Ω decoupling resistor and attach B- lead to Tr18 side of this resistor, in series with a resistance of about 2Ω (to limit collector current to a safe value if anything is wrong). Switch on B-supply, and note the current taken by the unit. It should be about 0.5 to 0.55 amp, and there should be a pronounced whistle from scan coils and transformer.
- (p) If all is well, remove the 2Ω series resistor and switch on again. E.H.T. should be 12kV max., c.r.t. A1 supply about +500V and the video supply -75 to -80V.
- (q) Connect oscilloscope to the test point, at the junction of R75 and R76, and observe the wave form of the collector fly-back pulse. With a perspex rod gently adjust the position of the two-turn coupling coil (which is wired between the two legs of the e.h.t. transformer) until the third harmonic falls on the peak of the flyback

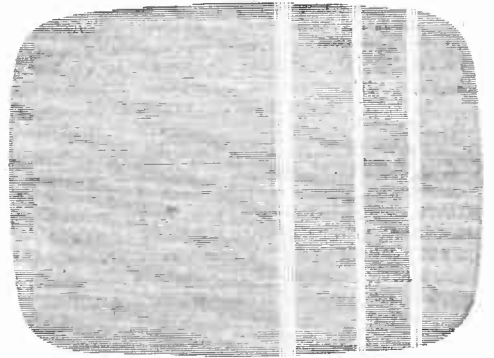

Fig. 28—Synchronisation of the timebase generator.

pulse, and the wave-shape of Fig. 21d (last month) is obtained. The peak collector voltage is then minimum. If possible, the adjustment should be made with the e.h.t. supplying 100μA load.

It is important to note that the output stage must never be switched on unless the oscillator speed is above 9,000 c/s, otherwise the output transistor may be damaged. When making up the receiver as a whole switching is arranged so that the on-off switch has four positions, as follows:

- 1—off
- 2—sound only
- 3—sound, with line and frame oscillators switched on
- 4—scan output stages brought into circuit.

This allows sound only to be listened to if desired (which means battery saving when using accumulators), and also allows the line-whistle to be heard before the output stage is connected to the supply. This last position of the switch also switches on the c.r.t. heater.

The circuit is a "fail-safe" device. If the oscillator should fail the base switch waveform is not generated and the output transistor stays "off".

It should be noted that VR4 is not actually used as the speed control for the timebase generator; this function is served by a potentiometer incorporated in the sync unit. It is, however, used in preliminary adjustments and as a temperature compensating device; hence it should be mounted so that its spindle projects outside the screening box and is accessible. It may be provided with a knob for ease of adjustment.

Adjustment of the E.H.T.

When the Olympic II was in its final development stages and a tube was required, Messrs. Mullard stated that the tube AW36-11 would not be available in this country, but offered the M36-11W (an industrial tube) instead. This policy has now been reversed, and it is understood that the AW36-11 is now available for this receiver. This is in a way a good thing, as the "entertainment" tube is a good deal cheaper than the precision monitor tube used in the prototype.

However, although the two tubes are very similar electrically, the AW36-11 is rated at 12kV working while the M36-11W takes 14kV. Consequently, if the receiver is made up precisely to specification there may be some danger of "flash-over" at the higher e.h.t. voltage. While some protection is specified, by way of

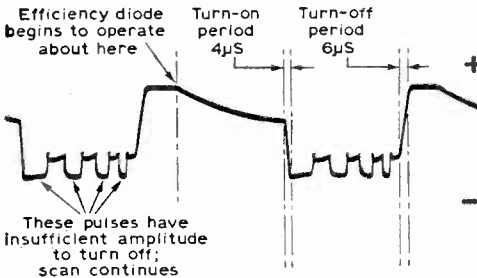

Fig. 27 (e)—Waveform at base of Tr18.

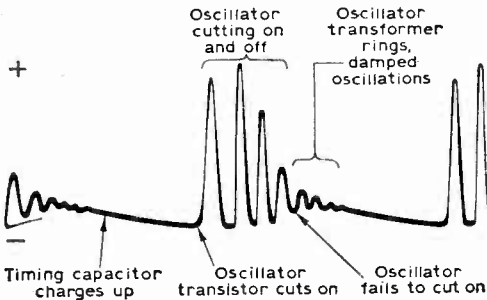

Fig. 27 (f)—Waveform at base of Tr16.

"decoupling" capacitors from final and focus anodes to the aquadag coating, a flash-over could damage some components, and is best avoided. An effective way of arranging this is to reduce the e.h.t. to some 11kV, by adjusting the period of fly-back, and this is done by adjusting the value of C79. Although a nominal value of 0.17 μ F has been specified, the adjustment is made by reducing its value from about 0.2 μ F in steps of about 0.01 to 0.02 μ F (using parallel capacitors) until the correct safe value of e.h.t. is obtained.

In order to do this properly, a suitable e.h.t. voltmeter is needed, and for those who do not own one a simple and safe design is described in this issue by the author.

Referring to Fig. 19, C79 (between the collector of the line output transistor Tr18 and chassis) controls the speed of flyback, and of the e.h.t. voltage generated. It is therefore necessary to adjust this component in value until the e.h.t. is of the correct value. It is also necessary to start with a larger value than the 0.17 μ F specified and to reduce this in steps of 0.01 μ F at a time, until the correct value of e.h.t. is reached. This ensures that in the early stages of adjustment less than rated e.h.t. is generated, the e.h.t. rising as adjustment proceeds.

The line output stage is connected up to the tube in the normal way, and the video (cathode) lead connected to the receiver. C79 is made up of the following capacitors in parallel, all of 250V rating at least: 0.1 μ F, 0.05 μ F, 0.02 μ F (2 off), 0.01 μ F (2 off).

After switching on, the raster is adjusted to an average value of overall brightness. The timebase generator should be running under synchronised conditions if possible, but if not the speed should be correct or as nearly so as can be judged.

The e.h.t. voltmeter is connected between chassis and the tube final anode, and the voltage read off. With the foregoing combination of capacitors, this voltage will probably be of the order of 8 or 9kV.

C79 is then adjusted downwards in value (switched off between trials) until a value of e.h.t. of between 11 and 11.5kV is attained, after which the capacitor combination is not changed again. The third harmonic coupling should be re-trimmed for minimum peak collector voltage (oscilloscope across the test points—i.e. across R76.) The adjustment is now complete, and the screening cover may be placed on the line-scan stage.

Field Scan Circuit

The field timebase generator and output stage also use a blocking oscillator as the driving element but the switching mode is not used as the output device. Study of Fig. 29, the theoretical circuit, will show that the blocking oscillator (Tr19) is used to provide a heavy positive pulse which is fed into a timing circuit consisting essentially of a resistance and capacitance in series. Considering C88, the 4 μ F timing capacitor as originally discharged (actually it is 4 μ F (C88) and 25 μ F (C89) in series) the action is that this begins to charge up to the -12V supply through R82 and VR6 in series. Before this capacitor is fully charged the positive pulse arrives, via D12, the 1S121 diode, and discharges it. Thus a repetitive sawtooth is produced whose amplitude is governed by the extent to which the timing capacitor is charged and whose repetition frequency is governed by the p.r.f. of the blocking oscillator.

A further 1S121 diode (D13) is inserted in the

**TABLE 4
INDUCTANCE AND TRANSFORMER
WINDING**

L25—Former

$\frac{3}{8}$ in. dia. approx. (popular size), fitted standard dust core. 230 turns No. 32 s.w.g. enam. copper wire, in layers, to occupy $\frac{1}{2}$ in. length. Iron dust core. Inductance without core, approx. 300 μ H. Adjust to approx. 400 μ H with caution, keeping the oscillator frequency nearly correct and watching current taken by the stage. See text.

T5—Oscillator transformer

Core—pair of ferrite cores type FX1238 (Mullard) no gap.

Primary 126 turns No. 32 s.w.g. enam. copper wire. Secondary 63 turns No. 32 s.w.g. enam. copper wire, no interleaving insulation.

Method—three strands wound together ("trifiler") ends 1, 2, 3; 1', 2', 3'

Connect 2' to 3. Primary is then 2 to 3', secondary 1 to 1'.

Inductances, measured under small-signal conditions at 1 kc/s, no d.c. component.

Lp=9.6mH, Ls=2.5mH

L leakage=38 μ H

T6—Driver transformer

Core—pair of ferrite cores type FX1239 (Mullard), no gap.

Primary: 4 layers, in all 122 turns 26 s.w.g. enam. copper wire.

Secondary: 1 layer, 16 turns No. 24 s.w.g. enam. copper wire.

Method—2 layers primary, 32+31 turns. 1 layer paper 0.001in. 1 layer secondary 16 turns. 1 layer paper 0.001in. 2 layers primary 30 and 29 turns.

Inductances: Lp 4.7mH

Ls 85mH

L leakage 40 μ H

Resistance wire

No. 34 s.w.g. bare eureka, $1\frac{1}{2}$ in. (coiled as necessary).

charging circuit for reasons to be mentioned later.

Between the sawtooth generating circuit and the base of the amplifying transistor is interposed a further adjustable network comprising a 2.2k Ω resistor (R83), an 8 μ F capacitor (C90) and a variable 1k Ω resistor (VR7). The purpose of this is to develop a parabolic wave from the generated sawtooth which, when added to the latter at the base of the amplifying transistor, will pre-distort it so that later on the distorting effect of the output choke will be alleviated. Fig. 30b shows simply how this is done. In fact, further correction is needed to obtain a really linear scan, and the means will be discussed shortly.

The input resistance of transistors operating in the common-emitter configuration is low, and because of this a severe load is placed on the timing capacitor which badly impairs linearity of charging. Consequently a composite transistor is used for amplification. This consists of transistors Tr20 (OC45) and Tr21 (OC81) arranged in a "Darlington pair"; this configuration of two cascaded emitter followers has an input impedance of the order of a megohm, which imposes negligible load on the timing circuit. From this combination, input for the power-amplifying transistor Tr22, an OC28, is derived.

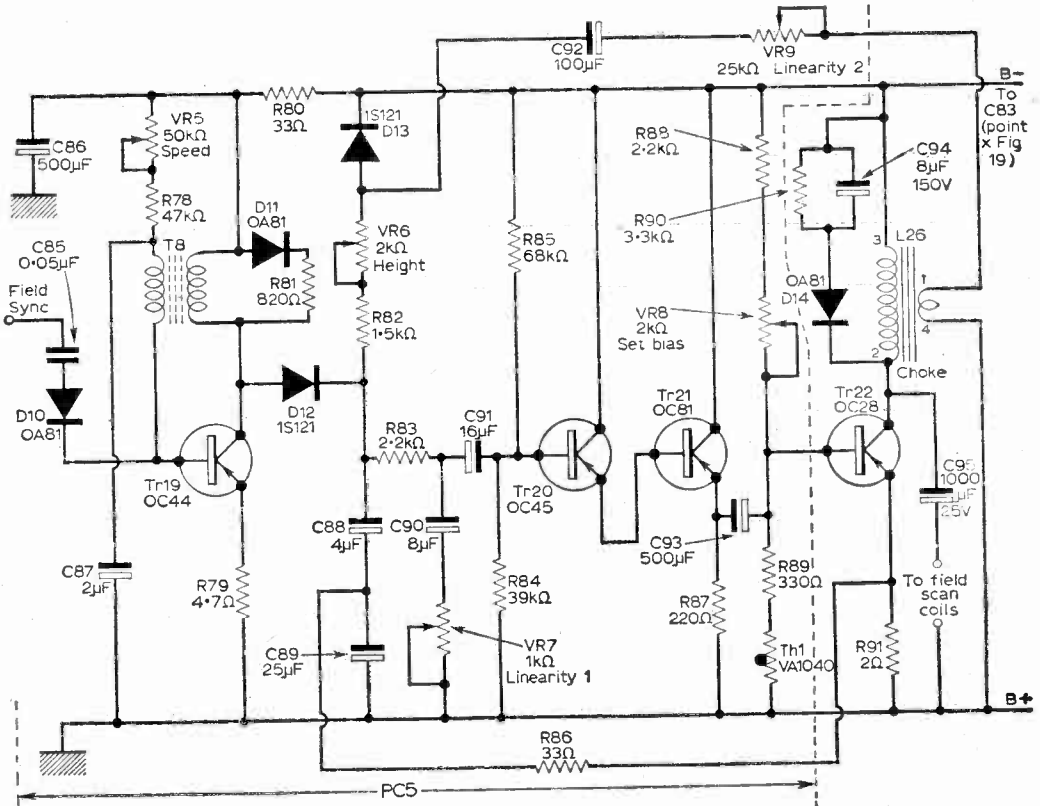

Fig. 29—The circuit of the field scan generator.

FIELD SCAN GENERATOR LIST OF COMPONENTS

Resistors:

- | | | |
|-----------|-----------|-----------|
| R78 47kΩ | R83 2.2kΩ | R88 2.2kΩ |
| R79 4.7Ω | R84 39kΩ | R89 330Ω |
| R80 33Ω | R85 68kΩ | R90 3.3kΩ |
| R81 820Ω | R86 33Ω | R91* 2Ω |
| R82 1.5kΩ | R87 220Ω | |
- All 10% 1/2W. * See text.

Potentiometers:

- | | |
|-------------------|-------------------|
| VR5 50kΩ carbon | VR8 2kΩ wirewound |
| VR6 2kΩ wirewound | VR9 25kΩ carbon |
| VR7 1kΩ wirewound | |

Capacitors:

- C85 0.05μF paper
- C86 500μF electrolytic 15V
- C87 2μF electrolytic 15V
- C88 4μF electrolytic 15V
- C89 25μF electrolytic 15V
- C90 8μF electrolytic 15V
- C91 16μF electrolytic 15V
- C92 100μF electrolytic 15V
- C93 500μF electrolytic 15V
- C94 8μF electrolytic 150V
- C95 1000μF electrolytic 25V

Transistors:

- | | |
|-----------|-----------|
| Tr19 OC44 | Tr21 OC81 |
| Tr20 OC45 | Tr22 OC28 |
- (with insulating kit)

Diodes:

- | | |
|-----------|-----------|
| D10 OA81 | D13 IS121 |
| D11 OA81 | D14 OA81 |
| D12 IS121 | |

Miscellaneous:

- Th1 VA1040 thermistor—Mullard Ltd.
- T8 Blocking oscillator transformer (see Table 5).
- L26 Field output choke (see Table 5). Aluminium sheet 16 s.w.g. 7 x 4in. (chassis "D").
- PC5 Copper-clad laminate 7 1/2 x 4 1/2 in. Quantity of 4BA nuts, bolts, solder tags and washers, tag strips, quantity of 26, 40 and 42 s.w.g. enam. copper wire (for L26 and T8). 6 1/2 in. length of 34 s.w.g. eureka resistance wire (R91).

A number of readers have written expressing difficulty in obtaining the Gilson driver and output transformers T3 and T4 specified in the audio section of the receiver.

As alternatives, Radiospares types T/T6 and T/T7 may be used without any alteration to circuit values. These transformers may be obtained through your local radio dealer or component stockist.

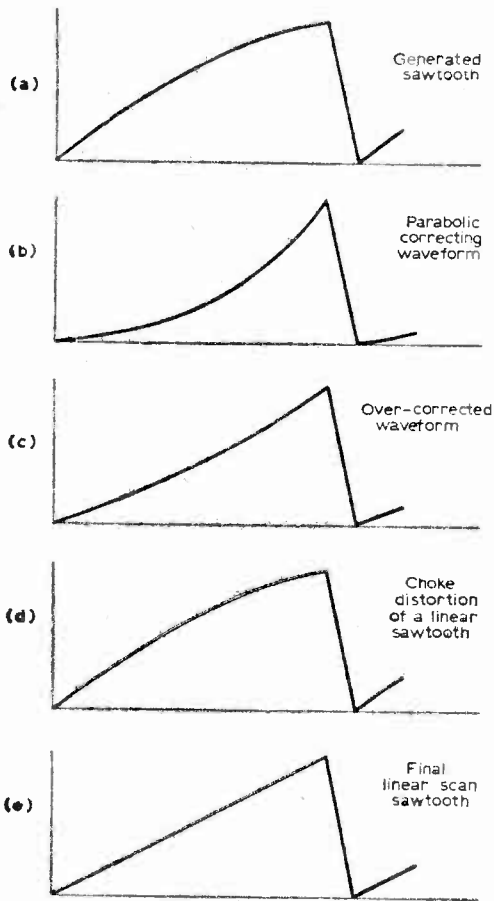

Fig. 30—Correction of the basic sawtooth for linear scan.

As it stands so far the scan coil current is by no means linear, even with the precautions and correction mentioned above. To improve matters, the initial sawtooth is linearised, so allowing the parabolic correcting wave to exert more effect. For this purpose a second winding is placed upon the output choke, and the voltage developed in this winding is fed back into the timing circuit. The purpose of D13, the second 1S121 diode will now be seen. As the timing capacitor begins to charge, the aiming potential is 12.6V. The early part of the charge is small, but because of the amplification arranged the voltage fed back from the choke also begins to rise. As soon as the voltage fed back rises above 12.6V the diode cuts off the battery, allowing the choke output to "take over" as the source of aiming potential. Thus as the timing capacitor changes up the aiming potential rises, and the exponential charging of the capacitor is transformed into a very linear rise.

This obviously can occur effectively only when the diode cuts off the battery supply, and although the main part of the scan is made very linear the first half inch or so (at the top of the picture) still tends to be rather cramped. This is dealt with by means of a further correcting circuit.

The feedback described above represents a type of "boot strapping", and the polarity of the feedback must be arranged appropriately by connecting the feedback windings of the choke (L26) the right way round. This can easily be found by trial and error. The actual amount of voltage feedback is governed by VR9, the 25k Ω potentiometer (linearity 2), and is necessarily in the right phase to maintain oscillation. Complete linearisation by this means involves that the gain in the feedback loop is unity, and this is also the condition for oscillation to occur. Consequently, something short of complete linearity has to be settled for. However, the original pre-distortion of the waveform as generated does not involve feedback, and so complete linearity can be attained providing correct adjustments are made. During the setting-up process oscillation may readily be obtained but this should cause no undue alarm as the circuit is so arranged that no harm comes of it. However, it should not be allowed to persist very long for obvious reasons!

The slight cramping at the very start of the scan could really be neglected; since plenty of "overscan" is provided for, and if necessary it could be hid behind the mask of the tube. However, for best possible display of the test card it is worth removing, and this is done by a feedback loop which includes an emitter resistor (R91) of 21 Ω in the output transistor circuit and the 25 μ F capacitor (C89) in the timing circuit. The feedback is controlled by a series resistor of 33 Ω (R86) and a moment's consideration of Fig. 30a will reveal that this feedback is operative throughout the scan period. It is most effective of course right at the start of scan, and performs its intended function accurately. This does not need to be made adjustable, but if preferred R86 may be replaced by a 100 Ω variable, or 250 Ω variable if the former is not readily available.

The best method of synchronisation is via a buffer amplifier, since the "backwash" from the blocking oscillator is thereby prevented as far as possible from affecting the interlace circuit. In order to obtain a pulse of the correct phase however a two-stage amplifier would be required, and the cost would not be justified. Accordingly a diode is used to isolate the blocking oscillator. The range of lock so obtained is entirely adequate, and in practice once set does not need to be altered at all. The speed control (VR5) could therefore be put at the back of the receiver out of the way, if desired.

The output transistor (Tr22) current required is only 125mA, and this could be supplied by an OC82, OC84 or 2G382. However, type OC28 is specified partly because of its higher collector-base voltage rating, but chiefly on account of the fact that it is a much more massive device; the small current taken does not warm it appreciably. Thus, with a good heat sink (the chassis, if one is used) and temperature compensation by means of Th1, the VA1040 thermistor (Mullard) in the base circuit, its characteristics change little when in operation, and negligible change in picture height occurs even after hours of continuous operation. The network comprising an OA81 (D14), 8 μ F capacitor (C94) and 3.3k resistor (R90) across the output choke L26, serves to minimise the large overswing voltage induced during flyback. A 2k Ω potentiometer (VR8) in the base circuit of Tr22 is for adjustment of bias in setting up. The collector current should be set to 125mA while scanning the tube. A preliminary setting of 120mA may well first be made.

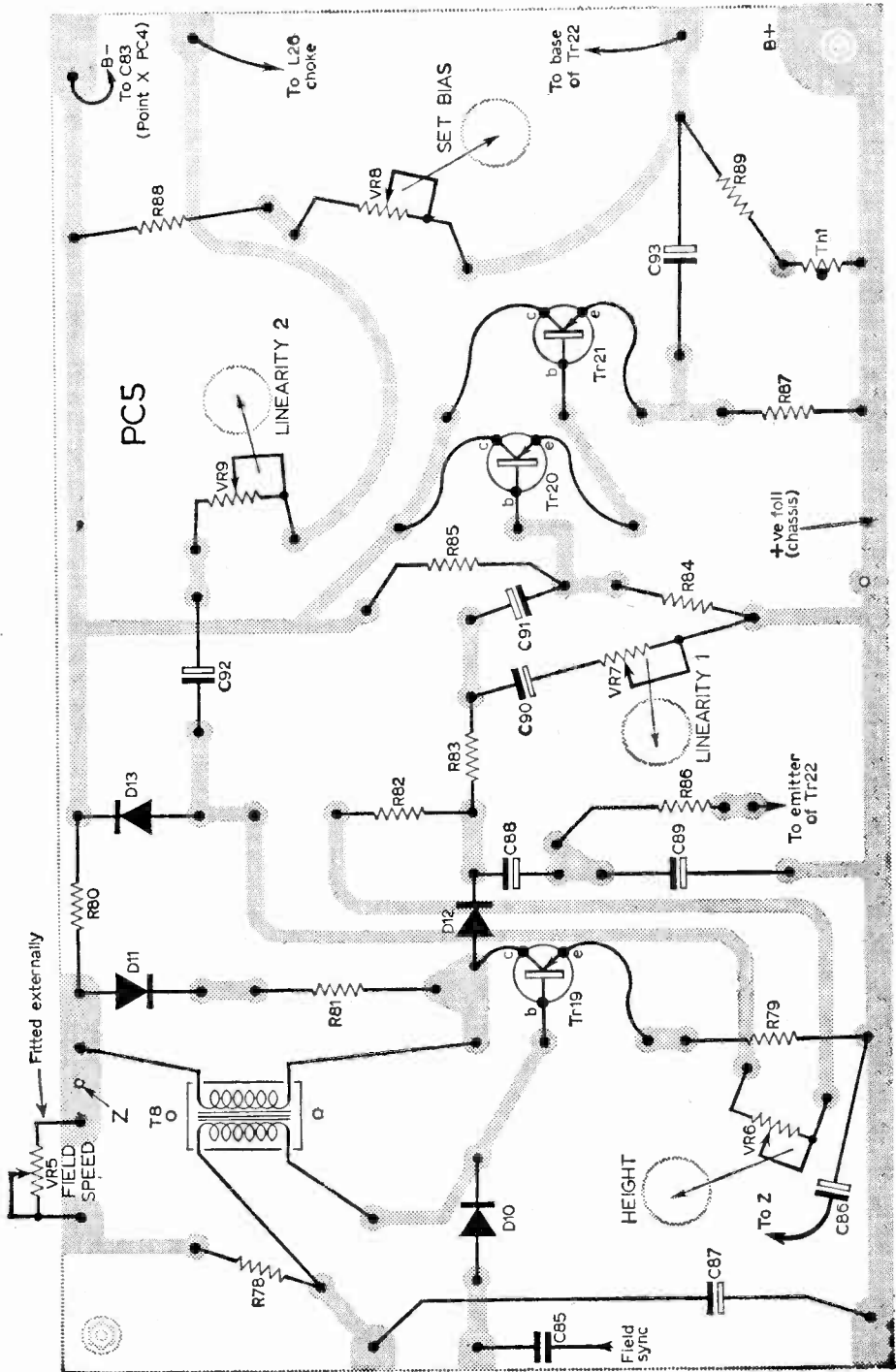

Fig. 31—The field scan printed circuit board, PC5. This is drawn full size with copper parts shown shaded.

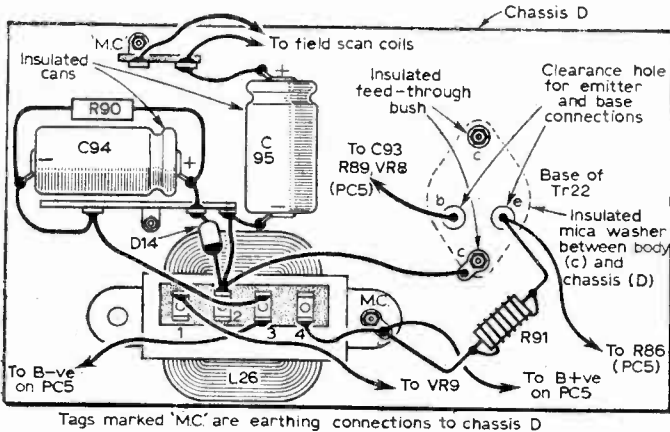

Fig. 32—Layout of the field scan generator output stage. Note that chassis "D" forms the heat sink for Tr22.

The Printed Circuit

The suggested etched circuit (PC5) is shown in Fig. 31, but there is nothing critical about it and if the constructor can find a simpler layout it might well be used. The circuit is not complete on this board, as with the line scan circuit; the output circuit comprising Tr22, L26 etc. is mounted on a 7 × 4 in. piece of

TABLE 5

Blocking oscillator transformer T8 (as in prototype).

Core: Mullard type LA1 assembly.
Windings: Secondary (put on first) 600 turns No. 42 s.w.g. enam. copper wire, random wound. Primary 1200 turns same wire, random wound. Interleaving—1 turn Sellotape.

Blocking oscillator transformer T8 (alternative specification).

Core: 0.5-in. stack of No. 18 E & I Silcor I laminations.
Windings: Secondary (put on first) 540 turns No. 42 s.w.g. enam. copper wire, random wound. Interleaving—0.002 in. paper, two layers. Primary, 1100 turns No. 42 s.w.g. enam. copper wire, random wound.

Output choke L26

Core: $\frac{3}{4}$ in. stack No. 35 E & I laminations Silcor 2 (M & EA).
Gap: 0.002 in.
Windings: Choke winding: 450 turns No. 26 s.w.g. enam. copper wire.
Feedback winding: 600 turns No. 40 s.w.g. enam. copper wire.
Interleaving 2 turns Sellotape.

2-ohm resistor R91

$6\frac{1}{2}$ in. length of No. 34 s.w.g. eureka wire.

(minimum heat sink dimensions) 16 s.w.g. sheet aluminium heat sink as shown in Fig. 32, using the insulating kit provided with the output transistor (which must be ordered with it). The emitter resistor (R91) consists of a length of resistance wire, conveniently wound on a $\frac{1}{4}$ in. dia. former and slipped off. The terminal board for L26 can also carry D14 and the voltage linearity CR network (C95), but the 1000 μ F capacitor (C94) is a rather bulky item and a tag strip is best used to anchor it firmly; this same tag strip can also carry terminals for the scan coil leads. Tr22 etc. may be alternatively mounted on the main chassis, which will then form its heat sink.

Setting-up for rough linearity can be accomplished on a received picture, or by applying an oscilloscope (Y-amplifier input) across a 1 or 2 Ω resistor in series with the scan coils. Near-perfect linearity

can be achieved only on the test card, and is done by trial and error. It will be found best to reduce height a little, so that a lin. gap appears at top and bottom of the picture. For this preliminary setting, VR9 should be set to a point well below that at which oscillation sets in. Best linearity should then be sought by means of VR7 (linearity 1), the 1k Ω potentiometer in the correcting circuit. Then VR9 should be adjusted, followed by adjustment of the height control VR6, to the correct value. Small further adjustments of both variable linearity controls will achieve a display of excellent linearity and at the correct height.

It is quite important to see that the OC28 collector current is adjusted to 125mA before the above adjustments are finalised.

The prototype employs as a blocking oscillator transformer a Mullard ferrite assembly type LA1. It was handy, small in size, and gives accurate timing in the blocking oscillator circuit. However, this is an obsolescent component, and its up-to-date alternative is not cheap. Hence an alternative specification is given in Table 5, which has been tried in the circuit and found satisfactory.

The thermistor Th1, used in series with R88 (330 Ω) in the base circuit of Tr22 is not always stocked by local dealers, but can be obtained without much delay at low cost. This is for correction for ambient temperature, and for testing purposes the series combinations may be replaced by a 470 Ω resistor. If this is left in circuit however it will be found necessary to alter the timebase height and linearity controls from time to time, as the room temperature changes.

It is emphasised that nothing in this receiver gets hot—except of course the c.r.t. heater and the heater of the DY86. The transistor which runs the hottest is in fact the video amplifier Tr8, and this gets barely warm to the fingers in long use. As the total receiver consumption is only 9 watts or so, the above will be understood. Heat sinks are provided for the transistors carrying fair currents, but these are not to prevent destruction of the transistors concerned but to ensure steady junction temperatures as far as possible.

—continued on page 512

A MUTUAL AND SELF-INDUCTANCE BRIDGE

A follow-up article to last month's "Measurement of Inductance"

by C. J. St. Clair

AN article* in last month's issue of this magazine described how it was possible to measure inductances between about $1\mu\text{H}$ and 100H using apparatus that is readily available for a very modest outlay. The device described here is extremely simple to build, will cover a comparable range and can measure mutual inductances from a few microhenries to several millihenries. It is not a precision instrument, but nevertheless is capable of giving results accurate to better than 5%; the accuracy depends largely on the accuracy of the resistors used as product arms. The author's own bridge is built into the box which houses a Wheatstone bridge, which simplifies matters considerably, as resistance values may be determined before a measurement of inductance is made. This arrangement is not, of course, essential; 1% tolerance carbon resistors will give very good results.

(a) The Maxwell self-inductance bridge

The bridge consists of a calibrated variable capacitor C , a variable resistor R_2 (actually two resistors in series, one for coarse balance and one for fine) and six terminals lettered A, B, C, D, E and F. These can be connected either as a Maxwell bridge or as a bridged-T network. Four coaxial sockets are used, one for the oscillator and three for the outputs from the various networks.

Fig. 1 shows the device connected as a self-inductance bridge. The specimen, represented by L and r , is connected to terminals C and D. The product arms

* page 456, Measurement of Inductance, by Peter C. Jones.

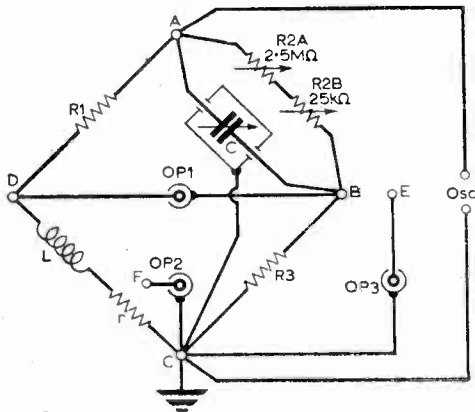

Fig. 1: The Maxwell self-inductance bridge.

R_1 and R_3 are connected externally to D and A, and to B and C. The capacitor C is wired internally to A and B; R_2 is wired to A internally and to B externally by a flexible lead coming through a hole in the panel. (This method of connection makes for easy and rapid exchange of resistors.) R_{2A} is a $2\text{M}\Omega$ linear carbon potentiometer; it is provided with a roughly calibrated dial in case the approximate value of coil losses should be needed. R_{2B} need not be calibrated. Its value will never be more than a few per cent of R_{2A} . The self-inductance of the unknown is found from

$$L = CR_1R_3$$

and the equivalent series resistance, r , from

$$r = \frac{R_1R_3}{R_2}$$

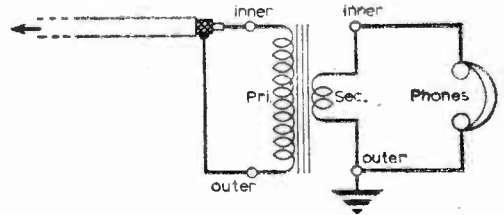

Fig. 2: Showing method of connecting headphones to bridge.

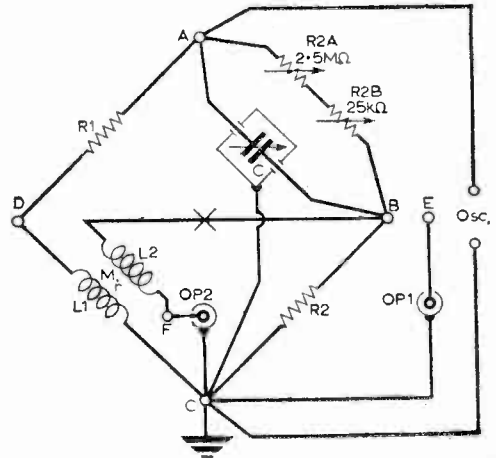

Fig. 3: The Maxwell mutual-inductance bridge.

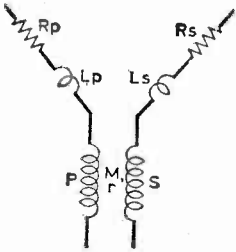

Fig. 4: A typical i.f. transformer analysed.

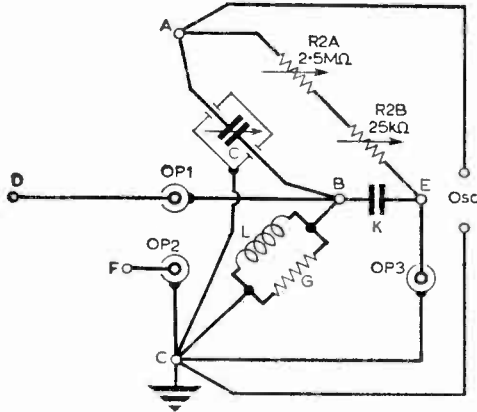

Fig. 5: Circuit of the bridged-T network.

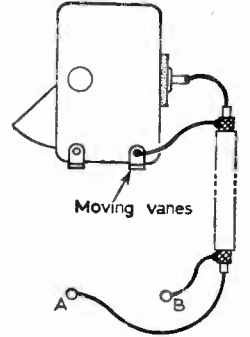

Fig. 6: Wiring the variable capacitor.

If R_1 and R_3 are chosen to give some convenient quantity (such as 10^5), measurement is only a matter of looking at the calibration of C. R_3 should be made the lower of the two product arms (e.g. 10Ω or 100Ω). The headphones are connected to the socket OP1 through a step-up transformer which is not incorporated in the bridge, as it has to be used with the other outputs. It should be connected as shown in Fig. 2. A high-ratio intervalve transformer or a low-ratio output transformer would be quite suitable; the ratio is not critical; 1:5 is quite satisfactory.

(b) The Maxwell mutual inductance bridge

The circuit of this arrangement is shown in Fig. 3. Suppose we wish to know the mutual inductance M between L_1 and L_2 (e.g. an i.f. transformer). The unknown inductor may be represented by the arrangement shown in Fig. 4. M is the pure coupled inductance between the primary P and the secondary S. L_p and L_s are the two uncoupled, or leakage inductances in these two windings and R_p and R_s the wire losses due to resistance.

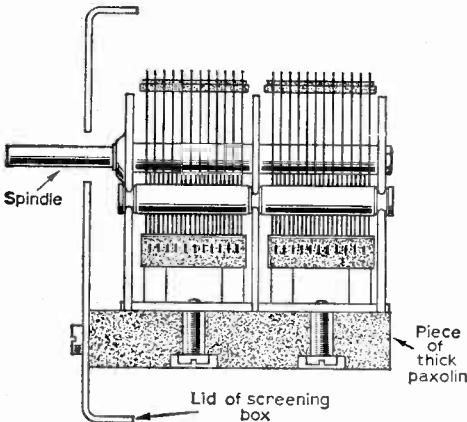

Fig. 7: The variable capacitor is mounted rigidly on a piece of paxolin, which is in turn screwed to the lid of the screening box. The capacitor spindle passes through the box without making contact.

The "unknown" in Fig. 3 shows only M and its core losses, r. L_p and R_p are in series with R_1 (which is high) and have a negligible effect on balance; L_s and R_s are in series with the headphones or detectors and can have no effect on balance. Therefore we shall measure only M and r. (For example, suppose $L_p = L_1 = 1\text{mH}$, and $R_p = 10\Omega$. At 1kc/s the total extra impedance in series with R_1 , which would be of the order of $10k\Omega$ is only about 0.1% of R_1 , which is negligible.)

The conventional place for the headphones is marked X in Fig. 3. But at balance no current flows in the B— L_2 —C branch of the network. Hence anything we do in that branch, (without disturbing M) has no effect on balance. We may therefore place the headphones at OP2 on the earthy side of L_2 , with the advantage that the oscillator, unknown and detector have a common earth at C.

Where the unknown is an air cored inductor it may be found impossible to achieve a perfect balance with the existing R_2 because of the very low value of r, the core losses in M (copper losses, R_p and R_s have been disposed of). In this case extra megohms may be added externally between B and R_2 , or R_2 can be left out of circuit altogether.

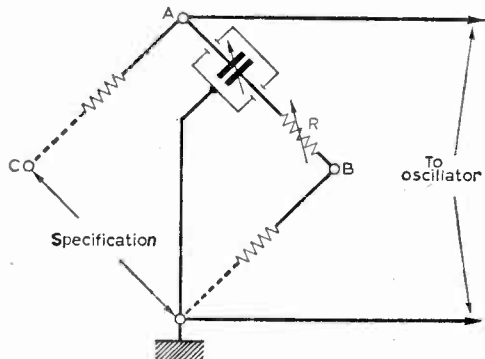

Fig. 8: This circuit shows why the variable capacitor must be isolated from the screws.

The values of M and r are obtained from

$$M = \frac{CR_1R_3}{R_1R_2}$$

and

$$r = \frac{R_2}{R_1}$$

The same transformer arrangement as shown in Fig. 2 may be used.

Neither the self nor the mutual inductance bridge is frequency sensitive, and the balance controls are independent of each other.

(c) The Bridged-T network

The two bridges just described will measure inductances up to 10mH or possibly a little higher without serious loss of accuracy. The bridged-T network described below will measure inductances from about 1mH to over 100H. It is slightly less easy to balance, as the controls are not independent; and as it is frequency-sensitive the measurements will depend on a knowledge of the applied frequency. The circuit is shown in Fig. 5.

The flexible lead from R2 is connected to E; a capacitor K, of known value is connected between B and E and the unknown L and its associated losses G is wired between B and C. The value of L is given by

$$L = \frac{1}{\omega^2(C+K)}$$

Table 2 in last month's article will be a useful guide in choosing the appropriate value of K.

Construction

There is very little that need be said about the construction of the device. All internal wiring should be taken direct to the appropriate bridge points A, B, C, D, E and F. The variable capacitor C should be wired as shown in Fig. 6, the screened wire being kept as short as possible. The leads to R2A and R2B should be short and thin, and unscreened.

The layout of the components is not critical.

Calibrating the variable capacitor

This process will be described in detail; numerical values quoted are those obtained by the author in certain experiments. The process is quite simple and may be performed in two operations. The first is to establish the shape of the capacitor calibration curve, i.e. to find how C1 varies with dial reading, and the second is to find the capacitance left in the circuit when C1 is at its minimum position.

Connect the apparatus up as shown in Fig. 10. R1 and R4 are about 100kΩ; they need not be matched, or even known accurately. Set C1 at its maximum and balance the circuit with C2 and C3 (e.g. 500pF fixed and 500pF variable). If the balance is not perfect, a small capacitor C4 (50pF or so), across R1 should

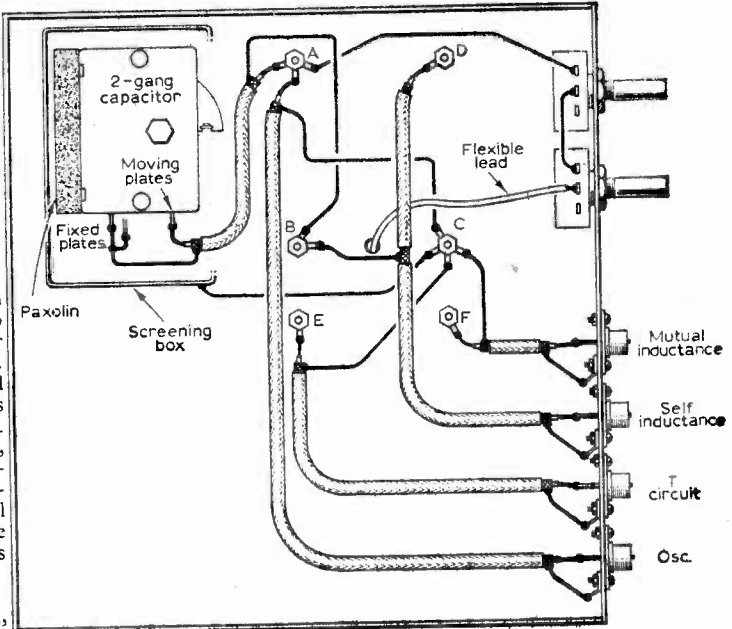

Fig. 9: The complete wiring of mutual and self-inductance bridge. The wiring of the earth circuits and screws is vital and should be done exactly as shown.

make it so. The headphones should be fed through a transformer, which need not have its secondary earthed. C2, C3 and C5 should not now be touched until this stage is over. From now on the only things changed are C1 and the calibrating capacitors. The author used silvered mica capacitors of 50pF, 100pF, 350pF, 470pF, 620pF and 770pF, 1% tolerances, and a few others. Connect a 50pF capacitor across A B, back off C1 until a balance is obtained and note the dial readings. Replace the 50pF by 100pF and repeat the procedure, again noting the dial reading. Continue doing this until C1 is at or near its minimum position.

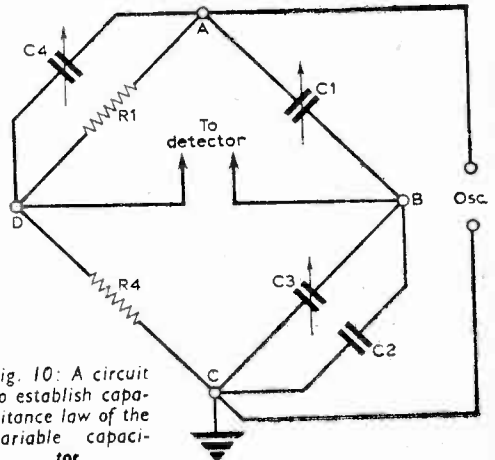

Fig. 10: A circuit to establish capacitance law of the variable capacitor.

There should now be two columns of figures similar to the first two in Table 1.

TABLE I

Added pF	Dial reading	Uncorrected scale	Corrected scale
0	180.6	700	758
50	170.4	650	708
100	161.6	600	658
150	153.2	550	608
etc.	etc.	etc.	etc.
670	30.8	30	88
675	24.9	25	83
685	23.5	15	73
690	17.0	10	68

Now draw a graph of added capacitance against C1 dial readings. It should be a smooth curve. If there are any sudden changes then probably C2 has been inadvertently shifted, in which case the whole process must be repeated until a smooth curve is obtained. It may be found that the balance becomes insensitive as C1 approaches its minimum; this is only to be expected, for the graph should become horizontal at this point; consequently more points should be plotted between say, 60° and zero than elsewhere. The exact intercept of the curve on the y-axis (the pF axis) should be within a few pF of the true value. This value is important, for it determines the accuracy of the final calibration.

Suppose the intercept is at 700pF; then the change in C1 between minimum and maximum is 700pF. Using the graph, we can now put down a third column of figures, giving the uncorrected calibration of C1, by subtracting the values in Col 1. from 700pF.

We now have to correct these values for the residual capacitance left when C1 is at a minimum. This residual capacitance need not be known very accurately, it is in the region of 50pF. If it is found within 5pF then the error, when C1 is at 500pF, is only 1% and it should be easy to find it to better than 5pF. First, set C1 to minimum, connect a fixed capacitor of about 330pF across A B and balance the bridge on C3 and C4. Now very carefully disconnect the inner conductor of the screened lead to C1 from the terminal A without disturbing anything else. The bridge is now unbalanced by the removal of the residual capacitance. Find the balance by adding small fixed capacitors across A B (e.g. 4 × 15pF in parallel; 3 × 22pF in parallel; 39pF + 15pF in parallel, etc.). The author found an approximate balance at 60pF and a slightly worse balance at 56pF; the true value was between these two; 58 pF was chosen as it was within 2pF of the true value.

By using this method of calibration, any stray capacitance across R4 and (C2 + C3) due to the headphones, etc. are accounted for; they remain constant, and they do not have to be known.

The final stage is simple; the residual capacitance is added to the uncorrected capacitance in Col. 3 Table 1, to give the corrected capacitance (Col. 4). This is plotted against dial reading and the calibration curve is obtained. This can either be used to find the capacitance of C1, or C1 can have its dial calibrated directly from this curve.

The balancing capacitor C1 in the original was a 2-gang 500pF variable. An accurately known mutual inductor of 249μH was measured on the prototype as being 254μH, an error of 2.5%, which is considered very satisfactory.

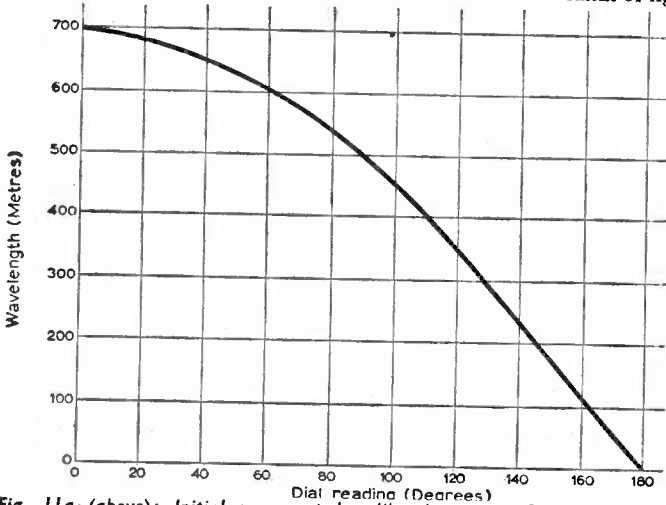
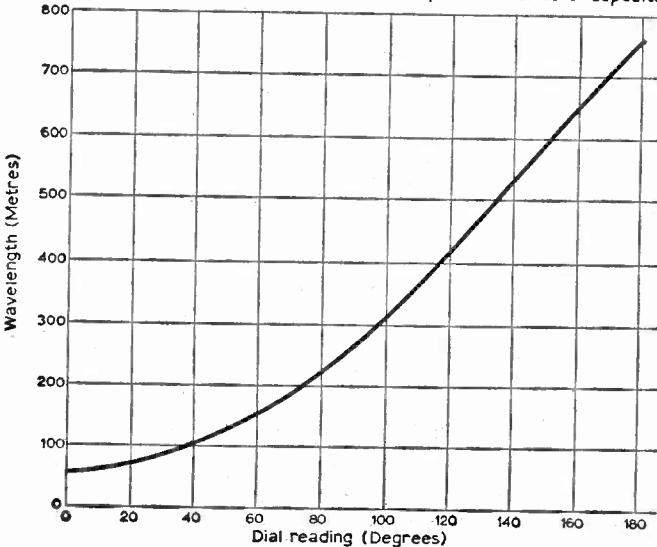

Fig. 11a (above): Initial uncorrected calibration curve for the variable capacitor.

Fig. 11b (below): Final corrected calibration for the variable capacitor.



A MONTHLY FEATURE
FOR DX ENTHUSIASTS

by Charles Rafarel

DX-TV

SINCE last month, Sporadic E conditions have really "opened-up", and late May and all June have been extremely rewarding. Only a few days have not produced a good quota of DX reception. The highlights, however, were on the following dates:—

May 20: USSR, Czechoslovakia, E. Germany, Poland, Norway.

May 21: Spain, Portugal, Switzerland. (Rare in the South of England due to short skip.)

May 22: Italy, Spain, Norway.

May 27: USSR, Spain, Portugal, Austria, Hungary.

May 28: Norway, Sweden, Denmark, Spain, Portugal.

May 29: Norway, Sweden.

June 7: Austria, Yugoslavia, Czechoslovakia, Italy.

June 9: Yugoslavia, Spain, USSR, Italy.

June 14: USSR, Czechoslovakia, E. Germany, Poland.

June 19: USSR, Czechoslovakia, Austria.

I hope that this list may help DX'ers to clear up some of the queries in their logs for reception on these dates. In this area, reception has been at least as good and probably even a little better than the same period in 1964.

One notable feature this year is the much improved Norwegian, Swedish, and Danish reception, although I myself have seen nothing from neighbouring Finland since January last, though other readers report it.

Another interesting feature this year is that Sporadic-E signals appear to be much more "directional" than usual, so in contradiction to earlier comments, I suggest that this year you point your arrays towards the required station (if this does not give you excessive local station interference); you may find it of advantage.

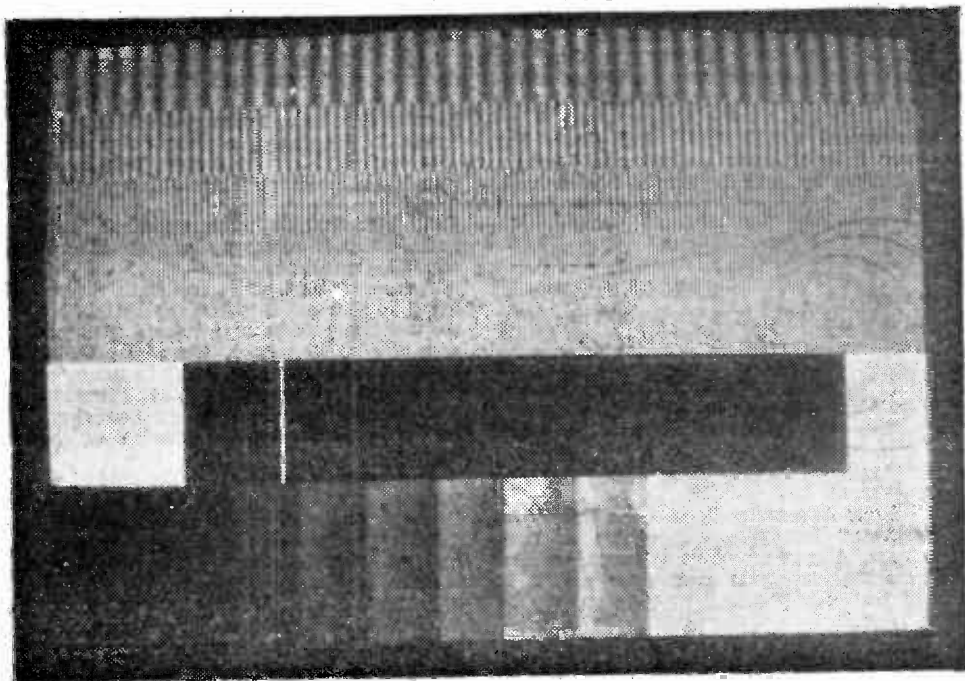

The new international Test Card proposed by the European Broadcasting Union for the use of its members.

Mysteries

As usual we have our crop of "mysteries" this year and I think that the Polish-Hungarian test card problem is the most vexing. This card, like that used by Belgium at times, has a centre square with diagonals, slightly reminiscent of a Union Jack and which was also used last year by Poland with wording above and below the centre square. This year it is well in evidence on channels R1, R2, E3 and E4 with *no* wording on it.

DX'ers seem to be equally divided in placing the origin of the R1 and R2 stations in Poland or Hungary. My own opinion is that both Poland and Hungary are using this card because observations of subsequent opening captions on R1 have sometimes indicated Poland, and sometimes Hungary.

On R2 I have only ever seen a Polish caption after it, but some DX'ers consider that this card emanates from Pecs, Hungary. As this very low powered station is rarely received, this seems to me to be unlikely. I would suggest that this card on R1 should not be relied on for identification, and other means (by captions) should be used.

This type of card on E3 and E4 would appear from later captions to emanate from Yugoslavia: E3 from Kapaonik, and E4 from Labistica, the latter new this year. These stations are easily identified by captions indicating Zagreb and Ljubliana studios and these have been well received.

New International Test Card

We are indebted to Monsieur E. Aisberg, director of our counterpart in France, the magazine "Télévision", for the illustration and the news that a new test card is proposed by EBU for future use, which will carry the name of the transmitter in white lettering on the black rectangle.

When this happy day arrives, providing the lettering is of adequate type size to read over interference, our identification problems will be largely solved!

For the record ORTF/UHF 2nd Chain has already been using this new pattern, and I have a photo of it taken by I. C. Beckett of Buckingham.



(From "Practical Television", August '35)

THE Hour Approaches", says the Editor, as PRACTICAL TELEVISION completes its first volume. Alexandra Palace is named as the site for the first television transmitter and it is announced that it is intended to open stations in Glasgow, Manchester and Birmingham in 1936, all of which will be radiating local programmes before the end of that year.

There still seems to be some suspicion, and open hostility, to the upstart Television, not only by the

The proposed dates for general use are not yet known.

News

Finland. Reports from readers show that at least one new station in Band I has opened up on channel E3. The original E2 Helsinki has been coming in as well and there has been a change of test card this year from the old "Cogged Wheel" type to a card similar to that of Norway and Denmark, i.e. test card C with outer white circle.

English reports and photos show the lettering at the bottom of the centre circle as "Yleisradio TV 1", and DX'ers seem to think this means the v.h.f. First Programme and a new u.h.f. service will carry "TV 2" below. This is not true, as we have a photo taken by Lother Scholz on channel E2 which shows the "TV 2" caption in Band I.

The location of the E3 transmitter in Finland is not yet to hand.

Sweden. The Swedish test card has been noted as carrying station names, including Boden, Sundsvall and Ostersund. I suggest that you keep a sharp look-out.

READERS' REPORTS

I am very sorry but lack of space this month leaves room for a brief summary only:—

R. Roper (Torpoint): Sweden E2 and E3, Norway E3, and Poland R1.

N. V. Dinsdale (York): Spain E2, E3, and E4, Sweden E2.

A. G. Challis (Brundall): Sweden, and Norway E2.

J. W. Thompson (Uppingham): France F2 (via Sporadic E).

E. H. Putt (Waltham Cross): Rumania R2, and USSR R1.

J. Cribbon (Althone): Sweden E3 (on his domestic receiver for 625 Irish TV).

Apologies for omissions in the above list but we hope to have more space available in next month's article. In the meantime please write and tell me of your successes, and ask for any help that you need with identification problems. This is your column!

Daily Press but by "certain sections" of the trade itself, which is unhappy about the effect of TV on the sale of radio receivers.

Announcements are carried in this issue concerning the Baird and the Marconi-EMI systems which are to operate on an experimental basis prior to the start of a public service. The Marconi-EMI system is for 405 lines, but the Baird Company states that "leading television authorities in Germany, France and America have agreed that nothing is to be gained by increasing the number of lines above 240."

And here is a round-up of the kind of news items which appeared in August 1935: The German Post Office is expected to open a 120-line head-and-shoulders television telephone service "in the spring". American and British film studios are building studios for staging scenes suitable for TV broadcasts. Holland is making experimental transmissions from Eindhoven. Canadian engineers have broadcast TV pictures over a distance of 60 miles. Films of German athletes training were used in a later broadcast from the Berlin station, a prelude to the 1936 Olympic Games.

A TRANSISTORISED E.H.T. VOLTMETER

by D. R. Bowman, B.Sc.

This unit was originally designed to facilitate adjustments to the "Olympic II" receiver, but is of course, ideal for service work on any receiver.

THE unit to be described was designed by the author to check and facilitate adjustment of television receiver e.h.t. supplies. Fig. 1 shows the circuit diagram, which uses a single transistor as the active element. By this means two main advantages accrue. The first is that the meter and its container are separated from the e.h.t. voltage and the second is that a robust type of meter can be used safely and accurately. In fact if desired a multimeter can be used instead of an integral meter.

described here uses cheap and readily obtained components and good accuracy with complete safety results.

Fig. 1 shows the very simple circuit diagram of the instrument. It is best arranged as a small piece of copper-clad laminate and mounted in a tin box together with the meter and battery. The whole thing is then self-contained and may be connected to the chassis of a television receiver without any worries about battery polarity and so on.

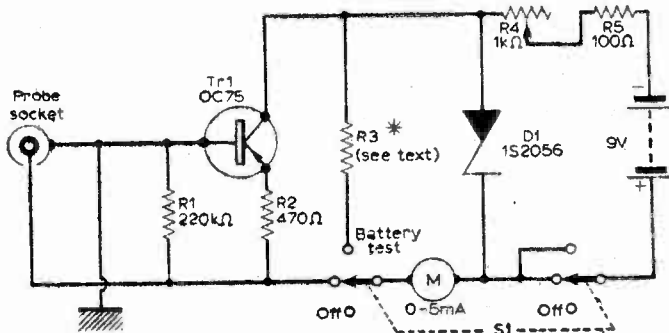

Fig. 1—The single-transistor circuit of the instrument.

The writer is acutely aware of the need for complete protection of the user from shock and the meter from damage. At first sight it might be thought that a well-insulated high-resistance multiplier attached to an ordinary meter would fill the bill. However, should the meter circuit breaker operate while a test was in progress the whole multiplier would acquire e.h.t. voltage; not only would there be severe sparking across the circuit breaker inside the meter but danger might result to the user. He might get a severe shock in both senses of the word.

Safety is, of course, not the only criterion, although an important one. Accuracy could hardly be achieved by a simple probe-type multiplier because of leakages along the surfaces concerned. These could be avoided by superlatively good (and expensive) insulation or by the use of "guarding" techniques. In view of all the factors concerned the best thing is to use a different method to achieve the required results. The device

The OC75 is chosen because of its high direct current gain, but because it is a p-n-p device and the e.h.t. of a television receiver is positive the circuit has to be arranged "upside down" as it were. Thus the meter battery and switch need to be well insulated from the containing box. The meter usually has a plastic case and the switch wafers (of ceramic or paxolin) are equally well insulated. The battery is a less reliable affair and it may be advisable to wrap it in a polythene bag before securing it in a suitable clip. A coaxial socket is provided for the input; the "inner" is therefore connected to the B+ line when the instrument is switched or while the base of the transistor is connected to the containing box. The latter must be of metal for safety and several types of household discard can be used.

If the d.c. gain of the transistor is 100 a change of base current of 50 μ A will give a collector current charge of 5mA. At zero input voltage the base of the transistor is connected to the positive end of

the emitter resistor (through a 220k Ω resistor) and the transistor is almost cut off. The slight leakage current is only a few microamps and reads on the meter. However, the deflection of the needle is so small as to be well within the zero adjustment.

When 50 μ A flows from the input terminal through the emitter-base-earth path the collector current is 5mA. Thus a robust meter can be used; a 2 $\frac{1}{2}$ in. diameter meter is quite suitable and may be obtained cheaply from several advertisers in this journal. If a 1mA meter is used it may be shunted by a suitable resistor to give the correct full-scale deflection.

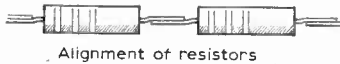

Fig. 2—The junction between elements of the resistor chain.

Construction of the Probe

The construction is straightforward but great care must be taken if safety is to be assured. The input current being 50 μ A maximum, for 20kV input a resistor chain amounting to 400M Ω in all is required, and this is made up to a close approximation by means of 18 22M Ω resistors in series with a 3.9M Ω resistor. Twenty per cent. tolerance components can be used, since if these are all taken at random the errors tend to cancel out when the "sample" is as large as 18 or 19. If 10% tolerance components are used the total resistance will be within 2% of the nominal figure.

Using the small carbon resistors of $\frac{1}{8}$ in. length and allowing a $\frac{1}{8}$ in. lead at each end for connecting up the total length from the beginning of the first resistor body to the end of the 19th will be 8 $\frac{3}{8}$ in.

The resistor chain is next wiped over carefully with a clean rag soaked in carbon tetrachloride or lighter fuel to remove traces of grease and is then dried in a current of warm air. It is next passed through the paxolin tube and the polythene "inner" forced tightly into the end of the tube. The size is just right. The resistor chain is arranged to be quite central in the tube.

The next process is to melt sufficient paraffin wax (candle grease will not do) and to raise its temperature to drive off all air and moisture. This can be done in a small aluminium saucepan (preferably a good pourer!) and should be continued until the wax is well above the boiling point of water. It is allowed to cool a little and then the paxolin tube is filled up with the wax. On solidifying the wax contracts, so enough liquid should be available to "top up" the tube to above the body of the last resistor. When cold and hard the next step can be taken.

This is to solder the last resistor lead to the inner of a piece of coaxial cable and then to pack between the "inner" insulation and the paxolin tube with insulating material. Strips of polythene are very good for this or alternatively insulation tape can be used. Lastly the outer braiding is teased out and slipped over the outside of the tube.

Then, starting at the end of the tube, 22s.w.g. tinned copper wire is wound tightly over the braiding and one-third way up the tube. Finally this is soldered up to hold it in position and give good, solid contact all along its length. A bicycle type rubber or plastic handle grip may then be fitted over the end and filled with resin-catalyst (as used in car repair outfits) to strengthen the cable end. The complete assembly is shown in

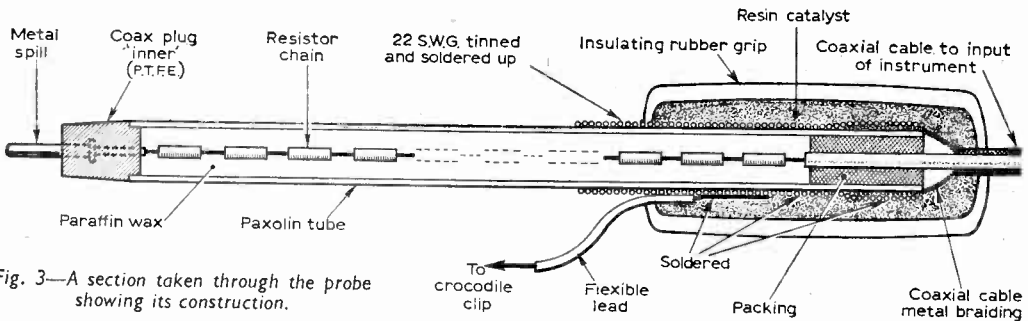

Fig. 3—A section taken through the probe showing its construction.

A piece of paxolin tube just over 9in. will therefore be required and its diameter should be $\frac{1}{8}$ in.

The 19 resistors are carefully soldered together in line, taking care to align them as accurately as possible; this is easy if the leads are bent over at a slight angle as close to the resistor body as possible. The chain can be rolled between two boards to finish off this operation (Fig. 2). Then to one end is soldered the inner insulated spill of a coaxial plug. The polythene type of plug is not so good as the p.t.f.e., although the latter is rather more expensive, insulation is better and as the melting point of p.t.f.e. is much higher soldering is simplified.

Fig. 3, which also shows how an earth lead is attached to the probe.

The purpose of the bare wire winding is twofold. In the first place it protects the user, since if a flashover should occur (very unlikely) it will be intercepted before reaching the fingers. In the second place any leakage that occurs will be along the outside of the tube, since the insulation inside the tube is entirely adequate. This leakage current will be directed to earth and not pass through the transistor and so will not affect the reading.

The cable may be of any convenient length and is terminated in a coaxial plug which fits into the corresponding socket. Whether the instrument is

switched on or off no more than 11V can appear across this socket.

Calibration merely consists of passing a known current into the socket and noting the meter deflection. This is readily accomplished by means of a battery, a variable resistance and a 0-50 μ A meter. Since the total resistance of the probe is known quite accurately and the input resistance of the instrument is negligible compared with the probe resistance a simple calculation gives the value of e.h.t. which would produce the same input current. It has been assumed that transistor gain will be 100 but it may be considerably more or less than this and hence the full-scale deflection of the meter may correspond to other than 20kV. If the scale goes up to as much as 30kV it will be best to change the transistor for one of higher current gain. If the meter has been shunted to decrease its sensitivity the shunt can, of course, be adjusted to obtain a full-scale deflection of around 20kV. Table 1 shows the values of e.h.t. corresponding to the calibration current used.

TABLE 1

E.H.T. corresponding (mark the meter scale with this value)

Calibration Current	value
5mA	2kV
10mA	4kV
15mA	6kV
20mA	8kV
25mA	10kV
30mA	12kV
35mA	14kV
40mA	16kV
45mA	20kV

The scale will not be quite linear at the lowest readings but above 5kV linearity is quite good. There is an advantage in this in that the higher readings are spread over a larger proportion of the scale and are more accurately marked.

It will be noted that a Zener diode is used together with a series resistor in the battery supply to regulate the voltage applied to the transistor. The variable resistor R4, also in series, enables an adjustment to be made for an ageing battery. The check is simple. The switch is turned to "battery test" position and R4 rotated from its minimum position until the voltage indicated no longer rises. At this point the Zener diode is "in" and is regulating the supply. The value of R3 should be chosen in conjunction with the full-scale deflection of the meter used. The specified Zener diode regulates at 5.6V, so if a meter deflection of 4mA approximately is required R3 should be 1.2k Ω .

The accuracy obtainable with this instrument is such that this simple regulation of the power supply is worth while for low e.h.t. readings especially. For readings above 10-15kV it is not really necessary but, if omitted, the battery test position of the switch should be included to enable a check to be made from time to time.

In use the resistor R4 should be adjusted so that the Zener diode just conducts on test and no more. Higher settings merely waste battery current!

NEXT MONTH IN

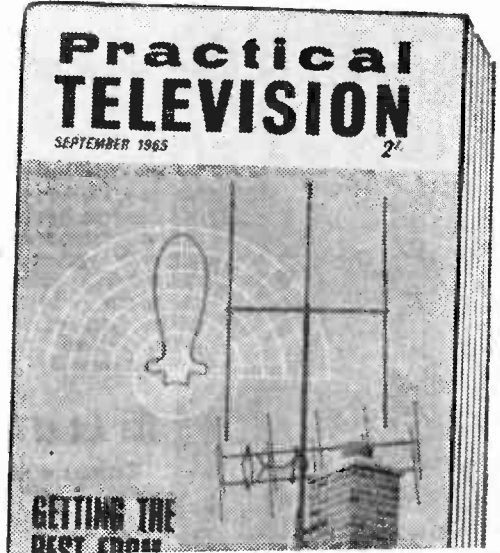

GETTING THE BEST FROM TV AERIALS

Installation, testing and maintenance of outdoor aerials to ensure the best possible, trouble-free reception.

FIRST TIME TESTS

First of an important new series on TV fault-finding by a professional engineer, using the minimum of equipment. Descriptions of circuitry under test will be particularly helpful to beginners.

THERMOPLASTIC VIDEO RECORDING

A novel method of recording video signals on tape, using thermoplastic principles.

PRACTICAL OSCILLOSCOPY

Outlines some of the practical uses of the oscilloscope, an instrument essential to much TV work.

★

September number out Aug. 19th

ORDER YOUR COPY NOW!

UNDER NEATH



THE DIPOLE

STARS come and stars go, both in the astral firmament and on the theatrical stage. Both are here to stay, in the sky and on the bills—until they fall! How did the principal actor, the actor-manager of a group of strolling players acquire the distinction of being called a "star"?

Elementary! It was because he found that a convenient method of indicating the dressing room of the "principal actor" was to fix a metal star on the outside of his door, for the information of visitors behind the scenes. This became a little confusing when two or three actors (or actresses), each allocated their own dressing rooms, acquired the rank, importance and prestige that was attached to a star dressing room. It applied particularly if these "star" rooms were all on the ground floor, level with the stage.

But this was back in the days of gas footlights (or even earlier), when dressing rooms were few and far between and the rest of the actors, performers or "supers" had to dress and make-up in whatever space they could find behind the stage.

Star Dressing Rooms

The theatre of today is positively luxurious by comparison, though there is a reluctance to provide sufficient plumbing in a few theatres at each floor level. Modern British television stations are exceptionally well equipped with green rooms, make-up rooms, comfortable dressing rooms, bathrooms and all modern conveniences, but the traditional "star" label has disappeared.

The Art of "Up-staging"

There are many other ways in which a star can register his importance, both with managements and with audiences. Some of these are minor quirks of mannerisms and movement, quite apart from good acting and diction. Unlike the performances of actors in the individual brief camera set-ups for film making, actors in theatre or television plays are left to their own devices to perform and entertain. That is, unless, as in the television studio, the actor is sufficiently professional to accept tic-tac signals from the floor manager off-stage to hurry or slow down (without giving the game away).

Therefore, the road is open for him to "steal" scenes from the other actors in various small but useful ways. Taking half-a-step back (in a two shot), he can almost face the audience and at the same time turn his colleague into a profile. When dialogue is being carried on by other characters, he need not become completely lifeless; he can scratch his head, light a pipe (or even break a match lighting it) in order to attract attention and keep in the picture.

Plenty of this kind of scene stealing happens in television features other than plays, but sometimes these ad lib interruptions become an annoyance.

Colour—and the grey scale

The failure of the Vienna conference on standards for world colour television will not hold back the technical progress of colour. It seems to me that the trend may be towards an agreement to differ. In the meantime, attention should be paid to the correct rendering of monochrome densities as representing the colours.

Faces and flesh tones are important and it is disturbing when they change from shot to shot. Continuity of colour balance on film or television shots is of major importance and difficult to achieve when switching from camera to camera. It is even more important than so-called colour accuracy. The monochrome equivalents should not be ignored.

Orthochromatic

Many years ago, in the days of the silent film, photographic negative was very sensitive to the blue (and violet) end of the colour spectrum but quite insensitive to the red end. It was called orthochromatic stock.

The red of pillar boxes or resplendent crimson uniforms of the North West Mounted Police reproduced as being practically black. Deep blue skies were reproduced all white, offering no contrast to white clouds. Actor's faces, particularly if they had ruddy complexions, turned to a dusky shade unless they covered their faces with light yellow make-up (usually Leichner's No. 5).

The Hepworth Golden Rules

Cecil M. Hepworth, producer of many important British silent films of fifty years ago issued instructions to his directors and cameramen, which became golden rules when filming on location.

One of the most important rules was for the actors to be manoeuvred into positions which had mid-tone or dark backgrounds, and to avoid skies altogether, excepting for landscape shots. Light backings, such as white-washed walls or houses were also to be avoided.

Panchromatic negative film, introduced generally in about

1928, was red sensitive, enabling make-up to be much less heavy or dispensed with altogether. The same applied with colour film. But the facial skin texture distortions have returned again in television, especially on filmed exteriors. Why is this?

Misleading Monitors

Directors of filmed television inserts in videotaped or tele-recorded plays have a tendency to fool themselves when they see the "rushes" of film prints of the previous day's exterior shooting reproduced on teletext or in a film projection theatre.

With modern extremely sensitive panchromatic negative and a reckless use of camera angles in cinéma vérité style, the results may be acceptable under the best reproducing conditions. But on the average domestic TV receiver, the influence of a.g.c. circuitry plays havoc with the arty-crafty subtleties of gimmick photography. Features of actors turn completely black when outshone with bright backgrounds, yet, when a reverse angle shot with a grey or dark background follows

up, their faces turn a deathly pale colour.

Breaking the Hepworth rules of fifty years ago gives an effect worse than it was possible to achieve with the old slow orthochromatic film stock. This effect was noticeable particularly in Scottish sequences in *Dr. Finlay's Casebook* and the Debussy issue of *Monitor*.

Out of Step

Off-beat productions please the film critics and the judges of film and television festivals, of which there are so many these days, usually in delightful places like Montreux, Cannes and Monte Carlo. A regular diet of TV series of conventional type bores them and they welcome so-called sophisticated fare.

The Man Without Papers was an example of the tangled web woven by Troy Kennedy Martin in a story of a particularly uncouth and unpleasant anti-hero who was a fugitive from the law. The basic story was completely lost in a spate of production gimmicks far removed from the author's *Z Cars*, a popular series, or even *Diary of a Young Man*, which was more gimmicky but less successful.

The Wednesday Play

One of the most objectionable features about the *Wednesday Play* series is the introductory title attached to the front of each

weekly presentation. This comprises a series of completely unconnected close and long shot scenes which are joined together and cut to synchronise with rather disagreeable musical backgrounds.

The quick jumps and flashes may be acceptable to a film editor who spends most of the day looking at film on a moviola and is able to take in the visual information of a couple of frames of film in about a tenth of a second. The average viewer looking at the average TV set is dazzled and bewildered by the mess of footage when the cuts follow one another at such a pace, with no attempt at continuity of subject matter or movement.

Film splicing exercises have long been professional jokes in film and television studios, and these should not be inflicted on innocent viewers, whether on feature programmes or commercials.

The most important ingredients of any drama, comedy or other type of feature on television should be the performances of the principal actors. Their performances should not be ruined by the repetitious mechanics of peculiar camera angles, gimmick cutting from shot to shot or over-busy stage settings, all of which claim the viewers' attention. It is the star who counts—and that is where we came in! (See paragraph 1).

Iconsos

In the August
**PRACTICAL
WIRELESS**

A
Solar-powered
Pocket
Receiver

and a host of other
constructional
articles

On Sale NOW
only 2/-

**THERE'S NO DOUBT
ABOUT IT...**

with the August
**PRACTICAL
ELECTRONICS**

**SIMPLE ANALOGUE COMPUTER
TRANSISTOR AND DIODE TESTER
ON SALE JULY 15**

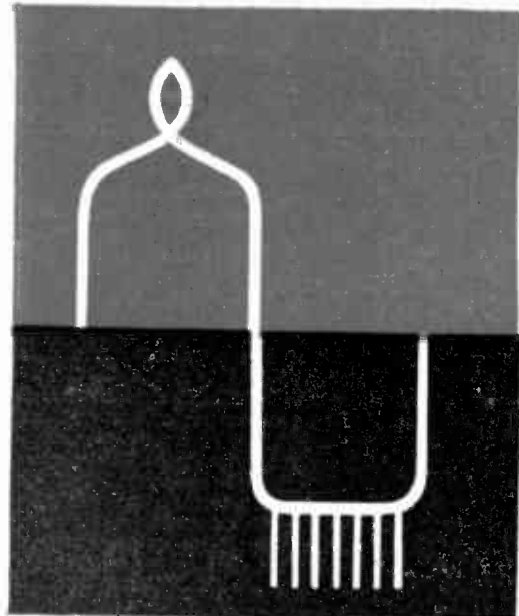

VALVES

and their habits

H. PETERS

D“DOUBLE” valves, particularly the triode pentodes, still appear to be the most troublesome. They are naturally more difficult to construct and, as the entire valve is discarded when one half breaks down, their chance of failing is consequently twice that of a “single” type.

Their versatility can indeed be their own downfall, since equipment designers often use them in a variety of unusual circuits quite removed from their original purpose.

EMERGENCY REPLACEMENTS

From time to time “emergency replacements” are mentioned in the text. These are valves with the same basing, usually the same heater current, and only slightly different characteristics. You will not find them given as equivalents in valve characteristic manuals but they have proved themselves capable of keeping receivers going at such critical times when new valves of the correct type are not obtainable.

BY100

Perversely enough our valve list begins with a diode. The BY100 silicon diode is to be universally found in modern dual-standard sets. Due to its size and price it may be used with

advantage to replace the h.t. rectifier in earlier receivers. Its main disadvantage is that it is too efficient and, if insufficient care is taken to absorb the switching-on surge, damage can result to the electrolytics and the on/off switch. The h.t. line may rise in excess of the specified voltage and a limiting resistor should be incorporated to absorb the excess.

DY86, DY87

These two 1.4V e.h.t. rectifiers have similar characteristics to the EY86. Their heater wattage is the same as the U26, for which they make an emergency replacement with shortened life. The only difference between the DY86 and the DY87 is a silicone treated glass envelope on the latter for better insulation in humid conditions.

EB91, (6D2, D77, 6AL5)

This sturdy little 6.3V 0.3A double diode has been used in detector, limiter, discriminator, and interlace circuits right from the beginning of post-war TV.

It has the habit of lighting up very brightly on switch-on, but this does not affect its performance. The commonest fault is heater-cathode leakage, causing hum in varying degrees. This may sometimes be cured in series heater circuits by removing the heater to the low potential end of the chain.

An alternative is to construct a “cold” EB91 using two OA71 crystal diodes on a seven-pin adaptor plug. Unequal halves only appear to affect line flywheel discriminator circuits of the balanced type and a simple check is to short the input anode and cathode together.

If the line whistle appreciably alters in pitch the valve is conducting unequally and should be replaced.

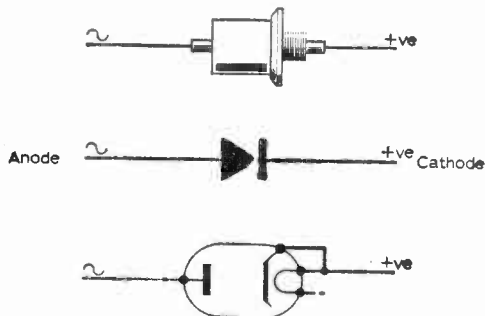

Fig. 1: This diagram of the BY100, its circuit symbol and valve equivalent, is for those readers who, like the author, can never remember its polarity.

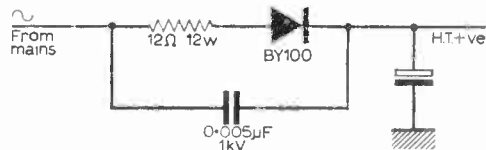

Fig. 2: A typical use of the BY100 in a power unit. The protective resistor and capacitor are advised by the manufacturers especially when used in place of a valve or metal rectifier.

INTRODUCTION

Since the original notes on "Valves and their Habits" appeared in "Practical Television" in February 1961 a new generation of enthusiasts has emerged. At the same time the industry has produced a new set of valves.

This revised version of the original article includes all the valves previously listed, even if some of them are no longer in common use, together with information on the latest types. The fact that a valve is mentioned in the list does not necessarily mean that it is certain to go wrong, or for that matter that it will not develop symptoms far removed from those given below.

EBF80, EBF89

Two 300mA double diode pentodes frequently encountered in i.f. stages. Main fault is intermittence, usually stimulated by a gentle tap. Both have the same base connections and are interchangeable in an emergency, although the EBF80 is "straight" and the EBF89 is "variable mu".

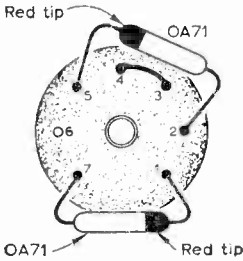
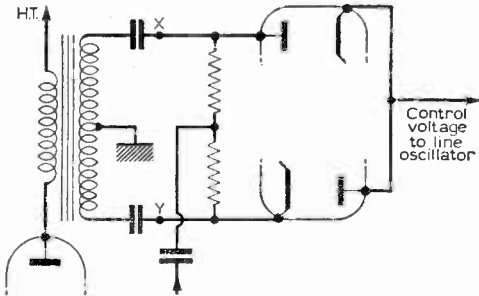

Fig. 3: This arrangement when used to replace an EB91, effectively deals with hum.

Fig. 4 (below): To check an EB91 for balance output in discriminators, short X and Y and ensure the line timebase whistle does not change.



EB91, (6F12, 8D3, Z77, 6AM6)

This is a good reliable valve used in almost all early TVs but nowadays superseded by the EF80 or similar valves. As an r.f. amplifier it works well. Also as a mixer or i.f. amplifier it is efficient (even if it reads "low" on test) but tends to give trouble if it is fitted into the video amplifier or sound output stages where it is being run pretty hard. The symptoms of low emission in the video amplifier stage are similar to a failing c.r.t.

ECC81 (12AT7)

This valve is a medium impedance double triode employed as a frequency changer in five-channel receivers. The oscillator section usually ceases to function first, although the heater remains intact.

ECC82 (12AU7)

A double triode valve of low impedance with many applications such as frame and line multivibrators, a.g.c. circuits, and driver stages in amplifiers. They prove most troublesome in multivibrator stages, the symptoms being variation of the line (or frame) speed when tapped or the timebase running fast and difficulty of bringing into lock by the hold control.

It also contributes to the variable contrast when it is faulty in the a.g.c. gating stages where one half is sometimes strapped as a diode. If only this section is faulty an OA71 crystal can be tried as a substitute to save replacing the valve.

ECC83 (12AX7)

The third valve in the trio of double triodes is high impedance and, although normally encountered in audio equipment, is frequently used in discriminator stages of line timebases. If you can only carry one of these three in the tool kit make it an ECC82.

NOTE

Tapped heaters are used on the above three valves (ECC81/82/83). In 0.15A circuits connect to pins 4 and 5, in 0.3A circuits join pins 4 and 5 and connect to their junction and pin 9. In the latter case one half of the heater sometimes blows prematurely, the symptoms being that the remainder of the chain is still lit but the other half of the faulty valve lights up much brighter than the rest.

ECC84

This is the 6.3V parallel heater version of the PCC84 cascode r.f. amplifier (see PCC84).

ECF80

This is the 6.3V parallel heater version of the PCF80 triode pentode (see PCF80).

ECL80 (6AB8, 1N152)

One of the earliest triode output pentodes (6.3V 0.3A), the ECL80, has a medium impedance triode and an output pentode capable of 1.4W output (class A). Despite both sections having a common cathode this versatile valve is used as line and frame multivibrator, frame and sound output, frequency changer, etc.

A favourite combination is to use a pair, coupling their triodes as frame multivibrator and using the pentodes as sync separator and frame output.

COMMON FAULT SYMPTOMS WITH ECL80 VALVES

Line multivibrator: The line speed varies when tapped—line frequency is too high to be brought into lock with the hold control. Watery verticals.

Frame multivibrator: The hold control needs constantly readjusting, the speed varies if tapped, the picture "judders" vertically.

Frame output: Lack of height, foldover at the bottom of the raster.

Sound output: Distortion and self-oscillation (but check the cathode bias decoupling capacitor first).

Mixer/local oscillator: The slow-heating triode section causes the sound and picture to arrive with a "bang" after the rest of the set has warmed up.

Coincidence detector (flywheel sync): Produces oscillating verticals—picture waves about snake fashion.

SHORTCUTS

The sound output and sync separator stages are the least troublesome as far as these valves are concerned and the ECL80s in these two stages may sometimes be successfully changed over with those in the more sensitive parts of the set.

In series heater circuits a PCL83 can be used as an emergency replacement provided that valve-holder pins 3 and 7 are joined—as they usually are.

overall response is peaked towards the vision carrier on a weak signal and is progressively flattened to give a wide passband on a strong one. This arrangement—"automatic bandwidth control"—has been in use for some years on one make of receiver.

A common fault is grid emission or inter-electrode leakage. This results in a positive voltage being fed to the a.g.c. line and produces negative pictures.

EF183, EF184

The two frame grid successors to the EF85 and EF80, giving double the gain with good design. The EF183 is variable-mu and the EF184 is "straight". The basing remains the same as the EF80, which you can use as an emergency replacement, but you will notice the difference. Well-made valves, giving little trouble.

EH90

Seven-pin heptode found in the audio stages of dual-standard sets where it serves as locked oscillator detector on 625/f.m. and a.f. amplifier on 405/a.m.

EL81

The 6V equivalent of the PL81 used in parallel heater circuits (see PL81).

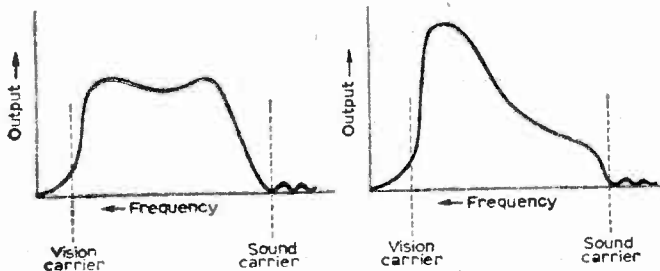

Fig. 5: EF85 (6F19) response curves illustrating the automatic frequency control effect. Left: band pass alignment accompanies a strong signal. Right: with a weak signal the response curve is peaked towards the vision carrier.

EF80

Another reliable valve which will give good results in i.f. stages even after many years' use. Although the characteristics are the same the internal appearance of EF80s may vary considerably. Inter-electrode shorts are sometimes denoted by a bright spot appearing near the top or bottom of the electrode assembly.

In series heater circuits this valve can be used as an emergency replacement for 30F5, EF85, 6F19, 6F23. The pin connections are the same even though the characteristics are slightly different.

EF85

The variable-mu companion to the EF80, this valve is commonly used as the first vision or common i.f. stage. Being variable-mu its gain can be controlled over a wide range by the vision a.g.c. line and, if the circuit is carefully arranged, the grid to cathode capacity can also be varied by the a.g.c. voltage.

In this way the input circuit tuning can be varied according to the signal strength so that the

EY51

A wire-ended e.h.t. rectifier with a 6.3V 90mA heater which is normally fed from a well-insulated winding on the line output transformer.

This is the original e.h.t. rectifier which in 1948 made the a.c./d.c. technique possible in the television set and which is still in extensive use today. During the years its peak inverse voltage rating has been raised to 17kV in order to cope with larger tubes and higher final anode potentials and its physical size has been slightly reduced.

General symptoms of its failure are blackening around the glass just below the bell and a picture which "blows up" in size as the brightness control is advanced (the latter fault may also be due to a displaced ion trap magnet).

The high voltages present when running make the valve difficult to check by conventional means and the filament colour provides a useful means of ascertaining the operating conditions by comparing it against the filament colour of a similar valve run from a 6V battery.

In many cases a dim filament will indicate a low-line output stage and it is not always appreciated that unless the line output stage is working

correctly the EY51 may not light up at all.

An e.h.t. short or excessive current drain by the c.r.t. will also dim the filament and this property is useful to enable the brightness control to be set to a working level before adjusting the ion trap magnet when a new tube is fitted. The author found that if the brightness control is set to just cause the valve filament to dim slightly a bright raster is ensured when the ion trap passes its correct position.

If the filament is too bright, short life usually results, and this may be overcome by fitting a small resistor in series with the heater lead to absorb some of the surplus. A 22Ω or 27Ω carbon resistor, $\frac{1}{4}W$, is usually adequate.

EY86

The EY86 is the plug-in version of the EY51 and has a slightly higher filament current and higher peak inverse voltage rating. These improvements make for easier servicing and better results with the wider angled tubes.

The fault symptoms and general notes on the EY51 apply equally to the EY86. Early productions of this valve had no apparent gettinger (the metallic patch on the glass being absent) but current valves are gettered in the conventional way.

In a certain make of receiver the EY86 suffers a short life and if continual replacements are required a special replacement type TY86 should be used.

EL38

This is a 6.3V octal based line output valve with similar characteristics to the PL38.

OA70, OA71

Two diodes which if carried in a tool kit will cover most applications likely to be encountered. The OA70 will replace any vision or sound detector diode and the OA71 will replace most limiter or a.g.c. diodes.

PC86

U.H.F. frame grid mixer/oscillator triode, the universal mixer valve in modern u.h.f. tuners.

PC88

U.H.F. frame grid r.f. amplifier, companion to the PC86 in u.h.f. tuners. Opinion is divided on the advisability of replacing either of these two types without returning the tuner for realignment. It would appear that in strong signal areas the valves may be replaced in situ.

PC95, PC97

Two frame grid seven-pin r.f. triodes found in the smaller new v.h.f. tuners. The PC95 is the variable-mu valve of the pair but in other respects they will interchange.

PC900

An improvement on the PC97 with different base connections.

PCC84 (30L1, 7AN7, B319)

The PCC84 is a double triode cascode r.f. amplifier with 7V 0.3A heaters for receivers

operating on Bands I and III. Its commonest fault symptoms are low gain and a "grainy" picture and in fringe areas has been superseded by the PCC89 and 30L15 valves.

These valves have the same base connections and the same heater current but their mutual conductance is double that of the PCC84, providing a considerable increase in gain, particularly on Band III. Unfortunately it is not possible to use these later types as direct replacements for the PCC84 or its equivalent without alteration to the tuner unit.

The author has found that in many cases a 30L15 will, however, give greatly improved results by merely retuning the small trimmers usually positioned at the top of the tuner or on the individual coil biscuits.

PCC85

300mA version of the ECC85. To be found in f.m./v.h.f. radio tuners in combined receivers.

PCC88

The original "frame grid valve". Has a wasp waist. Very reliable. Has the same base as the PCC85 and will interchange.

PCC89

A "frame grid" double triode cascode r.f. amplifier with 7V 0.3A heaters (see PCC84).

PCC189

Variable-mu version of the PCC88 with the same base and heater details.

PCF80 (30C1, 8A8)

This 9V 0.3A heater triode pentode was primarily intended as a mixer on Bands I/III tuners but was subsequently used for almost everything else.

A low triode or one which has been overloaded may usually be recognised by brown patches on the glass opposite the hole which is halfway up the triode anode side. Intermittent faults can usually be observed by giving the valve a gentle tap whilst running.

Other fault symptoms are a poor signal-to-noise ratio, which indicates a pentode fault, or a weak Band III (or no Band III but Band I satisfactory) indicates a triode fault.

Line Multivibrator: The line timebase runs fast and will not lock and the line hold control at the extreme end of its range. The line speed may vary when tapped or during an evening's viewing.

Sync separator—half-line oscillator: When used in this circuit pulling on picture (cogging), false line lock and line timebase runs fast may result if the valve is faulty. A negative picture may also occur (if a.g.c. is mean level).

Video amplifier/cathode follower: In this type of circuit a red-hot anode or red-hot G2 electrodes may occur. This is not usually due to a faulty valve but to a heater-to-cathode breakdown on the c.r.t., although the valve's emission will be impaired if the set is run for a while in this condition (see also PCF82).

AUDIO AMP FROM TV CHASSIS

A NUMBER of Ferguson TV Chassis (Models 992T—994T—996T—998T, varying in tube size from 12in. to 17in.) all have a similar chassis layout as shown in Fig. 1. They vary considerably in their timebase circuits but all use ECL80 in the audio circuit, the triode portion being used as first a.f. amplifier and the pentode as output (V11 in Fig. 1). As wired, it makes an excellent amplifier for a portable record player and can be removed as a complete unit from the old chassis by two hacksaw cuts, after some wiring modifications.

An inexpensive conversion incorporating a mic/preamplifier.

by T. D. Williams

Chassis Conversion

First remove the chassis. Take off the two front control knobs, stand the set on its face and remove the four chassis securing screws on the underside. Place the set back on its base, and the chassis, complete with tube, can be slid out of the cabinet.

The two speaker leads are of the plug-in type (usually), and should automatically detach themselves as the chassis is withdrawn, but over the years they may have been replaced and soldered into position. Many models will have had converters added to them and these will need to be removed before the chassis will clear the cabinet.

Dismounting the tube is simple. The wide metal band clamping it to the front tube mount is undone, the tube base socket and ion trap magnet removed and the tube slipped out from the scan coils and focus magnet. The tube is prone to stick against the rubber mounting strip placed between the bottom of the tube and the curved mounting bracket in which it sits. The only remedy is firm

but gentle pressure at the point of adhesion. Exercise care in this for if the tube loosens with a rush it is likely to break where the neck joins the flare, with the resultant implosion and flying glass. So remember, gentle pressure only!

Undo the nuts securing the two front controls, i.e. the volume and on/off on one side and the brilliance or contrast—depending on the model—on the other. Push the two controls out of their fixing holes. The front tube support can now be removed by unscrewing three self tapping screws on each side of the chassis.

On the main chassis, in a similar position to the one on the bracket, is a hole which will accommodate the Volume/on/off control. The hole has a rubber grommet and all leads to the control are fed through from the main chassis. Remove the wiring to the on/off switch, trace it through the grommet into the main chassis and snip it off as far back as possible.

Next note the position of the three leads to the volume control tags, remove them from the control, carefully pull them through the grommet and retain them as originally attached to the main chassis for later use. Push out the grommet and fit the volume control to the main chassis. Solder back on to the control the lead from pin 2 of the valve base to the centre contact and one from tag 7 of the tag strip. The third lead can be ignored.

Fig. 2 shows the tag strip adjacent to the valve base. In order to give the hacksaw a clear run, certain wires need to be snipped from this. Remove the red wire from tag 1 and the orange wire from tag 3. There are three leads connected to tag No. 6: one from tag 1, one going through the chassis to the output transformer and the third disappears into the general conglomeration of the wiring. Snip off this last one and pull it clear of the tag strip.

Trace the two heater leads (normally brown) to their next connection point and snip them off, leaving a reasonable length of wire attached to each pin. These will be used later. Two heavy wattage resistors numbered R24, and R25 in Figs. 1 and 2 are also soldered to tag 6. Snip these off.

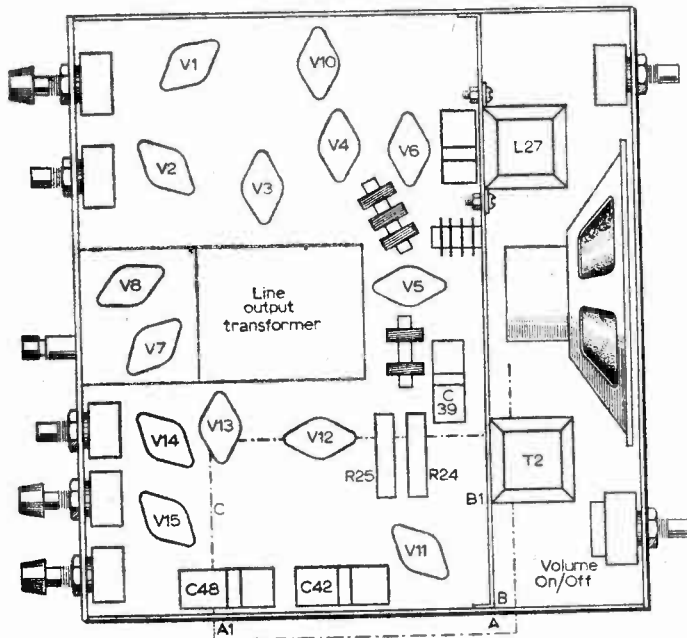

Fig. 1: The underchassis layout common to all the models which this conversion deals with. An enlarged view of the section enclosed by the dotted line is given in Fig. 2.

C39 in Fig. 2 is the cathode bias bypass capacitor. Unscrew the retaining clip from the chassis and cut off the negative lead as near the chassis as possible. C42 in Fig. 2 is the screen bypass and should be dealt with similarly. Remove and discard C48.

Carefully bend up the positive tags of C39 and C42 to allow maximum clearance from the valve base connections and refit them in the new position as indicated in Fig. 3. It is not possible to use the previous method of fixing; instead, by using the screws taken from the chassis when the tube support bracket was removed and the ready prepared holes from which they were taken, refit them as shown. Pass the screws through the self tapping

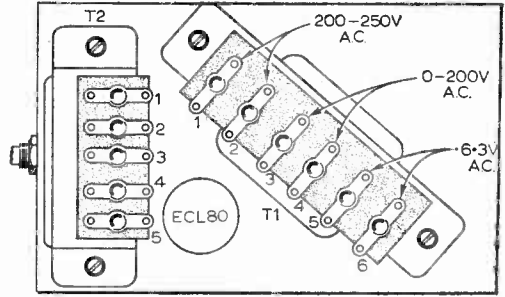

Fig. 4: Top view of the chassis with T1 and T2 mounted.

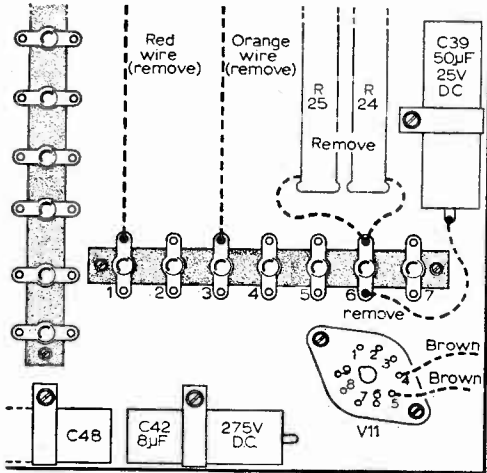

Fig. 2: The relevant section of the chassis showing wiring and components to be altered.

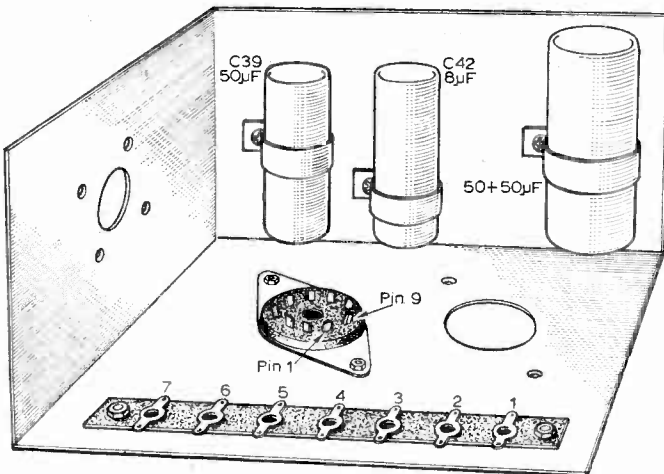

Fig. 3: Another underside view showing the new positions of C42 and C39 and the 50+50µF smoothing capacitor.

holes in the clips—they will be a loose fit—and screw them into the holes in the chassis side.

Remove from the old chassis any 0.1µF capacitor and solder it across the 0.005µF capacitor between tags 4 and 5 of the tag strip. This is the coupling component between the triode anode and the pentode grid. The alterations to the underside of the chassis are now complete.

T2 in Fig. 1 is the output transformer. Unsolder from this the red and blue leads to tags 2 and 4, noting their position. Unbolt the transformer and refix it in the position shown in Fig 4 (two new holes are necessary).

Reconnect the red and blue leads. If they are not long enough replace with new leads acquired from any part of the chassis. At this point the amplifier can be cut from the main chassis.

Measure 3in. from points "A" and "A1" and 4½in. from points "B" and "B1" (Fig. 1). Make hacksaw cuts from "A1" to "C" and from "B1" to "C", the latter encountering a tag strip not required. Cut through this and remove the pieces when the unit has been completely detached from the chassis. Whilst hacksawing, remove all valves to avoid shaking. A fine toothed saw blade will cut best in this application. Clean up the sawn edges with a file and slightly round off all sharp corners.

Power Pack

If nothing suitable is on hand, the items listed in Additional Parts List will be required for a power supply. The mains transformer was obtained from T.R.S. Ltd., who carry it as a stock item at 10s. 6d. plus postage. A silicon rectifier is specified but any half wave rectifier rated over 200V input and 50mA output will do the job.

The choice of power supplies is one which can be left very much to the taste of the constructor, but the one to be described fits neatly on the chassis, is effective and the parts cost less than £1.

The mains transformer is mounted on top of the unit as shown in Fig. 4. Run a pair of

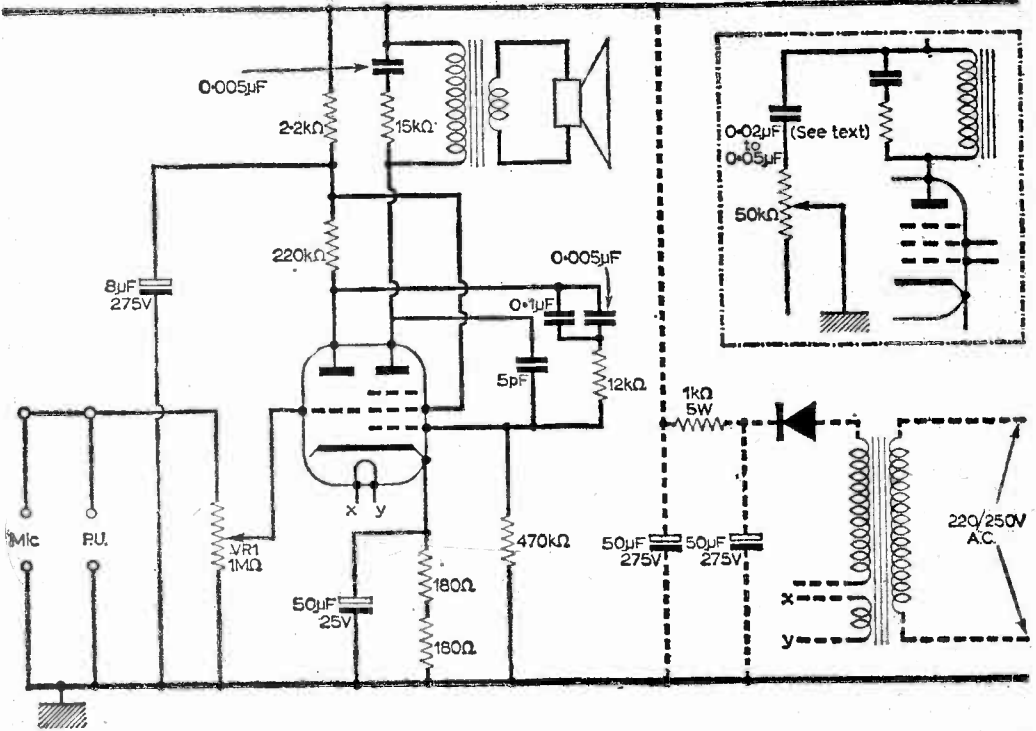

Fig. 5: Circuit of the unit. Additional parts for the mains unit are shown dotted. The inset diagram shows the optional provision for tone control.

leads from tags 1 and 2, one to each pole of the on/off switch. Connect a lead from tag 3 to tag 1 of output transformer T2 and from there to chassis on a solder tag clamped under the golding down bolt of this component.

Connect a lead from tag 4 of T1, through the chassis and solder to tag 2 on the under chassis tag strip as shown in Fig. 2. Solder to tags 5 and 6 of T1 the leads already attached to pins 4 and 5 of the valve base to complete the heater supply.

Mount in the position shown in Fig. 3 a 50+50μF electrolytic, a clip for which can be obtained from the old chassis. Connect to one 50μF section the positive side of the rectifier used. (At times the polarity is not marked on silicon rectifiers, but it is usual for the metal casing to form the positive side whilst the a.c. "in" point is the wire end which enters the device through the insulated plastic seal.)

The input side of the rectifier is attached to tag 2 on the chassis tag strip. From this tag connect a 1,000Ω 5W resistor (carbon or wirewound). Also connect a lead from tag 6 to the second 50μF tag on the smoothing electrolytic. The negative tag of this component is adjacent to a chassis solder point and a short lead to this will complete the power circuit.

Solder a length of twin mains lead, one to each vacant pole of the on/off switch, attach the speaker to tags 1 and 5 of the output transformer, and the leads from the record pick-up across the volume control. The amplifier is now complete.

Additional Parts for Main Amplifier

Mains transformer: Pri. (Messrs. T.R.S., 70,
200/250V a.c. Brigstock Rd., Thornton
Sec. 0/200V 25mA and Heath, Surrey.)
6.3V 1A.

Silicon or other rectifier.
Minimum rating 250V
at 50ma.
50+50μF .275V electro-
lytic
1 of 1,000Ω 5W resistor.

Tone Control

The amplifier gives more than adequate volume for the average room. If tone compensation is required connect a 0.02-0.05μF capacitor from tag 2 on the sound output transformer to chassis. To obtain a variable tone control connect in series with this capacitor a 50kΩ variable resistor recovered from the chassis. The control previously used for contrast or brightness will serve here. Wire the two components as per the inset to Fig. 5.

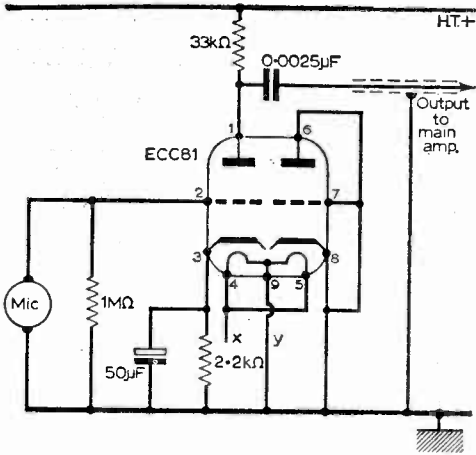
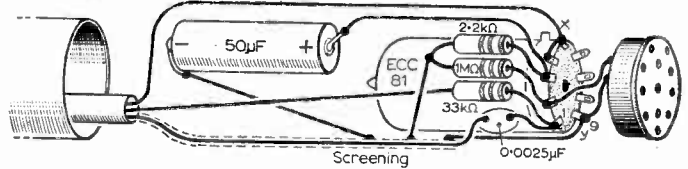

Fig. 6 (above): Circuit of the preamplifier.

Fig. 7 (right): Wiring of the unit



Additional Parts for Preamp.

- Crystal microphone capsule 1in. x 1/2in. Obtainable from T.R.S. Ltd.
- 5 pin DIN plug and matching socket.
- Length of 6mm. plastic sleeving.
- Length of single insulated screened microphone cable.

Mic and Preamp

By using further components from the old chassis we can produce a combined microphone and pre-amplifier to work in conjunction with the amplifier. Apart from the actual leads from microphone to amplifier and the crystal mic. capsule, all the components can be recovered from the TV chassis.

To house the microphone capsule and components we used the can of the main 100/200μF smoothing capacitor bolted to the top of the chassis parallel with the front edge.

Gently ease up with a screwdriver, or other suitable tool, the rim which clamps down the end seal of the capacitor, ensuring that the can and the end seal are not damaged. When the rim has been lifted all round, pull out the seal and snip off the connections to the underside of the tags. Retain the seal for later use.

As the first part of the rim is raised, air will be heard to hiss into the vacuum. With the end seal removed, clean out the whole inside of the can. Warm it sufficiently to soften up the wax, then push a screwdriver down through the centre of the tightly coiled paper and foil filling and wiggle the whole contents bodily from side to side until loose. They will then pull out cleanly, leaving the

aluminium can empty except for a layer of pitch on sides and bottom which should be removed down to the bare metal, as depth is vital in this can and an 1/8in. makes all the difference in the final stages.

To construct the preamplifier, recover the ECC81, (V2 in Fig. 1), a 50μF 12V electrolytic (C48 in Fig. 1) and 33kΩ, 1MΩ and 2.2kΩ 1W resistors and one of the heater decoupling discseal capacitors which have a value of 0.0025μF.

Finally recover the valve base which carries the PL81—V7 in Fig. 1. The paxolin valve bases are no use in this application. The V7 base has a metal rim with the actual B9A base clipped into it, and by easing out the four fold-over clipping pieces the actual base can be removed from the rim.

When this is done, gently bend each solder tag so that it is at right angles to the bottom of the base, noting that the base pins are extremely brittle. Remove the small tubular metal screen which passes through the centre of the base.

The circuit of the preamplifier is shown in Fig. 6 and the wiring diagram in Fig. 7. Note specially the location of the 50μF cathode decoupling capacitor, sited slightly to the side of the valve pinch to shorten the overall length of the amplifier.

Wire the remainder of the components as shown in the diagrams, keeping as closely as possible to the layout of Fig. 7 as accommodation within the can is strictly limited. Pins 6, 7, 8 of the valve base are not used and can either be left floating or strapped together and wired to the earth point.

The connecting cable is made up from two thin flexible wires (h.t.+ and l.t.), and a length of single insulated screened microphone lead, the inner of which is used to connect the output from the ECC81 via the 0.0025μF capacitor to the main amplifier, whilst the screening acts as h.t.- l.t. return and earth. The three leads can be carried in a length of 6mm dia. polythene sleeving.

Slightly thinner sleeving can be used if only a short lead is required but if it is more than 4ft. then 6mm sleeving becomes necessary as it is difficult to thread the three leads for any length through thinner sleeving than this. Connection to the main amplifier was made by DIN plug and socket.

A hole to admit the 6mm sleeving must be drilled in the bottom of the capacitor can, and when the lead is inserted a knot should be tied to bear up against the inside of the hole so that there is no strain on the soldered connections to the components within the can.

If the preamplifier has been built as shown in Fig. 7 it will slide into the can and leave a space of approximately 1/8in. to accommodate a crystal capsule. The wiring round the valve base will require a wrap of polythene or similar material to insulate the joints from the aluminium, and a disc of

fairly heavy polythene to insulate the base connections from the metal back of the microphone capsule which is placed in the can on top of the polythene insulating disc.

Drill out the three soldering tags from the circular can seal and press it back into its original position, very lightly holding it in place by slightly bending the edges of the can over. Do this only lightly enough to hold the seal so that it can be removed for servicing the pre-amplifier. The three drill holes are sufficient to admit all the sound required to actuate the microphone.

The prototype was covered with leatherette. A disc of the material very slightly larger than the diameter of the base of the can and with a hole for the connecting cable, was glued to the bottom of the can and allowed to bend up slightly over the straight part. A further piece was glued round the body of the can, with a little overlap. Before the adhesive had set a straight cut was made from top to bottom using a really sharp knife so that both

the overlap of material and the underneath piece were cut cleanly through in one operation. By this means a clean butt edge will be achieved. It is best to use a "contact" adhesive.

To complete the job recover from the chassis a rubber grommet, cut this in two from edge to edge and fix one half, again with contact adhesive, round the hole through which the sleeving enters the can to prevent it chafing. It is not possible to fix a full grommet due to limitation of depth within the can.

This type of conversion is very rewarding and can be applied to many of the older types of TV chassis. The components to construct a microphone of the type described are available from practically any old chassis and while the main amplifier might not be so compact and easy to extract in such a small unit as is the case with the particular range of Ferguson chassis quoted, any type of chassis having a dual audio valve of the ECL80 or PCL82 variety could be a suitable source of supply for the components required.

THE OLYMPIC II

—continued from 492

Setting-up the Field Generator

In the first place, when construction has begun, it is as well to complete building the frame oscillator before any other circuits are added to the etched board. Then a check should be made to see that the transformer connections have been made the right way round. In winding, primary and secondary will normally be in the same direction, and if this is the case the "outermost" wire of the primary goes to the collector and the "outermost" wire of the secondary to the base of the transistor. The two innermost ends of the windings (the centre top, if the windings had been continuous) are to the B- supply and the speed control resistor respectively. If correctly connected in circuit the stage will be heard to oscillate if a pair of headphones are wired across R81, the 820Ω resistor in the

collector circuit, or other suitable pick-up point. When this is correct, the rest of the generator may be built up.

OLYMPIC PRINTED CIRCUIT BOARDS

Printed circuit boards for the Olympic II, pre-fluxed to assist soldering and completely drilled, are available from Ajax Electronic products, 18a Rumbold Road, Fulham, London, S.W.6. Prices for the boards are as follows: PC1, 7s. 3d.; PC2, 8s. 3d.; PC3, 12s.; power pack board 3s. 9d. Stamps covering postage and packing should accompany all orders.

PART SIX NEXT MONTH

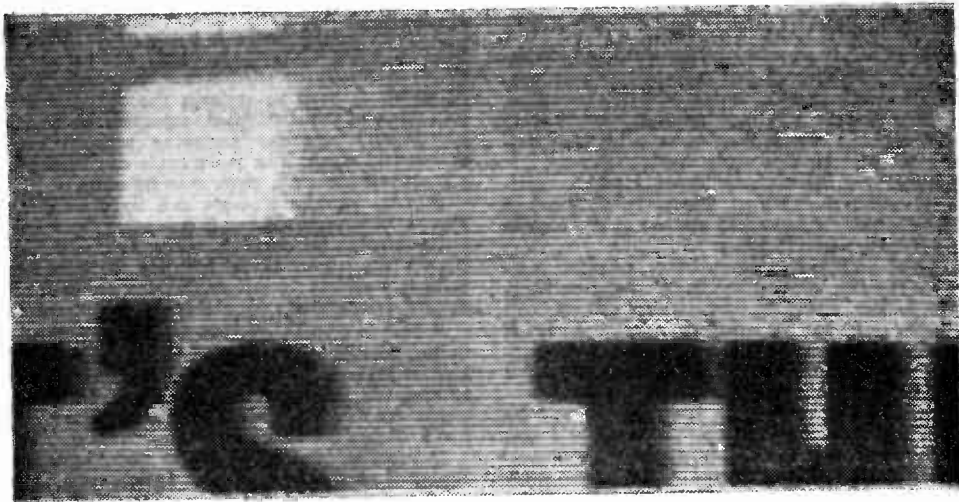

A small section of the prototype Olympic's screen, showing steadiness of scan and excellence of interlace. (This photograph was taken with Ilford FP3 film with a 10 sec. exposure at $f/32$; developed in Unital at 1:18 dilution, 65°F, 25 min.)



LETTERS TO THE EDITOR

THE OLYMPIC II

SIR,—I am interested in building the Olympic II but before making any decision I should like to know whether it would be a practical matter to build it for Swiss conditions for v.h.f. television, i.e. 625-line standards and f.m. sound. I believe there is also a point regarding the polarisation of the vision modulation. I have never attempted TV construction before but I have some experience in audio, f.m. and test equipment.—F. GUTTERIDGE (Geneva, Switzerland).

Not only is there the matter of f.m. sound with 625-line transmission but also a complete modification of the line output transformer. The "Elac" people can, however, supply a transformer to 625-line standards but, on the other hand, the output transistor is worked much nearer its limits on 625. The vision and sync polarities are reversed as contrasted with 405-line standards and this will necessitate in due course a redesign of the video amplifier and the sync separator stages. Also inter-carrier sound is a big advantage, though the double i.f. strip is a possibility and need only involve a retune and the provision of a discriminator.—Editor.

SIR,—Can the tuner of the Olympic II as described in the April issue of *Practical Television* be used as a sound only tuner for a transistor amplifier?—H. C. ELLIOTT (Saltash, Cornwall).

The tuner can be used for sound only. The Olympic II arranges for this as will be shown.—Editor.

THE LAYMAN'S MESS

SIR,—Re A. J. Littlewood's remarks (Letters to the Editor, June, 1965) on your most valuable and interesting articles "Your Problems Solved" and "Test Case". I would like to know what he really has to moan about. Even if he does have to sort out the "layman's mess", he is surely well paid for it anyway.—A. WHITTON (Hull, Yorkshire).

HULA, NASSER, IGLOO AND ???

SIR,—With reference to your Editorial in the June issue of *PRACTICAL TELEVISION*, I am sure that Alice, being a woman, would have spent some time before the looking-glass admiring her "SEQUINS".

I refer, of course, to one system you missed, the "Sequential Quadrature Inband System" put forward by Mr. Gargini of Rediffusion Research Ltd., and reprinted in your contemporary *Wireless World*, May, 1965 issue.—M. G. FOSTER, A.M.I.E.E., (Croydon, Surrey).

SPECIAL NOTE: Will readers please note that we are unable to supply Service Sheets or Circuits of ex-Government apparatus, or of proprietary makes of commercial receivers. We regret that we are also unable to publish letters from readers seeking a source of supply of such apparatus.

The Editor does not necessarily agree with the opinions expressed by his correspondents.

PROBLEMS SOLVED AND TEST CASE

SIR,—I read with great interest the letter from Mr. Littlewood (page 424, June issue) asking that Problems Solved and Test Case be discontinued.

If Mr Littlewood looks carefully at these problems, he will find that many of them are from people who have at least some idea of the workings of a TV and the damage that could result if the wrong thing is done.

Most of the sets in question are older models and they are still workable. Many an engineer, in his "ivory tower," will not bother to look at a set more than two years old. As for damage, well the engineer does not have to pay the cost. He either tells the customer what the damage amounts to, or he just charges a fee in case the man does not have it repaired because of the cost. No one plays around with a brand new TV set. Firstly it may be on H.P., or the firm would have nothing to do with it after it had been tampered with.

Please continue with the good work. Many experienced engineers are profiting by the notes made in these articles. Everyone who reads *PRACTICAL TELEVISION* has been warned more than once of the dangers when handling TVs without first carrying out the advice given by your valuable Journal.—S. KINNEAR (Bridlington).

A PROBLEM IS SOLVED

SIR,—I noticed the answer to one of your Problems Solved in the June issue, seemed rather odd. In the Pye Model V14 there is no PL82 as frame output or ECL80 as line oscillator as stated.

The correct valves are a PL83 as frame output and a PCF80 as line oscillator.—J. D'CRUZ, A.I.P.R.E., A.M.I.E. (London, W.2.).

The valves mentioned in the answer to the problem are those associated with the Pye V4, and this is the model number that should have headed the letter. You are, of course, correct so far as the V14 is concerned. Thank you for bringing this error to our notice.—Editor.

SIMPLE U.H.F. PREAMP

SIR,—With reference to the Simple u.h.f. Preamp (page 534, September 1964 issue). The battery polarity connections shown in Fig. 2 (top drawing) are incorrect and should be reversed with +ve to C2 and -ve to earth tag on chassis.—C. H. BANTHORPE (Northwood, Middlesex).

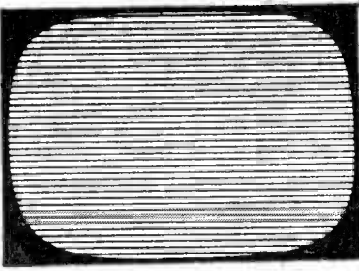

Servicing TELEVISION Receivers

No. 116: Pye, Pam, Invicta, Ekco, Ferranti and Dynatron switchable models, including: Pye 3, 11, 12; Pam 5100, 5102, 5106; Invicta 7013, 7019, 7020; Ekco T418, TC419, T420; Ferranti T1093, TC1094, T1095; Dynatron TV70, TV71, TV72. See text for full list.

by L. Lawry-Johns

arrangements. Among the models covered the following may be mentioned:

- Pye 11 and 15, later versions 3, 11, 12, 13, 14, 15 and 20.
- Pam 5100, 5102, 5106, 5111, 5112, 5114, 5116, 5140.
- Invicta 7013, 7019, 7020, 7039, 7194 and 7195.
- Ekco T418, TC419, T420, TC421, T422.
- Ferranti T1093, TC1094, T1095, TC1096, T1097.
- Dynatron TV70, TV71, TV72, TV73.

The tube fitted may be a Mullard or a Mazda 19in. or 23in.

THIS article covers a large number of models under quite a few well known brand names—Pye, Pam, Invicta, Ekco, Ferranti and Dynatron. The diagrams may not in all cases coincide with the exact receiver the reader may be handling, but the differences are of a minor nature except in the case of the tuner unit fitted and the mechanical

Dismantling and Access

The tuner unit knobs, both v.h.f. and u.h.f. are secured by a spring-tensioned peg which engages

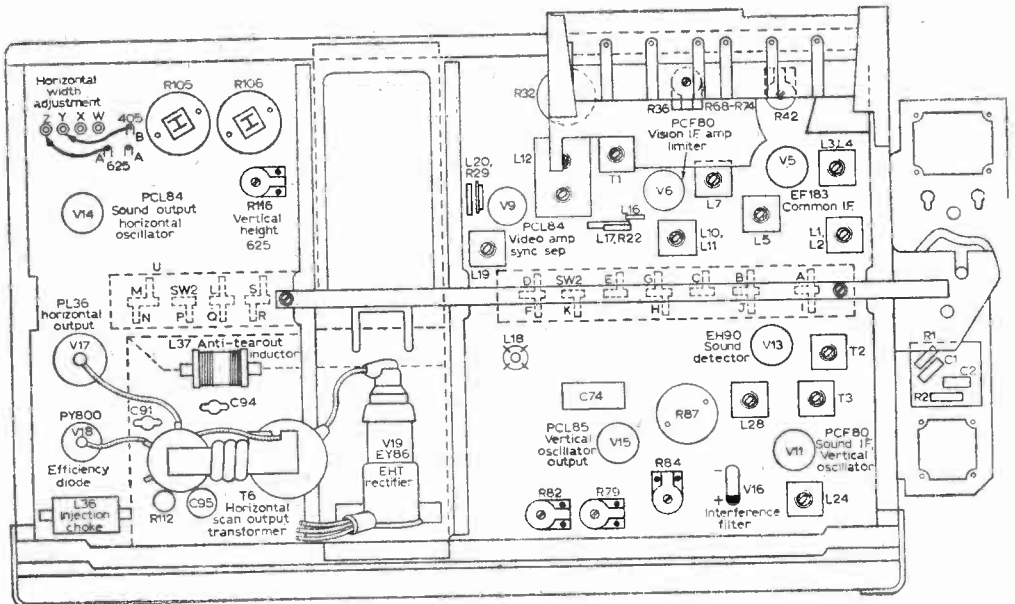

Fig. 1—A front view of the Invicta 7039 chassis with the tube removed.

in a slot in the tuner spindle. It is necessary to insert a fine blade behind the knob in order to depress the peg fully before the knob can be removed. On no account should force be used as the knob shank is easily damaged. The smaller knobs pull off in the usual way.

To Lower Chassis

Remove rear cover, pull off fine tuner extension spindle from rear of tuner unit. Slacken the four lower side screws, remove the two top fixing screws and lower chassis to extent required. Inspection will show that if two of the previously slackened screws are removed the chassis can be laid hori-

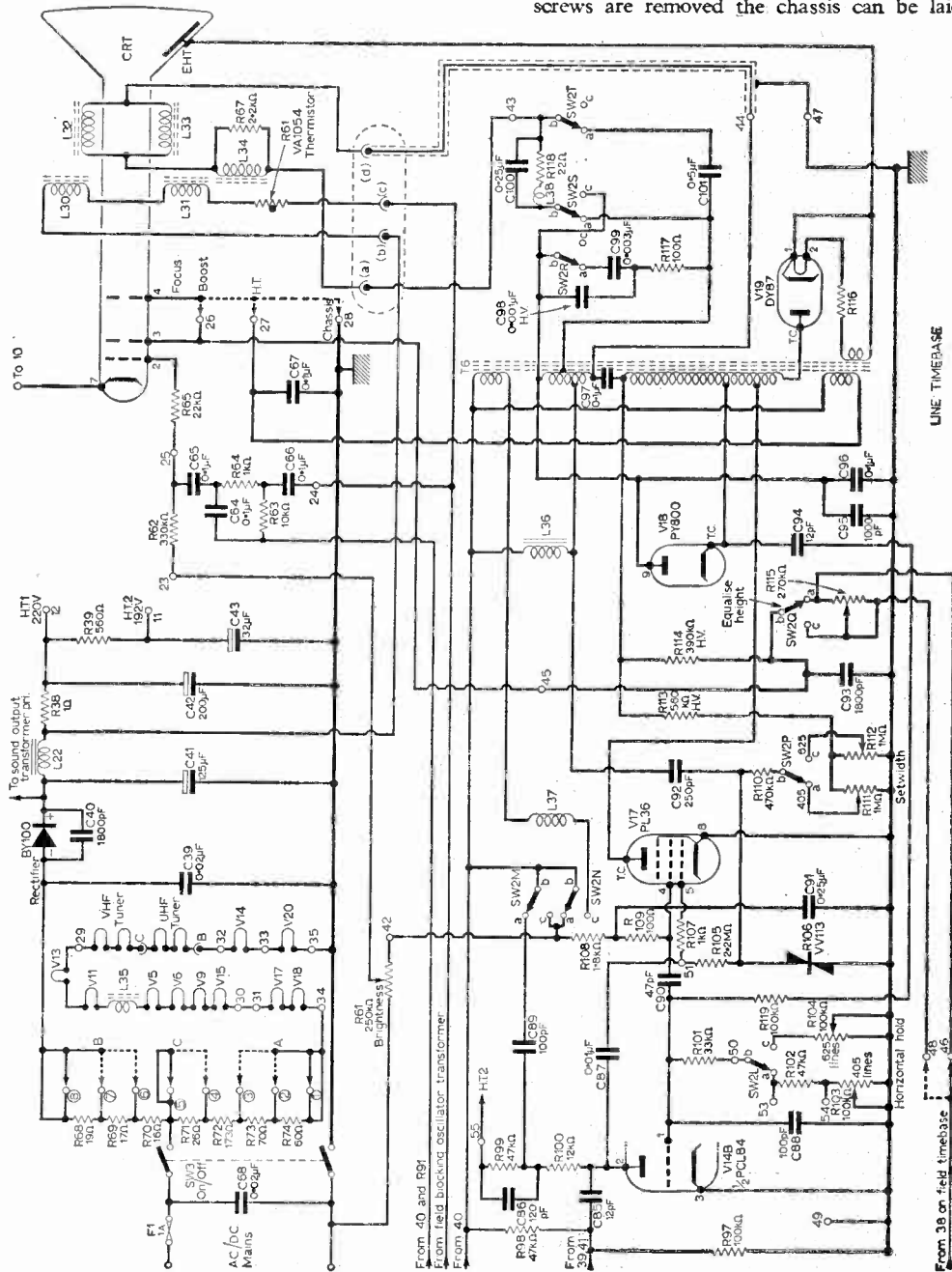

Fig. 2—The line timebase, c.r.t. and mains input stages of the circuit.

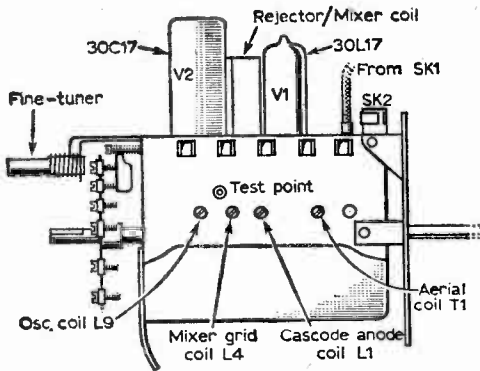
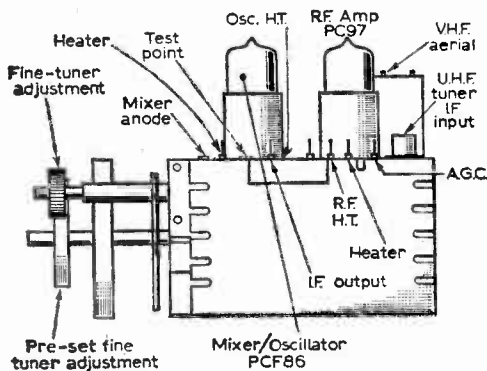

Fig. 3—Side views of two Invicta tuners; 7039 above and 7019 below.



zontal. It will also be noticed that on most models lowering the chassis disengages the tuner-cam switch coupler. The relative positions should not be altered during disengagement but if any alteration does occur turn the flat of the tuner spindle to the 12 o'clock position, when the peak of the cam should be in the 3 o'clock position as viewed from the rear.

When returning the chassis to the vertical position, ensure the e.h.t. lead to the side of the tube has not twisted so as to touch the PL36 envelope. If it does the insulation will melt and the resultant discharge will crack the PL36 glass leaving not only a PL36 to replace but probably also the e.h.t. lead. It is well worth watching this point.

To Remove Control Panel and Tuners

Remove knobs and lower chassis as previously described. Unclip the coaxial cables. Remove four 4BA nuts which secure the panel to the front of the cabinet. The panel can then be removed to the extent of the cables.

Complete Removal

Proceed as above and then remove the loud-speaker leads, or loud speaker, the tube base connector, the connector to the deflection coils and e.h.t. lead. Remove the two large side screws securing the chassis to the cabinet bracket.

Deflection Coils

Slacken the nylon screw at the rear of the assembly before sliding from neck of the tube. When replacing, ensure the coils are well against the flare of the tube and the picture is straight before clamping.

Width Controls

On most models there are two sliders, one for 405 the other for 625, on the upper right side. On some however they are as shown in Fig. 1, being preselected tapings. Lead "A" is for 625 width adjustment, lead "B" for 405.

Picture Centring

There are two rotary magnetic plates immediately behind the deflection coils. Rotate these independently until the picture is centred correctly.

Focus

A jumper lead from pin 4 of the c.r.t. base connects to tag 26 (boost line), 27 (h.t. line) or 28 (chassis), whichever gives optimum focus.

E.H.T. Rectifier

An EY86 was used in early versions and a DY87 in later ones. Generally speaking, if the width controls are of the slider type a DY87 will be found fitted. These valves of course are not interchangeable.

Line Output

A PL302 may be found fitted in some later models.

Field Output

V15 may be a 30PL15 in some models.

Flywheel Sync

Fringe versions employ a separate panel with an ECC82 valve and associated circuitry. The double diode is an R3-2V.

V13-EH90. This valve functions as a Quadrature detector (f.m.) for 625 and as an audio amplifier on 405 (a.m.).

Tuner Units

Several different types of tuner unit have been used and it is essential to fit the same type of valve as is found fitted. For example the EA15089 tuner uses a PC97 r.f. amplifier and a PCF86 frequency changer. The EB01532 uses PCC89 and a PCF86. The EB01478 uses a PCC89 and a PCF801. The AF00056 uses a 30L17 and a 30C17.

Common Faults

Apart from tuner unit faults which vary according to the type fitted (usually poor stud contact) the most common faults encountered so far by the author have been in the line output stage. The PL36 glass envelope has a habit of parting company with its base thus letting air in and putting the heater out, other valves continuing to glow normally. The EY86 fitted in earlier models often develops an internal short or an open circuited heater. The above faults of course result in a no picture, no raster condition.

CONTINUED NEXT MONTH

TRADE NEWS • TRADE NEWS TRADE NEWS • TRADE NEWS TRADE NEWS • TRADE NEWS TRADE NEWS • TRADE NEWS

Aerials for Winter Hill Area

ANTIFERRENCE announce the introduction of two specially designed aerials for the Winter Hill area. Both are in the "Uniray" series comprising combined v.h.f./u.h.f. aerials for BBC-1 (ch. 12), BBC-2 (ch. 62) and ITA (ch. 9).

Both models incorporate a semi-broadband band 3 "Trumatch" array covering channels 9-12 with a u.h.f. section for Group "C" channels 53-65, and are complete with tilting clamp for masts up to 2in. diameter. Separate v.h.f. and u.h.f. downlead connections are provided, the latter incorporating a Balun in the detachable cable junction unit.

The UV 0309 3-element band 3 plus 9-element u.h.f. aerial costs 62s. 6d. and the UV 0515 5-element band 3 plus 15-element u.h.f. aerial costs 75s. *Antiferrence Limited, Bicester Road, Aylesbury, Buckinghamshire.*

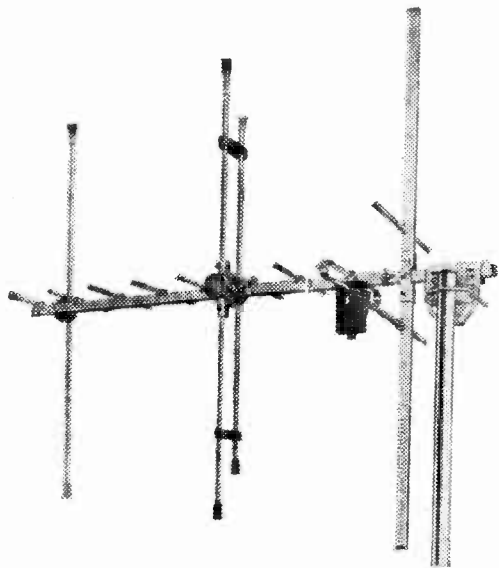

Model UV0309 3-element Band 3, plus 9-element u.h.f. aerial from Antiferrence.

Picture Tubes

MAZDA picture tubes shown on the Thorn-AEI Valves and Tubes Ltd. stand at The Component Show, Olympia, included 25in. and 11in. sizes. Both these types are suitable for adaptation to Rimguard self-protected construction, if required by the setmakers. The 11in. tube is

intended for mains operated transportable receivers, and both tubes have 6.3V heaters.

Now in production for setmakers is the Mazda CME1908 (A47-11W) which is said to be the first 110° 16in. tube to be offered by a British manufacturer. It employs an electrostatically focused unipotential gun with a 6.3V heater. *Thorn-AEI Radio Valves and Tubes Ltd., 155 Charing Cross Road, London, W.C.2.*

Gold-bonded Diodes

WITH the addition of four new types, the Mullard range of gold-bonded diodes is now believed to be the most comprehensive available in the UK. Typical stored charge ratings vary from 20pc for the fastest diode in the range to 750pc for the slowest with corresponding peak reverse voltage ratings from 8V to 100V.

The diodes are, AAY33 for use in very high speed switching and logic circuits of computers; AAY32 for use in medium speed switching circuits; AAY30 which has a better performance than the OA47 and is cheaper; and the AAY42 which is a high performance general purpose computing diode with a maximum stored charge of 400pc and a high peak reverse voltage of 70V. *Mullard Ltd., Mullard House, Torrington Place, London, W.C.1.*

Solder Kit

FROM Welding Equipment Service Co. Ltd., comes the Wescolite Solder Kit. It consists of a dispenser bottle of a new flux and a coil of soft silver solder, both in a handy plastic drum.

Metals previously considered impossible can be readily soldered with the Wescolite kit. For instance, chrome, stainless steel and galvanised parts can be soldered to themselves and each other. In fact all common metals except aluminium, magnesium and zinc diecast can be easily soldered. The cost of the kit is 7s. 6d., and it is obtainable from large ironmongers and do-it-yourself stores or direct from the manufacturers. *Welding Equipment Service Co. Ltd., Wescol Works, Lower Horseley Field, Wolverhampton.*

Grundig in Custom-built Cabinet

A K230 23in. screen television by Grundig (Great Britain) Ltd., is incorporated in a custom-built stereo cabinet recently completed by Regency Electronics Ltd., of Leamington Spa. This is the first of its type made by Regency although they undertake to build hi-fi and sound equipment to individual specification.

For delivery to London, W.1., the teak veneer finished cabinet comprises two large speakers either side of the television, with a stereo amplifier tuner and turntable above. There is a special tape recorder section below which takes a Grundig TK46 tape recorder. — *Grundig (Great Britain) Ltd., Newlands Park, Sydenham, S.E.26.*

The CATHODE RAY TUBE and its CIRCUITS

by J. McCarthy

CONTINUED FROM PAGE 471 OF THE JULY ISSUE

A TRIGGERED timebase is one which generates a single pulse in response to an input signal instead of a series of pulses. This is useful for photographing non-repetitive transients. Most time-bases can be modified to triggered operation—usually the grid-bias is modified. For example, assume a large negative voltage is applied to the grid of the thyratron in Fig. 9. The capacitor will charge up as usual, but will not be discharged again because the thyratron would be cut off. Now assume that a short positive pulse is applied to the grid, the discharge will be initiated and the flyback portion will be completed. The capacitor will then recharge as normal, giving a single saw-tooth pulse. The thyratron will then remain cut off till the next triggering pulse occurs.

Similarly, a Miller-integrator may be adapted to triggered operation. The modification consists of removing C2, the triggering pulses must be negative, and are applied to the suppressor grid.

In all cases of modifying free-running to triggered oscillators, the frequency control becomes a pulse length control.

Vertical Deflection Amplifiers in Oscilloscopes

An oscilloscope's vertical deflection amplifier should have a frequency response of at least ten times the maximum frequency likely to pass through it. The effects of poor h.f. response on square and saw-tooth waves is shown in Fig. 16. It should also have zero phase-shift; this has no effect on sine waves but composite waves are badly distorted since each component is displaced individually. In Fig. 18, a sine wave (a) added to its third harmonic (b) gives a resultant (c). If (a) is displaced relative to (b), (c) is totally different although both waves (c) have the same components. In general, r.c. amplifiers are used, since these have a flat frequency response. The basic circuit of a suitable amplifier is given in Fig. 17.

In some work it is required to display d.c. signals and very low frequency a.c. signals on an oscilloscope. If the voltages are sufficiently large to deflect the beam without amplification, all is well; if, however, amplification is required,

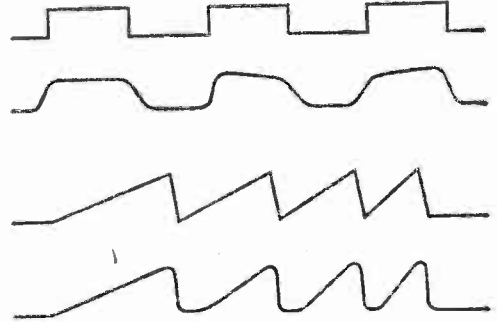

Fig. 16—Square (top) and saw-tooth (bottom) waveforms and the effect of poor h.f. response on them.

difficulties occur. Since the signal is d.c., no coupling capacitors may be used as they would charge up and block any further signal—obviously some form of direct coupling between the stages is required. A possibility would be as in Fig. 19. Assume V1 has 250V on its anode and the V2 requires $-3V$ grid bias. If a battery of 253V is connected between the anode of V1 and the grid of V2 in such a way as to oppose the whole $+250V$ and supply $-3V$ grid bias, the

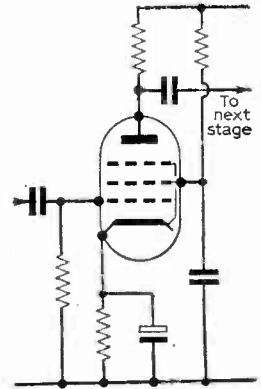

Fig. 17—The basic RC vertical deflection amplifier.

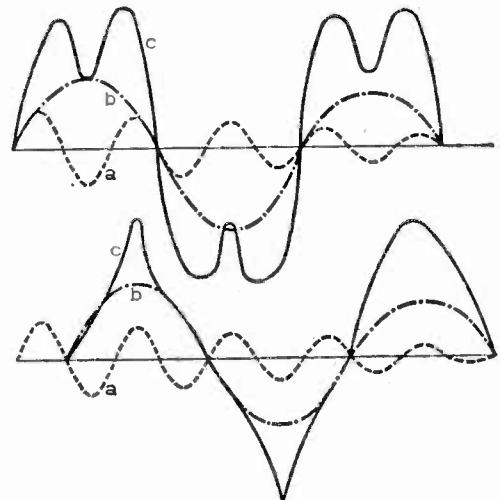
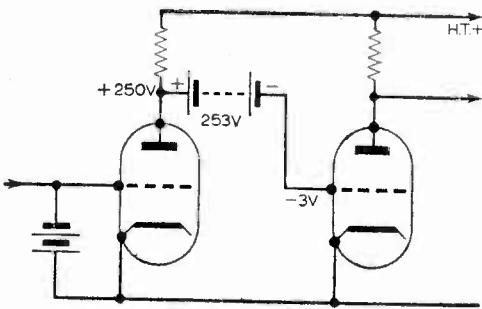

Fig. 18—Showing the resultant waveforms (c) of adding a sine wave (b) to its third harmonic (a).



(b) Using an intensity-modulated circle:
 One frequency—a standard, is applied to the four deflection plates in such a way as to produce a circle. The unknown frequency is applied between grid and cathode and the circle well modulated as in Fig. 22. A suitable circuit is given in Fig. 23. The standard frequency is displaced by 45° by R1 C1 and is applied to, say, the X-plates. It is also displaced by 45° in the opposite direction by R2 C2 and is applied to the Y-plates. The phase difference between the two signals being applied to the plates is now 90°—the condi-

Fig. 19 (left)—A vertical deflection amplifier for oscilloscope display of d.c. signals.

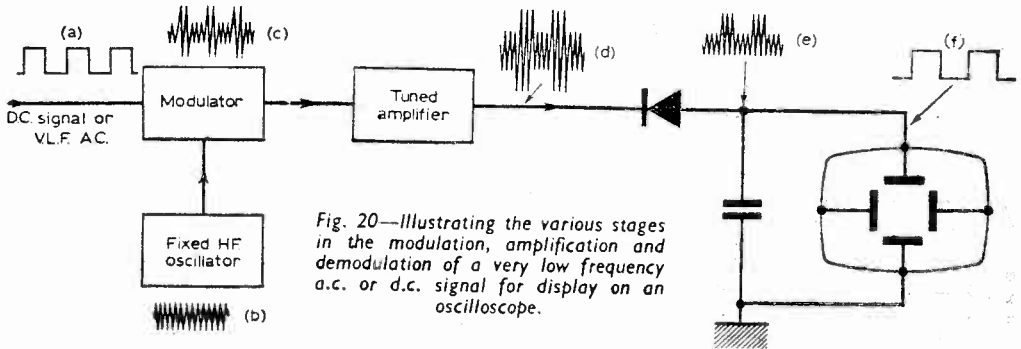

Fig. 20—Illustrating the various stages in the modulation, amplification and demodulation of a very low frequency a.c. or d.c. signal for display on an oscilloscope.

conditions for operation will be fulfilled. However, this has distinct advantages when several stages are to be used. The best method is to modulate a fixed frequency with the signal, to amplify the resultant, and then to demodulate this before connecting to the deflector plates. See Fig. 20. The advantages of this system are as follows:

- (i) As the frequency is fixed, tuned amplifiers can be used, resulting in greater amplifications.
- (ii) This system has no lower frequency limit.

If required, the demodulating components may be omitted, and the signal then displayed will be a luminous area bordered by the original d.c. signal at both the top and the bottom—i.e. the signal at (d). This arrangement may also be used on a.c. up to a frequency of roughly one-tenth of the "carrier" frequency.

Frequency Comparison

(a) Using a time-base.

The unknown frequency is applied to the Y plates of the tube, and an unsynchronised, accurately calibrated time-base is adjusted till a stationary pattern of a whole number of loops is formed.

$$\text{Unknown frequency} = \frac{\text{No. of visible c/s}}{\text{timebase frequency}}$$

The time-base may run free, or be synchronised to an external standard oscillator, but it must not be synchronised to an unknown frequency. Obviously, the time-base's frequency will be deviated and indicated on the dial if any sync is applied.

If the unknown frequency to standard frequency ratio is an odd number, multiple patterns will be formed. The frequency ratio is the equal to:

$$\frac{\text{Number of whole cycles per pattern}}{\text{Number of patterns}}$$

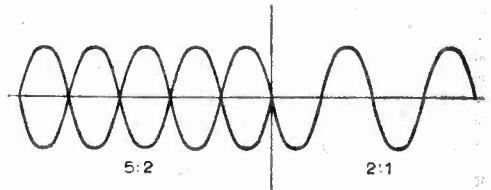

Fig. 21—Display showing frequency comparison using a timebase.

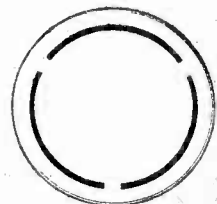

Fig. 22 (right)—The display showing frequency comparison using an intensity modulated circle.

Unknown = 3 x Standard

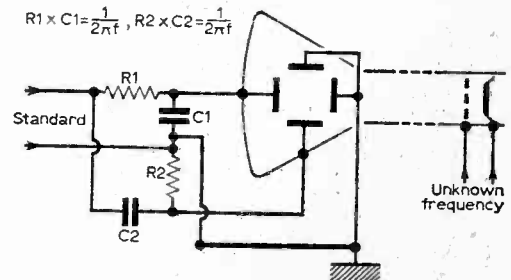

Fig. 23—The circuit to provide the display of Fig. 22.

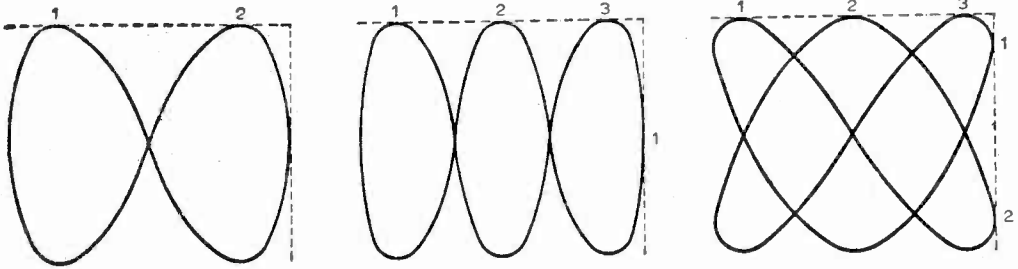

Fig. 24—Lissajous figures showing ratio of frequencies, from left to right: 2:1, 3:1, 3:2.

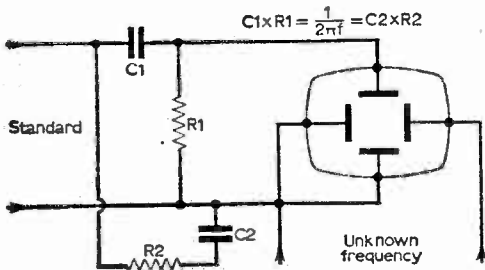

Fig. 25—A circuit to present the figures on a circular timebase.

imaginary pair of lines at right angles lying along the edges of the figure. See Fig. 24. To allow easy counting, the relative phase difference should be adjusted till there are no open loops. As may be imagined, difficulties arise in large frequency ratios. It is possible to present the figures on a circular time-base instead of the usual straight line time-base. A circuit suitable for this is given in Fig. 25, and its effect is shown in Fig. 26. The standard is shifted through 45° and applied to the X-plates. The unknown frequency, plus the standard displaced through 45° in the inverse direction to previously, is applied to the Y-plates. Finally, it should be mentioned that Lissajous figures will be formed if non-sinusoidal frequencies are used. They are distorted, however. See Fig. 27. As may be seen, multiple ratios (3:2, 3:5, etc.) of square waves produce figures which are quite impossible to interpret. A Lissajous figure produced by a pair of triangular waves is very similar to the corresponding figure produced by sine waves—however, the gentle curves of the latter are replaced by sharp peaks and straight lines.

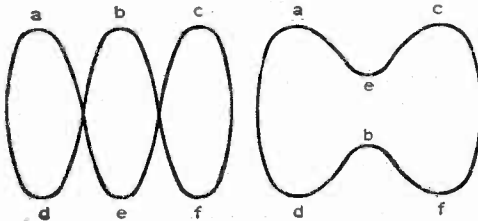

Fig. 26—The result of applying the circuit of Fig. 25.

tion required to produce a circle. If, say, three gaps are displayed, it means that the unknown frequency is three times the standard frequency.

Generalising: Unknown frequency = No. of gaps x standard frequency as long as the circle is not rotating.

(c) Using Lissajous figures:

This is quite a common mode of frequency comparison although it is not suitable for use at high frequency ratios. It consists of applying a known sinusoidal frequency to one pair of plates and the unknown to the other. A pattern known as a Lissajous figure, will be formed, and the ratio of the frequencies can be discovered by counting the number of loops touching an

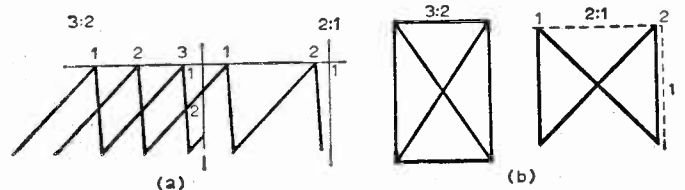
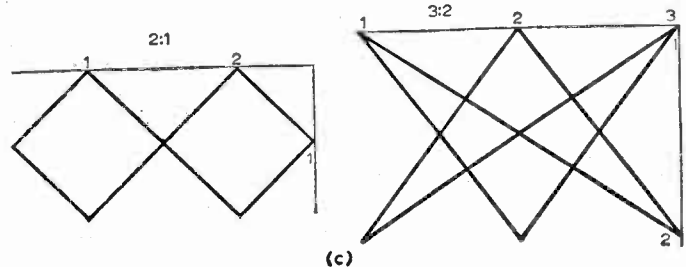
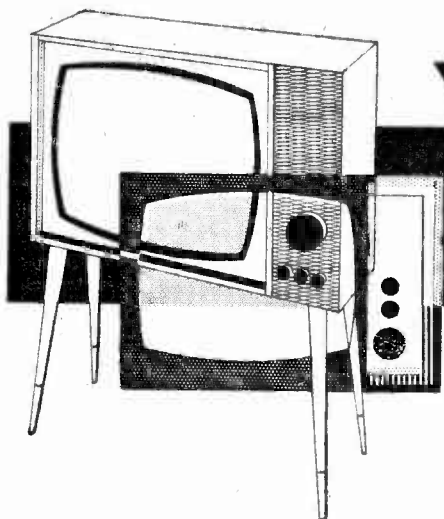

Fig. 27—Lissajous figures with (a) saw-tooth, (b) square and (c) triangular waveforms.





Your Problems Solved

Whilst we are always pleased to assist readers with their technical difficulties, we regret that we are unable to supply diagrams or provide instructions for modifying surplus equipment. We cannot supply alternative details for constructional articles which appear in these pages. **WE CANNOT UNDERTAKE TO ANSWER QUERIES OVER THE TELEPHONE.** The coupon from p. 524 must be attached to all Queries, and a stamped and addressed envelope must be enclosed.

EKCO T216

This set appears to be deflected in the timebase circuit on warming up. After 20 minutes a perfect picture can be obtained, but every 12 or 15 minutes the frame hold needs advancing to lock the picture. Also, during warm-up, the screen remains blank while the volume control is fully turned up, then a rolling and distorted picture makes itself evident.—P. Matthews (Bucknell, Salop).

The trouble is probably due to the change in value of the 1M Ω resistor connected between the frame blocking oscillator transformer and the frame hold control slider. Your symptoms during warm-up suggest instability of the i.f. stages, and we suggest you check the 0.003 μ F screen grid decoupling capacitors on the i.f. valves.

SOBELL T278

There is distortion on both the TV and f.m. sound resulting in a rasping of the emphasised words or music.—Robert Hodge (Glasgow, S3).

Check the 4.7k Ω resistor R59 to the noise limiter diode. Check the 100k Ω resistor to pin 9 of the PCL82 if necessary.

BUSH TV75

When this set is first switched on, the picture pulls sideways. After about a minute it is all right, but small all round. This then grows almost to full size inside ten minutes.

I have changed PL81, PY81, ECC83, PCL83, but suspect the metal rectifier which reads about 235V input.—H. Woodrow (Mitcham, Surrey).

The rectifier is a Westinghouse LW15. This should be replaced or bridged with a silicon diode (type BY100) in series with a 25 Ω wirewound resistor.

SOBELL TPS147

There is trouble with the height of the picture. I have replaced the PCL83 and PY82 valves but this has made no difference.

When the set is switched on, the picture is quite good with no lack of height but after about ten minutes the picture begins to creep up at the bottom to a maximum of about 2in.—R. Jennings (London, E.2).

This model is prone to frame creep at the bottom with increase in temperature. The trouble is aggravated by insufficient ventilation at rear and bottom and by running on the correct mains position on the voltage selector. Check these points. If the trouble persists, alteration in value of a component in the frame output stage could be responsible. The valves should be checked, if possible by substitution, as an ordinary check on a tester would not reveal the condition when the valve is hot under a full load.

ULTRA V814

The e.h.t. valve (U25) has a bright blue light, and the set gives no picture so I wish to change this valve but it is soldered in position and packed with some type of grease. I am assuming that this grease is solely to keep the valve in a fixed position. Will you please tell me if this is so and what type I can use as a replacement.—R. A. Jowett (Ilkeston, Derbyshire).

As well as checking the U25 you should also check the 500pF 15kV e.h.t. smoothing capacitor between the valve and the tube anode. The grease is packed in to stop discharge from the U25 connections not to fix the valve in position. Most grease can be used but we would recommend MS4 silicone grease which need not be used in such quantity as the original. Make sure the connections are made with a hot iron so as to leave smoothly rounded joints with no sharp edges.

LAWSON BRAND NEW CATHODE RAY TUBES

The rapidly increasing demand for a complete range of new tubes of the very highest quality is now being met by the new Lawson "CENTURY 99" range of television tubes.

SPECIFICATION:

The new "Century 99" range of C.R.T.s are the products of Britain's premier C.R.T. manufacturers. All types are exact replacements, manufactured to the original specification, but incorporating the very latest design improvements to give superb performance, coupled with maximum reliability and very long life.

"Century 99" C.R.T.s, available as direct replacements for the following makes and types

MULLARD		MAZDA		BRIMAR		EMISCOPE & EMITRON		GEC and COSSOR Also ENGLISH ELECTRIC	
MW43/69	AW43-80	CRM121	CME1706	C12FM	C175M	4/14			141K
MW43/64	AW36-80	CRM122	CME1901	C14FM	C19/7A	4/15			171K
MW36/24	AW36-21	CRM123	CME1902	C14GM	C19/16A	4/15G			172K
MW31/74		CRM124	CME1903	C14HM	C19/10AD	5/2			173K
MW31/16		CRM141	CME1906	C14JM	C19AH	5/2T			212K
MW43/80		CRM142	CME2101	C14LM	C19AK	5/3			6901A
MW36/44		CRM143	CME2104	C14PM	C21/1A	5/3T			7102A
MW53/80		CRM144	CME2301	C171A	C217A	14KP4			7201A
MW53/20		CRM152B	CME2302	C174A	C21AA	17ARP4			7203A
MW43/43		CRM153	CME2303	C175A	C21HM	17ASP4			7204A
MW41/1		CRM171	CME2306	C177A	C21KM	17AP4			7205A
AW59-91		CRM172		C17AA	C21NM	21CJP4			7401A
AW59-90		CRM173		C17AF	C21SM	SE14/70			7405A
AW53-88		CRM211		C17BM	C21TM	SE17/70			7406A
AW53-88		CRM212		C17FM	C23-7A				7501A
AW53-80		CRM141		C17GM	C23-TA				7502A
AW47-91		CME1402		C17HM	C23AK				7504A
AW47-90		CME1702		C17JM					7601A
AW43-89		CME1703		C17LM					7701A
AW43-88		CME1705		C17PM					



12" ... £4.10.0
14" ... £5.10.0
17" ... £5.19.0
19"-21" £7.15.0

Terms:
C.W.O.
C.O.D.
Carr. and
Ins. 8/6

DOUBLE GUARANTEE
All tubes fully guaranteed for 12 months and are supplied with a full money back guarantee if you are not delighted with their performance. Complete fitting instructions supplied

LAWSON TUBES
STATION ESTATE, MALVERN,
Offices and Enquiries:
2 PEACHFIELD CLOSE,
MALVERN WELLS,
MALVERN 2100

FIRST-CLASS RADIO AND T/V COURSES... GET A CERTIFICATE!

After brief, intensely interesting study—undertaken at home in your spare time—YOU can secure a recognised qualification or extend your knowledge of Radio and T.V. Let us show you how.

FREE GUIDE

The New Free Guide contains 120 pages of information of the greatest importance to both the amateur and the man employed in the radio industry. Chambers College provides first rate postal courses for Radio Amateurs' Exam., R.T.E.B. Servicing Cert., C. & C. Telecoms., A.M.I.E.R.E. Guide also gives details of range of diploma courses in Radio/T.V. Servicing, Electronics and other branches of engineering, together with particulars of our remarkable terms of

Satisfaction or refund of fee

Write now for your copy of this invaluable publication. It may well prove to be the turning point in your career.

FOUNDED 1885—OVER 150,000 SUCCESSES

CHAMBERS COLLEGE
(Incorp. National Inst. of Engineering)
(Dept. 462), 148 HOLBORN
LONDON, E.C.1

NEW VALVES!

Guaranteed Set Tested
24-HOUR SERVICE

1R5, 1S5, 1T4, 3S4, 3V4, DAF91, DF91, DK91, DL92, DL94, SET OF 4, 14/-
DAF96, DF96, DK96, DL96, SET OF 4, 23/6

1R5	4/-	EB91	1/9	PL36	8/6
1S5	3/3	EBC41	6/3	PL81	6/9
1T4	1/9	EBF80	5/9	PL82	5/9
3S4	4/3	EBF89	5/9	PL83	5/11
3V4	5/-	ECC81	3/6	PL84	6/-
6AM6	2/6	ECC82	4/6	PY32	5/6
6K7G	1/3	ECC83	5/3	PY33	3/6
6K8G	3/3	ECC85	5/3	PY80	4/9
6Q7G	4/3	ECF82	5/9	PY81	5/3
6V6G	3/-	ECH35	5/9	PY82	4/11
12K8GT	8/6	ECU42	7/9	PY83	5/6
20P4	13/3	ECH81	5/3	PY800	5/11
20P5	11/6	ECL80	5/11	U25	8/-
30FL1	9/6	ECL82	6/6	U26	8/6
30L15	10/3	ECL86	3/-	U191	9/6
30FL13	10/6	EP39	3/6	U301	11/-
35L5GT	5/6	EP41	9/9	U801	15/-
8CA2	5/9	EP80	4/3	UABC80	5/9
CL33	8/6	EP85	4/6	UAF42	6/11
DAC32	6/9	EP86	6/6	UBC41	6/-
DAF91	3/3	EP89	4/3	UCF80	8/3
DAF96	5/11	EP91	2/6	UCF86	5/6
DF91	1/9	EL84	4/6	UC85	6/-
DF96	5/11	EY51	5/11	UCF80	8/3
DK32	7/6	EY86	5/6	UCH42	6/9
DL94	4/-	EZ10	5/6	UC81	6/-
DK92	7/9	EZ80	3/9	UCL82	7/3
DK96	6/3	EZ81	4/3	UCL83	8/6
DL33	6/9	PCC84	5/6	UF41	6/6
DL35	4/9	PCC89	3/6	UF85	5/9
DL92	4/3	PCF80	6/3	U3A1	7/-
DL94	5/-	PCF82	6/-	UL84	5/3
DL96	5/11	PCF805	9/-	UY41	3/11
DY86	6/6	PCL82	6/3	UY85	4/11
DY87	7/6	PCL83	8/3	W77	3/-
EABC80	5/6	PCL84	7/6	Z77	2/6

Postage on 1 valve 9d. extra. On 2 valves or more, postage 6d. per valve extra. Any parcel insured against damage in transit 6d. extra.

Office address, no callers.

GERALD BERNARD
83 OSBALDESTON ROAD
STOKE NEWINGTON
LONDON, N.16.

BBC2 (625 LINE) TV AERIALS



Mast Mounting Arrays. 9 element 45/-; wide spaced high gain. 11 element 55/-; 13 element 62/6. **Wall Mounting** with Cranked Arm 9 element 60/-; wide spaced high gain. 11 element 67/8; 14 element 75/-; Chimney Arrays Complete, 9 element 72/-; wide spaced high gain. 11 element 80/-; 14 element 87/6. **Loft Arrays**, 7 element 32/6; wide spaced high gain. 11 element with Fitting Arm 62/6; 14 element 70/-; All high gain units have special Multi-rod Reflector. Low loss Co-axial cable 1/6 per yard. VHF transistor pre-amps from 75/-.

BBC · ITV · F.M. AERIALS



B.B.C. (Band 1). Telescope loft 21/-. External S/D 30/-.
I.T.V. (Band 3). 3 Element loft array 25/-. 5 element 35/-; Wallmounting, 3 element 35/-; 5 element 45/-.
Combined B.B.C./I.T.V. Loft 1+3, 41/3; 1+5 48/9; Wallmounting 1+3 56/3; 1+5, 63/9; Chimney 1+3, 63/9; 1+5, 71/3.
VHF transistor pre-amps from 75/-.

F.M. (Band 2). Loft S/D 12/6. "H". 30/- 3 element. 52/6. External units available more. Co-ax cable 8d. yard. Co-ax plugs. 1/3. Outlet boxes 4/6. Diplexer Crossover Boxes, 12/6. C.W.O. or C.O.D. P. & P. 36. Send 6d. stamps for illustrated lists.

K.V.A. ELECTRONICS (Dept P.T.)
3rd Godstone Road, Kenley, Surrey
CRO 2527

FERGUSON 506C

There is no e.h.t. Upon closer inspection I find the electrode assembly of the line output valve, PL81, glowing red-hot.

Removal of the top caps on either the PL81 or PY81 has the effect of cleaving the red-hot anode fault. Replacement of the line oscillator, line output, efficiency diode and e.h.t. rectifier has had no effect at all.

The sound is quite normal.—J. A. Smith (Uxbridge, Middlesex).

The fault lies somewhere in the line timebase. If the line whistle can be heard softly when the line hold control is adjusted the line amplifier section is responsible. However, if there is no line whistle a check should be made of the oscillator and coupling to the amplifier. If the whistle is present, but weak, suspect shorting turns in the line output transformer.

BUSH TV24C

Would you please inform where the boost capacitor is situated on this set.—H. E. Chamberlain (Newark-on-Trent, Nottinghamshire).

You will observe a 25 μ F tubular ceramic capacitor on the l.o.t. panel. The lower end of this goes to the junction of the scancoils, a 2.2M Ω resistor and the 0.1 μ F 500V boost line capacitor.

FERRANTI 20T6

The picture is quite good but for a "smeary" effect noticeably on white objects. I have tested the valves and put a new tube in, but the trouble still persists on both channels.—A. L. Brown (Bolton, Lancashire).

Check the V8 video amplifier components in the anode and cathode circuits. Particularly check the cathode circuit 50 μ F electrolytic, anode 8.2k Ω resistor and the grid leak 5.6k Ω .

DECCA DM4/C

Recently I have been bothered by a continual buzzing sound on BBC. So much so that it is impossible to get any sound at all. The picture is not affected however. ITV is quite all right.—P. Clark (Aberdeen, Scotland).

The buzzing noise on BBC is undoubtedly caused by the oscillator tuning inductance altering slightly, bringing the tuning point too near the vision carrier. This is confirmed by the fact that the ITV picture and sound, and the BBC picture are in order.

Remove the tuning knob and channel selector. These push off easily from the inside if they cannot be readily pulled off from the front. They are retained only by spring clips. Next, remove the decorative metal disc around the hole, and an extension to the main hole, or a nearby small hole will be revealed. With the fine tuner control in mid-position, insert a trimming tool made from a plastic knitting needle with a flattened end, and turn the brass core of the inductance slightly. Only a very slight movement is needed, and if first movement causes the picture to break up and sound increase, turn back the other way.

BUSH TV22

With the brightness control turned fully up, a dull picture can be seen (only in a dark room). Also, on turning the contrast down, the volume decreases and the line hold slips.

After the set has been on for about 10 minutes a whistle of varying pitch can be heard, and this then disappears after about 2 minutes.—D. H. Mountford (Ombersley, Worcestershire).

The dull picture is almost certainly due to a worn tube or incorrect operation of it. Check the setting of the ion trap magnet, the c.r.t. base voltages including the voltage drop across the heater pins. If all seems to be in order, change the tube.

G.E.C. BT2748

Periodically, but not to any particular time pattern, there is a "concertina" effect of bunching and stretching the picture vertically. It seems to start at the bottom, bunching and moving to the top, followed by a stretching then back to normal. It takes about 2 seconds for the effect to move from bottom to top of the picture. A different N309 frame output valve doesn't cure the fault.—R. Message (Eastbourne, Sussex).

We would advise you to check two capacitors in particular. One is the cathode (pin 3) 100 μ F electrolytic, the other is the 0.1 μ F from pin 6 and 8 of the LN319.

K-B RV60

The set works perfectly except for poor focus. The only valves that I have had to renew are 6AL5 and PL81. There is a small slide-type resistor at the rear of the set but this is at the end of its travel. Occasionally there is a cracking sound rather like e.h.t. flash-over, but I do not think this is the trouble.—B. Aplin (Birmingham).

Notice the effect on the focus when the slide element is disconnected at the chassis end. This control often changes value from its rated 2M Ω . Check the U26 if the focus varies with the brilliance level.

REGENTONE TT

The picture fills the screen and the sound is perfect, but after about 5 minutes the picture goes dark and gradually disappears altogether. I have fitted a new c.r.t., PCF80, PCC84, PL81 and PY51. I have also checked the aerial.—H. Finn (Ferryhill, Co. Durham).

You should make a voltage check at the tube base socket. The actual readings are not so important as the variation which occurs as the fault develops. If the first anode voltage at pin 10 (or 7) falls, check the 2.2M Ω supply resistor and the 0.1 μ F decoupling capacitor (which probably leaks).

If the cathode voltage at pin 11 rises, check the video amplifier V7 PCF80 and associated components. If the grid voltage falls at pin 2, check the 33k Ω resistor to the brilliance control.

ALBA T744/FM

The sound is in order but there is no picture, just a thin bright line across the middle of the screen. Adjustment of the controls will increase the width and brightness but still no picture. I have replaced some valves and others have been transposed. I have also checked the line output transformer and scan coils for continuity. I can get a good spark from the e.h.t.—H. Firth (Morley, near Leeds).

The thin, bright line across the centre of the screen (assuming that this is horizontally disposed) indicates failure of the field timebase circuits. This is the section of the set which gives the vertical deflection of the scanning spot. Complete failure, of course, could be caused by failure of almost any component in the field timebase. You will thus need to investigate this section to discover the faulty part. In the first instance you should have the field timebase valves checked as a fault in one of these may well be responsible.

FERGUSON 996T

The fault is that the line output transformer is overheating badly. I recently replaced the transformer as the original burnt out completely. I also replaced the c.r.t., PY81, PL81, and screen feed resistor.—A. Wharton (Liverpool, 11).

An overheating line output transformer normally indicates a shorted EY51 e.h.t. rectifier, in which case of course there will be no picture. If there is a picture, there may be shorted turns in the overwind. Fit a new transformer if this is so.

QUERIES COUPON

This coupon is available until AUGUST 19th, 1965, and must accompany all Queries sent in accordance with the notice on page 521.

PRACTICAL TELEVISION, AUGUST, 1965

TEST CASE -33

Each month we provide an interesting case of television servicing to exercise your ingenuity. These are not trick questions, but are based on actual practical faults.

? A Pye series receiver using flywheel controlled line sync exhibited the symptom of "no raster and no e.h.t. voltage, sound OK". Removing the aerial and listening closely at the rear of the set while the line lock control was adjusted indicated lack of line oscillation. While contemplating this an experimenter heard the gradual development of the line whistle and a few seconds later the e.h.t. rectifier valve lit up (signifying pulse voltage), as also did the screen of the picture tube.

In an endeavour to secure a picture the aerial was replaced. As soon as this connection was made the line whistle cut off sharply and the screen illumination collapsed to a thin, vertical line and then faded away altogether. On removing the aerial again the line oscillator started up and there was a gradual development of the raster as before. But each time the aerial was connected the e.h.t. voltage and the line timebase cut out.

It was noticed that this curious effect happened only when the set was adjusted to receive a station. For instance, when the channel selector was turned to a blank channel the raster stayed whether the aerial was connected or not.

What was the most likely cause of this symptom?

See next month's PRACTICAL TELEVISION for the answer and for another Test Case feature.

**SOLUTION TO TEST CASE 32
(Page 477, last month)**

The vigorous blue e.h.t. discharge, coupled with the similar discharge between the earthing clip and the external conductive coating on the tube, should have led to a check of the e.h.t. rectifier valve. This is because a discharge of that nature generally results from raw line pulse voltage as distinct from rectified pulse voltage or d.c. voltage. The latter is usually in the form of a "crackly" yellow discharge.

Although in the Test Case under examination no direct short could be established between the e.h.t. rectifier valve anode and cathode a replacement valve cured the trouble completely.

There are times when a poor vacuum inside the e.h.t. rectifier results in the ionisation of the gas atoms. A path then exists between the anode and cathode, thereby permitting a reverse flow of pulse current. While this may not totally destroy the rectification action it may well impair it and give rise to low e.h.t. voltage (responsible for the extra large picture) upon which may be superimposed a heavy pulse voltage (responsible for the sparking at the tube earthing).

EDUCATIONAL

THE INCORPORATED PRACTITIONERS IN RADIO & ELECTRONICS (I.P.R.E.) LTD. Membership Conditions booklet 1/- Sample copy of I.P.R.E. Official Journal 2/- post free. Secretary, Dept. C, 32 Kidmore Road, Caversham, Reading, Berks.

SERVICE SHEETS

SERVICE SHEETS (75,000), 4/- each. Callers welcome. ALWAYS OPEN. 5 South Street, Oakenshaw, Bradford.

SERVICE SHEETS, Radio, TV, 5,000 models. List 1/-. S.A.E. enquiries. TELRAY, 11 Maudland Bk., Preston.

SERVICE SHEETS

For all makes of Radio and Television—1925-1965. Prices from 1/-.
Free fault-finding guide with all Service Sheets. Please send S.A.E. with enquiries. Catalogue of 6,000 models, 1/6.

All types of modern and obsolete valves. Radio and TV Books. S.A.E. lists enquiries.

HAMILTON RADIO

Western Road, St. Leonards, Sussex.

SERVICE SHEETS, also Current and Obsolete Valves for sale. JOHN GILBERT TELEVISION, 1b Shepherd's Bush Road, London W8. Tel: SHE 8441. Nr Goldhawk Rd. Station.

STATE MODEL No. Radio 2/-, TV 2/6. S.A.E. Darwin. 19 George Street, St. Helens, Lancs.

SERVICE SHEETS

4/- each, plus postage

We have the largest supply of Service Sheets for all makes and types of Radios, Televisions, Tape Recorders, etc. in the country (speedy service).

To obtain the Service Sheet you require, please complete the attached coupon:

Name:

Address:

.....

To: **S.P. DISTRIBUTORS**

44 Old Bond St., London, W.1

Please supply Service Sheets for the following:

Make:

Model No. Radio/TV

Make:

Model No. Radio/TV

Make:

Model No.

I also require list of Service Sheets at 1/6.

(please delete items not applicable)

I enclose remittance of

MAIL ORDERS ONLY (Aug PT.)

RATES: 5/- per line or part thereof, average five words to line, minimum 2 lines. Box No. 1/- extra. Advertisement must be prepaid and addressed to Advertisement Manager "Practical Television", Lower House, Southampton Street, London W.C.2.

SETS & COMPONENTS

OLYMPIC II TV, S.a.e. for itemised price. 1st. AJAX ELECTRONICS, 18A Rumbold Road, Fulham, S.W.6.

DIRECT TV REPLACEMENTS LTD., largest stockists of TV components in the U.K. Line Output Transformers, Frame Output Transformers, Deflector Coils for most makes. Official sole suppliers for many set makers. Same Day Despatch Service. Terms: C.O.D. or C.W.O. Send S.A.E. for quotes. Day and Night Telephone: GIPsy Hill 6:66. 126 Hamilton Road, West Norwood.

TUBES. AERIALS. VALVES

C.H.F. aerials. Bands I, II & III aerials. U.H.F. transistorised boosters. ITV boosters. Re-tuned TV tubes. Valves, etc. New and second-hand TV sets, Transistor Radios and all types of Electrical Appliances. Quotations without obligation. Coaxial cable, fluorescent light fittings, all at special prices to the trade and Home Engineers. S.A.E. for list.

G. A. STRANGE

BROADFIELD, NORTH WRANHAM, nr. Chippenham, Wilts. Tel. Marshfield 206

TV SPARES, fully grtd. Makers' Parts Telephone orders sent same day C.O.D. Line O.P. Trans. Murphy V24H/250, 79/6, V270/280, 89.6, Ekco T31, 330, 231, 231, 231, 237 series and Pye VT4 etc. all 62/6. Most types stocked. Send S.A.E. for quote. Add 4/- p.p. Ekco/Ferr Plastic Hags, 15/- **KINGS (ORPINGTON) LTD.** 8 Cray Parade, Main Road, St. Paul's Cray. Kent. Orpington 30586.

STOP

FULLY GUARANTEED LINE OUTPUT TRANSFORMERS

NEW FROM STOCK

EKCO U25 TYPES

EMERSON ALL TYPES

FERGUSON 306-308

HMV 1865-1869

Our Streamline REWIND Service is now 24 hours. A few of the types are listed below. **50/-**

All at

BUSH TV 79, 92, 115, 105.

COSIOR 950

DECCA DM35, DM45, DMC/D/21C.

DEFIANT T41, 4109.

ENGLISH ELECTRIC T41.

GEC BT312, 455.

KB NF70, NV40, OV10, PVP20, Etc.

MASTERADIO TK7T, TG21T, TD4.

PAGEANT 7P20.

PYE 300s, etc.

PILOF 117U.

PETC SCOTT 1737, 1611, 738.

PHILCO 1019, 1961, 1030.

PHILIPS 177G, 100U, 1768U, etc.

REGENTONE T21FM, TEN-6-FM, 143.

RGD 1756, 600, 610, T21, DEEP 17

SOBELL T21.

ULTRA 200C, VT161, 2380.

Frame Output Transformers Rewinds, 50/-.

Please send old L.O.P.T. SAE all enquiries. P. & P. 4/- C.O.D. 6/- extra

WITWORTH TRANSFORMERS LTD.

26 ALL SAINTS ROAD

LONDON W.11 BAY 9071

SETS & COMPONENTS

(continued)

50 TRANSISTORS, all tested, marked and guaranteed AF, RF, Silicon and P.N.P. Unobtainable elsewhere at this low price of 35/-, plus P. & P. 1/- D. & W. LTD., 224 West Road, Westcliff-on-Sea, Essex.

TUBES—FAMOUS MAKES!

MW43/69, AW43/80, CRM171/2, AW43/88, etc. ALL BRAND NEW & 100% (Top manufacture). ALL £6.2.6. Carriage paid. **LISTS. One Year's Guarantee Card.** Also rebuilt 43/69, 36/44, 95/-!

NEW VALVES. 12 months' guarantee! BY100, EY51, EY86, PY81, PY801 ... 7/- PL81, PCF80, PCL82, 30C1, PC86-8 ... 9/- PY800, BY100, EBF69, EFB9, 72/- doz. mixed

FREE lists of valves, tubes, Transformers by Murphy, Ekco, Pye, Bush, etc.

Return of post service

P. BEARMAN, 43 Leicester Road, New Barnet, Herts. Tel. BAR 1934

OVER 300 ELECTRONIC COMPONENTS in one great parcel including printed circuit panel with condensers, resistors, coils, diodes, transistors, silicon rectifiers, potentiometers IF's, valve bases, tuning condensers, transformers, etc. You can't afford to miss this great bargain offer. Send 10/- plus P. & P. 2/6 to D. & W. LTD., 224 West Road, Westcliff-on-Sea, Essex.

R. & R. RADIO & TV SERVICE

44 MARKET STREET

BACUP, Lancs. Telephone: 465

Closed for Local Holidays July 23rd-August 5th

6F13	4/6	6F15	5/-	9BW6	5/-
6K25	10/-	6U4gt	5/-	6F1	2/6
630L2	5/-	EB91	1/-	EF80	1/6
EBF80	5/-	EBF89	5/-	ECL80	4/-
EF91	2/6	EF85	5/-	30P5	6/-
ECC82	4/-	EY86	4/-	PL36	7/6
20P3	5/-	20P4	7/6	PL82	4/-
30PL1	5/-	PL38	6/-	PY83	5/-
PCC84	4/-	PCF80	4/-	U301	6/-
PCL83	5/-	PL81	5/-	10P13	5/6
PL83	4/-	PY81	3/6	20F2	5/6
PZ30	5/-	U801	7/6	20P5	6/6
10F1	1/-	10LD11	5/-	30P4	7/6
10P14	5/-	20L1	5/-	PY82	5/-
20D1	2/-	20P1	6/6		
30FL1	6/6	30P12	5/-		
PY32	6/-	6L18	4/6		

Post 6d. per valve. Three or more post free. Ex used Equip. **Turret Tuners** ex TV as removed, 8/-, post 2/9.

Line output transformers, scan coils, etc. State make and model No. with all enquiries.

Fireball Tuners, as removed 14/6, **Selected Tuners**, 18/- post 2/9.

Ekco Line output shrouds, 8/- incl. post.

TV Transistor pre-amps, Band 1, 2 and 3. £3.17.6, post paid.

Model B45, covering any ten channels in Band 4 or 5, £4.5.0, post paid.

State clearly the channel you require.

TELEVISION TUBE SHOP

We have the following

Unused, Guaranteed Tubes

in Stock now

AW36-20, 21	£5. 2.6
AW36-80	£5. 7.6
AW43-80	£6. 7.6
AW43-88, 43-89	£6.12.6
AW47-90, 91	£7.10.0
AW53-80	£7.12.6
AW53-88, 53-89	£7.17.6
AW59-90, 59-91	£8.10.0
C14BM, FM	£5. 5.0
C17BM, FM, HM	£6. 7.6
C17LM, PM, SM	£6.12.6
C21 HM, SM, TM	£7.17.6
CME1402	£5.12.6
CME1702, 1703	£6.12.6
CME1705	£6.17.6
CME1901, 1903	£7.10.0
CME2101	£8. 7.6
CRM93	£5.10.0
CRM124	£5.10.0
CRM141, 2, 3, 4	£5. 7.6
CRM152, 153	£5.17.6
CRM171, 2, 3	£6. 7.6
CRM211, 212	£7.17.6
MW6-2	£6.17.6
MW22-16	£4.17.6
MW31-16, 74	£4.17.6
MW36-24, 44	£5. 2.6
MW41-1	£6.12.6
MW34-64, 69	£6. 7.6
MW43-80	£6. 7.6
MW53-20	£7.12.6
MW53-80	£7.12.6
T901A	£6.12.6
14KP4A, 141K	£5. 2.6
171K, 172K, 173K	£6. 7.6
6901A	£6.12.6
7201A, 7203A	£5. 2.6
7204A	£5. 5.0
7401A	£6. 7.6
7405A	£6.12.6

All tubes tested before despatch and guaranteed for 12 months.

CARRIAGE 10/-, via B.R.S. or 15/- via passenger train. Add 2/6 for Comprehensive Insurance.

TERMS £2 down (plus carriage) balance £1 per month.

Shop Soiled Tubes (unused)

(Subject to Availability)

12, 14, 15 inch	70/-
16, 17, 19 inch	90/-
21, 23 inch	110/-

All Guaranteed for 12 months.

TELEVISION TUBE SHOP

48 BATTERSEA BRIDGE ROAD
LONDON S.W.II. BAT 6859

South of the Bridge. Open Sats. until 4 p.m.

SETS & COMPONENTS

(continued)

A.1. POST FREE BARGAINS

RECLAIMED VALVE STOCK CLEARANCE

B36	3/-	PEN40	3/-	10H42	5/-	10P13	3/9
EB41	2/-	PL33	3/-	763	3/-	10P14	3/9
EB91	6d.	PL82	2/-	266	3/9	20D1	1/8
EBF80	3/9	PL83	2/-	6F1	1/-	20P2	4/3
EBJ82	2/-	PY31	1/8	6F13	2/9	20P1	3/-
ECL80	1/8	PY80	1/9	6F14	3/-	20P3	3/9
EF42	2/9	PY81	1/9	6F15	3/9	20P4	8/-
EF80	9d.	PY82	1/9	6H11	3/9	30P5	4/9
EL42	4/3	PZ30	1/9	6L18	3/-	30FL1	3/9
KT330	2/9	T41	4/6	6P25	3/-	30FL1	3/9
L63	2/-	U31	3/6	6P28	5/-	30P12	3/9
N37	3/-	U281	3/9	6P012	2/9	185BT	7/6
PCF80	2/3	UB11	3/6	10C2	3/9		
PCL83	3/3	UF42	1/9	10F1	6d.		

EF80 15/3 Doz. EB91 5/- Doz. ECL80 14/-Doz.
Above prices only while present stocks last.

A.1. Radio Components

14 The Borough, Canterbury, Kent

"HEATHKITS" can now be seen in London and purchased on H.P. Free Brochure. DIRECT TV REPLACEMENTS LTD., 126 Hamilton Road, West Norwood, SE27. GIPSY Hill 6166.

TV SPARES

Fully Guaranteed Makers Parts
Telephone Orders sent same day
Line Output Transformers

Alba 324 etc.	47/6.	Bush TV53, 79/6.
TV80, 95/-	Cossor 930-9, 52/6.	Ekco 221-231-284-310-311, 69/9.
Ferranti 69/9, 72/3.	Ferg. 306T-308T, 55/-	HMV 1840-1848, 62/6.
Murphy 240/250, 70/-;	270-280, 85/-;	310-350, 70/-;
410-540, 85/-;	659-759, 70/-.	Pye VT17, CW17, CTM17, 65/-.

Any other make or model supplied.
Scan Coils from 55/-.
Some used parts available.

Ekco-Ferranti Shrouds 15/-. De-Luxe 17/6 each.

SPECIAL—
Exchange Ekco-Ferranti L.O.P.T.s 40/- plus Old L.O.P.T.

Free Insurance and Quantity discounts
Open all day Saturdays
Terms: C.W.O. or C.O.D.
Post & Pack. 4/-

T.C.S.

M/O Dept.

BROCKLEY T/V LTD.

28 Brockley Cross : London, S.E.4

Tel.

TIDeway 5394 (Day) RODney 7917 (Night)

CALLERS WELCOME

SITUATIONS VACANT

RADIO AND TV Exams and Courses by Britain's finest home-study School. Coaching for Brit.I.R.E., City and Guilds Amateur's licence. R.T. E. B. P.M.G. certificate, etc. Free Brochure from British National Radio School, Russell Street, Reading.

FOR SALE

HAMMER FINISH PAINT. The modern finish for electronics. Can be brushed or sprayed. Blue or Silver. 2oz. tins 3/6, post 6d.; 1 pint 7/6, post 1/9. 1 pint 15/-, post 2/9. Orders over 30/- post free. Retailers supplied. Write for details. Amazing results. Return of post service.
FINNIGAN SPECIALITY PAINTS (PT), Hickley Square, Stockfield, Northumberland.

500 TELEVISIONS, not working, from 5/- Callers only. 39 Whitehorse Lane, E.1. opposite Stepney Green Station.

VALVE CARTONS at keen prices. Send 1/- for sample and list. J. & A. BOXMAKERS, 75a Godwin Street, Bradford 1.

METAL RECTIFIERS

RECTIFIERS—CONTACT COOLED
14RA1282 (PC101) type 250 v., 250 mA. 13/8;
14RA1283 (PC31) see 8150a ECI 13/-; FC116 7/8.
RECTIFIERS—FIN TYPE
Equivs. for RM4 13/8; RM5 17/8; 14A989 13/8;
14A86 10/8; 14A97 11/8; EK2 15/-; EK6 15/-;
14A949 19/-; LW15 19/-; LW7 19/-; H100 19/-;
PW19V 1A 5/-; 2A 7/-; 4A 10/8; 5A 13/8.
SILICON TV 7/8, or with instr. resistor-condenser 9/-.
MULTIMETERS from 32/-.
Stamped envelope for full latest selection and bargain offers in cheap meters, car radios and transistor radios. Under £1, P. & P. 6d, over £1, Post Free.

NO C.O.D.

DURHAM SUPPLIES

175 DURHAM ROAD, BRADFORD 8, YORKSHIRE

WANTED

NEW VALVES WANTED — EY51, EY86, PL81, PCC84, PCF80, PCL82, PCL83, PY81, R19, 30P19, U25 etc. Best cash prices by return. **DURHAM SUPPLIERS**, 175 Durham Road, Bradford 8, Yorks.

SERVICE SHEETS purchased **HAMILTON RADIO**, Western Road, St. Leonards, Sussex.

A PROMPT CASH OFFER for your surplus brand new valves and Transistors. **R.H.S.**, Beverley House, Mannville Terrace, Bradford 7.

URGENTLY WANTED, new modern Valves, Transistors, Radios, Cameras, Tape Recorders and Tapes, Watches, Tools, any quantity. **S. N. Willets**, 16 New Street, West Bromwich, Staffs. Tel. 2392.

DAMAGED AVO METERS WANTED. Models 7 and 8. Any condition. Any quantity. **HUGGETT'S LTD.**, 2/4 Pawsons Road, W. Croydon.

MISCELLANEOUS

CONVERT ANY TV SET into an Oscilloscope. Instructions and diagrams 12/6. **REDMOND**, 42 Dean-close, Portslade, Sussex.

BUSINESS OPPORTUNITIES

BUILD a fully automatic low cost telephone system. Ideal for renting or selling to Factories, offices etc. Up to ten lines, simple construction, full technical details, diagrams and instructions 15/6 inc. postage. **PARTBRIDGE TECHNICAL PUBLICATIONS**, Dept. P.T.J., 21-25 Hart Road, Thundersley, Benfleet, Essex.

Your complete basic guide devoid of mathematics and circuitry

BEGINNER'S GUIDE TO COLOUR TELEVISION

by Terence L. Squires, A.M.Brit.I.R.E.



Explains fully how the signals are created in the television studios, how they are transmitted and the techniques used to receive and display them. Covers: Historical Outline - The Colour Signal - The Chrominance Signal - Colour Transmission - Receiving the Colour Signal - Domestic Aerial Systems - The Receiver Block Diagram - The SECAM Receiver etc.

128 pages, 58 diagrams
only 15s. net
from all booksellers

or, in case of difficulty, 16s 3d. by post from George Newnes Ltd., Tower House, Southampton Street, London W.C.2.

NEWNES

PADGETTS RADIO STORES

OLD TOWN HALL
LIVERSEDGE, YORKS

Telephone: Cleckheaton 2886

17in. 13 Channel Untested complete TV Sets. 50/-. carriage 10/-.

14in. 13 Channel Untested TV sets, 30/-, carriage 10/-. Well packed but sent out at owner's risk.

Special Offer. Brand new rebuilt TV Tubes, 12 months guarantee (not seconds), MW43/69, £3.5.0. MW36/24/44, 37/6. carriage 10/-.

Single Phase 240 volt 1400 r.p.m. 1-h.p. motor with pulley, 26/-. less pulley, 24/-. fully guaranteed, ex washing machine. Carriage 8/6.

One Sixth H.P. Motor. 240 volts, 15/-, post 6/9.

VALVE LIST

Ex equipment. 3 months' guarantee

BL9	1/6	20P4	8/6	PCC84	4/-
EL80	2/-	U801	8/6	PCL82	5/-
ECC92	3/-	U281	5/-	PCL85	5/-
EY51	2/6	U282	5/-	PL36	5/-
EY86	5/-	U329	5/-	12AT7	3/-
BBF80	4/6	K736	3/-	6CH6	1/6
EB61	9d.	6V8GT	4/-	R18	3/6
BL38	5/-	6B3	1/6	ARP12	1/6
EF81	9d.	6K23	5/-	807	5/-
6F1	1/-	6P25	3/6	EF50	1/-
6F14	5/-	6U4	5/-	Doz.	6/6
6F15	5/-	PY38	5/-	EF30	1/6
10C2	3/-	PY30	3/-	Doz.	10/-
10F1	1/-	PY81	3/-	6K7	1/6
10P13	5/-	PL81	4/-	6V6	1/9
10P14	5/-	PL82	3/-	Doz.	18/-
20D1	2/-	PL83	3/-	6K8	1/9
20L1	5/-	PL38	3/-	Doz.	18/-
20P3	4/-	PY82	3/-	U25	5/-
20P1	4/-	PCF80	4/-		

Bush 9in. TV Set, BBC Only. Untested but complete. 21/-. carriage 10/-.

Just the Job for a Scope. Tested with good tube. 55/-: BHC-ITV. All channels, 75/-, carriage 10/- Well packed but sent at owner's risk.

Spare Tubes. 100%. 17/-. carriage 7/6.

PM Speakers, ex TV sets. All perfect.

Rola. 6 x 4. 3/-, post 2/-; six for 20/-, post free.

Goodmans, 7x 4. 5/-, post 2/-; six for 32/-, post paid.

Phillips, G.E.C. Plessey, 6in. and 5in. round. 3/-, post 2/-.

Reclaimed TV Tubes, Six Months' Guarantee. Mullard MW43/80, 30/-; Mullard MW43/69, 30/-; Mazda CRM 172, 30/-; Mazda CRM 142, 17/-. Carriage 10/-.

Ex R.A.F. Battery amp. complete with two Valves, Key Switch, Transformers etc. 2/-, post 4/6.

NYLON - P.T.F.E.

ROD, BAR, SHEET, TUBE, STRIP, WIRE

No quantity too small

List on application

ALUMINIUM, LIGHT ALLOYS
BRASS, COPPER, BRONZE

H. ROLLET & CO., LTD.

HOWIE STREET, S.W.11

BATtersea 7872.

Branches at Liverpool, Manchester,

Birmingham, Leeds, Glasgow.

Please mention
"Practical Television"
when replying to
Advertisements

TELEVISION BOOKS ON FREE TRIAL!

Then only 5/- per week for those you keep!

29-TELEVISION SERVICING HANDBOOK. 332 pages, nearly 200 illustrations, by Gordon J. King. Second edition (Enlarged). Price 38/6 including postage.

A thoroughly practical handbook for professional engineers and also of great interest to radio amateurs, students and apprentices. Has procedure charts to help you get repairs done faster. A good companion volume to the Coyne Pin-Point T.V. Troubles.

300-TELEVISION SERVICING COURSE.

If you want to clear up a few thoughts on the function of Television receivers you will find this course very refreshing. It's a big value too. Was originally sold as an expensive Home Study Course for very much more than the modest price now asked. You get 198 quarto pages of instruction and it is compiled by M. N. Beitman one of the greatest authorities on television and radio repair. Price Only 37/6, including postage.

22-PIN-POINT COLOUR T.V. TROUBLES IN 15 MINUTES.

By Robert G. Middleton. 548 pages. 382 Check Charts. Just about the biggest and most useful book on Colour Television repair available anywhere. Now is the time to seriously consider Colour T.V. and this is the best book we have seen published so far. At 48/- including postage it is big value and we know you will enjoy using this manual.

9-PIN-POINT TRANSISTOR TROUBLES IN 15 MINUTES.

By the world famous writer on transistors Louis E. Garner Jr. 486 pages.

A very practical handbook using the famous Coyne Check Chart Trouble shooting method. Covers all kinds of equipment including radios, T.V.s, Audio Amplifiers, Preamplifiers and just about everything. Hundreds of photos, illustrations, diagrams, check charts etc. Price 49/-, including postage.

38-RADIO & ELECTRONICS COURSE.

218 pages quarto size. 35 complete lessons. You will find this course easy to understand, practical. Early lessons make fundamentals clear even to the beginner while other lessons will give you the practical knowledge of an expert. Adapted from an expensive Home Study course. If you are just starting into radio or T.V. repairs we believe you will find this manual invaluable and use it for constant reference. Price 41/-, including postage.

8-PIN-POINT T.V. TROUBLES IN 10 MINUTES.

Over 340 cross indexed pages. Quickly and easily pin-points the trouble in any T.V. set. Covers 70 symptoms, 700 trouble spots; 90 time-saving check charts, 290 diagrams. See previous advertisement. NOW REPRINTING, will accept orders for delivery in four weeks' time. This is one of the best manuals we have ever handled well worth waiting for. Over 30,000 copies now used in the U.K. alone! Price 41/-, including postage.

IRONCLAD GUARANTEE

Any book not satisfactory may be returned within 10 days post-paid for full refund of the purchase price.

FREE BOOK OFFER!

If you include cash with order we will forward a free book of your choice from list on coupon for each book ordered. These books are authoritative and loaded with useful information. Would cost at least 4/6 to 5/- each in your regular bookstore!

FREE TRIAL COUPON

To SIM-TECH TECHNICAL BOOKS Dept. V.I.

West End, Southampton, Hants.

Please send the following books I have ordered:
29 39 200 22 8 8

If not delighted I may return any book post-paid without further obligation on my part. Otherwise I will pay cash or 5/- weekly (10/- fortnightly) commencing not later than 10 days after delivery. I am over 21 years of age. (If under 21 parent should place order).

I would like you to send me a free book as indicated below. I enclose cash to the sum of

Oscilloscope book. Transistor book.
 Electronics Gadgets book. Radio Instrument book.

Name

Address

City

County

Here's vital time-saving data

to earn money for you!

PROVE IT BY EXAMINING NEWNES RADIO & TV SERVICING — FREE

See for yourself the wealth of time-saving and money-making information contained in Newnes RADIO & TV SERVICING. Produced by a team of expert technicians this 12th Edition provides all the **CIRCUITS—DIAGRAMS—AND REPAIR DATA** you need for servicing nearly 2,300 models and including car radios, tape recorders, radiograms . . . 1964 back to 1958. Complete in six sturdily-bound volumes it is essential equipment that will repay you over and over again. Nearly 60,000 sets of previous editions have been sold . . . solid proof of its importance to you—the engineer in Radio and TV. Use this new edition for a week free—post coupon today!

3,500 PAGES OF REPAIR INFORMATION FOR NEARLY

2,300 Popular Models!

DATA FOR OVER 90 MAKES 1964 BACK TO 1958

Acc, Aerodyne, Ajax, Alba, Argosy, Baird, Beethoven, Berec, B.R.C., B.S.R., Bush, Capitol, Champion, Channel, Collaro, Cossor, Cyldon, Dansette, Decca, Defiant, Doric, Dynatron, E.A.R., Eddystone, Ekco, Elizabethan, Elpico, E.M.I., Emerson, Emisonic, Eumig, Ever Ready, Ferguson, Ferranti, Fidelity, Ford Motor Co., Garrard, G.B.C., G.E.C., Gramdeck, Grundig, H.M.V., Invicta, K-B., Magnavox, Marconiphone, Masteradio, McMichael, Motorola, Murphy, National, Neumatic, Pageant, Pam, Perdio, Peto Scott, Philco, Philips, Pilot, Playmate, Portadyne, Portogram, Pyc, Pye Telecommunications, Radiomobile, Raymond, Recording Devices, Rediffusion, Regentone, Retra, Revelation, R.G.D., Roberts Radio, Sobell, Sonolor, Sony, Sound, Spencer-West, Standard, Stella, Stereosound, Stuzzi, Thorn, Trans Arena, U.K.W., Ultra, Vidor, Volmar, Walter, Waltham-Standard, Zenith.

- TELEVISION
- RADIO
- RADIOGRAMS
- TAPE RECORDERS
- RECORD REPRODUCERS
- CAR RADIOS

POST COUPON NOW FOR

7 days FREE TRIAL

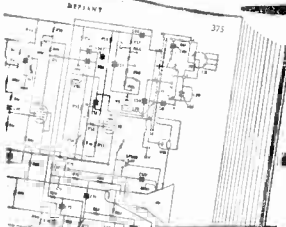

NEARLY 1,200 CIRCUITS

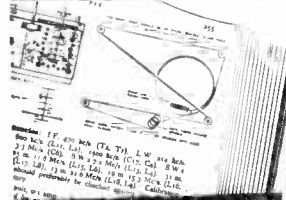

HUNDREDS OF DIAGRAMS

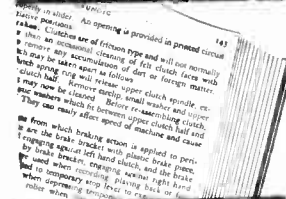

PACKED WITH REPAIR HINTS



GIVEN WITH EVERY SET NEWNES TV ENGINEERS POCKET BOOK (VALUE 12/6)

An invaluable companion to your set for on-the-spot repairs. 272 pages of reference data on installing, fault-tracing and repairing, servicing equipment, etc.



NO CHARGE FOR CREDIT IF KEPT AFTER FREE TRIAL

To: George Newnes Ltd., 15-17 Long Acre, London, W.C.2

If under 21 your father must fill up coupon.

Full Name (BLOCK LETTERS) (Mr., Mrs., Miss)

Address

Occupation

Signature (Mr., Mrs., Miss)

(RV)41/1324

Tick V where applicable The address on left is—

My Property	<input type="checkbox"/>
Rented unfurnished	<input type="checkbox"/>
Parents' Home	<input type="checkbox"/>
Furnished Accom.	<input type="checkbox"/>
Temporary Address	<input type="checkbox"/>

REBUILT TUBES!

You're safe when you buy from
RE-VIEW!

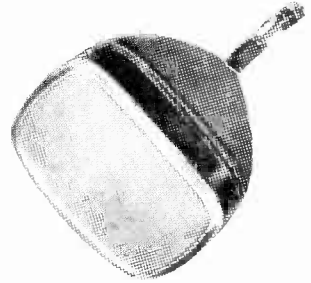

- ★ Each tube is rebuilt with a completely new gun assembly and the correct voltage heater.
- ★ Each tube comes to you with a guarantee card covering it for a year against all but breakage.
- ★ Each tube is delivered **free** anywhere in the U.K. and insured on the journey.
- ★ Each tube is rebuilt with experience and know-how. We were amongst the very first to pioneer the technique of rebuilding television tubes.

HERE IS WHAT YOU PAY:

12in. ...	£4.15.0
14in. ...	£5. 0.0
15in. ...	£5. 5.0
17in. ...	£5. 5.0
19in. ...	£5.15.0
21in. ...	£7. 5.0

Cash or cheque with order, or cash on delivery

—Discount for Trade—

Old Tubes Purchased

RE-VIEW ELECTRONIC TUBES

237 LONDON ROAD, WEST CROYDON, SURREY. Tel. THOrnton Heath 7735

BBC2, TV, RADIO & TAPE REC. SPARES

UHF 625 BBC2. Modify your set to BBC2. 1955 to 1963 models covered. Manufacturers' tuners, IF panels etc. Send for free lists. **SPECIAL OFFER.** Complete Pye Ekco UHF conversion kits—tuner, transistorised IF and T.B. panel, fittings, circuit, etc. New in manufacturers cartons. Normally 18 Gns.. Our Price **£8.10.0**, post 3/6. **TV SIGNAL BOOSTER UNITS.** Sensational gain all stations, trans. plug-in types, LABGEAR (Pye) BBC1/ITA or BBC2 75% PERDIO BBC2 70%, LABGEAR (Pye) MASTHEAD 105%/. Post free. **C.R.T.s** Rebuilt by long est. Nat. Co.. New guns guar. 12 months. Mullard, Mazda, 14", 17", **£45.0**; Brimar, Emiscope, **£415.0**, 21", **£6.10.0**, 110, 17 1/2 extra, carriage 10%.

LINE OUTPUT TRANSFS. Popular types available, brand new exact replacements fully guar. A selection which can be supplied:—

PHILIPS 1768 to 17TG100 etc.	96/6
8617 to 1007, etc.	42/6
EKCO 221 to 331 (U25) types	42/6
FERRANTI 1001 to 1011 (U25 types) ..	42/6
KCCO/FERRANTI (U26 perspex types) ..	42/6
FERGUSON 406 to 606 etc. 78/6; 306, 308	42/6
MARCONI VT157, 158, 160, 161 etc.	78/6
PHILCO 1000, 87/6; 1010, 1019 etc.	78/6
KB Royal Star PVP20, QV20	78/6
HMV 1840 to 1854, 487; 1865 to 1869	42/6
1870, 1890, 1910, 1020, etc.	78/6
SOBELL TS17, 346, 48/6; other models	72/6
PAM, INVICTA all models	64/6
PYE all types available V4 to V700 etc.	64/6

Postage and Packing for above L.O.T.s 3/6. C.O.D. 2/6 extra. **SCAN COILS.** Frame o/p frame osc. transf., width/linearity coils, sound o/p transf., mains droppers, control knobs, dual vol. controls, line osc. transf. resistors, condensers, etc.

TUNER UNITS. Fireball, Pye Miniature, incremental, turrets, channel coils, technical replacements service available.

TAPE REC/CHANGER. Drive Belts, Heads, Pinch Wheels, Idlers, Motors for most British (incl. WALTER) and Continental.

SALVAGED COMPONENTS. Large selection for popular models, clean, serviceable condition, turrets, transformers, etc. ENQUIRIES invited, prices by return. C.O.D. despatch available.

MANOR SUPPLIES

64 GOLDERS MANOR DRIVE, LONDON, N.W.11 (Callers: 589b, HIGH ROAD (nr. Granville Rd), N. Finchley N.12). Open all week incl. Sat., HIL 9118 (Day) SPE 4032 (Evg.).

VALVES SAME DAY SERVICE

NEW! TESTED! GUARANTEED!

SETS	1B5, 1B5, 1T4, 2B4, 3V1, DAF91, DFP91, DK91, DL92, DL94	set of 4 for 15/-, DAF96, DFP96, DK96, DL96, 4 for 24/6
1A7GT	7/6 7/6E	11/9 DAF96 6/- ECH35 6/- N18 5/6 TY801 10/6
1A5GT	7/3 7/6T	7/9 DFP96 6/9 ECH42 8/3 N108 7/11 1/25 8/6
1N3GT	7/9 7/5	7/9 DFP91 6/- P435 6/9 1/25 8/9
1R5	4/9 7/6	1/9 ECH80 6/3 P437 7/- 1/47 8/6
1R4	4/9 7/6T	4/9 DFP96 6/- ECH86 6/9 PCC84 5/6 1/52 4/6
1R6	3/9 7/4	5/- DFP75 3/6 ECH86 8/6 PCC89 9/6 1/54 8/9
1T4	1/9 10P1	9/9 DFP77 4/- EP36 3/9 PCP80 6/11 1/78 3/9
2P	19/6 10LD12	7/6 DFB1 12/6 EP41 6/3 PFP82 6/9 1/19 10/-
3A5	6/9 12A7	3/9 DK32 7/9 EP80 4/9 PPS84 7/9 1/281 8/6
3Q4	5/6 12A7	4/9 DK91 4/9 EP85 5/- PFP86 8/3 3/9 11/9
3B4	4/9 12A7	4/9 DK92 8/- EP86 6/9 PFP80 9/9 1/801 15/9
3V1	5/6 12K7GT	4/3 DK96 6/6 EP89 4/3 PFP82 9/9 1/ABC80 5/9
3V4	4/6 12K8GT	8/9 DL33 7/9 EP91 2/8 PFP85 9/6 1/AF42 7/9
5Y3GT	5/3 12Q4T	4/3 DL35 5/9 EP92 2/8 PFL82 6/11 1/BA41 6/9
5Z4/GT	7/- 19B66	6/9 DL92 4/9 EP97 7/6 PCL83 9/- 1/BS1 7/3
6J0L2	8/9 20E1	12/3 DL94 5/6 EP183 6/9 PCL84 8/3 1/BB80 6/9
6AL5	2/- 20P4	13/6 DL96 8/- EL33 6/9 PCL85 8/3 1/CF89 5/9
6AR6	2/6 20P5	4/3 DY86 6/9 EL41 7/3 PEX383 9/6 1/CC85 8/6
6AQ5	5/6 2B16GT	4/3 DY86 6/9 EL41 7/3 PEX383 9/6 1/CC85 8/6
6AT6	4/- 30C18	9/6 DY87 8/- EL84 6/- PEX396 6/9 1/CC80 8/6
6BA6	4/9 30P5	8/6 EAB90 6/- EL96 5/6 PFL200 17/6 1/CC42 7/6
6BE6	4/9 30P11	9/6 EAF42 7/6 EM34 6/9 PCL86 8/3 1/CH81 6/6
6BR6	5/- 30L16	10/3 EB41 4/- EM50 6/3 P181 7/- 1/CL82 7/6
6BL6	5/6 30L17	12/- EB91 2/- EM81 7/3 P182 5/6 1/CL83 18/9
6BW6	7/9 30P4	13/6 EB33 5/- EM84 5/9 P183 6/- 1/CL11 8/6
6F13	3/6 30P12	7/6 EB41 6/9 EM87 6/6 P184 8/3 1/CF82 7/6
6F14	6/- 30P19	13/6 EB80 6/- EY51 6/3 P1500 14/- 1/EF85 6/6
6K7C	1/6 30P11	9/6 EPB83 7/6 EY86 6/- P1801 7/6 1/UF89 6/3
6SL7GT	4/6 30P13	9/6 EB786 6/6 EZ40 6/9 PV25 7/9 1/CL41 7/3
6KRG2	7/6 30P14	11/6 EB121 10/3 BZ41 6/9 PV32 8/- 1/CL44 15/-
6P28	9/6 35L6GT	6/3 EVC40 6/9 EZ80 4/- PV33 8/- 1/CL46 8/6
6Q7G	4/9 35W4	4/6 EVC81 3/9 EZ81 4/6 PV80 5/3 1/UA8 8/6
9Q7GT	7/8 35Z4GT	5/6 EVC82 4/9 FWA 500 6/3 PV81 10/9 1/UY41 4/3
6SL7GT	4/6 35K1	8/6 EY88 6/6 EZ40 6/9 PV25 7/9 1/VA85 5/6
6N7GT	4/9 35S	4/6 EVC84 6/3 GZ37 8/9 PV83 5/9 1/VA11 12/6
6V8G	3/6 CL33	9/6 EVC85 5/6 KT51 6/6 PV88 7/6 1/VA11 12/6
6V6GT	6/6 CY1	12/6 ECF86 7/6 KT56 7/3 PV800 6/6 1/WT 3/6
6X4	3/6 DAC32	7/3 ECF82 8/- ME1400 15/- 1/TH10 9/6 1/XT 26/-
6X5GT	6/3 DAF91	3/9 ECF96 10/9 MU14 4/- TH233 7/9 2/77 2/6

READERS RADIO

24 COLBERG PLACE, and at 85 TORQUAY GARDENS, STAMFORD LONDON, N.16. STA 4587 REDBRIDGE, ILFORD ESSEX, CRE 7441

Postage on 1 valve 9d. extra. On 2 valves or more postage 6d. per valve extra. Any Parcel Insured against Damage in Transit 6d. extra.

for everything in..

COMPLETELY

REBUILT, RE-SCREENED, RE-ALUMINISED

TELEVISION TUBES

SUFFOLK & MIDLAND LEAD THE WAY!

Regular buyers of Suffolk and Midland Tubes have learnt to rely on their outstanding quality. Every tube guaranteed 12 months with proved PERFORMANCE & RELIABILITY

PRICES FROM £4.10.0 EACH — WRITE FOR BROCHURE

SUFFOLK TUBES LTD

1/3 UPPER RICHMOND ROAD
PUTNEY, LONDON, S.W.15

Tel: Vandyke 4304/5267

MIDLAND TUBES LTD

477 483 OLDHAM ROAD
MANCHESTER 10

Tel: Collyhurst 4412

THE LARGEST INDEPENDENT REBUILDERS IN THE U.K.

FREE TO AMBITIOUS ENGINEERS

— THE LATEST EDITION OF ENGINEERING OPPORTUNITIES

Have you sent for your copy?

ENGINEERING OPPORTUNITIES is a highly informative 156-page guide to the best paid engineering posts. It tells you how you can quickly prepare at home for a recognised engineering qualification and outlines a wonderful range of modern Home Study Courses in all branches of Engineering. This unique book also gives full details of the Practical Radio & Electronics Courses, administered by our Specialist Electronics Training Division—the B.I.E.T. School of Electronics, explains the benefits of our Employment Dept. and shows you how to qualify for five years promotion in one year.

SATISFACTION OR REFUND OF FEE.

Whatever your age or experience, you cannot afford to miss reading this famous book. If you are earning less than £30 a week, send for your copy of "ENGINEERING OPPORTUNITIES" today—FREE.

BRITISH INSTITUTE OF ENGINEERING TECHNOLOGY

(Dept. SE/20), 29 Wright's Lane, London, W.8

WHICH IS YOUR PET SUBJECT?

Mechanical Eng.,
Electrical Eng.,
Civil Engineering,
Radio Engineering,
Automobile Eng.,
Aeronautical Eng.,
Production Eng.,
Building, Plastics,
Draughtsmanship,
Television, etc.

GET SOME LETTERS AFTER YOUR NAME!

A.M.I.Mech.E.
A.M.I.C.E.
A.M.I.Prod.E.
A.H.I.M.I.
A.I.O.B.

B.Sc.
A.M.I.E.R.E.
City & Guilds
Gen. Cert. of Education
Etc., etc.

PRACTICAL EQUIPMENT

Basic Practical and Theoretical Courses for beginners in Radio, T.V., Electronics, Etc., A.M.I.E.R.E., City & Guilds
Radio Amateurs' Exam.
R.T.E.B. Certificate
P.M.G. Certificate
Practical Radio
Radio & Television Servicing
Practical Electronics
Electronics Engineering
Automation

INCLUDING TOOLS!

The specialist Electronics Division of B.I.E.T.

NOW offers you a real laboratory training at home with practical equipment. Ask for details.

B.I.E.T. SCHOOL OF ELECTRONICS

POST COUPON NOW!

Please send me your FREE 156-page "ENGINEERING OPPORTUNITIES"
(Write if you prefer not to cut page)

NAME _____
ADDRESS _____

SUBJECT OR EXAM THAT INTERESTS ME _____ (SE/20).

THE B.I.E.T. IS THE LEADING ORGANISATION OF ITS KIND IN THE WORLD