

Practical Television 16

FEBRUARY
1961

AND TELEVISION TIMES

*All about
rebuilt tubes*

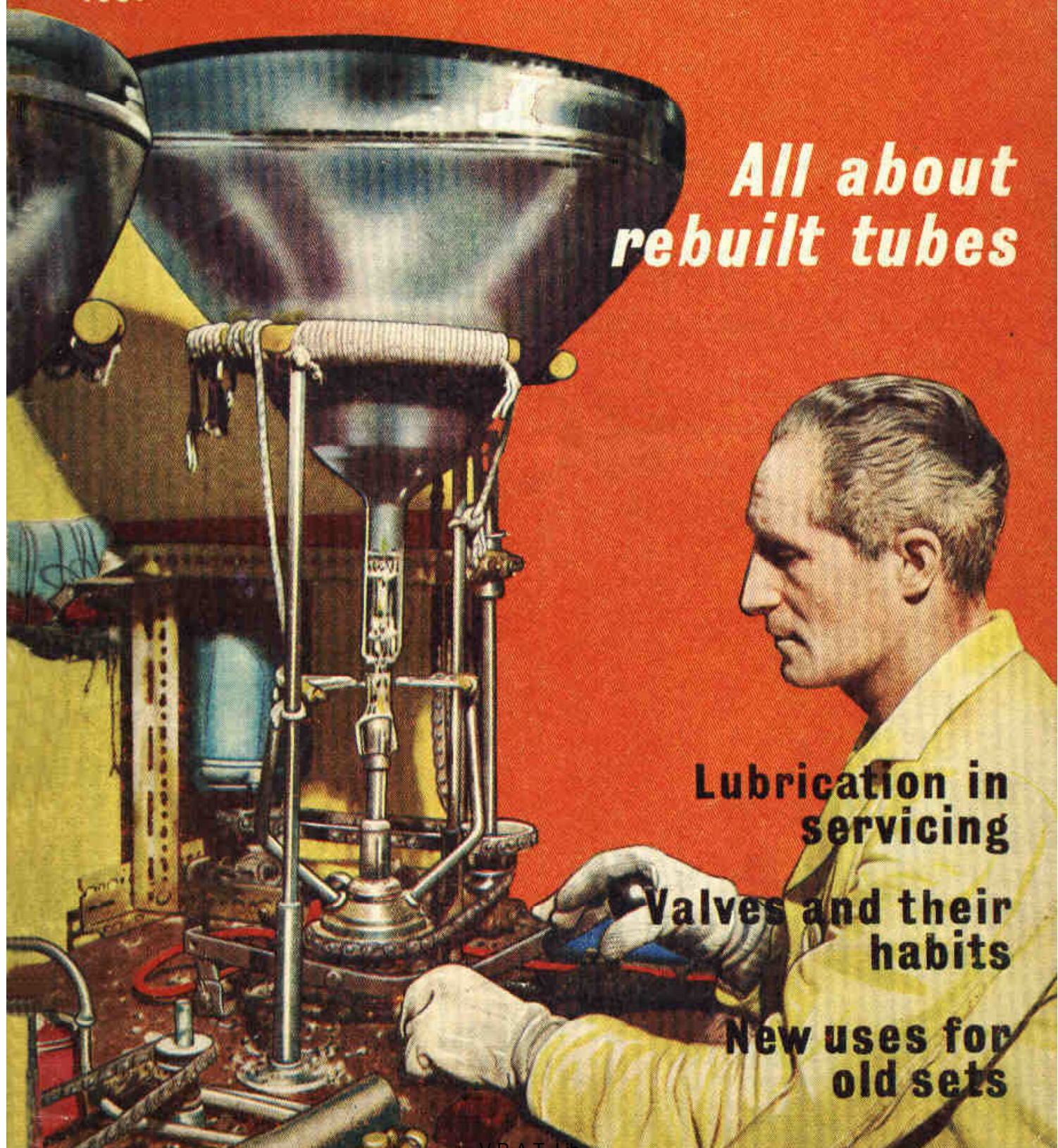

**Lubrication in
servicing**

**Valves and their
habits**

**New uses for
old sets**

LINE OUTPUT TRANSFORMERS SCAN COILS

AND ALL TIMEBASE COMPONENTS
For All Makes and Models Old and New

BY RETURN OF POST
(C.O.D. or C.W.O.)

ALL COMPONENTS BRAND NEW GENUINE REPLACEMENTS

WE HAVE THE MOST COMPREHENSIVE STOCK IN THE COUNTRY
(Please enclose S.A.E. with all enquiries)

NEWBURY RADIO

272 ROMFORD ROAD, FOREST GATE, LONDON E.7

MARyland 3100

MARyland 3739

SPECIAL FOR THE "HAMS" RADIO STATION

Illustrated

½ inch detachable bit
soldering instrument
List No. 70

Combined Protective Unit
with Wiper/Abrasion Pad
and Solder Reel
List No. 700

Apply SALES & SERVICE

ADCOLA
REGISTERED

(Regd. Trade Mark)

GAUDEN ROAD
CLAPHAM HIGH ST.
LONDON, S.W.4

Telephones:
MACaulay 4272 - 3101

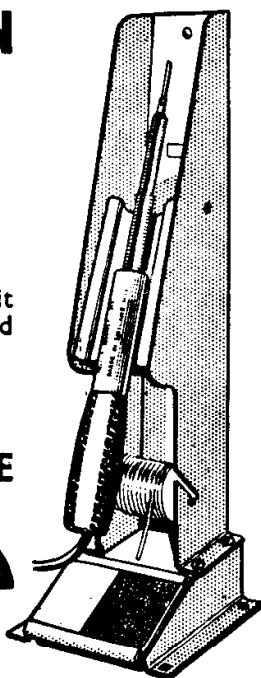

British & Foreign
Patents, Registered
Designs, etc.

Telegrams:
"SOLJOINT, LONDON"

1000's & 1000's
OF SATISFIED PEOPLE
VIEW ON

E.M.S.

**REBUILT TELEVISION
TUBES**

- ★ A NEW GUN IN EVERY TUBE
- ★ BUY DIRECT FROM THE FACTORY
- ★ 12 MONTHS' GUARANTEE

12 inch £5.0.0 14 inch £5.10.0
17 inch £6.10.0

Immediate dispatch on receipt of Remittance
Carriage and insurance 12/6 extra
£1 Refunded on receipt of your
old Tube

SPECIAL TERMS TO THE TRADE

MARSHALL'S for TELEVISION LTD.
131 St. Ann's Road, Tottenham, London, N.15
STAMFORD HILL 3267

7-VALVE AM/FM RADIOGRAM CHASSIS

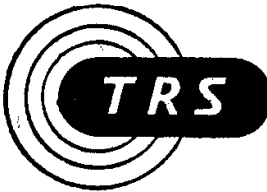

Valve Line up:
ECC85, ECH81
EF89, EABC80,
EL84 EM81 EZ80.

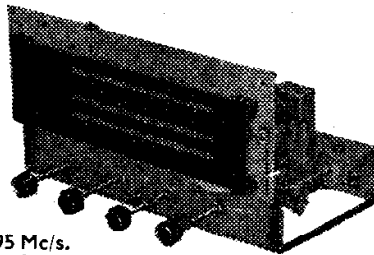

3 wave band and switched gram positions. Med. 200 m.-500 m., Long 1,000 m.-2,000 m., VHF/FM 88-95 Mc/s.
4 Controls. Vol., On-Off, Tone Tuning. Wavechange. P.U., Ae. and E., and speaker sockets. Magic eye tuning. Philips Continental tuning insert with permeability tuning on FM, and combined AM/FM IF transformers, 460 Kc/s and 10.7 Mc/s. Dust core tuning all coils. Latest circuitry, including AVC and Neg. Feedback. 3 watt output. Sensitivity and reproduction of a very high standard. Chassis size 13 1/2 in. x 6 1/2 in. Height 7 1/2 in. Edge illuminated glass dial 1 1/2 in. x 3 1/2 in. Vertical pointer. Horizontal station names, gold on brown background. A.C. 200/250 v. Indoor dipole aerial 3/6 extra. Complete with 4 knobs walnut or ivory to choice..

£13.10.0 Carr. and Ins. 5/- Recommended Speakers 8in. 21/6, 10in. 30/-
As previously announced fresh supplies are now being received, but we regret some slight delay may be experienced in fulfilling orders for this popular item.

New and	Guaranteed	Reduced	Prices
1R5, 185	7/6	DK92	9/6
IT4	6/-	ECC85	11/6
384, 3V4	7/6	ECH80	9/6
6Z4	9/-	ECL80	10/6
6K7	5/-	ECL82	10/6
6K8	7/6	EF89	9/-
6Q7	7/6	EF86	12/6
6V6	6/6	EF91	5/-
DAF98	9/-	EL84	8/6
DF98	9/-	EM81	9/6
DK96	9/-	EY61	9/6
DL96	9/-	EY86	10/-
		EZ80	7/6
		MU14	9/-
		PCO84	9/6
		PCF80	9/6
		PLL93	12/6
		PL81	12/6
		PL82	9/6
		PL83	10/3
		PY80	7/6
		PY82	7/6
		PY82	12/6
		U25	12/6

SPECIAL PRICE PER SET
1R5, IT4, 185, 384 or 3V4 25/-
DK96, DF98, DAF98, DL96 35/-
6K8, 6K7, 6Q7, 6V6, 6Z4 or 6X5 32/6

TRANSISTORS—BVA 1st GRADE—NEW
Reduced Price
MAZDA: XA101 14/6, XA102 16/6, XA103 15/-,
XA104 18/-, XB102 10/-, XC101 10/6,
MULLARD: OC70 9/6, OC71 12/6, OC72 15/-,
OC44 23/6, OC45 21/-, OC16 49/6,
G.E.C.: GET114 9/6, GET15 12/6, ditto matched
pairs 25/-.

NEWMARKET: "Goldtop" V15/10P 15/-.
GERMANIUM DIODES: OA70 2/6, OA81 3/6,
GEX34 4/-, GD4 3/6.

RECORD PLAYER CABINETS
Contemporary styled, Cabinet covered, rexine covered cabinet Price in two-tone wine and cream, or mottled red with white polka dot. Size 18 1/2 x 13 x ht. 8 1/2 in., fitted with all accessories, including baffle board and anodised metal fret. Space available for all modern amplifiers and autochangers, etc. Uncut record player mounting board 14 x 13in. supplied.

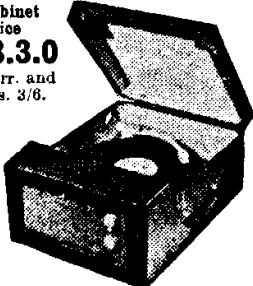

2-VALVE AMPLIFIER Mk. 2
Latest developed circuit giving a higher fidelity response and greater output (2-3 watts) using twin stage valves ECL82 and neg. feed back Tone Control. Complete with knobs, etc., wired and tested ready to fit in above cabinet.
ONLY £2.17.6 P. & P. 1/-.
6in. speaker and matching transformer, 22/-, P. & P. 1/6.

VOLUME CONTROLS
5k ohms—2 Megohms. All long spindles. Morganite Midget type, 10in. diameter. Guar. 1 year. Log or Lin. Ratios. Less Sw. 3/- D.P. Sw. 4/6. Twin Stereo Controls—Log or Lin. Less Sw. 6/6. D.P. Sw. 8/-.

CONDENSERS.—Silver Mica. All pref. values. 2 pf. to 1,000 pf., 6d. each. Ditto, ceramics 9d. each. Tubulars 450 v. T.C.C., etc., .001 mfd. .01 and .1/350 v., 9d. each. .02-1/500 v., 1/- each. .25 Hunts, 1/6. .5 T.C.C., 1/6. .001 6kv., 5/6, .001 20 kv., 9/6.
RESISTORS.—FULL RANGE 10 ohms—10 megohms 20% 1/2 w. and 1/4 w. 3d., 1/2 w., 5d. (Midget type modern rating), 1 w., 6d., 2 w., 9d., 10% Hi-Stab, 1/2 w., 5d., 1/4 w., 7d., 5% 1/2 w. 9d., 1% HI-STAB, 1/2 w., 1/6 (10-100 ohms 2/-).

RECORDING TAPE—SPECIAL OFFER

Manufacturers 1st grade Acetate Tape—BRAND NEW—sealed boxes.

Standard	Long/Play
5in. 600ft. . . . 15/-	850ft. . . . 19/6
5 1/2in. 850ft. . . . 18/6	1200ft. . . . 22/6
7in. 1200ft. . . . 21/-	1800ft. . . . 32/6

Plastic Tape Spools
3in., 2/6; 5in., 3/-; 5 1/2in., 3/3; 7in., 3/6

BAND 3 TV CONVERTER

All channels 7-13 (180-250 Mc/s).
Mk. 2 Model. Using ECC84 and EF80 valves. 18db gain, 200-250 v. A.C. Size 6 1/2 in. x 3 1/2 in. x 4 in. Simple to fit, ready to use. Only 79/6. P. & P. 2/6.
B1-B3 changeover Sw. and B.B.C. Aerial Socket fitted and wired, 8/- extra.
Band 3 Aerials. Single Dipole with 4 yds. cable, 13/8. 3 Element Beam, 25/-, 5 Element, 32/6, etc. B1-B3 Crossover Units, 7/6.

COAX 80 OHM CABLE

Stand. 1/2 in. diameter Low-loss Semi Air-Spaced Aerialial. A high-grade Coax at NEW REDUCED PRICES. NOW ONLY 6d. per yard.
Special prizes—quantity lengths.
20 yds. 9/-, Carr. 1/6. Coax. Plugs 1/-,
40 yds. 17/6, Carr. 2/-, Sockets 1/-, Couplers 1/3,
60 yds. 25/-, Carr. 3/-, Cable end Sockets 1/6,
Outlet Boxes 4/6.

CRT HTR ISOLATION TRANSFORMERS

New Improved types, low capacity, small size and tag terminated. Prim. AC 200/250V. Secondaries Nil, +25%, +50% BOOST for 2V, 4V, 6.3V, 12V or 13V Tubes. 12/6 each. P. & P. 1/6.

SENTERCEL RECTIFIERS. E.H.T. Type Fly-back Voltages, K3/25 2 kV., 5/-; K3/40, 3.2 kV. 6/9; K3/45 3.6 kV., 7/3; K3/50 4 kV., 7/9; K3/100 8kV., 13/6. **MAINS TYPE—RMI,** 125 v. 60mA, 4/9; RM2, 125 v. 100 mA, 5/6; RM3, 125 v. 120 mA; 7/8; RM4, 250 v. 250 mA, 16/-; RM4B type 270 mA, 17/8; RM5, 250 v. 300 mA, 21/- etc.

SPEAKER FRET.—Expanded Bronze anodised metal 8 x 8in., 2/3; 12 x 8in., 3/-; 12 x 12in., 4/6; 12 x 15in., 6/-; 24 x 12in., 9/- etc.

TYGAN FRET (Murphy pattern) 12 x 12in., 2/-; 12 x 8in., 3/-; 12 x 24in., 4/-, etc.

SPEAKERS P.M. 3 ohms 2 1/2in. Elac, 17/6. 3 1/2in. Goodmans, 18/6. 5in. R. & A., 17/6. 6in. Celestion, 18/6. 7 x 4in. Goodmans, 18/6. 8in. Rola, 20/-, 8in. Special Cone G'mans, 21/6. 10in. R. & A., 25/-.

BARGAINS GARRARD PLAYER UNITS

SINGLE PLAYERS: Model 48P £6.17.6. Carr. 3/6. Model TA Mk. 2, 27.19.8. Carr. 3/6. Model 4HF, 218. Carr. 3/6.
AUTOCHANGERS: Model RC210, with plug-in GC8 head, 10 gns. Carr. 4/6. Latest release Transcription Unit Model "A" Autochanger £18.19.8 Carr. and Ins. 5/-.

RE-GUNNED TV TUBES

New reduced prices . . . and now 12 months guarantee
All tubes rebuilt with new heater, cathode and gun assembly — reconditioned virtually as new.
12in. £5, 14in. £5.10, 17in. £6, etc.
10/- per exchange allowance on old tube
Carr. and Ins. 10/-. Comprehensive stocks—quick delivery.

(TRANSISTOR ONE-WATT) AMPLIFIER 6 v. operated

Latest Push-Pull, 4 Transistor circuit giving full 1 watt Output into standard 3 ohms speaker. Good sensitivity and improved freq. response. Neg. feedback. Var. Tone and Volume Controls. Chassis Size 6 1/2 in. x 3 1/2 in. x 1 1/2 in. Current consumption 10 mA quiescent—250 mA at 1 watt.

COMPLETE KIT—now ONLY 79/6. Carr. 2/6. 7in. x 4in. matching speakers, 18/6. Circuit and instruction leaflet for complete Portable Record Players 2/6, post free.

Driver Trans. 10/6 Special price per set ONLY
O/P Trans. 10/6 59/6, carr. 2/6
2 GET 15's 25/- pr.
2 GET 114 8/6 ea.

JASON FM TUNER UNITS (87-105 Mc/s)

Designer-approved kits of parts for these quality and highly popular tuners available as follows:
STANDARD MODEL (FMTU)—as previously extensively advertised. **COMPLETE KIT,** 5 gns., P. & P. 2/6. Set of 4 spec. valves, 20/-, post free.
LATEST MODEL (FMT2)—attractively presented, shelf mounting unit in enclosed Metal Cabinet with Built-in Power Supply. **COMPLETE KIT,** 27, P. & P. 3/6. Set of 5 spec. valves, 37/6.
LATEST MODEL (JTV2), Self-powered Switch-tuned Band 1-2-3 AM/FM Unit 5 pre-set stations AFC and AGC circuits. Complete kit, including ready-build Turret Tuner, £12.19.6. P. & P. 3/6.
NEW JASON COMPREHENSIVE F.M. HAND-BOOK, 2/6, post free. 48-hr. Alignment Service, 7/6. P. & P. 3/6.

ONLY A FEW ITEMS ARE LISTED FROM OUR COMPREHENSIVE STOCK. WRITE NOW FOR FULL BARGAIN LISTS, 3d.



RADIO COMPONENT SPECIALISTS

70 Brigstock Road, Thornton Heath, Surrey

Phone: THO 2188. Hours 9 a.m.—6 p.m. 1 p.m. Wed. Open all day Saturday. By Thornton Heath Station.

Terms. C.W.O. or C.O.D. post and packing up to 1/6. 7d. 1/6; 1/1 3/6; 1/6; 5/6. 2/-; 10/6; 2/9; 15/6. 3/6.

BENTLEY ACOUSTIC CORPORATION LTD.

38 CHALCOT ROAD, CHALK FARM, LONDON, N.W.1.

Telephone: PRIMROSE 9090

EXPRESS POSTAL SERVICE! ALL ORDERS DESPATCHED SAME DAY AS RECEIVED. TELEPHONE AND TELEGRAM ORDERS FOR CASH ON DELIVERY SERVICE ACCEPTED UP TO 3.30 P.M.

OZ4	5/-	6F6G	7/-	9D2	4/-	30PL1	10/6	DF96	8/6	EF39	5/6	HVR2A	6/-	PL820	18/7	U4020	16/7	XFG1	18/-
IA3	3/-	6F11	17/3	10C1	13/-	30PL13	12/6	DF97	9/-	EF40	15/-	KF35	8/6	PM2B	12/6	UABC80	9/-	XPY12	9/6
IA5	6/-	6F12	4/6	10C2	26/6	35A5	21/3	DH63	6/6	EF41	9/-	KL35	8/6	PM12	6/6	UAF42	9/6	XYF34	17/6
IA7GT	12/-	6F13	11/6	10D2	12/-	35L6GT	9/6	DH76	5/-	EF42	10/6	KLL32	24/7	PM12M	6/6	UB41	12/-	XH(1.5)	6/6
IC5	12/6	6F14	26/6	10F1	26/6	35W4	7/6	DH77	7/-	EF50(A)	7/-	KT2	5/-	PM24M	21/3	UBC41	8/6	XSG(1.5)	6/6
ID6	10/6	6F15	15/3	10F9	11/6	35Z3	10/6	DH101	28/6	EF50(E)	5/-	KT33C	10/-	PX4	10/6	UBC81	11/4	Y63	7/6
IG6	17/6	6F16	9/6	10LD3	8/6	35Z4GT	6/-	DH107	13/11	EF54	5/-	KT36	29/10	PX25	59/8	UBF80	9/6	Z63	7/6
IH5GT	10/6	6F17	12/6	10LD11		35Z5GT	9/-	DK32	12/-	EF73	10/6	KT41	12/6	PY31	16/7	UBF89	9/6	Z66	17/6
IL4	3/6	6F23	10/6		15/11	43	10/-	DK40	21/3	EF80	6/-	KT44	12/6	PY32	11/6	UBL21	23/3	Z77	4/6
ILD5	5/-	6F32	10/6	10P13	15/-	50C5	10/-	DK91	6/6	EF85	6/-	KT61	12/6	PY80	7/6	UCC84	14/7		
ILN5	5/-	6F33	7/6	10P14	19/3	50CD6G		DK92	9/-	EF86	10/6	KT63	7/-	PY81	8/6	UCC85	9/-		
IN5GT	10/6	6G6	6/6	12A6	5/-		36/6	DK96	8/6	EF89	9/-	KT66	15/-	PY82	7/-	UCF80	16/7		
IR5	6/6	6H6GT	3/-	12AC6	15/3	50L6GT	9/6	DL33	9/6	EF91	4/6	KT88	24/-	PY83	8/6	UCH21	23/3		
IS4	9/-	6J5G	5/-	12AD6	17/3	53KU	19/11	DL66	17/6	EF92	4/6	KTW61	6/6	PZ30	19/11	UCH42	9/6	Transistors	
ISS	6/6	6J6	5/6	12AE6	13/11	72	4/6	DL68	15/-	EF97	13/3	KTW62	7/6	QP21	7/-	UCH81	9/6	and diodes	
IT4	3/6	6J7G	6/-	12AH7	8/-	77	8/-	DL82	46/5	EF98	13/3	KTW63	6/6	QP25	14/6	UCL82	11/6	CG7E	7/6
IU5	6/-	6J7GT	10/6	12AH8	12/6	78	6/6	DL92	7/-	EF183	18/7	KTZ41	8/-	QS150/15		UCL83	9/6	GG10E	7/6
2P	26/6	6K7G	5/-	12AT6	7/6	80	9/-	DL94	7/6	EF184	18/7	KTZ63	7/6		10/6	UF41	9/-	GD3, 4, 5,	
2X2	4/6	6K7GT	6/-	12AT7	6/-	83	15/-	DL96	8/6	EK32	8/6	L63	6/-	R12	9/-	UF42	12/6	6, 8	4/-
3A4	6/6	6K8GT	10/6	12AU6	23/3	85A2	15/-	DM70	7/6	EL32	5/-	MH4(C)	7/-	R18	14/-	UF80	10/6	OA70	4/-
3A5	10/6	6K8G	6/6	12AU7	6/6	150B2	15/-	E80F	20/-	EL33	12/6	MHL4	7/6	R19	19/11	UF85	9/-	OA73	4/-
3B7	12/6	6K25	19/11	12AV6	12/8	161	10/6	EAS0	2/-	EL34	15/-	MHLD6	12/6	RK34	7/6	UF86	17/11	OA79	4/-
3D6	5/-	6L1	23/3	12AX7	7/6	185BT	33/2	EABC80	9/-	EL39	26/6	ML4	8/6	S130	22/6	UF89	9/-	OA81	4/-
3Q4	7/6	6L6G	8/-	12BA6	8/-	185BTA	33/2	EAC91	4/6	EL41	9/-	MS48	23/3	SP4(7)	14/6	UL41	9/-	OA86	6/-
3Q5GT	9/6	6L6M	9/6	12BE6	9/-	304	10/6	EAF42	9/-	EL42	10/6	MUI2/14	8/-	SP41	3/6	UL44	26/6	OA91	9/-
3S4	7/-	6L7GT	7/6	12BH7	21/3	305	10/6	EB34	2/6	EL81	12/6	N37	23/3	SP42	12/6	UL46	14/6	OA95	5/-
3V4	7/6	6L18	13/-	12E1	30/-	807	7/6	EB41	8/6	EL83	19/11	N78	19/11	SP61	3/6	UL84	8/6	OA210	23/-
5R4GY	17/6	6L19	23/3	12J5GT	4/6	956	3/-	EB91	4/6	EL84	7/6	N108	23/3	SU25	26/6	UM4	17/3	OA211	40/-
5U4G	6/6	6LD3	8/6	12J7GT	9/6	1821	16/7	EBC3	23/3	EL85	13/11	N308	20/7	SU61	9/-	UM80	15/3	OC16	54/-
5V4G	10/-	6LD20	15/11	12K5	17/11	5763	12/6	EBC33	5/-	EL86	17/3	N339	15/-	T41	23/3	URIC	18/7	OC19	54/-
5Y3GT	6/6	6N7	8/-	12K7GT	5/6	7475	7/6	EBC41	8/6	EL91	5/-	P61	3/6	TDD4	12/6	UU6	19/11	OC23	87/-
5Z3	12/6	6P25	12/6	12K8GT	14/-	9002	5/6	EBC81	8/-	EL95	10/6	PABC80		TH41	26/6	UU7	16/7	OC26	44/-
5Z4G	9/-	6P28	26/6	12Q7GT	5/-	AC/PEN		EBF80	9/-	EM34	9/6		13/11	TH233	33/2	UU8	26/6	OC28	25/-
6A7	10/6	6Q7G	6/6	12SA7	8/6	5-pin	23/3	EBF83	13/11	EM71	23/3	PCC84	8/-	TH2321	20/-	UU9	7/6	OC35	48/-
6A8G	9/-	6Q7GT	11/-	12SC7	8/6	7-pin	15/-	EBF89	9/6	EM80	9/-	PCC85	9/6	TP22	15/-	UY1N	18/7	OC44	26/-
6A8B	9/-	6R7G	10/-	12SG7	7/-	AC2PEN		EBL21	23/3	EM81	9/-	PCC88	18/-	TP25	15/-	UY21	13/11	OC45	23/-
6AC7	4/-	6SA7GT	8/6	12SH7	8/6	DD	12/6	EBL31	23/3	EM84	10/6	PCC89	11/6	TP2620	33/2	UY41	7/6	OC65	22/6
6AG5	5/6	6SC7	7/6	12SJ7	8/6	AC6PEN	7/6	ECS2	5/6	EN31	37/-	PCF80	8/-	TY86F	13/3	UY85	7/-	OC66	23/-
6AK5	8/-	6SG7GT	8/-	12SK7	6/-	AC/TP	33/2	ECS4	6/-	EY51	9/-	PCF82	10/6	U12/14	8/6	VMS4B	15/-	OC70	14/-
6AL5	4/6	6SH7GT	8/-	12SQ7	11/6	ATP4	5/-	EC70	12/6	EY83	16/7	PCF86	15/-	U16	10/-	VP2	12/6	OC71	14/-
6AM6	4/6	6SJ7GT	8/-	12SR7	8/6	AZ1	18/7	EC92	13/3	EY84	14/-	PCL82	10/-	U18/20	8/6	VP4	15/-	OC72	17/-
6AQ5	7/6	6SK7GT	6/-	12Y4	10/6	AZ31	10/-	ECC32	5/6	EY86	9/-	PCL83	10/6	U22	8/-	VP2B	14/6	OC73	20/-
6AT6	7/-	6SL7GT	6/6	1457	27/10	AZ41	13/11	ECC33	8/6	EZ35	6/-	PCL84	12/6	U24	29/10	VP4B	23/3	OC75	15/-
6AU6	10/-	6SN7GT	5/6	18	23/3	B36	15/-	ECC34	24/7	EZ40	7/-	PCL85	16/7	U25	17/11	VP13C	7/-	OC76	15/-
6AV6	12/6	6SQ7GT	9/-	19AQ5	10/6	BL63	7/6	ECC35	8/6	EZ41	7/-	PENA4	12/6	U26	10/-	VP23	6/6	OC77	21/-
6BBGT	5/-	6SS7GT	8/-	19H1	10/-	CI	12/6	ECC40	23/3	EZ80	7/-	PENB4	26/6	U31	9/6	VP41	6/-	OC78	17/-
6BA6	7/6	6U4GT	12/6	20D1	15/3	CIC	12/6	ECC81	6/-	EZ81	7/-	PEN4DD		U33	26/6	VR105	8/-	OC78D	17/-
6BE6	6/-	6U5G	7/6	20F2	26/6	CBL1	26/6	ECC82	7/6	FC2A	24/7		26/6	U35	26/6	VR150	7/6	OC81	18/-
6BG6G	23/3	6U7G	8/6	20L1	26/6	CBL31	23/3	ECC83	6/6	FC4	15/-	PEN25	4/6	U37	26/6	VT61A	5/-	OC170	38/-
6BH6	8/-	6V6G	7/-	20P1	26/6	CCH35	23/3	ECC84	9/-	FC13	26/6	PEN40DD		U43	9/-	VT501	5/-	OC200	54/-
6BJ6	6/-	6V6GTG	8/-	20P3	23/3	CK506	6/6	ECC85	8/6	FC13C	26/6		25/-	U45	9/-	W61M	26/6	OC203	58/-
6BQ7A	15/-	6X4	5/-	20P4	26/6	CL33	19/3	ECC88	18/-	FW4/500	8/6	PEN44	26/6	U50	6/6	W76	5/6	TJ1	40/-
6BR7	15/-	6X5GT	6/-	20P5	23/3	CV63	10/6	ECC91	5/6	FW4/800	8/6	PEN45	19/6	U52	6/6	W81M	6/-	TJ2	45/-
6BS7	25/-	6/30L2	10/-	25A6G	10/6	CY1	18/7	ECCF80	10/6	GZ30	9/-	PEN45DD		U54	19/11	W107	18/7	TJ3	50/-
6BW6	8/6	7A7	12/6	25L6GT	10/-	CY31	16/7	ECF82	10/6	GZ32	10/-		26/6	U76	6/-	W729	19/11	TPI	40/-
6BW7	6/-	7B6	21/3	25Y5G	10/-	D1	3/-	ECH3	26/6	GZ33	19/11	PEN46	7/6	U78	5/-	X24M	24/7	TP2	48/-
6BX6	6/-	7B7	8/6	25Z4G	9/6	D15	10/6	ECH21	23/3	GZ34	14/-	PEN383	23/3	U107	16/7	X41	15/-	TS1	10/-
6C4	5/-	7C5	8/-	25Z5	9/6	D63	5/-	ECH35	6/6	H63	12/6	PEN453DD		U191	16/7	X61(C)	12/6	TS2	12/6
6C5G	6/6	7C6	8/-	25Z6G	10/-	D77	4/-	ECH42	9/-	HABC80			33/2	U201	16/7	X61M	26/6	TS3	15/-
6C6	6/6	7D6	10/6	27SU	19/11	DAC32	10/6	ECH81	9/-		13/6	PEN/DD		U251	14/-	X63	9/-	TS4	24/-
6C9	13/6	7H7	8/-	28D7	7/-	DAF91	6/-	ECH83	13/11	HL2	7/6	4020	33/2	U281	19/11	X65	12/6	XA101	23/-
6C10	9/-	7R7	12/6	30C1	8/-	DAF96	8/6	ECL80	9/-	HL23DD	7/6	PL33	19/3	U282	22/7	X66	12/6	XA102	26/-
6CD6G	36/6	7S7	9/6	30F5	6/-	DD41	13/11	ECL82	10/6	HL41DD		PL36	12/-	U301	23/3	X76M	14/-	XA103	15/-
6CH6	9/-	7V7	8/6	30FL1	10/-	DET25	7/6	ECL83	19/3		19/3	PL38	26/6	U329	14/-	X78	23/3	XA104	18/-
6D3	19/11	7Y4	7/6	30L1	8/-	DF33	10/6	EF9	23/3	HL42DD		PL81	10/6	U339	16/7	X79	23/3	XB102	10/-
6D6	6/6	8D2	3/6	30L15	11/6	DF66	15/-	EF22	14/-		19/3	PL82	7/6	U403	16/7	X101	33/2	XB103	14/-
6E5	12/6	8D3	4/6	30P4	12/-	DF70	15/-	EF36	4/-	HN309	24/7	PL83	9/-	U404	8/6	X109	17/3	XB104	10/-
6F1	26/6	9BV6	15/3	30P12	7/6	DF91	3/6	EF37A	8/-	HVR2	20/-	PL84	12/8	U801	29/10	XD(1.5)	6/6	XC101	16/-

ALL GOODS OFFERED ARE NEW AND COVERED BY THE MAKER'S GUARANTEE. VALVES INDIVIDUALLY BOXED. WE DO NOT STOCK USED GOODS OR MANUFACTURERS' REJECTS

VOLUME CONTROLS

All with Long Spindle and Double-pole Switch. 4/6 each.	DRM1B 13/-	RM-1	5/3
10K 25K 50K 100K	DRM2B 15/6	RM-2	7/6
	DRM3B 15/6	RM-3	7/9
	LW7 21/-	RM-4	14/-
± mg. ½ mg. 1 meg. 2 meg.	RM-0 7/11	RM-5	19/6

METAL RECTIFIERS Full List with ratings free for S.A.E.

14A86

FIRST IN QUALITY - FOREMOST IN ECONOMY



Suffolk's reputation for reliability accounts for the rapidly increasing popularity of Suffolk rebuilt tubes. Now you can obtain C.R. Tubes of all types completely rescreened and aluminised—at an exceptionally low price!
12" £5. 14" £5.5. 15" & 17" £5.10.
21" £8.

Sensational value with the existing range of picture tubes!
12" £4.10. 14" £4.15. 15" & 17" £5.
21" £7.

Suffolk's FULL 12 MONTH GUARANTEE is your assurance of satisfaction. You get FREE DELIVERY anywhere in the U.K. when you trade with Suffolk, the largest independent tube rebuilders in London.

SUFFOLK TUBES LTD



SUFFOLK HALL, 1-3 UPPER RICHMOND ROAD, PUTNEY, S.W.15
Telephone: VAN 5267, 4304



Become a Television expert this easy way

The Bennett College offers you a complete course

You have to be really in the know to keep up with television these days. And the value of this special new course prepared by The Bennett College is that you are taught *all* the latest methods and techniques. You have the advantage of studying this profitable and fascinating medium in the quiet of your own home. And personal tuition by The Bennett College makes all the difference.

The Bennett College offers you a course that's non-mathematical and particularly easy to follow. It contains clear diagrams which cover everything you want to know from beginning to end (and

even includes the basic principles of sound radio if you wish).

The complete home-study course covers *everything*: Production of the signal, scanning and reproduction of picture from signals. Aerials, types and purpose. The cathode-ray tube. Time-base oscillators, and output circuits. Synchronisation. Video frequency amplifiers. The TV tuner, turret incremental, etc. Television test gear. Television faults.

For more details, please fill in the coupon below. Your studies cost very little and the book you need is included in the cost.

<p>To THE BENNETT COLLEGE (Dept. B55 NTV,) Sheffield</p> <p><i>Please send me details of the new TELEVISION SERVICING COURSE</i></p>	<p>NAME.....</p> <p>ADDRESS.....</p> <p>..... AGE.....</p>
---	--

YOUR C.R.T. completely FACTORY REBUILT

New heater and Cathode assembly

COMPARE OUR PRICES

**12 months'
Guarantee**

★ 12 in. **£3.0.0** ★ 14 in. **£3.10.0**
(Money back if not completely satisfied)

★ 17 in. **£4.0.0** ★ 21 in. **£5.0.0**

Carriage and Insurance add 12/6

PASSENGER TRAIN DISPATCH FOR SPEED

All Mullard and Mazda Types Rebuilt—Fast Service

Send your Tube now — Terms C.W.O. or Pro-forma Invoice

KING'S TELE SERVICE CO.

101-111, DAWES ROAD :: FULHAM, S.W.6

SPECIAL MAINS DROPPER RESISTORS
SMD1 Philips 209U 6/8
SMD8 Ultra Twin 50 5/8
SMD7 Ultra Twin 50 5/8
SMD15 Philips 141U and Stella ST105U 5/8
SMD27 Pye Piper 6/6
SMD30 KB Rhapsody MP151/1 6/9

CLAROSTAT POTENTIOMETERS FOR STEREOPHONIC AMPLIFIERS, etc.
50K x 50K Log., 100K x 100K Log., 500 x 500K A/Log, 1 Meg x 1 Meg Log, 250K x 250K Log, 1 Meg x 1 Meg, Linear, 500K x 500K Linear. All 6/8 each.

WAVE CHANGE SWITCHES
3 pole, 4 way 3/- each. 4 pole, 3 way 3/- each. 1 pole, 4 way 2/- each. 1 pole, 12 way 3/- each. 2 pole, 6 way 8/- each. 4 pole, 4 way 4/6 each. 3 pole, 3 way 3/- each. 3 pole, 3 way, 3 bank 8/8 each.

Best Quality Recording Tape
1,200ft. on 7in. spool 21/-
850ft. on 5in. spool 18/6
600ft. on 5in. spool 13/9
200ft. on 3in. spool 5/8

Collaro Junior
Single 4-speed record player unit in cream, complete with pick-up fitted turnover cartridge. Special Price 75/- each. Post 3/6.
Garrard GC2 Crystal Cartridge.
Black moulded case complete with Standard and LP stylus. Price 15/6.
4BA Terminals, Red and Black, suitable for Battery Chargers, etc. 1/6 each.
PANL-Air-drying Paint, Black Crackle (Crystalline Black), 3/- tin.
Tuning Indicator Escutcheon, suitable for EM80 type of valves, 2/- each.

TELEVISION TUBES REGUNNED 12 MONTHS' GUARANTEE
MW31/74, £5.10.0; CRM152B, 26; MW36/24, £5.10.0; CRM141, £5.10.0; CRM123, £5.10.0; MW43/69, 26; CRM171, 26. Carriage and insurance 10/- extra. Allowance on old tube if returned.

ALPHA RADIO SUPPLY CO.

VALVES GUARANTEED ALL TESTED BEFORE DESPATCH

AZ1	10/-	GZ32	11/6	3S4	7/6
AZ31	10/-	PCC84	5/6	3V4	8/-
DAF98	8/-	PCC85	11/6	5Y3G	8/-
DF98	8/-	PCF80	8/9	5Z4G	8/-
DK98	8/-	PCL82	12/-	6AL5	4/-
DL98	8/-	PCL83	13/6	6F1	14/-
EAF42	9/6	PL68	15/-	6F15	14/-
EBC93	6/9	PL38c.1.26/6	6/9	6J7G	6/6
EBC41	8/9	PL81	11/-	6K7G	3/6
ECC81	7/6	PL82	8/6	6K8G	6/6
ECC82	8/-	PL83	9/6	6K25	19/11
ECC83	8/-	PY32	17/11	6L6M	9/6
ECC84	10/-	PY31	8/6	6AM6	4/-
ECF30	12/-	PY82	7/-	6Q7G	7/6
ECF82	10/6	PZ30	19/11	6V8G	6/-
ECH42	9/6	TP25	10/-	6V8GT	7/6
ECH81	9/-	U25	13/6	6X5GT	7/-
ECL80	9/6	U26	10/-	7B8	10/6
EF39	5/6	U27	26/6	7H7	8/-
EF41	9/6	U281	18/11	7S7	9/6
EF80	7/-	U801	29/10	7Y4	8/-
EF88	12/6	UAF42	9/6	10P1	15/-
EL33	14/-	UBC41	8/6	10P13	17/6
EL41	9/-	YCH42	9/6	12AT7	7/6
EL42	10/6	UF41	9/-	12AX7	3/-
EL44	9/6	UL41	9/-	12AU7	8/-
EM34	9/6	UJ8	26/6	20P1	26/6
EM80	9/6	UY1N	12/6	25AG2	10/6
EY51	9/6	UY41	7/6	25Z4G	9/6
EY86	10/-	1R5	7/6	275U	19/11
EZ40	7/6	1R5	6/6	35L6GT	10/-
EZ81	7/-	1T4	5/6	35Z4GT	7/-

CATALOGUE
Our 1961 catalogue is now available. Please send 1/- in stamps for your copy. Trade catalogue also available. Please attach your business letter heading.

Printed Circuit Version of the PW Pocket Superhet. All components available from stock, Complete Kit, £9.15.0. Full detailed shopping list, point to point wiring diagram, fully illustrated, 1/6.

Coil Set (Osc. and 3 I.F.T.s)	28/6
Driver Transformer	11/6
Output Transformer	10/6
Ferrite Rod Aerial	10/-
Printed Circuits	9/-
50 Gang Condensers	11/-
Volume Control V.C. 1545 switch	10/6
Hardware Kit	5/6
Transistors (set of 6 plus crystal diode GD9)	4/6
Speaker	70/-
Case	19/10
Complete Kit of Condensers	7/6
Complete Set of Resistances	18/-
Trimmers (2)	8/6

All above components are brand new and are fully guaranteed.

T.S.L. SUBMINIATURE COMPONENTS
Solid Dielectric Tuning Condenser, Type PVC-2M.
Capacity Aerial, 196pF, Osc. 87pF, size 1 x 1 x 1in. 17/8 each.
I.F. Transformers. Set of 3 and Osc. coil, size of each 7/16 x 7/16 x 1in. high, per set, 21/-
Driver Transformer, type TR180/E1F, Ratio 2:1±1, size 3/8 x 1 x 1in., 6/8 each.
Output Transformer, type TR180/E1E, Ratio 5:3 to 1, Primary impedance 240 ohms, secondary 10 ohms, Max. output 800mW. Size 4/5 x 5/8 x 9/16in., 6/8 each.
TSL-LORENZ LOUSPEAKERS
2in. diameter speaker designed for miniature receivers, 4/500mW, impedance 10 ohms, freq. response 120-14,500c/s. Price 25/-

ALPHA RADIO TERMS.—Cash with order or C.O.D. Postage and Packing charges extra, as follows: Order value 10/- add 1/8; 20/- add 1/8; 40/- add 2/8; 85 add 3/8. Minimum C.O.D. Fee and Postage 3/-. Full terms of business see inside cover of our catalogue. Personal Shoppers p.a.m. to 5 p.m. Monday to Friday Saturday 10 a.m. to 1 p.m.

ALPHA FOR VALVES AND SPARES FROM STOCK. RETURN POST
103 LEEDS TERRACE, WINTOUN STREET, LEEDS 7.

DOUBLE BEAM "SCOPE"

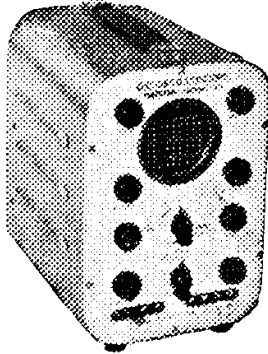

for D.C. & A.C. APPLICATIONS

Engineered to precision standards, this high-grade instrument is made available at the lowest possible price, incorporating the essential features usually associated with luxury instruments. This "SCOPE" will appeal particularly to Service engineers and Amateurs. A high gain, extremely stable differential

Y-amplifier (30 mV/C.M.). Provides ample sensitivity with A.C. or D.C. inputs. Especially suitable for measurements of transistor operating conditions where maintenance of D.C. levels is of paramount importance. Push-pull X amplifier; Fly-back suppression; Internal Time-base Scan Waveform available for external use; pulse output available for checking TV Line O/P Transformers, etc.; Provision for external 1/P and CRT Brightness Modulation. A.C. mains 200/250 v. £19.19.0, plus P. & P. 7/8, or 50/- deposit, plus P. & P. 7/8 and 12 monthly payments of 33/4.

FULL 12 MONTHS' GUARANTEE INCLUDING VALVES AND TUBE

ALIGNMENT ANALYSER TYPE MC12

A.C. mains 200/250 v. Provides: "Wobbulator" (Swept Frequency) operation, for FM/TV alignment linear frequency sweep up to 12 Mc/s. From 400 Kc/s-80 Mc/s. Capacitance Measurement. Two ranges provided 0-60pF and 0-120pF. Special Facility enables true resonant frequency of any tuned cct. I.F. transformer, etc., to be rapidly determined. Cash price £6.19.6, plus 5/- P. & P. H.P. terms 25/- deposit plus 5/- P. & P. and six monthly payments of 21/6.

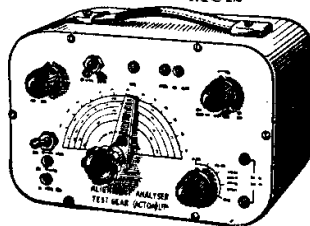

LINE E.H.T. TRANSFORMER

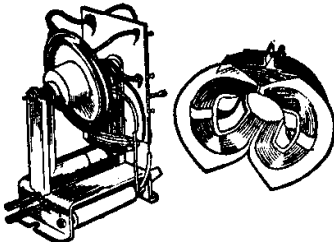

With built-in line and width control, 14 KV. Scan coil, 90in. deflection, on ferrite yokes. Frame O.P. transformer pf. 12 KV. smoothing condenser. Can be used for 14in., 17in. or 21in. tubes. Complete with circuit diagram.

29/6 Plus 4/- P. & P.

As above, but for 625 lines, £2.10.0, plus 4/- P. & P.

Focus Magnet suitable for the above (state tube), 10/-, plus 2/6 P. & P.

CYLDON TURRET TELETUNER

I.F. 34/38Mc/s. Brand new, complete with biscuits for channels 2, 4, 8, and 9, but less valves. Valves required P.C.C. 84, P.C.F. 80. 10/- plus 2/6 P. & P.

MAINS TRANSFORMERS

All with tapped primaries. 200-250 volts, 0-160, 180, 200 v., 60 mA, 6.3 v. 2 amp., 10/6. 280-0-280 80 mA, 6.3 v. 2 amp., 6.3 v. 1 amp., 10/6. 350-0-350 v., 70 mA, 6.3 v. 1 amp., 6.3 v. 2 amp., 10/6. 250-250 v., 70 mA, 6.3 v. 2 amp., 10/6. Postage and packing on the above, 3/-.

SURFACE BARRIER TRANSISTORS

Type SB305, 15 Mc/s, 7/8 each. 100% AUDIO TRANSISTORS, 5/- each.

TRANSISTOR TESTER

For both P.N.P. and N.P.N. transistors incorporating moving coil meter. In metal case, size 4 1/2 x 3 1/2 x 1 1/2 in. Scale marked in gain and leakage. Complete and ready for use. 19/6 Plus 2/6 P. & P.

A.C./D.C. POCKET MULTIMETER KIT

2in. moving coil meter, scale calibrated in A.C./D.C. volts, ohms and milliamps. Voltage range A.C./D.C. 0-50, 0-100, 0-250, 0-500. Milliamps 0-10, 0-100. Ohms range 0-10,000. Front panel, range switch, wirewound pot (for ohms zero setting), toggle switch, resistor and rectifier, 19/6, P. & P. 1/6. Wiring diagram 1/-, free with kit.

SIGNAL GENERATORS

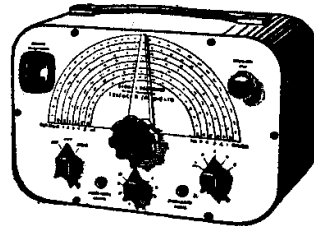

£6.19.6 or 25/- deposit and 6 monthly payments of 21/6. P. & P. 5/- extra. Coverage 100 Kc/s-100 Mc/s on fundamentals and 100 Mc/s to 200 Mc/s on harmonics. Metal case 10in. x 6 1/2 in. x 5 1/2 in., grey hammer finish. Incorporating three miniature valves and Metal Rectifier. A.C. Mains 200/250. Internal Modulation of 400 c.p.s. to a depth of 30%; modulated or unmodulated R.F. output continuously variable. 100 milli-volts, switch variable A.F. output and moving coil output meter. Grey hammer finished case and white panel. Accuracy plus or minus 2%.

C.W. and mod. switch, variable A.F. output. Incorporating magic-eye as output indicator. Accuracy plus or minus 2%.

Cash £4.19.6 or 25/- deposit and 4 monthly payments of 21/6. Plus Postage and Packing 5/-.

Coverage 120 Kc/s-84 Mc/s. Metal case 10in. x 6 1/2 in. x 4 1/2 in. Size of scale 6 1/2 in. x 3 1/2 in. 2 valves and rectifier. A.C. mains 230-250 v. Internal modulation of 400 c.p.s. to a depth of 30% modulated or unmodulated R.F. output continuously variable. 100 milli-volts, C.W. and mod. switch variable A.F. output and moving coil output meter. Grey hammer finished case and white panel. Accuracy plus or minus 2%.

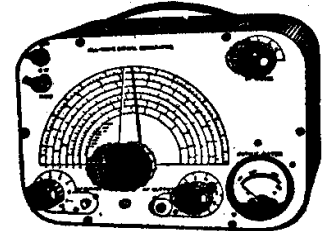

SIGNAL & PATTERN GENERATOR

£6.19.6 P. & P. 5/-.

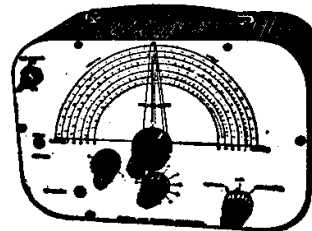

Or 25/- deposit, P. & P. 5/- and 6 monthly payments of 21/6. Coverage 7.6 Mc/s-210 Mc/s. in five bands, all on fundamental, slow motion tuning and audio output. 8 vertical and horizontal bars, logging scale. In grey hammer finished case with carrying handle. Accuracy ±1% A.C. mains 200-250 v.

CHANNEL TUNER

Will tune to all Band 1 and Band III stations. BRAND NEW by famous manufacturer. Complete with P.C.C. 84 and P.C.F. 80 valves (in series). I.F. 16-19 or 33-38. Also can be modified as an aerial converter (instructions supplied). Complete with knobs.

32/6 Plus 3/6 P. & P.

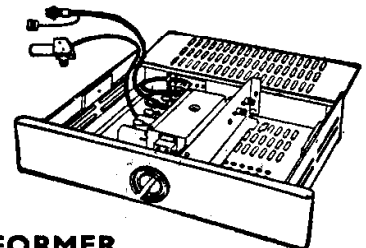

HEATER TRANSFORMER

To suit the above, 200-250 v., 6/-, Plus 1/6 P. & P.

8-WATT PUSH-PULL AMPLIFIER

COMPLETE WITH CRYSTAL MIKE AND 8in. LOUDSPEAKER

A.C. mains 200-250 v. Size 10 1/2 in. x 6 1/2 in. x 2 1/2 in. Incorporating 6 valves. H.F. pen., 2 triodes, 2 output pens and rectifier. For use with all makes and type of pick-up and mike. Negative feed back. Two inputs, mike and gram., and controls for same. Separate controls for Bass and Treble lift. Response at from 40 cycles to 15 Kc/s., ± 2 db; 4 db down to 20 Kc/s. Output 8 watts at 5% total distortion. Noise level 40 db down all hum. Output transformer tapped for 3 and 15 ohm speech coils. For use with Std. or L.P. records, musical instruments such as Guitars, etc. £4.19.6 Plus P. & P. 7/8.

Or 20/- deposit Plus P. & P. 7/8, and 4 monthly payments of 23/-.

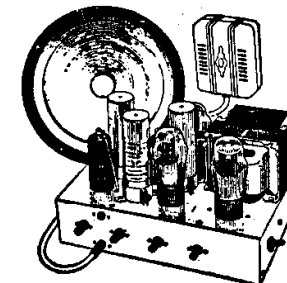

RADIO & T.V. COMPONENTS (Acton) LTD.

23c HIGH STREET, ACTON, LONDON, W.3.

All enquiries S.A.E. GOODS NOT DESPATCHED OUTSIDE U.K.

BRAND NEW AM/FM (V.H.F.) CHASSIS AT £13.6.8. (P. & P. 10/-)

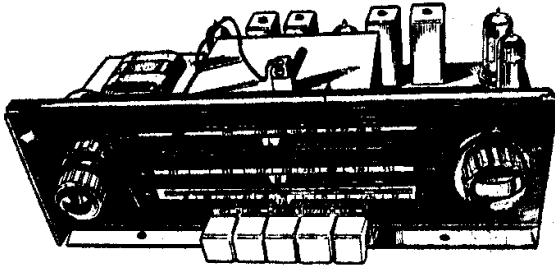

Tapped input 220-225 v. and 226-250 v. A.C. ONLY.
 Chassis size 15 x 6½ x 6½in. high. New manufacture.
 Dial 14½ x 4in. in gold and black.
 Pick-up. Extension Speaker, Ae., E., and Dipole sockets. Five "piano" push buttons—OFF, L.W., M.W., F.M. and Gram. Aligned and tested.
 With all valves & O.P. Transformer. Tone-control fitted.
 Covers 1,000-1,800 M.; 200-500 M.; 88-98 Mc/s.
 Valves EZ80 rect., ECH81, EF89, EABC80, EL84, EOC85. Speaker & Cabinet to fit chassis. 47/6. 10 x 6in. ELLIPTICAL SPEAKER, 20/-.

TERMS:—(Chassis) £4.16.8 down—10/- carr.—and 6 Monthly Payments of 30/-, or with Cabinet & Speaker £5.9.8 down and 7 Monthly Payments of 32/-.

"READY TO USE" ITA CONVERTER

We are specialists in ITA Converters. Our converters give direct switching ITA to BBC, metal rectifier, co-axial plug. Can be fitted in 5-10 mins., and need no alteration to your set. ALL AREAS. ALL SETS. ALL CHANNELS. 12 months' guarantee (3 months on valves).

Separate gain controls. Valves PCF80 and PCC84. Switch positions ITA (1)—ITA (2)—BBC. Bakelite moulded cabinet 8½ x 4 x 6in. Last 400 at 70/- (3/- P. & P.).

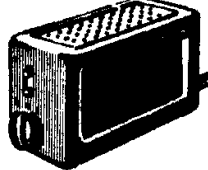

THE "CABY" TEST METERS

Prices include Test Prods., Batteries, Instruction Book. FULLY GUARANTEED. Also measure db. Accuracy: A.C. 3 per cent; D.C., 2 per cent.

A-10 **£4.17.6**

B-20 **£6.10.0**

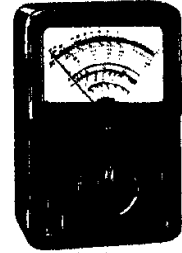

A-10—2K ohms/v. on A.C. and D.C. volts (10, 55, 250, 500 and 1000 v.); 10K and 1M ohms; ½ mA, 25 MA and 250 mA, D.C. Size: 5½ x 3½ x 1½in. Weight 17 ozs.
 B-20 10K ohms/v. on 0.5 v. and 2.5 v.; 4K ohms/v. on 10, 50, 250, 500 and 1000 v., A.C. and D.C. Resistance, 2K, 200K, 2M and 20M-ohms; D.C. Current, 100 microA, 2.5 mA, 25 mA, 250 mA. Size: 5½ x 3½ x 2½in. Weight 24 ozs.

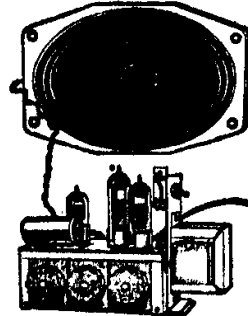

3-VALVE AMPLIFIER (INC. RECT.). Capable of giving 4 watts. Mains and output transformers. Valves ECC83, EL84, and EZ80, 3 Controls, volume, bass and treble. On/Off switch. Fully guaranteed. Chassis size 6½ x 3 x 2½in. (6½in. round or 7 x 4in. elliptical speaker, state which).

Not suitable for microphone input.

67/- (3/- p. & p.)

THE BRAYHEAD TURRET TUNER, £7.7.0 post free. Complete with booklet and fitting instructions. State set and model number when ordering. Converts your 5-channel BBC only set to receive ITA as well.

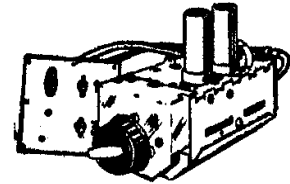

OFFER OF 13-CHANNEL INCREMENTAL TUNER

I.F. 34-38 Mc/s without valves. Removed from chassis but in working order. PCF80 and PCC84 required.

7/6 (2/6 P. & P.). Knobs 2/6 extra.

CYLDON TURRET TUNER

34-38 Mc/s. Brand new, with PCF80 and PCC84. With coils for channels 1-5 and 8-11. OUR PRICE 28/6 (Post 1/8). Knobs 2/6 extra.

NEW ITA AND BBC TUNER.

By well-known manufacturer for superhet TVs with 35-38 Mc/s I.F. For all areas; covers all 13 channels. Switch gives BBC and two ITA selections. Suits G.E.C. sets BT4543, 4544, 5146, 5147, 5543, 5842, and 6841

without alteration. Easily adapted as aerial converter, and instructions can be provided free. Has ITA and BBC co-axial sockets and separate gain controls.

WITH VALVES PCF80 and PCC84, 28/6 (P. & P. 3/-).

Some without valves at only 12/6 (P. & P. 3/-).

AUTOMATIC RECORD CHANGERS, COLLARO CONQUEST with manual play also. Turnover crystal pick-up, 4-speed, A.C. mains 200-250 v. see illus.

£7.10.0 (5/- P. & P.)

B.S.R. 4-speed UA14, auto-changer £7.10.0 or STEREO UA3 for only 26-17.6. Mono UA8 £6.10.0. (carr. 5/- on each.)

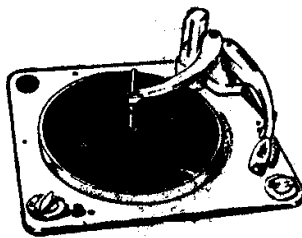

ITA AERIALS clipping to existing mast 1-2in. dia. 3-element, 28/-; 5-el., 30/-; 9-el., 50/-; Loft mounting, 3-el., 20/-; 5-el., 28/-; Combined single BBC and 5-el. ITA, 75/- with chimney-lashings; Co-axial cable semi-air-spaced, 7d. yd. or 20 yds., 11/-; Aerial prices carr. paid. Postage on cable 1/-.

NEW WAXED TUBULARS, 350 v. or above, 0.001, 0.002, 0.005, 0.01, 0.02, 0.05, 0.1, 0.25, 0.5 mF. Total 21 for 4/6, post 8d.



GRAMOPHONE AMPLIFIER with 5 in. SPEAKER. On Fabric-covered Baffle 12½ x 5in. Mains and Output Transformers. Valves EZ40 and EL41. Tone and Volume

Controls. On/Off switch. Plenty of Volume. Fully Guaranteed. Two Knobs supplied. Ready to play. Useful for Stereo

ONLY 57/-, post 3/-

SELF-POWERED VHF/FM TUNER CHASSIS.

Fully built VHF/FM Tuner covers 88-95 Mc/s sec. Wired, aligned and tested. Two diodes ECC85, EF81 and EF91. Mullard permeability Tuner. No frequency drift. Mains transformer. 200-240v. A.C. Supplied in chassis form, dimensions 10½ x 5½in. high x 4in. Metal rectifier. The complete set with ECL82 amplifier can be provided for 89s., (carr 4/-) and this is in a metal cabinet with 3-core mains lead and cabinet is illustrated above.



£7.10.0

(2/- P. & P.).

Delivery by return. C.O.D. 2/- extra. Terms: Cash with order or one-third down and balance plus 7/6 (up to £7.10.0) in four equal monthly payments. Balance over £7.10.0 add 1/- in £1 and pay in not more than 6 monthly payments. See special terms for A.M.-P.M. chassis. All new goods unless stated. Send 6d. for NEW 20-page catalogue.

GLADSTONE RADIO

(Camberley closed Sats. Bristol & Portsmouth closed Weds.)

POSTED ORDERS TO CAMBERLEY PLEASE

58A HIGH STREET, CAMBERLEY, SURREY. Tel. 34771
 56 Stokes Croft, Bristol, and 347 NEW ROAD, PORTSMOUTH

Practical Television

AND TELEVISION TIMES

VOL. 11, No. 125, FEBRUARY, 1961

Editorial and Advertisement
Offices:

PRACTICAL TELEVISION

George Newnes, Ltd., Tower House
Southampton Street, W.C.2.

© George Newnes Ltd., 1961

Phone: Temple Bar 4363.

Telegrams: Newnes, Rand, London.

Registered at the G.P.O. for trans-
mission by Canadian Magazine Post.

SUBSCRIPTION RATES
including postage for one year

Inland - - - - £1.2.0 per annum
Abroad - - - - £1.0.6 per annum
Canada - - - - 19s. per annum

Contents

	Page
Editorial	235
Servicing Tuners	236
New Uses for Old Sets	238
The Tunnel Diode	240
Valves and Their Habits	242
Servicing TV Receivers	244
Telenews	249
Line Oscillator and Sync Circuits	253
All About Re-built Tubes	256
The Olympic	259
Letters to the Editor	264
Underneath the Dipole	267
Lubrication in Servicing	271
Your Problems Solved	275

The Editor will be pleased to consider articles of a practical nature suitable for publication in "Practical Television". Such articles should be written on one side of the paper only, and should contain the name and address of the sender. Whilst the Editor does not hold himself responsible for the manuscripts, every effort will be made to return them if a stamped and addressed envelope is enclosed. All correspondence intended for the Editor should be addressed to: The Editor, "Practical Television", George Newnes, Ltd., Tower House, Southampton Street, London, W.C.2.

Due to the rapid progress in the design of radio and television apparatus and to our efforts to keep our readers in touch with the latest developments, we give no warranty that apparatus described in our columns is not the subject of letters patent.

Copyright in all drawings, photographs and articles published in "Practical Television" is specifically reserved throughout the countries signatory to the Berne Convention and the U.S.A. Reproductions or imitations of any of these are therefore expressly forbidden.

The Problem of Lines and Colour

RECENT announcements in the Press, coupled with questions and answers in the House of Commons have again brought to us and the TV industry a spate of enquiries on the advisability of buying a new set. These periodic reports of impending changes in our television system cannot but harm trade by putting doubts into the minds of the public who may be on the point of purchasing a new receiver. Unfortunately the BBC aggravated the present situation by announcing that it would endeavour to show colour at the next Radio Show, and permission was asked of the P.M.G. whose reply was that no permission could be given to go ahead with colour until the report of an investigating committee was received, and the earliest that this was expected was at the end of this year. This publicity also set off a battle in the trade, the preliminary announcement in the Press resulting in one of our largest manufacturers circularising the Trade to the effect that under no circumstances would they manufacture sets to receive colour on the 405-line system—because it is obsolete. Readers will remember that the colour system which has been proposed is an adapted version of the standard American system, which is based on 625 lines, and therefore it is, at the best, a compromise. This manufacturer also stated that if permission to radiate colour on 405 lines were given to the BBC they would apply for permission to transmit colour broadcasts on 625 lines.

As an immediate result of this circular, another manufacturer sent out a letter disagreeing with the point of view that the 405-line system is obsolete, and that the controversy was injurious to trade. Whatever the rights or wrongs of the differing points of view, there is little doubt that the moment a suggestion is made that there will be some kind of change in our television system the news is completely devoured by the general public, and proof of this is in the number of letters which we immediately receive—either asking whether the information is correct or not, or asking what the writer can do to enable him to participate in the change. In our opinion the first step is to make a change in the number of lines, and then to introduce colour, but no matter what changes are made by the transmitting organisations, they must be made in parallel with existing systems. It has already been stipulated that any colour system must be "compatible" which means that it must be received by owners of black-and-white apparatus with the same high quality that they pick up black-and-white transmissions, and if the number of lines is changed, there must be the same protection for the owners of existing apparatus. They must still have facilities for receiving pictures on their receivers without any deterioration in quality and without any additional expense. In general, a 405-line receiver cannot easily be modified to receive 625 lines, so new transmissions must definitely be introduced. As we have stated before, this means the introduction of new bands, and whilst it may be possible and practicable for the television authorities to radiate on such new channels and in new systems, the viewer must not be left in any doubt as to the utility of his receiver for the period of its serviceable life.

Our next issue, dated March, 1961, will be published on February 19th

SERVICING TUNERS

THE MECHANICS AND THEORY OF MODERN TURRET TUNERS

By G. J. King

(Continued from page 186 of the January issue)

THE coil biscuits are accurately aligned at the factory to take into account the standardised capacitance values associated with the circuits, and to ensure that biscuits of any channel will match into the turret without adjustment. This, of course, would not be the case if the small trimmers were adjusted in an endeavour to secure improved reception on one particular channel.

Circuit Diagram

In Fig. 2 (Jan. issue) was shown the circuit diagram of the Cyldon tuner, and the various component references corresponded with those given in Fig. 1. L6 is the I.F. output coil which couples the tuner signals to the common I.F. stage of the receiver. L6 is also adjustable from the top of the tuner chassis. Normally, this is adjusted to provide the optimum vision I.F. response, but it can sometimes be adjusted with advantage, especially in poor signal areas, for maximum vision consistent with good sound and picture definition.

The aerial circuit is designed to accommodate 78-80 Ω balanced feeder (and 300 Ω balanced feeder in certain tuners). Valve V1 is wired as a double-triode cascode amplifier, and in this circuit provision is made for the use of a gain control in the cathode circuit and for vision AGC, on the grid, if required. The first triode section is neutralised by C4 and the second is connected in the grounded-grid mode, the two together forming the well-known cascode circuit.

Operation

The triode pentode, V2 forms the frequency changer, the pentode being the mixer and the triode and local oscillator. The R.F. amplifier stage is coupled to the mixer control grid by a band-pass pair of coils, L3 and L4. The oscillator coil, L5, is mounted on the same biscuit (mixer coil assembly) and is thus inductively coupled to the mixer.

Fine adjustment of the oscillator frequency is provided by the variable dielectric capacitor, as described previously, the spindle of which is

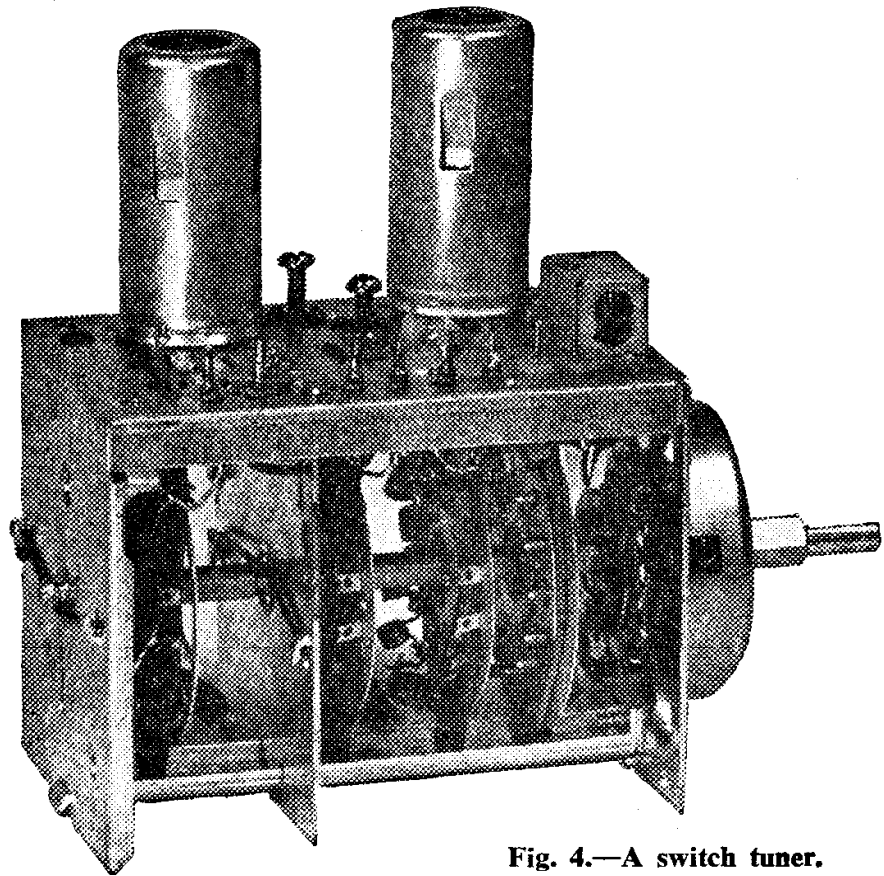

Fig. 4.—A switch tuner.

brought out concentrically with the main channel selector spindle, and was designated C14 in Fig. 2.

The mixer grid is biased by oscillator grid current in R7, while the grid coupling capacitor is C10. The grid end of this capacitor is connected to a "test point" which can be used to feed in an I.F. signal for circuit alignment (with the tuner switched to a Band III channel). This point may also be used to derive a visual display of the tuner's overall response curve, in conjunction with a wobulator and oscilloscope.

Servicing Hints

The stud contacts on the coil biscuits and the stationary spring contacts are, in general, silver-plated to ensure a low resistance connection. As with household silver, this plating can tarnish resulting in a high resistance contact. Dust is also likely to affect the contact resistance, and when either one of the above occurs the picture and sound may become intermittent or completely missing. Slight movement of the channel selector switch will indicate when this trouble exists.

The contacts should be cleaned with a soft lintless cloth, and little energy is required to remove the tarnish completely. On no account should cleaning fluids, such as carbon tetrachloride or trichlorethylene, be used on the contacts. A very light film of silicone compound (Type MS4—Midland Silicones Limited, 19, Upper Brook Street, London, W.1), Vaseline or petroleum jelly applied

to the contacts will make for smoothing operation and ease of channel changing. The contacts should not be touched after cleaning since the acid oils from the skin will cause the tarnish to return. The locator mechanism and the bearing should also be lubricated with Vaseline or petroleum jelly.

Resetting Springs

Should the spring tension of the fixed contacts be weak, they can often be reset by pushing them gently inwards until all the contacts are in line.

Band III frequencies the inductance of the leads and the capacitance between the parts are extremely critical and any disturbance will cause detuning of the unit and distortion of the overall response curve.

Fault Tracing

Intermittent operation and tuning drift are sometimes caused by a poor contact on the frequency changer valve holder. It is sometimes possible to extract the offending socket on the valve holder

Valve Voltage and Current Measurement measured with Avometer Model 8 (20,000 ohms per volt)							
	Type		Anode		Screen		Cathode
			V	mA	V	mA	V
V1	{ PCC84 30L1 }	Triode 1	90	15	—	—	1.6*
		Triode 2	170	15	—	—	90
V2	{ PCF80 30C1 }	Pentode	180	6.5	155	0.2	0
		Triode	55	7.5	—	—	0

* With contrast control at maximum

Tuner Measurement

H.T. to Tuner 180V at 30mA
Heater 16V at 0.3A

Table 1.—Typical voltages and currents in a tuner unit.

They can often be reached through the insulator on the side panel assembly, but the contacts must not be squeezed with pliers or distorted in any way. Wax from the capacitors, resistors and coil formers may drip on to the biscuit contacts after

and replace it by a similar contact from a spare holder. This is less frustrating in most cases than attempting to replace the holder complete or judiciously "prodding" with a pointed tool in an endeavour to secure an improved contact.

Frequency drift may also be caused by a fault developing in the connection which links the fine tuning capacitor to the oscillator. A poor connection on the fine tuner stud should also be suspected. The wire mentioned above is soldered to the centre of this stud and, although it may appear to be a good join, a dry joint may exist beneath the solder.

Approximate voltages and currents to be expected at the associated valves are given in Table 1, and a systematic check through these will reveal the majority of faults. If all channels are dead or if the gain appears low, the appropriate I.F. signal should be injected through the receiver from the "test point" in the mixer grid circuit. If the response is normal, then the trouble would lie somewhere in the R.F. stage. Complete failure or low sensitivity is sometimes caused by a short-circuit developing in the 1,000pF capacitor (C1) connected to the grid of the second triode of V1. This upsets the biasing and the general working of the amplifier circuit.

Feed-through capacitors also often go intermittently open-circuit. If such a component has to be removed this can be accomplished by applying heat to the metal screen immediately around the body of the component. When the solder becomes sufficiently soft the component can be withdrawn from the side which is in soldered connection with the screen or chassis.

(To be continued)

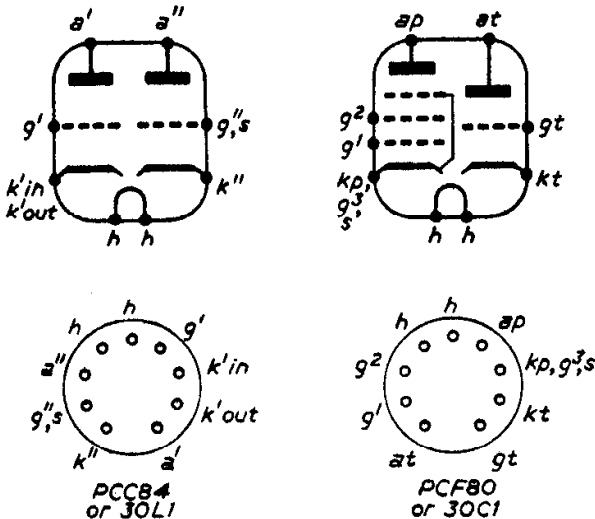

Table 2.—The base connections of valves often employed in tuners.

some months of use. This should be removed both from the biscuits and from the offending components.

Extreme care must be taken when replacing components or wiring, and it is most important to ensure that all leads are of the same length and any component replaced of the same type. At

NEW USES FOR OLD SETS

By L. E. Higgs

INEXPENSIVE CHECKING EQUIPMENT

MORE and more old BBC-only chassis are lying redundant after the expiry of the cathode ray tube, the last fatal fault that makes the owner buy a new set. Very often these sets are in good working order, needing only a tube to restore normal working. But as most of them are 12in., or under, few of us are inclined to spend even the cost of a regunned tube on them.

Uses

They can, however, provide a useful service aid on the bench without a CRT if a receiver is found with an isolated chassis (A.C. mains only). Here are the services that such a vintage receiver can supply:

H.T. supply: 200-300V D.C. for capacitor tests, substitute H.T. experimental power supply, flashover and leakage tests.

L.T. A.C.: 2-4-6-12V (depending on model) for general use when making up circuits needing valve heater current. L.T. soldering iron supply and for centring speakers, tube boosts.

A.F. amplifier: for testing microphones, signal tracing, and checking audible waveforms such as vertical, horizontal and sync signals.

EHT: 6-7kV for testing tubes when EHT is missing on a set under repair, for flashover and insulation leakage tests and to enable the folded, broken scan from a line OPT that normally supplies EHT.

Vertical sawtooth waveform for triggering frame multi-vibrator; testing vertical output stages by providing external drive.

Horizontal sawtooth waveform for tests on line timebases.

Video output waveform for tests on suspect low tubes and faults in limiters and video stages (the receiving section must be operative for this facility).

Bench loudspeaker for work on chassis without speakers.

A conveniently placed terminal panel is required in order to obtain quick access to the required supply, and the receiver is best left in its cabinet and permanently positioned on the bench. Choose a side of the cabinet clear of the speaker and internal obstructions and fit 4B.A. bolts in the wooden cabinet side, with a soldering tag connected internally (see Fig. 1).

Stagger the terminals in such a way that the crocodile connecting clip used for quick connection cannot short or drop across any two terminals. These terminals will be alive when the set is

switched on for use, and it is advisable to add a pilot lamp with a red warning cover on the terminal panel itself. This can be a 6V, 0.3A scale light connected across the heater supply to the valves.

Location

The panel can consist of any sheet of reasonable insulating material and fixed in the side of the TV, possibly in the cloth-covered vent area fitted on many sets of that generation. By recessing the panel a little way into the side, a safety drop flap can be fitted over the terminals after the service has been selected by the crocodile clip (Fig. 2). This safeguards against accidental contact by the hands with any live points.

All the facilities are supplied from the chassis of the TV and the appropriate terminal on the panel. This conveniently allows one of the crocodile clips to be left semi-permanently on to the earth or chassis terminal of the panel. The connecting lead should be of a good quality PVC lighting flex, sheathed and with the separate wires coloured red and black respectively to identify

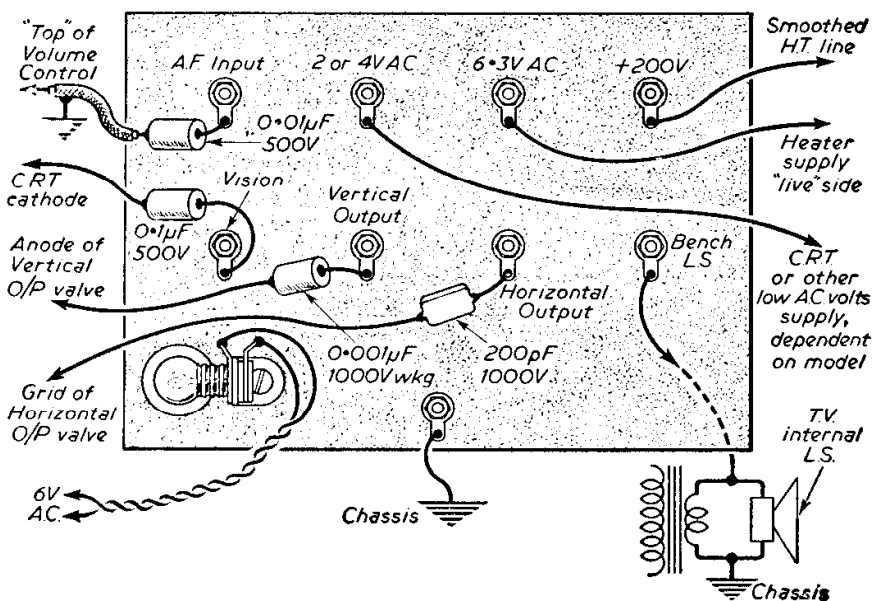

Fig. 1.—A rear view of the terminal panel.

polarity. To ensure that no errors can be made, a crocodile clip is fitted to the negative (black) wire and an insulated probe to the live (red) wire. When more permanent connections are required, then a separate flex lead can be used—soldered into whatever apparatus needs it.

These are the connections and the reasons for them from the terminal panel into the TV (Fig. 1).

H.T. Supply

Simply connect an insulated lead to the main smoothed H.T. in the receiver, and remember when

using this supply that a limit of 20mA is advisable for continuous running to avoid overtaxing the H.T. rectifier. The internal fuse in the supply receiver will blow if the leads are shorted.

H.T. Supply (reduced)

Often the experimenter needs a lower H.T. of about 100V. To cater for this, a "quiet" screen potential in the R.F. stages can be connected up to an additional terminal. Here remember that the rating of the feed resistor limits the load.

L.T. A.C.

The value of this will depend on the type of receiver used. Probably a 6V heater is the most useful, but 4V and 2V can be brought out if they are present, and that they have one side connected to chassis and the "live" taken to the terminal.

A.F. Amplifier

The most convenient place to connect into the sound section of the receiver is the top of the volume control, although some sets will vary, and it may be possible to use an amplifying stage that exists immediately prior to the volume control. Screened cable will be needed, to prevent the pick-up of timebase noise, and should be earthed at the volume control end. To isolate the input from accidental application of D.C. when probing about on a chassis under investigation, an isolating capacitor of 0.01µF 500VW is fitted in series at the terminal end. Screened cable wander leads must be used in these tests.

Signal Tracing

Apart from listening to audible frequencies with the A.F. amplifier as described above, R.F. can be monitored by means of a crystal diode probe.

Vertical Sawtooth Wave-form

The frame timebase section is tapped off to provide this test voltage for triggering sluggish multivibrators and testing vertical output stages. Use a good quality blocking-off capacitor of 0.001µF 1000VW at the rear of the terminal panel, as inductive "spikes" of voltage exist at the frame timebase. The take-off point is the anode of the vertical output valve.

Horizontal Sawtooth Wave-form

As in the above case, a D.C.-blocking capacitor is inserted between the terminal and the grid of the horizontal output valve. On no account attempt to obtain a higher output from the anode of this valve. The grid voltage should be sufficient for most purposes.

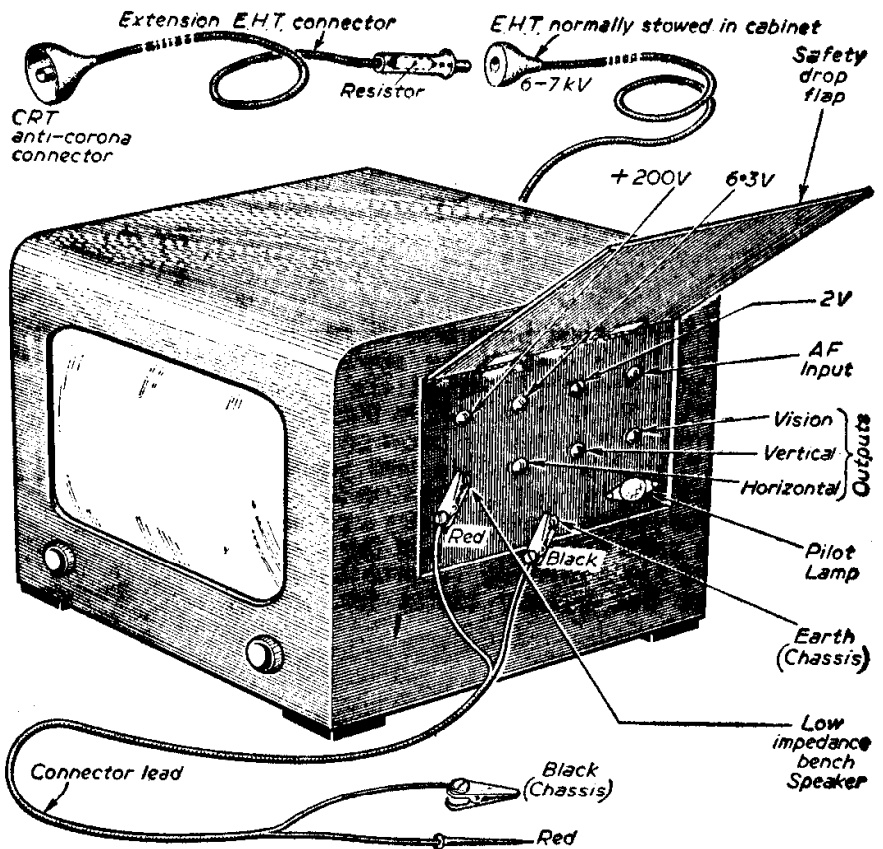

Fig. 2.—A servicing aid from a disused BBC receiver (A.C. only).

Video Output

The video waveform to the cathode ray tube is usually applied to the cathode of the CRT and has a D.C. component of about 100V, which is best blocked off with a capacitor of 0.1µF 350VW. The addition of this capacitor in series with the video waveform will cause floating of the black level owing to the absence of D.C. restoration. This is not important for the purposes of testing as no one is to view continuously for entertainment. Naturally, for this test the receiver being modified and supplying the video must be working with an aerial or no output will be present. This test is particularly handy for checking cathode ray tubes suspected of clipping peak whites—if application of separate video gives a good, contrasted, picture this clears the tube of blame and the limiting action of possibly video, detector or white spot limiter stages can be investigated. It may be necessary to have both sets working on the same channel so the video of the testing receiver modulates the tube and the receiver under test supplies the sync. The wire to the cathode of the suspect tube should be disconnected and a substitute D.C. bleed connected.

Bench Loudspeaker

Too often time is wasted when working on a chassis in rigging up a speaker to substitute for the one left fixed in the vacated cabinet. The internal speaker in the test receiver can be used for this, and it is always at hand. The only proviso here is that the speaker must have one side of its moving coil earthed to chassis; if not,

(Continued on page 272)

The TUNNEL DIODE

AN EXPLANATION OF THE LATEST
TYPE OF DIODE

By D. Harrington

PROBABLY the most important of the many recent advances in semi-conductor application is the Esaki diode, commonly called the "tunnel diode". In 1958 L. Esaki announced in the *Physical Review* "a new phenomenon in narrow germanium p-n junctions", and in less than two years the device described already has a complete literature of its own. What is more, tunnel diodes are actually available from more than one firm in this country—not perhaps in anything approaching an advanced form but already useful for certain applications.

p-n Junction

The reader will already be familiar with the physics of the p-n junction. The tunnel diode differs fundamentally from the normal junction diode, which uses "minority carriers" for its action, in that it relies upon majority carriers for its action. In the junction diode, biased in the forward direction, positive mobile carriers from the very slightly impure p-type semiconductor tend to flow in the direction of the biasing voltage, while negative mobile carriers—electrons—from the n-type semiconductor tend to flow in the opposite direction. When they meet at the junction they combine (that is, the electrons fill the vacant "holes") and disappear; a steady current is thus maintained. When the bias is reversed the carriers tend to separate rather than to move towards each other. A "depletion" layer containing few or no carriers is thus set up, and no current flows. Actually, of course, a small current does flow, and this is due to random positive and negative "pairs" being created, owing to heat which has its effect even at quite low temperatures. Fig. 1 shows the normal diode characteristic resulting from the above action.

The doping of the p and n type layers is very light indeed, and thus the carriers produced are not numerous by comparison with the number of atoms of semiconductor present. If the amount of impurity is increased the breakdown voltage—reverse bias—is diminished, until finally with an immense amount of impurity one might expect the "straight line through the origin" to indicate a linear conductor existed.

Negative Resistance

However, providing the "doping" does not go too far, and both p and n type halves of the junction are treated similarly, this does not happen. Instead a characteristic curve similar to that shown in Fig. 2 appears. This is a curious phenomenon, and might well be thought somewhat improbable. However, the drop in current as voltage is increased does actually occur; it can be explained

by the dual nature of electrons, both waves and particles at the same time, and is known as "quantum-mechanical tunnelling".

Briefly, this may be described as follows. With the normal junction diode, biased in the forward

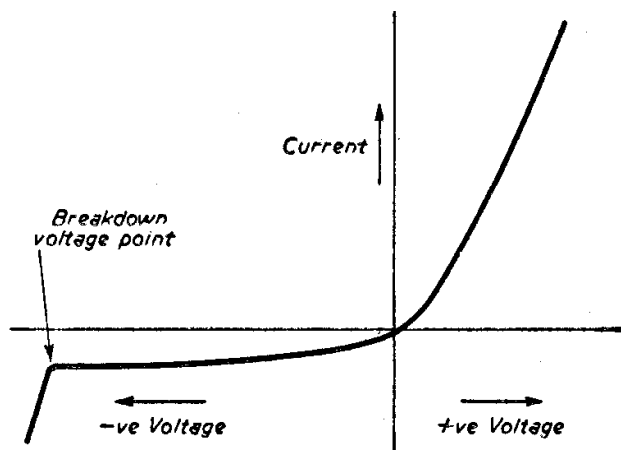

Fig. 1.—The characteristic curve of a normal diode, resulting from the action explained in the text.

direction, as the bias voltage is increased from zero, the thickness of the depletion layer decreases very rapidly until, at about 0.3V current begins to increase rapidly—the normal diode forward current begins. In the tunnel diode, as the forward bias voltage increases from zero the depletion layer thins very rapidly indeed, and because of the high doping, very large numbers of electrons are available. However, before the normal "conductor" voltage has been reached, some of these electrons are able to cross the still remaining depletion layer against the direction of the applied voltage, thus *reducing* the flow of forward current.

They do so for this reason, that an electron is not a small discrete particle—at least when it exists inside a bulk of matter—but rather a volume where the probability exists that an electric charge can be found. If this certain volume is of diameter of the same order as the depletion layer, there is thus a chance that electric charge may turn up on the unexpected side of the depletion layer. Admittedly it is not a large chance, but when vast numbers of electrons are concerned, it becomes a certainty for some of them, and the thinner the depletion layer the more electrons will cross it.

Conditions

It will now be seen that for this tunnelling to occur two conditions must be met. The first is that the depletion layer must be very thin indeed. In practical tunnel diodes it is of the order of a millionth of a centimetre. The second is that vast quantities of electrons must be present, and this is

accomplished by the very high level of doping used. It should be noted that "holes" do not play an appreciable part in this effect. They are not mobile enough to contribute to a significant extent. Further reference to Fig. 2 will show that this tunnelling is responsible for the portion of the curve BC. As voltage is increased still further, the depletion layer disappears and in the region C normal conduction by minority carriers, electrons and holes, takes place as in the ordinary diode. It will also be seen that the voltage at the point C of the curve corresponds to the voltage at which forward conduction begins with an ordinary diode, if the p-n halves were doped as heavily as those in the tunnel diode.

It would now be tempting to point out the negative slope of the curve BC in Fig. 2, and proceed as if the tunnel diode were a "black box" containing a negative resistance. Before physics is discarded for circuitry however, there is one very important point to make. In the ordinary diode, or transistor, current flows by virtue of the diffusion under the influence of the applied electric field of both electrons and "holes". Moreover in the transistor, these carriers have to traverse the width of the base, and this cannot therefore be a rapid phenomenon. It is this fact chiefly which has rendered the production of transistors for VHF such a difficult task. In the tunnel diode the majority carriers have only to traverse a very thin depletion layer; admittedly they do so against the electric field, but the transit time might well be expected to be shorter.

H.F. Performance

Actually, the electrons do not have to travel at all. They disappear at one point and reappear at another instantaneously. They may thus be said to travel at the speed of light, and thus transit effects are of no significance whatever. This means that the high frequency performance of tunnel diodes is limited only by the circuit configurations involved. However, these are very restrictive conditions, chiefly because of the very large capacitance associated with the depletion layer. The inductance of leads to the active p

and n elements is also a limiting factor. The table below gives the capacitances of some tunnel diodes available from British firms.

It has been found possible to produce oscillators in the kMc/s range with experimental tunnel diodes, and when sufficient work has been done with these devices one may expect big strides forward to be made. Silicon tunnel diodes are reported to have worked effectively at 650°F and a degree or two above absolute zero. Used as switching devices, operation in a fraction of a millimicrosecond has been found possible. Tunnel diodes are also believed to be highly resistant to nuclear radiation—over a thousand times more resistant than modern transistors.

Referring again to Fig. 2, it will be seen that the portion BC of the curve represents a negative resistance. Of course, no real "D.C." negative resistance can possibly exist, or if connected across an accumulator it would charge it up without the expenditure of energy—which is contrary to known laws of conservation of energy. However, if connected to an "A.C." circuit the tunnel diode behaves as a negative resistance when given the appropriate forward bias. If it reduces circuit losses, it does so by virtue of the "D.C." power consumed. With present diodes, the value of negative resistance is very low—of the order of 10 to 100Ω and this is not easy to use in a good many circuits. By the way, the reader should pause to note that a low negative resistance in parallel with a high positive resistance gives the total of a negative resistance—try it, using the well-known formula

$$\frac{1}{R} = \frac{1}{R1} + \frac{1}{(-R2)}$$

Manufacturer material	Type	Capacitance pF
STC (germanium)	JK9A	230
	JK10A	1000
	JK11A	1300
	JK19A	230
	JK20A	1000
	JK21A	1300
Texas Instruments (gallium arsenide)	IN650	40
	IN651	40
	IN652	40
	IN653	60

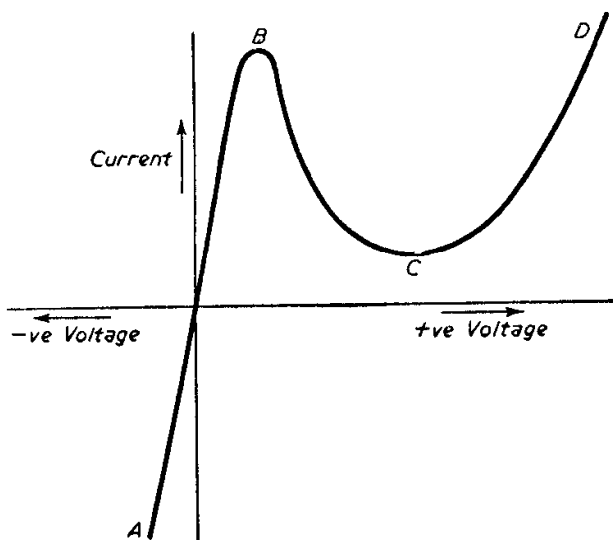

Fig. 2.—Curve modification as a result of the doping explained on the opposite page.

Uses

Tunnel diodes are expected to play a big part in the future for high speed digital computers, working perhaps 100 or 1,000 times as fast as present-day instruments. Its future for television and communications is very bright, largely because of its very low power consumption and excellent high-frequency characteristics; and above all for its low-noise properties which are at present excelled only by masers and parametric amplifiers. It is also likely to be important in "satellite" communication, in radio astronomy and radar.

Shortly, we shall publish some practical circuits using tunnel diodes currently available to the public, and it is hoped after that to give a design for a low-noise frequency charger for VHF incorporating the device.

Valves and their Habits

SOME OF THE CHARACTERISTICS OF VALVES USED IN TV RECEIVERS By H. Peters

THESE notes on various types of valve are intended to give a guide to their general behaviour in television receivers, with special attention to their fault symptoms. The fact that a valve is mentioned in the list does not necessarily mean that it is certain to go wrong, or for that matter that it will not develop symptoms far removed from those given below. "Double" valves, particularly triode pentodes, appear to be the most troublesome. They are harder to make, and as the entire valve has to be discarded when one half breaks down, their chance of failing is consequently double that of a "single" type. Moreover, their versatility encourages equipment designers to use them in a variety of unusual circuits often quite removed from their original purpose.

Emergency Replacements

From time to time "Emergency Replacements" are mentioned in the text. These are valves with the same basing, usually same heater current and only slightly different characteristics. They are not only given as equivalents in any valve manual, but have been proved capable of keeping receivers going at such critical times when new valves are unobtainable.

EB91 (6D2, D77, 6AL5)

This sturdy little 6.3V 0.3A double diode has been used in detector, limiter, discriminator, and interlace circuits right from the beginnings of post-war TV.

It has the habit of lighting up very brightly on switch-on, but this does not affect its performance. The commonest fault is heater-cathode leakage causing hum in varying degrees. This may sometimes be cured in series heater circuits by removing the heater to the low potential end of the chain. An alternative is to construct a "cold" EB91 using two OA71 crystal diodes on a seven pin adaptor plug.

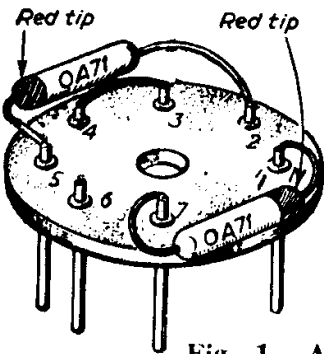

Fig. 1.—A crystal diode can be substituted for an EB91 valve where hum has to be eliminated.

Unequal halves only appear to affect line flywheel discriminator circuits of the balanced type and a simple check is to short the input anode and cathode together. If the line whistle appreciably alters in pitch the valve is conducting unequally and should be replaced.

EF91 (6F12, 8D3, Z77, 6AM6) 6.3V 0.3A

This is a good reliable valve used in almost all early TV's but nowadays superseded by the EF80 or similar valves. As an R.F. amplifier it works well. Also as a

mixer or I.F. amplifier it is efficient (even if it reads "low" on test) but tends to give trouble if it is fitted into the video amplifier or sound output stages, where it is being run pretty hard. The symptoms of low emission in the video amplifier stage are similar to a failing CRT.

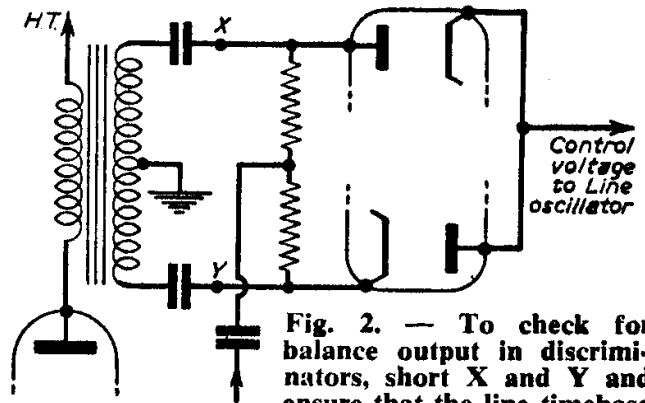

Fig. 2.—To check for balance output in discriminators, short X and Y and ensure that the line timebase whistle does not change.

ECC81 (12AT7)

This valve is a medium impedance double triode employed as a frequency changer in five channel receivers. The oscillator section usually ceases to function first although the heater remains intact.

ECC82 (12AU7)

A double triode valve of low impedance with many applications, such as frame and line multivibrators, A.G.C. circuits, and driver stages in amplifiers. They prove most troublesome in multivibrator stages, the symptoms being variation of the line (or frame) speed when tapped, or the timebase running fast and difficulty of bringing into lock by the hold control. It also contributes to the variable contrast when it is faulty in the A.G.C. gating stages, where one half is sometimes strapped as a diode. If only this section is faulty an OA71 crystal can be tried as a substitute to save replacing the valve.

Note.—Tapped heaters are used on the above two valves (ECC81/82). In 0.15A circuits connect to pins 4 and 5, in 0.3A circuits join pins 4 and 5 and connect to their junction and pin 9. In the latter case one half of the heater sometimes blows prematurely, the symptoms being that the remainder of the chain are still lit but the other half of the faulty valve lights up much brighter than the rest.

ECC84

This is the 6.3V parallel heater version of the PCC84 cascode R.F. amplifier. (See PCC84.)

ECF80

This is the 6.3V parallel heater version of the PCF80 Triode pentode. (See PCF80.)

ECL80 (6AB8, LN152) 6.3V 0.3A

One of the earliest triode output pentodes, the ECL80 has a medium impedance triode and an output pentode capable of 1.4W output (class A). Despite both sections having a common cathode this versatile valve is used as line and frame multivibrator, frame and sound output, frequency changer, etc. A favourite combination is to use a pair, coupling their triodes as frame multivibrator and using the pentodes as sync separator and frame output.

Common Fault Symptoms with ECL80 Valves

Line multivibrator:	The line speed varies when tapped—line frequency is too high to be brought into lock with the hold control. Watery verticals.
Frame multivibrator:	The hold control needs constantly re-adjusting, the speed varies if tapped, the picture "judders" vertically.
Frame output:	Lack of height, foldover at the bottom of the raster.
Sound output:	Distortion and self oscillation (but check the cathode bias decoupling condenser first).
Mixer/local oscillator:	The slow heating triode section causes the sound and picture to arrive with a "bang" after the rest of the set has warmed up.
Coincidence detector (Flywheel Sync):	Produces oscillating verticals—picture waves about snake-fashion.

Shortcuts

The sound output and sync separator stages are the least troublesome as far as these valves are concerned, and the ECL80's in these two stages may sometimes be successfully changed over with those in the more sensitive parts of the set.

In series heater circuits, a PCL83 can be used as an emergency replacement, provided that valve-holder pins 3 and 7 are joined—as they usually are.

EF80

Another reliable valve, which will give good results in I.F. stages even after many years' use. Although the characteristics are the same, the internal appearance of EF80's may vary considerably. Inter-electrode shorts are sometimes denoted by a bright spot appearing near the top or bottom of the electrode assembly.

In series heater circuits this valve can be used as an emergency replacement for 30F5, EF85, 6F19, 6F23. The pin connections are the same even though the characteristics are slightly different.

EF85

The variable- μ companion to the EF80, this valve is commonly used as the first vision or common I.F. stage. Being variable- μ its gain can be controlled over a wide range by the vision AGC line, and if the circuit is carefully arranged the grid to cathode capacity can also be varied by the AGC voltage. In this way the input circuit tuning can be varied according to the signal strength so that the overall response is peaked towards the vision carrier on a

weak signal and is progressively flattened to give a wide passband on a strong one. This arrangement—"automatic bandwidth control" has been in use for some years on one make of receiver. A common fault is grid emission or inter-electrode leakage. This results in a positive voltage being fed to the AGC line and produces negative pictures.

EL81

The 6V equivalent of the PL81, used in parallel heater circuits. (See PL81.)

EY51

A wire-ended EHT rectifier with a 6.3V 90mA heater, which is normally fed from a well insulated winding on the line output transformer.

This is the original EHT rectifier which in 1948 made the A.C./D.C. technique possible in the television receivers and which is still in extensive use today. During the years its peak inverse voltage rating has been raised to 17kV in order to cope with larger tubes and higher final anode potentials and its physical size has been slightly reduced. General symptoms of its failure are blackening around the glass just below the bell and a picture which "blows up" in size as the brightness control is advanced (the latter fault may also be due to a displaced ion trap magnet). The high voltages present when running make the valve difficult to check by conventional means and the filament colour provides a useful means

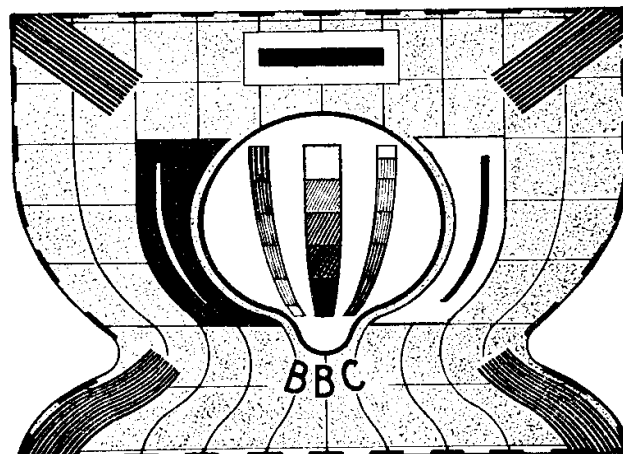

Fig. 3.—A "wasp-waisted" raster is caused by heater-cathode leakage on PL81.

of ascertaining the operating conditions by comparing it against the filament colour of a similar valve run from a 6V battery. In many cases a dim filament will indicate a low line output stage, and it is not always appreciated that unless the line output stage is working correctly, the EY51 may not light up at all.

An EHT short or excessive current drain by the CRT will also dim the filament and this property is useful to enable the brightness control to be set to a working level before adjusting the ion trap magnet when a new tube is fitted. The author found that if the brightness control is set to just cause the valve filament to dim slightly, a bright raster is ensured when the ion trap passes its correct position.

If the filament is too bright, short life usually results, and this may be overcome by fitting a small resistor in series with the heater lead to absorb some of the surplus. A 22 Ω or 27 Ω carbon resistor, $\frac{1}{4}$ W is usually adequate.

EY86

The EY86 is the plug-in version of the EY51, which has a slightly higher filament current and higher peak inverse voltage rating. These improvements make for easier servicing and better results with the wider angled tubes.

The fault symptoms and general notes on the EY51, apply equally to the EY86. Early productions of this valve had no apparent gettering (the metallic patch on the glass being absent), but current valves are gettered in the conventional way. In a certain make of receiver the EY86 suffers a short life, and if continual replacements are required a special replacement type TY86 should be used.

EL38

This is a 6.3V octal based line output valve with similar characteristics to the PL38.

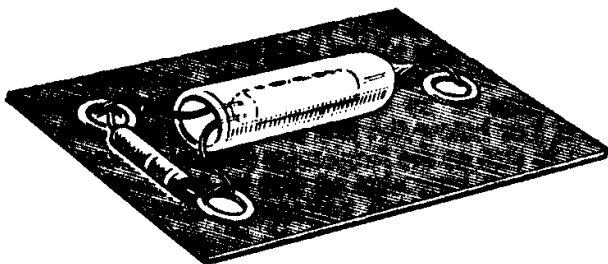

Fig. 4.—This shows the method of connecting a 15Ω resistor to absorb surplus heater current on valve type U25 (see page 268).

PCC84 (30L1, 7AN7, B319)

The PCC84 is a double triode cascode R.F. amplifier with 7V, 0.3A heaters for receivers operating on Bands I and III. Its commonest fault symptoms are low gain and a "grainy" picture, and in fringe areas is being superseded by the PCC89 and 30L15 frame grid valves. These valves have the same base connections and the same heater current but their mutual conductance is double that of the PCC84, providing a considerable increase in gain particularly on ITA. Unfortunately it is not possible to use these later types as direct replacements for the PCC84 or its equivalent without alteration to the tuner unit. The author has found that in many cases a 30L15 will, however, give greatly improved results by merely retuning the small trimmers usually positioned at the top of the tuner or on the individual coil biscuits.

PCC89

A "frame grid" double triode cascode R.F. amplifier with 7V, 0.3A heaters. (See PCC84.)

PCF80 (30C1, 8A8)

This 9V, 0.3A heater triode pentode was primarily intended as a mixer on BBC/ITA tuners but was subsequently used for almost everything else.

A low triode, or one which has been overloaded may usually be recognised by brown patches on the glass opposite the hole which is halfway up the triode anode side. Intermittent faults can usually be observed by giving the valve a gentle tap whilst running. Other fault symptoms are a poor signal-to-noise ratio which indicates a pentode fault or a weak ITA (or no ITA but BBC satisfactory) indicates a triode fault.

Line Multivibrator

The line timebase runs fast and will not lock, and the line hold control at the extreme end of its range. The line speed may vary when tapped or during an evening's viewing.

Sync Separator—Half Line Oscillator

When used in this circuit pulling on picture (cogging), false line lock and line timebase runs fast may result if the valve is faulty. A negative picture may also occur (if AGC is mean level).

Video Amplifier/Cathode Follower

In this type of circuit a red hot anode or red hot G2 electrodes may occur. This is not usually due to a faulty valve but to a heater to cathode breakdown on the CRT, although the valves emission will be impaired if the set is run for a while in this condition. (See also PCF82.)

PCF82

Another mixer with 0.3A heater, the PCF82 has the same basing as the PCF80, and can be used on higher working voltages than the normal 180V line; its characteristics (mainly the triode) are slightly different from the PCF80, but it may be used in its place (sometimes with improvement) in mixer and sync separator stages.

PCL82

A triode output pentode with 3.5W output, this valve is used predominantly as a frame oscillator/amplifier. Its fault symptoms—usually low emission pentode—are cramping at the bottom of the picture sometimes with foldover. This condition may correct itself slowly as the valve warms up. For repeated failures of this kind, check that the screen grid feed resistor has not changed in value. Sometimes encountered as a sound output stage where it gives little trouble. Check feedback condensers for leakage if distortion is present.

PCL83

A smaller version of the PCL82 with different basing. Used in a variety of circuits, but mainly in the sound output stage or frame timebase. As a sound output valve it commonly becomes microphonic and will probably cut off completely if tapped. It should also be suspected if hum is present after the interference limiter stage. In an emergency, a 30PL1 may be fitted in its place, and will give greater output.

PCL84

A video output pentode-with-triode, having the same base connections as the PCL82 this valve incorporates a Pentode with a higher slope but slightly less power output and a lower impedance triode. A comparative newcomer, the PCL84 has not developed any peculiar fault symptoms for the writer, but has behaved itself rather well.

PL36

A line output valve on an octal base for 90deg CR Tubes. Suitable to replace the PL38 and 30P4 in an emergency.

PL38

An early octal base line output valve. Fault symptoms are softness, when the valve glows bright purple (not blue, which is apparently normal) and grid sag which usually burns up the cathode resistor. This latter symptom is more often met when the valve is mounted upside down or horizontally.

PL81

This is a 0.3A heater, B9A based, line output valve. The symptoms of low emission are usually a narrow dim defocused picture possibly cramped on the right hand side. This does not apply to 110deg sets using a desaturated transformer where the valve can age considerably before a deterioration is noticed. A red hot grid denotes excessive screen grid current due to a change in value of the screen dropping resistor or insufficient drive. Heater cathode leakage can produce a "wasp waisted" effect and internal shorts are usually marked by bright flashes inside the valve. An alternative valve type is the 21B6, which is slightly fatter and may now be obtained and fitted as a direct replacement for the PL81. It is claimed to be more reliable. Parasitic oscillation sometimes produces a bright line on the left of the screen on ITA channels, and in many cases can be removed by fitting a ferrite bead at the anode or a magnet around the "waist".

PL82 (30P16)

Generally employed as a frame output pentode, the common symptoms of failure are a slow stretching out of the height for a good while after warming up, eventually producing cramping at the bottom of the picture, possibly with foldover. This valve may be exchanged with a 30P12 in an emergency but the difference in bias may prevent correct linearity from being obtained.

PL83

Designed as a video amplifier, in which stage it seldom gives trouble, but often used as a frame amplifier where it exhibits the same symptoms as the PL82 after a while. It frequently develops heater cathode leakage in which case a "judder" is imparted to the picture giving the effect of two flickering pictures one half an inch or so above the other. If these symptoms are combined with foldover the grid coupling condenser should be checked for leakage.

PL84

A newcomer to the frame output valve group with the same base, connections and heater current as the PL82. Intended for the extra power required by 110deg tubes, its chief failing to date has been the production of Barkhausen-Kurz (parasitic) oscillations. These take the form of a series of bunched scanning lines similar to telegraph wires which move slowly up and down in the middle of the screen (30P18 equivalent).

PY80 and PY82

These early 0.3A efficiency diode and H.T. rectifier have the same base connections and in an emergency

are interchangeable. The PY80 has better heater-cathode insulation but a lower H.T. current rating than the PY82.

PY81

A popular efficiency diode, this valve seldom goes low but may flash over internally due to flaky cathode. A red hot anode can denote an H.T. short in the line output stage, or a heater-cathode short in the valve itself. Lift the top cap (cathode) lead from the valve, and if the glowing ceases suspect the circuit but if it persists, suspect the valve. (See U251.)

PY32

These form the current H.T. rectifier for many TV's. The early form had a shaped envelope and two separate anodes connected to pins 3 and 5. Later versions have a straight sided envelope and a single long anode, and when this type is used it should be checked that pins 3 and 5 are joined on the valveholder. Fault symptoms are those of weak H.T., namely a dim, small, defocused picture and weak sound, all of which take longer to appear than normal.

PZ30

The early H.T. rectifier, comprising two separate rectifier sections in the same envelope. This led to several manufacturers using one half as efficiency diode and the other as the H.T. rectifier, but the trouble that this arrangement caused at first has now largely been overcome.

SP41/61

These two are early R.F. pentodes of similar design but having respectively 4V and 6V heaters. These valves were used widely in early post war receivers because of their availability from surplus Government stock. Apart from low emission the major faults are mostly physical—namely intermittent metallising due to the valve becoming loose in its base, a dry joint top cap causing noisy operation and erratic synchronising, weak heater valveholder contacts, due to the heavy current drawn. The offending valveholder pins may usually be taken out and tightened without replacing the entire holder.

(Continued on page 268)

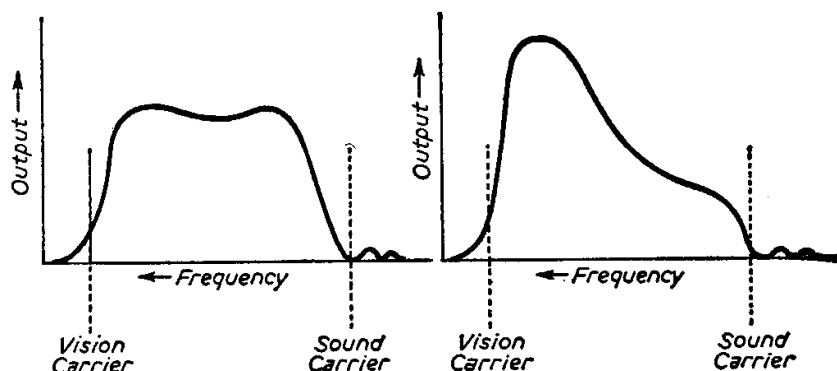
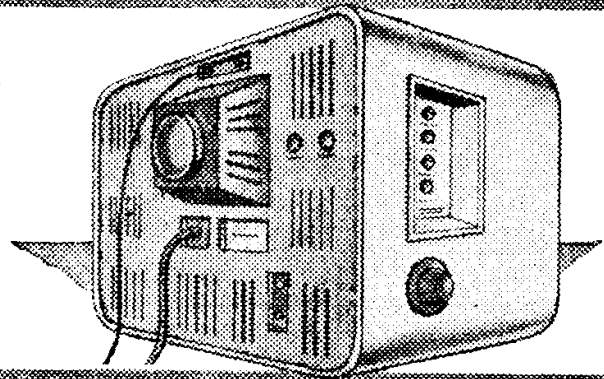

Fig. 5.—EF85; (6F19): Response curves showing the Automatic Frequency Control effect.

On the left, with a strong signal, a bandpass alignment is produced. On the right, with a weak signal, the response curve is peaked towards the vision carrier (see page 243).

Servicing Television Receivers



No. 64—THE HMV1854, MARCONI VT 153 AND ASSOCIATED MODELS By L. Lawry-Johns

THE 1854 was directly developed from the HMV 1840 series of receivers and the circuit is virtually the same although there are many minor variations. The tube is an Emiscope SE17/70 which uses a B12A base and has an ion trap assembly as a distinct break from the almost traditional B7B base and straight gun assembly of earlier Emiscope tubes. The heater of the SE17/70 is rated at 6.3V, 0.3A and it should be noted that this type of tube was fitted in later versions of the 1840 (SE14/70), 1842 (SE17/70) series and that these models were almost identical to the 1854 as the focus network was deleted and focus pin (6) was preset to connect to pin 10 (first anode), pin 11 (cathode) or chassis (pin 12).

The tuner unit fitted in all these models is the E.M.I. incremental inductance type which covers the whole of Band I and Band III by progressive switching of coils (Band I) and loops (Band II). The loops on the Band III sections look more like shorting strips and this has caused more than one user of our query service to be misled into thinking that the Band III sections were deliberately shorted out and the receiver fitted only for the reception of Band I.

A Very Common Fault

A confusing fault often occurs on these, and some other receivers, which consists of persistent arcing from the outer coating of the tube to the chassis members and coil assembly and in spite of efficient earthing, anointing various parts with silicone grease, etc. The condition persists to a point where the receiver becomes unusable. This should not be confused with the violent arcing which takes place when the cable from the line output transformer to the CRT anode breaks down and shorts to the perforated screen of the line output section. A replacement length of cable will put this right. The condition referred to is that which causes indiscriminate discharge at all points around the CRT bulb and neck. This is caused by a breakdown of insulation of the U151 (EY51) heater winding inside the line output transformer. This can be overcome by brave and determined enthusiasts who are prepared to delve into the grease-filled case and rewind the heater turns, but the writer would recommend the replacement of this transformer with a modified unit using an EY86 (plug-in) valve mounted in a more accessible position to avoid

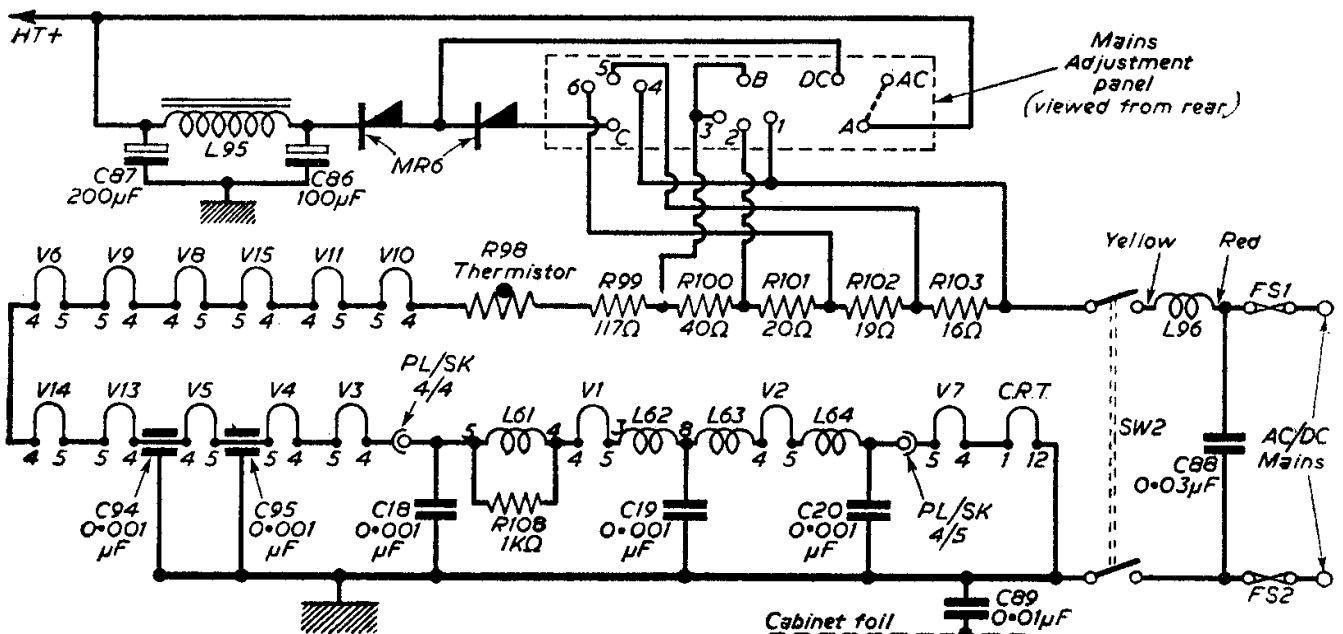

Fig. 1.—The heater chain of the receiver dealt with here.

further trouble. These exact replacement transformers are available from most dealers, and some of our advertisers. It will be realised that a defective U151 will give rise to similar replacement difficulty and the fitting of a modified transformer should be considered as an investment.

Adjustment of Line Drive

It is vitally important to ensure that the drive control (TC5) is correctly set. Incorrect setting can damage the line output valve, the line output transformer, or both, as well as giving rise to an inferior picture. It is initially set at the factory and should not require adjustment until the line output valve (PL81 V10) or line oscillator valve (PCF80 V9) is replaced or some repair has been carried out in the line timebase. The method of adjusting is as follows. Adjust the picture for normal reception. Reduce contrast and width to a **minimum**. Turn line drive control knob to **maximum anti-clockwise** when a faint white bar will appear near the centre of the screen. Turn

If the PL81 has a short life and lack of width necessitates its replacement again within a short time, check R77 which is the 4.7k screen dropper resistor to pin 8 of the PL81. A wire-wound resistor should be used in this position as carbon types do tend to change in value.

Trimmer TC5 will also require resetting when a new PL81 is fitted. Check V9 and R70 if necessary.

Poor Line Hold

If the hold is at one end of its travel (ensure that the carriage does traverse the element) and the screen is still a mass of lines or is perhaps resolving a picture or part of one at one end, try a replacement PCF80 in the V9 position and then check R69 (330k) and R109 (also 330k).

If the hold control is not at one end but is critical in its setting, see that TC10 is screwed up to maximum capacity and check V7 (PCF80).

If the picture is spoiled by horizontal tearing, although the control is not critical in its setting,

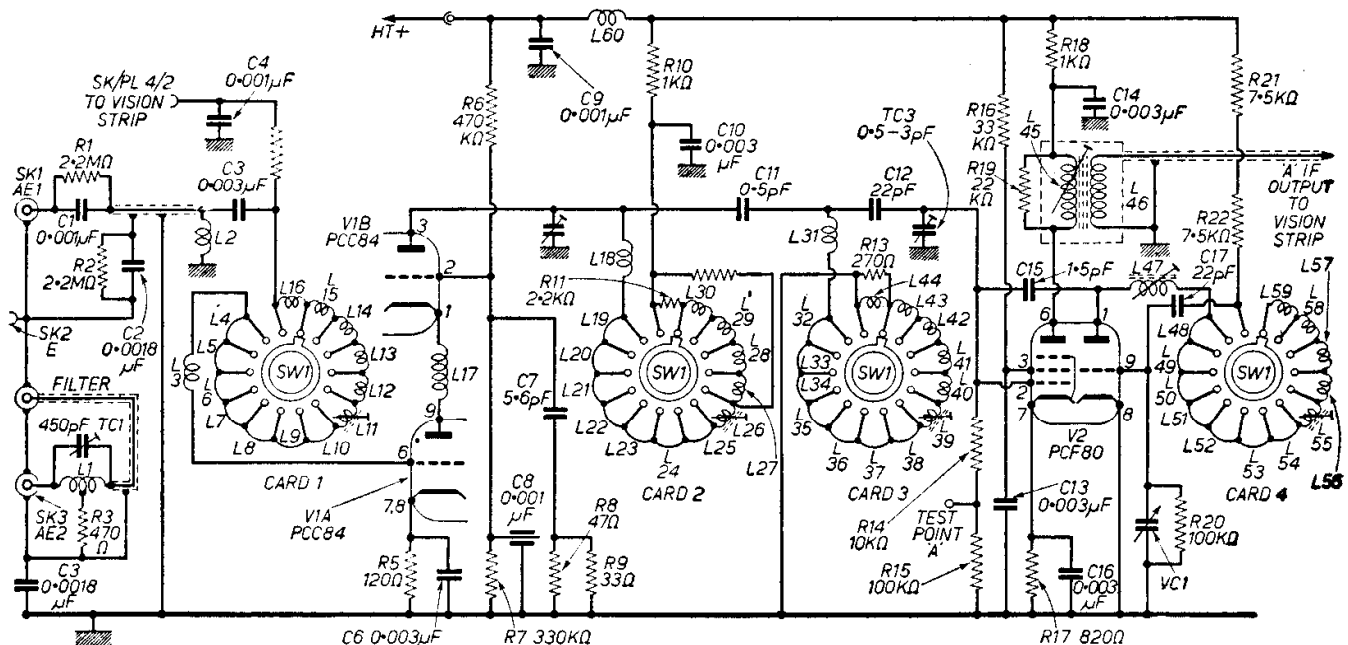

Fig. 2.—The incremental inductance tuning may be seen on the tuner circuit above.

the drive control clockwise just enough to eliminate this line. Do not adjust beyond this point. Reset width and contrast for normal conditions.

Lack of Width

When the width control is set to maximum and the screen is not completely filled, i.e. there is a gap either side, check the H.T. voltage at any convenient point (socket A on the mains panel).

Normally the D.C. voltage should be approximately 215. If the voltage is below 200, the metal rectifier (MR6), which is a type 14A949, should be replaced. If the voltage is over 200 however the PL81 (V10) should be suspected. When replacing this valve, note the position of the anti-parasitic ring (magnet) the purpose of which is to damp out any tendency to oscillation (B-K effect) in the valve which would give rise to ragged vertical interference down the left side of the screen.

unscrew TC10. These conditions may occur in areas of weak signal or heavy interference. Unscrewing TC10 will reduce the tendency to tear or for the verticals to have a ragged appearance but will result in a more critical setting of the hold control which may require resetting during the warming up period. This may be preferable to a picture which is spoiled by constant horizontal disturbance. Whilst on this subject of horizontal displacement of verticals it is pointed out that the reception of ghost images by the aerial will not only cause secondary images to the right of the original and thus mar definition but will also cause horizontal displacement, usually in bands according to the scene transmitted, giving the impression of a fault in the line timebase. One or more light bands may be seen down the left side of the screen.

The cure for this is to resite the aerial or use one of a more directional type. Placing the aerial on its side (in the loft) with one end pointing

to the source of the reflection (say a factory chimney) will often clear a stubborn ghost if the loss of gain can be tolerated.

Poor and Grainy Picture

When this is experienced particularly on Band III (ITV), first ensure that RV9 is properly set to obtain maximum gain without overloading on either channel. RV9 is the gain control which cancels out the negative AGC voltage applied to the PCC84 (V1). If advanced too far in some areas, overloading may occur in the form of sound on vision and vision on sound (cross modulation), it should be set to maximum where these effects do not occur. If RV9 is set correctly and the picture is still grainy, replace V1 and ensure the aerial system is efficient. The filter input can be used to reduce the BBC signal in some instances by tuning TC1 thus allowing RV9 to be set to maximum for best results on Band III. The purpose of the filter is to tune out interfering signals which may give rise to patterning of the picture or whistles on the sound. This is particularly useful when scatter transmissions are causing interference on Band I.

Lack of Contrast

When the vision signal is weak but not particularly grainy, and advancing the brilliance gives a bright raster, check V5 PCF80, V6PL83, MR1 and the components associated with V6 including R41, R42, R43, etc.

If advancing the brilliance only produces a grey or yellowish raster with a tendency to blur and cause the picture to turn negative, the tube itself is almost certainly at fault. After about four

years' wear this is almost inevitable and although a degree of boost may be applied, tube replacement cannot long be delayed. Boost may be applied by wiring a 5k 10W resistor from the top tag of the left side mains dropper to pin 1 (SE17/70) of the tube base socket. On 1840 series models using tubes 5/2 or 5/3, this would be pin 5.

No Vision or Sound Signals

This means that although no signals can be received some noise is heard in the speaker and a raster is resolved when the brilliance is advanced. Having checked the aerial input and other obvious points, the first suspect should be the V2 PCF80. (This could be the cause of no signals on Band III but normal signals on Band 1.) Then check V1, V3 and V4. If the valves are in order, check the voltage supplies to the valve bases and the tuner unit resistors particularly R21-R22. Quite often a short in a PCC84 or PCF80 will cause a resistor (R18 or R10) to burn out with probable damage to R5 or R17. If resistors are found damaged and the valves are not at fault, check the relevant 0.003µF or .001µF decoupling capacitors.

[Note—Although most of the decoupling capacitors are marked 0.001µF in the diagrams, these may be found to be 0.003µF].

Little or No Control of Contrast

First see that the contrast (RV1) slider is moving along the track of the element and then check the element (10k) which may be o.c. at one end. When RV9 is inoperative, check the AGC line decoupling capacitors particularly C62.

(To be continued)

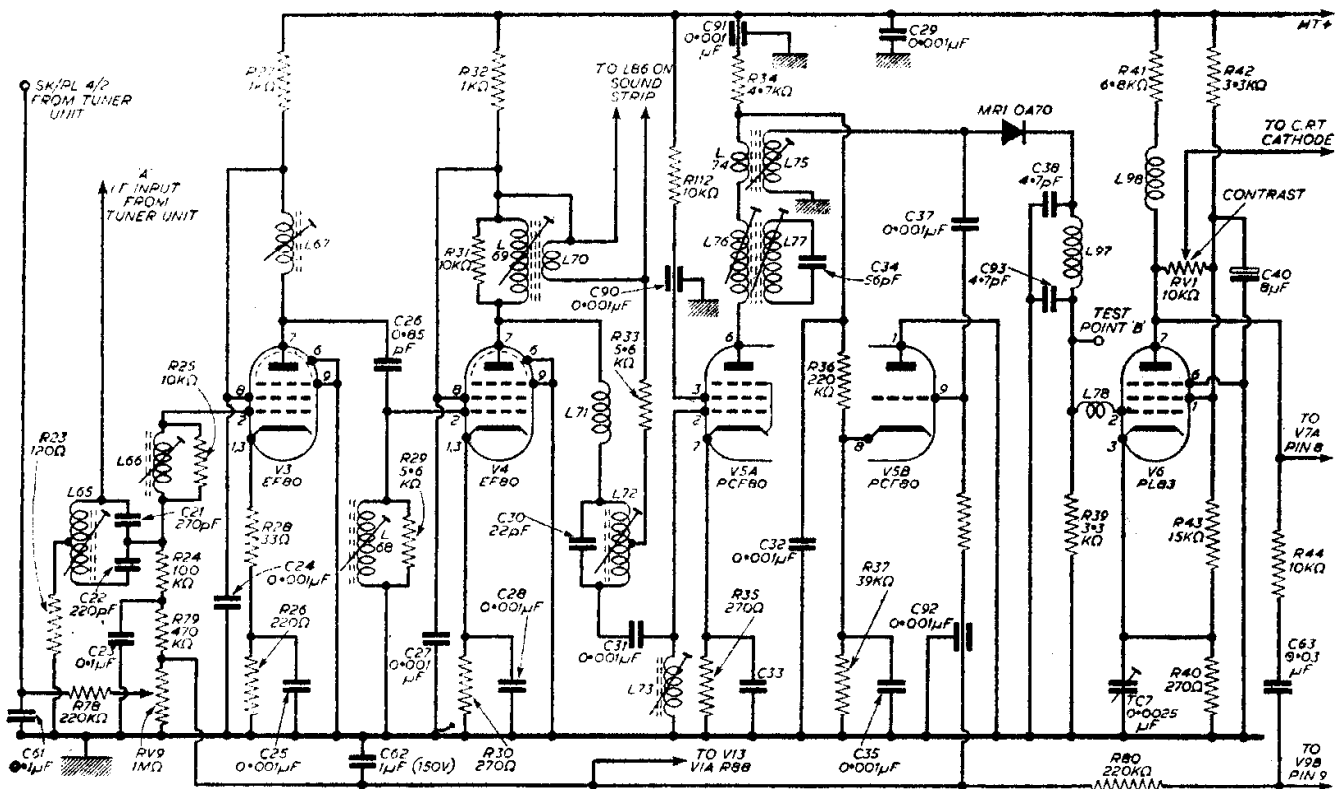

Fig. 3.—The vision strip of the 1854 and associated models.



Television Receiving Licences

THE following statement shows the approximate number of Television Receiving Licences in force at end of November 1960, in respect of television receiving stations situated within the various Postal Regions of England, Wales, Scotland and Northern Ireland.

Region	Total
London Postal	1,883,913
Home Counties	1,510,986
Midland	1,667,696
North Eastern	1,786,568
North Western	1,430,546
South Western	928,679
Wales and Border Counties	663,644
Total England and Wales	9,892,925
Scotland	980,435
Northern Ireland	155,360
Grand Total	11,027,821

Venezuela Orders More TV Transmitters

AN order for over £100,000 worth of additional television equipment for one of two commercial TV networks in Caracas, Venezuela, has been placed with Marconi's Wireless Telegraph Company by the joint owners, Corporación Venezolana de Televisión C.A. and American Broadcasting Company International.

The transmitters and associated equipment to be provided and installed by Marconi's will enable the station to establish a network service extending over the nearby Valencia-Maracay-La Victoria area and westwards to Barquisimeto and Maracaibo (a distance of about 400 miles).

Equipment to be provided under the new contract includes three vision and three sound transmitters.

First African Television News Team to Congo

TWO Western Nigerians will be the first African television news team to cover events in the Congo.

Despatched to Leopoldville by WNTV, Africa's first TV network, Tunji Shenjolsi, 25, and Amusa Lasisi, 27, will give Nigerian viewers a first-hand report on Congo developments by film and tape recorder.

Shenjolsi is a senior editor in the WNTV news department while Lasisi is the station's chief cameraman.

Interest in the Congo situation has mounted rapidly in Nigeria since it sent its own troops there to serve under the United Nation's command. The two newsmen will cover the Nigerian troops' activities as well as general news.

The films and tapes will be

flown back to the Ibadan station by special plane. WNTV officials say that there will be only 24 hours' delay between the time the news is gathered and broadcast.

TV and Inspection

A TV camera to probe for cracks in blocked sewer pipes has been developed by the industrial division of Pye TVT Ltd. The camera has a built-in lighting system to illuminate the pipes through which it is pushed on a rod.

Pipes of as little as eight inches diameter can be inspected—greatly simplifying maintenance and cleaning.

A successful pilot scheme has already been carried out in Wandsworth.

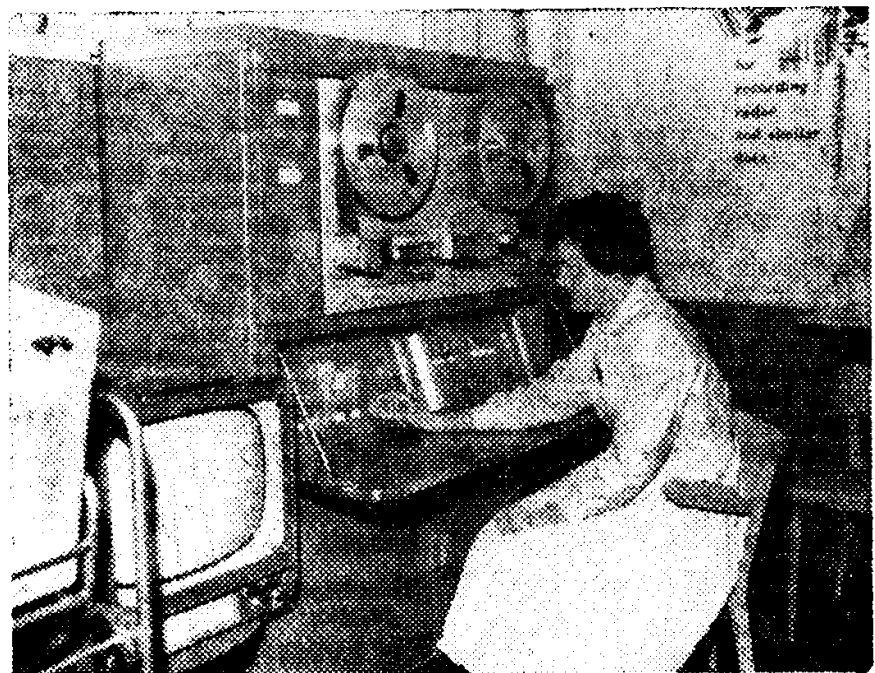

The control panel of a Videotape television recorder (Ampex VR-1001A), recently on show at the Industrial Photographic and Television exhibition held in London.

Low-Power Television Station for Hastings

THE BBC, as part of its plan to extend the coverage of its television service and to improve reception in areas where this is not at present satisfactory, is to open a low-power television transmitting station at Hastings.

This is an experiment in the use of a very low-power translator of a new type which has been developed by the BBC. It is hoped that such translators will be found suitable for improving reception in a number of other towns at a later stage.

The station will pick up the Crystal Palace transmissions and re-radiate them on Channel 4 (vision 61.75Mc/s, sound 58.25Mc/s). The transmissions will be horizontally polarised.

The site of the new station at Amherst Gardens, Hastings, has been chosen as a compromise since it is necessary to use a receiving site that will allow the best possible signals to be picked up from Crystal Palace, and at the same time will enable the transmitter to give improved service to as many people as possible. Despite the distance from the parent station, it is hoped that the pictures received and re-transmitted by the new station will be of a satisfactory technical standard. Although its range cannot accurately be predicted, the new station will provide many thousands of people in Hastings and St. Leonards with a considerably improved standard of reception.

New aerials, with the elements horizontal, will be necessary for receiving the new transmissions, and they should be directed so as to give the best results. Viewers who are doubtful whether the change will be worth while in any particular part of the town should consult their local radio dealer.

The experimental transmissions are to begin on Wednesday, 14th December, and will continue throughout normal television programme hours, including the trade test periods.

A Motorised Turret Tuner

A NEW motor-driven tuner designed to cover all TV channels and FM channels, has been introduced by the Plessey Co. Ltd. This new unit (type PL 14M) will facilitate the use of remote control and push button TV/FM tuning techniques in

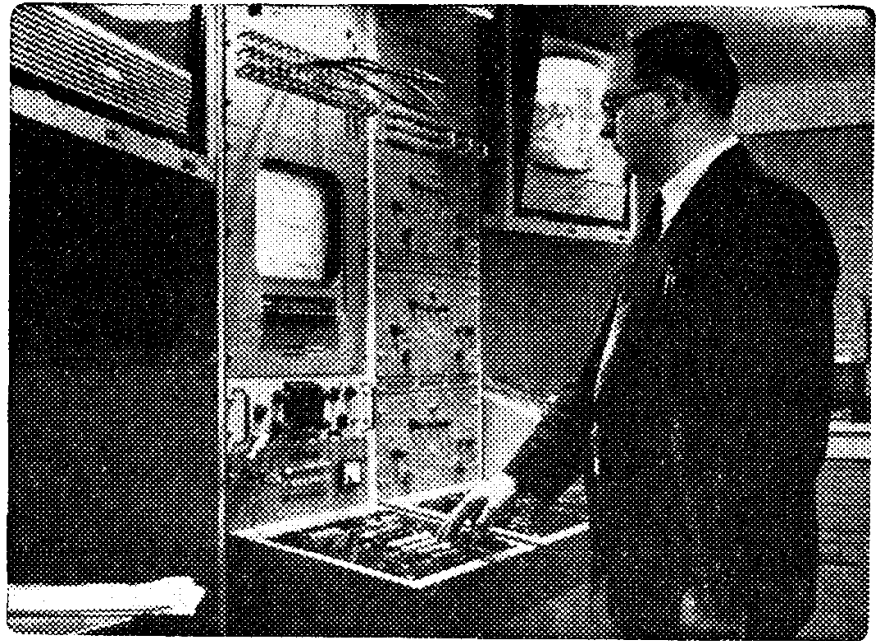

The new liner "Oriana" is fitted with a television installation by Marconi. The system enables passengers to enjoy local TV programmes at all ports of call and live and telecine programmes transmitted over a closed circuit system. The control console is shown above.

domestic TV receivers. No mechanical loading falls on push buttons, which are used only to switch electrical circuits.

Using the latest frame grid valves, the R.F./oscillator unit features high gain, low noise and low drift characteristics.

A new contact design in the turret affords accurate re-setting with minimum frequency drift. For special applications, however, a fine tuner is available as an optional fitment.

The specially developed motor drive unit for the turret tuner uses a mains voltage induction motor to eliminate interference. Accurate re-setting by self-indexing the turret, and automatic disconnection to prevent overrun when the motor is switched off, are provided by a special clutch unit.

This new motorised turret tuner can be mounted anywhere in the receiver as its position is not dictated by the need for external controls.

The operating time of tuner for 360° rotation is seven seconds.

Television Camera Channels for Mexico

ELEVEN Mark IV television camera channels made by Marconi, are currently awaiting shipment to Mexico for use there by two television broadcasting

authorities. Nine are to go to Telesistema Mexico, which operates three commercial transmitting stations from a large studio centre in Mexico City.

The remaining two have been ordered by Radio Television Mexico, a commercial organisation which operates at Tijuana, on the Mexican border with California. The coverage of the station thus extends well into United States territory.

Television on "Oriana"

THE television receivers in the new 42,500-ton liner "Oriana", forming part of the first round-the-world television system on a British ship, are Ekcovision 525-line export models. Some 60 receivers are fitted in the public rooms, first-class cabins and suites, for showing 525-line pictures when receiving American programmes, or 625-line pictures from stations using the Continental system. A special standards converter will permit reception of 405-line television when the vessel is within range of British transmitters, enabling the receivers to operate as 525-line models while showing our programmes. Passengers will also be able to enjoy Ekcovision viewing when the "Oriana" is hundreds of miles from land—via the ship's own 525-line closed-circuit film transmissions.

FOR READERS OF "PRACTICAL TELEVISION" AT REMARKABLY LOW COST!

RADIO, TELEVISION & ELECTRICAL REPAIRS



AMAZING 'KNOW HOW' BOOK Saves You Pounds

Here is just the practical, at-a-glance guidance YOU need, whether you wish to know how to service radio and TV sets, install lighting points, or repair any domestic appliance, from a bell or an iron to a vacuum cleaner or washing machine. Explains basic principles and working of modern radio and TV sets and electrical appliances. Shows how to test for faults, carry out maintenance and repairs by the most modern methods. Special section on the operation and servicing of frequency modulated receivers. 480 pages. Over 400 illustrations. Amazing VALUE—Standard Edition, 21/-. or De Luxe, superb leather-cloth, at nominal extra cost of only 2/-. Prices include postage, packing, etc.

ALL THIS—AND MORE IN ONE GREAT VOLUME!

Comprehensive Contents Include
Current, Voltage and Resistance. Coils, Capacitors and Valves. Basic Radio-receiver Circuits. Preliminary Tests. Instruments for Set Testing. Locating Faults. Dynamic Testing. Tuned Circuit Alignment. Noises, Interference, Distortion and Instability. Components. Loudspeakers. Pick-ups. Gramophone Motors. Frequency Modulation. Television Circuits and Test Gear. Television Faults, Symptoms and Cures. Aerials and Pre-Amplifiers. Maintenance of Domestic Electric Wiring. Small Appliances. Fires and Space Heaters. Vacuum Cleaners and Polishers. Rewinding Small Motors. Cookers and Boiling Plates. Washing Machines. Refrigerators. Electric Water Heaters. Battery Charging. Testing and Repairs, etc.

ESSENTIAL TO EVERY SERVICE ENGINEER, ENTHUSIAST AND HANDYMAN!

Getting the best from RADIO AND TV SETS

Here is expert advice that will enable you to make the necessary adjustments or repairs in order to get the best possible performance from any radio or TV set.

All you need to know about DOMESTIC WIRING

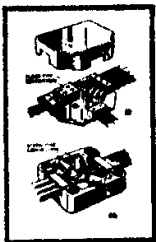

Learn from these helpful pages how to carry out all kinds of installations and extensions—with efficiency and safety! Complete guidance on conductors, insulation, safety regulations, conduits, cables, earthing, practical work, fuses, flexible cords, etc.

BASIC RADIO CIRCUITS

All you want to know about circuits, so that you can find your way around modern sets without hesitation. How components form various types of set: gives circuits for 1-valve receiver, 3-valve receiver, battery TRF receiver 4-valve superhet, Universal sets, etc.

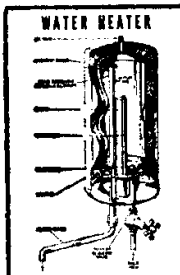

FIRES & SPACE HEATERS

Full, easy-to-follow instructions for servicing small domestic fires—whether of the radiant, reflector or convector type.

WATER HEATING

All you should know about the various types of electric water-heaters and how to install them and keep them in perfect working order. Advice that will save you POUNDS!

TRACKING DOWN TROUBLE

This grand book is invaluable for tracing faults in radio and TV sets. Tells you all you want to know—from how to carry out Preliminary Tests to how to align R.F. and I.F. circuits. Shows how to carry out Dynamic Testing. Also shows how to trace the causes of Noises, Distortion and Instability and deal with the trouble. Gives detailed information on Components and Loudspeakers and how to deal with any faults that may develop.

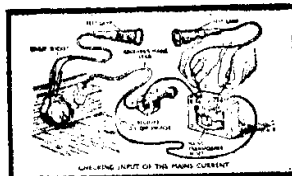

See how to maintain Vacuum Cleaners and Floor Polishers, Refrigerators, Cookers and Boiling Plates, Washing Machines, etc.

Do your own BATTERY CHARGING Here are clear, complete instructions.

DO THIS NOW!

Simply complete form, indicating Edition preferred, and post in a 2d. stamped, unsealed envelope to Dept. H.F.35, Odhams Press Ltd., Basted, Sevenoaks, Kent. Offer applies in the U.K. and Eire only, closes February 28th.

FULL SATISFACTION GUARANTEE

SEND NO MONEY NOW!

To: Dept. H.F.35, Odhams Press Ltd., Basted, Sevenoaks, Kent.

WITHOUT OBLIGATION reserve me "Radio, Television and Electrical Repairs" and send Special Invoice with "100— Satisfaction or No Charge" Guarantee.

Cross out edition Not required: STANDARD/DE LUXE

BLOCK LETTERS BELOW

NAME

Full Postal ADDRESS

H.F. 35/Feb. 61

LASKY'S RADIO

MAKER'S SURPLUS COMPONENT BARGAINS

- WIDE ANGLE 38 mm.**
 Line E.H.T. Trans. Ferroxcube core, 9-16 kV. 19/8
 Scanning Coils, Low imp. line and frame 19/8
 Ferroxcube cored Scanning Coils and Line Output Trans., 10-15 kV. EY51 winding Line Trans. with width and linearity controls, circuit dia., pair. ... 50/-
 Frame Output Transformer Frame or line block osc. Transformer 6/8
 Focus Magnets Ferroxcube P.M. Focus Magnets, iron Cored 12/6
 Duomag Focallisers 15/-
 300 m/a Smoothing Chokes 10/8
- STANDARD 35 mm.**
 Line Output Transformers 6.9 kV E.H.T. and 6.3 v. winding. Ferroxcube .. 17/8
 Scanning Coils. Low imp. line and frame 7/8
 Frame or line blocking oscillator Transformer .. 4/6
 Frame Output Transformer Focus Magnets: Without Vernier 9/8
 With Vernier 12/6
 200 m/a Smoothing Chokes 7/8

LIMITED NUMBER ONLY 17in. TV Chassis NEW AND UNUSED

200-250 v. A.C./D.C. Complete with 13 new Brimar valves, latest Fireball turret tuner covering all channels Bands I & III (i.f. 33-38 Mc/s). Ferroxcube line output transformer and wide angle 90° scanning coils, ion trap, latest electrostatic focus. All first quality components. Printed circuit construction. Overall dimensions: 8 x 15 1/2 in. Valve line-up: 3 PCF80, 1 PCC84, 3 6BW7, 1 PCL84, PCL82, PY82, PL81, PY83, EY51.

LASKY'S PRICE £18.19.6 Carr. & Ins., 7/6.
 Complete with valves, circuit diagram and full data.

Circuit diagram and full data available separately, 2/6.

C.R. TUBE. Brand new Brimar C17SM 17in. C.R. Tube, 13 amp. heater, electrostatic focus, 90° deflection. Guaranteed 12 months. List 10 Gns.
 Lasky's Price **£6.19.6** Carr. & Ins., 12/6.

SPECIAL OFFER OF CHASSIS AND ABOVE BRIMAR C.R. TUBE. £23.19.6 Carr. & Ins., 19/6.

A FEW CABINETS AVAILABLE

SEND FOR LASKY'S COMPONENTS CATALOGUE OVER 100 ILLUSTRATED PAGES, SIZE 8 x 5 1/2 in.
 Price 2/-. Post 6d.
 Latest 12-page BARGAIN BULLETIN included free.
20,000 VALVES in stock. Send for our new list.

207 EDGWARE ROAD, LONDON, W.2.
 PADDINGTON 3271/2.

42 TOTTENHAM COURT ROAD, W.1.
 MUSEUM 2605.

Both open All Day Sat. Early Closing, Thurs. Mail Orders to Dept. P.T., Edgware Road.

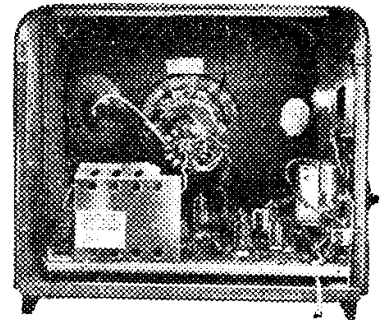

C.R. TUBES

New. Unused. Guaranteed.

FERRANTI 12in., T12/44, 4 volt heater. 49/6. Carr. & Ins., 12/6. Also 9in. T9/3, same price.

FERRANTI 17in. type TR17/10, 6.3 v., 0.3 amp. heater. **£6.16.6**. Carr. & Ins., 12/6.

16in. METAL CONE, famous make, type T901/A, 6.3 v., 0.3 amp. heater. **£6.9.6**. Carr. & Ins., 21/-.

REGUNNED C.R. TUBES GUARANTEED FOR 12 MONTHS

Type	Price	Carr. & Ins.
12in. round	£5 10 0	12/6
14in. rect.	£5 10 0	12/6
15in. & 16 round	£5 19 6	12/6
17in. rect.	£5 19 6	12/6
21in. rect.	£7 19 6	21/-

FIRST-CLASS TELEVISION and RADIO COURSES

GET A CERTIFICATE!

After brief, intensely interesting study—undertaken at home in your spare time—YOU can secure your professional qualification or learn Servicing and Theory. Let us show you how.

FREE GUIDE

The New Free Guide contains 132 pages of information of the greatest importance to those seeking such success-compelling qualifications as **A.M.Brit.I.R.E., City and Guilds Final Radio, P.M.G. Radio Amateurs' Exams., Gen. Cert. of Educ. London B.Sc. (Eng.), A.M.I.P.E., A.M.I.Mech.E., Draughtsmanship (all branches) etc.**, together with particulars of our remarkable Guarantee of

SUCCESS OR NO FEE

Write now for your copy of this invaluable publication. It may well prove to be the turning point in your career

FOUNDED 1885—OVER 150,000 SUCCESSES

NATIONAL INSTITUTE OF ENGINEERING
 (Dept. 462), 148 HOLBORN LONDON, E.C.1

S. Africa: P.O. Box 8417, Jo'burg.
 Australia: P.O. Box 4570, Melbourne.

VALVES SAME DAY SERVICE

NEW! TESTED! GUARANTEED!

SETS IR5, IS5, IT4, 3S4, 3V4, DAF91, DF91, DK91, DL92, DL94 .. any 4 for 19/6
 DAF96, DF96, DK96, DL96 4 for 27/6
 6K7G, 6K8G, 6Q7G, 6V6G, 6X5G, or 5Y3G 5 for 27/-

1A7GT 11/6	6L18 10/3	25Z6GT 9/6	EC92 11/-	EZ41 7/-	T41 9/6
1D5 8/-	6LD20 8/-	30L15 10/6	ECC81 5/-	EZ80 6/3	TH41 19/6
1H5GT 10/-	6P1 13/6	35A5 9/6	ECC82 6/3	EZ81 7/-	U22 7/3
1N5GT 10/-	8P25 9/-	35L6GT 9/-	ECC83 7/-	FW4/500 8/-	U25 13/-
1R5 5/8	6Q7G 6/-	35Z4GT 6/-	ECC84 8/9	GZ30 8/6	U26 10/-
1S4 8/-	6Q7GT 9/6	35Z5GT 8/6	ECC85 8/3	GZ32 9/6	U50 6/-
1S5 5/3	6SL7GT 6/3	50L6GT 8/9	ECF80 8/6	HBC90 7/-	U52 4/6
1T4 4/-	6SN7GT 4/9	AC/TH1 16/9	ECF82 8/6	KT33C 7/-	U78 4/9
1U5 5/9	6U4GT 11/-	AZ31 9/6	ECH21 13/6	KT41 11/6	UABC80 7/9
3A5 8/-	6V6G 5/-	B36 8/9	ECH35 6/3	KT44 6/6	UAF42 9/-
3Q4 7/-	6V6GT 6/6	CL33 12/3	ECH42 8/9	KT61 10/-	UBC41 7/9
3S4 6/-	6X4 4/9	DAC32 10/-	ECH81 8/-	KT63 6/6	UBF80 8/9
3V4 7/-	6X5GT 5/-	DAF91 5/3	ECL80 7/3	MU14 7/6	UBF89 8/-
5U4G 4/6	7B6 9/-	DAF96 7/6	ECL82 9/6	MX40 9/6	UC92 12/6
5V4G 8/-	7B7 7/6	DCC90 9/-	EF39 4/6	N18 7/-	UCC84 12/9
5Y3GT 6/-	7C5 7/6	DF33 10/-	EF41 8/3	N37 10/6	UCC85 7/6
5Z4G 7/9	7C6 7/6	DF91 4/-	EF42 9/6	PCC84 7/6	UCH80 14/-
6AL5 3/9	7H7 7/6	DF96 7/6	EF80 5/6	PCC89 11/-	UCH21 13/6
6AM6 3/8	7S7 9/-	DH76 4/9	EF85 6/-	PCF80 7/6	UCH42 8/-
6AQ5 6/-	7Y4 7/-	DH77 6/9	EF86 9/9	PCF82 8/-	UCH81 8/-
6AT6 6/9	10C1 11/6	DK32 11/6	EF89 7/-	PCL82 7/6	UCL82 10/9
6BA6 6/-	10C2 17/8	DK31 5/6	EF91 3/6	PCL83 11/6	UCL83 13/3
6BE6 5/9	10P13 14/6	DK92 7/6	EF92 4/3	PCL84 7/6	UF41 8/9
6BH6 5/9	12AT6 7/-	DK96 7/6	EL33 10/-	PEN A4 11/-	UF85 8/6
6BJ6 5/9	12AT7 5/-	DL33 9/-	EL41 8/6	PEN38C 8/-	UF89 7/-
6BW6 8/-	12AU7 6/3	DL35 9/6	EL42 9/-	PEN45 7/6	UL41 8/-
6C9 9/-	12AX7 7/-	DL92 6/-	EL81 12/-	PL36 11/6	UL84 7/6
6CD6G 26/9	12K7GT 5/3	DL94 7/-	EL84 7/-	PL81 9/-	URIC 8/-
6F1 12/6	12K8GT 11/6	DL96 7/6	EM34 6/9	PL82 7/-	UY21 11/3
6F6G 6/6	12Q7GT 7/9	EABC80 7/-	EM80 8/6	PL83 7/6	UY41 6/6
6F13 11/-	12Z3 4/6	EAF42 8/3	EM81 8/6	PL84 10/-	UY85 6/6
6F14 16/6	14S7 16/9	EB91 3/9	EM84 10/-	PY32 11/-	UYIN 10/9
6K7G 2/6	20F2 17/6	EBC33 5/-	EY51 7/6	PY80 7/6	VP4B 9/6
6K7GT 5/-	20L1 17/8	EBC41 8/-	EY81 9/-	PY81 6/6	VP41 5/-
6K8G 6/3	25A6G 8/-	EBF80 8/-	EY84 10/-	PY82 6/6	W76 5/3
6K8GT 9/3	25L6GT 7/9	EBF89 8/9	EY86 7/9	PY83 7/9	W77 4/6
6L1 14/-	25Z4G 7/6	EBL21 13/6	EZ40 6/9	PZ30 17/-	Z77 3/6

READERS RADIO

24 COLBERG PLACE, STAMFORD HILL LONDON, N.16 STA. 4587

Post 6d. per valve extra.
 Any Parcel insured Against Damage in Transit 6d. extra.
 Any C.O.D. Parcel 2/6 extra.

Line Oscillator and Sync Circuits

No. 3—FLYWHEEL CIRCUITS

By A. G. Priestley

(Continued from page 143 of the December issue)

Interaction of Line and Frame Sync

Poor synchronisation can be caused by the effect of line pulses on the frame sync pulses, which gives rise to bad interlace.* Similarly the effect of the frame pulses on the line sync pulses is to cause the top of the picture to bend before the rest of the picture goes out of synchronisation. This reduces the usable line hold range.

Both line and frame sync pulses are present at the anode of the sync separator, but from then on they have to be segregated. The long frame pulses are fed to the frame oscillator through a filter which will not pass the short line pulses, i.e. an integrator. The short line pulses are fed to the line oscillator through a filter which will not pass the long frame pulses, i.e. a differentiator (Fig. 11).

In practice these filters are not completely effective, and sync pulses usually have some effect on their opposing oscillators. Frame pulses added to line sync pulses affect the first few lines after the frame flyback period, and so the lines at the top of the picture become displaced.

It may be mentioned here that if the line sync is fed to an electrode on the oscillator which has a large output pulse on it, and no intermediate clipper stage is used, this pulse may be fed back through the differentiator, through the integrator to the frame oscillator, where it may cause bad interlace. Blocking oscillators are sometimes the culprits here.

Measuring Blanking Lines

This depends on the receiver having a stable spurious locking position. Not many do, but for the exceptions to this rule, the following explanation is given on measuring the line blanking period.

The speed at which the spot moves across the screen of the CRT must be known. Knowing that the picture is composed of 405 lines, and that this is repeated, or scanned, 25 times each second, then the total number of lines is $405 \times 25 = 10,125/\text{sec}$. Each line is therefore scanned in $1/10,125 = 98.9 \mu\text{sec}$. However, the spot spends about $15 \mu\text{sec}$ of this on the flyback stroke which is not seen, travelling from the end of scan on the right-hand side back to the beginning at the left-hand side. This leaves $(98.9 - 15) = 83.9 \mu\text{sec}$ for the forward stroke; say $84 \mu\text{sec}$.

Now we adjust the line amplitude and linearity controls so that the edges of the raster appear inside the edges of the CRT or mask, as the case may be, and are a convenient distance apart. This will be about 13in. on a 17in. tube, and the picture must be as nearly linear as can be adjusted. It can now be said that, since the spot travels 13in. (on a 17in. tube), in $84 \mu\text{sec}$, it takes $84/13 = 6.45 \mu\text{sec}$ to travel one inch.

Note that we are measuring the raster, not the picture.

Now having adjusted the hold control, with a signal applied, until the spurious locking position appears, the brightness can be set so that the front porch, sync pulse and back porch can all be seen. These are shown in Fig. 12, together with the time duration that they represent.

If these distances are measured, knowing that one inch, say, represents $6.45 \mu\text{sec}$, then, translating these into time intervals, they may be compared against the published standards.

This technique does not give completely accurate answers because the picture is sure to be slightly non-linear, and the exact flyback time is not known. It

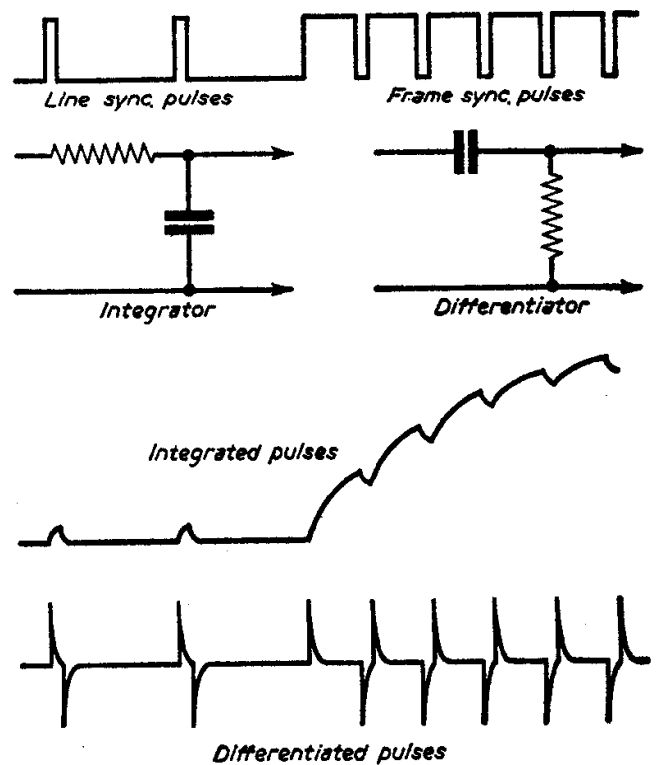

Fig. 11.—Action of differentiating and integrating circuits.

would therefore be rather unreasonable to assail the BBC or ITA with complaints every time the transmission standards appear to be outside their limits. However the method is sufficiently accurate to demonstrate some of the features of the transmitted signal.

Choosing the Circuitry

In an earlier part of the article the reception conditions in the region served by one transmitter, were divided into the inner and outer parts of the service area and the fringe area. This depended upon the strength of the wanted signal and the amount of

*See article on interlace in the May, 1959 issue of Practical Television.

unwanted electrical noise superimposed on it, and not necessarily upon the geographical location.

It is appropriate to design the sync and line oscillator circuits differently for each case, although commercial setmakers have to compromise and make only one or two different models to cover the whole signal range.

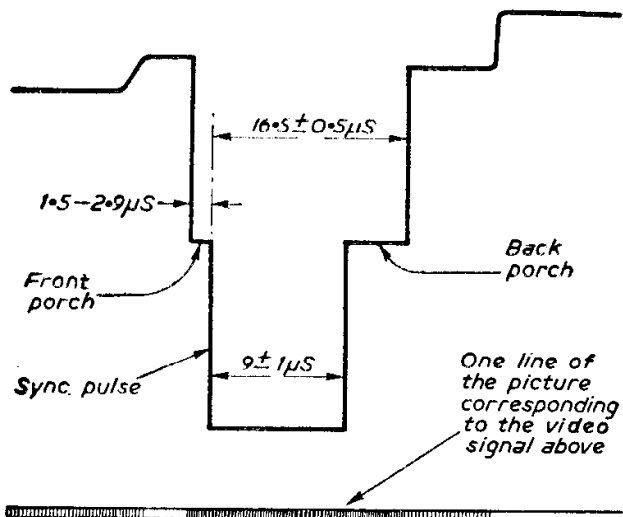

Fig. 12.—A spurious line-locking position will enable the front porch, sync pulse and back porch to be examined.

Inner Service Area

Here the signal is so strong that the synchronisation is hardly affected by noise and almost any circuit will be adequate. The sync pulses from the sync separator can be fed direct to the line oscillator and a clipper stage is not needed. The good engineer concentrates on making the circuit as simple, reliable and cheap to build as possible.

Outer Service Area

The signal strength in this region is high enough to make the cost and complexity of a flywheel oscillator and discriminator circuit unjustified, whilst the direct sync type of circuit needs good engineering in order that it shall give of its best. This is the commonest case and it will be discussed more fully later.

Normal Fringe Area

In this area the signal strength is so low and the noise level so high that there is little doubt that a flywheel circuit is needed if an acceptable picture is to be produced. Unfortunately these circuits are rather complex, and there are numerous variations of the basic idea, so there is only space for a general description of them in this article.

The effectiveness of a flywheel oscillator is best appreciated by comparing its mode of action with an ordinary relaxation oscillator fed with sync pulses direct. In the latter case the oscillator runs slightly irregularly by nature, and each cycle is triggered independently by a sync pulse. Each such pulse must therefore arrive at exactly the correct instant in time if a clean picture is to be obtained. In reception areas where noise forms a significant proportion of the total signal it is clear that the sync pulses are going to be distorted, and inevitably the picture synchronisation will not be perfect.

The flywheel oscillator has two important advantages. In the first place a sync wave type is normally

used and the tuned circuit gives a much more regular output, hence better triggering is obtained.

The most important effect is the way in which the sync is applied. Instead of each cycle being triggered by one individual pulse, matters are so arranged that the oscillator frequency is controlled by taking the average of several preceding sync pulses. One pulse arriving too early or too late has little effect, as in the case of a single push on the rim of a mechanical flywheel. A series of pushes controls the speed.

The point about this is that not only do ordinary isolated interference pulses have less effect but that the random electrical noise has a chance to average itself out over a comparatively long period of time such as ten lines of the picture.

The way this flywheel action is obtained is as follows. The incoming sync pulses are compared with a pulse from the oscillator or line transformer in a discriminator circuit, shown in Fig. 13. This produces a positive or negative change of a D.C. voltage depending on whether the oscillator is going too fast or too slowly (or vice versa). The D.C. output is fed via an integrator so that it can only change slowly, i.e. it takes, in effect, an average of several preceding line pulse/output pulse comparisons, and is not much affected by any one difference. This is a flywheel action. The varying D.C. voltage is fed to a reactance circuit such as the one illustrated in Fig. 14. This has the property of looking like a capacitance across its output terminals, and this capacity varies with change of D.C. bias applied to it from the discriminator. The reactance circuit in turn is connected across the tuned circuit of the oscillator.

Hence a change of oscillator frequency produces a D.C. bias in the discriminator which is applied to the reactance valve. This change of bias alters the capacity across the tuned circuit which makes the oscillator frequency come back into step.

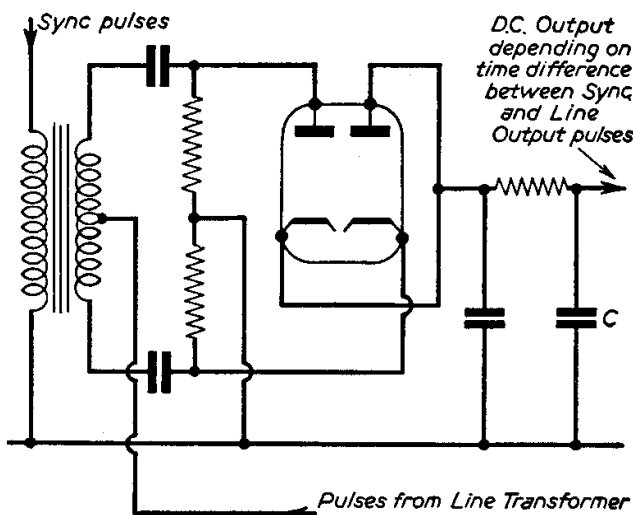

Fig. 13.—Typical simple discriminator circuit.

Flywheel Pull-in and Hold Range

The hold range of a flywheel oscillator is the range of free running frequency over which the picture will remain locked. In other words if you adjust the control to each end of the hold range and remove the signal each time, the difference between the two free running frequencies will be the hold range. This will probably be about 800–1000c/s. This action is the same as in a directly synchronised circuit. The size of

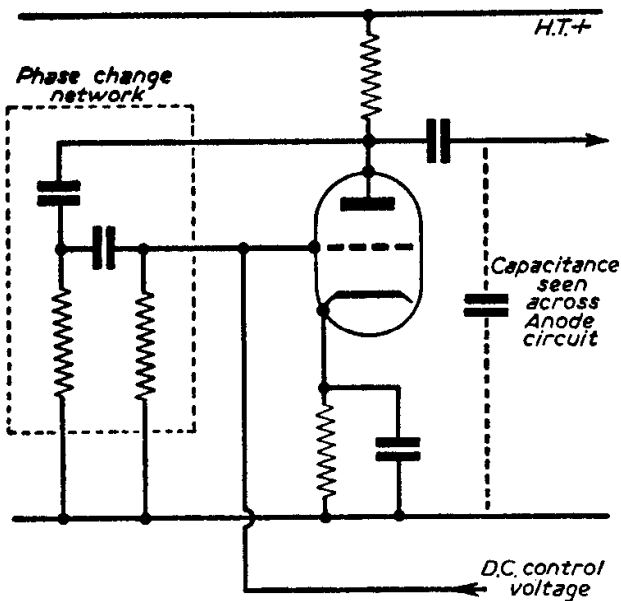

Fig. 14.—Basic reactance valve circuit—there are many variations.

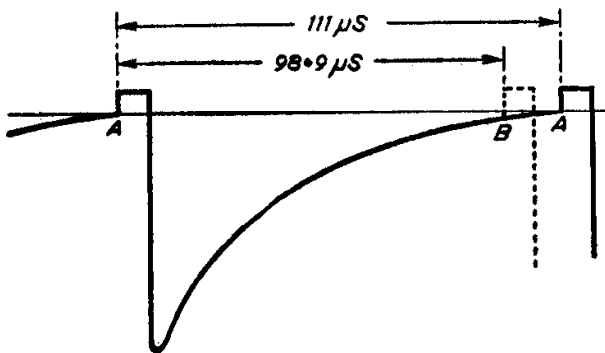

Fig. 15—Typical oscillator grid waveform.

the hold range depends on the sensitivity of the discriminator.

The more important characteristic is the pull-in range. This is the range of frequency over which the circuit will pull the oscillator back into synchronism even if the signal is removed and replaced—for instance by switching channels. This is a more stringent test, and the pull-in range is smaller than the hold range, and is commonly only about 250c/s. In the directly synchronised circuit the pull-in and hold ranges should be identical.

A small range means good sync performance but the control will need adjusting more often as the oscillator frequency drifts. Conversely a large range means freedom from adjustment, but not such good sync.

Commercial setmakers have to choose a pull-in range sufficiently large to ensure that their customers hardly ever have to adjust their hold control, because otherwise there would be complaints. If the owner or home constructor is willing to do this occasionally, he is free to use a smaller pull-in range, i.e. a heavier flywheel, and thus achieve better sync performance. In the discriminator, shown in Fig. 13, this can be achieved by increasing the value of C. If the line oscillator does not drift as the receiver warms up, the pull-in range can be made quite small, with the benefits mentioned.

In some circuits the integrating capacitor can be

quite hard to identify because the circuit is rather complex, and in this case it is usually quicker to do it by trial and error, by putting a capacitor in parallel with each likely one in turn. Note the effect on the pull-in range, and when the correct one has been found increase its value gradually until it is found that it is necessary to adjust the hold control occasionally owing to oscillator drift. The sync performance should then be the best compromise.

Outer Fringe Area

The reception conditions in these regions are so bad that the picture on even a well-designed flywheel receiver provides poor entertainment. The commercial market is small anyway in this country, because everyone is well served by transmitters, and it is not worthwhile making highly specialised receivers for these areas of poor reception. However the situation is rather different on the Continent and some new circuits have been developed which work very well.

These new circuits combine the advantages of both direct and flywheel sync action. Strong direct sync is used to get the picture approximately synchronised, and then this is switched out and a flywheel circuit takes over. Since the oscillator is running at more or less the correct frequency, the pull-in range of the flywheel can be very small, and so the sync performance is good.

Oscillators with Direct Sync

In this type of circuit, the sync pulses are fed more or less directly to an electrode on the oscillator and trigger each cycle individually. This is in contrast to the flywheel circuits just described.

The waveform on the grid of the oscillator valve depends on the particular circuit used, but is commonly of the general shape shown in Fig. 15. The grid is driven negative during the line flyback period, and then slowly charges up during the scan until it reaches the cut-off voltage, when it starts to conduct current. This causes the anode voltage to fall sharply as a result of positive feedback provided by the other half of the circuit. A negative-going pulse is therefore produced at the anode which can be shaped to the kind required for driving the line output valve.

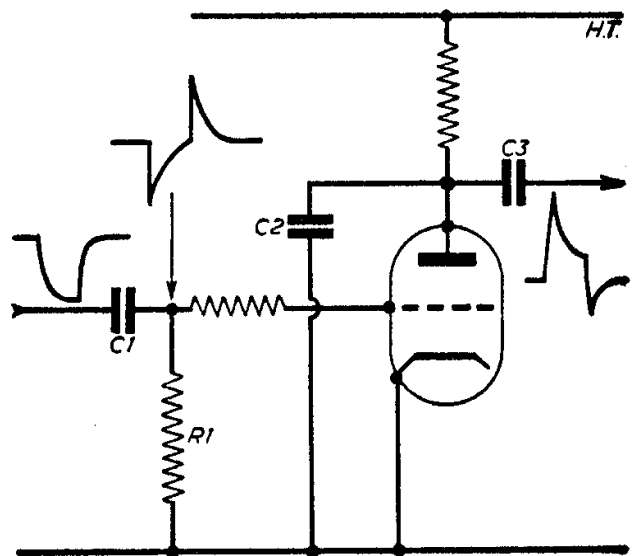
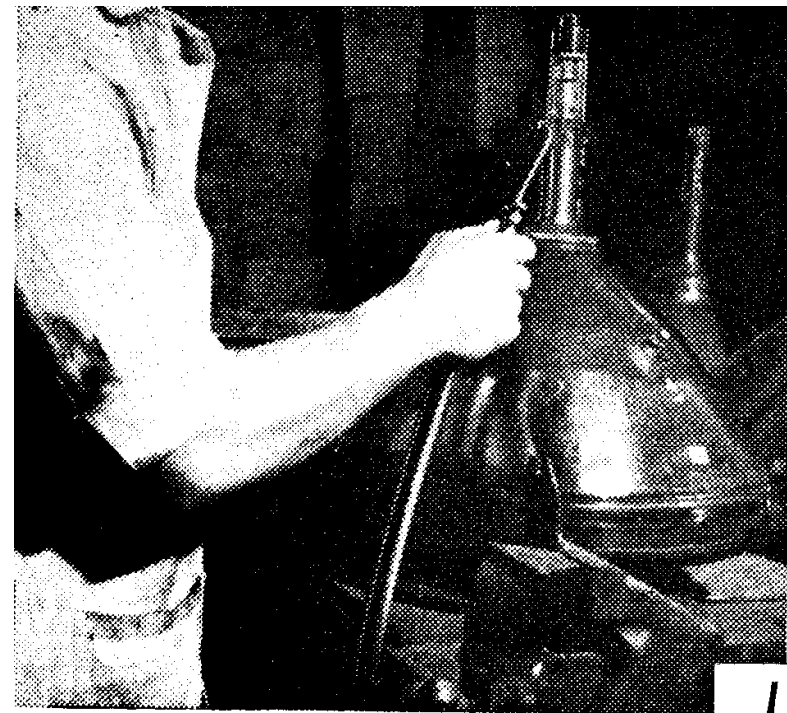
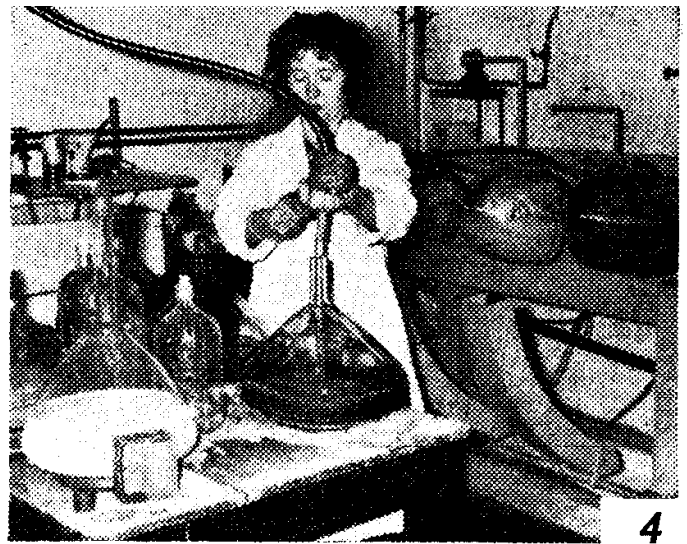

Fig. 16.—A clipper circuit. The positive portion of the grid input voltage is clipped by grid conduction.

(To be continued)



1



4

All about

THIS series of illustrations shows, in an abridged form, the complete process of rebuilding cathode ray tubes. (The photographs were taken at one of the south London factories of Suffolk Tubes Ltd.)

Every tube is fitted with a new gun and, where necessary, cleaned completely and the front buffed to remove any scratches. Often, tubes are so old that the gun assemblies are obsolete; then it is necessary to reconstruct a complete unit.

After the final stage of rebuilding—ageing—all tubes are thoroughly tested, with a picture, before being despatched.

The complete process of rebuilding takes several days as periods of drying and baking the tubes are necessary at various times while they are at the factory.



2

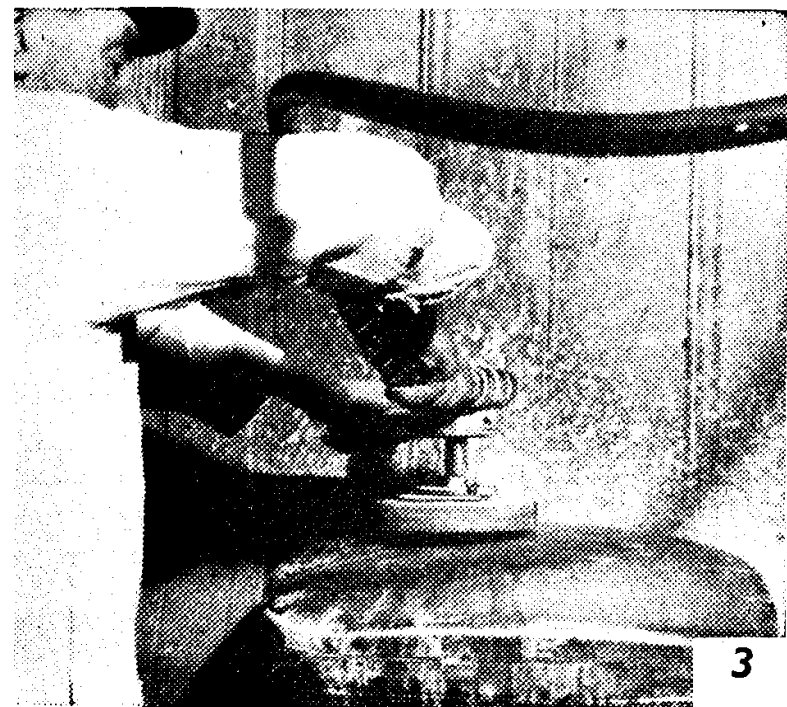

3

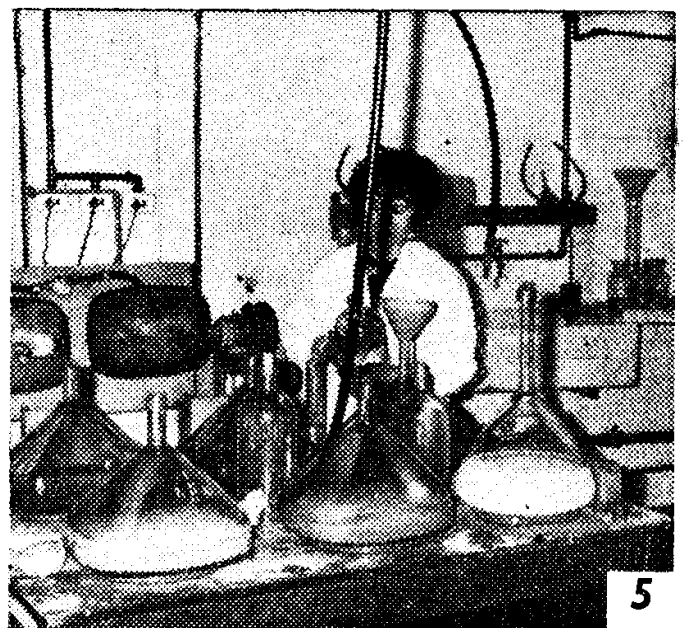

5

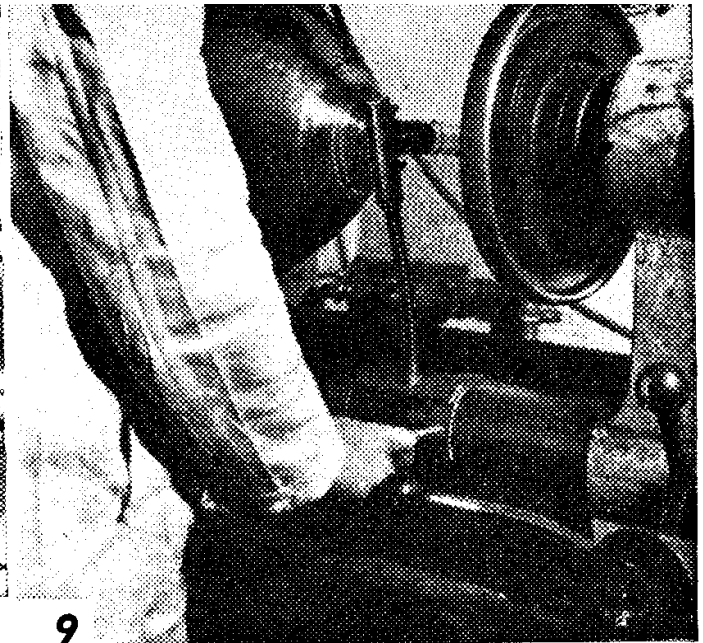
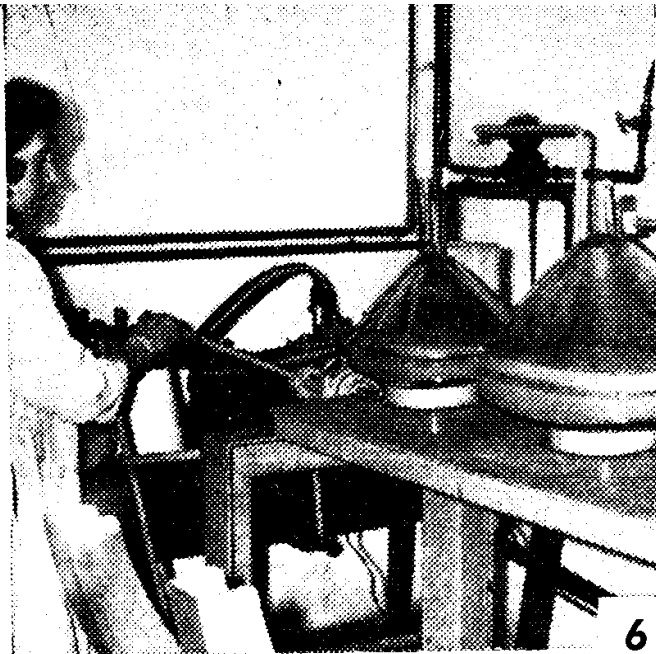

6 9

REBUILT TUBES

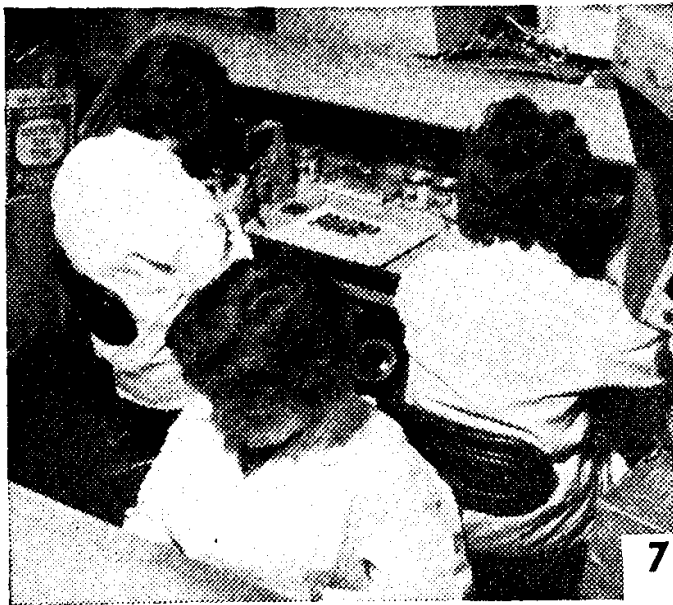

7

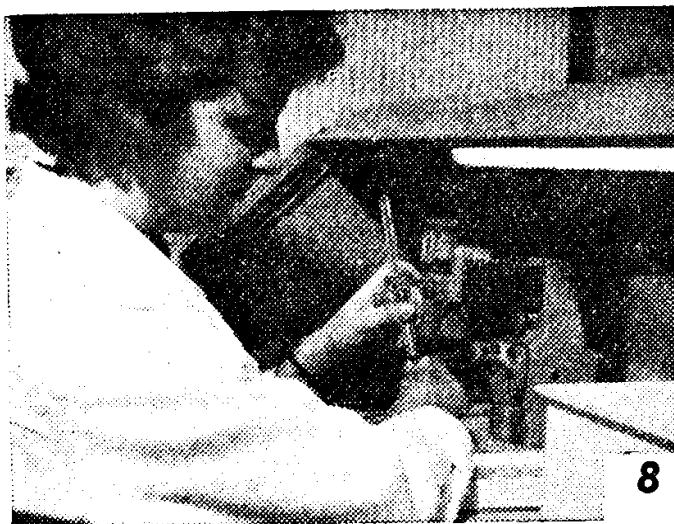

8

The order in which the different processes are shown in the illustrations, approximately follows that adopted in the factory.

- 1 The neck of the tube is first cracked all the way round by heating it to admit the air.
- 2 The tubes are then stored in racks overnight to allow the air to enter slowly. If the air were let in quickly the tube would probably implode or fracture severely. After this the end of the neck will break off easily.
- 3 At this stage any scratches or marks on the face of the tube are removed by buffing.
- 4 The interior of the tube is thoroughly cleaned. Then, phosphor is added in solution. It is allowed to settle for a period of 15min and then it is tipped slowly for 5min on to its side by the machine seen in the background of the illustration. The tubes are held in place by suction, while the board which holds the tubes rotates about a horizontal axis.
- 5 After drying, a compound is added which ensures a flat surface for the aluminium so that none of the reflecting surface is irregular which would cause bright spots to appear over the face of the tube.
- 6 The inside of the tube is now aluminised with the tube evacuated of all air. It is then baked in a special oven to remove all traces of the compound added in stage 5.
- 7 Occasionally the type of gun needed is obsolete or difficult to obtain and new components have to be constructed at the factory.
- 8 Here a new gun is being assembled by hand. Sometimes the new guns are damaged when they are packed, and these have to be repaired.
- 9 A length of glass tube is welded on to the neck of the CRT before the gun is mounted. The tube is held to the lathe by suction, and when the extra piece of neck is properly in line, a gas jet joins the two pieces of glass.

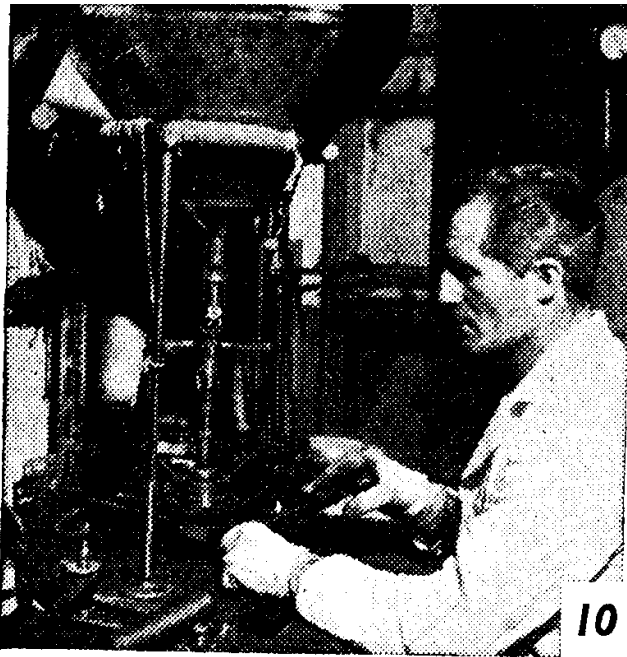

10

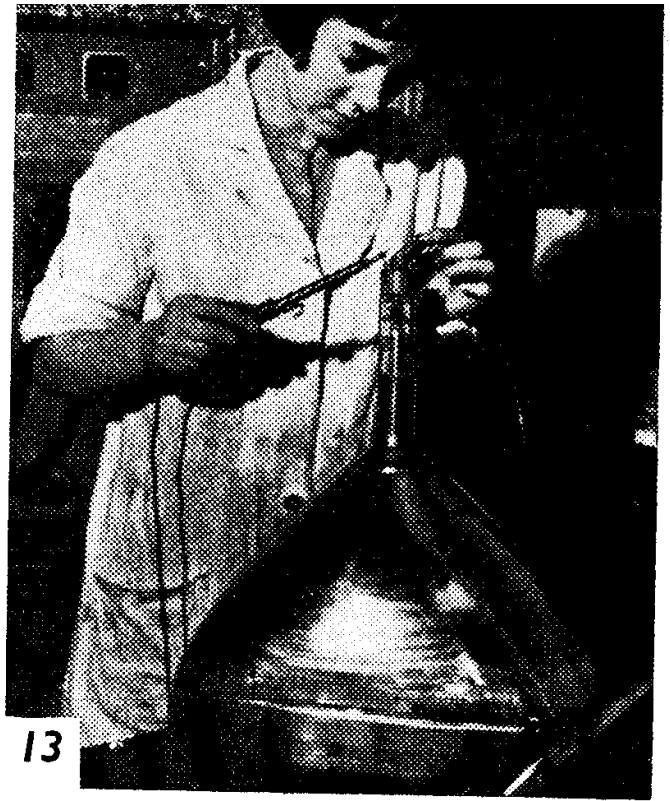

13

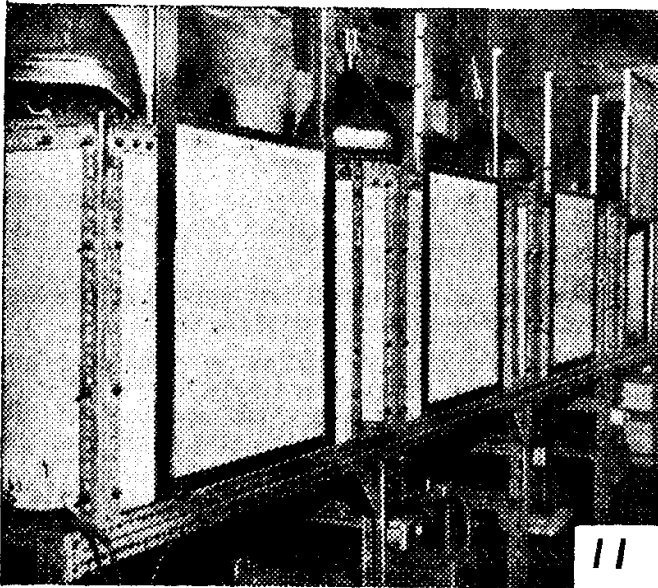

11

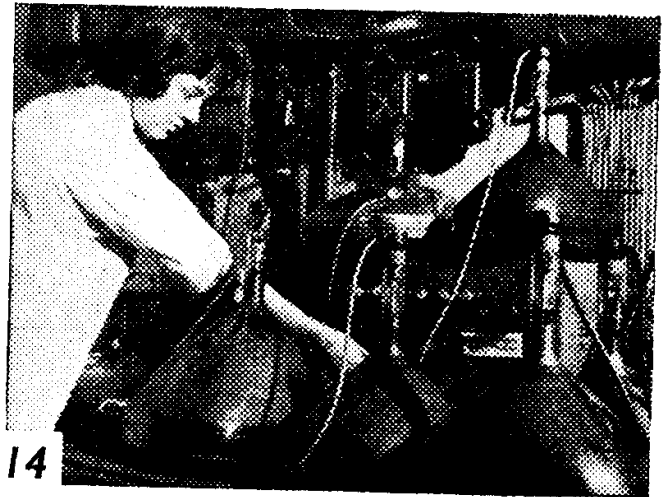

14

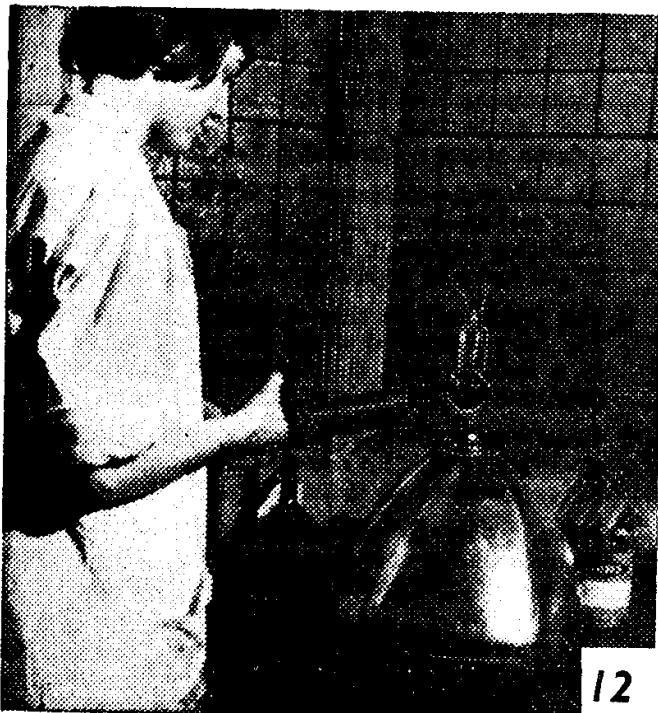

12

10 At this point the gun is welded into position. Two gas jets revolve around the neck of the tube and as the glass begins to melt, the glass of the new gun will be sealed to the tube.

11 The air is removed by vacuum pumps and the tubes are then activated.

12 This shows an operator firing the gettering by means of a high frequency coil.

13 Next, the base of the tube is fitted to the neck, and all the necessary soldering carried out.

14 The last part of the rebuilding process is ageing. The grid is made positive (normally the anode is positive) and a current is passed between grid and cathode. The final anode is not connected. The tubes are left in this state until they are ready to be tested. (The bulbs on the panel behind the tubes give an indication of when the tubes are ready) The time taken for the ageing process varies slightly with each tube.

The tubes are finally tested for any faults and are then packed and despatched.

The Practical Television

OLYMPIC

I. F. STAGE ALIGNMENT PROCEDURE

By D. R. Bowman

(Continued from page 216 of the January issue)

IN the last issue, details of how to blacken the inside of valve screens were described. Rough temperature measurements during development showed that valve envelope temperature could be reduced by nearly 40° C in this way and this not only minimises change of capacitance with temperature but also markedly prolongs the life of the valves. The finish is reasonably durable, but, of course, the treated cans should be handled carefully. They are, however, easily touched up if needed.

The use of unscreened valves in the timebases is made feasible by the interposition of a screen between the "line" valves and the "frame" valves. The half-screen round the line output transformer helps to avoid interaction between line and frame timebases and also decreases radiated interference which may affect radio receivers operating on medium and (especially) long waves. The inside of the cabinet should preferably be coated with aluminium foil, connected to the chassis. Such foil may be bought readily as a kitchen accessory.

Circuit Alignment

The alignment procedure is simple and straightforward. A signal generator covering the required frequencies is needed, and should be as accurately calibrated as possible. Before beginning the process, however, it is highly desirable to render the line output stage inoperative, otherwise undesirable results may be obtained. This is achieved by disconnecting the screen of the PL81 from H.T.+ and earthing it instead.

Switch on, and when all the valves are warmed up measure the H.T. voltage at the tag strip carrying H.T."X". Adjust this to 190V by varying the H.T. side of the mains dropping resistor. If this is already adjusted to 250V and the H.T. is still too high, insert a suitable resistor in series; about 20-30Ω 10W will be suitable in most cases. H.T."Y" may now be checked; it should be about 170-189V. Similarly H.T."Z" should be 100-110V. If it is desired not to have the cathode ray tube in circuit while these preliminaries are being carried out its heater may be short-circuited. The heater current to the remainder of the set is only slightly affected thereby, but it is preferable at the same time to put the heater side of the mains dropper to the next higher tapping.

A pair of headphones is now required, and its leads should be terminated in 0.1μF capacitors. One is connected to the chassis, and one is used as a probe lead. **It is quite essential to isolate the 'phones in this way, because the receiver is connected direct to the mains.** Otherwise, to pick up the soldering iron while wearing the 'phones, could lead to a severe if not fatal shock if the iron were not properly insulated.

The "probe lead", ending in the 0.1μF capacitor, carries, in addition, soldered to the free end of the capacitor, a choke consisting of 60 turns of 38s.w.g. enamelled wire wound on a resistor as a former. This enables it to be used with circuits where feedback may occur, without too much chance of oscillation being provoked.

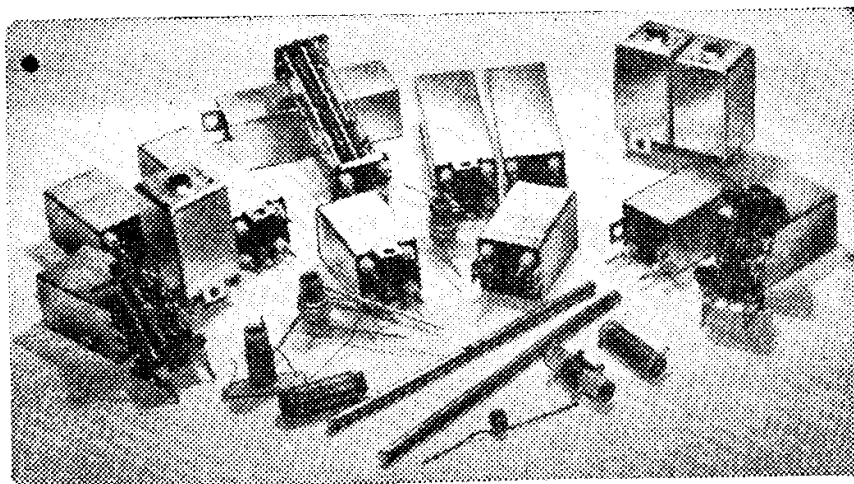

A set of the coils for the Olympic.

The attenuating wave guide screen is temporarily left off the vision I.F. amplifier, and alignment may now begin in the following manner.

1. Disconnect the H.T. lead to the last vision I.F. valve and the oscillator valve. Connect the probe lead to the video amplifier grid. Modulate the signal generator, and attach the lead from the generator to the anode of the last I.F. valve. Set the generator to 36.15Mc/s, maximum output. Rotate the core of L18 until resonance is obtained. The tuning is very flat, and if desired R30 may be temporarily replaced by 100k, when the tuning can be made much more exact.

2. Reconnect H.T. to the last I.F. valve and disconnect H.T. from the previous valve. Connect the generator lead to the grid of the last I.F. valve. Set the generator to 37.7Mc/s and tune L17 to resonance.

3. Disconnect H.T. from the first vision I.F. valve and reconnect H.T. to the second I.F. valve. Connect the generator lead to the grid of the second I.F. valve, reduce generator output, and set the frequency to 36.15Mc/s. Rotate the core

of L16 for maximum output. Rotate the core of L14 for maximum output.

4. Set the generator to 38.15Mc/s, and working back from the detector, as above, align the sound receiver as far as the adjustment of L22. Do not touch L21 at this stage.

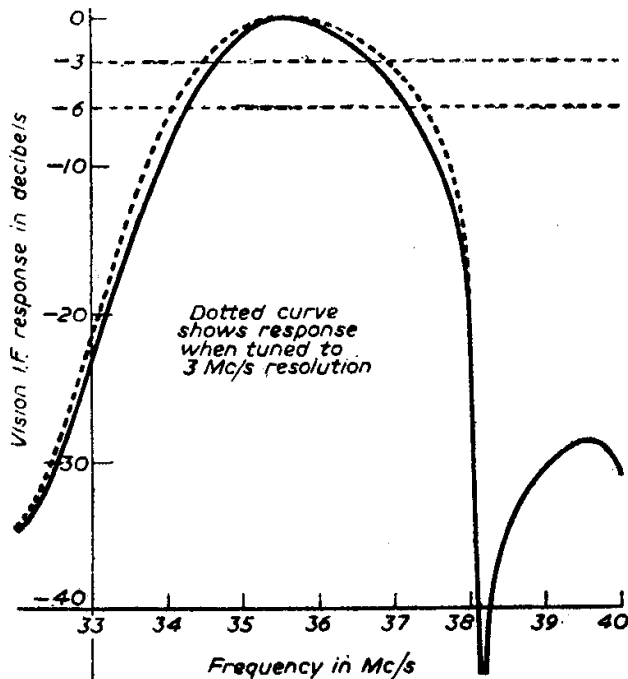

Fig. 19.—The vision I.F. amplifier response curve.

5. Without altering the signal generator setting in the least, connect its lead to the grid of the second I.F. valve and adjust L15 for zero output. The tuning will be very sharp indeed.

6. Reconnect H.T. to the first vision I.F. valve and reduce generator output. Set the generator to 37Mc/s and bring its lead about $\frac{1}{4}$ in. from the tag strip supplying I.F. from the tuner. Adjust L13 for resonance.

7. Set the generator to 34.5Mc/s. Rotate the core of L12 for resonance.

8. Set the generator to 35.5Mc/s and adjust L11 for maximum output.

9. Switch the tuner to BBC, set the generator to 36.15Mc/s and attach its lead to the aerial terminal. More generator output will now be needed. Adjust L8 (on tuner) for maximum output.

10. Set the generator to 38.15Mc/s and adjust L21 (on sound receiver) for maximum output.

The line output valve screen lead and oscillator H.T. may now be replaced, and the H.T. connections restored to normal.

The above method gives accurate alignment of both vision and sound amplifiers, and resolution of 2.75Mc/s at the video stage. Where 3 Mc/s resolution is required, the following variations are required:—

6—generator set to 37.7Mc/s.

8—generator set to 35Mc/s.

Final adjustment is carried out on the tuner when the test card is visible on the tubes, and a signal generator is not required. The method is always the same—tune the oscillator for maximum

sound output, and adjust the aerial and inter-stage tuning for best results on the tube. Finally, adjust the core of L21 for minimum vision-on-sound (high volume in periods of non-transmission of sound will be needed).

During the above operation care must be taken not to introduce feedback. This may arise if the leads to the 'phones come anywhere near the early parts of the amplifier or if hands are brought too close. A long insulated tool is needed for adjusting the cores of the transformers, and a 10in. length of Perspex, filed to a screwdriver point, is suitable, or a plastic knitting needle may be used. The lead from the signal generator may also cause feedback effects to appear, unless care is taken. It must be remembered that the gain of the receiver is very high, and it is possible that de-tuning from the prescribed frequencies may cause oscillation if this de-tuning brings the amplifier more into line—that is, if the bandwidth is reduced. For this reason it is very necessary to work back from the detector in every case, preserving the correct bandwidth and gain as alignment progresses. When the vision I.F. amplifier screen is put in position, no feedback effects are found to occur, even with all the circuits tuned to the same frequency.

It should be noted that L14 and L16 must not be varied from the specified frequency. If this were done the correct conditions for coupling could not be achieved because the coupling occurs via the sound trap L15, and thus the three are designed together and must operate together. Any "touching-up" of the response curve that may be

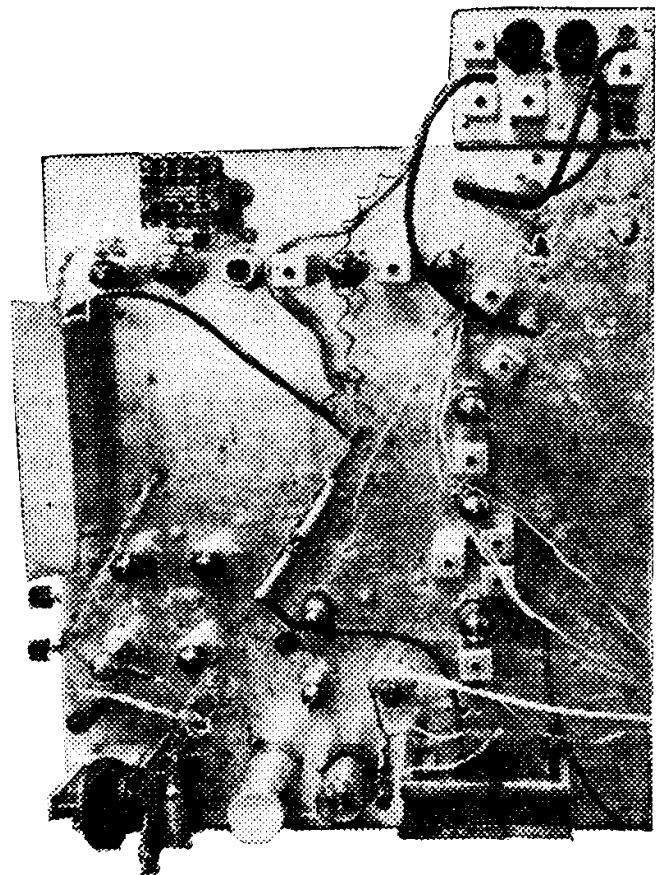

An above-chassis view of the receiver.

The decision is YOURS. To be a success in your chosen career; to qualify for the highest paid job . . . to control a profitable business of your own. ICS home-study courses put your plans on a practical basis; teach you theory and practice; give you the knowledge and experience to take you, at your own pace, to the top.

Choose the *RIGHT* course :

RADIO & TELEVISION ENGINEERING
INDUSTRIAL TELEVISION

RADIO & TELEVISION SERVICING
RADIO SERVICE AND SALES

VHF/FM ENGINEERING : ELECTRONIC
COMPUTERS & PROGRAMMING

ICS provides thorough coaching for professional examinations:

Brit. I.R.E., City and Guilds Tele-communication Technicians, C. & G. Radio & TV Servicing (R.T.E.B.); C. & G. Radio Amateurs.

Technical Training in Radio, Television and Electronics Engineering with

LEARN AS YOU BUILD

Practical Radio Courses

Gain a sound up-to-professional-standards knowledge of Radio and Television as you build **YOUR OWN** 4-valve T.R.F. and 5-valve superhet radio receiver, Signal Generator and High-quality Multi-meter. At the end of the course you have three pieces of permanent and practical equipment and a fund of personal knowledge and skill. ICS Practical Radio courses open a new world to the keen Radio amateur.

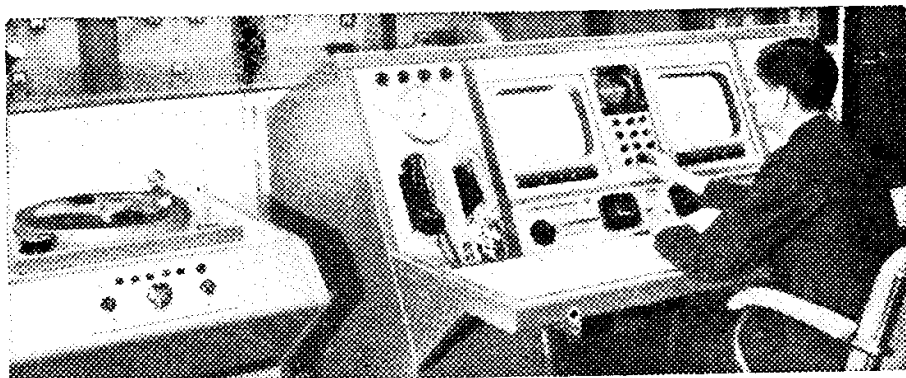

THERE ARE ICS COURSES TO MEET YOUR NEEDS AT EVERY STAGE OF YOUR CAREER. FILL IN AND POST THIS COUPON TODAY.

You will receive the FREE 60 page ICS Prospectus listing examinations and ICS technical courses in radio, television and electronics PLUS details of over 150 specialised subjects.

Other ICS courses include: MECHANICAL, MOTOR, FIRE, ELECTRICAL & CHEMICAL ENGINEERING. FARMING, GARDENING. ARCHITECTURE & WOODWORKING. SELLING & MANAGEMENT. ART. PHOTOGRAPHY, etc., etc.

PLEASE STATE ON COUPON SUBJECT YOU ARE INTERESTED IN . . .



INTERNATIONAL CORRESPONDENCE SCHOOLS
(DEPT. 170). INTERTEXT HOUSE, PARKGATE RD., LONDON, SW11
PLEASE SEND FREE BOOK ON.....
NAME
ADDRESS
.....
OCCUPATION..... AGE.....
2.61

ACCURATE READINGS IN ANY POSITION

ADVANCED DESIGN-MINIMUM WEIGHT

ALL-ROUND RELIABILITY

THE *NEW* SALFORD
SELECTEST

MODEL SUPER K: 1 mA movement.
39 self-contained ranges for measuring
A.C., D.C. voltages and currents and resistance.

MODEL SUPER 50 50 μ A movement

Send for leaflet No. S.K.50/6002/PT.

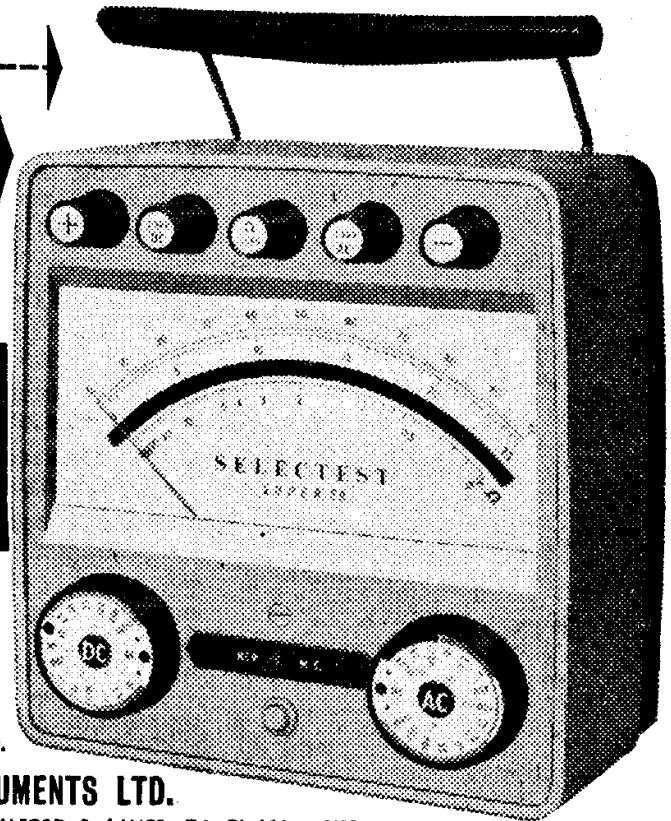

SALFORD ELECTRICAL INSTRUMENTS LTD.

PEEL WORKS, SILK STREET, SALFORD 3, LANCS. Tel: Blackfriars 6688

London Sales Office: Magnet House, Kingsway, W.C.2. Tel: Temple Bar 4668

A Subsidiary of THE GENERAL ELECTRIC CO. LTD. OF ENGLAND

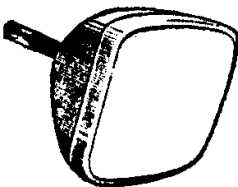

**TOP QUALITY AT
LOWEST PRICES**
with 12 months' Guarantee.

VIRTUALLY AS NEW

COMPLETELY REBUILT TUBES

TERMS—C.W.O. MULLARD - MAZDA AND
HARD GLASS TYPES

12-14 inch	£6. 0.0	} ELECTROSTATIC TYPES 10/- EXTRA.
15-17 inch	£6.10.0	
21 inch	£9. 0.0	

TRADE ENQUIRIES WELCOMED

PRICES SUBJECT TO RETURN OF OLD TUBE

Pass. Train, Carr. & Ins.-To You-& return of old tube,
in special containers. All covered for 20 - extra
anywhere in U.K. or N. Ireland. **BRAND NEW
TUBES WITH 2 YEARS' GUARANTEE—NOW
AVAILABLE** (i.e. 17 inch at £10). From:—

SABRINA C. R. TUBE CO.
Electron Works, North Bar,
BANBURY - OXON

Phone: 2390.

SPECIAL OFFER!
TO THE FIRST 100 CUSTOMERS
COSSOR 10" TUBES

Brand New **NOT A** Regun

108K 15/- plus 6/- carr & ins

75K 15/- plus 6/- carr & ins

12 MONTH GUARANTEE

ION TRAP MAGNETS

Suitable for all bent gun type tubes
2/9 EACH Plus 6d post & pack

**DON'T MISS OUR GREAT
STEREO AMPLIFIER OFFER**

(see page 173 of January
issue for details)

59/6

HARVERSONS SURPLUS CO. LTD.

83 High Street, Merton, S.W. 19

CHerrywood 3985/6/7

deemed necessary must be done elsewhere, and probably the best place is in the tuner. One cannot go too far even here, however, especially on Channel 1 where the radio frequency is quite close to the sound intermediate frequency, and feedback may be experienced if one departs too far from the optimum.

The neutralising condenser C2 does not have very much influence when adjusted, because most of the neutralising needed is performed by C1, which is parallel with it. C2 should be adjusted to give least noise on the picture, when tuned to the Band III frequency—or, if two Band III channels are used, to the weaker of the two.

It is not absolutely necessary to use a Band III signal generator for alignment of the Band III circuits. Harmonics of Band I provide enough signal for rough alignment of the tuner, and then when the signal is picked up from the aerial, oscillator, aerial and inter-stage tuning may be adjusted for best results. However, where constructors require two Band III channels, the following procedure must be used for adjustment.

1. The tuner is set to the higher frequency required, and circuits brought into line after a good warming-up period (ten minutes).

2. The tuner is then switched to the lower frequency position. The detailed circuit diagram of the tuner, and the illustration of a wafer (see page 180 of the January issue), show how small loops of wire are connected between adjacent inductances. The inductance of these loops on the oscillator wafer is adjusted by two methods. The first is by swinging them down over the switch contacts and so varying the space between them. It will be seen that R.F. current flows up the switch contact, down the wire, across, up the wire and down the switch contact. Part of the way the currents in the wire and the "contact" are in opposite directions, and thus the inductance can be varied by altering the spacing. Adjacent channels can be covered readily in this way. Where the local channels are not adjacent, the actual wire length will have to be varied to obtain the loading inductance required. This constitutes the second method of adjustment, and is much more difficult unless a signal generator is available. Unfortunately, even quite close adherence to the wiring diagram can result in widely differing lengths of wire being needed—"widely differing" means "differences of the order of half an inch". Patience is necessary here. Fortunately, in the signal frequency circuits, conditions are nothing like so critical, and a rough copy of the oscillator wafer's loading inductances will give excellent results. The inter-stage tuning is so flat on Band III that even this is hardly necessary, and so inter-stage tuning is not varied. However, the inter-stage Band III coil should be adjusted to give best results on the weakest signal required, and the strongest signal can be left at slightly lower gain to look after itself.

If more than one Band I channel is needed, extra small coils between the oscillator switch contacts will be required. These, as loading coils for the Channel 5 main tuning inductances, are roughly as follows: all are self-supporting, 28s.w.g. close-wound enamelled wire of $\frac{1}{8}$ in. internal diameter. Channel 4 : 4 turns; Channel 3 : 4 turns; Channel 2 : 4+3 turns; Channel 1 : 4+4 turns. Adjustment will be made by varying the

spacing between turns. These figures are an approximate guide only, much depending on circuit capacitances and layout, and experiment will be needed. For the aerial circuit, loading inductances of the order of 20 turns will be needed, and only a mid-band approximation is possible in the inter-stage (unswitched) circuit. For this reason only one Band I channel is recommended. There must be very few localities where more than one such channel will be required.

It must be realised that where the tuner is aligned for Channel 1, mistuning may easily bring the frequency-changer grid circuit to 38.15Mc/s or near it. This will almost certainly cause I.F. instability. For this reason it is best to peak L7 at 43Mc/s and leave it there, making any bandwidth adjustments needed on the aerial only. Matters are not so critical on the other Band I channels. It will be found that the tuner is quite stable when properly adjusted, and no difficulty should be experienced in obtaining the correct working conditions.

Adjustment of the Timebase Boosters and Sync Separator

The sync separator is first adjusted, using the broadcast signal. The probe lead is connected, choke still attached, to the junction of R67 and the diode anode, and the slider of VR68 is rotated. Over part of the range both line and frame sync pulses will be heard. As the slider is rotated a point will be reached where the line whistle suddenly disappears. Rotation should be continued for about 10-20° beyond this point. Everyone cannot hear a faint line whistle, and for this adjustment it is really best to observe the signal at this point on an oscilloscope. If this is not available, a young person can be asked to co-operate by listening for the line-cut-off point. Small children can often hear frequencies up to 20 or 25kc/s, but below the age of five or six years adequate understanding of the problem is not always present. This preliminary adjustment is essential if it is expected to secure the excellent interlace possible with this receiver.

The following valve data has already been given in the text but it is tabulated below for ease of reference.

VALVE DATA

Unscreened Valves: (no screen at all)	V14, V16—two ECC82
	V8 —one 6F33
	V15 —one PCL82
	V17 —one PL81
	V7 —one EB91
	V12 —one EF80
	V13 —one PL82
	V19 —one EY86
	V18 —one PY81

Valves with part screening: all the EF80s except (holders have skirts)
V12, i.e. V3, V4, V5, V9, V10.
V6—PCF80

Valves with full screening: V1—PCC89 (skirt and can)
V2—PCF80
V11—EB91

(To be continued)

Letters to the Editor

The Editor does not necessarily agree with the opinions expressed by his correspondents.

SPECIAL NOTE: Will readers please note that we are unable to supply Service Sheets or Circuits of ex-Government apparatus, or of proprietary makes of commercial receivers. We regret that we are also unable to publish letters from readers seeking a source of supply of such apparatus.

A STRANGE FAULT

SIR,—I saw the letter from D.K.L., of Aylesbury, in your December issue, and can offer a suitable explanation. Incidentally, I note that problems of this nature are often included in an American magazine and prove very valuable to others who may come up against the same problem, especially where faults of a more or less constantly appearing type come up. I have found that certain receivers go wrong in one particular point, and it is often a long while before the manufacturers incorporate a modification to remedy this. However, to get back to D.K.L.'s problem, the fact that a picture falls to a smaller scan and stays that way, is generally due to a faulty charging condenser. This develops a leak, and in many cases stays that way until the set is switched off. It appears that the current flowing through the condenser after leakage sets in, results in an ionised path which is conductive until the stream of ions is interrupted (by switching off, for instance). When stopped, the condenser in a way re-forms until a peak value of current produces the ionised path again. I think replacement of the condenser will cure D.K.L.'s trouble.—F. W. Entwistle (Barking).

MODERNISING OLD SETS

SIR,—I am the owner of a very old receiver which has, nevertheless, given yeoman service, and is still serving its purpose. However, I should like to introduce modifications which will bring this into the category of a modern set, and on looking over it I find that will necessitate replacing the scanning coil assembly and timebases, and in the final event, modifying the tuner and I.F. strip to a new I.F. Is such a step warranted, or is it better to make a new set? Expense is a problem, and I can't see anything against my proposal, which could be carried out on a step-by-step basis, starting with the coils and O/P transformers on the timebases. It seems that a new tube could also be introduced, as I do not need a larger one. I should think an article on these lines would be popular, as I am sure that there are many other readers who would like to carry out a really systematic modification to improve their domestic

instrument, without going to the expense and trouble of building a completely new set. Perhaps some other readers have tackled this problem and could help others to set about the task.—R. T. Hendig (Wembley).

COLOUR AND LINES

SIR,—the proposed new system and colour have been much in the news lately, and I am sure that there are many like myself, who are left undecided as to what to do about a new set. Obviously, if there is going to be a change in the foreseeable future, we do not want to buy or build a set which will soon be rendered obsolete. Neither do we wish to wait unnecessarily long before carrying out experiments to see if our existing equipment can be modified. There must, I feel sure, be amongst readers, those who have had practical experience either on the Continent or in America, or even with manufacturers in this country, who would be able to offer some help as to the way to set about modifying a set (if that is possible) to give us the benefits of new systems, without having to scrap existing equipment.—F. Davey (Malvern).

BROADCAST INTERFERENCE

SIR,—It is, I think, well known that a TV set can cause considerable interference with neighbouring broadcast receivers, and I recently had a visit from a neighbour who had just moved in next door and said my set was introducing a whistle. I had not previously had a complaint and so I investigated this problem. I found it was indeed my set, and I overcame the trouble in a simple manner which I think is worth passing on. I removed the back of the cabinet and found there was a small piece of tinfoil across the lower part of the cabinet, which was a console. I removed this and replaced it by a sheet of the aluminium foil now sold for kitchen use, and screwed a lead under a large washer into the back so that good contact was made with the foil. I then cut pieces for the sides of the cabinet and joined these up by the same means, and to the chassis I attached a piece of thin brass strip, slipping this under one of the bolts already in the chassis, after loosening it. I bent this strip so that it would make contact with the back sheet of foil when it was replaced, and on trying the set out the interference was almost completely removed. Finally, I fitted a suppressed plug to the mains lead to the set and provided one for my neighbour, and there is now absolutely no sign of any interference.—A. Malin (Glasgow).

TUBES

DIRECT FROM OUR FACTORY
New low prices. New top quality guns
ALL GUARANTEED

Carriage and Insurance 12/6	6 MONTHS REVACUUMED	12 MONTHS REGUNNED	12 MONTHS NEW TYPES
CRM69, MW22-7, MW22-14, MW22-14C, MW22-17, MW22-18, etc.	£1-10	£3	MW31/74 £4-10
12KPA, 121K, C12B, CRM121, CRM121A, CRM121B, CRM122, CRM123, MW31-14C, MW31-16, MW31-18, MW31-74, etc.	£2	£4	MW36/24 £5.15
141K, 7201A, G14FM, CRM141, CRM142, CRM143, MW36-24, MW36-44, etc.	£2-10	£4-10	AW43/80 £6-15
17ASP4, 171K, AW32-21, C17FM, CRM171, CRM172, MW43-64, MW43-69, 7401A, AW42-80, C14BM, C17BM, CRM151, CRM152A, CRM152B, CRM153, CRM173, MW43-80, MW41-1, etc.	£3	£5-5	MW43/64 £6-15
AW53-80, CRM212, MW53-20, MW53-80	£4	£6-10	

13 CHANNEL TV'S

TABLE MODELS, FAMOUS MAKES. Complete with all valves and tubes. These sets are unequalled in value due to huge purchase direct from source. They are untested and are not guaranteed to be in working order.

- AMAZINGLY POPULAR-IDEAL SECOND SETS**
- 12" - £3.19. (p. & p. 12/6)
 - 14" - £6.19. (p. & p. 15/-)
 - 12" 5 CHANNEL TV'S 45/- (p. & p. 12/6)
 - 14" 5 CHANNEL TV'S 85/- (p. & p. 12/6)

LINE OUTPUT TRANSFORMERS. Most makes available from 25/-.

NEW 108K (10in.) TUBES SPECIAL OFFER: 29/-

COMPLETE RECORD PLAYERS
4-speed Auto in 2 tone Case. Few only **£13.15**

4-SPEED RECORD PLAYERS
Latest B.S.R. TU9. Turntable together with lightweight Star Galaxy dual supply crystal turnover pick-up head. **£3.10** Carr. Truly amazing value at 3/-

100 CONDENSERS 10/-
Assortment of miniature silver mica and ceramic condensers. 3-5,500 pF. List value over £5.

100 RESISTORS assortment 1/2-watt. **6/6**

PM SPEAKERS 3 ohms, top makes, performance guaranteed.
8in. **8/-** 5in. **11/-** 10in. **13/-**
6 1/2in. **7X4**

CO-AX standard and low loss, 25 yds., 12/6. 50 yds., 22/6. 100 yds., 42/6. Co-ax. Plugs 1/8. Wall outlet boxes 3/6.

SMASH HITS

STEREO AUTOCHANGERS
B.S.R. UAS Monarch with famous Xtal Stereo Cartridge. Unrepeatable. **£6.19**

STEREO OUTFITS
Consisting of Stereo B.S.R. UAS, together with two separate 3 watt mains amplifiers, 3 valves (10F2, 10P14, U19) with sim. Speakers in two tone cases with controls. Also screened leads. **NOTHING ELSE TO BUY! £11.10!**

3 WATT AMPLIFIERS
As above, ideal for P.A. Guitars Grams. **49/-** etc. Ex. quality.

TV PROJECTION UNITS
Complete Standard Philips optical units with Mullard MW6-2 projection tube (untested) at a fraction of cost. **£3.10**

VALVES SOILED GUARANTEED 3 MTHS.
EY51, PL81 AMAZING VALUE 4/6

12in. TV'S 5 channel table models including speaker, line trans. cabinet. Top makes requiring only valves and tube to complete your choice if available (carr. 4/-). (Or £8 per dozen carr. free.) **15/-**

14in. TV'S 5 channel as above (carr. 4/-). **35/-**

RECTIFIERS 12 volt 3 1/2 amps, 9/6; 250 v. 80 mA., 5/-; RM1, 6/6; RM2, 8/-; RM3, 9/-; RM4, 15/6; RM5, 21/-; 14A86, 17/-; 14A97, 23/-; 14A100, 25/-; 16RC1-16-1, 7/9; 18RA1-1-16-1, 7/9; 18RD2-2-8-1, 14/-; 14RA1-2-8-2, 17/-; 14RA1-2-8-3, 20/-.

TURRET TUNERS
38 Mc. IF. Standard Famous Make with coils listed. £7. Complete with PCF80 and PCC84 valves, boxed (carr. 3/-). Ditto complete except for 1 oscillating coil, 29/-.

EXTERNAL I.T.V. CONVERTERS WITH POWER PACK. Very compact. PCC84/PCF80. No alterations to set. Separate easy-mount control box. Listed at £77/70. Our Price, carr. 2/6. **39/-**

B.S.R. MONARDECK TAPE DECKS £9 10 0
COLLARO TRANSCRIPTION DECKS £18 15 0

VALVES BY RETURN OF POST

10% DISCOUNT SPECIAL OFFER TO PURCHASERS of any SIX VALVES marked in black type (15% in dozen). Post: 1 valve, 6d., 2-11, 1/-

NEW LOW PRICES GUARANTEED 3 MONTHS

FREE TRANSIT INSURANCE. All valves are new or of fully guaranteed ex-Government or ex-equipment origin. Satisfaction or Money Back Guarantee on goods if returned unused within 14 days.

OZA 5/6	6A6G 3/6	6J7G 5/6	6X5G 5/6	12B5GT 3/6	43	7/6	LF61 4/-	EC88C2 6/8	EM84 8/6	N152 10/6	TH30C 12/8	UCL53 13/6
1A5GT 5/-	6AQ5 6/-	6J7GT 7/9	6X5GT 6/-	12K7GT 5/6	50C5 9/6	DF96 7/6	DF96 7/6	EC88C3 7/-	EM80 9/3	P41 4/8	U14 8/-	U141 8/6
1A7GT 11/9	6AT6 7/-	6K6GT 6/8	7A7 7/6	12K8GT 11/6	50L6GT 9/3	DH83 6/9	EC88C4 8/9	EC88C5 8/3	EM81 9/3	P61 2/3	U18 3/6	UF42 6/9
1C5GT 9/6	6AU6 7/9	6K7 5/9	7B5 12/6	12Q7GT 5/6	53KU 10/6	DH70 5/6	EC88C6 9/9	EC88C7 9/9	EM82 10/6	PCC84 7/8	U24 15/-	UF80 9/-
1D5 9/6	6B7 9/6	6K7G 2/3	7B6 9/6	12S6GT 5/6	54KU 8/9	DH77 7/6	EC88C8 11/9	EC88C9 11/9	EM83 16/-	PCC85 9/3	U25 18/6	UF86 14/6
1F6 9/9	6B8G 3/6	6K8GT 5/-	7B7 7/3	12S7 5/6	61SPT 11/-	DK32 6/-	EC88D1 6/-	EC88D2 14/-	EM84 9/9	PCC86 19/3	U26 11/-	UF89 7/3
1H5GT 9/9	6BA6 6/-	6K8G 5/6	7C5 7/6	12S7GT 8/6	57 6/6	DK92 8/6	EC88D3 9/8	EC88D4 8/6	EM85 10/6	PCC87 19/3	U31 7/3	UL41 7/6
1I4 3/6	6BB6 6/-	6K8GT 10/-	7C6 7/6	12S8 9/6	57 6/6	DK96 7/6	EC88D5 8/6	EC88D6 8/6	EM86 10/6	PCC88 19/3	U33 13/-	UL44 12/6
1LD5 3/6	6BG6G 12/6	6L1 12/6	7E7 9/6	12Y4 9/6	78 7/6	DK96 7/6	EC88D7 8/6	EC88D8 8/6	EM87 10/6	PCC89 19/3	U35 8/9	UL46 9/9
1LN6 4/6	6BH6 6/-	6L6 9/9	7H7 7/6	1487 14/9	80 6/6	DL33 8/9	EC88D9 8/3	EC88D10 8/3	EM88 10/6	PCC90 19/3	U37 20/6	UL84 2/9
1NG6T 9/9	6BJ6 6/-	6L6G 7/6	7K7 8/-	19AQ5 7/-	83 6/6	DL35 9/9	EC88E1 7/6	EC88E2 10/-	EM89 10/6	PCC91 19/3	U38 8/9	UM60 9/6
1R5 6/-	6BK7 9/3	6L7 9/-	7R7 10/6	19B6G 15/-	90AV 4/6	DL82 9/6	EC88E3 14/6	EC88E4 10/-	EM90 10/6	PCC92 19/3	U39 5/6	UM6 12/6
1R4 8/6	6BW6 7/9	6L7G 7/6	7R7 7/6	20D1 9/6	117Z7 10/8	DL91 10/8	EC88E5 14/6	EC88E6 12/-	EM91 10/6	PCC93 19/3	U41 5/6	U07 9/6
1S5 5/3	6BW7 6/6	6L8 9/-	7V7 7/9	20F2 9/6	183BT 16/-	DL92 6/-	EC88E7 12/-	EC88E8 3/3	EM92 10/6	PCC94 19/3	U42 9/6	U08 16/6
1T4 4/-	6BX6 6/6	6L9 12/6	7Y4 7/-	20L1 13/6	723A 29/-	DL94 7/-	EC88E9 7/6	EC88E10 7/6	EM93 10/6	PCC95 19/3	U43 5/6	U09 9/6
2D21 4/8	6C4 3/6	6L13 8/6	7Z4 7/6	20P1 11/6	807A 5/-	DL96 9/6	EC88E11 7/6	EC88E12 10/-	EM94 10/6	PCC96 19/3	U44 9/6	U10 11/-
3A4 5/6	6C5 5/6	6L14 7/6	8D3 3/6	20P3 12/6	807B 3/9	EA50 9/6	EC88E13 7/6	EC88E14 7/6	EM95 10/6	PCC97 19/3	U45 9/6	U11 11/-
3A5 9/6	6C6 4/9	6L20 8/6	10C1 11/-	20P4 17/-	808 15/-	EA80 7/6	EC88E15 8/6	EC88E16 8/6	EM96 10/6	PCC98 19/3	U46 9/6	U12 11/-
3Q4 7/8	6C9 9/6	6N7 8/6	10C2 18/6	20P5 18/-	955 2/9	EA91 4/9	EC88E17 8/6	EC88E18 2/-	EM97 10/6	PCC99 19/3	U47 14/-	U13 6/6
3Q5GT 8/9	6CD6G 18/6	6P1 14/-	10C14 9/-	25A6G 8/-	956 2/9	EA92 8/6	EC88E19 8/6	EC88E20 8/6	EM98 10/6	PCC100 19/3	U48 14/-	U14 6/6
3R4 6/-	6CH6 9/3	6P25 9/-	10F1 6/9	25L6G 6/9	2050 10/-	EB41 7/-	EC88E21 14/-	EC88E22 14/-	EM99 10/6	PCC101 19/3	U49 12/6	U15 6/6
3V4 7/-	6D1 9/-	6P28 12/6	10F9 10/3	25L6GT 9/-	5733 10/-	EB41 7/-	EC88E23 14/-	EC88E24 14/-	EM100 10/6	PCC102 19/3	U50 12/6	U16 6/6
5R4G 9/6	6D2 3/9	6Q7G 6/9	10L14 8/-	25V5G 9/-	9001 4/-	EB91 3/9	EC88E25 14/-	EC88E26 14/-	EM101 10/6	PCC103 19/3	U51 11/-	U17 6/6
5U4G 5/-	6D3 12/6	6Q7GT 9/3	10L13 8/3	25Z4G 7/3	9003 4/-	EB92 3/9	EC88E27 14/-	EC88E28 14/-	EM102 10/6	PCC104 19/3	U52 11/-	U18 6/6
5V4G 9/6	6D6 4/9	6R7G 7/6	10L12 8/9	25Z5 8/-	ATP4 2/9	EB93 5/6	EC88E29 14/-	EC88E30 14/-	EM103 10/6	PCC105 19/3	U53 11/-	U19 6/6
5X4G 11/-	6F1 5/9	6SA7 5/9	10L13 9/6	25Z6 9/-	AZ31 9/-	EB94 8/6	EC88E31 14/-	EC88E32 14/-	EM104 10/6	PCC106 19/3	U54 11/-	U20 6/6
5Y3G 6/-	6F6G 6/3	6SG7 4/9	10P14 9/6	278U 16/-	B36 8/6	EB95 8/6	EC88E33 14/-	EC88E34 14/-	EM105 10/6	PCC107 19/3	U55 11/-	U21 6/6
5Y3GT 6/6	6FM 7/6	6SH7 4/9	10P18 8/6	30C1 7/6	B65 4/9	EB96 8/6	EC88E35 14/-	EC88E36 14/-	EM106 10/6	PCC108 19/3	U56 11/-	U22 6/6
5Z4G 8/6	6F12 3/9	6S45 5/3	12A6 5/3	30F5 7/6	CL33 21/-	EB97 8/6	EC88E37 14/-	EC88E38 14/-	EM107 10/6	PCC109 19/3	U57 11/-	U23 6/6
5Z4GT 11/-	6F13 3/9	6SK7 5/3	12A17 6/9	30FL1 9/6	CL33 21/-	EB98 8/6	EC88E39 14/-	EC88E40 14/-	EM108 10/6	PCC110 19/3	U58 11/-	U24 6/6
6A7 10/-	6F14 9/6	6SL7GT 6/9	12A18 9/8	30FL2 9/6	CL33 21/-	EB99 8/6	EC88E41 14/-	EC88E42 14/-	EM109 10/6	PCC111 19/3	U59 11/-	U25 6/6
6A8G 9/6	6F15 9/6	6SN7GT 4/9	12A16 7/9	30P4 12/6	DL63 4/6	EC92 3/9	EC88E43 14/-	EC88E44 14/-	EM110 10/6	PCC112 19/3	U60 11/-	U26 6/6
6A8GT 13/6	6F16 8/9	6SG7 6/3	12A17 5/9	30P12 5/9	D77 3/9	EC90 3/6	EC88E45 14/-	EC88E46 14/-	EM111 10/6	PCC113 19/3	U61 11/-	U27 6/6
6A8S 8/3	6F33 6/9	6SS7 5/8	12A17 6/8	30P16 7/9	D152 6/6	EC91 6/6	EC88E47 14/-	EC88E48 14/-	EM112 10/6	PCC114 19/3	U62 11/-	U28 6/6
6A7 4/3	6H6 2/-	6U4GT 10/6	12A17 7/-	30P11 10/6	DA30 12/6	EC92 6/6	EC88E49 14/-	EC88E50 14/-	EM113 10/6	PCC115 19/3	U63 11/-	U29 6/6
6AG5 4/3	6J5 6/6	6V5G 6/6	12A16 8/-	35L6GT 10/6	DA90 2/6	EC92 6/6	EC88E51 14/-	EC88E52 14/-	EM114 10/6	PCC116 19/3	U64 11/-	U30 6/6
6AG7 8/-	6J5GT 2/9	6V6G 5/6	12B66 8/9	35W3 6/9	DAC32 9/9	EC93 6/6	EC88E53 14/-	EC88E54 14/-	EM115 10/6	PCC117 19/3	U65 11/-	U31 6/6
6AK5 6/9	6K6GT 3/9	6V8GT 6/6	12B17 10/8	35Z4GT 5/6	DA91 5/3	EC93 6/6	EC88E55 14/-	EC88E56 14/-	EM116 10/6	PCC118 19/3	U66 11/-	U32 6/6
6AL5 3/9	6J6 4/-	6X2 8/9	12C8 8/9	35Z5GT 8/6	DA96 7/9	EC95 6/9	EC88E57 14/-	EC88E58 14/-	EM117 10/6	PCC119 19/3	U67 11/-	U33 6/6
6AM5 4/6	6J7 7/9	6X4 5/6	12E1 12/6	42 7/8	DF33 9/9	EC95 6/9	EC88E59 14/-	EC88E60 14/-	EM118 10/6	PCC120 19/3	U68 11/-	U34 6/6

Post: 2 lbs. 1/6, 4 lbs. 2/-, 7 lbs. 2/9, 15 lbs. 3/6 etc. No C.O.D. ALL ITEMS LESS 5% & POST FREE IN DOZENS. Callers always welcome. LIST OF 1000 SNIPS 6d.

TECHNICAL TRADING CO.

350-352 FRATTON ROAD, PORTSMOUTH. P.O. BOX 21 (W)

TRUE **ECONOMY** *Depends* *on Quality*

Midland rebuilt C.R.T.s conform to the highest standard of reliability—offering you the finest value available today. Each tube is completely rescreened, aluminised and fitted with a new gun unit.

Midland's reputation for quality and the rapidly growing demands for these dependable tubes are your assurance of satisfaction.

12 and 14in.—£5.0.0 15 and 17in.—£5.10.0 21in.—£8.0.0 (all types).

Reliable Rebuilds at Popular Prices.

Exceptionally low-priced Midland Rebuilds—the tubes you can always depend on.

12in.—£4.10.0 14in.—£4.15.0 15 and 17in.—£5.0.0 21in.—£7.0.0 (all types).

ALL TYPES COVERED BY MIDLAND'S 12 MONTH GUARANTEE AVAILABLE NOW—FROM STOCK

MIDLAND TUBES LTD.

37 GEORGE STREET, MANCHESTER, 1. Telephone: CENTRAL 4568/9



FREE TO AMBITIOUS ENGINEERS

— THE LATEST EDITION OF ENGINEERING OPPORTUNITIES

Have you sent for your copy?
ENGINEERING OPPORTUNITIES is a highly informative 156-page guide to the best paid engineering posts. It tells you how you can quickly prepare at home for a recognised engineering qualification and outlines a wonderful range of modern Home Study Courses in all branches of Engineering. This unique book also gives full details of the Practical Radio & Electronics Courses, administered by our Specialist Electronics Training Division—the B.I.E.T. School of Electronics, explains the benefits of our Employment Dept. and shows you how to qualify for five years promotion in one year.

We definitely Guarantee
“NO PASS — NO FEE”

Whatever your age or experience, you cannot afford to miss reading this famous book. If you are earning less than £25 a week, send for your copy of “ENGINEERING OPPORTUNITIES” today—FREE.

BRITISH INSTITUTE OF ENGINEERING TECHNOLOGY (Incorporating E.M.I. Institutes)
(Dept. SE/20), 29 Wright's Lane, London, W.8

WHICH IS YOUR PET SUBJECT ?

Mechanical Eng.,
Electrical Eng.,
Civil Engineering,
Radio Engineering,
Automobile Eng.,
Aeronautical Eng.,
Production Eng.,
Building, Plastics,
Draughtsmanship,
Television, etc.

GET SOME LETTERS AFTER YOUR NAME!

A.M.I. Mech. E.
A.M.I.C.E.
A.M.I. Prod. E.
A.M.I.M.I.
A.I.O.B.
A.F.R.Ae.S.
B.Sc.
A.M. Brit. I.R.E.
City & Guilds
Gen. Cert. of Education
Etc., etc.

PRACTICAL EQUIPMENT

Basic Practical and Theoretic Courses for beginners in Radio, T.V., Electronics, Etc., A.M. Brit. I.R.E. City & Guilds Radio Amateurs' Exam. R.T.E.B. Certificate P.M.G. Certificate Practical Radio Radio & Television Servicing Practical Electronics Electronics Engineering Automation

INCLUDING TOOLS!

The specialist Electronics Division of B.I.E.T. (incorporating E.M.I. Institutes) NOW offers you a real laboratory training at home with practical equipment. Ask for details.

B.I.E.T. SCHOOL OF ELECTRONICS



POST COUPON NOW!

Please send me your FREE 156-page “ENGINEERING OPPORTUNITIES” (Write if you prefer not to cut page)

NAME.....

ADDRESS.....

SUBJECT OR EXAM THAT INTERESTS ME (SE/20.)

THE B.I.E.T. IS THE LEADING ORGANISATION OF ITS KIND IN THE WORLD

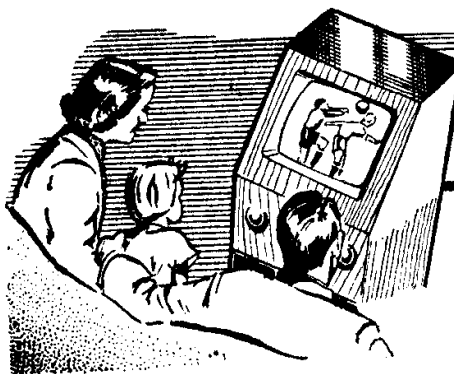

UNDERNEATH THE DIPOLE

TELEVISION PICK-UPS AND REFLECTIONS

By *Iconos*

EVERYBODY likes to see a wedding — particularly a royal wedding. The wedding of King Baudouin of the Belgians and his bride, the new Queen Fabiola, provided interesting pictorial material for newspapers, newsreels and television. The Belgian Television Service certainly went to town with a very comprehensive coverage of the event, distributed to twelve countries over the Eurovision Network. The BBC made the most of this important royal occasion by relaying the morning transmission complete, and also presenting an edited version of a telerecording in the evening. I saw the late night transmission of the recording, via the BBC's North Hessory Tor transmitter and a "piped" television receiver in an hotel, and was most impressed.

A Technical Triumph

Technically, it was somewhat variable in picture quality, due to large variations in the lighting values of interiors and exteriors and the unavoidable degradations introduced in the long electronic chain between the cameras in Brussels and the British viewers' sets. Just think of it—the pictures from dozens of cameras of different types and makes, O.B. trucks, microwave links, and the like were fed to a central point for European transmissions on 625 lines. This was picked up by the BBC's special receiving station near Dover, where it was converted to the British 405 line standard and sent up co-axial cables to London, for redistribution to the BBC Network. The final result was highly creditable to all the technicians and programme personnel involved—not to mention the magnificence of the occasion itself. The pageantry and pomp of the processions, the glittering uniforms, the prancing

horses, the solemn ritual in the Cathedral and—best of all—the fine personal close-ups of the King and Queen, which so clearly revealed the happiness of the royal couple and the devoted attentions of the King. My one regret was that the transmission was not in colour.

Tam Rating

Seven millions or so British viewers can't be wrong. I suppose, if they all switch to particular items in the ITV programmes, thus putting "Bootsie and Snudge," "Take your Pick" or "Double your Money" into the top ten of public popularity. Apart from the BBC's own audience research department, there is now only one poll organisation — Television Audience Measurement—which carries out really comprehensive sampling of viewers' opinions in all areas. The results are depressingly real in their assessment of public taste, encouraging television producers to play safe with routine trivialities rather than to blaze new trails. That, however, is not a new state of affairs in show business. He is a brave man who risks his money in promoting a minority-appeal theatrical production, other than in a small specialised theatre like the Court Theatre, London.

ITA versus Tam Viewership Maps

I am quite prepared to accept without question the relative popularity of the programmes, as reported week-by-week by TAM, but I can't help being a little suspicious about the actual numbers of viewers. These numbers must, in turn, be proportionate to TAM's own estimate of the total numbers of viewers in each of the regional areas, numbers which vary considerably from the ITA's official

figures and maps. I have myself investigated the quality of reception on many TV sets within the contours of TAM published reception maps and found in some cases that interference was so bad as to reduce the entertainment value to nil. Elaborate aerial arrays pointing towards certain TV Stations does not necessarily mean that the owners tune to those stations very often. In some districts, it simply indicates good salesmanship on the part of the local television retailers, who sold the aerials. After several weeks of viewing a fringe picture through periodic blizzards of interference, the viewer loses interest and switches permanently to the stronger local station. The larger the television screen, the more objectionable becomes interference. Few rooms in dwelling houses are large enough for 21in. screens—at any rate, on the 405 line standard.

Bristol Studios

Bristol is now an important television centre, both for the BBC and for ITV. The new Arnos Court Studios of TWW are now open and are operated in conjunction with the TWW studios at Pontcanna, Cardiff. The main studios at both centres are large, Pontcanna having a 60ft x 80ft stage and Arnos Court having a 90ft x 65ft stage. Both of these TWW television centres were built from the ground, especially designed for television purposes instead of being conversions of old warehouses or theatres. The result in both cases has been bright and airy modern buildings appropriate to this new and growing industry. Walter Kemp, Technical Controller, and Treadgold and Elsey, Architects, are to be congratulated on their efforts. Another brand new television stage will shortly be erected at Manchester by

Granada, who were the first programme contractors to build new, and Westward's new Plymouth studios have made great progress, in spite of appalling weather conditions.

The ITV studios at Cardiff, Bristol and Plymouth all receive their network programmes and IT News via a Post Office switching centre at Bristol, which also serves the BBC studios in the same cities. Reverse network facilities to London are also available at Bristol, but not in Plymouth, which will have one-way microwave link connections from Bristol. The Post Office engineers have been constructing these links under great difficulties of floods and inclement weather, but rapid progress is being made, all the same.

Zoom Lenses

We first recognised the value of the zoom lens years ago when the BBC enterprisingly attached a motion picture camera zoom lens to a television camera for sports events. Now it has become more or less a commonplace optic on television cameras of all types and also on BBC and IT News film cameras. The longer focus zoom lens, with focal length variable from about 8in. to 20in., corresponding to acceptance angles of about 10°

to 3°, enable close-ups of batsman to be obtained from great distances. Taylor, Taylor and Hobson, the British lens makers, are now supplying fine zoom lenses, with focal length variable from 2in. to 8in. This type of lens is more suitable for studio use, and even finds a place in the rather small studio of Independent Television News. The zoom lens can be used to take the place of a number of separate fixed focal length lenses on a turret. I will hazard a guess that

the television camera of the future will be designed around a zoom lens—instead of vice versa—and that all controls of zoom, iris and focus will be remote controlled. There is no point in having separate lenses if one lightweight zoom can be made to do the job. In this respect, we have three first-class British optical firms: Watson; Taylor, Taylor and Hobson; Dallmeyer—all competing and well ahead of foreign optical manufacturers.

PRACTICAL WIRELESS

Chief Contents of the February Issue

Now on Sale, 1/6

A STEREO AMPLIFIER
80-METRE AERIAL COUPLER
AN EFFICIENT MAINS FILTER
AMPLIFIED D.C. TRANSISTOR RECEIVER
A VERSATILE TAPE RECORDER
GUITAR TREMOLO UNIT
A BAND II PRE-AMP
CLUB NEWS
ETC., ETC., ETC.

VALVES AND THEIR HABITS

(Continued from page 245)

T41 and 6K25—Thyratrons

The T41 has 4V heaters and Mazda octal base and the 6K25 6.3V heaters and international octal base. Apart from this they are identical. Widely used in early post war receivers as line and frame generators but subsequently abandoned due to their non-linearity, comparatively low linear output, and unsuitability for A.C./D.C. techniques. Commonest symptom is frame judder or dither, usually presenting two complete pictures, one half an inch above the other, both flickering.

U22

This valve is an EHT rectifier with 2V 2A heater and Mazda octal base. It is used exclusively on mains EHT units. The usual signs of failure are a bright purple glow inside the entire envelope and/or bright white sparks flying from the top and bottom of the heater. The maximum EHT is 5kV.

U24

Also an EHT rectifier with 2V 0.15A heater and international octal base, used in early receivers with flyback EHT. If it is difficult to obtain, change the base and use a U26 or wire in a U25. The maximum EHT is 7kV.

U25

The U25 is a wired-in EHT rectifier with 2V 0.2A heater. Fault symptoms are low emission (a picture which expands rapidly with increased brilliance) and a flaking cathode (ragged edge with width variations and defocusing). If no gettering can be seen around the top of the bell the valve is becoming "soft", or if filaments repeatedly blow, wire a 15Ω, ¼W resistor across the heater pins.

If U25's fail due to internal shorts, check the efficiency diode which often fails shortly afterwards.

U26

This is the plug-in version of the U25, with a much higher working voltage. Fault symptoms are the same as those of the U25 for which it may be substituted in an emergency, taking 150mA greater heater current. This makes it an ideal replacement for the U25 in cases where repeated failures occur in lieu of the 15Ω shunt mentioned in the U25 section.

(To be continued)

INTRODUCING THE "REAL COMPANION" CAR RADIO/PORTABLE

Now available is a modern receiver quite easy to make up and with all the features of sets being sold at twice the price. The circuit has been well tried and proved and will perform well all over the country. Here at Eastbourne, recognised as a bad reception area, performance on the Home, Light and many Continental Stations including Luxemburg, is extremely good. Demonstration Models can be heard at Eastbourne and our London address.

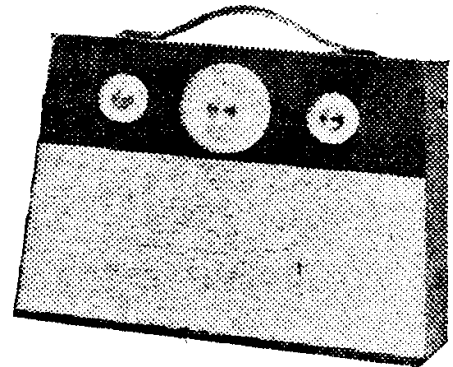

NOTE THESE FEATURES

- 400/500 mw. Output Push-pull.
- 6 First Grade Transistors.
- Latest Type Superhet circuit.
- Medium and Long Wave.
- Internal Ferrite aerial litz wound.
- High "Q" coils.
- Latest type printed circuit with components plan.
- Slow motion tuning.
- Car aerial attachment.
- Two-tone cabinet.
- High flux elliptical speaker.
- Size 11 x 8 x 8in. approximately.
- Easy to follow instructions.
- 12 month guarantee all components.
- No technical knowledge required.
- Service available at moderate charges.

ORDER IN CONFIDENCE

Money returned in full if parcel not up to expectation and returned unassembled. Price complete, less battery, £8.19.6, plus carriage and insurance 7/6.

TRANSISTOR LOUDSPEAKER POCKET RADIOS

Read these testimonials

- Mr. J. Brown, Glamorgan, S. Wales.**
"My Pocket 3 arrived safely. I must say I am very pleased with it indeed. It is absolutely wonderful. Thank you very much. I now enclose 16/6 for your conversion parcel to Pocket 4".
- Mr. J. Bell, Wolverhampton.**
"I am writing to express my satisfaction at the standard of your kit for your Pocket 4 Transistor set and also to state that it has come up to my expectations in regard to performance".
- Mr. K. Edwards, Boreham Wood, Herts**
"I have completed the assembly of your Pocket 3 and am very pleased with the results".
- Mr. N. Elliott, Pontypool.**
"I have completed the assembly of your Pocket 4 radio and am pleased to say that it works from the first switching on".
- Mr. F. Jackson, Ickenham, Middx.**
"I have built the Pocket 4 and am more than pleased with the results".
- Mr. G. Bamford, Ramsgate.**
"I find this set even better than you claim it to be and most certainly up to your usual standard of quality. I feel that nobody could fail to build it and get results. Even the first-time-ever novice, as your circuit diagrams and instructions are so clear and precise".
- Mr. Graham, Birchington-on-Sea.**
"Re Pocket 4. I must say that it is all you say of it. The stations roll in, and good volume too".
- Mr. T. Bell, London, S.W.11.**
"I have made up one of your 55/- transistorised radios and I am very pleased with the results".
- Mr. A. J. Simmonds, Welling, Kent.**
"I purchased from you a week ago the Pocket 4 Transistor Kit. I put it together last night in 1 1/2 hours on switching on the set, I was right on Radio Luxemburg. I must say thank you, because not only has the set a very attractive appearance, it also behaves fantastically".

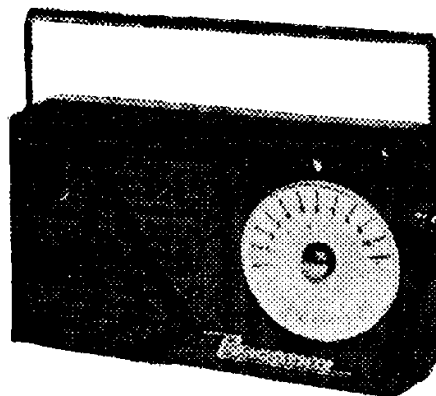

Now available with first grade transistors. Circuit comprises 2 HF transistors reflexed to equal 4 stages. Permanent germanium diode and high gain AF output stage, fitted with miniature speaker, proper tuning condenser, volume control and in case with handle as illustrated (less monogram), completely portable. No aerial or earth required. Pocket 4 uses 3 transistors and 1 diode, price 52/6, plus 2/6 post and insurance. Pocket 5 uses 4 transistors and 1 diode and has feedback control, price 67/6, plus 2/6 post and insurance. **Results Guaranteed**
Nothing can be more disappointing than to find that despite care in making up, your radio just will not work or needs a long high aerial and water pipe earth. We guarantee good results in all areas and we guarantee all components for 12 months. Read just a few of the hundreds of testimonials we have received from constructors who have made, these sets. Send in confidence. Money refunded if parts or guarantees not up to your expectations. Plans free with parts, or separately 1/6. More details S.A.E.

THE ORIGINALS MAY BE SEEN AT THIS OFFICE

- Mr. S. Rigby-Jones, South Molton, N. Devon.**
"I was delighted to receive my Pocket 4 Transistor set. After I assembled and tested it I was amazed such a small receiver had such good reception".
- Mr. E. Balcombe, Manchester.**
"I have constructed your Pocket 4 Loudspeaker radio and am delighted with its performance and appearance, for the cost I consider it excellent".
- Mr. R. Belt, Newcastle-on-Tyne.**
"I have built your Pocket 5 Transistor set I am very pleased with it".
- Mr. R. Morse, Birchington-on-Sea.**
"I knew nothing whatever about radio but I have just made up your transistor set from the kit of parts you sent. I am happy to say that it works perfectly and does all you claim of it. As you see, I live a good way from London, yet the B.B.C. comes in quite loud. The little set can be heard working in a good-sized room. Quite a number of other stations can be heard at night time with quite good separation. Wonderful value for money".
- Mr. N. Stewart, Leeds.**
"Having completed Pocket 3 Kit, which I received from you I have had results on first attempt. I must say that in my opinion this small transistor radio gives results far better than any other set".
- Mr. J. Hayden, Bolton, Lancs.**
"I have had great pleasure in buying from you a Pocket Transistor 5. I have built it up and it is perfect".
- Mr. R. Dobbin, Ronkswood, Worcester**
"I wish to inform you that I am very pleased indeed with the Pocket 5 Transistor Radio set I recently purchased from you. I wish to say the reception is quite good".

ELECTRONIC PRECISION EQUIPMENT LTD.

66, GROVE ROAD, EASTBOURNE, SUSSEX

This is the correct address for post orders and for prompt attention please mark your envelope Dept. 5, also enough for postage. Personal shoppers should use one of the companies below.

- | | | | |
|--|--|---|---|
| Electronics (Croydon) Ltd.,
266 London Road,
Croydon.
Phone: CRO 6558
Half day Wednesday | Electronics (Finsbury Park) Ltd.,
29 Stroud Green Rd.,
Finsbury Park, N.4.
Phone: ARChway 1049
Half day Thursday | Electronics (Manor Park) Ltd.,
520 High Street North,
Manor Park, E.12
Phone: Ilford 1011
Half day Thursday | Electronics (Ruislip) Ltd.,
42-46 Windmill Hill,
Ruislip, Middx.
Phone: RUISLIP 5780
Half day Wednesday |
|--|--|---|---|

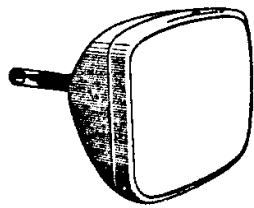

REPLACEMENT REBUILT TV TUBES

12 months' guarantee
Terms available over 20 weeks

21in. TUBE £8.10.0
17in. TUBE £7.10.0
12, 14, 15in. TUBES £5.10.0

Carr. & Ins. 15/6
£2 allowed on old Tube.
£1 allowed on old Tube.

PLESSEY TV CHASSIS FOR SPARES

56 resistances, 54 condensers, 13 valve holders, 4 transformers, Chokes 250 mA. Metal rectifiers, 300v at 250 mA. Fuse panel, focus magnets, plugs, sockets. Carr. 7.6.

5/9

DE LUXE TAPE RECORDER CABINET

ONLY 29/9



Beautifully made Tape Recording Cabinet. Size 13 x 10½ x 7in. Covered in two tone coloured rexine cloth. Stylish design with detachable lid. Easily adapted to Record Player Cabinet. Exceptional value at this very low price. P. & P. 4/6.

AMPLIFIERS

All portable. 12 mths. guarantee
Mk. D2A 79/6
Latest design incorporating negative feedback giving 4 watts output. ECL82 triode pentode valve and contact cooled metal rectifier. Tone and volume control panel on flying leads with compact amplifier chassis suitable to mount under modern auto-changers. A.C. only. Mains isolated, output for 2-3 ohms. P. & P. 3/6.
Mk. D3A 89/6
As above but de luxe model with separate tone controls for treble and base. P. & P. 3/6.
Mk. D5 39/6
Simple circuit employing ECL80 triode pentode output valve giving 3 watts output. A.C. only. Mains isolated. Single control for volume and on/off switch with knob. P. & P. 3/6.

17in. TV COMPLETE 19 gns.

ITV/BBC. Beautifully styled polished cabinet Table Models. 17in. rectangular tube guaranteed for 12 months. Chassis and valves—guaranteed for 3 months. (Chassis salvaged but reconditioned.) Tube despatched separately for insurance coverage, instructions for fitting included. Where possible, personal collection advised. Demonstration given. Deposit £7 and 20 weekly payments of 15/-. Carr. and Ins. 30/-.

Listed at 31 Gns.

LATEST RELEASE! COMPLETE TAPE!

OUR PRICE 18 Gns.

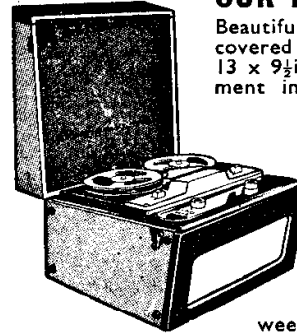

Beautifully styled rexine covered cabinet. Dia. 14½ x 13 x 9½in. Storage compartment in lid for tapes and microphone. Limited quantity. Compact set using latest 5 valve amplifier. B.S.R. Tape Deck. 5½in. tape. 3 months' guarantee. Ins., Carr. 12/6. Deposit £8, plus Ins. and Carr. and 20 weekly payments of 17/-.

TAPE RECORDER AMPLIFIER £7.19.6

Compact well designed 5 valve amplifier. Output 3.5 watts. Input for Microphone, Radio and Gram.

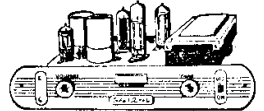

Size 8½ x 3 x 4½in. Ins., Carr. 4/6. Deposit 30/- plus Ins., Carr. and 20 weekly payments of 7/6.

DUKE & CO. (LONDON) LTD.

621/3 Romford Road, Manor Park, E.12. ILF 6001/3
SEND FOR FREE LIST

FACTORY REBUILT

TELEVISION TUBES

After considerable development work and extensive trials under working conditions, the manufacturer is confidently offering an

18 MONTHS' WRITTEN GUARANTEE on all tubes

To ensure extreme reliability, not only are the best available materials used under controlled conditions, but all tubes are given

12 THOROUGH TESTS after completion of the processes

12"	£5.7.6
14"—16"	£5.10.0
Allowance on old tube 10/-	
17"	£6.19.6
Allowance on old tube 20/-	
21"	£8.19.6
Allowance on old tube 30/-	

C.W.O. or C.O.D. Carr. and Ins. 10/-

TELEVIEWER SUPPLIES

95 Caldmore Road, Walsall, Staffs.

For Safety's Sake
use
AVO Prodclips

Pat. No. 748811

...with Trigger-Action Spring-Loaded Clips

PRESS TRIGGER TO OPEN
RELEASE TO GRIP

Safety first every time with these patented spring-loaded AVO Prodclips.

Cleverly designed for use as insulated prods, they are invaluable for reaching and holding test points which are difficult of access.

Suitable for use with AvoMeter, Multiminor and Avo Electronic Test Meter Leads.

Post Free
15/-
per pair.

AVO LTD • AVOCET HOUSE,
92-96 VAUXHALL BRIDGE ROAD, LONDON, S.W.1.
VICtoria 3404 (12 lines)

A MEMBER OF THE METAL INDUSTRIES GROUP OF COMPANIES

LUBRICATION IN SERVICING

DECREASING CONTACT FRICTION AND REDUCING RESISTANCE

By L. E. Higgs

LUBRICATION and cleaning are fast becoming specialised subjects of their own in the maintenance and servicing of domestic TV and radio apparatus.

Years ago, a squirt of oil given to the dial pointer slide or pulleys of the condenser drive was all the attention a radio needed in the way of lubrication. Now, however, the situation is quite different.

At first sight a TV appears to be pure circuitry with no moving parts. Yet the bottles, tins, tubes of fluids and greases decorating the bench of service man and enthusiast prove otherwise.

Tuners

The turret alone of a multi-channel TV requires

three or more different liquid treatments. Tarnished silver-plated contacts need to be lightly scrubbed with a volatile switch cleaner on a thin stippling brush. The switch cleaner used should be chosen with care as some solvents dissolve away the surface of the plastic insulants, including the polystyrene turret coil formers used by at least one manufacturer. Haphazard sprinkling about of this fluid into the turret can have disastrous effects on the synthetic cabinet-polish—and the Perspex screen itself if it trickles through. A dirty, permanent, streak of roughened texture results that is beyond erasure.

A controversy still exists as to whether high frequency contacts should be lubricated. The "all dry" school of thought wins if all atmospheric pollution can be sealed off from the silver surfaces. In practice, nearly all tuners arrive from the makers with smears of silicone or petroleum jelly protecting the surface contacts from the ravages of the climate, oil and gas heater fumes—and kitchen condensation. The later proprietary cleaners contain grease dissolved in them. In fact, one of the wartime standbys was a bottle of carbon tetrachloride with a blob of petroleum jelly inside. This disappeared after a couple of days leaving a slightly amber liquid. The layer of grease deposited can spoil the low-loss ceramic surfaces used in turrets, if the liquid is not applied

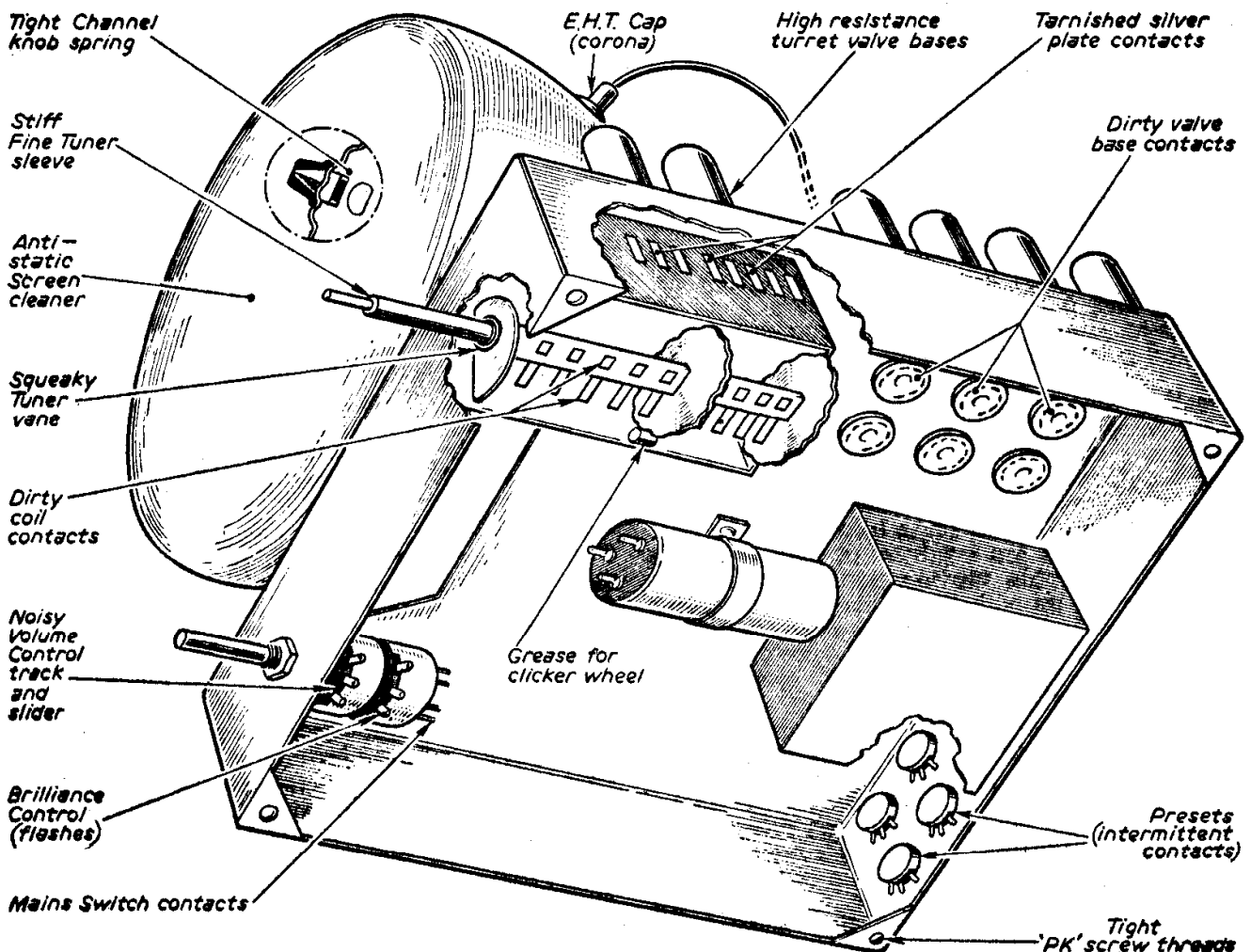

Fig. 1.—Some of the positions in a TV receiver where lubrication is necessary.

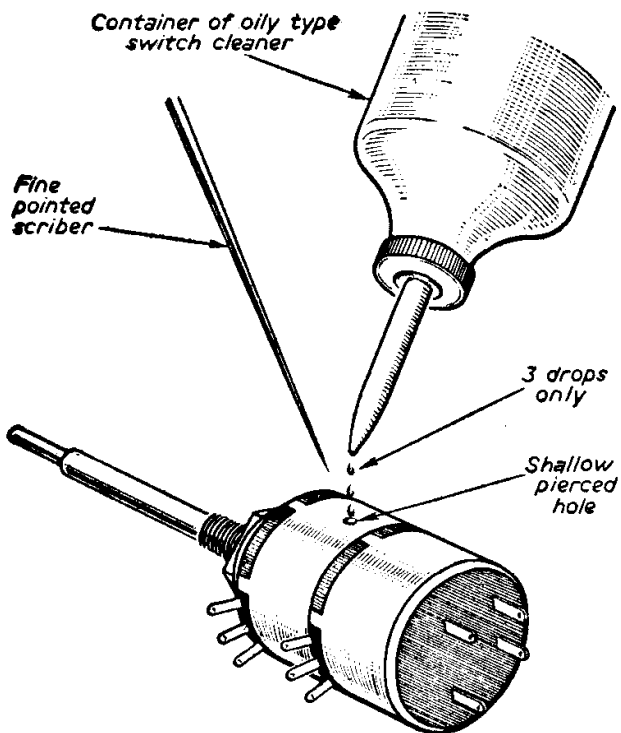

Fig. 2.—A small hole in a volume control allows quick and easy lubrication.

drip by drip to the point to be cleaned. Remember while dealing with the turret to run a drop of oil up the fine tuner sleeve if it is stiff, and to put a spot of grease on the clicker locating-wheel. The smooth action can be felt afterwards by the user and gives a practical proof that the turret has been given attention. (Fig. 1.)

Valves and Volume Controls

Valve contacts on low-loss bases should not have cleaner poured over them while jiggling the valve up and down. True, this clears a lot of intermittent contacts easily, but the removal of the valve and separately burnishing the pins with fine emery cloth is longer lasting. Other turret lubricating points are the rotor bonding contact, and the eccentric bearing slots in the more complicated fine tuner systems. A smear of grease on the spring-clipped fine tuner or channel knob will also be worthwhile. This facilitates the easy removal of the knobs at some later date.

Volume controls are a subject of their own, but because they contain moving parts and so often are now ganged up with the brilliance control and the mains switch, the work involved and time taken to obtain a manufacturer's special control makes it necessary to try to wash away minor crackles, provided we do not remove off the whole of the graphite track, as so often happens with vintage radios. A little in the right place is the rule. A small hole pierced in the case of the control with a scriber enables the cleaner to be introduced quickly and easily without flooding the surrounding chassis. (Fig. 2.) Difficult cases that do not yield to fluid can be opened up and the rotor track and carbon track wiped clean, then lubricated with Vaseline. Retensioning the slider and patching up a worn track with soft pencil lead or a trace of fire grate blacking (an old wartime

dodge) is legitimate with obsolete controls where modifying new types to suit is a very involved job.

Switches in the FM sections of TV receivers suffer from corroded contacts after a few years' use and care should be taken to see that the set is off before applying any switch cleaner. Too often in the past with old wafer switches application of cleaner while the set is on has started up arcing and tracking across the insulation from H.T. points and earth. Switch clickers, too, respond with easier action when given a smear of grease and the focus controls remote controlled by cables and cords benefit from a little light oil.

Corona

EHT top caps are lately provided with dry corona protectors, but the older sets and those in damp, or steamy, locations are prone to cause the "snow storm" effect of EHT tracking over the surface of the surrounding glass. An application of silicone grease to the area affected, **after cleaning**, usually stops this. The thinnest possible barrier only is required here and gives the best results.

Generally thick grease is used for slow moving parts, and thin oil for fast movers. A hypodermic oiler is a handy tool for many of the jobs described.

The furniture part of TV and radio equipment when attended to makes another good impression on the customer. Squeaky castors, piano hinges on console doors and radiogram lids, and roller shutters all work better oiled than dry. But do not make the mistake of over-doing it and finish up with an oil-stained carpet!

NEW USES FOR OLD SETS

(Continued from page 239)

a simple wire link can be added. The parallel load of the unused internal matching transformer will, of course, shunt the output appreciably, but it is required only for monitoring sound and not for musical appreciation when on test.

E.H.T. Supply

Care must be taken with this service, and the tube anode lead must always be kept stowed away in the cabinet except when this test is required. As the internal anode lead will be too short for direct contact, an extension lead in EHT cable must be made up and plugged in when required. The test receiver must be switched off when connecting and most important—**link the test chassis to the earth terminal**, or the insulation of the mains transformer of the testing receiver can be broken down. As an additional safeguard against shorts, add a 2M resistor in the extension lead as shown in the diagram. This facility again helps diagnosis of faulty low emission tubes, and broken-down flyback EHT transformers, and, more important, an estimate of the tube condition. This cannot always be done until the costly work of replacement has been completed.

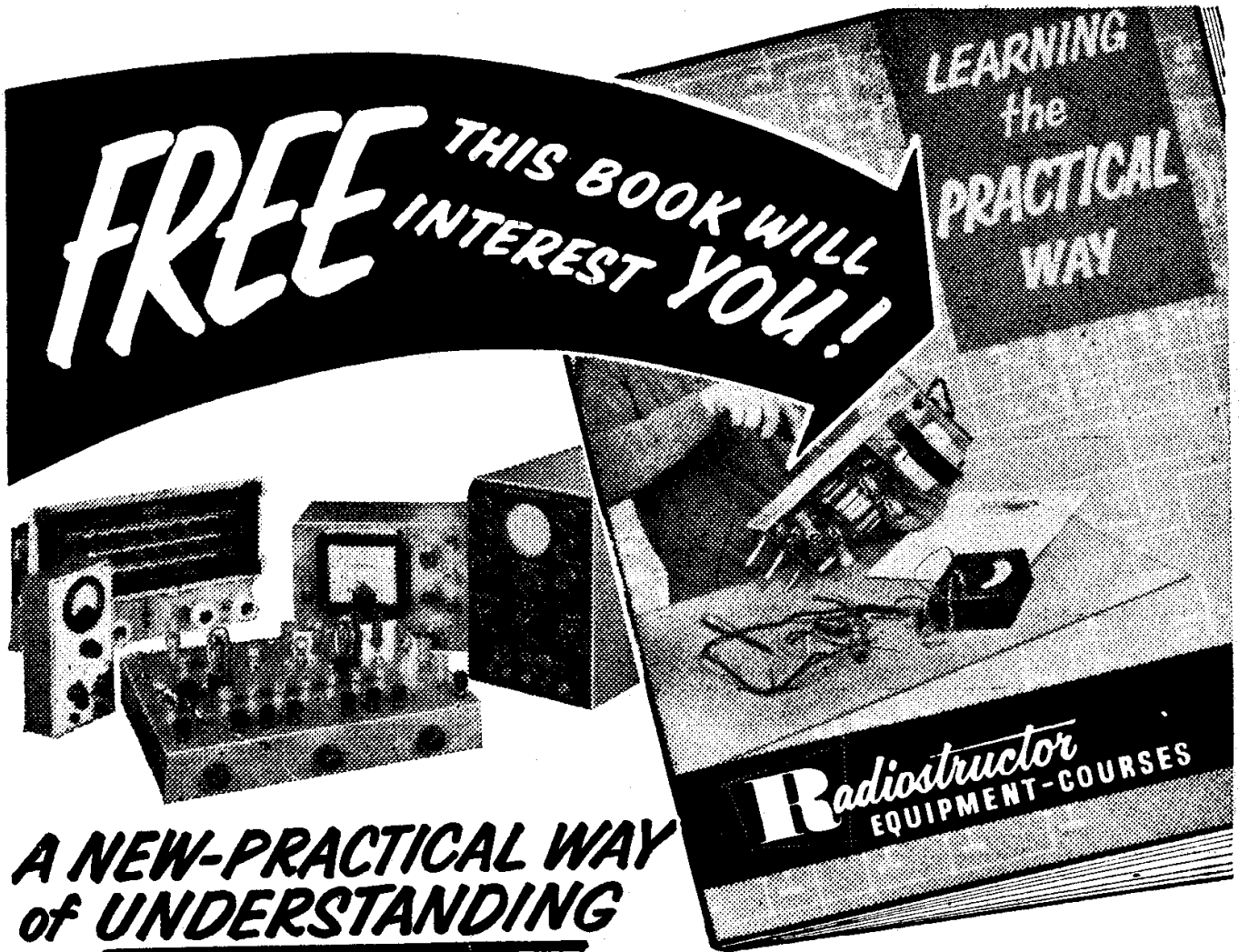

A NEW-PRACTICAL WAY of UNDERSTANDING

Radio · Television · Electronics

Including: Transistors; VHF/FM; Hi-Fi equipment; Computers; Servo-mechs; Test Instruments; Photo-electrics; Nucleonics, etc.

FOR ...Your Career...Your Own Business...An Absorbing Hobby

Radiostructor—an organisation specialising in electronic training systems offers a new self-instructional method using specially designed equipment on a "do-it-yourself" basis. You learn by building actual equipment with the big kits of components which we send you. You advance by simple steps, performing a whole series of interesting and instructive experiments—with no complicated mathematics! Instructional manuals employ the latest techniques for showing the full story of electronics in a practical and interesting way—in fact—you really have fun whilst learning! Post the coupon below, now, for full details—

RADIOSTRUCTOR

LEADS THE WORLD IN ELECTRONICS TRAINING

POST NOW

To RADIOSTRUCTOR (Dept. G102)
READING; BERKS.

Please send brochure, without obligation, to:

★ Name _____

Address _____

2161

★ **BLOCK CAPITALS PLEASE**
(We do not employ representatives)

PORTABLE AMPLIFIER Mk. D.1 59/6. Brand new. Latest design. Famous manufacturer. Size 7 x 2½ x 5in. A.C. Mains, isolated, 4 watts output. Knobs 2/6 extra. P. & P. 3/6.

TAPE RECORDER AMPLIFIER 47.19.6. Compact well designed 5-valve amplifier. Output 3.5 watts. Input for Microphone, Radio and Gram. Size 8½ x 3 x 4½in. Ins., carr. 4/6. Dep. 30/- plus Ins., carr. & 20 wkly pmts. of 7/6.



8in. P.M. SPEAKER BARGAIN 5/9. "Money-back Guaranteed". They have a slight cone fault, that is repaired, not affecting quality. P. & P. on 1, 2/6; on 2, 3/6.
8in. P.M. SPEAKERS 9/9. Perfect, with O.P. transformer. P. & P. on 1, 2/6; on 2, 3/6.
ELLIPTICAL SPEAKERS, 7 x 4in. 15/9. Brand new. P. & P. 2/9. 8 x 3in. 15/9. Brand new. Slot speaker. Postage 2/9.

EXTENSION SPEAKERS 19/9. In polished cabinet. Complete, fitted with 8in. P.M. Speaker of the highest quality, flex and switch. Ready for immediate use. Ideal for "Bedroom, Kitchen, Workshop", etc. Insurance and Carriage 3/9.



SOUND/VISION STRIP 1/-. "Plessey". I.F.'s 10.5 Mc/s sound. 14 Mc/s vision. 8 valve holders. Circuit drawings available. Post and Packing 2/6.

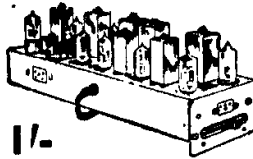

SOUND/VISION STRIP 1/-. Not tested. Complete sound and vision strip. 8 valve holders, I.F.'s 16-19.5 Mc/s. Drawings FREE with order. Post and Packing 2/6.

TELEPHONE SETS, 7/9. Ex. W.D. Wireless remote control unit. E. Mk.11 (ZA11954). Including Morse key, switches, jack plugs, etc.; less hand set. Insurance and Carriage 3/6.



REMEMBER

COMPONENTS LTD.

of 219 ILFORD LANE, ILFORD, ESSEX

RECORD PLAYER CABINET 29/9

Petite record player cabinet in smart two-tone colour scheme. Sturdy handle and fittings. Size 12 x 10½ x 6in. Ins. and carr. 4/6.

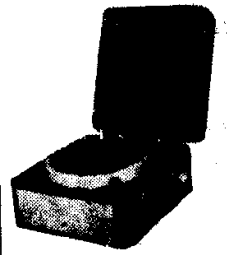

TV AERIALS 23/6. For all I.T.A. Channels. For outdoor or loft. 3 elements. Sold at half the normal price. PP. 2/6.

TV AERIALS 35/6. Single dipole B.B.C. with 3 elements I.T.A. Swivel bracket for universal fixing. P. & P. 2/6.

TV AERIALS 11/9. Room type. Folded dipole with 12ft cable. P. & P. 1/9.

CO-AX CABLE 6d. per yard. Good quality. Cut to any length. 1/3 postage on 20 yards. 45/- per 100 yards. P. & P. 3/6.

MAINS TRANSFORMER, 5/9. Pri. 200-250 volt. Sec. 300-0-300 6 volt at 3.3 amp. 5 volt at 2 amp. P. & P. 2/9.

350-0-350 volts at 250 mA. 7/9. 6.3V at 4A, 4V at 4A, 4V at 7A. 4V centre tapped at 1A. Primary 200-250 V. 50 cycles. Post and Packing 3/9.

MAINS AUTO. 5/9. 0-205-225-245V at 300mA. Isolated windings of 6.3V at 2-6A. 8.3V at 3-6A. 2V at 1-4A. Postage 3/9.

I.F. TRANSFORMERS, 1/- per pair. 466 Kc/s. P. & P. 1/-.

RECTIFIERS, 2/9. Westinghouse, 250V, 100mA. Half wave. Salvage guaranteed. Post and packing 1/3.

COIL PACK, 2/9. Contents: 7 way, 4 pole Yaxley switch, 12 coils and transformers mounted on switch. H.F. choke, 30075 uf V/Condensers, 12 capacitors, varied, 6 mixed resistors, tag boards, nuts, bolts, screws. Aluminium partition chassis, size 4 x 4 x 5in. Post and Packing 2/3.

COIL PACK SET, 3/9. This bargain contains 3 wave band coil, pair of I.F. transformers (466 Kc/s) standard two gang condenser. P. & P. 2/8.

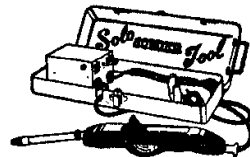

SOLO SOLDERING TOOL. Only 12/8. A.C. mains or Car Battery, 110V or 6V and 12V. Adaptor for 200-260V, 10/- extra. Automatic solder feed. For electronic soldering or car wiring. Cannot burn. Fitted in a light metal carrying case, with full instructions. Brand new. Post 3/6.

CLARKSON'S TUBE CHANGE

6A DENISON ROAD, LEEDS 2
Tel. Leeds 24576.

We are now able to offer SUPER SCREEN TV TUBES with 12 months' guarantee at the keenest exchange price ever.

Example:

Tubes all types	Cash allowance on return of old tube	Actual Cost of Tube
12" - 14" £5	15/-	£4. 5. 0
15" - 17" £6	25/-	£4. 15. 0
21" £8	30/-	£6. 10. 0

Carriage and Insurance 10/- extra

These tubes are COMPLETELY REBUILT by experts, with the most up-to-date electronic equipment, and are fitted with the famous American Superior Electron Gun. Many thousands of these tubes are in service today. Our factory is open to inspection to readers of "Practical TV". Technical advice and queries are answered free of obligation. All tubes are dispatched with adhesive paper and return labels. Cash allowance is sent on receipt of old tube.

RST

MAIL ORDER DEPARTMENT
211 Streatam Road, Mitcham, Surrey
ALL VALVES LISTED ARE NEW STOCK
• Terms C.W.O. or C.O.D. Postage 3d. per valve.
MITCHAM 6201

AZ31 15/6	EF92 5/-	PCF82 9/6	UY85 7/6	6K8G 7/6
B65 8/6	EL42 10/-	PCL82 9/6	VP4B 17/6	6K8GT 5/9
DAF91 7/6	EL84 7/-	PCL82 11/6	W81M 5/9	6L1 12/6
DAF96 9/6	EL90 8/6	PCL93 12/6	W142 9/-	6L15 15/6
DF91 4/-	EM80 10/-	PENA4 17/6	W719 7/6	6L6G 7/6
DH719 7/6	EM81 10/-	PEN4A 17/6	W727 7/6	6L18 12/6
DK91 9/-	EY81 10/6	PEN4VA 221 12/6	X78 21/-	6L19 21/-
EABC80 7/6	EY84 10/6	PL36 15/-	X79 21/-	6N7G/GT 7/6
EAF42 10/-	EY86 9/6	PL81 14/9	Z21 12/6	6SL7GT 6/6
EB91 5/-	EY91 9/-	PL82 8/-	Z77 4/9	6SN7GT 5/6
EBC41 9/6	EZ35 7/-	PL83 10/6	Z152 6/6	6V8G 5/6
ERF80 9/6	EZ40 7/6	PY80 9/-	Z719 7/6	6X5GT 5/6
EBF89 9/-	EZ41 7/6	PY81 7/6	IR5 9/-	7S7 10/6
EC91 9/6	EZ80 7/6	PY82 8/-	5U4G 4/6	8Y4 7/6
ECC33 5/-	RZ91 7/6	PY83 8/6	5V4G 9/6	8D3 4/-
ECC81 8/-	EC2 21/-	R10 21/-	6A8GT 10/-	10LC11 15/-
ECC83 9/6	FC4 17/6	R19 19/6	8AL5 6/-	12AH8 10/-
ECC84 9/6	FC13 17/6	TDD4 17/6	6AM6 4/-	12AT8 9/-
ECC85 9/6	FC13C 21/-	TP22 17/6	6AN6 7/6	12AT7 8/-
ECF80 12/6	GZ32 11/6	U142 8/-	6AQ5 8/3	12AU7 9/-
ECF82 12/6	H30 5/6	U147 7/-	6BA6 7/6	12AX7 9/6
ECH42 10/-	H63 9/6	U153 9/6	6BE6 7/6	12BA6 9/-
ECH81 9/-	HRC90 9/6	UABC80 9/6	5BJ6 7/6	12BE6 9/6
ECL80 9/-	HL92 6/6	UAF42 9/6	6BR7 15/-	12BH7 15/-
ECL82 12/6	HL133D 10/-	UBC41 9/6	6BW6 7/6	12J7G/GT 9/6
EF37A 8/6	KT33C 10/-	UBF80 9/6	6BX6 6/-	12K7GT 8/6
EF40 15/-	KT86 17/6	UCH42 9/6	6D2 5/-	12K8GT 8/6
EF41 9/3	LZ319 12/6	UCH81 9/6	6F1 15/6	12Q7 12/6
EF42 10/8	MKT4(5) (OF 7) 17/6	UCL83 9/6	6F12 4/9	12Q7GT 8/6
EF50(A) 4/-	ML4 15/-	UF41 13/6	6F13 17/6	12Q7GT 8/6
EF80 6/-	MSP4 17/6	UF41 9/6	6J5G 4/6	35Z4GT 7/6
EF85 6/6	MU14 9/-	UF89 9/6	6J7GT 9/6	50L6GT 9/-
EF88 11/-	MX40 17/6	UL41 9/6	6K7 4/6	
EF89 10/-	N142 9/6	UL84 9/6	6K7G 3/6	
EF91 4/9	N153 11/6	UY41 7/6	6K7GT 10/6	
	PCC84 9/6			
	PCF80 10/6			

SEND FOR LISTS.

Quotations given for any types not listed. Obsolete and old types a speciality.

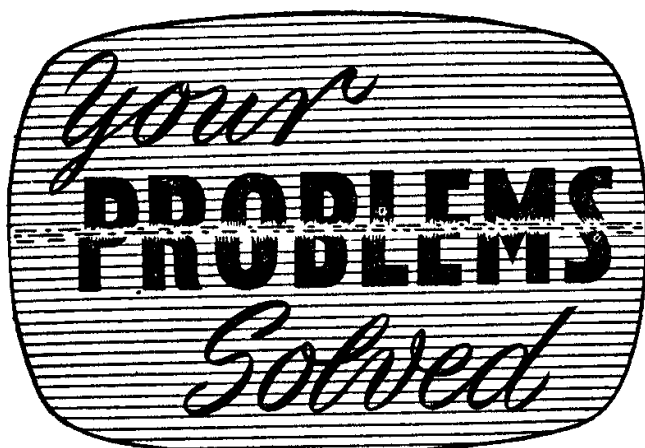

Whilst we are always pleased to assist readers with their technical difficulties, we regret that we are unable to supply diagrams or provide instructions for modifying surplus equipment. We cannot supply alternative details for constructional articles which appear in these pages. WE CANNOT UNDER-TAKE TO ANSWER QUERIES OVER THE TELEPHONE. The coupon from p. 279 must be attached to all Queries, and if a postal reply is required a stamped and addressed envelope must be enclosed.

STELLA ST6417U

On switching on the set the picture breaks up and the adjustment of the hold rights it, but only for a short while. For an evening's viewing the hold must be continually adjusted but I have found that a sharp touch on the cabinet corrects it also.—S. Sirl (Salisbury).

You should check the ECL80 valve, change the hold control (if necessary) and the load resistor of the ECL80 triode section (pin 1) from 220k to 100k as described in the servicing article April 1960, Philips 1115U—Stella ST8314U.

BUSH TV75

The symptoms are decrease of width, slightly more on the left some evenings. The height decreases forming a square (with the lack of width). After the evening's viewing, when the set is switched off, the familiar "pin point" of the disappearing picture is very often absent.—A. Biscoe (Romford).

The symptoms seem to indicate that the metal rectifier on the lower right side is failing (check H.T.) or the PL81 valve inside the screened section on the right side may be in need of replacement.

H.M.V. REPLACEMENT OF TUBE

Is it possible to use an Emiscope 5/2T as a replacement for an Emiscope 4/14S on this set, 1828A?—M. Evans (Carmarthen).

You will have to remove the focus magnet of the 4/14 assembly and fit a clamp type shift magnet just behind the scanning coils and apply a focus potential to pin 1 of the CRT base. This may be derived from pins 2, 3, 6 or 5, whichever gives the best focus.

DECCA DM45C

There are two faults on this receiver. When first switched on with a blank raster the screen is full, but on inserting the coaxial plug, the top of the picture is cramped, leaving about 1in. at the top

blank. In the course of about 20 minutes this fills out to give a full size picture. When the picture is full size the right-hand side of the picture is distorted and vertical lines are curved, giving the effect of squares over the screen.—C. Blurton (Burgess Hill).

The top compression is caused by a "lazy" PL84 valve situated on the lower centre of the chassis. The right side distortion, if at the extreme edge, is probably an optical effect caused by the thickness of the glass at this point, but check the position of the corrector magnets on either side of the scanning coils.

FERGUSON 315T

The volume of the sound has recently decreased. The dealer informed me that the set needed a thorough overhaul, which he carried out. The sound was back to normal but the picture was unsatisfactory. The picture now has a "rainy" effect, the whole surface seems to be vibrating all the time. The dealer states that it is the best he can do, but as I had such a clear picture before I think it needs adjustment. Can you tell me what adjustments to make?—S. Johnson (Surbiton).

Simple adjustment would not correct this trouble. It would appear from your remarks that the alignment of the set has been altered to provide greater sound sensitivity at the expense of vision. You should point this out to your dealer, and ask him to realign the set completely and bring the vision side up to its original standard.

PHILIPS 2168U

I renewed a faulty PL36 valve. After using a new valve there were horizontal lines at the top of the screen. I can remove some of these lines by adjusting the height control to the limit, also the horizontal hold control can be rotated without any effect on the picture. I have renewed the ECL80s, PCL82, 18pF capacitor to pin 6 line oscillator ECL80. Two resistors 220k, 300k associated with pin 2 of the ECL80 have been renewed and the associated 120pF capacitor.—C. Smith (Lancaster).

You should check the anode and screen potential divider resistors in the sync separator circuit. These are R54-56 and R57-186-180. If these are in order, check the suppressor and control grid resistors.

ULTRA V48W

The contrast control has burnt out. I changed this but now the sound is very feeble and tinny.—V. Barrington (Weston-super-Mare).

We do not associate the contrast control replacement with the loss of sound gain and quality. This is likely to be due to a faulty 1M resistor to the D1 diode (noise limiter), a faulty UL46 sound output valve (or leaky 0.04μF coupling capacitor to it) or a distorted loudspeaker coil or cone. Check valves 6F15, 6LD20 if necessary.

VIEWMASTER

To this set I have fitted a 3/16 tube. The only alteration I have made to the circuit is the heater supply to the tube. I obtain on this tube good

focus and picture, except when I turn up the brightness and contrast to make the picture clearly visible. There is then a curved flaring effect. The flaring is not horizontal but curved, the radius and length of which increases with brightening of the picture. Could it be the tube being overdriven with the EHT too high?—W. Mairn (Glasgow).

From your description we are certain that your CRT is being overdriven, the distortion being aggravated by your particular scanning coils, focus magnet and perhaps extraneous magnetic fields. We regret that there is nothing we can recommend to overcome the fault. The EMI 3/16 is not a CRT which was recommended for use with the Viewmaster.

DEFIANT 1454/TB3

There is no sound hum or picture on this set. The tube and all valves light up except the EY51. There is no spark at either end of the EY51, the EHT clip to the tube or at the top of the PL81 and PY81. I have replaced in turn each valve in the set, including the EY51, without results—W. Wild (Oldham).

You should replace the H.T. rectifier. This is the flat, contact-cooled, type on the centre of the chassis front. The replacement type is the Westinghouse FC101.

INVICTA TV126

The picture started to roll both vertically and horizontally, but by "juggling" the various controls it was made to lock. Now there are four pictures of inferior quality—one at each corner of the screen. I have tried a new sync valve but it did not make any difference.—L. Bank (Doncaster).

Check the main 200 μ F electrolytic capacitor, then the sub-H.T. line 16 μ F capacitors (in triple unit cans).

G.E.C. 1746

On this set there are three fixed positions giving one BBC and two ITV stations. On the ITV, channel 9 was tuned in on one of the positions. This position started to fade out; the BBC channel was not affected. After switching off, and leaving for a while the set goes for a few days or a few weeks, but then the picture begins to fade again with the exception of the BBC channel. I tuned the spare channel in to channel 9, but after two days the same fault occurred. The two valves in the tuner unit have been tested and found to be in order.—R. Smythe (Belfast).

As this fault occurs on both Band III frequencies, it will be something that is common to both. This can be the frequency changer valve being intermittently faulty on high frequencies. (This is common with this valve V2, PCF82 or LZ319.) The switch contacts may be faulty.

STELLA ST86211

I have lost both sound and vision. I have replaced the tuner valves and the EBF89. I have a raster and EHT. I have substituted EF80 and ECL80. The drill lead has also been checked, and there is a "swishing" in the speaker.—A. Hatfield (Leeds, 11).

The fault apparently lies in the tuner unit. You should check the H.T. input to this, trace pin 1 of the PCF80 to the switch bank and you will find a fairly large resistor, partly covered, leading to this from the decoupled H.T. point. This resistor should have a value of 6.8 Ω . It is rated at 1W and does tend to overheat and burn out. Check other tuner resistors.

PETO SCOTT TV1412

This is a five channel 14in. receiver. I have a G.E.C. converter for this set and can receive channel 11 but there is quite a lot of patterning. When the BBC has closed down, there is quite a good picture. Can I do anything to improve this without too much alteration? — J. Korduk (Norwich).

A certain amount of patterning is almost inevitable due to pick-up of BBC signal on the converter-to-receiver coaxial cable. A turret tuner would overcome this fault, and we would suggest you use a Cyldon P10L or Brayhead 10S. V1 (EF80) is removed and replaced by the R.F. plug and V2 (ECL80) is replaced by the mixer plug or adaptor. See that the I.F. output connects to pin 6, not pin 7, on the mixer plug.

COLUMBIA 506

I am troubled with erratic frame hold about every 15 minutes when I have to adjust the frame hold to stop the picture from moving up or down.—P. Prescott (Wigan).

It would appear that the interlace diode (small metal rectifier) is defective. This is connected from the ECL80 sync separator to pin 1 of the frame timebase ECL80 via a coupling capacitor. You should also check the ECL80 and the resistor associated with the rectifier.

VIEWMASTER

I wish to change this set from Holme Moss to Rowridge and would be glad of any advice.—E. Smith (Louth).

To modify your Holme Moss receiver for reception of Rowridge, it is only necessary to remove one turn from each coil except L110 and L112, which are not touched, and then realign.

FERRANTI 17T6

I can receive a good picture on channel 10, but it frequently fades and reappears, and occasionally the line hold goes. In each case a small adjustment of the fine tuner on the turret restores the picture. On channel 2, I cannot tune out sound on vision by means of the fine tuner. I tried retuning the local oscillator coil to no avail and finally I tried a new set of channel 2 coils, but the trouble still remains.—J. Walton (Doncaster).

Fading on channel 10 may be due to improper contact between the springs and studs in the tuner which should be cleaned. Ensure the PCF80 and PCC84 valves are properly seated in their sockets and clean the pins if necessary. Sound on vision may be due to excessive input signal. If the receiver has a sensitivity control on the rear left side, reduce the setting of this on BBC. If there

AERIALS

BAND I BAND II BAND III

Combined Arrays I and III

- 1+3 Element Loft Mounting .. 38/3
- 1+5 Element Loft Mounting .. 46/9
- 1+3 Element Wall Mounting .. 45/3
- 1+5 Element Wall Mounting .. 61/-
- 1+3 Element Chimney M'ting. 57/10
- 1+5 Element Chimney M'ting. 66/9

Band I

- Single Dipole Wall Mounting .. 24/7
- Single Dipole Chimney M'ting. 40/2
- X Aerial Chimney Mounting .. 62/3
- H Aerial Chimney Mounting .. 67/7

Band III

- 3 Element Yagi Wall Mounting 33/-
- 6 Element Yagi Wall Mounting 43/-
- 9 Element Yagi Wall Mounting 56/-
- Chimney Lashing Mounting add 10/-
- Double 6 Array, only with clamp 83/-

Band II

- Single Dipole Wall Mounting .. 20/5
- Single Dipole Chimney M'ting. 29/9
- H Array Chimney Mounting .. 52/4



REPAIR KITS

- Band III Folded Dipole With Insulator, Complete .. 9/3
 - Band I Insulator With Two 1/2 inch Dipoles For 1 or 1/2 inch Booms, Complete .. 19/5
 - 6 inch Lashing Kit, 12/11, 7 1/2 inch Lashing Kit .. 14/8
 - 6 inch Wall Bracket With U Bolts .. 7/10
 - 1-1; 1-1 inch Clamps, 3/10, 1-2 inch Clamps Universal 5/4
 - Bracket Repair Kit, J Bolts; U Bolts; 20ft. Lashing Wire; Thimbles; Corner Plates .. 6/-
 - Insulators, All Types .. (Enquire)
 - Co-Ax. Semi Air Spaced, 7d. vd. .. Plugs, 1/2
- Send 6d. for Lists. Please state Channel when ordering.

Cash with Order. Post and Packing 3/- extra.

SATISFACTION OR MONEY BACK GUARANTEE

WALKER & SQUIRES

PINNOX STREET, TUNSTALL, STOKE-ON-TRENT

Phone: Stoke-on-Trent 88767

**"Better get the best—
it costs less"**

VIDIO

Offers you the finest rebuilding service available today. Each tube is completely rescreened aluminised and fitted with a new Gun Unit. Available now — for IMMEDIATE DELIVERY.

12"—£5. 14"—15"—17"—
£5. 10. 21"—£8.



**VIDIO'S SECOND CHOICE
—GUN UNITS.**

12"—£4. 10. 14"—£4 15.
15"—17" £5. 21"—£7.

**ALL TUBES GUARAN-
TEED FOR ONE YEAR.**

Get full details now from

VIDIO REPLACEMENTS LTD.

Hales St., Deptford High St.
London S.E.8. Tel: TID 4506

BRAND NEW TV TUBES!

NEW REDUCED PRICES!

CARRIAGE PAID! 100% GUARANTEED!

10" **£1.10.0** 10"

Cossor type 75K.

12" **£4.0.0** 12"

Direct replacement for MW31-16, MW31-74, C12FM, 121K, 12XP4, 12XP4A, T12/100.

14" **£6.0.0** 14"

Direct replacement for MW36-22, MW36-24, MW36-44, C36-24, C14HM, 14LP4, 14KP4A, TR14/22

15" **£3.3.0** 15"

Cossor type 85K.

17" **£7.0.0** 17"

Direct replacement for Mazda CRM171, but with a 6.3 volt heater instead of 12.6 volt and non-aluminised.

17" **£7.5.0** 17"

Direct replacement for Mazda CRM172.

These tubes are not reconditioned, or "seconds", or export rejects but BRAND NEW BOXED STOCK direct from the factory and made available by special bulk purchase which are un-repeatable.

Unconditionally guaranteed for full twelve months from date of purchase if returned securely packed.

Take advantage of this special bargain now. Orders executed by return. Send cash, cheques, etc., with order to:

**ST. JAMES'S STREET
GENERAL TRADING AND INVESTMENT
CO. LTD.**

2 SERJEANT'S INN, LONDON, E.C.4

Please note that we are MAIL ORDER only. We regret that we cannot cater to callers.

LAWSON EXACT REPLACEMENT Completely Reprocessed TUBES

(4) New Mullard, Mazda, Emiscope, etc., electron guns.

(2) Exact plug-in replacements.

(6) New getters and regraphited.

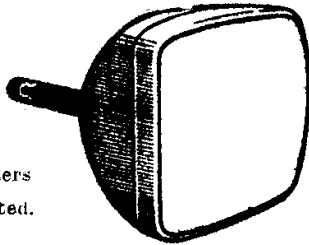

(5) Specially reprocessed glass envelopes.

(1) New silver activated screens.

(3) Micro fine aluminised.

12 MONTHS' NEW TUBE GUARANTEE

ALL MATERIALS AND COMPONENTS USED IN THE MANUFACTURE OF THESE TUBES ARE COMPLETELY NEW, EXCEPT THE GLASS ENVELOPE AND ONLY ENVELOPES WHICH WILL PASS INSPECTION TO NEW GLASS STANDARD ARE USED.

LAWSON TUBES

156 PICKERSLEIGH RD., MALVERN, Worcs. MAL. 3798

POINTS FOR PERFORMANCE

(3) MICRO FINE ALUMINISING

The total useful light output of any CRT can be increased by as much as 50%, by aluminising of the phosphor screen. However, the thickness of this film is of critical importance, if it is too thick, a dull picture will result, if too thin, screen burns will become evident (even in ion trap tubes). The exclusive "Micro Fine" process gives this careful control of aluminising thickness giving improved light output in all tubes. This control also enables ALL types of CRT's to be aluminised, giving a very real improvement in picture brightness and quality when fitted in place of an original non-aluminised tube.

ALL MAKES ALL TYPES FROM STOCK

12" - £5.10.0

14" - £5.19.0

15-17" - £6.10.0

20/-

Gladly refunded if you wish to return your old tube.

Carr. and Ins. 7/6 (express passenger).

BRAND NEW TUBES

12 months' guarantee

TOP CLASS MAKE

CARR. & INSURANCE PAID

12" MW 31-74 etc. £5.5.0

14" MW 36-24 etc. £6.6.0

17" MW 43-64; 43-69 £8.0.0
(In short supply)
CRM 171, 172

NEW, BOXED, ex Factory

WHITE SPOT TRANSISTORS, 4/- ea.
GREEN YELLOW SPOT 4/- ea.
RED YELLOW SPOT 6/6 ea.
GERMANIUM DIODES 9d. ea.
Post 6d.

VALVES! UNUSED, GUARANTEED. EX NEW EQUIPMENT

ECC81	5/-	6CH6	8/-
ECC82	6/-	6F1	12/6
ECC83	8/-	6F14	15/-
EB91	3/6	6Q7GT	8/6
EF91	3/-	7C8	8/-
OZ4	5/-	7H7	7/-
		12E1	12/6

Post 6d. per valve. Send S.A.E. for list of 12 months' guaranteed valves.

TRADE ENQUIRIES INVITED

LINE OUTPUT TRANSFORMERS

Direct Replacements for 500 sets.

Baird, T29, T163	53/-
T164, T167, T172, 2014, 1712	60/-
Bush, TV 11A, B; 12A, B; TVF 12A, TUG 12A, B; TRG 12A, B	45/-
TV12AM; TV22, 24; TRG24, TUG 24	60/-
Cossor, 890, 931, 933, 934, 948, etc.	58/-
Ekco, TS146; TS113-114; T161, 164; T222, 231; TSC311, etc.	47/6
Ferguson, 841, 2, 3; 841 to 845	55/-
990T-998T; 103-145T; 203-246T	66/6
Ferranti, 14T3, 14T4, 17K3, 17T3	45/-
14T2, T1205, T1215, T1225, T1325, T1405, T1415, T1425, T1505, T1825	65/-
G.E.C. and H.M.V. mostly 55/- to	60/-
Invidia, T101-104; T108-110	52/-
T114-128; T133-142	60/-
Murphy, V114C, V116C, V118C	45/-
V120C, V180, V178, V200, V202C	57/6
Philips, 114 UF/UM, 1115 U, 1437 U, 1446 U, 1726 U, 1746 U, 1747 U	65/-
383A, 463A, 563A, 663A	60/-
Pye, LV30, 16T, CS17, etc.	60/-
CTM4, V4, VT4; V7, VT7; VT17	52/6

Add 2/6 post. Also Scan Coils, etc.

SPECIAL! NEW L.O.T. COMPLETE with: — Linearity and width controls. — Eyebase and top cap. — Valve connectors. — E.H.T. leads. — Circuit diagram. Beautifully made. **ONLY £1** post 2/6.

IS IT THE L.O.T.?

Be SURE with the SKANTEST. The most compact low-priced line output and time base component shorting turn tester. Will indicate even one shorting turn. **£7.10.0.** Carriage 6/-.

LIGHTWEIGHT MINIATURE CRYSTAL EARPIECE for transistor sets. Complete with transparent ear insert, 3 feet very fine cord, sub-miniature plug and socket. 12/6 ea., Post 1/-.

BBC TRANSISTOR RADIO

Two transistors and diode. Medium and Long wave. Complete kit with circuit and wiring instrus., 32/6. Earphone, 6/6 extra. Miniature Earpiece, plus lead, etc., 12/6 extra. Full details, 6d.

MAINS TRANSFORMERS—SPECIAL! Semi-shrouded, drop-through. Ex new equipment. By well-known manufacturer. 350-0-350 v. at 80mA, 6.3 v. at 3 amp, 5 v. at 2 amp. ONLY 12/6 ea., plus 2/6 P. & P.

POCKET VOLT TEST METER. Two D.C. ranges, 0-25 v. 0-250 v. with test prods and leather case. 12/6 ea., P. & P. 1/6.

SUPERB CABY MULTI-METERS

Sensitive—Accurate—Durable

Model A.10: D.C. volts (Sensitivity 2K ohms/V) 10, 50, 250, 500, 1000V. A.C. volts (Sensitivity 2K ohms/V) 10, 50, 250, 500, 1000V. Resistance, 10K ohms, 1 Meg. ohm. D.C. current, 0.5mA, 25MA, 250MA. Measures decibels. **£4.17.6.**

Model B.20: D.C. volts (Sensitivity 10K ohms/V) 0.5, 2.5 (Sensitivity 4K ohms/V) 10, 50, 250, 500, 1000V. A.C. volts (Sensitivity 4K ohms/V) 10, 50, 250, 1000 V. Resistance, 2K ohms, 200K, 2 Meg., 20 Meg. D.C. current, 100 micro-amp, 2.5mA, 25mA, 250MA. Measures decibels. **£8.10.0**

S.A.E. for leaflet. With test prods, instruction book, batteries.

HI-FI JASON Constructional Kits Also Leak, Quad, Trix, Wharfedale, Rogers, Goodmans, etc. Leaflets available. Let us quote for your requirements.

S.A.E. with enquiries please.

5 Westward Way
Preston Road, Harrow, Middx.

WESTWAY RADIO

is no sensitivity control (some models were produced without) use an attenuator to reduce the channel 2 input.

BUSH TV24

Two bright lines about 1½ in. apart appear after the set has been working for one to two hours. They appear at the top of the screen and travel slowly down during the course of the evening. The set has recently been fitted with a new line oscillator valve (ECL80), line amplifier (PL38), H.T. rectifier (PZ30), vision detector (EB91) and EY51.—R. Howell (Swansea).

You should replace the ECL80 on the left side of the chassis (interchange with the new right-side ECL80). If the fault persists, check the capacitors in the circuit.

PHILIPS 1772U

This set has developed a fault with the following symptoms: 1, on switching on, the line hold takes several minutes to "settle down"; 2, the line hold is critical on weak signals; 3, any alteration of brightness control causes verticals to bend and the line hold needs adjusting again. I have checked C76 and 42 by connecting other electrolytics across them and changed V8. Can you suggest any other components that might change their value with age and cause the above faults?—F. Smith (Woodbridge).

First change the line oscillator valve—PL81, V9. If the fault continues check V13, ECL80 and associated components. If the H.T. is slow to reach nominal value, change the PY32.

EKCOVISION T312

This set has suddenly become completely blank and there is no sound at all. All the valves light up with the exception of the EHT rectifier U26. There is no spark at the tube anode or from the top cap of valve 14, 30P4 or V15U191. I replaced V16 U26 with no results. Upon testing the remainder of the valves, including V14 and V15 for H.T. I found that there was a reduced amount still flowing at about 50V drop from normal. The U26 is cradled in what I believe to be the line output transformer, and it is this component that I suspect.—P. Anderson (Ashford).

Your symptoms do not suggest a low EHT rectifier, but rather one or both PY82 HT rectifiers becoming faulty. Suspect also the 35Ω wire-wound surge limiting resistors feeding the anodes of each of these valves.

G.E.C. GT5147

There is no vision on this receiver. I found, and replaced, a burnt-out PL82, but this has shown no result, only overheating of replacement valve. Everything appears to be in order; whistle is also present.—R. Williams (Llanelly).

Check video demodulator GEX35 and V5 Z77. Video amplifier, also the two 12k resistors in

parallel feeding the anode of V5. These are on top and to the left of the subdeck. The CRT should be checked for inter-electrode shorts. C58 0.1μF to grid of PL82 should be suspect and C73 500μF in the cathode circuit of this valve.

H.M.V. TV1824

I have fitted a turret tuner to the above receiver and wish to add vision AVC using a negative bias taken from the grid of sync separator valve V7. However, I notice that the grid leak of this valve is returned not to chassis, but to frame output cathode and shall be glad if you will advise me whether you consider that this is a suitable point to obtain AVC bias.

Also I have a slight fault, not affecting normal viewing at present. A good picture is obtained with the brilliance control only slightly past "minimum" but advancing this control results in a decrease in width and increase in height without much increase in brightness. Advancing the control further beyond this point causes the screen to go completely blank. I suspected a low emission EHT rectifier and replaced this with a new valve, but this proved faulty and I had to replace the original.—D. Roberts (Manchester, 23).

Although the grid of the sync separator is returned to a source of positive potential, the potential at the control grid is still heavily negative on the reception of normal signals. This can be tapped off through high value resistor and, say, 0.1μF smoothing capacitors to form an AGC system, but a clamp diode must be included to prevent the line going positive in the absence of signals.

Some versions of the 1824A used a refined form of this AGC system.

The U151 (EY51) must be replaced.

TELEVOICE TR.115

I wish to convert this 15in. console receiver to receive channel 10 ITV. Could you tell me of a suitable internal converter which I could use? Can you also tell me the I.F.'s of this set?—B. Marsden (Leeds).

The I.F. is 10-14Mc/s; sound 10.5Mc/s; vision 14Mc/s. The valves are series-connected with 10F1s in the V1 and V2 positions. A suitable tuner unit should have the above I.F. output and "U" series valves (UCC84-UCF80). An example of a suitable turret tuner is the Cyldon U10L. The Brayhead 10S could be used with "U" valves as above. We have not noticed many surplus tuners being offered with this specification.

QUERIES COUPON

This coupon is available until FEBRUARY 22nd, 1961, and must accompany all Queries sent in accordance with the notice on page 275.

PRACTICAL TELEVISION, FEBRUARY, 1961.

AERIALS

MAKE YOUR OWN AERIALS
SAVE 22%

TV aerial manufacturer offers "do-it-yourself" kits. 50 components include castings, pressings, mouldings, tubes, brackets, can be utilized to make 100 different models, TV, V.H.F., amateur. Brochure gives full illustrations, element dimensions and prices. Discounts for quantities.

THE RICHARD MAURICE
EQUIPMENT CO.,

Portsmouth Road, Cobham, Surrey.
COBHAM 3239.

SETS & COMPONENTS

BOURNEMOUTH

14in., 15in., 17in. Round and Rectangular TV Tubes, £6.19.6 (10/- allowed on your dud tube), 12 months' guarantee. 3 element ITV/BBC aerial with wall bracket, 34/6. Both carr. paid.

EF80	7/8	EZ80	7/8	ECC81	7/8
EL84	8/8	EF91	6/8	ECC82	7/11
PY82	8/9	PL81	12/8	ECC83	7/11
EY51	11/8	PL82	11/8	PCF80	11/8
6V6	5/8	PY81	8/9	PCC84	10/8
12A7	7/8	EC91	4/-	ECL80	10/8
12AX7	7/11	12AU7	7/11	ECC91	5/-

Complete range of capacitors, resistors, Hi-Fi radiogram chassis, amplifiers, motors, pick-ups, mono and stereo.

BOURNEMOUTH'S HI-FI AND
CONSTRUCTORS' CENTRE

NATIONAL RADIO SUPPLIES

66 HOLDENHURST RD., BOURNEMOUTH
Tel. 25232

TV TUBES, New gun, 17in. £5. Twelve months' guarantee. Dealers supplied. Aerials and Coax cheap. **TV ELECTRIC & CYCLE CO.**, 1, High Street, Chalvey, Slough. Tel.: Slough 21860.

IT4	3/6	EB91	3/6	PCF80	7/6
IL4	1/9	EF91	3/6	PCC84	7/6
IR5	3/6	ECC81	5/-	PL81	8/6
IS5	3/6	ECC82	3/6	6K8G	5/-
DK92	8/-	ECH42	9/-	6SN7GT	4/-
DK96	8/-	ECL80	7/6	6V6G	4/6
DL92	6/6	EY51	7/6	12AH7	4/-
DL96	6/9	EY86	7/6	954	1/3
DL94	7/6	EF86	9/-	EF50	1/-

All brand New and Boxed. C.W.O. Over 200 Types Available, Woodward, 56 Wiverton Road, Forest Fields, Nottingham.

SPARE VALVES (TV). Set of 8 for 25/-. Also sold separately. List 2d. 85, Charminster Ave. Bournemouth.

REBUILD TELEVISION TUBES—12in. £5; 14in. £5/10/-; 17in. £8/10/-. Twelve months' guarantee. 10/- carr. **BRAYHEAD TURRET TUNERS**—£6/10/8. Carriage paid. State coils. All types BBC and ITA **AERIALS**. **AIRSPACED COAXIAL CABLE** from 6d per yard. **TELEVISION SPARES AND EXACT REPLACEMENTS**. The latest BSR UA14 four-speed Changer £9/10/-. Carriage paid. All leading makes of **TAPE RECORDERS, TAPES, AMPLIFIERS, TAPE DECKS, RECORD PLAYERS, TELEVISIONS AND RADIOS**. All new goods on Easy Hire Purchase Terms. **TRANSISTORS RED SPOT 5/6**. **TRANSISTORS WHITE SPOT 5/8** each. **GERMANIUM DIODES 1/-** each. Stamped addressed envelope, please, for inquiries and callers are welcome.

DEVIZES TELEVISION SERVICE
20-30, The Nursery, Bath Road,
Devizes, Wilts. Tel.: Devizes 1100.

RATES: 4/- per line or part thereof, average five words to line, minimum 2 lines. Box No. 1/- extra. Advertisements must be prepaid and addressed to Advertisement Manager, "Practical Television" Tower House, Southampton St., London, W.C.2.

SETS & COMPONENTS

(continued)

SPARES - VALVES - TUBES

1930-1960

Guaranteed Perfect, set tested, ex-working equipment. **LOTS** from £1. **FOTS**, **Osc. Tr. Def. Coils**, etc., cheap. **TUBES**, guaranteed 6 months. **FITTED FREE**. Picture shown to callers. 9in., 30/-, 12in. 50/-, 14in. 60/-, 17in. 70/-, **VALVES**, 3,000 types stocked. EF50, SP61, 1/-, EF91, EB91, 6H6, 277, D77, 6J5, 2/-, EF80, UF42, 6F1, 6F13, 6AG5, UB41, 20D1, 3/-, 10F1, B36, 6V6, KT61, 6AG5, EL32, B36, 6P25, 4/-, PCC84, PCF80, PL81, PL82, PY81, ECL80, PCL83, 6K25, EBC91, EY51, EL33, 5U4, 5/-, KT33C, 10P14, 10C1, UCH42, UL41, ECH35, HVR2, 7C5, 7Y4, 6/-, EL38, KT38, PY31, U22, U35, U281, UUG, 7/6, PL38, PZ30, 20P1, 20P3, 185BT, UUG, U24, U25, 10/-, U801, 20P4, 6CD6, 27SU, U37, 12/6. Pre-war 4, 5 and 7 Pin, 5/- each Postage 6d. "Constructor's Parcel." 2 lbs. assorted resistors, condensers, pots, etc., from modern TVs, 7/6. Postage 2/6. Write or phone. Send S.A.E. for list or with enquiries.

"ST. JOHN'S RADIO". 156 St. John's Hill, S.W.11. BAT. 9838

RECLAIMED VALVES. All tested and perfect; modern and obsolete; huge stocks; all one price. 5/-, plus 6d. postage each, delivered by return. LEWIS, 46, Woodford Avenue, Ilford, Essex.

TV SPARES

London's Largest
Range—New or Used

LINE OUTPUT TRANSFORMERS and SCAN COILS

for nearly every make and model
New from 45/-, Used from 20/-
Just a few examples from our extensive range **IN STOCK**. Add 2/6 for P. & P. **TELEPHONE ORDERS SENT SAME DAY C.O.D.**

NEW LINE O.P. TRANSFORMERS

Pye V4/7, VT4/7, 52/6; LV30, FV1, 52/6.
Ferranti 14T2/3/4/5, 45/-; T1225, 62/6.
Ferguson 992/6/7/8, 66/9; 941-55, 57/6;
Ekco T221/231, 50/-; T161, etc., 45/-.
H.M.V. 1824-9, 58/6; 1840-8, 59/6.
Cossor 930-9, 58/6; 916-25, 75/-.
Alba T301/504, 45/-; 362/441, 47/6.
Murphy V240/250, 62/6; V200, 49/6.
Ultra VT9-17, etc., 108/6, with U25.
New Scan Coils for Pye, V4/7, VT/7, 62/6.
We also stock a complete range of spares for nearly all makes and models, e.g. **LOPT's**, Line and Frame Blocking Trans., Frame Output Trans., valves, resistors, capacitors, ion traps, etc., etc.
PLEASE SEND S.A.E. FOR IMMEDIATE QUOTE

Used Chassis or most of the older sets at only 50/- plus 20/- carriage.

TELEVISION CONSUMER SERVICES LTD.
28 BROCKLEY CROSS, S.E.4.
TIDeway 5394
112 CAMBERWELL RD., S.E.5.
RODney 7917

SETS & COMPONENTS

(continued)

ONLY AVAILABLE from us (by mail). (No kits/new bargains!). Transistor 4-speaker radio, printed circuit, they need no aerials 5½ gns. De-luxe 6 model 8½ gns. De-luxe Super Job 11½ gns. Poa transistor, batt. radio/gram., 15½ gns. (batt. p.p. all 5/6). Super 7 car transistor radio 15½ gns., p.p. 4/6. Car aerial, telescopic 37/6 p.p. 2/6. TV light Lux-AFN aerial interference filter, twin aerials, earth (GPO apd). 38/6 p.p. 2/6. LW/MW super transistor 2 radio with speaker and aerial 58/6 batt., p.p. 3/6. C.W.O. reg. post. (No cheques or P.O. save time and money). **DERLO GAYTIME**, 41 Newfield, Sandbach, Ches.

LIVER TUBES

Fully Guaranteed 12 months
All makes — 12" to 21"

BLANE & MARTIN
ELECTRONICS

70 High Street, Wavertree
LIVERPOOL

Details on request
Tel. SEF. 3428

DEC. P.T.V. Loft Aerial, 9 elements + folded dipole, 3in. Al. tube, 11/-, state channel. Limited quantity. **AERIAL SUPPLY**, 165 Beoley Road, Redditch, Wores.

TUBES — AERIALS — VALVES

Regunned tubes, guaranteed one year, prices from £5, allowance on old tube. Revacuumed tubes, all sizes, 50/- guaranteed 4 months. Full range of aerials at trade prices, double five costs only 58/-. Full range of valves, example PCC84 cost 8/-. ITV pre-amplifiers, £3.15.0. self-contained in case. ITV converters, £5. Brayhead tuners, £4.12.6. New TV sets and transistor radios supplied ask for quotation. Low loss co-axial, 1/1 yd.: Standard 6d. yd. Dplexers, 8/8 each. All items carriage extra. S.A.E. for lists.

G. A. STRANGE
BROADFIELD, NORTH WRAXHALL,
Nr. Chippenham, Wilts. Tel. Marshfield 233

H.P. on Regunned C.R.Ts.

At No Extra Charge
12 Months' guarantee
12" & 14" .. £3.10.0
17" .. £4.10.0
21" .. £5.10.0

Phone or Call only:
Rod 7778

P. J. F. Andrews
61-63 ROSEMARY RD.
LONDON, S.E.15

SETS & COMPONENTS (continued)

C. EDWARDS
1070 HARROW ROAD
LONDON, N.W.10
LADBROOKE 1734

Offers
S/H TV in
First-class
Condition

12in. £5.0.0
14in. £7.10.0
17in. £13.10.0
(all 5 channel)
+ 15/- carriage.

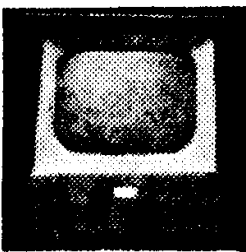

Guaranteed
VALUES

10F1, 10/-; 10C2,
10/6; 20D1, 6/-;
6F1, 5/-; SP61, 7/-; 6K25, 8/-; 20P1, 10/-;
PZ30, 8/-; PL33, 7/-; ECL80, 8/-; EB91,
6/- Plus 6d. post.
S/H 12in. Tubes, 50/- plus 7/6 post.

FERGUSON, EKCO

70/- STAR. Regunned CR tubes up to
17in., 12 months' guarantee. Carriage
extra. A. SLARK, 43 Thicketford Rd,
Bolton. Phone 6684.

COMPLETELY REBUILT

Cathode Ray Tubes as supplied to
the trade now available to you. Fully
guaranteed 12 months', 9in. to 17in..
25/10/0 plus 7/8 carriage; 21in..
28/17/6 plus 10/- carriage. Money
back if not 100% satisfied. Cash with
order to:-

CASE'S RADIO LTD.
Platt Bridge, WIGAN, Lancs.

**VALVES, RECORD CHANGERS and
Players, Speakers, Rectifiers, Valve
Testers, Condensers, Resistors.** Send
for list. H. F. JAMES, 21, Claremont
Road, Twickenham, Middx.

TELEVISION TUBES! 1st quality,
new guns. Year's guarantee, most
75/- exchange. Rescreened from 85/-.
3 Pank Ave. New Barnet. BAR 1934.

Television Tube Shop

now stock

Tubes for every make of set

NEW REDUCED PRICES

12 inch, Mullard type	24. 5.0
12 inch, Mazda type	24.15.0
14 inch, Mullard type	25. 5.0
14 and 15 inch, Mazda type ..	25.15.0
17 inch, All types	26-10.0
17 inch, Slim line 110°	26-17.8
21 inch, All types	28-10.0

Also G.E.C. BRIMAR, E.M.I. types.
Add 10/- for delivery to your door within
48 hours or 5/- B.R.S. Terms 22 down.
All Tubes Carry 12 months' guarantee.
A few shop-soiled tubes available. Good
picture. Fully guaranteed, from 50/-.
Spare-time Service Engineers—send for
details of our rebate scheme.

TAPE RECORDERS

Latest Collaro "Studio" 3-speed
Tape Deck, complete £18-17-6
Fitted to Motor Board with 1,200
feet E.M.I. tape, knobs etc. to fit
into your own cabinet £15-15-0
6.3 watt Amplifier, specially de-
signed for the "Studio" complete
with power pack knobs, etc. £10-10-0

VALVES

A very wide range at 50% off list price. Send
for complete price list of these and other
Bargains.

TELEVISION TUBE SHOP

46 Battersea Bridge Road, LONDON
S.W.11 BAT 6859. Open Saturdays.

SETS & COMPONENTS (continued)

GUARANTEED VALVES

1L4	2/8	12AT7	6/8	EF91	3/-
6F1	6/8	20D1	6/8	EL82	3/-
6F13	5/6	20F2	7/8	PCC84	6/8
6F14	7/8	20L1	3/8	PY80	6/8
6F15	7/8	D77	3/8	PY82	6/8
10C1	7/8	EABC80	7/8	UF41	7/8
10F1	6/8	EF80	5/-	UL46	7/8

Postage 6d. each List 9d.

SERVICE, SHEETS, BOOKS, COMPONENTS.

Lists 3d.

Hamilton Radio (T), 13 Western Rd., St. Leonards, Ex.

"HEATHKITS" can now be seen in
London and purchased on easy terms.
Free brochure. DIRECT TV REPLACE-
MENTS LTD., Dept PT/22/1, 138,
Lewisham Way, S.E.14, Tideway 6666.

SALVAGED VALVES

2/6 each

Tested on Mullard High Speed Valve Tester
New and Boxed Valves
all at 10/- each

S.A.E. FOR LIST

ARION TELEVISION, 4 Maxted Road,
S.E.15
NEWX 7152

SERVICE SHEETS

SERVICE SHEETS Radio, TV, 5,000
models. Lists 1/-. S.A.E. enquiries:
TELRAY, 11, Maudland Bk., Preston.

FAULTFINDER FILES (TV) showing
common faults that each receiver is
prone to and other useful servicing
information, 2/- each. List 9d., plus
postage. S.P. DISTRIBUTORS, 44,
Old Bond Street, London, W.1.

SERVICE SHEETS (1930-1961). From
1/- with free fault-finding guide.
Catalogue 6,000 models 6d. Books,
components, valves, constructors kits,
lists 3d. S.A.E. Enquiries: HAMILTON
RADIO (T), 13 Western Road, St.
Leonards, Sussex.

SERVICE SHEETS. — We have the
largest stock of Radio and TV Service
Sheets in the country for sale at 4/-
ea. Why tolerate delay in obtaining
your supplies when we will dispatch
by return? Service Sheet List 1/-. Also
Manufacturer's Manuals for sale and
hire. 1961 List now available 1/-.
S.A.E. please. Mail orders only to:
S.P. DISTRIBUTORS, 44, Old Bond
Street, London, W.1.

SERVICE SHEETS, TV 4/- ea. Radio
3/- ea. List 1/-. All orders dispatched
on day received. Also manuals for
sale and hire. SULTAN RADIO, 29,
Church Road, Tunbridge Wells, Kent.

SERVICE SHEETS, TV 3/3 each,
radio 2/9 each. Post free. DARWINS,
45, Shaw Street, St. Helens, Lancs.

MISCELLANEOUS

**HOW TO USE EX-GOV. LENSES
AND PRISMS.** Nos. 1 and 2 2/6 ea.
List free for S.A.E. H. W. ENGLISH,
469, Rayleigh Road, Hutton, Brent-
wood, Essex.

BOOKS

**FIND TV SET TROUBLES IN
MINUTES** from that great book "The
Principles of TV Receiver Servicing."
10/6 all book houses and radio
wholesalers. If not in stock from:
Secretary, I.P.R.E., 20, Fairfield Rd.,
London, N.8.

**TV PHONE
TRANSFORMERS BY 3 p.m.
SENT SAME DAY C.O.D. ON
ALL ITEMS BELOW IN STOCK**

LINE OUTPUT TRANSFORMERS

Makes	Models	Prices
ARGOSY:	T2, CTV517	59/6
DECCA:	D17 & C	59/6
DEFIANT:	TR1758	59/6
R.G.D.:	6017T, 7017C, C54	59/6
REGENTONE:	17C, 17T, 17 Comb.	59/6
BAIRD:	2014, 2017, 2114, 2117	49/6
COBBOR:	930 & T, 931, 933-4-5, 937, 939 & A & F, 939 & A & F, 943T, 946	59/6

H.M.V.:	1824 & A, 1825 & A, 1826 & A, 1827 & A, 1829 & A	65/6
MARCONI:	VT68DA, VT69DA	65/6
SOBELL:	TS17, T346	63/6
FERGUSON:	308T, 308T	63/6
H.M.V.:	1865, 1869	63/6
FERGUSON:	992T-997T, 998T	69/9
PYE:	V4, VT4, V7, VT7, CTM4	55/6

All other makes available (3-5 days)

S.A.E. ALL ENQUIRIES

LINE BLOCKING OSC. TRANSFORMERS

ARGOSY:	T2-3, CTV517	8/6
DECCA:	D14, D17, D17C	8/6
DEFIANT:	TR1454-5-6, 1562, 1754-5-6	8/6
MARCONI:	VT63DA	8/6
REGENTONE:	14-5-7T, 143T, 173T	8/6
R.G.D.:	6012-4-5-7T series	8/6
H.M.V.:	1824 & A, 1825 & A, 1826 & A, 1827 & A, 1829 & A, 1840-1-2- 3-4-5-6-7-8	14/6

MARCONI:	VT68DA, VT69DA, VT150, VC & VT151, VC152-3	14/6
FERGUSON:	992T-997T, 998T	16/9
PYE:	V4, VT4, V7, VT7, CTM4	16/9

FRAME BLOCKING OSC. TRANSFORMERS

ALBA:	T801, 304, 312, 372 & B, 394, 483 & B series	19/9
ARGOSY:	T8-3, CTV517	12/9
DECCA:	D14, D17, D17C	22/6
DEFIANT:	TR1454-5-6, 1562, 1754-5-6	12/9
MARCONI:	VT63DA	12/9
R.G.D.:	6012-4-5-7T series	12/9
REGENTONE:	14-5-7T, 143T, 173T	12/9
VIDOR:	CN4216, CN4225 series	19/9
PHILIPS:	385U, 485U, 492U, 683U, 704A, 1502U	15/-
STELLA:	1522U	15/-
PHILIPS:	1400A, 1700A, 1800A, 2347A E.H.T., Osc. Tx. 1400A, 1700A, 1800A, 2347A	15/-
PHILIPS:	1101U, 1200U & VF, 1400A, 2337A, 2347A	15/-
PHILIPS:	1114UM, 115U, TG1437U, 1446U & /45, 1726U, 1748 U & /45, 1747U	18/-
STELLA:	8314U, 8317U	16/-
PYE:	FV1 & C, FV2C, V2, FV4C & CDL	11/6
PAM:	904, 908, 952-3-4, 958	11/6
INVICTA:	T105, 107-3, 110-1-2-4-5-7-8-9, T120	11/6

FERRANTI:	14T3-4-5-6, 17T3-4-5-6, 20T4- 5-6, 21K5-6, 24K4, T1325, 1625, 1825	14/6
SOBELL:	TS17, T144, T145 & C, T174 & C, TRG174, T175 & LC, TRG 175, T274, T277, T346	15/-
BANNER:	BT114, BT117 & C	15/-
COLUMBIA:	503, 506-6	15/-
H.M.V.:	1814, 1816, 1821, 1824 & A, 1825 & A, 1826 & A, 1827 & A, 1829 & A, 1840, 1841, 1842, 1843, 1844, 1845-6-7-8	14/8

MARCONI:	VC68DA, VT69DA, VC80DA, VC82DA, VT68DA, VT69DA, VT150, VC & VT151, VC152-3	14/6
PYE:	V4, VT4, V7, VT7, CTM4	11/9

All Makes Available.

FRAME OUTPUT TRANSFORMERS

BANNER:	BT114, 117 & C	22/6
COLUMBIA:	C503, C505, C508	25/6
SOBELL:	TS17, T121, T122, T143, T144, T145 & C, T174C, TRG174, T175 & LC, TRG175, T176, T224, T274, T277, T346	25/-
PYE:	V4, VT4, V7, VT7, CTM4	22/6
FERGUSON:	992T-998T	21/6

All Makes Available.

SCAN OILS

PYE:	V4, VT4, V7, VT7, CTM4	65/6
FERGUSON:	992T-998T series	52/6
EKCO:	T217, TC173, TC186, T205, T206, TC207	22/6

All Makes Available.

S.A.E. ALL ENQUIRIES

Post and Packing all Items, 1/6. C.O.D. 1/6 extra.

Wyndor Television Service
ST. ALBANS ROAD
BARNET, HERTS.

BAR. 1769

Closed Thursday 1 o'clock

FOR SALE

VALVE CARTONS at keen prices. Send 1/- for sample and list. J. & A. BOXMAKERS, 75a, Godwin Street, Bradford 1.

SERVICE SHEETS; also Current and Obsolete Valves for sale. JOHN GILBERT RADIO, 20, Extension, Shepherd's Bush Market, London W.12 ((Phone: SHE 3052).

1,000 TELEVISIONS, all makes, from £3 working, 10/- not. Callers only 9 till 6 including Sats. 39, Whitehorse, Lane, Stepney, London.

TELEVISIONS

All sizes including Projections. Require attention from £3. In working order:—
12in. BBC from £5.
12in. and 14in. BBC/ITA from £10.
Regunned CRT £6 extra 17in. from £25.
Send for Lists. Carriage Paid.

CADMANS

SERVICE DEPARTMENT
BRYAN STREET, HANLEY
STOKE-ON-TRENT

100 BAYS Brand New Adjustable Steel Shelving, 72in. high x 34in. wide x 12 in. deep; stove enamelled dark green, sent unassembled. Six shelf bay £3/15/0. Sample delivered free. Quantity discounts. N. C. BROWN LTD., Eagle Steelworks, Heywood, Lanes. Tel.: 69018.

COMPLETE MADE-UP Premier Television with Service Bulletins including 17in. Brimar tube, all valves, many spares and 10in. speaker. Scan coils need rewinding, otherwise perfect, less cabinet. Real bargain for experimenter £5/10/0 cp. MARKHAM, 40 King's Rd., Bury St. Eds., Suffolk.

TV AERIALS for disposal, many types. From ITV indoor 5/- to BBC Double-3 30/-. Also many aerial tubes and components, 4-way 3in. alloy inspection boxes, boxed 8/- dozen. RICHARD MAURICE EQUIPMENT, Portsmouth Road, Cobham 3239.

CUT THE ADS!

ARMCHAIR VOLUME CONTROL unit, easily fitted. Perfectly safe. 30/-, C.W.O. Post free. C.O.D. 2/6.

BRAYHEAD TURRET TUNERS, FEW ONLY. 10m/c, £4.10.0. 35m/c & 16m/c, £6.6.0. complete. State 2 channels. C.O.D. only.

DURHAM SUPPLIES

175 Durham Road, Bradford 8, Yorkshire

WANTED

WANTED Service Sheets. No quantity too large, highest prices paid. SULTAN RADIO, 29, Church Road, Tunbridge Wells, Kent.

A PROMPT CASH OFFER for your surplus Brand New Valves, Speakers, Components, Test Instruments, etc. R.H.S., 155, Swan Arcade, Bradford 1.

BEST PRICE paid by return for new Valves and equipment. STAN WILLETS, 43, Spon Lane, West Bromwich, Staffs. Tel: WES 2392.

WANTED (continued)

WANTED, FIFTY Televisions, must be Pye chassis, not more than two years old. Write: TELERENTAL, 7a, Abbey Green, Nuneaton, Warwicks.

NEW VALVES WANTED. — EY51, ECL80, PCC84, PCF80, PCL83, PL81, PCL82, PY81, R19, U801, 30P4, etc. Best Cash prices by return. DURHAM SUPPLIES, 175, Durham Road, Bradford 8, Yorkshire.

WANTED—VALVES. Modern TV and radio types. Large or small quantities. Box No. 22.

NEW TV VALVES WANTED. Send valves, cash by return to: P. J. F. ANDREWS, 61-63, Rosemary Road, London, S.E.15.

SITUATIONS VACANT**CENTRAL ELECTRICITY GENERATING BOARD****SOUTH WESTERN DIVISION****BERKELEY****NUCLEAR POWER STATION**

Applications are invited for the following appointments on the permanent staff at Berkeley Nuclear Power Station.

Instrument Mechanics for Electronic and other Instrument Maintenance.

The duties will include repair, testing and calibration of all instruments associated with a nuclear power station.

Applicants should have sound technical understanding and practical experience of the servicing of electronic equipment. Knowledge of repair work in other instrumentation fields would be an advantage but training in this aspect will be given if necessary.

General conditions of service will be in accordance with the N.J.I.C. Agreement for the Electricity Supply Industry—5 day—42 hour week; rate of pay 6/1d. per hour. Voluntary Superannuation Scheme. Housing will be made available in appropriate circumstances.

Application on Form A.E.6/M obtainable from the Station Superintendent, Berkeley Nuclear Power Station, Berkeley, Gloucestershire, should be completed and returned to him by 7th February, 1961.

EDUCATIONAL

★ **LEARN** ★
RADIO & TV
SERVICING
for your OWN
BUSINESS/HOBBY

● by a new exciting no-maths system, using practical equipment recently introduced to this country.

FREE Brochure from:—
RADIOSTRUCTOR
DEPT. G78

READING, BERKS. 2/61

EDUCATIONAL (continued)

FREE FROM THE I.P.R.E. Syllabus of famous radio and TV Courses. Membership Condition booklets, 1/-. Sample copy the Practical Radio Engineer, 2/- post free. Secretary, 22, Fairfield Road, London, N.8.

Radio Television & Electronics

Learn at home with the world's largest home study organisation. Brit. I.R.E.; City & Guilds; R.T.E.B., etc. Also Practical Courses with equipment. No books to buy.

Write for **FREE** prospectus stating subject to

Dept. 516 **I.C.S.**
Intertext House, Parkgate Road,
London, S.W.11.

"HOW AND WHY" of Radio and Electronics made easy by a new, non-maths practical way. Postal instructions based on hosts of experiments and equipment building carried out at home. New courses bring enjoyment as well as knowledge of this fascinating subject. Free brochure from Dept. 12, P.T. RADIOSTRUCTOR, 40, Russell Street, Reading.

"AS-NU"

Regunned TV Tubes

Supplied from stock, and despatched by British Railways same day.

COMPLETE NEW GUNS

fitted in every tube and fully guaranteed for TWELVE MONTHS.

	Mullard	Mazda
12 in. ...	£4.10.0	£4.10.0
14 in. ...	£4.15.0	£5.10.0
15 in. ...	—	£6. 0.0
16 in. ...	£6.10.0	—
17 in. ...	£5.10.0	£5.17.6
21 in. ...	£8.10.0	£8.10.0

Plus 10/- Carr. & Ins.

PLEASE NOTE OUR NEW ADDRESS

Other types available. Please contact:

J. P. WRIGHT

103 Carr House Road, Doncaster

Sole Distribution Agent

'Phone: DON 2636

NEW VALVES!

Guaranteed Set Tested
24 HOUR SERVICE

1R5, 1R5, 1T4, 3S4, 3V4, DAF91, DF91, DK91,
DL92, DL94, SET of 4, 18/6.
DAF93, DF93, DK93, DL93, SET of 4, 26/-.

1D6	7/-	DL92	5/11	PCF82	7/6
1R5	5/-	DL94	6/9	PCL82	7/6
1R5	4/6	DL96	6/9	PCL83	11/-
1T4	8/9	EB91	3/-	PCL84	7/6
3S4	5/11	EBC41	7/9	PL36	10/9
3V4	6/9	EBF80	7/9	PL81	8/-
5U4G	4/3	EEL21	12/6	PL82	7/-
5Y3GT	6/6	ECC81	4/9	PL83	7/-
5Z4G	7/3	ECC82	5/9	PL84	9/8
6AM6	2/9	ECC83	6/3	PY32	10/3
6K7G	1/9	ECC84	8/-	PY80	7/-
6K9G	4/9	ECC85	7/9	PY81	6/6
6Q7G	5/6	ECP80	8/3	PY82	6/3
6V8G	4/9	ECP82	8/3	PY83	7/3
6V8GT	6/6	ECH21	12/6	U25	12/-
6X5GT	4/9	ECH22	7/9	U26	10/-
12K7GT	4/9	ECL80	7/6	UABC80	7/6
12K8GT	11/-	EF41	7/6	UAF42	8/6
12Q7GT	4/6	EF90	4/9	UBC41	7/-
35L6GT	8/6	EF95	5/6	UBF80	8/6
35Z4GT	5/3	EF98	9/6	UCC85	7/-
AZ31	8/9	EF99	6/9	UCH21	12/6
CL33	11/9	EF91	2/9	UCH42	7/6
DAC32	9/6	EL41	7/-	UCH81	8/-
DAF91	4/6	EL94	6/3	UCL82	10/-
DAF93	6/9	EY51	7/3	UCL83	13/-
DF33	9/6	EY86	7/6	UF41	7/9
DF91	3/9	EZ40	6/-	UF85	8/-
DF96	6/9	EZ41	6/9	UF89	6/6
DR77	8/-	EZ80	5/9	UL41	7/-
DK32	11/-	EZ81	6/6	UL84	7/-
DK91	5/-	GZ30	8/-	UY21	11/-
DK92	7/3	MT14	7/-	UY41	5/9
DK96	6/9	PCC84	7/3	UY85	6/3
DL33	8/6	PCC89	10/-	VP4B	8/6
DL35	8/6	PCF80	7/3	Z77	2/6

Postage 6d. per valve extra. Any Parcel Insured Against Damage in Transit 6d. extra. Any C.O.D. Parcel 2/6 extra. Office address, no callers.

GERALD BERNARD
90 CARR MANOR AVENUE, LEEDS 17

NEW THIRD EDITION TELEVISION ENGINEERS' POCKET BOOK

Much new information has been added to the enlarged and fully revised third edition. Experienced engineer and the newcomer to the service work will find this handy book invaluable for the on-the-spot repairs.

Edited by
J. P. Hawker

12/6. Postage 6d.

PIN-POINT TV TROUBLES IN 10 MINUTES, a Coyne Pub. 31/6. Postage 1/-.

TELEVISION SERVICING HANDBOOK, by G. J. King. 30/-, Postage 1/3.

TV FAULT FINDING, by Data Pub. 5/-, Postage 6d.

TUBES & CIRCUITS, by G. J. Christ. 28/-, Postage 1/-.

AN ELECTRONIC ORGAN FOR THE HOME CONSTRUCTOR, by A. Douglas. 15/-, Postage 9d.

TAPE RECORDER MANUAL, by W. S. Sharps. 21/-, Postage 1/-.

COMPLETE CATALOGUE 1/-.

THE MODERN BOOK CO.

BRITAIN'S LARGEST STOCKISTS of British and American Technical Books

19-21 PRAED STREET,
LONDON, W.2.

Phone: PADDINGTON 4185
Open 6 days 9-6 p.m.

REBUILT TV TUBES

FULLY GUARANTEED
12 MONTHS

Complete New Gun fitted in every Tube

12in., 14in. ...	£5.0.0
15in. ...	£5.10.0
17in. ...	£6.0.0
21in. ...	£8.0.0

Immediate Delivery
Carriage and Insurance 10/- extra
Allowance on old tube

NU-GUN TELETUBES LTD.

3 The Mews, Duckett Rd.
Harringay, London, N.4

Telephone: MOUntview 2903

Please mention Practical
Television when replying
to advertisements

TRANSISTORS

Red Spot 3/-	White Spot 4/6
OC70 9/-	OC44 20/-
OC45 16/-	OC170 45/-

Crystal Diodes 1/-

OA70, OA81, GD4, GEX34,
GEX 35, all 4/- each

Connecting Wire, six assorted colours
1 yd. each colour, 1/9, 2 yds. each, 2/9,
10 yds. each 10/6. Valveholder, can
and spring complete 1/6, size B7G or
B9A. Resistors, all values 10% 1/2 W,
6d., 1W, 9d.

All prices post paid

OAKFIELD RADIO

121 MACCLESFIELD ROAD, HAZEL GROVE,
STOCKPORT, CHESHIRE

MAIL ORDER ONLY

B.B.C. - I.T.V. - F.M. AERIALS

B.B.C. (BAND 1). Tele-
scopic loft, 19/6. External,
S/D, 28/3.

I.T.V. (BAND 3). 3 Element
loft array, 24/-, 5
Element, 32/6. Wall
mounting, 3 Element, 33/8.
5 Element, 41/3.

COMBINED B.B.C. +
I.T.V. Loft 1+3 Element,
41/3. 1+5 Element, 49/8.
Wall mounting, 1+3 Element,
56/3. 1+5 Element,
63/9. Chimney and mast
mounting units also available.

F.M. (BAND 2). Loft "H" 26/-, 3 Element
loft, 52/6. S/D loft, 12/6. External
S/D, 26/3. State channel when ordering.
C.W.O. or C.O.D. P.P. 2/6. Coaxial cable,
8d. yd. Coaxial plugs, 1/3. Send 6d.
stamps for illustrated lists.

K.V.A. ELECTRONICS (Dept. T.P.)

3B Godstone Road, Kenley, Surrey

LINE OUTPUT TRANSFORMERS

Most types available.

State Make and Model.

Number of Receiver when
ordering.

S.A.E. please with all inquiries

HOWORTH

51 POLLARD LANE,
BRADFORD 2, YORKS.
Tel. 37030

RES/CAP. BRIDGE 38/-

p. & p. 2/-

Checks all types of resistors, condensers
6 RANGES

Built in 1 hour. Direct reading
READY CALIBRATED

Stamp for details of this and other kits.

RADIO MAIL (Dept. HV)

Raleigh Mews, Raleigh Street, Nottingham

SPECIAL VALVE OFFER

For Limited Period

EB91	4/-	UF42	7/-	6L1	8/-
ECL80	7/6	UL41	7/-	6L18	9/-
ECL82	8/-	UL44	7/6	6P25	6/6
EF80	8/-	UL46	7/6	6LD20	7/6
EF91	4/-	UBC41	7/6	6SN7GT	5/6
EL38	10/6	UCH42	7/6	6P28	8/6
EY83	7/6	U35	8/6	757	9/8
GZ32	8/-	SP81	2/6	10F1	8/6
KT93C	6/6	3D6	2/6	10P14	8/6
PCL83	12/6	8AT8	6/6	12AT7	8/-
PL33	3/-	6CH6	7/-	20D1	7/6
PL82	7/6	6BG6G	10/6	UY41	5/6
PL83	7/6	6F1	6/-	N37	8/-
PY90	7/-	6F13	6/-	ECC83	7/-
PY82	7/-	6F14	6/-	807	6/6
PZ30	11/-	6F15	6/-	PY31	7/6
UAF42	8/6	6J5GT	5/-	1625	6/-

Postage 4d. per Valve.

Coaxial Cable, 75 ohms, 6d. yd. Ion Traps,
5/-; Midget 2 Gangs, 6/6; New 7 x 4 P.M.
Speakers, Large or Small Magnet, 15/-.

TV AERIALS: We carry large stocks;
send S.A.E. with your requirements and we
shall reply and send leaflets by return.

MAIL ORDER ONLY - NO CALLERS

Terms: C.W.O. or C.O.D. minimum C.O.D.
3/-; postage, packing other than valves,
under £2. 1/6; under £5. 2/-; aerials, 2/6.

ELECTRO SERVICES & CO.

221 BATTERSEA PARK RD., S.W.11

Mac. 6833/4

OUR COMPREHENSIVE SERVICE INCLUDES:

12 CHANNEL TURRET TUNERS, 10, 16, 38 Mc/s. 40/-; VALVES, PCF80 and PCC84, 7/3 each. Cabinets, Glasses, Masks, Condensers, Resistors, Ion Traps, Speakers. RECLAIMED C.R. TUBES (Not boosted or reactivated) 9in. and 12in., 35/-; 14in., 50/-; 17in., 60/- All picture tested, taken from stripped TV's.

REGUNNED C.R. TUBES

(12 month guarantee) 12in., 80/-; 14in., 90/-; 17in., 100/- EXAMPLE OF TRANSFORMER LIST L.O.P.T. SCAN COILS

FERGUSON: (New) (Used) (New) (Used) 103T, 105T 89/8 35/- 60/- 35/- 992/4/6/8 .. 89/8 35/- 60/- 35/-

These are only examples of stocks, we have many thousands more, and would be pleased to quote for any component you may require.

We pride ourselves that we can obtain and supply any TV spare.

OUR GIGANTIC STOCKS INCLUDE:

LINE OUTPUT, FRAME OUTPUT, SOUND OUTPUT, LINE AND FRAME BLOCKING OSC. TRANS. AND SCAN COILS, FOR ANY MAKE OR MODEL TELEVISION.

SOME OF OUR VALVES

Table listing various valves (AZ31, B36, D77, etc.) with their prices and specifications.

These are only examples of our valves: if you do not see what you require send stamped addressed envelope for special quotation.

For the Finest, Fastest Service in the country, contact-

D. & B. TELEVISION 131a KINGSTON ROAD SOUTH WIMBLEDON LONDON S.W.19.

Phone: Cherrywood 3955

And that's not all-- WE ARE OPEN FROM 10 a.m. UNTIL MIDNIGHT.

For any information or problems you have Call on us of Phone, we are always pleased to help.

TERMS: S.A.E. all enquiries. C.W.O. or C.O.D. 3/- extra. Postage on Valve 6d. each, C.R.T.s 12/6 inc. insurance. SATISFACTION ASSURED

RETURN POST SERVICE

DID YOU KNOW

COYNE'S NEW TROUBLE-SHOOTING SERIES TAKES HEADACHES OUT OF ALL SERVICING PROBLEMS



Pin-Point TV troubles in 10 minutes

Find the exact sound or picture trouble in ANY TV set from 700 possibilities! Latest Edition now has 332 pages of solid, down to earth TV Service-

ing information: 300 diagrams, check charts, 31/6. Postage 1/-.

Pin-Point Transistor troubles in 12 minutes



Trouble-shoot every type of circuit in ALL transistorized equipment! 525 pages; hundreds of illustrations; 120 check charts. 47/6, postage 1/6.

SIMPLE CHECK CHART SYSTEM SAVES TIME

These amazing practical handbooks with ENTIRELY NEW METHOD show you how to find the trouble in ANY TV, or transistor circuit FAST! Index tells you where to look; famous Check-Charts help you to pin-point the exact trouble in minutes! These on-the-job books quickly pay for themselves in profitable new business and valuable time saved!

SEND NO MONEY

Just mail coupon for free trial. After 7 days send only low price or return books and pay nothing! If you keep both books send only 19/- after 7 days and 41 a month until a total of 79/- has been paid.

If ordering one book, pay one half after seven days and the other half in 30 days.

FREE TRIAL OFFER Mail Coupon Now for FAST RETURN SERVICE

Mail Order Division, SIM-TECHBOOK COMPANY, Gater's Mill, West-End, Southampton, Hants.

- Check boxes for Rush 2-book PIN-POINT Series for 7-day FREE TRIAL per offer (postage free), I do not require both books, please send me the following book as per offer, TRANSISTORS, 47/6, plus postage, TV TROUBLES, 31/6, plus postage.

Name

Address

City..... County.....

Check here if enclosing full price; we pay postage. Same 7-day money-back guarantee.

EDDY'S (Nottm.) LTD.

172 ALFRETON ROAD, NOTTINGHAM POCKET RADIO, 2 Transistor with miniature speaker. 2 wave band. Complete with all parts wiring diagram and full instructions 27/6. Batteries 1/-, P. & P. 2/6. THROAT MIKES 1/- each Super quality Model 2/- each. Post 6d. Could be used for electrifying musical instruments, etc. V.H.F. EXPANDING AERIALS. Complete and easy to fit. No technical knowledge required. 6/11, Post 10d.

Build your own CAR RADIO!

★ 7 Transistors ● Long and Medium Waves ● Two Watts Output ● R.F. Stage and Automatic Gain Control

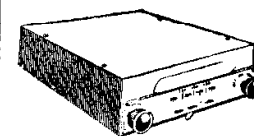

10 1/2 Gns. P & P 5/- extra

6 or 12 volts (state which) Supplied with full instructions

Size 7 3/4 x 7 1/4 x 2 1/2 in.

SPEAKER, extra 17/11

Table listing various valves (DAF91, DAF96, DF91, etc.) with their prices and specifications.

All above are NEW and Guaranteed New or Surplus Valves, Guaranteed and Tested by Return Post.

Any parcel insured against damage in transit for only 6d. extra per order. All uninsured parcels at customers' risk. Post and Packing 6d. per valve extra. C.W.O. or C.O.D. only. C.O.D. charge 3/- extra. S.A.E. with enquiries.

Build your own Aerials...

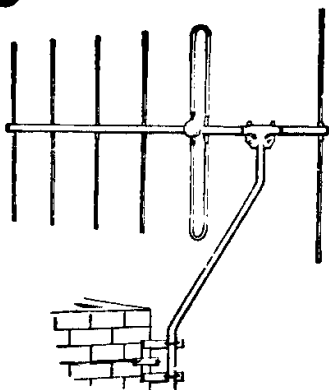

AT HOME

AERIAL FITTINGS FOR BAND III, BAND I & RADIO F/M. Useful formulæ and hints for constructing your own aerial quickly and cheaply. Catalogue illustrating our increased range of Diecast Alloy Fittings, including Band III to Band I Mast Couplers, Reflector and Director Rod Holders, Insulators (both "Inline" and "H" types), Masthead Fittings, Masts and Elements, Chimney Brackets, etc. Send 1/- in stamps for the above, to:—

Fringelevision Ltd.

MARLBOROUGH, WILTS. Phone : 657/8

TELEVISION TUBES REBUILT BY "RE-VIEW"

	PRICE:			
12in.	£5. 0.0
14in.	£5. 0.0
15in.	£5.15.0
17in.	£6. 0.0
21in.	£8.10.0

SAVE £££s

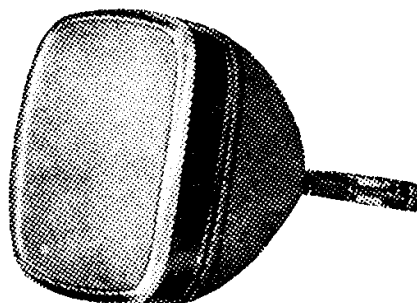

TWELVE MONTHS' GUARANTEE

Carriage and insurance 10/-.

Be one of our satisfied customers. Call and see our TUBES REBUILT and TESTED

RE-VIEW (London) LTD., 10 High St., Colliers Wood, London S.W.19

Terms to the Trade

Tel.: LIBERTY 3272

C.R.T. BOOSTER TRANSFORMERS
TYPE A. OPTIONAL 25% and 50% BOOST.
 2 V. OR 4 V. OR 6.3 V. OR 10.8 V. OR 13.3 V. MAINS INPUT. 12/6

TYPE A2. HIGH QUALITY. LOW CAPACITY. 10/15 pF. OPTIONAL BOOST 25%, 50%, 75%. MAINS INPUT. 16/6

TYPE B. MAINS INPUT, MULTI OUTPUT 2, 4, 6.3, 7.3, 10 and 13 VOLTS. BOOST 25% AND 50%. LOW CAPACITY. 21/-

TRIMMERS. Ceramic. 30, 50, 70 pF, 9d.; 100 pF, 150 pF, 1/3; 250 pF, 1/8; 500 pF, 750 pF, 1/9.

RESISTORS. Preferred values. 10 ohms to 10 meg., 1/4 w., 4d.; 1/2 w., 4d.; 1 w., 6d.; 1 1/2 w., 8d.; 2 w., 1/-.

HIGH STABILITY. 1 w., 1/-; 2/- Preferred values 10Ω to 10 meg. Ditto, 5%, 100Ω to 5 meg. Ω. 9d. 5 watt }
 10 watt } **WIRE-WOUND RESISTORS** 1/8
 15 watt } 25 ohms - 10,000 ohms 2/-
 12.5K to 50K 10 w. 3/3

AMERICAN "BRAND FIVE" PLASTIC RECORDING TAPE

Double Play 7in. reel, 2,400ft	60/-	Spare
5in. reel, 1,200ft	37/6	Plastic
Long Play 7in. reel, 1,800ft	35/-	Reels
5 1/2in. reel, 1,200ft	23/6	3/- ea.
5in. reel, 900ft	18/6	Metal
Standard 7in. reel, 1,200ft	25/-	7 Reels
5in. reel, 600ft	16/-	2 ea.

"Instant" Bulk Tape Eraser and Head Defluxer. 200/250 v. A.C. 27/3. Leaflet, S.A.E.

O.P. TRANSFORMERS. Heavy Duty 50 mA, 4/6. Multitap, push-pull, 7/6. Miniature, 384, etc., 4/6. Push-pull 10 w., 15/6. L.F. CHOKES 15-10 H. 60-65 mA. 5/-; 10 H. 85 mA, 10/6; 10 H., 150 mA, 14/-

MAINS TRANSFORMERS 200/250 v. A.C. STANDARD. 250-0-250, 80 mA, 6.3 v. 3.5 a. tapped 1 v. 4 a. Rectifier 6.3 v. 1 a. 5 v. 2 a. or 4 v. 2 a. ditto, 350-0-350 ... 22/6

MINIATURE 200 v. 20 mA, 6.3 v. 1 a. 10/6

MIDGET, 220 v. 45 mA, 6.3 v. 2 a. 15/6

SMALL, 220-0-220, 50 mA, 6.3 v. 2 a. 17/6

STD., 250-0-250, 65 mA, 6.3 v. 3.5 a. 17/6

HEATER TRANS. 6.3 v. 1 1/2 amp. 7/6

Ditto, tapped sec. 2, 4, 6.3 v., 1 1/2 amp... 8/6

Ditto, sec. 6.3 v. 3 amp. 10/6

GENERAL PURPOSE LOW VOLTAGE. 2a, 3, 4, 5, 6, 8, 9, 10, 12, 15, 18, 24, 30 v. 22/6

AUTO TRANSFORMERS. 150 w. 0, 10, 120, 200, 230, 250 v. 22/6

ALADDIN FORMERS and core, 1in., 3d.; 1in., 10d. 0.3in. FORMERS 5987/8 and Cans TV1/2. 1in. sq. x 2 1/2in. and 1in. sq. x 1 1/2in., 2/- ea., with cores.

SOLOID Soldering Iron, 220/40 v. 25 w. 24/-.

REMPLOY Instrument Iron, 230 v. 25 w., 17/6.

MAINS DROPPERS. 3in. x 1 1/2in. Adj. Slider, 0.3 amp., 1,000 ohms, 4/3. 0.2 amp., 1,000 ohms, 4/3.

LINE CORD. 0.3 amp., 60 ohms per ft., 0.2 amp., 100 ohms per ft., 2-way, 6d. per ft., 3-way, 2d. per ft.

LOUDSPEAKER P.M. 3 OHM. 5in. Rola, 17/6. 8in. Plessy, 19/6. 6in. x 4in. Rola, 13/6. 6in. Rola, 13/6. 10 x 6in., 27/6. 10in. Rola, 30/-.

4in. Hi-Fi Tweeter, 25/-.

12 in. R.A., 30/-.

STENTORIAN HF1012. 10in. 3 to 15 ohms, 10 w., 95/-.

12in. Baker 15 watt 3 ohms, or 15 ohms, 105/-.

CRYSTAL DIODE G.E.C., 2/-. GEX34, 4/-.

HIGH RESISTANCE PHONES. 4,000 ohms, 15/- pr. MIKE TRANSF. 50 : 1, 3/9 ea.; 100 : 1, Potted, 10/6.

SWITCH CLEANER. Fluid squirt sprout, 4/3 tin.

TWIN GANG TUNING CONDENSERS. 365 pF miniature 1in. x 1 1/2in., 10/-.

0.0005 standard with trimmers, 9/-; less trimmers, 8/-; midget, 7/6.

SINGLE, 50 pF, 2/6; 75 pF, 100 pF, 160 pF, 7/-. Solid dielectric 100, 300, 500 pF, 3/6.

SPEAKER FRET. GOLD CLOTH. 17in., 25in., 5/-.

25in. x 35in., 10/-.

Tyran 4in. 6in. wide, 10/-.

3in. wide, 5/-.

Brown, green or red. Samples S.A.E.

New and Boxed VALVES 90-day Guarantee.

1R5	7/6	6K6G	7/6	6A1	8/6	6AC6	8/6
185	7/6	6L6G	10/6	6B91	6/-		12/6
1Y4	6/-	6N7M	8/6	6B33	8/6	6VR2A	6/6
2X2	3/6	6Q7G	8/6	6B41	8/6	6U14	9/-
384	7/6	6SA7	6/-	6B50	10/-	6U1	3/6
3V4	7/6	6SA7M	6/-	6C84	9/6	6CC84	9/6
5U4	7/6	6SN7	6/6	6C80	9/6	6CF80	9/6
5Y3	7/6	6V6G	6/6	6C142	10/6	6CL82	11/6
5Z4	9/6	6X4	7/6	6C182	10/6	6EN25	6/6
6AM6	5/-	6X5	6/6	6E91	5/6	6L82	10/6
6B8	5/-	6ZAT7	8/-	6E94	9/6	6P80	7/6
6BE6	7/6	6ZAU7	8/-	6E95	5/6	6P81	9/6
6BH6	9/6	6ZAX7	8/-	6E96	5/6	6P82	7/6
6BW6	9/6	6ZBE6	8/6	6E97	8/-	6P61	3/6
6D6	6/-	6ZK7	6/6	6E98	5/-	6B41	9/6
6F6G	7/6	6ZQ7	6/6	6E92	5/6	6C142	9/6
6H6	3/6	6ZL6	9/6	6E93	5/6	6L41	9/6
6J5	5/6	6Z5Z4	7/6	6E84	8/6	6L41	9/6
6J8	5/6	80	9/6	6EM1	9/6	6Y41	9/6
6J7G	6/6	807	5/6	6E240	7/6	6U22	8/6
6K6GT	6/6	954	1/6	6E280	7/6	6VR105	9/6
6K7G	5/6	EA50	1/6	6E1148	1/6	6VR150	9/6

TELEVISION REPLACEMENT LINE OUTPUT TRANSFORMERS
 70/- ea. from stock.
 For Makes and Models

Argosy: T2, CTV517. **Decca:** D17 & C. **Defiant:** TR1753. **RGD:** 6017T, 7017C, C54. **Regentone:** 17C, 17T, 17 Comb.

Cossor: 930 & T, 931, 933-4-5, 937, 938 & A. & F. 939 & A & F, 943T, 946.

Decca: DMI, DM2C, DM3, DM4, DM4C, DM5, DM17, 444, 555.

Ferguson: 103T, 105T, 113T, 135T, 142T, 143T, 145T, 990T, 991T, 992T, 993T, 994T, 995T, 996T, 997T.

H.M.V. 1824 & A, 1825 & A, 1826 & A, 1827 & A, 1829 & A, 1865, 1869.

Marconi: VT68DA, VT69DA.

Pye: V4, VT4, V7, VT7, CTM4.

Sobell: TS17, T346.

Ferguson: 306T, 308T.
 Most other makes available (7 days). S.A.E. with all enquiries.

LINE BLOCKING TRANSFORMERS. 10/- to 16/6.

FRAME BLOCKING TRANSFORMERS. 13/6 to 21/-.

FRAME OUTPUT TRANSFORMERS. 27/6 to 39/-. Most makes available (7 days). S.A.E. with all enquiries.

HIGH GAIN TV PRE-AMP KITS
BAND I BBS
 Tunable channels 1 to 5. Gain 18dB. ECC84 valve. Kit price 23/6 or 43/6 with power pack. Details 6d. (PC84 valves if preferred.)
BAND III ITA - Same prices.
 Tunable channels 8 to 13. Gain 17dB. ECC84 valve. (PC84 valves if preferred.)

CRYSTAL MIKE INSERT by Acos, precision engineered. Size only 1in. x 3/16in., 6/6.

ALUMINIUM CHASSIS. 18 s.w.g. undrilled. With 4 sides, riveted corners and lattice fixing holes. 2 1/2in. sides, 7 x 4in., 4/6; 9 x 7in., 5/9; 11 x 7in., 6/9; 13 x 9in., 8/6; 14 x 11in., 10/6; 15 x 14in., 12/6; 18 x 16 x 3in., 16/6.

JASON F.M. TUNER COIL SET, 29/-. H.F. coil, aerial coil. Oscillator coil. Two I.F. trans. 10.7 Mc/s. Ratio Detector and heater choke. Circuit book using four 6AM6, 2/6.
COMPLETE JASON F.M. KIT, FMTI, with set of 4 valves, etc., 26.5.0.

BBC TRANSISTOR RADIO. Med. and Long Wave. Two transistors and diode. Complete kit, 32/6, phones 7/6 extra. Deaf Aid Earpiece with Special Lead, 12/6. Details 6d.

CYLDON TURRET TELETUNER
 I.F. PCB mugs, complete with frame-grid valves, 30C1, 30L15. With coils for channels 1 to 5 and 8 to 11. Brand new, price 45/-, operating data and circuit supplied.
IDEAL for P.T. "OLYMPIC".

RECORD PLAYER BARGAINS



4 Speed Autochangers, B.S.R., U.A.8 26.15.0
4 Speed Autochangers, U.A.8 Stereon. 27.10.0
Collaro Conquest 27.19.8
Garrard Model 210, GCS Head 210.10.0
4 speed Single Players, EM1 26.19.6
Garrard TA Mk.II, GCS Head 28.0.0
Garrard 4 HF Transcription, GCS 217.19.6
Garrard Stereo Head, 22 extra.
Suitable player cabinets (except 4 H.F.) 49/6
Amplifier player cabinets (except 4 H.F.) 63/-
2-valve amplifier and 6in. speaker 70/6
3-valve amplifier and 6in. speaker 85/-
Wired and tested ready for use with above.

Volume Controls 80 ohm CABLE COAX
 Long spindles. Guaranteed 1 year. Midget 5K ohms to 2 Meg. No Sw. D.P. Sw. 3/- 4/6
 Linear or Log Tracks. Semi-air, spaced. 1in. dia. Losses cut 50%. Fringe Quality Air Spaced. 6d. yd. 1/- yd.

COAX PLUGS 1/- **LEAD SOCKET** 2/-
PANEL SOCKETS 1/- **OUTLET BOXES 4/6**
BALANCED TWIN FEEDER yd. 6d. 80 or 300 ohms.
DITTO SCREENED per yd. 1/6. 80 ohms only.
WIRE-WOUND POTS, 2 WATT. Pre-set Min. TV Type. All value 10 ohms to 25 K, 3/- ea. 30 K, 50 K, 4/- (Carbon 30 K, to 2 meg., 3/-).
WIRE-WOUND 4 WATT. Pots Long Spindle Values, 50 ohms to 50 K, 6/6; 100 K, 7/6.
CONDENSERS. New Stock. 0.001 mfd. 7 kV. T.C.C., 5/6; Ditto, 20 kV., 9/6; 0.1 mfd., 7 kV., 9/6; Tubular 500 v. 0.001 to 0.05 mfd., 9d.; 0.1, 1/-; 0.25, 1/6; 0.5/300 v., 1/9; 0.1/350 v., 9d.; 0.01/2,000 v. 0.1/1,000 v., 1/9; 0.1 mfd., 2,000 volts, 3/6.
CERAMIC CONDS. 500 v., 0.3 pF to 0.01 mfd., 9d.
SILVER MICA CONDENSERS. 10% 5 pF to 500 pF. 1/-; 600 pF to 3,000 pF, 1/3. Close tolerance (+1 pF) 1.5 pF to 47 pF, 1/6. Ditto 1% 50 pF to 815 pF, 1/9; 1,000 pF to 5,000 pF, 2/-.

I.F. TRANSFORMERS 7/6 pair
 465 Kc/s Slug Tuning Miniature Can. 1 1/2 x 1 1/2 in. High Q and good bandwidth. By Pye Radio. Data sheet supplied.
WEYMOUTH. Standard size, 465 Kc/s, 12/6 pair.

NEW ELECTROLYTICS. FAMOUS MAKES

TUBULAR	TUBULAR	CAN TYPES
1:350v. 2/-	50/350v. 5/6	16/500v. 4/-
2:450v. 2/3	100/25v. 2/-	32/350v. 4/-
4:450v. 2/3	250/25v. 2/6	100/270v. 5/6
8:450v. 2/3	500/12v. 3/-	2,500/3v. 4/-
8:500v. 2/9	8+8/450v. 3/6	5,000/6v. 5/-
16:450v. 3/8	8+16/450v. 3/9	32+34/450v. 6/6
16:500v. 4/-	8+16/500v. 5/6	32+32+32/350v. 7/-
32:450v. 3/9	16+16/450v. 4/3	50+50/350v. 7/-
25:25v. 1/9	16+16/500v. 6/-	64+120/350v. 11/6
50:50v. 2/-	32+32/350v. 4/8	100+200/275v. 12/6

RECTIFIERS SELENIUM 300 v. 85 mA, 7/6.
CONTACT COIL 250 v. 50 mA, 7/-; 60 mA, 8/6; 85 mA, 9/6; 200 mA, 21/-; 300 mA, 27/6.
COILS Wearite "P" type, 3/- each. Osamor Midget "Q" type adj. dust core from 4/-. All ranges.
TELETON. L & Med. T.R.F., with reaction, 3/6.
FERRITE ROD AERIALS. M.W., 8/9; M. & L., 12/6.
T.R.F. COILS A/H.F. 7/- pair. H.F. CHOKES, 2/6.
FERRITE ROD, 8in. x 3in. dia., 2/6.
FULL WAVE BRIDGE SELENIUM RECTIFIER: 2, 6 or 12 v. 1 1/2 amp., 8/9; 2 a., 11/3; 4 a., 17/6.
CHARGER TRANSFORMERS. Tapped input 200/250 v. for charging at 2, 6 or 12 v., 1 1/2 amps., 15/6. 2 amps., 17/6; 4 amps., 22/6. Circuit included.
VALVE and TV TUBE equivalent books, 5/-.
TOGGLE SWITCHES, S.P. 2/-, D.P. 3/6. D.P.D.T. 4/-.
WAVECHANGE SWITCHES
 5 p. 4-way 2 wafer long spindle 6/6
 2 p. 2-way, or 3 p. 2-way short spindle 2/6
 2 p. 6-way, 4 p. 2-way, 4 p. 3-way long spindle 3/6
 3 p. 4-way, or 1 p. 12-way long spindle 3/6
VALVEHOLDERS. Pax Int. Oct., 4d. EF50, EA50. 6d. B12A, CRT, 1/3. Eng. and Amer. 4, 5, 6 and 7 pin, 1/-.
MOULDED MAZDA and Int. Oct., 6d.
 B7G, B9A, B9G, B9A, 9d. B7G with can., 1/6. B9A with can., 1/9. **CERAMIC EF50, B7G, B9A.** Int. Oct., 1/-.
S/CANS B7G, B9A, 1/- ea.

RADIO COMPONENT SPECIALISTS

OUR ONLY ADDRESS
 337 WHITEHORSE RD.,
 WEST CROYDON

Post and Packing 1/-, over £2 free. (Export post Extra.) C.O.D. 1/6. (Wed. 1 p.m.) THO 1665 Buses 133 or 68 V.R.A.T. Lib.