

A HOME CONSTRUCTED TELEVISION RECEIVER

Practical Television 13

OCTOBER 1958

AND TELEVISION TIMES

EDITOR: F.J. CAMM

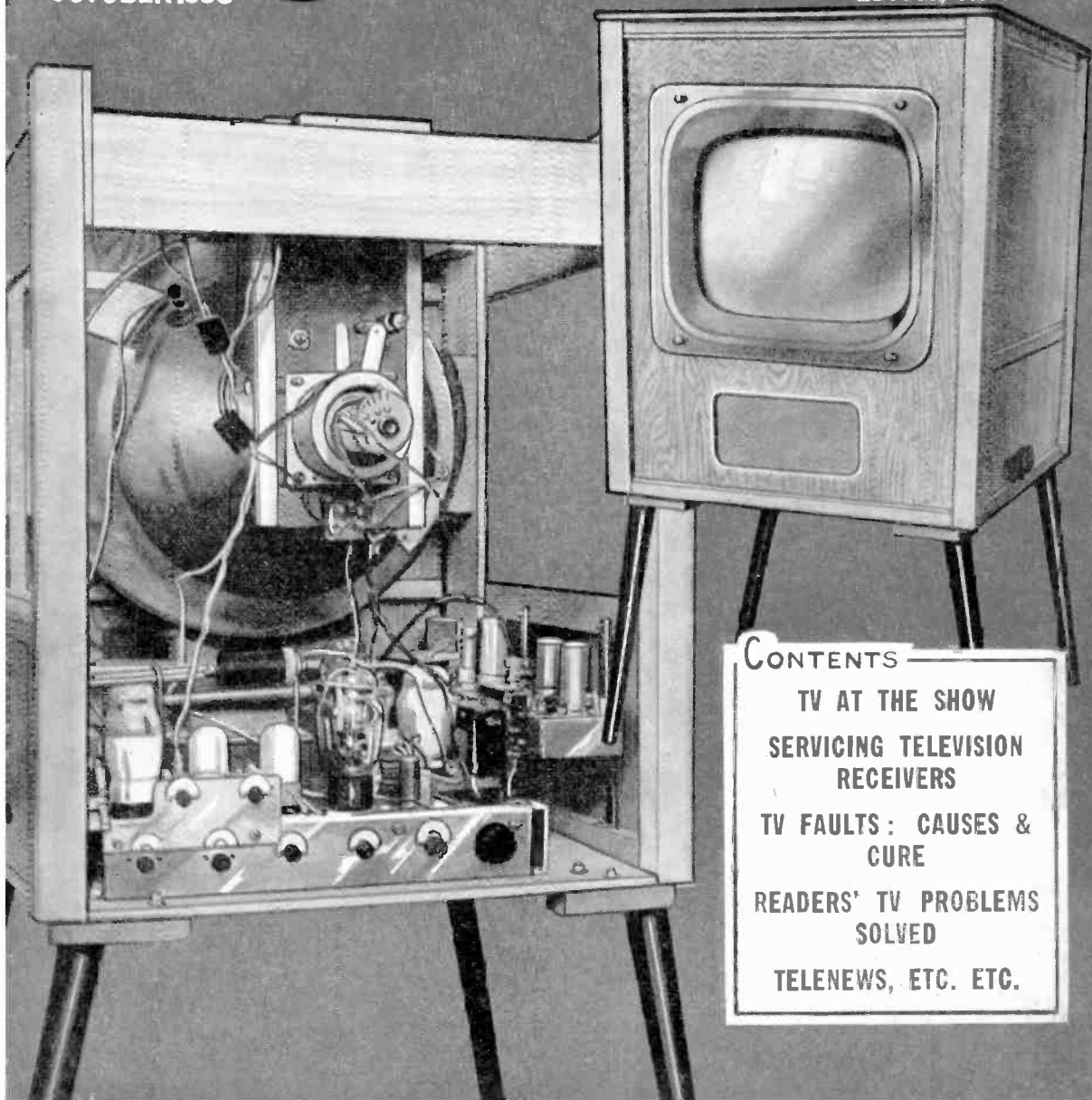

CONTENTS

- TV AT THE SHOW
- SERVICING TELEVISION RECEIVERS
- TV FAULTS: CAUSES & CURE
- READERS' TV PROBLEMS SOLVED
- TELENEWS, ETC. ETC.

Build your own Aerials...

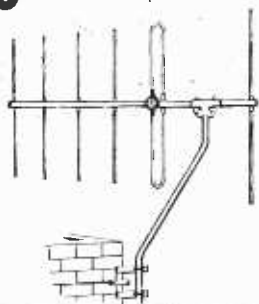

Fringelevision Ltd.

MARLBOROUGH, WILTS. Phone : 657/8

AT HOME

AERIAL FITTINGS FOR BAND III, BAND I & RADIO F.M.
 Useful formulæ and hints for constructing your own aerial quickly and cheaply. Catalogue illustrating our increased range of Diecast Alloy Fittings, including Band III to Band I Mast Couplers, Reflector and Director Rod Holders, Insulators (both "Inline" and "H" types), Masthead Fittings, Masts and Elements, Chimney Brackets, etc. Send 1/- in stamps for the above to —



ADCOLA
(Regd. Trade Mark)

SOLDERING EQUIPMENT

THE INSTRUMENTS CREATED FOR THE DISCRIMINATING USER.

British & Foreign Pats., Regd. Designs, etc.

ILLUSTRATED Protective Shield (Cat. No. 68)
 Instrument $\frac{1}{8}$ " Bit (Cat. No. 70)

The ideal combination for transistor and other intricate work.

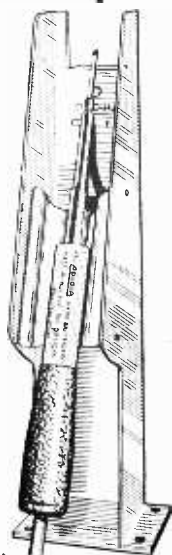

Apply direct for catalogues :—
ADCOLA PRODUCTS LTD.,
 GAUDEN RD.,
 CLAPHAM HIGH ST.,
 LONDON, S.W.4.

Telephones 4272
 MACaulay: 4272 and 3101

TELEVISION TUBES

WE OFFER
MULLARD — COSSOR — EMITRON
 Etc., From Stock

12" TUBES - - - £6

Re 12" tubes, please confirm before placing order.

14" MULLARD TUBES £6

(Or equivalent)

14" MAZDA TUBES £6 10.

17" TUBES - - £7 10.

Please add 12/6 Carriage and Insurance.
 12" tubes guaranteed for 3 months ;
 14" & 17", 6 months

MARSHALLS for TELEVISION

131 St. Ann's Road, Tottenham,
 London, N.15.

Callers welcome. STAmford Hill 3267

EMI "HIS MASTER'S VOICE" MARCONIPHONE · COLUMBIA

Announce NEW PRACTICAL WAY OF LEARNING AT HOME

NEW — completely up-to-date methods of giving instruction in a wide range of technical subjects specially designed and arranged for self-study at home under the skilled guidance of our teaching staff.

NEW — experimental outfits and lesson manuals are despatched on enrolment and remain the student's property. A tutor is allotted to each student for personal and individual tuition throughout the course.

Radio and television courses, with which specially prepared components are supplied, teach the basic electronic circuits (amplifiers, oscillators, detectors, etc.) and lead, by easy stages, to the complete design and servicing of modern Radio and T/V equipments.

If you are studying for an examination, wanting a new hobby or interest, commencing a career in industry or running your own full-time or part-time business, these practical courses are ideal and may be yours for moderate cost. Send off the coupon to-day for a free Brochure giving full details. There is no obligation whatsoever.

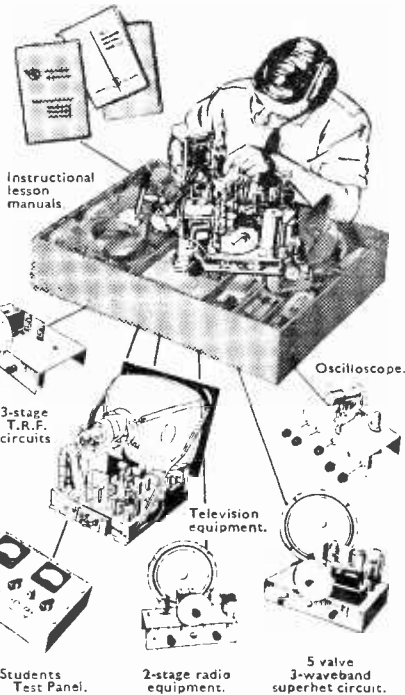

Courses with Equipment

RADIO · SHORT WAVE RADIO

TELEVISION · MECHANICS

CHEMISTRY · PHOTOGRAPHY

ELECTRICITY · CARPENTRY

ELECTRICAL WIRING · 'HI-FI'

· DRAUGHTSMANSHIP · ART etc.

E.M.I. Factories at Hayes England.



EMI INSTITUTES

Fill in for **FREE BROCHURE**
 E.M.I. INSTITUTES, Dept. 138X, London, W.4.

Name Age
 (if under 21)

Address

I am interested in the following subject(s) with/without equipment

(We shall not worry you with personal visits)

1C107

FREE

BLOCK CAPS PLEASE

OCT./58

The only Home Study College run by a World-wide industrial organisation.

**SUPER
EMISSION**

VALVES

**LONG
LIFE**

EXPRESS SERVICE!!!

PHONE OR WIRE THAT URGENT ORDER FOR IMMEDIATE DESPATCH C.O.D. ALL POST ORDERS ARE CLEARED SAME DAY AS RECEIVED.

ANY PARCEL UP TO £10 INSURED AGAINST DAMAGE IN TRANSIT FOR ONLY 6d. EXTRA. ORDERS OVER £10 INSURED FREE.

024	6/-	6B7	10/6	6S7GT	8/-	12K7GT	7/6	83V	12/6	DL92	7/6	EF86	17/6	KTZ41	8/-	SP61	3/6	W77	5/6	
IA3	3/-	6B8G	4/6	6SH7	8/-	12K8GT	14/-	85A2	15/-	DL94	9/-	EF89	10/-	KTZ63	10/6	SU61	10/6	W81M	6/1	
IA5	6/-	6B8GTM	5/-	6S17	8/-	12Q7GT	7/6	90AG	32/6	DL96	10/-	EF91	7/6	L63	6/-	TH30C	25/-	X61	12/6	
IC5	12/6	6BA6	7/6	6SK7GT	8/-	12SA7	8/6	150B2	15/-	DLS10	10/6	EF92	5/6	LN152	14/-	TP22	15/-	X63	10/6	
ID6	10/6	6BE6	7/6	6SL7GT	8/-	12SC7	8/6	220P	10/6	DM70	8/6	EL32	5/6	LP2	9/6	U16	12/-	X65	12/6	
IHSGT	11/-	6BJ6	7/6	6SN7GT	7/6	12SG7	8/6	807	7/6	E180F	20/-	EL35	19/6	LZ319	9/-	U18/20	10/-	X66	12/6	
IL4	6/6	6BR7	11/6	6S57	8/-	12SH7	8/6	956	3/6	EA50	2/-	EL41	11/-	MH4	7/-	U22	8/-	XD(1.5)	6/6	
ILD5	5/-	6BW6	9/6	6U4GT	14/-	12S17	8/6	1203	7/-	EA70	9/6	EL42	11/6	MHL4	7/6	U26	14/-	XD(2.0)	10/6	
ILN5	5/-	6BW7	8/-	6U5G	7/6	12SK7	8/6	4033L	12/6	EABC80	9/-	EL81	5/6	MHLD6	12/6	U31	10/-	XE2	£5	
INSGT	11/-	6BX6	8/-	6U7G	8/6	12SQ7	8/6	5763	12/6	EAC91	7/6	EL84	10/6	ML4	12/6	U43	10/6	XE3	£5	
IR5	8/-	6C4	7/-	6V6G	7/-	12SR7	8/6	7193	5/6	EAF42	10/6	EL91	5/6	ML6	6/6	U45	10/6	XFG1	18/-	
IS5	8/-	6C5	6/6	6V6GTG	8/-	12Y4	10/6	7475	7/6	EB34	2/6	EM34	10/-	MU14	10/-	U50	8/-	XFR1	£21/-	
IT4	6/6	6C6	6/6	6X4	7/-	14R7	10/6	9002	5/6	EB41	8/6	EM80	10/6	OA10	12/6	U52	8/6	XFR2	£21/-	
IU5	10/-	6C8	12/6	6X5GT	6/6	14S7	17/-	9003	5/6	EB91	6/6	EM81	10/6	OA70	5/-	U76	7/6	XFR3	£21/-	
2A7	10/6	6C9	12/6	6Z4/84	12/6	19AQ5	11/-	9006	6/6	EBC33	7/6	EN31	34/9	OA71	5/-	U78	7/6	XFR5	27/6	
2C26	4/-	6C10	12/6	6Z5	12/6	19D1	10/-	AC6PEN	7/6	EB41	10/-	EY51	10/6	OC72	30/-	U251	15/-	XFW10	17/6	
2D13C	7/6	6CH6	12/6	6/30L2	10/-	20D1	16/-	AC/HL/	10/6	EBF80	10/-	(Small)	10/6	P61	3/6	U404	10/6	XFW40	17/6	
2X2	4/6	6D6	6/6	7A7	12/6	25L6GT	10/-	DDD	15/-	EBF89	9/6	EY51	10/6	P215	10/6	UABC80	10/6	XFW50	17/6	
3A4	7/-	6E5	12/6	7B7	8/6	25Y5	10/6	AC/P4	8/-	EC52	5/6	(Large)	12/6	PABC80	15/-	UAF42	10/6	XY12	6/6	
3A5	12/6	6F6G	7/-	7C5	8/-	25Y5G	10/6	AC/VP1	15/-	EC54	6/-	EY86	14/6	PCC84	9/-	UB41	12/7	XY15	24/6	
3B7	12/6	6F6GTM	8/-	7C6	8/-	25Z5	10/6	AL60	10/6	EC70	12/6	EZ35	6/6	PCC85	12/6	UBC41	8/6	XY34	17/6	
3D6	5/-	6F8	12/6	7H7	9/-	25Z4G	10/-	AP4	7/6	ECC31	15/-	EZ40	8/-	PCF80	9/-	UBC41	8/6	XY35	17/6	
3Q4	7/6	6F12	7/6	7Q7	9/-	25Z6G	10/-	ATP4	5/6	ECC32	10/6	EZ41	10/6	PCF82	12/6	UBF80	9/6	XY41	17/6	
3Q5GT	9/6	6F13	12/6	7S7	10/6	27	7/6	AZ31	10/6	ECC33	8/6	EZ80	9/6	PCL82	12/6	UBF89	10/6	XY43	17/6	
354	7/6	6F17	12/6	7V7	8/6	28D7	7/6	BL63	7/6	ECC35	8/6	EZ81	9/-	PCL83	11/6	UC85	10/6	XY51	17/6	
3V4	9/-	6F32	10/6	7Y4	8/-	30	7/6	CK506	6/6	ECC81	8/-	FV4/800	10/-	PEN40DD	11/6	UCH42	11/6	XY53	17/6	
5U4G	8/6	6F33	7/6	8D2	3/6	30C1	9/-	CK523	6/6	ECC82	7/6	GZ30	10/6	PEN45	19/6	UC82	15/6	XY54	17/6	
5V4G	11/6	6G6	6/6	8D3	4/-	30FL1	10/-	CV63	10/6	ECC83	9/-	GZ32	12/6	PEN46	7/6	UCL1	9/-	XH(1.5)	10/6	
5X4G	12/6	6H6GTG	3/-	9D2	4/-	30L1	9/-	CV85	12/6	ECC84	10/6	GZ34	14/-	PL81	16/-	UF80	10/6	XH2.0	10/6	
5Y3G	8/-	6H6GTG	3/6	10C1	15/-	30L1	9/-	CV271	10/6	ECC85	9/6	H30	5/6	PL82	10/-	UF85	10/6	XLI.5	10/6	
5Y3GT	8/6	6J5G	5/-	10F1	19/6	30P12	12/6	CV428	30/-	ECC91	5/6	H63	12/6	PL83	11/6	UF89	10/6	XL2.0	10/6	
5Y4	12/6	6J5GTG	5/6	10F9	11/6	30P16	10/-	D1	3/-	ECF80	13/6	H63	12/6	PL82	12/6	UL41	10/6	XLO1.0	10/6	
5Z3	12/6	6J5GTG	5/6	10F18	12/6	30P1L	12/6	D42	5/6	ECF82	13/6	HABC80	10/6	PM12	6/6	UL46	15/-	XLO2.0	10/6	
5Z4G	10/6	6J6	5/6	10LD3	8/6	31	7/6	D63	5/6	ECH35	9/6	HK90	10/6	PM12M	6/6	UL84	11/6	XPI.5	12/6	
5Z4GT	12/6	6J7G	6/-	10LD11	16/9	33A/158M	D77	6/6	ECH42	9/6	ECH81	9/-	HL23	10/6	PM12M	6/6	UL84	11/6	XPI.5	12/6
6A8	10/-	6J7GT	10/6	10P13	17/6	30/-	DAC32	11/-	ECH81	9/-	ECL80	14/-	HL41	12/6	PM12M	6/6	UL84	11/6	XPI.5	12/6
6AB7	8/-	6K6GT	8/-	11E3	15/-	35/51	12/6	DAF91	8/-	ECL80	14/-	HL41	12/6	PM12M	6/6	UL84	11/6	XPI.5	12/6	
6AB8	14/-	6K7G	5/-	12A6	6/6	35A5	11/-	DAF96	10/-	ECL82	12/6	HL133DD	12/6	PM12M	6/6	UL84	11/6	XPI.5	12/6	
6AC7	6/6	6K7GT	6/-	12AH7	8/-	35L6GT	9/6	DF33	11/-	EF36	6/-	HVR2	20/-	QP21	7/-	VMP4G	15/-	XV52.0	15/6	
6AG5	6/6	6K8G	8/-	12AH8	10/6	35W4	8/6	DF91	6/6	EF37A	8/-	HVR2	20/-	QP25	15/-	VP2(7)	12/6	XW1.5	15/6	
6AJ8	9/-	6K8GTG	8/-	12AT6	10/6	35Z3	10/6	DF96	10/6	EF39	6/-	HVR2	20/-	QP25	15/-	VP2(7)	12/6	XW1.5	15/6	
6AK5	8/-	11/-	12A7T	8/-	35Z4	7/6	DH63	10/6	EF40	15/-	KF35	8/6	QS150/15	15/-	VP4(7)	15/-	XW2.0	15/6		
6AK8	9/-	6L6G	9/6	12AU7	7/6	35Z5GT	9/-	DH76	7/6	EF41	9/6	KL35	8/6	VP13C	7/-	VP41	6/6	Y63	7/6	
6AL5	6/6	6L18	13/-	12AX7	9/-	41MTL	8/-	DH77	8/6	EF42	12/6	KT2	5/-	QV04/7	15/-	VP41	6/6	Y65	10/6	
6AM5	5/-	6N7	8/-	12BA6	6/6	50C5	12/6	DK91	8/-	EF50(A)	7/-	KT33C	10/6	R2	10/6	VR105/30	9/-	Z63	10/6	
6AM6	7/6	6Q7G	10/-	12BE6	10/6	50L6GT	9/6	DK92	10/6	EF50(E)	5/-	KT44	15/-	R12	12/6	VR150/30	9/-	Z66	20/-	
6AQ5	8/6	6Q7GT	11/-	12E1	30/-	72	4/6	DK96	10/6	EF54	5/-	KT63	7/-	SD6	12/7	VR150/30	9/-	Z77	7/6	
6AT6	8/6	6R7G	10/-	12HM6	3/-	77	8/-	DL2	15/-	EF73	10/6	KTW61	8/-	SP4(7)	15/-	VT61A	5/-	Z77	7/6	
6AU6	10/6	6SA7GT	8/6	12J5GT	4/6	78	8/6	DL33	9/6	EF80	8/-	KTW62	8/-	SP41	3/6	VT501	5/-	Z719	8/-	
6B4G	6/6	6SC7	10/6	12J7GT	10/6	80	9/-	DL66	15/-	EF85	7/6	KTW63	8/-	SP42	12/6	W76	7/6	Z729	17/6	

NEW METAL RECTIFIERS, FULLY GUARANTEED

DRM1B	15/4	RM-2	7/6	W6	3/6	14A97	25/-	14B261	11/6	16RD 2-2-8-1	12/-
DRM2B	16/2	RM-3	9/6	WX3	3/6	14A100	27/-	14RA 1-2-8-2	19/-	16RE 2-1-8-1	8/6
DRM3B	23/3	RM-4	20/-	WX4	3/6	14A124	28/-	14RA 1-2-8-3	23/6	18RA 1-1-8-1	4/6
RM-O	7/11	RM-5	24/-	WX6	3/6	14A163	38/-	14RA 2-1-16-1	21/-	18RA 1-1-16-1	6/6
RM-I	7/-	W4	3/6	14A86	18/-	14B130	35/-	16RC 1-1-16-1	8/6	18RA 1-2-8-1	11/-
										18RD 2-2-8-1	15/-

Hivac miniature valve list or Metal rectifier technical leaflet free on receipt of S.A.E.

TERMS OF BUSINESS:—CASH WITH ORDER OR C.O.D. ONLY. POST/PACKING CHARGES 6d. PER ITEM : ORDERS VALUE £3 OR MORE POST FREE. C.O.D. 2/6 EXTRA. WE ARE OPEN FOR PERSONAL SHOPPERS MON.-FRI. 8.30-5.30. SATS. 8.30-1 P.M.

ALL VALVES, NEW, BOXED AND SUBJECT TO MAKERS' FULL PERIOD GUARANTEE. FIRST GRADE GOODS ONLY, NO SECONDS OR REJECTS. LATEST CATALOGUE OF OVER 1,000 DIFFERENT VALVES, INCLUDING MANY SCARCE TYPES, WITH FULL TERMS OF BUSINESS, PRICE 3d., PLUS 2d. POST.

PLEASE ENQUIRE FOR ANY VALVE NOT LISTED. 3d. STAMP, PLEASE.

BENTLEY ACOUSTIC CORPORATION LTD.

THE VALVE SPECIALISTS

38 CHALCOT ROAD, LONDON, N.W.1

Nearest Underground Station, Chalk Farm.

PRImrose 9Q90.

REBUILT TUBES MULLARD AND MAZDA

GUARANTEED SIX MONTHS

7 days delivery time as from receiving order.

12in.	£8	0	0
14in.	£19	0	0
17in.	£12	0	0
21in.	£14	0	0

Plus 12/6 P.P. & ins.

AS A RESULT OF PURCHASE TAX REGULATIONS WE CAN ONLY REBUILD YOUR CWN TUBE. THESE SHOULD BE SENT Via BRITISH ROAD SERVICES (PARCELS) LTD.

We have a number of good reclaimed Tubes at **£5.00** incl. 12in. All sizes. Guaranteed 3 months. P.P. & ins. 12/6.

Brayhead Converters **£6.10.0** inc.

Call, write or phone.

ST. MARY'S ELECTRONICS

18, PRAED STREET, LONDON, W.2.
(Ambassador 9795)

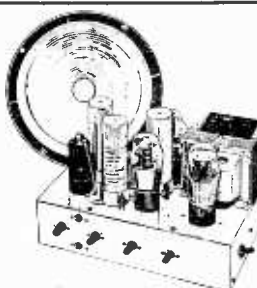

COMPLETELY BUILT 8 WATT AMPLIFIER.
A.C. Mains 110/250 v. Size 10 1/2 in. x 6 1/2 in. x 2 1/2 in. Incorporating 6 valves, H.F. pen., 2 triodes, 2 output pens., and rectifier. For use with all makes and types of pick-up and mike. Negative feedback. Two inputs, mike and gram, and controls for same. Separate controls for Bass and Treble lift. For use with Std. or L.P. records, musical instruments such as Guitars, etc. Complete with 8 in. speaker and ready for use. **£4.9.6**
Plus P. & P. 5/-

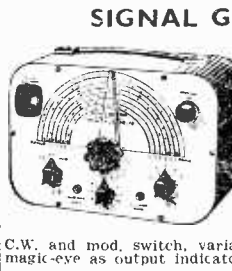

SIGNAL GENERATORS
£6.19.6 or 25/- deposit and 6 monthly payments of 21/6. P. & P. 5/- extra. Coverage 100 Kc/s-100 Mc/s on fundamentals and 100 Mc/s to 200 Mc/s on harmonics. Metal case 10 1/2 in. x 6 1/2 in. x 5 1/2 in., grey hammer finish. Incorporating three miniature valves and Metal Rectifier. A.C. Mains 200/250. Internal Modulation of 400 c.p.s. to a depth of 30%; modulated or unmodulated R.F. output continuously variable. 100 milli-volts. C.W. and mod. switch, variable A.F. output. Incorporating magic-eye as output indicator. Accuracy plus or minus 2%.

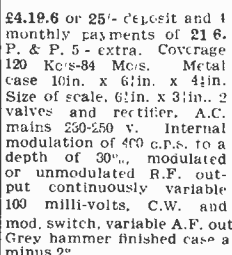

£4.19.6 or 25/- deposit and 4 monthly payments of 21/6. P. & P. 5/- extra. Coverage 120 Kc/s-84 Mc/s. Metal case 10 1/2 in. x 6 1/2 in. x 4 1/2 in. Size of scale, 6 1/2 in. x 3 1/2 in. 2 valves and rectifier. A.C. mains 250-250 v. Internal modulation of 400 c.p.s. to a depth of 30%, modulated or unmodulated R.F. output continuously variable 100 milli-volts, C.W. and mod. switch, variable A.F. output and moving coil output meter. Grey hammer finished case and white panel. Accuracy plus or minus 2%.

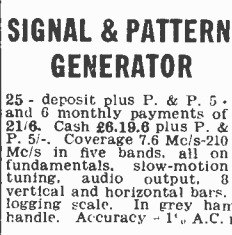

SIGNAL & PATTERN GENERATOR
25/- deposit plus P. & P. 5/- and 6 monthly payments of 21/6. Cash **£6.19.6** plus P. & P. 5/-. Coverage 7.6 Mc/s-210 Mc/s in five bands, all on fundamentals, slow-motion tuning, audio output, 8 vertical and horizontal bars, logging scale. In grey hammer finished case with carrying handle. Accuracy - 1%, A.C. mains 200-250 v.

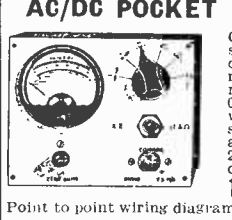

AC/DC POCKET MULTI-METER KIT
Comprising 2 in. moving coil meter scale calibrated in AC/DC volts, ohms and milli-amps. Voltage range AC/DC 0-50, 0-100, 0-250, 0-500, milli-amps 0-10, 0-100. Ohms range 0-10,000. Front panel, range switch, wire-wound pot (for ohms zero setting), toggle switch, resistors and rectifier. Basic movement 2 mA. In grey hammer finished case. **19/6** Plus P. & P. 1/6. Built and tested 7/6 extra.
Point to point wiring diagram 1/-, free with kit.

13 CHANNEL TUNER
I.F. 11-13 Mc/s. Complete with PCF80 & PCF84. These have been removed from chassis. **19/6** Plus P. & P. 2/6.

RADIO & T.V. COMPONENTS (Acton) LTD.
23, HIGH STREET, ACTON, LONDON, W.3
All enquiries S.A.E. GOODS NOT DESPATCHED OUTSIDE U.K.

SUPER-VISION LIMITED

EVERY ITEM BRAND NEW AND GUARANTEED AT LOW PRICES

- Enamelled Copper Wire**
12 to 45 SWG from 11/6 lb. Also available in smaller quantities.
- Valve Holders**
Int. Octal, 4d. each. BTG, 4d. each. E9A, 6d. each. CER, B9A with screen, 1/9 each.
- Condensers**
2 to 100 pF., 5d. each. 220-5,000 pF., 7d. each. .01 to .1, 8d. each.
- Coil Formers and Screens**
3/4 x 3/4 x 1 1/2, 3 dia. with iron dust core, 2/- each.
3/4 x 3/4 x 2 1/2, 3 dia. with two iron dust cores, 3/- each.
- Resistances**
Carbon.
10 to 5 M., 1/2 W., 3d. each. 1/2 W., 4d. each. 1 W., 6d. each.
2 W., 1/- each.
Wire Wound.
2,200 5 M., 1 W., 1/3 each. 5, 10 and 20 ohms, 10 W., 1/6 each.
5, 10, 50 and 100 ohms, 20 W., 3/- each.
- Variable T/V type pots**
3 K., 5 K., 25 K. and 1 M., 2/6 each.
- Egen Slider type**
3 K., 5 K. and 25 K., 1/9 each.
- Volume Controls**
5 M., 2/9 each. 5 M. with DPS Switch, 4/3 each.
- Electrolytics**
60/100 mfd., 5/6 each. 32-1/2 32-1/2 16 mfd. 350 v., 3/6 each.
40+40 mfd., 450 v., 3/6 each. Clips 3d. each. 50 mfd. 12 v. 8d. each.
- Auto. Transformers**
50 W. to 1,000 W. from **£1.10.0** to **£9.0.0**.
Send for list, price 3d.

SUPER-VISION LIMITED

136 HIGH ST. TOTTENHAM, MIDD. KIN: g:ton 4393.

Wireless Set 19-30/-

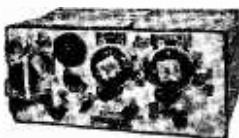

Transmitter receiver contains £20-£30 worth of spare parts. Complete and in good condition less valves and meter. Price 30/- plus 5/-.

Small Clock Movement

7-day mechanism beautifully made and fully jewelled, few only sale price 12/6 plus 1/6 each.



Simplex Transistor Kit



Makes ideal bedroom radio. Uses one transistor and one crystal diode. Complete less case 19/6, case 5/- extra, post 1/6.

Mains Isolation Transformer



Makes servicing safe. Input tapped 200-250 v., output tapped 200-250 v. Rated at 500 watts, intermittent rating 2,000 watts. Screens for suppressing mains interference. Size 14in. x 6in. x 6in., weight 40lbs. Price £5.12.6. Carriage 7/6 (up to 250 miles).

Car Starter Charger Kit

All parts to build 6- and 12-volt charger which can be connected to a "flat" battery and will enable the car to be started instantly.

- Mains transformer ... 22/6
- 5-amp. rectifier ... 17/6
- Regulator Stud Switch ... 3/6
- Resistance Wire ... 2/-
- Resistance Former ... 2/6
- Mains on/off Switch ... 2/6
- 0.5 amp. Moving Coil Meter ... 12/6
- Construction Data ... 1/6
- Or if bought all together price ... 52/6
- Is
- plus 3/6 post and packing.

Variable Rheostat



Heavy duty slider resistor rated at 25 amps. Basic resistance is 4 ohms. Can be rewired to suit individual requirements. Ideal for dimmer circuit, etc. Price 8/3, post 3/6.

Suppressor Condenser



Stop your drill or other appliances interfering with your or your neighbours' radio or television. Simple instructions given 1/6 each, 12/- dozen.

Latest AVO Testmeter



Can be yours for only 10/- deposit and 19 payments of 10/- weekly. Like all AVO meters it is a very fine instrument. It has a sensitivity of 10,000 ohms per volt and 19 most useful ranges, a s D.C. volts

0-1,000 (seven ranges), A.C. volts 0-1,000 (five ranges), D.C. current 0-1 amp. (5 ranges), resistance 0-2 meg. (2 ranges) (complete with test leads). Immediate delivery. Cash price £9.10.0. **FREE GIFT**—All purchasers will receive Range Extender scale and data which add; capacity 0-1 mfd. in two ranges. Inductance 0-100 henrys, etc. etc.

THERMOSTATS

2 1/2in. x 1in. x 1 1/2in. high. Useful for the control of appliances such as convector, gluepots, vulcanisers, hot plates, etc. Adjustable to operate over temperature range 50-550 deg. F., fitted with heavy silver contacts. 8/6. Other types: 1 1/2 amp. 3/6; 5 amp., 8/6; 2 amp. QMB, 5/6; 15 amp. QMB, 15/-; 15 amp., encased wall mounting type, 29/6.



Introducing . . . THE INDUCTOR 80

80 w. flt. fluorescent fitting with a 5 year guarantee—uses the latest type of impregnated induction (choke) control gear—absolutely quiet in operation—all steel built-in construction stove enamelled white—suitable for direct mounting or for suspending. Undoubtedly the most modern fitting available will last a lifetime and will save its cost in lamps and electricity in about 12 months. Two models available—Type A, fixed voltage suitable for 200-240 v., price 39/6. Type B, Variable voltage suitable for 200-250 v., price 45/-, carriage and insurance up to 150 miles 5/6; up to 250 miles 7/6. Tubes, latest type which give more light for same electricity, daylight or natural to your choice, 14/6 each—no extra carriage if ordered with fittings.

£10 FOR AN IDEA

With the equipment described below you can see but cannot be seen in the dark. It has many obvious uses, driving in the fog, bird and animal watching, rat catching, watching for intruders, etc., but we believe it has many novel uses and we invite readers suggestions, in fact for the best novel use suggested we will give a prize of £10. If you have an idea, send it in. Closing date October 31st.

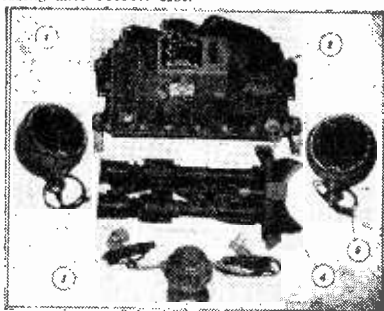

As fitted to Army vehicles for night driving, etc. Comprises: 2 Infra Red Radiators, adjustable binoculars, power pack for 6 or 12 volts, control units and inter-connection cables. Original cost probably around £100. Unused and in perfect order—£10, carriage and insurance 10/-, or 10/- deposit and 21 weekly payments of 10/-.

SUPER SENSITIVE (2,000 O.P.V.) MULTIMETER KIT

17 ranges including D.C. volts to 1,000 v., A.C. volts to 1,000 v., D.C. milliamperes to 500, ohms to 2 meg., capacity and inductance. All the essential parts, including metal case, selected resistors, wire for shunts, selected switches, calibrated scale and instructions. 32/8, plus 2/6 post and ins.

Process Timer for 15/-

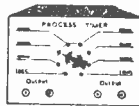

Make a time delay switch to work off mains (A.C. or D.C.), all the parts (less case), Price 15/-, post and ins. 2/6.

Instantus Heater

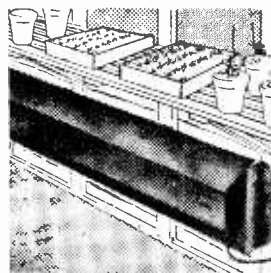

Convactor heater. Made from heavy gauge sheet steel (galvanised). For greenhouse, workshop, aviary, etc. 500 watt, £11.2.6; 1,000 watt, £210.0. 1,000 watt with wired but separate thermostat, £31.7.6. 2K watt free standing or wall mounting, £3.19.6; 2K watt with built-in thermostat, £4.19.6. Carriage and insurance 5/- per heater. ALL ARE GUARANTEED FOR 5 YEARS.

Making a Solder Gun



A 7-second solder gun of the type costing £3-£4 was described in "Practical Mechanics". Only two essential parts are required—(a) the transformer and (b) the push switch. These we can supply at 13/6, plus 2/- post. The rest of the parts you will have in your own "junk" box. Copy of the article concerned given free with the kit.

STOP PRESS

Long, Medium and Short Wave Coil Pack

An exceptionally well made coil pack which covers the standard long, medium and short wave bands for 465 Kc. I.F. complete with diagram of connections, 14/6 plus 1/- postage and insurance—limited quantity only.

50 More T.V. Service Sheets.

—Readers already possessing our service sheets numbers 1-160 will be glad to know that 101-150 are now ready, price 10/- post free.

Install 2-way Switches.

Our outfit comprises: 30 yd. multicore cable, two 2-way switches, two wood blocks. Full instructions, 9/6 each, post and insurance 2/6.

THE TRANSISTOR 8.

A superb little portable receiver which is also loud enough and sensitive enough to be a car radio. All parts, prepared chassis, 6 selected transistors, 7in. x 4in. elliptical speaker and handsome carrying case—supplied for £11.10.0 or 10/- deposit and 24 weekly payments of 10/-.

Band III Converter

Suitable Wales, London, Midlands, North, Scotland, etc. All the parts including 2 EF89 valves, coils fine tuner, contrast control, condensers, and resistors. (Metal case available as an extra.) Price only 19/6, plus 2/6 post and insurance. Data free with parts or available separately, 1/6.



Please send two more kits, the one you sent last week is performing magnificently.

We receive this sort of letter every day of the week, so if you have hesitated because you thought our kits too cheap you need hesitate no longer.

All-Mains Amplifier

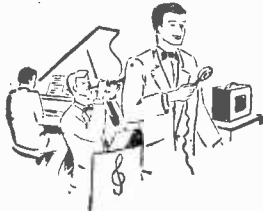

Powerful three-valve mains amplifier ideal for dances, parties, etc. Complete less chassis, cabinet and speaker (available if required)—data 1/6 (free with parts). Price 19/6, plus 2/6 post and insurance.

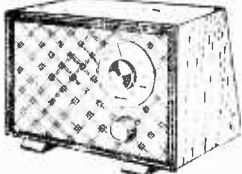

The Skysearcher

This is a 2-valve plus-metal receiver set useful as an educational set for beginners, also makes a fine second set for the bedroom, workshop, etc. All parts, less cabinet, chassis and speaker, 19/6. Post and ins., 2/6. Data free with parts or available separately, 1/6. 3-valve battery version also available at the same price.

A.C./D.C. Multimeter Kit

Measures: D.C. volts 0-50, 0-100, 0-500, 0-1,000, A.C. volts 0-50, 0-100, 0-500, 0-1,000, D.C. milliamps 0-50, 0-100, 0-50,000 with internal batteries, 0-500,000 with external batteries. Measures A.C. D.C. volts, D.C. current and ohms. All the essential parts including metal case, 2in. moving coil meter, selected resistors, wire for shunts, range selector, switches, calibrated scale and full instructions, price 19/6, plus 2/6 post and insurance.

85 More T.V. Service Sheets Readers already possessing our service sheets numbers 1-100 will be glad to know that 101-150 are now ready, price 10/-, post free.

Build this 17in. T.V. in an evening

Undoubtedly the most up-to-date television for the home constructor. You can build it in an evening and the set when finished will be equal to a factory made equivalent.

- All miniature valves, and metal rectifier.
- 12-channel turret tuner.
- Multivibrator time bases.
- Ferroxcube E.H.T. and scan coils.

The building cost (less tube) is only £29.10.0, plus 10/- carriage and insurance. Or £5 down and 28 weekly payments of £1. All parts guaranteed twelve months.

Full information and data free with parts or available separately, price 3/6.

Now 2 Models Turret Tuner

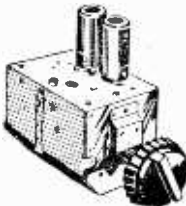

Brand new stock, not surplus, with coils for Band I and III complete with valves. Model I I.F. output 33/33 Mc/s. Series heaters Model 2 I.F. output 16/19 Mc/s. Parallel heaters. With instructions and circuit diagram, 79/6. With knobs 3/6 extra, post and insurance 2/6.

Medresco Hearing Aid

As supplied by National Health, completely overhauled and in good working order with six months' guarantee. Only £2.15.0 plus 2/6 post and ins. Complete with earphone and new ear plug but not batteries, these can be supplied as an extra for 5/- per set.

Instructions showing how to convert to pocket radio available free if requested.



Short Wave Communications Receiver R.208. Only £6.19.6. 10/- Deposit

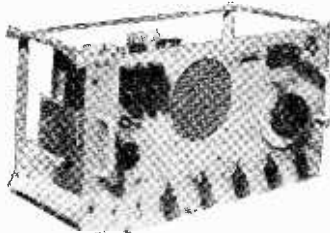

This is a super short-wave receiver covering 5-30 metres (10-60 Mc/s). Uses 6 valves. Has R.F. stage, 2 I.F. stages, B.F.O., etc. Multirad instrument drive, two internal power packs, mains and battery vibrator pack. Complete with own P.M. speaker. Provision for phones and speaker muting. Complete in metal transit case: size approx. 24 x 18 x 12in.; weight 70lb. Suitable A.C. mains 100-250 and 6 volt battery. In perfect condition, practically unused. Tested before despatch and guaranteed. Handbook free with each. Price £6.19.6, carriage and insurance 15/-. Or 10/- deposit, plus 15/- carriage and ins., then 15 weekly payments of 10/- each.

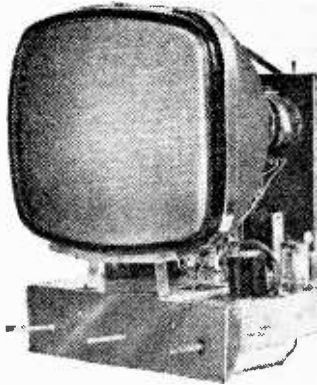

This Month's Snip Somweave



This really lovely loud-speaker fabric we offer at half price, namely 7/6 per yd., 48" wide. This is also very suitable for covering plain wooden cases for portables.

Yaxley Switches

3-pole, 2-way	1/3
12-pole, 2-way	1/6
3-pole, 3-way	1/6
3-pole, 3-way	2/-
2-pole, 4-way	2/6
6-pole, 4-way	2/6
4-pole, 5-way	2/6
2-pole, 6-way	2/6
1-pole, 7-way	2/6
1-pole, 12-way	2/6
6-position shorting switch	2/-

Double-pole mains switch for attaching to Yaxley switches... 1/6 Discount of 10% allowed where a dozen of one type ordered. Special quotes 144 or over.

Ganged Pots for Stereo, etc.

Made by Morganite, these are a first class control, unfortunately only linear type, are available, in the following values: 5K+5K, 50K+50K, 100K+100K, 1 Meg., 1 Meg., 2 Meg., 2 Meg. All in original cartons price 3/- each, special quotes for quantities.



STOP PRESS!

8 Watt Stereo Amplifier.—Complete with valves, ready to work, £8 plus 7/6 carriage & insurance.

ELECTRONIC PRECISION EQUIPMENT, LTD

Post orders are dealt with from Eastbourne, so for prompt attention please post your orders to 66, Grove Road, Eastbourne, marked Department 5.

- | | | | |
|--|---|---|---|
| 42-46, Windmill Hill, Rushlip, Middx. Phone: RUISLIP 5790 Half day, Wednesday. | 66, Grove Road, Eastbourne, Sussex. Half day, Saturday. | 29, Stroud Green Rd., Finsbury Park, N.4. Phone: ARCHWAY 1049 Half day, Thursday. | 266, London Road, Croydon. Phone: CRO 6558 Half day, Wednesday. |
|--|---|---|---|

BRIMAR 6T8

The Brimar 6T8 is a triple-diode triode in which one diode has a separate cathode. The triode section has a high amplification factor making the valve suitable for use in AM/FM receivers in the demodulation and first stage audio circuits. The diodes may be used in series shunt limiter circuits, for example, in the audio sections of television and communications receivers, followed again by the triode section for A.F. amplification.



Near Equivalents
EABC80 DH719
6AK6

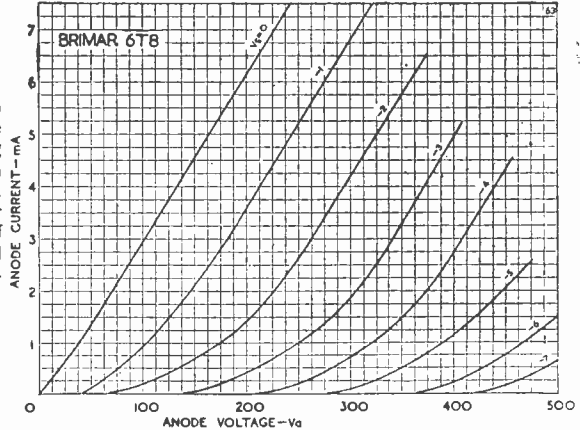

Typical Triode Operating Characteristics as an R.C. coupled amplifier.

Anode Supply Voltage	250	250 volts
Anode Load Resistor	0.25	0.25 megohm
Grid Resistor	1.0	10 megohms
Cathode Bias Resistor	3	0 kilohms
Peak Output Voltage	43	40 volts
Stage Gain (for 24 V peak to peak output)	42	42
Distortion (for 24 V peak to peak output)	1	5%

Keep this for further reference or write to the Publicity Department for a data sheet.

Standard Telephones and Cables Limited FOOTSCRAY S'DCUP KENT Footscray 3333

How's this!

YOUR VERY OWN TEST SET NOW

It's as simple as this. You just send 47 6 deposit to have one of the newly stylised M.I.P. Multi-Range Series 100 Test Sets posted to you almost by return of post. Balance is payable over 6 months at £1.16.0 per month. Cash price is £12.7.6. Post coupon now for full details.

There is also the **SERIES 90 MULTI-RANGE TEST SET**, having 19 SELF-CONTAINED ranges a.c./d.c. volts up to 1,000 V., d.c. current up to 500 mA., a/c current up to 200mA., resistance 0-200,000 Ω.

Deposit 35/- and six monthly payments of 28/10. (Cash price £9.15.0.)

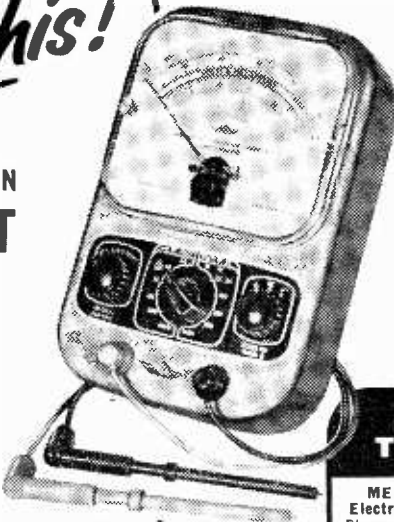

21 RANGES

covering

- 10-1,000 d.c. volts
- 10-1,000 a.c. volts
- 100 Microamps to 500 Milliamps d.c.
- 100 Microamps a.c.
- 0 to 1 Megohm
- 0 to 10,000 ohms



MULTI-RANGE TEST SET - SERIES 100

MEASURING INSTRUMENTS (PULLIN) LTD.
Electrin Works, Winchester St., Acton, London, W.3.
Please send illustrated leaflet of the Series 100 Test Set with details of new easy payments scheme

.....
Ditto Series 90

*Please indicate instrument required.

NAME

ADDRESS

D 10 39



Practical Television



& TELEVISION TIMES

Editor : F. J. CAMM

Vol. 9 No. 99

EVERY MONTH

OCTOBER, 1958

TELEVIEWS

Editorial and Advertisement Offices :
PRACTICAL TELEVISION
George Newnes, Ltd., Tower House,
Southampton Street, Strand, W.C.2

© George Newnes Ltd., 1958.

Phone : Temple Bar 4363.
Telegrams : Newnes, Rand, London.
Registered at the G.P.O. for trans-
mission by Canadian Magazine Post.

SUBSCRIPTION RATES

including postage for one year

Inland - - - 19s. per annum
Abroad - - 17s. 6d. per annum
Canada - - - 16s. per annum

CONTENTS :

	Page
Televiws	115
Band III Double Array	
Aerial	116
More About Shared Aerials	118
An Improved Video Amplifier	120
Servicing Television Receivers	123
Television Troubles	125
Telenevs	128
Analysing and Servicing TV Receivers	130
Home Constructed Television Receiver	136
TV at the National Radio Show	140
Underneath the Dipole	147
Correspondence	151
Your Problems Solved	155

The Editor will be pleased to consider articles of a practical nature suitable for publication in "Practical Television." Such articles should be written on one side of the paper only, and should contain the name and address of the sender. Whilst the Editor does not hold himself responsible for manuscripts, every effort will be made to return them if a stamped and addressed envelope is enclosed. All correspondence intended for the Editor should be addressed to: The Editor, "Practical Television," George Newnes, Ltd., Tower House, Southampton Street, Strand, W.C.2.

Owing to the rapid progress in the design of radio and television apparatus and to our efforts to keep our readers in touch with the latest developments, we give no warranty that apparatus described in our columns is not the subject of letters patent.

Copyright in all drawings, photographs and articles published in "Practical Television" is specifically reserved throughout the countries signatory to the Berne Convention and the U.S.A. Reproductions or imitations of any of these are therefore expressly forbidden.

THE RADIO SHOW

AS far as television is concerned, there were no surprises, and beyond minor improvements and reduction in size and prices, 1959 receivers are as they were. One firm showed a push-button receiver covering all 13 channels with instantaneous channel choice. On another receiver, the push button controls definition. The wide-angled tubes have enabled designers to make their receivers shallower, without the unsightly protrusion at the back of the set. Self-contained portables were also shown by two makers. Although 21in. and 24in. receivers were available, the 17in. tube models still remain the most popular. Most of the TV receivers made use of printed circuits in some part of the circuit and transistors, of course, were much in evidence. One manufacturer showed red and green lighting on the switch to distinguish between BBC and ITV channels. There was also shown a unit-constructed TV.

Stereophonic sound really stole the show and it is a marked improvement on the older system, a special Audio Hall being set aside for demonstration, particularly of stereophonic gramophone records. Of 160 exhibitors, at this 25th Silver Jubilee Exhibition only 36 manufacture radio and TV receivers. Many receivers were equipped for reception of V.H.F./F.M. sound broadcasting. Some receivers were fitted with the new electrostatic focus tube with a deflection angle of 110 deg., but most tubes had the 90 deg. deflection angle. Several manufacturers listed legs for fitting to table models as an optional extra. A number of exhibitors showed loft aerials of an improved form. They can easily be fixed and permit tilting, rolling, and turning for anti-ghosting. It was noteworthy that colour television demonstrations dropped out of the show.

"A BEGINNER'S GUIDE TO TELEVISION"

THERE has been a huge demand for "A Beginner's Guide to Television" (7s. 6d.) or 8s. 3d. by post, and as with the companion volume, "Beginner's Guide to Radio," the edition will soon be exhausted. It is necessary therefore to order now to secure a copy.

TV SPREADS OVER THE WORLD

THE annual production of television receivers in Australia at present is 310,000, and receivers go from the dealers into the home as fast as they are delivered. Retailers have negligible stock. Other countries not at present equipped with TV have laid plans to develop such a service and soon there will be world-wide coverage, and further possibilities for B.B.C. programmes are augmented by Continental TV linkages.—F. J. C.

Our next issue, dated November, will be published on October 22nd

Band III Double Array Aerial

THIS ARTICLE DESCRIBES A CONNECTOR BOX

By M. S. Ford

READERS who made up the Band III aerial described in *PRACTICAL TELEVISION* for June, 1957, may like to try out a double array, by making an exactly identical aerial and positioning it a short distance away. Although theoretically this arrangement should give twice the input it gives somewhat less. However, the

their appropriate plug and/or socket to agree. The cylindrical body was made from $1\frac{1}{2}$ in. dia. brass tubing, but if obtainable aluminium tube might be used. Top and bottom covers were cut out of aluminium sheet. The set screws were of 4 B.A. brass screwed rod.

Construction

The simple method of fixing connectors snugly into the tubing is shown, slots being cut in the brass body at equal distances around the periphery 120° apart. The main sleeving of each connector is then cut at each side with a small junior hacksaw, and the connectors pushed into the slots. A certain amount of care should be exercised here, but it does not matter greatly if the saw cuts penetrate right through. Do not cut right round, of course, or you will have two rings. Just cut at each side. Assemble the three connectors to try out the arrangement and if correctly cut the connectors should point exactly toward the centre of the body. Remove the connectors and make a wire connection to each in

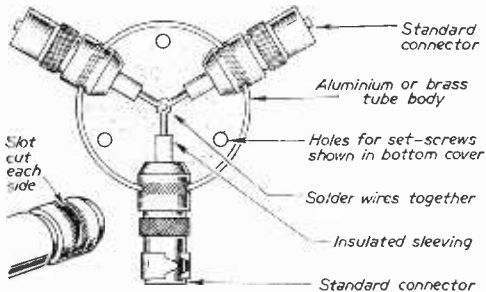

Fig. 1.—An open view of the connector.

improvement in reception is very marked and can eliminate certain ghost images and other interference.

General Description

This article describes the actual coupling made from standard connectors to couple two such aerials. In general, it is a three point coupling allowing a short lead from two aerials (Band III) to be joined to one down lead to the Band III socket of the set.

It takes the form of a cylindrical box, with two input and one output plugs or sockets, equally spaced around the periphery. The central contact wire from each is soldered together at the exact central position in the box, and are, of course, perfectly insulated from the metal. The metal of the connectors, is, of course, common to the connector box and forms the other lead via the metal braiding of the co-axial cable.

Fig. 1 shows an open view of the connector box. Figs. 2, 3, 4 and 5 show the separate parts, whilst Fig. 6 illustrates the exploded assembly, with one standard connector omitted to show the slot arrangement.

Materials

The writer used three metal type standard connectors and chose two plug types and one socket type. It is just a matter of personal choice, but whatever type is used they must have

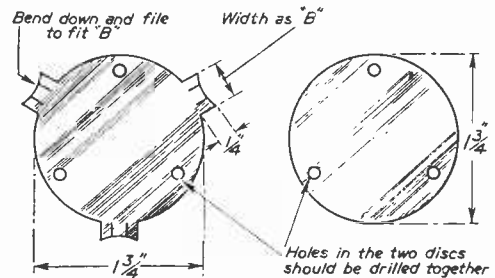
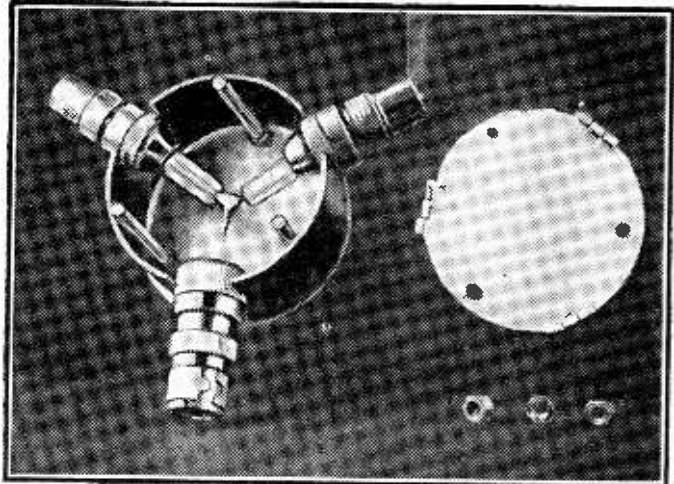
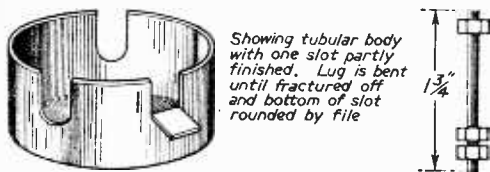

Fig. 2 and 3.—The top and bottom covers.



The completed unit and cover.



Figs. 4 and 5.—The tubular body and set screw.

the usual way, each being soldered and protruding about $\frac{1}{2}$ in. Push in each connector and slip on short lengths of plastic sleeving. Join the wires at the exact centre and solder together. Fit the top and bottom covers by the lengths of screwed rod. It will be noted that the top cover has lug pieces. These not only close the small gaps left, but also completely locks the three connectors and forms quite a rigid job. Although short, the wiring inside the box must be stranded, as contained in the Band III type co-axial cable and soldering is, of course, most important. The dimension "B" (width of slot) has been omitted as the standard connector varies just slightly in different makes. A pair of callipers would be useful to measure the sleeve diameters.

Method of Cutting Tube

Fig. 7 shows a simple method of cutting tubing to give an even cut right round. A line is scratched by a scriber against a paper strip of known machined edge.

Fig. 8 shows diagrammatically the arrangement in use. The short cable lengths from each array should be identical in length. Again the dimension marked "A" has been omitted, but one

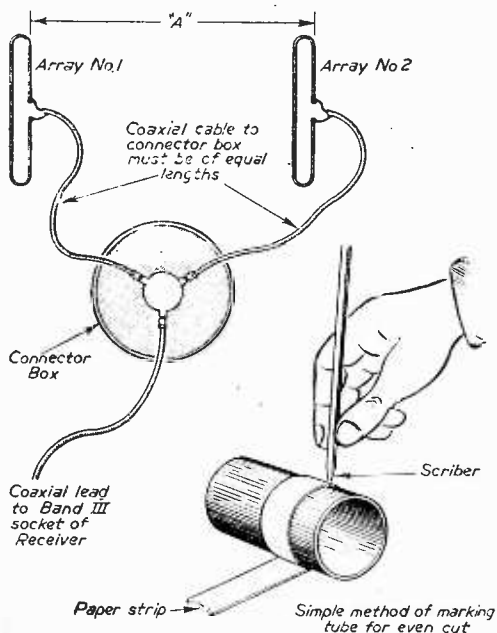

Figs. 7 and 8 — (Below) How to cut the tubing. (Above) Showing diagrammatically the arrangement in use.

wavelength, i.e., $53\frac{1}{2}$ in. for channel 9, is suggested as quite convenient in most lofts. Experiment is quite possible, of course, indoors.

The short saw cuts seen in the lugs of the top cover were found to make bending down of these lugs easier, and retains as far as possible the circular form of the cover. It is a good plan to drill the holes in the top and bottom covers together, clamping the discs in a vice.

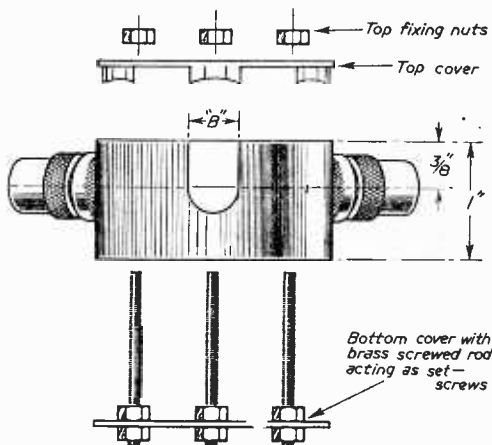

Fig. 6.—An exploded assembly, with one standard connector omitted to show the slot arrangement.

Aerials

Finally, a word about the two aerials. These should agree, of course, exactly, and should be mounted at same heights. A slight variation in alignment one from the other can be experimented with to give interference free reception as far as is practicable.

GOOD COMPANIONS!

A Beginner's Guide to Television

By F. J. Camm

A Complete Course in 15 Lessons (with Dictionary of Technical Terms) 128 Pages—61 Illustrations

7/6, by post 8/4

AND

A Beginner's Guide to Radio

By F. J. Camm

A Complete Course in 27 Lessons. 160 Pages—100 Illustrations

7/6, by post 8/4

from

The Book Publisher, George Newnes Ltd., Tower House, Southampton Street, Strand, London, W.C.2

More About Shared Aerials

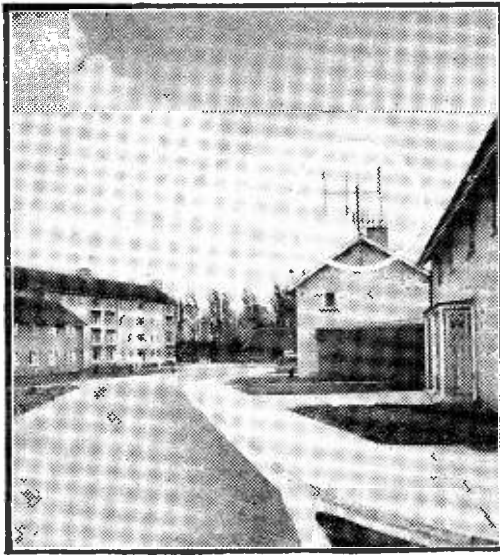

This estate of 73 dwellings is supplied with BBC and ITV television signals from a common aerial system, seen ringed in the photograph.

THE value for the "star" network resistors must be chosen to suit the coaxial cable employed and the number of outlets required. Since the cable impedance is usually the same all the way round, the resistors should have like value, which can be discovered very quickly from the following expression: $R = Z(n - 1/n + 1)$, where Z is the characteristic impedance of the cable and n is the number of outlets. Thus, for a two-outlet network using standard 72 ohm feeder, the resistors must each be 24 ohms.

Unfortunately, however, there is a price to be paid for this maintenance of matching, and that is the input to each receiver is less than the aerial signal by $20 \log n$ db. This means that with a two-outlet system the signal at each set is half that at the aerial, with a three-outlet system the signal at each set is a third of that at the aerial

PROBLEMS WHICH ARISE WHEN SEVERAL RECEIVERS OPERATE FROM THE SAME AERIAL

by S. J. Jackson

and so on as the number of outlets is increased.

All is well in an area of high signal strength, where it matters little if the signal is divided among the outlets in this fashion, but in fringe areas there is a call for amplifiers to make good the network losses. Then, of course, there is the loss in the cable itself to be considered.

Amplifiers Required

The diagram in Fig. 4 shows a simple set-up which may be employed to supply three receivers. If the aerial signal is $500 \mu\text{V}$, which is a desirable level to operate a receiver adequately, and it is required to have the same signal level at each outlet, then it is obvious that an amplifier will have to be used to make good the losses in the network and cables.

Losses and gains are usually expressed in decibels (db) instead of voltage ratios. If a signal is doubled then it is said to have increased by 6db; if it is halved then it is said to have decreased by 6db. Plus and minus signs are often used to indicate losses and gains in db. It is much easier to work in db than in voltage ratios direct, and the db equivalent of any voltage ratio can be found from db tables without trouble.

To get back to Fig. 4. Here the loss in the star network is 0.5db (corresponding to a three to one signal loss) and in the cable, from the star network to an outlet, 5db, thus, the total loss is 14.5db (db are simply added or subtracted). Clearly, then, in order to get $500 \mu\text{V}$ from each outlet, the amplifier will need to have a gain of 14.5db.

In Fig. 5 the exercise has been complicated a little by the requirement for the system to

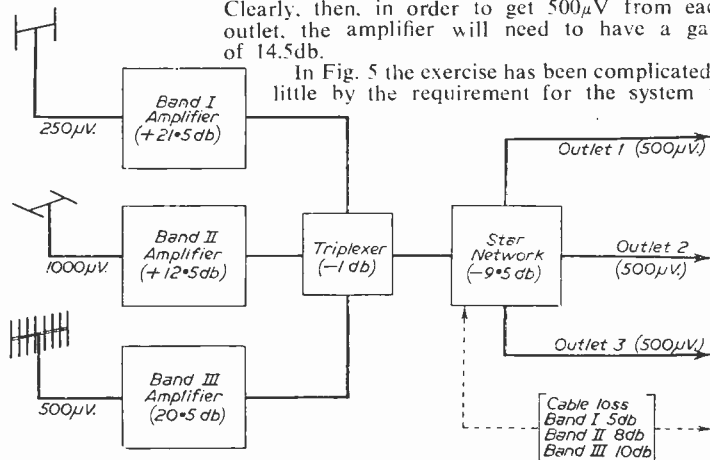

Fig. 5.—A more complex arrangement in which the signals of three bands are fed to three outlets at a level of $500 \mu\text{V}$.

carry signals in Bands I, II and III. The aerial signals are also different, as would be expected, but in spite of this and the fact that the attenuation value of the cables differs over the three bands, it is a relatively simple matter to secure $500\mu\text{V}$ of signal on each band at the three outlets by adjusting the gain of the amplifiers accordingly.

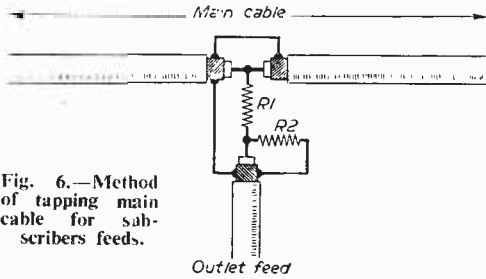

Fig. 6.—Method of tapping main cable for subscribers feeds.

In this system it will be seen that a triplexer is used to combine the outputs into a common feeder.

On Band I there is only $250\mu\text{V}$ of signal, which is 6db below the required $500\mu\text{V}$ to start with; there is 1db of loss in the triplexer and 5db in the cable at Band I frequencies. Plus the 9.5db loss presented by the star network, the amplifier is required to raise the signal by 21.5db (equal to the sum of all the losses).

On Band II the aerial signal is 6db up on $500\mu\text{V}$. Thus, the gain required for the Band II amplifier is found by subtracting 6db from the sum of the losses; it will be observed in this case that the cable losses are 8db, becoming greater as the frequency rises. On Band III the aerial signal is the same as required at the outlets, so it is a matter of adding up all the losses, including the 10db cable losses, and arranging the amplifier to have equivalent gain.

Amplifiers

There are on the market amplifiers which are highly suitable for this kind of work, which can, for example, be rigged up in the roof-space below the aerial system and energised continuously from the mains supply. The power requirements are quite modest, and, provided due consideration is

given to the ventilation, there is little danger of overheating. Nevertheless, the amplifiers should be lightly fused and adequately earthed. The author has under his control aerial amplifiers which have been running continuously for three years without component failure of any kind! Indeed it would appear that the valves and components live

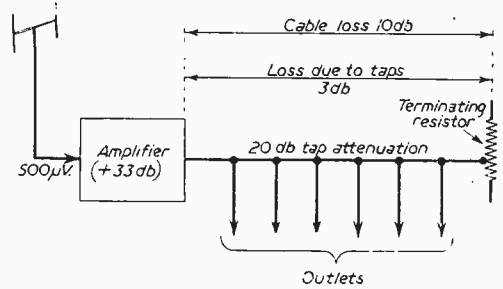

Fig. 7.—A simple signal distribution system.

longer when the equipment is permanently energised than when it is intermittently switched on and off.

Some amplifiers feature pre-set gain controls which can be adjusted to provide a balance of signal at the outlets, but in cases where such a facility is not available, fixed or variable attenuators can be introduced at the outlets of the amplifiers to serve the same purpose.

There is another method of tapping the required level of signal at various points along a main cable feed for subscribers' outlets, as shown in Fig. 6. Here the signal in the main cable is at fairly high level since it is obtained from the output of a distribution amplifier, and it is extracted by breaking into the cable as shown, but instead of the feed cable being connected directly into the main cable, it is isolated by means of resistor R1, while a second resistor R2 serves to load the end of the outlet feed cable to avoid standing waves and stub effects.

In effect, the resistors form a potential divider across the main cable at the point of entry, and the signal level fed into the feed cable is dependent on the ratio of the resistors. The

(Continued on page 122.)

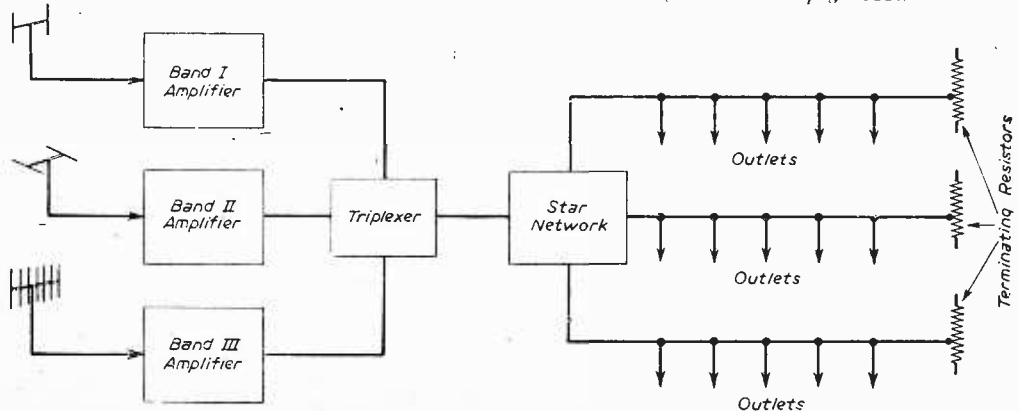

Fig. 8.—A more advanced three-band signal distribution system.

An Improved Video Amplifier

THIS ARTICLE DEALS WITH THE PRINCIPAL FACTORS INVOLVED

By S. D. R. Bowman

THE video frequency amplifier is without doubt the most critical circuit in a receiver from the design aspect, apart perhaps from the timebases. In this stage a great deal can be lost and, what is perhaps worse, much can actually be introduced to spoil a picture. Commercial design is fair, but a number of the cheaper receivers display faults which the home designer can, for a little trouble, avoid altogether.

idea that the larger the number of stages the more opportunity for correction.

Theoretical Details

It is not proposed to go into the theoretical details of the design, but the reader may care to be reminded of the principal factors involved. In the first place, all amplifying devices possess self-capacitance, partly in the valves themselves and partly in the circuit. While at low frequencies this is insignificant, at high frequencies this capacitance causes two adverse effects—loss of amplification due to the familiar "by-passing" effect, and change of phase. In audio-frequency amplifiers the latter is of minor significance, but in video amplifiers it becomes a great nuisance. For these reasons it is essential for the circuits to possess intrinsically low impedance, and this limits severely the load resistance which can be employed; this in turn reduces stage gain.

By putting inductance in the circuit, the capacitance can be "tuned out," thus enabling the load resistance to be increased, giving higher gain—and, incidentally, much improving the amplification characteristics at high frequencies. The size of the inductances used has to be calculated with care, otherwise more harm than good can result. Overshoot can occur quite readily. By this is meant that if a square wave is applied to the input, the output voltage shows a momentary jump above its final value. This will cause a light band on the left-hand side of a white object on the cathode-ray tube screen. "Undershoot" can similarly occur, resulting in a darker edge to a dark object. While this is sometimes done deliberately to improve the

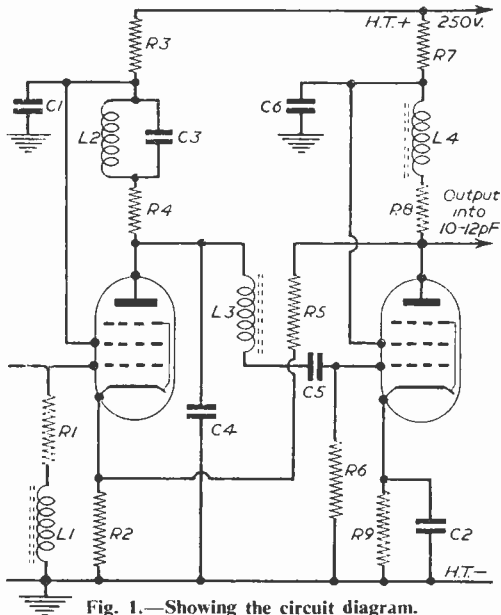

Fig. 1.—Showing the circuit diagram.

The characteristics of a perfect V.F. amplifier are, briefly, as follow:

- Linear amplification of frequencies from zero to 3 Mc/sec. (or whatever upper limit is nominally imposed on transmissions).
- Zero phase shift of all frequencies amplified.
- Zero rise time to an input voltage "step"—i.e., to a square wave, with zero "overshoot."

The amplifier here described represents an approximation to the ideal, and its gain is such that it may be found a better alternative, in fringe areas, to the use of an extra I.F. or R.F. stage.

The Circuit Diagram

Fig. 1 shows the circuit diagram. It is a two-stage amplifier of fairly conventional design, with negative feedback. This may cause some eyebrows to be raised; as is well known, the larger the number of stages of video amplification the more the possible sources of loss in performance. However, the writer met this challenge with the

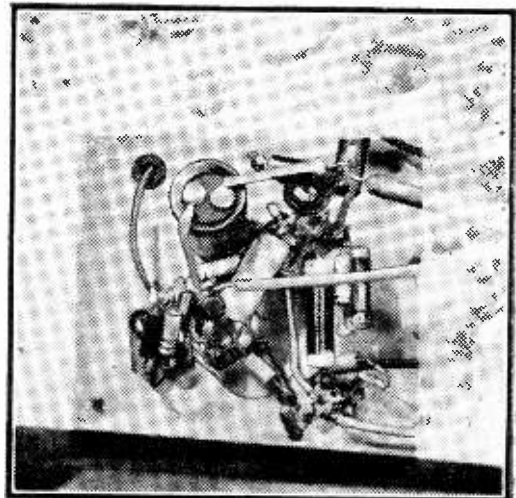

The Video amplifier.

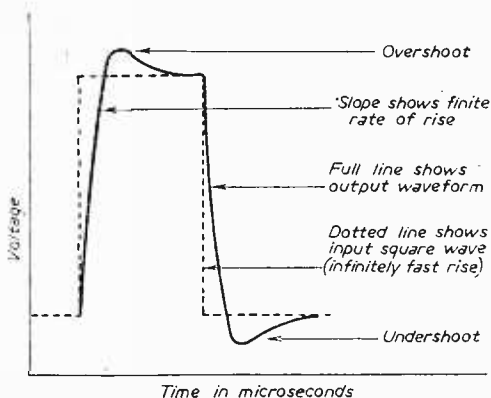

Fig. 2.—The “overshoot” and “undershoot.”

apparent “resolution” of a picture it is actually a source of degradation of detail, and it should be minimized. Fig. 2 shows overshoot and undershoot.

Both shunt and series inductances are used in the present circuit, and their proportions are such that overshoot has been made negligible (a little under 2 per cent.).

The chief requirement is, however, a very fast rise of output voltage when a square-wave input occurs. This also affects the calculation of the compensating inductances, and when compromising between linear amplification up to high frequencies and fast rise it is better to let the

LIST OF COMPONENTS

- | | |
|--------------------------------|-------------------------------|
| R1—3.8 K. | C3—See text. |
| R2—100 Ω . | C4—See text. |
| R3—2.2 K. | C5—1 mfd. (physically small). |
| R4—3.3 K., $\frac{1}{2}$ watt. | C6—16 mfd. elec. |
| R5—5.6 K., 1 watt. | L1—65 μ H. |
| R6—1 M. | L2—37 μ H. |
| R7—1.2 K., 3 watt. | L3—130 μ H. |
| R8—1.5 K., 3 watt. | L4—56 μ H. |
| R9—100 Ω . | V1—6AM6. |
| C1—16 mfd. elec. | V2—6CH6. |
| C2—220 pF. | |

linearity take second place. For British transmissions a maximum rise time (from 10 per cent. to 90 per cent. of final output voltage) of 0.1 microseconds or a little more is essential if all fine detail is to be displayed on the tube face. In this circuit the rise time is 0.038 microseconds—well under the maximum allowable.

Low-frequency Response

Low-frequency response is also important, and in this connection the chief difficulty is the avoidance of “sag” when a low-frequency pulse is applied to the input. Fig. 3 shows the effect. This is due to couplings having too low a time-constant ($t = C.R.$) so allowing “leakage” during the pulse. Grid couplings, cathode screen and anode decouplings, can all give rise to this undesired effect. In the amplifier just described, grid coupling has a time-constant of 1 second,

which enables a complete frame scan to be achieved without noticeable sag. In anode and screen circuits, it is impracticable to achieve a time-constant as long as this. With resistors of low enough value to give high enough screen and anode voltages, decoupling capacitors would have to be impossibly large. Compensation by R3, C1 and R7, C6 has, therefore, been introduced and it is important that the circuit values given are adhered to quite closely. With this arrangement, the sag is reduced to negligible proportions and in fact amounts to only 1.7 per cent. The difficulty about sag due to the cathode bias resistor-condenser combination is avoided by omitting the bias condenser altogether. (The 220 pf condenser across V1 cathode resistor is for frequency compensation purposes only, and

LIST FOR COIL CONSTRUCTION

- L1—140 turns No. 40 gauge wire enam., on former 0.3 in. dia. V.H.F. (purple coded) dust core fully inserted.
- L2—Same as above without dust core.
- L3—Wearite M.W. oscillator coil (P.O.2), with small winding removed completely and $\frac{1}{2}$ the turns taken off the other.
- L4—80 turns No. 36 gauge enam. wire—Aladdin former .4 in. dia. with iron dust core.

does not count in low-frequency considerations.) The negative feedback so resulting is actually beneficial rather than otherwise, although, of course, gain is considerably reduced.

In order to reduce phase change still further and to level out the frequency response over a wide spectrum, a little negative feedback is added from the output anode to input grid—note, of course, that the cathode bias resistor of V1 is part of the V1 grid circuit. This feedback is D.C. coupled—a real necessity here—and the amount possible is limited by the inherent characteristics of V1. The network R5, R2 would have to be changed if any valve but one having the D.C. cathode current of a 6AM6 were used. The resulting gain of the whole amplifier is thus about 100—six to ten times that usually obtained in a single-stage amplifier—and therefore needs less than a volt input to modulate a C.R.T. fully.

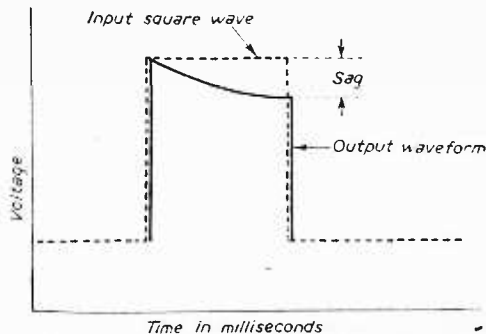

Fig. 3.—“Sag” at L.F.

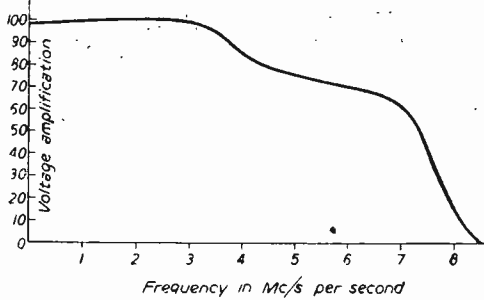

Fig. 4.—The frequency response curve.

Frequency Response

Fig. 4 gives the frequency response curve, and it will be seen that the whole range of British TV frequencies can be dealt with easily. Fig. 5 is a curve which shows the rise time actually achieved with this amplifier. Again, overshoot is very small and the rise time well within what is allowable.

Construction

The construction and layout presents no special difficulties, except the avoidance of stray capacitance. It should be remembered that unwanted feedback can occur, and screening of each stage is indicated.

C3 should be a total of 3 pf including "strays." If L2 is wound according to the table its self capacitance will be 1.2 pf, and the rest can be made up by normal circuit capacitance. It is,

SHARED AERIALS

(Continued from page 119).

approximate degree of attenuation in db given by the network can be expressed as $20 \log (2R1/R2)$.

The diagram in Fig. 7, shows a main cable on which six taps are made along its length and which is loaded at the far end by a resistor equal to the cable's characteristic impedance. In order to secure a good figure of isolation between outlet feeds and the main line, and to avoid interaction between outlets, the attenuation given by the tapping network at the far end of the main line should not be less than about 15db. Each tapping network has a slight loading effect on the main line, and thus tends to increase the line attenuation, but this is usually little more than about 0.5db per tap. With six taps, therefore, the 3db loss should be added to the 10db cable loss and the 20db attenuation of the end tapping network, giving a total loss of 33db, which has to be made up by the amplifier if a signal of equal level to that at the aerial is to be obtained at the far outlet. If required, the attenuation of the other taps can be arranged to increase progressively towards the amplifier to obtain a constant $500\mu\text{V}$ signal at each outlet.

The diagram in Fig. 8 shows this kind of distribution network can be extended to cater for all channels and a greater number of outlets.

therefore, not a physical component. C4 is a trimmer; for the valves specified it is 4.7 pf, but if others are used it may well be advisable to make it 0-10 pf variable and to adjust it for minimum overshoot with a test-card on the screen of the C.R.T.

The circuit is intended to work into about 10 pf. This represents a reasonable value for an average cathode-ray tube, but best results are had by setting up the circuit, with tube in position, as follows:

Alignment

With signal generator set to 4.6 Mc/sec., apply about .3 volts to V1 grid. Temporarily short-circuit R8 and, with a valve-voltmeter connected to V2 anode through a 2 pf condenser, adjust the core of L4 for maximum response. If a maximum cannot be found screw the core right home: the circuit is evidently of lower capacitance than designed for, and no ill results will occur if then used as it stands. Remove the short-circuit on R8 and the amplifier is ready for use.

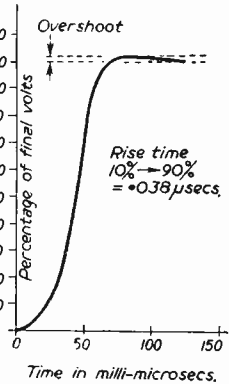

Fig. 5.—Amplifier rise time.

Additional amplifiers can be introduced to extend the coverage with little difficulty.

The photograph shows an estate of some 73 dwellings which is supplied with both BBC and ITV television signals from the common aerial system seen mounted on the wall of one of the houses. This system, which is in a fringe area and uses Spencer West distribution amplifiers, has now been in operation for nearly three years with excellent results.

In conclusion, it should be made clear that a Post Office Relay Licence is usually required to operate a large shared aerial system of this nature, but this may not be necessary if just a few neighbours get together to share a common aerial as a means of reducing expense and preserving the amenities.

PRACTICAL TELEVISION CIRCUITS

288 pages, 156 illustrations

15/- net or 15/6 by post, from

GEO. NEWNES, LTD., Tower House,
Southampton Street, Strand, W.C.2.

the blade in contact with the metal tube support. If EHT is lacking at this point, a test of a similar kind can be made at the anode of the EY5 EHT rectifier, but this time a connection should not be made between the screwdriver blade and chassis. If only a minute spark can be drawn from this point, or if it is totally dead, the trouble lies in the line timebase circuit, which are given in Fig. 2. If a healthy spark can be drawn from the anode, but not at the heater or EHT connector, then the EY51 should be replaced.

A frequent cause of line timebase failure is shorting turns in the line output transformer (T3), but before contemplating its replacement a series of tests should be made in the associated circuits. On a number of occasions the 470 pF waveform correction capacitor (C1 in Fig. 2) has been known to develop a slight leak and load the circuit so much that it fails to produce EHT. When this fault occurs there is no glow from the heater of the EY51 valve, though a faint 10 kc/s whistle, which alters slightly in pitch as the line hold control is rotated, can usually be heard from the line output transformer.

As will be seen from Fig. 2, the line timebase uses two valves, which are coupled and caused to oscillate by way of the output transformer and the 300 pF capacitor C2. Thus, failure of C2 represents another possible cause of the symptom. In this case, however, the stages will be completely dead from the point of view of oscillation; there will be no line whistle and the PL38 valve will rise to a high temperature owing to lack of bias, which is normally produced by the drive signal.

A short-circuit in the 2 mF electrolytic capacitor (C3) connected in the cathode circuit of V5a (efficiency diode) also destroys the EHT by promoting failure of the timebase. A clue in this connection is given by measuring the voltage either at the cathode of V5a or the screen of the line amplifier V3 when, instead of its normal 280 volts, it will be in the region of 180 volts.

Other causes of the symptom are: (a) poor insulation of the "drive" compression trimmer (C4); (b) poor insulation of C2 resulting in the grid of V2a going positive; (c) low emission of V2a or V3; (d) failure of V5a; (e) open-circuit or short-circuit of the coupling capacitor C5 and (f) shorting turns in the line output transformer.

In the case of a suspect line output transformer, a substitution check is the most conclusive and satisfying, but in the event of a replacement transformer not being available tests of winding continuity and resistance sometimes assist in establishing a definite fault, but it should be remembered that a short between adjacent turns will prevent operation of the circuit though will not show up in terms of a resistance test. However, as a guide to readers the approximate resistance values to be expected across the various windings on the transformer are given below: section A, 7.5 ohms; section B, 30 ohms; section C, 800 ohms; section D, 14.2 ohms; section E, 1.3 ohms; section F, 1.5 ohms.

Poor Line Linearity

This symptom is not very common on the model under discussion, but if it does occur and

the line timebase valves are in good order, attention should be directed to the series-connected resistor capacitor across a section of the width coil (C6 and R1 in Fig. 2). Low H.T. voltage also causes the trouble, since then a too far advanced setting on the width control is demanded in order to secure adequate line amplitude—check the PZ30 valve.

Failing Line Scan

This often happens, and while the picture may appear perfectly normal at first, as the set warms up the picture will suddenly fade out, starting with a collapse of width and fading eventually to a dim pillar of light before disappearing completely. The trouble is caused by a fracture in the cathode circuit in the PZ30 valve (section V5a). There is continuity when the valve is cool, but as it warms up and the electrodes expand a break occurs in the circuit.

(To be continued)

More Vidicons in Use

THE conversion of variations in light over a picture area into equivalent proportions of electrical signal information—an essential process in any television service—is carried out by two principal methods, photoemissivity and photoconductivity. An example of the former is, of course, the Iconoscope or one of its variations while in the latter class we have the Vidicon. Generally speaking the first named device, in which a concentrated beam of electrons striking a photoemissive surface brings about a release of free electrons from it, is much more sensitive, but of late, particularly in America, more television stations have been using Vidicon equipment.

Glass Face at End of Tube

At the end of the Vidicon tube is a glass face backed by a transparent conductive coating which is again backed by a photoconductive target. It has the advantage of signal storage in addition to being cheaper than its photoemissive counterpart. It has a very good signal to noise ratio, but at low levels of light intensity a Vidicon has been rather insensitive.

The new tubes, which are now available, show a considerable improvement in this connection, with the result that even for live television broadcasts Vidicon camera chains are now being employed. This is quite apart from its use in telecine equipment and industrial camera devices.

JOIN THE PRACTICAL GROUP

Edited by F. J. CAMM

PRACTICAL WIRELESS	1/3
PRACTICAL TELEVISION	1/3
PRACTICAL HOUSEHOLDER	1/3
PRACTICAL MECHANICS	1/3
PRACTICAL MOTORIST & MOTOR CYCLIST	1/3

They are all published monthly

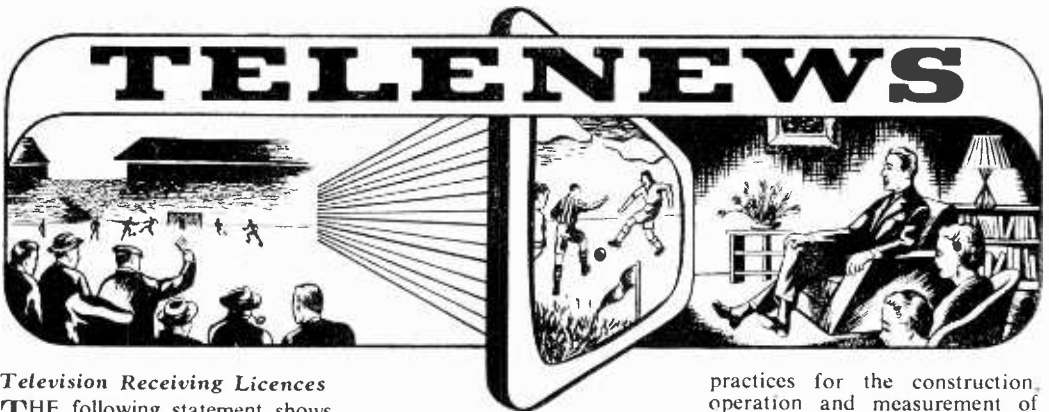

Television Receiving Licences

THE following statement shows the approximate number of Television Receiving Licences in force at the end of July, 1958, in respect of receiving stations situated within the various Postal Regions of England, Wales, Scotland and Northern Ireland.

Region	Total
London Postal	1,597,023
Home Counties	1,026,530
Midland	1,328,431
North Eastern	1,337,250
North Western	1,160,704
South Western	648,431
Wales and Border Counties	479,675
Total England and Wales	7,578,044
Scotland	627,454
Northern Ireland	89,411
Grand Total	8,294,909

Increase in Power at Blaen- plywff TV Station

ON August 8th the power of the BBC television station at Blaen-plywff, near Aberystwyth, was doubled; the station was opened in April 1957 with an effective radiated power of 1 kilowatt and this will now be increased to 2 kilowatts. This increase in power should improve reception, particularly in the fringe areas. It will not, however, materially increase the area served by the station, which extends around Cardigan Bay from Pwllheli in the north to Aberporth in the south.

ITV for the South

TOP ITV programmes are now being transmitted to southern England to a population of approximately 2½ million. These are the shows with the highest viewing ratings, produced, filmed or bought from abroad by the four major TV contractors. They are beamed by the new independent TV station,

Southern Television, over 3,500 square miles in a rough D-shape from Weymouth to Brighton and northwards to Newbury.

Television for Miners

MINERS in the Nórgrad coal-field, in Hungary, have decided to build a television booster station at Salgotarjan. The TV mast will be sited on top of a 492ft. hill, and will enable viewers to watch programmes within 12½ miles radius.

100,000 Saw Southern TV Exhibitions

WELL over 100,000 people have been introduced to independent television and Southern Television through a series of exhibitions arranged by Southern TV.

Centrepiece of the exhibitions was the new station's outside broadcasting unit transmitting on a closed circuit to TV sets on the stands of retailers taking part.

Standardising Video Tape Practice

IN answer to the rising need for standardisation of video tape recording practices in the television industries, Mr. Axel G. Jensen, Bell Telephone Labs, engineering vice-president of the Society of Motion Picture and Television Engineers, has announced the formation of a Video Tape Recording Engineering Committee, by the society.

The official scope of the committee, which will be chaired by Mr. Howard A. Chinn, CBS Television, will be "to propose standards and good engineering

practices for the construction, operation and measurement of video tape recording and reproducing equipment and for those video tape or other characteristics which affect performance and interchangeability."

Items to be Standardised

Initially, the committee plans to consider standardisation of the following: tape (dimensions and identification), tape reels (hub and flange), tape tracks (locations, video-, audio-, control- and cue-tracks), recorded signal electrical characteristics (video, audio, control and cue), tape leaders, methods of measurement, terminology and tape splicing.

New Features

New features include an image orbiting device which is designed to prevent "sticking" on static pictures (thereby prolonging the useful life of the pick-up tube) and a new picture and waveform monitor with 14in. picture and 5in. waveform tubes. The camera control and power supply are arranged for rack or mobile mounting, and the control panel contains no valves whatsoever.

Temporary Stations in Orkney and Caithness

THE BBC is building a combined television and V.H.F. sound broadcasting station in Orkney, and another near Wick; the latter is to fulfil the dual purpose of relaying the signals to the Orkney station and providing a service for listeners and viewers in Caithness. When they are in their final form these stations will carry the BBC television service and the three

sound programmes to almost the whole of the Orkney Islands and Caithness, with a total population coverage of some 43,000. In order to provide a television service before the constructional work on the permanent stations can be completed, it has been decided to provide temporary installations both in Orkney and at Wick, which it is hoped to complete early in the new year. Since the temporary aerials at these stations will be lower and less effective than the permanent aerials, the coverage in the temporary condition will be restricted to the immediate neighbourhood of Kirkwall and Wick respectively.

Skeleton Slot Aerial

OPTICESSORY PRODUCTS.

Treharris, Glam. state that they can supply a Skeleton Slot Aerial, similar to that described in the May issue, at 28s., carr. free.

It is supplied folded flat, though completely assembled, the user having only to swivel the arm at 90 deg. to frame and tighten two screws. Both ends of the arm are shaped to suit the frame, thus giving a deadlock location.

Tested against a normal five element the S.S. had a slightly higher gain with good bandwidth and better Band I rejection.

Light and robust, it is ideal for use outdoors, being easily fixed to any wall or chimney, quickly and permanently, or with the universal clamp, to any 1in. to 2in. diameter mast.

Due to its size it can be used anywhere indoors, even "hidden" under the TV table, or in a cupboard.

New TV Camera

MARCONI'S latest design of television camera channel is currently undergoing operational trials with the British Broadcasting Corporation at their Riverside Studios. Fifteen of these camera channels were recently ordered by the BBC for their new White City Television Centre, and the Australian Broadcasting Commission have also ordered eight for their new television studios at Brisbane and Hobart. This new image orthicon camera channel, known as the Mark IV, is equally suit-

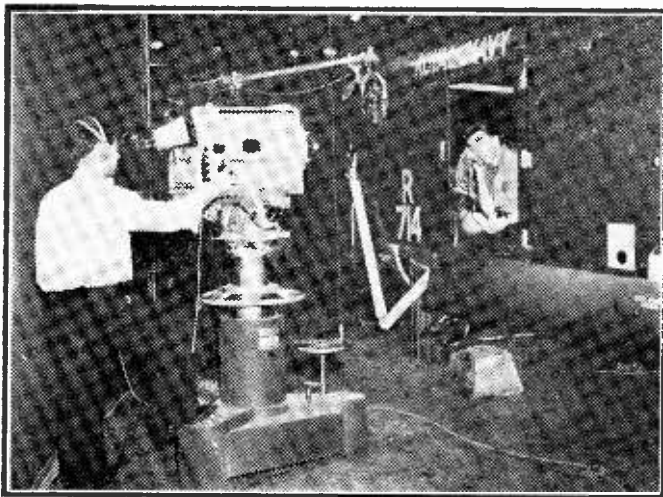

Showing the Mark IV in use on "The Skylarks" set at the BBC's Riverside Studios.

able for outside broadcast and studio work. This design has been derived from the highly successful Mark III channel which pioneered the use of the 4½in. image orthicon pick-up tube and which has been adopted by the BBC, the I.T.A. programme contractors and television authorities throughout the world. The Mark IV camera, which weighs less than 100lb., allows full advantage to be taken of the technical superiority of the 4½in. tube, at a weight comparing favourably with cameras designed specifically to take only the 3in. tube. It can, of course, be easily adapted for use with the smaller tube.

New TV Link for Orkneys

THE BBC has recently placed a contract with E.M.I. Electronics Ltd., for a temporary microwave radio link to serve the new transmitting station in the Orkneys so as to bring television to people living in the Kirkwall area nearly a year sooner than would otherwise have been possible. The link will relay the BBC's programmes from a site near Wick to the new broadcasting station at Nether Button in the Orkneys. This station is due to be brought into service in a temporary condition early in 1959 and will eventually carry a full V.H.F. sound and television service.

The television link will operate

in the 7,000 Mc/s band. It is designed for unattended operation and will comprise duplicate channels working into common aerial systems. A passive reflector system will be used at the receiving end of the link at Nether Button. Provision will be made for remote control over a separate radio link for change-over from one channel to the other.

E.M.I. Awarded Contract for Temporary Link

EARLIER this year E.M.I. was awarded a contract for a similar temporary link installation as mentioned above to relay television programmes to the BBC's new transmitting station at Peterborough. This station is due to be completed early in 1959.

A "Special Form" Tube

IT is amazing to see the strides which have been made to reduce the length of cathode-ray tubes used in television receivers. It was not long ago that boxed-in projections at the back of the cabinet to protect the cathode end of the tube were more the rule than the exception. Developments in wide angle deflection have been rapid, however, and the latest has been made manifest in a briefcase portable television set which makes use of a 17in. diameter tube made by Philco. This is called a "Special Form" and is just over 10½in. long!

A NEW SERIES

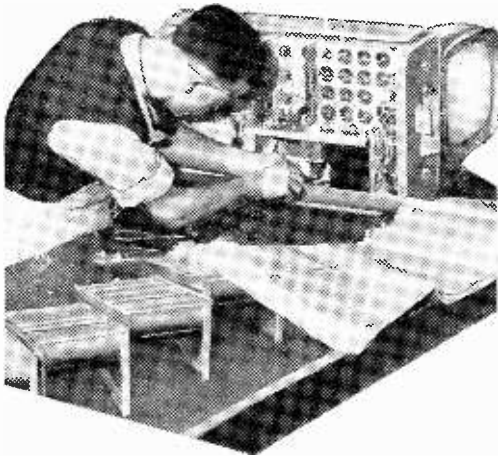

Analysing and Servicing TV Receivers

No. 2.—The Mixer Oscillator Stage

By "Diadem"

overall change in capacity in the oscillator circuit due to heat, as any drifting will be very noticeable in the sound channel.

C1 and C2 have other uses besides frequency stabilising, by altering their value various frequencies can be covered which would otherwise be outside the range of the oscillator, and they also help to make the adjustment of the oscillator trimmer less critical.

The circuit shown in Fig. 7 works in a similar manner to Fig. 6 except a separate oscillator is used giving greater gain in the mixer stage, the gain from a single valve frequency changer being practically nil. The pentode is strapped as a triode. The total capacity of the oscillator coupling condenser is split into two halves, C5 and C6. C5 is mica, C6 is ceramic. These two capacitors have a similar stabilising influence to C1 and C2 in Fig. 6, but they don't have the same function of course. C5 and C6 can be likened to C4 in Fig. 6. The output from the oscillator is taken through C8 and fed into the mixer grid.

Fig. 8 is another type of frequency changer using a single valve. This is not the self oscillating type as in Fig. 6. The oscillator being formed by the control and screen grids and the reaction

(Continued on page 133)

THE amplified R.F. signal appearing across the tuned anode coil is capacitively coupled to the oscillator coil L2 (Fig. 6). The signal is then fed to the control grid of V2 through the coupling capacitor, C4. V2 is a self oscillating frequency changer employing the usual Colpitts oscillator. C3 is the oscillator trimmer while C1 is a mica capacitor, C2 is a ceramic with a negative temperature coefficient. Temperature within the cabinet and of surrounding components may affect the oscillator frequency causing drift. Capacitors are particularly affected by heat changes. Heat will increase the value of C1 while it will decrease C2 by a similar amount, this helps to cancel out any

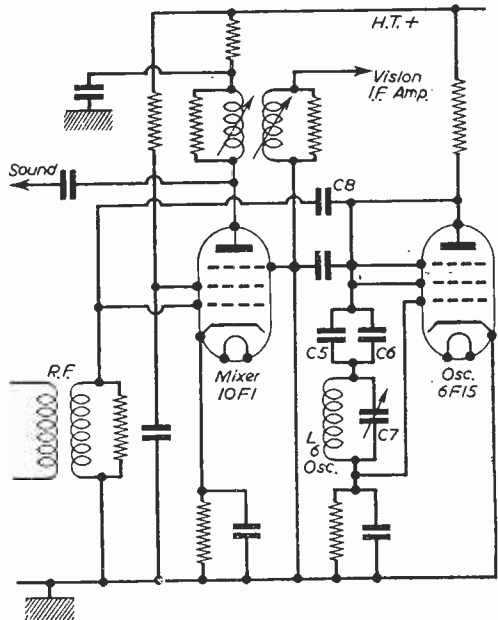
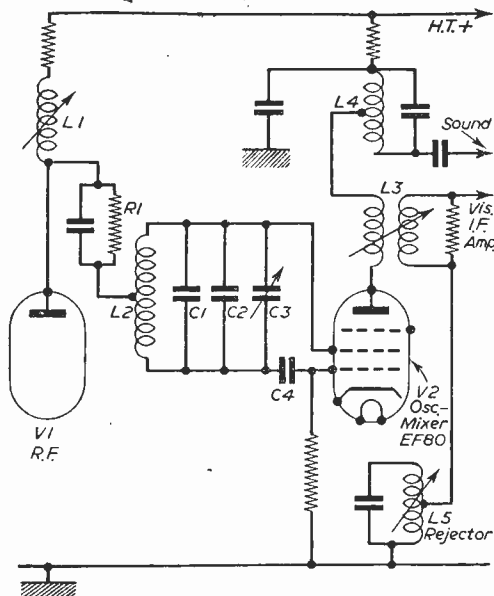

Figs. 6 and 7.—(Left) A self-oscillating frequency changer. (Right) This circuit works in a similar manner as Fig. 6, except that a separate oscillator is used.



Our specialist buying knowledge and reputation ensure a square deal... and enable us to

SPEEDY MAIL ORDER SERVICE

offer the best for your money!

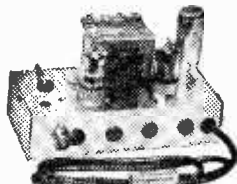

VOLUME CONTROLS

10,000 ohms—2 Megohms. All long spindles, Morganite Midget type, 11" diameter. Guar. 1 year. Log. or Linear Ratioes. Less Sw. 3/-. D.P. Sw. 4/9. RESISTORS.—Full range, 10 ohms—10 Megohms. 20% 1 w. 3d., 1 w. 5d., 1 w. 6d., 1 w. 9d. 10% Hi-Stab. 1 w. 5d., 1 w. 7d. 5% 1 w. 9d. 1% Hi-Stab. 1 w. 1/8 (10 ohms—100 ohms, 2/-). **COLLABO TAPE TRANSCRIBOR Mk. IV** This latest tape deck featured as an advertising order. Limited stocks. New and sealed in Mfrs. cartons. Bargain. 22 rms. Post Free. **RECORDING TAPE.**—1,200 ft. on 7 in. Plastic reel. 8S type. Hi Quality Product. Each boxed, 22/6.

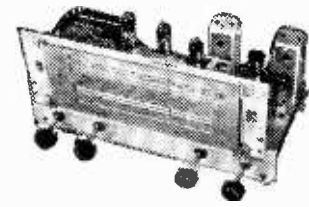

ALL-WAVE RADIOGRAM CHASSIS

3 WAVEBANDS S.W. 16 m.—60 m. M.W. 200 m.—600 m. L.W. 600 m.—2,000 m. Brand new and guar. A.C. 200/250 v., 4 pos. W/C sw. Short-Medium-Long-Gram. P.U. socket. High Q dust core coils. Latest circuit technique, delayed AVC and neg. feedback. O/P 4 watts. Chassis size 13 1/2 x 5 1/2 x 2 1/2 in. Dial 10 in. x 4 1/2 in. Hor. or Vert. station names. Walnut or Ivory knobs to choice. Aligned and calibrated ready for use. Sensitivity and Quality at Low Cost. Chassis isolated from mains. **BARGAIN 9 1/2 GNS.** Carr. and ins. 4/6. **PRICE 20/- and 25/-**. 7 Valve De Luxe, push-pull EL41 version, 7 watt output, with H/Duty O/p Trans. 212.10.0. Carr. & ins., 5/-. **5 VALVES LATEST MIDGET R.V.A. SERIES**

RECORD PLAYER BARGAINS

4 sp. BSR (TU9), 92/6, 4 sp. **COLLABO JUNIOR**, 24.10.0. 4 sp. **GARRARD** (4 S.P.), 27.16.0. Carr. & ins., 2/6. **AUTO CHANGERS.**—4 sp. BSR (UAS), 27.19.0. 4 sp. **COLLABO**, 27.19.0. 4 sp. **GARRARD** (RC120/4H2), 210.5.0. Carr. & ins., 4/6. All above units are latest models and are fitted with modern styled 1" weight Xtal. P.U. with turnover head and twin sapphire stylus. **ALL BRAND NEW BOXED AND GUAR.**

BAND 3 T/V CONVERTER—180 Mc/s -205 Mc/s
Suitable for London, Midland, North, Scottish, Welsh and I.o.W. ITA Transmissions

Mk. 2 Model as illustrated. Latest Cascade circuit using ECC84 and EF80 valves giving improved sensitivity (+ 18db) over standard circuits. Built-in Power supply AC 200-250 v. Dimensions only 6 1/2 in. x 3 in. Ht. 4 in. Simple and easy to fit—only external plug-in connections, wired, aligned and tested ready for use. State Channel required. Guar. Bargain Offer—good results or full refund.

only £3.19.6. Carr. & Pack. 2/6. Band 1 fitted 3 c/o Switch and BBC aerial socket, fitted and wired to converter, 8/- extra. **CONVERTER ACCESSORIES**
Band 1-Band 3 Cross-over Unit, 7/6. Var. Attenuators (db-3cdb), 7/6. BBC Pattern Filter 8/6. Band 3 Aerials—outside Single Dipole with 4 yds. co-ax., etc., 13/9. 3 Element Beam, 27/6. 5 Element, 35/-, etc.

C.R.T. Heater Isolation Transformers

New improved types—mains prim. 200/250 v. tapped.

All Isolation Transformers now supplied with alternative no load, plus 25%, and plus 50% load type, at no extra charge.

2V.	2A type	12 6 (P. & P. 1.6)
6.3V.	3A	12 6 ..
10.5V.	3A	12 6 ..
15V.	3A	12 6 ..

Other voltages in course of production. Small size and low terminal for easy fitting.

JASON F.M. TUNER UNIT 87-105 Mc/s.

Designer Approved Kit of parts to build this modern highly successful unit, drilled chassis and superior type dial. Coils, cans, and all quality components, etc., for only 5 gns., post free. Set of 4 spec. EP91 or equiv. valves, 30/-, post free. Illustrated handbook with full details, 2/-, post free, FREE WITH KIT. 48 hr. alignment service, 7/6 plus 2/- P. & P.

NEW VALVES

BOXED	ALL GUARANTEED
1K5, 1T4 7/6, DF96 9/-	EF41 10/6, PCF82 10/6
1K5, 1R4 7/6, DK96 9/-	EF80 10/6, PCL83 12/6
3K4, 3V4 8/-, DL96 9/-	EF80 13/6, PL81 14/6
5Z4 9/6, 5ZL 6 10/6	EP91 9/6, PL82 10/-
6AT6 8/6, EABC80 9/6	EL41 10/6, PL83 11/6
6K7 6/6, EB91 6/6	EL41 11/6, PY80 9/6
6K8 8/6, EB41 10/6	EM85 11/6, PY81 9/6
6Q7 8/6	ECC83 9/6, EY51 12/6
6N7 8/6	ECC84 12/6, EY80 14/6
6V6 7/6	ECC780 12/6, EY81 9/6
6X4 7/6	ECC82 12/6, EY80 9/6
6X5 7/6	ECH42 10/6, EY81 8/6
7C5 9/6	ECH81 10/6, MU14 9/6
7Y4 8/6	ECL80 12/6, PC84 10/6
DAF96 9/6	ECL82 12/6, PC80 10/6

SPECIAL PRICE PER SET
1K5, 1T4, 1K5, 1R4 or 3K4, or 5V4 ... 27/6
DK96, DF96, DAF96, DL96 ... 35/-
6K8, 6K7, 6Q7, 6V6, 5Z4 or 6X5 ... 35/-

RECONDITIONED TV TUBES

Re-vacuumed and re-activated. (Guar. 6 months.)
12in. Mullard, Mazda, etc., 26.10.0 (as available).
14in. Mullard, Mazda (Rect.), 27.0.0.
17in. Mullard, Mazda (Rect.), 26.10.0.
Carr. and ins., 12/6.

AND NOW—NEW HEATER, CATHODE AND GUN ASSEMBLIES FITTED TO YOUR OWN TUBES.—Reconditioned virtually as new. Only 30/- extra. Uncon. guaranteed. 7 days delivery. Regret only Mullard and Mazda types at present. Carr. & Ins. 12/6. As used in our own Workshops.

ELECTROLYTICS ALL TYPES NEW STOCK

Tubular Wire Ends	22+32/350 v. B.E.C. 5/6
25, 25 v., 50/12 v. 1/9	Can Types, Clips 3d. ea.
25/50 v. T.C.C. 2/-	8/200 v. Dub. 2/-
50/50 v., 4/500 v. 2/-	8+8, 450 v. T.C.C. 4/6
100/25 v., 2/450 v. 2/-	8+16, 450 v. T.C.C. 5/-
8+450 v. T.C.C. 2/3	16+16, 450 v. T.C.C. 6/6
8+8, 450 v. B.E.C. 4/6	32/350 v. B.E.C. 4/6
8+16, 450 v. T.C.C. 4/6	32+32, 375 v. Hunts 4/6
16/450 v. B.E.C. 3/6	32+32, 450 v. T.C.C. 6/6
16, 500 v. Dub. 4/-	250/350 v. B.E.C. 3/6
16+16, 450 v. T.C.C. 5/6	60, 350 v. T.C.C. 6/6
32/350 v. B.E.C. 4/-	60+100/350 v. B.E.C. 11/6
32, 500 v. Dub. 5/6	60+250, 275 v. B.E.C. 12/6
50+50/350 v. B.E.C. 12/6	100+200/275 v. B.E.C. 12/6

RECORD-FLAYER CABINETS



Contemporary style, resin coated cabinet in fawn and brown with cream interior. Size 14 1/2 x 12 1/2 x 11 in. 8 1/2 in., fitted with all accessories, including speaker baffle board and plastic fret. Space available for all modern amplifiers and autochangers, etc. Inset record player mounting board 14 x 12 in. supplied.

Cabinet Price, £3. 3. 0. Carr. and Ins., 2/6.

2-VALVE AMPLIFIER Mk. 1

200/250 v. A.C. Modern circuit with High Gain EL84 output and double wound Mains Transformer, variable tone and volume controls, wired and tested with 6in. Speaker and O/P Trans. complete with knobs and drilled ready to fit Baffle Board in above cabinet. Only 23.12.6. Carr. & Pack, 2/6.

2-VALVE AMPLIFIER Mk. 2

200/250 v. A.C. Specification as above but a higher fidelity and greater output (approx. 3 watts) is obtained by using latest Twin Stage Triode-pentode Valve ECL82 and negative feedback Tone Control. Complete wired and tested as above 23.19.6. Carr. & Pack, 2/6.

SPEAKER FRET.—Expanded Bronze anodized metal 8 x 8 in., 2/3; 12 x 8 in., 3/-; 12 x 12 in., 4/6; 12 x 16 in., 6/-; 24 x 12 in., 9/-, etc.

TYGON FRET (Murphy pattern) 12 in. x 12 in., 2/-; 12 x 18 in., 3/-; 12 x 24 in., 4/-, etc.

TRANSFORMER & COIL WINDING CAPACITY AVAILABLE FOR PROTOTYPES & SMALL RUNS.



Listed above are only a few items from our very large stock. Send 3d. stamp today for Complete Bargain List.

Terms: C.W.O. or C.O.D. Kindly make cheques, P.O.s, etc., payable to T.R.S. Post/Packing up to 1lb. 7d., 11b. 1, 1, 3lb. 1, 6, 5lb. 2, 10lb. 2, 9. Hours: 9 a.m.-6 p.m. 1 p.m. Wed. Open all day Saturday.

RADIO COMPONENT SPECIALISTS (Est. 1946)

70 BRIGSTOCK ROAD, THORNTON HEATH, SURREY (THO 2188)

50 yards Thornton Heath Station. Buses: 130A, 133, 159, 166 and 190

PREMIER RADIO CO.

(Regd.) B. H. MORRIS & CO. (RADIO) LTD.

207, EDGWARE ROAD, LONDON, W.2.

23, TOTTENHAM COURT ROAD, LONDON, W.1.

Telephone : AMBossador 4033. PADdington 3271/2.

Telephone : MUSeum 3451.

The "Petite" PORTABLE

May Be Built For

£7.7.0

plus 3/- p. & p.

★ Size only 8in. x 8in. x 4½in.

Batteries Extra. HT 10/- (Type B126) or equivalent.

LT 1/6 (Type AD35) or equivalent.

Battery Eliminator now available for 3/6.



8-WATT AMPLIFIER

This design includes 5 miniature Valves of the latest types, an Ultralinear Output Transformer suitable for Speakers of 3 and 15 ohms and a very attractive Perspex front panel with gold lettering, complete set of parts, £8.8.0.

Built and Tested **£10.19.6**. Postage & Packing 5/- extra.

Read what a customer says about the MAYFAIR Telesivor

"I am writing to tell you that this set is a complete success, it is all you claim for it—Plus.

"Some 40 miles from the station a picture was obtained with a short length of flex, while a somewhat crude loft aerial produces results which astound my neighbours with their expensive factory-made sets.

"Construction was begun in some trepidation, the groaners implying that this was a somewhat risky operation to undertake, that the picture received would be an inch wide stripe on the screen, that the coils would be out of line, etc. You can imagine my delight when I switched on for the first time to find all the controls performed their various functions exactly—on sound and vision. This achievement on your part and mine gives added pleasure to viewing. Congratulations on an excellent circuit and kit."

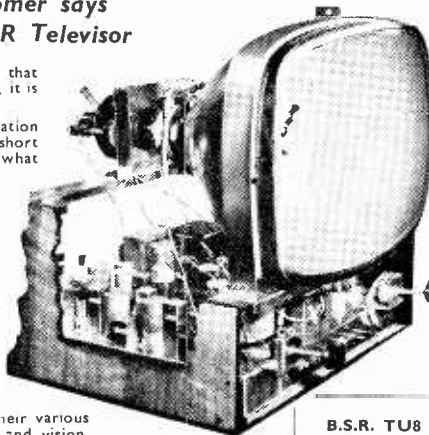

B.S.R. TU8

3-speed record player **£3.19.6**, plus 2/6 postage and packing.

MAY BE BUILT FOR £33.7.11

Plus cost of C.R.T. Send for Inst. Book 3/6.

PLEASE ADDRESS ALL MAIL ORDER ENQUIRIES TO Dept. (PT3), 207 EDGWARE RD., LONDON, W.2

VALVES • SAME DAY SERVICE

All Guaranteed New and Boxed

1.4 v. midget. 1R5, 1S5, 1T4, 3S4, 3Q4, 3V4, DAF91, DF91, DK91. DL82, DL84; ANY 4 for 27/6.

1C5GT	13/-	6V6GT	7/6	DF33	11/-	EP30(S)	4/6	PY80	8/-
1D5	9/6	6X4	7/6	DF91	7/6	EP80	7/6	PY81	8/6
1H5GT	11/-	6X5GT	6/6	DF95	8/6	EP85	14/-	PY82	8/6
1N5GT	11/-	7B6	12/6	DH76	7/6	EP91	6/9	PY83	8/6
1R5	8/-	7B7	8/-	DH77	7/3	EP92	5/6	PZ30	13/-
1S1	10/-	7C5	8/-	DK32	19/6	FL33	16/9	R19	18/-
1S5	7/6	7C7	8/-	DK31	8/-	EL33	22/6	SP41	2/6
1T4	7/-	7H7	8/-	DK32	8/6	EL41	9/6	SP61	3/6
1U5	6/6	7S7	9/-	DK35	8/6	EL42	11/6	U25	15/-
3A5	10/6	7Y4	8/-	DL33	9/-	EL34	8/9	U50	7/6
3Q4	8/6	12AH8	9/-	DL35	13/-	EM80	9/6	U52	7/-
3S4	7/6	12AT7	8/-	DL32	7/6	ENL	10/-	U76	7/6
3V4	8/6	12AU7	7/-	DL4	8/6	EY51	11/6	U78	7/-
5U4G	7/-	12AX7	8/-	DL95	8/6	EY86	12/6	UABC80	9/-
5V4G	11/9	12BA8	8/6	EAB(C8)	7/9	EZ10	7/9	UAF42	9/6
5Y3GT	7/6	12K7GT	7/6	EAF42	9/6	EZ41	10/3	UBC41	8/6
5Z4G	9/6	12K8GT	12/6	EB91	5/6	EZ80	6/6	UBF80	9/6
6AL5	5/6	12Q7GT	7/6	EB(C3)	7/6	EZ91	9/6	UGL49	14/6
6AM5	5/-	15S7	15/6	EB(C4)	9/6	FW1500	10/6	UCC85	9/-
6AM6	6/9	19AQ5	7/6	EBF80	8/9	GZ32	11/-	UCF80	10/6
6AQ5	7/6	25A6G	11/6	EC(C8)	8/-	KT30C	8/6	UCH42	9/9
6AT6	7/3	25L6GT	8/6	EC(C2)	7/-	KT67	6/6	UCH81	9/6
6BA6	7/6	25Z4G	9/6	EC(C3)	8/-	MH4	6/-	UCI43	14/6
6BB6	7/-	25Z6GT	9/6	EC(C4)	9/6	MU1	9/6	UF41	8/-
6BH6	9/-	35L4GT	9/6	EC(C5)	9/6	N18	8/6	UF42	15/-
6BJ6	7/-	35Z4GT	7/6	ECF80	10/6	PC(C8)	9/-	UF89	9/6
6BR7	10/6	35Z6GT	9/6	ECF82	11/-	PCF80	9/-	UL41	9/3
6BW6	8/3	50C1DG	24/6	ECH21	16/9	PCF82	10/-	UL44	22/6
6BW7	7/6	50L6GT	8/6	ECH35	10/-	PCF82	10/-	UL84	8/6
6CD6G	26/9	AZ31	11/6	ECH32	8/-	PCL82	11/6	URIC	9/6
6F6G	6/6	B36	15/6	ECH81	8/-	PEN44	11/-	UY21	15/-
6K7G	4/6	C133	16/9	ECL30	11/9	PEN36C	9/6	UY41	6/6
6K7GT	6/-	D77	5/6	ECL82	11/9	PEN46	6/-	UY85	7/6
6K9G	7/9	DAC32	11/-	EP37A	8/6	PL39	22/6	VP1B	9/6
6Q7GT	8/6	DAF31	7/6	EP41	9/6	PL51	15/-	VP41	6/6
6SL7GT	7/-	DAF95	8/6	EP41	9/6	PL82	8/6	W76	7/6
6SNTGT	7/6	DC(C9)	10/6	EP42	11/6	PL83	10/6	W77	5/6
6U4GT	11/-	7/-				X79	7/6	ZIT	6/9
6V6G	7/-								

Postage 6d. per valve extra.

Anv Parcel Insured Against Damage in Transit 6d. extra.

READERS RADIO

24, COLBERG PLACE, STAMFORD HILL, LONDON, N.16 STA 4587

T.V. TUBES

ALL MAKES, MOST SIZES, £5.0.0 EACH, PLUS POSTAGE AND INSURANCE 15/-.

GUARANTEED THREE MONTHS

12in. MAZDA 6 weeks delivery

GOVERNMENT SURPLUS & MANUFACTURERS CLEARANCE

I.T.A. AERIALS. NEW AND BOXED. 3 ELEMENT, 22/6. 5 ELEMENT, 27/6. CO-AX CABLE, 6d. per yd. AIR SPACED, 9d.

METERS. MOVING COIL 2½in. DIAM. 50 Micro-amp. £2.10.0 100 Micro-amp, £2.5.0. 100 milliamp, 12/6. 0-50 amp A.C., 4½in. diam., 25/-.

NIFE CELLS. 3 x 2½ x 1in., unused, 5/- each. 50/- doz. NIFE CELLS. 1½ v., 2/- each. 18/- doz.

RELAYS. High speed. 1,000+1,000 ohms. Plat. cont., 7/6. P.O. 3,000 type, 23,000 ohm coil 4-pole c/o, 20/- each. 6,500 ohm coil, 2 make 2 break, 11/6.

TORCH BULBS. Ever Ready 2.5 v. and 3.5 v., 16/- per 100. 9/- per 50.

HEADPHONES. Moving iron, low impedance, 6/- High, 9/- Balanced armature, low, 13/- High, 15/- Moving coil, low only, 10/- per pair.

VALVES. All valves tested before despatch on MULLARD'S latest ELECTRONIC TESTER.

3A4	6/-	6F1	7/6	6V6	7/-	EB91	5/6
50C5	10/-	6J5	6/-	6X4	7/-	ECH42	9/6
5Z4	9/6	6I6	6/-	6X5	7/-	EF36	6/-
6AB8	10/-	6J7	8/-	12AH8	10/-	EF37A	9/6
6AG5	5/-	6K7	4/6	12AT7	7/6	EF39	6/-
6AL5	5/6	6L5	7/-	12AU7	8/6	EF80	9/6
6AM6	7/6	6SC7	4/6	12AX7	8/6	EF91	7/6
6AQ5	7/6	65J7	6/-	12BH7	10/-	EF92	8/6
6AU6	8/-	65K7	5/-	12SH7	6/6	DAF96	9/6
6BE6	7/6	65L7	7/-	12SJ7	7/6	DF96	9/6
6BV6	8/6	65N7	8/-	12SK7	6/-	DK95	9/6
6C4	6/-					DL95	9/6

HUGGETT'S LIMITED

2/4, Pawsons Road, West Croydon.

Fig. 8. — Another type of frequency changer using a single valve.

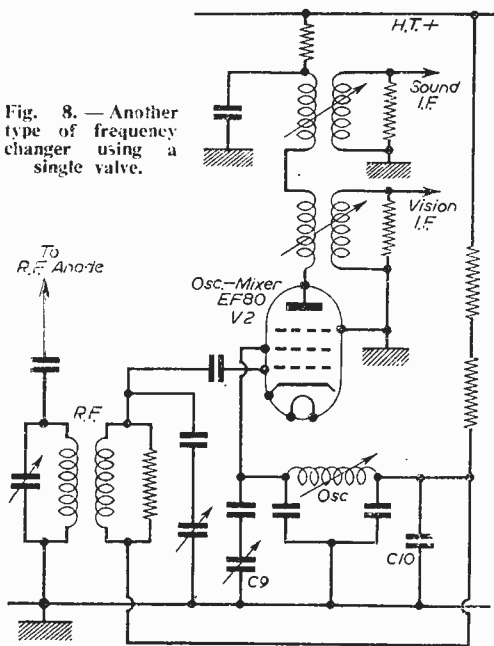

coupling between them being across the common impedance C10. The oscillator trimmer is C9. The amplified output from the R.F. stage is combined with the oscillator voltage in V2 which produces the separate sound and vision intermediate frequencies at the anode of V2.

Fig. 9 is a modern version of Fig. 7, the pentode section being the mixer and the triode section the oscillator. Automatic mixing of oscillator and signal frequencies does not take place in this valve as it does with the triode hexode where an internal connection is extended from the oscillator grid into the mixer section. The triode pentode is two separate valves in one envelope and therefore either an inductive or capacitive coupling is necessary between the two sections. The capacitor coupling seems the most popular and this is carried out by a very small value, usually about 2 P.F. by C11. The oscillator trimmer being C12.

The I.F. Amplifier

The R.F. and I.F. circuits must be designed to give a substantially flat response of 3.5 Mc/s where only the lower sideband is used. The I.F. usually chosen lies between 10 Mc/s and 38 Mc/s.

The vision signal appearing across the I.F. bandpass transformer L1/2 is fed to the I.F. amplifier V2 control grid, the amplified signal appears across L4/5 and is then passed to the diode detector. R1 and R2 in Fig. 10 are damping resistors shunted across the primary and secondary I.F. coils to maintain the required bandwidth necessary for good picture definition. The contrast control R3 operates the same as the gain control in the R.F. stages which has already been explained. Breakthrough of sound on vision is prevented by the sound I.F. rejector coil L3. This rejector

is only one of many types that can be used. The cathode circuit rejector mentioned in the forthcoming faults section as upsetting the stability of the stage if incorrectly adjusted is shown in Fig. 12.

The I.F. amplifier shown in Fig. 11 works in a similar manner to Fig. 10 except the I.F. coils L6 and L7 are of the single wound stagger tuned type which are much simpler for the amateur to design and align. But simplicity always has its snags. In this case it is the time constant developed by C1 and R4. In resistance capacity coupled circuits such as this a heavy burst of interference will charge C1 and cause grid blocking until the extra bias has leaked away, thus cutting down the stage gain to a low level. In bad cases the picture may be blacked out altogether for a few seconds. A stagger tuned circuit of this type does not normally require damping resistors across the coils and the value of the anode resistor in the previous stage can be slightly increased, which also reduces the damping effect giving higher gain to the stage.

The bandwidth is preserved by tuning two of the I.F. coils slightly to either side of the correct frequency and the third coil tuned to the frequency. This gives an overall pass-band of the required width. It should be remembered that too much staggering will reduce the overall gain. In fringe areas the coils can be peaked up a little to give a restricted bandwidth of 2 Mc/s, this will give greater gain per stage. But even greater gain can be obtained from a correctly designed and aligned I.F. transformer.

The Detector-video Amplifier and Noise Limiter Stages

Fig. 13.—The vision signal from the final I.F. stage L1 is passed to the detector anode VIA. The positive going video signal developed across R1 is fed to the grid of the video amplifier V2. The output from the amplifier is negative going on signal and is therefore suitable for feeding direct to the tube cathode. The sync pulse is always the reverse of the vision signal and is therefore positive going.

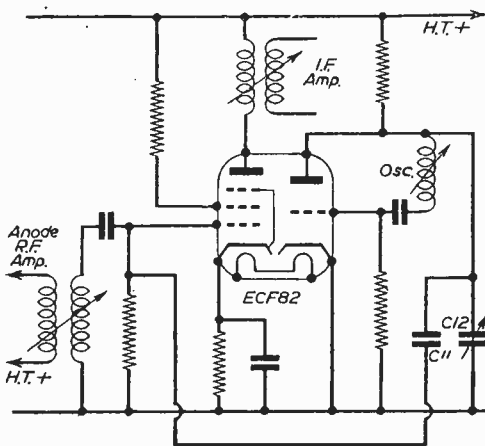

Fig. 9.—This is a modern version of Fig. 7.

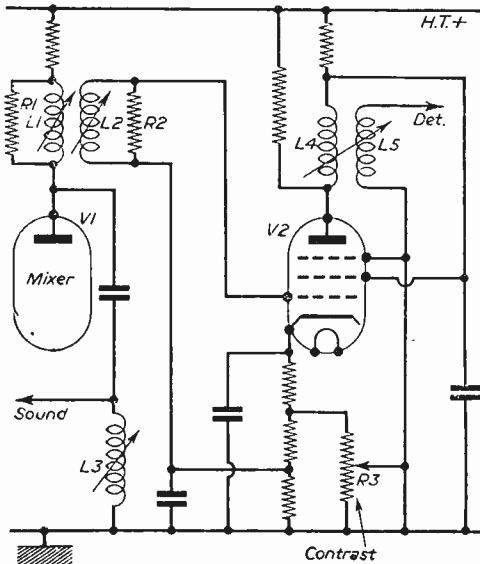

Fig. 10.—I.F. amplifier circuit.

The video frequency correcting circuit comprises of R2 and the choke L2, L3, and the damping resistor R3 prevents L3 from ringing at certain frequencies.

V1B is the interference limiter. bursts of interference send the cathode negative causing the valve to conduct, and this shorts out the video output momentarily through C1 to chassis, the voltage on the anode of V1B is varied by the limiter control R4 and the setting of this adjusts the level at which the valve conducts. The brilliance control network is also part of the potential divider feeding V1B, variation of the brilliance control will also affect the voltage on the limiter anode. V1B must be a low impedance type of valve otherwise it will not form an effective shunt during conduction.

Fig. 14.—As it will be immediately noticed that the two diodes and the input and output phase symbols to V4 are in reverse to those in Fig. 13, the cathode bias resistor is considerably lower in value. All this is necessary when the vision signal is fed to the tube grid. The output of V4 must be positive going on signal and the sync pulse is therefore negative going. The coil L4 is a filter coil to prevent voltages at intermediate frequencies from being fed into the video amplifier from the detector stage, the coil also provides a measure of compensation at the higher end of the video frequency band. The coil with the input capacitance of V4 resonates at about 4 Mc/s.

R5 is a damping resistor to prevent ringing. R6 is the diode load, its value is lower than the resistor in a similar position in the sound detector circuit. A low value of about 5K is necessary when the valve has to deal with frequencies of several megacycles per second in order to maintain the required frequency response. Now we have arrived at the detector a word or two about phasing may be helpful to the reader.

Phasing commences at the vision rectifier V3A. Notice should be taken of this valve to see which way round it is connected. If, for instance, this detector was reversed and the output from V4 was taken to the tube grid as shown, the vision signal would have the wrong polarity, and the picture would be the same as viewing a photographic negative. The sync pulses feeding the line and frame generators would also receive synchronising pulses of incorrect polarity and difficulty may be experienced in holding the picture steady. Further diagrams of correct phasing will be seen in the tube and time-base sections. This is one reason why it is not wise for the newcomer to TV to mix circuits, but to stick to a published design unless they have sufficient knowledge to take the polarity problems into consideration. Other examples which may confuse beginners are that in some receivers two video amplifying stages may be used, this means the polarity will again be reversed, the above remark does not apply to two video output valves in parallel. The same phase reversal takes place when a sync separator is followed by a sync amplifier or triode line and frame clippers are used prior to the generators, also when a phase splitter or cathode follower is used to feed the picture signal to the tube, at its anode will appear sync pulses of reversed polarity to those at its grid.

In Fig. 14 a positive going sync pulse could be taken from the cathode of V4 if required, or a negative going pulse from V2 cathode in Fig. 13, these connections will depend on the type of timebase in use.

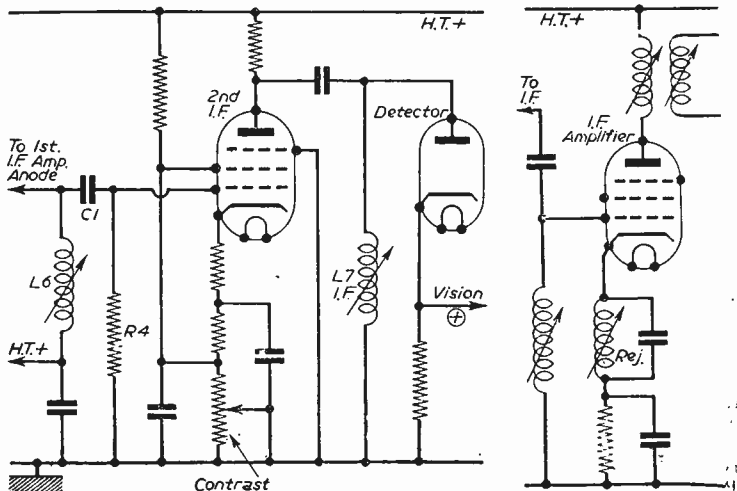

Figs. 11 and 12.—(Left) Another I.F. amplifier. (Right) The cathode circuit rejector.

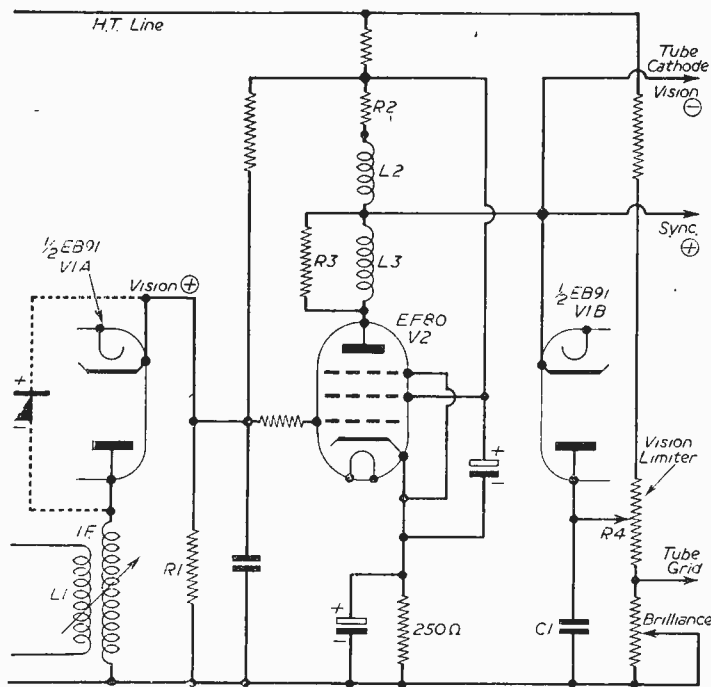

Fig. 13.—Germanium crystals can be used in place of the diodes.

In place of the diodes in Figs. 13 and 14 some designers prefer to use germanium crystals, but the ultimate results are the same. These are shown by the dotted lines.

Faults Affecting the Vision Strip

Sound on Vision.—Bars on picture, with trembling picture varying with sound intensity. A strong signal can cause overloading, attenuate the signal at the aerial or reduce contrast or gain control, tune oscillator to max. sound; also check for incorrect setting of the sound rejectors and for microphonic valve.

Ragged Verticals does not always originate in the sync stage, but may be weak signal in vision strip if accompanied by snow (grain specks on picture); also check aerial.

Loss of Highlights (Whites).—Check interference limiter for faulty components and tube for low emission, if the whites are clipped as though the vision interference limiter is at max., the fault may only be instability; check the decoupling condensers in the strip or if excessive contrast Check Det., Video Amp., and EHT.

Smearing. Flaring or Right-handed Overshoot.—Can be due to L.F. phase distortion; check the I.F. alignment and the crystal detector; check the black and white rectangle on top of the test card. Bad low frequency response can also be caused by faulty decoupling condensers especially the ones in the video amplifier, and check the voltage in this stage.

Pulling on Whites or Stepped Verticals.—Check the H.F. response. The fault is usually caused by

misalignment of one or more coils in the vision strip, this causes the sync pulse to fire the line oscillator out of step. Try staggering the tuning; check the video output valve and its components. If the fault still persists and picture definition is good, check the input condenser to the sync control grid and all the sync components (see sync faults).

Black after White or Reverse.—Misalignment fault again. Poor H.F. response. Check the damping resistors across the coils for high resistance or open circuit, examine the video amplifier and its components.

Plastic Effect.—Caused by poor L.F. response; align the tuned circuits; check the decoupling capacitors, the coil damping resistors and video correction chokes.

Smearing.—The faults on smearing given in an earlier paragraph should not be confused with smearing due to leakages across electrodes in

the C.R.T.; check also the damping resistors across the tuned circuits for O/C or high resistance.

Uncontrollable Brilliance.—This can be caused through other than tube defects or brilliance network faults. Check the video output stage components and valve and also the vision noise limiter.

(To be continued)

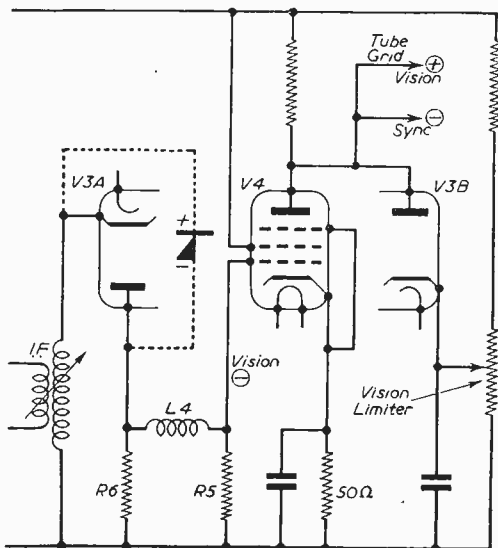
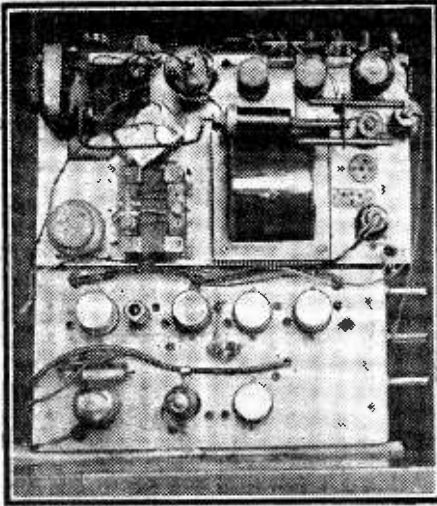

Fig. 14.—If required the positive going sync pulse can be taken from the cathode of B4.

A Home Constructed

A MODIFIED VERSION OF THE "VIEW MASTER" BBC CONVERTERS



Top view of the chassis.

As there has been a large number of requests from readers for constructional details of television receivers, the author decided to pick the best parts from past designs in this magazine and to bring them up to date.

"View Master" Circuits

It was intended to follow the "View Master" circuits, with all the modifications that have

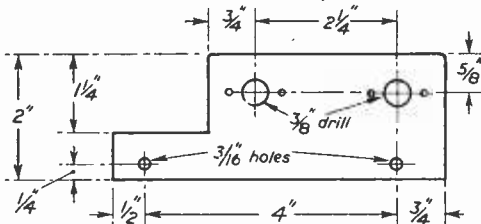

Fig. 4.—Extension piece for 2 controls.

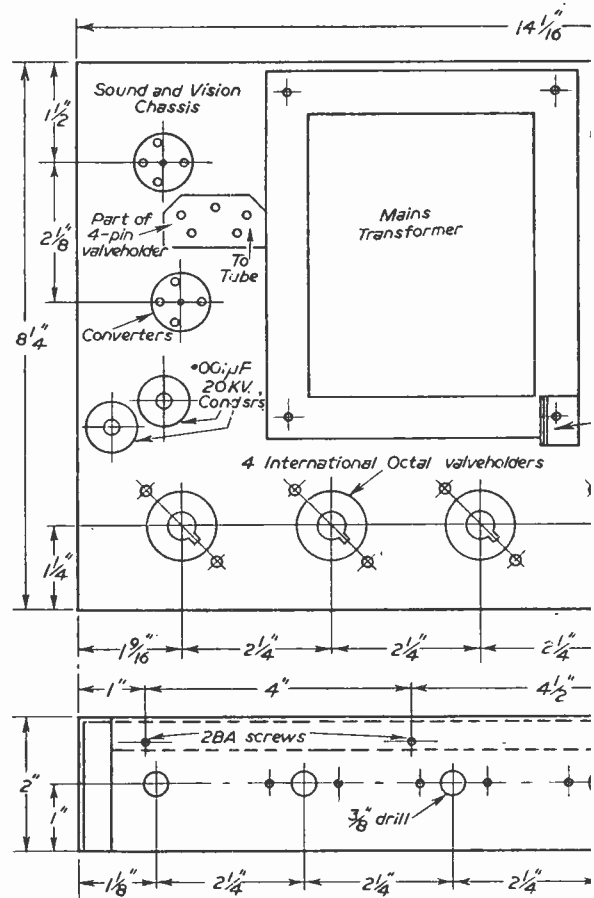
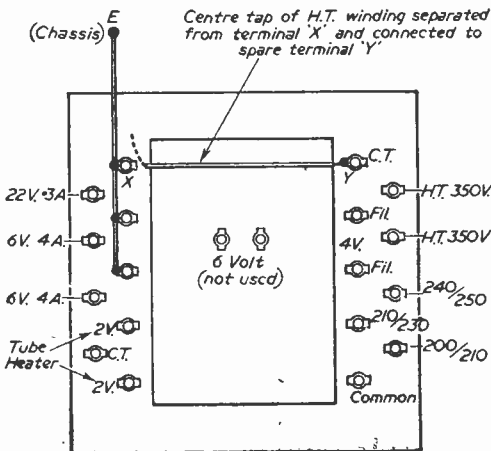
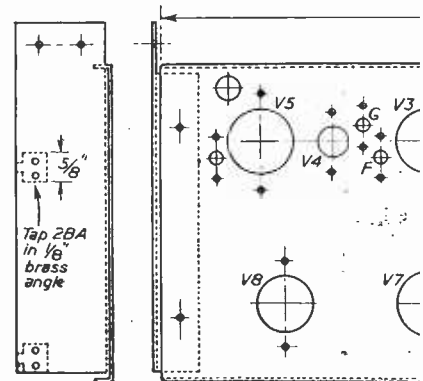

Fig. 2.—(Above) Modifications to chassis for power pack and time base (old Ultra power chassis).

Fig. 3.—(Left) Mains transformer showing modifications for centre tap.

Fig. 1.—(Right) Showing modifications to "View Master" chassis.



stated TV Receiver

ER" WITH DETAILS FOR MAKING ITV AND
By P. Green

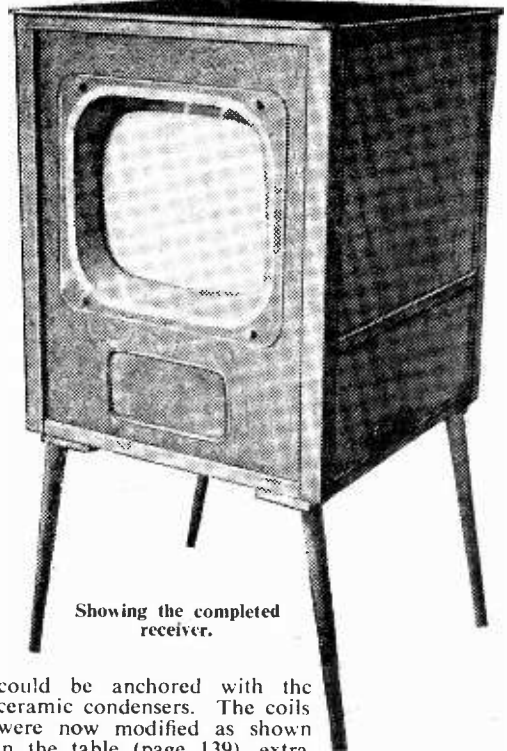

Showing the completed receiver.

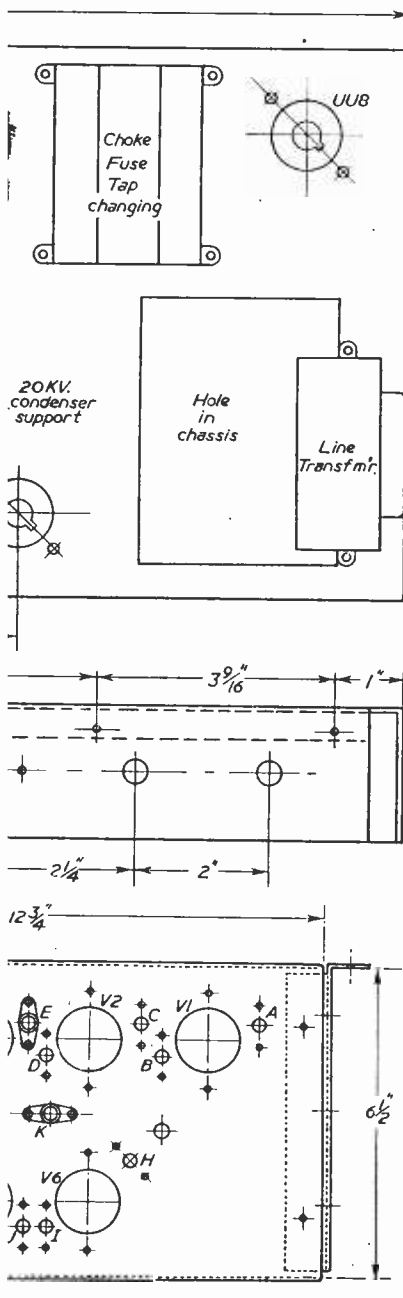

appeared in PRACTICAL TELEVISION from time to time. Wishing to obtain both BBC and ITV, a suitable sound and vision chassis was made, as shown in Fig. 1. The .0005 micadiscs were omitted and .001 ceramics used instead for fear of instability in the receiver due to insufficient decoupling when operating at lower frequencies, and a small terminal post was fitted at each micadisc position, so that the leads

Fig. 5.—(Right) Modifications to line time base. Values given for components changed.

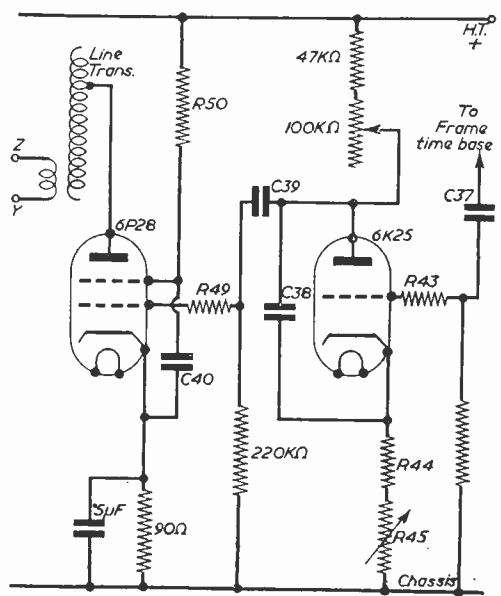

could be anchored with the ceramic condensers. The coils were now modified as shown in the table (page 139), extra turns being added as given for the conversion to 33-38 Mc/s in PRACTICAL TELEVISION dated December, 1955. The sound rejector coil was also wound on one of the spare formers. In wiring, the "View Master" diagrams were followed with

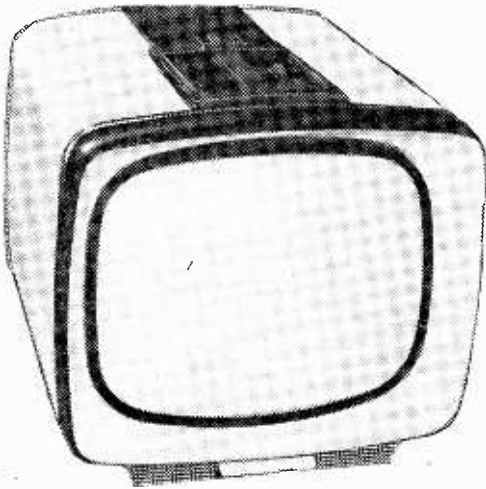

The Bush 14in. push-button transportable model.

LAST year portability was the main feature in television design and although a number of portable receivers were again in evidence at the show, this year the emphasis was on television receivers equipped with V.H.F./F.M. radio, and the use of printed circuits.

Purely as a novelty was a 29 transistor portable television receiver with an 8½ in. tube which operated from an 18 volt battery. It was shown working on the Vidor stand but is not available to the public as it was an experimental model Vidor have been working on for the past 18 months.

The Ferguson "400" series television receivers incorporated many new technical features, among them "Sequential Auto-Gain," which enables the best possible signal-to-noise ratio to be achieved combined with very good cross modulation characteristics. Another exclusive feature is a "Resonant Spot Limiter" which results in interference pulses (e.g., car ignition) appearing only as a grey dull spot instead of a bright white spot. Other technical features are "Stabilised EHT," "Frame Flyback Suppression," "Optimised D.C. Components," "Anti-drift Line Synchronisation" and "Positive Interlaced Circuit."

Large Picture Area

Ferguson showed a number of table models with either 17in. or 21in. electrostatically focused aluminised 90 deg. deflection angle tubes, and "push through" presentation affords the largest possible picture area. Two models were equipped with V.H.F./F.M. radio. The V.H.F. radio unit is entirely separate from the television circuit. Two other models had a sync-cancelled A.G.C. system with gated amplifier which gives a true black-level control over a wide range of signals and minimises re-adjustment when switching from one channel to another. A pre-set "local/distant" control enables the receiver to be adjusted upon installation for the best possible signal-to-noise

T/V AT THE NATIONAL RADIO SHOW

The Trend in Design at This Year's Exhibition

ratio. The flywheel line synchronisation uses a sinusoidal oscillator—an exclusive feature of Ferguson receivers.

All the models are convertible, matching legs being available for the 17in. models as an optional extra at two guineas and matching stands for the 21in. models at three guineas.

Printed Circuits

H.M.V. "New Highlight" receivers featured an electrostatically-focused 90 deg. deflection tube and a new type of tuner. Coils for all 13 channels are incorporated and a "slot" front facing speaker is fitted. Printed wiring is used for the sound and vision I.F. amplifiers and for the line output stages. An important feature in these new television models is the speaker, which occupies a relatively small space. The new-type multi-coil radial turret tuner has an exclusive colour-coded illuminator, showing green for BBC and red for ITV.

New is the resonant spot limiter for neutralising interference and automatic sensitivity compensation for best possible signal-to-noise ratio.

The above firm also showed a 17in. table model which included a self-contained radio unit to receive V.H.F. sound programmes. The fringe area models incorporated keyed automatic gain control to minimise output variation over a wide range of signal input, thus reducing the effect of fading due to weather and other conditions.

Dynatron offered many outstanding features in

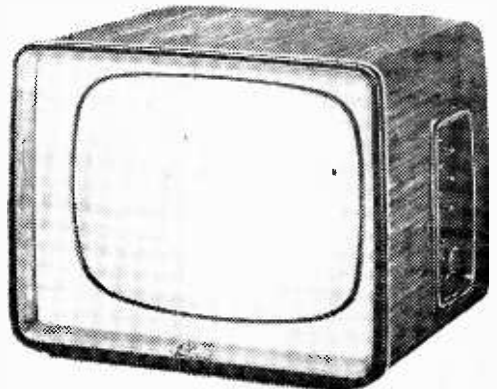

Marconiphone Model VT157, which is a 17in. A.C./D.C. table receiver for normal reception areas.

their receivers. They included aluminised tubes, automatic control of picture and sound and a highly efficient turret tuner. A wide choice of cabinet styles, for both console and table models, are available to suit varying tastes in furnishings.

A highlight of the Cossor exhibit was a new printed circuit television receiver of "unit construction" design. The receiver is composed of separate printed circuit boards which simplify servicing to a considerable degree. The 17in. 90 deg. aluminised tube is push through mounted

or fringe form. A standard model is also available incorporating V.H.F. radio.

Another push-button model was exhibited by Bush and is dealt with later.

Murphy Range

Murphy showed a universal television receiver incorporating V.H.F./F.M. radio which is identical externally with the now familiar V310 and retains all the features of that receiver. The

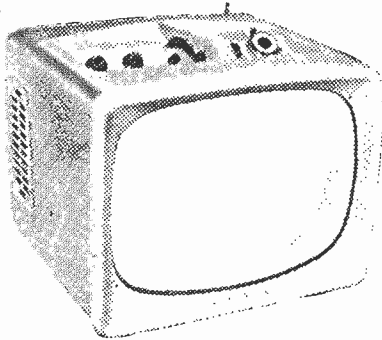

(Left) Another attractive transportable is the Ekco 14in. receiver incorporating VHF radio (Right) The Argosy Model 17 F41 for fringe reception.

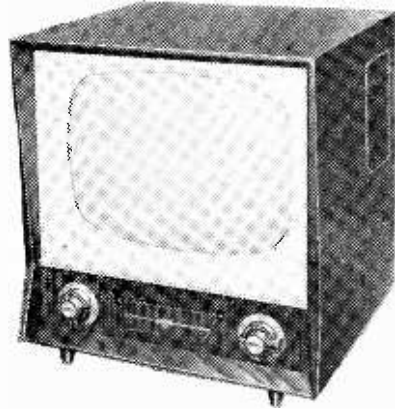

which means that maximum picture area is obtained as no part of the screen is masked.

A 21in. table model incorporated automatic picture control and syncrolock self-centering flywheel synchronisation to ensure a rock-steady picture. Also with a 21in. tube was a receiver specially designed for operation in Band I or Band III fringe areas. Universal models were also seen.

Another fringe area model with a 17in. aluminised electrostatic tube with direct synchronisation, automatic picture control, frame flyback

exclusive Murphy feature of easy operation on television with no fine tuner has been maintained. The special tuner provided serving for the selection of V.H.F. programmes only. The vision side of this receiver is also identical with the V310 but the sound channel has an innovation in that a double superheterodyne circuit is used. By permitting a low final I.F. this results in selectivity

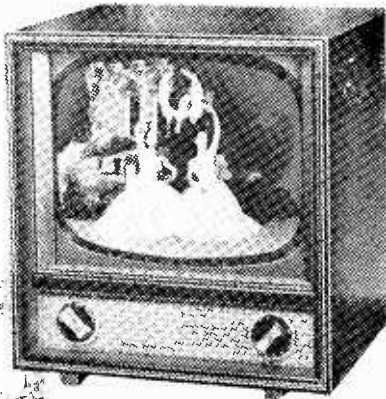

Two other attractive receivers are (Left) the Pye SP17 and (Right) the Invicta Model F.237.



suppression and automatic sound noise limiter was shown by Argosy.

Push-button Model

A push-button, high definition 17in. table model was shown by Pye, which, by pushing a button the highest possible definition picture automatically appears. The set is available in standard

on V.H.F. reception similar to that of a normal radio set.

The turret is provided with a special pair of coil biscuits to cover all BBC stations in the F.M. band. When these are brought into position a cam, fitted to the turret control shaft, operates the multi-pole changeover switch. Thus in changing over to V.H.F. the timebase valve heaters are switched off, as also are the tube heaters. In order to keep the heater current constant, an extra resistor is switched into circuit.

This resistor is located adjacent to the other heater droppers.

A Varite thermistor is provided within the switched heater chain to prevent current surges from damaging valves or tube. The H.T. connections to the timebase circuits are also broken and a ballast resistor is substituted to prevent the H.T. line from rising and causing valves and components to over-run. The vision I.F. amplifier is also muted to protect the video stage and tube. As the cascode and common I.F. valves are used both on television and F.M., they are switched to maximum gain for F.M. reception.

Ekco had three new 17in. receivers incorporating a channel selector on which the BBC and ITV stations are side by side. One of these models was suitable for the fringe area.

Unique Test Method

In the R.G.D. television range pride of place was occupied by the Deep Seventeen. A unique feature of this set is the fact that it begins its

Kolster-Brandes featured a 17in. lightweight portable TV, the Royal Star. It weighs only 38lb. and is available with a telescopic aerial, which is not required in all areas, and is therefore optional. The specification includes 14 valves, 3 germanium diodes, 90 deg. self-focus tube, miniature 13 channel tuner, printed circuits and wide range A.G.C. circuits. It measures 16in. X 16in. X 16½in.

24in. Model

Large size pictures are provided by a 21in. Console and a Consolette. Both of these models are available with V.H.F./F.M. if desired. The range of receivers has also been increased with a 17in. fringe model. The 24in. Regina Consolette provides one of the largest direct viewing pictures in Great Britain.

A 17in. screen receiver incorporating printed circuit design was shown by Spencer-West as standard and fringe models. Another receiver incorporated a vertically-mounted chassis with

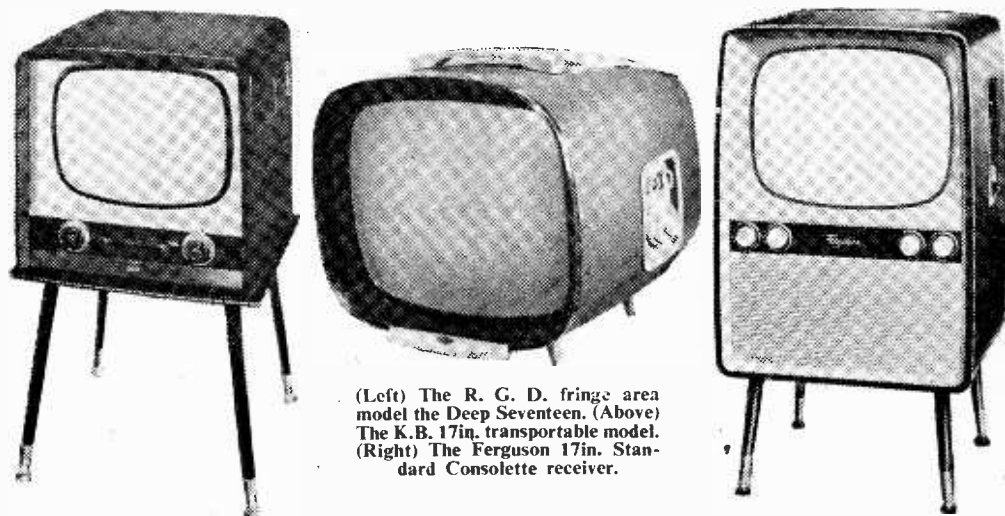

(Left) The R. G. D. fringe area model the Deep Seventeen. (Above) The K.B. 17in. transportable model. (Right) The Ferguson 17in. Standard Consolette receiver.

working life, fully operational, while still travelling along the factory conveyor line. Taking current from a live rail, it is subjected to a series of transmission tests, the results of which are computed electronically. R.G.D. engineers claim that their test methods, even at peak production, give a quality graph which is constant to within 3 per cent.

Bush exhibited a large number of receivers, the highlight of which was the Twin Set, which has a separate V.H.F. circuit and is for fringe area reception.

The first television receiver with push-button instantaneous switching from BBC to ITV and vice versa without further adjustment was the Bush 14in. transportable model. It covers all thirteen channels, but only four buttons are fitted, two for adjusting to any two channels on the BBC band (Band I—channels 1 to 5) and the other two channels on the ITV band (Band III—channels 6 to 13).

printed circuit, hinged for complete accessibility for servicing, at the same time leaving all hand controls in the mounted position for operation enabling testing to be carried out under ideal conditions.

Television Cameras

A novelty on the Peto Scott stand was a studio and an industrial television camera shown in conjunction with their 14in. and two 17in. television receivers, the latter having automatic self-locking synchronisation circuits to prevent line tearing, frame flyback suppression and regulated EHT. The studio camera was British built and the industrial camera is suitable for 405 and 625 line transmission.

Masteradio showed receivers with 17in., 21in. and 24in. tubes. Features of the sets was a new type of elliptical speaker facing front, improved automatic picture control, a new automatic focusing system giving freedom from focus and ion

trap adjustments and electrostatic focusing cathode ray tubes.

A number of sets from 14in. to 21in., including fringe models, were shown by Invicta Radio.

TV/Radiogram

Where living room space is a problem, this was overcome by Ferranti who introduced a TV/radiogram. Combined in this receiver were a 17in. television set, V.H.F./F.M. radio and a record player.

A new 21in. receiver introduced by G.E.C. incorporated V.H.F./F.M. radio and twin loud-speakers. Printed circuit technique was used in some of their designs.

Each of the new range of television receivers

date type for every purpose. Three of these valves, the 6/30I2, the 30FL1, and the 30PL1 possess identical characteristics in the triode sections, allowing an unusual flexibility in constructional layout.

The Mullard stand also showed new developments in cathode ray tubes and valves. A giant wire model of a valve was seen, the main features of which were highlighted and emphasised by explanatory captions.

Aerials and Components

Combined arrays for covering BBC and ITV reception were to be seen on J-Beam Aerials stand. To these can be added attachments for V.I.F. radio if required. Prominent among

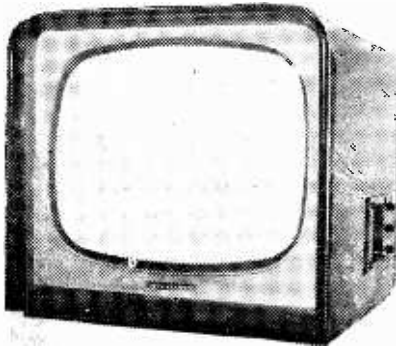

(Left) The Spencer-West Model 174. (Right) The Labgear picture equaliser.

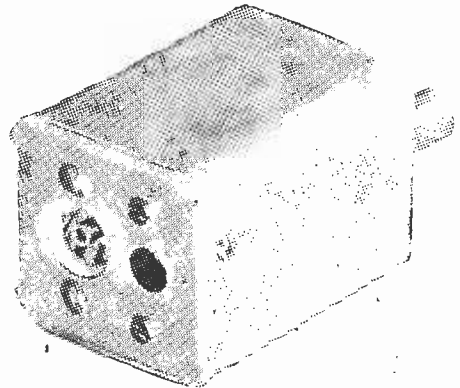

by McMichael used printed circuits and had V.H.F./F.M. radio. Two of their sets had multiple-speaker systems.

On the Pam stand was a transportable 17in. receiver capable of receiving V.H.F./F.M. broadcasts.

Features of the Philco range was 17in. receivers with variable interference suppressors and V.H.F./F.M.

The advantages of indirect viewing shown by the Valradio 48in. large screen projection receiver is the absolute absence of flicker and the photographic quality of the life-size 48in. picture.

Cathode Ray Tubes

One of the interesting features of the Siemens Edison Swan stand was the presentation of new developments in tube design.

Examples included the new 21in. electrostatic focus tube with a deflection angle of 110 deg. Another 21in. tube was the C.R.M. 212 90 deg. magnetic focus. The 17in. range was represented by two new electrostatic focus tubes: the first again had a deflection angle of 110 deg., and with it was the new C.M.E. 1702—a 90 deg. deflection tube with a maximum overall length of 15in. In addition, two new 14in. electrostatic focus tubes were seen: the C.M.E. 1402, which has a 90 deg. angle of deflection, and another tube which has appeared recently, the C.M.E. 141, with a 70 deg. deflection angle.

For the television receiver, a complete first preference range of 0.3 amp. heater current type valves was being displayed, providing an up-to-

these were the long and medium range folding double beam arrays being basically a two element Band I with a double four slot beam Band III for medium range, and a three element Band I with a double four slot beam Band III for long range. The skeleton slot principle is not only used to give optimum gain and bandwidth on Band III, but the matching properties on the skeleton slot are utilised to enhance the Band I

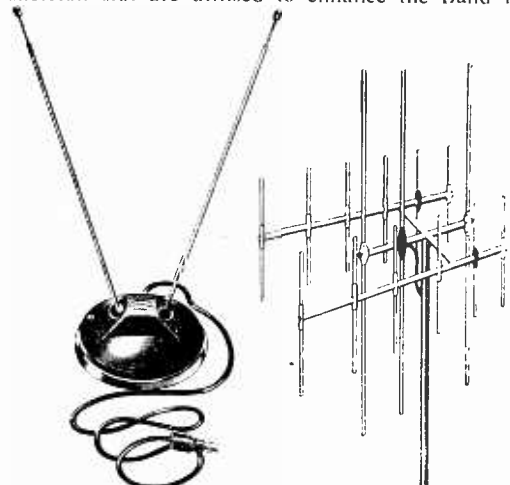

(Left) The Antiference, Ltd., Vantenna all-band room aerial. (Right) The Aerialite Acramatch 3 twin-band model 840 T.

performance. Complete isolation of each band is ensured by the use of co-axial isolating sections which even allow Band II elements to be added with no effect whatsoever on the television bands. For stronger signal areas there was the Unibeam and Twinbeam.

Burwell products showed the View Well range of Band III and combined aeriels, Band I and II aeriels, dipoles, loft aeriels, conversion kits for stacked arrays and chimney lashing kits.

On the Belling Lee stand was a comprehensive display of aeriels and accessories. Of interest was the Golden V television aerial attractively styled in black, with gold plated telescopic elements. It may be placed anywhere in the room—on top of the set or hung on wall or picture

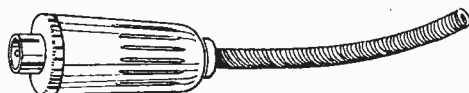
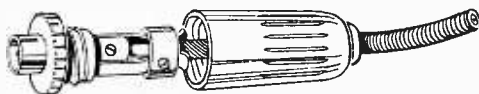

The Wolsey all-polythene construction solderless co-axial plug and socket.

rail. It is simply plugged into the set and the length and position of the elements adjusted to obtain the best results. A range of collapsible Band III attic aeriels made from flat aluminium strip were shown, as also were a new range of combined BBC/ITV attic aeriels for use in primary service areas. Among the accessories were diplexer and triplexer coupling units including waterproof versions, co-axial plugs and sockets and attenuators.

Room Aerial

Several important additions to the Antiference range included the Vantenna which is a new all-band room aerial and a range of loft aeriels for Bands I, II and III. The latter are of complete new design. The mast/boom clamp, angled arm and bracket provide a versatility which overcomes all loft mounting difficulties as well as permitting vertical or horizontal mounting plus tilting, rolling and turning for anti-ghosting.

Completing the display were a wide selection of diplexers, triplexers, outlet boxes, co-axial plugs and sockets, etc.

On the Aerialite stand the emphasis was on the range of twin band aeriels with the exclusive Crosslink connection. Within this range is a special array for every locality. Aerialite twin bands are not only supplied for varying distances from the transmitter but are also available in all channel combinations for loft, wall and chimney mounting.

Labgear showed their space match range for Bands I, II and III. This represented a departure from conventional design in as much as it uses space impedance termination to secure a uni-directional polar diagram from a V beam configuration.

The normal high gain associated with this type of array is thereby still further enhanced by an extra 3dB yielding an overall performance equivalent to an eight or nine element Yagi. In order to match the characteristic impedance of free space a skeleton conical arrangement is employed which greatly extends the band width enabling all existing channels on Band III to be covered. The aerial operates as a broad band half wave dipole on all channels in Band I and as a full wave broad band dipole on Band II and in this latter instance has mixed polarisation. It is, therefore, suitable for V.H.F./F.M. reception whether used in a Band I/III area of vertical or horizontal polarisation.

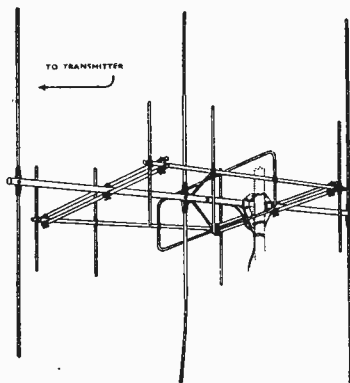

Folding double beam aerial shown by J-Beam Aerials, Ltd.

In addition there is a super model which incorporates a channelised Band I reflector for areas of poor Band I reception. This is an add-on unit enabling independent orientation on Band I and III.

Amplifier System

Wolsey Electronics have produced a completely new and flexible amplifier system. They can supply single amplifiers of large, medium and small gain for Bands I/III. The system provides a wide variety of amplifier units in many combinations for distribution purposes. For example, a unit is now available providing 12 outlets each having a Band I/III signal with a variable gain control on each input channel. Another example is a single outlet amplifier with a gain in the order of 50dB on Band III. This is also available for Bands I and II. The whole range has been designed to provide extremely high signal/noise ratio.

A solderless safety co-axial plug was also introduced by the above firm. Being entirely constructed from polythene no metal parts can be touched by hand when the plug is inserted in the socket. Further models will be dealt with next month.

WIRELESS COILS, CHOKES AND TRANSFORMERS

8th Edition.

Price 6/-, by post 6/9.

WONDERFUL OFFER OF A.M.-F.M. CHASSIS AT £14 (P. & P. 10/-)

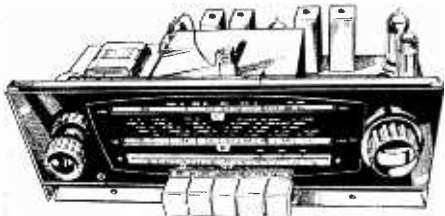

Why buy a F.M. Tuner at the same price?
 Tapped input 200-225 v. and 226-250 v. A.C. ONLY.
 Chassis size 15" x 6 1/2" x 5 1/2" high. New manufacture.
 Dial 14 1/2" x 4" in gold, red and deep brown.
 Pick-up, Extension speaker, Ac., E. and Dipole sockets.
 Five "piano" push buttons—OFF, L.W., M.W., F.M. and Gram. Aligned and tested. With all valves.
 Covers 1,000-1,900 M.; 200-500 M.; 88-99 Mc/s.
 Valves EZ80 rect., ECH81, EF89, EABC80, EL84, ECC85.
 Speaker & Cabinet to fit, polished, with back, 70/-.
 10" x 6" ELLIPTICAL SPEAKER 20/-.

TERMS:—(Chassis) £5 down + carr. and 5 Monthly Payments of 33/-, or with Cabinet and Speaker £6 down + carr. and 6 Monthly Payments of £2.

BEST VALUE FOR MONEY IN CONVERTERS

I.T.A. high gain converter. ALL CHANNELS ALL AREAS—ALL SETS. (For twin feeder input use a matching transformer at 5/- extra.) Direct switching (I.T.A. to B.B.C.); internal power pack; valves PCF80 and PCC84; moulded cabinet 8 1/2" x 4" x 6". No alteration to your set; fitted in 10 mins. 12 months' guarantee. Terms—see below.



£5.50 p. & p. 3/-

GRAMOPHONE AMPLIFIER with 5in. SPEAKER

WHY PAY MORE? ONLY 60/- (POST 3/-)

On Fabric-covered Baffle 12 1/2" x 5".
 Mains and Output Transformers. Metal Rectifier, ECL82 Valve. Tone and Volume Controls. On-off switch. Plenty of Volume. Fully Guaranteed. Two Knobs supplied. Ready to play.

BATTERY ELIMINATOR. Converts your Battery Set to Mains. For 4 Low Consumption Valves (DK96 range). 90 v. 15 mA. and 1.4 v. 250 mA. 42/6 (2/6 post). 200-250 v. A.C. Size 5 3/4" x 3 3/4" x 2".

I.T.A. AERIALS clipping to existing mast 1-2" dia. 3-element, 27/-; 5-el., 35/-; 9-el., 55/-; Loft mountg. 3-el., 20/-; 5-el., 27/6; Combined single B.B.C. and 5-el. I.T.A., 75/- with chimney lashings; Co-axial cable semi-airspaced, 8d. yd. or 20 yds., 12/6; aerial and cable prices carr. pd.

SEND 6d. FOR CATALOGUE

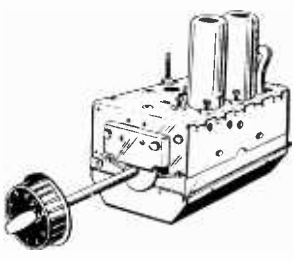

CYLDON 16 Mc/s and 19 Mc/s TURRET TUNER with two sets coils (state B.B.C. & I.T.A. channels). Extra pairs of coils, 5/- pr. With knobs. ONLY 77/6 (2/6 post). Brand new in original carton. Valves PCC84 and PCF80 included.

A NEW LINE FOR US



Electric shaver by Swiss precision watchmakers. As good as anything on the market and better than most. Rotary cutters with trimmer (patented) for sides and moustache. Make shaving a pleasure. 12 mths. guarantee. Proved in the difficult American market. A.C. and D.C. mains. Two types (A) 220-240 v., £7.17.6 in Gold Filled Red Box; (B) 110 v. and 200-250 v. in Presentation Case. £8.10.0, both post paid. No free trials as they work first time.

UNIC.

THE BRAYHEAD TURRET TUNER. £77.0, post free.

Complete with booklet and fitting instructions. State set and model no. when ordering.

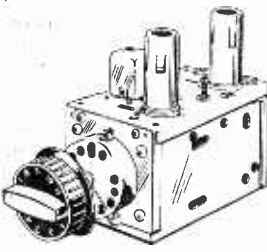
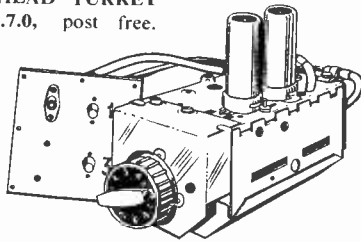

INCREMENTAL TURRET TUNER by famous manufacturer for 35 Mc/s only; with knobs. Valves PCC84 and PCF80. ONLY 77/6 post free or without valves, 60/-.

PERSPEX UNSCRATCHED, post 2/- each size, 6 post free: sizes in ins. 14 1/2 x 11 x 3/16 clear, 5/-; 12 x 9 1/2 x 1/4 clear, 4/-; 16 x 14 x 3/16 clear, 7/-; 15 x 12 x 1/4 tinted, 6/-.

Ex.-W.D. PERISCOPES, size 10in. x 6in., 7/6 (p. and p. 2/6).

ELECTROLYTICS 200-200-200 mf. 275 v., 7/6 (post 1/6). 200-100 mf. 275 v., 4/6 (post 1/-); many others.

BATTERY CHARGER. 1 amp. 6 v. and 12 v., £2, post paid.

Posted Orders to Camberley, please. Delivery by return. Terms:—One-third down and balance plus 7/6 in four equal monthly payments. Postage with down payment. (C.O.D. 2/- extra.)

These terms are applicable to all items except A.M.-F.M. chassis.

GLADSTONE RADIO

82B, High Street, Camberley, Surrey, and 3, Church Road, Redfield, Bristol. Tel.: 51207.

MAINS TRANSFORMERS
A new range of mains transformers for many post-war receivers. Mains input 200-230-250 volts. Mains List No. Output Price

MTD 1 210-0-210 v., 80 m.a., 6.3 v., 3.5 a. ... 32/-
MTD 2 230-0-230 v., 80 m.a., 6.3 v., 3.5 a. ... 32/-
MTD 3 250-0-250 v., 80 m.a., 6.3 v., 3.5 a. ... 32/-
MTD 4 260-0-260 v., 80 m.a., 6.3 v., 4.5 a. ... 32/-
MT MR 210 v., 70 m.a., 6.3 v., 3 a. ... 30/-

HEATER TRANSFORMERS
Primary 220-240 volts.

2 v., 1 a. ... 5/-
 2 v., 3 a. ... 8/3
 4 v., 1 1/2 a. ... 5/6
 4 v., 3 a. ... 10/-
 5 v., 2 a. ... 10/-
 6.3 v., 1 a. ... 5/6
 6.3 v., 1 1/2 a. ... 6/9
 6.3 v., 3 a. ... 10/-
 12 v., 1 a. ... 5/9

METAL RECTIFIERS each

12 v., 1 a. ... 1/6
 250 v., 45 m.a. ... 5/9
 250 v., 75 m.a. ... 6/6
 300 v., 60 m.a. ... 6/6

Full Wave:
 12 v., 1 a. ... 5/3
 12 v., 1 a. ... 9/-
 12 v., 4 a. ... 15/6

LINE OUTPUT TRANSFORMERS
Type No. Used in Model No's. Price

LO1 Pye V4-V7-V14-V17
 PAM 908-909-952-953-958, Invicta 118-119-120 ... 55/2
 LO13 Regentone BIG 125 ... 81/11
 LO17 Alba T372, T472, T372B, T392, T492, 9812B, TR9872, U1253 ... 43/2
 LO24 Corsor 927-932-929 ... 58/6

ALPHA RADIO SUPPLY CO.

VALVES
GUARANTEED ALL TESTED BEFORE DISPATCH

DAF96	10/6	KT33C	10-	3V4	9/-
DF96	10/6	KT66	15-	5U4	8/-
DK96	10/6	KTW61	8/-	5Y3GT	8/-
DL96	10/6	N78	12/6	5Z4	11/-
EBC33	7/6	OZ4	5/6	6A7	13/-
EBC41	10/-	PCC84	10/6	3AL5	6/6
EBF80	10/6	PCF80	13/6	6AM6	7/6
ECC84	10/4	PL81	16-	6P8G	14/-
ECC85	9/6	PL82	8/6	6P13	14/-
ECH35	10/6	PK25	12/6	6P15	5-
ECH42	10/6	PY30	9-	6K7G	8/6
ECH61	11-	PY81	10/-	6K8G	9-
ECL90	13/6	PY82	9/-	6L6G	9-
EF39	7/6	PEN4VA	15-	6Q7G	7/6
EF40	14/6	PEN25	5/-	6SN7	8/-
EF41	9/9	PEN4A1	15-	6SL7	14/-
EF50	4/-	SP41	3-	6V6G	7/6
EF41	9/6	SP61	3-	6V6GT	9/-
EF42	14/-	TP25	27/10	6X5G	9/-
EF80	9/-	U14	8/6	12AT7	9/-
EF86	14/6	U25	14/6	12AU7	8/-
EL41	11-	UCH42	10-	12A7	9/-
EL42	12/-	UL41	10-	12A7	8/-
EL81	10/6	VU39	8/9	12AX7	9/-
EM80	10/6	1C5	12/6	25A6	11/6
EY51	13/6	1H5	10/6	25L6	10/-
EY85	13/6	1N5	10/6	25Y5	9/-
EZ40	9/-	1R5	8/6	35L6	9/6
EZ80	8/9	1S5	7/6	35Z4	8/-
EZ12	12/-	1T1	7-	42	8/-
G23	8/6	3S4	8/-	80	8/6
HLZ3DD	8/6	3S4	8/-	80	8/6

BRIMISTORS

CZ1 ... 3/6 CZ8A ... 2/6
 CZ2 ... 2/6 CZ9A ... 2/6
 CZ3 ... 1/6 CZ10 ... 1/6
 CZ4 ... 5/- CZ11 ... 4/-
 C4 ... 5/- CZ12 ... 5/6
 CZ6 ... 3/6

CHASSIS
Aluminium Undrilled with Reinforced Corners. Available in the following sizes:

each each
 6" x 4" x 2 1/2" ... 4/6 12" x 8" x 2 1/2" ... 8/6
 8" x 6" x 2 1/2" ... 6/3 14" x 3" x 2 1/2" ... 6/-
 10" x 7" x 2 1/2" ... 5/9 14" x 9" x 2 1/2" ... 12/-
 12" x 3" x 2 1/2" ... 5/9 16" x 6" x 2 1/2" ... 8/6
 12" x 5" x 2 1/2" ... 6/9 16" x 10" x 2 1/2" ... 14/-
 8 - All are four-sided ideal for radio receivers-amplifiers-power packs, etc.

HARDWARE

Brass nuts
 2BA, 7/6 4BA, 3/- 6BA, 2/- 8BA, 2/-
 Brass Bolts (Round Headed)
 2BA x 1", 3/9 4BA x 1", 3/- 6BA x 1", 2/6
 2BA x 1", 4/6 4BA x 1", 2/6 6BA x 1", 2/9
 2BA x 1", 4/9 4BA x 1", 4/6 6BA x 1", 4/-

LOUDSPEAKER UNITS
* All Brand New * Note Special Prices * All Permanent Magnet 3 ohms Impedance.

each
 5" Units by Plessey, Goodmans, Lectrona ... 17/6
 6 1/2" Units by Plessey ... 18/6
 8" Units by Goodmans ... 19/6
 10" Units by Elac, Plessey ... 25/6
 6" x 4" Units by Plessey ... 19/6
 7" x 4" Units by Goodmans ... 19/6
 7" x 5" Units by Goodmans ... 19/6
 8" x 5" Units by Goodmans ... 25/6
 10" x 6" Units by Plessey ... 25/6
 Our 1958/9 Catalogue is available - send 1/- in stamps for your copy.

"T.V. Faults," by N Stevens—a quick reference fault guide, giving more than 60 faults with test procedure. 5/4 post free. TERMS: Cash with order or C.O.D. Postage and Packing charges extra, as follows: Order value 10/- add 1/3; 20/- add 1/9; 40/- add 2/6; £5 add 3/6. Minimum C.O.D. Fee and Postage 3/-. For full terms of business see inside cover of our catalogue. Personal Shoppers 9 a.m. to 5 p.m. Monday to Friday. Saturday 10 a.m. to 1 p.m.

103 LEEDS TERRACE, WINTOWN STREET, LEEDS, 7.

AN ELECTRONIC ORGAN FOR THE HOME CONSTRUCTOR

By Alan Douglas, M.I.R.E., M.A.I.E.E.
 Here is a do-it-yourself book which gives straightforward instructions for building an inexpensive electronic organ. Compact and easily transportable, the instrument has been specially designed for amateur use in church, hall or home. Detailed step-by-step instructions are given, as well as a complete list of materials and their suppliers.

Illustrated with photographs and diagrams. From booksellers, 15/- net.

PITMAN

Parker St., Kingsway, London, W.C.2

BAND III CONVERTOR for ANY SET in ANY AREA

This unit has been widely used since I.T.A. Transmissions began to convert all types of sets, Superhet and T.R.F., to receive on Band III.

Unlike many other convertors this unit is small enough to be fitted inside your cabinet, enabling the job to appear finished and perfectly safe for all to use.

- The wiring is simple to follow, and alignment is not difficult.
- ★ IT will convert any set, any age, T.R.F. or Superhet.
- ★ IT includes station switching.
- ★ IT provides pre-set contrast balancing.
- ★ IT uses only one aerial input for both bands
- ★ IT provides manual tuning on Band III.
- ★ IT is totally screened.
- ★ IT completely rejects unwanted signals.
- ★ IT requires no additional power supply where either 6.3 v. or .3 amp. heater line is available.

CONVERTOR wired and aligned with fitting instructions ... £3 10 6
KIT complete in every detail, less knobs ... £2 10 6
KNOBS each ... 1 0
CIRCUIT and instructions in detail (free with kit) ... 1 6
KITS made up by customers checked and aligned, including post ... 12 6

When ordering please state present B.B.C. Station and I.T.A. Orders over £2 post free.

C. & G. KITS
 285, LOWER ADDISCOMBE ROAD, ADDISCOMBE, CROYDON, SURREY
 Phone: ADDiscombe 5262

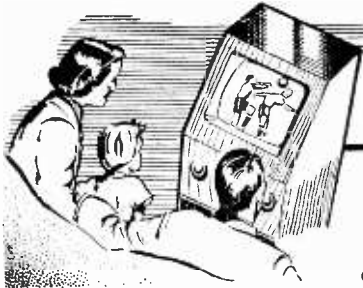

UNDERNEATH THE DIPOLE

A MONTHLY COMMENTARY

By *Iconos*

Manchester Progress

BOTH Granada and ABC-TV are spending a lot of money on improvements at their Manchester Studios. Having got their new large and well-fitted stage into operation, Granada have now branched out into extensions of ancillary premises and plant. There will be a special sound effects studio for all types of programmes, music and tape recording libraries, an Ampex recording department for magnetic recording of pictures, together with new wardrobe, make-up and dressing-room facilities. This is a practical indication of the success of commercial television in the Northern area, excerpts only of which are seen in the South from time to time. A small point which puzzles some of my friends in Lancashire is the Granada Network's habit of omitting the National Anthem at the end of the programmes. I feel this must be an oversight, as occurred at the start of BBC television after the war. I admit that I may not always look and listen to the National Anthem at the end of television on BBC or I.T.A., but I would feel very offended if it wasn't there. As far as I know, all other television organisations in this country always end their programmes with the National Anthem.

I.T.A. Extensions

I.T.A. programme companies are now making a reasonable profit, commensurate with their early losses, as one executive put it. And as those initial losses went into millions, the returns must now be highly satisfactory, to say the least. At any rate, nearly all the area stations are expanding rapidly and now spending quite a lot of money on new equipment and facilities. Apart from the

extensions already mentioned at Granada's Manchester Television Centre, their London Chelsea television theatre is being refitted with new permanent control rooms, additional lighting by Mole-Richardson, improved lighting control equipment by Strand Electric and new 4½in. Image Orthicon cameras by Marconi. Associated Rediffusion are planning large studio extensions at Wembley, including a huge studio stage, which will probably be the largest television stage in Europe. Scottish Television are also spending a lot of money on new lighting equipment and expanding their facilities. Southern Television, having converted the Plaza Cinema, Southampton, into a compact yet very complete television centre, are arranging for Post Office lines to London for reverse network operation. This will not come into operation immediately, and the opening all-star programme, together with a weekly mystery serial will be sent to London via a number of temporary microwave link "hops." When I called at the studio recently, some of this equipment, supplied by E.M.I. was just arriving. Most of the television equipment at Southampton will be provided by E.M.I., though a flying-spot

telescope apparatus will be supplied by Cintel.

East Anglia

THE changed financial climate of independent television operation has also put a different aspect on the planning of future studios in the smaller areas yet unoccupied, East Anglia, for instance, with an I.T.A. transmitter at Mendlesham, Suffolk, will be served by the Anglia studios, Norwich. This will be quite an elaborate set-up in the large Agricultural Hall building in the centre of that city, formerly used for circuses, exhibitions and agricultural shows. This is an 80-year-old building, slightly reminiscent of a small Alexandra Palace, which is ideally suited for conversion into two quite large television stages, with plenty of space for ancillary offices, dressing-rooms and workshops. I understand that the Mendlesham aerial will be highly directional, radiating most of its power in a north-westerly direction, and will be mounted on one of the highest television masts in Europe—1,000ft. high.

Regional Tastes

BOTH BBC and I.T.A. cater to some extent for local

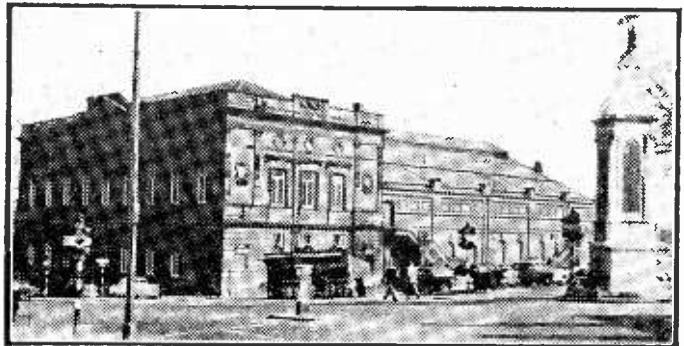

Showing the imposing building of the Agricultural Hall at Norwich.

tastes. I.T.A. companies take the majority of the programmes from the I.T.A. Network, but these are varied with a few local programmes, together with films specially obtained and run on the local telecine equipment. Local programmes are especially popular in Scotland and Wales, some of them obtaining quite high ratings from the public opinion polls—T.A.M. and Nielsen. I would expect that a strong regional flavour will also be appreciated when the South Western area I.T.A. transmitters start operating for Devon and Cornwall. Cornish viewers in particular appreciate a local flavour to their entertainment. BBC regional studios in Manchester, Birmingham, Glasgow and Cardiff make frequent contributions to the BBC programmes, and to these will shortly be added a studio at Southampton.

Automation

THE keynote of most of the new equipment coming along for television studios is automation—or, at least, semi-automation. When the BBC reopened the Riverside Studios, Hammersmith, a year or so ago, with two large stages and a very elaborate lighting equipment, it was considered to be the most up-to-date television studio in the world. It still is one of the best from the facilities point of view, but several further developments in lighting and lighting control have been made as a result of experiences there. Both Mole-Richardson and G.E.C. have produced new types of lightweight spotlights, the focus and other adjustments on which can be made with "lamp-lighter" poles, manipulated by an electrician on the studio floor. This avoids lowering the lamp for adjustment or the use of ladders or steps to reach the lamp. Telescopic and lazytongs types of lamp support are now in general use, various types of runners are installed for moving lamps from one part of the stage to another in the shortest possible time and with the minimum of labour. Strand Electric have also improved their elaborate organ console remote lighting control, and various new types of memory devices have been

devised for "punching up" lighting arrangements for different stage settings in advance, with their dimmers pre-set to give the best results as determined at rehearsals. Mole-Richardson have also produced a new lightweight general purpose lamp, which can be readily converted from a flood to a spotlight. Many of these devices are in the course of being installed at BBC and I.T.A. studios and will improve the general quality of the picture. Operation of the lighting is then in the hands of one man, who should be well versed in the art of portrait photography.

A High Density

IN the United States, an investigation carried out by an advertising research body, has brought to light the amazing fact that 84 per cent. of the homes in that country have television installed. The actual figures are 50,540,000 homes and 42,400.00 with TV. This represents a substantial increase over the survey carried out two years ago, when the respective figures were 48,800,000 homes and 35,500,000 with television, a percentage of 72.8.

Colour TV Demonstrated in Poland

DURING the course of the recent Polish International Trade Fair in Posnan, colour television was demonstrated by the Radio Corporation of America. This is said to be the first time such a show has been organised behind the Iron Curtain. All the programmes were originated in a specially erected studio inside the American Pavilion and were

watched by visitors on a number of R.C.A. colour TV receivers.

Television in China

USING a 625 line standard, the first television station in China has been opened in Peiping. During the course of the next year a second station is to be established in Canton.

Hong Kong Vision Service

IN May 1957, the first public television service to be operated in any British Colony was opened by the Governor on behalf of Rediffusion. This was an additional service to the relaying of sound programmes in the three main Chinese dialects which had been functioning for some years. The rapid growth of this combined service has necessitated the provision of plans for a new nine storey building and it is anticipated that this will be ready for occupation next year.

Creating a TV Commercial

A DETAILED presentation showing the creation of a TV commercial was the theme of the display by the five agencies of The Advertising Service Guild at the first European Television Exhibition at Park Lane House, London, W.1. from May 19th to 24th.

A huge wall display, 27ft. X 9ft. in the form of a progress chart, simplified by colour and illustrated by photographs, traced the creation of a TV commercial from the first contact with the client and product research to the final transmission—and subsequent audience inquiry. Separate panels also illustrate the work in television of each agency.

PRACTICAL WIRELESS

CHIEF CONTENTS OF OCTOBER ISSUE

NOW ON SALE, 1/3.

A 3-TRANSISTOR 200 mW AMPLIFIER
 A HIGH QUALITY RECORD PLAYER
 CAR RADIO INTERFERENCE SUPPRESSION
 BEGINNER'S CONSTRUCTIONAL COURSE
 SERVICING PRINTED CIRCUITS
 A TOP-BAND TRANSMITTER
 A TRAWLER AND MEDIUM WAVEBAND
 DIRECTIONAL RECEIVER

The decision is yours. To be a success in your chosen career ; to qualify for the highest paid job . . . to control a profitable business of your own. ICS home-study courses put your plans on a practical basis ; teach you theory and practice ; give you the knowledge and experience to take you, at your own pace, to the top.

Technical Training in Radio, Television and Electronics Engineering with

Choose the **RIGHT** course :

RADIO AND TELEVISION ENGINEERING : RADIO AND TV Servicing ; RADIO SERVICE AND SALES : ELECTRONICS : VHF/FM ENGINEERING

ICS provides thorough coaching for professional examinations :

A.M. BRIT. I.R.E., City and Guilds Telecommunications, Radio Amateurs P.M.G. Cert. (Marine).

LEARN AS YOU BUILD

Practical Radio Courses

Gain a sound up-to-professional standards knowledge of Radio and Television as you build **YOUR OWN** 4-valve T.R.F. and a 5-valve superhet radio receiver Signal Generator and High-quality Multi-tester. At the end of the course you have three pieces of permanent and practical equipment and a fund of personal knowledge and skill. ICS Practical Radio courses open a new world to the keen Radio amateur.

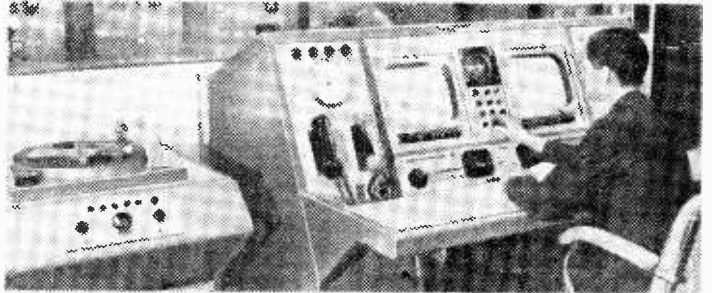

THERE ARE ICS COURSES TO MEET YOUR NEEDS AT EVERY STAGE OF YOUR CAREER FILL IN AND POST THIS COUPON TODAY.

you will receive the FREE 60 page ICS Prospectus listing examinations and ICS technical courses in radio, television and electronics PLUS details of over 150 specialised subjects.

Other ICS courses include : AGRICULTURE, HORTICULTURE, ARCHITECTURE, WOODWORKING, SALES-MANSHIP AND SALES MANAGEMENT, ART, PHOTOGRAPHY, MECHANICAL ENGINEERING, MOTOR ENGINEERING, FIRE ENGINEERING, CHEMICAL ENGINEERING, Etc., etc. **A WHOLE WORLD OF SKILL AND KNOWLEDGE FOR THE KEEN STUDENT.**



INTERNATIONAL CORRESPONDENCE SCHOOLS

(DEPT. 172 S), 71 KINGSWAY, LONDON, WC2

PLEASE SEND FREE BOOK ON

NAME

ADDRESS

OCCUPATION AGE.....

10.58

RADIO SUPPLY CO. (LEEDS)

(opposite)

LTD., Dept. N, MAUDE ST. parish church school), LEEDS 2.

Post Terms C.W.O. or C.O.D. NO C.O.D. under £1. Postage 1/6 extra under £2. 2/9 under £5. Open to callers 9 a.m. to 5.30 p.m. Sats. until 1 p.m. S.A.E. with enquiries, please. Full list 6d.; Trade list 5d.

R.S.C. TRANSFORMERS

Fully Guaranteed
Interleaved and Impregnated.
Primaries 200-230-250 v 50 c/s screened
TOP SMOOTHED DROP THROUGH
260-0-260 v 70 ma, 6.3 v 2 a, 5 v 2 a ... 16/9
350-0-350 v 80 ma, 6.3 v 2 a, 5 v 2 a ... 18/9
250-0-250 v 100 ma, 6.3 v 4 a, 5 v 3 a ... 23/9
350-0-350 v 100 ma, 6.3 v 4 a, 5 v 3 a ... 23/9
350-0-350 v 150 ma, 6.3 v 4 a, 5 v 3 a ... 29/9

FULLY SHROUDED UPRIGHT
250-0-250 v 60 ma, 6.3 v 2 a, 5 v 2 a
Midget type 21-3-31n. 17/9
250-0-250 v 100 ma, 6.3 v 4 a, 5 v 3 a ... 26/9
250-0-250 v 100 ma, 6.3 v 6 a, 5 v 3 a
for K1355 Conversion 31/-
300-0-300 v 100 ma, 6.3 v 4 a, 5 v 3 a ... 23/9
350-0-350 v 100 ma, 6.3 v 4 a, 5 v 3 a ... 23/9
350-0-350 v 150 ma, 6.3 v 4 a, 5 v 3 a ... 33/9
425-0-425 v 200 ma, 6.3 v 4 a, C.T. 6.3 v
4 a, C.T. 5 v 3 a ... 49/9

FILAMENT TRANSFORMERS
All 200-250 v 50 c/s Primaries; 6.3 v
1.5 a, 5.9; 6.3 v 2 a, 7.6; 0-4-6.3 v 2 a, 7.9;
12 v 1 a, 7.11; 6.3 v 3 a, 8.11; 6.3 v 6 a, 17.9.

CHARGER TRANSFORMERS
200-250 v 0-9-15 v 1 a, 11.9; 0-9-15 v 3 a, 16.9;
0-9-15 v 5 a, 19.9; 0-9-15 v 6 a, 22.9.

OUTPUT TRANSFORMERS
Standard Pentode 0-9-15 v 3 ohms ... 4/9
Small Pentode 5,000 to 3 ohms ... 3/9

SMOOTHING CHOKES
100 ma 10 h 250 ohms ... 8/9
80 ma 10 h 350 ohms ... 5/6
80 ma 10 h 400 ohms ... 4/11

SELENIUM METAL RECTIFIERS
250 v 250 ma, 12.5 v 20 v 40 ma, 3.9;
6/12 v 1 a F.W., 4.11; 240 v 50 ma, 4.11;
6/12 v 2 a F.W., 8.9; 6/12 v 4 a, 14.9; 250 v
80 ma, 7.9; 6/12 v 6 a F.W., 19.9; 6/12 v
10 a, 25.9; 6/12 v 15 a, 35.9; 24 v 2 a, 14.9.

CAXIAL CABLE 1in. 8d. 3d.
75 ohms 14.3d.
Twin-screened Feeder ... 11d. 3d.

BATTERY SET CONVERTER KIT
All parts for converting any normal type
of Battery Receiver to A.C. mains 200-250 v
50c/s. Supplies 120 v, 90 v or 60 v at 40 ma,
fully smoothed and fully smoothed L.T.
of 2 v at 0.4 a to 1 a. Price including circuit
49/9. Or ready for use, 9/9 extra.

**ALL DRY RECEIVER BATTERY
ELIMINATOR KIT.**—All parts for the
construction of a unit (metal-case
51-41-2in.) to supply Battery Portable
receivers requiring 90 v and 1.5 v. Fully
smoothed. From 200-250 v 50 c/s mains.
Price, inc. point-to-point wiring diagrams,
39/9. Or ready for use, 46/9.

**EX-GOVT. DOUBLE WOUND STEP
UP/STEP DOWN TRANSFORMERS**
10-0-100-200-220-240 v to 5-0-75-115-135 v
or REVERSE, 80-100 watts. Only 12.9,
plus 2 p. post. 10-0-100-200-220-240 v to
9-0-110-122-136-148 v or Reverse, 200
watts. 35.9, plus 7.6 carr. Both 50 c.p.s.

EX-GOVT. CASES. Well ventilated,
black crackle finished, undrilled cover.
Size 14 x 10 x 8 1/2 in. high. IDEAL FOR
BATTERY CHARGER OR INSTRUMENT
CASE, OR COVER COULD BE USED FOR
AMPLIFIER. Only 9.9, plus 2.9 postage.
Size 13 1/2 x 8 1/2 x 6 1/2 in. with undrilled perforated
cover finished stoved grey enamel,
7.9, plus 2.9 post.

EX-GOVT. VALVES (NEW)

1R5	7.9	6K7G	3.9	DF96	8.9
1T4	7.9	6Q7G	9.11	EBC33	6.9
185	7.9	6X5GT	7.9	EB91	8.9
384	8.9	6SN7GT	8.9	ECC91	4.6
5Y3G	7.9	6L6G	11.9	EP91	8.9
6U4G	8.9	907	7.9	EL32	3.9
6J5C	4.9	12A6	7.9	EL91	5.9
6K8G	9.9	25Z4G	8.9	FV4/500	8.9
6SJ7GT	6.9	35Z4	6.9	KT61	7.9
6V6G	7.9	3MH4	4.9	KT66	11.9
6U5G	3.9	6AT6	7.9	SP61	2.9
6J6	4.9				

EX-GOVT. MAINS TRANSF.
Removed from New ex-Govt. units.
Primary 0-200-130-250 v. Secs 275-0-275
v 100 ma, 6.3 v 7 a, 5 v 3 a

All 200-250 v 50 c/s input.
230-0-230 v 80 ma, 12.6 v 1.5 a, 5 v 2 a ... 11/9
250-0-250 v 150 ma, 5 v 3 a ... 16/9
350-0-350 v 160 ma, 6.3 v 5 a, 5 v 3 a ... 27/9
400-0-400 v 250 ma, 5 v 2 a, 5 v 2 a ... 18/9
450-0-450 v 150 ma, 6.3 v 5 a, 6.3 v 1 a,
5 v 3 a ... 29/9
450-0-450 v 250 ma, 6.3 v 3 a, 6.3 v 1 a,
5 v 6 a ... 49/9
12.5 v 3 a, 5 v 3 a ... 12/9

EX-GOVT. SMOOTHING CHOKES—
80 ma 10 h 150 ohms ... 3/11
100 ma 5 h 100 ohms Tropicalised ... 3/11
100 ma 8-10 h 100 ohms Parmeko ... 6/-
120 ma 12 h 100 ohms ... 9/9
150 ma 6-10 h 150 ohms Trop. ... 6/9
150 ma 10 h 150 ohms ... 11/9
250 ma 20 h 200 ohms ... 18/9
200 ma 3 h 100 ohms ... 9/9

ELECTROLYTICS (NEW)

Tubular		Can Type	
8 mfd 450 v	1.9	8-9 mfd 450 v	2.11
16 mfd 450 v	2.9	8-16 mfd 450 v	3.11
8-16 mfd 500 v	4.11	16-16 mfd 450 v	4.11
25 mfd 25 v	1.3	32-32 mfd 350 v	4.9
50 mfd 12 v	1.3	32-32 mfd 450 v	5.9
50 mfd 50 v	1.9	150 mfd 450 v	5.9
100 mfd 25 v	2.9	100-100 mfd 350 v	5.9
3,000 mfd 6 v	3.9	100-200 mfd 275 v	6.9
6,000 mfd 6 v	3.11		6.11

BATTERY CHARGERS.—For mains
200-250 v 50 c/s. Output for charging 6 v or
12 v at 1 amp. In strong metal case. Only
27.9. Above can also be used for electric
train power supply.

14 c. SUPPLY KIT.—Suitable for
Electric Trans. Consists of mains trans.
200-250 v 50 c.p.s. A.C. 12 v 1 a Selenium
F.W. Bridge Rectifier, 2 Fuseholders, 2
Fuses, Change Direction Switch, Variable
Speed Regulator. Partially
drilled Steel Case, and Circuit. 29/9

NEW-MAX ELECTRONICS LTD.

For London's Finest Bargains in
electronics, television and radio
equipment.
500 REPOSESSED AND SHOP SOILED
T.V. SETS IN STOCK. ALSO LARGE
SELECTION OF TAPE RECORDERS
ALL GUARANTEED.

T.V. TUBES

RECLAIMED & GUARANTEED
10in. and 12in. £6; 14in. £5; 15in.
and 17in. £7.10.0.

BRAND NEW FULLY GUARANTEED
14in. M.W. 36-24 tubes. £16.10.0.

17in. M.W. 43-84 tubes. £17.10.0.
P.P. & Insurance on all tubes, 15/-.
BRAND NEW T12 91 12in. flat face 2 volt
filament. Ferranti tube with replace
Brimar-Mazda G.E.C. 12in. tubes. Price
£10.10.0. Guaranteed 6 months.
Also Ferranti 9in. T12 brand new 4 volt
filament will replace G.E.C., Mazda or
Brimar. £7.0.0.

SPECIAL OFFER. The Schmidt T.V.
projection optical box for 22in. picture
back projection including focus and
frame coils, less tube. Original price £30.
Our price including P. & P. £25.10.
A full range of F.M. and A.M. Tuners,
Hi-Fi and stereophonic amplifiers,
record players, record changers, A.M.
and F.M. Radiogram chassis. All types
and makes of test Instruments, shavers,
typewriters, radios (battery and trans-
istors).

SPECIAL OFFER. 1,200ft. recording
tape on 7in. reels, well-known make—
list price, 35/- . Our price 22.6 or 6
for 120/-.

Orders and Callers to:

NEW-MAX ELECTRONICS LTD.
220 Edgware Road, London, W.2
PAD 5807

LINE OUTPUT TRANSFORMERS

replacement or
rewind. Send
us your faulty
one and we will
be pleased to
quote and save
you money.

AUDIO LTD.

Tower Road, London, N.W.10

OPPORTUNITIES IN TELEVISION



148 pages
Free!

Television offers unlimited
scope to the technically
qualified. Details of the
easiest way to study for
A.M. Brit. I.R.E., R.T.E.B.
Cert., City and Guilds,
Television, Television
Servicing, Sound Film
Projection, Radio
Diploma Courses, etc.,
are given in our 148-page
Handbook "ENGINEER-
ING OPPORTUNITIES"
which also explains the
benefits of our Appoint-
ments Dept.

**We Guarantee
"NO PASS—NO FEE"**

If you are earning less than
£20 a week you must read
this enlightening book.

Send for your copy NOW—FREE and
without obligation.

WRITE TO-DAY!

British Institute of Engineering Technology
237, College House,
29-31, Wright's Lane, **BIET**
Kensington, W.5.

CORRESPONDENCE

The Editor does not necessarily agree with the opinions expressed by his correspondents. All letters must be accompanied by the name and address of the sender (not necessarily for publication).

ENGLISH ELECTRIC TV DEFECT

SIR.—I wish to thank you and express my appreciation for your reply to my query regarding a fault in an English Electric TV set, and also to let you know that your diagnosis was correct.

One of the .001 mfd high voltage capacitors was leaking, and after this was replaced the set is once again working satisfactorily.

It may interest you to know that the leaking capacitor was detected with the aid of a 250 volt D.C. supply, taken from the A.C. mains via a metal rectifier, and a neon-lamp rigged up on the lines of the Condenser Condition Tester described in the February, 1958, issue of *Practical Wireless*. This has proved to me the value of this instrument, and I shall certainly be making this up in the near future.

Many thanks for two very valuable journals—*PRACTICAL TELEVISION* and *Practical Wireless*.—W. A. THOMAS (Enfield).

TROUBLE WITH PROJECTION RECEIVER

SIR.—With regard to "D.F." in the August issue of *PRACTICAL TELEVISION*. The trouble indicated with the Philips 1400A is clearly indicative of the C.R.T. grid being driven too far positive. It is common practice with projection receivers to connect the negative end of the brilliance control network to a negative supply; the tube is, therefore, biased beyond cut-off at all settings of the control. The tube is brought within its grid base by a positive potential derived, via the protection circuits, from the timebase output stages. Failure of either scan, therefore, blacks out the tube.

I suggest that "D.F.'s" negative supply has failed and so the tube grid is driven positive. Connection of resistance, small compared with the brilliance control network (usually a few megohms), between grid and earth will reduce this positive voltage but is extremely unwise as the benefits of the protection circuits are lost. Anyone who has seen a projection tube on which a scan has failed and the protection circuits not operated will appreciate the folly of this. The correct course is to restore the negative supply to the brilliance control.—J. C. NELSON (Leeds, 16).

EXPERIENCES WITH MURPHY V310

SIR.—I note the letter in August issue, from G. W. Warner (Morecambe) regarding Murphy V310. I have the same model, new last October, the picture on both stations is very good, but the test cards are the same as described by your correspondent. More information could be given by the makers on how to tune up from zero; the dealers do not run after you every five

minutes as the makers seem to think.—E. RAKEHURST (Hendon, N.W.4).

PAM 13 CHANNEL TV ADAPTOR

SIR.—Reading G. Parkinson's query regarding the Pam 13 Channel TV adaptor, and your reply (August issue), has prompted me to write this letter. I purchased one of these adaptors to convert my receiver, a Cossor 12in. table model No. 932.

The way in which I have achieved this conversion despite the difference in frequencies, will, I hope, be of interest to your readers, some of whom have, no doubt, purchased this adaptor.

By the simple expedient of connecting a 10 pF

mica condenser across the aerial, R.F. and oscillator coils I have brought the tunable frequency of the input stages within the band of adaptor output frequency.

The success of this method makes me think that other receivers could be likewise modified.

Naturally, for different sets different values of condenser will be needed but the values quoted were sufficient for my purposes.

The results obtained are good as the extra noise that is present is far offset by the increase of signal.

I might add that this locality is known as a black spot for TV reception but my results are obtained with a simple H mounted below roof height.—E. M. STONER (Bath).

THE QUAD AERIAL

SIR.—I should like to report on the Quad aerial described in your June issue. I have tried this out in the Furness peninsular, in a location which is average for the district and the results are nothing short of amazing. I supported the aerial, in the loft, by laths nailed to rafters and floor joists, with cross-laths lashed to them. A good signal was obtained using the aerial element only, but was improved by addition of the reflector. But the interesting point is that the same aerial suits ITV perfectly also, stations are, Holme Moss and Bolton—Channels 2 and 9, but I also received sound on Channels 5 and 8. The aerial has 5ft. sides and the reflector, 2ft. behind, has 5ft. 3in. sides. I intend trying the effect of a director of 4ft. 9in. sides, 2ft. in front of the aerial. This is not required here, but should prove interesting.—F. GATES (Ulverston).

SERVICE DATA

SIR.—I also support the suggestion that space should be devoted to requests for service data. Manufacturers should really not presume that all their customers are nitwits and unable to service receivers themselves. Some of us know

SPECIAL NOTE

Will readers please note that we are unable to supply Service Sheets or Circuits of ex-government apparatus, or of proprietary makes of commercial receivers. We regret that we are also unable to publish letters from readers seeking a source of supply of such apparatus.

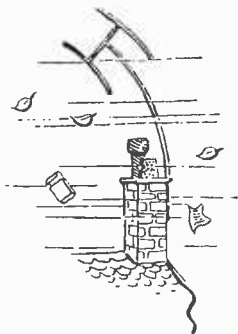

"Here is a gale warning."

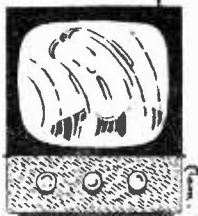

a great deal more about it than agents into whose hands they try to force us. Some branded receivers are precisely the same as others, the only difference being the brand name. One factory makes for several firms.

Readers should bear in mind when purchasing a TV receiver that it is important to ascertain whether circuit diagrams and service data are available, and they should only support those manufacturers who give such information. Only in this way will manufacturers be forced to change their "dealer only" policy, and the public be protected from the exploiting dealer who charges you for new parts when such are not necessary.—A. H. K. (Sevenoaks).

"YOUR PROBLEMS SOLVED"

SIR.—In my opinion the most valuable part of your journal is the feature entitled "Your Problems Solved." I am a service engineer and there are lots of practical hints in those replies which are outside the ordinary service drill. I have found them most valuable. I always cut them out and paste them in a book classifying them under the various makes. In my opinion also these should be republished annually in book-form.—S. T. (Ipswich).

HOME BUILT SETS

SIR.—I support the views of A. P. (Kenton) for readers to submit details of receivers they have made or modified. This would be particularly useful especially if such are designed around ex-Government apparatus, service data for which is hard to come by. I suggest that readers send you such service data for which they have no further use so that you can lend it out to readers.—E. N. G. (Walthamstow).

[We shall be delighted to inaugurate a loan service such as is suggested here. The difficulty is, however, in getting readers to return service sheets. Often several letters are necessary before they are forthcoming, and this makes unnecessary work. Some readers retain the sheets and ignore correspondence. If a sufficient number of service sheets are sent in we will consider a scheme for loaning them out against a deposit of 10s., as with our companion journal the "Practical Motorist and Motorcyclist."—Ed.]

"HORIZONTAL AERIALS"

SIR.—Replying to the criticism of your correspondent "Senior Research Engineer" regarding the "incorrect" theory of my "Horizontal Aerials" article, I would point out that I have been incorrectly quoted twice. I did not say that "the acceptance angle is wider than when mounted in the horizontal plane," and my remarks regarding the impracticability of combined aerials were solely confined to Channel II for the benefit of the long suffering viewers in East Anglia.

Their two stations will be about 25 miles apart, each with directional aerials, the I.T.A. radiating between 200 KW and 20 KW E.R.P. and the BBC between 10 KW and 1 KW E.R.P., so every village on the map will present its own problems to the local man, who in many cases is still erecting three-element yagis to receive good BBC.

The diagrams and data of the article were the result of practical experiments carried out without too much regard to prevailing theory. Two factors brought this about. One was that before a start was made many previous articles on aerials were read and the dimensions given were carefully tabulated. No two were alike. The other was the deep seated mistrust of aerial manufacturers data brought about by cold hours of disillusionment up among the chimney pots.—"SERVICEMAN" (Thetford).

SERVICE DATA

SIR.—I am in full agreement with P.B. (Cheltenham) that space should be provided for circuit requests. The good service provided by Messrs. Marconi, could apply to H.M.V. as some chassis are interchangeable between the two makes. I have just received a most insulting letter from a service department refusing data. It went on to question the technical qualifications of the applicant. In some strange way they seem to assume the receiver still belongs to them, and no one else must touch it but their agents.

In contrast the service given by Messrs. Cossor and Messrs. Pye is very good indeed.—A. M. (I.O.W.).

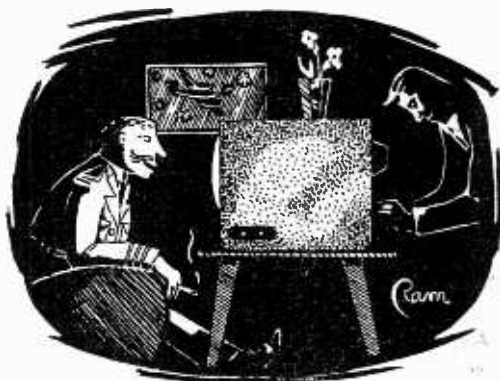

R.A.F. Pilot to dealer aligning TV receiver: "Left . . . Right . . . Climb . . . Target in sight . . . Steady . . . Steady . . ."

Everything for the T.V. & Radio Enthusiast

17in. T.V. CHASSIS, TUBE & SPEAKER, £19.19.6.

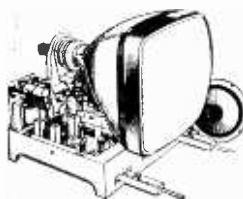

17in. Rectangular Tube on modified chassis. Supplied as single-channel chassis covering B.B.C. channels 1-5 or incorporating Turret Tuner which can be added as an extra, at our special price to chassis purchasers. 50/-, giving choice of any 2 channels (B.B.C. and I.T.A.). Extra channels can be supplied at 7/6 each. Chassis size: 12in. x 14 1/2in. x 11in. Less valves. Similar chassis were used by well-known companies

because of their stability and reliability. With Tube and Speaker £19.19.6. With all valves. £25.19.6. Complete and working Turret Tuner. £28.9.6. 12 months' guarantee on the tube, 3 months' guarantee on the valves and chassis. Ins. Carr. (incl. tube) 25/- Complete and working Turret Tuner. £28.9.6. 12 months' guarantee on the tube, 3 months' guarantee on the valves and chassis. Ins. Carr. (incl. tube) 25/-.

PLESSEY SOUND & VISION STRIP, 25/6.

Superhet. Tested. I.F.'s 10.5 Mc/s sound. 15 Mc/s vision. 8 valve basis (6-6F1's and 2-6D2's not included). Size 8 1/2in. x 5 1/2in. x 4 1/2in. high. Post and packing 2/6. The Turret Tuner plugs directly into this chassis.

SOUND & VISION STRIP, 10/6.

Superhet. Complete vision strip. Less valves. Not tested. Drawings free. Postage 2/6.

POWER PACK & AMPLIFIER, 19/6.

Output stage 6V6 with O.P. trans. Smoothed H.T. 350 v. 250 mA. 6.3 v. at 5 A. 22 v. at 3 A. 6.3 v. at 4 A centre tapped. Less valves. Free drawings. Ins. carr. 5/6.

POWER PACK & AMPLIFIER, 19/6.

Output stage PEN 45, O.P. trans. choke. Smoothed H.T. 325 v. at 250 mA. 4 v. at 5 A. 6.3 v. at 5 A. 4 v. at 3 A centre tapped. Less valves. Carr. 5/6.

CHASSIS, 1/- each.

6 or 8 valve. Latest type midjet valve design for A.M. or F.M. Brand new cadmium plated. Size 12 1/2in. x 7 1/2in. x 2 1/2in. Post 1/9. 4 for 4/-, post 3/-. 12 for 10/-, carr. 5/-.

SUPER CHASSIS, 99/6.

ELECTRIC CONVECTOR HEATER, 99/6.



A.C. D.C. Switched for 1 or 2 kW. Illuminated grille. Size 26in. x 18in. x 7 1/2in. deep. Ins. carr. 10/6.

INSULATING TAPE, 1/6.

Finest quality. 75in. x 1/2in. wide. Post 9d.

GANG CONDENSERS, 1/9.

2 and 3 gang. .0005 pF. Standard. Salvaged. Tested. P. & P. 1/3.

BEAUTIFUL EXTENSION SPEAKERS, 29/9.

Fitted with 8in. P.M. speaker W.B. or Gormans of the highest quality. Standard matching to any receiver. (2.5 ohms.) Switch and flex included. Unrepeatable at this price. Money back if not completely satisfied. Ins. carr. 3/6.



STEREOPHONIC SOUND!

These extra speakers will now be required. 8in. P.M. SPEAKERS, 9/9. With O.P. transformer fitted. 10/-, Postage 2/9. 8in. P.M. SPEAKER, 12/6. Postage 2/9.

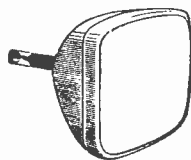

REGETTERED IMPROVED VACUUM T.V. TUBES.

17in. £7.10.0.
14in. £5.10.0.
12 MONTHS' GUARANTEE.

6 months' full replacement, 6 months' progressive. Made possible by the high quality of our tubes. Ins. Carr. 15/6. 9in., 10in., 14in., 15in. and 16in. round tubes. Our special offer of these sizes, £5. 12in. T.V. TUBES, 2/6. Three months' guarantee on round tubes. Ins. Carr. 15/6.
14in. RECTANGULAR T.V. TUBES with burns, 30/-. Ideal as a standby or testing. Carriage 10/-.

EXPRESS DESPATCH SERVICE

Phone to confirm tube in stock. Send Telegraph Money Order. On receipt of same, tube despatched Passenger Train same day.

TRANSFORMERS

MAINS TRANSFORMERS, 15/9. 350-0-350 v. 250 mA., 6 v. at 5 amp., 4 v. at 4 amp., 22 v. at 6 amp., extra winding for 2 v. or 4 v. tubes. Primary 200-250 v., 50 cycles. Post and Packing 3/9.

MAINS POWER TRANS., 350-0-350 v., 12/9. 250 mA. 6 v. heater at 5 amp., 4 v. at 5 amp., 4 v. centre tapped. Droptthrough type. Prim. 200-250 v. (4 1/2in. x 5 1/2in.). Post 2/9.

MAINS TRANS., 3/9. 350-0-350 v. 80 mA., 4 v., 4 v. heaters. 250-250 v. prim. Post 2/3.

MAINS TRANS., 5/9. 280-0-280 v. 90 mA., 5 v., 4 v. heaters. 200-250 v. prim. Post 2/3.

O.P. TRANS., 1/3. Standard size, 2.5 ohms. Post 1/-, 20 for £1. Post 5/6.

MAINS TRANSFORMERS, 12/9. 425 v. 300 mA. Single secondary 6.3 v. at 12 amp., 6.3 v. at 0.6 amp., 200-250 v. screened primary. Post and Packing 3/6.

SOLO SOLDERING TOOL, 12/6.

110 v. or 6 v. (special adaptor for 200/240 v., 10/- extra). Automatic solder feed, including a 20ft. reel of ERSIN 60/40 solder and spare parts. It is a tool for electronic soldering or car wiring. Revolutionary in design. Instantly ready for use and cannot burn. In light metal case with full instructions for use. Post 2/9.



HOME RADIO, 79/6.

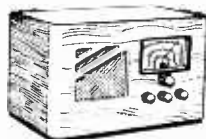

Five-valve (octal) superhet, 3 waveband receiver. Can be adapted for your gram. p.u. at a little extra cost. Two A.C./D.C. sizes: 9 1/2in. x 18 1/2in. x 11 1/2in. and 20 1/2in. x 12 1/2in. x 11 1/2in. Wooden cabinets. Ins. Carr. 4/6. Please state mains and size when ordering.

NEW BAKELITE CABINETS, 9/9.

Attractive style. Size: 12in. x 7in. x 5 1/2in. Ideal for small receivers, converters, etc. P. & P. 2/6.

AMPLIFIERS 159/6.

HI-FI AT LOW COST! Valve line up 6CK5 (V.2), 6CK5 (V.3), ECC81 (V.4, V.1b), V.1A as amplifier, V.1B as resistance, capacity coupled phase splitter. V.2, V.3 in push-pull as the output stage, giving up to 10 watts of audio. Negative feedback to the first stage. Three controls, volume control with mains switch, bass and treble. Hygrade output transformer outputs of 3, 7.5, 15 ohms. Size 12 1/2 x 7 1/2 x 2 1/2in. Carr. Ins. 4/6.

TERMS AVAILABLE
Liverpool St. to
Major Park 10
Mins.

Send for free catalogue to:
DUKE & CO.
(Dept. E.10), 621/3, Romford Road, Manor Park, E.12.
Telephone ILF. 6001/3

OPEN SATURDAY
ALL DAY
CLOSED THURSDAY
1 p.m.

NEW BOXED VALVES!

EQUIVALENT TO FOLLOWING TYPES

AC 50	GU50	MX40	VP4 7-pin
AC 5G	1R50	1EN4VA	VP4B
AC 6EN	MSPEN 5-pin	PEN30C	VMS4
AC VP15-pin	MSPEN 7-pin	PP36	VMP4G
AC VP1 7-pin	MVSPEN 5-pin	SP4 5-pin	W42
AC VP2	MVSPEN 7-pin	SP4 7-pin	1D5
AC HLDD	MVSPENB	S4VB	7D5
CY1C	MHD4	TDD4	7D6
DC14	MKT4	URIC	41MPG
FC4	MS4B	VP4 5-pin	

10/- each

A SELECTION FROM OUR LARGE RANGE :

ATP1	4-	HL2	3/6	1T4	8-	6SJ7	7 8
AZ-1	12 6	KT2	5-	1R5	8-	6Q7	10-
D12	5-	MU11	8 6	1S5	9-	6J6	6-
DM73	9-	OZ4	7-	1S4	8-	6BX6	9-
DK4J	10-	PX25	12 6	3S4	8-	6SK7	7 6
EA50	2-	PX25A	12 6	3V4	9-	6V6G	7 6
EB34	3/6	TDD2A	8 6	5U4	8 6	7S7	9-
EB31	7 6	VR105/30	4 6	5Z4	10-	12A6	7 6
EF50	4-	VR65	4-	6AM6	7 6	12AT7	9-
ECC81	9-	XH0.5 c.c.	4/-	6AL5	7 6	25A6	10-
ECL80	12 6	XP (2 v.)	4/-	6SN7	7 6	43	10-
EP92	9-	Y63	8 6	6SK7	7 6	50L6CT	10-
CS13	17 6	Z77	7 6	6J5M	5-	807	7 6

SEND FOR OUR FREE COMPLETE VALVE LIST

TRANSISTORS (PNP)

GREEN YELLOW Audio Frequency. Amp. 7/6.
 WHITE SPOT 2.5 Mc/s R.F. and I.F. Amp. 15/-
 RED YELLOW 1.5 to 8 Mc/s R.F. and I.F. Amp. 15/-
COMPLETE RANGE OF MAZDA TRANSISTORS IN STOCK

Build yourself a miniature Transistor receiver. Send S.A.E. for all Lists and circuits available.

SHORT-WAVE RECEIVER

10-60 Mc/s (5-30 Metres)
 RECEPTION SET TYPE 208

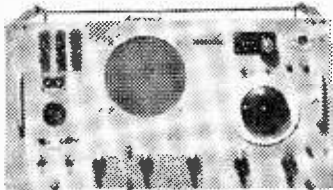

Complete with 6 valves, 2-6K8C, 2-EF39, 6Q7G and 6V6G. Internal mains power pack and 6 v. vibrator pack. Built-in 6 1/2" speaker. Muirhead slow-motion drive. B.F.O. and R.F. stage. Provision for 'Phones and Mutings and 600 ohms. Combined Input 100/250 v. A.C. or 6 v. D.C. All sets in new condition and air tested. I.F. Frequency 2 Mc/s. **£6/19/6** Carr. 15/6.

BE PREPARED TO LISTEN TO THE SATELLITES

PYE 45 Mc/s STRIP TYPE 3583

Complete with 10-EF50's, EB34 and EA50 valves. Unit is in new condition. **ABSOLUTE BARGAIN! 39/6**
 Including modification data.

R.F. UNITS

Type 25 Switched Tuning 20 to 30 Mc/s. Unit includes 35P61's. 10/- carriage 2/6. Circuits available.
 Type 20. Variable Tuning from 50 to 65 Mc/s. Including 2-EF34's and EC52. 25/- carriage 2/6. Circuits available.

QUARTZ CRYSTALS IN STOCK

Frequency ranges from 100 kc/s to 36.7 Mc/s. Send for free list.

T.V. Pre-Amp., 45 Mc/s Pre-amp unit with 2-VR91 (slight modification necessary). 12 6.

IF IT IS NOT ADVERTISED WE MAY STILL HAVE IT.
 OPEN MONDAY to SAT. 9-6. THURS. 1 o'clock.

HENRY'S RADIO LTD.

5 HARROW ROAD, EDGWARE ROAD, LONDON, W.2
 TEL.: PADDINGTON 1903-9

Build your own HI-FI

—with an entirely NEW range of Hi-Fi units and cabinets!



Imagine the pleasure of having this magnificent Hi-Fi equipment in its beautiful contemporary style furniture for your home... and experiencing an entirely new realism in sound reproduction. Yet the Emistructor Hi-Fi will save you money and give you all the extra fun and satisfaction of building it yourself—and being able to service and maintain it afterwards. Special instruction manuals guide you at each stage and teach you all about the equipment in simple terms as you build. No skill or experience is needed—only a few simple tools.

Emistructor equipment is made to the highest quality standards and is a product of E.M.I. Institutes Ltd.—part of a Company world famous for sound recording and reproducing equipment.

There is a wide variety of equipment and cabinets at different price levels to suit individual tastes and requirements. The range varies from a complete Hi-Fi installation with separate speaker enclosures to a simple all-in-one compact system for those with more modest requirements. All equipment is suitable for stereo or non-stereo reproduction of records. Full details and complete specifications will be sent with our free Brochure.

EMISTRUCTOR Dept. H.F. 138, 43, Grove Park Road, London, W.4

Associated with one of the World's largest recording organisations comprising—

"HIS MASTER'S VOICE" · CAPITOL · COLUMBIA · MGM etc.

OCT/58

IC137

TUBES REBUILT

SEND YOUR DUD MULLARD AND MAZDA TUBES TO US FOR REBUILDING

Via B.R.S. (Parcels) Ltd., or BRITISH RAILWAYS.

MULLARD	12"	£7.10	14"	£8.10
Emitron, Cossor & Cathodeon	16" & 17"	£10.10	21"	£12.10
MAZDA	14" & 15" & 17"	£10.10	21"	£12.10

TERMS TO TRADE

Carriage and Insurance 15/- each tube.
FULLY GUARANTEED SIX MONTHS

LINE OUTPUT TRANSFORMERS AND DEFLECTOR COILS

Most types can be supplied. State set make, model number and part required. S.A.E. please.

BRAYHEAD TURRET CONVERTERS

Foremost in performance. With Instruction booklet, £6.19.6. Plug-in Adapter if needed 7/6. P. & p. 2/6. State set, model number and channels required.

Terms C.W.O. or pro forma

PRIME ELECTRICS (Dept W/2)
 36, QUEENSDALE ROAD, LONDON, W.11.
 (Near Shepherds Bush Central Line.) Phone - PARK 1131.
 CALLERS: 10.30-3 MON.-SAT. Closed WED.



Whilst we are always pleased to assist readers with their technical difficulties, we regret that we are unable to supply diagrams or provide instructions for modifying surplus equipment. We cannot supply alternative details for constructional articles which appear in these pages. **WE CANNOT UNDERTAKE TO ANSWER QUERIES OVER THE TELEPHONE.** The coupon from p. 156 must be attached to all Queries, and if a postal reply is required a stamped and addressed envelope must be enclosed.

PYE V4

My set is fitted with the makers' tuner unit. Once the set has warmed up the picture takes a saw-tooth effect which appears to ripple from the bottom upwards.—R. Carslaw (Glasgow).

We suggest you check the ECL80 line oscillator which is in front of the "black box." Another possible cause is a faulty EY51 inside the "black box," and if this is the case reducing the brightness will reduce the amount of "saw-toothing."

ALBA 17in. T304, T494

I converted the set with one of the two models of turret tuner as advertised in "Practical Television." It worked well until recently, when I found out that the sound on ITV had fallen off considerably. Previous to this the sound or volume was equal to the BBC. I still have good sound from the BBC, but not quite so good on ITV (Wenvoe). If I retard the contrast control sound diminishes even more.

The set has recently been serviced with a L/O transformer and two new rectifier valves (PY82). Could you give me any advice as to where the trouble is likely to be?—B. Green (Llanelli).

From the description given it is difficult for us to say whether the drop in ITV volume is due to deterioration in the receiver sound valve stages or whether it is due to tuning drift in the tuner unit. If the latter provides maximum sound with the fine tuner midway, it may be assumed that it is the receiver which is at fault and the V9-V10 (EF80), V11 (EB91) and V12 (PL82) sound valves should be tested. If these are in order, check the core trimming of the sound I.F. coils and the 25 mfd. capacitor associated with the PL82 cathode circuit.

BUSH TV63

The receiver is a Bush TV63, tuned to Sutton Coldfield (no I.T.A. aerial although 12 channel tuner in set). Trouble is uneven illumination of picture; sometimes top and bottom lighter than

middle, other times middle of picture lighter than top and bottom. The picture also is too contrasting but when contrast is turned down the picture breaks up eventually after the verticals have become wavy. When brilliance is turned down the parts of picture which are dark go black and only the lighter part of the picture is left. The fine tuning control is very sensitive; any slight movement and the picture breaks up.

I am fairly sure it is not the tube because when the aerial is disconnected or when the channel selector on tuner is turned to a not used position the screen is illuminated uniformly and brilliance control reduces illumination. Sound is all right, but a very slight hum is heard which changes very slightly when vertical hold is revolved through its entire travel. When width control was operated to reduce width of picture the left-hand side of front of picture was an uneven edge.—C. Nutall (Mon.).

The symptoms indicate a defective PCF80 video amplifier-cathode follower. If replacement of this valve does not cure all the fault symptoms, we would suggest you replace also the line oscillator ECC82.

INVICTA 126

After my Invicta 126 has been on some time the picture breaks up and the only way to get it back is by letting it cool off. The line oscillator PCF80 has already been changed six times. After this it will be all right for a week. There is a pre-set condenser with a fixed one across it, but all adjustment has gone. I have tried new ones, but only get multiple pictures and shortened scan. The value of the two condensers pre-set is 250 pF and fixed 910 pF. Changing these and keeping them away from heat makes no difference.—W. Kinghorn (Peterborough).

The symptoms described may be due to a defective PL81, the screen dropping resistor of this valve, a defective metrosil associated with the cathode circuit of the PCF80 or a defective 25 mfd. capacitor (there are two), again associated with the cathode circuit.

PHILIPS 1800A

The grid of test card "C" is received on above set with the left-hand side much smaller than the right. Two squares normal to 1½ small, horizontally. This is not noticeable on the other programme. Lately a black border on the left side has cut short the picture. I have been able to keep a full size picture by adjustment to tube magnet and variable controls at set face. I appear to be at the end of this latter adjustment horizontally though picture is fairly good and steady. Apart from valves could you advise which condenser/resistor or both to test? I have not been able to secure a circuit or data sheet.—T. W. Carr (Hull).

We would advise you to have the inner of the two PZ30 valves tested. This, if failing, would account for the poor width on the left-hand side. Also have the UL44 line output valve tested and check the resistors and capacitors associated with this and the UY41.

We have dealt with the 1800A receiver in a past issue of PRACTICAL TELEVISION, namely the September, 1955, issue.

PHILIPS 1446U

I have a Philips 1446U set which at present has no coils in the tuner for Channel 11. If I fit these coils is there any other adjustment necessary to the set?—L. Coombs (Andover).

If a correct pair of Channel 11 coil biscuits is obtained and fitted, there may not be any need to carry out any further adjustments. However, you may find it necessary to remove the small stop screw (which prevents the turret from rotating fully) from the rear of the tuner unit if this has not already been done, and it may be necessary to insert an insulated trimming tool into the hole in the front of the tuner unit to adjust the core of the new oscillator coil if the fine tuner does not produce maximum sound at, or about, its mid-position.

The sensitivity control should, of course, be well advanced.

K.-B. KF60

I noticed my EHT rectifier was running low on emission so I replaced it. On completion of doing the necessary soldering I switched on and found it wouldn't light. I have checked the line output transformer and find I get a spark from the anode connection of R12. I get a slight spark from the H.H.K. of same, does this suggest the L.O.T. is gone, or is there a condenser causing the trouble?—J. O'Donnell (Glasgow).

You should check the setting of the horizontal linearity control. Then have the 8D3, 6CD6G, and 6U4GT valves tested.

If in order, check the 16 mfd. wired from pin 3 of the 6CD6G to chassis. Then ensure that the resistor wired between the O.T. windings (on the transformer) is 15 kilohm. Check .1 mfd. capacitors associated with the 6U4GT.

FERRANTI 17T3

My trouble is fuses blowing. First time H.T. fuse 1 amp. went I hadn't a 1 amp., so used 1.5 amp. When I switched on again mains fuse 2 amp. went.

I have tested (with Avo 7) all condensers, etc., and have had rectifier valve tested, but cannot find anything wrong.

One peculiarity of set has been that on switching off a small bright spot remains on centre of tube. This can be removed only by turning down brightness control.

I should be much obliged if you would suggest the way to find cause of blown fuses.—C. W. Richards (Madeley).

You should first replace the PZ30 valve. This may have been tested, but it still remains by far the most likely suspect.

If the fuses still continue to blow, however, we will assist you further if you will let us know the period of time which elapses between switch-

ing on the set and the fuses blowing and any other signs you may have observed as they blow. The residual spot which remains when the receiver is turned off is quite normal.

K.-B. "QUEEN" HV40

The picture is brilliant and clear, but highlights in it are accompanied by horizontal shadows both sides of the highlights.

The fault appears at its simplest and most obvious forms in captions. Thus a caption consisting of three lines of simple lettering, white on black, will appear as though the lettering is set on bands darker than the normal background.

The effect is also to be seen in, say, a close-up of a man with white hair. From the top of the picture to a horizontal line touching the top of the head the black level is lighter than below that horizontal line.

In intervals between "shots" short lines are evident thus:

They are evenly spaced.

There are reserves of contrast and brightness and definition is good.—A. S. Maultby (Ilford).

We would advise you to check the resistors associated with the 6AL5 detector and the 6AM6 video amplifier. The 6.8 kilohm anode load of the video amplifier is likely to have changed value, the 15 kilohm resistor (across the video grid coil) may be open circuit or the video amplifier cathode (pin 2) components may be at fault.

DEFIANT 14in.

I live in a black spot and do not get a good picture on I.T.A. Would a booster on I.T.A. improve my picture?—I. Jones (Holyhead).

We would say that in a situation like yours the use of a Band III preamplifier would be definitely advantageous. It would "load up" the A.G.C. circuit and enable a picture to be held under varying conditions even if an amount of "snow" is the price of such amplification. In all cases, however, every effort should be made to secure better reception by means of a highly efficient aerial rather than a preamplifier. As intimated above, the latter does tend to introduce valve noise which appears as background "snow" or mush on the picture.

BUSH TV24

Loud blurring noises on sound occur; these are intermittent and sometimes cut the speech out.—J. Houlihan (Norwich).

The noises referred to are often due to a defective PL33 sound output valve. If this is not responsible, check the volume control wiring for poor connections.

QUERIES COUPON

This coupon is available until OCTOBER 21st, 1958, and must accompany all Queries sent in accord with the notice on page 155.

PRACTICAL TELEVISION, OCTOBER, 1958

LASKY'S RADIO

MAKER'S SURPLUS COMPONENT BARGAINS

- WIDE ANGLE 38 mm.**
 Line E.H.T. Trans. Ferro-cube core, 9-16 kV. EYEI Scanning Coils. Low imp. line and frame..... 25/-
 Ferro-cube cored Scanning Coils and Line Output Trans., 10-15 kV. EYEI winding Line Trans. with circuit dia., pair..... 50/-
 Frame Output Transformer 6 6
 Scanning Coils. Low imp. line and frame..... 17 6
 Frame or line block osc. Transformer..... 4 6
 Focus Magnets Ferro-cube 19 6
 P.M. Focus Magnets, Iron Cored..... 19 6
 Duomax Focallisers..... 22 6
 30) m a Smoothing Chokes... 15-
STANDARD 35 mm.
 Line Output Transformers 6.9 kV. E.H.T. and 6.3 v. winding. Ferro-cube..... 19 6
 Scanning Coils. Low imp. line and frame..... 12 6
 Ditto, by Igranic..... 14 9
 Frame or line blocking oscillator Transformer..... 4 6
 Frame Output Transformer 7 6
 Focus Magnets :
 Without Vernier..... 12 6
 With Vernier..... 17 6
 200 ma Smoothing Chokes 10 6

THE "STIRLING" BAND III CONVERTER

AVAILABLE ON CREDIT SALES TERMS



CASH PRICE
6 GNS.

Post paid

or 21/- deposit and 5 monthly payments of 21/-

This very efficient CONVERTER employing R.F. amplifier ECC85 and metal rectifier is TUNABLE OVER ALL 13 CHANNELS and incorporates its own power supply for 200-250 v. A.C. mains. Can be fixed to rear of set or used as separate unit. Metal brown crackle finish case : 4in. wide, 7in. deep, 2in. high.

TURRET TUNERS. All types in stock—Cydon, Brayhead, Telenge, Valradio. Describe your set and we will quote you. Prices from 79/6.

C. R. TUBES, new, unused. 14", £14.19.6. 17", £16.19.6. 12", £8.19.6. 9", £5.17.6. Carr. & ins. 22 6.

MAIL ORDERS TO HARROW ROAD, PLEASE
LASKY'S (HARROW RD.) LTD.
 42, TOTTENHAM COURT ROAD, W.I.
 Telephone : MUScum 2605.

370, HARROW ROAD, PADDINGTON, W.9.
 LADbrooke 4075 and CUNningham 1979.
 Open all day SATURDAY. Half day Thursday.

SPECIAL OFFER OF SOLDERING IRONS

SOLON, ex-Govt., new and unused. Pencil bit, 65 watts, 220-250 v. A.C./D.C. List 27/6. Lasky's Price 16/6
 Post 1/6. Spare Bits, 1/- each. Spare Element (state voltage), 5/9.

SPEAKER BARGAIN

Special Purchase of Plessey P.M. Speakers, 5in. round or 7in. x 4in. elliptical. Lasky's Price 14/6
 Post 1/6.



COLLARO 4-SPD MIXER AUTO-CHANGERS

RC. 456, incorporates auto and manual control. Complete with Studio crystal P.U. and sapphire stylus. List £13/17/-. Lasky's Price £7.19.6
 Post 3/6.

Collaro RC. 457 or "Continental," £8.19.6. Post 3/6.

B.S.R., type UA8, 4-spd., with latest B.S.R. ful-fi P.U., £6.19.6. Post 5/-.

RST

MAIL ORDER DEPARTMENT
 211 Streatham Road, Mitcham, Surrey.
 ALL VALVES LISTED ARE NEW STOCK.
 Terms C.W.O. or C.O.D. Postage 3d. per valve.

MITCHAM 6201.

AZ31 10/6	EF42 12/-	N142 9/6	UCL83	6J7GT
B65 8/6	EF50 (A)	N153 11/6	15/6	10/-
DA33 9/9	EF60 4/6	N154 11/3	UF41 9/-	6K7 4/6
DAF91 9/-	EF80 8/6	N727 6/6	UF89 10/-	6K8GT 10/-
DAF96 9/6	EF85 7/6	PCC84 9/6	UL41 9/6	6K8GT
DD820 10/6	EF86 12/-	PCF80	UL84 9/-	6L1 12/3
DF33 9/9	EF89 10/-	12/6	UU8 23/6	6L1 17/6
DF91 8/6	EF91 8/6	PCF82	UY41 7/6	6L6G 7/6
DF96 8/9	EP35 14/-	PCL82 11/6	UY85 8/-	6L18 12/6
DH719 9/6	EL42 10/-	PCL82	VP4B 17/6	6L19 21/-
DK91 9/-	EL84 9/-	12/6	W81M 8/6	6N7G/GT
DK96 9/6	EL90 8/6	PCL83	W142 9/6	8/-
DL33 9/9	EM89 10/-	12/6	W719 8/6	6SL7GT 7/6
DL92 8/-	EM81 11/6	PENA4	W727 8/6	6SN7GT
DL96 8/9	EY31 10/-	11/6	X75 19/-	8/6
EABC80	EY84 13/-	PEN4VA	Z21 10/6	6X5GT 8/6
9/6	EY91 9/-	11/6	Z77 10/6	757 12/6
EAF42 10/-	EZ35 8/6	PL36 15/-	Z152 8/6	7Y4 7/6
EB91 5/9	EZ40 8/-	PL82 10/-	ZL19 8/6	8D3 8/6
EC141 9/3	EZ44 10/6	PL83 11/6	ZY37 8/6	10LD11
EBF80 9/6	EZ80 8/6	PY80 8/3	1/6	14/9
EBF89 9/6	EZ81 8/-	PY81 8/-	5Y3GT 8/6	12A8H 10/-
EC91 8/9	FC2 14/6	PY82 8/6	5Z4G 10/-	12AT6 8/9
ECC33 8/6	FC4 23/6	PY83 8/6	6A8GT	12A7 8/9
ECC81 8/6	FC13 14/6	R10 22/-	10/-	12A7 8/9
ECC82 9/-	FC19 19/6	R19 19/-	6AL5 5/9	12A7 9/-
ECC83 9/-	G232 11/8	SP41 3/6	6AM6 9/-	12AXT 9/-
ECC84 10/-	H30 4/9	SP61 3/6	6AN5 5/-	12BA6 8/9
ECC85 10/6	H63 10/-	TD4 15/-	6AQ5 7/6	12BB6 9/3
ECF80	HBC90 8/6	TP22 12/6	6BA6 8/6	12BH7 10/-
12/6	HL92 11/6	U142 8/6	6BE6 8/3	12J7G/GT
12/6	HL133D 9/6	U147 9/9	6B36 7/6	10/-
ECH35	KT33C 11/6	U153 9/6	6BR7 7/6	12K7GT 10/-
12/6	12/6	UABC80	6BW6 8/6	12K8GT 10/6
ECH42 9/6	KT66 16/6	10/-	6BW7 9/6	12K8GT 10/6
ECH81 9/6	LC319 12/6	UAF42 10/-	6BX6 8/6	12Q7 12/3
ECL82	MKT45) 13/6	UBC41 8/6	6CD9G	12Q7GT 8/6
13/6	(or 7) 21/-	UBF80 9/6	6D2 27/-	29/6
EF37A	ML4 12/6	UCH42 10/-	6F1 19/6	35Z4GT 8/6
EF30 10/3	MSP4 15/-	10/-	6F12 8/6	8/6
EF40 15/-	MX14 10/-	UCH81 10/-	6F13 18/6	50L6GT 10/-
EF41 9/6	MX10 15/-	10/6	6J5G 6/6	10/-

Quotations given for any types not listed. Obsolete and old types a speciality. Send for lists.

REVACUATED T.V. TUBES

SIX MONTHS' STRAIGHT GUARANTEE

Mullard			Mazda		
in.	£	s. d.	in.	£	s. d.
14 MW 36-22	5	10 0	14 CRM 141	5	10 0
14 MW 36-24	5	10 0	14 CRM 142	5	10 0
14 MW 36-44	5	10 0	14 CRM 143	5	10 0
14 AW 36-21	5	10 0	15 CRM 153	6	10 0
16 MW 41-1	7	0 0	17 CRM 171	7	10 0
17 MW 43-43	7	10 0	17 CRM 172	7	10 0
17 MW 43-64	7	10 0	21 CRM 211	10	10 0
17 MW 43-69	7	10 0	21 CRM 212	10	10 0
21 MW 53-20	10	10 0			
21 MW 53-80	10	10 0			

14 in. Marconi, Emitron, Ferranti, G.E.C. £5 10 0.
 17 in. Marconi, Emitron, Ferranti, G.E.C. £7 10 0.

Carriage and Insurance 12/6 (U.K.). Cash with order.
 Personal Callers Welcome.

VIDIO REPLACEMENT CO.

HALES ST., DEPTFORD HIGH ST., LONDON, S.E.8
 Telephone : TIDEWAY 4506

SETS & COMPONENTS

MAINS FROM 12v. CAR BATTERY.—American Dynamotor Unit, runs 200/250 AC/DC radios, televisions, tape recorders, etc., from 12v. car battery, continuous duty, perfect, cost £25.80/-; s.a.e. full details. SCIENTIFIC PRODUCTS, Cleveleys, Lancs.

T.V. TUBES as new, revacuumed; all makes; 6 months' straight guarantee. 14in. £5/10/-, 17in. £7/10/-; carriage and insurance 12/6 U.K. Free delivery greater London. VIDIO REPLACEMENT CO., Hales St., Deptford High St., London, S.E.8. (Tideway 4506.)

MAKE YOUR AERIALS with our fully machined parts. Examples: Band 1. "H," complete with lashings, for £3/10/-; 5 Element. Band 3. with folded dipole, mast and clamp for 45/- Get further details from our illustrated lists and data on all aerials, sent for 1/- P.O. (Trade supplied.) SKYLINE WORKS, Burn-sall Rd., Coventry. (Tel.: 60418.)

ASSIST-U-AERIAL KITS, containing insulator and cap for 1in. boom, 10 elements, 20 1/2in. plugs, 2 1/2in. end plugs, 2 1/2in. grommets, suitable for construction of Band II or Band III Aerials, 6/6 complete. Send P.O. with order. ROBERT MOSS, LTD., 35, Banbury Rd., Kidlington, Oxford. Trade enquiries invited.

T.V. TUBES

14in. Rectangular types, £4.0.0. 14in. Round types, £3.10.0. 15in. CRM 153, £4.0.0. 17in. Types, £5.0.0. Picture tested and guaranteed 3 months. A few 14in. and 17in. for testing or boosting at 25/- each. All carriage paid. Your own tube reconditioned at 4/- per inch, return carriage paid, 48 hour service. S.A.E. all enquiries please.

MIDLAND TUBES LIMITED

37, George St., Manchester, 1. Central 0432.

CATHODE RAY TUBES used but in good working order, with three months' written guarantee. 12in. to 17in. Mazda, Mullard and Equivalent types only, at £4/10/-, plus 12/6 for carriage and insurance. Enquiries and orders to BHP DISTRIBUTORS (LONDON) LTD., 379, Staines Rd., Hounslow, Middlesex. (Tel.: HOU 5144.) Our terms are c.w.o. or c.o.d.

UNREPEATABLE OFFER.—12in., 5-channel T.V., £15; 14in., £22; good working order. C. EDWARDS, 1070, Harrow Rd., London, N.W.10. (Phone: LADbroke 1734.)

CATHODE RAY TUBES, ex-chassis, picture-tested, 3 months' guarantee. Mullard, Mazda, Brimar, etc., 9in., 12in., 14in., 15in., £3/10/-; 17in., £4; carriage and insurance, 15/-. Miniature Valves, 10/- dozen. S.C.L., 77, Cranleigh Rd., Bournemouth.

T.V. TUBES

14in. Rectangular types, £4; 14in. Round types, £3.10.0. 15in. CRM 153, £4; 17in. Types, £5. Picture tested and guaranteed 3 months. A few 14in. and 17in. for testing or boosting at 25/- each. All carriage paid. Your own tube reconditioned at 4/- per inch, return carriage paid, 48 hour service. S.A.E. all enquiries please.

S. BRADLEY

6, Beadon Avenue, Waterloo, Huddersfield.

RATES: 4/- per line or part thereof, average five words to line, minimum 2 lines. Box No. 1/- extra. Advertisements must be prepaid and addressed to Advertisement Manager, "Practical Television," Tower House, Southampton St., Strand, London, W.C.2.

SETS & COMPONENTS continued

CALLING CENTRAL SOUTHERN REGION! Convert NOW. It's simple with the BRAYHEAD TURRET TUNER. In stock for ANY AREA. State Channels, set make and model No. £6.19.6. post/ins., 2/6.

The RADAR KILOVOLTER measures E.H.T. 3-30 kV., £5.17.6. post/ins. 2/6. Line and Frame osc. and C.P. transformers for 500 sets. EXACT REPLACEMENTS. State make and number with enquiry (3d. stamp).

WESTWAY RADIO

5, Westward Way, Harrow, Middx.

TELEVISIONS, 9in. models, £7/10/-; 12in. models, £13/10/-; 12in. 5-Channel models, £19/10/- each; all working; carriage paid. Send for list. TOMLINS, 127, Brockley Rise, Forest Hill, S.E.28. (FOR 5497.)

TELEVISION BARGAINS.—12in. from £9, 14in. from £18; 17in. from £25. TYLER TELEVISION, 63, Lee High Rd., Lewisham, S.E.13. (Lee 3979.)

12 MONTHS' GUARANTEE! The very best reconditioned c.r.t. ever offered. 12in. £9, 14in. £10, 15in. and 17in. £12/10/-, 21in. £16; carriage and insurance 22/6. S.C.L., 77, Cranleigh Road, Bournemouth.

LINE OUTPUT and Blocking Osc. Transformers, Scan Coils, etc., for all models. For engineers, technicians and serious amateurs, comprehensive professional trade television and radio engineers' Trimmer Tool Kit. £5/2/6; c.w.o. S.A.E. all enquiries. L. BRENNER, 23, Meadow Close, Barnet, Herts.

TELEVISIONS FROM £5. Radios from £2, all working. Tubes, Valves, Components, cheap (callers only). J. PALMER, 32, Neasden Lane, N.W.10.

CHANNEL 11 OFFER.—5 Element folded Dipole array with mast and universal clip for fixing to any size Band 1 aerial mast, 39/6. Trade rates 6 or more. Post paid. All types of Aerials and Machined Parts available. Send 1/- P.O. only for details and technical data for "Do it Yourself." SKYLINE WORKS, Burn-sall Rd., Coventry.

TELEVISIONS, London only. 12in., £10; 5-channel, 12in., £14; 14in., £18; 17in., £27; 13-channel, 12in., £20; 14in., £25; 17in., £35. (Callers only.) JOHN GILBERT TELEVISION, 1B, Shepherds Bush Rd., London, W.6. (SHE 8441.)

YOUR T.V. TUBE RECONDITIONED AT 4/- PER INCH

(Sole Patent Rights, D.H.P. System) OR SUPPLIED ALREADY RECONDITIONED FROM OUR STOCK WITH ONE YEAR'S GUARANTEE. Also Reclaimed Tubes in all sizes from £3. Television Sets from £5 and Valves and Spares from the year dot.

Write for Details and Free Lists to

LES. HOWE & SONS, LTD. (Dept. M.O.), 5, Auckland Close, Tilbury, Essex.

SETS & COMPONENTS continue 1

TELEVISION TUBES

FACTORY reconditioned T.V. picture tubes. SIX months' guarantee.

	£	s	d
12in. MW31-74, CRM123, etc...	7	0	0
14in. MW36-24, AW36-21, etc...	7	15	0
17in. MW43-64, MW43-80, etc...	9	15	0
21in. MW53-20, MW53-80, etc...	13	10	0

CATHODE-RAY TUBE SERVICE
35, Broomwood Road, St. Paul's Cray
Orpington 21285

NEW MAZDA CRM171 17in., c.r.t. manufacturers' guarantee unwritten. £45, carriage paid. New Aerilite 2-stage Band III Pre-amplifier. £4. 77, Cranleigh Road, Bournemouth.

METAL RECTIFIERS H.W. 270v., 80 mA., 5/6; 350v., 80 mA., 6/6; 600v., 30 mA., 6/-; 1kV., 30 mA., 7/6; 500v., 30 mA., 4/6; 240v., 100 mA., 4/-; Bridge: 12v., 1 A., 2/6; 12v., 1.5 A., 7/6; metertype 5 mA., 5/6; 120v., 1 A., 30/-. List and enquiries: S.A.E. please! Terms c.w.o. Postage extra. Immediate despatch. W. A. BENSON, (P.T.), 136, Rathbone Road, Liverpool, 15.

TELEVISION BARGAINS.—Huge quantity of Televisions offered at absolutely rock bottom prices. 9in., £4/10/-; 12in., £10/10/-; 5 Channel, 12in., £13/10/-; 14-15in. from £18; 17in. from £24. Also latest 17in. and 21in. Receivers, prices on request. All above in good working order. Non working: 9in., £2; 12in., £4. Please add £1 carriage. Also quantity of Spares, including Scan Coils and Line Transformers. Callers welcome; trade supplied. GRAINGERS, 21, Kenwyn Ave., Blackpool, Lancs.

COMPONENTS, Valves, Tubes, etc. Write or phone for free list. ARION TELEVISION, 4, Maxted Rd., Peckham, S.E.15. (New Cross 7152.)

RECLAIMED TUBES, 12in., 14in., 17in., all at £5 each, guaranteed; 100 (5 channel) T.V. Ekco 161, Ferguson 988, £15 each. C. EDWARDS, 1070, Harrow Rd. (Phone: LADbroke 1734.)

TELEVISIONS? Not working sets from: 9in., £2; 12in., £3/10/-; 14in., £10. Working sets: 9in., £5; 12in., £9; 14in., £15. (Trade enquiries invited.) RELYON RADIO, 439, Katherine Rd., London, E.7. (Tel.: GRA 1820.)

TELEVISION SPARES for 9in., 10in., and 12in. T.V.s. Valves, Components, Brayhead I.T.V. Converters, £4/18/-; s.a.e. LONDON TELEVISION, 4, Henderson Rd., Eastney, Portsmouth, Hants.

RF27 or 26. 18/-; 25 or 24. 11/-; brand new, post 3/6. E.W.S. CO., 69, Church Rd., Moseley, Birmingham.

TELEVISION CATHODE RAY TUBES

Reconditioned and Guaranteed 6 months. 14" round Mazdas—£5.0.0. 15" round Mazdas—£6.0.0. 17" rect. Mazdas—£6.0.0. Carriage and Insurance, 10/-. Cash with orders to "TELESPEED," Dept. 2/B, 6, Clements Street, Coventry, Tel. 41062.

SETS & COMPONENTS *continued*

Save 30% on all outdoor aerials and fittings. Example: Double Five Array costs only 70/- Self-contained Band III Pre-amplifiers only 60/- Converters 80/- complete. Fringe Area Super Low-loss Co-axial, 1/4 yard. Reconditioned T.V. Tubes, 6 months' guarantee. 12" & 14" 110/-, 17" 150/-, 21" 210/- C.W.O. carriage 10/- extra. Tubes delivered in 24 hours all parts U.K. S.A.E. FOR FULL LISTS.

G. A. STRANGE

North Wrexall, Nr. Chippenham, Wilts.
Tel.: Marshfield 236.

AUCTIONS

EVERY THURSDAY AT 11 a.m.

Sales by private treaty.

DAILY 9-5.30. SATS. 9-5 p.m.

Over 500 TVs from £3 working, 10/- not. Radios, gramms, washing machines, fridges, vacuum cleaners, typewriters.

EASTERN AUCTION MART

Whitehorse Lane, Stepney, London, E.1

FOR SALE

MAINS RADIO IN YOUR CAR, complete unit runs 200/250 AC/DC radio, television, tape recorders, etc., from 12v. battery, perfect, cost £25. 80/- stamp full details. **SCIENTIFIC PRODUCTS**, Cleveleys, Lancs.

HOW TO USE EX-GOV. LENSES and Prisms. Nos. 1 and 2, 2/6 ea. Vertical Enlarger Plans for 35mm. to 2 1/2 in. sq., 3/6 ea. Optical Condensers and Achromatic Lens to suit, 33/- Lists. S.A.E. H. W. ENGLISH, Rayleigh Rd., Hutton, Essex.

VALVE CARTONS at keen prices. Send 1/- for samples and list. J. & A. BONDMAKERS, 75a. Godwin St., Bradford, 1.

AMAZING OFFER.—Originally £40/£100 each. Ekco, Pye, H.M.V., Marconi, Philips, Murphy, etc., 9/10in. Televisions, complete, not working, 50/- each; carriage paid; immediate dispatch, 12in. £5/5/-; 15in., £9; Philips 17in. Projection Televisions, £9/15/-. **TOMLINS**, 127, Brockley Rise, London, S.E.23.

TELEVISION BARGAINS. 12in., O.K., £10; 14in. and 17in. cheap for cash. New sets at bargain price. T.V. SUPPLIES, 1, High St., Chelvey. (Tel.: Stough 21860.)

CO-AXIAL CABLE, unbeatable offer. 8d. a yard air spaced.

TELEVISION TABLES cancelled order. 20" x 20", 18" legs, 4-quartered veneering, veneered both sides, in medium oak, walnut and supele. Unrepeatable offer while stocks last. 39/-, carriage 3/6.

MARSHALLS
FOR
TELEVISION

131, ST. ANN'S ROAD,
TOTTENHAM, N.15.

Phone: STAmford Hill 3267.

FOR SALE *continued*

SECONDHAND TELEVISIONS, 9in. to 21in.; all makes; faulty and working. **WILKINSON'S**, 146a, Goldhawk Rd., Shepherd's Bush, 4379.

SUPERTONIC SUNLAMPS, listed £7/10/-, 80/- S.A.E. **SCIENTIFIC PRODUCTS CO.**, Cleveleys, Lancs.

EFFICIENT AERIALS, test, compare with latest aerial current meter. **HOBLEY**, 109, The Drive, Wellingborough.

PRACTICAL AERIALS, outdoor Band III folded dipole, fitted insulator, reflector, 3 directors, 3in. dia. alloy, bc/ts, assemble to your own boom, alloy, wood, etc. Send 19/- P.O. S.A.E. queries. 165, Beoley Rd., Redditch, Worcs.

100 BAYS of brand new adjustable steel Shelving, 72in. high x 34in. wide x 12in. deep, stove enamelled, dark green; sent unassembled, 6-shelf bay, £3/15/-, sample delivered free; quantity discounts. **N. C. BROWN, LTD.**, Eagle Steelworks, Heywood, Lancs. (Tel.: 69018.)

USEFUL SPARES

INSULATED TAPE, 1.6. Finest quality in sealed metal container. 75ft. x 1/2 in. wide. Postage on 1 tin. 9d. Postage on 6 tins. 2/-.

SOLDER REELS, 1.6. 20ft. on plastic spools 60-40 3 core ERSIN. Postage 4d.

VALVE SCREENING CANS, 1/- doz. Latest midget type. Aluminium. 2in. high x 2in. dia. Postage on 1 doz., 6d.

DUKE & CO. (DEPT. E.10), 621/2, Romford Road, Manor Park, E.12. Tel.: H.F. 6001-9.

WANTED

ALL TYPES OF VALVES WANTED. PL81, ECL80, EY51, U25, PCF80, FZ30, U801, etc., etc. Best cash price by return. **STAN WILLETT'S**, 43, Spon Lane, West Bromwich, Staffs. (Tel.: WES 2392.)

NEW VALVES WANTED.—EY51, PL81, ECL80, and similar types. **R.H.S.**, 155, Swan Arcade, Bradford, 1, Yorks.

IMPORTANT.—All types new B.V.A. Valves wanted. Same day payment. **ROBERT**, 414, Whitefoot Lane, Bromley, Kent.

SERVICE SHEETS

SERVICE SHEETS for sale and hire. Radio/T.V.; s.a.e. enquiries. **J. PALMER**, 32, Neasden Lane, N.W.10.

SERVICE MANUALS/SHEETS Tel/Radio for hire. Sale and wanted. Mixed Manuals and Sheets, 12 for 10/-; s.a.e. enquiries. **W. J. GILBERT (P.T.)**, 24, Frithville Gdns., London, W.12.

ENGINEER has complete range Radio/T.V. Service Sheets, 4/- each; s.a.e. State Model No. required; c.w.o. **L. BRENNER**, 23, Meadway Close, Barnet, Herts.

EDUCATIONAL

FREE! Brochure giving details of Home Study Training in Radio, Television and all branches of Electronics. Courses for the Hobby Enthusiast or for those aiming at the A.M.Brit.I.R.E., City and Guilds, R.T.E.B. and other Professional examinations. Train with college operated by Britain's largest Electronics organisation. Moderate fees. Write to **E.M.I. INSTITUTES**, Dept. PT28, London, W.4.

STUDY RADIO, TELEVISION AND ELECTRONICS with the world's largest home study organisation—**I.C.S.** Courses for the enthusiast and for those seeking examination qualification. **Brit. I.R.E.**, City and Guilds, R.T.E.B., etc. Build your own equipment with Practical Radio Course. Write to-day for free book: **INTERNATIONAL CORRESPONDENCE SCHOOLS**, 71, Kingsway, (Dept. 515), London, W.C.2.

BUILD YOUR OWN T/V and learn about its operation, maintenance and servicing. Qualified engineer-tutor available while you are learning and building. Free Brochure from **E.M.I. INSTITUTES**, Dept. PT58, London, W.4. (Associated with H.M.V.)

INCORPORATED Practical Radio Engineers home study courses of radio and T.V. engineering are recognised by the trade as outstanding and authoritative. Moderate fees to a limited number of students only. Syllabus of Instructional Text is free. "The Practical Radio Engineer," journal, sample copy 2/-. 6,000 Alignment Peaks for Superhets, 5/9. Membership and Entry Conditions booklet, 1/-, all post free from the **SECRETARY, I.P.R.E.**, 20, Fairfield Road, London, N.8.

LEARN IT as you do it—we provide practical equipment combined with instruction in Radio, Television, Electricity, Mechanics, Chemistry, Photography, etc. Write for full details to **E.M.I. INSTITUTES**, Dept. PT47, London, W.4.

II+
EXAMINATION

Write for **FREE 24-page GUIDE** and Test stating age of child to The Registrar (Dept. M.7),
MERCER'S
CORRESPONDENCE COLLEGE,
69 Wimpole Street, London, W.1.

PROPERTY

BERRYLANDS (Surbiton). Adjoining station in a fully built-up area, parade of spacious shops with 2 floor upper parts just constructed. To be let or sold. Trades already reserved Grocer and Provision Merchant, Greengrocer, Ladies' Outer- and Underwear, Shoe Repairer, Tobaccoist and Confectioner, Dyers and Cleaners, Retail Builders' Merchant and Pet Shop. Full details: **MESSRS. WHIDDINGTON**, Chartered Surveyors, 133, High Street, Teddington. (KINGston 1216/3781). £ :

IS YOUR T.V. TUBE DIMMING ?

YOU CAN EXTEND THE LIFE OF THAT TUBE AND IMPROVE THE PICTURE

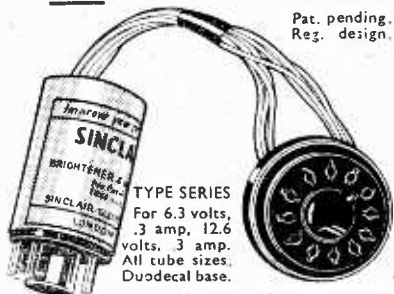

Pat. pending.
Reg. design.

TYPE SERIES

For 6.3 volts, 3 amp. 12.6 volts, 3 amp. All tube sizes. Duodecal base.

PRICE **30/-**

Package & Postage 1/6.
(Postal Orders C.W.O. C.O.D.)

- NO SOLDERING
- NO WIRING
- JUST PLUG IN
- IT'S AUTOMATIC
- IT'S GUARANTEED !

Sinclair Electronics introduces the first series wired plug in booster unit, for all universal TV sets, using Mazda & Mullard Tubes & equivalents, operating off A.C. mains. Any voltage. For A.C. TV sets only (A.C. parallel type can be supplied). If not satisfied money refunded within 7 days.

SINCLAIR ELECTRONICS,
247, BRICK LANE, LONDON, E.2.
Phone : SHO 7424

SOMETHING NEW !!

A PRE-AMP FOR BOTH I.T.V. AND B.B.C.

Following the success achieved by our Band III Pre-amp, we introduce a combined unit designed to overcome the difficulties experienced in situations where reception of both I.T.V. and B.B.C. is extremely poor.



Units now available —
"DUAL BAND"

★ Co-ax Inputs for Bands I and III.

★ I.T.V.—amplified.

★ B.B.C.—amplified.

★ Single Output to Receiver.

Price £9.10.0 C.W.O. or C.O.D.

"SINGLE BAND"

★ Co-ax Inputs for Bands I and III.

★ I.T.V.—amplified.

★ B.B.C.—Diplexed.

★ Single Output to Receiver. Price £6.6.8, C.W.O. or C.O.D. Please state channels required.

Both Units have a high signal to noise ratio, and will produce excellent results in localities where the signal is normally unusable.

Units have Built-in Power Packs 200-50 v. A.C. Dimensions : 6 x 4 x 2 1/2 in. (Fly Lead, 3/6 extra).

"AIRVISION"

(Electronic Equipment Manufacturers)

14 BOULTON RD., SOUTHSEA, HANTS.

59 Gns.—'17'

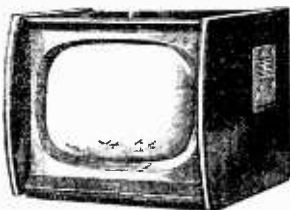

A full specification 17in. Television Receiver to Spencer-West standards now available at your Dealers. Remarkable performance and priced at 59 Gns. only, complete.

For Leaflet apply to:—

SPENCER - WEST LTD.
Quay Works, Great Yarmouth
Norfolk

Phones : Works 4794; Sales 3009
Grams: Spencer-West, Great Yarmouth

A BEGINNER'S GUIDE TO TELEVISION

A Series of lessons on persistence of vision and scanning; the cathode-ray tube and timebase; interlacing; the aerial; the T.V. camera; scanning systems; colour and stereoscopic television, technical terms, etc. 61 illustrations

7/6 by F. J. Camm. Postage 6d.

PRACTICAL TELEVISION CIRCUITS.

By F. J. Camm. 15/-

Postage 9d.

TELEVISION SERVICING.

By G. N. Patchett. Vol. I, Vol. 2, 5/- ea.

Postage 4d. ea.

BEGINNER'S GUIDE TO RADIO.

By F. J. Camm. 7/6. Postage 6d.

IMPROVE YOUR RECEPTION.

By J. Cirra and L. Stanley. 5/- Postage 6d.

TELEVISION ENGINEERING VOL. IV.

By S. W. Amos and D. C. Birkinshaw. 35/- Postage 1/2.

RAPID T.V. REPAIR.

By G. W. Heath. 23/- Postage 1/-.

RADIO VALVE DATA.

6th Ed. Cam. "WW". 5/- Postage 9d.

THE MODERN BOOK CO.

BRITAIN'S LARGEST STOCKISTS of British and American Technical Books

19-23 PRAED STREET, LONDON, W.2.

Complete catalogue 6d.
Phone : PADdington 4185
Open 6 days 9-6 p.m.

Television Aerials. Band III 3-element 24/6; 5-element, 37/6; 8-element, 57/6. B.B.C. Single Dipole, 32/6; H. 74/6; "X" 74/6. We carry large stocks of good aerials. Send S.A.E. with your requirements and we will reply by return.

Air-Spaced Coaxial Cable, 9d. per yd. 70/- per 100 yds. Crossover Boxes, 12/- Coaxial Plugs, 1/- Coaxial Sockets, 1/- Ion-Trap Magnets, 5/- Television Tables, 62/6. Electrolytic Condensers, 61+120 mfd., 9/-, 100+200 mfd., 10/6. 100 mfd., 6/6. 15 mfd., 3/-, 8-8 mfd., 2/6. 8 mfd., 1/3. Speakers, 5in., 19/6. 6in., 18/6. 8in., 22/6. 12in., 28/6. 7 x 4in., 18/6. 9 x 5in., 22/6. Guaranteed Brand New Stock. Electric Blankets, Single Size, 67/6. Double Size, 87/6. B.S.R. 4-speed Record Changer, 87.12.6, plus 3/6 carriage.

Guaranteed Valves			
AZ1 12/-	PCL83	UCL83	3C4 12/6
AZ31 12/-	PL33 18/6	UL45 15/-	5Y3 10/6
CB11 19/6	PL38 21/6	UCC83 15/-	5U4 10/6
CB131 17/6	PY31 17/6	UL41 11/-	5V4 10/6
CL33 14/6	PY32 17/6	UL44 21/6	6A7 17/6
CY31 12/6	PZ30 17/6	UL46 18/6	6AQ5 8/6
DD74 18/6	PCF80 17/6	UL84 11/-	6BA8 8/6
EBL31 19/6	PY81 12/6	UY85 8/6	6BG6 17/6
ECB33 14/6	PY82 8/6	IA7 16/6	6CD8C 22/6
EP85 9/6	PL81 15/6	1N5 13/6	6F8 8/6
EP86 11/6	PL86 18/6	1H5 13/6	6V6GT 9/6
EL33 14/6	PCC84 10/6	1C5 13/6	6L6C 17/6
GZ32 15/-	MU11 12/6	2A3 15/-	6SN7 12/6
FCL82 15/-	UBC41 8/6	2A5 16/6	6S7A 8/6
EL38 21/6	UCH32 9/6	2B7 16/6	6S7D 10/6
PCL82 15/-	UBF80 10/6	3A4 15/-	6S7E 10/6
		63A4 15/-	607 8/6
		15-UCL82 15-3A5 18/6	16Z5 5/-

MAIL ORDER ONLY—NO CALLERS
Terms : C.W.O. or C.O.D. Minimum C.O.D. charge 3/6. Postage and packing per valve, 6d. Other items, under 22, 1/6; £5, 2/-; Aerials 3/- carriage.

ELECTRO-SERVICES & Co.

221 BATTERSEA PARK ROAD, LONDON, S.W.11. MAC 8155

Wanted!

QUALIFIED MEN AND WOMEN

Industry and Commerce offer their best posts to those with the qualifications—appointments that will bring personal satisfaction, good money, status and security. As part of a modern industrial organisation, we have skilled knowledge of what is required and the best means of training personnel for present day and future requirements. We specialise also in teaching for hobbies, new interests or part-time occupations in any of the subjects listed here. Write to us to-day for further information. There is no obligation of any kind.

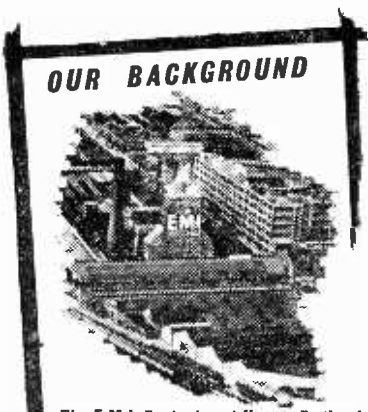

The E.M.I. Factories at Hayes, England.
The only Home Study College
 operated by a world-wide
 manufacturing organisation

EMI

INSTITUTES

PERSONAL & INDIVIDUAL TRAINING IN—

- | | | | |
|---------------------------------------|-------------------------|-----------------------|----------------------|
| Accountancy | Draughtsmanship | Mathematics | Sales Management |
| Advertising | Economics | M.C.A. Licences | Sanitary Engineering |
| Aeronautical Eng. | Electrical Eng. | Mechanical Eng. | Salesmanship |
| A.R.B. Licences | Electrical Instal. | Metallurgy | Secretaryship |
| Art (Fashion, Illustrating, Humorous) | Electronics | Motor Eng. | Servo Mechanisms |
| Automobile Eng. | Electronic | Painting & Decorating | Shorthand & Typing |
| Banking | Draughtsmanship | Photography | Short Story Writing |
| Book-keeping | Eng. Drawing | P.M.G. Certs. | Short Wave Radio |
| Building | Export | Police | Sound Recording |
| Business | Gen. Cert. of Education | Production Eng. | Telecommunications |
| Management | Heat & Vent. Eng. | Production | Television |
| Carpentry | 'Hi-Fi' Equipment | Planning | Time & Motion Study |
| Chemistry | High Speed | Radar | |
| City & Guilds Exams | Oil Engines | Radio | |
| Civil Service | Industrial Admin. | Radio Amateur | Tracing |
| Commercial | Jig & Tool Design | (C & G) Licence | Transistors |
| Subjects | Journalism | Radio Engineering | Welding |
| Commercial Art | Languages | Radio & Tele- | Workshop Practice |
| Computers | Management | vision Servicing | Works M'gement |
| Customs Officer | Maintenance Eng. | Refrigeration | etc., etc. |

Also courses for GENERAL CERTIFICATE OF EDUCATION, A.M.I.H.&V.E., A.M.S.E., A.M.Brit.I.R.E., A.M.I.Mech.E., A.M.I.E.D., A.M.I.M.I., A.F.R.Ae.S., A.M.I.P.E., A.M.I.I.A., A.C.C.A., A.C.I.S., A.C.C.S., A.C.W.A., City & Guilds Exams., R.T.E.B. Servicing Certificates, R.S.A. Certs., etc., etc. Moderate fees.

NEW! Courses with PRACTICAL EQUIPMENT

in RADIO · TELEVISION · MECHANICS
 CHEMISTRY · ELECTRICITY
 DRAUGHTSMANSHIP · PHOTOGRAPHY etc., etc.

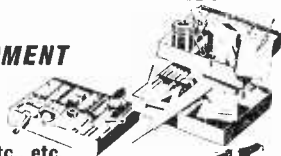

POST THIS TODAY

To :- E.M.I. INSTITUTES, Dept. 138K, London, W.4.

NAME AGE
 (if under 21)

ADDRESS

I am interested in the following subject(s) with/without equipment:

OCT., 58 (We shall not worry you with personal visits)

FREE

BLOCK
 CAPS
 PLEASE

-part of "His Master's Voice" Columbia, etc., etc.

I. F. STRIPS—POWER PACKS

SOUND & VISION STRIPS, 10.6. 8 het. Takes 6 EP91, 1 6P12, 1 6P14. Not tested. Post 2/6.

SOUND & VISION STRIP. PLESSEY, 25.6. 8 het. Takes 6 6P11, 2 6P12 (valves extra). Not tested. I.F.s 10.5 Mc/s sound, 15 Mc/s vision. Bargain. Post 2/6.

TIMEBASE, 4.9. With counting coil, focus unit. Line trans., loss valves. FREE drawing. Post 3/6.

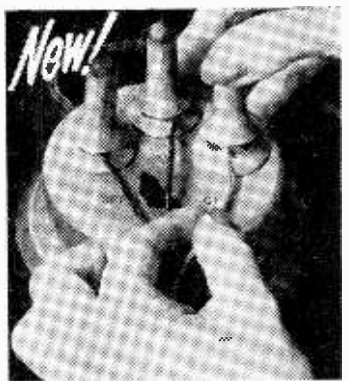
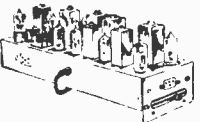

AT LAST!
A REAL I.T.V.
CONVERSION SERVICE

WE OFFER A COMPLETE AFTER-SALES SERVICE WITH ALL I.T.V. EQUIPMENT SOLD BY US.

Your problems settled by return mail. Whether novice or expert, let our extensive I.T.V. experience ensure your success.

PRE-AMPS
I.T.V. SIGNAL BOOSTER AT 37/6 COMPLETE

- **SMALL.** Fits neatly in cabinet corner.
- **EFFICIENT.** Simple but clever circuitry giving pentode gain and triode noise level.
- **EASIFIX.** One-hole fixing to cabinet fillet. Plug-in feeder steals power from main T.V.

STATE CHANNELS, SET MAKE AND MODEL WITH ORDER. Standard pattern suits most T.V.s using EF80 valves.

CONVERTERS

THE FAMOUS BRAYHEAD TURRET TUNER AT £6.19.6 COMPLETE.

- **EASIFIX.** Over 600 models converted by simple plug-in technique.
- **SPECIAL OFFER.** We can supply a modified version of our standard I.T.V. booster as an add-on fitment, thus improving I.T.V. performance. Special at 25/- extra.

STATE CHANNELS, SET MAKE AND MODEL WITH ORDER.

AERIALS

OUR 5-ELEMENT ADD-ON I.T.V. AERIAL 39/6-COMplete with Universal Clamp and Stand-off Arm.

- **Diplexers and Low-Loss Cable** to order. State your needs or **ASK OUR ADVICE** with order.

WILSON

48, CATHAY, BRISTOL, 1 (Phone BRISTOL 26242) Mail Order only. Terms: C.W.O. Postage 1/6, above £2 free except aerials 2/6.

Boxed	VALVES	Guaranteed	
4111	6 9/35Z4	8 9/EF40RD	RL55 1 9
6AM5	3 9/35L6	8 8	5 9/SP61 8 9
6AM6	7 9/68MPT	2 9/EP80	8 9/122 10 9
6B3	1 9/210VPT	5 9/EP85	8 9/1P41 8 9
6B4	3 9/7193	3 9/EP91	7 9/1U06 7 9
6P12	7 9/AR6(2V)	1 9/EP92	3 9/152 8 9
6F14	8 9/ARP35	3 9/EL94	10 9/VE65 6 9
6H6M	1 9/CV1083	3 9/EZ50	8 9/VT32 6 9
6J5M	2 9/101	1 9/EZ80	8 9/VT501 6 9
6S47M	8 9/1H76	6 9/FW4500	VW36 1 9
6V6M	8 9/1K96	8 8	10 9/TT11 6 9
6P28	12 6/DP66	5 9/KTW61	5 9/W76 8 9
68A7M	3 9/EAG0	1 9/KTW63	8 9/W81 3 9
68C7	3 9/EABC90	9 6/L10	1 9/ZZ7 7 9
68C7M	2 9/EAP42	8 9/NR41	3 9
8D2	3 9/ER34	1 9/PEN45	6 9/UX TYPES
8D3	7 9/EP36	6 9/PEN46	6 9/18 3 9
9D2	6 9/EB33	6 9/PEN220A	32 3 9
11F3	5 9/ECN81	8 9	3 9/75 3 9
12A5	8 9/ECH42	8 9/PL82	8 9/78 3 9
12AT7	8 9	4 9/PM202	1 9/1106 3 9
12BE6	6 9/EP37	4 9/PP225	3 9/25RE 3 9
12K7	8 9/EP39	3 9/PY81	8 9/547 3 9
12Y1	8 9/EP50	2 9/P61	6 9/77 3 9

EF51 VALVES, 8.9. Ex-equipment. Tested. Post 9d.
FOCUS MAGNET, 3.9. .35 mm. Permanent magnet type. Salvage, Plessey. Post 1/9.

ELAC FOCUS MAGNET, 5.9. .35-.38 mm. Permanent magnet. Salvage. Post 1/9.

FRAME OUTPUT TRANSFORMERS, 3.9. To match low impedance coils. Post 1/3.

ELAC FOCUS MAGNET, 12.9. Brand new. .35-.38 mm. Post 1/9.

VISCONAL CONDENSERS, 5.9. .1 to 7 KV. working and .001 at 12.5 KV. Post 6d.

RECTIFIERS, 2.9. 250 v. 100 mA. Full or half-wave. Salvage. Post 1/3.

INSULATING TAPE, 1.6. 75 ft. x in. wide. Post 9d.

SOLDER REELS, 1.6. 60-40 Erwin 3 corr. 20ft. on plastic spool. Post 6d.

HEADPHONES, 3.9. Marconi. New. 60 ohms. Very sensitive. Post 1/-. Less leads.

VOLUME CONTROLS, 1.9. 1 megohm. New, boxed. Long spindle. Post 1/-.
VOLUME CONTROLS, 1.3. 20KΩ. Unused. Short spindle. Carbon. Post 1/-.
VOLUME CONTROLS, 2.6 doz. Assorted parcel of volume and tone controls taken from working chassis. Post 1/9.

GANGED CONDENSERS, 1.9. 2 and 3-gang 0.0005. Std. size. Salvage. Post 1/3.

I.F. TRANSFORMERS, 1/- pair. 465 kc/s. Tested. Post 9d.

TRIMMERS, 6d. 3-50 pF., 5 - doz. Post on 1. 4d. on doz., 1/-.

CAR AERIALS, 6.9. Plated. Whip antennae. 60in. long. Collapsing to 11in. One-hole fixing. Post 1/-.
CO-AX. CABLE, 6d. yard. Good quality. Cut to any length. Post on 20 yds., 1/6. 45 - per 100 yds. Post 3/6.

COIL PACKS, 3.9. 3-gang. Also include one pair I.F. trans., 465 kc/s and 2-gang condenser. Post 2/3.

TRANSFORMERS

MAINS POWER TRANSFORMER, 15.9. 350-0-350 v. 250 mA. 5 v. 3 A., 4 v. 5 A., 4 v. 2 A. Isolated. Post 3/3.

MAINS POWER TRANSFORMER, 9.9. 350-0-350 v. 250 mA., 0.3 v., 5 A., 6.3 v., 4 A., 22 v., 0.3 A. and 4 v. centre tapped. Post 3/3.

EF51 TRANSFORMER (Heater) 1-1 ratio. Suitable 6.3 v. tubes as isolation trans., 5.9. Post 1/9.

P. P. COMPONENTS LTD. (Dept. T8)
219 ILFORD LANE, ILFORD, ESSEX. Phone: ILF 0295

Send 3d. stamp for FREE Catalogue.

T.I.M. Snap-action Appliance Connector
TEST BENCH MODEL

Equipment under test connected to mains without plugs or screw terminals. Safe, positive grip contact is made and unmade in an instant. A low-priced workshop time saver for both amateurs and manufacturers. With colour coded Mycalex insulated terminals and on/off switch.

Stove enamelled, Price, 35/- each.

MYCALEX & T.I.M. LIMITED,
ASHCROFT ROAD, CIRENCESTER, GLOS
Telephone: Cirencester 400.

from one source

Denco, Repanco, J.B., T.C.C., Woden, Elac, McMurdo, Radiospares, Eddystone, Elstone, Bulgin, Belling & Lee, Hunts, Sorad, Acos, Brown, Mullard, Igranic, Corsor, Taylor, Avon, Henley, E.M.I., etc.

Orders dealt with day received

54 page illustrated catalogue No. 11, with 108 photographic illustrations and over 2,000 new guaranteed lines by leading makers. 9d. post free.

SOUTHERN RADIO and ELECTRICAL SUPPLIES

SORAD WORKS . REDLYNCH SALISBURY . WILTS

TRANSFORMERS ?

CONTACT **Forrest FIRST!**

Rewinding and manufacture of all types for Television, Radio and Electronic Application.

FORREST (TRANSFORMERS) LTD., Shirley, Solihull, Warwickshire. Phone: SH1. 2483. Est. 34 years.

RES/CAP. BRIDGE 35/-

p. & p. 2/- Checks all types of resistors and condensers.

Easy to Build Up Easy to Use
READY CALIBRATED
Stamp for details of this and other kits.
RADIO MAIL (Dept. VF)
Raleigh Mews, Raleigh Street, Nottingham

LINE OUTPUT TRANSFORMERS

Most types available. State Make and Model Number of Receiver when ordering.

S.A.E. please with all enquiries.

HOWORTH
51 POLLARD LANE,
BRADFORD, 2, YORKS
Tel. 37030

Selling fast . . . F. J. Carrm's A BEGINNER'S GUIDE TO TELEVISION

Covers persistence of vision and scanning; the cathode-ray tube and timebase; interlacing; the aerial; the TV camera; scanning systems; colour and stereoscopic television, etc. 61 illustrations.

From all booksellers or Rs. 3d., by post from **GEORGE NEWNES LTD., Tower House, Southampton Street, W.C.2.**
7s. 6d.

COVENTRY RADIO

Audio & Component Specialists Est. 1925
189-191, Dunstable Rd., Luton, Beds.
HI-FI EQUIPMENT CABINETS IN STOCK

Record Housing: Nordik Range in Oak, Walnut, Mahogany.

Speaker Enclosure . . . £5.17.6
Equipment Cabinet . . . £5.19.6
Record Cabinet (150 records) £4.17.6
Continental Bench . . . £4.17.6

Polenaise Hi-Fi Cabinet . . . £19.19.0

W.B. Prelude Speaker Cabinet £11.11.0

W.B. Prelude Equipment Cabinet £13.13.0

W.B. Prelude Corner Speaker Cabinet £10.10.0

W.B. Table Equipment Cabinet £9.19.6

W.B. Senior Hi-Fi Console . . . £16.16.0

W.B. Junior Hi-Fi Console . . . £12.12.0

W.B. Junior Base Reflex . . . £9. 9. 0

W.B. Standard Base Reflex . . . £10.10.0

W.B. Senior Base Reflex Corner £11.11.0

B.K. AUDIO PLAN

B.K. Speaker Cabinet . . . £16.19.6

B.K. Equipment Cabinet . . . £17.19.6

B.K. Record Cabinet . . . £16.16.0

B.K. Continental Bench 48in. . . £7. 7. 0

B.K. Continental Bench 72in. . . £13.13.0

B.K. Set 4 Legs tilt & glide feet £2. 2. 0

B.K. Set 4 Legs Plain Ebónised 19.6

SOUTHDOWN HI-FI Cabinet

£29.10.0

R.C.A. Lowboy Cabinet . . . £18.10.0

HEALS Chairside for Quad . . . £29.15.0

HEALS Chairside . . . £37. 0. 0

BREARCLIFFE Equip. Cab. £30. 9. 0

BREARCLIFFE Equip. Cab. £22. 1. 0

ARMSTRONG Equipment Cabinet £34.19.0

Leaflets available on request.

FIRST-CLASS TELEVISION and RADIO COURSES

GET A CERTIFICATE!

After brief, intensely interesting study—undertaken at home in your spare time—YOU can secure your professional qualification or learn Servicing and Theory. Let us show you how!

FREE GUIDE

The New Free Guide contains 132 pages of information of the greatest importance to those seeking such success compelling qualifications as A.M.Brit.I.R.E., City and Guilds Final Radio, P.M.G. Radio Amateurs' Exams., Gen. Cert. of Educ., London B.Sc. (Eng.), A. M. I. P. E., A.M.I.Mech.E., Draughtsmanship (all branches), etc., together with particulars of our remarkable Guarantee of

SUCCESS OR NO FEE

Write now for your copy of this invaluable publication. It may well prove to be the turning point in your career.

FOUNDED 1885—OVER

150,000 SUCCESSSES

NATIONAL INSTITUTE OF ENGINEERING
(Dept. 462), 148, HOLBORN, LONDON, E.C.1.

B.B.C.-I.T.V.-F.M. AERIALS



B.B.C. (Band D)—Telescopic loft, 19/6. External S.D. 23/6. "X" Chinney unit. 75/-
I.T.V. (Band 3)—3-element loft array. 24/-; 5-element, 32/6. Wall mounting, 3-element, 33/9; 5-element, 41/3.
Combined B.B.C. & I.T.V. Loft 1-3 element, 41/3; 1+5 element, 48/9. Wall mounting, 1-3 element, 56/3; 1+5 element, 63/9.
Bellini "Golden V" room aerial, 42/-.
Antiference "V" 25/-
F.M. (Band 2)—Loft "H" 28/-; 3-element, 52/6. S/D loft, 12/6. External S/D, 26/3. State channel when ordering.
C.W.O. or C.O.D. P.P 2/6. Coaxial cable, 8ft. yd. Coaxial plugs, 1/3. Send 3d. stamps for lists.

K.V.A. ELECTRONICS (Dept. T.P.),
3B, Godstone Road, Kenley, Surrey

CONVERT YOUR PRE-1954 ULTRA TO I.T.V.

Specialty designed to give the best, clearest ITV reproduction on Ultra sets.

Fixes permanently by means of clamps, or stands beside the set. Neat 'flick of a switch' programme selector. £9.9.0 (incl. P1)

Inquire from your Ultra Dealer, or send money order or post card for further details to Dept. 1, Ultra Electric Ltd., Western Avenue, W.3.

EDDY'S (Nottm.) LTD.

DEPT. P.T.

172, ALFRETON ROAD, NOTTINGHAM.

ACOS CRYSTAL MIKES. Excellent for Tape Recorders, Baby Alarms, Amplifiers, etc. Our Price 29/11. List Price 50/-. Plus 3/- Post and Packing. Brand New and Boxed.

MIDGET BATTERY ELIMINATORS. To convert all types battery portables to mains operation, 57/6 each, 2/6 Post, etc. Size 3.7 in. x 2.5 in. x 1.8 in. Smaller than H.T. battery alone. (Please state make and model No.) Brand New and Boxed.

ACOS CRYSTAL TURNOVER PICK-UPS (2 Sapphire styli), 29/11, 2/6 extra Post, etc. Brand New and Boxed.

B.S.R. MONARCH 4-SPEED AUTOMATIC CHANGERS. Complete with High Fidelity turnover head type H.C.P.37-1. Capacity of 10 records, plays 12 in., 10 in., 7 in. intermixed in any order. 78, 45, 33, 16 r.p.m. For A.C. Mains 100-250 volts, £6.19.6. Brand New with full instructions. Post, etc., 5/-.

ACOS CRYSTAL MIKE INSERTS, 4/11 each. High Quality. Can be used for Tape Recorders, Baby Alarms, Musical Instruments, etc. Post and Packing 8d. extra. Brand New and Boxed:

THROAT MIKES, 1/- each, Post etc., 6d. extra. Can be used for electrifying musical instruments, etc.

GERMANIUM DIODES, 1/- each, 10/- doz. Post, etc., 4d. extra.

MORSE TAPPERS. Plated contacts, Adjustable Gap, Heavy Duty, Good quality. Special Price, 3/6, Post, etc., 9d. each.

ALL NEW AND GUARANTEED

1D5	10/-	25L6G	9/11	EF91	7/6
1R5	7/6	25Z4G	9/11	EL41	10/6
1T4	6/6	35A5	10/6	EL42	10/6
3Q5GT	9/6	35L6GT	9/11	EL91	5/-
5U4G	6/6	35W4	7/6	EY86	14/6
5Y3G	8/-	35Z3	13/6	EZ80	8/3
5Z4G	9/-	35Z4G	7/6	EZ81	9/11
5Z4M	10/-	807(B)	3/9	GZ32	12/6
688G	2/11	807(USA)		KT33C	8/6
6F1	13/11		5/6	KT66	15/-
6F13	12/6	954	1/6	L63	6/-
6J5	2/11	955	3/11	PCC84	9/-
6K7G	2/11	956	2/11	PCF80	12/6
6K8G	7/6	AZ1	12/11	PCF82	12/6
6L6G	6/11	AZ31	12/11	PCL83	15/6
6L18	12/6	CY31	12/11	PL36	15/-
6Q7G	8/6	DAF96	9/6	PL38	19/6
65K7GT	6/-	DF96	9/6	PL81	16/-
65N7GT	5/9	DH77	7/11	PL82	9/6
6V6G	5/11	DL96	9/6	PL83	10/6
6X4	6/-	DM70	7/11	PY80	8/3
6X5GT	6/6	EB91	5/11	PY81	8/6
7C6	8/-	EBC41	9/11	PY82	8/6
7H7	8/6	ECB80	9/11	TDD4	12/6
757	9/11	ECC81	8/-	UAF42	10/6
7Y4	7/11	ECC82	8/-	UF41	8/6
10F9	10/6	ECC83	8/11	UF42	14/6
12A7	7/6	ECC84	8/11	UL41	9/6
12K7	7/6	ECC85	8/11	UL84	9/6
12SH7	5/6	ECL80	13/6	UY41	7/6
12S17	7/6	EF40	13/11	UY85	8/11
12SK7	7/6	EF41	9/6	VT52	2/11
14S7	15/6	EF42	12/6	Z63	10/6
25A6G	12/11	EF80	8/-	Z66	8/6

GUARANTEED NEW AND SURPLUS VALVES

All tested before despatch. C.W.O. or C.O.D. only.

Postage and Packing 6d. per valve extra. Over £3 Free.

S.A.E. with enquiries.

Any parcel insured against damage in transit for only 6d. extra per order. All uninsured parcels at customer's risk.

AN ESSENTIAL "PIECE OF EQUIPMENT" FOR
RADIO & TV ENGINEERS
Technicians and Keen Amateurs

This new 2nd Edition provides in compact form all the information required by those engaged in design, maintenance, technical sales, operation and servicing of modern radio and TV transmitting and receiving equipment. It supplies the practical data, formulae, calculations and information you need, and which is often not obtainable without recourse to numerous references. For the technician and executive-to-be it is indispensable.

CRAMMED WITH FACTS, FIGURES AND DATA
WRITTEN BY 41 SPECIALISTS

Formulae & Calculations. Electron Optics & Colour TV. Materials. Studios & Equipment—*planning, lighting, camera tubes, etc.* Broadcasting Transmitters & Power Plant. Communication Transmitters—*design, components, marine, ground-to-air, mobile, international call signs, etc.* Amateur Radio Equipment—*licences, frequencies, H-F transmitter and receiver design, etc.* R.F. Transmission Lines. Wave-guides. Broadcasting Receivers—*design, developments, V.H.F., etc.* TV Receiver Design—*frequency conversion, channel selection, V.H.F. Converters, colour TV, etc.* Commercial H.F. Radio Links. Broad-Band Radio Systems. Navigation & Radar. Aero Equipment. Industrial TV Aerials—*vertical rod-inverted L-loop-aerials, V.H.F.—band III, car aerials, fundamentals, fringe equipment, etc.* Transistors. Crystal Diodes. Resistors. Capacitors. Inductors & Transformers. Microphones. Loudspeakers. Interference—*causes, etc.* Recording. Gramophone Mechanisms. Batteries & Conversion Equipment—*dry, storage, charger, vibrators, etc.* Measuring & Test Equipment. Radio & TV Installation & Servicing—*equipment, alignment, precautions, fault-finding, etc.* Projection TV—*tubes, adjustment, theatre, etc.* Quartz Oscillators & Frequency Allocations. Units & Symbols, etc., etc.

BROADCASTING • COMMUNICATIONS • NAVIGATION • SERVICING

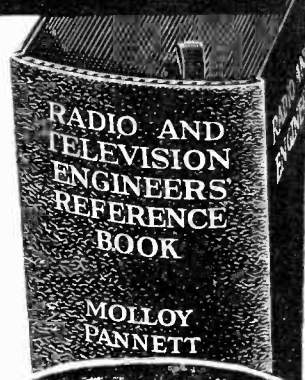

STUDY IT—TEST IT
IN YOUR OWN HOME
WITHOUT COST OR
OBLIGATION

- 1,800 pages of technical data to meet your everyday needs.
 - 46 main sections, written and compiled by leading authorities.
 - 2,000 diagrams, tables, standard formulae, calculations, measurements.
- 3,260 cross-referenced index entries enabling wanted information to be found in an instant.

PROVE ITS VALUE—

FREE FOR 7 DAYS

POST TO - DAY

We cannot list above more than a small fraction of its invaluable contents—seize this opportunity to examine it freely in your own home. A "must" for the radio enthusiast.

To : George Newnes, Ltd., 15-17 Long Acre, London, W.C.99.

Please send me Newnes RADIO AND TELEVISION ENGINEERS' REFERENCE BOOK without obligation to purchase. I will either return the work within eight days or I will send the first payment of 7s. 6d. eight days after delivery, and then seven monthly subscriptions of 10s. until the sum of 77.6 has been paid. Cash price within eight days is 72.-.

Name

Address

Occupation.....

Your Signature

(Or your parent's signature if under 21)

Tick (✓) where applicable

House OWNER	
Householder	
Living with Parents	
Lodging Address	

RB13

Post coupon in 2d. unsealed envelope.

YOUR OWN TELEVISION TUBE RE-BUILT

THE FOLLOWING TYPES AND SIZES ONLY

MULLARD . . 12in. £7-10-0. 14in. £8-10-0.
 OR EQUIVALENTS
COSSOR-EMITRON-CATHODEON 17in. £10-10-0. 21in. £12-10-0.

48 Hr. SERVICE

All Tubes plus 10/- carriage and insurance.

SIX MONTHS' GUARANTEE

Terms to the Trade.

OWING TO PURCHASE TAX REGULATIONS WE CAN ONLY RE-BUILD YOUR OWN TUBE. THESE CAN BE SENT TO US BY BRITISH ROAD SERVICES (Parcels) LTD., CARRIAGE FORWARD.

TERMS, CASH WITH ORDER or C.O.D.

RE-VIEW (LONDON) LTD.

81, HIGH STREET MERTON S.W.19

Telephone : CHERRYWOOD 3255

THE LABGEAR BAND III PRE-AMPLIFIER



Model E.5044.
 £6.15.0 for Channels
 8-9-10
 Model E.5044 A.
 £6.15.0 for Channels
 9-10-11.

- ★ High gain 15db.
- ★ Low Noise Level.
- ★ Self-contained Power Unit.
- ★ Broad Bandwidth 3.5 Mc/s at 1.5 db.
- ★ Easy to fit.
- ★ Small Physical Size.
- ★ Automatically switched ON/OFF by receiver.
- ★ Will work with any T.V. Receiver capable of reception on Band III.
- ★ Single-stage of Cascode.
- ★ 75 ohm input and output.
- ★ Power consumption only 10 watt.

OBTAINABLE FROM LEADING RETAILERS OR IN CASE OF DIFFICULTY WRITE TO :—

LABGEAR LTD. WILLOW PLACE, CAMBRIDGE
 Tel. : 2494.

C.R.T. ISOLATION TRANSFORMER

Type A. Low leakage windings. Optional 25% and 50% boost on secondary. 2 v. or 4 v. or 6.3 v. or 10.8 v. or 13.3 v. with mains transformer. 12.6. Type B. Mains input. Multi Output 2, 4, 6.3, 10, 15 and 13 volts. Boost 25% and 50%. Low capacity. 21. Type C. Low capacity transformer for 2 volt tubes with falling emission. Mains Primary. Output 25-125-215 volts at 2 amp. 17.6.

TRIMMERS. Ceramic. 30, 50, 70 pf. 9d.; 100 pf. 1.3; 250 pf. 1.8; 500 pf. 750 pf. 1.9. RESISTORS. Preferred values. 10 ohms to 10 meg. 1 w., 4d.; 1 w., 4d.; 1 w., 6d.; 1 w., 8d.; 2 w., 1. HIGH STABILITY. 1 w., 1.2. Preferred values. 100 Ω to 10 meg. 100 w., 100 pf. 500 pf. 1.8d. 5 watt. WIRE-WOUND RESISTORS. 1/8 to 10 watt. 25 ohms-10,000 ohms. 1.8 15 watt. 50,000 ohms. 2 15,000 ohms-50,000 ohms. 5 w., 1.9; 10 w., 2.3.

12.6 PURETONE RECORDING TAPE

1,200 ft. on standard 7" Metal reels. Spare Reels 7 plastic, 4-7 metal, 2.3. SUPERIOR 1,200 ft. Plastic Tape on 7" Plastic Reels. Quality Guaranteed. 21.

O.P. TRANSFORMERS. Heavy Duty 30 mA., 4.6 Midget 250-250-pull, 7.6. Miniature, 384, etc., 4.8. I.F. CHOKES 15-10 H. 60-65 mA., 5-10 H. 10 mA., 10-6; 10 H. 150 mA., 14.

MAINS TRANSFORMERS

STANDARD. 250-0-250, 80 mA., 6.3 v. tapped. 4 v., 8 v., Heater 6.3 v., 5 v. or 4 v., 22.6 DITTO 250-0-250 22.6 MINIATURE. 200 v., 20 mA., 6.3 v., 1.4, 10.0 MIDGET. 220 v., 45 mA., 6.3 v., 2.4, 15.6 SMALL. 250-0-250, 50 mA., 6.3 v., 3.4, 17.6 STANDARD. 250-0-250, 65 mA., 6.3 v., 17.6 HEATER TRANS. 200-250 v., 6.3 v., 4.1 amp. 7.6 DITTO, Tapped sec. 2, 1, 6.3 v., 1.1 amp. 8.6 DITTO, Sec. 6.3 v., 3 amp. 10.6

ALADDIN FORMERS and core. 1lb., 8d.; 2lb., 10d. 4oz. FORMERS 5957 8 and Cans TV1 2. 7in. sq. x 7in. and 7in. sq. x 1in. 2- each. with cores. TYANA - Midget Soldering Iron. 200-220 v. or 250-250 v., 10.9. Solon Instrument Iron. 24.5

MAINS DROPPERS. 250 v., 1.1in. M.D. Midgets. 500, 720 ohms, 4.3. 0.2 amp. 1,000 ohms, 4.3. LINE COR. 3 amp., 60 ohms per foot, 2 amp., 100 ohms per foot, 3-way, 8d. per foot, 3-way, 7d. per ft. LOUDSPEAKER P.M. 3 OHM. 2 1/2in. x 3in., 17.6. Min. Plessey, 1.6. 7in. x 4in. 400 ohms, 21. 6in. 400 ohms, 18.6. 10in. x 4in. A.S. 30-784, Tweeter, 1.8H73, 8.6. 12in. Plessey, 30.6. Min. M.E. 2mk. fluid, tapped O.P. tray, 24.6. 15 ohm Plessey 10 wt. 12in. with Tweeter, 97.6. CRYSTAL DIODE. 1.5, 4.2. GEK34. ETC. RESISTANCE PHONES. 1,000 ohms, 16.6 pr. MIK. TRANS. 30:1, 3.9 ea.; 100:1, Potted, 10.6. SWITCH CLEANER. Fluid squirt sprout. 4.3 tin. TWIN GANG TUNING CONDENSERS. 305 pf. miniature 1in. x 1in. x 1in. 10.6. Standard with Trimmers, 8-1 each. miniature, 8.2. Miniature, 7.6. SINGLE. 30 pf., 2: 100 pf., 7-1; 150 pf., 8.6. Solid dielectric 100, 300, 500 p.f., 3.6. SPKAKER FRET. Expanded Metal Silver, 2 1/2in. x 9in., 2- each. GOLD CLOTH. 7in. x 2 1/2in., 5/-; 2 1/2in. x 2 1/2in., 10/-; Tyran 4 1/2in. wide, 10/-; 4 1/2in. wide, 5/- ft.

Table with 4 columns: Part No., Value, Price, and Description. Includes various valves like 6X5, 6X4, 6X3, 6X2, 6X1, 6X0, 6A5, 6B6, 6B7, 6B8, 6B9, 6C1, 6C2, 6C3, 6C4, 6C5, 6C6, 6C7, 6C8, 6C9, 6D1, 6D2, 6D3, 6D4, 6D5, 6D6, 6D7, 6D8, 6D9, 6E1, 6E2, 6E3, 6E4, 6E5, 6E6, 6E7, 6E8, 6E9, 6F1, 6F2, 6F3, 6F4, 6F5, 6F6, 6F7, 6F8, 6F9, 6G1, 6G2, 6G3, 6G4, 6G5, 6G6, 6G7, 6G8, 6G9, 6H1, 6H2, 6H3, 6H4, 6H5, 6H6, 6H7, 6H8, 6H9, 6I1, 6I2, 6I3, 6I4, 6I5, 6I6, 6I7, 6I8, 6I9, 6J1, 6J2, 6J3, 6J4, 6J5, 6J6, 6J7, 6J8, 6J9, 6K1, 6K2, 6K3, 6K4, 6K5, 6K6, 6K7, 6K8, 6K9, 6L1, 6L2, 6L3, 6L4, 6L5, 6L6, 6L7, 6L8, 6L9, 6M1, 6M2, 6M3, 6M4, 6M5, 6M6, 6M7, 6M8, 6M9, 6N1, 6N2, 6N3, 6N4, 6N5, 6N6, 6N7, 6N8, 6N9, 6O1, 6O2, 6O3, 6O4, 6O5, 6O6, 6O7, 6O8, 6O9, 6P1, 6P2, 6P3, 6P4, 6P5, 6P6, 6P7, 6P8, 6P9, 6Q1, 6Q2, 6Q3, 6Q4, 6Q5, 6Q6, 6Q7, 6Q8, 6Q9, 6R1, 6R2, 6R3, 6R4, 6R5, 6R6, 6R7, 6R8, 6R9, 6S1, 6S2, 6S3, 6S4, 6S5, 6S6, 6S7, 6S8, 6S9, 6T1, 6T2, 6T3, 6T4, 6T5, 6T6, 6T7, 6T8, 6T9, 6U1, 6U2, 6U3, 6U4, 6U5, 6U6, 6U7, 6U8, 6U9, 6V1, 6V2, 6V3, 6V4, 6V5, 6V6, 6V7, 6V8, 6V9, 6W1, 6W2, 6W3, 6W4, 6W5, 6W6, 6W7, 6W8, 6W9, 6X1, 6X2, 6X3, 6X4, 6X5, 6X6, 6X7, 6X8, 6X9, 6Y1, 6Y2, 6Y3, 6Y4, 6Y5, 6Y6, 6Y7, 6Y8, 6Y9, 6Z1, 6Z2, 6Z3, 6Z4, 6Z5, 6Z6, 6Z7, 6Z8, 6Z9.

FINEST VALUE



1953 RADIOGRAM CHASSIS THREE WAVEBANDS FIVE VALVES S.W. 16 in.-50 in. LATEST MULLARD M.W. 200 in.-50 in. B3H42, EP41, EB41. L.W. 200 in.-2,000 in. EP41, EP41, EP41. 12-month guarantee.

A.C. 200-250 v. I-way Switch - Short-Medium-Long-Cram. A.V.C. and Negative feedback. 42 watts. Chassis 12 1/2 x 7 1/2 x 2 1/2 in. Glass 10 x 4 1/2 in. horizontal or vertical. available. 2 Pilot Lamps, Four Knobs, Walnut or Ivory. Aligned and calibrated. Isolated Chassis.

£9-10 Carr. & Ins. 1/6.

TERMS - Deps. £5.5.0 and five monthly of £1. MATCHED SPEAKERS for above CHASSIS. 5in., 17.6; 10in., 25/-; 12in., 30/-.

EXCEPTIONAL OPPORTUNITY

COLLARO 4 564 4-speed Single Record Player, including heavyweight turntable and lightweight Studio Q Pick-up. Autostop fitted.

OUR PRICE 6 gns. Carr. 4/-

GARRARD 4-SPEED SINGLE RECORD PLAYER 4SP.

AUDIO PERFECTION

Designed to play 16, 33, 45, 78 r.p.m. Records 7in., 10in., 12in. Lightweight Xial pick-up. GC2 turnover, two separate sapphire styl.

OUR PRICE £8.0.0 each. Post Free.

COLLARO HIGH-FIDELITY AUTOCHANGER

Mixer Model RC456 4-SPEEDS 10 RECORDS With Studio "O" pick-up BRAND NEW IN MAKER'S BOXES OUR PRICE £8.5.0. post free

BUILD THIS REPRODUCER BARGAIN SINGLE PLAYER KIT Ready for immediate assembly.

4-speed Collaro "Junior" Unit. £12 12 6 Handmade case. 17.2. 12.5. 7in. £2 5 0 Ready-built 3 watt amplifier with two valves and loudspeaker. £3 12 6 or £9.15.0 complete kit post free.

£35.0 extra with Garrard Model 4SP. ALUMINIUM CHASSIS. 18 w.g. drilled. With 4 sides, riveted corners and lattice fixing holes, 2 1/2in. sides, 7 x 4in., 4.6; 9 x 7in., 5.6; 11 x 7in., 6.6; 13 x 9in., 8.6; 14 x 11in., 10.6; 15 x 14in., 12.6; 18 x 16 x 3in., 16.6.

GOLTO TRANSISTORS

Product of Pyc. Ltd., Cambridge. Complete data supplied. Audio VALTos. 15/-; R.P. V6R2. 24/-

HANDY VOLT METERS. 0-25 v. and 0-250 v. D.C., with leads and leather case. 9.6.

CRYSTAL MIKE INSERT by Acos, precision engineers. Size only 7in. x 3 1/2in., 6.6.

ACOS CRYSTAL HAND MIKE, complete, 25/-.

HI-GAIN BAND 3 PRE-AMP KIT. Cassette circuit with valve (V6C8). Price 29.6. With Power Pack, 49.6. Instructions only 1.6. Band 1 version same prices.

COSSOR COMPANION

SUPERHET MODEL 527 X FOR ALL-DRY BATTERY OPERATION S.W.1 13.6 to 45 mcs. S.W.2 42.8 to 136 mcs. Medium 187 to 575 mcs. A fine All-wave receiver giving world-wide reception on three wavebands. 6in. speaker. The cabinet is mahoon and beige with gold trimmings. Valves: PK92, 2E, Close tolerance. 01.96 (H.T., 90 v., L.T. 1.5 v.). SIZE 9 1/2 in. x 6 1/2 in. x 4 1/2 in. Lead £1 S.A.E. OUR PRICE £6.6.0. (Battery 18.6 extra. Carr. & Ins. 4/-)

Volume Controls 80 CABLE COAX

Long spindles. Guaranteed 1 year. Midget 5K ohms to 2 Meg. No Sw. 1.9. 1/2 in. 4.9. Linear or Log Tracks. Semi-air spaced Polystyrene insulated. Pin dia. stranded core. 9d. Losses cut 50%. Prime Quality. Air Spooled. 1/6 yd.

COAX PLUGS ... 1 DOUBLE SOCKET ... 1.3

SOCKETS ... 1 OUTLET BOXES ... 4.6 BALANCED TWIN FEEDER yd. 6d. 80 or 300 ohms. DITTO SCREENED per yd. 1.6. 80 or 300 ohms. WIRE-WOUND POTS. 3 WATT. Pre-set Mini. T.V. Type. All values 25 ohm to 100 K, 3-5 ohms, 200 K to 10 M, 2 in. to 3 in. WIRE-WOUND 4 WATT. Pots 2 1/2in. Spindle. Values, 100 ohms to 500 K, 5.6; 100 K, 6.6. CONDENSERS. New stock. 3001 mfd., 7 kV. 100K, 5.6; 1000, 20 kV., 9.6; 100 pf. to 500 pf. Micas, 6d.; Tantalum 500-1001 to 401 mfd., 8d.; 100 pF. 1.25, 1.6; 2500 pF. 1.9; 14500 v., 9d.; 10 2,000 v., 1.9; 1 mfd., 2,000 volts, 3.6. CERAMIC CONDS. 500 v., 33 pf. to .01 mfd., 10d. SILVER MICA CONDENSERS. 100 pF. to 200 pf., 1/-; 100 pf. to 10,000 pf., 2/-; Close tolerance. 100 pF. to 47 pf., 1.8. DITTO 100, 50 pf. to 845 pf., 1.8; 1,000 pf. to 3,000 pf., 2/-.

I.F. TRANSFORMERS 7/6 pair.

400 Kc a Stag tuning Miniature Can. 2 1/2 in. x 1 in. High Q and good bandwidth. By Pye Radio. Data sheet supplied. Weatrite M300 I.F. 465 Kcs. 12.6 per pair. Weatrite 550 I.F. 465 Kcs. 12.6 per pair.

NEW ELECTROLYTICS. FAMOUS MAKES

TUBULAR CAN TYPES 2.450 v. 2 - 100-25 2/- 8-16 500 v. 5.6 2.450 v. 2.3 8-8 500 v. 4.6 16-16 450 v. 5.6 4.450 v. 2 - 104-16 500 v. 25-20 450 v. 5.6 4.450 v. 2.3 6- 32-32 350 v. 4.6 8.450 v. 2.8 CAN TYPES 32-32 450 v. 6.6 16-16 50 v. 6 100-100 50 7/- 18-180 v. 6 16-150 v. 4- 50-150 350 v. 7/- 32-450 v. 5.6 32-350 v. 4- 60-100 350 v. 11.6 25-25 v. 1.9 64-330 v. 5.6 100-150 275 v. 12.6 50-25 v. 2 - 500 12 v. 3- 1,000-1,000 6 v. 6 50-25 v. 2 - 9-110 v. 5- 6.6

SENTERCEL RECTIFIERS. E.H.T. TYPE FLY-BACK VOLTAGE.

KV. 25-2 kV. 5/-; K3-40 3.2 kV., 7/-; K345, 3.6 kV., 7.6; K3-50 4 kV., 8/-; K3-100 8 kV., 14.6. 50-amp. voltage, 50% of above. MAINS TYPE SELENIUM 300 v., 85 mA., 7.6. CONTACT COOLED 500 v., 50 mA., 7.6; 60 mA., 8.6; 7.6 - 1.8A1-2-83, 27.6.

COILS Weatrite "P" type, 3/- each. Osamor Midget "Q" type add. dust cover 4/-.

All ranges. TELETRON. L & Mod. T.R.P., with reaction, 3.6. FERRITE ROD AERIALS. M.W. 6d. 4.6. 12.6. T.R.F. COILS A.H.P. 7 pair. H.P. CHOKES, 2.6. FERRITE ROD TUNING, 2.6.

JASON F.M. TUNER COIL SET 28 - H.F.

coil, aerial coil, oscillator coil, two I.F. trans. 10.7. Mica. Lamin. Detector and heater choke. Circuit book using four 6AM6, 2-.

COMPLETE JASON F.M. KIT WITH VALVES.

£9.15.0. Fringe area kit, 22.6 extra. MULLARD 3-3 AMPLIFIER READY BUILT spare power for Tuner, etc., £7.17.6.

FULL WAVE BRIDGE SELENIUM RECTIFIERS:

2.4 500 v. 11 amp. 8.9; 4. 113.4 amp. 17.6. CHARGER TRANSFORMERS. Tapped input 200/250 v. for charging at 2, 6 or 12 v., 11 amp., 15.6. 2 amp., 17.6; 4 amps., 22.6. Circuit included. VALVE and T.V. TUBE equivalent loads, 5- TOGGLE SWITCHES. 8 v. 10 v., D.P. 3.0, D.U.D.T. 4- W.A. EXCHANGE SWITCHES 3- 4-way 2 wafer long spindle ... 8.6 2-p. 2-way 3 p. 2-way short spindle ... 2.6 2-p. 6-way 4 p. 2-way 4 p. 3-way long spindle 3.6 3-p. 4-way, 1 p. 12-way, long spindle ... 4.6 VALVE HOLDERS. 100 v. Oct. 4d. EP50, EA 50, 6d. B12A, CRT. 1.3. Eng. and Amer. 4, 5, 6, 7 and 9 pin. 1- MOULDED MAZDA and Int. Oct. 6d B17G, B8A, B8C, B9A, 9d. B7G with con., 1.6. VCR7, 2.6. B9A with con. 2.6. CERAMIC EP50, B17G, B9A, Int. Oct. 1/-; B7G with con. 1.9.

NEW AND ENLARGED SHOWROOMS NOW OPEN. H.P. AVAILABLE. OUR WRITTEN GUARANTEE WITH EVERY PURCHASE. Please address all Mail Orders correctly as below.

RADIO COMPONENT SPECIALISTS 337 WHITEHORSE RD., WEST CROYDON

OPEN ALL DAY—(Wed. 1 p.m.) Catalogue 6d. Tel. THO 1665. Buses 133 or 68 pass door. 48-hour postal service. P. & P. 1/-, over £2 post free. (Export Extra) C.O.D. Service 1/6.