

A TV PATTERN GENERATOR

# Practical Television '13

JUNE, 1958

AND TELEVISION TIMES

EDITOR: F.J. CAMM



## Contents

HORIZONTAL AERIALS  
AMATEUR TV RECORDING  
TRACING OBSCURE FAULTS  
THE QUAD AERIAL  
TEMPERATURE  
COMPENSATION



# Build your own Aerials...

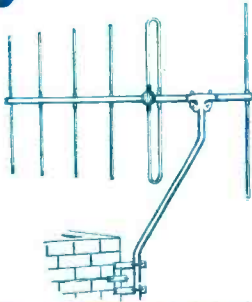

## AT HOME

**AERIAL FITTINGS FOR BAND III, BAND I & RADIO F/M.**  
 Useful formulæ and hints for constructing your own aerial quickly and cheaply. Catalogue illustrating our increased range of Diecast Alloy Fittings, including Band III to Band I Mast Couplers, Reflector and Director Rod Holders, Insulators (both "Inline" and "H" types), Masthead Fittings, Masts and Elements, Chimney Brackets, etc. Send 1/- in stamps for the above to :-

# Fringevision Ltd.

MARLBOROUGH, WILTS. Phone : 657/8

# ADCOLA

PRODUCTS LIMITED  
 (Regd. Trade Mark)

## SOLDERING EQUIPMENT

**ILLUSTRATED**

3/16" Detachable bit type (List No. 64)

Protective Shield (List No. 68)

Catalogues sent FREE

Telephones:  
 MACaulay 4272 & 3101



British and Foreign Pats.

Reg. Designs, etc.

Head Office, Sales:

**ADCOLA PRODUCTS LTD.**

Gauden Road, Clapham High St., London, S.W.4

# TELEVISION TUBES

WE OFFER

**MULLARD — COSSOR — EMITRON**

Etc., From Stock

**12" TUBES - - £5 10.**

**14" MULLARD TUBES £6**

(Or equivalent)

**14" MAZDA TUBES £6 10.**

**17" TUBES - - £7 10.**

Please add 12/6 Carriage and Insurance. All Tubes Guaranteed for 6 months.

**MARSHALLS for TELEVISION**

131 St. Ann's Road, Tottenham, London, N.15.

Callers welcome.

STAmford Hill 3267

# EMI "HIS MASTER'S VOICE" MARCONIPHONE · COLUMBIA

## Announce NEW PRACTICAL WAY OF LEARNING AT HOME

**NEW** — completely up-to-date methods of giving instruction in a wide range of technical subjects specially designed and arranged for self-study at home under the skilled guidance of our teaching staff.

**NEW** — experimental outfits and lesson manuals are despatched on enrolment and remain the student's property. A tutor is allotted to each student for personal and individual tuition throughout the course.

Radio and television courses, with which specially prepared components are supplied, teach the basic electronic circuits (amplifiers, oscillators, detectors, etc.) and lead, by easy stages, to the complete design and servicing of modern Radio and T/V equipments.

If you are studying for an examination, wanting a new hobby or interest, commencing a career in industry or running your own full-time or part-time business, these practical courses are ideal and may be yours for moderate cost. Send off the coupon to-day for a free Brochure giving full details. There is no obligation whatsoever.

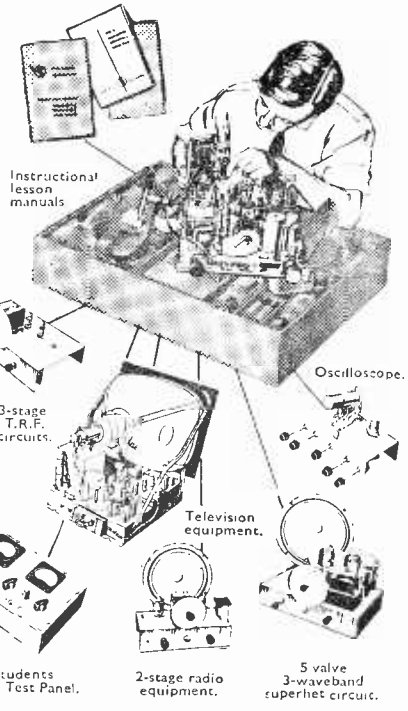

**Courses with Equipment**  
 RADIO · SHORT WAVE RADIO  
 TELEVISION · MECHANICS  
 CHEMISTRY · PHOTOGRAPHY  
 ELECTRICITY · CARPENTRY  
 ELECTRICAL WIRING · 'HI-FI'  
 DRAUGHTSMANSHIP · ART etc.

E.M.I. Factories  
 at Hayes  
 England.



# EMI INSTITUTES

Fill in for **FREE BROCHURE**  
 E.M.I. INSTITUTES, Dept. 138X, London, W.4.

Name ..... Age .....  
 (If under 21)

Address .....

I am interested in the following subject(s) with  
 without equipment .....

(We shall not worry you with personal visits)

**FREE**

BLOCK CAPS PLEASE

JUNE/58

*The only Home Study College run by a World-wide industrial organisation*



# SPECIAL OFFER!!!

**SMALL  
TYPE  
ONLY**

# EY51 10/6

**BRITISH  
MADE**

**EXPRESS SERVICE !!!**  
C.O.D. ORDERS RECEIVED BY 3.30 P.M., EITHER BY LETTER, PHONE OR WIRE, DESPATCHED THE SAME AFTERNOON. ALL ORDERS RECEIVED BY FIRST POST DESPATCHED SAME DAY.

**FOR ONLY 6d. EXTRA PER ORDER WE WILL INSURE YOUR VALVES AGAINST DAMAGE IN TRANSIT. ALL UNINSURED PARCELS AT CUSTOMER'S RISK.**

3A3	3/-	6AU6	10/6	6L18	13/-	12AH8	10/6	35/51	12/6	D42	10/6	ECC84	10/-	FW4/500	12/6	PCF82	12/6	UBC41	8/6	
1A5	6/-	6B4G	6/6	6N7	8/-	12AT6	10/6	35A5	11/-	D63	5/-	ECC85	9/6	12/6	PCL82	12/6	UBF80	9/6		
1A7	15/-	6B7	10/6	6Q7GT	11/-	12AT7	8/-	35L6GT	9/6	D77	6/6	ECC91	5/6	GZ30	10/6	PCL93	17/6	UBF89	10/6	
1D6	10/6	6B8G	4/6	6R7GT	11/-	12AU7	7/6	35W4	8/6	DAC32	11/-	IECF80	13/6	GZ32	12/6	PEN40DD		UCC85	10/6	
1H5	11/-	6B8M	5/-	6R7G	10/6	12AX7	9/-	35Z3	10/6	DAF91	8/-	EFC82	13/6	GZ34	14/-	25/-		UCH42	11/-	
1L4	6/6	6BA6	7/6	6SA7GT	8/6	12BA6	9/-	35Z4	7/6	DAF96	10/-	ECH35	9/6	H30	5/-	PEN45	19/6	UCH81	11/6	
1LD5	5/-	6BE6	7/6	6SC7	10/6	12BE6	10/-	35Z5	9/6	DF33	11/-	ECH42	11/-	H63	12/6	PEN46	7/6	UCL82	15/6	
1LN5	5/-	6B16	7/6	6SG7GT	8/-	12EI	30/-	41MTL	9/6	DF91	7/-	ECH81	9/-	HABC80		PL82	10/-	UF41	9/-	
1N5	11/-	6BRT	11/6	6SH7	8/-	12J5GT	4/6	50C5	12/6	DF96	10/-	ECL80	14/-		13/6	PL83	11/6	UF80	10/6	
1R5	8/6	6BW6	9/6	6S7	8/-	12J7GT	10/6	50L6GT	9/6	DH63	10/-	ECL82	14/-	HK90	10/-	PM2B	12/6	UF85	10/6	
1S5	8/6	6BW7	8/-	6SK7GT	8/-	12K7GT	7/6	72	4/6	DH76	7/6	EF36	6/-	HL23	10/6	PM12	6/6	UF89	10/6	
1T4	7/-	6BX6	8/-	6SL7GT	8/-	12K8GT		77	8/6	DH77	8/6	EF37A	8/6	HL41	12/6	PM12M	6/6	UL41	10/6	
1U5	10/6	6C4	7/-	6SN7GT	7/6		14/-	78	8/6	DK32	15/-	EF39	6/-	HL13DD		PY80	9/-	UL46	15/-	
2A7	10/6	6C5	6/6	6SS7	8/-	12Q7GT	7/6	80	9/6	DK91	8/6	EF40	15/-		12/6	PY81	9/-	UL84	11/6	
2C26	7/6	6C6	6/6	6U4GT	14/-	12SA7	8/6	83V	12/6	DK92	12/6	EF41	9/6	HVR2	20/-	PY82	9/-	UY41	8/6	
2D13C	4/6	6C8	12/6	6USG	7/6	12SC7	8/6	85A2	15/-	DK96	10/6	EF42	12/6	HVR2A	6/-	PY83	9/6	UY85	10/6	
2X2	4/6	6C9	12/6	6U7G	8/6	12SG7	8/6	150B2	15/-	DL2	15/-	EF50(A)	7/-	KF35	8/6	QP21	7/-	V1507	5/6	
3A4	7/-	6C10	12/6	6V4G	7/6	12SH7	8/6	220P	10/6	DL33	9/6	EF50(E)	5/6	KL35	8/6	QP25	15/-	VLS492A	23	
3A5	12/6	6CH6	12/6	6V6GT	8/-	12J37	8/6	807	7/6	DL66	15/-	EF54	5/-	KT2	5/-	QS150/15		VMP4G	15/-	
3B7	12/6	6D6	6/6	6X4	7/-	12SK7	8/6	956	3/6	DL92	8/-	EF73	10/6	KT33C	10/-		10/6	VP2(7)	12/6	
3D6	5/-	6E5	12/6	6XS7GT	6/6	12SQ7	8/6	1203	7/6	DL94	9/-	EF80	8/-	KT44	15/-	QV04/7	15/-	VP4(7)	15/-	
3Q4	9/6	6F6G	7/-	6Z4/84	12/6	12SR7	8/6	4033L	12/6	DL96	10/6	EF85	8/-	KT63	7/-	R12	10/6	VP13C	7/-	
3Q5GT	9/6	6F6GT	8/-	6Z5	12/6	12YA	10/6	5763	12/6	DLS10	10/6	EF86	17/6	KTW61	8/-	SD6	12/6	VP41	7/6	
3S4	8/-	6F8	12/6	6J30L2	10/6	14R7	10/6	7193	5/-	DM70	8/6	EF89	10/6	KTW62	8/-	SP4(7)	15/-	VR105/30	9/-	
3V4	9/-	6F12	7/6	7A7	12/6	14S7	17/-	7475	7/6	EA50	2/-	EF91	7/6	KTW63	8/-	SP41	3/6	VR150/30	9/-	
5U4	8/6	6F13	12/6	7B7	8/6	19AQ5	11/-	9002	5/6	EA76	9/6	EF92	6/6	KTZ41	8/-	SP42	12/6			
5V4	12/6	6F16	9/6	7C5	8/-	19H1	10/-	9003	5/6	EABC80	9/-	EL32	5/6	KTZ63	10/6	SP61	3/6			
5X4	12/6	6F17	12/6	7C6	8/-	20D1	16/-	9006	6/6	EAC91	7/6	EL41	11/-	L63	6/-	SU61	10/6	VT61A	5/-	
5Y3G	8/6	6F32	10/6	7H7	8/-	25L6GT	10/6	AC6PEN	7/6	EAF42	10/6	EL42	11/6	LN152	14/-	TP22	15/-	VT501	5/-	
5Y3GT	8/6	6F33	7/6	7Q7	9/-	25Y5	10/6	AC/HL/		EB34	2/6	EL81	15/-	LZ319	10/-	U16	12/6	W76	7/6	
5Y4	12/6	6G6	6/6	7S7	10/6	25Y5G	10/-	DDD	15/-	EB41	8/6	EL84	10/6	MH4	7/-	U18/20	12/6	WB1M	6/-	
5Z3	12/6	6H6G	3/-	7V7	8/6	25Z5	10/6	AC/P4	8/-	EB91	6/6	EL91	5/-	MHL4	7/6	U22	8/-	X61	12/6	
5Z4G	10/6	6H6M	3/6	7Y4	8/-	25Z4G	10/-	AC/VP1	15/-	EBC33	7/6	EM34	10/6	MHL6	12/6	U25	15/6	X63	10/-	
5Z4GT	12/6	6I5G	5/-	8D2	3/6	25Z6G	10/-	AL60	10/6	EBC41	10/6	EM80	10/6	M14	12/6	U31	10/6	X65	12/6	
6A8	10/6	6I5GTG	5/6	8D3	7/6	28D7	7/-	AP4	7/6	EBF80	10/6	EM81	10/6	MU6	6/6	U43	10/6	X66	12/6	
6A87	8/-	6I5GTM	6/-	9D2	4/6	30	7/6	ATP4	5/-	EBF89	9/6	EN31	34/9	MU14	10/6	U45	10/6	XD(1.5)	6/6	
6A88	14/-	6I6	5/6	10C1	15/-	30C1	10/-	AZ31	12/6	EC52	5/6	EY51	10/6	OA10	12/6	U50	8/6	XFY12	6/6	
6AC7	6/6	6I7G	6/-	10F1	19/6	30F5	8/-	BL63	7/6	EC54	6/-	(Small)		OA71	5/-	U56	7/6	XH(1.5)	6/6	
6AG5	6/6	6I7GT	10/6	10F9	11/6	30FL1	10/-	CK505	6/6	EC70	12/6	EY51		OA75	5/-	U57	6/6	Y12	6/6	
6AJ8	9/-	6K6GT	8/-	10F18	12/6	30L1	9/-	CK506	6/6	ECC31	15/-	(Large)	12/6	OC72	30/-	U107	11/10	XSG(1.5)	6/6	
6AK5	8/-	6K7G	5/-	10LD3	8/6	30P12	13/6	CK523	6/6	ECC32	10/6	EY86	17/6	P61	3/6	U251	15/-	Y63	7/6	
6AL5	6/6	6K7GT	6/6	10LD11	16/9	30P16	10/6	CV63	10/6	ECC33	8/6	EZ35	6/6	P215	10/6	U404	10/6	Z63	10/6	
6AM5	5/-	6K8G	8/-	10P13	17/6	30PL1	19/6	CV85	12/6	ECC35	8/6	EZ40	8/6	PABC80	15/-	UABC80		Z66	20/-	
6AM6	7/6	6K8GT-G	11/6	11E3	15/-	31	7/6	CV271	10/6	ECC81	8/-	EZ41	10/6	PCC84	9/-		10/6	Z77	7/6	
6AQ5	8/6		11/-	12A6	6/6	33A/158M		CV428	30/-	ECC82	7/6	EZ80	9/6	PCC85	12/6	UAF42	10/6	Z719	8/-	
6AT6	8/6	6L6G	9/6	12AH7	8/-		30/-	D1	3/-	ECC83	9/-	EZ81	10/6	PCF80	10/-	UB41	12/7	Z729	17/6	

## NEW METAL RECTIFIERS, FULLY GUARANTEED

RM-0	6/-	RM-5	24/-	WX6	3/6	14A163	38/-	14RA 2-1-16-1	21/-	18RA 1-1-8-1	4/6
RM-1	7/-	W4	3/6	14A86	18/-	14B130	35/-	16RC 1-1-16-1	8/6	18RA 1-1-16-1	6/6
RM-2	7/6	W6	3/6	14A97	25/-	14RA 1-2-R-2	19/-	16RD 2-2-8-1	12/-	18RA 1-2-8-1	11/-
RM-3	9/6	WX3	3/6	14A100	27/-	14RA 1-2-8-3	23/6	16RE 2-1-R-1	8/6	18RD 2-2-8-1	15/-
RM-4	20/-	WX4	3/6	14A124	28/-						

Full technical details free on receipt of S.A.E.

**TERMS OF BUSINESS:—CASH WITH ORDER OR C.O.D. ONLY. POST/PACKING CHARGES 6d. PER ITEM; ORDERS VALUE £3 OR MORE POST FREE. MINIMUM C.O.D. FEE AND POSTAGE 3/-. EACH ADDITIONAL VALVE 6d. EXTRA. WE ARE OPEN FOR PERSONAL SHOPPERS MON.-FRI. 8.30-5.30. SATS. 8.30-1 P.M.**

**ALL VALVES, NEW, BOXED, TAX PAID, AND SUBJECT TO MAKERS' GUARANTEE. FIRST GRADE GOODS ONLY. NO SECONDS OR REJECTS. GOODS ARE ONLY SOLD SUBJECT TO OUR TERMS OF BUSINESS, OBTAINABLE FREE ON REQUEST. CATALOGUE OF OVER 1,000 DIFFERENT VALVES 3d.**

# BENTLEY ACOUSTIC CORPORATION LTD.

THE VALVE SPECIALISTS

38 CHALCOT ROAD, LONDON, N.W.1

Primrose 9090

PLEASE ENQUIRE FOR ANY VALVE NOT LISTED. 3d. STAMP, PLEASE.

**BARGAINS TO CLEAR**

**E.H.T. Transformers**

Standard 50 c.p.s. Mains input secondary 3,000 volts tapped at 2,000, 2,200, 1,900 volts. All at 20 mA. Also low voltage secondaries 2 v. at 1.5 amp. 4 v. at 1 amp. 25 - plus 2 6 carriage and insurance.

**Vibrator Transformer**

Primary 12 v. centre tapped, secondary 250-250 v. 100 mA. 20 - each. 79 mA. 15 - each. Ditto but 6 v. 70 mA. 12 6. All plus 1 6 post and insurance.

**Dimmer or Regulator**

Total resistance 1,000 ohms, maximum current of .59 amps. This is a beautiful unit which uses a 32 position stud switch, resistance is divided into 31 sections each approx. 30 ohms. In ventilated metal case, size approx. 7in. x 7in. x 5 1/2in., with wall mounting brackets and large control knob. 15 - plus 2 6 post and insurance.

**Electrical Brake**

Disc type suitable for stopping lathes, coil winders, etc. Operates on approximately 100 mA. complete with mounting stand. 25 - plus 1 6 post and ins.

**Flexible Drive Shaft**

For remote control, tuning etc. 6 ft. long. 45 - each. Other lengths this available - please enquire.

**500 Microamp Moving Coil Meter**

Flush mounting. Scale marked 0-500 microamps. 17 6 plus 1 6 post and ins.

**Flexible Spindle Coupler**

For 1in. spindle insulated and/or aligned. 2 6 each.

**Heavy Duty Springs**

(19 gauge) for supporting Cathode Ray Tubes, etc. 1/6 or 15 - doz.

**Slider Resistor**

1,000 ohm with insulated knob and locking device. 1 9 each.

**Standard Volume Controls**

With good length 1in. spindle, less switch, 2 -. With single pole switch, 3 3. With double pole switch, 3 9. All popular values.

**.3 Amp Vitreous Dropper**

Total resistance of main section 500 ohms with tapings marked 200V., 225V. and 250V., also isolated separate winding of 100 ohms. 3 6 each.

**Close Tolerance Micacs**

Up to 100 pF. 6d. each; 110-500 pF., 9d. each; 500-800 pF., 1 - each; 1,000-5,000 pF., 1 3 each; all one or two per cent. tolerance.

**Power Chokes**

10H. 5 amp., 15 -	15H. 2 0 mA.,
10H. 3 0 mA., 17/6	
3H. 2 0 mA., 15 -	3H. 1 0 mA., 10 -
3H. 2 0 mA., 12 -	3H. 1 0 mA., 10 -
14H. 2 0 mA., 20 -	20H. 1 0 mA., 5 -

**Connecting Wire**



P.V.C. covered in 100 ft. coils—2 9 a coil or four coils different colours. 10 - post free.

**FOUR ITEMS FOR PRICE OF ONE!**

**Band III Converter**

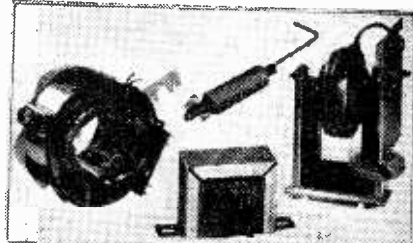

This set of modern T.V. parts is equally suitable for modernising an old television or for building into a new one. Suitable for wide angle 14in. or 17in. tubes using E.H.T. or 12-11 kV. The four items comprise: (1) Line output E.H.T. transformer. (2) 50 scanning coils on ferrite yokes. (3) Width control with ferrite core. (4) Frame output transformer. With these parts we also give free, complete circuit diagram of modern television which used them. We offer the whole lot at the price of the Line output transformer only, namely, 57 6. plus 2 6 post and insurance.

Suitable Wales, London, Midlands, North Scotland, etc. All the parts including 2 EF90 valves, coils, fine tuner, contrast control, condensers and resistors. (Metal case available as an extra) Price only 19 6, plus 2 6 post and insurance. Data free with parts or available separately, 1 6.

**Tube Tester and Re-Activator**

We can supply all the main components for making this unit which will not only test Cathode Ray Tubes but also will re-activate them. Supplied, complete with full instructions. Price £3. plus 2 6 post and ins.

**THIS MONTH'S SNIP**

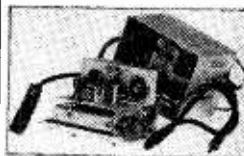

Breakdown unit contains: miniature relay, push-pull input transformer, push-pull output transformer, valveholders, condensers, resistors, useful Bakelite enclosed hand switch which can also be used as foot switch if mounted on base, all in really useful aluminium case with easily removable for building Pattern Generator or similar instrument. Special snip price this month 8 6, plus 1 6 post and insurance.

Breakdown unit contains: miniature relay, push-pull input transformer, push-pull output transformer, valveholders, condensers, resistors, useful Bakelite enclosed hand switch which can also be used as foot switch if mounted on base, all in really useful aluminium case with easily removable for building Pattern Generator or similar instrument. Special snip price this month 8 6, plus 1 6 post and insurance.

**R208 Yours for 10/- Deposit**

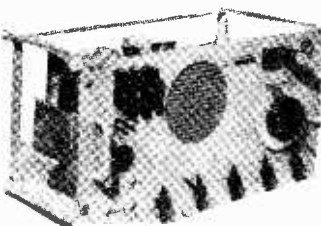

Communications receiver covering 5 - 3 0 metres (10 - 6 0 Mc/s) Uses 6 valves. Has R.F. stage, 2 I. F. stages, B. F. O. etc. Muirhead in-housed and guaranteed. Handbook free with each. Price 26.19.6. carriage and insurance 15 -.

Communications receiver covering 5 - 3 0 metres (10 - 6 0 Mc/s) Uses 6 valves. Has R.F. stage, 2 I. F. stages, B. F. O. etc. Muirhead in-housed and guaranteed. Handbook free with each. Price 26.19.6. carriage and insurance 15 -.

**A.C./D.C. Multimeter Kit**

15 Basic Ranges  
Measures A.C. D.C. volts, D.C. current and ohms. All the essential parts including metal case, 2in. moving coil meter, selected resistors, wire for shunts, range selector, switches, calibrated scale and full instructions. Price 19 6, plus 2 6 post and insurance.



**Madresco Hearing Aid**

As supplied by National Health, completely overhauled and in good working order with six month's guarantee. Only £2.15.0 plus 2 6 post and ins. Complete with ear-phonene and new ear plug but not batteries, these can be supplied as an extra for 5 - per set. Instructions showing how to convert to pocket radio available free if requested.



**Beginner's Superhet**

All the components including valves, metal rectifier coils, tuning condenser, etc., etc., required to build the "Beginner's Superhet" as described in the January issue, are available as a parcel. Price £3. plus 3 - post and insurance.



**Geiger Counter**

As described in "Practical Wire-less" April issue. All the parts including the 20th Century tube type G24 and other specified valves and components but not the chassis or case. 25 7 6, plus 3 6 post and insurance.

**T.V. Pattern Generator**

All the parts for the unit described in the April issue of "Practical Television", including valves and other parts but not the chassis or case. 45 - plus 3 6 post and insurance.

**Response Curve Generator**

All the parts to make the unit described in the April issue of "Practical Television", including valves and other parts but not the chassis or case. 5 - plus 2 6 post and insurance.

**ELECTRONIC PRECISION EQUIPMENT, LTD.**

For prompt attention post orders should be sent to our Eastbourne address marked Dept. 5.

42-46, Windmill Hill, Rustlip, Middx. 66, Grove Rd., Emsayre, Sussex. 29, Stroud Green Rd., 286, London Road, Emsayre, N.4. Croydun, Croydon. Phone: RUISLIP 5720 Eastbourne, Sussex. PHONE: ARChway1049 Phone: CROYDON 6568 Half day, Wednesday. Half day, Saturday. Half day, Thursday. Half day, Wednesday.

# BRIMAR 6T8

The Brimar 6T8 is a triple-diode triode in which one diode has a separate cathode. The triode section has a high amplification factor making the valve suitable for use in AM/FM receivers in the demodulation and first stage audio circuits. The diodes may be used in series shunt limiter circuits, for example, in the audio sections of

television and communications receivers, followed again by the triode, section for A.F. amplification.

Near Equivalents  
EABC80 DH719  
6AK8

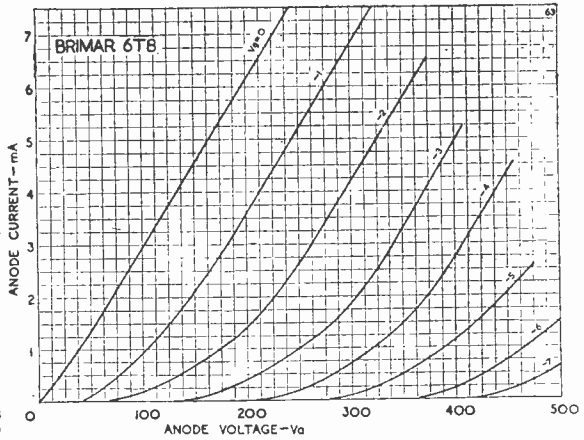
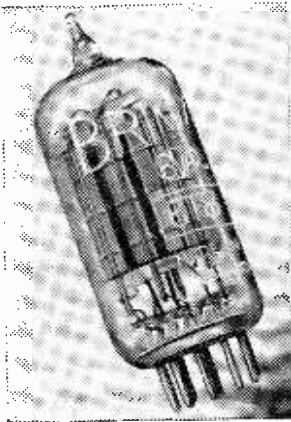

### Typical Triode Operating Characteristics as an R.C. coupled amplifier.

Anode Supply Voltage	...	...	...	250	250 volts
Anode Load Resistor	...	...	...	0.25	0.25 megohm
Grid Resistor	...	...	...	1.0	10 megohms
Cathode Bias Resistor	...	...	...	3	0 kilohms
Peak Output Voltage	...	...	...	43	40 volts
Stage Gain (for 24 V peak to peak output)	...	...	...	42	42
Distortion (for 24 V peak to peak output)	...	...	...	1	5%

Keep this for further reference or write to the Publicity Department for a data sheet.

Standard Telephones and Cables Limited    FOOTSCRAY SIDCUP KENT    Footscray 3333

# A NEW ANTI-GHOSTING AERIAL FOR FLAT DWELLERS

(and others who cannot use an outside T/V aerial)

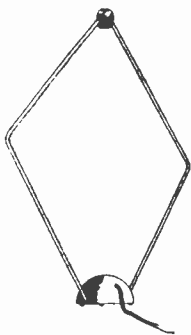

DEFINITELY more sensitive, more directional than any other "stand-on-the-set" aerial available. That means greater range, better contrast, less ghosting and less interference than ever before.

**COVERS ALL T/V CHANNELS—YET HAS NO SLIDING RODS OR CONTACTS TO WEAR OUT.** Finished in Black and Gold with non-slip, anti-scratch rubber base.

LIST PRICE 39/6

STOCKED BY LEADING T/V RETAILERS or in case of difficulty write to the sole manufacturers :

**Labgear Ltd.**    WILLOW PLACE, CAMBRIDGE  
'Phone 2494.    'Grams : Labgear, Cambridge.



# Practical Television



## & TELEVISION TIMES

Editor : F. J. CAMM

Vol. 8 No. 95

EVERY MONTH

JUNE, 1958

Editorial and Advertisement Offices :

**PRACTICAL TELEVISION**  
George Newnes, Ltd., Tower House,  
Southampton Street, Strand, W.C.2.

© George Newnes Ltd., 1958.

Phone : Temple Bar 4363.  
Telegrams : Newnes, Rand, London.  
Registered at the G.P.O. for trans-  
mission by Canadian Magazine Post.

### SUBSCRIPTION RATES

including postage for one year  
Inland - - - 19s. per annum  
Abroad - - - 17s. 6d. per annum  
Canada - - - 16s. per annum

### CONTENTS:

	Page
Televiess	509
Horizontal Aerials	510
Magnetic Picture Recording	515
Temperature Compensation	517
The Quad Aerial	519
Amateur TV Recording	521
Tracing Obscure Faults—2	522
Servicing Television Re- ceivers. The Bush TV 36C. etc.	523
A TV Pattern Generator	529
More Interesting Faults	533
Underneath the Dipole	537
Telenews	541
Correspondence	545
News From the Trade	546
Your Problems Solved	549

*The Editor will be pleased to consider articles of a practical nature suitable for publication in "Practical Television." Such articles should be written on one side of the paper only, and should contain the name and address of the sender. Whilst the Editor does not hold himself responsible for manuscripts, every effort will be made to return them if a stamped and addressed envelope is enclosed. All correspondence intended for the Editor should be addressed to: The Editor, "Practical Television," George Newnes, Ltd., Tower House, Southampton Street, Strand, W.C.2.*

*Owing to the rapid progress in the design of radio apparatus and to our efforts to keep our readers in touch with the latest developments, we give no warranty that apparatus described in our columns is not the subject of letters patent.*

*Copyright in all drawings, photographs and articles published in "Practical Television" is specifically reserved throughout the countries signatory to the Berne Convention and the U.S.A. Reproductions or imitations of any of these are therefore expressly forbidden.*

## TELEVIEWS

### VISION ELECTRONIC RECORDING

**E**LSEWHERE in this issue we give details of the BBC vision electronic recording apparatus for recording the vision and sound signals of television programmes for subsequent reproduction. It will be recalled that in America a system of recording TV programmes on tape has been produced. The earliest system of recording TV pictures was developed in this country some years before the war in connection with the Baird 30 line programmes. Recordings were on ordinary gramophone discs and they were marketed by the firm of Plew. High-definition programmes, however, presented a different problem because of the high frequency range involved.

As explained in our article the new BBC system employs a three-track method of recording, two of the tracks being devoted to the recording of the video signal and one to the sound signal. This is a most important development and should contribute much to reduction in the cost of programmes.

### "BEGINNER'S GUIDE TO TELEVISION"

**E**VER since our series of articles entitled "Beginner's Guide to Television" was completed, there has been a continuous demand from readers for the back issues containing the series. All of the issues are, however, out of print. Readers may be interested to know that they are now being reprinted in book form and that copies will be available on July 17th at 7s. 6d., or 8s. 3d. by post. It forms a companion volume to "A Beginner's Guide to Radio," which has run through several editions and is now being reproduced in Braille for the benefit of the blind.

### "THE PRACTICAL PHOTOGRAPHER"

**R**EADERS interested in photography will be pleased to learn that our companion journal "Practical Mechanics" now includes each month a 16-page pull-out supplement entitled "The Practical Photographer." It contains articles on all aspects of photography—colour, developing, printing, posing, indoor and outdoor photography, etc.

### THE QUERY COUPON

**O**NCE again may we remind readers that it is essential to enclose the query coupon from the current issue as well as a stamped and addressed envelope when submitting queries. We are receiving many letters from non-readers and we are compelled, therefore, to insist upon adherence to these rules.

We would also point out that we cannot undertake to answer questions relating to home-built receivers which we have not sponsored, and such queries should properly be addressed to the publishers concerned.—F.J.C.

*Our next issue dated July will be published on June 20th.*

# Horizontal Aerials

INCLUDED in this year's proposed extended I.T.A. coverage are a transmitter at Burnhope, near Consett, Co. Durham, serving the North-east of England, and one near Mendlesham in Suffolk, for East Anglia.

Although I.T.A. are unable to state definitely it is fairly certain that both of these stations will radiate horizontally polarised signals, thus being in the same plane as the local BBC transmitter. The following information is therefore subject to confirmation.

## N.E. Station

The Burnhope station will use Channel 8, i.e., 186.25 Mc/s for sound and 189.75 Mc/s for vision. Its E.R.P. will be 100 kilowatt which is nearly ten times as powerful as Pontop Pike and should enable better balanced pictures to be obtained on the edge of the service area. Ghosts may be more prominent, but patterning will be reduced when using the external type of converter.

The Mendlesham station will use Channel 11, i.e., 201.25 Mc/s for sound and 204.75 Mc/s for vision, and due to its closeness to the Continent is restricted to medium power with a directional aerial pointing away from the South. This is a feature of its BBC counterpart at Talconeston, near Norwich, which has had to increase to full strength very gradually to avoid causing co-channel interference to the Belgian station at Liege. The heavily populated Ipswich area has thus been poorly served by BBC TV, being just on the outer fringe of the Crystal Palace, and almost dead in line with the rejection lobe of the Talconeston aerial. To even up its own coverage the I.T.A. have chosen a site nearer Ipswich about 20 miles away from the BBC station. The advantages of co-siting can only be expected in the narrow band between Norwich and Cromer.

Regarding receiving aerials each station presents a different aspect and since they are our first two horizontally polarised Band III stations, practical experience in aerial construction is somewhat restricted. However, with certain small exceptions it is expected that aerials will behave similarly to their BBC and V.H.F. counterparts and reasonable results have been obtained in low power field tests of the aerials suggested below. The exceptions are mainly to do with "ghosting" which is more prevalent on Band III than Band I.

Many readers will know to their cost that an aerial which behaves very nicely vertically can easily produce a queer polar diagram when turned sideways. The ordinary "X" type is a good example. For vertically polarised areas it is usually connected as a unipole, i.e., the two shorter front rods are joined to the lower rear rod and connected to the coax outer, whilst the

inner is taken to the insulated upper rear rod. Connected thus a polar diagram such as Fig. 1 (a) is obtained and the aerial is quite efficient.

If the same aerial is placed horizontally the null point is not behind the maximum, but slightly to one side as in Fig. 1 (b). By rearranging the connections to the elements so that the array becomes a dipole and director a more conventional polar diagram results as in Fig. 1 (c).

With multi-element Band III Yagi arrays the forward gain is substantially the same whether upright or flat, but the acceptance angle is wider when mounted in a horizontal plane. There are also differences in the pick-up pattern around the back of the aerial and side lobes make certain types less effective against "ghosts."

## AERIALS FOR HORIZONTALLY POLARISED STATIONS

By "Serviceman"

## Practical Channel 8 Aerials

The dimensions of a five-element Yagi are given in Fig. 2. This can be regarded as a basic service area type comparable to the H and X on Band I. It takes up very little room and can be mounted

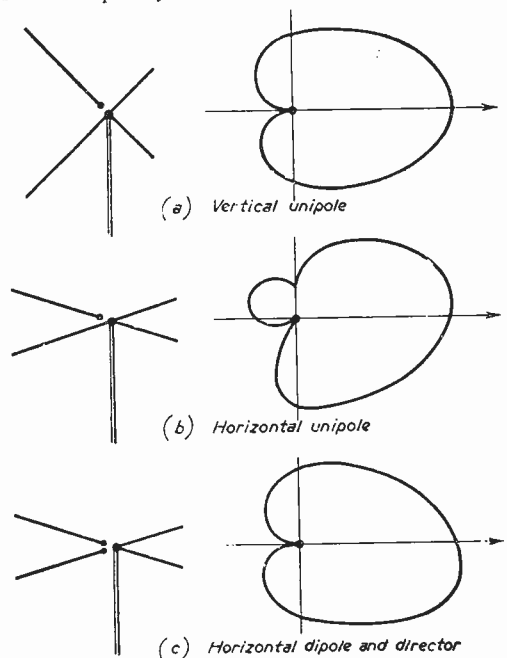

Fig. 1.—Behaviour of an X aerial turned sideways.



in a loft or on the existing Band I pole. Directional properties are good, as Fig. 3 will show, and construction can be varied to suit the materials to hand. The elements can be between 3/16in. and 3/8in. diameter aluminium tubing or rod and the crossarm between 3/4in. to 1 1/4in. diameter aluminium tubing for outdoor use, or a wooden pole for use indoors. There seems to be no difference in the sensitivity of aërials constructed with a wooden crossarm, whether the centres are connected electrically with an earth wire or not. For extra sensitivity more directors can be added. They should be the same length as D2 (Fig. 2) and should be inserted between D2 and D3 with the same spacing.

Examples of combined aërials are given in Fig. 4. They mainly comprise "V" shapes which are approximately one-quarter wavelength on Channel 5 and three-quarter wavelength on Channel 8. No dimensions are given for Channels 3 and 11 as they do not bear a good

	R	Ae	D1	D2	D3	A	B
Channel 8.....	32"	29 1/2"	28"	27 1/2"	27"	11"	15"
Channel 11.....	29 1/4"	26 3/4"	26"	25 1/2"	25"	10 3/4"	13 1/2"

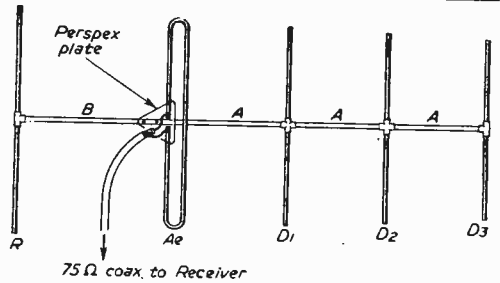

Fig. 2.—A basic 5 element Yagi.

has two "driven" elements connected by rods or a transmission line which is one-quarter wavelength on Band I and three-quarter wavelength on Band III. For the dimensions given the take-off impedance is 300 ohm (the American standard feeder with less loss on Band III but which hates getting wet), but it will work with our standard 80 ohm semi low-loss co-axial.

**Practical Channel 11 Aërials**

The 5-rod Yagi illustrated in Fig. 2 is once again a good basic aerial upon which to build. Extra elements can be added as with the Channel 8 version, and may indeed be necessary, as in tests carried out recently a marked falling off in sensitivity was noticed in receivers, converters, pre-amps, etc., as Channel 10 was left behind. No combined aërials for this Channel are given here because of the poor harmonic relationship between the two channels. Conventional types of combined aerial such as "H" types with "fishbones" added are impractical due to the stations not being co-sited, for it will not be possible to rotate the "fishbones" independently of the Band I aerial without the dipole element

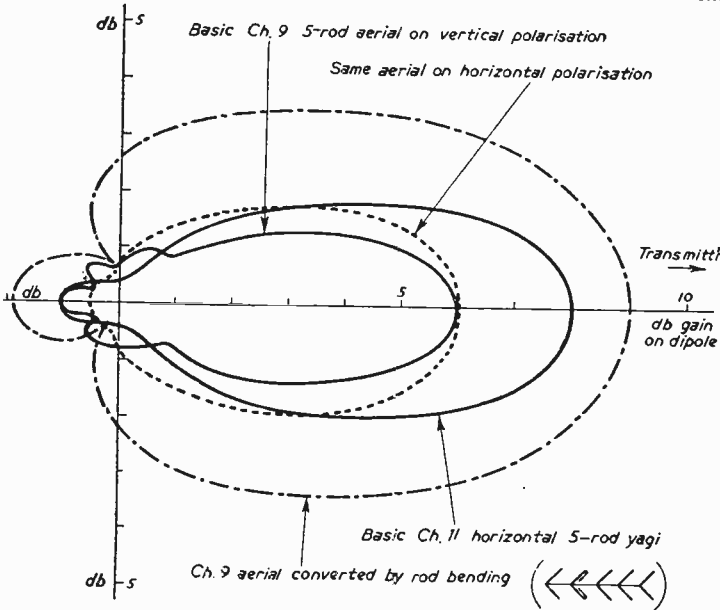

Fig. 3.—Polar diagrams of Low Power Channel II tests using various aërials.

harmonic relationship and the areas in which they are suitable are scarce. Fig. 4 (a) has slight forward gain on Band I and is efficient on Band III, but it is not a good "anti-ghost" type, so its use is restricted to areas enjoying a clean, strong signal.

Fig. 4 (b) is substantially the same with a reflector added. This had good forward gain on Band I and is in fact in general use throughout horizontally polarised areas. Its Band III performance shows a considerable improvement on Fig. 4 (a).

Fig. 4 (c) shows an aerial widely used in America. It

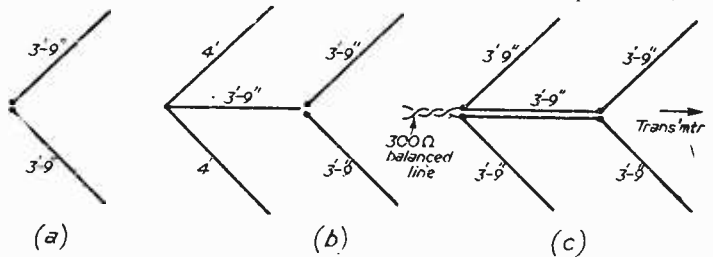

Fig. 4.—Combined Channel 5-8 aërials.

being fouled by the rear Band III director if the two stations are over 30 degrees apart. The added complication of widely differing field

gain, is to bend the elements forward as in Fig. 6. There is no need to shorten any rods or spacings in this conversion.

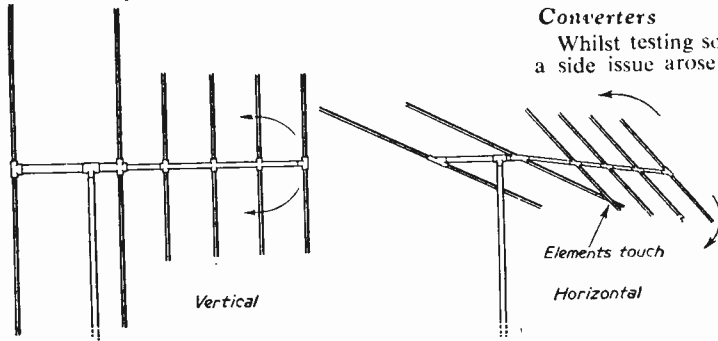

Fig. 5.—Illustrating the impracticability of conventional combined aerials used horizontally.

strengths for each channel in a given location makes it a more economic arrangement to clamp two separate aerials to the same pole, keeping them well apart to reduce "ringing" caused by interaction, and diplexing the outputs into a single downlead in some nice accessible place such as under the eaves above the bedroom window.

**Conversions**

A number of readers in both areas will have vertical Yagis in use for fringe reception of existing stations. In the North East these are mainly Channel 10, in East Anglia Channel 9.

The first step in conversion is to turn them sideways on the pole and reorientate them, and in the majority of cases it is all that will be necessary. The physical problem of mounting the array horizontally is easiest overcome by purchasing one of the many universal mast clamps now available. Where tuning is inefficient, due to ghosting or a narrow bandwidth aerial, the existing array will have to be modified. In the case of the Channel 10 to Channel 8 conversion, where the rods will need to be extended, it will suffice in most cases merely to extend or replace the reflector rod, making it a total length of 32in.

Changing from Channel 9 to 11 requires approximately 1in. to be sawn off each end of each rod including the folded dipole and reducing the spacing to the dimensions given in Fig. 2 if practicable.

An easier way, which incidentally gives more

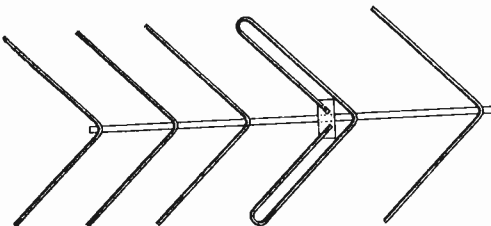

Fig. 6.—Suggested Channel 9 to 11 conversion. The rods are bent 45 deg. but not shortened.

**Converters**

Whilst testing some of the foregoing suggestions a side issue arose with interesting if not disturbing implications. Since a non-A.G.C. Band I set was available with its contrast knob calibrated in microvolts it was decided to use this with a "double superhet" converter to carry out field tests, but severe patterning was experienced even with the BBC off the air.

Investigation showed this to be a feature of all converters changing Channel 11 to Channel 3 and is likely to be just as annoying in the

Chillerton Down and Rowridge area. Some of the patterns were due to the V.H.F. Home Service (94.1 Mc/s Norwich and 92.9 Mc/s

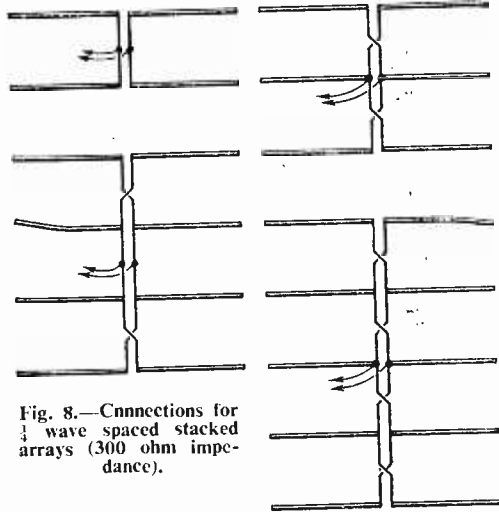

Fig. 8.—Connections for 3 wave spaced stacked arrays (300 ohm impedance).

Rowridge) beating as second channel with the local oscillator in the converter (148 Mc/s) to produce 53.9 and 55.1 Mc/s respectively which is within the vision passband.

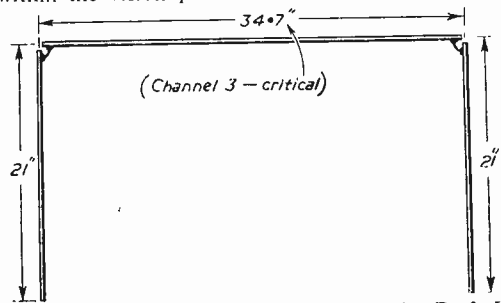

Fig. 7.—V.H.F. rejector for insertion in Band I downlead.





# Magnetic Picture Recording

DETAILS OF THE NEW BBC PICTURE RECORDING SYSTEM, KNOWN AS "VERA"

CONSIDERABLE interest was recently aroused by the news that the BBC had perfected a system of magnetic recording of the TV programmes which was simpler and much cheaper than the American system. This was demonstrated to the press and later to the public in the programme Panorama, and the following description of the apparatus has been supplied by the BBC. The name given to the system is VERA which stands for Vision Electronic Recording Apparatus and it has been designed to record the vision and sound signals of any television programme for subsequent reproduction at any time after the recording has been effected. An illustration of one machine is shown below. The channels which are to be put into service will consist of two such machines which can be controlled from a central control desk. The machine employs half-inch magnetic tape and a reel (20 in. diameter) such as those shown, will accommodate 15 minutes of programme. Continuous recording is possible by the use of two machines and the control desk.

The tape speed employed in the present model is 200in./sec. and the magnetic tape used may be a normal thin-base sound recording tape of good quality.

## Three Tracks

The machine employs a three-track system of recording, two of the tracks being devoted to the storing of the video signal and one to the storing of the sound signal. Separate recording and reproducing head-stacks are employed, each stack containing three identical heads separated from each other by copper screens and aligned to the accuracy required in the manufacturing process. Continuous monitoring of the recorded signal during the process of recording may be carried out.

## Tape Drive

In the tape transport system embodied in the machine most of the power required to drive the tape is supplied by the spooling motors which are arranged to move the tape past the

heads at a speed just below the chosen recording speed of 200in./sec. and close to the constant tension required, even when the drive motor is not engaged. This result is obtained by varying the power fed to the spooling motors in accordance with (a) their torque/speed characteristic and (b) the amount of tape on the reels at any particular moment, the latter determining the speed of rotation required of the reels. When the drive is engaged the drive motor is, therefore, required to supply only a limited amount of power to bring the tape speed up to 200in./sec. The drive is engaged by lowering two rubber idlers on to a common capstan so that a loop of tape, largely isolated from transient effects in the reels by these idlers and other mechanical filtering elements, is formed. Inside this loop lie the recording and reproducing head-stacks. The erasing head is placed at a convenient point which lies outside the loop and precedes the recording head. A "Velodyne" system of speed control and correction of the driving capstan is employed. During recording periods the servo driving motor is made synchronous with the mains frequency whilst on reproduction the output of the machine is frame-synchronised to station synchronisation signals. The

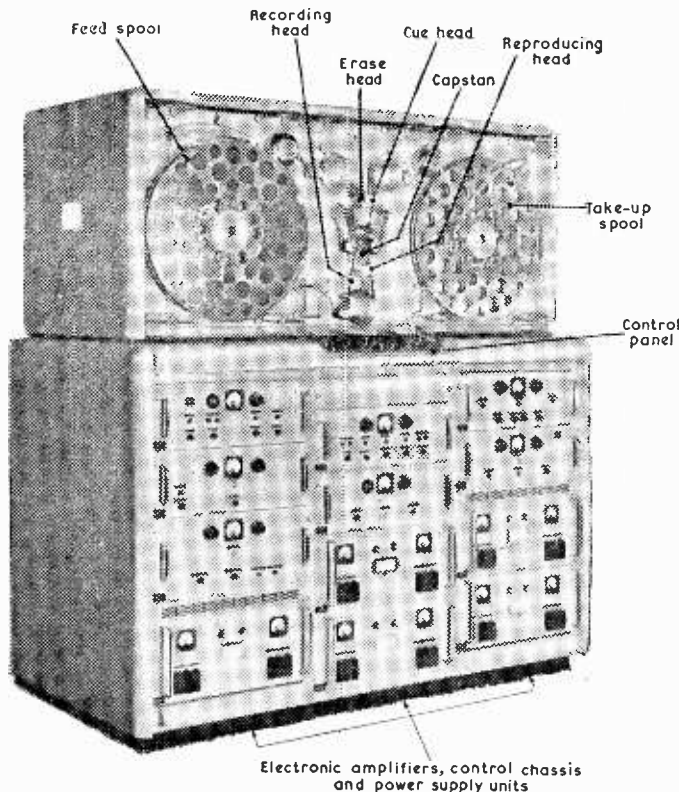

A view of the complete "VERA" recorder.



machine is fitted with the usual facilities for braking and for spooling the tape backwards or forwards at a variable speed when the drive system is not engaged.

### The Circuit

For storing the video signal the two video tracks are associated on the recording side, with a band-splitting system in which the video signal is divided into two frequency bands of approximately 0-100 kc/s and 100 kc/s-3 Mc/s. The 0-100 kc/s video band is made to frequency-modulate a carrier and this frequency-modulated carrier is recorded on one track. The low-frequency content of the video signal is thereby transferred to a frequency band corresponding to shorter wavelengths so that both the low-frequency and the long-wavelength difficulties inherent in the conventional magnetic-recording system are avoided. In addition, the amplitude-limiting facilities normally associated with the reception of frequency-modulated signals may be incorporated in the reproducing chain to eliminate undesired amplitude fluctuations and overcome almost all "drop-out" difficulties, even when employing thin-base sound recording tape not specifically manufactured for video or instrumentation purposes. The higher vision band, from 100 kc/s upwards, is recorded simultaneously on the second video track in a conventional manner.

On reproduction the output from the frequency-modulated video track is limited, demodulated, and added to the output from the higher-frequency track to reform the composite television waveform. Before transmission to line the synchronisation information, including line and frame synchronising signals and suppression periods, is extracted, reconstituted and added back into the video signal.

It is, of course, obvious that the higher-frequency video band, which employs a conventional recording/reproducing system, will be subject to the same unwanted amplitude-modulation which is being eliminated by the frequency-modulation system of the lower frequency video band. It is, however, an important finding that in practice this does not appear of major importance, for as long as the synchronisation signals and the main brightness structure of the picture, represented by the 0-100 kc/s band of the video signal, are maintained intact, reasonable variations in the higher-frequency band do not noticeably degrade the subjective result.

### The Sound Channel

All the low-frequency and long-wavelength difficulties which, in the case of the lower video frequency, are overcome by the use of the carrier system, will also be manifest in the sound channel if a conventional recording of the sound signal is attempted under the higher tape-speed conditions dictated by the video-signal requirements. The difficulties are, however, overcome by an identical technique to that employed to store the lower video frequencies. Accordingly the sound signal is, before recording, made to frequency-modulate another carrier which is recorded on the third track. On reproduction the

carrier is limited and demodulated to provide a sound signal of high fidelity exactly synchronous in time with the video information reproduced from the other two tracks.

### Editing

As in other forms of picture or sound recording a requirement will arise in the use of magnetic vision recorders for the editing of programme previously recorded. Simple editing, in the form of replaying extracts from a previously recorded programme, may be achieved by starting the machine at any predetermined point in the recording. This facility is available because the machine is equipped with the usual facilities for spooling the tape backwards and forwards to find a desired point in the recording. The method may be extended, as in magnetic sound-recording practice, by cutting and joining extracts from various recordings or different parts of the same recording. Individual frames cannot, however, be examined in a "gate," as in optical film editing, for the tape must be reproduced at the correct speed before a picture can be reproduced on a monitor. A cueing arrangement for the "marking" of editing points has, therefore, been provided. The method adopted is to provide an extra cueing head, lying outside the isolated tape loop, which is fed through a separate recording amplifier from a 30 Kc/s oscillator. When the tape is being normally reproduced and the observer wishes to mark some particular point for subsequent cutting he presses a "Cue" key on the control panel of the machine which causes a 30 Kc/s burst of signal to be recorded on the sound track of the tape. At this frequency it will not appear in subsequent normal reproduction since it lies well below the frequency-modulated carrier signals which carry the sound programme and any interference effects it might otherwise have will be removed by the limiting process which precedes detection of the television sound signal. However, when the tape is being slowly transported past the reproducing head, using the spooling speed control, at a fraction of the normal speed, the cue signal will produce an audible note in the loudspeaker or headphone system so that the point previously marked is found. The cutting and joining of tapes is accurately and quickly carried out by the use of a splicing device provided and the resultant join provides no visible disturbance in the picture.

**A NEW HANDBOOK**

**AMPLIFIERS: DESIGN & CONSTRUCTION**

By F. J. CAMM

17/6, Post 18/6

Containing Designs for Radio, Gramophone, Tape-Deck, P.A. Amplifiers, with a special chapter on D.C. Amplifiers.

From **GEORGE NEWNES, LTD.**  
Tower House, Southampton Street, Strand, W.C.2

# Temperature Compensation

METHODS OF OVERCOMING DRIFT CAUSED BY RISES IN TEMPERATURE IN A RECEIVER

By R. H. Mapplebeck

**I**N these days of narrowband receivers where temperature variation is likely to affect the frequency of tuned circuits it is often desirable to apply some form of automatic compensation. The exact manner of application depending upon the range of compensation required.

## Coils

To understand the necessity for compensation before going on to practical ways of achieving it, let us examine some of the physical changes that occur in coils and condensers with change of temperature.

For a single layer solenoid, a shape in common use in television and shortwave radio, the approximate inductance is given as  $L = \frac{r^2 N^2}{9r + 10l}$  mohenries

Where  $l$  = the length of winding.  $r$  = radius of winding.  $N$  = turns of coil. All dimensions in inches.

If we look at this formula carefully it is seen that a change of radius has a greater effect on the inductance than a change in length owing to the term of  $r^2$ . Increasing the temperature therefore makes the coil expand radially more than it does longitudinally which increases the inductance.

The ratio of change in frequency from a fixed datum due to the unhindered expansion of a copper coil is  $8 \times 10^{-6}$  parts per degree centigrade, or for a normal temperature rise during warming up (which may take an hour or two), of say, 30 deg. C. the change in frequency is 240 parts in a million or 240 c/s in 1 Mc/s.

Since the increase in radius has the opposite effect to increase in length it is possible, by suitably selecting the material of the coil and its former, to make the inductance reasonably independent of temperature over the small changes likely to be encountered in low power circuits such as receivers, wavemeters, oscillators and similar equipment.

One way of doing this is to select a material such as invar for the coil or by shrinking the coil on to a former of lower coefficient of expansion. This is not an economic proposition however, but results good enough for average needs may be obtained by using ordinary copper wire and compensating by indirect means such as employing a high Q single turn loop loosely coupled to the coil to be compensated, but mounted on a device which moves the loop relative to it with change of temperature.

Two such arrangements are shown at Fig. 1 (a) and (b). In (a) the coupling loop is mounted between two rods of insulating material such as bakelite anchored at opposite ends of the main coil former respectively and free to move at the other. Expansion or contraction of these rods

imparts a rotary movement to the one turn loop giving a frequency shift to the coil. By a little experimenting with the position of the loop it may be arranged to compensate for coil expansion or contraction.

In sketch (b) movement of the loop is provided by a spiral of bi-metal strip which tends to coil and uncoil with change of temperature, and it is a relatively simple matter to adjust the length of the strip and the position of the loop to obtain optimum compensation.

## Condensers

Changes in geometry other than that of the plate systems of commercially constructed variable condensers i.e., distortion of framework, may occur with temperature changes due to stresses and strains set up by expansion and more important still quite large changes of permittivity may take place in the solid insulators. Variable condensers often have a high temperature coefficient due to poor quality insulation and their effect on oscillator frequency is generally much greater than coil changes, which explains in part why some designers of H.F.

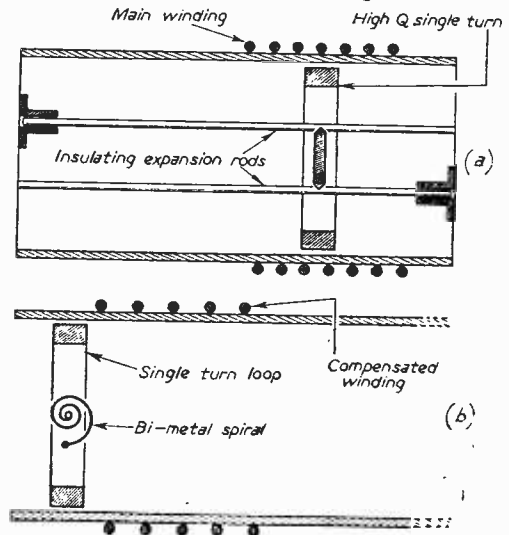

Fig. 1. Sectionalised views of inductive temperature compensators.

equipment prefer to utilise high quality fixed capacitors with variable inductance preset tuning. Also the temperature coefficient of a variable condenser is rarely constant throughout its range of travel therefore, for correct compensation, its coefficient should be in conformity with its "law" otherwise compensation will only be complete at one part of the spindle setting.

falling off in effectiveness either side of that point.

A method of making a compensator is to replace an end vane of the moving plates with one of similar shape constructed from bi-metal sheet with many radial slots cut round its periphery as in Fig 2. Compensation occurs with change of temperature by the automatic bending which takes place of each slotted portion of the bi-metal plate. This plate must of course be mounted the right way round so that increase of temperature causes it to bend either inwards to increase capacitance or outwards to decrease according to the coefficient required. That is, depending on which way the frequency is drifting.

For those not wishing to be so meticulous it is possible partially to offset the effects of temperature change by compensating for an "effective" coefficient of capacitance equivalent to all the circuit lumped values of L and C.

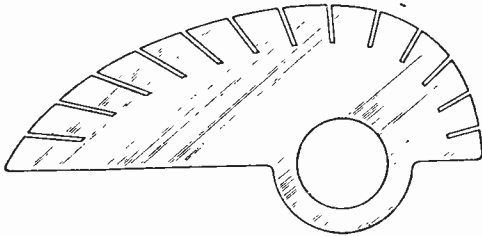

Fig. 2. Bi-Metal Split vane for capacitive temperature compensation.

Such collective circuit compensation may be used with considerable advantages in many instances, but it is possible only if the coil and its tuning condenser are at the same temperature. The application should therefore be limited to apparatus of low power such as receivers. In transmitters or other high power equipment the tuning coils and condensers may well be at different temperatures caused by their differing oscillatory currents.

It is quite usual to use this method, and commercially the compensator frequently consists of a fixed capacitor which may vary from 2pF to 8pF and having a predetermined temperature coefficient, either positive or negative. These can be purchased quite easily from the condenser manufacturers, but are more used where the design engineer has already ascertained what value is required. For the home constructor where the temperature coefficient is probably an unknown factor it is quite an easy matter to "knock up" an adjustable compensator which can be connected across the tuned circuit concerned in close proximity to it and adjusted over a period of time. Fig. 4.

These compensators require a little patience to adjust as a number of trial temperature runs may have to be made. The closer together the plates of the compensator the greater will be its change of capacitance for a given temperature change. Thus it can be easily understood that too close an adjustment will over-compensate and vice versa.

A glance at Fig. 3 will show what is meant.

The curves show how the tuning frequency of a receiver tested by the author drifted over a period of three hours. In the first run (A) with no compensator attached the tuning frequency drifted 6 Kc/s. The plate of the compensator was then set at a low trial value and connected up across the tuned circuit of the oscillator, and another run established a drift of only 2 Kc/s. Curve (B). A further adjustment (C) showed a change in a negative direction from the original set position so it was realised that the optimum point had been passed. A slight opening of the compensator plate gave the curve at (D) which indicates quite a satisfactory state of affairs. Only a drift of about 300 c/s had taken place which is infinitely preferable to the uncompensated condition in curve (A).

All this does not mean that the set must be watched all the time. That indeed would be too tedious. It is sufficient to note the total drift after three hours from switch-on, meanwhile

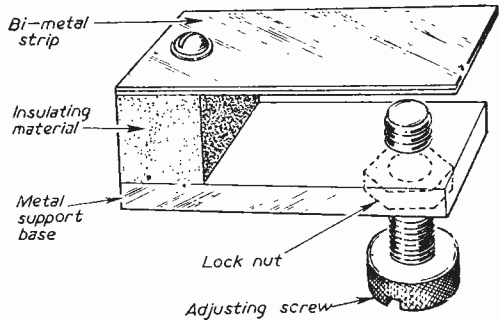

Fig. 4. This bi-metal strip compensator is in effect a small pre-set condenser.

one may be elsewhere so long as nobody touches the set. Then switch off and allow the set to cool completely for several hours. Make the new adjustment and switch on again, retune and then note the drift after a further three hours. A convenient way of doing this is to take a reading each night. In the laboratory a very accurate crystal controlled monitor would be used, but as broadcasting station carrier waves are crystal controlled they make very good monitors.

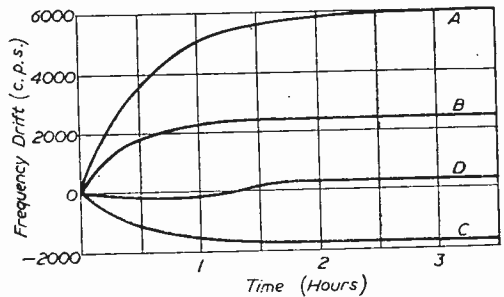

Fig. 3. Curves showing drift with and without compensation.  
 A...No Compensation B...Some Compensation  
 C...Over Compensation D...Optimum Compensation

**W**HILST the Quad aerial is not unknown in amateur circles, its use in the V.H.F. sphere has, doubtless, been neglected and in the television field particularly. Yagi configurations largely prevail.

Although a well-built Yagi array does offer high-gain conditions the use of such an array is scarcely a practical proposition for those who, from necessity, are forced to accept an indoor installation. Lofts are frequently utilised by viewers so situated to house TV aerials, and roof tiles doubtless hide a varied assortment. In areas of reasonable signal strength no problem arises but in fringe locations a three- or perhaps four-element beam might be necessary in order to obtain adequate signal pick up. To get an array such as this into a loft is, in a great many cases, impossible. Skeleton slots are sometimes used where headroom is small but this type of aerial is hard to feed correctly as the impedance is fairly high, making connection to 75 ohm coaxial cable rather tricky. No such problem arises, however, with the Quad aerial and a series of experiments made recently shows that it is an excellent arrangement well suited to indoor use. A well-matched "H" made a preamplifier necessary at the particular location (which is in hilly country almost 60 miles from the transmitter) and although an "X" showed some improvement, neither equalled the performance of the Quad, which rendered the preamplifier unnecessary. This is not surprising as even 4 db is difficult to achieve with simple "H" and "X" configurations.

**Gain**

With the Quad aerial a fairly large frontal area is offered to the incoming signal and, whilst no actual measurements have been possible, the experiments suggest gains of 3 db for a single loop and 8 db when a slightly larger loop is placed 0.2 wavelength behind the driven loop to act as a parasitic reflector. Gain could doubtless be further improved by adding another loop and operating it as a director, although this would make the assembly cumbersome. Backing the driven loop with a reflector not only increases the forward gain and improves

# THE QUAD AERIAL



*The Quad Aerial is coming into favour for TV purposes. Some details are given here. By A. Sydenham.*

the front to back ratio but also brings the feed point impedance down to approximately 80 ohms.

**Physical Shape**

The driven loop, more conveniently made into a square, should have sides each one-quarter wavelength long and may be considered as two half-wave elements. The length of wire needed for the driven loop is not unduly critical and may be derived, for any particular channel, from the simple formula

$$L = \frac{984}{f}$$

where L is in feet and f represents the operating frequency in megacycles.

For Channel 5, therefore, the

length would be  $L = \frac{984}{65} = 15.13$  feet. (Side lengths of 3ft. 9in. would suffice.)

The wire needed for the reflector should be 5 per cent. longer than that used for the driven loop.

**Polarisation**

This is vertical when the feed point opening is made in a side as in Fig. 1 (a), and horizontal when the opening is made at the bottom as in Fig. 1 (b). Fig. 2 shows an alternative arrangement that may be adopted where the aerial is to fit under the tiles of the loft. Polarisation is easily remembered if one thinks of a folded dipole: the Quad is such a dipole pulled out to form a square.

**Construction**

Making the aerial is simple, and stranded copper wire can be used if necessary, supported on two horizontal 5ft. bamboo canes secured at their mid points to a broom handle acting as the main support. The whip of the canes tends to keep the wire taut and the upright may be let into a base plate for securing to the attic beams (see Fig. 3). The reflector is similarly constructed and may be mounted independently of the driven loop. This makes a very light assembly. Small holes drilled in the canes at appropriate points retain the wire.

A more substantial construction results if  $\frac{3}{8}$  in. lightweight tubing is used and this method is recommended as bandwidth is improved.

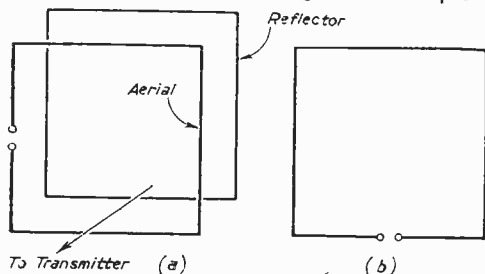

Fig. 1.—Diagrams of the Quad aerial.

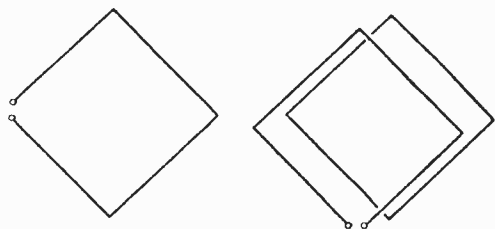

Fig. 2.—An alternative form of construction.

### Conclusion

The Quad aerial would also seem useful for Band III purposes as the side lengths would approximate to only 16in. An increase of some 3 db could be achieved by stacking Quads side by side, spacing them one half wavelength apart and feeding them in phase. Phasing lines made from 125 ohm twin cable should permit a reasonable match to 75 ohm transmission line. Coaxial phasing lines are not recommended due to a low velocity factor. Unfortunately Band III is not yet practicable at this location but a Quad has been used for Band II transmissions with excellent results.

When an opportunity occurs the aerial will be tested on Band III, and the results will be given in these pages.

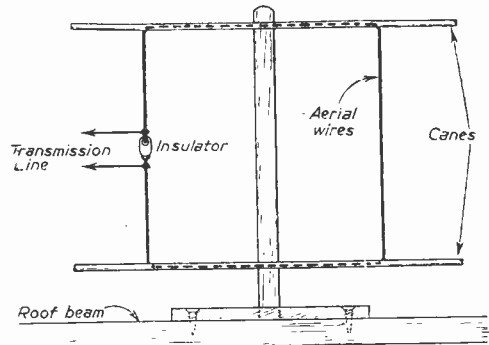

Fig. 3.—Practical details of a Quad aerial.

## Australian Reception of BBC

FOLLOWING the recent notes of the reception of Australian TV in New Zealand, we have received some very interesting details from one of our readers in Australia who has successfully received the BBC on many occasions on standard British receivers. We give below a copy of his letter, and accompanying this is an illustration of his elaborate aerial array, which is rotatable, and mounted on a 95ft. lattice mast. Mr. Palmer also sent with his letter a full page cutting from a local paper which showed him in his "den" with the three British receivers. As the Australian TV utilises the CCIR system, with 625 lines and sound on F.M., the BBC cannot be picked up by American or Australian receivers. Here is the main part of Mr. Palmer's letter:

"I am a regular reader of Practical Television and read with interest your report on the Telenews page of last month's (February, 1958) edition referring to Australian TV being received in New Zealand and that the American police transmissions break through on British TV receivers periodically in your country.

"I would like to mention that for the past two years I have been TV dx-ing in this country and have heard and tape-recorded on many occasions American police here breaking through similarly on my two British standard receivers over a distance of 9,000 and 10,000 miles and at this distance I have heard and made most splendid recordings of American police not only on 42 Mc/s but up to 46 Mc/s, since November, 1955. In addition I pick up American call service stations on 43.5 Mc/s daily.

"As for TV reception my results may be of interest to readers. I have received the BBC sound on 25 occasions since December 3rd last and the picture on three occasions only, this distance being about 11,000 miles from Melbourne to London via short path. Naturally I have recorded the sound reception and in all have about five hours of tape of BBC TV programmes as received here. Copies of some of these recordings are already in BBC archives and reference to their research department (Mr. Dennis) will confirm my claims to being the

first person to have seen around the world by looking in on the BBC. My having seen the S.E. London rail crash films on the BBC on December 5th was widely reported in the London press and other world dailies. Now that the BBC is transmitting TV on 200 kW I am hopeful of even better results at the next band opening. The sound was received here at terrific strength and excellent quality but the picture on 45 Mc/s was indeed snowy.—G. F. PALMER."

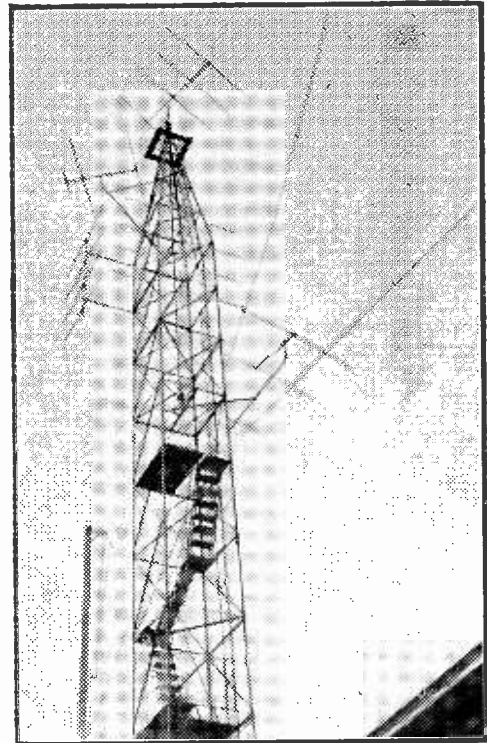

Mr. Palmer's elaborate aerial array. The BBC aerial is on top (95ft. up), and the other aeriels are for American reception.



# Amateur TV Recording

IS IT POSSIBLE FOR THE AMATEUR TO RECORD TV PROGRAMMES? THIS ARTICLE WAS WRITTEN BEFORE THE ANNOUNCEMENT OF "VERA" (see page 515)

By "Recordist"

ASK the experts if you can record TV programmes and you will get a pretty smart "NO!" for an answer. Ask for reasons and there will be much smart talk of information content, and entropy, and bandwidth, and so on . . . and you are supposed to retire, abashed and blushing, ashamed of your temerity. It is unnecessary for me to beg you not to do so: I know perfectly well you won't—not if you are a true amateur, in the best traditions of the game. Because if you had asked, not so very long ago, whether short waves could span the Atlantic, the answer would have been the same. Just as emphatic and just as soundly based on sound scientific principles. The older hands will remember that the amateurs were granted the privilege of transmitting on 20, 40 and 80 metres because all the wise men were certain that these bands would never have any practical application. True, they buckled to and found the reasons why they were wrong, but it was the amateur who proved them wrong in the first place!

Now, the reasons given for the uselessness of the short waves for DX work were perfectly sound. Only there was room in the theory, a gap unnoticed by the learned, for an effect—ionospheric reflection—as yet undiscovered, to make nonsense of all the calculations. The amateurs didn't discover the effect—they used it, and left the analysis to others. Is there any such gap in the reasoning which decrees that the recording of TV signals is beyond the capabilities of the amateur experimenter?

## A Clue

In fact there is. The television picture is what is called in information theory "redundant." There can be no doubt that a better system of transmitting the information content of a picture, more economical in bandwidth, remains to be found. I am taking a big chance when I say that I do not think that this better system will be discovered by an amateur experimenter; but it is not at all impossible that such a person, as a result of his "fiddling" with TV recording, might turn up a result which, upon analysis, could lead the experts to the heart of the matter. The experts will scoff at this, of course; but we have heard that noise before, too.

Let us, then, take a look at the fundamental difficulties. Bandwidth. We all know that a set which is defective in this respect, which will not accept the full range of frequencies making up the picture, gives imperfect definition. The finer details are lost. We can no longer distinguish the 3 Mc/s bars on Test Card C. But if we are to get a start at all we must build some kind of a recorder and no known recorder of simple type will go up to 3 Mc/s. What, then, is the

minimum definition acceptable for "getting a start"? Well, a good many years ago I recorded TV on wax! My frequency response was up to about 8 Kc/s, and I took the picture from the BBC's experimental Medium Wave TV transmissions. I lost practically no definition because the maximum bandwidth available for these transmissions was the current 9 Kc/s of a broadcast transmitter. Definition was very poor, of course, since the standard was only 30 lines; but it was a picture, and it was recorded. What happens if you try to record 405 line pictures on tape, accepting perhaps 12 Kc/s? Well, if you are lucky you will get a picture. A poor one, but a start. It will take a lot of "fiddling," but it can be done—has been done. All sort of troubles crop up—synchronisation is very, very difficult—but these are things which offer a pleasurable challenge to the real experimenter.

## Speeds and Heads

The next stage? It has been shown possible to record up to 500 Kc/s on ordinary tape. Rather high speeds are required, and very carefully designed and constructed heads; but the man who did it was an amateur at heart, though a professional in name, for it was done by "fiddling." No new principles were required, no new theories invoked—he just made everything a bit better, a bit faster . . . presto, 500 Kc/s!

Could you build a 500 Kc/s tape recorder? I think you could, if you were to put your mind to it, provided you have a decent workshop and a good pair of hands. And what sort of picture do we get by recording 500 Kc/s? It would not pass muster as the result of direct viewing from an aerial signal; but it is really not at all bad. It gets us to the stage where every man must start developing his own brainwaves, must strike out for himself. One will be confident that he can go on and improve his simple, linear-tape machine. He will be laughed at by any expert friends he may have, but he won't be worried, even if he fails. He will just think up another crazy idea. . . . Another will see that only a small portion of a given picture is in fact in motion at any given time, and will dream up a sampling unit for the input to his recorder, with a system of loops to store the slowly changing parts of the frame. . . . We know, it's been tried, it doesn't work . . . but maybe that man will make it work, just by means of good old-fashioned stubbornness. Somebody else will reason that six recorders, each accepting 500 Mc/s should somehow be the equivalent of a single machine accepting 3 Mc/s; they will be told that Walt Disney Studios, Inc., lost two million dollars chasing that particular illusion. They should reply "But maybe they didn't chase it in the right direction!"

# Tracing Obscure Faults—2

SOME STRANGE SYNC AND VIDEO FAULTS DESCRIBED

By F. E. Apps

**F**AULTS in this portion of a television receiver are often difficult to trace after one has eliminated the valve or valves and the components from suspicion. One of the main reasons for this is, I believe, that this part of the circuit is not often in trouble, and also, the actual working of the frame and line sync pulses are not understood as thoroughly as the working of the remainder of the circuit. Another point is that although the fault may appear to be due to the lack of sufficiency of these sync pulses, the fault may be in another part of the circuit. An instance of this is given in the following example.

The set in question was very erratic on both line and frame. Line tearing and frame slip were frequent. These circuits were carefully checked and found to be O.K. The sync circuit now appeared to be causing the trouble. This was carefully checked and no fault was apparent. Finally an oscilloscope was connected and the sync pulses were found to be compressed or limited. The trouble was therefore now shifted to the intermediate frequency stages. Here the trouble was located; a screen resistor to one of the valves had gone high, reducing the gain and limiting the sync pulses. It should be pointed out that the oscilloscope was not necessarily essential to finding this fault as a careful check of voltages on valve electrodes of the intermediate frequency amplifier would have discovered it.

Another fault that may lead to suspicion of the synchronising stage is poor interlacing. This gives a moiré effect to picture and is generally due to incorrect setting of the vertical hold control. In the example quoted, however, this control did not have any effect upon this fault. A complete check of components located the fault in the integrating network of the frame circuit. A condenser had become open circuit. By the way, some sets have two integrating networks in series so check both. See Fig. 1.

## The Video Amplifier

Faults in this stage do not necessarily mean no picture. A good many give a picture but with the higher or lower frequencies considerably attenuated, thus giving a fuzzy or poor definition picture. Before tackling the video amplifier section, make certain that the video detector is working O.K., either by substitution of components or checking with meter. When this stage has been cleared, it may be as well to check the alignment of the intermediate frequency stages. If, for instance, the trouble is due to attenuation of the higher frequencies, the intermediate frequency stages tuned to the lowest intermediate frequency may be mis-tuned. When this has been done and no improvement found, then attention must be paid to the video amplifier components, in particular the low and high frequency networks and peaking coils in the anode circuit of the video amplifier, with any

resistors paralleled across them. Voltages on valve electrodes are important. Check these.

In another case, which was due to a video amplifier circuit fault, the picture was hard to hold on the frame and there was a dark band running across the screen horizontally. Now this can be a heater cathode fault on video amplifier, but it was not so in this case. An investigation of the circuit showed that the H.T. for the I.F. and video amplifier was in one circuit, so this was checked and the trouble located. A smoothing condenser had gone low capacity thus introducing hum into this H.T. line.

## Timebase Faults

There can be quite a few obscure and tricky faults in this part of the circuitry. I will deal with the frame timebase first. The first example was a receiver where the picture was stretched out in a vertical direction with no or little control of height. Distortion was also apparent. Frame valves were checked and found O.K. so therefore the various components were taken next. It was found that one of the condensers forming the negative feedback circuit to the frame output valve was O/C. This, of course, caused excessive output from the anode of this valve. Replacement of the faulty component did not completely cure the trouble, and further investigation showed that the frame output transformer had been damaged by this excessive voltage and a replacement was necessary.

## Frame Fault No. 2

In this example the height of picture was intermittently falling. A check up of valve controls, etc., gave no clue. All was apparently in order. The frame output transformer was checked for resistance and was apparently O.K., but to make sure, this was changed. Still intermittent height. This left only the deflection coils. They were removed from tube and carefully examined. It was then found that here was the trouble. An intermittent short circuiting of turns was taking place. New coils effected a cure.

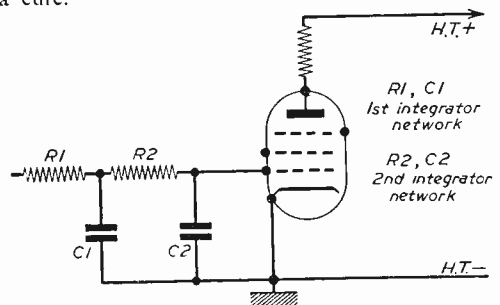
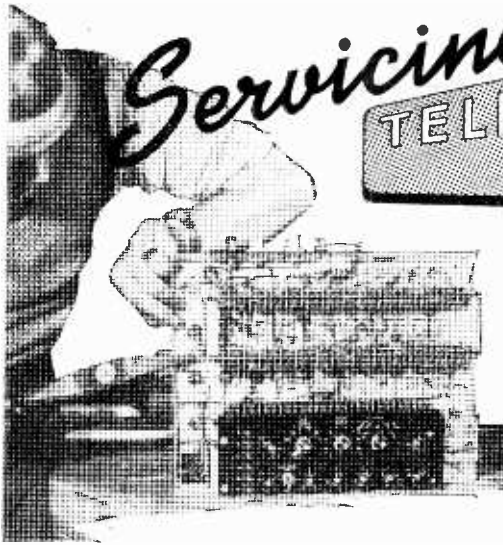

Fig. 1.—Circuit of the sync stage referred to in this article.



# Servicing TELEVISION RECEIVERS

No. 38.—THE BUSH TV36C, TV43 AND SIMILAR MODELS

By L. Lawry-Johns

from this applied to the BBC coaxial socket only. To enable the receiver to function on both bands the following small modification should be carried out.

### Dual-band Modification

Immediately to the right of the BBC socket are the two holes which form the Band III socket. The top tag of this should be directly connected to the inner tag of the BBC socket; the connection requires approximately an inch of wire. Now connect a 47 pF disc-type capacitor from the top screw of the coaxial (BBC) socket body to the 6BA nut of the receiver unit immediately behind, using a tag washer so as to facilitate removal (as this nut and three others have to be removed to enable the unit screening cover to be taken off). If the Band III signal is much weaker than the BBC, remove the cover and note that some contacts are left spare on the end of the switch spindle. Note also which pair are shorted when switched to Band III. Connect one of these tags to chassis, the other across to the rear right side sensitivity control, centre contact. The control is now shorted out when the switch is in the Band III position, thus enabling it to be set correctly for optimum BBC reception conditions. This modification is worth while since it obviates continuous adjustment when switching over. It should also be noted that if the sensitivity control is too far advanced in areas of good BBC signal strength, sound on vision—picture vibrating in sympathy with sound modulation—and vision on sound—buzz on sound varying with picture content—will be experienced. The obvious cure for this, assuming the tuning knob is correctly

THIS article is intended to help in the servicing of four main models, namely the TV36C, TV43, T36 and TUG36C, but the notes will apply in several respects to certain other models such as the TV24C, TUG34A, TUG36, TV32 and TV33. The differences are considerable and readers are advised to consult Newnes Radio and Television Servicing for the actual circuit diagrams and explanations, which are outside the scope of this article. A layout diagram of the main deck is not given since all valves are of differing types with the exception of the two EF80 valves and the text makes the function of each quite obvious. A diagram of the receiver unit is given to enable the valve functions to be more readily understood. The four main receivers and the TV24C employ the type A63 receiver unit or the modified version, the A78, which has greater sensitivity on Band III. These are, of course, dual-band units, continuously tunable over whichever band is selected. The other models mentioned are for Band I use only, the TC184 conversion unit being usually fitted by Bush dealers to enable the Band III programmes to be received. As originally supplied, the A63 receiver unit (lower R.F. chassis) had two inputs, one for Band I (coaxial) at 75  $\Omega$ , the other for Band III (twin feeder) at 300  $\Omega$ . This latter type of cable is very rarely used and although the majority of receivers have by now been modified, we will outline the accepted method of altering the aerial input so as to enable a single coaxial input to suffice for both bands. Where two aerials are in use, the two feeder cables should terminate in a diplexer or cross-over unit, and the single output

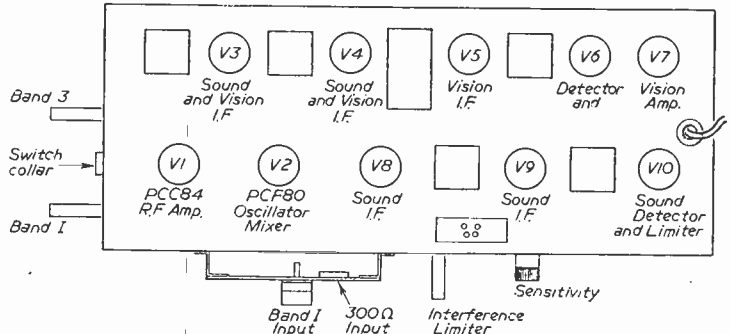

Fig. 2.—Type A63—receiver unit.

adjusted, is to reduce the sensitivity and advance the contrast if necessary.

The same remarks will apply in areas of high Band III signal. The effect of a matching stub may be tried in areas of poor Band III signal, the original Band III socket providing a convenient point of connection. Prepare the end of a short length, say, 20in., of coaxial and apply to the socket. Now trim off  $\frac{1}{4}$ in. at a time with wire cutters, noting the effect of the ends being shorted by the cutters immediately prior to actually cutting completely. To satisfy theoretical requirements, the matching stub should be inserted into the actual feeder cable a quarter wave-length from the receiver socket but little benefit is actually found from this in practice.

**Removal of Receiver Unit**

At first sight the removal of the receiver unit presents a problem, but in actual fact no difficulty should be experienced. First remove the plugs and lead terminations, then slacken band switch control spindle, grub screw through hole provided beneath the cabinet, and knob fixing screw as well. Remove knurled knob from top of unit and lift off plate with spindle springs. Now unscrew tuning knobs, removing completely. After the chassis retaining screws have been removed the chassis is free for complete withdrawal.

**Removal of Main Deck**

Remove bottom inspection cover and insulating panels covering main chassis fixing bolts. Remove front control knobs by inserting screwdriver through holes provided and releasing spindle screws. Unscrew control mounting brackets and remove speaker leads where necessary. Remove chassis bolts and turn receiver upright (table models). Remove two nuts, one each side of main chassis and cabinet foil connecting leads. Remove chassis plugs, C.R.T. base socket, etc., and withdraw chassis from

(Continued on page 527)

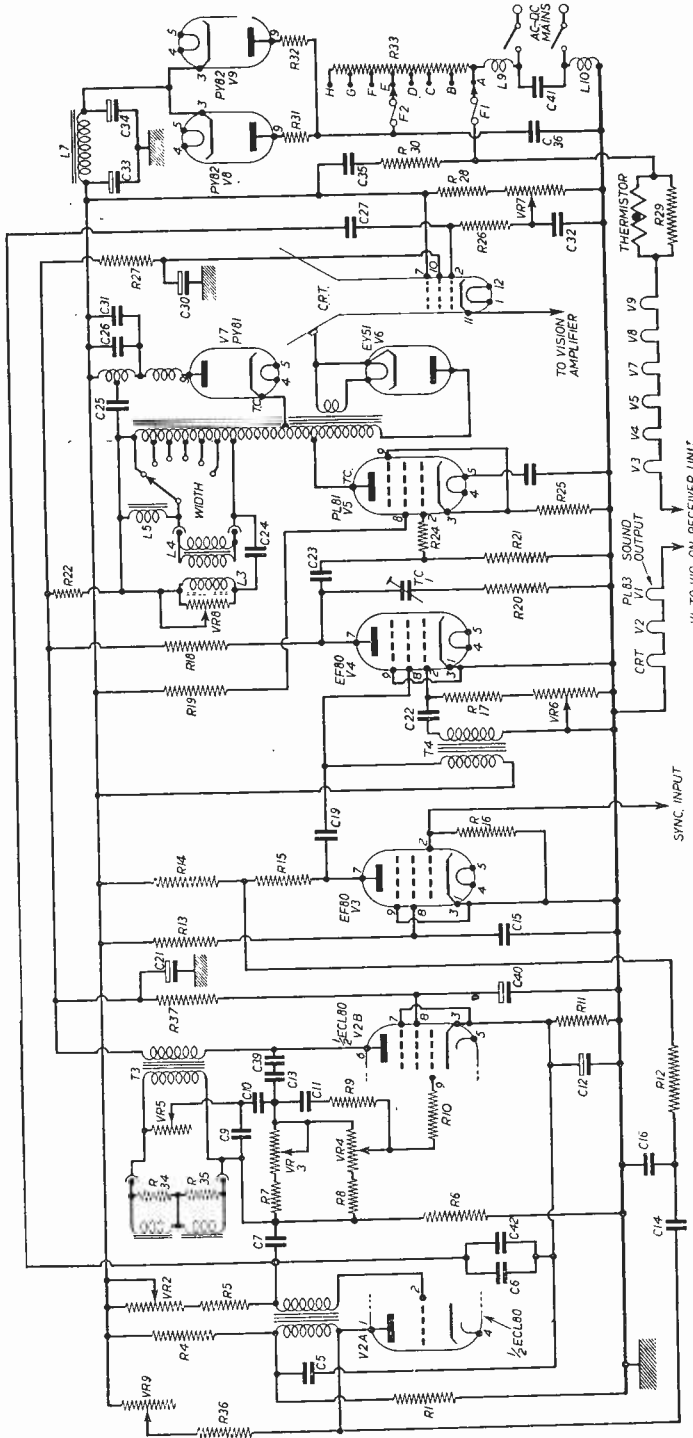

Fig. 1.—Circuit of frame and line timebases, C.R.T. and sync separator. R25 is shunted by a capacitor in the TV43.

# Speaking for BRITAIN



## ***What does Operation Britain mean to us?***

AT HOME AND ABROAD, too little is known or even remembered of the active part that Britain plays today. We feel it. We believe in it. But is this enough?

For what is Britain? She is neither more nor less than we, her people, make her. She is our united efforts; she is our pride; she is our energy, our wisdom and our talents.

Our fathers made her past, and our children will make her future. It is up to us to make her present, building on past achievements a foundation for that future. This means action—now, and by every single one of us.

Ours is a vital nation: and it is to tell of this vitality that we have formed Operation Britain, gathering together eminent men from

all parts of British life—experts in their own field of activity: labour, management, government—united by their belief in Britain's future.

At home, we must look beyond our British understatements, and seeing our real strength, build to greater strength. Abroad we must ensure that our achievements are assessed at their real worth to the world and the world's future.

Ours is a heritage no longer bounded by the seas: ours is a vital role in world affairs. It is only by knowing this, each one of us, aware of our real ability, that we can build towards the future that is our birthright—the world's birthright—a future that is bright with promise.

## **This is an "Operation Britain" Organisation advertisement**

*Write for details of corporate and individual membership of the organisation to:—*

THE OPERATION BRITAIN ORGANISATION • 165 FLEET STREET LONDON EC4 • FLEET STREET 5011



**SIGNAL GENERATORS**

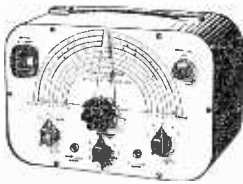

£3.19.6 or 25/- deposit and 6 monthly payments of 21/6. P. & P. 5/- extra. Coverage 100 Kc-s-100 Mcs on fundamentals and 100 Mcs to 200 Mcs on harmonics. Metal case 10in. x 6 1/2in. x 5 1/2in. Grey hammer finished case and white panel. Incorporating three miniature valves and Metal Rectifier. A.C. Mains 200-250. Internal Modulation of 400 c.p.s. to a depth of 30%. modulated or unmodulated R.F. output continuously variable. 100 millivolts.

C.W. and mod. switch, variable A.F. output. Incorporating magic-eye as output indicator. Accuracy plus or minus 2%.

£1.19.6 or 25/- deposit and 4 monthly payments of 21/6. P. & P. 5/- extra. Coverage 120 Kc-s-4 Mcs. Metal case 10in. x 6 1/2in. x 4 1/2in. Size of scale, 6 1/2in. x 3 1/2in. 2 valves and rectifier. A.C. mains 230-250 v. Internal modulation of 400 c.p.s. to a depth of 30%. modulated or unmodulated R.F. output continuously variable 100 milli-volts. C.W. and mod. switch, variable A.F. output and moving coil output meter. Grey hammer finished case and white panel. Accuracy plus or minus 2%.

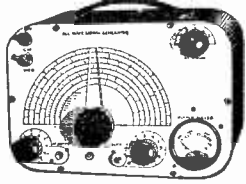

**SIGNAL & PATTERN GENERATOR**

25/- deposit plus P. & P. 5/- and 6 monthly payments of 21/6. Cash £8.19.6 plus P. & P. 5/-. Coverage 7.6 Mcs-210 Mcs in five bands, all on fundamentals, slow-motion tuning, audio output, 8 vertical and horizontal bars, logging scale. In grey hammer finished case with carrying handle. Accuracy ±1%. A.C. mains 200-250 v.

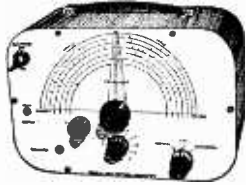

**COMMERCIAL TELEVISION CONVERTER SUITABLE ANY T.V. (Except Philips, Bristol area and valley areas Wales) WITHIN 35 MILES OF I.T.A. TRANSMITTER. ALL CHANNELS NO ALTERATIONS TO SET.**

Complete with built-in power supply. 200-250 v. A.C. mains. Crackle finish case 5 1/2in. long, 3 1/2in. wide, 4 1/2in. high. Incorporating gain control and band switch. Illus. with cover removed. Complete with Wolsey 3 element I.T.A. outside or loft aerial, 36 ft. I.T.A. lead and 2 plugs. (Wolsey 5 element 10 - extra.) 25/- deposit plus P. & P. 5/-. Coverage £1.5.6. Cash £5.17.0 plus P. & P. 5/-. Converter only £3.19.6 plus P. & P. 2/6.

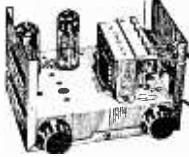

**AC/DC POCKET MULTI-METER KIT**

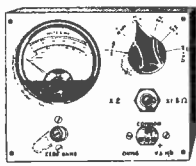

Comprising 2in. moving coil meter scale calibrated in AC/DC volts, ohms and milli-amps. Voltage range AC DC 0-50, 0-100, 0-250, 0-500, 0-10,000. Ohms range 0-10,000. Front panel, range switch, wire-wound pot (for ohms zero setting) toggle switch, resistors and metal rectifier. Basic movement 2 mA. In grey hammer finished case. 19/6 Plus P. & P. 1/6. Built and tested 7/6 extra.

Point to point wiring diagram 1/-, free with kit.

**PORTABLE AMPLIFIER**—Size 6 1/2in. long, 5in. high, 2 1/2in. deep. Will suit any type of crystal pick-up. Output approx. 2 watts. Incorporating ECC83 double triode. Cossor 142BT output pentode and contact cooled rectifier. Fully isolated mains transformer for 230-250 v. A.C. mains. Bass, treble and volume controls. 49.6 plus P. & P. 3/6. 5in. Speaker and 1 1/2" Transformer, if purchased with above, 18/6. plus P. & P. 1/6.

**COLLAR 4-SPEED AUTOMATIC CHANGER** Model 457 (suitable for use with above amplifier). Type "O" pick-up. Size 12in. x 13 1/2in. Min. clearance above board 5in., below 2in. 10 records. A.C. mains, 230-250 v., turnover crystal head. Brand new, fully guaranteed. £8.19.6, plus P. & P. 5/-. Or 25/- deposit plus P. & P. 5/- and 7 monthly payments of £1.5.0.

**RADIO & T.V. COMPONENTS (Acton) LTD.**

23, HIGH STREET, ACTON, LONDON, W.3  
All enquiries S.A.E. GOODS NOT DESPATCHED OUTSIDE U.K.

**RST**

MAIL ORDER DEPARTMENT  
211 Streatham Road, Mitcham, Surrey.  
ALL VALUES LISTED ARE NEW STOCK. ● Terms C.W.O. or C.O.D. Postage 3d per valve. MITCHAM 6201

AZ1	15 6	EF40	15 -	ML4	12 0	UC183	13 0	6F13	18 6
AZ31	10 6	E241	9 6	MSP4	15 -	UC41	0 -	6J30	6 6
B65	8 6	EF42	12 -	MU14	10 -	UF89	10 -	6Z1U	10 -
DA2C2	9 0	EF50(A)	4 6	MX40	15 -	UL41	5 0	6K7	4 0
DAF01	9 -	EF50	8 -	N37	13 3	UL84	9 -	6K40T	30 -
DAF96	9 6	EF55	7 6	N78	11 6	UL8	23 6	6K8GT	12 6
DF020	10 6	EF56	14 6	N142	9 6	UY41	3 0	6L1	15 0
DF33	9 0	EF59	10 -	N153	11 3	UY85	9 -	6L6	7 6
DF91	8 6	EF91	8 6	N154	11 3	VP26	19 -	6L8	12 6
DF96	8 6	EF92	0 -	N257	8 6	W17	5 0	6L19	21 -
DLH79	9 6	EF95	14 -	PC84	9 -	W77	5 0	6N7G	0 T
DK91	9 -	EL38	23 6	PC880	12 6	W81M	5 0	6N7GT	7 0
DK92	10 6	EL41	10 -	PC89	11 6	W142	9 0	6N7GT	5 0
DK96	9 6	EL42	10 -	PC82	12 6	W719	8 0	6X1	7 0
DL33	9 0	EL51	17 6	PC84	12 6	W727	8 0	6X5GT	6 6
DL35	15 -	EL54	9 -	PEN44	11 6	X18	11 6	6X7	12 6
DL32	8 -	EL59	8 6	PEN4VA	11 6	X78	13 -	6Y4	7 6
DL44	8 -	EM50	10 -	PL26	15 -	Z21	10 6	80B	8 6
DL96	8 6	EM81	11 6	PL28	23 6	Z77	10 6	10C1	15 -
EABCO	9 6	EM85	15 -	PL2	10 -	Z152	8 6	10C2	18 6
EAF42	10 -	EY81	10 -	PL8	11 6	Z19	8 6	10P1	22 6
EB41	10 6	EY84	13 -	PL8	11 6	Z19	8 6	10P1	22 6
EB91	5 9	EY91	9 -	PY80	8 3	PC2	11 9	10L11	14 9
EB41	8 4	EZ35	8 6	PY81	8 6	1F3	8 6	10P13	22 0
EBF80	9 6	EZ40	8 -	PY82	8 6	1F5	0 -	12AH8	10 -
EBF89	9 6	EZ41	10 6	PY83	8 6	1T4	8 -	12AT6	8 9
EBL21	21 -	EZ49	8 -	PZ30	18 6	51346	8 6	12AT7	8 9
EBL31	21 -	EZ81	8 -	R10	22 -	5Y3GT	9 6	12AX7	8 -
EC91	8 9	EZ90	7 6	R19	19 -	Z446	10 -	12AX7	0 -
EC92	8 6	EZ92	14 6	SP41	3 6	6A8GT	10 -	12BA6	8 9
EC94	17 6	F04	23 6	SP61	3 6	6AL5	5 8	12BF6	9 3
EC981	8 6	F013	14 6	TD04	18 6	6AM6	0 -	12BH7	10 -
EC982	9/-	F013	19 6	TP22	12 6	6AX5	5 -	12J7G	10 -
EC983	9 -	GZ52	11 6	U78	8 -	6AQ5	7 0	1K7	7 0
EC984	10 -	H30	4 9	U142	8 6	6AT6	5 3	1K7	10 -
EC985	10 6	H63	10 -	U147	9 9	6BA6	8 6	12K8GT	10 6
EC980	12 6	HB90	8 -	U153	8 6	6BE6	8 3	12K8GT	10 6
EC982	12 6	HL22	11 6	U463	9 5	6B46	7 4	19Q7	13 3
EC921	21 -	HL33D	11 6	U501	27 6	6B47	12 6	19Q7	8 6
EC935	12 6	HY90	7 6	UCAB80	10 -	6BW6	8 6	12Q7GT	8 4
EC942	9 6	HY90	7 6	UCAP12	10 -	6BW7	8 6	19P1	23 0
EC981	9 6	K233C	12 6	UCAP12	10 -	6B8	6 6	20L1	23 0
EC180	12 6	K256	16 6	UCB41	8 6	6C196G	27 -	6W4	7 6
EC182	13 6	L2319	12 6	UCB80	9 6	6D2	5 9	35Z4GT	8 6
EP9	21 -	MK145	10 -	UCF42	10 -	6E	11 9	36L6GT	10 6
EP37A	10 3	(or 7)	21 -	UCH110	6	6F12	8 6		

Quotations given for any types not listed. Obsolete and old types a speciality. Send for lists.

**REVACUUMED T.V. TUBES**

SIX MONTHS' STRAIGHT GUARANTEE

Mullard		£ s. d.		Mazda		£ s. d.			
14 MW	36-22	5	10	0	14 CRM	141	5	10	0
14 MW	36-24	5	10	0	14 CRM	142	5	10	0
14 MW	36-44	5	10	0	14 CRM	143	5	10	0
14 AW	36-21	5	10	0	15 CRM	153	6	10	0
16 MW	41-1	7	0	0	17 CRM	171	7	10	0
17 MW	43-43	7	10	0	17 CRM	172	7	10	0
17 MW	43-64	7	10	0	21 CRM	211	10	10	0
17 MW	43-69	7	10	0	21 CRM	212	10	10	0
21 MW	53-20	10	10	0					
21 MW	53-80	10	10	0					

Brimar		£ s. d.		
14	CI4BM	5	10	0
17	CI4FM	5	10	0
14	CI7BM	7	10	0
17	CI7FM	7	10	0
17	CI7JM	7	10	0

Cossor		£ s. d.		
14	141K	5	10	0
17	171K	7	10	0
17	172K	7	10	0

14 in. Marconi, Emitron, Ferranti, G.E.C. £5 10 0.  
17 in. Marconi, Emitron, Ferranti, G.E.C. £7 10 0.

Carriage and Insurance 12/6 (U.K.). Cash with order. Personal Callers Welcome.

**VIDIO REPLACEMENT CO.**

HALES ST., DEPTFORD HIGH ST., LONDON, S.E.8

Telephone: TIDEWAY 4506

cabinet, leaving C.R.T. in cabinet (some models). The precise directions depend, of course, upon whether the table or console models are being handled. When dealing with console models always lay the cabinet face down before attempting to remove the C.R.T.

### Common Faults

No picture, no raster upon advancing brilliance, sound O.K. Remove left side (main deck) screening cover. Note PL81, PY81 and EY51 EHT rectifier. Is line timebase whistle audible? If so, carry out the usual spark tests on EY51 and note whether the heater of this valve is glowing or if the valve is blue inside. If in doubt replace the EY51, soldering with nice round blobs of solder. If still defective, remove C.R.T. anode cap and test for spark again. If C.R.T. promotes fault condition, consult previous issues for information; do not replace the tube unless the tube neck itself is glowing purple or blue—showing impaired vacuum. Assuming, however, that no spark is available at the single wire end of the EY51, have PL81 and PY81 valves tested and check H.T. line voltage. If there is no line whistle at all, and the H.T. line voltage is approximately correct, check EF80 line oscillator and associated components, on left side. The EF80 on the right side is the sync separator.

### MAIN DECK VALVES

V1—PL83 (sound output).  
 V2—ECL80 (frame generator output).  
 V3—EF80 (sync separator).  
 V4—EF80 (line generator).  
 V5—PL81 (line output).  
 V6—EY51 (EHT rectifier).  
 V7—PY81 (efficiency diode).  
 V8—PY82 (H.T. rectifier).  
 V9—PY82 (H.T. rectifier).  
 CRT 17in.—MW43-64.  
 CRT 14in.—MW36-24.

Check 270 K $\Omega$  load resistor of the line oscillator (H.T. to pin 7) and the horizontal form control for leakage or shorts. The main 60  $\times$  250  $\mu$ F main smoothing electrolytic capacitor should not escape attention as the 60  $\mu$ F section may become open-circuited resulting in a serious loss of H.T. voltage.

In the main, however, it may be said that the

### LIST OF CONDENSERS AND RESISTORS

R1—270 K $\Omega$   
 R4—220 K $\Omega$   
 R5—680 K $\Omega$   
 R6—1 M $\Omega$   
 R7—220 K $\Omega$   
 R8—220 K $\Omega$   
 R9—1 M $\Omega$   
 R10—1 K $\Omega$   
 R11—820  $\Omega$   
 R12—10 K $\Omega$   
 R13—1.5 M $\Omega$   
 R14—39 K $\Omega$   
 R15—27 K $\Omega$   
 R16—1.8 M $\Omega$   
 R17—37 K $\Omega$   
 R18—270 K $\Omega$   
 R19—2.7 K $\Omega$   
 R20—47 K $\Omega$

R21—470 K $\Omega$   
 R22—2.2 K $\Omega$   
 R23—  
 R24—1 K $\Omega$   
 R25—47  $\Omega$   
 R26—100 K $\Omega$   
 R27—2.2 M $\Omega$   
 R28—27 K $\Omega$   
 R29—400  $\Omega$   
 R30—3 K $\Omega$   
 R31—39  $\Omega$   
 R32—30  $\Omega$   
 R33—105  $\Omega$   
 R34—3.3 K $\Omega$   
 R35—3.3 K $\Omega$   
 R37—100 K $\Omega$   
 R38—4.7 K $\Omega$

line oscillator stage is fairly trouble-free, as is the H.T. supply. In the majority of cases, the faults will occur in the line output stage and

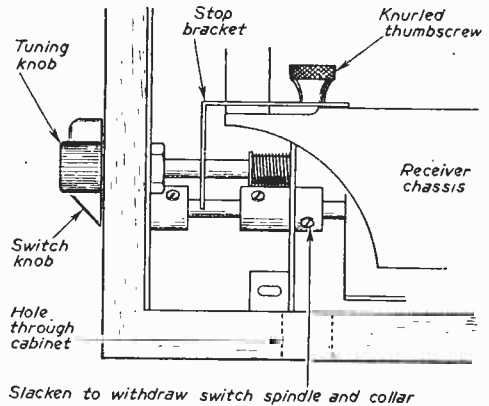

Fig. 3.—Cut-away view of receiver unit showing tuner and switch knobs, etc.

involve the EY51 or PL81 valves or the tube itself. After a few years' use, however, a very simple fault occurs in these receivers which has nothing to do with the line output stage or the

### VARIABLE RESISTORS

VR1—1 M $\Omega$  volume control (D.P. switch).  
 VR2—1 M $\Omega$  vertical hold.  
 VR3—2 M $\Omega$  vertical form.  
 VR4—2 M $\Omega$  height control.  
 VR5—20 K $\Omega$  vertical form.  
 VR6—50 K $\Omega$  horizontal hold.  
 VR7—50 K $\Omega$  brightness control.  
 VR8—30 K $\Omega$  anti-ring control.  
 VR9—100 K $\Omega$  interlace control.  
 VR10—1 M $\Omega$  contrast control.

circuit. The effect of heat over a period of time cracks the fibre strap if the ion trap magnet, thus breaking the clamp. The magnet, which is then loose, moves, causing the picture to fail altogether or go very dim, according to the amount of movement. Although this may appear a very obvious fault, it can escape attention. As

a temporary expedient, the fibre strap may be removed and the "rings" bent inward to form a clamp to retain the magnet in its proper position. A replacement trap is the I.T.9 for the 14in. and 17in. tubes or I.T.6 for the 12in. of the TV24C.

#### Variation of Picture Size

If the whole picture expands and dims as the brilliance is increased, or on light scenes, change the EY51. If the width decreases as the brilliance is increased, check PL81, PY81 and setting of horizontal form control, finally checking PY82 valves and EF80 line oscillator and its 270 K $\Omega$  load resistor. It will be noted that the height increases with the reduction of width.

If the picture is extended at the top and compressed at the bottom, check right side ECL80 (centre valve) and setting of vertical form controls (2) with height adjustment. If the controls are

#### MAIN DECK VALVE VOLTAGES

	Pin	V	Pin	V	Pin	V
V2	1	140	—	—	—	—
	6	350	8	180	3	10
V3	7	156	8	200	1/3	—
	7	160	8	200	1/3	—
V5	—	—	8	148	3	10
	9	198	—	—	—	—
V8/V9	9	205A/C	—	—	3	200

fully set or only cause further distortion and the ECL80 is in order, check the 8  $\mu$ F screen decoupling electrolytic connected to pin 7 of the ECL80, actually mounted under the chassis on the front slope. It is a separate small metal can type.

Lack of height with little distortion should direct attention to the 220 K $\Omega$  load resistor of the ECL80 triode section which may increase in

value to a marked extent. This is wired from the H.T. line to the ECL80 pin 1 via the primary winding of the frame blocking oscillator transformer.

#### Poor Sensitivity

Check tuner unit valves PCC84 and PCF80 (V1 and V2) and valves V3-V7, all in receiver unit.

#### Poor Brilliance

Check setting of ion trap magnet. If properly set, check effect of brilliance control and contrast. If picture is flat and tends to turn negative, check vision interference limiter (may have been altered instead of sensitivity control) and then

#### INTERMEDIATE FREQUENCIES

Vision 34.5 Mc/s	Sound 38 Mc/s
FUSES	
One 750 mA.	One 500 mA.

suspect failing tube emission. If tube emission is indeed failing a temporary boost to the heater may be applied and a 5 K $\Omega$  5 watt resistor may be wired from the mains side of one of the fuses to pin 1 of the tube base socket, keeping the resistor clear and ventilated. This increases the heater current through the tube only and whilst the heater/cathode insulation of the tube remains sound, saves the expense of a booster transformer.

The PL83 valve on the main deck, situated on the rear right side, is the sound output. Its grid is fed direct from the volume control. An unusual feature of the receiver unit is that two stages of sound and vision I.F. amplification are followed by one stage of vision I.F. and two stages of sound.

## G.P.O. Orders U.H.F. Link

THE G.P.O. has placed an order with Marconi's Wireless Telegraph Company Ltd. for the supply and installation of a single-way U.H.F. radio link between London and a point near Norwich. The link provides two broadband channels primarily intended for the conveyance of television signals, but, if the necessary return channels were provided, they could be used for telephony, each being capable of providing up to 600 high-grade telephone channels simultaneously.

The contract is particularly interesting on three counts: Not only will the equipment handle black-and-white television signals, it has also been designed with a view to transmitting 405- or 625-line colour television signals, should this be required. It is the first order for all-travelling-wave-tube equipment ever to be placed for use in this country, and will be engineered to C.C.I.R. and C.C.I.T.T. standards for the provision of the 600 telephone-channel facility.

The route will run from the Museum Exchange in London, via repeater stations at Ongar, Sibleys and Ousden, to the terminal station between Norwich and Ipswich. Marconi HM 200 equipment will be used at the terminals, with HM 250 repeaters at the intermediate stations.

It is hoped to bring the link into operation in the spring of next year.



The output stage of a Marconi HM 200 U.H.F. F.M. Radio Terminal.

**W**HEN the writer first sat down with log tables and book of valve data to design this apparatus, it was with some sense of misgiving. On the one hand there was the major expense involved in purchasing a reliable generator, and on the other the complexity of the problem for home construction. Nevertheless, the need was urgent for an instrument able to produce a workable imitation of the BBC television waveform.

It was realised from the start that it might not work properly. The British TV waveform is almost incredibly complex when analysed in detail, and the means to produce it synthetically in an accurate fashion must likewise be complex. Complexity in apparatus involves certain undesirable matters such as cost, reliability, difficulty of setting-up, portability, and so on. Besides these, the probability of unwanted stray couplings between the various sections increases geometrically as the number of circuits increases, and the cut-and-try development involved in experimenting with layouts might well be prohibitive in time and money. So to aim at simplicity seemed sensible for all possible reasons.

In this case, simplicity in circuitry is necessarily tied up with simplification of the result to be achieved. And the first thing to do was to take a critical look at the British TV waveform and to try to estimate what is essential and what is luxury.

First, as to interlacing. It would be wise to have it, certainly; but to introduce it would have meant at least four extra stages, and for this reason it was reluctantly decided to make do without. After all, few receivers get a good interlace, and on a good many de-focusing or "whites" is so bad that it is hardly useful when it is attained.

Next, both vertical and horizontal modulation was considered. Horizontal detail is a function of the goodness of receiver design adjustment, and therefore horizontal detail had to be included in the form of vertical bars. These must be adjustable at will from "coarse definition" to "very fine detail," and therefore means has been provided to have between ten and 300 vertical bars; this corresponds to 100 kc/s and 3 Mc/s definition, and any number of bars can be tuned in at will.

Vertical definition is, however, a function of sharpness of focus and steadiness of trace, and this can readily be investigated by other means than a pattern generator. Horizontal bars would

# A TV Pattern Generator

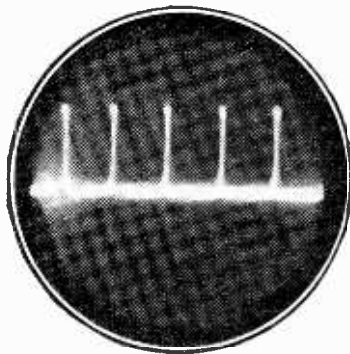

This Useful Test Set Duplicates the BBC Waveform for Test Purposes  
By D. R. Bowman

involve at least two more stages—so again they were not included in this design.

Both horizontal and vertical modulation bars can be used to test linearity. The vertical bars are the only good test for horizontal linearity, but again the horizontal bars are not strictly needed because each line of the picture is a horizontal bar and vertical linearity can be investigated by inspection.

For the rest of the design it may be said briefly that the sync pulses are a good imitation of the British standard; the line fly-back pulses are identical, the frame pulses closely similar. No front or back "porch" has been provided—again for simplicity in circuitry—but their loss has not been felt acutely.

To sum up then, it may be said that with the instrument now to be described a steady raster can be obtained consisting of 200 lines repeating at 50 frames per second, with six to ten lines suppressed during frame fly-back. Thus a receiver will respond to it just as to the BBC or ITV waveforms, without line or frame speed modification. In addition, the raster can be modulated at will with any number between ten and 300 vertical bars, which enables both linearity and resolution to be investigated. Also, the R.F. oscillator incorporated can tune over the whole of the I.F. range of receivers; and on harmonics the entire BBC television band. It may be said at once that this generator is for the experienced constructor only, because its simplicity is only relative!

## The Circuit

The generator consists essentially of the following circuits:

- (a) A multivibrator running at approximately 10,000 pulses per second, as pulse train generator.
- (b) A multivibrator "counting down" to 700 pulses per second.
- (c) A multivibrator running at 50 pulses per second for frame pulse gating.
- (d) A gating stage, combining the outputs of multivibrators (a) and (c) above.
- (e) A keying stage, to be explained later.
- (f) A R.F. oscillator, generating sine waves at frequencies between 100 kc/s and 3 Mc/s.
- (g) A long-tailed pair combining R.F. and sync pulses.
- (h) A R.F. oscillator, modulated by the output of stage (g), generating R.F. at the output frequency suitable for application to the aerial or I.F. amplifier of a TV receiver.

In addition, phase inverting circuits, differentiating and pulse shaping circuits are included as necessary.

**Description**

Stage (a) is an asymmetric multivibrator generating positive pulses at its second anode, at a rate of nominally 10,000 per second, each pulse being about 8  $\mu$ s in width. This output is fed into a

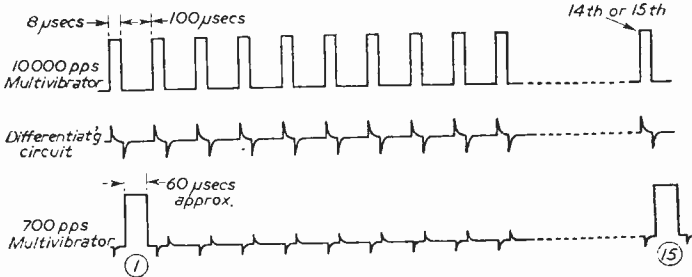

Fig. 1.—“Counting down” with multivibrators.

cathode-follower type phase-splitter giving both positive and negative pulse outputs.

Stage (a) is arranged also to trigger a second multivibrator running at a nominal speed of 700 pulses per second. The correct sync pulse is obtained by passing the positive-going pulses through a differentiating stage, which produces positive and negative “pips”: the negative-going pip is used for triggering, and thus there is a delay of about 8  $\mu$ s in the triggering. Fig. 1 shows the waveform involved, together with the pulse train eventually developed at the second anode of the second multivibrator.

There are some points worth noting about these multivibrators, and they are conveniently discussed at this stage. The particular type of multivibrator used is the direct-coupled cathode-coupled circuit, shown in Fig. 2.

This circuit has been described previously in PRACTICAL WIRELESS (December, 1955), but it was there intended essentially as a saw-tooth generator. It was chosen for this

application for the following reasons:

- (a) It has fast rise and fall times, giving a good rectangular output at V2 anode.
- (b) Its output is positive-going at V2 anode.
- (c) It is exceptionally stable, when used in this circuit.

It seemed originally that a symmetrical multivibrator whose mark-to-space ratio was variable, would prove most suitable, especially as for reasons given later both positive-going and negative-going pulses are required. These circuits were found, however, to be susceptible to a particular fault, which caused the counting down to vary in ratio, apparently at random. The master oscillator stage (a), running at nominally 10,000 pulses per second; this synchronises a 700 pps multivibrator which in turn triggers a 50 pps multivibrator. The

three are locked together. If the count-down ratio alters, either between stage (a) and stage (b) or between (b) and (c), the number of frames per second varies and therefore,

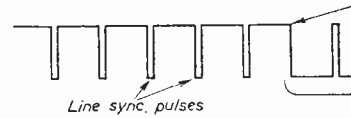
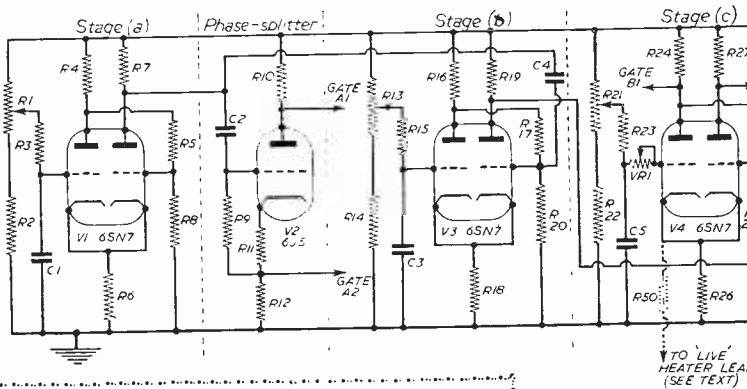
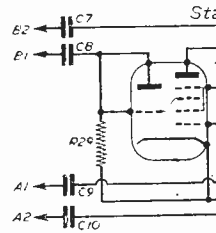

Fig. 4.—Combining phase-splitter of synchron



**LIST OF C. AND R. VALUES**

C1—500 pF	C16—.1 $\mu$ F	R6—5.6 K	R22—200 K	R37—68 K
C2—.02 $\mu$ F	C17—8 pF	R7—5 K	R23—2.2 M	R38—2.2 M
C3—.01 $\mu$ F	C18—250 pF	R8—10 K	R24—33 K	R39—1.5 K
C4—50pF	C19—500 pF	R9—2.2 M	R25—27 K	R40—2.2 K
C5—.1 $\mu$ F	C20—25 pF	R10—10 K	R26—5.6 K	R41—10 K
C6—500 pF	C21—.1 $\mu$ F	R11—1 K	R27—1.5 K	R42—1.5 K
G7—.1 $\mu$ F	C22—15 pF	R12—10 K	R28—10 K	R43—2.2 M
C8—.1 $\mu$ F	C23—.01 $\mu$ F	R13—1 M var.	R29—2.2 M	R44—2.2 M
C9—.002 $\mu$ F	C24—50 pF var.	R14—100 K	R30—2.2 M	R45—see text
C10—.002 $\mu$ F	C25—50 pF var.	R15—4.7 M	R31—1.8 K	R46—470 K
C11—8 pF elec.	R1—200 K var.	R16—40 K	R32—15 K	R47—2 K
C12—50 pF elec.	R2—200 K	R17—27 K	R33—330 $\Omega$	R48—27 K
C13—.1 $\mu$ F	R3—2.2 M	R18—5.6 K	R34—2.2 M	R49—5 K
C14—16 pF elec.	R4—40 K	R19—1 K	R35—2.2 M	R50—see text
C15—500 pF var. (low min. capacity)	R5—25 K	R20—10 K	R36—680 K	VR1—50 K
		R21—200 K var.		VR2—10 K



on the TV raster, the number of lines displayed. This gives rise to "jittering" which was found to be quite unacceptable.

Fig. 1 shows how the synchronising is arranged in this apparatus. It will be noted that the trailing edge of each pulse produces, on differentiations, a negative-going sharp pip which affords a very accurate sync pulse suitable for synchronising the lower-speed multivibrator. Each pip is preceded by a positive-going pip; this serves the purpose of "holding-off" the second multivibrator if it was about to trigger before time, and very consistent synchronisation is obtained. In 4½ hours operation, no change in division ratio has been observed except that manifestly due to ignition or mains interference.

The same device is used between the 700 pps and the 50 pps multivibrators. The latter needs a variable mark-to-space ratio, but this can be arranged without difficulty.

There is, of course, only a limited choice of multivibrator speeds obtainable by the controls provided, but Table 1 (page 532) shows that this need cause no inconvenience. The limit of choice is due to the fact that counting down can occur in the whole-number ratios only.

It will be noted that in every case the "frame" multi-

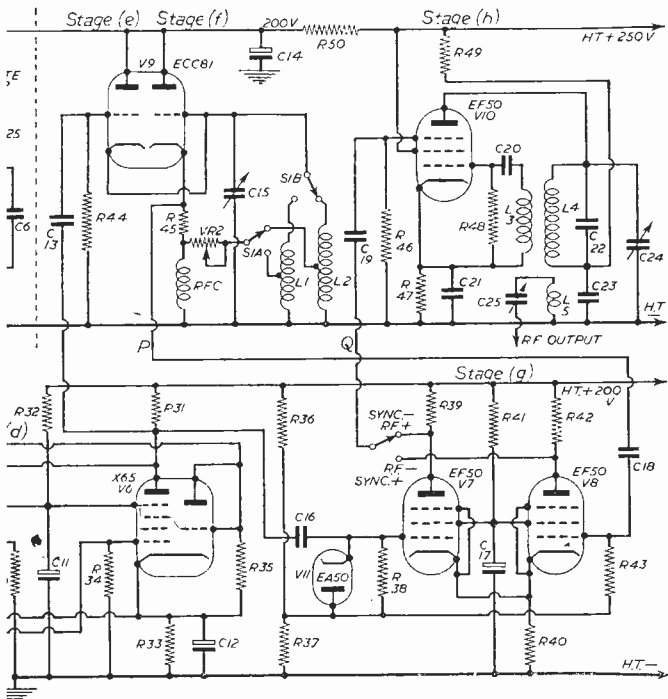
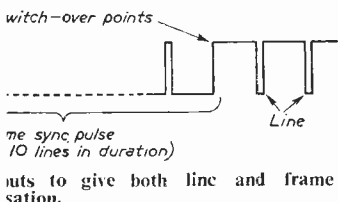

Theoretical circuit of the Pattern Generator.

vibrator runs at 50 pps. This is, of course, in order to coincide with the mains frequency, and it is highly recommended that this feature is adhered to in operation. It may not matter to be a cycle per second out, or there-

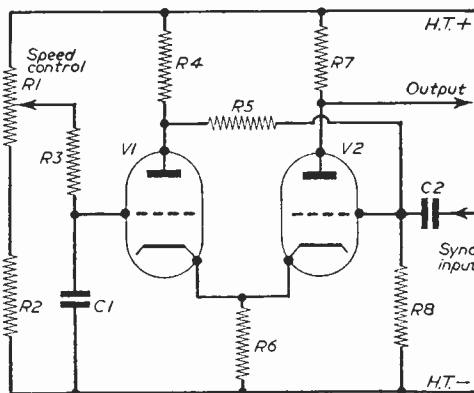

Fig. 2.—Asymmetric cathode-coupled multivibrator—general arrangement.

abouts, but some commercial TV receivers do not "lock" properly at any but the mains frequency. The adjustment to the correct frequency will be dealt with later.

**Phase-splitting Circuit**

Besides synchronising stage (b) the output from stage (a) is fed to the grid of a cathode-follower type phase-splitter. This valve has equal anode and cathode load resistors, and hence nearly equal but relatively "inverted" outputs are obtained. Fig. 3 shows the two pulse trains.

It will be seen that while the output from the anode is the usual line-frequency sync pulse train, that from the cathode is sufficiently nearly the frame-frequency sync pulse train. The way in which the two are combined is explained in the next paragraph: here it may be noted that if the two outputs are switched on and off at the required intervals a train of pulses similar to that of Fig. 4 can be achieved.

**The Gating Stage (Stage d)**

In order to combine the pulse trains, the gating stage of Fig. 5 is employed. Two valves, V1 and V2, have a common anode load R. The line pulse trains from the phase-splitter are passed

**VALVE AND SWITCH DATA**

- V1—6SN7
- V2—6L5
- V3—6SN7
- V4—6SN7
- V5—X65
- V6—X65
- V7—EF50
- V8—EF50
- V9—ECC81
- V10—EF50
- V11—EA50
- S1—2-pole, 2-way
- S2—1-pole, 2-way

to the grids of V1 and V2; and if this were all, the output developed across R would be zero. If to a second grid of V1 and V2 antiphase switching pulses are applied:

(a) When V1 is cut off by a negative switching pulse only V2 is operating and positive-going pulses appear across R.

(b) When V2 is cut off by a negative switching pulse—simultaneously with the positive pulse on V1—only negative-going pulses appear across R.

By properly arranging the switching pulses, the desired sync pulse train, consisting of both line and frame sync pulses, is obtained.

It should be noted that in order to simulate the correct sync pulses for frame fly-back, several "lines" have to be suppressed, and a frame sync pulse, consisting of several broad negative-going pulses, has to be substituted. This entails the correct output from stage (c), the "frame" multi-vibrator. For adjustment, the mark-to-space ratio

inclusion of Rg. When V1 is cut off and C1 is charging through R3, no grid current flows and therefore Rg has no effect. When V1 cuts on

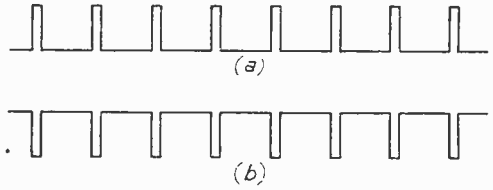
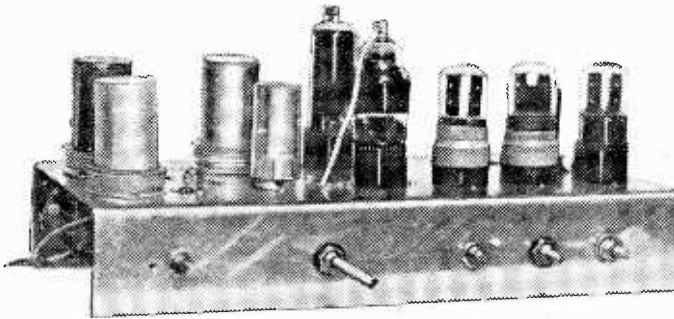

Fig. 3.—Outputs from phase-splitter: (a) cathode; (b) anode.

and C1 is discharging Rg is placed in the discharge path, altering the time-constant and achieving the desired result. It will now be seen that the frame pulse from the stage (c) multi-vibrator can not only be made to give the correct number of the line sync pulses in the output of the gating stage, but also the correct number and duration of frame sync pulses.

For the gating stage itself, simple valves were not found suitable. The best choice among them was the 6F33 pentode, whose suppressor characteristics were tried in use. The ex-Government VR116 also gave passable results. In both cases, however, the internal capacity between anode and suppressor grid rather spoilt the line pulse waveform, and in addition a considerable difference existed between "frame gating" and "line sync" pulse voltages needed. The simplest solution was found in the use of the triode-hexode X65. The oscillator section of this valve was only used indirectly, by virtue of the



The completed unit.

is variable. Reference to Fig. 2 shows that the fly-back time of the multivibrator depends on the D.C. resistance of the grid-cathode path of V1 and R6 in series. To alter the fly-back time this resistance has to be changed. It cannot be done by altering R6 because this materially affects the frequency of operation of the stage. Instead, therefore, a variable resistor is introduced, as shown in Fig. 6. Here part of Fig. 2 is reproduced u c e d, showing the

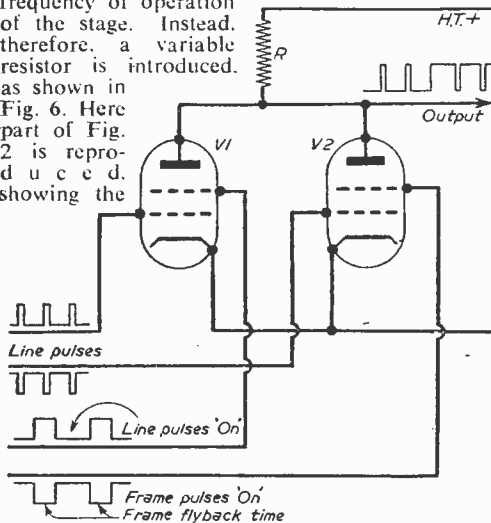

Fig. 5.—Simplified circuit of gating stage.

TABLE ONE

Stage (a) running at—pps.	Count-down ratio	Stage (b) running at—pps.	Count-down ratio	Stage (c) running at—pps.
9,600	12	800	16	50 pps.
9,800	14	700	14	
9,750	13	750	15	
10,200	12	850	17	
10,400	13	800	16	
10,500	14	750	15	
10,500	15	700	14	
11,050	13	850	17	
11,200	14	800	16	
11,200	16	700	14	

direct connection between the oscillator grid and the third grid of the hexode section. To avoid capacitance effects, and the introduction of hum, the oscillator anode and grid are connected together.

**The Vertical Bar Generator**

The vertical bar generator, stage (f), has to generate radio frequencies between 100 kc/s and 3 Mc/s. For this purpose a rather unusual oscillator is employed, shown in detail in Fig. 7.

(To be continued)



# More Interesting Faults

A SERVICE ENGINEER GIVES DETAILS OF SOME FURTHER UNUSUAL FAULTS

**T**HE first case I wish to quote shows the advisability of having a range of known good valves available. In this instance, it was unfortunate that the valve in question was at the moment in short supply. The set in question was a Murphy V310. The symptoms were as follows. On first switching on everything was O.K. but within ten minutes or so, the line would start tearing at the top three inches giving the rather unusual result, that, if one person was on the screen, they would have four heads. In other words the top three inches was at four times the speed of the rest of the screen. The line output valve was naturally suspected, a 30P4, but as previously stated, one was not available at the time. Now some modifications had been promulgated by Murphy's for line tearing. These were duly carried out, but on switching on the same symptoms occurred. Checks were made of voltages and components but nothing appeared untoward. The set was therefore placed on one side until a valve was available. When this arrived it was fitted, and everything was correct. Thus a lot of time was wasted, due to the fact that a selection of tested valves, or I should say, this valve in question, was not handy.

## Fault No. 2

This occurred on a 17in. Pye printed circuit job. The symptoms were: sound O.K. but vision intermittent. The first things to be suspected were, of course, the video amplifier and the video detector. The tube was checked for intermittency and found O.K. The video amplifier valve, a PCF80, was changed and also the video detector, a germanium crystal inside one of the cans. No change. In passing I may mention that this intermittency was irregular and corrected itself before one had a chance to get a meter on to crucial points. It was at last found to be the .25  $\mu$ F screen decoupler on the video amplifier going short circuit. Now on this job, a printed circuit set, this condenser stood upright on the panel. The lower connection was O.K. but the top one was bent over tightly to pass down through the panel to the appropriate connection on the printed circuit. The intermittency occurred through this sharp bend over. A suggestion here arises that on printed circuit jobs, condensers should be designed with both leads at one end.

## Fault No. 3

This fault occurred on a Bush 63 series. The symptoms were line tearing and a large reduction of width. These symptoms were intermittent. The line oscillator, a multivibrator, and the line output valve were first suspected. Changing them, however, made no difference. Components were the next check. The line output transformer was changed over from a similar set. This, by the

way, is the easiest line transformer to change—no soldering is required. The cause was eventually found to be a 100 pF condenser in the multivibrator circuit, between the anode of one section and the grid of another going very low capacity, enough apparently to keep the multivibrator going but causing low drive to output stage.

## Fault No. 4

An Ekco portable receiver developed an interesting fault. There was a large amount of horizontal foldover on the right of the picture. All valves concerned were replaced but with no improvement. Now in this model this trouble is often due to a faulty line output transformer but care should be taken to see that there is no trouble with deflection coils. In this case D.C. resistances in both cases were O.K., but it is perhaps better to point out here that in the case of the line output transformer this does not tell you much. It was decided to change the line output transformer, and it was the answer. The interesting point is that this transformer was tried in an identical set and worked satisfactorily. However, it was sent back to the makers for investigation.

## Fault No. 5

This fault occurred in a Bush receiver. Symptoms were loss of width and height. H.T. was checked and found to be within reasonable limits. An investigation of boost volts was carried out. These were found to be 100 volts low. The booster diode was changed. No alteration. The line oscillator and the line output valve were also changed. Still no change. Then it was noticed that valves were not so bright as usual, although the difference was small. Checking of heater volts gave the answer. In this circuit there is a thermistor with a 400 ohm resistor in parallel. The thermistor although not O/C was faulty, not dropping its resistance as current rose, consequently the heater circuit was starved of current, which accounted for the symptoms.

## Fault No. 6

This fault occurred in an H.M.V. 1842. The owner complained of a strong smell of ozone. Naturally EHT was suspected. The location of it was interesting in the fact that it could not be observed. In this set the EHT rectifier is inserted in a hole at the top of the line output transformer. The valve is an EY86. The anode points downwards and has a polythene sleeve over it to prevent this occurring. This sleeving had split slightly and was the cause of the arcing and the ozone smell.

## Fault No. 7

This was actually not a fault with the set but rather with the installation engineer. The

owner complained of loss of width and height. The set was collected and put on test and found to be O.K. It was finally decided to test at owner's residence. The point is that the set was installed in daytime but the owners only used it in the evening. A check of mains volts in the evening, solved this query. Their mains voltage dropped sufficiently in the evening to cause this effect, because the voltage tapping on the set was incorrectly set. An adjustment to tapping was arranged and proved satisfactory.

#### Fault No. 8

This fault occurred on a G.E.C. 5144. The symptom was a vertical white bar that appeared on the left-hand side of screen. Ordinary valve changing failed to effect a cure. All components appeared to be O.K. This was finally solved by a slight modification which stopped the

overswing in the line timebase. This was as follows. A 47K ohm resistor was connected between pin 5 on C.R.T. and the junction of R52 C43 and the slider of brightness control. Also a 1 meg resistor between same pin on C.R.T. and the centre tap of line timebase transformer. This is tap number 6.

#### Fault No. 9

This was a fault in a G.E.C. 2147. Symptoms: sound O.K., intermittent, and finally, no vision. Here the fault was traced to the video detector, a germanium diode which was replaced. Vision then O.K., but failed again shortly afterwards. It was then found that the video detector had again failed. Investigation showed a faulty video amplifier which was causing detector to fail. Replacement of video detector and video amplifier cured this fault.

## New Marconi TV Camera

MARCONI'S WIRELESS TELEGRAPH COMPANY LTD. announce the production of a new television camera channel for use in closed-circuit applications. The Marconi Type BD871, as it is known, possesses unique features and represents a significant advance upon earlier techniques. It has been designed with particular attention to simplicity of control and reliability and can operate completely unattended.

The new equipment is of two-unit construction, comprising the camera proper and its associated control unit. The camera unit is contained in a small steel cylinder 4in. in diameter and 11in. long, while the control box measures only 14in. X 17in. X 8in.

The "eye" of the camera is an English Electric 1in. Vidicon pick-up tube, which, with the scanning coils and head amplifier, makes up the camera unit. The encasing cylinder acts as a dustproof container and as a shield against stray magnetic fields. The heat generated in the unit is conducted through the casing to be dispersed by radiation.

One unique feature of the equipment is the incorporation of automatic sensitivity control, which compensates for wide variations of lighting levels without recourse to the adjustment of the manual controls—a feature which, in practice, enables the equipment to operate completely unattended.

#### Remote Control

Focusing can be carried out by means of an adjustment at the rear of the camera, or, if desired, by remote control; in the latter event an additional unit, 3in. in length and of the same diameter as the camera, is fitted on to the end of the latter. The camera control unit can be installed at any convenient location up to 1,000ft. away; control adjustments can either be effected at this point or, by making use of a special "detached control" feature in the equipment, at

any chosen spot within 500ft. of the camera control unit. A modification allows this length to be extended if circumstances make it desirable.

The Type BD871 equipment will operate on either British, American or C.C.I.R. standards. The display screens can either be monitors operating with a video frequency or 20 Mc/s input, or standard television receivers.

The new camera was first seen at the Instruments, Electronics and Automation Exhibition at Olympia in three typical applications.

On the stand of Foster Instruments Ltd. it was in use with a periscope for the remote viewing of furnace flame conditions, while Counting Instruments Ltd. showed it to illustrate remote viewing of instrument dials. A third camera was in use on the stand of The English Electric Co. Ltd., viewing a model of a 20in. Merchant Mill.

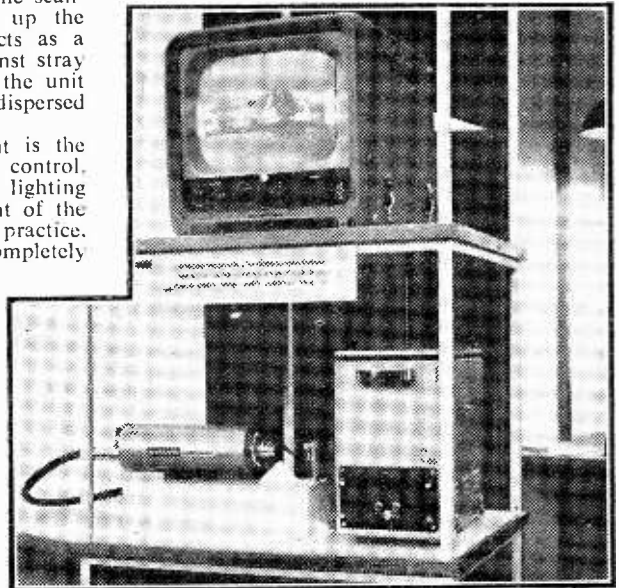

The new Marconi camera at the I.E.A. Exhibition.

AN ESSENTIAL PIECE OF EQUIPMENT FOR

# RADIO & TV ENGINEERS

## Technicians and Keen Amateurs

This new 2nd Edition provides in compact form all the information required by those engaged in design, maintenance, technical sales, operation and servicing of modern radio and TV transmitting and receiving equipment. It supplies the practical data, formulae, calculations and information you need, and which is often not obtainable without recourse to numerous references. For the technician and executive-to-be it is indispensable.

**CRAMMED WITH FACTS, FIGURES AND DATA**

**WRITTEN BY 41 SPECIALISTS**

Formulae & Calculations. Electron Optics & Colour TV. Materials. Studios & Equipment—*planning, lighting, camera tubes, etc.* Broadcasting Transmitters & Power Plant. Communication Transmitters—*design, components, marine, ground-to-air, mobile, international call signs, etc.* Amateur Radio Equipment—*licences, frequencies, H-F transmitter and receiver design, etc.* R.F. Transmission Lines. Waveguides. Broadcasting Receivers—*design, developments, V.H.F., etc.* TV Receiver Design—*frequency conversion, channel selection, V.H.F. Converters, colour TV, etc.* Commercial H.F. Radio Links. Broad-Band Radio Systems. Navigation & Radar. Aero Equipment. Industrial TV. Aerials—*vertical rod-inverted L-loop-aerials, V.H.F.—band III, car aerials, fundamentals, fringe equipment, etc.* Transistors. Crystal Diodes. Resistors. Capacitors. Inductors & Transformers. Microphones. Loudspeakers. Interference—*causes, etc.* Recording. Gramophone Mechanisms. Batteries & Conversion Equipment—*dry, storage, charger, vibrators, etc.* Measuring & Test Equipment. Radio & TV Installation & Servicing—*equipment, alignment, precautions, fault-finding, etc.* Projection TV—*tubes, adjustment, theatre, etc.* Quartz Oscillators & Frequency Allocations. Units & Symbols, etc. etc.

**BROADCASTING • COMMUNICATIONS • NAVIGATION • SERVICING**

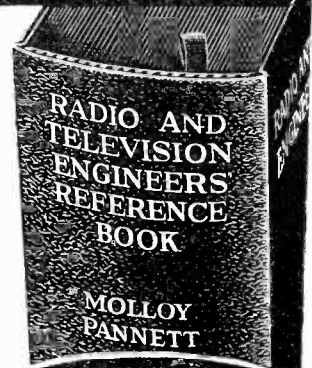

**STUDY IT—TEST IT  
IN YOUR OWN HOME  
WITHOUT COST OR  
OBLIGATION**

- 1,800 pages of technical data to meet your everyday needs.
- 46 main sections, written and compiled by leading authorities.
- 2,000 diagrams, tables, standard formulae, calculations, measurements. 3,260 cross-referenced index entries enabling wanted information to be found in an instant.

PROVE ITS VALUE—

# FREE FOR 7 DAYS

### POST TO - DAY

We cannot list above more than a small fraction of its invaluable contents—seize this opportunity to examine it freely in your own home. A "must" for the radio enthusiast.

To: George Newnes, Ltd., 66-69, Great Queen Street, London, W.C.99.

Please send me Newnes RADIO AND TELEVISION ENGINEERS' REFERENCE BOOK without obligation to purchase. I will either return the work within eight days or I will send the first payment of 7s. 6d. eight days after delivery, and then seven monthly subscriptions of 10s. until the sum of 77.6 has been paid. Cash price within eight days is 72/-.

Name .....

Address .....

Occupation .....

Your Signature .....

(Or your parent's signature if under 21)

**RB3**

Place X where it applies.

HouseOWNER

Householder

Living with Parents

Lodging Address



**FOR VALVES**  
**GUARANTEED ALL TESTED BEFORE DESPATCH**

AIG6PN6/8	DOH21 24/4	EZ80 8/9	PCL82 14/8	U404 11.10	X79 11/8	6AU6 10/8	6J7/6 6/8	6V6M 8/8	12K7GT 8/8	30P5 11/6
AC 7HT1	DOH35 10/6	EZ90 11/10	PCL83 14/6	U801 31.4	Y63 9/8	6B4 5/8	6J7M 9/8	6X4 7/8	12K7GT 8/8	30P11 12/6
AT P4 3/8	DOH42 10/6	EZ90 8/8	PL33 27/10	UABCS0	Z309 9/8	6B4G 4/8	6K6A1 7/8	6X3G 7/8	12K7GT 8/8	30P12 7/8
AZ31 17/5	ECH81 9/8	EL148 3/8	PL81 16/8	Y63 10/6	Z359 9/8	6BA6 7/8	6K7G 5/8	6X5GT 7/8	12K7GT 8/8	30P21 12/6
CB131 24/4	ECH80 13/6	EW4 10/8	PL82 9/6	YAF42 10/6	Z359 9/8	6BE5 8/8	6K7GT 7/8	6X5GT 12/6	12K7GT 8/8	30P21 12/6
CC35 24/4	EP22 8/6	GZ32 12/8	PL83 11/6	YB41 9/6	1A3 9/8	6B6G 24/4	6K7M 6/9	7H7 8/8	12K7GT 8/8	30P21 12/6
CL33 20/2	EP38 6/8	H30 5/8	PK35 12/6	YBC41 10/8	1ASGT 10/8	6B76 10/8	6K8G 8/8	7C5 9/8	12K7GT 8/8	30P21 12/6
CT31 17/5	EP37A 13/8	HL23DD	PK80 9/8	YBF60 9/8	1A7 12/6	6B8E 9/8	6K8GT 10/8	7G6 8/8	12K7GT 8/8	30P21 12/6
DAF96 10/8	EP39 6/8	HL23DD	PK81 10/8	YBC8420 11/2	11/2 11/8	6BR7 11/6	6K82 20/11	7G6 8/8	12K7GT 8/8	30P21 12/6
DF96 10/8	EP40 13/6	HL23DD	PK82 8/6	YCF80 23/8	1C5GT 12/6	6B8W 8/8	6L6G 9/8	7H7 9/8	12K7GT 8/8	30P21 12/6
DH63 9/8	EP41 9/9	KF35 8/6	PK83 10/8	YCH42 10/6	1I6 12/6	6B8W7 10/8	6L7 7/8	7H7 9/8	12K7GT 8/8	30P21 12/6
DK36 10/8	EP42 14/8	KK32 23/8	PK84 11/6	YCH81 11/6	1I6 12/6	6C4 7/8	6L7 7/8	7H7 9/8	12K7GT 8/8	30P21 12/6
DL96 10/8	EP43 14/8	KL32 8/6	PK85 12/6	YCL82 23/8	1H5GT 10/8	6C4GT 8/8	6P23 27/10	7Y4 8/8	12K7GT 8/8	30P21 12/6
DM70 6/8	EP51 6/8	KT24 5/8	PK86 10/8	YCL83 25/9	1I4 6/8	6C6 5/8	6Q7G 9/8	8D2 2/8	12K7GT 8/8	30P21 12/6
EA50 1/6	EP55 10/8	KT33C 8/6	PK87 10/8	YCL83 25/9	1I4 6/8	6C6 5/8	6Q7G 9/8	8D2 2/8	12K7GT 8/8	30P21 12/6
EABCS0	EP80 9/8	KT36 27/10	PK88 10/8	YCF80 23/8	1I4 6/8	6C6 5/8	6Q7G 9/8	8D2 2/8	12K7GT 8/8	30P21 12/6
10/8	EP85 9/8	KT55 13/6	PK89 10/8	YCF80 23/8	1I4 6/8	6C6 5/8	6Q7G 9/8	8D2 2/8	12K7GT 8/8	30P21 12/6
EAC91 7/6	EP86 13/8	KT66 15/8	PK90 10/8	YCF80 23/8	1I4 6/8	6C6 5/8	6Q7G 9/8	8D2 2/8	12K7GT 8/8	30P21 12/6
EAF42 10/6	EP88 10/8	KT66 15/8	PK91 10/8	YCF80 23/8	1I4 6/8	6C6 5/8	6Q7G 9/8	8D2 2/8	12K7GT 8/8	30P21 12/6
EB31 8/8	EK32 8/8	KTW61 8/8	PK92 10/8	YCF80 23/8	1I4 6/8	6C6 5/8	6Q7G 9/8	8D2 2/8	12K7GT 8/8	30P21 12/6
EB41 9/8	EL32 8/6	KTZ1 8/6	PK93 10/8	YCF80 23/8	1I4 6/8	6C6 5/8	6Q7G 9/8	8D2 2/8	12K7GT 8/8	30P21 12/6
EBUC3 7/8	EL33 20/2	MT91 7/6	PK94 10/8	YCF80 23/8	1I4 6/8	6C6 5/8	6Q7G 9/8	8D2 2/8	12K7GT 8/8	30P21 12/6
EBU41 10/8	EL38 27/10	MH4 7/6	PK95 10/8	YCF80 23/8	1I4 6/8	6C6 5/8	6Q7G 9/8	8D2 2/8	12K7GT 8/8	30P21 12/6
EBF50 10/8	EL41 10/8	MH41 7/9	PK96 10/8	YCF80 23/8	1I4 6/8	6C6 5/8	6Q7G 9/8	8D2 2/8	12K7GT 8/8	30P21 12/6
EBF90 12/1	EL42 12/6	MS45 12/6	PK97 10/8	YCF80 23/8	1I4 6/8	6C6 5/8	6Q7G 9/8	8D2 2/8	12K7GT 8/8	30P21 12/6
EBL21 24/4	EL84 10/8	MS4 7/6	PK98 10/8	YCF80 23/8	1I4 6/8	6C6 5/8	6Q7G 9/8	8D2 2/8	12K7GT 8/8	30P21 12/6
EBL31 24/4	EL84 10/8	MSP 17/10	PK99 10/8	YCF80 23/8	1I4 6/8	6C6 5/8	6Q7G 9/8	8D2 2/8	12K7GT 8/8	30P21 12/6
EC91 7/6	EM80 10/6	N78 12/6	PK100 10/8	YCF80 23/8	1I4 6/8	6C6 5/8	6Q7G 9/8	8D2 2/8	12K7GT 8/8	30P21 12/6
EC94 12/6	EM81 11/8	OZ4 5/6	PK101 10/8	YCF80 23/8	1I4 6/8	6C6 5/8	6Q7G 9/8	8D2 2/8	12K7GT 8/8	30P21 12/6
ECX84 10/3	EX31 13/8	PE1 3/6	PK102 10/8	YCF80 23/8	1I4 6/8	6C6 5/8	6Q7G 9/8	8D2 2/8	12K7GT 8/8	30P21 12/6
ECC85 6/8	EX36 17/6	PCF84 10/8	PK103 10/8	YCF80 23/8	1I4 6/8	6C6 5/8	6Q7G 9/8	8D2 2/8	12K7GT 8/8	30P21 12/6
ECCF83 13/6	EZ40 10/8	PCF85 13/6	PK104 10/8	YCF80 23/8	1I4 6/8	6C6 5/8	6Q7G 9/8	8D2 2/8	12K7GT 8/8	30P21 12/6
ECP82 12/6	EZ41 10/8	PCF82 12/6	PK105 10/8	YCF80 23/8	1I4 6/8	6C6 5/8	6Q7G 9/8	8D2 2/8	12K7GT 8/8	30P21 12/6



103 LEEDS TERRACE  
 WINTOON STREET  
**LEEDS 7**

**TERMS:** Cash with order or C.O.D. Postage and Packing charges extra, as follows: Orders value 10/- add 1/-; 20/- add 1/6; 40/- add 2/-; £5 add 3/- unless otherwise stated. Minimum C.O.D. fee and postage 3/-. All single valves posted 6d. Personal shoppers Monday-Friday 9 a.m. to 5 p.m. Saturdays 10 a.m. to 1 p.m.

# EDDY'S (Nottm.) LTD.

(DEPT. P.T.)  
 172, ALFRETON ROAD, NOTTINGHAM

**MIDGET BATTERY ELIMINATORS.** To convert all types Battery Portables (please state make and Model No.) to mains operation. 57/6 each, plus post and packing, etc., 2/6. Smaller than Midget H.T. Battery alone.

**SINGLE PIECE THROAT MIKES, 1/- each.** Post, etc., 6d. each. Could be used for electrifying musical instruments.

**MAP CASES, 2/6 each,** post 6d. extra. Ideal for Service Sheet holders and job cards, etc.

**ACOS CRYSTAL MIKE INSERTS, 4/11 each.** High quality. Can be used for Tape Recorders, Baby Alarms, Musical Instruments, etc. Post and packing 8d. extra.

**B.S.R. 4 SPEED AUTO-CHANGE UNITS.** Turnover Crystal Cartridges 200-250 volts A.C. Special Price £7.19.6. Postage and packing 5/- extra.  
 ALL NEW AND GUARANTEED.

**THIS MONTH'S SPECIAL VALVE OFFERS**

1T4 5/11	6Q7G 8/11	6K8G 7/11	PCC84 9/-
6LG6 5/11	6V6G 5/11	6F1 13/11	6J5G 2/11
6K7G 2/11	954 1/6		EF80 8/6
6B8G 2/11	955 3/11	6SN7GT 5/11	10F1 15/11

**ALL NEW, SURPLUS AND GUARANTEED VALVES**

C. O. D. or C.W.O. only. All valves tested before despatch. For only 6d. extra per order we will insure your valves against damage in transit. All uninsured parcels at customers' risk. S.A.E. with all Enquiries. Postage and packing 6d. per valve extra. Over £3 free.

## REBUILT TUBES

**HIGH QUALITY FULLY GUARANTEED SIX MONTHS**

3/16	£8.10	CRM 121	CRM 171
MW 36-24	£10.10	CRM 123	CRM 172
4/14		MW 31-16	MW 43-64
CRM 141		MW 31-74	MW 43-69
CRM 142		CRM 152	4/15

RECLAIMED 12" - £6; 14" - £5; 17" - £7.10  
 Prices include carriage and insurance.

## Line Output Transformers and Deflector Coils

Most types can be supplied. State set make, model number and part required. S.A.E. please.

## BRAYHEAD TURRET CONVERTERS

Foremost in performance, design and reliability. Six types of converter and eleven types of adapter combine to permit plug-in conversions of over 600 TV Receivers. Instruction booklet supplied.  
**CONVERTERS £6.19.6.** Plug-in Adapter if needed 7/6. Postage and packing 2/6. State set make, model number and channels required.  
 Terms C.W.O. or pro forma

**PRIME ELECTRICS (Dept W/2)**  
 36, QUEENSDALE ROAD, LONDON, W.11.  
 (Near Shepherds Bush Central Line.) Phone - PARK 1131.  
 CALLERS: 10.30-3 MON.-SAT. Closed WED.

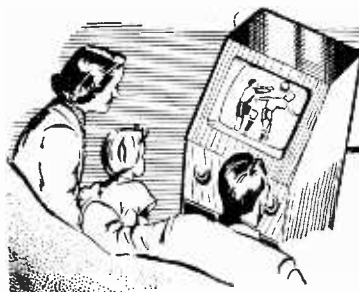

## UNDERNEATH THE DIPOLE

TELEVISION PICK-UPS AND REFLECTIONS

By Iconos

### Press Advertising

**D**ETERMINED to retain the initiative, the I.T.A. programme companies are now regularly using the national press for advertising their programmes. Bold stylised advertisements bid the viewer to watch "*Chelsea at Nine*" and other Granada presentations each week, and in addition hand-bills and throw-aways are distributed by the same organisation. A particularly attractive hand-bill set out the Granada offerings in the form of an old-time theatre playbill, with the characteristic variations of printer's type which were the fashion a hundred years ago. ABC-TV have also produced attractive advertising which catches the eye. The BBC cannot very well counter this by taking advertising space in the newspapers, which is very expensive; but they have developed their own advertising "slots" in programmes, into which they insert short trailer announcements of future programme items, including, on occasion, items of special interest which are to be transmitted later in the same evening. These BBC self-adverts are not at all objectionable to most viewers; they have become thoroughly used to the punctuation of programmes with commercials, and rather like them!

### Zoo Time

**O**NE of the most popular afternoon programmes is the weekly *Zoo Time*, networked every Thursday by Granada. This unit is now in full operation, with a small studio and production offices in the grounds of the London Zoo, close to the cages containing birds of prey. When not shooting in various parts of the grounds, the live television unit works in the little studio, with a stage about 25ft. × 35ft.,

well equipped with lights. Animals of the tamer varieties are brought along here, sometimes in lorries, to be "rehearsed" in their "turns."

On the occasion of a recent visit I made to this compact little television unit, an ape was being tested on his initiative in recovering some grapes, which had been slowly placed in a box which was itself put inside another box, and then yet another box, the lid of which was held in place with rubber bands. Having watched this procedure, the ape was released and immediately opened one box after another until the grapes were found and eaten. This operation was timed by stop watch at one minute ten seconds, and the ape was declared to have passed his audition! On the Thursday, a television truck with microwave radio link would be coming to the Zoo to present this in *Zoo Time*, sending it thus to the Post Office Museum exchange for networking to the I.T.A. transmitters.

### Animal Filming

**N**OT all animals are so accommodating, however, and Granada have now decided to add a small film unit to their Zoo studio, to wait patiently for those moments when animals are in the right frame of mind to do their tricks. Too often have they decided to go to sleep when they were wanted for live television. Douglas Fisher, a cinema cameraman well known for his animal and plant photography, has been engaged. His equipment is largely for 16mm, but includes all the intricate devices for speeding up photographically the growth of flowers and plant life generally. Most of this nature study work will be shot without sound, which will be added afterwards with commentary.

### Radio Links

**T**HE use of microwave links between outside broadcast trucks and a television studio centre is now a regular practice with most of the programme companies. Operating at about 7,000 Mc/s. their range is about 15 miles under average conditions, but with high aerials at both transmitting and receiving ends, the range can be increased to 30 miles or so in one hop. However, it is usually easier and less expensive to extend the range by relaying through an intermediate microwave receiver and transmitter, sited on a high building, water tower or such-like about midway between the outside broadcast and the studio aerial. High aerial towers are quite expensive to erect. Ordinary masts will not do when dished directional aerials have to be carefully adjusted, and it is essential for an engineer to be able to get right up to them easily and quickly. The use of microwave links was pioneered by the BBC, but is now almost an everyday operation by all the television companies, who use beautifully made microwave apparatus of standard design instead of the original hay-wire lash-up sets.

### Television Cameras

**T**HE design of television cameras has probably made more progress during the last six months than in the previous two years. The 3in. Image Orthicon camera, which was originally intended for outside broadcast use, has had a long spell in the studios, its reliability and sensitivity being so great as to offset the somewhat unflattering results it often gave on actresses' faces. This "ageing" effect was due to compression at the white end of the scale, which exaggerated any

wrinkles or other facial blemishes. Much improved results have been obtained with Image Orthicon cameras which have a 4½ in. photo-cathode. The C.P.S. Emitron, too, has been improved considerably. This camera, used for most of the BBC dramatic productions, has given finely graded photographic results but, hitherto, required more light than other types, and the picture had a tendency to "peel off" or burst when overloaded with sudden contrasts. It was desirable, for instance, to have the actors wearing yellowish collars and boiled shirts with evening dress, for instance. These disadvantages have now been overcome with a more sensitive photo-cathode and, at the same time, the overloading troubles have been banished with a clever limiting device. I notice that the BBC have ordered a number of cameras which will operate either with a 4½ in. Image Orthicon or a C.P.S. Emitron tube fitted. The BBC Engineering Department deserve the highest praise for sponsoring such a versatile television camera. After all, who knows which type of camera tube will be the best in a couple of years' time? It might, of course, be neither of these tubes, but be a further development of the Vidicon, the storage type tube used in many telecine machines!

### Magnetic Sound

TELEVISION has made the film camera makers get a move on, too, with new and advanced designs of special interest to television programme companies. There is an ingenious adaptation by the Rank Precision Industries Ltd. of the German 16 m.m. Arriflex camera, fitted with a tiny magnetic recorder. This records sound on a magnetic stripe 100 mils wide on the edge of the picture negative film. The film is processed and the sound is unaffected. After development, the negative can be put straight on to the 16 m.m. telecine machine for transmission or prints can be made. In the latter case, the sound has to be re-recorded on to similar stripes on the corresponding positive prints.

### "2000 Minus 60"

GOODNESS knows just how many journeys into space have taken place in films, horror "comics," radio plays and television during the last two or three years. They must total thousands. The dramatisation of the mechanical age was initiated by Jules Verne in his books of seventy years or so ago, about mechanical clippers of the clouds and fantastic submarines. The theme was further developed by H. G. Wells in several novels, by Karel Capek in his play *R.U.R.* and by Fritz Lang in the great film *Metropolis*.

All of these were classics of their own particular medium of expression, which have now slightly tarnished with age. The formula still works, however, with nuclear energy and electronics replacing the rusty cog-wheels of yesteryear. *2000 Minus 60*, James Workman's television play, makes effective

use of radar screens, asdic sounds and television master control rooms to tell the story of a runaway rocket circling the earth loaded with a nuclear war-head, due to land in forty-five minutes and certain to kill millions of people. It was a thrilling affair for viewers, who were given a marvellous tension-building sequence of filmed rocket shots, radar, and public "panic" scenes before the futuristic-looking A.R.P. staff managed to destroy it high up in the air. The technical dialogue was fast, crisp and plausible and the production values first-class, thanks to Peter Graham Scott, the director. It was a smooth piece of "hokum" that was very nearly spoiled by the ugly martian uniforms and costumes. These were of the conventional *R.U.R.* pattern. A pity that Mr. Scott couldn't think of more appropriate wardrobe. Still, it was a very good show.



The lightweight camera referred to on the left, with a magnetic recorder between camera and tripod head. The mike amplifier, slung from the operator's waist, is transistorised.



Our specialist buying knowledge and reputation ensure a square deal... and enable us to

offer the best for your money!

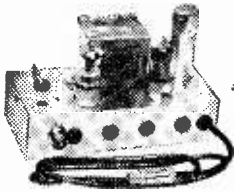

**BAND 3 T/V CONVERTER—180 Mc/s-205 Mc/s**

Suitable for London, Birmingham, Northern, Scottish and Welsh ITA Transmissions.

Mk. 2 Model as illustrated. Latest Cascode circuit using ECC84 and EF80 valves giving improved sensitivity (-18 db) over standard circuits. Built-in Power supply AC 200-250 v. Dimensions only 6 1/2 in. x 3 in. Ht. 4 in. Simple and easy to fit—only external plug in connections, wired, aligned and tested ready for use. State Channel required. Guar. Bargain Offer—good results or full refund.

only £3.19.6. Carr. & Pack, 2.6. Band 1, Band 3 Change-over Switch and B.B.C. Aerial socket, 8/- extra.

**CONVERTER ACCESSORIES**

Band 1-Band 3 Cross-over Unit, 7.6. Var. Attenuators 6db-36db., 7.6. BBC Pattern Filter, 8.6. Band 3 Aerials—outside Single Dipole with 4 yds. coax, etc., 13.9. 3 Element Beam, 27.6. 5 Element, 25.0, etc.

**Volume Controls**

Log. ratios, 10,000 ohms  
—2 Megohms. Low  
spindles. Low  
guarantee. Midget Ebs-  
swan type.  
No Sw. S.P.S.A. D.P.N.W.  
3.- 4.- 4.9  
Linear Ratio, 10,000  
ohms — 2 Megohms.  
Less switch, 3/- each.  
Coax sockets, 1.2. Coax  
cables, 1.-. Complers,  
1.3. Outlet boxes, 4.6.

**80 ohm COAX**

STANDARD 1/4 in. diam.  
Polythene insulated.  
GRADE "A" ONLY.

8d. yd.

SPECIAL — Semi-air  
spaced polythene. 30  
ohm Coax 1/4 in. diam.  
Standard core. Losses  
cut 50%.

9d. yd.

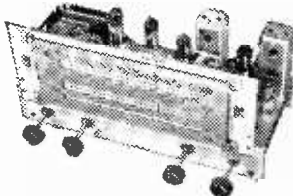

**ALL-WAVE RADIOGRAM CHASSIS**

3 WAVEBANDS 5 VALVES  
S.W. 16 m.—50 m. LATEST MIDGET  
M.W. 200 m.—500 m. B.V.A.  
L.W. 800 m.—2,000 m. SERIES

Brand new and guar. A.C. 200-250 v., 4 pas. W.C. sw. Short-Medium-Long-Gran. P.U. socket. High Q dust core coils. Latest circuit technique, delayed AVC and neg. feedback. O.P. 4 watts. Chassis size 15 1/4 x 5 1/4 x 2 1/2 in. Dial 10 in. 4 1/2 in. Hor. or Vert. station features. Walnut or Ivory knobs to choice. Aligned and calibrated ready for use. Sensitivity and Quality at Low Cost.

Chassis isolated from mains. BARGAIN 01 gns. Carr. & Ins., 4.6. PRICE 02 gns.

8 or 10 in. speakers to match. 20 x 20 25/-  
7 Valve De Luxe, push-pull EL41 version, 7 watt output, with H Duty Output Transformer, £12.10.0. Carr. & Ins., 5.-.

**RECORD PLAYER BARGAINS**

4 sp. BSR (T'9), 92.6. 4 sp. COLLARO JUNIOR, £4.10.0. 4 sp. GARRARD (1 S.P.), £7.15.0. Carr. & Ins. 3.6.  
AUTO CHANGERS—4 sp. BSR (T'AS), £8.10.0. 4 sp. COLLARO, £8.15.0. 1 sp. GARRARD (RT20 4H 2), £10.5.0. Carr. & Ins., 4.6.  
All above units are latest models and are fitted with modern styled 1/2 weight Xtal. P.U. with turn-over head and twin sapphire stylus.

**TV TUBES RECONDITIONED**

All Tested and Guaranteed 6 months.  
GENUINE OFFER—All tubes Reconditioned and Re-examined and virtually as good as new.  
12 in. Mullard, Mazda, etc., £8.10.0.  
14 in. Mullard, Mazda (Rect.), £7.0.0.  
17 in. Mullard, Mazda (Rect.), £8.10.0.  
Carr. & Ins. 12.6.

**COMPREHENSIVE STOCKS—QUICK DELIVERY**

**I.F. TRANSFORMER—465 kc/s.**  
Brand new ex-manufacturer's timing I.F.T. size 2 1/2 in. x 1 in. x 2 in. dust core tuning. 1 1/2 oz wound coils, High Q. Bargain offer, 7.6 pair.

**NEW BOXED**

VALVES	GUARANTEED	ALL
1R5, 1T4 7 6	DE96 9/-	EF11 10.6
1S5, 1S4 7 6	DK96 9/-	EP80 10.6
2S4, 2V18 11	DL96 9/-	EP86 12.6
2Z4	6 6	35L6 10.6
6AT6	8 6	EAB90 9.6
6K7	6 6	EB91 6.6
6K8	8 6	EB41 10.6
6Q7	8 6	EC93 9.6
6N27	9 6	EC84 12.6
6V6	7 6	ECF80 12.6
6X4	7 6	ECF82 12.6
6X5	7 6	ECF42 10.6
7C5	9 6	EH81 10.6
7Y4	8 6	EL80 10.6
DAF96	7 6	EL22 12.6
		EL28 8.6
		EL29 8.6
		EL30 8.6
		EL31 8.6
		EL32 8.6
		EL33 8.6
		EL34 8.6
		EL35 8.6
		EL36 8.6
		EL37 8.6
		EL38 8.6
		EL39 8.6
		EL40 8.6
		EL41 8.6
		EL42 8.6
		EL43 8.6
		EL44 8.6
		EL45 8.6
		EL46 8.6
		EL47 8.6
		EL48 8.6
		EL49 8.6
		EL50 8.6
		EL51 8.6
		EL52 8.6
		EL53 8.6
		EL54 8.6
		EL55 8.6
		EL56 8.6
		EL57 8.6
		EL58 8.6
		EL59 8.6
		EL60 8.6
		EL61 8.6
		EL62 8.6
		EL63 8.6
		EL64 8.6
		EL65 8.6
		EL66 8.6
		EL67 8.6
		EL68 8.6
		EL69 8.6
		EL70 8.6
		EL71 8.6
		EL72 8.6
		EL73 8.6
		EL74 8.6
		EL75 8.6
		EL76 8.6
		EL77 8.6
		EL78 8.6
		EL79 8.6
		EL80 8.6
		EL81 8.6
		EL82 8.6
		EL83 8.6
		EL84 8.6
		EL85 8.6
		EL86 8.6
		EL87 8.6
		EL88 8.6
		EL89 8.6
		EL90 8.6
		EL91 8.6
		EL92 8.6
		EL93 8.6
		EL94 8.6
		EL95 8.6
		EL96 8.6
		EL97 8.6
		EL98 8.6
		EL99 8.6
		EL00 8.6

**SPECIAL PRICE PER SET**

1R5, 1T4, 1S5, 1S4 or 2S4, or 2V1 27.6  
DK96, DF96, DAF96, DL96 ... 35  
6N8, 6K7, 6Q7, 6V6, 2Z4 or 6X5 ... 35



**RECORD PLAYER CABINETS**

Contemporary style, rexine covered cabinet in fitted red with cream interior. Size 18 1/2 x 12 1/2 x 11 1/2 in., fitted with all accessories, including speaker, baffle board and plastic feet. Space available for all modern amplifiers and autochangers, etc. Unique record player mounting board 14 x 15 in.

Cabinet Price, £3. 3. 0. Carr. and Ins., 3.6.

**2-VALVE AMPLIFIER MK. I.**

200-250 v. A.C. Modern circuit with High Gain EL84 output and double wound Mains Transformer, variable tone and volume controls, wired and tested, with fin. speaker and O.P. Trans. complete with knobs and drilled ready to fit Baffle Board in above cabinet. Only £3.12.6. Carr. & Pack, 2.6.

**2-VALVE AMPLIFIER MK. 2.**

200-250 v. A.C. Specification as above but a higher fidelity and greater output (approx. 3 watts) is obtained by using latest Twin Stage Triode-pentode Valve BC122 and negative feedback Tone Control. Complete wired and tested as above £3.19.6. Carr. & Pack, 2.6.

**SPEAKER FRET.**—Expanded Bronze anodised metal 8 x 8 in., 2.3; 12 x 8 in., 3.-; 12 x 12 in., 4.6; 12 x 16 in., 6.-; 24 x 12 in., 9.-, etc.

**TYGAN FRET** (Murphy pattern) 12 in. x 12 in., 2.-; 12 x 18 in., 3.-; 12 x 24 in., 4.-, etc.



**F.M. TUNER UNIT (87 Mc/s—105 Mc/s)**

As described in Radio Constructor. Decoded Approved Kit of parts to build this modern hi-fi successful unit, drilled chassis and superior 150 Ohm glass dial, coils, etc. and all quality components, etc., for only 5 Gns., post free. Set of 1 specified min. valves, 30/-, post free. Illustrated handbook, with full details, 2/- post free. 2-day align out service now available, 7.6/ by P. P.

**ELECTROLYTICS ALL TYPES NEW STOCK.**

Tubular Wire Ends 32 x 52 x 50 v. B.T.C. 5.6  
25 25 v. 50 12 v. 9  
Can Types, Clips 50. ca. 2.6  
50 50 v. 4 500 v. 2 - 8 450 v. 2.6  
100 25 v. 2 450 v. 2 - 8 450 v. 4.6  
8 450 v. B.T.C. 2.3  
8 500 v. Dub. 2.9  
8 500 v. Dub. 4.6  
8 16 450 v. T.C.C. 5 - 32 32 275 v. Hums 5.8  
16 450 v. B.E.C. 3.6  
16 500 v. Dub. 4 - 250 350 v. B.E.C. 8.6  
16 16 450 v. T.C.C. 5.6  
22 350 v. Dub. 4 - 60 1 100 350v. B.E.C. 11.6  
32 500 v. Dub. 5 - 100 250 275v. B.E.C. 12.6  
50 50 350 v. B.E.C. 6.6  
Many other types in stock.

**TRANSFORMER & COIL WINDING CAPACITY AVAILABLE FOR PROTOTYPES & SMALL RUNS.**

Listed above are only a few items from our very large stock. Send 3d. stamp today for Complete Bargain List.

Terms: C.W.O. or C.O.D. Kindly make cheques, P.O.s, etc., payable to T.R.S. Post, Packing up to 1lb. 7d., 1lb. 1, 3lb. 1, 5lb. 2, 10lb. 2.  
Hours: 9 a.m.-6 p.m. 1 p.m. Wed. Open all day Saturday.



**RADIO COMPONENT SPECIALISTS** (Est. 1946)

70 BRIGSTOCK ROAD, THORNTON HEATH, SURREY (THO 2188)

50 yards Thornton Heath Station.

Buses: 130A, 133, 159, 166 and 190



# RADIO SUPPLY CO. (LEEDS) LTD., Dept. N, MAUDE ST., (opposite parish church school), LEEDS 2.

Post Terms C.W.O. or C.O.D. NO C.O.D. under £1. Postage 1/6 extra under £2. 2/9 under £5. Open to callers 9 a.m. to 5.30 p.m., Sat. until 1 p.m. S.A.E. with enquiries, please. Full list 6d.; Trade list 5d.

## R.S.C. TRANSFORMERS

Fully Guaranteed

Interleaved and Impregnated.

**Primaries 200-230-250 v. 50 c/s - screened TOP SHROUDED DROP THROUGH**  
 230-0-230 v 70 ma. 6.3 v 2a, 5 v 2a ... 16/9  
 350-0-350 v 80 ma. 6.3 v 2a, 5 v 2a ... 18/9  
 250-0-250 v 100 ma. 6.3 v 4a, 5 v 3a ... 23/9  
 350-0-350 v 100 ma. 6.3 v 4a, 5 v 3a ... 23/9  
 350-0-350 v 150 ma. 6.3 v 4a, 5 v 3a ... 29/9  
**FULLY SHROUDED UPRIGHT**  
 250-0-250 v 60 ma. 6.3 v 2 a, 5 v 2 a  
 Midget type 21-3-3in. ... 17/9  
 250-0-250 v 100 ma. 6.3 v 4a, 5 v 3a ... 28/9  
 250-0-250 v 100 ma. 6.3 v 6 a, 5 v 3 a  
 for RL35 Conversion ... 31/-  
 300-0-300 v 100 ma. 6.3 v 4a, 5 v 3a ... 23/9  
 350-0-350 v 100 ma. 6.3 v 4a, 5 v 3a ... 29/9  
 350-0-350 v 150 ma. 6.3 v 4a, 5 v 3a ... 33/9  
 425-0-425 v 200 ma. 6.3 v 4a, C.T. 6.3 v  
 4a, C.T. 5 v 3a ... 43/9

**FILAMENT TRANSFORMERS**  
 All with 230-250 v 50 c/s Primaries: 6.3 v  
 1.5 a, 5/2; 6.3 v 2 a, 7/6; 0.4-3/3 v 2 a, 7/9;  
 12 v 1a, 7/11; 6.3 v 3a, 8/11; 6.3 v 5a, 17/9.

**CHARGER TRANSFORMERS**  
 200-250 v 0-9-15 v 1: a, 11/9; 0-9-15 v 3a, 16/9;  
 0-9-15 v 5 a, 19/9; 0-9-15 v 6 a, 22/9.

**OUTPUT TRANSFORMERS**  
 Standard Pentode 5,000 to 3 ohms ... 4/9  
 Small Pentode 5,000 to 3 ohms ... 3/9

**SMOOTHING CHOKES**  
 250 ma 5 h 50 ohms ... 11/9  
 100 ma 10 h 250 ohms ... 8/9  
 60 ma 10 h 400 ohms ... 5/6

**SELENIUM METAL RECTIFIERS**  
 25 v 250 ma, 11/9; 12 v 40 ma, 3/9;  
 6/12 v 1 a F.W., 4/11; 240 v 40 ma, 4/11;  
 5/12 v 2 a F.W., 8/9; 6/12 v 4 a, 14/9; 250 v  
 80 ma, 7/9; 6/12 v 15 a, 35/9; 21 v 2 a, 14/9.

**CO.-ANAL. CABLE 1in.**  
 75 ohms 14/36 ... 8d. yd.  
 Twin-screened Feeder ... 11d. yd.

**BATTERY SET CONVERTER KIT**  
 All parts for converting any normal type  
 of Battery Receiver to A.C. mains 200-250 v  
 50 c/s. Supplies 120 v, 90 v or 60 v at 40 ma.  
 Fully smoothed and fully smoothed L.T.  
 of 2v at 0.4 a p.o.l.a. Price including circuit  
 49/9. Or ready for use, 9/9 extra.

**ALL DRY RECEIVER BATTERY  
 ELIMINATOR KIT**—All parts for the  
 construction of a unit (metal-case  
 5 1/4-4 1/2 in.) to supply Battery Portable  
 receivers requiring 90 v and 1.5 v. Fully  
 smoothed. From 200-250 v 50 c/s mains.  
 Price, inc. point-to-point wiring dia-  
 grams, 39/9. Or ready for use, 46/9.

**EX-GOVT. DOUBLE WOUND STEP  
 UP/STEP DOWN TRANSFORMERS**  
 10-0-100-200-220-240 v to 5-0-75-115-135 v  
 or REVERSE. 80-100 watts. Only 11/9,  
 plus 2/9 post. 10-0-100-200-220-240 v to  
 9-0-110-122-136-148 v or Reverse. 200  
 watts, 35/9, plus 7/6 carr. Both 50 c.p.s.

**EX-GOVT. CASES.** Well ventilated black  
 crackle finished, undrilled cover. Size 14  
 x 10 x 8 in. high. IDEAL FOR BATTERY  
 CHARGER OR INSTRUMENT CASE.  
 OR COVER COULD BE USED FOR  
 AMPLIFIER. Only 9/9, plus 2/9 postage.  
 Size 13 1/2 x 8 1/2 x 6 1/2 in. with undrilled perforated  
 cover finished stoved grey enamel,  
 7/9, plus 2/9 post.

**EX-GOVT. VALVES (NEW)**

1R5	7/9	6J6	4/9	6AT6	7/9
1T4	7/9	6KT6	3/9	EB91	6/9
1S5	7/9	6XSGT	7/9	ECC91	4/6
3S4	8/9	6SN7GT	8/9	EF50	8/9
5Y3G	7/9	6L6G	11/9	EF50	4/9
6J5G	4/9	8A7	7/9	EL32	3/9
6K8G	9/9	12A6	7/9	EL81	10/6
6STJGT	6/9	15D2	4/9	EL91	5/9
6V6G	7/9	35Z4	9/9	KT66	11/9
6U3G	3/9	MH4	4/9	SP61	2/9

**EX-GOVT. MAINS TRANSF.**  
 Removed from New ex-Govt. units.  
 Primary 200-150-250 v. Secs 275-0-275  
 v 100 ma. 6.3 v 7a, 5 v 3a ... 21/9

**EX-GOVT. SMOOTHING CHOKES**—  
 80 ma 10 h 150 ohms ... 3/11  
 100 ma 5 h 100 ohms Tropicalised ... 3/11  
 100 ma 8-10 h 100 ohms Parmeko ... 6/-  
 120 ma 12 h 100 ohms ... 9/9  
 150 ma 6-10 h 150 ohms Trop. ... 6/9  
 150 ma 10 h 150 ohms ... 11/9  
 250 ma 5 h 50 ohms ... 12/9  
 100 ma 20 h 200 ohms ... 19/9

**BATTERY CHARGER KITS.**—Consist-  
 ing of attractive Blue Hammer Case,  
 Transformer, F.W. Rectifier, Fuse, Fuse-  
 holder, Tag Strip Grommets and Circuit.  
 For mains input 200-230-250 v 50 c/s,  
 25/9; 6 v or 12 v 2 a, 31/6; 6 v or 12 v 4 a,  
 53/9. Any type assembled and tested for  
 6/9 extra.

**R.S.C. 6 v. or 12 v. 4 a.  
 BATTERY CHARGER**  
 For normal A.C. mains  
 input 200-230-250 v 50 c/s  
 Selector panel for 6 v or  
 12 v charging. Variable  
 charge rate of up to 4  
 AMPS. Fuse, and with  
 meter. Well ventilated  
 case with attractive  
 hammer finish. Guaranteed  
 for 12 months.  
 75/- Carr. 3/6.



**BATTERY CHARGERS.**—For mains  
 200-250 v 50 c/s. Output for charging 6 v or  
 12 v at 1 amp. In strong metal case. Only  
 27/9. Above can also be used for electric  
 train power supply.

**D.C. SUPPLY KIT.**—Suitable for Elec-  
 tric Trains. Consists of mains transformer  
 200-250 v 50 c.p.s. A.C. 12 v 1 a Selenium  
 F.W. Bridge Rectifier, 2 Fuses, 2  
 Fuses, Change Direction Switch, Variable  
 Speed Regulator. Partially  
 drilled Steel Case, and Circuit. 29/9

## LINE OUTPUT TRANSFORMERS

Most types available. State Make and Model  
 Number of Receiver when ordering.  
 S.A.E. please with all enquiries.

### HOWORTH

51 POLLARD LANE, BRADFORD, 2, YORKS

Tel. 37030

... a reliable guide to the  
 principles, practice and terminology!

## TELEVISION AND RADAR ENCYCLOPEDIA

A comprehensive book, covering British and American terms used in connection with Television and Radar, with sections contributed by leading experts in the television world. Contains full explanations in simple language of all the technical terms used in these rapidly developing branches of radio engineering. Illustrated. 2nd Edition.

30s. net  
 from all booksellers  
 ... in case of difficulty 3/5s. 3d.  
 from GEORGE NEWNES LTD.,  
 Tower House, Southampton  
 Street, London, W.C.2.

## St. Mary's Electronics

(Tel. : AMBassador 9795)

18, PRAED STREET, LONDON, W.2

## T/V TUBES

	12 in.	14 in.	17 in.
MULLARD ...	£5	£6	£7
MAZDA ...	£5	£6	£7
EMITRON ...	£5	£6	£7

ALL OTHER TYPES EX-STOCK.

TERMS : 3 MONTHS' GUARANTEE. P.P. INS. 10/- C.W.O.

## REBUILT TUBES

	12 in.	14 in.	17 in.
MAZDA ...	£9	£11	£12.10.0
MULLARD ...	£9	£11	£12.10.0

ALL PRICES INC. P.P. & INS.

ALL REBUILT TUBES ARE GUARANTEED  
**SIX MONTHS**

PLEASE SEND S.A.E. FOR ANY ENQUIRIES

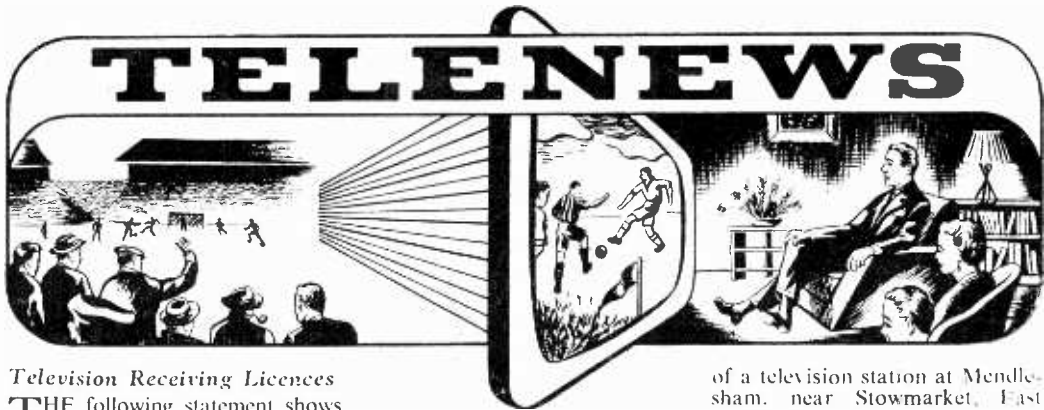

**Television Receiving Licences**

THE following statement shows the approximate number of Television Receiving Licences in force at the end of March, 1958, in respect of receiving stations situated within the various Postal Regions of England, Wales, Scotland and Northern Ireland.

Region	Total
London Postal ... ..	1,587,843
Home Counties ... ..	993,185
Midland ... ..	1,299,737
North Eastern ... ..	1,300,222
North Western ... ..	1,132,815
South Western ... ..	625,079
Wales and Border Counties ... ..	465,405
Total England and Wales ... ..	7,404,286
Scotland ... ..	600,227
Northern Ireland ... ..	85,490
Grand Total ... ..	8,090,003

**Programme Controller for T.T.Tv.**

**TYNE TEES TELEVISION** Ltd., programme contractors for the North-East England Independent Television Station, announce the appointment of Mr. Bill Lyon-Shaw, at present Executive Producer for Associated Television Ltd., as their Programme Controller. He will start his new job on June 1.

**British TV Equipment for Yugoslavia**

THE Yugoslavian Broadcasting Authorities have ordered from Britain a considerable quantity of equipment for the establishment of a television link between Belgrade and Ljubljana, an overall distance of 569 kilometres.

Marconi's Wireless Telegraph Company Ltd., are to supply this link, together with an ATE-Marconi engineering order wire system. The approximate value of the contract is £51,000.

The television link has two features of particular technical

interest. Working on UHF (in the 1700-2300 Mc/s range) it employs an all-travelling-wave tube technique both in the terminal and repeater stations; the wide band provided by travelling-wave tube amplifiers enables a high-definition television signal to be accommodated, together with its associated sound channel. In this instance the sound channel is conveyed on a pilot carrier inserted above the vision base-band. Marconi's are the first manufacturers in this country to be in full production with all-travelling-wave tube equipment.

**East Anglian I.T.A. Station**

THE Independent Television Authority has now received formal approval for the erection

of a television station at Mendlesham, near Stowmarket, East Suffolk. This station will serve over one and three-quarter million people and the service area will include practically the whole of Norfolk and Suffolk and will have Peterborough on its western boundary. To ensure that the power transmitted in the direction of the Continent is kept to a minimum a directional transmitting aerial will be used and this will beam the maximum power of the order of 200 kilowatts in a north-westerly direction, bringing Cambridge and King's Lynn into the reception area.

The Authority plans to open this station in the autumn of 1959 and advertisements have appeared inviting applications from those wishing to provide the programmes to be transmitted from it.

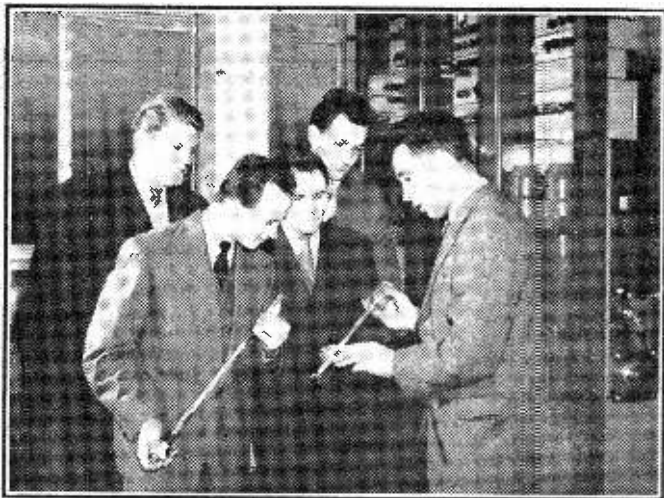

Yugoslavian engineers examining travelling-wave tubes ready for the new TV link between Belgrade and Ljubljana.

### Outside Broadcasts

ALAN CHIVERS and Michael Peacock have been appointed Assistant Heads of Outside Broadcasts in BBC Television. This follows a departmental reorganisation.

Alan Chivers, who played a leading part in the production of last summer's important programmes about the Fighting Services, will act as Deputy to the Head of Outside Broadcasts, Peter Dimmock, and be respon-

works and stations are expected to celebrate her feast, which falls on August 12.

### Eric Winstone

ERIC WINSTONE—a man with many strings to his bow—has been appointed Music Director of Southern Television, Ltd., the independent television contractors who start transmissions in southern England on August 30th.

As a composer, broadcaster, TV star (in *Holiday Night*, *Off the Record* and *International Fare*) and also as recipient in 1955 of an Ivor Novello Award for contributions to British music, no one is better suited for the job. He will bring to southern viewers the best and most popular in British music today.

He has recorded and broadcast with every type of musical combination from a quartet, accordion band, dance orchestra to a string orchestra and concert orchestra.

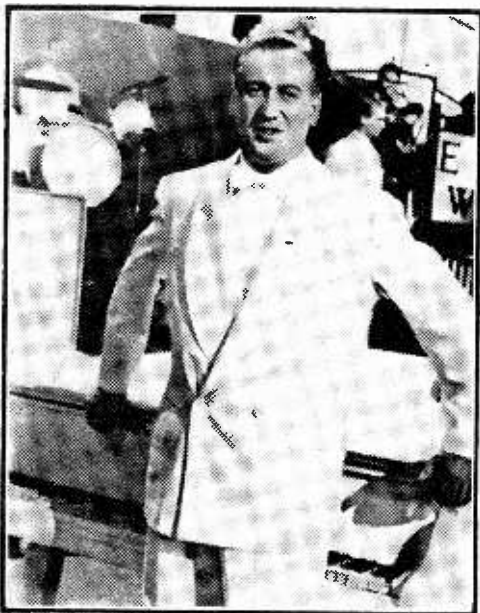

Eric Winstone—new Musical Director to Southern Television.

sible for the overall planning of programmes in the field of actuality. He took up his new duties on March 10.

Michael Peacock will be concerned with planning the documentary or "built" type of outside broadcasts. Since the autumn of 1955 he has been producer of "Panorama," one of BBC Television's most popular programmes. The date of his transfer from the Talks Department will be announced later.

### TV Saint

ST. CLARE OF ASSISI. This Saint has been proclaimed the patron saint of television throughout the world by Pope Pius XII. Roman Catholic TV performers and many TV net-

### Mr. Eric Maschwitz

MR. ERIC MASCHWITZ has accepted the invitation of the BBC to take over the post of Head of Light Entertainment (Television) recently made vacant by the appointment of Mr. Ronald Waldman as Business Manager (Television Programmes).

Mr. Maschwitz, who was with the BBC from 1926 to 1937 as Editor, "Radio Times," and the Corporation's first Variety Director, resigned in order to seek experience in other forms of entertainment: he has since worked in Hollywood and New York, and in the London theatre, where his name has been associated with many successful musical plays and revues.

During the war he served as a Lieut.-Colonel in the Intelligence Corps and was, in 1945, responsible for setting up the British Forces Network in Germany.

### 24 Countries Have Commercial Television

SPEAKING about commercial TV throughout the world, Dan Ingram, director, Young and Rubicam Ltd., and chairman of Commercial Television Circle, screened commercials and programme excerpts from 13 countries.

Of 48 countries with television systems, he said, 24 operated commercial or semi-commercial services, the remainder being government-controlled. There were over 1,000 stations and more than 63,000,000 sets currently in operation.

The 24 countries with commercial were: Argentina, Australia, Brazil, Canada, Cuba, Dominican Republic, Finland (experimental), W. Germany, Guatemala, Hongkong (closed circuit), Italy, Japan, Korea, Luxembourg, Mexico, Monaco, Philippines, Portugal, Puerto Rico, Thailand, United Kingdom, Uruguay, U.S.A. and Venezuela.

### TV's Prompter-camera

A HIDDEN television camera with a built-in "telly-cue" has been designed by Pye to help artistes and well-known celebrities who feel uneasy before the camera to relax.

"By hiding the actual camera apparatus behind a screen of one-way glass, but leaving the 'telly-cue' clear so that the artiste is assured of his lines, we have found that most people are instantly more confident and give a much better performance," said a spokesman for the manufacturers.

The first of these cameras is to be exhibited at the European Television Exhibition at Park Lane House, London (May 19th to 24th).

The prompter, designed by Autocue, is the type that the Duke of Edinburgh always uses when he is making a film or TV broadcast. It is also used frequently by many professional actors and TV performers.

# PREMIER RADIO CO.

(Regd.) B. H. MORRIS & CO. (RADIO) LTD.

207, EDGWARE ROAD, LONDON, W.2.

23, TOTTENHAM COURT ROAD, LONDON, W.1.

Telephone: AMBassador 4033. PADdington 3271 2.

Telephone: MUSeum 3451.

## Build the NEW "MAYFAIR" TELEVISOR which gives complete SAFETY to the constructor!

These Televisors use a double wound mains transformer which gives you complete safety from contact with the mains supply when handling the chassis or controls.

### ★ B.B.C. & I.T.A. DESIGN With New

Turret Tuner may be built for **£33.7.11** Plus cost of C.R.T.  
Build in 5 easy stages. Full Construction details available. Instruction Book, 3/6 Post Free.  
Console Cabinets with full length doors for 14in., 16in., and 17in. tubes. Price £14.14.0.  
H.P. Terms: Deposit £7.7.6 and 9 monthly payments of 18/6.  
Console Cabinets. Half door £12.12.0.  
H.P. Terms: Deposit £6.6.0 and 8 monthly payments of 18/3.  
On above cabinets add 21/- for pkg. and carr.

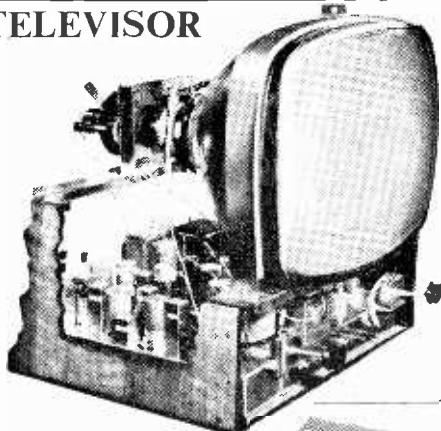

## The "Petite" PORTABLE

MAY BE BUILT FOR

**£7.7.0**

plus 3/- post & packing

★ Size only 8in. x 8in. x 4 1/2in.

Batteries extra.

HT 10/- (Type B126) or equivalent.

LT 1/6 (Type AD35) or equivalent.

Battery eliminator now available for 37/6.



## PREMIER BATTERY ELIMINATOR

Housed in two containers which are exactly the same size as AD35 & B126 Batteries.

KIT **37/6** Plus 2/- post & packing.



## 8-WATT AMPLIFIER

This design includes 5 miniature Valves of the latest types, an Ultralinear Output Transformer suitable for Speakers of 3 and 15 ohms and a very attractive Perspex front panel with gold lettering, complete set of parts, £8.8.0.

Built and Tested **£10.19.6**. Postage & Packing, 5/- extra.

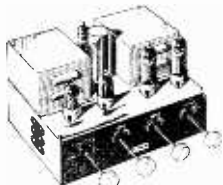

## RECORD PLAYERS

Collaro 3/544—£6.19.6. Collaro Junior—£4.14.6.

B.S.R. TU8

3-speed record player **£3.19.6**, plus 2/6 postage and packing.

**WHY** buy surplus or reconditioned tubes when these Fully Guaranteed Wide Angle Tubes are available? The latest type 17in. Rectangular Tube MW43/64 by Telefunken at £17 (inc. tax), post and packing 21/- extra.

**SAVE POUNDS  
and put it  
together  
yourself!!**

TOTAL COST ONLY

**£9.19.6**

plus 5/- post & pack.

Each Unit may be purchased separately as follows —

Amplifier Cabinet in maroon or fawn (size 13 1/2 x 11 x 6 1/2in.).....	£2/10/-
1 Valve Amplifier.....	£2/19/6
7 x 4in. Elliptical Speaker.....	£1/11/6
B.S.R. TU8 Turntable and Pickup.....	£3/19/6

This can also be supplied complete with the Latest Collaro 4-speed Junior Turntable and Pickup for only £10/12/6 plus 5/- packing and postage.

If any of the individual items are purchased, kindly add the postage as follows: Cabinet 3/-, Amplifier and Speaker 3/-, Turntable 2/6.



**SAVE POUNDS  
and put it together  
yourself!!**

Cabinet, £2/19/6 plus 5/- pkg. & post.

Premier 1-valve Gram. Amplifier, £2/19/6.

plus 2/6 pkg. & post.

Premier 2-valve Printed Circuit

Amplifier, £3/5/6

plus 2/6 pkg. & post.

8in. x 5in. Speaker, 27/6

plus 1/6 pkg. & post.

Collaro 4-speed Changer, £8/19/6 plus 5/- pkg. & post.

BSR 4-speed Changer, £8/15/0 plus 5/- pkg. & post.

If a set of parts are purchased together, pkg. & post will be 10/-.

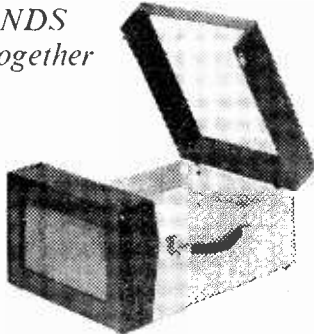

**PLEASE ADDRESS ALL MAIL ORDER ENQUIRIES TO (Dept. PT3), 207 EDGWARE RD., LONDON, W.2**

## HIGH GAIN BAND 3 T.V. CONVERTERS

NO ALTERATIONS REQUIRED TO YOUR SET

RETURN OF POST SERVICE. All new goods. Terms available.

Posted orders to Camberley, please. All 3/- each extra post (4/- for 2), 2/- extra C.O.D.

Following apply to all converters; full instructions supplied. Can be fitted in 10 mins.; free from drift; fitted with co-axial plug; fully wired ready for use; with power pack including metal rectifier; double wound transformer; 2 valves; mains on-off switch; fine tuner; B.B.C. to I.T.A. at turn of switch; 12 months' guarantee (B.V.A. valves 90 days); Terms available one-third down and balance plus 7/6 in four equal monthly payments; postage with first payment. FOR ALL SETS EXCEPT PHILIPS WITH TWIN FEEDER.



### £4.7.6

ECC81 valves.  
With metal cabinet as illustrated. Stove enamel grey hammer finish. 5 in. x 7 in. x 4 in.

### 13 CHANNEL CONVERTER

Switch positions. off-I.T.A.-B.B.C. Valves PCF80 and PCC84. Moulded cabinet 8 1/2 in. x 4 1/2 in. x 6 in.

Don't confuse with similar article being offered without power pack.



### £5.5.0

State local B.B.C. station. Walnut wood cabinet. £4 17 6. Chassis less cabinet. £3 17 6. Variable attenuator. 7 6 (1/- p. & p.). Aerial splitter. 8 - (1/- p. & p.).

External crossover unit. 7 6 (post 1/6). Genuine low-loss co-axial. 8d. yd. Aerialite Filter Box (Diplexer) 14 - post free. Postal charges in brackets.

**LOFT MOUNTING BAND 3 AERIALS.**  
Inverted "T" 16 - (1/6).  
5-element with floor Stand 26 - (2 -).

Screens for T.V. PERSPEX, tinted, 14 in. x 11 in., 5' - (2 -); White 14 1/2 in. x 11 in., 5' - (2 -); LAMINATED GLASS, tinted, 14 1/2 in. x 11 in., 5' - (3/-).

Battery eliminator for 4 low consumption valves 90v. 15 ma. and 1.4v. 250 ma.. 35 - (2 6). 200-250v. A.C. (Size 5 1/2 in. x 3 1/2 in. x 2 in.).

Robust Band 3 AERIALS for 1in. to 2in. diam. mast or for loft. 3-element, 27' -; 5-element, 35' -; 9-element, 55' -; carr. pd.

### BRAYHEAD TURRET TUNER £7.7.0.

Fitted in 15 mins. For all sets. State B.B.C. and I.T.A. and make and model number of set. Full instruction book supplied. Post Free.

### SPECIAL OFFER OF CYLDON TURRET TUNER.

16 Mc vision and 19.5 Mc sound. 16 v. heater supply required or .3 amp. heater chain. Valves PCF80 and PCC84. Brand New. Only 700 available at 77/6 (post 2 6).

Power Pack on Chassis, 22/6 extra (post 1/6).

## GLADSTONE RADIO

82B, High Street, Camberley, Surrey. 3, Church Road, Redfield, Bristol. Tel. 51207.

## ACE RADIO SERVICE

Spare Dept.:

Office:

109, BENSHAM LANE 62, HIGH ST., CROYDON

All valves tested and guaranteed before despatch.

DK91	7/6	ECC80	15/-	EY86	17/-	UCC84	15/-	6F15	12/-
DAF91	7/6	ECC84	15/-	GZ32	10/-	PY80	11/6	6K7	7/-
DF91	7/6	EF36	7/6	KT66	10/-	PY82	11/-	6K8	8/-
IS4	7/6	EF39	7/6	MJ14	7/6	PL81	13/6	6V6	7/6
DL92	8/6	EF80	12/-	OZ4	9/-	PL82	12/6	6D3	5/6
DL93	8/6	EF80	12/-	OZ4	9/-	PL83	13/6	10F1	8/-
DK96	10/-	EF92	7/6	PCF80	10/-	U25	13/6	10C2	8/-
DF96	10/-	EL32	7/6	ECC80	10/-	U08	15/-	10P14	10/6
DAF96	10/-	EM80	12/-	ECC84	10/-	UY41	10/6	10P13	15/-
DL96	10/-	EY51	8/-	ECL80	8/-	6L18	12/-	20F2	15/-
ECL82	11/-			All Valves	6d. Post.			20P1	15/-

All other types. Mullard, Mazda, etc., also obsolete, please inquire.

### TV TUBES

Re-vacuumed and gtd. 3 months. All types 12in. to 17in., £5, plus 15/- carr. and ins.  
Line Output Transformers supplied for any set; new and gtd. for 3 mths. Quote Model No. when inquiring.  
Projection Line Output Transformers used, but O.K., 30/-, plus 5/- carr.  
Coaxial Cable, 80ohm, 1in. diam. Super Air Spaced (white), 1/- yd.  
Tygan Plastic Fret, 14in. wide, 2/- per foot.

### NEW ELECTROLYTICS

Special offer of 250 x 60 x 10 x 350 v. working, 6/6, all other types in stock.  
Radio Scales. A.M. F.M. Gram. 6in.-14in., 3/6.  
Push Button Tuner Units, piano key type, suitable A.M. F.M. Receivers, 10/-.  
Transistors, red spot, 5/-; white spot, 10/-.  
Ferrite Rod Aerials. M. and L. wave, 7/6.  
A large selection of continental style plastic knobs from 1/6 each large type, 9d. small type.  
All types of 9in.-12in. Chassis, part stripped, hoards of components (pots, condensers, etc.), 10/- each, plus 5/- carr.  
Speakers, 6in., 10/-; 8in., 12/6; others available, all 2-4 ohms. Post 2/6.  
Latest AVO 19 Range Multiminor, £9.10.0d., plus 3/6 post & ins.  
All orders over £1 post free (except where stated). Otherwise add 1/-.

## SOMETHING NEW!!

A PRE-AMP FOR BOTH I.T.V. AND B.B.C.

Following the success achieved by our Band III Pre-amp, we introduce a combined unit designed to overcome the difficulties experienced in situations where reception of both I.T.V. and B.B.C. is extremely poor.

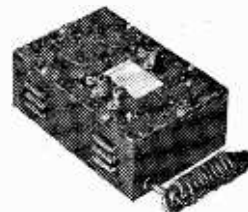

Units now available :-  
"DUAL BAND"

★ Co-ax Inputs for Bands I and III.

★ I.T.V.—amplified.

★ B.B.C.—amplified.

★ Single Output to Receiver.

Price £9.10.0 C.W.O. or C.O.D.

"SINGLE BAND"

★ Co-ax Inputs for Bands I and III.

★ I.T.V.—amplified.

★ B.B.C.—Diplexed.

★ Single Output to Receiver. Price £6-6-8. C.W.O. or C.O.D. Please state channels required.

Both Units have a high signal to noise ratio, and will produce excellent results in localities where the signal is normally unusable.

Units have Built-in Power Packs 200-50 v. A.C. Dimensions: 6 x 4 x 2 1/2 in. (Fly Lead, 3/6 extra).

## "AIRVISION"

(Electronic Equipment Manufacturers)

14 BOULTON RD., SOUTHSEA, HANTS.

# CORRESPONDENCE

The Editor does not necessarily agree with the opinions expressed by his correspondents. All letters must be accompanied by the name and address of the sender (not necessarily for publication).

## AERIAL DESIGN

**S**IR.—Further to reader Bretherton's letter in the March issue, I am in agreement with him re the customer wanting to buy a complicated aerial and relying on the dealer for good advice. It's all very well for us as technicians to talk about polar diagrams, front to back ratios, forward lobes, etc., but we have to show the results to a non-technical person in most cases. These results are judged on a set visually by the customer. We have to show the difference in an XYZ aerial at £16, better than an MNO aerial at £6. The main factor is the received signal; if it is poor, it's immaterial of the type of aerial you intend to use, and we have to show this signal on the set. Possibly the set is in poor shape; the viewer may have moved from a good area to a poor area. The usual story, "it was perfect at our last home." If the signal is poor, you cannot make it good by aeriels or preamps. Re the statement "we have 4-cylinder cars more powerful today than 6-cylinder cars." this is all very well, but what a much smoother ride and glide-away in a 6-cylinder car—a joy to ride in. Also, "the H aerial being higher gain, etc., than a multi element of another manufacturer." Prove it to the customer! Surely the manufacturers of aeriels test them, and surely they all have the necessary "know how," or have they? They use all various sizes for the elements, various spacings, ideas of insulating the dipoles; they have even used silly thumb screws that tear the fingers to pieces during assembly, or break at the touch of pliers. All claiming theirs to be the cats whiskers. Remember, the results to be shown to the buyer or the customer are the final decisions. For him or her to spend money on an aerial is hard, and we have to show the advantages over Mrs. Smith's next door, allowing for different sets.—J. BROWN (Cornwall).

## FERGUSON 306T

**S**IR.—With reference to the correspondence in the March and December copies of PRACTICAL TELEVISION concerning modifications to the 1956 model Ferguson 306T.

It is my experience as a field service engineer, that the modifications quoted by Mr. A. V. Adams are not a sure fire cure for failure of the EY86 valve.

It may not be common knowledge that, since about October 1957, there has been in production by Mullard a valve type TY86F.

This valve was designed as a replacement for the EY86 in the above model, but only for serial Nos. 1,001—above 93,000. In the model 308T serial Nos. 1,001 to 36,000.

The TY86F is not suitable for any other serial or in any other make—in fact, if used in such may last only about five minutes or so.

Trusting that these few observations will be of some help to the owners of this most popular and otherwise reliable model.—L. J. SUCKLING (Harlow).

## AN EHT MULTIPLIER

**S**IR.—I think your contributor, H. Peters, is a bit mixed up. The article described in the March issue, is simply and purely a "bleeder chain" and the illustration shows the meter measuring current at the "earthy end."—WILLIAM REID (Baughurst).

*(The author writes: I will admit that in this modern age the title "Meter Range Extender" would have been a less ambiguous way to head my article. I was unfortunately schooled in the old-fashioned belief that anything added to a meter*

*was either a shunt or multiplier, and have adhered to this belief encouraged by the fact that Avo Ltd., who market a similar article to the one I described, also call it an "EHT Multiplier"—H. P.)*

## PRINTED CIRCUITS

**S**IR.—I feel that your correspondent "Windy" (April issue) was being unduly alarmed at the increasing popularity of printed circuits.

With two years fault finding experience on printed circuits, I can assure him that his fears are unfounded.

Are the components in the conventional "wired set" easier to locate? The neat layout and component numbers marked on the printed circuit panels, gives the serviceman a head start in locating faults.

A major repair task, like replacing a valve-holder, can be accomplished on a printed circuit by the average serviceman in approximately ten to fifteen minutes without damage to any surrounding components!

My advice to printed circuit "first timers" is:

1. A light behind a printed circuit panel will indicate where component ends are soldered.
2. Do not hold the soldering iron on the printed copper too long or damage may result.—P. DUPEN (Lowestoft).

## AN AERIAL HINT

**S**IR.—I am writing to tell you of an idea for bringing into the house the TV aerial lead, temporary or permanent, without harming the walls or having holes by the window.

With summer here, the lead can be fed down the chimney, and in the case where people are now using oil heaters full time instead of coal, the lead can be left inside the chimney.—C. E. WILKINSON (Windsor).

### SPECIAL NOTE

Will readers please note that we are unable to supply Service Sheets or Circuits of ex-government apparatus, or of proprietary makes of commercial receivers. We regret that we are also unable to publish letters from readers seeking a source of supply of such apparatus.

# News From the Trade

## Plessey and Brayhead Tie-up

THE Plessey Company Limited and Brayhead (Ascot) Limited announce that they have entered into a joint development and manufacturing agreement covering television tuners and F.M. permeability tuners.

It is understood that the agreement provides for the complete interchange of tooling and technical and manufacturing processes covering radio and television tuners. Although independent laboratories are being maintained, the two companies will co-operate closely in all forward development.

The first Plessey-Brayhead products to be marketed under the new arrangement will be the successful Brayhead BT16 tuner now to be known as the P-B 1, and the new Plessey F.M. permeability tuner to be known as the P-B 2. These products will be sold in the United Kingdom by both companies and throughout the rest of the world by Plessey International Limited.

The rationalization achieved by the co-operation of these two important producers will, it is believed, result in the long term in substantial technical and economic advantages to the trade, as well as placing Britain in a strong competitive position overseas as the European Common Market develops.—Plessey Co. Ltd., Ilford, Essex.

## New 17-inch Portable TV

A NEW transportable 17in. television set of revolutionary design, which includes a V.H.F./F.M. sound receiver, is now offered for the first time by McMichael Radio Limited at the attractively low price of 66 guineas, tax paid. Known as the "Voyager," the new set incorporates a 14-channel tuner that covers all 13 TV channels, present and planned, as well as V.H.F. sound.

An illuminated dial is provided for V.H.F. tuning. This not only enables one to range through the entire band used for BBC sound broadcasts, but also means that the "Voyager" needs no adjustment if it is used in another part of the country.

The "Voyager" will normally be used with its own twin telescopic aerial, which enables it to operate in any good-reception area where there is a mains point. An important feature of the "Voyager" is the use of silver-plated circuits for the first time in this country. Thanks to this new technique, a full-performance set has been packed into a surprisingly compact cabinet, the total weight being only about 35lb.

The McMichael "Voyager" is handsomely finished in fawn and beige leather-cloth, with brown and gold trim. The special twin telescopic

aerial, if required, costs 1 guinea tax paid.—McMichael Radio Ltd., Langley Park, Slough, Bucks

## TV Tube Price Reductions

MULLARD announce cuts in prices of the more modern types of TV picture tube as from April 1st, 1958. Details are given below.

This is the second reduction made in the price of Mullard TV tubes in the last two years, and has been made possible by improved production methods.—Mullard Ltd., Torrington Place, W.C.1.

Tube Type	Price before 1.4.58	P.T.	Price after 1.4.58	P.T.	Total reduction
	£ s. d.	£ s. d.	£ s. d.	£ s. d.	£ s. d.
AW36/20 (14")	12.15.0	5.11.11	12.0.0	5.5.4	1.1.7
AW36/80 (14")	12.15.0	5.11.11	12.0.0	5.5.4	1.1.7
AW43/80 (17")	14.15.0	6.9.6	14.0.0	6.2.11	1.1.7
AW43/69 (17")	14.15.0	6.9.6	14.0.0	6.2.11	1.1.7
MW43/80 (17")	14.15.0	6.9.6	14.0.0	6.2.11	1.1.7

## Wolsey Electronics Ltd.

HIGH performance Band V aerials are available to manufacturers and others interested in conducting tests on the Crystal Palace Band V transmissions on 651.25/654.75 Mc/s.

Wolsey Band V aerials are available in 5-Element Yagi and Double Yagi 5-Element (Broadside) types. These have high gain and optimum electrical characteristics with robust mechanical design. They are supplied with universal clamp to fit 1/2in. to 2in. diameter masts. The illustration below shows the single 5-element array, and the use of strip for the dipole element should be noted.—Wolsey Electronics Ltd., Cray Avenue, St. Mary Cray, Orpington, Kent.

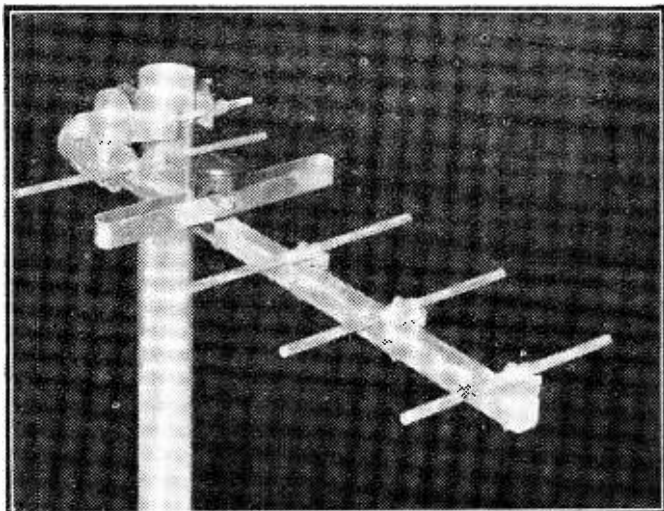

One of the Wolsey Band V Aerials. Note the use of flat strip for the dipole.



# Wanted!

**QUALIFIED MEN AND WOMEN**

Industry and Commerce offer their best posts to those with the qualifications—appointments that will bring personal satisfaction, good money, status and security. As part of a modern industrial organisation, we have skilled knowledge of what is required and the best means of training personnel for present day and future requirements. We specialise also in teaching for hobbies, new interests or part-time occupations in any of the subjects listed here. Write to us to-day for further information. There is no obligation of any kind.

**PERSONAL & INDIVIDUAL TRAINING IN —**

- |                                       |                         |                              |                     |
|---------------------------------------|-------------------------|------------------------------|---------------------|
| Accountancy                           | Draughtsmanship         | Mathematics                  | Sales Management    |
| Advertising                           | Economics               | M.C.A. Licences              | Sanitary            |
| Aeronautical Eng.                     | Electrical Eng.         | Mechanical Eng.              | Engineering         |
| A.R.B. Licences                       | Electrical Instal.      | Metallurgy                   | Salesmanship        |
| Art (Fashion, Illustrating, Humorous) | Electronics             | Motor Eng.                   | Secretaryship       |
| Automobile Eng.                       | Electronic              | Painting & Decorating        | Servo Mechanisms    |
| Banking                               | Draughtsmanship         | Photography                  | Shorthand & Typing  |
| Book-keeping                          | Eng. Drawing            | P.M.G. Certs.                | Short Story Writing |
| Building                              | Export                  | Police                       | Short Wave Radio    |
| Business                              | Gen. Cert. of Education | Production Eng.              | Sound Recording     |
| Management                            | Heat & Vent. Eng.       | Production                   | Telecommunications  |
| Carpentry                             | 'Hi-Fi' Equipment       | Planning                     | Television          |
| Chemistry                             | High Speed              | Radar                        | Time & Motion       |
| City & Guilds Exams                   | Oil Engines             | Radio                        | Study               |
| Civil Service                         | Industrial Admin.       | Radio Amateur                | Tracing             |
| Commercial                            | Jig & Tool Design       | (C & G) Licence              | Transistors         |
| Subjects                              | Journalism              | Radio Engineering            | Welding             |
| Commercial Art                        | Languages               | Radio & Television Servicing | Workshop Practice   |
| Computers                             | Management              | Refrigeration                | Works M'gement      |
| Customs Officer                       | Maintenance Eng.        |                              | etc., etc.          |

Also courses for GENERAL CERTIFICATE OF EDUCATION, A.M.I.H.&V.E., A.M.S.E., A.M.Brit.I.R.E., A.M.I.Mech.E., A.M.I.E.D., A.M.I.M.I., A.F.R.Ae.S., A.M.I.P.E., A.M.I.I.A., A.C.C.A., A.C.I.S., A.C.C.S., A.C.W.A., City & Guilds Exams., R.T.E.B. Servicing Certificates, R.S.A. Certs., etc., etc. Moderate fees.

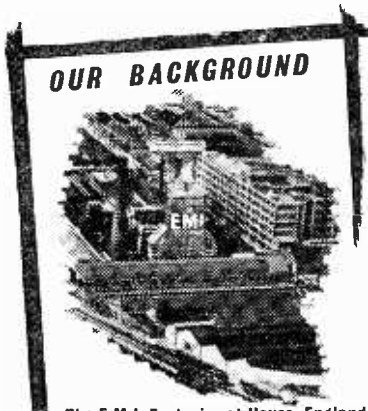

The E.M.I. Factories at Hayes, England.  
 The only Home Study College  
 operated by a world-wide  
 manufacturing organisation

# EMI

## INSTITUTES

**NEW!** Courses with PRACTICAL EQUIPMENT

in RADIO · TELEVISION · MECHANICS  
 CHEMISTRY · ELECTRICITY  
 DRAUGHTSMANSHIP · PHOTOGRAPHY etc., etc.

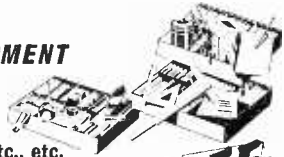

**POST THIS TODAY**

To :- E.M.I. INSTITUTES, Dept. 138K, London, W.4.

NAME \_\_\_\_\_ AGE \_\_\_\_\_  
 (if under 21)

ADDRESS \_\_\_\_\_

I am interested in the following subject(s) with/without equipment \_\_\_\_\_

JUNE/58 (We shall not worry you with personal visits)

**FREE**



BLOCK  
 CAPS  
 PLEASE

IC92

-Part of "His Master's Voice" Columbia, etc., etc.

**P. P. COMPONENTS LTD.**  
219, ILFORD LANE, ILFORD, ESSEX  
Phone: ILF 0295

1P2	2/9	12Y4	8/9	EF42	8/9	PP225	3/9
411	6/9	35Z4	8/9	EF50	2/9	PY81	6/9
5V3	6/9	35L6	8/9	EF50	(red)	P61	6/9
6AM5	2/9	638PT	2/8	5/9	RL57	1/9	
6AM6	6/9	7/7	3/9	EF80	8/9	SP61	6/9
6B7	1/9	210VPT	5/9	EF85	8/9	TT11	6/9
6B8G	3/9	7193	3/9	EF91	7/9	U22	10/9
6F12	7/9	AR6(2V)	3/9	EF92	3/9	UF41	8/9
6F14	6/9		1/9	EL84	10/9	UUG	7/9
616M	1/9	ARP35	3/9	EL91	3/9	U52	6/9
6J5M	2/9	CV1083	3/9	EZ40	3/9	VE63	6/9
6K7M	3/9	CV189	3/9	EZ80	8/9	VT32	6/9
68J7M	6/9	D1	1/9	FW4/509	VT501	6/9	
6V6M	6/9	DH76	8/9	10/9	VW36	1/9	
6P28	12/8	DK96	8/9	KTW63	8/9	W76	8/9
6S47M	3/9	DF66	5/9	KTW63	8/9	W81	3/9
6S47	3/9	EA50	1/9	L410	1/9	Z77	7/9
63G7M	2/9	EABC80	9/6	NR41	3/9		
8D2	3/9	EAF42	8/9	PEN45	6/9	UK	
8D3	7/9	EB34	1/9	PEN46	6/9	UK	
91P2	6/9	EB33	6/9	PEN20	3/9	UK	
11E3	5/9	ECW4	3/9	PEN230	42	3/9	
12A6	6/9	ECU142	8/9	PEN230	75	3/9	
12A7	6/9	EF36	5/9	PL22	8/9	78	3/9
12BE5	6/9	EF37	4/9	PL83	8/9	1196	3/9
12K7	6/9	EF89	3/9	PM202	1/9	25RE	3/9

**T.V. AERIALS, 25/6.** For all I.T.A. channels. Outdoor or loft; 3-element. Half normal cost. P. & P. 2/6.

**CAR AERIALS, 8/9.** Whip antenna. 50in. long, collapsing to 11in. 1-hole fixing. Post 1/6.

**GANGED CONDENSERS, 1/9.** 2- or 3-gang. Salvage, guaranteed. 4005. Post 1/3.

**I.F. TRANSFORMERS, 1/- pair.** 465 kc/s. Tested, guaranteed. Post 1/-.

**PHILLIPS CONICAL TRIMMERS, 6d.** each, 5/- doz. 5-50 pF. The world's finest trimmer. Unused. Post 4d., 1/- doz.

**T.V. SLIDER CONTROLS, 9d.** 10K and 2K only, wirewound. Post 6d., 4 for 2/6.

**8in. P.M. SPEAKERS, 8/9.** Ideal gift if fitted in small cabinet. "Treat the lady at home." PIT one in kitchen or cupboard door. With O.P. trans. 10/- Post 2/6.

**RECTIFIERS, 2/9.** 250 volt 100 m/a. Full- or half-wave. Salvage. Guar. Post 1/3.

**ION TRAPS, 5/-.** For all and any type of tube requiring a trap. Post 6d.

**RESISTORS, 8d.** doz. 270 ohms, 1 watt ceramic. Post on 1 doz., 6d., on 4 doz., 1/-, on 10 doz., 2/6.

**INSULATING TAPE, 1/6.** 75ft. x 1/4in. wide. Post on 1 9d., on 6 only, 2/-.

**SOLDER REELS, 1/6.** 60-40, 3-core Ersin. 20ft. on plastic spool. Post 6d.

**O.P. TRANSFORMERS, 1/3.** Salvage, guaranteed. 2-5 ohms. Matching Pentode or Tetraode. Post 1/9. 20 for 2/1. Post 5/6.

**HEADPHONES, 1/9.** Single earphone and band. C-LR type. Grand bargain. Ideal for crystal sets, extension on T.V. or radio. Post 1/6.

**CO-AXIAL CABLE, 6d.** yard. Cut to any length. Good quality. Post on 20 yds., 1/6. 45/- per 100 yards. post 3/6.

**DROPPERS, 9d.** each. 750 ohms, 2 amp. Post 9d. 5/- dozen. post 2/6.

**CHASSIS, 1/- each.** 6- or 8-valve, latest type midgeet valve design for A.M. or F.M. New. Cadmium plated on a.w.g. steel. 12 1/2in. x 7 1/2in. x 2 1/2in. Post 1/9. 4 for 4/-, post 3/-; 12 for 10/-, carr. 5/-.

**ALLEN SCANNING COILS, 7/6.** Low imp.; for 14in. or 17in. wide-angle tubes. Post 1/6.

**F.M. TUNER UNIT, 7/6.** With 2-gang condenser. Takes ECC85 valve (not inc). Post 1/6.

**VOLUME CONTROLS, 1/9.** 1 megohm. Long spindle. New, boxed. Post 1/6.

**RELAYS, 9d.** (10P/1479), 150 ohms. Break 1 make 2. (G.P.O. pattern. Used. Post 1/-.

**CONDENSERS, 9d.** 32 mid., 450 volt working. Card-board. New. Post 1/6. 12 for 7/-, post 3/6.

**R.F. FILTER UNITS, 1/9.** G.P.O. specifications. Beautifully made in solid brass case. Fitted with in-out switch. Simply fitted in the aerial. Has 2-stage tuning. Limited stock. Post 1/3.

**VALVE SCREENING CANS, 1/- doz.** Latest midgeet type. Aluminium. 2 1/2in. x 1/2in. dia. Post 6d.

**NICKEL-CHROME WIRE, 1/-.** .014 dia., on 50-yard spools; .022 dia., on 25-yard spools. Packed in ready-use (not in rust) mechanism, special dulled finish. Rustproof. Ideal for gardeners and outdoor use. Post 9d. 25 for 2/1, post 2/6.

**SPRING STEEL WIRE, 6d.** .014 dia., on 50-yard wood spools. Post 9d. 25 for 10/-, post 2/6.

**CHOKES**

250 m/a, 4/9. Salvage, guaranteed. P. & P. 2/6. 10 for 30/-, P. & P. 7/6.

80 m/a, 2/9. Salvage, guaranteed. P. & P. 2/6. 10 for 20/-, P. & P. 7/9.

60 m/a, 1/9. Salvage, guaranteed. P. & P. 2/6. 10 for 10/-, P. & P. 6/6.

**TORCH LANTERNS, 6d.** each. Ek-W.D. Including 2 bulbs. Uses 800 battery. Post 1/6. 5/- doz., post 3/-.

**FLUO HIGES, 1/6 pair.** Chrome. New. 7in. long. Post 6d.

Send 3d. stamp for FREE catalogue.

**from one source**

Denco, Repanco, J.B., T.C.C., Woden, Elac, McMurdo, Radiospares, Eddystone, Elstone, Buigin, Belling & Lee, Hunts, Sorad, Acos, Brown, Mullard, Igranic, Cossor, Taylor, Avo, Henley, E.M.I., etc.

Orders dealt with day received

56 page illustrated catalogue No. 11, with 108 photographic illustrations, and over 2,000 new guaranteed lines by leading makers. 9d. post free.

**SOUTHERN RADIO and ELECTRICAL SUPPLIES**

SORAD WORKS · REDLYNCH SALISBURY · WILTS

**"VIEWMASTER"**

**Printed Circuit Converter No Patterning or Breakthrough**

We can supply the complete kit of parts including valves, **£5.0.0.**

Set of coils for conversion of Viewmaster receiver, **£1.0.0.**

Complete set of parts for building scanning coils (see P.T. March). Two line coils, two frame coils wound. Ready to form. Two Ferroxcube castellated cores, clamp, spacer, and panel complete with tags, **16/-.**

ALL ITEMS POST FREE.

**AUDIO LTD.**  
162 Gray's Inn Rd., London, W.C.1

**B.B.C. - I.T.V. - F.M. - AERIALS**



Band I (B.B.C.) Telescopic loft. 19/6. External 5p Dipole. 26/3. Band 3 (I.T.V.) 3 element loft array. 24/- 5 element. 32/6. External wall mounting 3 element. 33/9. 5 element. 41/3. Combined (BBC-I.T.V.). Loft 1+3 element. 41/3. 1+5 element. 48/9. External wall mounting 1+3 element. 56/3. 1+5 element. 63/9. Room aerial. 12/9. Band 2 (F.M.) Loft "H". 29/- 3 element. 52/6. 4 element. 56/3. P.P. 2/6. Co-axial. 8d. yd. Co-axial plugs. 1/3. State channel when ordering. C.W.O. or C.O.D. S.A.E. for price list.

**K.V.A. ELECTRONICS (Dept. 11)**  
189, Kent House Road, Beckenham, Kent. SYD. 2488.

**FIRST-CLASS TELEVISION and RADIO COURSES . . .**

**GET A CERTIFICATE !**

After brief, intensely interesting study — undertaken at home in your spare time — YOU can secure your professional qualification or learn Servicing and Theory. Let us show you how !

**FREE GUIDE**

The New Free Guide contains 132 pages of information of the greatest importance to those seeking such success compelling qualifications as A.M.Brit.I.R.E., City and Guilds Final Radio, P.M.G. Radio Amateurs' Exams., Gen. Cert. of Educ., London B.Sc. (Eng.), A. M. I. P. E., A. M. I. Mech. E., Draughtsmanship (all branches), etc., together with particulars of our remarkable Guarantee of

**SUCCESS OR NO FEE**

Write now for your copy of this invaluable publication. It may well prove to be the turning point in your career.

**FOUNDED 1885—OVER . . . 150,000 SUCCESSES—**

**NATIONAL INSTITUTE OF ENGINEERING**  
(Dept. 462), 148, HOLBORN, LONDON, E.C.1.

**59 Gns.—'17'**

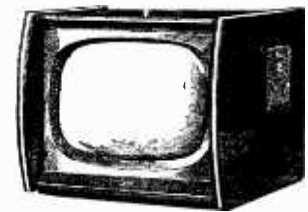

A full specification 17in. Television Receiver to Spencer-West standards now available at your Dealers. Remarkable performance and priced at **59 Gns.** only, complete.

**SPENCER - WEST LTD.**  
Quay Works, Great Yarmouth Norfolk

Phones: Works 4794; Sales 3009  
Grams: Spencer-West, Great Yarmouth



*Whilst we are always pleased to assist readers with their technical difficulties, we regret that we are unable to supply diagrams or provide instructions for modifying surplus equipment. We cannot supply alternative details for constructional articles which appear in these pages. WE CANNOT UNDERTAKE TO ANSWER QUERIES OVER THE TELEPHONE. The coupon from p. 553 must be attached to all Queries, and if a postal reply is required a stamped and addressed envelope must be enclosed.*

#### ULTRA 84

My problem is lack of height. I have a picture 1½ in. that curls over at the top, and a tearing at the edges of the lines when the contrast is turned down. I have replaced the 6K25, interchanged UL46 with UL46. I am not quite sure if the latter number is correct. And I have had no luck. And I have been unable to obtain service sheets. Hoping you may be able to help me.—G. H. Churcher (Highbury).

We suggest you check the .5  $\mu$ F coupling condenser between the 6K25 anode and UL46 grid. Another possible cause of your trouble is a faulty 40  $\mu$ F electrolytic which is in series between the frame scanning coils and chassis. We are unable to assist you regarding service sheets but suggest you try our advertisers. Quote V80 as an alternative sheet. It is very similar and easier to obtain.

#### EKCO TC209

The fault is waving or snaking of verticals; very obvious sometimes, other times not so obvious. The only servicing the set has had since new is a new U25 EHT rectifier. I have the makers service cards, and an Avometer Model 7, and should add that I am very much an amateur.—F. L. Smith (Ramsey, I.O.M.).

The normal cause of bent verticals is heater-cathode leakage in either the 20D1 discriminator or 20L1 line oscillator, both of which are just outside the EHT compartment. If neither of these valves is at fault the usual remedy is to add a 50  $\mu$ F condenser across the 2.7 K bias resistor to pin 4 of the 20L1.

#### MARCONI VT53DA

The fault is distortion of sound and sound break-through on the picture. I have had all the valves tested and found to be all right. I am using a "Dulcie" Band III converter and when in use both sound and picture are all right, but when I use the set with or without the converter

for BBC only I get this distortion of sound and break-through on picture. I have tried another speaker and no improvement has been obtained. I have added 50  $\mu$ F 12 v.w. across the output valve bias resistance (150 $\Omega$ ); this made a slight improvement in cutting out the feed-back to the output stage. I am not getting full sound output, it is just audible on BBC with or without the converter and just a little more on I.T.A.—P. Screerey (S.E.12).

The trouble is almost certainly due to excessive BBC signal input. An attenuator, inserted into the BBC aerial lead will cut down the signal. The noise limiter load resistor (3.3 M $\Omega$ ) should be replaced if the distortion remains.

#### MASTERADIO T917

I was most interested in the article in the March issue on multi-channel tuner installation which renewed my enthusiasm to convert my televisor for Band III reception. I have previously considered this project but neither Cyldon or Brayhead list a model for the set in question. I have no data nor do I know the I.F. of this receiver, but in view of the fact that the aforementioned manufacturers do not cover this model in their lists, I take it there must be some snag.—R. F. Sydenham (Fishponds).

The Brayhead 16S tuner unit can be used, wiring heaters in series with C.R.T. heater. The I.F. of the T917 is vision 19.75 Mc/s, sound 23.25 Mc/s. This means that the oscillator tuning cores of the tuner unit will have to be screwed well in in order to cover the required channels.

#### PAM T750

Difficulty is experienced in obtaining a good line lock. It is possible to view for an evening after adjustment of line hold control, but will again require adjustment the next time switched on. I have no circuit diagram. Would you kindly indicate suspect valves, etc., and location. The frame hold control is also fully over one way for satisfactory lock.—Kenneth Allford (Stansted).

You should replace the PCF80 valve located on the top centre of the chassis, to the right of the pre-set line hold control. Also check ECC82 if frame hold is required to be reset to centre of its travel.

#### FERGUSON TV9916T

After switching on, the picture appears but is only about half the normal height. It takes about five to seven minutes to reach the full height of the screen and does not decrease during a whole evening's programme. The fault can best be described as "taking a long time to warm up." The brightness and detail of the picture is excellent, and all controls work normally. Incidentally, the upper half of the screen expands slower than the lower. A friend diagnosed the fault as a greedy tube and suggests fitting a heater transformer for the tube supply.—E. J. Walker (Balham).

The Ferguson 991T is a different receiver from the 996T and as you quote 9916T we are not quite sure which is intended. However, the frame

timebase valves (ECL80) should be tested. Referring to your friend's advice, this could have quite an element of truth in it if the picture inclines to "uncurl" upwards, etc., rather than the top and bottom edges being straight and gaining height gradually. If the edges are curled, the tube emission is weak (not greedy) and insufficient to overcome the slight dampness on the tube face.

#### EKCO TS105

I have been considering renovating this set with a view to bringing it into line with more modern receivers, and would appreciate your advice on the most suitable replacement tube for this purpose. I am quite willing to carry out any feasible circuit alteration to achieve this. Also could you tell me whether daylight viewing should be possible on this set as at the moment no picture can be seen in normal daylight.—D. H. J. Richards (nr. Petersfield).

The largest tube that is economically possible to fit to your set is the Mazda 12in. CRM121B, as anything needing more scanning power and EHT would entail the redesign of the entire timebase. The CRM121B can be fitted with no amendment to the circuitry but will need physical support. The picture should be viewable in daylight, but not, of course, in direct sunlight.

#### FERRANTI T1225

This started to short from one of the connections on the filament side of the EY51 to chassis; now there is no EHT and the filament of the EY51 does not light up at all, but the filament of the PL81 glows a very bright red, which is reduced to normal if the top connecting cap is removed. There is also a frying sound emitted from this region which can also be heard on the loudspeaker: this ceases when the PL81 is removed. The EY51 has been replaced recently with a new one and has also since been tested; the PL81 has been tested twice and both are O.K.—J. W. Crompton (Farnworth).

The symptoms you describe suggest that the line output transformer is defective. Before replacing this, however, ensure that the tube is free from fault by disconnecting the anode cap and noting the red glow in the PL81 and the heater of the EY51.

#### KOLSTER-BRANDES MV50

There is a terrific line pull every few minutes, which starts at the top of the picture, and then forms two thin lines across the centre of the picture, then a wide one at the bottom of the picture. This clears after 40 seconds or so, and the picture is fair. Two dry joints were found, which when remade up changed slightly the pattern of the line pull form. Not having a service manual I can only quote the large valve with a top cap at the rear of the flyback transformer, as having a loose top cap, would this have any bearing on the line pull? This valve also glows blue for 60 seconds or so whilst warming up. I cannot quote the valve number as the markings have become obliterated. Another defect is that the horizontal make-up lines widen from the half

screen and the lines are so far spaced at the top of the picture that the picture takes on a grotesque appearance. No adjustment whatsoever will remove this state of affairs. When switching over to Channel 10 the above happenings are not so pronounced, this I put down to St. Hillary working at a higher frequency than Wenvoe.—R. G. Hunt (nr. Bridgend).

You should check the condition of the 12AU7 frame and line oscillator valve. The line output valve (with top cap) is a 6CD6G. In order to be sure of the 12AU7, it would be better to replace this rather than rely upon a somewhat dubious valve test. The frame scan distortion should respond to vertical linearity adjustment. If it doesn't, check 6BW6 frame output valve.

#### MURPHY V204

The picture is woolly and sufficient contrast cannot be obtained. On turning up contrast the picture goes into negative. The focus control does not produce sharp focus. In the cabinet is mounted a C.R.T. transformer which had no connection to the + 20 per cent. tap. I have moved one C.R.T. lead to this tap—no great improvement. The focus can be sharpened, however, with an adjustment of the mains supply to the set. My voltage is 240, but if I use the selector plug in the 220 hole some sharpening occurs, but I do not use the set in this way for more than a moment or two. If the answer to this problem is failing C.R.T. please advise me whether I should replace with a round tube as advertised in "Practical Television," or whether adaptation to a more modern type would be advantageous.—K. W. Thomas (Rhyll).

Your fault could be due to your tube being low, or else to a low H.T. rectifier. If this latter is the case you will also have difficulty in obtaining full width and height. Regarding the replacement of your tube by a 17in. type, this is practicable but involves quite a bit of work which you may not consider worth while since you only gain ½in. picture all round.

#### ULTRA V80M

When I was given this receiver I was told the line output transformer was faulty. However, when putting in the valve a line was obtained across the screen. I assume that the transformer is working. Having obtained this line I cannot get height even by adjusting the frame hold or the height control. May I please ask your advice? Firstly, having obtained a line (and EHT) on the screen is the line output transformer correct? Secondly, in order to obtain the height what valve or component do you advise checking or replacing in the frame section? I have no service sheet for this receiver.—L. C. Johnson (Jacksdale).

If the line of light goes right across the screen you can safely assume that your line and EHT stages are all right. Your frame timebase, which is the one not working, comprises a 6K25 Thyatron scan generator coupled to a UL46 frame amplifier via a .5  $\mu$ F condenser. The anode load

(Continued on page 553)

**SETS & COMPONENTS**

**LOUDSPEAKERS** repaired promptly. MODEL LOUDSPEAKER SERVICE. Bullington Rd., Oxford.

**5-CHANNEL TELEVISIONS:** 12in. screen Ferguson 988, Ekco 161, etc., £22 each. A good selection of 12in. T.V.s (London), 100% condition. From £12: 9in. from £7, also 12in. T.V.s, slight faults, from £5; 9in. from £3. TYLER TELEVISION, 63, Lee High Rd., Lewisham, S.E.13. (LEE 5979.)

**RECLAIMED TUBES,** 12in., 14in., 17in., all at £5 each, guaranteed; 100 (5 channel) T.V. Ekco 161, Ferguson 988, £15 each. C. EDWARDS, 1070, Harrow Rd. (Phone: LADbroke 1734.)

**TELEVISION, GENUINE RECEIVERS.** Under contract to clear 1,500 regardless of cost. 12in., £6 to £9; 9in., £2 to £5. Trade enquiries invited. These sets are London Channel table models, and absolute Bargains. GREEN, 4, Hendersson Rd., Portsmouth. (Phone: 32972.)

**ELECTRADIO,** Co-ax. low loss. 9d. yd.; Plugs, Sockets, 1/- each. Multi-core Solder, 2/6 per packet. Stirling Band III Converter, all channels, 6 gns., post free. 18, Broadlands Av., Kcynsham, Som.

**UNREPEATABLE OFFER.**—12in., 5-channel T.V., £15; 14in., £22; good working order. C. EDWARDS, 1070, Harrow Rd., London, N.W.10. (Phone: LADbroke 1734.)

**CATHODE RAY TUBES,** ex-chassis, picture-tested, 3 months' guarantee. Mullard, Mazda, Brimar, etc., 9in., 12in., 14in., 15in., £3/10/-; 17in., £4; carriage and insurance, 15/- S.C.L. 77, Cranleigh Rd., Bournemouth.

**TELEVISIONS,** 9in. models, £7/10/-; 12in. models, £13/10/-; 12in. 5-Channel models, £19/10/- each; all working; carriage paid. Send for list TOMLINS, 127, Brockley Rise, Forest Hill, S.E.23. (FOR 5497.)

**GUARANTEED TELEVISION,** 12in. 5-Channel models; first-class picture. £26 each, carriage paid. THE GRAMOPHONE SHOP, 19-21, Brockley Rise, London, S.E.23.

**TELEVISIONS,** some faulty or needing tubes, all cheap. WILKINSON'S, 146, Goldhawk Rd., W.12. (SHE 4379.) Callers only

**TELEVISIONS?** Not working sets: from 9in., £2; 12in., £3/10/-; 14in., £10/10/-. Working: 9in., £5; 12in., £10; 14in., £15. RELYON RADIO, 7, Barnsbury Rd., N.1. (Near "Angel.")

**NEW AND USED VALVES,** Radio and T.V. from 4/- each; state requirements. Cellular Polythene Co-axial Cable, 6d. per yd. S.A.E. PEARSON, Withens Head, Halifax, Yorkshire.

**TELEVISION TUBES**

FACTORY Reconditioned T.V. Tubes.

SIX Months guarantee.

12ins. CRM 121 etc. .... £7 0 0  
 14ins. .... 7 15 0  
 17ins. .... 9 15 0  
 21ins. .... 13 10 0

**CATHODE RAY TUBE SERVICE**

35 Broomwood Rd., St. Paul's Cray Orpington 21285

**RATES:** 4/- per line or part thereof, average five words to line, minimum 2 lines, Box No. 1/- extra. Advertisements must be prepaid and addressed to Advertisement Manager, "Practical Television," Tower House, Southampton St., Strand, London, W.C.2.

**CALLING CENTRAL SOUTHERN REGION!** Convert NOW. It's simple with the **BRAYHEAD TURRET TUNER.** In stock for ANY AREA. State Channels, set make and model No., £6.19.6. post ins., 2.6.

The **RADAR KILOVOLTAGE** measures E.H.T. 3-39 kv., £3.17.6. post ins. 2.6. Line and Frame osc. and O.P. transformers for 500 sets. EXACT REPLACEMENTS. State make and number with enquiry (3d. stamp).

**WESTWAY RADIO**  
 5, Westward Way, Harrow, Middx.

**TELEVISION TUBES.** Only the very best reconditioned Tubes supplied: 6-month unconditional guarantee: 12in. and 14in., all makes, £5/10/-; 15in., £6/10/-; 17in., £7/10/-. Carriage and insurance 10/- extra. C.W.O. MIDLAND TUBES LTD., 37, George St., Manchester. 1.

**CATHODE RAY TUBES** used but in good working order, with three months' written guarantee. 12in. to 17in. Mazda, Mullard and Equivalent types only, at £4/10/-, plus 12/6 for carriage and insurance. Enquiries and orders to BHP DISTRIBUTORS (LONDON) LTD., 379, Staines Rd., Hounslow, Middlesex (Tel.: HOU 5144.) Our terms are c.w.o. or c.o.d.

**TELEVISIONS,** London only. 12in., £10; 5-channel, 12in., £14; 14in., £18; 17in., £27; 13-channel, 12in., £20; 14in., £25; 17in., £35. (Callers only.) JOHN GILBERT TELEVISION, 1B, Shepherds Bush Rd., London, W.6. (SHE 8441.)

**RADIO TRANSMITTER/RECEIVER,** type T-25-TTS-2, type R-36-TTS-2, line voltage 115v., Serial No. 169. Antenna base and 40ft. steel aerial mast, right and left hand Antenna section, complete with case of spare valves, capacitors, resistors, etc. Unit complete in special carrying cases, £28. D. S. DISCOUNT SALES, Holyhead Rd., Chirk, N. Wales.

**BAND III** pre amp. channels 8, 9, 10, cascade low noise, 17-19 DB gain, air tested, self-contained A/C power pack, £4/12/6, p. and p. 2/6; c.w.o. RMS, 60, Portway, Warminster, Wilts.

**T.V. TUBES** as new, revacuumed; all makes; 6 months' straight guarantee; 14in., £5/10/-, 17in., £7/10/-; carriage and insurance 12/6. U.K. Free delivery Greater London. VIDEO REPLACEMENT CO., Hales St., Deptford High St., London, S.E.8. (Tideway 4506.)

**METERS (NEW BOXED M.O.S.)**  
 Ammeters, 6in. round, switchboard mounting, moving iron, 50 cycles A.C., scaled 0-50. Price £4, postage 3/6.  
 Ammeters, 2in. round, moving coil, complete with shunt, 5m. a basic movement, scaled 0-20. Price 10/6, postage 1/6.  
 Voltmeter, moving coil, 2in. round, 10,000 ohms resistance, scaled 0-50. Price 10/6, postage 1/6.  
 Voltmeters, 2in. round, moving iron, 50 cycles, scaled 0-300. Price 15/-, postage 1/6.  
 Voltmeters, 2in. round, moving iron, scaled 0-500. Price 17/6, postage 1/6.  
 Voltmeters, 6in. round, moving iron, scaled 0-300. Price £5, postage 3/6.  
 Wireless Components. Amazingly low price. Send for free list.

**SPEED ELECTRICS** EASTWOOD NOTIS

**VALVES** from 1/6. Radio, T.V. Components, low prices. Lists 3d. J. PALMER, 32, Neasden Lane, N.W.10.

**SUPERB NEW EHT METERS,** 2-8 kv (scale x2), plus 5-20 kv (scale x5), loading neglig. (300 meg.), case, prods. £7/10/-. Callers by appt. (private res.). H. S. CROSER, 53, Forest Rd., Kew, Richmond, Surrey.

**COMPONENTS,** Valves, Tubes, etc. Write or phone for free list. ARION TELEVISION, 4, Maxted Rd., Peckham, S.E.15. (New Cross 7152.)

**CATHODE RAY TUBES,** most types available and in good working order. £5, including carriage and irrespective of size. A limited number at £2/10/-. All £5 tubes carry a 3 months guarantee. TELLTUBE SERVICES, 26, Barton Hill Road, Bristol 5. (Tel.: 56648.)

**AMAZING OFFER.**—Originally £40/£100 each. Ekco, Pye, H.M.V., Marconi, Philips, Murphy, etc., 9/10in. Televisions, complete, not working, 50/- each; carriage paid; immediate dispatch. 12in., £5/5/-; 15in., £9; Philips 17in. Projection Televisions, £9/15/-. TOMLINS, 127, Brockley Rise, London, S.E.23.

**SOUND POWERED,** breast mics., with switch, 5/-; DLR3 SP Headphones, with muffs and plug, 8/6. GPO Mic. Inserts, carbon 1 6, bal. armature 3/-. Transformers: Input 230v. 50c. Outputs 620-550-375-0-375-550-620v. 200 mA. and 250 mA. simultaneously available at 5s. 2A. twice new, 24in. nett, £3, delivered mainland. Drives: slow-motion; Admiralty, 200:1 ratio, scaled 0-100, 5/6; Muirhead, 4in. dial (brass), 7/6; R1155B, good condition, fully valved, tested with "N" drive, handbook supplied, £7/10/- (rall 10/-). CR100, brand new, power transformers. 30/-; Command Receivers, brand new, 6 valves, med. wave 0-52-15 mc/s., 97/6; usc. £2/6 (post 3/6). Conversion data and circ. to Car Radio, 1/6. I.F. Strip 373 new, with valves, 37/6. Vibrapacks 6v. D.C. to 250v. 80 mA. smoothed, cased, 22/6 (post 3/6). Brand new R.F.26, 20/- (post 3/-); R.F.27, good cond., 17/6. Dynamotors (post 3/6), 6v. to 200v. 80 mA. 12/6; 11v. to 200v., 50 mA. and 13v. smoothed, filtered, cased, 12/6; 60 mA (small), 8/6. Metal Rectifiers: 12v. 4A. bridge, 2/6; 270v. 80 mA., H.W. 5/-; 250v. 100 mA., 4/-; 350v. 80 mA., 6/-; 12v. 4A. Bridge, 17/6; 240v. 30 mA., 3/6; 1,000v. 30 mA., 7/6. Meters contain 2 separate micro-amp movements and 2 beams, new 8/6. Cross-over needle (L R), 100 mA each section, good condition, 8/6. R.F. unit with 2/EP91, 1/F93, motor tuned (20-35 mc/s.), 1.F.15 mc/s. new, 30/- (p.p. 3/6). List and enquiries: S.A.E. please! Terms, c.w.o., postage extra. Immediate despatch. W. A. BENSON (P.T.), 136, Rathbone Road, Liverpool, 15.

**COPPER WIRE FOR SALE**

The following sizes of Surplus Stock are offered:

12 SWG	Enbestos Covered	2/6	per	lb.
13	"	2/6	"	"
20	Enamel	4/-	"	"
21 1/2	Paper	7/-	"	"
23	DCC	8/-	"	"
30	Enbestos	4/-	"	"
32	DCC	8/-	"	"

Minimum Quantity Supplied 4 lb. Postage 1/- per £1.

**TRANSFORMERS (WATFORD) LTD., SANDOWN RD., N. WATFORD, HERTS.**

(Continued overleaf)

**SETS & COMPONENTS** *continued*

**TV TUBES**, re-vacuumed as new: 6 months written guarantee. 12in. £14in. £5/10/-; 17in. £7/10/-; 21in. £10/10/-. C.W.O. 5% discount. Carriage, etc., 12 6. Free delivery Greater London. **ELECTRONIC DEVELOPMENT (ERITH) CO.**, 165, West Street, Erith, Kent. (Erith 4095.)

**A FEW** of the brand new 230v. ex-R.N. Oscilloscopes left, complete with VR97 and all valves at £5/15/- each. Only small mod., repeat small mod., required. Send 6d. for full mod. and details booklet, but hurry, hurry, first come first served. Ask your friends who have purchased one what a terrific bargain they are. **DIGGINS**, 129/135, Radnor St., Hulme, Manchester. 15 (MOS 2419.)

**RF27** or 26. 18/-; 25 or 24. 11/-, brand new, post 3/6. **E.W.S. CO.**, 69, Church Rd. Moseley, Birmingham.

**MAKE YOUR AERIALS** with our fully machined parts. Examples: Band 1, "H," complete with lashings. For £3/10/-; 5 Element. Band 3, with folded dipole, mast and clamp for 45/-. Get further details from our illustrated lists and data on all aerials, sent for 1/- P.O. (Trade supplied.) **SKYLINE WORKS**, Burn-sall Rd., Coventry. (Tel.: 60418.)

**T.V. TUBES**, 14in. £3/10/-; 15in. £4/-; 17in. £4/10/-; all picture-tested and guaranteed 3 months. A few 12in. and 14in., suitable for testing or boosting, 25/- each; all carriage paid. **BRADLEY**, 6, Beadon Ave., Waterloo, Huddersfield

**SOUND & VISION STRIP, 25/6**

Sound I.F. 10.5 Mc/s Vision I.F. 11 to 14 Mc/s. Less Valves. Valve line up, 6 6Fls. 26/2s.

Any single channel 1-5 supplied, a turret tuner is easily fitted. Power Pack Supply 230 v. H.T. 6.5 v. heaters. P & P. 2/6.

**12 CHANNEL TURRET TUNER 26/17.6**. Supplied with any two channels, extra channels, 7/6 each. Parrell heaters. I.F. output 10.5-14.0 Mc/s. Post Free.

**DUKE & CO.**, 621-3, Romford Road, Manor Park, E.12. ILF 6010/3.

**SERVICE SHEETS**

**SERVICE SHEETS** for sale and hire. Radio/T.V.; s.a.e. enquiries. **J. PALMER**, 32, Neasden Lane, N.W.10.

**SERVICE MANUALS/SHEETS** Tel/Radio for hire. Sale and wanted. Mixed Manuals and Sheets, 12 for 10/-; s.a.e. enquiries. **W. J. GILBERT** (P.T.), 24, Frithville Gdns., London, W.12.

**ENGINEER** has complete range new Radio/T.V. Service Sheets, 3/- each. Static Model No. required. c.w.o. **L. BRENNER**, 23, Meadway Close, Barnet, Herts.

**WANTED**

**ALL TYPES OF VALVES** REQUIRED for cash. State quantity and condition. **RADIO FACILITIES LTD.**, 33, Chalcut Road, N.W.1. (PRImrose 9092.)

**VALVES WANTED**. ECL80, EY51, EY66, PL81, PCF80, and all Miniature Types, U25, 10C1, 10C2 10P1, etc. 32G, 6K6G, 6V6G, brand new only; prompt cash by return. **R.H.S.**, 155, Swan Arcade, Bradford, 1.

**WANTED**. Mains Transformer for Cosor T.V., model 920. Box No. 11; c/o PRACTICAL TELEVISION.

**FOR SALE**

**TELEVISION BARGAINS:** 9in., seen working. £7/10/-; 17in., £37/10/-; new 17in. Sets, 59 gns. Aerials and Co-ax. cheap. **CLAYTON'S**, of Church St., Chalvey, Slough.

**HOW TO USE** ex-Gov. Lenses and Prisms, Nos. 1 and 2. 2/6 ea. Vertical Enlarger Plans for 35mm. to 2 1/2 in. sq., 3.6 ea. Optical Condensers and Achromatic Lens to suit. 33/-. Lists s.a.e. **H. W. ENGLISH**, Rayleigh Road, Hutton, Essex.

**"MAINS" FROM 12v. BATTERY**.—Brand new American Dynamotor Unit in beautiful black crackle case. Weighs about 38lb., but neat and compact. Thousands of uses, no conversion required. In seconds makes marvellous, powerful 200 250 A.C./D.C. electric motor, electric fan, dynamotor (gives 250 volts at about 100 watts from 12-volt car battery), runs mains radio, bulbs, etc. Makes ideal rotary transformer, battery charger, etc. Continuous duty, quiet running, doesn't overheat; worth £25—our price 80/-, with instructions; carriage paid. Satisfaction guaranteed. Send remittance with order. Dept. 8. **SCIENTIFIC PRODUCTS**, Manor Works, Cleveleys, Blackpool.

**SUPERIONIC SUNLAMPS**, listed £7/10 - 80/-. **S.A.E. SCIENTIFIC PRODUCTS CO.**, Cleveleys, Lanes.

**TELEVISIONS**. Clearance of 12in. B.B.C. sets all in good order. £12 each; carriage extra. Callers preferred. Many others. **C.W.W.**, 12, Dockhead, S.E.1. (BER. 3756.)

**VALVE CARTONS**.—We can supply from 12 to 100,000 off the shelf. Plain white or printed. Miniatures, 10/-; "G.T.s." 12/-; "Gs." 14/- per 100, plus 2/- postage. Also printing done to your special requirements; quotations gladly given. **J. & A. BOXMAKERS**, 75a, Goodwin St., Bradford, 1.

**EVERYTHING FOR THE AMATEUR**.—Write for our new List catering for Home Engineers, Hi-Fi Fans, Tape Recording Fans, etc., etc. Probably the most comprehensive in the trade. Price 1/-. **R.H.S.**, 155, Swan Arcade, Bradford, 1.

**PYE POWER TRANSISTORS**, brand new. 25 - each; AC R109 Power Packs, fully smoothed. 30/-; Receivers, 85/-, new; 10-watt Amplifiers with Mullard 5-10 preamplifier mixer, 3/15 ohms out. £6/19/6; 12 volt, 12 watt new Amplifiers with mike, makers' guarantee, 6 gns.; 6-volt Charger Transformers with rectifier, 12/6, 12-volt, 15/6. Send 3d. stamp for large list. Transistor Components, Amplifiers, etc. **TRANSISTOR TECHNIQUES**, 175, East Dulwich Grove, London, S.E.22. (GIP 1275.)

**V.M. TUNER (L)**, complete, unused, with coils for V.M. chassis, cheap. Box 10. c/o PRACTICAL TELEVISION.

**SITUATIONS VACANT**

**AGENTS** REQUIRED to sell I.T.V. Converters, Aerials, etc., s.a.e. for details. **G. A. STRANGE**, N. Wraxall, Chippenham, Wilts.

(Continued on page 54.)

**SALE**

**SATISFACTION OR MONEY BACK GUARANTEE**

If returned unused within 7 days  
**13 CHANNEL CONVERTERS**  
For T.R.F. or Superhets. Famous make, fine tuner, 9 quick-set trimmers giving any 3 channels, output to aerial socket. Beautiful case. With PC84, PCF80. Full instructions. £3.15.0 (Post 3/-).  
**Focus Magnets**, w.a., centring, mounted, 9/6; ditto, double magnet, 12/6. 10N TRAPS, 4 - 10FL, COILS, 35 mm., 7/6. Super 38 mm., 15-, 100-200 Mfd. 275 v. w. Conds., 5/6. **T.V. CABINETS**, 14 inch, attractive, mask, glass, front spkr., 25/-.

**GUARANTEED T.V. TUBES!**

(EX. EQUIPMENT)  
12in. (MW31-74, 3/31, etc.)..... £5. 5.0  
14in. (MW36-24, CRM41, etc.)..... £4. 10.0  
17in. (MW49-54, 4/15, Post.)..... £6. 10.0  
17in. (CRM71 only)..... £8. 0.0  
(All guaranteed 6 months. (Carr. & Ins. 12/6.)

**4 SPEED AUTO STAAR GALAXY**  
Modernise your radiogram or build a super record player. Famous Ultra-Modern Autochangers (as shown but less base) with Lightweight turnover Sapphire Pickups. Beautiful Cream and Chrome finish. 10 Records taken of any size or speed. For all mains voltages. Spares Available (post 4/-).

**£3-19-6!** (listed approx. £13)



Above Autochanger mounted on streamlined high-finish case, as shown, to make complete add-on Player, which will play any 10 Records through your Radio or Amplifier for all mains voltages. (Post 4/-).  
**COMPLETE PLAYER in covered two-tone quality portable Case, with above Autochanger, excellent 3-valve Amplifier, 7-inch Speaker, beautiful reproduction (worth over £20).** (Post 5/-).  
**STAAR GALAXY SPARES**, 100s available, low prices, including rubber idler pulleys, tone-arms, p.u. cartridges (Acos, Power Point, Sonotone), etc.  
**GT. WARRANTED RADIO VALVES,**

BOXED, SAME DAY SERVICE			
31G	6 6E94GT	12 6E981	8 - PC84 9/-
32AG	9 - 6Y6G	8 - E92C	8 6Y6G5 11/6
6A7	5 6X5BM	8 6E988	8 6Y6F8 12/6
6AL5	5 6X4	8 - E92C4	10 6 - PCF82 11/6
6AM6	7 6X5GT	5 - E92C5	9 - PCF82 11/6
6BA6	6 6L6C1	12 6E980	12 - PL81 13/6
6BE6	6 6Y6P	10 - E92C2	12 - PL82 9/-
6C4	4 9 10L114	12 6E982	9 6Y6G 11/6
6CH6	11 - 10P14	15 - E92L0	13 6Y69 8/-
6E14	14 - 12A17	9 - E92C3	4 - PY81 8/6
6E15	13 - 12A17	8 6E929	5 - PY82 9/-
6E56	3 - 12AX7	8 6E950(A)	3 6Y6G 8/6
6E75	4 6E977G	6 6E950(B)	4 8P41 2/6
6E94	7 6E977G	7 - E92G	8 6Y6H 2/6
6E19	15 - 25Z6GT	6 6E985	7 - 11G 9/6
6E20	15 - 25Z6GT	7 6E989	9 8 122 7/6
6Q7G	9 6S070R	3 6E991	7 - 124 12/6
6S47M	7 - 807AM	5 6E993	8 6Y65 12/6
6S67M	5 6E991	5 6E994	8 - 152 6/6
6S67M	7 - E92B3	7 - E92C6	7 6E942 9/6
6S67GT	8 - 807A	6 6E994	5 - CY41 8/-
6S74T	5 9E922	9 - M14	9 - 286 12/6

**S.A.E. FOR FREE LIST OF 500 SUPER SNIPS**

All items less 5%, and post free for a dozen. Postage 13 in 2d. Min. 6d. No. C.O.D. 10,000 SNIPS TO CALLERS.

**TECHNICAL TRADING CO.**  
350/352, FRATTON ROAD  
PORTSMOUTH

of the U146 is resistive and the scan coils are capacity coupled by virtue of a 40  $\mu$ F condenser from their earthy end to chassis. We suggest you check these components, starting with the valves. They are to be found behind the line output stage as you look in from the back.

#### MURPHY V204

If brilliance or contrast controls are advanced too much picture goes somewhat negative and white content goes fluorescent-looking. Fitting a 25 per cent. booster transformer to tube has improved matters a little but whites still go fluorescent if contrast or brilliance advanced too far. Retarding sensitivity control has slight improving effect. Do you think there is a low emission valve in the vision strip, possibly video amplifier? Mains tapping now on 200 volts, if placed in 240 volts, picture much too small, width and height. Have considered fitting a new tube but would like to fit a 17in. daylight viewer instead of the 15in. Mazda CRM152B. Could you suggest a suitable 17in. type or if not possible to do so, a suitable 15in. daylight viewer? R. T. Marley (Brynmawr).

We would say that your tube, although boosted, is still low emission. A check on your video amplifier is to measure its anode voltage, which should be 190v and if this is high, check the valve and anode load. Your small picture is no doubt due to a low metal H.T. rectifier. A 17in. tube such as the CRM172 can be fitted to your set if you supply a suitable mounting and 13 volts for the heater. You will also need to earth the graphite coating to chassis, reduce the focus field by physical or electrical shunts, supply an A1 voltage (there is 410v at the heater—not cathode—of the U281) and fit an ion trap magnet, I.T.9.

#### ULTRA VT917

My fault is an inch blank space at the bottom of the screen and about  $\frac{1}{4}$ in. at the top of screen, the height control being fully turned on. As the set warms up this blank space increases about  $\frac{1}{2}$ in. at the bottom. The width is all right except for a very slight wave in the raster on the extreme left of screen. The picture quality is perfect.—William Prance (Devoran).

We suggest you check the 20P3 frame output valve which is just beyond the EHT box next to a large resistor. If this does not cure your fault try the 20L1 frame oscillator beyond it and the 250  $\mu$ F and 100  $\mu$ F which decouple the 20P3 cathode to chassis and H.T. respectively. The VT917 was dealt with in our January and February issues this year, but we suggest you try our advertisers for a circuit for the Bush TV24 series.

#### EKCO TS1105

On switching on the picture comes on broken up horizontally. This can be cured by adjustment to the line hold, and quite a good bright picture is obtained, but during the next hour or

so the picture tends to stretch to the right and then break up. This can be cured by the line hold so that this control is returned to its first position. Also during this time the picture grows darker and closes up at the bottom about half an inch; any attempt to increase the brilliance of the picture results in the highlights flaring up, lack of contrast, negative picture and no picture. Sections of the picture are for most of the time slightly out of focus. These sections can be varied by use of the focus control. The raster lines are not clearly defined and no raster is obtained with aerial lead unplugged and brilliance fully advanced. Spark from EHT cap on C.R.T. will jump about  $\frac{1}{4}$ in. All valves have been changed or checked except PZ30 and 6D2.—F. J. Albutt (Coventry).

If all of your faults started about the same time we suggest you suspect the PZ30 and its circuit. As a check it should have about 250v D.C. on its cathode, which should not vary unduly throughout the evening. Components to suspect around the line oscillator circuit are the 2.2 megohm between H.T. and grid, and the two .001 mica condensers connecting anode to grid and screen to suppressor. Your "negative" effect is a symptom of failing tube emission, and your foldover at the bottom could be due to faulty valve pin contacts on the frame output SP61.

#### MURPHY 134C

This has been serviced by a local dealer for sound on vision. It was returned with a good picture but it was still affected by the sound. The cores of the tuning coils have now been altered and with a loudspeaker connected in the video valve (V6) I find I can tune in a strong sound signal, which shows as hash on the screen, but I cannot get vision and although the strength of the sound varies I cannot get rid of it. I have removed the first sound valve to make tests easier, V10. A milliammeter in the video output gives a no signal reading of 18 milliamps and when an aerial is plugged in this drops to 2 milliamps. I do not see that I can use a grid dip meter to check the alignment of coils owing to the cans and the leads are too short to get at.—W. Dossset (Perivale).

The V134C was designed to operate from the old double sideband transmission and has no sound rejector. We suggest that you fit one into the cathode lead of V4 and tune L19 for minimum sound on vision instead of maximum sound. We agree that a grid dip meter is not very good for alignment and advise you to revert to the alignment which you originally had before fitting the extra rejection.

#### QUERIES COUPON

This coupon is available until JUNE 21st, 1958, and must accompany all Queries sent in accord with the notice on page 549.

PRACTICAL TELEVISION, JUNE, 1953



**EDUCATIONAL**

**A.M.I.P.R.E.**—For details of suitable study courses (only a limited number of students accepted, send for free Syllabus of Instructional Text, I.P.R.E. Conditions of membership booklet 1/-. "The Practical Radio Engineer" journal, sample copy, 2/3. 6,000 alignment peaks for Superhets 6/-. All 2st free from SECRETARY, I.P.R.E., 10, Fairfield Road, London, N.8.

**FREE!** Brochure giving details of Home Study Training in Radio, Television and all branches of Electronics. Courses for the Hobby Enthusiast or for those aiming at the A.M.Brit.I.R.E., City and Guilds, R.T.E.B. and other Professional examinations. Train with college operated by British largest Electronics organisation. Moderate fees. Write to E.M.I. INSTITUTES, Dept. PT23, London, W.4.

**BUILD YOUR OWN T.V.** and learn about its operation, maintenance and servicing. Qualified engineer-tutor available while you are learning and building. Free Brochure from E.M.I. INSTITUTES, Dept. PT58, London, W.4. (Associated with H.M.V.)

**LEARN IT** as you do it—we provide practical equipment combined with instruction in Radio, Television, Electricity, Mechanics, Chemistry, Photography, etc. Write for full details to E.M.I. INSTITUTES, Dept. PT47, London, W.4.

**NEW-MAX ELECTRONICS LTD.**

For London's Finest Bargains in electronics, television and radio equipment.

500 REPOSSESSED AND SHOP SOILED T.V. SETS IN STOCK. ALSO LARGE SELECTION OF TAPE RECORDERS ALL GUARANTEED.

**T.V. TUBES**

RECLAIMED & GUARANTEED

10in. and 12in., 26/-; 14in., 25/-; 15in. and 17in., 27.10.0.

REBUILT TUBES with 6 mths. guarantee. 10in., 22.10.0.; 12in., 22/-; 14in., 21.10.0.; 15in., 21.2.10.0.; 17in., 21.4.

BRAND NEW FULLY GUARANTEED 14in. M.W. 30-24 tubes, 18.10.0. 17in. M.W. 43-64 tubes, 21.7.10.0. P.P. & Insurance on all tubes. 15/-

BRAND NEW T12 91 12in. flat face 2 volt filament. Ferranti tube will replace Brimar-Mazda-G.E.C. 12in. tubes. Price 21.0.10.0. Guaranteed 6 months. Also Ferranti 9in. T9-3 brand new 4 volt filament will replace G.E.C. Mazda or Brimar. 27.0.0.

B.S.R. Monarch 4-speed. 27.19.6 plus P. & P. 5/-

SPECIAL OFFER. The Schmidt T.V. projection optical box for 22in. picture back projection including focus and frame coils, less tube. Original price 80. Our price including P. & P. 25.10.

Orders and Callers to:

**NEW-MAX ELECTRONICS LTD.**

220 Edgware Road, London, W.2.

PAD 5807

**OPPORTUNITIES IN TELEVISION**

148 pages

**Free!**



Television offers unlimited scope to the technically qualified. Details of the easiest way to study for A.M.Brit.I.R.E., R.T.E.B. Cert., City and Guilds, Television, Television Servicing, Sound Film Projection, Radio Diploma Courses, etc., are given in our 148-page Handbook "ENGINEERING OPPORTUNITIES" which also explains the benefits of our Appointments Dept.

**We Guarantee "NO PASS—NO FEE"** If you are earning less than £20 a week you must read this enlightening book.

Send for your copy NOW—FREE and without obligation.

**WRITE TO-DAY!**

British Institute of Engineering Technology  
237, College House,  
29-31, Wright's Lane, **BIET**  
Kensington, W.8.

**T.V. RECTANGULAR TUBES**  
12 MONTHS GUARANTEE

17in. 27.10.0      14in. 25.10.0

Six months replacement, six months progressive. Made possible by the high quality of our tubes. Ins. Carr. 15.6. Convert your 9in., 10in., 12in. tubes to 11in., 15in., 16in. (round tubes). Our special offer for these sizes: 45/- Details on how to "Do-It-Yourself" in our free catalogue. 12in. T.V. Tubes, 28/- Three months guarantee on all round tubes. 15.6ins. Carr. on all tubes.

**EXTENSION SPEAKER, 29/9**



Complete. Fitted with 8in. P.M. speaker "W.B." or "GOODMANS" of the highest quality. Standard matching to any receiver (25 ohms). Flex & Switch included. Unrepeatable at this price. Money refunded if not completely satisfied. Ins. Carr. 3.6.

8in. P.M. SPEAKER, 8/9. Ideal for kitchen and bedroom extension. Let the lady of the house listen to that radio or T.V. programme. With output transformer fitted. 10/- P. & P. 2.6.

8in. SPEAKERS, 12/9. Goodmans or Elac. Highest quality 8in. P.M. Speakers. Complete with output transformer. 14/- P. & P. 2.9.

**HOME RADIO, 79/6**

Five-valve octal superhet three waveband receiver. Can be adapted for your gram. P.U. at a little extra cost. A.C. Size: 9 1/2in. x 9 1/2in. x 11 1/2in. A.C./D.C. Size: 9 1/2in. x 10 1/2in. or 9in. x 20 1/2in. x 12in. In attractive wooden cabinets. Ins. Carr. 4.6. Please state mains and size required when ordering.



GANG CONDENSERS, 1/9. 2 and 3 C17g Condensers. 500 p.f. Salvaged. Tested. P. & P. 1.3.

R.F. E.H.T. COIL, 19/6. 7-10 kV. R.F. frequency approx. 10 kc. Uses 6V6 or 761 as osc., suitable for ULTRA model V600, W700 and others. Size: 4 1/2in. x 2 1/2in. dia. Base, 4in. x 4 1/2in. Circuit drawings available. P. & P. 2.6.

Open SATURDAY ALL DAY.  
Liverpool Street Station—Manor  
Park Station 10 minutes.  
FREE 1958 CATALOGUE (just released).

**17in. T.V. CHASSIS, TUBE & SPEAKER, £19.19.6**

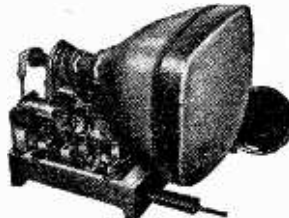

Latest improved circuits. Higher E.H.T. (brilliant picture), improved sensitivity (for greater range). Chassis easily fitted in any cabinet. 17in. Rectangular tube on adapted chassis. Less valves. 12 months guarantee on tube, three months guarantee on valves and chassis. With valves, 225.19.6. Valve line-up: 6SN7G, 6V6, EY61, 2 6D2s, EL28, EL11 and 7 6F1s. Turret Tuner. 50/- extra.

State B.B.C. & I.T.A. channel required. Extra channels supplied at 7.6 each. Ins. Carr. (incl. tube) 25/-

**14in. T.V. CHASSIS, TUBE & SPEAKER, £13.19.6**

As above with 14in. round tube, less valves. Three months guarantee. With valves, 219.19.6. Turret Tuner. 50/- extra. Ins. Carr. (incl. tube) 25/-

**POPULAR RADIO OR RADIOGRAM CHASSIS, 39/9**

Three waveband and gram. 5 het. Five valve (incl. octal). Ideal for tablegram, but still giving high-quality output. 4-knob control. 8in. P.M. speakers, 7/9 extra. Set of knobs 2/-. Size: 15 1/2in. x 7 1/2in. x 8 1/2in. Less valves. Ins. Carr. 5.6.



INSULATING TAPE, 1/6. Large roll in sealed metal container. BARGAIN! 75ft. x 1 1/2in. wide. It's a must at this price. Post 9d. N.B.—Postage on 6 tins is only 2/-. Buy now and save money.

SELF-FEED SOLDERING TOOL, 19/6. 110 volt or 6-12 volt. Made for the American market. Car batteries or mains, export quality. Complete in light carrying case. Reel of solder and spare parts. P. & P. 2.0. Adaptor 200-250 volts, 10/- extra.

**DUKE & CO.**

(Dept. 2) 621, ROMFORD ROAD,  
MANOR PARK, E.12.  
Tel: ILF 6001-3.

# LASKY'S RADIO

## MAKER'S SURPLUS COMPONENT BARGAINS

- WIDE ANGLE 38 mm.**
- Line E.H.T. trans. Ferro-cube core, 9-16 kv..... 25/-
  - Scanning Coils low imp. line and frame..... 25/-
  - Ferro-cube cored Scanning Coils and Line Output Trans., 10-15 kv. E.H.T. winding Line Trans. with circuit dia. pair..... 50/-
  - Frame Output Transformer Scanning Coils low imp. line and frame..... 18/6
  - Frame or line block osc. Transformer..... 4/6
  - Focus Magnets Ferro-cube P.M. Focus Magnets, Iron Cored..... 19/6
  - Duomag Focallers..... 22/6
  - 300 ma Smoothing Chokes... 15/-
- STANDARD 35 mm.**
- Line O.P. Trans. No. E.H.T. 12 6
  - Line Output Transformer, 6.3 kv. E.H.T. and 6.3 v. winding. Ferro-cube..... 19/6
  - Scanning coils. Low imp. line, and frame..... 12/6
  - Ditto by Igranite..... 14/9
  - Frame or line blocking oscillator transformer..... 4/6
  - Frame output transformer 7/6
  - Focus Magnets:
    - Without Verrier..... 12/6
    - With Verrier..... 17/6
  - 200 ma Smoothing Chokes 10/6

# LASKY'S LATEST SUPER BARGAIN! 13-CHANNEL ADAPTOR

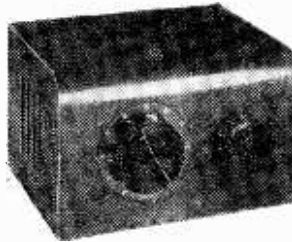

Brand New and Unused.  
LIST PRICE 7½ GNS.

LASKY'S PRICE **49/6**

Post and Pkg. 3/6

By famous manufacturer of the Pye group. This is a superb Front End Tuner incorporating 2 valves. Covers all Band I and Band III channels. I.F. output 33-38 mcs. Power requirements: 6.3 v. .3 amp heaters, 200/220 v. H.T.

In smart wood Cabinet, walnut veneer, 7½" x 6" x 5", complete with adaptor plugs, 2 new Mullard valves, knobs, in makers' original cartons. Note: Unit can be removed from Cabinet and fitted inside your TV set if desired.



**COLLARO 4-SPD. MIXER**  
**AUTO-CHANGERS** incorporating auto and manual control. Complete with Studio crystal p.u. and sapphire stylus. Mdl. RC.456, list £13,17/-.

LASKY'S PRICE **£7/19/6**  
Latest mdl. RC.457 or Continental. LASKY'S PRICE **£8.19.6**, Post 3/6.

C. R. TUBES, new, unused. 14", £14.19.6, 17", £16.19.6, 12", £8.19.6, 9", £5.17.6. Carr. & ins. 22/6.

### LASKY'S (HARROW ROAD) LTD.

42, TOTTENHAM COURT ROAD, W.I.  
370, HARROW ROAD, PADDINGTON, W.9.

Telephone: MUScum 2605  
LAD 4075 and CUN 1979

Open all day SATURDAY, Half-day Thursday.

PLEASE ADDRESS ALL MAIL ORDERS TO HARROW ROAD.

## TRANSFORMERS ?

### CONTACT Forrest FIRST!

Rewinding and manufacture of all types for Television Radio and Electronic Application.

**FORREST (TRANSFORMERS) LTD.,**  
Shirley, Solihull, Warwickshire.  
Phone: SH1. 2483. Est. 34 years.

## NEW CATALOGUE

of  
Radio and Television components available on request to

**J. T. FILMER**

82, Dartford Road, Dartford.  
Tel.: Dartford 4057

## RADIO AND TELEVISION COMPONENTS

We operate a prompt and efficient MAIL ORDER Service. 3d. stamp (only) for Lists.

**JAMES H. MARTIN & CO.**

Dept. PF.,  
FINSHAWALE, NEWBY-BRIDGE,  
ULVERSTON, LANCs.

## RES/CAP. BRIDGE 35/-

Checks all types of resistors and condensers.

Easy to Build Up Easy to Use  
**READY CALIBRATED**

Stamp for details of this and other kits.  
**RADIO MAIL (Dept. VA)**  
Raleigh Mews, Raleigh Street, Nottingham

## COVENTRY RADIO

Audio & Component Specialists Est. 1925  
189-191, Dunstable Rd., Luton, Beds.

### HI-FI EQUIPMENT CABINETS IN STOCK

Record Housing: Nordik Range in Oak, Walnut, Mahogany.

- Speaker Enclosure ... .. £5.17.6
- Equipment Cabinet ... .. £5.19.6
- Record Cabinet (150 records) £4.17.6
- Continental Bench ... .. £4.17.6
- Polenaise Hi-Fi Cabinet ... £19.19.0
- W.B. Prelude Speaker Cabinet £11.11.0
- W.B. Prelude Equipment Cabinet £13.13.0

- W.B. Prelude Corner Speaker Cabinet ... .. £10.10.0
- W.B. Table Equipment Cabinet £9.19.6
- W.B. Senior Hi-Fi Console ... £16.16.0
- W.B. Junior Hi-Fi Console ... £12.12.0
- W.B. Junior Base Reflex ... £9. 9.0
- W.B. Standard Base Reflex ... £10.10.0
- W.B. Senior Base Reflex Corner £11.11.0

### B.K. AUDIO PLAN

- B.K. Speaker Cabinet ... .. £16.19.6
- B.K. Equipment Cabinet ... £17.19.6
- B.K. Record Cabinet ... .. £16.16.0
- B.K. Continental Bench 48in. ... £7. 7.0
- B.K. Continental Bench 72in. ... £13.13.0
- B.K. Set 4 Legs tilt & glide feet £2. 2.0
- B.K. Set 4 Legs Plain Ebonised 19.6

### SOUTHDOWN Hi-Fi Cabinet

- R.C.A. Lowboy Cabinet ... £29.10.0
- HEALS Chairside for Quad ... £18.10.0
- HEALS Chairside ... .. £29.15.0
- HEALS Chairside ... .. £37. 0.0
- BREARCLIFFE Equip. Cab. £30. 9.0
- BREARCLIFFE Equip. Cab. £22. 1.0
- ARMSTRONG Equipment Cabinet £34.19.0

Leaflets available on request.

Airspaced Coaxial Cable, 75/30 ohms, new, 9d. per yd., 70/- per 100 yds.

Meters. 500 microamps, F.S.D. marked, 15/600 v., 2in. dial, 15/-.  
Pico All-in-one Meter, 0/6/240v., 0.9 ma. and circuit test, 32/8.  
Ion-Trap Magnets, 5/- Chrome car aerial, 37/6.

Sapphire Stylus Replacement Needles, Standard or L.P. All types at 8/- including T.C.4, HG.P37, HG.P50, Studio "O", T.C.5, etc. Please state cartridge number when ordering or enquiring. We will give you the "Needle" Postage 3d.

Television Aerials, Band III, 3-element, 28/8; 5-element, 30/8; 8-element, 36/8; Band I Single Dipole, 32/6; "H", 7/6. Also we carry huge stocks of all types. Why not send S.A.E. to us with your enquiry and we will answer by return.

Television Tables, Walnut finish, 20in. x 22in. x 24in. high. Packed flat in cartons, only four wing nuts to assemble. 72/6.  
Television Condensers, 100 mid. 450v., 6/8; 84 x 120 275 v., 13/6.  
Crossover Boxes for T.V., 12/- Coaxial Plugs, 1/-.

### GUARANTEED VALVES

- |       |      |        |       |       |        |
|-------|------|--------|-------|-------|--------|
| OZ4   | 5/-  | 6CD6G  | ECL82 | UCH42 | 8/6    |
| 1A5   | 3/-  | 24/6   | 12/8  | UL41  | 10/-   |
| 11LN5 | 2/6  | 19BC6G | EF85  | 8/6   | DL170  |
| 2X2   | 3/-  | 21/6   | EF86  | 10/6  | DL170  |
| 3D6   | 2/6  | 6BW5   | 8/6   | EL94  | 10/-   |
| 5U4   | 9/6  | 6BBG   | 5/6   | PC084 | 12/6   |
| 5Z4   | 8/6  | 6U7    | 6/-   | 12/6  | GSN7GT |
| 6AQ5  | 8/6  | 6EB1   | 5/-   | 35Z4G | 10/6   |
| 6AV6  | 8/6  | ECL80  | 1625  | 6/6   | 11/6   |
| 6BC6G | 19/6 | 12/6   | UCB41 | 8/-   | 6X4    |

MAIL ORDER ONLY—NO CALLERS.

Terms: C.W.O. or C.O.D. Minimum C.O.D. charge, 3/6. Postage and packing per valve, 6d. Other items: under £2, 19/-; under £5, 2/- All aeriels, 2/6 carriage. Aeriels cannot be sent C.O.D.

## ELECTRO-SERVICES & Co.

221 BATTERSEA PARK ROAD  
LONDON, S.W.11. MAC 1555

## SPUTNIK SPECIAL

SHORT-WAVE RECEIVER 10-80 Mc/s (5-30 Metres)  
RECEPTION SET TYPE 208

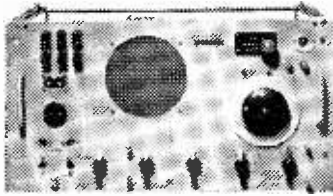

Complete with 6 valves, 2-6K8C, 2-EF39, 6Q7G and 6V6G. Internal mains power pack and 6 v. vibrator pack. Built-in 6 1/2" speaker. Muirhead slow-motion drive, B.F.O. and R.F. stage. Provision for Phones and Muting and 600 ohms. Combined Input 100/250 v. A.C. and 6 v. D.C. All sets in new condition and air tested. I.F. Frequency 2 Mc/s.

£6/19/6 Carr. 15.6.

BE PREPARED TO LISTEN TO THE SATELLITES

## "TRANSISTOR-8"

COMBINED CAR-RADIO & PORTABLE PUSH-PULL SUPERHET  
Can be built for £11/10/-

Send for Free Booklet and Price List. Car Radio Conversion Components, 8/- extra.

We can supply all these items including Cabinet for all parts sold separately.

## MINI-TWO

TWO-TRANSISTOR MINIATURE POCKET RADIO  
The smallest Transistor set offered on the market. Variable Tuning. Drilled Chassis, Plastic Case size 3in. x 2in. x 1in.. Miniature Hearing Aid. 2 Transistors and all components including 3 volt Battery. Circuits and full practical layout diagrams.  
Total Cost **47/6** Complete

## "EAVESDROPPER"

THREE TRANSISTOR POCKET RADIO  
(No Aerial or Earth required)

Variable Tuning. Total cost, as specified including Transistors, Transformers, Coils, Condensers and Battery, etc., with circuit and plastic case. **70/-** POST FREE.  
All items sold separately.  
With Balanced Armature, 73 6. With Acos Mike, 82/6. With High Impedance Hearing Aid, 86 -.

## MINI-7 POCKET TRANSISTOR PORTABLE JUST ARRIVED!

Complete with Plastic Case, Repanco Coils and all Components. Drilled Chassis and Point-to-Point Wiring. At an inclusive price of £9 19 6. P.P. 26. Long Wave 10 6 extra.

Send 1 6 for Booklet and Diagrams.

## "HOMELIGHT"

2-TRANSISTOR PERSONAL PORTABLE  
Variable Tuning

We can supply all components including 2 Transistors Diode, Resistors, Condensers and Miniature Hearing Aid and Plastic Case size 4 1/2 x 2 1/2 x 1in. and 1 1/2 v. Battery.

FOR **52/6**

All items sold separately.

## "HOMELIGHT III"

As above but with extra Transistor stage increasing output. Complete with 3-Transistor, etc.. **58/6**

## TRANSISTORS

RED-SPOT 800 kc/s Audio Frequency, 7 6.  
WHITE-SPOT 2.5 Mc/s R.F. and I.F. Amp., 15 -.  
RED YELLOW 1.5 to 8 Mc/s R.F. and I.F. Amp., 21 -.

SEND STAMPS FOR NEW 1958 28-PAGE CATALOGUE  
OPEN MONDAY to SAT. 9-6. THURS. 1 o'clock.

**HENRY'S RADIO LTD.**  
5 HARROW ROAD, EDGWARE ROAD, LONDON, W.2  
TEL.: PADDINGTON 1008-9

# VALVES • SAME DAY SERVICE

All Guaranteed New and Boxed

1.4v. midget, 1R5, 1S5, 1T4, 3S4, 3Q4, 3V4, DAF91, DF91, DK91, DL92, DK92, DL94.; ANY 4 for 27/6.

1A7GT	13/6	6U4GT	11/-	B36	15/-	EF42	11/6	PL81	16/-
1C5GT	13/-	6V6G	7/-	CL33	16/9	EF50		PL82	8/6
1D5	12/6	6V6GT	7/6	D77	5/6	FXL		PL83	10/8
1R5GT	11/-	6X4	7/6	DAC32	11/-	EF55	9/6	PY80	8/-
1N5GT	11/-	6X5GT	8/6	DAF86	8/6	EF80	7/6	PY81	8/-
1R5	8/-	7B6	12/6	DF33	11/-	EF91	7/3	PY82	8/-
1S5	7/6	7B7	8/-	DF96	8/6	EF92	5/6	PY83	8/6
1T4	7/-	7C5	8/-	DH76	7/6	EL33	18/9	PZ30	18/-
3A5	10/6	7C6	8/-	DH77	7/3	EL36	22/6	R19	15/-
3Q4	7/6	7HT	8/-	DK32	13/6	EL41	9/6	SP41	3/6
3Q5GT	9/6	7E4	9/-	DK92	8/6	EL42	11/6	SP61	3/6
3S4	7/6	7Y4	8/-	DK96	8/6	EL84	8/6	U50	7/6
3V4	8/6	12AH8	9/-	DL33	9/-	EM80	9/6	U76	7/6
5U4C	8/-	12AT6	8/-	DL35	13/-	EM81	10/-	U78	7/-
5V4C	11/9	12AT7	8/-	DL96	8/6	EY51	11/6	UABC80	9/-
5Y3GT	7/6	12AU7	8/-	EABC80	7/9	EY86	15/-	UAF42	9/6
5Z4C	9/6	12AX7	8/-	EAF42	9/6	EZ40	7/9	UBC41	8/6
6AL5	5/6	12BA6	8/-	EB91	5/6	EZ41	9/6	UBF80	9/-
6AM5	5/-	12J7GT	10/8	EB33	7/6	EZ80	7/6	UCC85	9/-
6AM6	7/3	12K7GT	7/6	EBC41	9/6	EZ81	9/-	UCH42	9/-
6AQ5	7/6	12K8GT	13/6	EBF80	8/9	FW4500	11/6	UCH81	9/6
6AT6	7/3	12Q7GT	7/6	ECC81	8/-	GZ32	11/-	UCL83	15/6
6BA6	7/-	12Z3	7/6	ECC82	8/-	KT33C	8/6	UF41	8/-
6BE6	7/-	14S7	12/-	ECC83	8/-	KT63	6/6	UF42	15/-
6BH6	9/-	19AQ5	7/6	ECC84	9/6	MH4	8/-	UF89	9/-
6BJ6	7/-	22AG7	13/6	ECC85	9/6	MU14	9/-	UL41	8/9
6BR7	8/6	25A6T	8/6	ECP80	10/6	N18	7/8	UL44	22/6
6BW6	7/6	25Z4G	9/6	ECP82	11/-	PCF84	9/-	UL84	8/6
6BW7	7/6	25Z6GT	9/-	ECH21	16/9	PCF80	10/-	UR1C	12/6
6CD6G	25/-	35L6GT	9/6	ECH35	10/-	PCF82	10/-	UY21	14/6
6F6C	6/6	35Z4GT	7/6	ECH42	9/-	PCL82	10/-	UY41	8/6
6K7G	4/6	35Z5GT	9/6	ECH81	8/-	PCL83	12/-	UY85	7/6
6K7GT	6/-	43	12/6	ECH80	10/-	PEN44	11/-	VP4B	14/6
6K8G	7/9	50CD6G		ECL82	12/-	PEN36C	14/6	VP41	6/6
6L18	12/6			EF37A	8/6	PEN46	8/-	VP1321	21/-
6Q7GT	9/-	50L6GT	8/6	EF39	6/-	PL36	15/-	W75	7/6
6SL7GT	7/-	AZ31	11/6	EF41	9/6	PL38	22/6	W77	5/8
6SN7GT	7/6					Z77			7/3

Any Parcel Insured Against Damage in Transit 6d. extra.

## READERS RADIO

24, COLBERG PLACE, STAMFORD HILL,  
LONDON, N.16 STA. 4587

# BAND III CONVERTOR

for ANY SET in ANY AREA

This unit has been widely used since I.T.A. Transmissions began to convert all types of sets, Superhet and T.R.F., to receive on Band III.

Unlike many other convertors this unit is small enough to be fitted inside your cabinet, enabling the job to appear finished and perfectly safe for all to use.

The wiring is simple to follow, and alignment is not difficult.

- ★ IT will convert any set, any age, T.R.F. or Superhet.
- ★ IT includes station switching.
- ★ IT provides pre-set contrast balancing.
- ★ IT uses only one aerial input for both bands
- ★ IT provides manual tuning on Band III.
- ★ IT is totally screened.
- ★ IT completely rejects unwanted signals.
- ★ IT requires no additional power supply where either 6.3 v. or .3 amp. heater line is available.

CONVERTOR wired and aligned with fitting instructions	£3 10 6
KIT complete in every detail, less knobs	£2 10 6
KNOBS each	1 0
CIRCUIT and instructions in detail (free with kit)	1 6
KITS made up by customers checked and aligned, including post	12 6

When ordering please state present B.C. Station and I.T.A.

Orders over £2 post free.

## C. & G. KITS

285, LOWER ADDISCOMBE ROAD,  
ADDISCOMBE, CROYDON, SURREY

Phone: ADDISCOMBE 5262

## YOUR OWN TELEVISION TUBE RE-BUILT

THE FOLLOWING TYPES AND SIZES ONLY.

<b>MULLARD</b> ..	12in. £7-10-0.	14in. £8-10-0.
OR EQUIVALENTS COSSOR-EMITRON-CATHODEON	17in. £10-10-0.	21in. £12-10-0.

<b>MAZDA</b> ..	14in. £8-10-0.	17in. £10-10-0.
-----------------	----------------	-----------------

All Tubes plus 15/- carriage and insurance.

### SIX MONTHS' GUARANTEE

Terms to the Trade.

Tubes can be sent to us by British Road Services (Parcels) Ltd. Carriage forward.

TERMS, CASH WITH ORDER or C.O.D.

## RE-VIEW (LONDON) LTD.

81, HIGH STREET . . . MERTON S.W.19

Telephone : CHERRYWOOD 3255

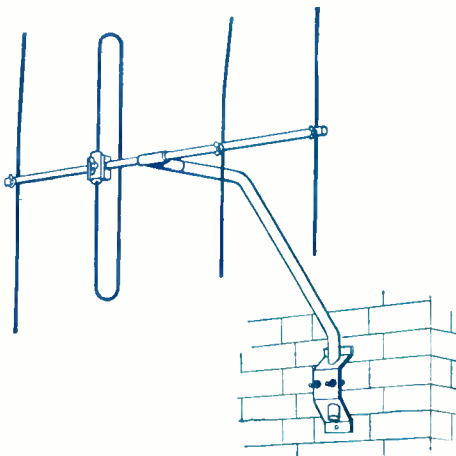

This powerful 4-element, pre-assembled, wide spaced Band III beam Aerial by a leading manufacturer. Supplied complete with cranked pole and wall fixing brackets, can also be loft mounted. Listed at 55/6.

**Our price, Brand New, in maker's sealed carton, 39/6.**

4-element Aerials, array only, for mounting to 1½ in. diameter mast, 25/-.

Cellular polythene Co-axial Cable at 8d. per yard supplied if required.

## SPECIAL OFFER THIS MONTH LIMITED QUANTITY

### SPIRAL

The easiest possible dual-band aerial to fit. Just plug it into the set. Ideal for ranges up to 10/15 miles, depending upon locality. Bargain offer 19/11 post free.

Double 4-element Aerials, array only, complete with Cross-over unit. Matching Stubs wired to folded dipoles. Few only, 79/6.

Terms : Cash with order or C.O.D.  
Carriage on aerials 2/6 extra.

MAIL ORDER ONLY.

**G. C. EQUIPMENT CO. LIMITED**  
2, Park Row, Leeds, 1



C.R.T. ISOLATION TRANSFORMER

Type A. Low leakage windings. Ratio 1:1.25 giving a 25% boost on secondary. 10 v. 10.6; 4 v. 10.8; 6.3 v. 10.8; 10.8 v. 10.6; 13.3 v. 10.6.

Type B. Mains input 220-240 volts. Multi output 2, 4, 6.3, 7.5, 10 and 12 volts. Input has two taps which increase output volts by 25% and 50% respectively. Low capacity suitable for most Cathode Ray Tubes, 21". Ditto for 6 v. C.R. Tubes only, 17/8.

Type C. Low capacity wound transformer for use with 2 volt Tubes with falling emitters. Input 220-240 volts. Output 2-2 1/2-2 1/2-3 volts at 2 amps. With Tag Panel, 17/8 each. NOTE.—It is essential to use mains primary types with T.V. receivers having series-connected heaters.

TRIMMERS, Ceramic, .30, .50, 70 pf., 8d.; 100 pf. 150 pf. 1.3; 250 pf., 1.6; 500 pf., 750 pf., 1.9. RESISTORS, Preferred values, 10 ohms to 10 meg., 2 w., 4d.; 1 w., 6d.; 1 1/2 w., 8d.; 2 w., 1s. HIGH STABILITY 1% 100 ohms to 10 meg., 7d. WIRE-WOUND RESISTORS (13 10 watt) 25 ohms—10,000 ohms..... 1 6 10,000 ohms—50,000 ohms, 5 w., 1 9; 10 w., 2 3

12 6 PURETONE RECORDING TAPE

1,200 ft. on standard 7" Metal reels. Spare Reels 7" plastic 4-, 7" metal, 2 3. SUPERIOR 1,200ft. Plastic Tape on 7" Plastic Reels, 21/-.

O.P. TRANSFORMERS. Heavy Duty 50 mA., 4/6. Multitrate, push-pull, 7/6. Miniature, 484, etc., 4/6. L.F. CHOKES 15-10 H. 60/65 mA., 5/-; 10 H. 80 mA., 8/6; 10 H. 150 mA., 12/6. MAINS TRANS. 350/0-350, 80 mA., 6.3 v. tapped, 4 v. 4 s. 5 v. 6 v. 7.5 v. 10 v. 12 v. 250-0-250, 80 mA., 6 v. 4 s. 4 v. 2 s. 15/- HEATER TRANS. Tapped prim., 200-250 v., 6 v. 11 amp., 7/6; tapped sec., 2, 4, 6.3 v., 11 amp., 8/6; prim. 250 v. Sec. 6.3 v. 3 amp., 10/6. ALADDIN TRANSFORMERS and cores, 10 in., 10d. 6 in. FORMERS 50/75 and 100/125, 2 in. sq. x 2 in. sq. x 2 in., 2 s. ea., with core, 2/0. TYANA.—Midget Soldering Iron, 200-220 v. or 200-250 v., 10 9. Solon Instrument Iron, 24/-.

MAINS DROPPERS. 3 in. x 1 1/2 in. All Sliders. 1 s. 750 ohms, 4 3; 921 amp., 1 amp. ohms, 4 3. LINE CORD, 3 amp., 60 ohms per foot, 2 amp., 100 ohms per foot, 2-way, 6d. per foot, 3-way, 7d. per ft. LOUDSPEAKER P.M. 3 OHM. 2 in. Dia. square, 17 6. 5 in. Goodmans, 17 6. 7 in. x 4 in. Goodmans, 21-. 2 1/2 in. Squares, 18 21-. 2 in. Plessey, 19 6. 6 in. Goodmans, 18 6. 10 in. x 6 in. Potted, 10 6. T.S.L. Speaker, LS475, 8 6. 12 in. Plessey, 30 6. M.E. 2-2k. field, tapped O.P. trans., 24 6. 15 ohm Plessey 10 w. 12 in. with Tweeter, 97 6. CRYSTAL DIODE G.E.C. 2 s. GEX34, 4/-. HIGH RESISTANCE PHONES. 500 ohms, 18 6 pr. MIKE TRANS. 50/75 and 100/125, 2 in. sq. x 2 in. sq. x 2 in., 2 s. ea., with core, 2/0. SWITCH CLEANER Fluid squirt sprout, 4 3 1/2 in. TWIN GANG TUNING CONDENSERS. 363 pf. miniature lin. x 1 1/2 in. x 1 1/2 in., 1000 standard with trimmers, 9/-; less trimmers, 8/-; midget, 7 6; SINGLE, 50 pf., 2 6; 100 pf., 2/-; 150 pf., 8 6. 500 pf. dielectric 100, 200, 500 pf., 3 6. SPEAKER FRET. Expanded Metal Silver, 4 1/2 in. x 9 1/2 in., 2 s. each. GOLD CLOTH. 17 in. x 25 in., 5 s.; 25 in. x 35 in., 10/-. Tzvan 4 ft. 6 in. wide, 10/-; 20 ft. 3 in. wide, 5/- ft.

All Boxed VALVES New and Guaranteed

Table listing various vacuum tube valves with their types and prices. Columns include valve type (e.g., 6X4, 6BE6), price, and other specifications.

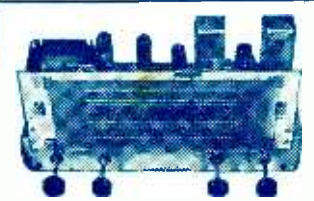

1958 RADIOGRAM CHASSIS

THREE WAVEBANDS. FIVE VALVES S.W. 16 m.—50 m. LATEST MULLARD M.W. 200 m.—550 m. ECH2, EF41, EBC11, L.W. 800 m.—2,000 m. E41, E240, E42

12-month guarantee. Short-Medium-Long-Range, A.V.C. and Negative feedback 4.2 watts. Chassis 14 1/2 x 5 1/2 x 2 1/2 in. Glass dial 10 x 4 in. horizontal or vertical available. 2 Pilot Lamps, Four Knobs, Walnut or Ivory. Aligned and calibrated. Chassis isolated from mains.

10 gns. Carr. & Ins. 4 6.

TERMS: Deposit £5.5.0 and six monthly payments of £1.10.0. LATEST MULLARD MATCHED SPEAKERS FOR ABOVE CHASSIS. Size, 17/8; 10 in., 25/-; 12 in., 30/-.

\* COLLARO & HIGH-FIDELITY AUTOMATIC Model R456 4-SPEEDS—10 RECORDS With Studio "O" pick-up BRAND NEW IN MAKER'S BOXES

OUR PRICE £9.15.0. post free. TERMS: Deposit £5.5.0 and six monthly payments of £1. Suitable Player Cabinets, 49 6. Amplifier Player Cabinets, 63 -.

IMPORTANT NOTICE

ALL THESE RECORD PLAYERS ARE FULLY GUARANTEED AND SPARES ARE AVAILABLE

GARRARD 4-SPEED SINGLE RECORD PLAYER 45P.

AUDIO PERFECTION

Designed to play 16, 33, 45, 78 r.p.m. Records. 7 in., 10 in., 12 in. Lighter, Metal pick-up. G2C turnover head, two separate sapphire styl.

OUR PRICE £8.0.0. each. Post Free. TERMS: Deposit £5 and 4 monthly payments of £1. Space required 14 in. x 12 in. Amplifier Player Cabinets 45 -.

BUILD THIS REPRODUCER BARGAIN

Special Single Player Kits. Famous Maker's surplus stocks. 4-speed Collaro Junior gram. pick-up unit, £4 12 6. Handmade portable case, 17 in. x 12 in. x 7 in., 22/5 0. Rose and Cream Revine. Ready-built 3-watt amplifier with valves and 7 in. elliptical loudspeaker, £9 12 6. All available separately or if all purchased together, £9 15 0. complete kit, post free, £3 5 0 extra, with Garrard 4 Sp.

ALUMINIUM CHASSIS. 15 s.w.g. un drilled. With 4 sides, riveted corners and lattice fixing holes, 2 1/2 in. sides, 7 x 4 in., 4 6; 8 x 7 in., 5 9; 11 x 7 in., 8 9; 13 x 9 in., 8 6; 14 x 11 in., 10 6; 15 x 11 in., 12 6; 18 x 11 in., 16 6.

TRANSISTORS. Audio, 10/-; R.F. 2/6 M.C. 21 -; Mullard OC71, 20 -.

HANDY VOLT METERS. 2 in. Twin Range, 0-25 v. 0-250 v. D.C. with leads and leather case 12 6 complete.

CRYSTAL MIKE INSERT by Acos, precision engineered, size only 1 1/2 in. x 1 1/2 in. Bargain Price 6 6. No transformer required.

TELETRON CRYSTAL SET KIT. Cabinet chassis components. Price 15/-, with H.R. Phones, 30/-.

HI-GAIN BAND 3 PRE-AMP KIT. 4-speed circuit using valve PC84. Price 27 6. With Power Pak 49 6. Instructions only 1 6.

COSSOR COMPANION

SUPERHET MODEL 527 X FOR ALL-DRY BATTERY OPERATION S.W.A. 13.6 to 43 metres, S.W.2 428 to 195 metres, Medium 187 to 575 metres. A fine All-wave receiver giving world wide reception on three wavebands. 6 in. speaker. The cabinet is maroon and beige with gold trimmings. Valves: HK21, DF90, HA100, DL90. SIZE 9 1/2 in. x 6 1/2 in. x 4 1/2 in. Loudet S.A.E. OUR PRICE £66.0. (incl. H.T. 17 6 extra) 10000 ohms to 2 Meg. No. Sw. 11 P.S.W. 3 - 4 9. Fringe Quality. 1/6 yd. Linear or Log Tracks. Air Stated.

Volume Controls 80 ohm (CABLE) COAX

Long spindles. Guaranteed 1 year. Midget 10,000 ohms to 2 Meg. No. Sw. 11 P.S.W. 3 - 4 9. Fringe Quality. 1/6 yd. Linear or Log Tracks. Air Stated.

COAX PLUGS — 1 - DOUBLE SOCKET — 1 3 SOCKETS — 1 - OUTLET BOXES 4 8 BALANCED TWIN FEEDER yd. 6d. 800 to 200 ohms, DITTO SCREENED per yd. 1-. 80 ohms only WIRE-WOUND POTS. 3 WATT. Pre-set. Mini. 3 Types. All values 20 to 20 K. 3 s. ea. 20 K. 4 s. (carbon 50 K. to 200 K. 3/-). WIRE-WOUND 4 WATT. Pots 2 1/2 in. Spindle Values. 100 ohms to 20 K. 5 6; 100 K. 6 6. CONDENSERS. New Stock. 100 mfd. 7 kV. 1 1/2 s. 5 6. 100 pf., 20 kv., 9 6; 100 pf. 100 pf. Micas 64. Tubular 500 v. 100 to 10 mfd. 9d.; 100 v. 100 to 10 mfd. 9d.; 50 v. 100 to 10 mfd. 9d.; 25 v. 100 to 10 mfd. 9d.; 10 v. 100 to 10 mfd. 9d.; 5 v. 100 to 10 mfd. 9d.; 2.5 v. 100 to 10 mfd. 9d.; 1 mfd. 2,000 volts, 3 6. CERAMIC COND. 500 v. 3 pf. to 10 mfd. 10d. SILVER MICA CONDENSERS. 10% close tolerance (1 p.p.f.) 1.5 pf. to 47 pf., 1 6. Ditto 1% 50 pf. to 815 pf., 1 9; 1,000 pf. to 5,000 pf., 2 -.

I.F. TRANSFORMERS 7/6 pair.

485 Kcs Slug tuning Miniature Can. 2 1/2 in. x 1 in. x 1 in. High Q and good bandwidth. By Pre Radio. Data sheet supplied. Wearite M800 I.F. 485 Kcs 12 6 per pair. Wearite 550 I.F. 485 Kcs 12 6 per pair.

NEW ELECTROLYTICS. FAMOUS MAKES

Table listing electrolytic capacitors from various manufacturers (TUBULAR, CAN TYPES) with their values and prices.

SENTECER RECTIFIERS. E.H.T. TYPE FL6

250 v. 200 v. 500 v. 1000 v. 1500 v. 2000 v. 2500 v. 3000 v. 3500 v. 4000 v. 4500 v. 5000 v. 5500 v. 6000 v. 6500 v. 7000 v. 7500 v. 8000 v. 8500 v. 9000 v. 9500 v. 10000 v. 10500 v. 11000 v. 11500 v. 12000 v. 12500 v. 13000 v. 13500 v. 14000 v. 14500 v. 15000 v. 15500 v. 16000 v. 16500 v. 17000 v. 17500 v. 18000 v. 18500 v. 19000 v. 19500 v. 20000 v. 20500 v. 21000 v. 21500 v. 22000 v. 22500 v. 23000 v. 23500 v. 24000 v. 24500 v. 25000 v. 25500 v. 26000 v. 26500 v. 27000 v. 27500 v. 28000 v. 28500 v. 29000 v. 29500 v. 30000 v. 30500 v. 31000 v. 31500 v. 32000 v. 32500 v. 33000 v. 33500 v. 34000 v. 34500 v. 35000 v. 35500 v. 36000 v. 36500 v. 37000 v. 37500 v. 38000 v. 38500 v. 39000 v. 39500 v. 40000 v. 40500 v. 41000 v. 41500 v. 42000 v. 42500 v. 43000 v. 43500 v. 44000 v. 44500 v. 45000 v. 45500 v. 46000 v. 46500 v. 47000 v. 47500 v. 48000 v. 48500 v. 49000 v. 49500 v. 50000 v. 50500 v. 51000 v. 51500 v. 52000 v. 52500 v. 53000 v. 53500 v. 54000 v. 54500 v. 55000 v. 55500 v. 56000 v. 56500 v. 57000 v. 57500 v. 58000 v. 58500 v. 59000 v. 59500 v. 60000 v. 60500 v. 61000 v. 61500 v. 62000 v. 62500 v. 63000 v. 63500 v. 64000 v. 64500 v. 65000 v. 65500 v. 66000 v. 66500 v. 67000 v. 67500 v. 68000 v. 68500 v. 69000 v. 69500 v. 70000 v. 70500 v. 71000 v. 71500 v. 72000 v. 72500 v. 73000 v. 73500 v. 74000 v. 74500 v. 75000 v. 75500 v. 76000 v. 76500 v. 77000 v. 77500 v. 78000 v. 78500 v. 79000 v. 79500 v. 80000 v. 80500 v. 81000 v. 81500 v. 82000 v. 82500 v. 83000 v. 83500 v. 84000 v. 84500 v. 85000 v. 85500 v. 86000 v. 86500 v. 87000 v. 87500 v. 88000 v. 88500 v. 89000 v. 89500 v. 90000 v. 90500 v. 91000 v. 91500 v. 92000 v. 92500 v. 93000 v. 93500 v. 94000 v. 94500 v. 95000 v. 95500 v. 96000 v. 96500 v. 97000 v. 97500 v. 98000 v. 98500 v. 99000 v. 99500 v. 100000 v. 100500 v. 101000 v. 101500 v. 102000 v. 102500 v. 103000 v. 103500 v. 104000 v. 104500 v. 105000 v. 105500 v. 106000 v. 106500 v. 107000 v. 107500 v. 108000 v. 108500 v. 109000 v. 109500 v. 110000 v. 110500 v. 111000 v. 111500 v. 112000 v. 112500 v. 113000 v. 113500 v. 114000 v. 114500 v. 115000 v. 115500 v. 116000 v. 116500 v. 117000 v. 117500 v. 118000 v. 118500 v. 119000 v. 119500 v. 120000 v. 120500 v. 121000 v. 121500 v. 122000 v. 122500 v. 123000 v. 123500 v. 124000 v. 124500 v. 125000 v. 125500 v. 126000 v. 126500 v. 127000 v. 127500 v. 128000 v. 128500 v. 129000 v. 129500 v. 130000 v. 130500 v. 131000 v. 131500 v. 132000 v. 132500 v. 133000 v. 133500 v. 134000 v. 134500 v. 135000 v. 135500 v. 136000 v. 136500 v. 137000 v. 137500 v. 138000 v. 138500 v. 139000 v. 139500 v. 140000 v. 140500 v. 141000 v. 141500 v. 142000 v. 142500 v. 143000 v. 143500 v. 144000 v. 144500 v. 145000 v. 145500 v. 146000 v. 146500 v. 147000 v. 147500 v. 148000 v. 148500 v. 149000 v. 149500 v. 150000 v. 150500 v. 151000 v. 151500 v. 152000 v. 152500 v. 153000 v. 153500 v. 154000 v. 154500 v. 155000 v. 155500 v. 156000 v. 156500 v. 157000 v. 157500 v. 158000 v. 158500 v. 159000 v. 159500 v. 160000 v. 160500 v. 161000 v. 161500 v. 162000 v. 162500 v. 163000 v. 163500 v. 164000 v. 164500 v. 165000 v. 165500 v. 166000 v. 166500 v. 167000 v. 167500 v. 168000 v. 168500 v. 169000 v. 169500 v. 170000 v. 170500 v. 171000 v. 171500 v. 172000 v. 172500 v. 173000 v. 173500 v. 174000 v. 174500 v. 175000 v. 175500 v. 176000 v. 176500 v. 177000 v. 177500 v. 178000 v. 178500 v. 179000 v. 179500 v. 180000 v. 180500 v. 181000 v. 181500 v. 182000 v. 182500 v. 183000 v. 183500 v. 184000 v. 184500 v. 185000 v. 185500 v. 186000 v. 186500 v. 187000 v. 187500 v. 188000 v. 188500 v. 189000 v. 189500 v. 190000 v. 190500 v. 191000 v. 191500 v. 192000 v. 192500 v. 193000 v. 193500 v. 194000 v. 194500 v. 195000 v. 195500 v. 196000 v. 196500 v. 197000 v. 197500 v. 198000 v. 198500 v. 199000 v. 199500 v. 200000 v. 200500 v. 201000 v. 201500 v. 202000 v. 202500 v. 203000 v. 203500 v. 204000 v. 204500 v. 205000 v. 205500 v. 206000 v. 206500 v. 207000 v. 207500 v. 208000 v. 208500 v. 209000 v. 209500 v. 210000 v. 210500 v. 211000 v. 211500 v. 212000 v. 212500 v. 213000 v. 213500 v. 214000 v. 214500 v. 215000 v. 215500 v. 216000 v. 216500 v. 217000 v. 217500 v. 218000 v. 218500 v. 219000 v. 219500 v. 220000 v. 220500 v. 221000 v. 221500 v. 222000 v. 222500 v. 223000 v. 223500 v. 224000 v. 224500 v. 225000 v. 225500 v. 226000 v. 226500 v. 227000 v. 227500 v. 228000 v. 228500 v. 229000 v. 229500 v. 230000 v. 230500 v. 231000 v. 231500 v. 232000 v. 232500 v. 233000 v. 233500 v. 234000 v. 234500 v. 235000 v. 235500 v. 236000 v. 236500 v. 237000 v. 237500 v. 238000 v. 238500 v. 239000 v. 239500 v. 240000 v. 240500 v. 241000 v. 241500 v. 242000 v. 242500 v. 243000 v. 243500 v. 244000 v. 244500 v. 245000 v. 245500 v. 246000 v. 246500 v. 247000 v. 247500 v. 248000 v. 248500 v. 249000 v. 249500 v. 250000 v. 250500 v. 251000 v. 251500 v. 252000 v. 252500 v. 253000 v. 253500 v. 254000 v. 254500 v. 255000 v. 255500 v. 256000 v. 256500 v. 257000 v. 257500 v. 258000 v. 258500 v. 259000 v. 259500 v. 260000 v. 260500 v. 261000 v. 261500 v. 262000 v. 262500 v. 263000 v. 263500 v. 264000 v. 264500 v. 265000 v. 265500 v. 266000 v. 266500 v. 267000 v. 267500 v. 268000 v. 268500 v. 269000 v. 269500 v. 270000 v. 270500 v. 271000 v. 271500 v. 272000 v. 272500 v. 273000 v. 273500 v. 274000 v. 274500 v. 275000 v. 275500 v. 276000 v. 276500 v. 277000 v. 277500 v. 278000 v. 278500 v. 279000 v. 279500 v. 280000 v. 280500 v. 281000 v. 281500 v. 282000 v. 282500 v. 283000 v. 283500 v. 284000 v. 284500 v. 285000 v. 285500 v. 286000 v. 286500 v. 287000 v. 287500 v. 288000 v. 288500 v. 289000 v. 289500 v. 290000 v. 290500 v. 291000 v. 291500 v. 292000 v. 292500 v. 293000 v. 293500 v. 294000 v. 294500 v. 295000 v. 295500 v. 296000 v. 296500 v. 297000 v. 297500 v. 298000 v. 298500 v. 299000 v. 299500 v. 300000 v. 300500 v. 301000 v. 301500 v. 302000 v. 302500 v. 303000 v. 303500 v. 304000 v. 304500 v. 305000 v. 305500 v. 306000 v. 306500 v. 307000 v. 307500 v. 308000 v. 308500 v. 309000 v. 309500 v. 310000 v. 310500 v. 311000 v. 311500 v. 312000 v. 312500 v. 313000 v. 313500 v. 314000 v. 314500 v. 315000 v. 315500 v. 316000 v. 316500 v. 317000 v. 317500 v. 318000 v. 318500 v. 319000 v. 319500 v. 320000 v. 320500 v. 321000 v. 321500 v. 322000 v. 322500 v. 323000 v. 323500 v. 324000 v. 324500 v. 325000 v. 325500 v. 326000 v. 326500 v. 327000 v. 327500 v. 328000 v. 328500 v. 329000 v. 329500 v. 330000 v. 330500 v. 331000 v. 331500 v. 332000 v. 332500 v. 333000 v. 333500 v. 334000 v. 334500 v. 335000 v. 335500 v. 336000 v. 336500 v. 337000 v. 337500 v. 338000 v. 338500 v. 339000 v. 339500 v. 340000 v. 340500 v. 341000 v. 341500 v. 342000 v. 342500 v. 343000 v. 343500 v. 344000 v. 344500 v. 345000 v. 345500 v. 346000 v. 346500 v. 347000 v. 347500 v. 348000 v. 348500 v. 349000 v. 349500 v. 350000 v. 350500 v. 351000 v. 351500 v. 352000 v. 352500 v. 353000 v. 353500 v. 354000 v. 354500 v. 355000 v. 355500 v. 356000 v. 356500 v. 357000 v. 357500 v. 358000 v. 358500 v. 359000 v. 359500 v. 360000 v. 360500 v. 361000 v. 361500 v. 362000 v. 362500 v. 363000 v. 363500 v. 364000 v. 364500 v. 365000 v. 365500 v. 366000 v. 366500 v. 367000 v. 367500 v. 368000 v. 368500 v. 369000 v. 369500 v. 370000 v. 370500 v. 371000 v. 371500 v. 372000 v. 372500 v. 373000 v. 373500 v. 374000 v. 374500 v. 375000 v. 375500 v. 376000 v. 376500 v. 377000 v. 377500 v. 378000 v. 378500 v. 379000 v. 379500 v. 380000 v. 380500 v. 381000 v. 381500 v. 382000 v. 382500 v. 383000 v. 383500 v. 384000 v. 384500 v. 385000 v. 385500 v. 386000 v. 386500 v. 387000 v. 387500 v. 388000 v. 388500 v. 389000 v. 389500 v. 390000 v. 390500 v. 391000 v. 391500 v. 392000 v. 392500 v. 393000 v. 393500 v. 394000 v. 394500 v. 395000 v. 395500 v. 396000 v. 396500 v. 397000 v. 397500 v. 398000 v. 398500 v. 399000 v. 399500 v. 400000 v. 400500 v. 401000 v. 401500 v. 402000 v. 402500 v. 403000 v. 403500 v. 404000 v. 404500 v. 405000 v. 405500 v. 406000 v. 406500 v. 407000 v. 407500 v. 408000 v. 408500 v. 40900