

Sanders

PRACTICAL MECHANICS AND SCIENCE 2/-

JULY 1963

**OFFSHORE
OIL TERMINAL**



**RENDEZVOUS IN SPACE
TRANSISTORISED FLASHGUN
A CELLAR DARKROOM**

A Professional Finish ... and money saved

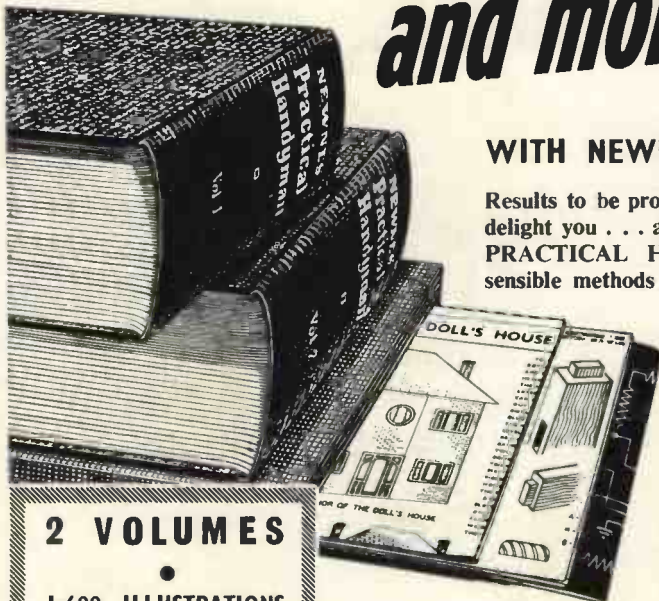

WITH NEWNES PRACTICAL HANDYMAN

Results to be proud of . . . a speed and knack that will delight you . . . are yours with the know-how in Newnes PRACTICAL HANDYMAN. The clearly written, sensible methods given in its two volumes and case of charts will save you pounds year after year. The *right* way with tools, correct use of materials and how to obtain an expert finish are shown step by step. Profusely illustrated and packed with helpful suggestions it covers every aspect of handyman activity. See the complete set at home for a week without cost or obligation! Post the coupon to-day.

2 VOLUMES

1,600 ILLUSTRATIONS

Plus case of 19 charts on how to make Hi-Fi Amplifier, Garden Seats, Doll's House, Aquarium, Table Lamps, Bookshelf, etc.

Use it FREE for 7 days

EVERYTHING YOU NEED TO SAVE MONEY

Build your own Garden and Tool Shed. Paths and Drives. Painting and Decorating. Plastering. Glazing. Making Garden Furniture. Water Systems. Drainage. Roofing and Tiling. Gutters. Trellis. Fences and Gates. Water Butts. Crazy paving. Damp wall treatment. Bricklaying and Pointing. Concrete Work—mixes, pebble-dash, ornamental. Dry rot, wet rot and woodworm. Floors—repairing, staining, polishing, parquet, plastic, etc. Varnishing. Enamelling. Lacquering. French polishing. Veneering, graining, marquetry. Built-in furniture. Shelves. Re-upholstering. Making temporary and kitchen furniture. Making bookcase, bedside table, folding table, first aid cabinet, firescreen, etc. Metal work—riveting, soldering, cutting, beaten copper work. Electric power tools. Householder Law, and much more besides.

Given Away

THE FAMOUS ECLIPSE 44 MULTIPLE TOOL

(value 8/6d.)

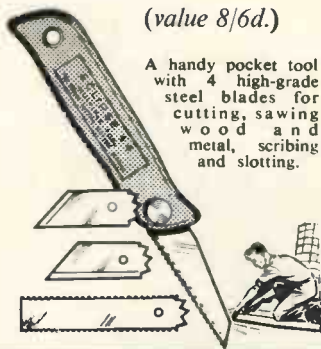

A handy pocket tool with 4 high-grade steel blades for cutting, sawing wood and metal, scribing and slotting.

POST TO-DAY

To: George Newnes Ltd.,
15-17 Long Acre,
London, W.C.2.

Please send me PRACTICAL HANDYMAN without obligation to purchase. I will return it in 8 days or send 6/- deposit 8 days after delivery, and you will then send the Free Eclipse Multiple tool. Thereafter I will send twelve monthly payments of 10/- paying £6. 6s. in all. Cash price in 8 days £6.

Full Name and Address in Block Letters please

Mr. }
Mrs. }
Miss }

Address

Occupation

Signature

Parent's Signature if you are under 21 } Mr.
Mrs.

Tick V where applicable
The address on left is—

My Property	<input type="checkbox"/>
Rented unfurnished	<input type="checkbox"/>
Parents' Name	<input type="checkbox"/>
Furnished Accom.	<input type="checkbox"/>
Temporary Address	<input type="checkbox"/>

(HA) 505/97

ASTRO-TERRESTRIAL TELESCOPE. 40 x 80. Altazimuth mounting on extending tripod. (5 ft.). £10.10.0. Carr. 5/-.

PANCREATIC TELESCOPE. 15 to 60 x 60 mm. O.G. Rack and pinion focus. On small tripod, £7.7.0.

SCOUT TELESCOPES. Ex-Govt. Unused condition. 25 x 50 with leather case. £8.5.0 each. Orthoscopic eyepieces to fit. 50X and 75X. 50/- each extra. Tripods to mt. with pan and tilt heads. 15/- each.

NEWTONIAN 6in. parabolic mirror scopes, 80-400X, with geared altazimuth and equatorial mounting and metal tripod. £55 ex works, or in kit form, £37.10.0 approx.

4in. Mirror Kits. Optics only. 40in. mirror, flat, and eyepiece. 40X. £4 each.

6in. dia. Parabolic Mirrors. 1 wave. 48in. focus. £9.5.0. Flats 17/6. Prisms 35/-.

7in. dia. Parabolic Mirrors. 1 wave. f.8. £17.5.0.

ORTHOSCOPIC EYEPIECES, R.A.S. thread. 1in., £5. 1in., 45/-, 1in., 45/-, Keplar 1 1/2in. in focussing mount, 8/6. (Govt. surplus bargain.)

ROSS 7 x 50 heavy battleship binos, lever focus. Interocular adjustment, swing-over filters etc. Cost £180. In excellent condition. £15 pr., or tripod mounted with pan and tilt head, £23. Carr. and Packing 30/-.

ROSS 3 1/2 x 25. Similar to above but smaller O.G. Ultra wide angle. IDEAL for converting to higher power. Excellent condition. £7.10.0 pr. Carr. 15/-.

U.S.A. WIDE ANGLE TELESCOPE. Approx 7X, with double filters, plus polaroid variable density filters. As new and bloomed. All brass, weight 20 lb., £12 each. Easily converted to higher power.

See our lists, free for S.A.F., for the widest range of optical and scientific equipment in the British Isles. Telescopes and binoculars a speciality. All types, all prices.

'How to use Ex-Govt. Lenses and Prisms.' Nos. 1 and 2, 2/6 each.

H. W. ENGLISH, 469 RAYLEIGH ROAD, HUTTON, BRENTWOOD, ESSEX.

WE WILL SUBMIT ON APPROVAL

- The CHARLES FRANK PROFILE PROJECTOR. Built-in viewing screen 7" x 5" £35
 - PROJECTION MICROSCOPE. An amazing new instrument designed by Charles Frank..... £23.10.0
 - TRACING PAPER. Plastic backed ETHULON paper in 60ft rolls 29 1/2" wide, cost £6 18/6
 - Ex-M.O.S. HARDENED CHESTERMAN COMBINATION SET No. 92, with 12" rule. Brand new condition. £6.15.0
 - TOOLROOM CLINOMETERS. M.O.S. Micrometer type..... 35/-
 - Ex-R.A.F. ILLUMINATED MAGNIFIERS with 3" diam. lens 38/6
 - M.O.S. NSF 10" VERNIER GAUGES reacting to 1 thou in polished wood case, unused £8.15.0
 - GERMAN DRAWING INSTRUMENT SETS..... £2.19.6
 - CHARLES FRANK LTD., 67/75 SALTMARKET, GLASGOW. C.1
- Britain's greatest stocks of new, used and Ex-Government Optical and Scientific Equipment. Send for Illustrated Catalogue.*

**Now in a new 3rd edition . . .
A BEGINNER'S GUIDE
TO TELEVISION**

The modern miracle of television is here explained in a series of seventeen lessons. Written in non-technical language which the veriest beginner can understand, the reader is taken by easy stages through every aspect of TV transmission and reception. A further lesson has been added on the conversion of 405 to 625 line pictures. Illustrated.

only 8s. 6d. from all booksellers
... or, in case of difficulty, 9s. 6d. by post from George Newnes Ltd., Tower House, Southampton St., London, W.C.2.

NEWNES

**A PLACE
FOR
EVERYTHING**

SPACE SAVERS



£12.0.0 each

36 DRAWERS



£11.0.0 each

18 DRAWERS

The most compact, versatile cabinet we've ever made. 36 drawers 5 1/2" wide, 3" high, 10 1/2" long. Or 18 drawers 10 1/2" wide, 3" high, 10 1/2" long. Both cabinets overall size 42" high, 24 1/2" wide, 12" deep. Each drawer is provided with a divider, identification card and transparent protective shield.

BUDGET DRAWER UNIT

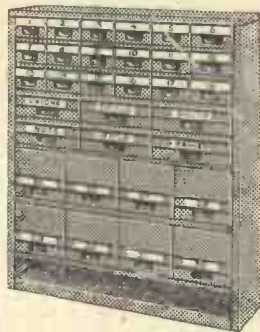

32 assorted drawers for stores or assembly lines. 18 drawers 5 1/2" wide, 3" high, 10 1/2" long; 6 drawers 10 1/2" wide, 3" high, 10 1/2" long; (each drawer has provision for 7 dividers, 24 dividers provided free). 8 drawers 8" wide, 7" high, 10 1/2" long. Unit 42" high, 35" wide, 12" deep. All heavy gauge steel, stove enamelled dark green.

£16.10.0 each

QUANTITY DISCOUNTS

OTHER MODELS SHOWN IN FREE CATALOGUE

N. C. BROWN LTD.

Dept. D122 EAGLE STEELWORKS, HEYWOOD, Lancs. Tel. 69018 (11 lines)

LONDON: 25 NEWTON ST., KINGSWAY, W.C.2. Tel. HOL. 7931.

VALUABLE NEW HANDBOOK FREE TO AMBITIOUS ENGINEERS

Have you had your copy of "Engineering Opportunities"?

The new edition of "ENGINEERING OPPORTUNITIES" is now available—without charge—to all who are anxious for a worthwhile post in Engineering. Frank, informative and completely up to date, the new "ENGINEERING OPPORTUNITIES" should be in the hands of every person engaged in any branch of the Engineering industry, irrespective of age, experience or training.

**We definitely Guarantee
"NO PASS—NO FEE"**

This remarkable book gives details of examinations and courses in every branch of Engineering, Building, etc., outlines the openings available and describes our Special Appointments Department.

**WHICH OF THESE IS
YOUR PET SUBJECT?**

MECH. ENGINEERING
Gen. Mech. Eng.—Maintenance Eng.—Diesel Eng.—Press Tool Design—Sheet Metal Work—Welding—Eng. Pattern Making—Inspection—Draughtsmanship—Metallurgy—Production Eng.

RADIO ENGINEERING
General Radio—Radio & TV Servicing—TV Eng.—Telecommunications—Electronics—Sound Recording—Automation—Practical Radio—Radio Amateurs' Exam.

CIVIL ENGINEERING
General Civil Eng.—Municipal Eng.—Structural Eng.—Sanitary Eng.—Road Eng.—Hydraulics—Mining—Water Supply—Petroleum Tech.

ELEC. ENGINEERING
General Electrical Eng.—Installations—Draughtsmanship—Illuminating Eng.—Refrigeration—Elem. Elec. Science—Elec. Supply—Mining Elec. Eng.

AUTO ENGINEERING
General Auto Eng.—Auto. Maintenance—Repair—Auto. Diesel Maintenance—Auto. Electrical Equipment—Garage Management.

BUILDING
General Building—Heating & Ventilation—Plumbing—Architecture—Carpentry—Painting—Decorating—Specifications & Quantities—Surveying—Architectural Draughtsmanship.

WE HAVE A WIDE RANGE OF COURSES IN OTHER SUBJECTS INCLUDING CHEMICAL ENG., AERO ENG., MANAGEMENT, INSTRUMENT TECHNOLOGY WORK STUDY, MATHEMATICS, ETC.

Which qualification would increase your earning power?
A.M.I.Mech.E., A.M.S.E., A.M.I.C.E., A.M.Brit.I.R.E., A.F.R.Ae.S., B.Sc., A.M.I.P.E., A.M.I.M.I., A.R.I.B.A., A.I.O.B., A.M.I.Chem.E., A.R.I.C.S., M.R.S.H., A.M.I.E.D., A.M.Mun.E., CITY & GUILDS, GEN. CERT. OF EDUCATION, ETC.

BRITISH INSTITUTE OF ENGINEERING TECHNOLOGY
410A COLLEGE HOUSE, 29-31 WRIGHT'S LANE, W.8.

THIS BOOK TELLS YOU

- ★ HOW to get a better paid, more interesting job.
- ★ HOW to qualify for rapid promotion.
- ★ HOW to put some letters after your name and become a key-man . . . quickly and easily.
- ★ HOW to benefit from our free Advisory and Appointments Depts.
- ★ HOW you can take advantage of the chances you are now missing.
- ★ HOW, Irrespective of your age, education or experience, YOU can succeed in any branch of Engineering.

156 PAGES OF EXPERT
CAREER - GUIDANCE

You are bound to benefit from reading "ENGINEERING OPPORTUNITIES", and if you are earning less than £25 a week you should send for your copy now—FREE and without obligation.



POST NOW!

TO B.I.E.T. 410A, COLLEGE HOUSE, 29-31 WRIGHT'S LANE, W.8.

Please send me a FREE copy of "ENGINEERING OPPORTUNITIES." I am interested in (state subject, exam., or career).

NAME _____

ADDRESS _____

WRITE IF YOU PREFER NOT TO CUT THIS PAGE

2½d. stamp
if posted in
an unsealed
envelope.

THE B.I.E.T. IS THE LEADING INSTITUTE OF ITS KIND IN THE WORLD

PRACTICAL MECHANICS AND SCIENCE

Vol. XXX

July, 1963

No. 351

Editorial and Advertisement
Offices

"PRACTICAL MECHANICS
AND SCIENCE"

George Newnes Ltd., Tower
House, Southampton Street,
Strand, W.C.2.

© George Newnes Ltd., 1963

Phone: Temple Bar 4363
Telegrams

Newnes, Rand, London

SUBSCRIPTION RATES

including postage for one year

Inland - - - £1 8s. per annum

Abroad - - - £1 6s. 6d. per annum

Canada - - - £1 5s. per annum

Copyright in all drawings, photo-
graphs and articles published in
"Practical Mechanics and Science" is
specially reserved throughout the
countries signatory to the Berne Con-
vention and the U.S.A. Reproduction
or imitations of any of these are
therefore expressly forbidden.

CONTENTS

Talking point	435
Offshore oil terminal	436
The Luton Major	438
Private space communi- cation system	443
An automatic fish-feeder	444
The day of the airship	446
Picture news	448
Simple slot cutting tool	449
Italy's reeling shafts	450
Fahrenheit or Centigrade	453
Towards perfect slide projec- tion	454
The story of a darkroom laboratory	456
Watch making in Wales	460
Lathe gadgets	462
Transistorised electronic flash-gun	464
That's a good idea	467
Rendezvous in space	470
An extension cable reel	474
Hunting Earth's magnetic disturbances	476
Trade news	477

CONTRIBUTIONS

The Editor will be pleased to consider articles of a practical nature suitable for publication in "Practical Mechanics and Science". Such articles should be written on one side of the paper only, and should include the name and address of the sender. Whilst the Editor does not hold himself responsible for manuscripts, every effort will be made to return them if a stamped and addressed envelope is enclosed. All correspondence intended for the Editor, should be addressed: The Editor, "Practical Mechanics and Science", George Newnes, Ltd., Tower House, Southampton Street, Strand, London, W.C.2.

Science siftings

A SCIENTIST is by nature inquisitive. The challenge of the unknown stimulates him to explore. And, of all his experiences, none is more gratifying than discovery. To explore the frontiers of science, medicine, the universe, to uncover the secrets of nature and to harness them for man's betterment, these can be life's most exciting and rewarding achievements. History is filled with the chronicles of men whose quest for knowledge has led to results that are deeply imprinted on the daily lives of us all. New discoveries along the frontiers of science are continuously transforming our lives. And yet, the scientist still seeks further afield. His motto is, evidently, "What's past, is prelude." Each new discovery opens further vistas for exploration, and each accelerates the pace for advance. What are some of the latest discoveries made by scientists? Well, here are a few to get on with:

While architects are designing larger and taller buildings, some scientists are apparently thinking in miniature. Currently on the drawing boards are: An electric motor just 6/1,000 inch in diameter; telephone-sized television sets; pocket-sized record players, and radios no bigger than a fountain pen.

A hormone found in sheep has been found effective in making an 18-year-old dwarf grow a quarter of an inch. Growth in young persons is controlled by a growth hormone secreted by the pituitary gland. Some persons whose pituitary gland does not function properly stop growing and become pituitary dwarfs. Only human or monkey growth hormone will induce growth in human beings; that of lower animals will not work, although human and monkey growth hormone will make animals grow.

An electric light bulb so hot it can braze or solder metal; a fluorescent lamp which produces a light equivalent to 15,000 candles; a mercury vapour lamp which will produce useful light for more than 16,000 hours; a household light bulb with one-third longer life than conventional lamps . . . all of these unusual light sources are the outcome of recent research.

Air bubbles recently protected a new bridge when blasting operations took place nearby. The theory is simple; shockwaves from an underwater explosion are carried by water and can do considerable damage, but an artificial "wall" of air bubbles in the water will cushion the shock. Perforated pipes were sunk round the blast area in the water, compressed air was forced through to create a curtain of bubbles, and instruments recorded almost no vibrations during the blast.

The colour of your motor car may mean the difference between life and death, according to recent scientific investigation. Blue and yellow are best car colours from a standpoint of safety. The colour of an approaching car influences a driver's judgement of how far away it is. Judged from a distance of 200 feet, objects of some colour appear to be up to six feet closer than objects of other colours. Under average conditions, an error of six feet in judging distance may easily mean the difference between a serious accident or no accident. Of the various colours tested on 164 subjects, blue and yellow made distant objects closer—under both day and night conditions. Grey shades made objects appear to be farthest away. Blue was ranked safest in daylight and fog, and yellow safest at night.

The August 1963 issue will be published on July 31st, 1963. Order it now!

www.americanradiohistory.com

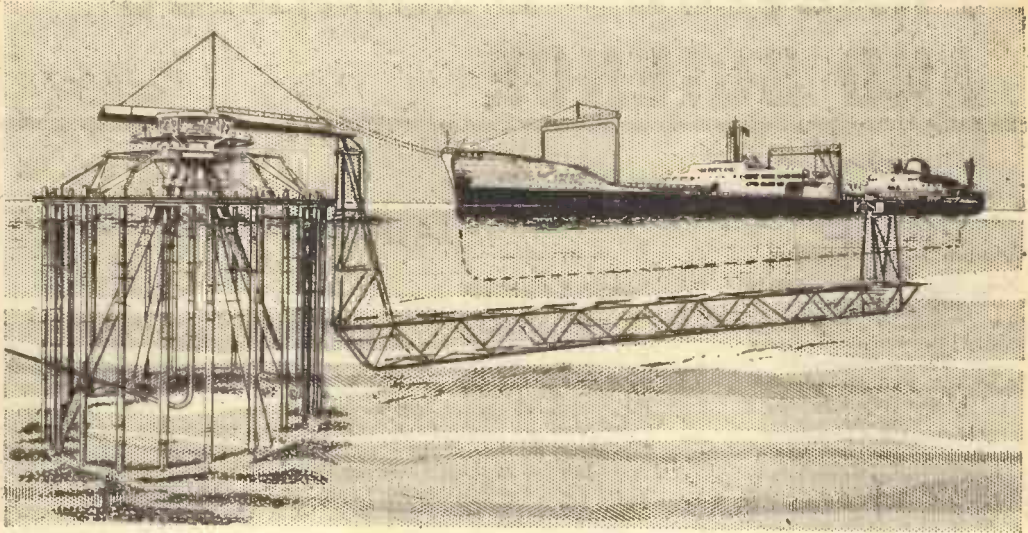

Offshore

A UNIQUE off-shore steel structure, weighing 2,800 tons, for loading sea-going oil tankers of any size and under adverse weather conditions, has been put into operation off the coast of Libya.

At Marsa el Brega, site of the oil terminal of Esso Standard Libya Inc., the 77,000 d.w.t. tanker "Esso Austria" loaded the first shipment of crude oil from a stationary structure erected in 100ft of water a mile from shore. The complex assembly is known as a "bow mooring device" since it enables a tanker to moor from its bow to the stationary structure, permitting 360° rotation of the ship in high winds and heavy seas while it is receiving a cargo of crude oil from an underwater pipeline.

The device was designed by Esso with the assistance of consulting engineers. It was developed in order to load tankers where only limited harbour facilities exist, under adverse weather conditions if necessary and with a minimum amount of time spent in mooring and getting under way. It consists of three basic units—a 145ft tower positioned on the sea bottom, a 140ft boom that rotates on the top of the tower, and a 560ft underwater arm extending downwards from the boom and extending under the water to a floating platform which rises from the sea beside the

vessel. Crude oil from Libya's Zelten and Raguba fields flows through a 42in. submarine line leading from a meter battery on shore to the tower and out through the free-swinging arm through two 28in. pipes—part of the arm's structure—to the ship's loading compartments. The boom, extending from the top of the tower, rotates with the long arm, as winds and currents swing the ship.

The tower structure rests on the sea bottom on a circular platform in the shape of a doughnut ring, 120ft across, which is constructed of steel pipe 12ft in diameter. Four main supports rise from the circular base, meeting at the centre of the structure above the water line. Rising vertically from the doughnut base are 24 fender piles connecting to a fender ring on the top of the tower. At the top of the tower is an enclosed platform housing equipment for the unit. During loading operations men on the ship can regulate the depth of the floating arm by adjusting its buoyancy chambers so the elevated platform at its end will be level with the tanker.

With the introduction of the new device, Esso Libya has doubled its maximum loading rate since the new structure can handle tankers of any size. The original two berths were each limited to ships of not more than 50,000 tons.

Photo top right.—The Esso Austria being loaded with a cargo of oil at Marsa el Brega. The Esso Austria was the first tanker to be loaded at the bow mooring.
"An Esso photograph".

Photo right.—Close up view of the Esso Austria while loading oil at the bow mooring. The end of the loading arm and the hose connections to the tanker can be seen.

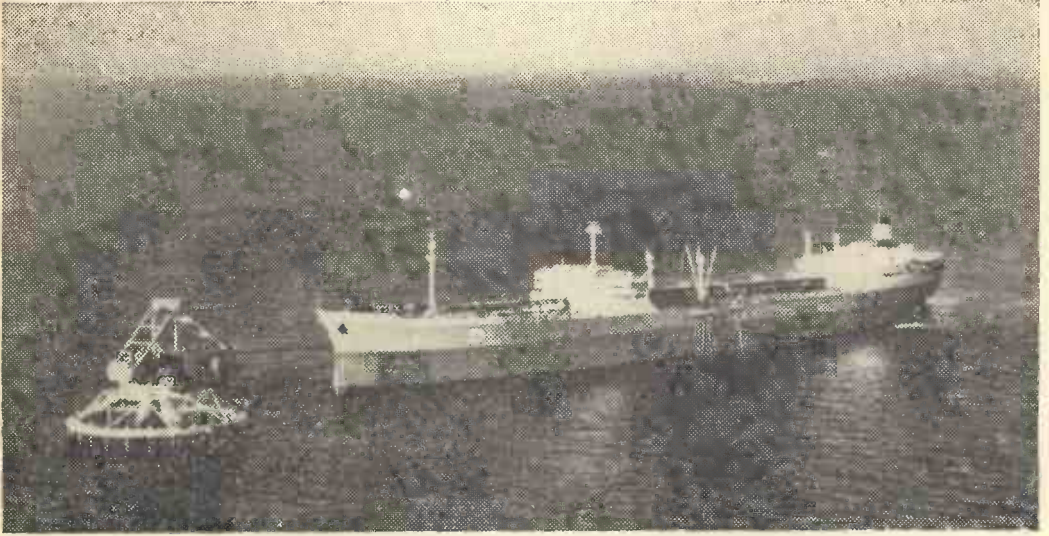

Oil Terminal

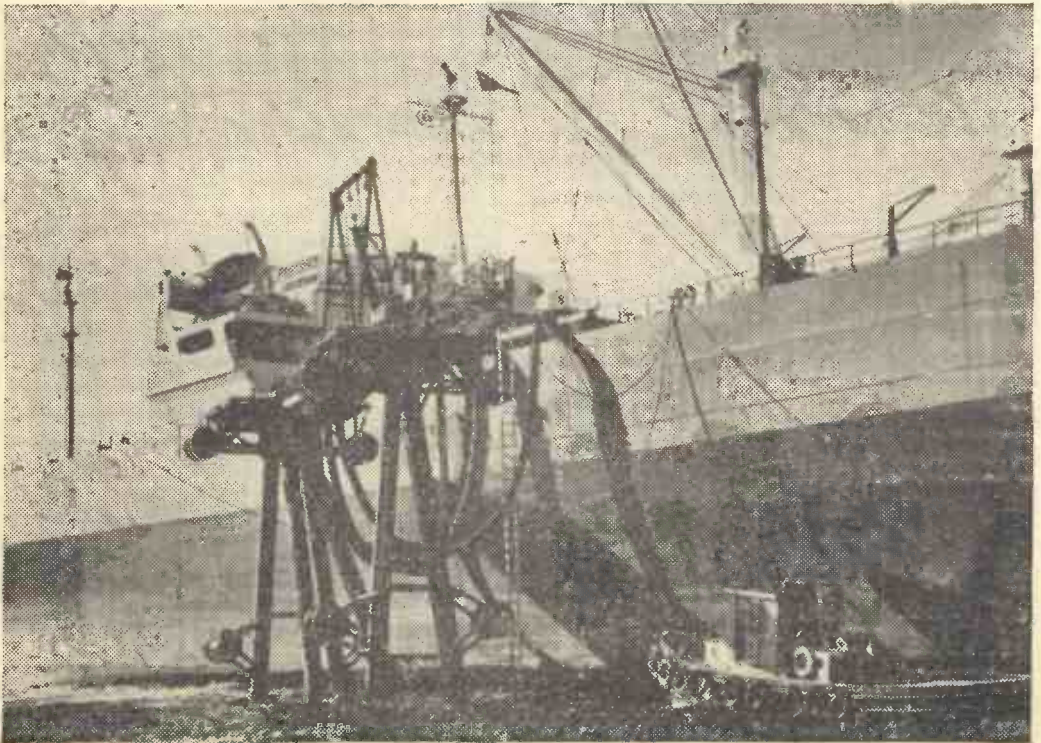



- Fuselage, continued
- Tube bending, slotting and flattening
- Wing rib jig
- Making the ribs
- Building the ailerons

NEXT the three steel cross-tubes, 507-1, 507-2 and 508-1, together with their respective end fittings, should be placed in position. The end fittings should be lightly bolted to the tubes to check their positioning, but final assembly should not take place until the bottom skin has been fixed. Also fit the spruce cross-struts required within the parallel length of the longerons. (Note that tube 508-1 protrudes $\frac{1}{2}$ in. below the bottom longerons, after Drg. No. 508, issue C.)

The tail ends may now be pulled in towards each other, making use of the trestle for proper alignment: the aid of a sash cramp will be found most helpful in holding the width at cross-strut "g" at $23\frac{3}{4}$ in. Fit the remainder of the cross-struts over the rear fuselage, together with the sternpost and both bulkheads; careful marking out and cutting of these members before fitting will help to ensure "squareness" of the fuselage.

The bottom skin may be scarfed up in one piece or may be applied in suitable lengths, scarfed on the cross-members, still no gluing being done over the foremost bay. The undercarriage and lift-strut fittings may now be completed.

The fuselage structure may now be removed carefully from the jig; detach the support blocks from the jig vertical members and replace the fuselage in the jig in the upright position. Check again for correct alignment and clamp again to the supports. Fit all main, top cross-struts except at the engine bulkhead; fit the locker base and all plywood gussets.

Operations may now commence on the unfinished nose portion. Prepare the forward ply decking and the cabin floor. The bottom longerons, which should preferably have been left long, may be tied together with cord and pulled inwards approximately the required amount by means of a tourniquet. The top longerons may be pulled in with sash cramps or other means, to allow the engine bay top cross member and the horizontal decking to be fixed in position. If the decking has been cut accurately to shape and is positioned with care, the longerons also should come into correct position by adjustment of the cramps. However, a horizontal line along the centre top of the decking will be found useful. It should coincide with a cotton stretched between the centre point of the forward bulkhead and a point on the sternpost centre line. The top

Fig. 25.—Symmetrical and asymmetrical flattening of tube ends between shaped vice clamps.

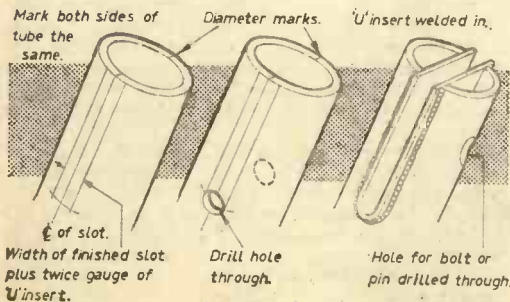
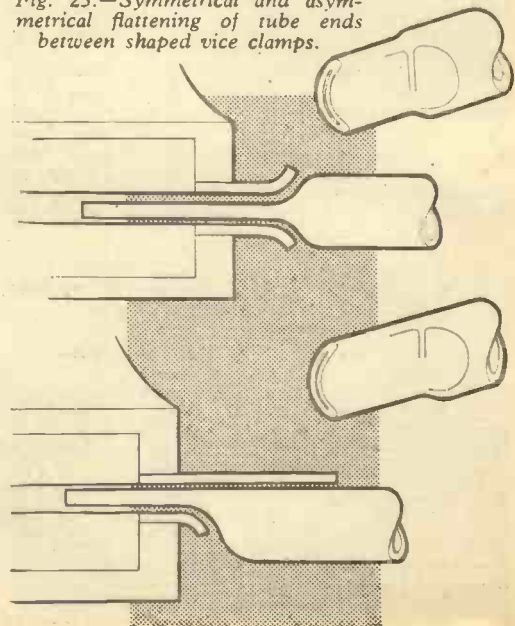

Fig. 24.

longeron, sawcut and with the plywood insert, should be glued just prior to fixing the decking. Now complete the engine bulkhead, pulling in and gluing the bottom longerons similarly. Now finish the plyskinning on the sides and bottom.

The cabin superstructure should now be completed in accordance with the drawings. But first re-align the fuselage carefully and check all distances between important centres, and cross-trammel for squareness. Fit the two tubular steel cross members at the front and rear spar positions, checking for the correct spar spacings, together with all four spar attachment fittings and the front and top cross-overs. Take extreme care to get all locating dimensions correct in accordance with drawing 509 and ensure that the port side positioning corresponds with the starboard side. Particular care should be exercised to ensure that the rear spar fittings are accurately aligned with the lift-strut attachment fittings and incline rearwards at 3°. The ends of bolts holding all the main fittings must be peened over eventually, but it is best to leave this operation until the structure is complete, in case some fittings have to be removed for any reason.

The rear fuselage decking merges the rectangular cabin section with the turtleback tail portion. This has to be done without double curvature of the plywood covering. The frame shapes aft of frame "D" have been designed to produce straight lines connecting the forward and aft ends and it is as well to apply a long straight-edge over the frames, after positioning, and to check for high spots and depressions, which should be rectified before covering. Note: in some earlier drawings the frame shapes did not comply exactly with this requirement. Provided the frames the correctly aligned as described, the exact positions of the stringers are not of vital importance.

The rear fuselage decking presents no difficulty aft of frame "D", provided the frames are shaped exactly to the sectional drawings. The frames are made of 1/4 in. plywood, backed with 1/4 in. spruce, the plywood frames extending down the face of the fuselage cross struts, to which they are glued. The shaped gussets shown in some earlier drawings may be dispensed with as they serve little purpose. It should be possible to fit a continuous, scarfed-up sheet of plywood, but it is much easier to apply it in separate lengths, commencing at the forward end, and to scarf on the frames. The developed shape of each section may be obtained by means of large sheets of paper or, with the aid of an assistant, by offering up the sheet of plywood and marking out the shape direct. Allow 1 in. overlap at each side

Fig. 26.—An easily made device for marking diameters across tube or rod ends.

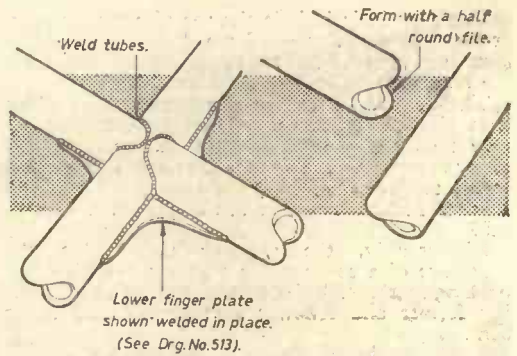
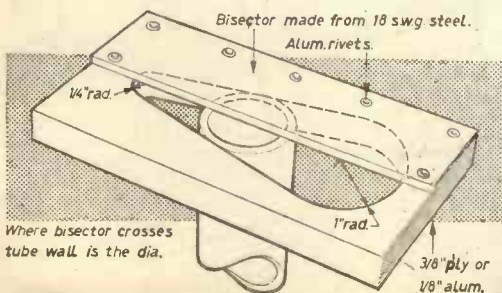

Fig. 27 (left).—A cross-over joint in tubes. (right).—Shaping one tube end before welding to a second tube.

for scarfing to the fuselage side skins. The ply may be held tightly by means of tapes or straps tied over each frame, scarfing along both longerons being completed with the aid of tacking strips.

The two bays forward of frame "D" form the transition section, in which the cabin rectangular section merges with the turtleback rear portion. Frame "E" has been designed to achieve this and the drawing shape should be carefully adhered to. First fit the stringers in position—it will be found that some of the frame "E" slots may require opening up a little to allow for the angular setting of the stringers. The two additional stringers, forming a "V", should be packed on the outer face with additional lengths of 1/4 in. x 1/4 in. spruce, each packing piece being planed on the outer face so as to form a wedge with the apex angle decreasing until it fades entirely at the front end (Fig. 29). The two side panels, running from aft of the luggage locker to frame "D" may now be fixed in position, the upper edges being attached to the packing pieces just described, followed by the top capping panel covering the triangle formed by the "V" stringers. Paper patterns may be made for the shapes of the side panels, but the capping panel should be left oversize until after it has been fixed in position. It may then be carefully pared away to give a good clean edge.

Tube bending

When bending a tube, due to the fact that it has no resistant central core, the tube will tend to flatten at the bend. This results in an increase of the axis at right angles to the bend and a corresponding decrease in the axis in the plane of the bend.

However, by bending the tube round a block of the same radius as the desired bend and having a groove in it equal to the tube diameter, this deforming can be resisted to a large extent. Special tube bending machines are available which almost eliminate deformation of the cross-section of the tube.

Thin tubing is the hardest to bend, for the inner radius tends to buckle. Some expensive machines are made which make use of a "mole" which is a shaped rod slipped inside the tube and which follows up the bend, ensuring a smooth, uniform section.

Thin steel tubes can be bent using a well-greased spring whose outside diameter is the same as the inside of the tube.

Other methods include the use of a fusible alloy or low-melting-point metal which fills the tube, is bent with the tube and then removed by immersing the bent tube in boiling water or oil.

The method which the amateur can best adopt is to plug on end of the tube with wood, pack the tube tightly with sand (it must be dry sand) and plug the other end. The tube then should be heated with a torch or blow-lamp and bent over a radiused former. Make the former of durable wood such as oak.

Alternatively, the amateur may enlist the assistance of a co-operative plumber and his tube-bending machine. Remember to use the right bending former and follower for the diameter being bent.

Slotting and flattening tubes

To slot the end of a tube as, for example, to take a "U" insert, mark out the full width of the slot from the centre line of the tube on each side (Fig. 24) and drill a hole to mark the termination of the slot.

Now cut with the hacksaw and finish off to size with a thin flat file. On large-diameter tubes it is better to hold the saw at an angle and cut each slot individually, eliminating the chance of inaccurate cutting of the other side.

Fig. 25 shows the right method to employ when flattening the ends of tubes symmetrically or asymmetrically. Always heat the tube red hot first if tubes are to be closed completely flat at the end. The shaped vice clamps can be simply made from stout pieces of smooth angle iron.

When cutting a narrow slot in a tube as, for example, to weld in a single 16s.w.g. plate, use two hacksaw blades together in the saw. Cut carefully, for one blade will be slightly tighter in the frame than the other.

Use a hacksaw blade with the right number of teeth per inch when cutting tubing. Very thin tubes can be sawn by keeping the hacksaw at a tangent to the surface all the way round by rotating the tube as it is cut. Remove the internal burrs with a half-round smooth file.

Where one tube meets another, the meeting tube should be filed to a snug fit all round (Fig. 27). This should be done with a round or half-round bastard file.

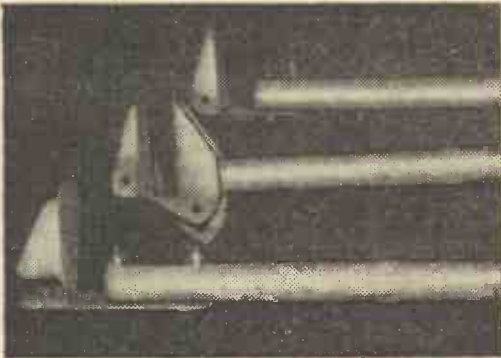

Fig. 28.—The three fuselage cross-tubes and fittings. Photograph by Mr. W. J. Sproat, of Kirkcudbright.

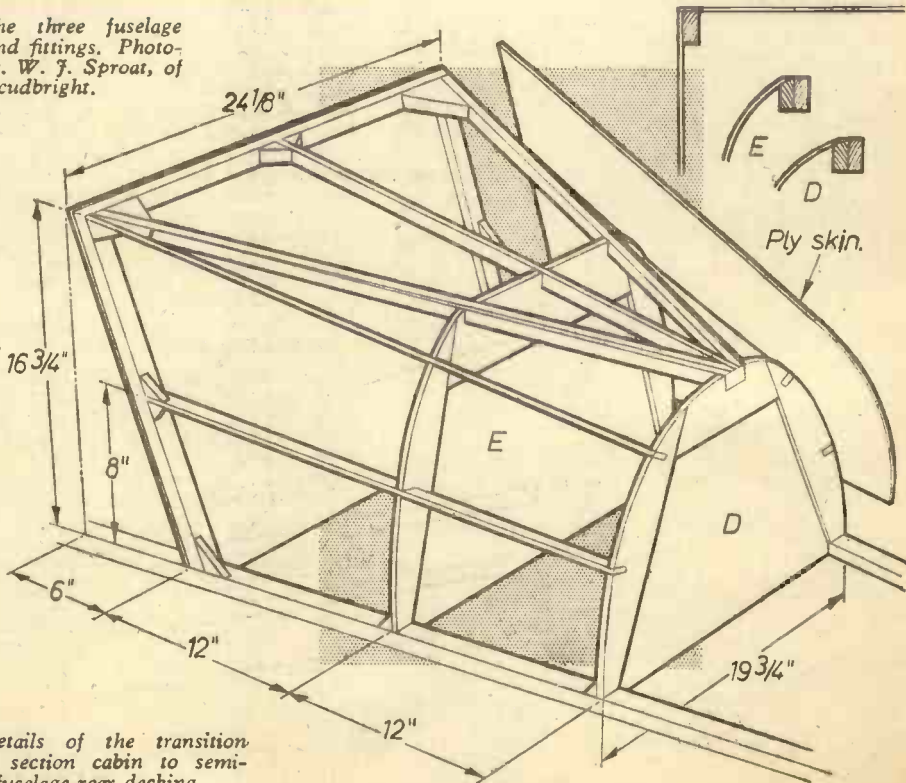

Fig. 29.—Details of the transition from square section cabin to semi-circular fuselage rear decking.

Making a sleeved splice

When making up control cables, eyes must be formed in the cable ends. The use of a sleeved splice avoids the difficult process of making a tucked splice in wire.

Insert the end of the cable through a 3in. length of $\frac{3}{16}$ in. o.d. x 20s.w.g. copper tube which has first been annealed, and flattened to an oval section in the vice. Double the cable end over and thread it back through the tube. Put the thimble in place and draw the cable taut. Make sure that the mark denoting the required length of the cable is in fact central on the eye. Using a mallet and a wooden block, dress the copper sleeve to the wire.

Lightly clamp the splice vertically in the vice and heat with the soldering iron until it is possible to flow solder down through the sleeve around the wire. When it is thoroughly tinned and still molten, again dress the tube with the mallet. Take care not to spurt hot solder in your face. Avoid excessive heat in soldering as this will affect the strength of the cable.

Clamp the splice vertically in the vice so that about $\frac{1}{4}$ in. of the copper sleeve is firmly held in the jaws. Using either a hand-vice or a pair of smooth-jawed parallel grips, hold the other end of the sleeve, again $\frac{1}{4}$ in. from its end, and carefully give one and a half full turns, twisting cable and sleeve into a spiral. Unclamp and re-tin with the soldering iron. Trim the spare end back to the end of the sleeve. This splice is very strong and does not need to be pre-stretched before use.

The wing rib jig

A piece of blockboard, about 5½ft x 1ft, will do for the building base. On this, about 4in. from the bottom edge, draw a continuous horizontal line in pencil to form the datum. Take care to make this absolutely straight, and mark the first (zero) station 1½in. from the end, following with all other stations

as given on the drawing. Set out vertical lines above and below the datum and along these mark the rib ordinates. With the aid of thin splines or battens, complete the upper and lower profiles. If any points appear to lie outside these faired curves, their ordinates should be checked and any necessary adjustment made. Lines denoting the inner faces of the capstrips may then be added $\frac{1}{16}$ in. from the profile lines if desired, though this is not essential.

Carefully mark the spar centre lines 10.0in. and 43.75in. from the leading edge and cut pieces of wood, say ½in. thick, to the size of the spar cross sections. Screw these in position to represent the spars. Now, from a length of ½in. square wood, cut about 60 pieces 1in. in length, to hold the rib components in position. These blocks should be tacked along the outer faces of both capstrips, positioned to coincide with the locations of both spars and the intermediate vertical members. The positions of the vertical and diagonal members should likewise be determined by means of a pair of blocks at, or near, each end. The inner faces of the capstrips may be located by separate blocks, or the blocks for the cross members may be made to serve both purposes. It is as well to insert lengths of the actual ribstock when positioning the locating blocks to ensure correct separation. Over the nose portion the blocks should be closely spaced on the outer face whilst half a dozen eccentric buttons, ½in. in thickness may be substituted for blocks on the inside face, to facilitate the insertion of the capstrip over this more curved portion. The completed jig should receive two coats of hot linseed oil to prevent glue from adhering to the wood.

This jig is correct for ribs A6 and A7, but requires slight modification for ribs A1 to A5, to allow for the cut-away of the trailing-edge over the root part of the span. Note also that the ribs in the aileron section are of different construction behind the rear spar and should be severed at this point, the severed rear portions being required later for

Fig. 30.—The flying controls layout and positioning relative to the seat box.

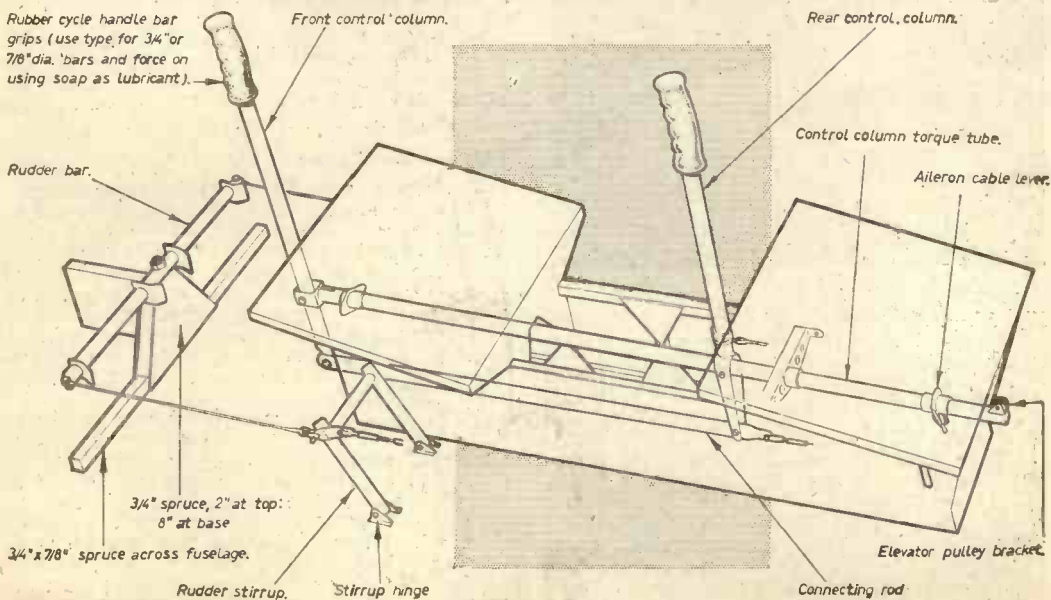

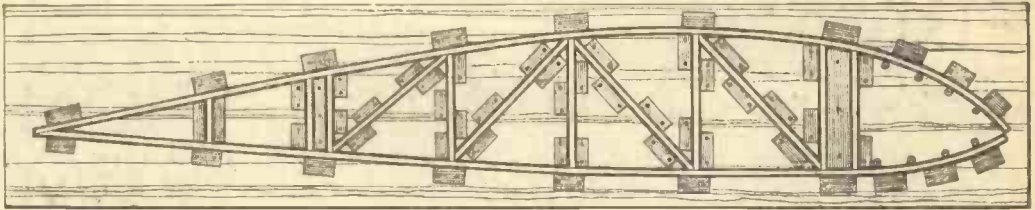

Fig. 31.—Details of a wing rib jig, using wooden blocks and eccentric buttons.

Fig. 32.—A typical wing rib, built by Mr. R. A. Jancey, of Australia.

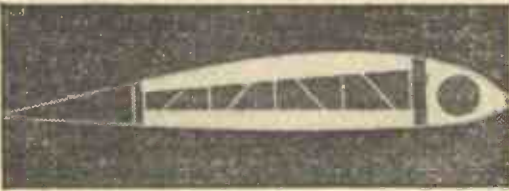

Fig. 33.—A partly completed seat box by Mr. Jancey.



Fig. 34.—A partly completed fuselage, also by Mr. Jancey.



Fig. 35.—This picture demonstrates the attractive lines of the Luton Major.

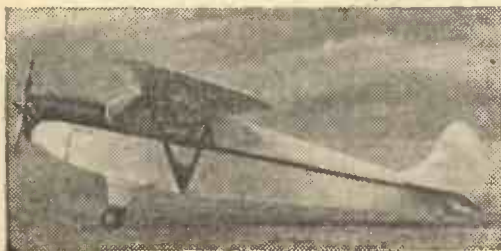

the ailerons. If desired, the front and rear portions of these ribs may be made separately, using the same jig.

The three tip ribs—two required of each—should be made in separate jigs, in which small headless nails may take the place of the wooden blocks. Alternatively, the solid plywood web of the tip rib may be made to serve as a jig, by building the rib on to it.

Making the ribs

Place two lengths of capstrip in position, top and bottom, allowing the upper one to extend beyond the lower at the trailing-edge. Tighten the eccentric buttons. If considered desirable, the forward ends, particularly of the upper capstrip, may be preformed prior to positioning; by immersing the end 12in. or so in boiling water for five minutes and then clamping in a curved position. Cut and fit all vertical and diagonal members, using up the shorter pieces of ribstock for this purpose, and apply glue to all parts to which plywood gussets are to attach. Place the (previously shaped) gussets in position and fix with $\frac{1}{4}$ in. x 20g brass gimp pins, or wire staples (to be removed later). Leave until the glue has set properly and then release the eccentric buttons and gently prise the rib from the jig. The two triangular gussets on the reverse face of the nose portion may now be fitted.

The outer edges of the ply gussets should be sanded off smooth. Slots $\frac{1}{2}$ in deep x $\frac{1}{2}$ in. should be cut at the leading-edge to accommodate the edge member, which will be pinned and glued to the small spruce vertical. At the trailing-edge, the bottom capstrip should be cut back 1 $\frac{1}{2}$ in. and the top member cut to receive the 1 $\frac{1}{2}$ in. x $\frac{1}{2}$ in. trailing-edge members (Fig. 36, next month).

Building the ailerons

The aileron ribs, already made, require careful trimming to butt against the rear face of the aileron spar, the joint being completed with vertical "soldiers" and plywood gussets. The aileron spar should be laid on a perfectly flat table or bench, with the rear face upward, and the ribs may then be attached in their correct positions, taking care to keep the trailing-edges in line by means of a length of string. Also fit the diagonals and fit the trailing-edge member in position, but do not glue at this stage (Fig. 36).

To build the aileron nose portion, turn the aileron through 180°, i.e. with the forward face of the spar uppermost, remove the trailing-edge and support on two trestles, having their top faces parallel and in the same plane. The trailing-edge may then be clamped in position to give added rigidity (Fig. 36). The nose formers may now be fixed, together with the hinges and control lever, followed by the 1mm ply nose covering. Remove from the trestles and glue the trailing-edge in place.

PRIVATE SPACE COMMUNICATION SYSTEM

BY OUR SCIENCE CORRESPONDENT

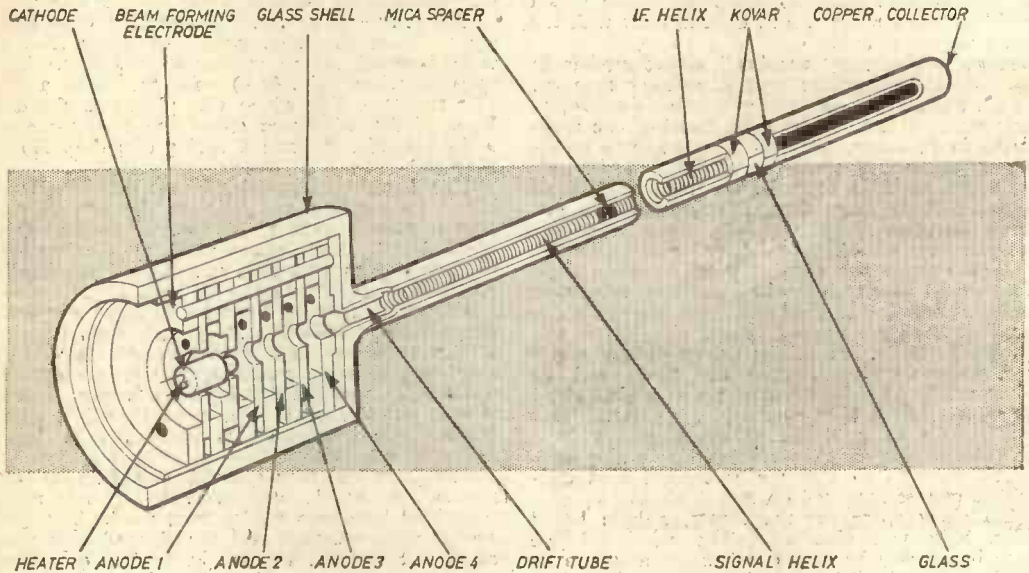

Radio messages between orbiting space vehicles can be overheard or jammed from Earth. Under development is this method of using radar waves of too high a frequency to penetrate the atmospheric layers surrounding the earth.

UNDER development at the present time are three millimeter-wave travelling-wave tubes which could be the heart of a future spacecraft-to-spacecraft radar communication system immune to detection from earth.

Two of the tubes would operate in tandem to amplify the signal of a space transmitter to a frequency and power ten times higher than that possible in existing tubes. The third tube, a travelling-wave mixer, would combine the functions of more than 80% of the system's complete receiver inside a single envelope only 8in. long.

The three tubes, in the early development stages at the Sperry Rand Corporation's New York laboratories, are designed to operate at a frequency of 55Gcs. The amplifiers are expected to put out 50,000W of peak power at this frequency, with an input of only 1mW.

The super-high frequency of the system would give it security. For instance, a signal beamed from earth at that frequency in an attempt to jam or interfere with communications between space vehicles, would be absorbed by the density of the earth's atmosphere.

The two new transmitter tubes (STV-197 and STV-198) are being designed to operate in tandem as an amplifier chain with the STV-197 as a driver and the STV-198 as the output tube of the space system. The mixer tube will combine four major receiver stages in a single envelope. The 55Gcs input will be coupled to one of the tube's two helices, where it will be pre-amplified and then mixed with an internally generated local oscillator signal. The second helix, in tandem and differing in size and turn spacing, will amplify the intermediate frequency signal.

The high-beam power density and operating frequencies of the mixer will demand structural tolerances to within thousandths of an inch. The ultimate in precision manufacturing processes will assure the critical straightness of the helices, whilst the spacing between each turn of the helices will have to be matched to within one ten-thousandth of an inch. Supports for the helices will be of unconventional design. Instead of the usual three-rod frame a grooved ceramic block into which the full lengths of the helices will be fitted, will align them with the electron gun structure.

AN AUTOMATIC FISH-FEEDER

BY AQUARIST

AS is the case with most beginners to the hobby, I commenced tropical fish-keeping with guppies, which caused no great concern when I was absent during the holidays. In due course, however, more expensive fish were obtained, including some non-algae-eating varieties, so I decided to make an automatic device which could be relied upon to feed the fish daily with the usual amount of food.

A perusal of the "surplus" advertisements in the technical magazines brought to my notice the ideal basic unit—a mains-driven time-switch movement, having a final shaft speed of one revolution in 24 hours. Several types of these movements are advertised (some of them clockwork); mine was obtained from H. W. English, Rayleigh Road, Hutton, Brentwood, Essex, price 17s. 6d., some time ago.

Since a non-slipping drive was essential, Meccano chain was decided upon for the device. The length of chain required depends, of course, upon the number of links advanced per day. The smallest Meccano sprocket wheel available is one having 14 teeth. If this is driven by the motor previously mentioned, then the chain will be advanced by 14 links per day, giving a total chain movement of 208 links over a 14-day period. This corresponds to a length of approximately 31in. of chain, which must be accommodated in a horizontal position so that the individual food containers can be mounted on it.

To allow space for the motor, a base board 38in. long was obtained. The width of the base board may be varied to suit the motor to be used, so that the drive sprocket, when mounted on the motor shaft, will lie approximately in the middle of the base board. A 2in. length of board was cut off for use later.

The motor that I used required slight modification. As supplied, the actual motor movement occupied only half the depth of the case, so that the shaft did not project beyond the case. To rectify this, the motor was dismantled and the case was cut down so as just to cover the movement when re-assembled. This left the shaft projecting beyond the case. On this motor the shaft was terminated in a screw-on brass cap. The 14-tooth sprocket wheel (Meccano Part No. 96A) was soldered to this as centrally as possible (see Fig. 1).

At this stage, the motor was run to check the direction of rotation. It was to be mounted on the base board so that the upper surface of the chain would travel from the motor to the "delivery" end. The simplest method of mounting the motor at the end of the base board is by means of a metal strap bent over the motor and screwed down tightly to clamp the motor firmly. (In my version, Meccano perforated strip No. 1A was used.)

Attention was next turned to the "delivery" end of the device. The individual food containers must be arranged so that as the chain travels over the sprocket wheel at the end of the base board, the food is tipped into the tank. Consequently, the chain at this point must project over the end

of the base board, and because of this, a somewhat larger sprocket wheel was used, namely Meccano Part No. 95A, which is 1½ inches in diameter and has 28 teeth. Fig. 2 shows how this wheel was mounted. The part numbers quoted are those for Meccano. Firstly the two trunnions (No. 126) were screwed to the base board so that they were in the centre of it with the uprights about 1½in. apart. Next the 2½in. perforated strips (No. 5) were fastened to the trunnions as shown. The sprocket wheel (No. 95A) was secured to a 2in. axle rod (No. 17), which was placed in the end holes of the perforated strips and held there by a washer (No. 38) and a spring clip (No. 35) at each end.

Two lengths of sprocket chain (No. 94) were joined by opening the links at the end of one length and attaching the other length, then re-closing the links. Care must be taken to join the two lengths with both sets of links pointing in the same direction.

The chain was now fitted by laying it over both sprockets and adjusting for length, then forming it into a continuous loop in the same manner as that by which the two lengths were joined. If the two 2in. perforated strips are slackened slightly at this stage, they can be used to adjust chain tension after the loop is formed, then being tightened securely.

The chain was then removed and the food containers were fitted. For these, the press-on metal tops from lemonade bottles were used. The cork inserts were removed and the cleaned tops were soldered to the chain as in Fig. 3. The containers were attached every 14 links. When all the 14 containers had been fitted, the whole device was re-assembled with the row of containers uppermost. Owing to the weight now present on the top length of chain, the whole row tipped sideways. This was rectified by fitting a 31in. length of hard-board, 1½in. wide, to the base board on 2½in. double angle brackets (No. 48A). The supports were bent where necessary so that the top length of chain was just supported by the length of hard-board. Thus the containers could not tip over enough to spill the contents.

Finally, two perforated strips 12½in. long (No. 1) were screwed to the edge of the base board, as in Fig. 4, and the 2in. piece which was previously removed from the base board was used here as shown.

In use, the feeder is set up on top of the fish tank so that the food will tip over the end of the base board into the feeding ring in the tank as in Fig. 5. A convenient point to connect the motor is the socket normally occupied by the tank light. If the feeder is fitted to a small tank and a heavy motor has been used, any tendency to tip can be counteracted by attaching a weight to the opposite end.

The construction of this device lends itself to adaptation easily; for example, a 5-day version can be made considerably smaller, and could be driven by a standard 8-day clockwork time-switch. One feature which I value is that of being able to vary the type of food given, day by day.

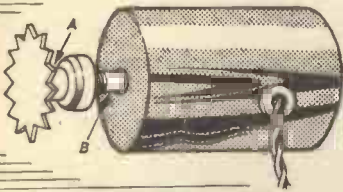

Fig. 1. A 14-tooth sprocket wheel (A) is soldered to the cap at the end of the shaft (B) from the motor.

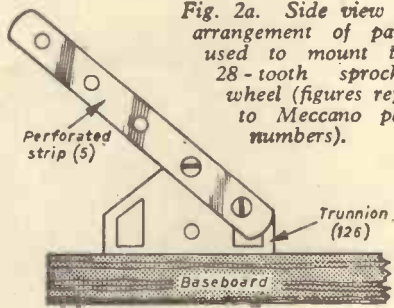

Fig. 2a. Side view of arrangement of parts used to mount the 28-tooth sprocket wheel (figures refer to Meccano part numbers).



Fig. 3. In B an end link of the chain A is shown opened for attachment to the end of another length of chain. C, side view of bottle cap soldered to a link of the chain for use as food container.

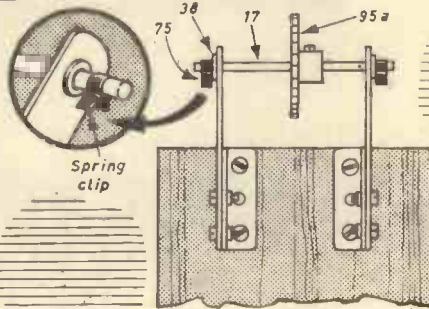

Fig. 2b. View from above of 28-tooth sprocket-wheel mounting at "delivery end" of the base board.

Fig. 4. View from above of "delivery end" of base board to show projecting perforated strips and crosspiece (2in. Wide) of board (at extreme left).

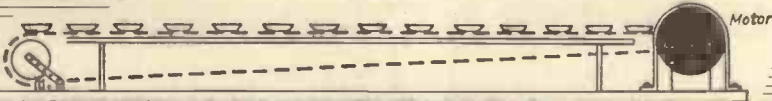
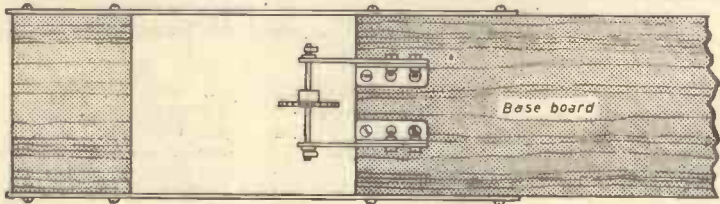
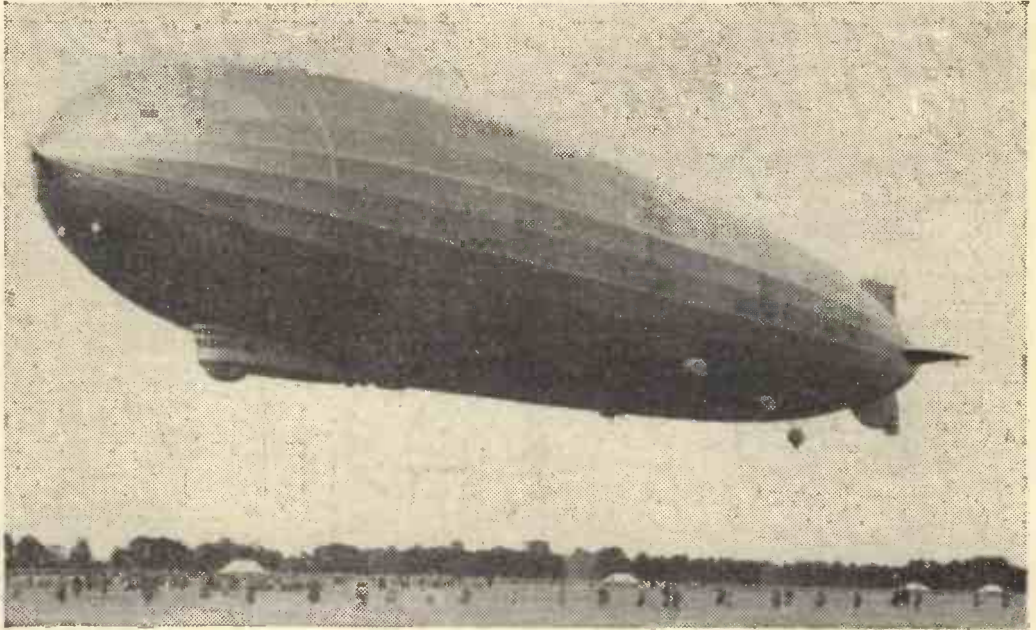

Fig. 5. Side view of automatic feeder in position on aquarium. The motor (M) is at the right.





The Graf Zeppelin

'The day of the Airship'

By Ronald Pearsall

THE news that the Russians are considering the use of airships again has caused considerable interest in the world of aviation. To many people the airship is a lost cause, a vehicle rendered obsolete by the tremendous advances in conventional aircraft in the last quarter of a century, but despite this the view has always been held amongst a small but influential section of the public that the airship should be re-investigated as a means of transport.

What, of course, influenced the trend against airships between the wars were the appalling tragedies that occurred. The most famous was the catastrophe of the R101, which flared up and took with it some of the best brains of the century. And the R101 was not the only casualty. First doubts about the efficiency of the airship were created during the first World War when the Zeppelins sent over by Kaiser Wilhelm were destroyed in great numbers as they tried to bomb London. They were a considerable terror weapon and no one who saw the massive sausage shapes hovering over the Metropolis during that war will ever forget the chill it sent through the bones.

Airships got off to a great start. Compared with the aeroplane there were few technical problems. The principle of the balloon, and subsequently the airship, had been known for centuries. The Montgolfier brothers, who may properly be termed

the fathers of modern aeronautics, made many ascents over their native Paris, using hot air to drive their huge balloon into the skies. Every child was familiar with the balloon. Its grandson, the airship, thus had no prejudice to flight in its early days.

The first true airships were invented during the last decade of the last century. Hiram Maxim, that very talented genius (remember the Maxim gun?) was in the lead, and he was followed by that strange and exotic genius Santos-Dumont, who also was one of the great experimenters with the aeroplane. The Army was interested and during the last year of the Boer War plans were drawn up for Army Airship No. 1. As is so often the case in peacetime, the fact that plans were drawn up did not mean that the construction of the craft was imminent and, in fact, this airship was not completed for a further five years. When it was ready it was given another name, "Nulli Secundus", Latin for "second to none", rather an ambitious title for a quaint aircraft only 122ft long with a maximum diameter of 26ft—very, very small compared with the monsters that came after it within ten years or so.

It was powered by one 8-cylinder V-block Antoinette engine giving between 40 and 50 horsepower. This, weather permitting, drove the airship along at a top speed of 16 miles per hour. In other words, it could be outpaced by an active

cyclist! The envelope was made of goldbeaters' skin, which is the outside membrane of the large intestine of the ox. This the goldbeaters use by placing it between the leaves of gold as they beat them. It can be beaten extremely thin and it was once used on cuts and bruises, but it could hardly have been expected to be used as the skin of an airship.

Despite this inauspicious beginning (or so it seems nowadays) the authorities went ahead with more airships. The second one was called "Baby" and the third "Beta" and this last one took part in the Army manoeuvres of 1910, just four years before the Great War began. Curious spectators watched it fly over London during that year and many older people must remember it.

Improvements on these airships multiplied apace and their cubic capacity was increased a thousand-fold over Army Airship No. 1. In the meantime the Navy had not been sleeping and sponsored Naval Airship No. 1, prettily called the "Mayfly". This met with disaster and the project was dropped, to be reopened the year later. Despite all this activity England went into the Great War with but a handful of airships and it was left to the Germans to fashion them as a weapon of war. However, the use of non-rigid types of airship, known by various names such as "blimps", was widespread by all the great Powers. They were used as observation posts in great numbers on the Western Front and

were shot down with alacrity by all concerned. There can hardly have been more of a sitting target than the observer sitting beneath his tethered, gently-floating blimp. This type of craft was well known to us in the last war, when many thousands of them were sited throughout the length and breadth of Britain as barrage balloons. Whether they were very effective or not is a moot point that is still argued, but they did afford some degree of comfort to the anxious civilian.

When, after the first World War, Naval Rigid Airship R34 flew across the Atlantic and back in 11 days it seemed that the way was wide open for a new dimension in flight. But disasters struck one after another despite constant improvements. Helium, first isolated in 1895, was non-inflammable and became widely used as the inflating gas, but still the airships crashed.

Now that the whole question of lighter-than-air transport is being re-opened what can we expect in the way of advances? Very little has been done in the way of experiment for more than 30 years. We may expect that plastics, light and virtually indestructible, will form the airship envelope. Airship engines will doubtless be more powerful. We must remember that at the outbreak of the last war no aircraft engine developed more than 1,000 horsepower. Together with other advances there may well be a chance that airships may once more be a common sight in the sky.

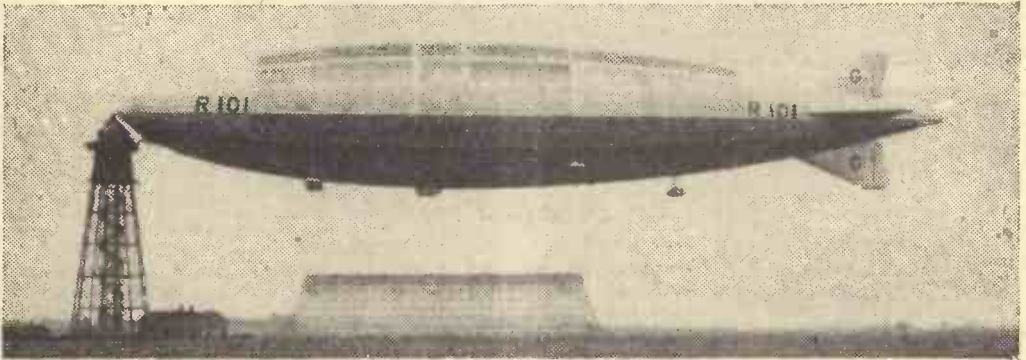

The R101

The Graf Zeppelin in flight

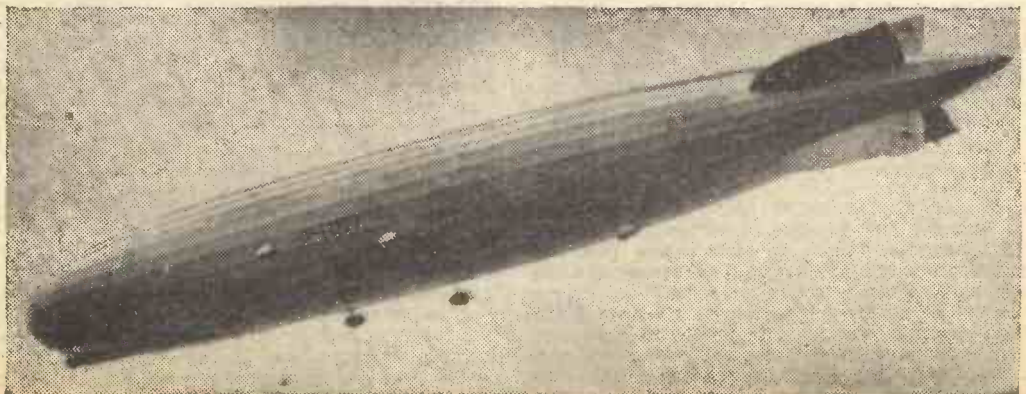

PICTURE NEWS

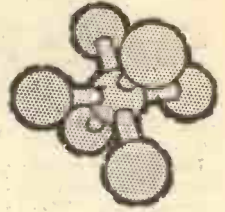

FROM THE WORLD OF SCIENCE

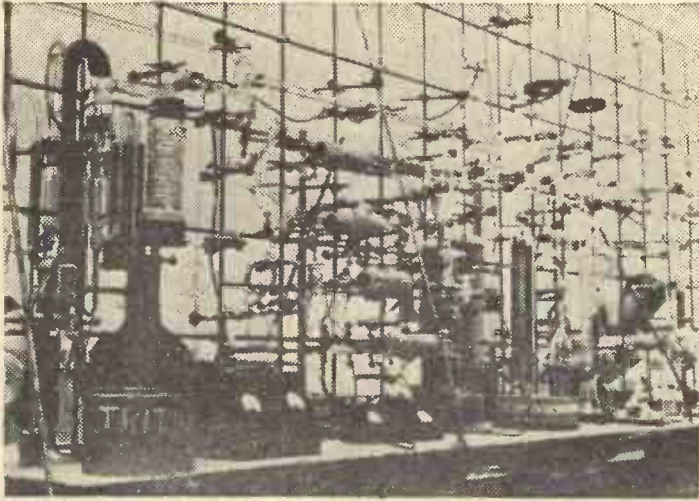

How old is the ocean?

THE intricate piece of apparatus shown here is one that scientists use to prepare sea water, prior to determining its age. The sea water, taken from a depth of 2½ miles, is passed through this atomic equipment and then the age is calculated by an atomic "clock".



Weather on tap

AN industrial scientist using a device that imposes the harshest conditions for determining resistance to corrosion. Outdoor weather, especially in England, plays havoc with stone, steel, painted surfaces and most other things. This particular test shows panels that have been coated with a new synthetic-latex metal primer which is expected to offer resistance to salt and sea air as well as other atmospheric chemical compounds.



Down periscope?

NOT exactly! In what looks like an empty submarine a shot-blaster prepares an acid-carrying railway tank wagon for the installation of a special rubber lining. More than 2,000 United States tank wagons are protected against corrosive liquids by such linings.

Simple slot cutting tool

BY R. C. GRAPER

A TOOL for cutting equally spaced slots to a given depth in either plastics material or soft metal will often be found invaluable for small work, and the results far more accurate than can be achieved by normal marking-off and cutting. The tool, made from a length of brass curtain runner channel, has a cutting blade and a spacing strip, these two being spaced at a distance apart equal to the desired spacing of the slots it is intended to cut.

blade should be reversed and used as the locating strip. Both blades should be soldered to the curtain runner section at the bottom, as shown.

Fig. 2 shows the tool before fitting the blade and locating strip. The cut-away portion should be removed with a small piercing-saw blade. The latter are similar to ordinary fretsaw blades but for cutting metal. The depth "X" will be determined by the depth of slots required.

Fig. 3 shows a section at "AA", through the

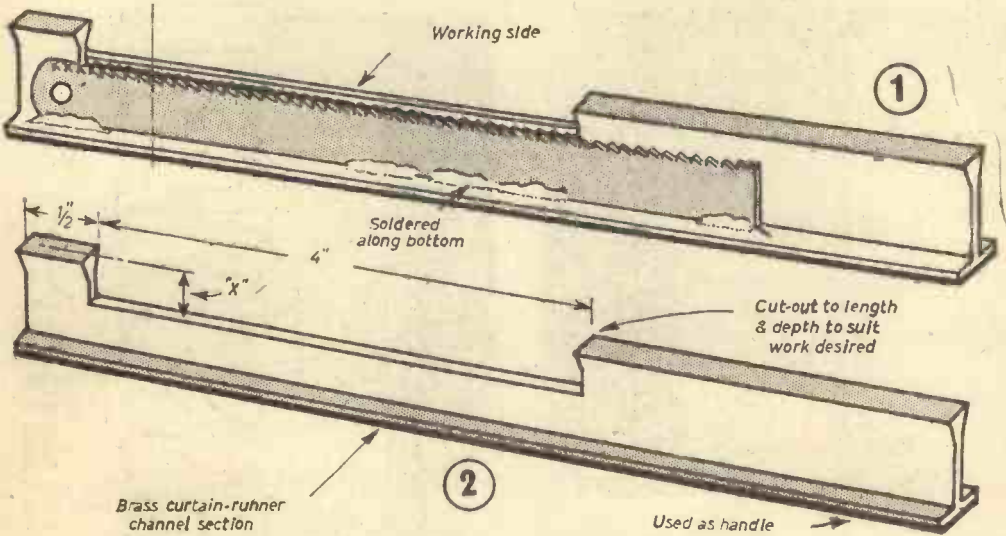
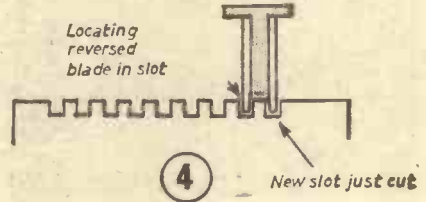
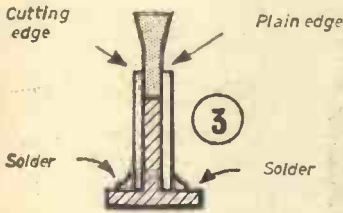

When using the tool a first slot should be cut, then the plain or locating edge inserted in this cut. With this automatically correct spacing the next cut can be made. The locating edge should then be inserted in cut number two and number three cut made—and so on.

Fig. 1 shows the completed tool upside down for convenience of illustration. A normal hacksaw blade should be broken in half and one piece used as the cutter. The other half of the

blade and locating strip. The soldering of the blades should be done using killed spirit flux and a good heavy soldering iron—preferably electric.

Fig. 4 shows the type of work produced, and shows the saw and locating strip in use. If wider spacing than the thickness of the curtain runner is needed, this must be arranged by adding strips of metal before soldering, though a limit of 1/4 in. is about the maximum space that will be workable without the tool becoming unwieldy.

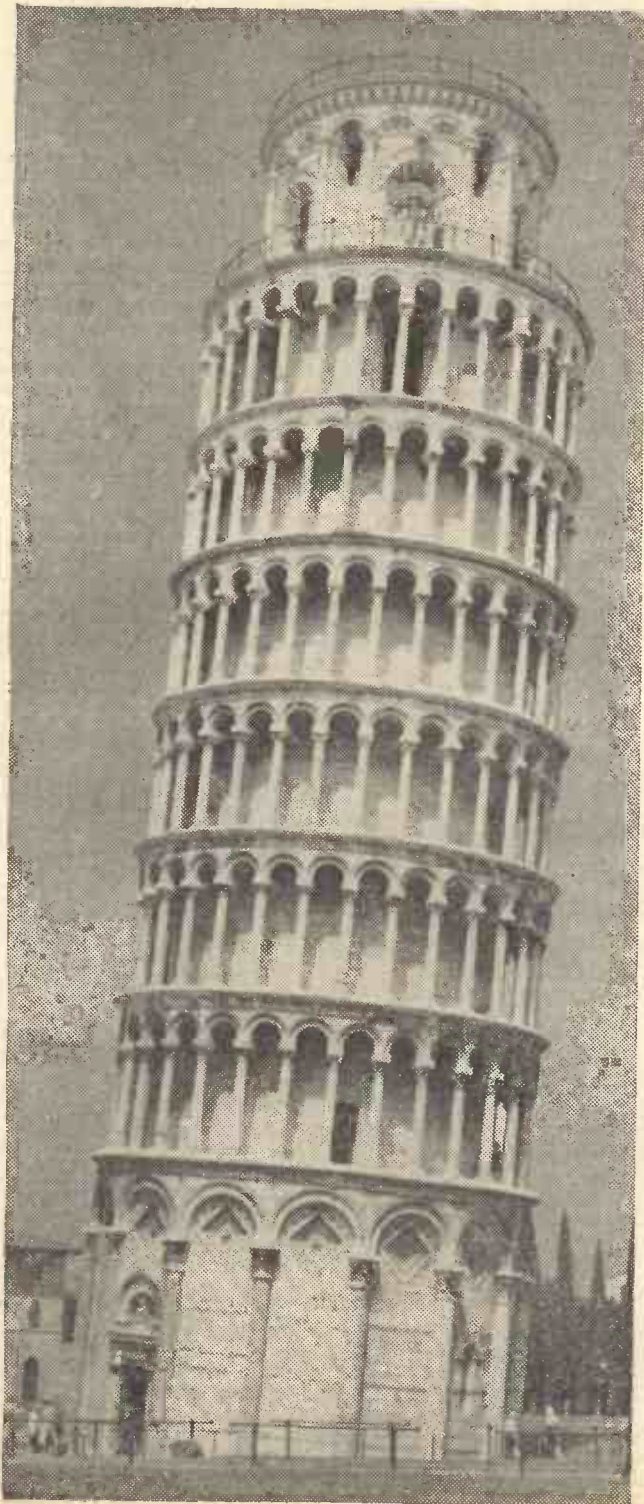

ITALY'S REEFLING SHEAFETS

By PAUL BROCK

THE genius who comes up with a solution to what is known as "The Pisa Problem" in engineering will make himself a fortune. At the same time, according to the City Fathers of that ancient Italian tourist mecca, he will be made an honorary citizen of Pisa for the rest of his natural life. All he has to do is produce a workable plan to stop the now dangerous decline and fall of the famous Leaning Tower!

True, the Pisa problem has remained unsolved for seven centuries, but today the answer is "more desperately needed than ever", according to Italy's Government Commission of Vigilance for the Stability of the Bell Tower of Pisa. The Tower, which emerged practically unscathed from an artillery duel in and around the city during World War II, is actually threatening to collapse of its own initiative. Because it is now leaning much too far for safety, the Commission of Vigilance has issued an appeal to engineers all over the world for help to keep it from toppling. Since it was built in 1174 it has tipped fifteen feet out of line, and in recent years the tilt has been increasing by about one millimetre (1/25th of an inch) annually.

Pisa is built on the rubble brought down by the Arno, and the whole of the river's broad basin is filled to an unknown depth with rolled limestone, pebbles, and sand, from the Appenines. The foundations of the leaning tower are only ten feet deep and their circumference is only as broad as the tower itself. Men have been warned against building on sand since history began, but if it is necessary to build on it, commonsense would tell us to broaden the base so that the weight above can be distributed over the widest possible area. Gothic architects bore this in mind everywhere except in Italy. There, campaniles run up to a great height and, unlike Gothic towers and spires generally, they have no buttresses. It is probable that the feeling for classic architecture always pre-

vailed in Italy, and the mediaeval architects avoided the introduction of buttresses because there was no warrant for it in antiquity.

The ancients did not bother to run up these lofty towers, but the Italian architects of the Middle Ages, with a fine flourish, had to build lofty churches and high campaniles, and were hampered by their adherence to precedence. They did not buttress them boldly and sensibly, because the old Roman architects had not used the buttress. The consequence was that they got into difficulties. Elsewhere in Europe the church tower was attached to the church, which helped to put a shoulder to the tower and keep it up. But this was not done in Italy, for experience proved that the tower, being heavier, cracked the walls and pulled the church down. So the bell towers were built detached. At Pisa a cathedral was built, with a tower detached from it, both of white marble. It was fortunate that they did keep their distance. The cathedral, standing on a broad base, remains upright today, but the campanile has sunk on one side and leans over.

If a man wishes to support a great weight on his head he instinctively plants his feet apart. This should have taught the Italian architects what to do when they built a tower. However, it did not, and that is why Northern Italy is the land of towers staggering in all directions. Pisa is certainly the most remarkable, and of it Charles Dickens said: "Sismondi compares the tower to the usual pictorial representations in children's books of the Tower of Babel. It is a happy simile, and conveys a better idea of the building than chapters of laboured description". The tower was begun in 1174. It has eight storeys and rises 179 feet. A stairway of 300 steps built in the walls leads to the top which commands a magnificent view of the city and of the sea six miles away. Each storey is formed of arches supported by columns, the several storeys being divided by ornamental cornices. The tower was not finished

The leaning tower and the cathedral, Pisa.

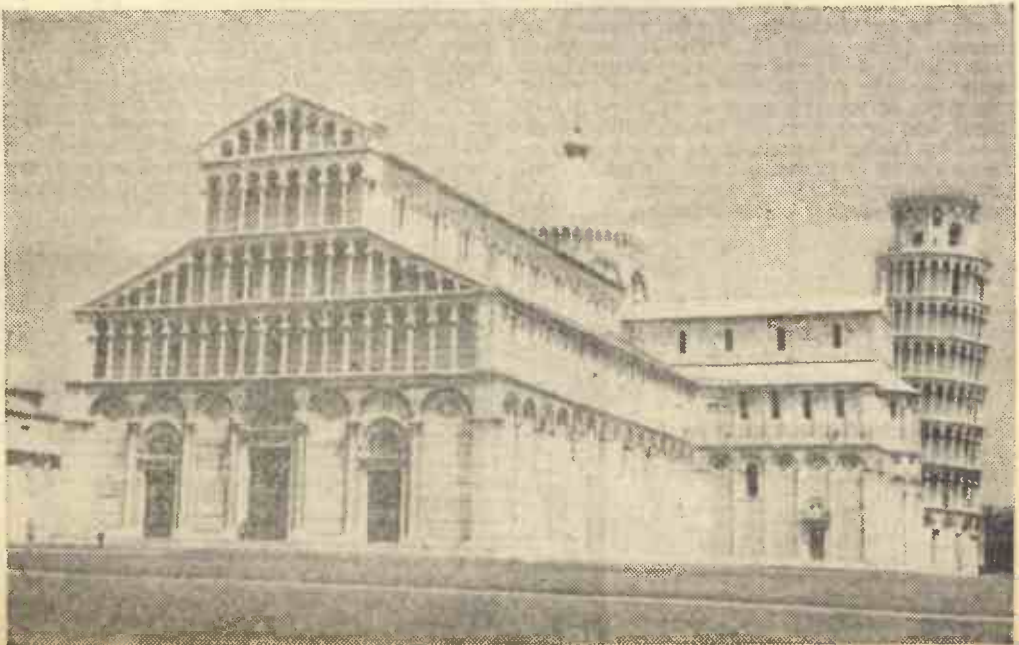

until 1350. It started to lean after the first three galleries had been built, but the work went on with slightly changed plans. The scientist Galileo, who was born in Pisa, used the tower in experiments to determine the velocity of falling bodies, thus making a virtue out of its tilt. In spite of its inclination and its great age it has withstood the ravages of time with more than ordinary success, and at the present time there is hardly any perceptible sign of decay in the actual structure.

Precisely the same conditions exist at Venice, and in the basin of the Po, as at Pisa. At Venice the subsoil is mud, and buildings have to be erected on piles driven into the bottom of the shallow Adriatic. The district between the Apennines and the Alps is a plain composed of rolled stones brought down from the mountains by the Po and its tributaries; the stones intermingled with sand. The great cities of Northern Italy—Milan, Bologna, Mantua, Piacenza—are all planted on this mighty rubble-bed. Here, too, the architects of the Middle Ages attempted the impossible—to erect towers of great altitude on absurdly narrow bases. Bologna is perhaps even more striking than Pisa in this respect. It simply bristles with towers. It became a matter of pride among the noble families in the Middle Ages to have these tall and useless structures. They were mere monuments of human perversity, for they were not even designed to hold bells. Neither were they adaptable as strongholds.

In a piazza at Bologna stand two of these towers. The Torre degli Asinelli was begun in 1109. It is 320 feet high and 4 feet out of the perpendicular. Close to it is another, La Garisenda, built in 1110 by the brothers Filippo and Oddo Garisendi. This was unfinished and is only 163 feet high but it is as much as 10 feet out of the perpendicular. The first sight of these towers is apt to make one blink one's eyes. They are square and windowless and look like square-section rulers set up on end and toppling over. Dante compares the giant Antaeus, bending to lift him so as to bear him to the depths of the Inferno, to La Garisenda. Goethe expressed an interesting theory about it. "The leaning tower has a frightful look, and yet it is most probable that it was built thus designedly. In the troublesome times of the city every large house was a fortress, and every powerful family had a tower. By-and-by the very possession of such a building became a mark of importance and distinction, and as at last a perpendicular tower became a perfectly common and everyday object, a leaning tower was

built. Architect and owner attained their end; the mass of upright towers are just glanced at, and all hurry on to examine the leaning one".

This theory that La Garisenda's lean was intentional is not supported by historical details. The extraordinary height of the Aniselli tower is said to have excited the envy of the rival family and the Garisendi tower was begun on the same dimensions at the base, 18 feet square, a few paces from it, with the object of overtopping it. However, the fates were not sympathetic. The precarious sand and rubble at the base shifted and the tower lurched over. It was carried up as far as possible till the centre of gravity would no longer fall within the base, and then reluctantly abandoned.

Looking down on the city of Bologna from the north side one sees a whole range of reeling shafts. There is the Leaning Tower of Guerrmani, the lofty campanile of the church of S. Giacomo, the Palazzo del Podesta which has a street running under it, so that it rests on arches—a still greater interference with the base—and the tower of the Palazzo Pubblico, or municipal palace. But perhaps the finest tower in Northern Italy is the campanile of La Ghirlandina at Modena. This is 335 feet in height and was erected between 1224 and 1319. Its name is derived from the sculpture which enwrathes it like a garland. Not only is the tower out of the perpendicular, but so is the cathedral adjoining.

It is doubtful whether anything will be done to correct the Tower of Pisa's lean and bring it back to the perpendicular. The tower is one of the most valuable tourist attractions in Italy and many Pisan families make their living by carving and selling models of the off-centre structure. Cement was injected under the weak side of the tower years ago. It helped but didn't stop the ever-increasing lean. Italian engineers have estimated that as much as ten thousand tons of cement would have to be used to underpin it properly—a big undertaking for a city that suffered fifteen million dollars-worth of damage during the war, and is still plagued with the more humanitarian problem of re-housing its population of some 70,000.

And yet the famous Pisa problem was "solved" in no time at all by a ten-year-old Italian schoolgirl who wrote to the Commission of Vigilance recently with her solution: "Get a spade", she said, "and just dig out some of the sandy soil underneath the other side of the tower. It will then settle back until it's straight—you see if it doesn't".

Panorama looking west taken from the top of the Torre Degli Asinelli . . . one of the many leaning towers of Bologna.



FAHRENHEIT or CENTIGRADE ?

By P. LEE

IT has been stated that with the current trend towards the decimal system, we will eventually use the centigrade scale for common temperature measurements, instead of Fahrenheit. This of course has already happened in the B.B.C. weather forecasts. This article is intended to prepare the uninitiated for any general change of system.

Gabriel Daniel Fahrenheit was born in Danzig, on 14th May, 1686, although most of his later life was spent in England and Holland. In 1714, with an alcohol thermometer, he attempted to obtain two fixed points of reference. His zero was obtained by using a mixture of ice, water and common salt. As the upper reference, he chose the temperature of a human being, which at that time was thought to be constant. This he called 24°. With the scale so obtained, he found that the temperature of melting ice and boiling water were 8° and 53° respectively. Later, using a mercury thermometer, Fahrenheit decided to multiply the values by 4, which gave a finer graduation. At this point, he discarded his zero, which he was finding unreliable, because of variations in the relative proportions of ice, salt and water. Thus the scale as we know it was formulated, i.e.:—

Melting point of ice, 32°F.

Boiling point of water at normal atmospheric pressure, 212°F.

The interval (180 divisions) between these fixed points is called the "fundamental interval".

Anders Celsius, of Uppsala, Sweden, is credited with proposing the centigrade or 100 division scale, in 1742, when he took the boiling of water as 0° and the melting point of ice as 100°. It is said that a colleague, Stromer, inverted the scale to its present form, i.e.:—

Melting point of ice, 0°C.

Boiling point of water at normal atmospheric pressure, 100°C.

In this case, the "fundamental interval" is 100 divisions.

As a matter of interest, the two scales are numerically equal at -40°, but that, of course, is so low as to be only a laboratory proposition. Let us now consider the methods of conversion from one scale into the other.

If we compare the "fundamental intervals" of the two scales it will be seen that they are in the ratio 180 : 100, or, to put it rather more simply, 9 : 5. Thus there is a direct relationship. In any calculation, however, we must also take into account the 32° on the Fahrenheit scale before the lower of the fixed reference points is reached.

We can express our relationship, therefore, as a basic mathematical formula:

$$^{\circ}\text{C} = \frac{5}{9} (^{\circ}\text{F} - 32) \quad \text{and} \quad ^{\circ}\text{F} = \left(\frac{9}{5} \times ^{\circ}\text{C} + 32\right)$$

A further method would be to reduce this formula to a ratio table, shown in Table 1. Note that when converting from °C into °F, the final step is the addition of 32°. Similarly, when converting from °F into °C, the first step is the subtraction of 32°.

Table 1. Ratios of °C and °F

°C	°F	°F	°C
add 32 after		subtract 32 before	
1	1.8	1	0.56
2	3.6	2	1.11
3	5.4	3	1.67
4	7.2	4	2.22
5	9.0	5	2.78
6	10.8	6	3.33
7	12.6	7	3.89
8	14.4	8	4.45
9	16.2	9	5.00

Examples of the use of the tables are as follows:

- (i) 4° = 7.2°F + 32 = 39.2°F
- (ii) 38°F - 32 = 6°F = 3.33°C

The table can also be used for tens as well as units

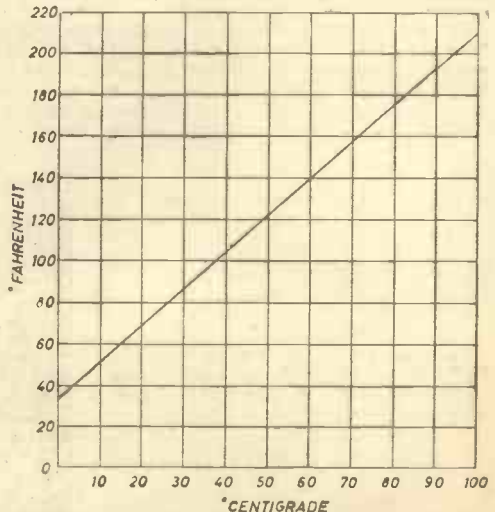

Graph for interconversion of Fahrenheit and Centigrade temperatures.

- (iii) $20^{\circ}\text{C} = 36^{\circ}\text{F} + 32 = 68^{\circ}\text{F}$
- (iv) $72^{\circ}\text{F} - 32 = 40^{\circ}\text{F} = 22.2^{\circ}\text{C}$

Other numbers can be split into tens plus units

- (v) $23^{\circ}\text{C} = 20^{\circ}\text{C} + 3^{\circ}\text{C} = 36^{\circ}\text{F} + 5.4^{\circ}\text{F} + 32 = 73.4^{\circ}\text{F}$

equivalent of 80°F . We first of all find 80° on the $^{\circ}\text{F}$ scale and then trace across the graph in a horizontal direction, being careful not to deviate vertically from our 80° position. When the diagonal line is reached, we trace vertically downwards until the scale marked $^{\circ}\text{C}$ is reached. The point at which this scale is crossed is the equivalent value

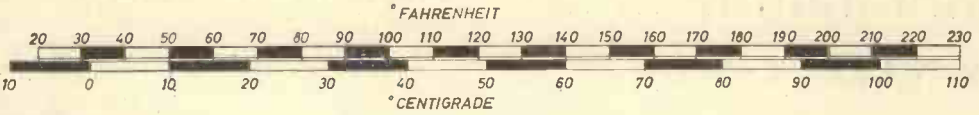

Table 2.

- (vi) $75^{\circ}\text{F} - 32 = 43^{\circ}\text{F} = 40^{\circ}\text{F} + 3^{\circ}\text{F} = 22.2^{\circ}\text{C} + 1.67^{\circ}\text{C} = 23.87^{\circ}\text{C}$

Another convenient method, where a high accuracy is of no importance, is by use of a simple scale, or abac. This is shown in Table 2, and is self-explanatory.

Finally, another method of conversion is to use a graph, where one axis is used for $^{\circ}\text{C}$ and the other for $^{\circ}\text{F}$. Use of the graph is best shown by example. Let us say that we wish to obtain the

that we wanted to obtain. For 80°F we find from the graph that the corresponding value in $^{\circ}\text{C}$ is 27.

Checking this with the accurate mathematical method, an exact value of 26.666°C is obtained. The graph, then, can be considered as reasonably accurate.

In closing, perhaps we should note that, according to British Standard BS.1991, we should no longer refer to the 100 degree scale as Centigrade, but in future we are recommended to say "degrees Celsius".

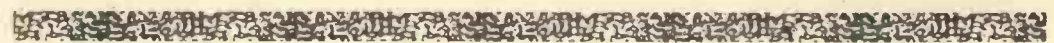

Towards Perfect Slide Projection

Part 1

By A. E. BENSUSAN



THE sales figures for films of different kinds show that the quantities of colour materials used are gradually becoming greater. A part of this increase is in colour negative materials, from which prints are made, but the majority is due to the considerable interest in reversal stock, which is processed to form slides for projection. There are now very many low-priced projectors on the market, most of excellent quality and quite suitable for home use.

However, the possession of a well-built projector does not, in itself, guarantee satisfactory slide projection. There are a number of other factors to be considered if a showing, whether it is for one's own entertainment or for that of an audience, is to be a success.

The first step must be to ascertain that the projector is giving its best possible performance. It is essential to use a bulb of the correct voltage to suit the mains supply and, if the machine has

variable tappings on a built-in transformer, to select the right position. An overrun lamp will fail very quickly, although it will produce an exceptionally bright light throughout its short life. On the other hand, a bulb intended for use with a higher voltage supply, and therefore under-run, will last far longer but will emit a yellow-red light which will spoil the colour-balance of the transparencies. A properly used bulb should have a total burning life of approximately twenty-five to fifty hours.

Most projectors have their internal optical systems well protected from dust, and they need

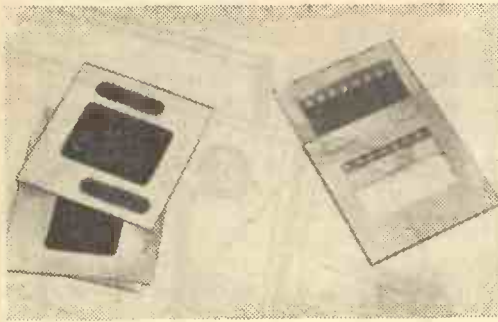
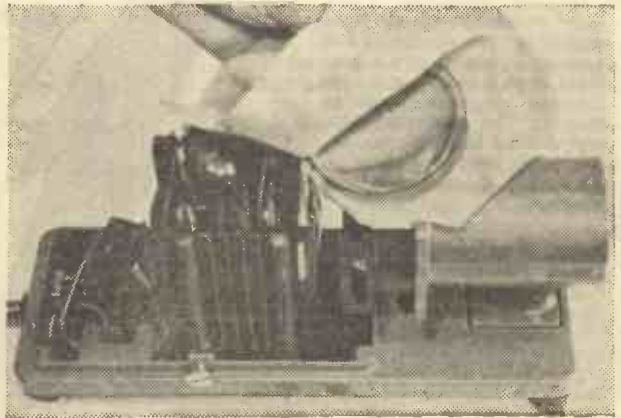

Fig. 1 (left).—Typical card mounts in which transparencies are returned from processing. (right).—Transparencies should be re-mounted in metal or plastic slides as soon as possible, to prevent damage.

Fig. 2.—Handle projector lenses with great care, using a chamois leather to avoid finger marks.



only occasional cleaning. The bulb and condensers should always be treated with great respect when they are removed for cleaning and, in fact, the latter are best handled with a soft chamois leather. Optical quality glass is surprisingly delicate and liable to marking, either by gritty dirt, or by the etching effect of the acids in skin oils. Therefore, it is wise to dust off condenser surfaces with an artist's brush, before polishing with the chamois, at the same time holding the component in the leather (Fig. 2).

Bulbs which have been burned for some time tend to have brittle filaments, and need to be handled with considerable care if their lives are not to be unduly shortened. This tendency is at its greatest when the lamps are still hot, and no attempt should be made to move a projector until the bulb

is quite cold. Always store the machine in a place where it is not liable to knocking and vibration.

Just as important as maintaining the projector properly, is the habit of keeping the slides in good condition. In most cases, the transparencies are returned from the processing station already mounted in cardboard slides, as shown on the left-hand side of Fig. 1. This method is quite satisfactory for running the slides through the projector once or twice, just to see what the pictures are like, but prolonged use will result in scratched and dirty transparencies. Therefore, at the first opportunity, the transparencies should be re-mounted into metal or plastic slides with glass inserts. One of the many different types available is shown on the right-hand side of Fig. 1.

Putting the transparencies into rigid slides is not a difficult undertaking and, after a routine has been established, it becomes an almost automatic action. However, it is vital that no dust particles are trapped inside the glasses or on the film itself. Under the magnification obtained through the projector, the smallest speck is immediately obvious on the screen. Use a soft chamois, or an anti-static cloth from a photographic dealer, to polish the glasses and the film. Treat the film very gently when cleaning it, or it will become scratched and pitted. Once enclosed in the mount, the transparency will be completely protected, and should be free from the annoying popping out of focus which usually affects card-mounted slides.

When loading the projector slide-carrier, always handle the slides by their edges or the glasses will become covered with fingerprints. Although these marks may be practically unnoticeable when the slides are viewed in the hand, they become all too obvious and assume considerable proportions, when shown on the screen.

Before giving a projection show, set the machine up so that it is exactly square to the screen in all planes, otherwise the picture will taper and one edge will be unsharp. Never stand the projector on a very soft mat, or the underneath cooling louvres will be obstructed and the machine will overheat.

In the second part of this article, the combination of a sound commentary with slide projection will be described.



Above. The retaining wall to the 3ft 6in. high area under construction. Note the shuttering, and reinforcing bars driven into the earth face.

Although the existing 3ft 6in. high cellar area covered a large area under the house, it was only necessary to excavate part of it. The remainder is entered by means of the concrete steps 2, built into the reinforced concrete retaining wall 3. The excavated area was divided into two rooms, one being used as a chemical laboratory 4 with sink and benches.

Below. A corner of the darkroom. Partitions were faced one side and braces arranged at suitable heights to carry benches and shelves.



THE STORY OF A DARKROOM and

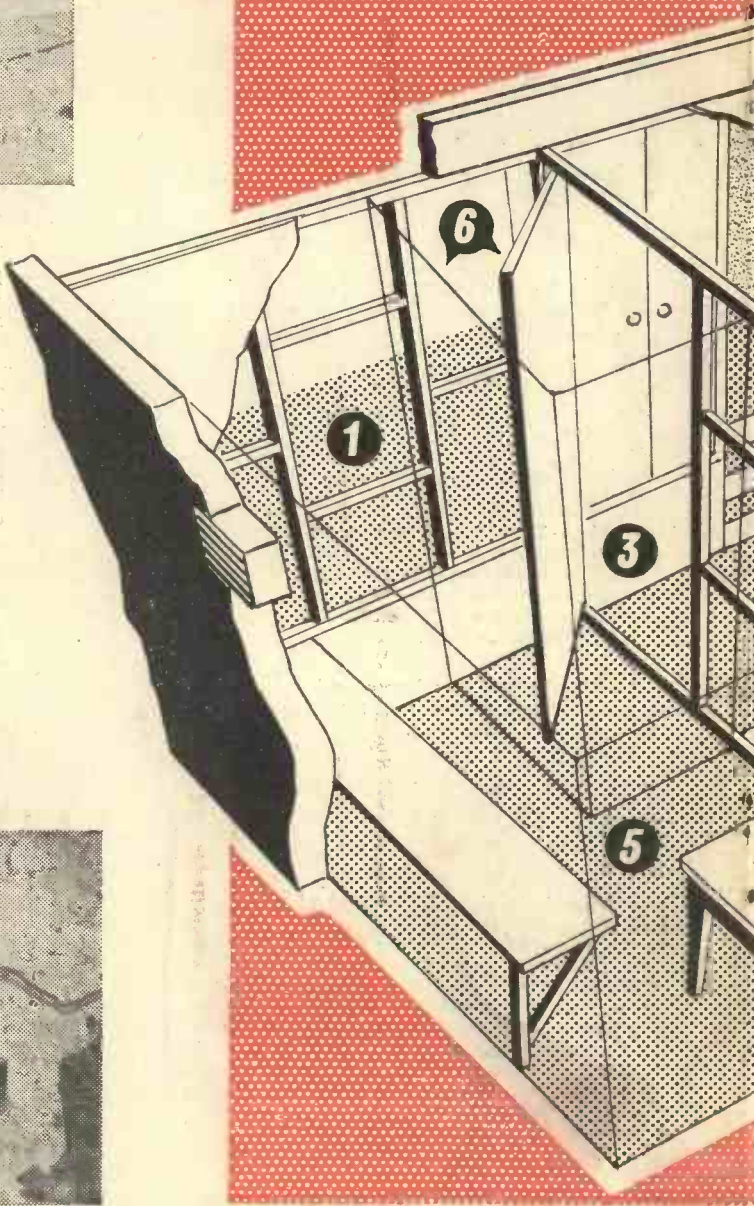

LABORATORY

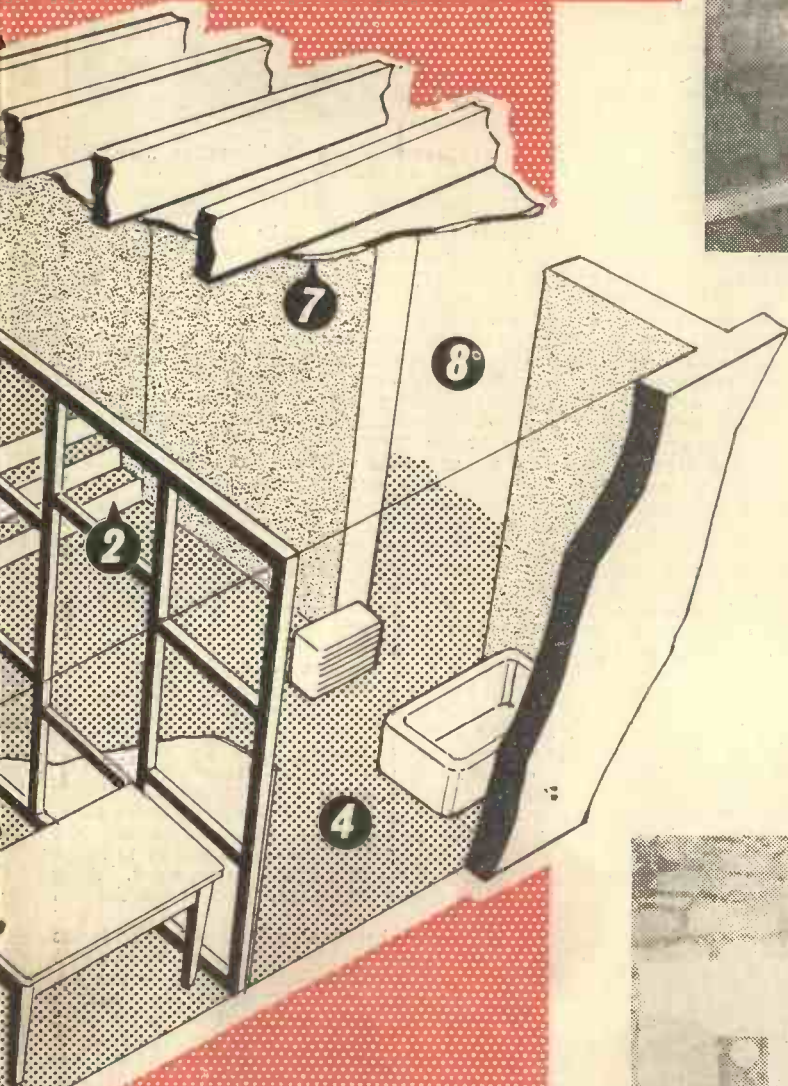

Above. The work at an advanced stage, viewed from the workshop. Excavation and concreting are complete and the partitions ready for facing.

The other room 5 is used as a photographic darkroom which would be the envy of many amateurs. It is entered through a light lock formed by a door and curtains 6. The ground floor joists were covered with hardboard 7 as a precaution against dust filtering through the floor. The laboratory opens out from the existing workshop area 8.

Below. A corner of the well-equipped laboratory. There is ample experiment bench space built-in cupboards for apparatus storage, and a sink.

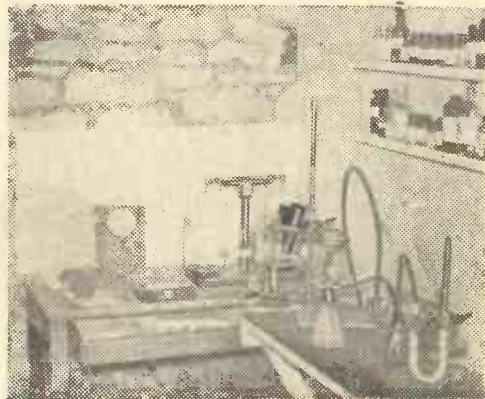

by D. Horler

UNDERNEATH the house we have a very large cellar, most of it being 6ft 2in. high. This area is used as a workshop but due to the lack of other space this has had to be the centre of all our hobbies—woodwork, metalwork and photography—and a play den for the two boys, aged 13 and 11, both being very interested in electricity and chemistry.

Whenever we wished to do photography the windows had to be blacked out, the bench cleared and the enlarger taken from its cupboard. All this preparation took up valuable time and when the photo-session was over everything had to be stowed away again. Another serious disadvantage was the ever-present dust which could not be completely eliminated. Having spent 18 months in Berlin at the end of the war, with free access to a fully-equipped darkroom, made me realise just what we were missing in not having a separate darkroom.

At the end of the workshop cellar a doorway opened off to another cellar, but this was only 3ft 6in. high and was used for storing garden produce. One morning the two boys and I discussed the possibility of removing the floor of this cellar and making it into a chemical laboratory and darkroom. On first sight this seemed to be a most formidable task, especially as my building knowledge and experience were practically negligible. The local builder was consulted and assured us that we would not damage the foundations or interfere with the main structure of the building. Having got this assurance we decided to have a go.

The concrete floor of part of the 3ft 6in. area was smashed up with sledgehammer and crowbars and removed. Next came the job of wheeling out 150 barrows of excavated earth. The zeal and speed with which the boys did this surprised me—they must have thought they were digging holes at the seaside!

Construction of floor

The area was roughly divided into three sections and lengths of 2in. x 2in. wood placed in position with a batten laid across the top. A spirit level was placed on this batten and the level noted with the

Another corner of the laboratory, showing a shelf fixed to a partition cross-brace.

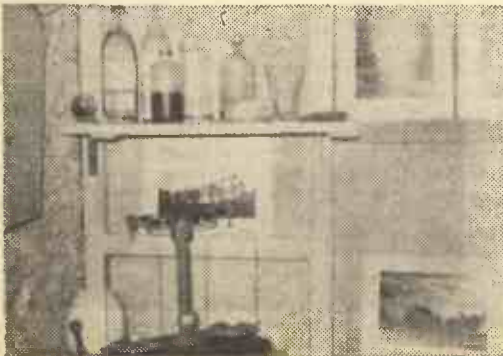

There is no lack of space in the laboratory, here being put to good use.

batten in various places. The 2in. x 2in. lengths were then raised or lowered slightly as required to give the best overall result on the spirit level.

As it was not necessary to dig out the whole 3ft 6in. high area it was essential to build, or rather cast, a retaining wall to support the existing floor at the higher level and also to carry the partition at the end of the darkroom. The rough earth was given a slope from top to bottom and lengths of old iron bars were driven into the earth at an angle, to form a key for the cement. Next, wood shuttering was fitted up, supported by 2in. x 2in. uprights, held in position at the bottom by means of stakes driven into the ground and wedged at the top under the rafters of the ceiling. Care was taken to ensure that the shuttering was vertical and that the lengths of iron rod driven in for keying were clear of the inside edge of the shuttering. Otherwise they would have projected through the concrete and defaced the wall. The cement and aggregate were then mixed, using proportions of five to one. This was well rammed in until it began to squeeze out of a 1in. gap left between the shuttering and the earth. This then formed a key to the floor when this was laid later. When the space between the shuttering and the earth was completely filled the surface was rendered smooth and level with the existing floor. Before it set, three lengths of flat mild steel 1in. x 1/2in. and 6in. long, with one end hooked and a 1/2in. hole drilled in the other, were pushed into the concrete. These metal bars were put in to locate the base of the partition and to secure it. After three days the shuttering was removed and the wall inspected.

The floor area having already been levelled it was now covered with small stones, care being taken that all the stones were below the top of the 2in. x 2in., by at least 1/2in. The floor was dealt with in three sections, the centre section being the first. After damping the stones with a watering can with its rose on, the mix was thrown in and roughly spread out with a shovel. After this it was levelled out with a length of wood by rubbing this to and fro across the 2in. x 2in. timbers. After the concrete had set, the 2in. x 2in. lengths were removed and the gaps filled with concrete and smoothed off level. This completed the floor. Next the steps to the existing floor at the higher level were cast. The same method was used except that the shuttering was almost filled up with large stones. The treads were then smoothed off.

The partitions

The position of the darkroom was so selected that it was only necessary to build two partitions to enclose the darkroom area, the outside walls providing the other walls. The partitions were constructed of 2in. x 2in. softwood, the vertical members being notched into the horizontal bars and secured by 3½in. oval nails. When nailing it should be remembered that nails should be driven at an angle and when nailing near the ends it is often advisable to drill a guide hole through the first piece of timber. The whole structure was secured at the top by screwing into the ceiling joists and at the bottom by bolting to the iron bars cast into the concrete. The horizontal members between the uprights were not fitted symmetrically but were arranged to the best advantage for fixing the shelves and benches in the chemical laboratory and darkroom. When the frames had been fitted into position they were covered with ½in. thick hardboard after first soaking the back with water to prevent possible buckling after nailing in position.

The door was constructed of 1in. x 4in. timber suitably braced, with the bracings arranged to carry the hinges and handles. This frame was then covered with hardboard. The ceiling was next covered, also with ½in. hardboard, to prevent dust falling when the floor above was walked on. Advantage was taken of two existing wall vents to provide adequate ventilation in the hot summer months. It was therefore necessary to make light traps for these.

The benches and shelves in the darkroom are arranged for the most convenient working, wet chemicals being kept near the developing bench to

The enlarger and copying apparatus have their own table, at a convenient working height.

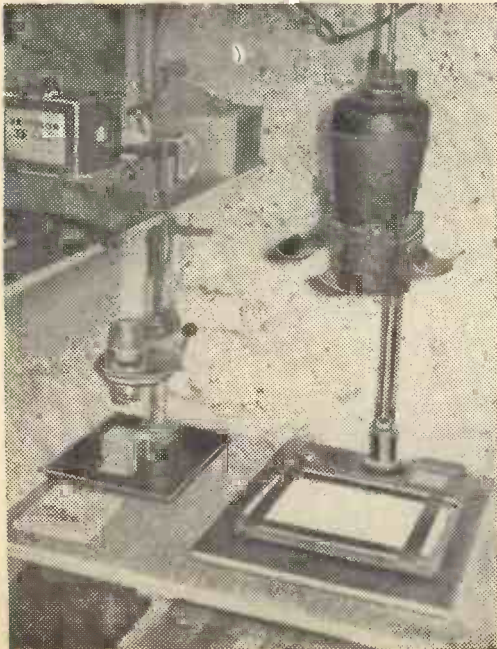

prevent possible contact with papers and negatives. The table for the enlarger is arranged so that it is at a convenient height to sit down and work. This also allows the enlarger to be used at its fullest extension in the somewhat limited headroom. Under the table a light-tight paper drawer has been fitted. All the bench tops in the darkroom are covered with good-quality lino, supplied as offcuts from the local dealer. Kept well polished with silicon polish the surface is resistant to stains.

Two safelamps are fitted. One is an adjustable type near the enlarger as it is often advantageous to be able to deflect the light away from the enlarger when focusing a difficult negative, the other, a fixed safelamp, is near the end of the developing bench. Before using the darkroom, tests were made to ensure that the positions of the lamps were safe for the working bench and enlarger and that no fogging takes place. A switched socket was fitted for the enlarger and also a socket for an electric fire or glazing machine as and when required. The sockets are fed from a fused spur box, while the lights are an extension to the existing workshop circuit, this having been first checked as to its permissible loading. No separate white light is fitted in the darkroom as this could be disastrous if switched on at the wrong time. It is a simple matter to remove the safelight filter from either of the safelamps if required.

A black curtain forms a light lock behind the door and prevents light spillage if the door is inadvertently opened. It will be noticed and, of course, is open to criticism, that the darkroom is not fitted with a sink. A sink was available but it was decided that it would be far more useful to fit this in the laboratory than in the darkroom as it is an easy matter to carry a dish of prints out to the laboratory for their final washing.

The interior of the darkroom was finally decorated with plastic emulsion paint and several of the best prints decorate the walls.

The *modus operandi* described here will probably be frowned upon by professionals but the job is complete, workable and extremely comfortable. Besides pleasing our egos the expense saved by doing it ourselves is in itself a sufficient reward.

TRANSISTORISED FLASH GUN

(Continued from page 468)

dependent on the state of the batteries and the number of condensers in circuit. When the neon fails to strike in a reasonable time the batteries should be replaced. Note: The unit should always be switched off and the tube then flashed *before* switching to a different power output, or before making any adjustment to the unit. Should the flash-tube require replacement (its life is usually more than 10,000 flashes) or the flash-head need to be opened, disconnect the power pack as well.

The batteries should give well in excess of 100 flashes before they need to be replaced. Leakproof cells are preferable for only intermittent use.

The effective flash duration is of the order of 1/1,200th second. The flash factors for various films can be calculated from a series of shots taken at varying apertures and a known distance; for medium speed film the factor should be about 65

WATCH MAKING IN WALES



By G. PIKE, F.B.H.I.

ABOUT 15 miles North East of Swansea in a part of South Wales that was as Swiss as Switzerland during the recent big freeze, lies the village of Ystradgynlais. Once it was well-known as the centre of an iron-ore smelting area. Now the biggest watch factory in the British Isles stands on the very same spot.

All this has been accomplished in about 15 years for it wasn't until 1947 that work really started. In those days the factory was very much smaller and only four kinds of watches were coming off the production lines. Now, with an area of 110,000 square feet and a payroll of 1,300 the Anglo Celtic Watch Co. Ltd. make as many as 350 different kinds of gent's and ladies' watches. The aerial picture shows part of the works. Administration and drawing offices are situated at the front, material and piece part stores behind, then the tool room, press shop and machine shops. All the watch assembly is done in the large U-shaped two storey building at the rear.

Watches and their parts start off on the drawing board, often a hundred times bigger than they actually will be. When all the ideas have been finalised, a prototype watch is made. Then the tools are designed and made for mass production of the new watch. The tool room at the Gurnos works with its staff of highly skilled tool-makers, might well be described as the nerve centre of the factory:

Here, the tools which make the watch parts, are themselves made. Highly sensitive jig borers and costly profile grinders are located in a special pressure and temperature controlled section of the tool room. Press tools from the tool room can be seen in operation in the press shop blanking out such things as the plates (the main frame of a watch), wheel blanks etc. The blanks from one modern high speed press are removed by high pressure air and caught in a wire basket.

To the layman the machine shop of any factory is fascinating. Even more so the machine shop of a watch factory, where row upon row of machines are automatically turning out thousands of tiny parts. Many can hardly be seen, except in the receptacle for catching them, as they are parted off from the raw material. Among the 130 automatics in echelon formation are a number of Whali pinion cutting machines. These have a magazine feed and operate continuously day and night behind locked doors. The magazines can hold as many as 10,000 pieces. Tiny things like balance staffs and hairspring pins are separated from the turning swarf at a later stage, and these are weighed on very sensitive scales which give an accurate assessment of quantity.

My guide was the Managing Director, but like everyone else he is subject to a special order which requests everyone to put on rubber overshoes before entering the assembly building. This, of course, is



Aerial view
of Anglo Celtic
Watch factory.



A general view
of the assembly
shop.

to prevent as little dirt or dust as possible reaching the air-conditioned and dustproofed benches. Double-glazed windows, flush surface block floors, individual strip lighting over the benches and arm rests for the operators all help to create ideal working conditions. On the ground floor numerous sub-assembly jobs, such as fitting wheels to pinions, are carried out on the right-hand side of the building. On the left-hand side a well proved pocket watch is assembled. One operator inserting the balance unit has been doing the same job for 13 years. In that time more than 8,000,000 pocket watches have been made.

Assembly of the three smaller sizes of movement is confined to the upper storey. Almost the whole of one side is concerned with the balance and hairspring unit, and as many as 50 women and girls have a share in this delicate work. Probably the most fascinating pieces of equipment in the factory are the Super Spiromatic hairspring vibrating machines. In these an electronic brain times the

hairspring, finds the correct pinning point and cuts the spring to length. These machines are entirely automatic and capable of vibrating 200 balances an hour.

Inspection of raw material, the parts as they leave the machines, and the watch movements is a continuous process and as many as 10 per cent of the factory personnel may be engaged on inspection. As the finished movements leave the conveyor belt they are again inspected and then timed in two different positions, for three days later, when the dials, hands and cases have been fitted the watches are tested on racks and large revolving drums for a week. In the Plating Department hundreds of bright aluminium cases are plunged into boiling red dye, to emerge after a few seconds, looking remarkably like gold.

Watches with such well-known names as Ingersoll and Smiths start to tick in this busy factory which is geared to a production figure of a million and a half a year.

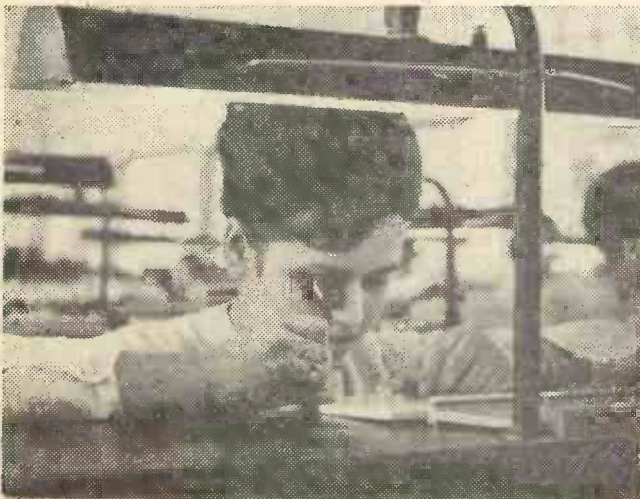

An adjusting
operator inspecting
a balance unit.

LATHE GADGETS

Part 19

BATCH PRODUCTION AIDS

By L. C. MASON

ALTHOUGH the model engineer is not normally much concerned with true mass production methods and techniques, he may be called upon to produce a batch of items all as nearly alike as possible. These are most likely to be bolts, nuts, studs, spacers, or something similar.

A versatile centre lathe would not be the choice of someone mainly concerned with quantity production, but when attempts at this are made in a small way on the ML7, one or two simple fixtures can help very much in taking out some of the repetition fiddling. One operation which can take up a fair proportion of the total time is gauging and measuring at various stages during production, and it is here that quite a bit of time and work can be saved.

Bolt heads to be chamfered can be gripped in the three jaw chuck with the underside of the head against the jaws, so that facing and chamfering with the saddle and topslide in the same position throughout produces heads all the same thickness. This is not the case with things like studs or columns for spacing clock plates, where there is no enlarged diameter to act as a register. However, any number of single-diameter items can be held in the three-jaw and faced straight away to a constant length by means of the socket stop shown.

This is merely a mild steel plug, taper turned to fit the mandrel and tailstock sockets, and tapped to some convenient size. The one shown was tapped $\frac{1}{8}$ in. B.S.F., because this is the size adopted as standard by the writer for holding-down studs used with tee nuts on the cross-slide. A length or two of commercial studding cut into various lengths, provides a set of clamping studs which between them can cope with anything likely to be met. By tapping the stop plug the same size, a similar range of stops is available for it in adjustable lengths from 0 to about 5 in.

To use it on the column job mentioned above, the plug should be inserted in the mandrel socket, a suitable bolt or length of studding screwed into the end, complete with locknut, and the chuck screwed in place over the stop. The length of stop protruding from the plug should be adjusted so that when the item to be held in the chuck touches the end of the stop, the right amount extends from the chuck for working. On fixing the right position for the stop it should be locknutted in the plug. For small diameter jobs, the tapped hole in the plug can be fitted with a screwed adapter, tapped 4B.A. or whatever may be suitable to the diameter of the job. The machining then only involves the speedy business of popping each piece into the chuck as far as it will go, knowing that if the tool position along

the bed is not disturbed, each one will be faced off to exactly the same length. After the initial setting up, no direct measurement is needed at all.

The same gadget can be useful in the tailstock socket for parting off regular short pieces from a length of rod. As before, the tool should be left in the same position all the time, with relation to the chuck, and merely fed forward to part off each piece. The tool position should be located as near as possible to the chuck. Sufficient rod should be extended from the chuck to provide the length required, and then the tailstock barrel should be fed forward till the stop touches the end of the rod. Note the measurement on the tailstock barrel scale, and withdraw the stop slightly, to leave the end of the rod free. After parting off, for item number two the tailstock needs merely to be fed forward again to the previous mark, the rod brought out of the chuck to touch the end of the stop, the stop retracted slightly, when all is set to part off the second piece. Again, no measuring or tool shifting along the rod to get the length right is needed.

This same system of stops can be applied with even greater effect to tool movement via the saddle. Where a reduced diameter may be required on the end of a number of pieces, an adjustable stop can very simply be fitted to stop the tool travel when the turned down portion is the right length. The stop here consists of a simple angle bracket carrying a short sleeve. The bracket should be bolted to the edge of the saddle, using the tapped hole already provided for the travelling steady. The sleeve should be drilled $\frac{1}{8}$ in. to hold the actual stop, which again is merely a suitable length of the same studding fitted with a nut or locknuts. The nut is positioned on the stud and the stud pushed into the sleeve so that the end of the stud contacts the headstock across the gap, at the required tool position. The saddle traverse *must* be by hand with this fitment in use. A number of prepared studs can be brought into use one after the other, should the job call for a number of different diameters to various lengths. In the case of jobs like columns with reduced and screwed ends, the saddle stop can be used with the mandrel socket stop already mentioned.

The production of quite complex items having a number of different diameters becomes a comparatively speedy business when each diameter is

Mandrel socket stop with adjustable saddle stop and bracket.



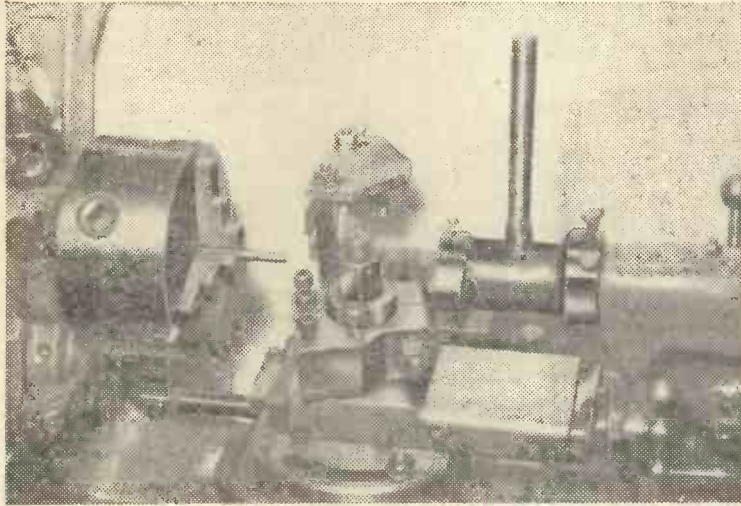

Set up for quantity production of hexagon bolts. Saddle stop can be seen in position, with back parting tool and tail stock dieholder.

produced by merely feeding in to a noted index dial figure, with its length determined by traversing to a fixed stop.

When turning out hexagon head bolts, the back parting off toolpost is a great help too, as the parting tool or blade can be positioned so that its cut comes nearer to the chuck than the end of the turning, by an amount equal to the bolt head thickness. This should be fixed by the position of the topline first, then the end-of-cut position set by the saddle stop. When once these relative positions are fixed, the topline should be left alone right through. Having finish turned to length and threaded the item, the cross slide needs merely to be

brought forward at that position to part off to correct head thickness. The photo shows the ML7 set up on these lines for small bolt production. Check the occasional item so produced to see that tool point wear or possible movement of stop nuts through vibration has not altered dimensions.

Neither of the items shown really needs any directions for making. Both were produced from oddments of mild steel from the scrap box, the sleeve for the saddle stop being brazed into its bracket. Dimensions are not at all critical, and the only fit required anywhere is that of the taper plug in the mandrel.

Details of the various components.

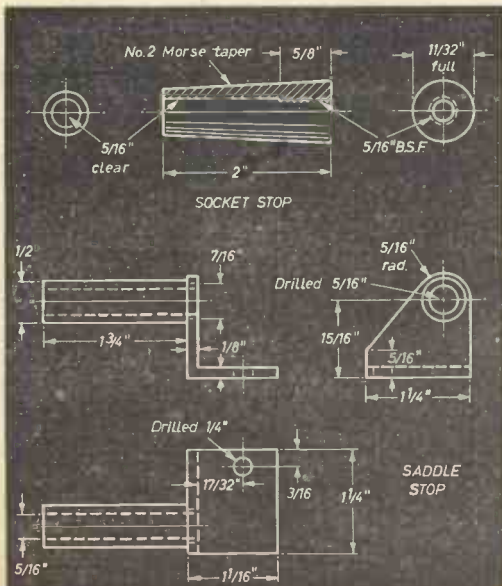

THE P.M. BLUEPRINT SERVICE

- 12 FT. ALL WOOD CANOE. New Series. No. 1, 4s.*
- COMPRESSED-AIR MODEL AERO ENGINE. New Series. No. 3, 5s. 6d.*
- AIR RESERVOIR FOR COMPRESSED-AIR AERO ENGINE. New Series. No. 3a, 1s. 6d.
- "SPORTS" PEDAL CAR. New Series. No. 4, 5s. 6d.*
- F. J. CAMM'S FLASH STEAM-PLANT. New Series. No. 5, 5s. 6d.
- SYNCHRONOUS ELECTRIC CLOCK. New Series. No. 6, 5s. 6d.*
- ELECTRIC DOOR-CHIME. No. 7, 4s.*
- ASTRONOMICAL TELESCOPE. New Series. Refractor. Object glass 3in. diam. Magnification x 80. No. 8 (2 sheets), 7s. 6d.*
- CANVAS CANOE. New Series. No. 9, 4s.*
- DIASCOPE. New Series. No. 10, 4s.*
- EPISCOPE. New Series. No. 11, 4s.*
- PANTOGRAPH. New Series. No. 12, 2s.*
- COMPRESSED-AIR PAINT SPRAYING PLANT. New Series. No. 13, 8s.*
- MASTER BATTERY CLOCK.* Blueprints (2 sheets), 4s. Art board dial for above clock, 1s. 6d.
- OUTBOARD SPEEDBOAT. 11s. per set of three sheets.
- P.M. TRAILER CARAVAN.* Complete set, 11s.
- P.M. BATTERY SLAVE CLOCK, 2s. 6d.
- P.M. CABIN HIGHWING MONOPLANE, 1s. 6d.
- THE MECHANIKART, 15s.*

The above blueprints are obtainable, post free from Messrs. George Newnes, Ltd., Tower House, Southampton Street, Strand, W.C.2.

* denotes constructional details are available free with the blueprints.

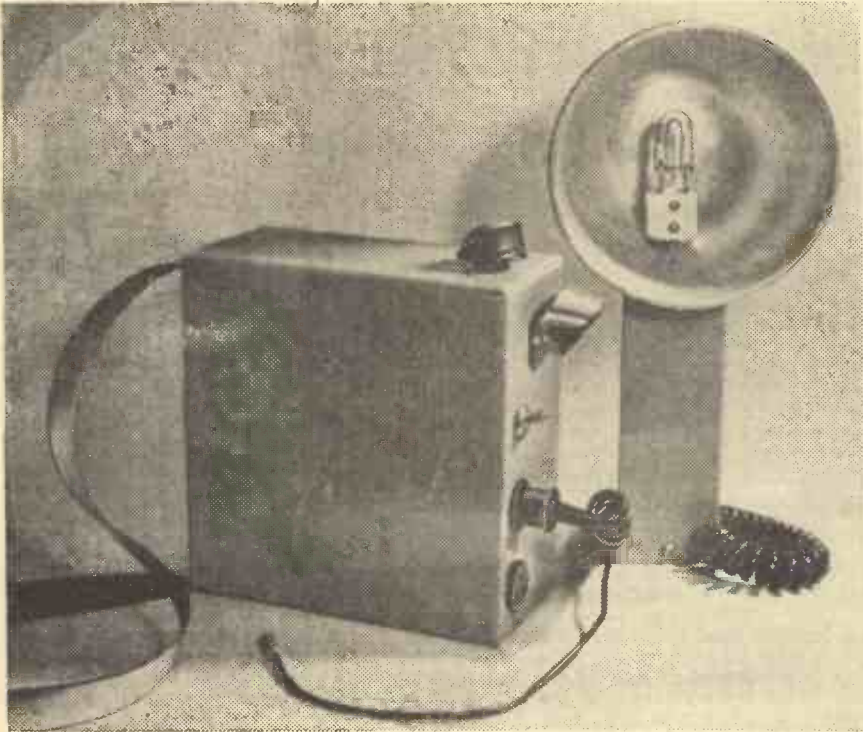

BY E. W. SUMMERS, B.Sc.

A TRANSISTORISED ELECTRONIC FLASH GUN

THE outfit described below is a completely self-contained unit of approximately 90 joules output. It has switching for $\frac{1}{2}$ and $\frac{1}{4}$ power and there is provision for an extra flash-head; this latter facility being particularly useful in portraiture to obtain good modelling.

Circuit

The basic wiring diagram is shown in Fig. 3. The two transistors Q_1 and Q_2 , powered by a 12V battery, are connected in a push-pull oscillator circuit, positive feedback being provided by a separate winding on the transformer T_1 . The resistors R_1 and R_2 provide a slight forward bias to the transistors to ensure that the circuit always starts oscillating as soon as it is switched on. Approximately 300V appears across the secondary winding of the transformer and this is rectified by four silicon diodes, D_1 , D_2 , D_3 and D_4 connected in a bridge circuit. The resulting d.c. voltage is applied to the main condensers C_1 , C_2 and C_3 via the limiting resistors R_3 , R_4 and R_5 . The neon lamp N strikes at about 200V and indicates that the unit is ready for firing. Closing the open-flash button S_3 or firing by means of the synchronising lead connected to a camera shutter, discharges the trigger condenser C_4 through the trigger coil T_2 . This discharge ionises

the gas in the flash-tube and allows the main condensers to discharge through the flash-tube.

The flash-head is connected to the power pack via a spiralled three-core cable which should be plugged into one of the output sockets, the other socket being utilised for an additional flash-head, triggered from the main head, if required. When using this additional head the output is split, i.e. 45 joules maximum each.

Constructing the power pack

Most of the components can be obtained from surplus stores. The pack is enclosed in a rectangular box made from $\frac{1}{4}$ in. opaque Perspex sheets glued together with Perspex cement or polystyrene cement. The Perspex was obtained from F. J. Bly of Laycock Street, N1, who will cut to size; the same firm also supplies off-cuts at 3/- per lb. As the box is only 6in. x 2 $\frac{1}{2}$ in. x 6 $\frac{1}{2}$ in. internal dimensions, this provides an extremely cheap way of making it. The condensers should be of 500 microfarad capacity at 275V working, or higher, and should be purchased before making the box as different makes vary in size. The can usually encloses up to three capacitors and these are added together by joining all the tags except the common (black). The condensers in the author's unit are nominally 400+100+32 yielding

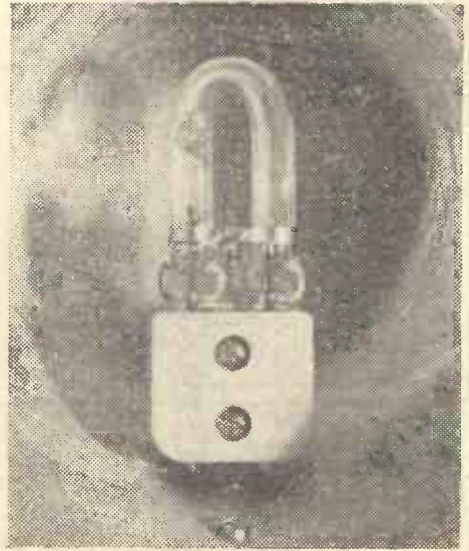
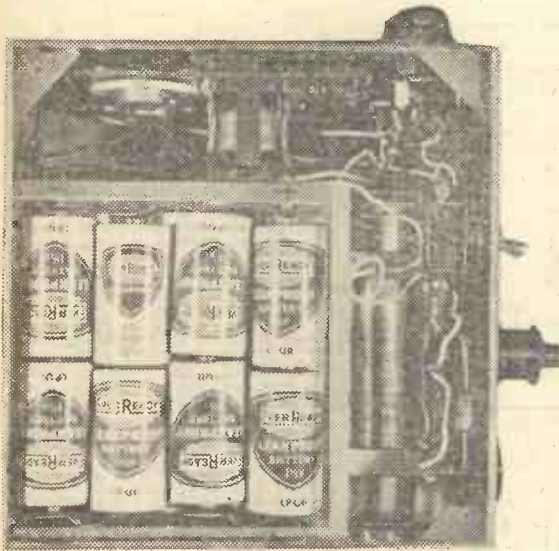
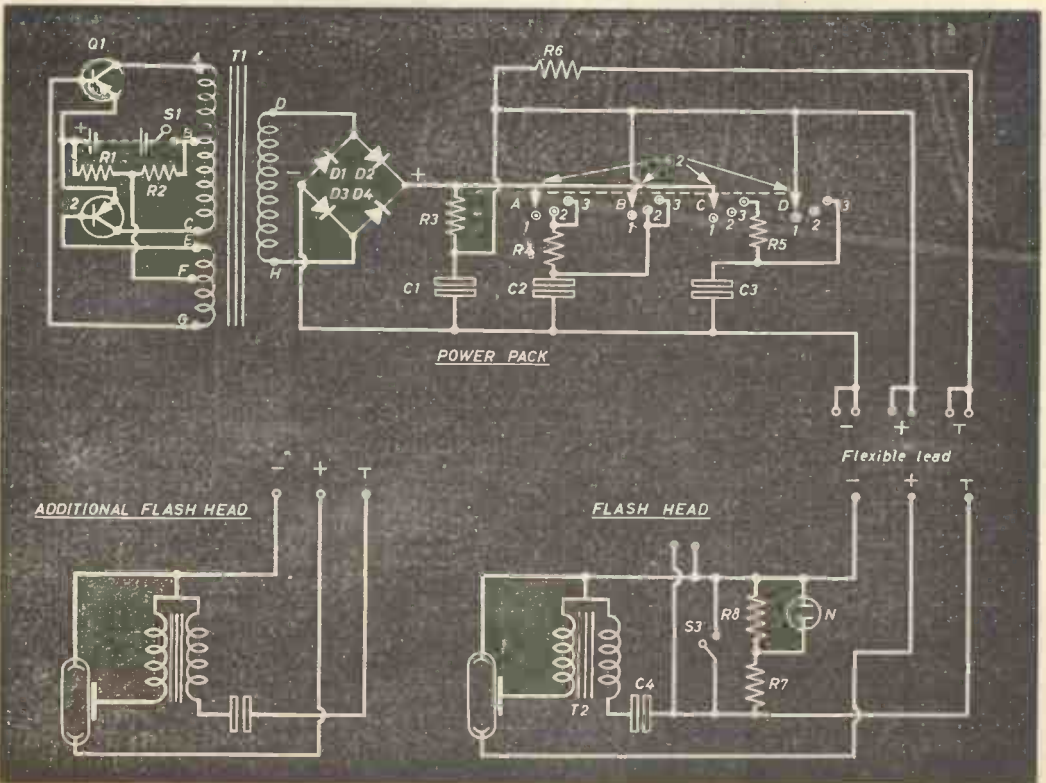
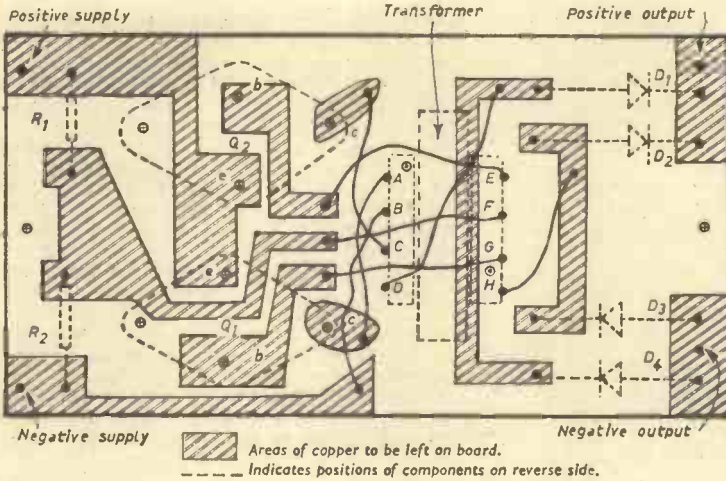

Fig. 1. The power pack with the cover removed. The condenser bank is behind the battery compartment.

Fig. 2. The flash tube is mounted in the female half of a 2-amp 2-pin cord connector.

Fig. 3. The circuit diagram of the transistorised power pack and the two flash heads.





- ⊙ 4 B.A. clearance drill
- ⊙ 6 B.A. clearance drill
- ⊙ 1/8 in., or similar, drill

Notes: No nuts except those marked "C" should touch the printed circuit.

Fig. 4. The printed circuit layout.

532 microfarads in all. C_1 and C_2 are two such condensers whilst, in fact, C_3 consisted of two others joined together. The condenser pack should be separated from the eight single-cell batteries (U.11's or better still, the recently introduced Mallory alkaline batteries of the same size and voltage. These have a lower internal resistance and much longer life) by a sheet of Perspex. To this further pieces of Perspex should be fitted at right angles, strips of springy brass being bolted to them to provide contacts for the batteries. The batteries should be arranged top-to-tail and correct polarity *must* be adhered to. As a safety precaution positive and negative signs may be marked on the battery holder. Two Bulgin miniature three-pin sockets should be fixed to one side of the box, below an on/off toggle switch (S_1), to provide outlets to the flash-heads. The sockets should be wired together in parallel. At the top of the case is the selector switch S_2 which

is a four-pole three-way rotary type condenser. In position 1, "1", condenser C_1 only is charged; in position 2, "1/2", C_2 is charged also and in position 3, "full", C_3 is brought into circuit with the other two condensers. The remainder of the components are conveniently mounted on a printed circuit board which is suspended from the top of the case by two 4B.A. bolts. Boards for making printed circuits may be obtained already coated with copper and the procedure for making the printed circuit is as follows. Alternatively, conventional wiring may be used.

The printed circuit

The board should be cut to size and the drilling centres transferred to the copper side of the board by lightly centre punching. The printed circuit pattern should then be painted on the copper, a suitable material being a cheap nail varnish. The board

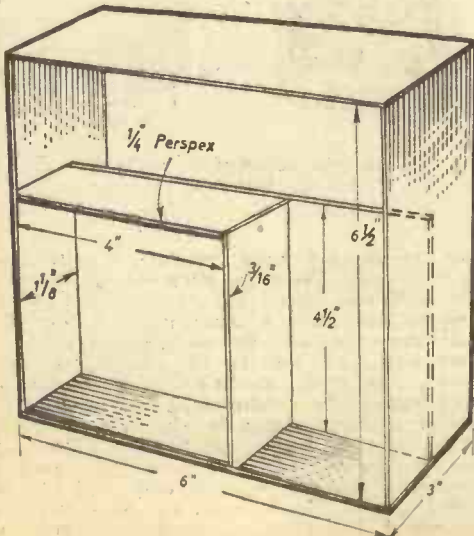

Fig. 5. The power pack case.

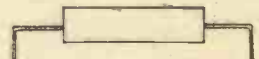

Fig. 6. Correct shape of resistor and diode wires, before soldering.

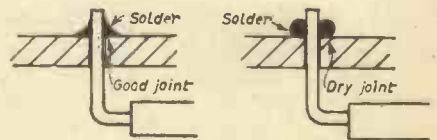

Fig. 7. Good and bad solder joints.



Fig. 8. The transistor connections as seen from below.

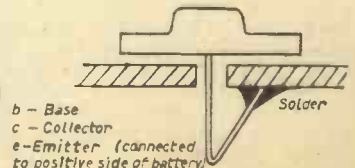

Fig. 9. Soldering to the transistor connecting wires.

should be immersed in a strong solution (about one in five) of ferric chloride in water, agitating occasionally until all of the unpainted copper has dissolved away. This generally takes between 20 minutes and half an hour. Caution: Do not use a metal dish for this purpose and do not pour the used solution down the sink—it may play havoc with the plumbing!

The nail varnish should now be removed with acetone (not a proprietary nail varnish remover) and the board cleaned with the finest emery paper. The holes should then be drilled.

The component wires should be bent as in Fig. 8, and the ends pushed through the appropriate holes. The iron and solder should be applied together for as brief a time as possible. A good joint is shown in Fig. 7 (left). A joint that looks like Fig. 7 (right) almost certainly indicates that the solder has not taken to the metal—the joint will have poor mechanical and electrical properties. The collector connection to the transistors (Fig. 8) is formed by the contact between one securing bolt and the copper coating of the board. The base and emitter wires should be carefully bent as in Fig. 9 taking care *not* to bend the wire where it leaves the transistor. When soldering these wires, and also those from the diodes, it is essential to prevent damage to the component by heat; a pair of long-nosed pliers-clamped on the wire between the component and the joint during the soldering operation will be satisfactory. Leaving it in place until the joint has cooled. The connections to the transformer tags should be made with short lengths of insulated wire. The transistors should be secured to the panel with 4B.A. nuts and bolts with washers between the board and the transistors, whilst the transformer should be held by two short 6B.A. screws screwed directly into it. *Note:* On no account should any of these bolts touch the circuit except the two marked "C".

All Perspex parts should be cemented together with strengthening strips where possible. One of the large sides of the box, however, should be held to the case with countersunk chrome 6B.A. bolts, screwed into holes tapped into the corner strengthening pieces. This allows easy access to the batteries when replacements are required. The box should be finished off by rounding the corners with a fine file and polishing with metal polish. The shoulder strap—a length of shelf edging—was secured to the case with 4B.A. bolts.

The flash head

Perspex sheet, $\frac{1}{8}$ in. thick, is again used for the construction of the body of the flash-head. The components to be enclosed in it are: trigger coil, trigger condenser, neon lamp, two resistors, open-flash switch and terminal block. In addition, the power lead and a synchronising lead enter at the base whilst the FA10 flash-tube is in the reflector fitted at the top. To avoid showing a large number of bolt heads the components should first be mounted as shown, on a piece of clear $\frac{1}{8}$ in. Perspex, $1\frac{1}{2}$ in. x $5\frac{1}{2}$ in. The open-flash switch S_3 should be a surplus micro-switch mounted on a piece of $\frac{1}{8}$ in. Perspex, in turn cemented and bolted to the base sheet. The support for the neon should be a piece of $\frac{1}{2}$ in. Perspex shaped like an executioner's block. A 4 in. length of 16 gauge $\frac{1}{8}$ in. aluminium strip should be secured to one end of the base sheet and bent as shown. A suitable slot should be cut in the side of the reflector, parallel to the base and 1 in. from it. The reflector—a 5 in.

diameter aluminium pudding basin—should be bolted to the angled aluminium strip, and to the extreme end of the strip the flash-tube holder—one half of a 2-amp 2-pin cord connector should be attached. The components should be connected according to the wiring diagram (Fig. 11), sleeving being used as required. The trigger coil, which should be held in a strip of bent tin-plate, has three leads issuing from it. The sleeved one should be secured to the trigger bridge of the flash-tube, either by winding the wire round it or better, soldering to the wire a small spring clip fashioned from very thin metal to be a push fit over the bridge. The other two wires are enamelled and are interchangeable.

When wiring has been completed the base sheet should be cemented to a piece of $\frac{1}{8}$ in. opaque Perspex sheet, 6 in. x 2 in., which forms the front of the flash-head body. The rest of the body (Fig. 10) is also constructed mainly from $\frac{1}{8}$ in. opaque Perspex and should be attached to the front with

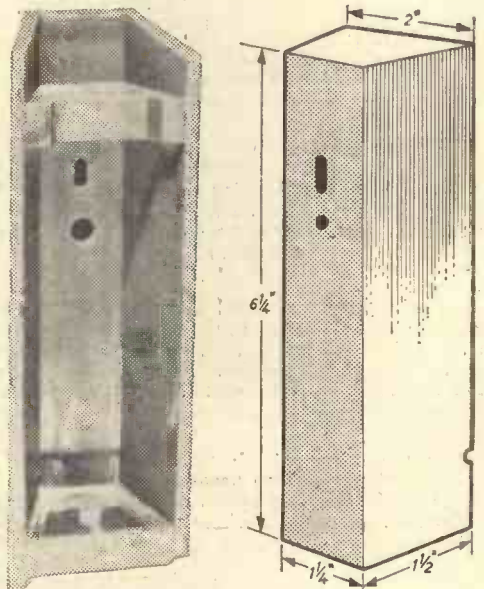

Fig. 10: The construction of the rear part of the main flash head.

two chrome 4B.A. bolts screwed into holes tapped in the blocks. The lower block should also have a $\frac{1}{8}$ in. BSW hole tapped into it so that the flash-head may be attached to a camera-bar or tripod. Two holes should be cut in the case, a slot to observe the neon and a $\frac{1}{8}$ in. hole for the push-button of the switch. Slots should also be cut to admit the power-pack lead and the synchronising lead. Foam plastic draught-excluder should be affixed to the outside of the reflector in such a position that it fits snugly on the body. The whole assembly should be finished by rounding off square edges with a file and polishing with metal polish, and by painting the exterior of the reflector. To avoid "hot spots" the interior of the reflector should be matted by rubbing with fine emery paper.

That's a good idea!

Useful hints
passed on by
our readers

Rolled metal cuts easier

NEXT time you cut a strip of sheet metal lengthwise with tin snips use the tinner's trick of rolling the sheet loosely before making the cut. There's less distortion of the metal along the cut and less tendency of the metal to curl. Not only that but the sheet is easier to handle and you're less likely to injure your fingers along the cut edges. The trick is especially helpful when cutting a long strip.

In an emergency you can cut circular openings or other holes in light sheet metal by using a stubby knife blade and hammer. Pencil outline of hole, drive knife blade through metal and guide it along pencil line while tapping blade with hammer.

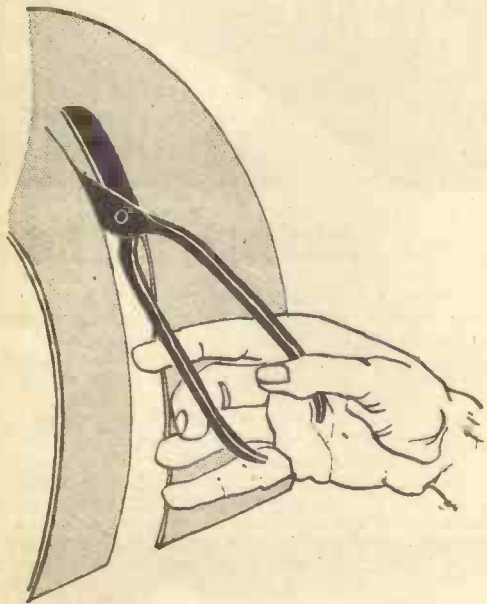

To set a nail

WHEN you need to set the heads of common nails in soft wood for concealing with putty, don't use a nailset; instead use the head of a nail of the same size. Just place the head of the set nail on the head of the driven nail and strike with the hammer as illustrated. Usually one light hammer blow will sink the nail head sufficiently for concealing with putty. The one thing to make sure of in this method is that the head of the set nail is centred squarely on the head of the driven nail so it doesn't skid off when struck.

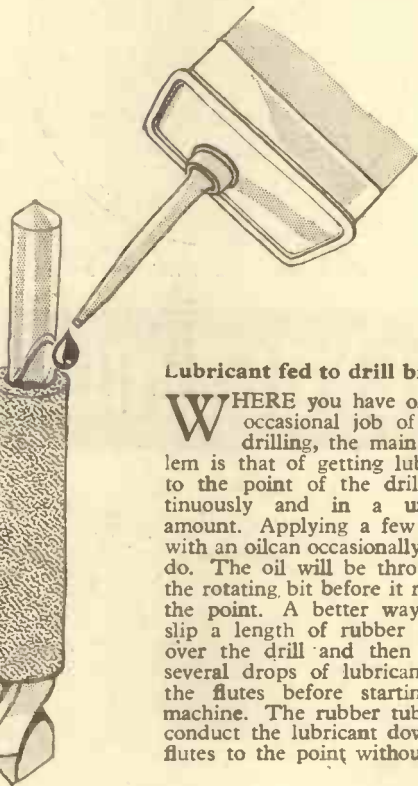

Lubricant fed to drill bit

WHERE you have only an occasional job of metal drilling, the main problem is that of getting lubricant to the point of the drill continuously and in a uniform amount. Applying a few drops with an oilcan occasionally won't do. The oil will be thrown off the rotating bit before it reaches the point. A better way is to slip a length of rubber tubing over the drill and then pump several drops of lubricant into the flutes before starting the machine. The rubber tube will conduct the lubricant down the flutes to the point without loss.

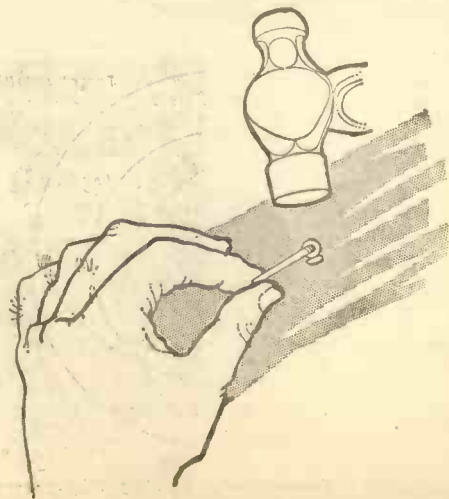

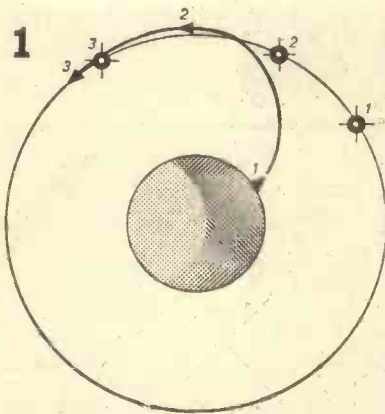

1. Launch and mid-course 2. Terminal 3. Docking

BRINGING two objects together in space while they are travelling at some 17,000 miles per hour obviously presents problems. Satellite rendezvous involves the controlled launch, ascent and physical coupling of a chase vehicle with a target satellite already in orbit.

Satellite rendezvous will have many uses. In the near future it could provide a means for obtaining the maximum utilisation from small boosters. For example, a manned lunar mission could be accomplished by rendezvousing two vehicles in an earth



described by D. S. Fraser

orbit—one a fuel tanker and the other a manned lunar capsule which had been launched with a partially-filled fuel tank. This would enable the capsule to be sent up by a much smaller booster. The manned lunar vehicle could thus be refuelled and launched from orbit towards the moon.

On a much longer-range basis a lunar rendezvous could save payload. A main earth-moon spaceship could be "parked" in a lunar orbit while a manned landing vehicle descended to the moon's surface. When the mission was completed the smaller craft would rejoin the main vehicle. Future deep space exploration will probably be made by large vehicles driven by electrical propulsion engines. While such propulsion is economical for outer space work, such engines have a very low thrust. These space vehicles will have to be boosted into earth orbit by conventional liquid or solid fuel rockets and assembled in space.

Plans are presently under way to put a permanent earth satellite into orbit for use as a space test station. Here flight crews could be trained for future lunar and deep space missions. Zero gravity and high vacuum would provide the necessary environment for testing space suits, life support systems, propulsion systems, etc. As the frequency of manned earth orbital launches increases so will the chance for an equipment breakdown, preventing the astronaut's re-entry. A rescue system is needed with satellite rendezvous capability and the ability to subsequently re-enter the atmosphere.

When unmanned satellites become large enough it will become economical to send a rendezvousing

RENDEZVOUS IN SPACE

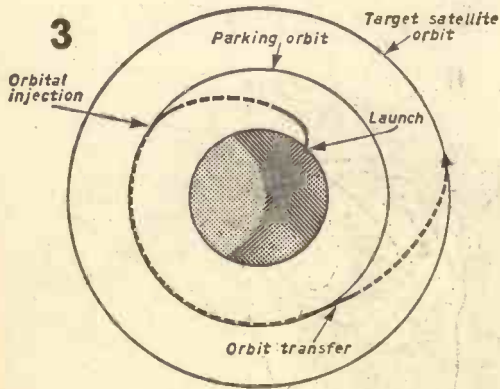
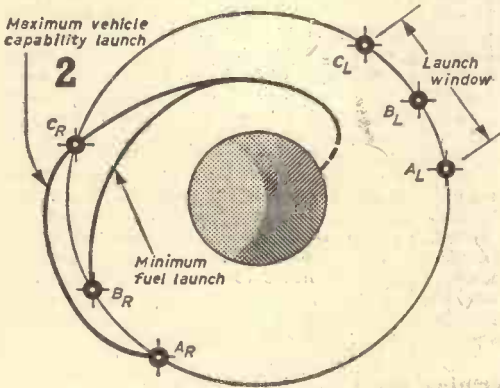

Powered flight ————— Coasting flight - - - - -

satellite up for repair purposes rather than put a new satellite into earth orbit. A system capable of inspecting satellites of unknown origin is also needed. Westinghouse Air Arm Division is presently contracted to provide the guidance rendezvous sensor suitable for such an application.

With these anticipated uses of satellite rendezvous in mind, scientists and engineers at the Air Arm Division have been conducting a two-year study programme. The following ground rules have guided the study: (1) The target was assumed to be co-operative, i.e. it could employ radar or optical sensors of its own, perform appropriate manoeuvres (although it was restricted to simple rotational movements for the purposes of the study) and incorporate part of the docking mechanism. This left open the question of a rescue mission where the target satellite could be friendly but not capable of being co-operative. (2) The rendezvous method should be adaptable to automated operation. For example, in a multiple refuelling mission the crew probably would not be put in orbit until the final rendezvous. (3) The vehicle performing the rendezvous mission should be of useful size. Payload transfers as high as 50,000lb were postulated for the study. The actual figure is not critical since engine size, fuel consumption, etc., vary with payload weight; the rendezvous guidance apparatus, however, is completely independent of the space vehicle size. The results of this programme have produced the following ideas and techniques applicable to a system capable of performing co-operative rendezvous.

Launch and mid-course guidance

The basic phases of a satellite rendezvous system are shown in Fig. 1. Complete knowledge of the target satellite orbit is needed to determine launch time and mid-course path of the chase vehicle. Generally the chase vehicle will be launched when the orbital plane of the target is nearly in line with the launch station. This opportunity exists twice a day if the latitude of the launch station does not exceed the inclination angle of the target orbit. For launch stations at greater latitudes an in-plane launch is impossible and rendezvous can be accomplished only by an orbital transfer to the target orbital plane. (An orbital transfer for a difference in inclination angle of only 10° at a 300-mile altitude would require 3,500lb of fuel for a vehicle initially weighing 10,000lb in earth orbit.)

In addition to an in-plane launch the target satellite must be in a position that nearly coincides

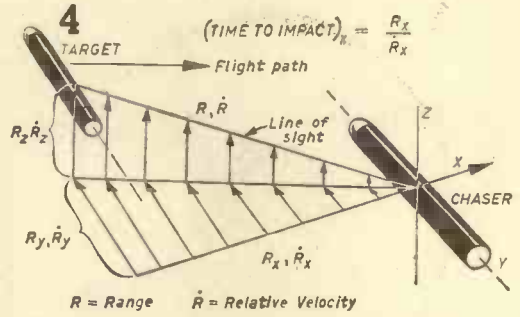

with the ascent trajectory of the chase vehicle. Of the innumerable ascent paths possible two represent a minimum fuel and a maximum vehicle capability launch (Fig. 2). The spread between possible satellite positions at time of launch is known as the "launch window". The greater the vehicle capability the larger the launch window. For reasonable vehicle capabilities launch windows are small — only a few degrees of orbital arc.

The small launch window places a stringent requirement on launch time. For example, a satellite at a 300-mile altitude travels 4° per minute; therefore for a 4° launch window the time of launching must be held to within one minute. The size of the launch window can be increased by first launching the chase vehicle into an orbit of lower altitude than the target satellite. In this "parking" orbit the chase vehicle has a higher angular velocity than the target satellite and will thus gain on the target satellite, eventually placing itself in a favourable position for orbital transfer to target satellite altitude, as shown in Fig. 3.

The launch and mid-course guidance phase places the chase vehicle in the neighbourhood of the target satellite. At this time the chase vehicle is approaching its apogee (highest point) and has separated from its booster stage. Since ground tracking is not accurate enough to guide the actual rendezvous manoeuvres the terminal flight path must be determined by sensing and computing systems in the chaser and target satellites.

Terminal guidance

Engineers selected a variable "time-to-go" guidance technique to direct the terminal manoeuvres. The chase vehicle is first stabilised

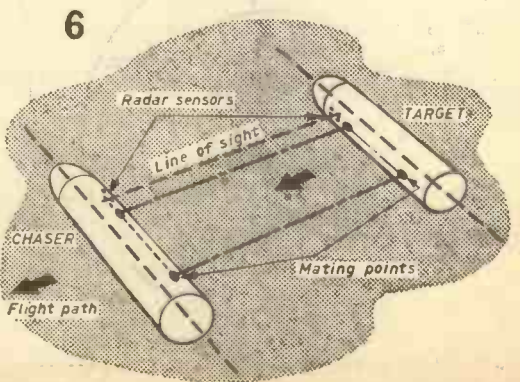
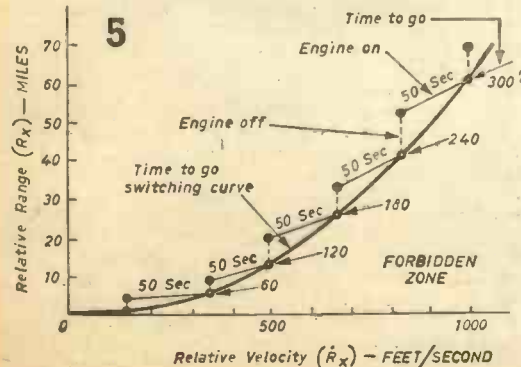

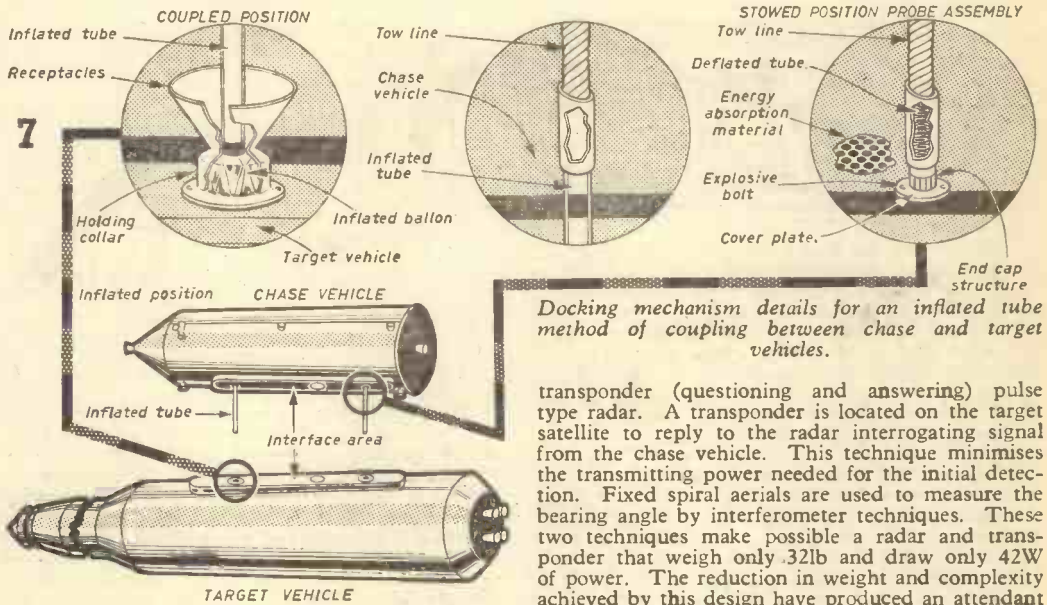

Docking mechanism details for an inflated tube method of coupling between chase and target vehicles.

transponder (questioning and answering) pulse type radar. A transponder is located on the target satellite to reply to the radar interrogating signal from the chase vehicle. This technique minimises the transmitting power needed for the initial detection. Fixed spiral aerials are used to measure the bearing angle by interferometer techniques. These two techniques make possible a radar and transponder that weigh only .32lb and draw only 42W of power. The reduction in weight and complexity achieved by this design have produced an attendant increase in reliability.

with respect to the horizon and its main thrust engine is aligned along the orbital path so that it can accelerate the chase vehicle to orbital velocity. Its terminal guidance sensor measures the range, closing velocity and bearing angle to the target (Fig. 4). The ratio of range to closing velocity provides the time-to-go figure. As shown in Fig. 4 these values are resolved along the three major axes of the chase vehicle. Fixed-thrust engines aligned along the three axes are then operated for brief intervals to reduce closing velocity to zero in finite steps as time-to-go nears zero along each axis.

The terminal guidance programme shown in Fig. 5 illustrates the braking principle. Only the vehicle axis along the orbital path is shown. Rendezvous begins at a range of 70 miles and a closing velocity of 1,000ft per second. The programme shown in Fig. 5 takes the chase vehicle to a range of 500ft and a closing velocity of less than 10ft per second. (These latter points are too close to the origin to be shown in the figure.)

Range, closing velocity and bearing angles are determined by a radar sensor. Radar was selected rather than optical methods because of its well-developed ranging techniques and a negligible sun and background problem. To perform this task, engineers developed a unique interrogator-

Satellite docking

The terminal guidance phase ends and the docking phase begins when the two vehicles are 500ft apart. This distance permits transfer to the docking guidance mode at a sufficient separation to avoid inadvertent collision from terminal guidance errors. In docking, the relative position between target and chaser now becomes the basic reference so that proper orientation of each satellite can be provided before docking.

The transition to docking is initiated by the chaser and target satellites aligning themselves, by

Docking mechanism details for a magnetic clamp method of coupling between chase and target vehicles.

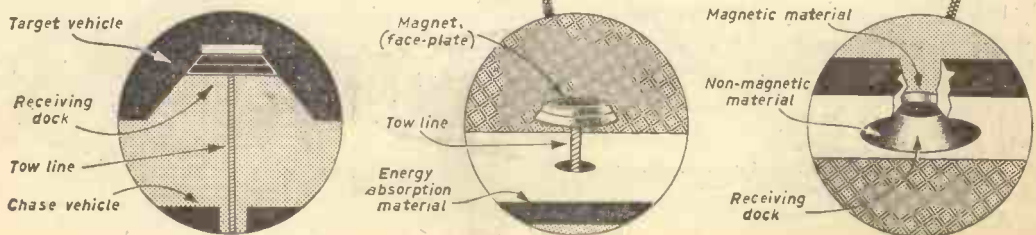

8

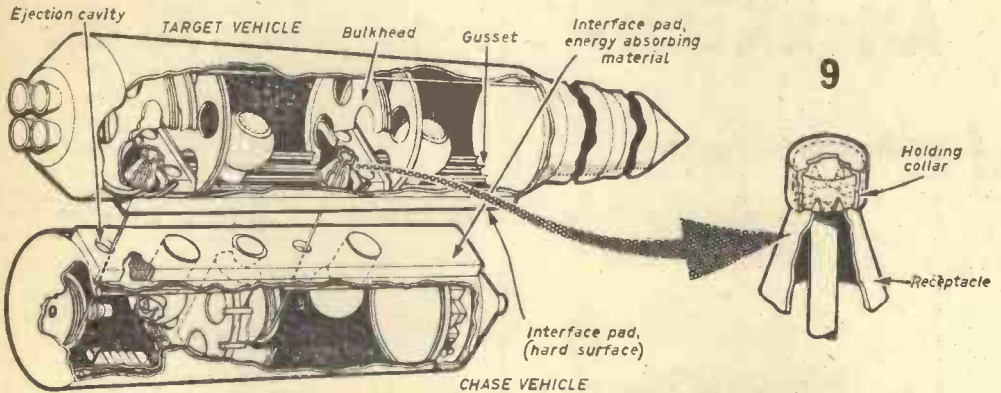

Side-to-side docking, showing the additional structures necessary to absorb contact and rebound stresses.

means of rotational movements, so that the two vehicles are perpendicular to the radar line of sight, with the long axis of the vehicles stabilised to the horizon. This is shown in Fig. 6 for side-to-side docking. Once the vehicles are aligned they are maintained parallel. Deviations from this line of sight are detected by the radar sensor and corrected by altering the velocity of the chase vehicle; the target maintains its attitude by purely rotational movements. Velocity movements are used only by the chase vehicle so that cross-coupling problems can be minimised, thus avoiding the two vehicles chasing each other to no purpose.

Closing velocity is reduced and held between 1ft and 4ft per second. Range and angle movements are accomplished by small gas jets or some similar system. Main thrust engines are no longer needed, thus obviating the problem of rocket flame damaging the target. When the range is reduced to 5ft to 10ft, physical coupling between the vehicles is accomplished by a mechanical docking mechanism.

The basic sequence for physically coupling the satellites, regardless of the docking configuration (e.g. side-to-side or end-to-end), is as follows:

1. Align vehicles.
2. Couple vehicles at close range.
3. Absorb energy of docking at first contact.
4. Absorb energy of rebound.
5. Bring vehicles in contact by coupling mechanism.
6. Engage any mechanisms necessary to accomplish mission.

Close range coupling prior to contact prevents any rebound after the docking impact. Otherwise this further separation would require additional fuel expenditure to attempt a second rendezvous. Energy absorption at the first contact and at the rebound are necessary to dissipate the momentum

of the closing vehicles. To absorb the initial contact energy, soft absorption material can be placed on the impact surface of the chase vehicle to contact a hard surface on the target vehicle. The maximum closing velocity will determine the energy absorption requirements. The docking mechanism must also have a built-in capability of absorbing the rebound energy.

After the rebound energy has been absorbed the vehicles will be standing apart and must be brought together by a drive on the coupling mechanism. Transfers between vehicles will be accomplished by such mechanisms as vehicle-to-vehicle couplings to allow fuel transfer to the target vehicle, airlocks for transfer of personnel, or a mechanical coupling arrangement for the addition of booster sections.

After the mission is accomplished the vehicles can be separated by releasing the coupling mechanism and applying a thrust from the attitude stabilisation jets. Separation should be accomplished so that the target vehicle can accept further rendezvous.

Docking techniques

Many techniques are possible for accomplishing the docking sequences. Some factors that should be considered in selecting a system are: weight, reliability, suitability for use with space vehicles, capability of accomplishing the mission and compatibility with other rendezvous system (guidance and control, etc.). The basic docking method should be capable of coupling the two space vehicles side by side or end to end. Advantages and disadvantages exist for each technique. The basic components required for the chase vehicle are the coupling mechanism and its associated controls.

(Continued on page 478)

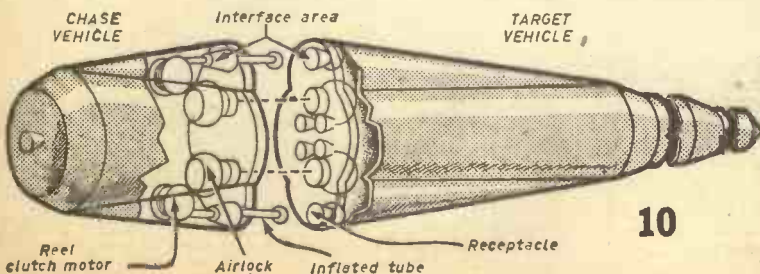

10

End-to-end docking has advantages in some cases. It may also be used in conjunction with side-to-side docking when assembling complex space stations.

AN EXTENSION CABLE REEL

By S. A. SEAGER

HAVING cause to use an extension cable I quickly found that its storage and use raised several problems. In order to keep the cable under control I made the reel shown in the drawing; it serves its purpose well and only the minimum length of cable lies on the floor.

with dividers, 10in. diameter for the rear disc, 8in. diameter for the disc carrying the Terry clips. A grommet hole was drilled in this disc at 3in. radius and a hole to take the handle at $4\frac{1}{2}$ in. radius. If hand tools are used to drill the holes it is easier to drill them before cutting the discs from the drum ends. The hole sizes should be 1in. for the drum centre, $\frac{1}{8}$ in. for the Terry clips, $\frac{1}{2}$ in. for the grommet and $\frac{1}{4}$ in. for the handle. The Terry clips are to control the cable socket which protrudes from

(Continued on page 478)

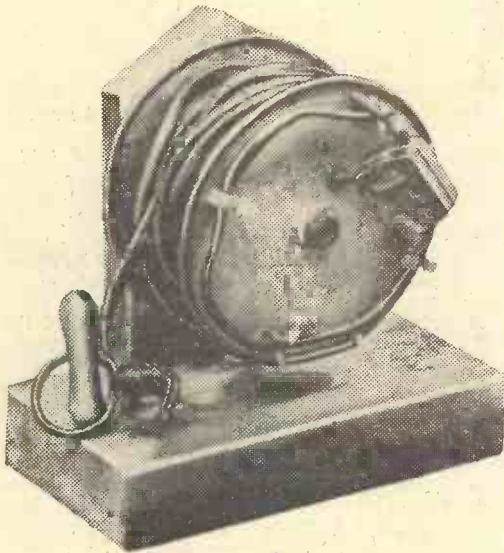

The completed cable-reel.

It is designed so that the reel is nearer to the power tool being used than to the actual power point. A detachable handle is used to reel in the cable when required. The reel described fits on a heavy wooden stand which, though cumbersome, prevents the reel from rolling away. This fault is very common with loose reels and the user generally snatches at the tool cable in an effort to hold back or tip over the reel. Because this piece of equipment is carrying an electrical conductor, care must be taken that no jagged edges of metal show at any point or these will someday find and cut into the cable.

The main item from the constructor's point of view is to obtain the pieces of electrical conduit threaded as shown. One of these should be $\frac{1}{2}$ in. o.d. and fits inside the reel centre (1) which should be 1in. o.d. If one has an electrician friend the supply of these is no problem, otherwise both parts can be supplied by an electrical contractor for the cost of 15 minutes work. The two lengths needed are (1) $5\frac{1}{2}$ in. long, 1in. o.d., threaded for $\frac{3}{8}$ in. from each end; (2) $8\frac{1}{2}$ in. long (see alternative), $\frac{1}{2}$ in. o.d., threaded from one end for $\frac{1}{2}$ in., from the other end for $2\frac{1}{2}$ in. The longer length (2), which acts as the reel spindle, fits into the wooden upright.

The reel end discs were cut from the bottoms of two 5-gallon oil drums. Marking out was done

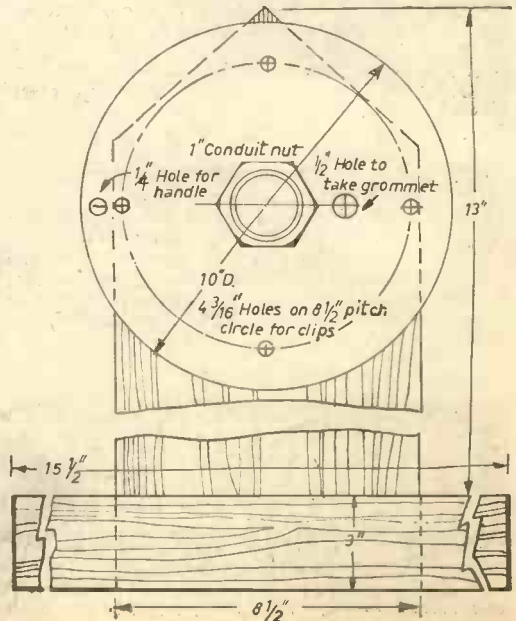
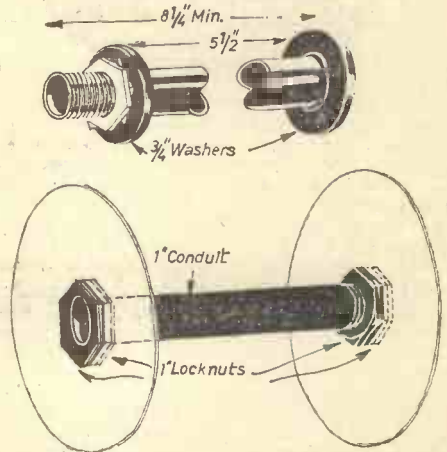

AT HOME ON THE RANGE



You'll be quite at home with the Johnson-Wray Optical Rangefinder, it's so easy to use and it fits almost every camera. You get perfect focusing every time, with every shot needle sharp! This beautifully made rangefinder has the largest possible viewing window that shows a bright, clear image. To find the range you just turn the milled wheel until a secondary yellow image is super-imposed in the viewing window. Then read off the distance and set your focus. Easy! Price. 48/10. Ask to see it at your photographic shop.

JOHNSONS
OF HENCOON LTD
FOR CONFIDENCE IN PHOTOGRAPHY

GAMAGES

BRAND NEW AT LESS THAN HALF PRICE

G.E.C. $\frac{1}{4}$ H.P.
ELECTRIC MOTORS

230/250 volts, 1,440 r.p.m. A.C. Split phase start Induction Type.
2" x $\frac{1}{4}$ " Dia Spindle. Carr & Pkg. 7/6



'PICADOR' CABINETS



Strong Metal Frame. Finished Hammer Silver, stove enamelled. Drawers Transparent Plastic with partitions. 24-DRAWER CABINET approx. 11 $\frac{1}{2}$ " x 12 $\frac{1}{2}$ " x 6 $\frac{3}{4}$ ". Drawers approx. Inside sizes 5 9/16" x 2 $\frac{1}{4}$ " x 1 $\frac{1}{2}$ " deep. 6 sets partitions.

GAMAGES PRICE **55/-**
Extra sets of partitions Carr. & Pkg. 4/-. 1/8 per set.

Height Wide Deep	No. of drawers	Sets of partitions	Gamages Price	Post & Pkg.
6 x 12 $\frac{1}{2}$ x 6 $\frac{3}{4}$ in.	12	3	30/-	3/-
8 x 12 $\frac{1}{2}$ x 6 $\frac{3}{4}$ in.	16	4	40/-	3/6
15 $\frac{1}{2}$ x 12 $\frac{1}{2}$ x 6 $\frac{3}{4}$ in.	32	8	70/-	4/-
18 $\frac{1}{2}$ x 12 $\frac{1}{2}$ x 6 $\frac{3}{4}$ in.	40	10	85/-	4/6

RUBBERISED WATERPROOF TOOL BAGS

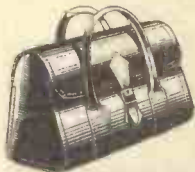

Exceptionally strong handles-carried under base for extra strength. Metal studs on base to take wear. Waterproof. Black only. Approx. Height 10in. Length 14in. Diameter at base 6in.

Post & Pkg. 2/6. **18/9**
Tool and Car Accessory List FREE.

GAMAGES, HOLBORN, LONDON, E.C.1 HOLborn 8484

A NEW-PRACTICAL WAY of UNDERSTANDING

RADIO • TELEVISION • ELECTRONICS

Including: Transistors; VHF/FM; Hi-Fi equipment; Computers; Servo-mechs; Test Instruments; Photo-electrics; Nucleonics, etc.

Radiostrucor—an organisation specialising in electronic training systems—offers a new self-instructional method using specially designed equipment on a "do-it-yourself" basis. You learn by building actual equipment with the big kits of components which we send you. You advance by simple steps performing a whole series of interesting and instructive experiments—with no complicated mathematics! Instructional manuals employ the latest techniques for showing the full story of electronics in a practical and interesting way—in fact, you really have fun whilst learning!

FREE THIS BOOK WILL INTEREST YOU!
LEARNING the PRACTICAL WAY
Radiostrucor EQUIPMENT COURSES

FOR .. Your Career
.. Your Own Business
.. An Absorbing Hobby

RADIOSTRUCOR

LEADS THE WORLD IN ELECTRONICS TRAINING

POST NOW

To RADIOSTRUCOR (Dept. G28) READING, BERKS. Please send brochure, without obligation, to:—

*Name.....

*Address.....

7/63

(We do not employ representatives) *Block Caps Please



Equipment taken to the Azores for a study of the earth's magnetic field being prepared and tested by the research team.

Hunting earth's magnetic disturbances

By OUR SCIENCE CORRESPONDENT

UNDER the auspices of the United States Navy Office of Naval Research, three General Dynamics scientists recently visited the Azores. Their mission was to investigate flutters in the earth's magnetic field—which have been a limiting factor in space communications—and discover, if possible, what causes them. The results of these tests, when they are available, will be of especial interest to scientists concerned with space communications.

When they reached the Azores, the team "pitched camp" on a rocky, windswept beach, and made tape recordings of magnetic waves, some of them of such low frequencies that their wavelengths are interplanetary in magnitude. Later these recordings were taken back to Rochester, New York, for analysis and study. Perhaps they will hold a key to the extra terrestrial influences which cause these magnetic disturbances. Disturbances which occasionally become so severe that they disrupt not only radio but wire line communications on earth.

The team flew to Santa Maria Island in the Azores group, where the airfield is about seven miles from the shoreside site where they were to set up their gear. Covering this distance, across extremely rugged and rocky terrain, was something they had not anticipated, although in preparation for their studies the research trio spent several months fabricating the special antennas that were to be the "eyes and ears" of their equipment. These were ten large loops of fine copper magnet wire, each four foot in diameter, each loop containing 5,000 turns. This works out at approximately 12 miles of wire per loop. After being wound on a special jig fitted to a lathe, the loops were individually sealed in an epoxy plastics material as a protection against damage and moisture.

For the magnetic measurements, the loops were carefully aligned and bolted between two plywood faceplates. Brass bolts were used, to avoid the presence of any magnetic materials near the antennas. Three sets of measurements were made, one with the loops arranged vertically in a north-south plane, another in an east-west plane, and the third with the loops horizontal.

There were a number of reasons for the selection of Santa Maria Island as the site for this project. Ideally the measurements should have been made on a fixed, non-magnetic platform in the middle of the ocean—but no such platform exists. It would have been impracticable to try and use a ship, not only because of the ship's magnetic characteristics, but even more because it is necessary to hold the antennas absolutely motionless for many hours during the tests. Santa Maria Island was a reasonably good substitute for a mid-ocean platform. It was located in the right latitude, it had an isolated beach where the equipment could be set up and operated virtually at the water's edge, and there was no large electric generating plant or distribution line on the island which might have created local magnetic disturbances. The General Dynamic team of scientists took their own portable generating set to provide the electric power for operating the test equipment, and it was located about a quarter of a mile away, using shielded cables to supply power to the equipment.

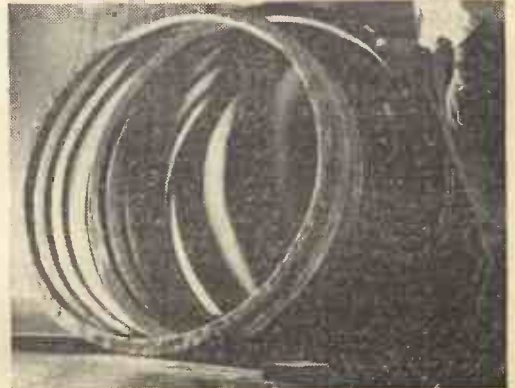

These loop antennas were used in a study of variation in the earth's magnetic field. There were 10 of the loops in all, and each loop contained approximately 12 miles of copper magnet wire.

TRADE NEWS



'Speed-Master' gearbox

INCORPORATING machine-cut gears, a heavy-duty ball race and die-cast body this latest speed reducer for electric drills gives a 4 to 1 reduction for use when drilling masonry or ceramics, tank-cutting, countersinking, etc.

The "Speed-Master" is designed primarily to fit Bridges drills but also directly fits the Black and Decker D.800, or other models by using an adapter. It costs 39/6 post free from the makers: A. N. Clarke (Engineers) Ltd., Binstead, Ryde, Isle of Wight.

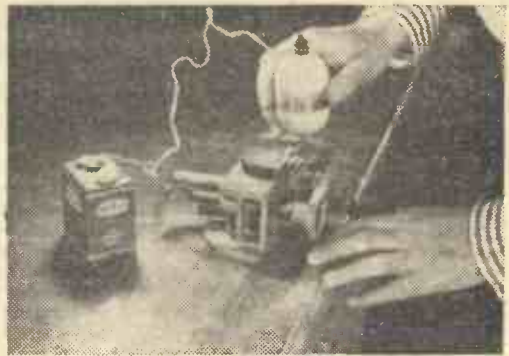

Diminutive drills

THE Minidrill is a battery-operated modern equivalent of the watchmakers' archimedian drill. Illustrated is the No. 6 outfit for 6-12 volts; price 67/6. The No. 1 outfit uses two U2 cells in its torch-like case; price 27/6. Henri Pickard and Frere Ltd., 34/35 Furnival Street, London EC4.



The 'Rolla' Sander

THIS useful sanding block, available in various sizes, contains its own supply of sandpaper, saving those annoying hunts for a new sheet. A sponge backing pad ensures good contact with the work. The photo shows it dismantled. Available from Super Tools, 67 Victoria Road, Scarborough.

RENDEZVOUS IN SPACE

(Continued from page 473)

energy absorbing material, drive mechanisms and tow line. The target vehicle will require some form of coupling receptacles and a hard contact area.

Other components not required for the actual docking operation but needed for specific mission operations include airlock mechanisms, fuel transfer systems (pumps, tanks, connectors, etc.), mechanical and electrical connectors, etc.

One possible method of docking is illustrated in Fig. 7. Explosive bolts hold cover plates over cavities in the chase vehicle. Each cavity contains an inflatable hose and end-cap structure. During ground installation the tube assembly (including the end-cap structure) is pumped nearly free of air. Upon release of the cover plates the tube is inflated by the small amount of residual air so that an inflated tube and end-cap structure protrude from each of the cavities. This action takes place at a distance between the vehicles greater than 10ft. The end cap of the tube enters the funnel-shaped receptacle in the target vehicle. This receptacle must be large enough to offset the inevitable small guidance errors of the radar control system. The end-cap structure consists of an inflatable balloon contained within a series of hinged, curved segments that make up a cylindrical tube. The assembly is held in place by an explosive bolt arrangement. As the end-cap assembly passes into the throat of the receptacle it intersects a magnetic field in the target vehicle. A sensor located in the lower section of the end-cap structure is activated by this magnetic field and triggers the explosive bolt, causing the balloon to inflate. This forces the hinged segments into the position shown in Fig. 7. The balloon assumes the shape of the cavity and provides the necessary grip to secure the tow line. When the balloon is inflated another sensor acti-

vates a drive reel in the chase vehicle (Fig. 9) and the tow line slack is taken up. When the vehicles impact the energy absorption material on the chase vehicle removes most of the kinetic energy. The rebound energy is dissipated by a torque-limiting clutch which limits the tension loads on the inflated tube and end-cap structure. When the vehicles come to rest a speed-controlled motor reels the tube in, bringing the vehicles together. Vehicle separation is accomplished by deflating the tube end-cap balloon, reeling it into the chase vehicle and activating the propulsion system. Another possible docking technique employs a magnetic clamp or plate which is guided into a receiving dock fabricated from magnetic material (Fig. 8).

Side-by-side docking has an advantage over end-to-end docking because it provides a larger interface or contact area for the energy absorption material, mechanical and electrical connectors, cargo or personnel transfer, refuelling lines, etc. Side-by-side docking would provide a feasible means for building a cluster of modules for eventual rendezvous with a spacecraft unit. Since the majority of space vehicles are designed primarily to resist end-on loads it is necessary to include additional bulkheads, stiffeners, intercostals, gussets, etc., in the spacecraft for side-to-side docking. With proper design the loads can thus be transferred from the impact area to the spacecraft structure.

End-to-end docking (Fig. 10) requires a minimum of additional structures. A structure that has been designed to withstand the launch and boost acceleration loads should be nearly sufficient for reasonable levels of impact loading. End-to-end docking provides a useful means for adding new sections in line to a space vehicle.

AN EXTENSION CABLE REEL

(Continued from page 474)

the reel, the grommet protects the cable passing through the sheet metal and is very necessary.

Cut the discs from the drum bottoms with a cold chisel, trim up with tin snips and true up with a file to the scribed line. Two lengths of scrap tough rubber cable, each 36in. long, should be slit and the wires removed. These should be fixed with Bostic adhesive around the edges of the discs to cover the sharp edges, trimming as necessary.

To fit the discs to the 1in. conduit two locknuts, one at each end, should first be screwed on. These must be screwed up tightly. Place the discs in position and screw on two more locknuts to secure the discs firmly. The $\frac{3}{4}$ in. o.d. conduit should have two locknuts, tightened against each other, at the end threaded for $\frac{1}{2}$ in. When this has been done slip on a $\frac{3}{4}$ in. bright steel washer to come between the nuts and the reel. Place the reel in position and slip on another $\frac{1}{2}$ in. washer. Secure the reel with two more locknuts so that it rotates freely.

The timber stand can be made from a block of yellow pine, base size $15\frac{1}{2}$ in. x $8\frac{1}{2}$ in. x 3in. with an upright 16 in. x $8\frac{1}{2}$ in. x 2in. The upright should be let into the base. Three 6in. nails were used to fix the upright, although 4in. woodscrews would have made a more "honest" job. To make the reeling-in handle, cut the head from a 6in. nail and drive into an old file handle. Drill a $\frac{1}{4}$ in. hole in the base to hold the handle when not in use.

Alternatives

Two 1in. brass female bushes outside the discs to clamp them to the conduit and one $\frac{3}{4}$ in. brass female bush on the outside end of the $\frac{1}{2}$ in. conduit give a much better finish. Instead of locking the $\frac{3}{4}$ in. conduit spindle in the upright with locknuts a $\frac{3}{4}$ in. fitting called a "dome lid" can be used. If this method is used be sure to allow extra length on the $\frac{3}{4}$ in. conduit.

SALES AND WANTS

The prepaid charge for small advertisements is 9d. per word, with box number 1/6 extra (minimum order 9/-). Advertisements, together with remittance, should be sent to the Advertisement Director, PRACTICAL MECHANICS AND SCIENCE, Tower House, Southampton Street, London, W.C.1.

PERSONAL

WANTED: INVENTIONS

We are seeking ideas and inventions for technical and commercial development. Send us particulars for advice by our team of consulting experts.

The Commercial Director

INVENTOROUS LIMITED
278/282 High Holborn, W.C.1

PATENTS

PATENTING SERVICES. Advice qualified Agent. C. L. BROWNE, 124 Greenhayes Avenue, Banstead, Surrey.

SITUATIONS VACANT

A.M.I.Mech.E., A.M.Brit.I.A.E., City and Guilds, G.C.E., etc., bring high pay and security. "No pass—no fee" terms. Over 95% success. For details of exams and courses in all branches of Engineering, Building, Electronics, etc., write for 148-page handbook, free. B.I.E.T. (Dept. 967B), London W8.

SKILLED PRACTICAL ENGINEERS and CRAFTSMEN are eligible for associate membership of The Institute of Engineers. Write for details to:

Dept. P.M., 118 Westwood Park, London S.E. 23.

PUBLIC SCHOOL leaver required as an electronic and/or electro-mechanical trainee to assist in the design and construction of industrial controls for use in the manufacture of glass fibre products. Starting salary £728. Write giving details of education and interests to FIBRELITE INDUSTRIES, Trafford Hall, Chester.

FOR SALE

CLUB, CAR and Lapel Badges at realistic prices from: **TESTER HATCHER & CO. LTD.**, Cliffe, Rochester, Kent.

WASHING MACHINE Spares, new and second hand. J. AND D. ELLISON, Barkerhouse Road, Nelson.



24 Drawer, sub divided Pico-dor Cabinets, 8 1/2 x 4 1/2 x 6 in. Each drawer has lid making it completely dustproof. 35/- plus postage 2/6. Send for FREE illustrated lists.

J. J. LAWSON
95 Godwin St., Bradford 1
Watch Materials, Tools, Bracelets, Straps Watches, Novelties, Clocks, Diamond Kings.

FOR SALE

(continued)

HYPODERMIO SYRINGES. Brand new 2cc Sima, excellent for livestock injection and diling, etc., 4/9 each. Also needles, size 18, 4/- per dozen. **FORTH SUPPLIES CO.**, 16 Clyde Street, Liverpool 20.

UNOWOT WHISTON SELLS. S.A.E. 3,000-Item Catalogue, 200 useful mixtures. **WHISTON (Dept. PMU)**, New Mills, Stockport.

MATCHBOX SIZE Crystal Sets. all parts with instructions 3/6 p.p. **BAILEYS (P.M.)**, 23 Fir Lane, Royton, Oldham.

ELECTRO WELDING from 6 volt AC/DC source. S.A.E. details. **DRES-DEENA**, The Harrow Way, Basingstoke, Hants.

ASTRO TELESCOPE making. Standard Ramsden push-in eye-pieces, 1in., 1 1/2in., 2in. focus, 35/-; with R.A.S. thread 42/6 each. S.A.E. list. Object Glasses, Newtonian Mirrors, Diagonal Mounts, Focusing Mounts, Azimuth Mountings and Tripods for Refractors and Reflectors. **W. BURNETT**, 99a West St., Boston, Lincs.

Ex Government 7 x 50 Prismatic Binoculars, Best Quality, Ross and other famous British Makers. Do not confuse with cheap Foreign Types. These cost over £60 a pair when new. Individual Eye-piece Focusing, £15 per pair, plus 2/6 post or £3 deposit plus post, and 4 monthly payments of £2.10.0. As above by Taylor, Taylor Hobson, 6 x 30 £7.10.0 per pair, 2/6 post, or £3 deposit, plus post and 3 monthly payments of £1.10.0.

Brand New (ex Admiralty) Cintel Photo Electric Cells Type V.S.35, suitable for all normal uses such as sound film reproduction, Self-Opening Doors, Burglar Alarms, etc. Very compact size only 1 1/2in. long, 1/2in. diameter. Leads attached to glass envelope 80 No Base Holder required. Real Bargains for experimenters. Only 17/8 each plus 1/6 post.

Bakers Model C Episcopes, 1000 watt lighting complete with lamps, Blower cooled, shows illustrations up to 6 x 6in., 3 1/2in. slides. Standard 200-250 A.C. Mains Input. 17 1/2in. F.A.S. Anastigmat lens, £36. As above but in original cases and believed New £40.

Newtons Episcopes as above, 500 watt lighting £30. Reasonable Credit Terms to suit Purchaser on any of the above.

Latest Ministry Release, Kodak Eastman Plus X 35mm. Safety Negative Film, Sealed 100ft. this with spool, only 29/-, post 2/-.

Bromide Paper, Ex-Ministry Ilford Rolls 6 1/2in. x 100ft. (approx.) min. weight glossy, hard or soft grade 7/10.0. Carr. 5/-.
Ditto 5 1/2in. x 100ft. (approx.) normal grade £6.0.0. Carr. 5/-.

Cut Paper in packets of 50 or 100 available in most sizes at lowest surplus trade prices.

Projection Lamps.

110 v. 500 watt 3 pin for L.516 projector 9/- each (3 for 25/-), post 1/6.
110 v. 300 watt prefocus cap 9/- each, post 1/6.
110 v. 750 watt 3 Pin base for Debris Projector, 15/- each, post 1/6.
100 v. 1000 watt G.E.S. base, giant tubular, 12/6 plus 2/6 post.
12 v. 100 watt prefocus base 3/- each, post 1/6.

16mm. Film Spliers, Used Ex.M.O.S. but good condition, heavyweight types, Ensign with built-in scraper 40/-, Premier 50/-, Post 2/6. S.A.E. for List Please. All Goods supplied on 14-day money back guarantee.

R. SANKEY, Regal Cinema, **ATHERSTONE** **WARWICKS.** Tel.: Atherstone 2220, 3210

MISCELLANEOUS

AQUALUNG AND COMPRESSOR Equipment, Ballraces and Miscellaneous items. Lists 3d. **PRYCE**, 157 Maiden Road, Cheam, Surrey.

TOOLS

LARGEST STOCKS of Bargain new Cutting Tools. Send for free list. **G. P. ENGINEERING TOOLS LTD.**, 313 New North Road, London N1. Phone: Canonbury 9977. Cables: Gephtra Londonnl.

WOODWORKING

ANGLIAN RANGE Saw Spindles, 10in. R/F Sawbenches, 6in. and 8in. Planers, 6in. Sawplanes and Woodworking Lathes. Send 6d. postage for brochures and price list to: **THE EAST ANGLIAN TRADING COMPANY**, 5 Guardian Road, Norwich, Norfolk. **NOR55A.**

HOME BOAT BUILDING

FULLY PREFABRICATED Kits to assemble a boat at home for two-berth Cabin Cruisers, fast Runabouts, Canoes, Frams, Enterprise Sloop, Sailing Dinghies, Leaflets from **WYVERN BOATS (WESSEX) LTD.**, Milborne Port, Sherborne.

PLANS AND ALL MATERIALS for Canoes, Dinghies, Runabouts, Cruisers. Send 1/- for 30-page details **YORK MARINECRAFT (Dept. PM)**, Worthington St., Bradford 8, York shire.

HOBBIES

CATALOGUE No. 15. Government surplus Electrical and Radio Equipment. Hundreds of items at Bargain Prices for the Experimenter and Research Engineer, 2/6 post free. Catalogue cost refunded on purchase of 50/- **ARTHUR SALLIS RADIO CONTROL LTD.**, 93 North Road Brighton.

PHOTOGRAPHY

TEN PER CENT DEPOSIT secures a high-class Camera at **WALLACE HEATON**, 64 Cheapside, London EC2. Write for Free Lists.

PROJECTORS. Home Assembly Kits. all types and sizes and stereo from 88/2/6. Fan Base Kit 23/7/6. Opticals, Screens, S.A.E., **MARSHALL SMITH LTD.**, 64 Norwich Avenue Bournemouth.

(Continued on next page)

RADIO

RADIO, TELEVISION Service Sheets. All types Valves, S.A.E. list, JOHN GILBERT TELEVISION, 1b Shepherd's Bush Road, London W6 SHE 8441.

WATCHMAKERS

WATCH REPAIRERS. Send 9d. for Catalogue of Watch Parts and New Watches at lowest wholesale prices, also Used movements. Instructional Books. Special Kit for Beginners. T. G. LOADER & CO. (Dept. B) 36 Milestone Road, Carterton, Oxford.

NEW WATCHES. Watch Movements, Watchmakers' Tools and Materials, Instructional Books, etc., at unbeatable prices. Also Watch Repairs undertaken. Send 1/- for Bumper Bargain Catalogue. **THE WATCHMAKERS' SUPPLY COMPANY,** "Time House", Carterton, Oxford.

ELECTRICAL

ALL TYPES of Electrical Goods at extremely competitive prices, e.g. 5-amp Twin Cable, 35/- 100yd.; Lampholders, 7/- doz.; 5ft Batteries, 49/-. Quality and immediate dispatch guaranteed. Request list. **JAYLOW SUPPLIES,** 93 Fairholt Road, London N16 (Tel.: Stamford Hill 4384).

SMALL ELECTRIC CIRCULATING PUMPS

for hot or cold water, fish tanks, ornamental fountains, waterfalls, milk cooling, greenhouse watering, pot washers, etc., comprising 120 watt unshrouded type, shaded pole. A.C. motor, coupled to centrifugal die-cast pump. Output 250 g.p.h. Maximum head 6 feet. 220/250 volts. Silent continuous running. New.

Price £3.10.0. Post paid.

H. MIDDLETON, 639 ABBEYDALE RD. SHEFFIELD, 7.

EDUCATIONAL

"HOW AND WHY" of Radio and Electronics made easy by a new non-maths, practical way. Postal instructions based on hosts of experiments and equipment building carried out at home. New courses bring enjoyment as well as knowledge of this fascinating subject. Free brochure from: Dept. 12, P.M. **RADIOSTRUCTOR,** Reading.



's MADE

By repairing Radio and TV Sets as a job or as a spare time business. Our practical course will show you the way. No previous experience is required.

SEND FOR **FREE BOOK TODAY!**

RADIOSTRUCTOR

I.p.t. (G80-7/63)

READING, BERKS.

The best book yet on the subject — now in its 2nd Edition . . .



RADIO CONTROLLED MODELS

Covers: **SIMPLE STEERING CONTROL GEAR—A SINGLE-VALVE SUPER-REGENERATIVE RECEIVER—A TWO-VALVE TRANSMITTER FOR RADIO CONTROL—CONTROL BOX: WAVEMETER: INTERFERENCE: LAYOUT—OBTAINING A SECOND CHANNEL USING THE "MARK/SPACE" SYSTEM—A PROPORTIONAL STEERING CIRCUIT AND REVERSIBLE SEQUENCE ENGINE CONTROL GEAR—A DETAILED DESIGN FOR A RADIO-CONTROLLED BOAT USING A GLOW-PLUG ENGINE AND AN ELECTRIC MOTOR IN THE POWER UNIT—A SIX-VALVE SUPER-HETERODYNE RECEIVER FOR MODEL CONTROL—A SINGLE-VALVE CRYSTAL-CONTROLLED TRANSMITTER—RADIO CONTROL FOR MODEL AIRCRAFT (SEQUENCE SYSTEM)—TUNED REEDS AND AUDIO CONTROL—MORE ABOUT MODEL ACTUATORS—TUNING MODEL-CONTROL TRANSMITTING AERIALS—A BULB MODEL-CONTROL FREQUENCY METER—AN AUTO-SWITCH FOR MODEL-CONTROL TRANSMITTERS—A RADIO-CONTROLLED MODEL BATTLESHIP—BUILDING A RADIO-CONTROLLED MODEL AIRCRAFT—MODEL-CONTROL AERIAL EFFICIENCY.**

192 pages

150 diagrams

The standard work on radio controlled models

12s. 6d. FROM ALL BOOKSELLERS

... or, in case of difficulty, 13s. 6d. by post from C. ARTHUR PEARSON LTD., Tower House, Southampton St., London, W.C.2.

PEARSON

FREE INFORMATION SHEETS

TITLES include "Condensation Rates"; "Steam Distribution"; "Condensate Return"; "Boiler Feed Tank"; "Direct Steam Injection"; "Flash Steam Recovery"; "Air in Steam Plant"; "Oil Burning Installations"; "Steam Heated Calorifiers"; "Compressed Air". Copies and full list free of charge or obligation.

SPIRAX-SARCO LTD. (TECHNICAL DEPT.), Cheltenham, Glos.

THE FAMOUS HARRIS ELECTRIC WELDER and Complete Kit



For Welding, Soldering, Brazing and metal construction & repairs in the home, on the car or cycle. Instant heat 6,000°F. Works from 6v or 12v car battery or transformer from A.C. mains. Complete kit of Welding Tool, 9ft. cable, clip, carbons, cleansing fluid, fluxes, filler rods, goggles, instructions, hints, thousands in daily use. As supplied to Dept. of H.M. Government, I.C.I., Standard Telephones, etc. Welds all Metals up to one-eighth inch. **57/6** C.O.D. IF REQUIRED. Obtainable only from: Post & Pkg., 3/6.

HARRIS ENGINEERING CO. (Dept. P.M.51) 269 KINGSLAND ROAD LONDON E.2.

INTRODUCING A NEW PORTASS LATHE

3½" x 16½" B.G.S.C. bench lathe complete with faceplate, catchplate and backplate, changewheels, etc., flat or vee drive. Complete satisfaction or remittance refunded in full. Ex-works write:

CHARLES PORTASS & SON Buttermere Works, Sheffield 8 Est. 1889 Cash or terms

ROGERS 31/33 NELSON ST. SOUTHPORT.

Fibre Washers, 144 Assorted	..	3/6
Mercury Switches	..	8/6
Timer Motors, 1 r.p.m.	..	26/-
Rec.ifiers 8/12 v. at 6 amps.	..	17/-
Transistors, GT11 Branded	..	2/8
Motorsised Water Pumps	..	95/-
Instrument Cases, 12in. x 8in. x 6in. New	..	7/3
Thread Gauges	..	4/9
Races, Belts, Valves, Pulleys, Pumps, Brass, Steel, Aluminium, etc.	..	

10 PAGE LIST FREE, STAMP PLEASE

Please mention "PRACTICAL MECHANICS AND SCIENCE" when replying to advertisers

Keep Practical

WITH THESE INVALUABLE MAGAZINES



PRACTICAL HOUSEHOLDER

Britain's first and foremost do-it-yourself magazine.

MONTHLY, 1s. 6d.

PRACTICAL MOTORIST

Saves you pounds on repair, maintenance and overhaul.

MONTHLY, 1s. 9d.

PRACTICAL WIRELESS

Covers every aspect of radio, set design and construction.

MONTHLY, 2s.

PRACTICAL TELEVISION

The television enthusiast's own magazine, packed with technical data.

MONTHLY, 2s.

PLACE A REGULAR ORDER WITH YOUR NEWSAGENT NOW!

Published about the 30th of each month by GEORGES NEWNES LIMITED, Tower House, Southampton Street, London, W.C.2, and Printed in England by Watmoughs Limited, Idle, Bradford; and London. Sole agents for Australia and New Zealand—Gordon & Gotch (Asia), Ltd. South Africa and Rhodesia—Central News Agency Ltd. East Africa—East African Standard Ltd. Subscription Rate (including postage): For one year: Inland £1.8s., Overseas £1.6s. 6d., Canada £1.5s. Registered for transmission by Canadian Magazine Post.

EARN

The. s plenty of room at the top for technically trained men—room for YOU if you want quick promotion or a better-paid more interesting career. Chambers College can quickly give you a *guaranteed* sparetime Postal Training, in the comfort of your own home and open up a whole new world of opportunity for you.

Find out, as thousands of others have done, how *easy* it is to learn at home with Chambers College. Send for *Success in Engineering*—136 pages of information you can use—and details of pay-winning Courses in all branches of Engineering, Building, Local Government, etc. Get your copy today—FREE!

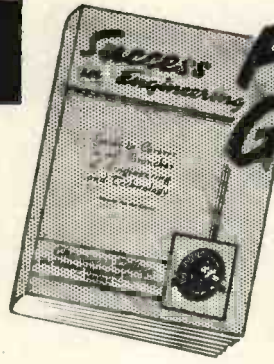

FREE GUIDE!

One of the following Courses taken quietly at home in your spare time can be the means of securing substantial well-paid promotion in your present employment, or entry into a more congenial career with better prospects.

MORE

This remarkable FREE GUIDE explains:

- * Openings, prospects, salaries, etc., in Draughtsmanship and in all other branches of Engineering and Building.
- * How to obtain money-making technical qualifications through special RAPID FULLY-GUARANTEED COURSES.

A.M.I.Mech.E., A.M.I.M.I., A.M.Brit.I.R.E., A.M.I.Prod.E. A.M.I.C.E., A.M.I.Struct.E., A.M.I.Mun.E., M.R.S.H., A.M.I.E.D., London B.Sc., Degrees.

Fully guaranteed postal courses for all the above and many other examinations and careers. Fully described in the New Free Guide.

SOON

We definitely guarantee that if you fail to pass the examination for which you are preparing under our guidance or if you are not satisfied in every way with our tutorial service—then your Tuition Fee will be returned in full and without question. This is surely the acid test of tutorial efficiency.

If you have ambition you must investigate the Tutorial and Employment services we offer. Founded in 1885, our success record is unapproachable.

**ALL TEXTBOOKS ARE SUPPLIED FREE
PROMPT TUTORIAL SERVICE GUARANTEED
NO AGENTS OR TRAVELLERS EMPLOYED**



BECOME A DRAUGHTSMAN - EARN BIG MONEY

Men and Youths urgently wanted for well paid positions as Draughtsmen, etc., in all Branches of Engineering. Our Guaranteed "Home Study" courses will get you in. Those engaged in the General Drawing Office should study some specialised Branch, and so increase their earning capacity.

CHAMBERS COLLEGE

THE GATEWAY TO BETTER LIVING

A.I. POSTAL COURSES

ENGINEERING, RADIO, AERO, ETC.

- | | |
|--------------------------|----------------------------|
| Aero, Draughtsmanship | Elec. Draughtsmanship |
| Jig & Tool Design | Machine |
| Press Tool & Die Design | Automobile " |
| Sheet Metalwork | Structural " |
| Automobile Repairs | R/F Concrete " |
| Garage Management | Structural Engineering |
| Works M'gmt. & Admin. | Mathematics (all stages) |
| Practical Foremanship | Radio Technology |
| Ratefixing & Estimating | Telecommunications |
| Time & Motion Study | Wiring & Installation |
| Engineering Inspection | Television |
| Metallurgy | Radio Servicing |
| Refrigeration | Gen. Elec. Engineering |
| Welding (all branches) | Generation & Supply |
| Maintenance Engineering | Aircraft Mainten. Licences |
| Auto Engine Technology | Aerodynamics |
| Diesel Engine Technology | Electrical Design |

BUILDING AND STRUCTURAL

- | | | |
|-----------------------|------------------|--------------------------|
| A.I.O.B. | A.I.A.S. | M.R.S.H. |
| A.M.I.P.H.E. | A.A.L.P.A. | A.I.Q.S. |
| Building Construction | Costs & Accounts | Builders' Quantities |
| Surveying & Levelling | Clerk of Works | Carpentry & Joinery |
| Quantity Surveying | | Building Inspector |
| | | Building Draughtsmanship |
| | | Heating & Ventilating |

GENERAL, LOCAL GOVERNMENT, ETC.

- | | |
|---------------------------|----------------------------|
| Gen. Cert of Education | A.C.I.S., A.C.C.S. |
| Book-keeping (all stages) | A.C.W.A. (Costing) |
| College of Preceptors | School Attendance Officer |
| Woodwork Teacher | Health Inspector |
| Metalwork Teacher | Civil Service Exams. |
| | Housing Manager (A.I.Hsg.) |

POST COUPON FOR FREE BOOK

Please send me a FREE copy of "Success in Engineering".

NAME

ADDRESS

Subject or exam of interest.....

CHAMBERS COLLEGE
(Incorp. National Institute of Engineering)
(Dept. 29) 148-150 Holborn London EC1