

Practical

1'6

AUGUST-1962

MECHANICS

**CHANNEL TUNNEL
PROJECT**

49



50

**MIDGET 8 VOLT
ACCUMULATOR**

A pistol type BUNSEN BURNER

**PIPELINES
across BRITAIN**

Practical books for the man who likes to make things for himself . . .

THE AMATEUR'S LATHE

by Lawrence H. Sparey

A book that every amateur, every garage proprietor and every light engineer will find of unending interest . . . it succeeds in giving a complete course of instruction embracing almost every process that can be accomplished on the highly adaptable small lathe. Contents include: The Lathe - Choosing a Lathe - Installing - Accessories - Measuring Equipment - Lathe Tools - Drills and Reamers - Holding Work in the Lathe - Marking out Plain Turning and Boring - Taper Turning, Crankshaft Turning, Disc and Ball Turning - Screwcutting - Milling, Shaping and Grinding in the Lathe - Lapping and Honing - Metal Spinning, Spring Winding, Turning Rubbers, etc. - Production Methods in Small Lathes - Care of Lathe and Accessories - Handy Tables for Home Mechanics. **20s. net (21s. £d. by post)**
224 pages 229 illustrations



The 1st "Practical Mechanics"

HOW-TO-MAKE-IT BOOK

edited by F. J. Camm

It shows you how to construct all these valuable articles: Tape Recorder - Electronic Organ - Electric Washing Machine - Hand Vacuum Cleaner - Electrically-operated Garage Doors - Bagatelle Table - Reflecting Telescope Stand - Harmonograph - "Designograph" - 15-in. Four-Heddle Hand-Loom - Potter's Wheel - Pottery Kiln - Electric Oven - Westminster Tubular Door Chimes - Cycle Trailer - Pedal-Cycle Sidecar - Portable Air Compressor - Water Softener - Spanish Hawaiian Guitar - Steel-stringed Ukulele - Double-seater Canoe - Radio Deaf-Aid Unit - Garden Pool Vertical Enlarger - Photo-electric Exposure Meter - Synchronised Flashgun Combined Printing Box and Safelight - Diascopes and Episcopes - Steam Driven Motor Boat - Electric Wall Bracket - Inexpensive House Telephones - Electric Gas-lighter - Adjustable Drawing-table - Toboggan. **15s. net (16s. by post)**
224 pages. 320 illustrations.



The 2nd "Practical Mechanics"

HOW-TO-MAKE-IT BOOK

edited by F. J. Camm

Contents: Reflecting Enlarger - One-string Fiddles - Folding Steps and an Extending Ladder - Electric Guitarette - Miniature Billiard-Table - Synchronous Electric Clock - Glove Puppet Theatre - Automatic Garden Sprinkler - Midget Camera - Potter's Wheel - Catamaran - Rowing Machine - Aqualung - Home-made Fishing Tackle - Installing a Tropical Aquarium - Snow Scooter - Under-water Photography - Skis - Projecting Time on the Ceiling - Harpoon Gun - Small Wind-power Plants - Electric Hedge Trimmer - Bathroom Scales - Folding outboard Motor-boat - Flash Photography - Gas Fired Pottery Kilns - Back-projection Episcopes - Motorising Your Lawn Mower - Skeleton Synchro-electric Clock - Viewer and Printer for 35 mm. Film - Cycle Trailer - Electric Imitation Coal Fire - Mechanical Potato Peeler - Home-made Duplicator - Making Rubber Stamps. **15s. net (16s. by post)**
102 pages 306 illustrations

PRACTICAL MECHANICS HANDBOOK

by F. J. Camm

This valuable handbook has been compiled to meet the needs of all handymen and those engaged in the mechanical hobbies. Its scope includes sections on lathe work, small tools, filing, fitting and marking out, the dividing head, the micrometer and vernier, mensuration, screw-cutting, hardening and tempering, electro-plating, silver soldering, brazing, soft soldering, etc. There is a large section of the most constantly consulted tabular matter and it is packed with facts, figures and data on the many practical branches of the world of mechanics. **16s. net (17s. by post)**
400 pages, 396 illustrations

FROM ALL BOOKSELLERS

. . . or in case of difficulty at post prices shown
from GEORGE NEWNES LTD., Tower House,
Southampton Street, London, W.C.2.

NEWNES

**ANY ITEM SUBMITTED
ON APPROVAL—
WITHOUT
OBLIGATION**

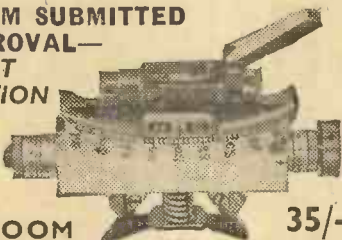

**TOOLROOM 35/-
CLINOMETERS (Micrometer Bubble Type)**

An Engineer's Clinometer of great precision. Main scale is divided 0.20° in 1° divisions. Angles can be read on the micrometer thimble to within 5 minutes. For their original military purpose a clip was fitted to the base but this clip can easily be removed in the Machine Shop. Net weight 22 ozs. Length of base 3 1/4 in.

GERMAN DRAWING INSTRUMENT SETS

Brand new in velvet lined case **£2.10.6**
WALTHAM TIME & MOTION STUDY STOPWATCHES
Current value approx. £10. Offered at **£3.15.0**.
With decimal dial, £4.10.0. Fully guaranteed.

OPTICAL EXPERIMENTAL SET in Transparent Pack. Type A contains 30 grad lenses. Type B contains 30 selected lenses, prisms and polaroids. Either type 42/- per set.

The NEW RUSSIAN MICROSCOPE as shown at the Soviet Trade Fair. **£47.10.0**

GBL 516 16mm. SOUND PROJECTORS—perfect **£55.10.0**.

EX-R.A.F. ADJUSTABLE BENCH LAMPS **33/6**

EX-R.A.F. ILLUMINATED MAGNIFIERS with 3 1/4 in. dia. lens. **38/6**

Ex-M.O.S. HARDENED CHESTERMAN COMBINATION SET No. 92, with 12" rule. Brand new condition **£6.15.0**

CHARLES FRANK LTD. Phone: BELL 2106/7 Grams: BINOCAM Glasgow

6775 SALTMARKET, GLASGOW, C.I. Est. 1907

Britain's greatest stocks of new, used and Ex-Government Optical and Scientific Equipment. Send for Illustrated Catalogue.

English of Brentwood for the finest Telescopes

- List No.
- T.10. **The FAMOUS SCOUT MK.II.** 25 x 50. Three draw lightweight, only 2 1/2 lbs. Superb object glass made for government regardless of cost puts this scope in a class of its own. A collector's piece. All brass, leather covered, with case and sling. 2" dia. O.G. Milt. condition. 28 ea. Used from £8.10.0.
50X or 75X eyepieces to fit above 50/- ea. extra. 3 ft. tripods to fit. New 15/- ea.
Rods 30 x 75. Elbow type Built-in filters. Near New. 24 ea.
 - T.17. 7 x 50. C.T.S. Elbow. Bloomed, lightweight, lever focus, with neutral filter. New and boxed. Definition and brilliance out of this world. The finest 7 x 50 we have yet seen regardless of price. Only 25 ea.
 - T.18. 7 x 50. C.T. Screw focus, unbloomed. £2.15.0. New.
 - T.3. **VARIABLE POWER TELESCOPE, 7-21X. ZOOM ACTION:** As specified in A.C.W. for long range bird photography with cine cameras. Weight 10 lbs., length 30". As New and in fitted hardwood case with lock and key. £4.10.0 ea. Used from £4.10.0.
 - T.5. As above but 5-15X angle type. 2" OG. Length 28". Weight 13 lbs. As new in fitted case. 25 ea. Used from £2.15.0.
 - T.1. **6" PARABOLIC REFLECTING TELESCOPE, 48" focus, 80-400X.** Infinitely variable. Complete on equatorial or altazimuth mounting with circles and geared drives. 55 ea EX-WORKS. Also available in Kit form or sep. parts. Plans 2/- ea. with full parts list.
 - T.25. **FINDER TELESCOPE, 6 x 30.** Astro type. Fixed focus (ad. O.C.) with or without crossline. Gr. 45/- ea.
 - P.2. **PRISM KIT.** For 35mm (2 x 2). Triple condenser in mounts, 4" lens in push focus mounts. Uses 100W 20V lamp. Gives 3 ft. picture at 8 ft. We guarantee this kit when made up as per our plans, to give results equal to if not better than any other projector up to 300 watts and costing up to £25. This applies to brilliance of image, evenness of illumination, definition from centre to far corners, low heating of slides, and correct colour rendering due to the fact that no heat filter is required and lenses throughout are best quality white glass and last but not least "It is properly designed". Optics only in mounts. 37/6.
Plans for above and 5 other types with full parts list 2/- ea.
- Booklets, "How to use Ex-Govt. Lenses and Prisms", Nos. 1 and 2 2/6 ea. Lists Free for S.A.F.**
FOR OPTICAL EQUIPMENT DESIGNED BY EXPERTS AT PRICES YOU CAN AFFORD, CONSULT
H. W. ENGLISH, 469 RAYLEIGH ROAD, HUTTON, BRENTWOOD, ESSEX. Brent. 1685.



**IN THE DARK
ABOUT
DEVELOPING?**

It is much easier than you think to develop your own films and this new UNIVERSAL tank from Johnsons makes it easier still. You only have to load the film in the dark, the rest of the job—developing, fixing and washing—is carried out in the light. Everything has been designed for ease of manipulation and the tank is adjustable for several widths of film—120/620, 127, 35 mm./828 or 16 mm. (5 feet.)

With fully illustrated instruction book. At your dealers' now, 32/6.

**JOHNSONS
OF HENDON LTD**

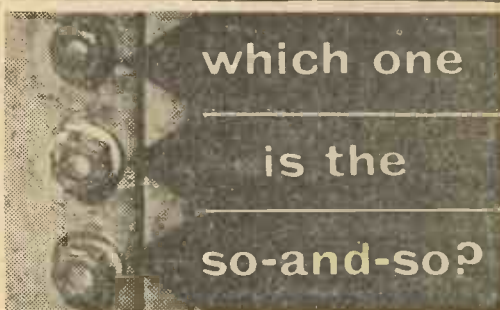

EEZIT WILL SHIFT IT!

Yes, Sir or Madam—NEW 3-WAY EEZIT certainly shifts them... nuts, bolts, screws, hinges — in the home, garden, garage or workshop.

Let NEW 3-WAY EEZIT—the universal spanner—take the strain, without force or broken studs.

A few drops of EEZIT releases rust-bound and corroded metal parts. NEW 3-WAY EEZIT is a penetrating anti-corrosive that's an ideal lubricant.

8 oz. Spouted tin 2/6d
10 oz. Aerosol Spray 5/6d

Obtainable from your Ironmonger, Garage, Accessory Dealer and Garden Supplier.

Manufactured by J. BENNETT HEYDE & CO. LTD. MANCHESTER.



VALUABLE NEW HANDBOOK FREE TO AMBITIOUS ENGINEERS

Have you had *your* copy of "Engineering Opportunities"?

The new edition of "ENGINEERING OPPORTUNITIES" is now available—without charge—to all who are anxious for a worthwhile post in Engineering. Frank, informative and completely up to date, the new "ENGINEERING OPPORTUNITIES" should be in the hands of every person engaged in any branch of the Engineering industry, irrespective of age, experience or training.

**We definitely Guarantee
"NO PASS—NO FEE"**

This remarkable book gives details of examinations and courses in every branch of Engineering, Building, etc., outlines the openings available and describes our Special Appointments Department.

WHICH OF THESE IS YOUR PET SUBJECT?

MECH. ENGINEERING
Gen. Mech. Eng.—Maintenance Eng.—Diesel Eng.—Press Tool Design—Sheet Metal Work—Welding—Eng. Pattern Making—Inspection—Draughtsmanship—Metallurgy—Production Eng.

RADIO ENGINEERING
General Radio—Radio & TV Servicing—TV Eng.—Telecommunications—Electronics—Sound Recording—Automation—Practical Radio—Radio Amateurs' Exam.

CIVIL ENGINEERING
General Civil Eng.—Municipal Eng.—Structural Eng.—Sanitary Eng.—Road Eng.—Hydraulics—Mining—Water Supply—Petroleum Tech.

WE HAVE A WIDE RANGE OF COURSES IN OTHER SUBJECTS INCLUDING CHEMICAL ENG., AERO ENG., MANAGEMENT, INSTRUMENT TECHNOLOGY WORK STUDY, MATHEMATICS, ETC.

Which qualification would increase your earning power? A.M.I.Mech.E., A.M.S.E., A.M.I.C.E., A.M.Brit.I.R.E., A.F.R.Ae.S., B.Sc., A.M.I.P.E., A.M.I.M.I., A.R.I.B.A., A.I.O.B., A.M.I.Chem.E., A.R.I.C.S., M.R.S.H., A.M.I.E.D., A.M.Mun.E., CITY & GUILDS, GEN. CERT. OF EDUCATION, ETC.

BRITISH INSTITUTE OF ENGINEERING TECHNOLOGY
410A COLLEGE HOUSE, 29-31 WRIGHT'S LANE, W.8

ELEC. ENGINEERING
General Electrical Eng.—Installations—Draughtsmanship—Illuminating Eng.—Refrigeration—Elem. Elec. Science—Elec. Supply—Mining Elec. Eng.

AUTO ENGINEERING
General Auto. Eng.—Auto. Maintenance—Repair—Auto. Diesel Maintenance—Auto. Electrical Equipment—Garage Management.

BUILDING
General Building—Heating & Ventilation—Plumbing—Architecture—Carpentry—Painting & Decorating—Specifications & Quantities—Surveying—Architectural Draughtsmanship.

THIS BOOK TELLS YOU

- ★ HOW to get a better paid, more interesting job.
- ★ HOW to qualify for rapid promotion.
- ★ HOW to put some letters after your name and become a "key-man" . . . quickly and easily.
- ★ HOW to benefit from our free Advisory and Appointments Depts.
- ★ HOW you can take advantage of the chances you are now missing.
- ★ HOW, Irrespective of your age, education or experience, YOU can succeed in any branch of Engineering.

156 PAGES OF EXPERT
CAREER - GUIDANCE



You are bound to benefit from reading "ENGINEERING OPPORTUNITIES," and if you are earning less than £25 a week you should send for your copy now—FREE and without obligation.

POST NOW!

TO: B.I.E.T. 410A, COLLEGE HOUSE, 29-31 WRIGHT'S LANE, W.8.

2½d. stamp if posted in an unsealed envelope.

Please send me a FREE copy of "ENGINEERING OPPORTUNITIES." I am interested in (state subject, exam., or career).

NAME _____

ADDRESS _____

WRITE IF YOU PREFER NOT TO CUT THIS PAGE

THE B.I.E.T. IS THE LEADING INSTITUTE OF ITS KIND IN THE WORLD

Practical

MECHANICS

Vol. XXIX

August, 1962

No. 340

Editorial and Advertisement
Offices
"PRACTICAL MECHANICS"
George Newnes Ltd., Tower
House, Southampton Street,
Strand, W.C.2.

© George Newnes Ltd., 1962
Phone: Temple Bar 4363
Telegrams:

Newnes, Rand, London
SUBSCRIPTION RATES

including postage for one year
Inland - - - - 22s. per annum
Abroad - - - 20s. 6d. per annum
Canada - - - - 19s. per annum

Copyright in all drawings, photo-
graphs and articles published in
"Practical Mechanics" is specially
reserved throughout the countries
signatory to the Berne Convention and
the U.S.A. Reproduction or imita-
tions of any of these are therefore
expressly forbidden.

CONTENTS

Fair Comment	483
All Weather Auditorium ...	484
Lathe Gadgets	486
Midget 8 volt Accumulator	488
Pipelines across Britain ...	491
Oblique Drilling Guide ...	494
Science Notes	496
Using the Sub-Minature Camera	498
Electrifying a Hand Lawn- mower	500
A Pistol Type Bunsen Burner	503
Evening Star	504
Fibre Optics	508
Channel Tunnel Project ...	511
Brazing Hearth	515
Packaway Dark Room ...	517
Do-it-Yourself Instru- mentation	519
Automatically Controlled Milling for Complicated Parts plus Sheet Metal Detail Fitting	521
Puzzle Corner	523
Your Queries Answered ...	525

CONTRIBUTIONS

The Editor will be pleased to consider articles of a practical nature suitable for publication in "Practical Mechanics." Such articles should be written on one side of the paper only, and should include the name and address of the sender. Whilst the Editor does not hold himself responsible for manuscripts, every effort will be made to return them if a stamped and addressed envelope is enclosed. All correspondence intended for the Editor, should be addressed: The Editor, "Practical Mechanics," George Newnes, Ltd., Tower House, Southampton Street, Strand, London, W.C.2.

FAIR COMMENT

New Format

THE main purpose of the Questionnaire in our March issue was to discover at first hand what type of article readers would like to see in future editions of PRACTICAL MECHANICS. A person buys a magazine that deals with his or her main interest, and hobbies. It is the Editor's duty with any specific type of magazine to ensure that the reader is getting satisfaction.

PRACTICAL MECHANICS has always enjoyed a good following with the man who has a workshop and likes to make things. For this man we have covered many fields. We have also included a number of interest features, particularly dealing with space exploration from its very early stages.

The word "science" is used as an umbrella term today, it applies to many subjects hitherto coming under the heading of "mechanics". Even workshop projects are becoming more "scientific".

Commencing with the September issue this magazine will be known as "PRACTICAL MECHANICS AND SCIENCE". Also we intend to broaden our field of subjects even further and include articles on radio and electronics, car and home maintenance, boat building and many other workshop projects.

In order to give the best possible reproduction to illustrations and drawings our paper quality will be improved. This automatically brings increased production costs and the price of the September issue will be 2/-.

One Man Autogyro

This main feature and cover subject from our June issue has brought a flood of enquiries from "Mechanics" anxious to build their own machine. Unfortunately we are unable to give any constructive advice, as, at the present time the entire production of this Autogyro is being devoted to military purposes and no technical details are being released by the manufacturers. The advice we are giving to readers interested in this type of project is that they write to Bensen Aircraft Corp., Raleigh-Durham Airport, Raleigh, N.C. This American company is selling drawings and complete specifications for constructing what they call a One-Man Copter and a Copter-Glider, a machine very similar in appearance to the Beagle Autogyro.

Brazing Hearth

To the followers of L.B.S.C.'s "Evening Star" series this issue brings the first details of the boiler construction, and in order to make this part of the locomotive a brazing hearth will be required. Those of you who do not possess such equipment will be grateful to the efforts of our contributor C. M. Leonard who has compiled an article on making "A Simple Brazing Hearth" especially for this issue.

The Sept. 1962 issue will be published on August 22nd, 1962. Order it now!

ALL-WEATHER AUDITORIUM

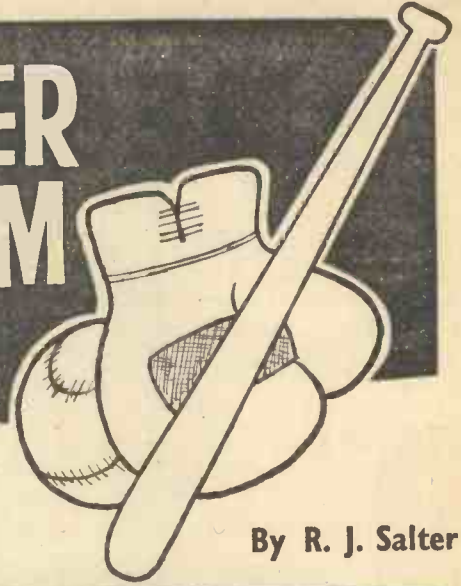

GIANT CONCRETE UMBRELLA PROTECTS 13,000
PEOPLE FROM THE ELEMENTS AT THE TOUCH
OF A SWITCH

By R. J. Salter



The Public Auditorium of Pittsburgh and Allegheny County was open to the skies when it was dedicated in September 1961. More than three years in construction, it is the nucleus of a cultural centre projected as part of Pittsburgh's redevelopment programme. A symphony hall, an art museum and a theatre, as well as a large middle-income housing project are also being planned for the area.

(Photo courtesy U.S. Information Service)

THE weather is no longer a problem for sports followers whose team plays in the new civic auditorium at Pittsburgh. For if the rain comes on in the middle of a match the sliding dome shaped stainless steel roof can be noiselessly closed at the touch of a switch.

Open air concerts, circuses and exhibitions as well as boxing matches can be held in the auditorium which holds up to 13,000 spectators. If the weather is hot the roof can be kept open to give spectators the benefit of the breeze. Should the

weather change a roof can slide into position within two-and-a-half minutes.

Circular in plan the auditorium, described as one of the most outstanding buildings of the 1960's, has a central flat area of 90ft. by 205ft. which can be used for many different purposes. Ringed around this central area are between ten and thirteen thousand seats according to the kind of event taking place.

Covering the whole of the auditorium is the dome-shaped roof, 415ft. in diameter and 316ft. high at the centre. It is divided up radially into eight approximately equal sections, six of which are movable and two of which are stationary. At the top is a pivot which connects the moving and fixed sections and which is supported by a long arm curving up from the ground and around the top of the building. Along their bottom edges the moving roof sections rest on carriages running on wheels.

When looking down directly from above on to the dome shaped roof each section of the roof is a 45 degree segment of a circle with a radius of 207 feet and a weight of 300 tons.

To open the auditorium to the sky the six moving sections glide one over the other to rest on top of the two fixed roof sections. Power to move the heavy 3ft. thick roof leaves is supplied by individual electric motors driving wheeled carriages running on rails. There are three rails set on a

strong reinforced concrete beam which runs completely around the building at a height of 30ft. above the ground. Two leaves run on each rail, one travelling clockwise and the other in an anti-clockwise direction.

To the citizens of Pittsburgh this effortlessly moving gleaming steel roof is a symbol of the change that is taking place in their town, once famous for its slag heaps, soot and grime. This spectacular space age structure has as background the famous Golden Triangle at the junction of the Allegheny and Monongahela rivers where the skyline equals that of the New York waterfront.

The retractable dome is one of the unique features of the new Public Auditorium here. Composed of eight pie-shaped wedges, six movable leaves can quickly be nested into two stationary parts, converting the building from a closed arena to an open-air amphitheatre. Electronic controls can open or close the building noiselessly in two-and-a-half minutes.

(Photo courtesy U.S. Information Service)



LATHE GADGETS

Part 8

BACK TOOLPOST

By L. C. MASON

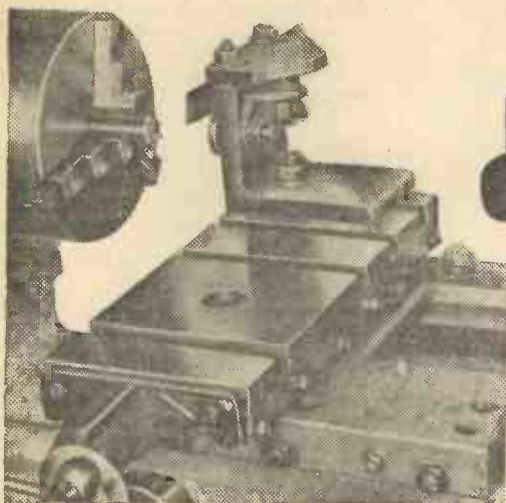

Back Toolpost in working position ML7 cross-slide.

IT is not always appreciated that for parting off a generally better job results from using a parting tool or blade in a back toolpost. There are two main reasons for this. Parting off is a form of cutting using a tool with a wider cutting edge than normal, and the effect of this is to increase the loads and pressures all round. With a parting tool in the toolpost the normal reaction to the work of cutting is to try and lift the work piece and spindle nose upwards. When parting is carried out in the back toolpost however, the reaction is downwards, as the tool cuts on its underneath edge. This makes for a more solid support to the job as the structure of the lathe provides a rigid support to downwards loads. That is one reason; the second is that a back toolpost is not mounted on the top-slide, and therefore gains in stiffness by the elimination of one set of clearance contacts—in the topslide way.

Back Toolpost partly disassembled with parting blade in position.

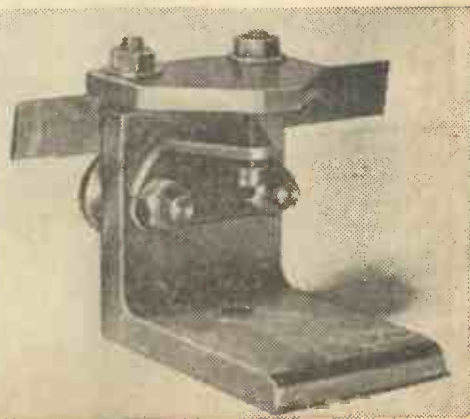

A number of back toolpost accessories are available, making use of castings for mounting the tool. This certainly makes for maximum rigidity, but some very useful work can be done with a back toolpost made from heavy section steel angle, which makes it possible to fabricate the whole affair and cut out the casting and necessary pattern. The one shown, built up around a short length of $\frac{1}{2}$ in. thick steel angle, has a number of times smoothly parted off discs for gear blanks from $2\frac{1}{2}$ in. diam, mild steel bar. This capacity should cover the average model engineer's normal requirements.

As will be seen, the body of the toolpost is a piece of $3 \times 3 \times \frac{1}{2}$ in. mild steel angle which is bolted down on the further end of the cross-slide, and which carries the tool clamping arrangements on its shortened vertical web. The tool—in this case a commercial parting blade—rests on the top edges of a pair of round-headed bolts. These bolt heads are slightly eccentric to the shanks, so that a small height adjustment is provided for the tool by slightly rotating the bolts in their holes in the angle. The blade is held down by a top clamp plate bearing on the top edge of the blade, and supported by a jack screw through a small bracket held against the back of the angle by the nuts on the blade support bolts. This screw is adjusted to bring the clamp plate level, according to the height setting of the blade. Pressure on the clamp plate is provided by two $\frac{1}{2}$ in. studs tapped into the top edge of the angle.

It will be noticed that the holes in the clamp plate for the studs are elongated into slots; this is so that the plate can be slid across to provide more overhang should it be required to hold a normal tool of $\frac{3}{8}$ or $\frac{1}{2}$ in. square section instead of the parting blade. In this case, a second pair of round-headed supporting bolts are necessary, having heads appropriately thicker, to provide solid support under the square section tool. For the same reason, the clamp plate is wide enough over the jack screw to bear on it in whichever position it is used.

The body angle should be squared off all ways to the dimensions shown, and care taken to produce a regular flat surface underneath where it contacts the surface of the cross-slide. It must sit down firmly and solidly when bolted in position. The position of the bolting hole given is a compromise between setting the attachment as far back as possible to provide maximum work clearance, and placing it as far forward as possible to provide the greatest possible seating area on the cross-slide. If the Myford extra long slide is fitted, the bolt hole could well be placed further forward, bringing it more underneath the tool point and utilising the extra length of the slide underneath for back support. Drill and tap the holes for the clamp studs in the top edge $\frac{1}{2}$ in. B.S.F., $\frac{3}{16}$ in. deep.

The round head tool support bolts are best turned out of silver steel for hardness of the head, or case hardened over the head if from mild steel. The shafts are $\frac{1}{16}$ in. eccentric to the 1 in. diameter head, and threaded $\frac{1}{8}$ in. B.S.F.

The top clamp plate is a plain filing and drilling job from $\frac{1}{2}$ in. mild steel plate. Black material would do quite well for this if the underside is drawn flat for even contact with the parting blade upper edge. The jack screw can be any handy 2B.A. bolt. Any style of head is acceptable here, as it is never used for anything but finger adjustment while the clamp pressure is released. If a special bolt is turned up for the job, a small knurled head would be the most suitable.

If any tendency is shown for the blade support bolts to turn while being tightened, and so upsetting the height adjustment, a paper washer under the head of each will give the heads sufficient grip to stay put and resist the spanner twist.

In setting up the attachment, place the blade in position with the minimum overhang that will penetrate the depth required, and have all the nuts only finger tight. Adjust the support bolts to bring the blade level and the cutting tip exactly at centre height. For the dimensions shown the bolts should come about midway between the extremes of possible adjustment. The blade is ground with a thickness clearance over its width, which means that the thinner edge will come on the top. Check with a square stood on the cross-slide that this clearance is equal on both sides of the blade, which will thus show a very slight gap between the face of the angle web and the upper edge of the blade when the lower side of the blade is contacting the face of the angle. With the blade correctly located, adjust the jack screw to bring the clamp plate level and tighten the nuts on the clamp studs down fairly hard. The blade can now be left in this position until needing sharpening and the complete unit removed and replaced without further disturbing the blade.

(Concluded on page 526)

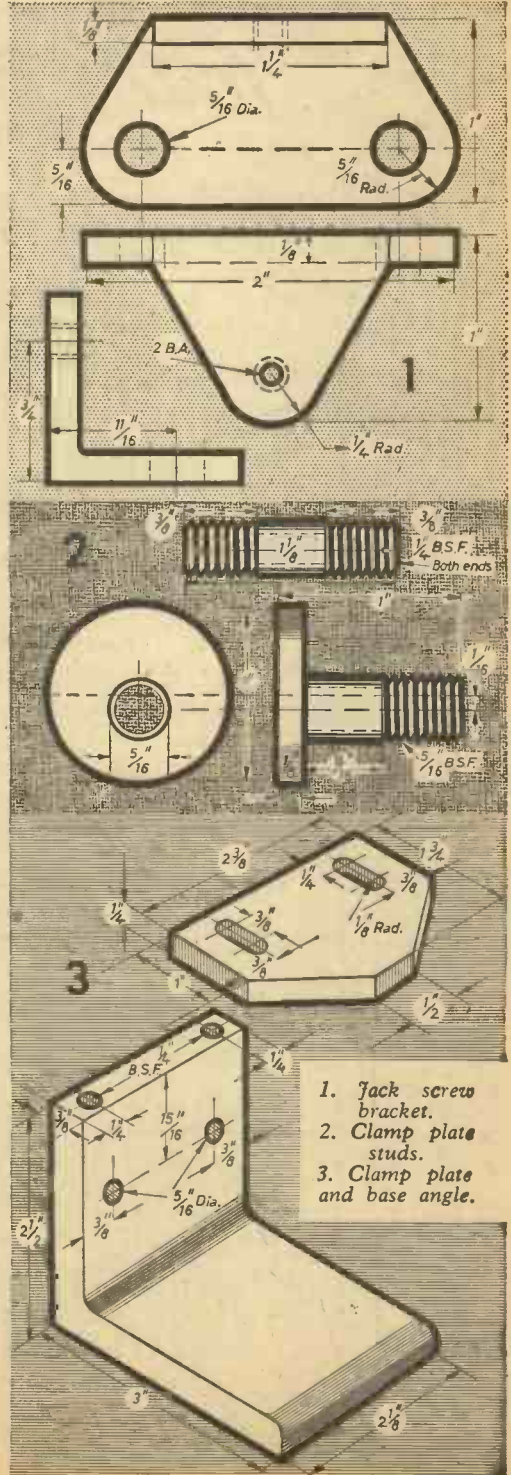

Make a Midget Eight Volt Accumulator

by N. G. RICHARDSON

IT may not be generally realised how easy it is to manufacture reliable midget lead acid accumulators which can be used for a variety of purposes. They can replace dry batteries in hand lamps and other electrical equipment with two distinct advantages. Firstly they are rechargeable and will give years of service. The cost of charging from the mains is often only a fraction of a penny. Secondly they give an almost constant voltage during discharge. With a dry battery the voltage starts to fall from the moment that it is put into use.

The eight volt battery described in this article was made for use with a large transistor receiver. With this set it was found that although the recommended dry battery had quite a long useful life the sparkling performance which the set gave

with a brand new battery was lost after the battery had been in use for only a short time. The accumulator is actually smaller than the battery it has replaced and the set now has its "new battery" performance all the time, and runs for many hours between charges.

Providing the basic principles are followed there is no reason why batteries of any reasonable capacity and voltage should not be made. The voltage will be determined by the number of cells and the capacity by the amount of active material in the plates.

MATERIALS REQUIRED

Sheet lead about $\frac{1}{8}$ in. thick. Eight pieces $2\frac{1}{2}$ in. x $\frac{1}{2}$ in. Or small quantity of scrap lead.

Tufnal tubing, $\frac{1}{4}$ in. square inside, $\frac{11}{16}$ in. outside. 1ft. Manufactured by Tufnal Ltd., Birmingham.

Piece of Tufnal sheet about $\frac{1}{8}$ in. thick (eight pieces $\frac{1}{2}$ in. square).

Litharge. PbO. 2ozs.

Red lead. Pb₃O₄. 2oz. (See text.)

Small quantity of pure sulphuric acid and distilled water or four separate bottles of dilute sulphuric acid of the following Specific Gravity.

1.1; 1.12; 1.25; 1.4.

Small quantity of: Shellac Varnish; Paraffin Wax; Glass Wool.

If the plates are to be cast a piece of soft asbestos sheet $\frac{1}{8}$ in. thick to make three pieces about 2 in. x 3 in. will be required.

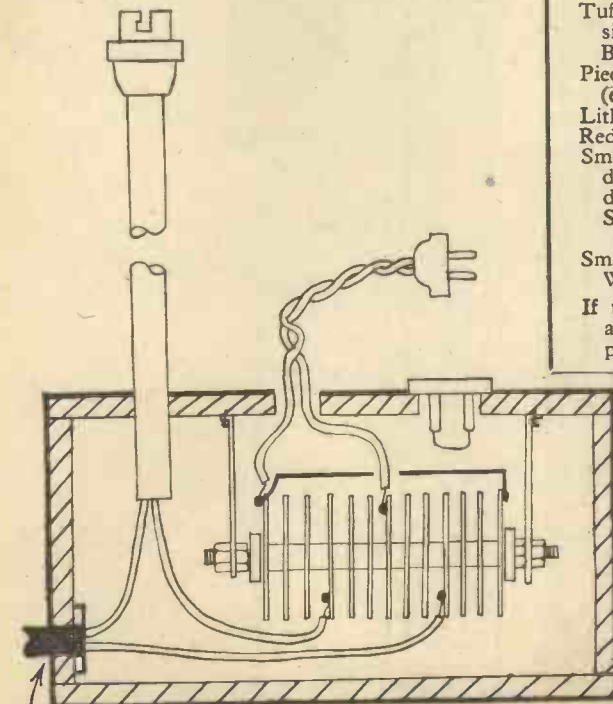

Mains

*Suggested
Construction
for a simple
Charger*

Construction: Making the Plates

Eight lead plates are needed as shown in Fig. 1. These can be cut from lead sheet or cast from scrap lead. In either case it is best to drill the $\frac{3}{8}$ in. diameter holes after forming the basic shape. Fig. 2 shows a simple jig to hold the plates while the holes are drilled. Lightly countersink the holes both sides to remove burrs. It is quite easy to cast the plates from scrap lead as follows. Obtain three pieces of soft asbestos sheet about $\frac{1}{8}$ in. thick and 3 in. x 2 in. On one piece mark out the shape of the plate so that the top of the lug is against one edge of the asbestos. See Fig. 3. Cut this shape out cleanly with a razor blade or sharp knife, taking care not to break the surrounding asbestos. Sandwich the frame so formed between the other two pieces of asbestos and clamp the whole between two pieces of wood with the aperture formed by the lug uppermost. Melt some lead in a small ladle over a gas flame without making it too hot. Rake off any dross from the surface and pour the metal into the hole at the top of the mould. A small excess may be allowed to form a button on top. Wait a minute for the metal to set. Part the mould and ease out the casting. Reassemble the mould and repeat until

desired number of plates has been cast. Trim up the plates with a file so that they are an easy fit in the Tufnol tubing and drill as above.

Pasting the Plates

Mix the following paste in a glass vessel with a stick or glass rod.

	For this battery.
	metric grammes
4 parts by weight Red Lead	24
1 part by weight Litharge	6
1 part by weight Sulphuric acid S.G.1.12	5.6ccs.

Mix the litharge and red lead first and then add the acid slowly with thorough stirring. A stiff paste will form. Continue to mix until this is workable. Do not thin by adding more acid. Place four of the plates on a sheet of paper and force the paste into the holes using a flat piece of wood as a spatula. Turn the plates over and repeat from the other side. Scrape off any excess and put the plates away for a few days to dry. These will be the positive plates and may be marked with a dab of red paint. After drying for a few days dip the plates in sulphuric acid 1.25 S.G. and redry.

The dilute acid can be prepared by adding the strong acid carefully with stirring to distilled water. The dilute acid must be cooled to room temperature between additions and hydrometer reading taken until the required density is reached. For most workers it will be simpler to purchase four bottles of acid of the strengths required. Similarly,

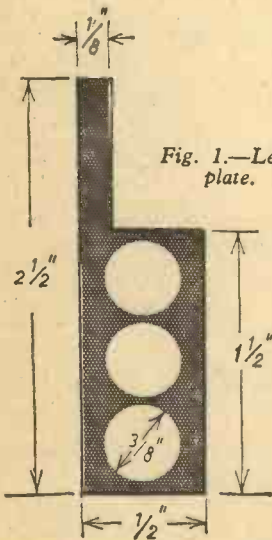

Fig. 1.—Lead plate.

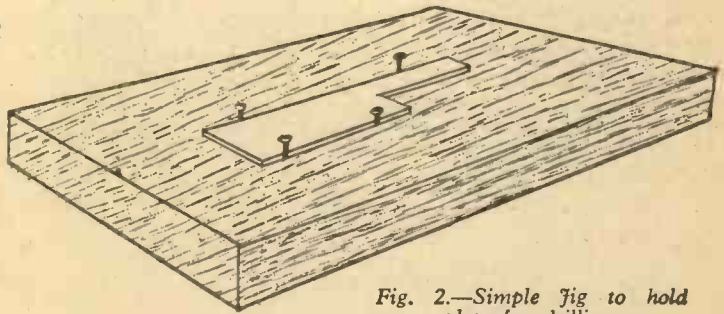

Fig. 2.—Simple jig to hold plate for drilling.

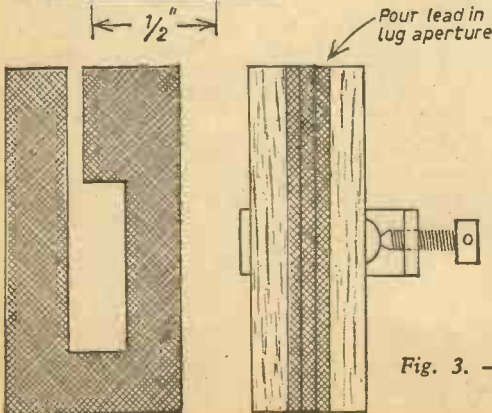

Fig. 3.—Moulds for casting plates.

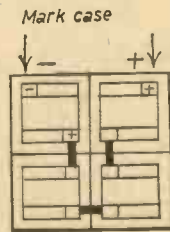

Fig. 4.—Assembly.

Making a midget Eight Volt Accumulator (continued)

if facilities for accurate weighing are not available have the chemist mix some red lead and litharge in the 1:4 proportion and store this dry mixture for positive plates.

For the negative plates make the following paste and use as above.

5 parts by weight Litharge
1 part by weight Sulphuric acid S.G.1.10 5.5ccs.
The acid can be measured out from a burette or graduated measure.

Making the Case

While the plates are drying the case can be made from the Tufnol tubing.

Cut four pieces $2\frac{1}{2}$ in. long and prepare eight pieces of the Tufnol sheet $\frac{1}{2}$ in. square. Make the squares so that they are a tap fit in the tube. Tap one square into one end of each tube so that the inner face is about $2\frac{1}{2}$ in. from the open end of the tube. Stand the tubes upright with the blanked ends uppermost and pour a little shellac varnish into each. Tilt the tubes so that the varnish runs all round the edge of the blanketing piece. Allow to dry and then fill the cavity above the blank piece with molten paraffin wax. Allow to set. This will form an effective acid proof seal in one end of the tube. Using the shellac varnish, stick the four tubes together to form a square case with four cells.

Charging the Plates

After preparing and drying the plates clamp them together into positive and negative sets ready for charging. It is convenient to place all the plates of one type together and to grip the ends of the lugs in a bulldog clip. Place the two sets of plates in a glass jar taking care to see that they cannot make contact while charging and just cover the active part of the plates with sulphuric acid S.G.1.12. Charge them by passing D.C. through the cell observing correct polarity, i.e. positive lead to positive plates. It is important to keep the charging current low for this first charge. To charge the plates for the battery described in this article grouped together as above the current should not exceed 0.25 amps. A suitable charger will be described at the end of this article. Charging should continue until the positive plates are a rich chocolate brown all over and the negative plates are a grey lead colour all over. The sets of plates described can safely be left on charge at about 0.2 amps for 12 hours.

Assembly

When the plates have been fully charged remove them from the acid, separate them, and rinse in distilled water. Assemble them in the case following the diagram Fig. 4. As each pair is slipped in a small piece of glass wool should be pushed down between them with a flat piece of wood. This need be only a small piece of glass wool, just enough to form a firm wad at the bottom of the case between the plates. This will hold the plates in position during the rest of the assembly.

Before fitting the tops to the cells the plates must be just covered with jelly electrolyte.

Preparing the Electrolyte and Filling the Cells

To prepare the electrolyte pour one part of sodium silicate S.G.1.2 into three parts of cold Sulphuric acid S.G.1.40. Pour the silicate in slowly stirring all the time. The mixture will set in about 5 minutes, so once mixed must be poured into the cells without delay. If the strength of the silicate is unknown it is advisable to experiment with the mixture before attempting to fill the cells. If the jelly forms too rapidly dilute the silicate slightly with distilled water before measuring out and mixing. If any liquid separates on the surface after the jelly has set draw it off with a small piece of blotting paper.

Finishing Off

When the plates have been covered with the jelly fit the square pieces of Tufnol into the tops of the cells. Small pieces will have to be cut from the appropriate corners of the squares to clear the lugs on the plates and a small hole about $\frac{1}{2}$ in. diameter should be drilled through each piece. Tap each piece into place so that it is just below the rim of the tube and run a little shellac varnish around each edge and around the edges of each lug. If the fit round the lugs is not too good fill in the gaps with scraps of paper folded and dipped in shellac. Allow the shellac to set.

Connect the cells together in series by soldering a bare wire between the lugs as shown in the assembly diagram. If the accumulator is to replace a dry battery which has a socket on it, the socket can be removed from an exhausted dry battery and Selo-taped on to the side of the accumulator. The necessary connections are then made between the end lugs on the accumulator and the pins on the socket. Observe polarity. When this wiring is complete cover all the lugs and wires around the top of the accumulator with two good coatings of shellac varnish.

Made as described this accumulator will easily give a current of 0.5 amps, although this rate of discharge is not to be recommended. Batteries can, of course, be constructed using a different number of cells. For practical purposes each cell may be assumed to have a voltage of 2.0.

Suggestion for Simple Charger

A simple charger for this small accumulator can be made in the form of a reading lamp with a full wave rectifier in the base. See diagram. The resistance of the lamp controls the current and the charging rate can be varied by using different wattage bulbs. Since the current required is so small the expense and bulk of a transformer is unwarranted. For the accumulator described a 40W lamp is about right. The battery may be left on charge overnight. A mains voltage rectifier must be used capable of passing 0.25 amps minimum. If the battery is fitted with a socket fit a matching plug to the charger. It is important that this should have a thick and thin pin or similar device to prevent accidental reverse charging. To determine the polarity of the leads dip a wire from each into a glass of salt water. A stream of bubbles will rise from the negative lead. When not in use as a charger insert the plug in the shorted socket. The lamp can then be used as a bedside lamp etc.



PIPELINES ACROSS BRITAIN

BY ARTHUR NETTLEFOLD

The transportation of oil by road or rail may soon be outmoded in Britain, and a start has already been made to provide a network of long-distance pipelines which will provide an easier and cheaper way of distributing the precious liquid from the refineries near our ports.

MILES of hidden pipelines snaking across Britain will soon be carrying oil products from the mammoth refinery at Fawley, near Southampton, to distant distribution centres and processing plants.

The longest of these pipelines, 76 miles long, will link Fawley with Severnside, near Bristol, and will be used for supplying feedstock to the gigantic chemical plant there. Six inches in diameter, it is being routed across the New Forest before bypassing Salisbury and Stonehenge on its way to Salisbury Plain. After crossing that wild region and skirting Bath, it will reach its destination by following a line a few miles north of Bristol.

The other pipeline, twelve inches in diameter, will connect Fawley with a new distribution depot near Staines, twelve miles west of London, and will convey light liquid oil products—chiefly petrol, kerosene and gas oil—for delivery by road to the whole of West London.

A separate pipeline will take aviation fuel to London Airport. The total distance covered by this Fawley-London pipeline will be 63 miles instead of the 220 miles journey necessary at present.

So far, light liquid fuels have had to be shipped by tanker from Fawley to Purfleet on the Thames and borne upstream to the bulk plant at Fulham. This plant will be bypassed by the pipeline and in consequence a considerable reduction in the road tanker traffic in a congested part of the Metropolis will be effected.

Reducing such congestion, in fact, is one of the purposes in providing Britain with long-distance oil pipelines. Such means of transporting oil are not exactly new to the United Kingdom, for airfields were supplied with aviation fuel in that way during the war, and about 1,200 miles of pipelines capable of carrying oil products already exist in this country.

But because every centre of population in this island is within one-hundred miles of a port, and because the volume of oil handled has been comparatively small, oil pipelines have not been as necessary or as economic as in some other parts of the world.

Today, with substantial increases in consumption and new ways of using oil products continually being perfected, pipelines can provide a more useful and more economic method of getting oil from one place to another. Intermediate handling operations are eliminated and there is less need for large fleets of road tankers which increase road congestion.

It is somewhat paradoxical that the growth of road traffic in Britain, which has pushed up the demand for oil, has made it economic to switch the transportation of liquid petrol products from the roads, but this is the situation that has arisen.

Planning the new oil arteries has been a complicated job, as complex as arranging for a new motorway. From the outset the aim has been to interfere as little as possible with other activities, such as farming, and to avoid spoiling the countryside.

The lines are being laid at least 3ft underground, so that when the ground is restored they will be out of everybody's way and sight. Topsoil and subsoil are kept separate, so that when they are replaced the ground is almost indistinguishable from the surrounding land.

The legal formalities relating to the scheme have been complex, the co-operation of more than 1,000 owners and occupiers of land having to be obtained. Each had to be assured that no permanent damage would occur and that due compensation would be given for temporary loss or damage.

Although a Private Parliamentary Bill was passed, empowering the compulsory purchase of land for the laying of the pipes, in more than 99% of cases the owners and occupiers along the routes have agreed voluntarily to the project.

The pipes for both the Fawley-Severnside and Fawley-London schemes, though of different diameters, are all seamless and manufactured in lengths of 30-40ft for welding on the site. Each section is pressure-tested before being buried in the ground, and special measures are being taken to protect the metal tubes from corrosion.

They are expected to serve for at least 25 years before requiring renewal. Long life is essential because it costs about £6,000 to lay one mile of 6in. pipe and twice that sum to lay a 12in. one.

Much of the route is being excavated by modern mechanical equipment, but in some areas the old fashioned pick and shovel are having to be used. The two long-distance pipelines cross more than 220 roads and minor tracks, 19 railways and 70 waterways of various widths, including Southampton Water and the Thames.



A trenching machine at work near Box in Wiltshire. Normally the line is laid at a depth of 3½ to 4ft, although this may vary slightly with differing soil conditions.

Lowering a section of the line into the trench. Afterwards there will be nothing to show where the line lies except for a few valves and electrical connections for the cathodic protection system—all sited so as to be completely unobtrusive.





Great care is taken to separate top soil and to reinstate the disturbed ground as nearly as possible to its original condition after trenching and laying the pipeline. Here a dragline crane replaces sub-soil on a farm. The top soil separated during trenching is on the left-hand side of the cut ready for final covering.

Photo below shows:—only the new replacement fencing and the gaps in the hedges give any indication of where the pipeline lies.



Where they cross the Thames they are being placed in a metal sleeve as a safeguard against oil leaking into the river. The section across Southampton Water will be approximately 2,270yds in length and will lie 11ft below the sea bed, in a trench excavated by dredgers.

Perhaps the most interesting point about these pipelines is that their use need not be restricted to one kind of oil product. As many as eleven different products can be conveyed in sequence, provided they are not allowed to travel at a lower speed than about 4 m.p.h. If this precaution is observed, they will not become mixed, and each successive product can be diverted to its own storage-place at the receiving end.

A shorter oil pipeline linking the Shell-Mex and B.P. refinery at Walton-on-Thames to London Airport has already been functioning for several months. Nine miles long, it passes under Kempton Park racecourse and was laid along that section of the route without injuring the turf. Nor did the job interfere with horse racing, for it was carried out between race meetings.

The much more ambitious schemes, to transport large quantities of oil between more widely separated points in Britain, may herald the day when a complicated network of oil pipelines exists for that purpose. This is the logical outcome of present-day trends, which make oil an increasingly vital necessity to both transport and industry.

PRACTICAL MECHANICS BINDING OFFER



These self-binders, in which copies can be inserted as received, cost 10s. 6d. post free, from: Publisher (Binding Dept.), Geo. Newnes Ltd., Tower House, Southampton Street, Strand, W.C.2. The binders are in black waterproof and greaseproof cloth, attractively lettered in gold. When the volume is complete our annual index can be inserted.

The index for Volume 28 Oct. 1960 to Sept. 1961, is now available, price 1s. 3d. post free.

OBLIQUE DRILLING GUIDE

BY MAJOR D. MACCOLL



with the spokeshave, working from the sides to the top, the grain of the wood running vertically. Rounding-off is not essential, but the rough shape is, otherwise the pillars may interfere with the drill if a deep drill is required. Accurate rounding-off of course improves the appearance of the finished article. When the pillars are shaped and true, drill the axle-hole to fit the axle. This should be stout—I suggest a Meccano axle. Both pillars should be worked together, to ensure they make an accurate pair.

Now turn to the Arm (Figs. 1, 2 and 4). Again, make the side-pieces ($\frac{1}{2}$ in. wood) as a pair, to the dimensions shown in Fig. 1. This time the rounding of the ends is essential, any irregularity will cause fouling when the device is assembled.

After rounding the ends, plane the bevel. This should be at an angle to suit your power-drill. Do not drill the axle-holes yet. Make the Distance Piece (D.P.) and ensure that the ends are parallel planes. This and the battens are all of $\frac{1}{2}$ in. square-section wood. Do not drill the holes for the strut axle, but prepare the strut, also of $\frac{1}{2}$ in. wood, $\frac{1}{8}$ in. across by $7\frac{1}{2}$ in. long. Plane off the wedge so that the angle of the wedge is less than 60° . To ensure this, make a cardboard template and use this to test.

The life of the wedge will be considerably increased if you make a "shoe" to fit it of, say, a piece of unrolled sypur- or cocoa-tin. With a pair of shears cut a piece $\frac{1}{8}$ in. x 2in., fold it in half and hammer the fold flat. Open it up enough to force the wedge in, punch holes for, say, 4 x $\frac{1}{8}$ in. cobblers' nails on each side. Now fit it over the wedge and nail it firmly. Lastly, drill the axle-hole. This must be accurately done, and I suggest you get an extra pair of eyes to help—one pair looking at the work North to South, and the other East to West, so to speak. (It is a pity you have not yet got the guide to do this job for you!)

Finally, cut the four battens from the $\frac{1}{2}$ in. square-section wood.

You have now 12 screw-holes to drill—two each for each pillar and batten. The screws for the

"XIX!XIX Squint again." You can avoid this again by making and using this simple guide.

As this is a gadget to promote accuracy, you should use the hardest wood which you can handle comfortably. If it is too hard you are liable to make mistakes in your work, so forfeiting accuracy, and if it is too soft it will not stand up to much use. I favour oak, but box would be best.

First prepare the base, 10in. x 3in. x $\frac{1}{2}$ in., taking particular care to see that the top and bottom are parallel planes. Mark the underside with the positions of the pillars and the holding screws (Fig. 3). Do not yet make any positioning marks for the battens. Make sure that when the pillars come to be fixed their long sides are perpendicular to the front end.

Next make the two pillars of $\frac{3}{4}$ in. wood, dimensions as in Fig. 1. The radius for the semi-circular tops is $\frac{1}{2}$ in., and these should be marked and cut before the axle holes are drilled. Saw the pair roughly to the semi-circle, and then finish

pillars should be slim $\frac{3}{4}$ in., and for the battens slim $\frac{1}{4}$ in. Drill the holes to suit the screws you are going to use, and counter-sink the heads (Fig. 2). The pillar-screws go from the bottom of the base up into the pillars, while the batten-screws go through the battens into the top of the base.

Assembling the Guide

Having got all the pieces ready, proceed to assemble. Start with a "mock-up" on the base of pillars and the side-pieces of the arm. Hold, or better, clamp, the two latter pieces together, and place them between the pillars, holding all four pieces together as if they were in the "90° position", i.e. upright.

Now lift the arm-pieces slightly in relation to the pillars, say $\frac{1}{8}$ in., and use a nail to mark the positions for the axle-hole through the holes you have already drilled in the pillars. Keep the arm-pieces clamped and in one of the marks lightly hammer a gramophone needle or similar headless spike, to use as a guide for drilling. Drill these axle-holes (using two pairs of eyes as before) and drill the axle-hole for the strut-axle.

Separate the arm-pieces and mark the position for the distance piece. Insert the axles and, using the strut to keep the arms parallel, glue the distance piece into position; cramp the arm and leave to set. (It may be necessary to use pieces of card to ensure that the arm pieces are parallel—the strut

may be less wide than the distance piece, but must not be wider.)

When the arm assembly has set, uncramp and slide the pillars over the axle. Place the assembly on the front end of the base and mark the positions of the pillars. While the arm must be able to rotate, there should be no play between it and the pillars. Glue the pillars to the base. If you have two cramps, do this as one operation, with the arm still in place; if you have only one cramp, glue on one pillar first, when it is set, glue on the other pillar with the arm in position. When both pillars are set, screw in the holding screws.

While all this glue is setting you can make the templates for positioning the battens. Do not rely on measurements taken from the diagrams. I selected angles of 90°, 75°, 60° and 45°, but you can easily set up the guide for any angles you choose. Make three set-squares of plywood on a base not longer than 4 in., and one base angle accurately cut to one of the angles you have selected for the guide. You do not need a template for the 90° angle—if you have a carpenter's square! You are now ready to set up the angles.

Swing the strut in position on its axle, have your four battens ready, and enlist, this time, a second pair of hands.

Set the arm vertical and let the strut wedge lie on the base. Press the wedge towards the arm, and (Concluded on page 526)

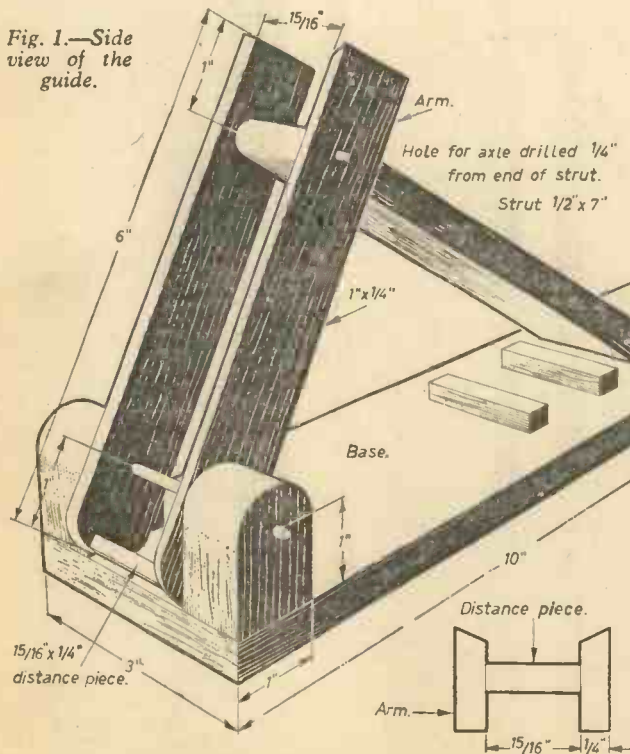

Fig. 1.—Side view of the guide.

Fig. 2.—Assembly details.

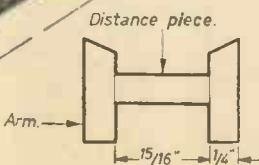
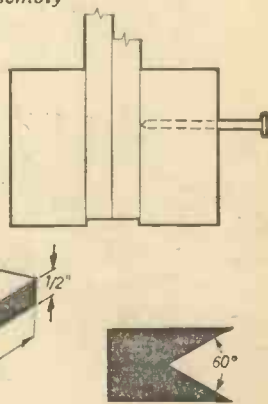

Fig. 4.—Arms with distance piece fixed in.

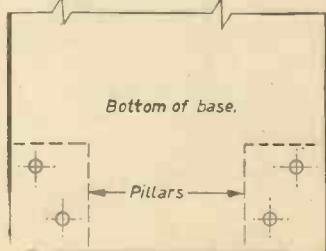
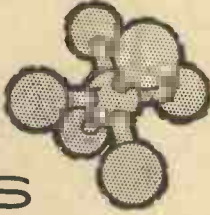

Fig. 3.—Bottom of the base marked for positions of the pillars and holding screws.

SCIENCE NOTES



A Thimbleful of Transistors

SIZE counts for nothing—when it comes to transistors. Twelve of the latest ultra-fast switching transistors that are now being made could be tucked into a thimble. These transistors have been designed for use in the newest and fastest transistorised computers now entering the design stage. The transistors will utilise an epitaxial layer and the mesa structure in conjunction with a gaseous diffusion process.

They are an extremely fast-switching device with a maximum total switching time of 80 nanoseconds in conservative circuitry. They also have a maximum collector cut-off current rating of 18 microamperes at an ambient temperature of +70 degrees C. and a minimum beta of 20 at an ambient temperature of -55 degrees C. It is believed to be the first standard germanium mesa transistor to have these parameters specified at extreme temperatures.

The transistor has a typical gain bandwidth product of 1,000 megacycles, has other important characteristics, including its narrow beta range of

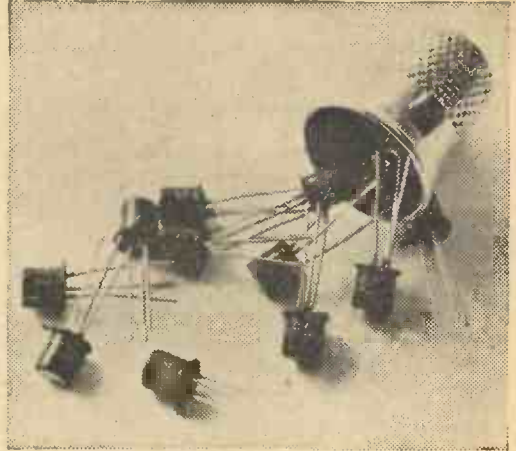

Thimbleful of Transistors.

three to one, its total power dissipation rating of 2,000 milliwatts in free air and its low maximum saturation voltage of 0.18 volts at a collector current of 10 milliamperes.

The new transistor is faster than standard mesa transistors and makes possible the design of smaller equipment with fewer components because of the fan-in and fan-out capability. In almost all circuit designs they can be substituted directly for plain mesa transistors, without other circuit modifications, for improved speed and lower VCE (SAT).

Number Three X-15

A NEW adaptive flight control system has been designed for the National Aeronautic and Space Administration's number three X-15. The first two numbers of the X-15 aircraft have already been described in PRACTICAL MECHANICS.

For its maiden research mission the flight is primarily designed to check out the aircraft and its systems, including the new flight control system. This system, which will be employed only on number three X-15, replaces the stability-augmentation system used in the other two X-15 aircraft, which have all made 45 flights to date.

The adaptive flight control system essentially performs the same function as the older system—aiding the pilot by sensing motions and feeding correction into the hydraulic control system. However, whereas the stability-augmentation system required the pilot to establish "gains" in the pitch, roll and yaw axes, the new system performs this task automatically. The adaptive flight control system also integrates the aircraft's hydraulic and reaction controls, the latter designed to control the X-15 in upper atmosphere areas where conventional controls do not respond.



Number Three X-15.

The number three X-15 is basically the same aircraft as its stablemates, designated numbers "One" and "Two". It is expected the number three aircraft will be used primarily to evaluate new systems and for the majority of high-altitude flights scheduled in the future. The 250,000ft design altitude flight already scheduled, however, will be made by one of the two other aircraft.

The number three X-15's rocket engine is capable of 57,000lb thrust.

Photo Right shows Dr. Carl Snyder, Goodyear scientist, steadying an experimental solar condenser as it slowly inflates. The melon-shaped plastic balloon, its lower half coated with a film of aluminium, is designed to be inflated in space, where the two halves will separate, leaving the aluminised section to collect solar energy to run delicate satellite machinery.



Rubber and Plastics in Space

RUBBER and plastics sent into space as films, foams and coatings for solar collectors and other expandable space structures may actually become stronger than on earth when exposed to environmental extremes that can weaken or destroy metal.

This was reported by Dr. Carl E. Snyder at a U.S. Air Force conference recently when he was evaluating the reaction of polymers (rubber and plastic) to the extreme vacuum and ultra-violet radiation.

He stated that laboratory tests and calculations prove that polymers have lower volatility than metals and therefore will not boil away as easily as metals under the influence of the near-complete vacuum of space.

Those molecules which do boil away from polymers, due to vacuum, are the molecular system's "weak sisters" whose loss frequently leaves behind an enhanced polymer.

The tendency of many polymers to deteriorate under the influence of ultra-violet radiation can, paradoxically, prove to be beneficial. Gases such as oxygen tend to fuse the ends of molecular chains broken by ultra-violet bombardment, thus making the break permanent. But oxygen exists only in small quantities in space, so even if the molecular chains break they can recombine to form a strong, and sometimes even stronger, polymer structure.

It was reported that butyl rubber presently appears to be an outstanding candidate for space use. Second in desirable properties is neoprene rubber. In plastics, laboratory tests approximating actual space conditions show polyethylene terephthalate and polypropylene as outstanding candidates, the scientists reported.

THE P.M. BLUEPRINT SERVICE

12 FT. ALL WOOD CANOE. New Series. No. 1, 4s.*
COMPRESSED-AIR MODEL AERO ENGINE. New

Series. No. 3, 5s. 6d.*

AIR RESERVOIR FOR COMPRESSED-AIR AERO
ENGINE. New Series. No. 3a, 1s. 6d.*

"SPORTS" PEDAL CAR. New Series. No. 4, 5s. 6d.*

F. J. CAMM'S FLASH STEAM-PLANT. New Series.

No. 5, 5s. 6d.*

SYNCHRONOUS ELECTRIC CLOCK. New Series.

No. 6, 5s. 6d.*

ELECTRIC DOOR-CHIME. No. 7, 4s.*

ASTRONOMICAL TELESCOPE. New Series. Refractor.

Object glass 3in. diam. Magnification x 80. No. 8 (2 sheets),

7s. 6d.*

CANVAS CANOE. New Series. No. 9, 4s.*

DIASCOPE. New Series. No. 10, 4s.*

EPISCOPE. New Series. No. 11, 4s.*

PANTOGRAPH. New Series. No. 12, 2s.*

COMPRESSED-AIR PAINT SPRAYING PLANT. New

Series. No. 13, 8s.*

MASTER BATTERY CLOCK.* Blueprints (2 sheets), 4s.

Art board dial for above clock, 1s. 6d.

OUTBOARD SPEEDBOAT. 11s. per set of three sheets.

P.M. TRAILER CARAVAN.* Complete set, 11s.

P.M. BATTERY SLAVE CLOCK, 2s. 6d.

P.M. CABIN HIGHWING MONOPLANE, 1s. 6d.

THE MECHANIKART, 15s.*

The above blueprints are obtainable, post free from
Messrs. George Newnes, Ltd., Tower House, Southampton Street, Strand, W.C.2.

*denotes constructional details are available free with the blueprints.

Using the Sub-miniature Camera

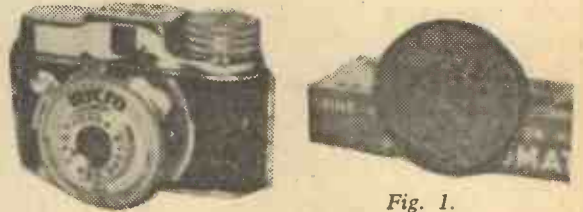

Fig. 1.

by A. E. BENSUSAN

THE sub-miniature camera can safely be described as the photographic instrument of the future. As films become better in their resultant negative quality, and lenses are improved in their resolving power, processes which are continuously proceeding, the need for large cameras producing extensively sized negatives is correspondingly reduced. For many years the term "miniature" in relation to negatives and cameras meant standard 36 x 24mm. formats on 35mm. wide perforated motion picture film. Now negatives of just as good a quality are made to half that area on the latest miniature instruments.

The next step is the sub-miniature and here the prefix refers to the gauge of the film rather than the quality obtainable. All sub-miniature cameras presently available are manufactured in various

countries abroad, and they take films from 9.5 to 16mm. wide, either in tiny rolls with spools and backing paper or in special chargers.

The writer has recently been experimenting with the cheapest sub-miniature camera on the market. The small overall size can be seen from Fig. 1, which shows the pigskin ever-ready case alongside the camera (costing well under £4 in all) and a penny balanced against a carton of six films. Although the films are not marked with a definite speed rating, 50 A.S.A. has been found to be perfect with development in Unitol for the same period as a Group 4 film.

This camera has a f4.5, 20mm. lens which can be stopped down to f11 and a shutter marked for "bulb", 1-25th, 1-50th and 1-100th of a second. The short length of the lens renders focusing unnecessary as the depth of field is so great. A cable release socket is provided, film winding is by



Fig. 2.—Enlarged photo taken with sub-miniature.

Fig. 3.—The camera concealed in a bag.



knob while viewing the normally number-printed backing paper through a slide-closing window at the rear. The shutter needs to be set for each exposure by depressing a small lever. Naturally, details vary from one make to another, with the more expensive models having greater facilities.

The smaller the lens aperture used the better the definition on the 1/4 in. square negative, but even at f5.6 the quality is adequate for enprint size results, as can be seen from Fig. 2, which is an enlargement from part of a sub-miniature negative. At f11 overall definition is very good indeed. The higher shutter speeds are preferable as any traces of camera shake show up more clearly on small negatives.

These sub-miniatures can be carried in the pocket at all times, so avoiding the possibility of missing interesting pictorial or valuable news pictures through not having a camera present continuously. Their other use is for candid pictures which can be taken unobserved on the beach, in streets and well-lit indoor public places, trains, buses and with especial reference to children who tend to be rather camera-shy. In the latter connection some form of concealment aids the camera in remaining unobserved.

The simplest disguise is to enclose the camera in a small paper or opaque plastic bag so that the lens protrudes through a hole in one side as shown in Fig. 3. A piece of thin card glued locally inside the bag prevents the hole from being enlarged. A further hole at the other side enables the film winding window to be observed.

All taking controls can very easily be handled through the material of the bag—i.e., setting the shutter, firing it and rotating the winding knob—without removal, while stop and speed can be pre-set. Carrying the bag so that the hole away from the user's body is covered by the hand until the moment of use excites no interest in other people. The viewfinder cannot be used, but that matters little as the lens covers a fairly wide angle and the entire camera is easily aimed as a unit.

An alternative is to strap the camera to the wrist, in a similar manner to a watch, so that it is nor-

Fig. 5.—Assembly of leg or arm band.

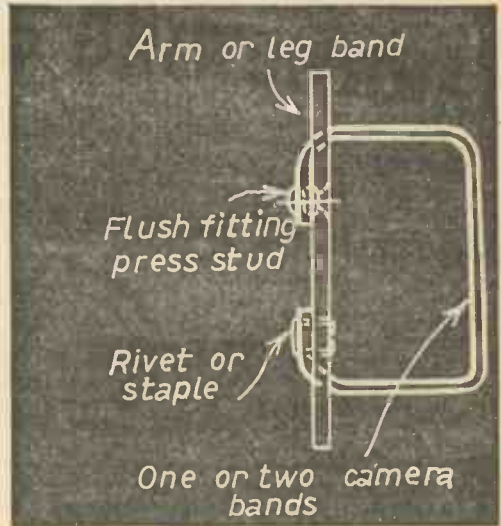

mally covered by the sleeve except when the latter is specifically drawn back (Fig. 4). A fairly wide band of leather is cut so that it passes comfortably around the arm and fastens with a buckle inside the wrist. Two smaller leather bands, passing across the larger one and through slots cut in it, secure the camera.

One of these transverse bands can be rigidly fixed in place at both ends with staples or rivets so that the camera can be tucked in, but the other must be fixed at only one end. The free end should have a small, flush-fitting press-stud inserted, as shown in Fig. 5, so that the camera can be released when required.

(Concluded on page 526)

Fig. 6.—Leg mounting.

Fig. 4.—Wrist strap mounting.



LAWNMOWING made EASY

details of how to electrify a hand lawnmower

BY K. BERRY



WHILST lawns greatly improve the appearance of a house they do unfortunately require a considerable amount of attention, not the least of which is the never-ending (or so it seems!) need to mow the lawn. Gardening experts tell us that if a close-knit, "bowling green" appearance is to be obtained, then the lawn must be cut frequently and not allowed to grow to ankle depth and then be given a "short back and sides". This is all very fine but unless one is very enthusiastic there is little enjoyment to be obtained from perspiring up and down a lawn pushing a lawnmower. So all too often mowing the lawn is a task which is left until it becomes a necessity—and by this time it has become quite hard (and hot!) work. The author endured many years of grinding away behind a lawnmower but eventually decided that he had had enough and some easier method of cutting the grass was sought. It was decided to use the existing lawnmower and add to it a suitable electric motor. This would involve the minimum of work and cost and should result in a reasonably quiet, cheap to run, and easy to maintain motor mower. The lawnmower is a "Qualcast Panther" roller lawnmower and the information in this article is directly applicable only to this make and model. However, the principles involved apply to any roller lawnmower and little difficulty should be experienced in motorising other models and makes.

Choice of Electric Motor

The first consideration is what power electric motor would be necessary to do the job? It was decided that on the grounds of safety and simplicity the motor would be used solely to do the job of cutting the grass—i.e., forward motion of the lawnmower would be obtained by pushing it. This results in the need for a smaller powered motor than if it were used to both revolve the cutter and propel the machine; it also enables the cutter to be run at a sensible speed whilst manoeuvring the lawnmower in difficult corners. In any case the effort required just to wheel the lawnmower across the lawn without cutting the grass is quite small.

In order to arrive at a figure for the power of motor required the following calculation was made:

$$P = \frac{V \times F \times 1}{550 \times E}$$

where

P = Power required in horsepower.

V = Estimated speed at which mower would normally be used (feet per second).

F = Estimated force required to push mower at speed V (pounds).

E = Overall efficiency of motor and mower (per cent)

the following values were used:

$$V = 2 \text{ m.p.h.} = 2 \times \frac{88 \text{ ft./sec.}}{60}$$

$$F = 30 \text{ lb.}$$

$$E = 66\frac{2}{3}\%$$

therefore:

$$P = \frac{2 \times 88 \times 30}{60} \times \frac{100}{66\frac{2}{3}}$$

$$= \frac{2 \times 88 \times 30 \times 3}{60 \times 550 \times 2}$$

Power required = 0.24 h.p.—i.e., $\frac{1}{4}$ h.p. motor is required.

Now, whilst a $\frac{1}{4}$ h.p. motor is indicated by this calculation and the author has, in fact, used a $\frac{1}{4}$ h.p. motor himself, it is felt that one of the large-framed $\frac{1}{2}$ h.p. electric motors as used in some compressor refrigerators would probably suffice, though if a $\frac{1}{4}$ h.p. motor can be obtained it should obviously be used.

Whilst a suitable motor should be readily obtainable from a scrapyards for about £1, if one does not wish to go to the bother of going and getting a "scrap" motor, brand new manufacturers' surplus motors can be purchased from dealers specialising in such lines for between £3 and £5.

Choice of Drive

With a suitable motor obtained, the method of transmitting the drive to the cutter had to be decided. Although the cutter was originally driven from the roller by means of a roller chain it was felt that a belt drive using a rubber Vee-belt would be more suitable and easier to effect. The next problem was that of determining a suitable speed of rotation for the cutter. A calculation based on the diameter of the roller, the number of teeth on the existing sprockets, and an estimated maximum speed of propulsion suggested that the maximum speed of rotation of the cutter with manual use was about 450 r.p.m. It was decided to allow the cutter to rotate at a somewhat higher speed than this when electrically driven and a speed of 700 r.p.m. was chosen. Now since the speed of the normal four-pole induction motor running from a 50 c/s supply is 1,500 r.p.m. less the slip = 1,425

r.p.m. a reduction of 2 : 1 is required. This was achieved by using a 3in. diameter pulley on the cutter and a 1½in. diameter on the motor. The pulleys used were "Picador" pulleys with a ½in. bore. These pulleys are clamped to the shaft by means of an "Allan" grub screw. The pulleys and belt will cost about 9s. from toolshops and/or ironmongers.

A big advantage of using a belt drive instead of the original chain drive is that if the cutter becomes jammed the belt will just slip and no permanent damage will result. A rubber belt drive is also much quieter than a roller chain drive.

Fitting the Motor

The motor was of the standard type provided with four cast fixing feet and, unless this type of motor is obtained, difficulty may be experienced in mounting it.

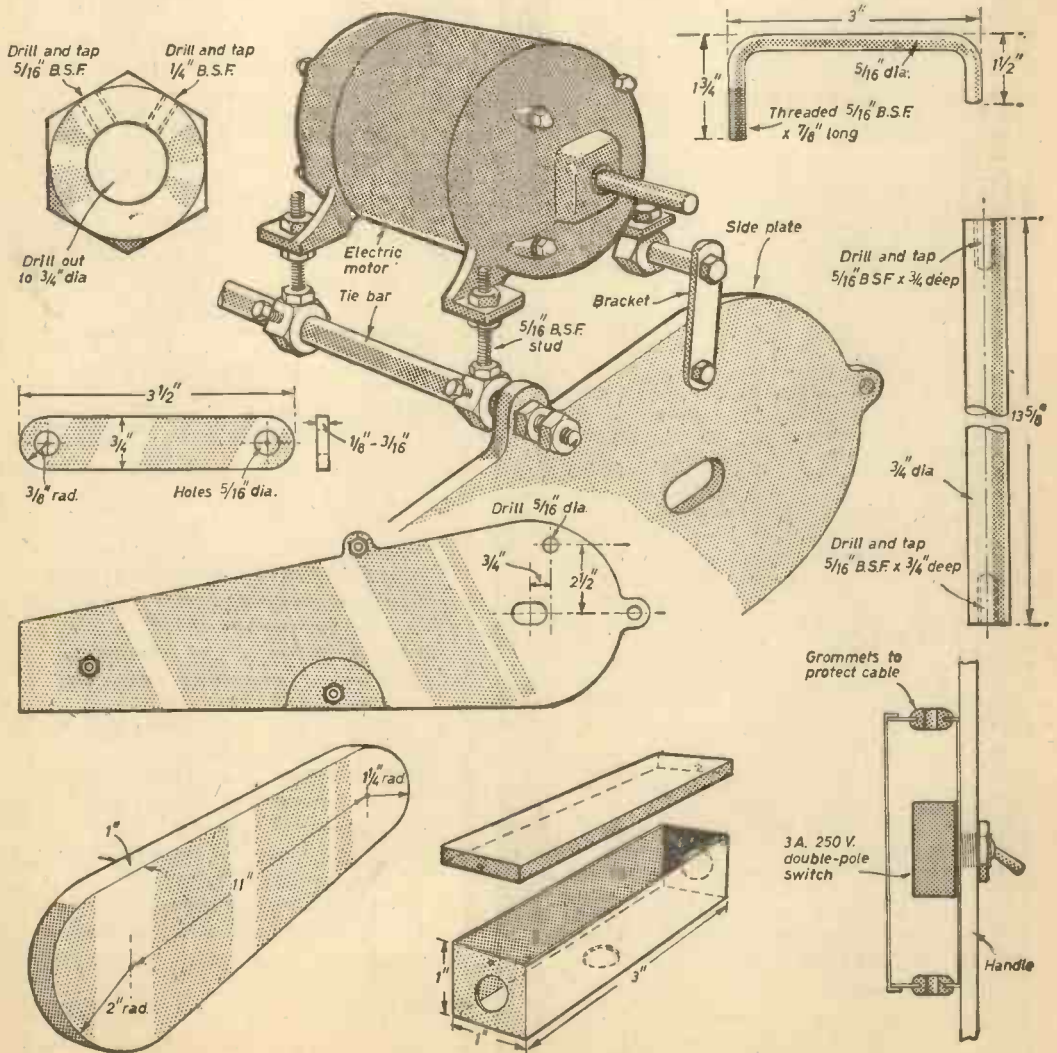

The motor is mounted on four $\frac{1}{8}$ in. B.S.F. studs some 3 in. in length. These studs (which were obtained by cutting off the heads of 3 in. hexagon-headed screws) allow the position of the motor to be varied in order to adjust the belt tension. The studs screw into holes drilled and tapped into one of the hexagon faces of $\frac{1}{2}$ in. nuts. Two of these nuts (all four of which have had their original $\frac{1}{8}$ in. thread removed by drilling or filing out to $\frac{1}{4}$ in. diameter) are mounted on the original tie bar which holds the mower cast side plates together at the top. The other two mount on a new $\frac{1}{2}$ in. mounting bar of suitable length which is fixed to the mower side plates by two brackets. These brackets are also bolted to the mower side plates. The $\frac{1}{2}$ in. nuts are prevented from sliding along the bars upon which they are mounted by means of $\frac{1}{4}$ in. B.S.F. clamping bolts which have been inserted in holes drilled and tapped into another of the hexagon faces. The belt and pulleys are covered by a guard to prevent accidents. Details of the items required are shown in the drawing. The mower side plates are drilled $\frac{1}{8}$ in. diameter to take the mounting bar fixing brackets, also shown in the drawing.

Constructional Details

With all the items collected together assembly can commence. One of the mower side plates must be removed so that the two $\frac{1}{2}$ in. nuts can be fitted to the side plate tie bar. Drilling of the side plates is facilitated if these are removed from the machine. This involves dismantling the machine and it is recommended that this is done at the start. The bearings may then be thoroughly cleaned and repacked with grease (Castrolase Medium or similar should be suitable) before the machine is reassembled. Having fitted the first two $\frac{1}{2}$ in. nuts, the mounting bar fixing brackets should next be bolted to the mower side plates. This done, the remaining pair of $\frac{1}{2}$ in. nuts should be slipped on to the new mounting bar and the bar bolted into position. The $\frac{1}{8}$ in. B.S.F. studs should now be screwed into the sockets prepared in the $\frac{1}{2}$ in. nuts and locked with a $\frac{1}{8}$ in. B.S.F. nut. A nut and washer should now be run about $1\frac{1}{2}$ in. down each stud. The motor is then placed in position and a further washer placed on each stud so that it rests on top of each of the motor fixing feet. A nut is run down each stud until finger tight. The pulleys should be fitted to the motor and cutter spindles and the whole motor assembly slid along the mounting bars and the two pulleys lined up. The $\frac{1}{4}$ in. B.S.F. clamping bolts are screwed into each $\frac{1}{2}$ in. nut and tightened on to the mounting bars, thus locking the assembly. The belt is fitted next; position the motor on the studs for correct belt tension. The motor fixing nuts are then tightened. The belt guard is next positioned. No details of the fixing brackets for this item have been given, but three simple "L" brackets made from 16s.w.g. tinplate, brass, etc., should suffice. The brackets can be soft-soldered or rivetted to the flange of the guard and the assembly secured to the side plate by means of No. 2 B.A. screws screwing into tapped holes in the side plate.

Electrical Details

When the lawnmower is not in use the mains lead is wound round four lugs bolted to the handles,

details of these lugs are also shown.

The motor is controlled by means of a double-pole toggle switch rated at three amperes at 250 volts. This is the type of switch used for radio and electronic equipment and is mounted in a small metal box on the right-hand handle side member. The box is secured to the handle by the switch itself, the bush of which passes through the box and the handle side member.

The mains lead itself is a stout three-core rubber insulated and covered cable. The two supply leads are switched by the toggle switch, whilst the earth lead is connected directly to the motor frame. The author runs his mower from a three-pin five-amp socket and this has proved satisfactory. On two occasions when the cutter has become jammed, due to long, wet grass, the belt has slipped for 10-15 seconds, whereupon the five-amp fuse in the house has ruptured. It must be emphasised, however, of the vital necessity of having the motor (and mower) properly earthed.

ON NO ACCOUNT SHOULD THE MOWER BE RUN FROM A TWO-PIN SOCKET WITHOUT AN EARTH CONNECTION.

Furthermore, the earth connection to the motor and inside the mains plug should be inspected and preferably tested every two or three months.

The mains lead from the motor to the switch and before it enters the switch box is held in position in several places by means of the rubber grips sold for securing cables to bicycle frames, though insulation or binding tape (varnished afterwards) would be just as suitable.

Practical Householder

SEPTEMBER ISSUE NOW ON SALE

PRICE 1/3

CONTENTS INCLUDE:

ALL-ELECTRIC WARM AIR CENTRAL HEATING
WOODWORKING TOOLS
BED-SITTER FOR A TEENAGE BOY
MODERNISE YOUR KITCHEN SINK
FURNITURE MAKING WITH A JIG
WHAT'S BEHIND THE CURTAIN
LOW COST ELECTRIC WATER HEATING
BED-HEAD RECESS WITH TWIN WARDROBES
QUICK MOVE KITCHEN UNIT
SLIP DOWN LOFT LADDER
PUTTING UP A BOLD FRONT
LIGHT ALLOY NAILS IN THE HOME
LEGAL NOTES
PAINTING THE GREEN-HOUSE
NEW LOOK FOR STAIR-CASE
COMBINE TOWEL AND DRIP-DRY RACK
PLUS USUAL REGULAR FEATURES.

THE bunsen burner is probably one of the most useful items in a laboratory and workshop because it can supply an intense heat for the speedy heating of liquids or the melting of soft metals and for preparing a soldering iron, but most of these articles are base mounted and this means they are somewhat restricted to a vertical or near vertical position when being operated, and there are many occasions especially during assembly of a complicated article—electrical apparatus is a typical example where this can occur—that a more versatile piece of equipment is necessary which can be directed to the required position without having to resort to pieces of packing to hold it steady. The adaptation of the orthodox bunsen burner to one of the pistol grip variety is not a new idea, but because it has this useful feature and the cost of constructing such an item is so little, this design is offered as an article well worth its place in any workshop.

A piece of $\frac{1}{2}$ in. diameter tube "A"—brass or steel is suitable and the diameter can be varied slightly, but do not have it larger than the above mentioned size—is the basis of this design, and to this detail is fitted a brass jet "J" which is illustrated in the detail drawing. The outside diameter of this piece is tinned and then inserted into the tube—a fairly close slide fit is essential prior to tinning—and on smearing the tube bore with flux and heating the two parts over the gas flame, the solder will melt and cause the jet to adhere to the tube.

Having assembled the jet a length of rod is dropped down the tube to ascertain exactly the position of the end face, and this dimension will determine where the air hole will appear. A half round file is the best tool for making this hole and continue filing until it begins to merge into the jet; then leave it alone and wait for a convenient tryout period as this shows whether the hole is sufficiently large in relation to the amount of gas supplied.

The small air sleeve "B" is again a short length of brass tube which slides over the main tube, and the addition of two tiny pins—even domestic pins will suffice—soldered into the latter item, will prevent the sleeve from sliding away from the air hole and so causing difficulties when the burner is being used.

A metal handle will soon become hot if the burner is used for a protracted period, so a wood—hard for preference—or plastic is used for this item. A few suggested dimensions are given on this drawing and the method of securing it to the burner is indicated. Two vees are cut either by machining or filing and a pair of metal clamps "E" are made with matching vees and holes for the 2B.A. bolts which will give sufficient pressure to provide a tenacious hold. A gas cock of the type usually associated with bunsen burners, completes the assembly and the latter item is merely threaded into the jet end. A tight fit ensures the joint is gas tight, but a smear of plumber's jointing compound is often necessary with such parts in order to achieve this condition.

The finger grip is a minor yet important item and the position is best determined when the handle is assembled—in fact grip the burner tube "A" gently in a vice taking care not to distort it—hold the handle and offer the finger grip with the other hand until an easy grip is obtained. Mark the position with the aid of a scribe and solder this part in place. A piece of brass $\frac{1}{8}$ in. thick x $\frac{1}{4}$ in. wide will make an admirable grip and the bend is about $\frac{1}{2}$ in. radius.

A test will reveal whether the air hole is large enough and to ascertain this condition, the burner should show a very small amount of unburnt gas which is in the shape of a tiny blue cone in the roaring flame. A flame in the region of a foot long emerges from the tube and this large flame is often advantageous because it heats a considerable area prior to introducing the "roarer". Armoured or rubber pipe is used for connecting.

a pistol type bunsen burner

By JOHN WALLER

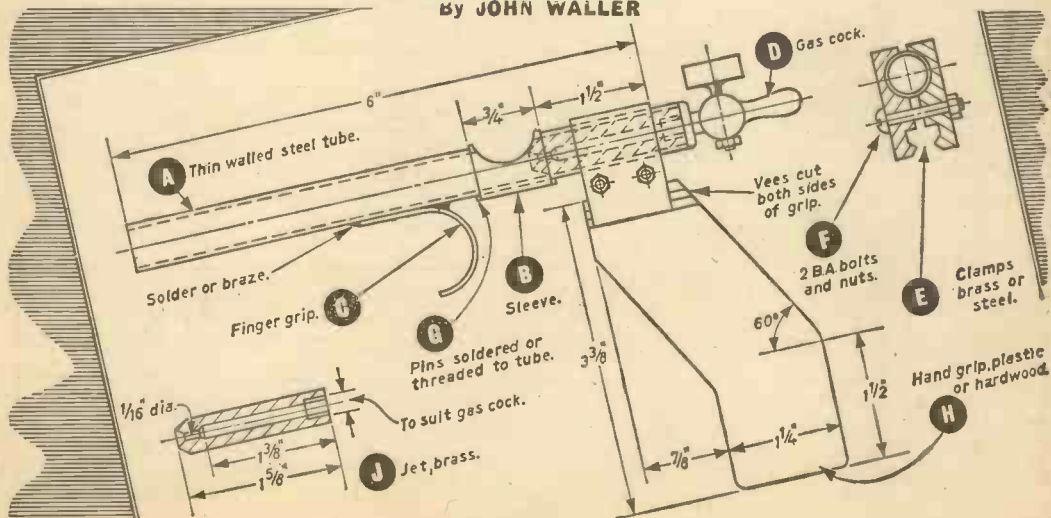

L.B.S.C.'s 3½ in. Gauge

EVENING STAR

PART 18
FIRST DETAILS
OF THE BOILER

THERE are a few more oddments needed to complete the chassis, such as cylinder cocks and so on, but if builders are anything like your humble servant they will be glad to give the fiddling jobs a rest, and get on with the boiler. For beginners' benefit I might explain that while a small locomotive boiler can be made to resemble that of the full-size article very closely, as far as external appearance goes, the inside of it has to conform to the laws of Nature, if the boiler is to be a successful steamer. I have been building locomotive boilers for over half a century, and have long since lost count of the number I have built—they are scattered all over the world—so you can take it for granted that the boiler shown in the drawings is the result of actual personal experience, and not what I call a "paper design". It is similar to that which I specified for *Britannia* and several other 4-6-2 locomotives, and although it looks rather complicated at first sight, there is nothing very difficult about the actual building, as many beginners have agreeably discovered.

It isn't the actual size of a boiler, nor the maximum number of square inches of heating surface, that ensures successful steaming. It is the way the heating surface is arranged, and most important of all, the amount of heat applied to that surface. The domestic kettle boils up quickly enough if it is placed on a gas ring, but not so quickly if you put a candle underneath it, though the size of the kettle and the heating surface of the bottom of it remain unchanged! The most valuable part of the heating surface of a locomotive boiler is the firebox, the plates of which get direct heat both by radiation and convection. Long tubes are not efficient, because there is a considerable difference between the temperature of the firebox gases in the tubes, at the ends nearest the firebox, and the smokebox ends. Now in a long-barrelled boiler such as *Evening Star's*, we can kill two birds with one shot, and obtain maximum efficiency, if we increase the heating surface of the firebox by adding a combustion chamber; and as this automatically shortens the tubes—well, as they say in the classics, Bob's your uncle!

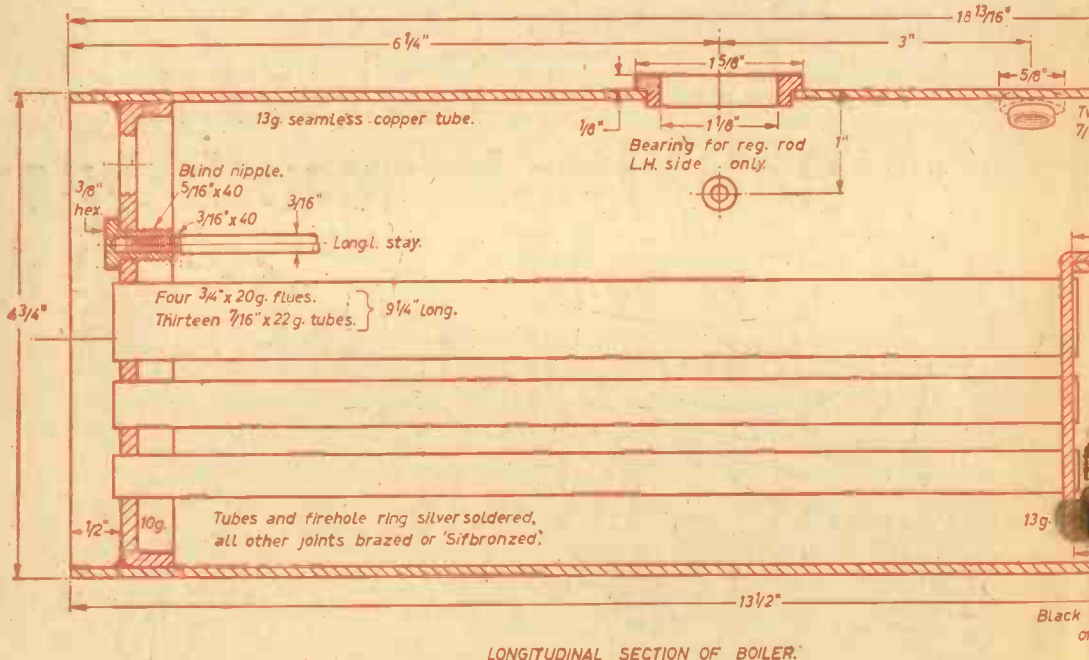

Fig. 118.

The idea is, of course, not new; there is nothing new under the sun. McConnell, Beattie, Cudworth and others used combustion-chambers in full-size boiler barrels way back in the Victorian era, but for different purposes. Old ideas can, however, be mighty useful if brought up to date. In my experimenting, I found that by making the combined length of firebox and combustion chamber approximately equal to the length of the tubes, and staying the combustion chamber by means of stout water-tube struts, best part of the heat from the fire was transferred to the water, the smokebox remaining comparatively cool. None of my own engines ever suffered from blistered paint on the smokebox, and that was good proof.

Tube diameter was another important factor. If too small, they become choked. If too large, they don't pick up the heat as they should but allow a kind of core of heated gas to pass through the middle and be blown to waste up the chimney. Superheater flues must of necessity be large, but as the elements carrying the steam are in the middle, the hot core is utilised to heat them. In the boiler shown, there will be one complete element in each flue. Some of my own locomotives have 1in. flues with two elements in each, and I prefer this, but had I specified them for *Evening Star*, there wouldn't have been sufficient space for the requisite number of smaller tubes. Hence the arrangement shown. I have also done quite a lot of experimenting, to find the simplest method of construction, yet at the same time able to stand all the stresses to which the boiler might be subjected.

The final results are embodied in the boiler shown. So much for that; now to the actual job of building the boiler, with some tips for beginners.

Tools for the Job

For a brazing pan, a rectangular iron tray not less than 2ft long, 1ft wide, about 2in. deep at front and 8in. or more at the back, will be required. My own is made from 16-gauge sheet steel. A hefty pair of blacksmiths' tongs will be needed for holding the boiler when hot, and a small pair for holding short lengths of brazing material. I made mine from 1/2in. x 5/8in. black mild steel strip, with handles a foot long. To break up flux bubbles, bend one end of an 18in. length of 1/2in. iron wire into a ring, and file the other end to a point. If an oxy-acetylene blowpipe isn't available, a 5-pint paraffin blowlamp will be required, or its equivalent in air-gas blowpipes; also a smaller one for the lighter jobs.

The brazing material can either be any good brand of easy-running strip spelter, or Sifbronze. The former works best with Boron compo as flux; the latter with the special flux sold for use with it. For tubes and bushes, use either best grade silver-solder in strip form, with powdered borax as flux, or "Easyflo" and the special flux sold with it.

A leaden or earthenware container big enough to hold the boiler will be needed for pickling or cleaning the boiler after each stage of the brazing operations. Special advice to beginners—never work on a dirty boiler. You'll not only get un-sound joints, but probably skin troubles as well,

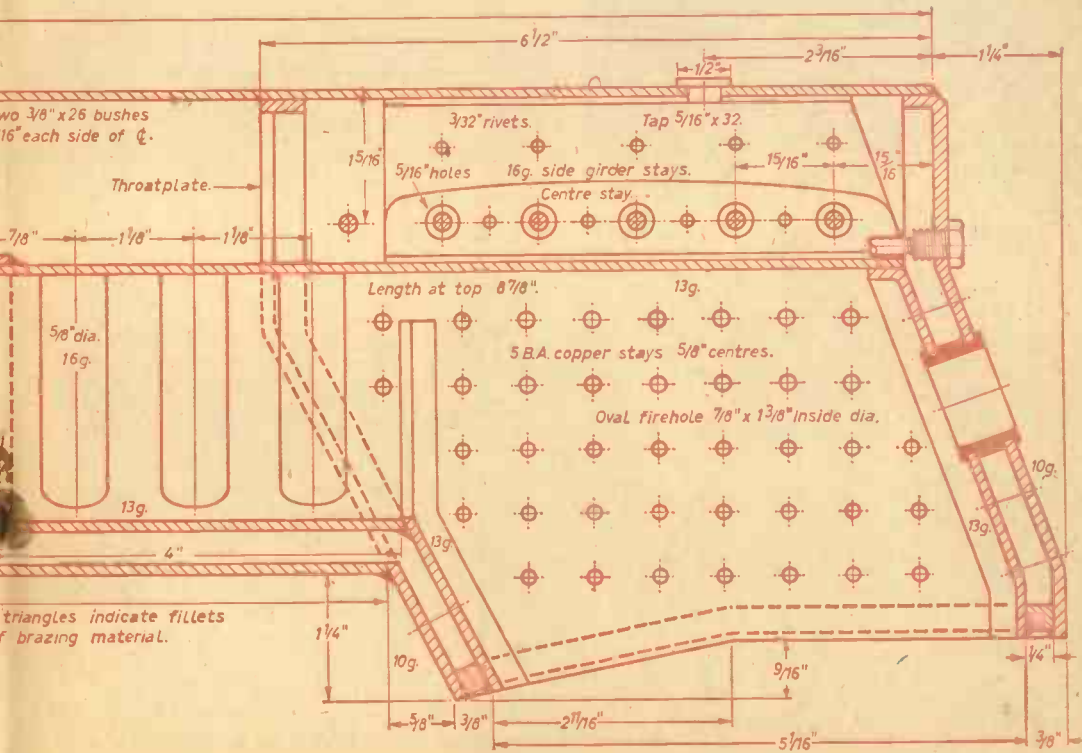

should any of the stuff on dirty copper find its way into stray cuts or scratches. I made my pickle bath, which is approximately 2ft x 1ft x 1ft, from a sheet of lead $\frac{1}{8}$ in. thick, bending it up like a painter makes a paper box for holding small quantities of paint. It is seamless, and therefore leak-proof. When new, I put it in a wooden box, to prevent it getting knocked about; but the wood has long since rotted away, leaving the lead "naked and unashamed". I keep a lid on it, to prevent rainwater getting in and diluting the solution too much, or causing overflow. The pickle is the same as I have mentioned for small jobs, viz. one part commercial sulphuric acid to about 16 of water, or one part stale accumulator acid to four of water.

Most important tip of all—if you can possibly do your brazing in the open air, that's the best place. If inside, make sure that there is adequate ventilation. I do mine in a glass-topped lean-to, nicknamed the Crystal Palace, and my brazing forge is alongside the door, which is always wide open when a job is being done. The big window above the forge is also opened wide. I keep my oxy-acet cylinders alongside the forge, and also laid in a coal-gas pipe, so everything is nice and handy, and no time is wasted. Time is precious nowadays! Now to business.

Boiler Barrel

The boiler barrel is made from a piece of $\frac{3}{8}$ in. (13-gauge) seamless copper tube $4\frac{1}{2}$ in. outside dia. and a full $13\frac{1}{2}$ in. long. One end must be trued up in the lathe. Plug each end with a disc of wood. Grip one end truly in the four-jaw chuck, and run the tailstock centre into the middle of the other end to a depth of about $\frac{1}{8}$ in. enough to prevent it from slipping under cut. Run the lathe at slow speed, and trim up the edge of the tube truly, with a roundnose tool set in the rest at an angle. Apply some cutting oil to the job with a brush, or the copper will probably tear. Keep the tool sharp, as copper is very finicky stuff to turn, and slightly round off the edges of the tube, to avoid risk of cut fingers.

The other end of the tube has to be shaped to fit the throatplate, see Fig. 120. At $1\frac{1}{2}$ in. from the end, scribe a line on the tube projecting down $2\frac{3}{8}$ in. from the top. I use a flexible steel rule for this job, keeping it flat on the copper and at right angles to the tube. Grip the tube in the bench vice (leave the wood plug in, to avoid distortion) and with a 32-tooth blade in the hacksaw frame, carefully saw down to the end of the line. A brushful of cutting oil on the saw blade helps a wonderful lot. Now turn the tube the other way up, and saw down diagonally to meet the first cut. If the vice jaws won't open wide enough to take the tube, an extra inch or so can often be managed by removing the two steel insets from the jaw tops. Trimming up the saw-cuts and fitting the locating tags, must be left until the throatplate and outer firebox assembly is made.

Throatplate

The throatplate is made from $\frac{1}{8}$ in. (10-gauge) sheet copper, and is flanged over an iron forming-plate, or former, as it is called. Our advertisers will be supplying cast-iron formers for all the flanged plates in the boiler, and the use of these

saves a lot of work; but if preferred, formers can be sawn from $\frac{1}{4}$ in. iron or steel plate. Hard wood has been used, but where more than one plate has

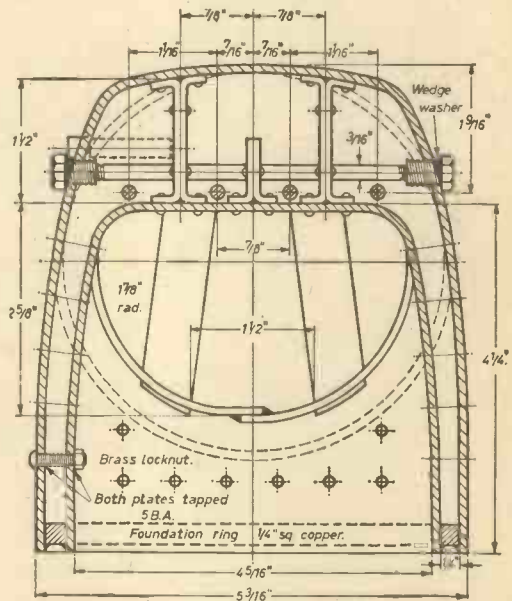

CROSS SECTION AT THROATPLATE

Fig. 119.

to be flanged, wooden formers aren't very satisfactory, as they won't stand up to the terrific bashing that has no effect on metal ones. To make one, mark out on a piece of iron or soft steel plate, the outline shown dotted on the drawing of the throatplate (Fig. 121) making it $\frac{1}{2}$ in. longer at the bottom, to allow for the bend in the throatplate. Saw to outline, using a coarse-toothed blade, say 14 teeth per inch, and plenty of cutting oil. Tip for beginners: take slow steady strokes, pressing down heavily on the forward stroke, and you'll be surprised by the way the saw walks through the metal. Trim the sawn edges with a file, and round off one edge of the curved part.

Lay the former on a piece of $\frac{1}{8}$ in. sheet copper, and mark a line all around, except at bottom, a full $\frac{1}{8}$ in. away from the former, but keeping to the exact shape. I cut out my copper plates with a Driver jig-saw, using a 32-tooth blade lubricated with beeswax; but an ordinary piercing-saw (glorified hand fretsaw) can be used, lubricated with cutting oil. No need to file out the sawmarks. Heat the copper to medium red, in the domestic fire or over a gas ring, then drop it into a pail of clean cold water. Place the former in the middle of it, rounded edge next to the copper, and grip the lot in the bench vice tightly, with one edge projecting about $\frac{1}{2}$ in. above the jaws. Then, with a 2lb hammer, beat down the edge of the copper over the former. Repeat operation until the whole of the curved edge has been flanged.

Beware of cracking. Copper goes hard when hammered; so re-anneal it by heating and quench-

ing as mentioned above, two or three times if necessary, during the flanging process. Smooth off the ragged edges and clean up the flange all around, with a coarse file. The scratches form a champion "key" for the brazing material.

At $2\frac{1}{4}$ in. from the top, and midway between sides, make a centrepop, and from this, scribe a circle $4\frac{1}{2}$ in. dia. Cut around this with a piercing-saw, or drill a circle of $\frac{1}{8}$ in. holes, breaking out the piece and trimming to size with a half-round file. At $2\frac{1}{4}$ in. from the top, saw a V-shaped piece out of the flange at each side. This will allow the lower part of the throatplate to be bent back easily until the bottom edge is $1\frac{1}{4}$ in. behind the upper part, as shown in Fig. 121. This will raise the lower part of the hole, so file away the copper until the hole is $4\frac{1}{2}$ in. from top to bottom measured vertically.

Firebox Wrapper

The best way to get the shape and size of the piece of sheet copper required for the firebox wrapper plate, is to use a paper pattern, or template. In my childhood days, a dressmaker to whom I rendered some services, taught me a lot about paper patterns, but never dreamed of the use to which I would put her teaching! Cut a piece of thick brown paper about 15 in. x 8 in. and lay it around the flange of the throatplate. Keep it in close contact with a clip at the bottom of each side.

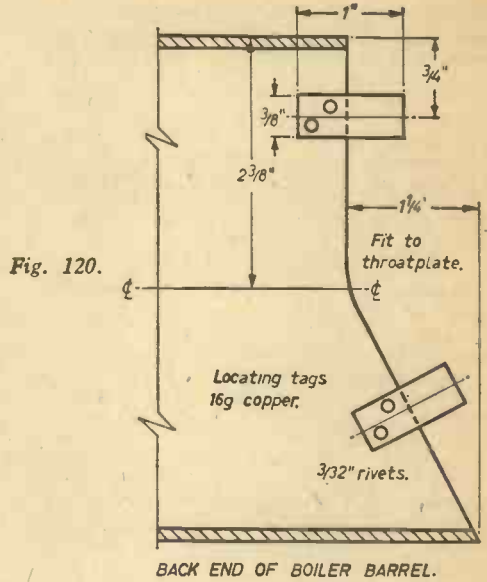

Fig. 120.

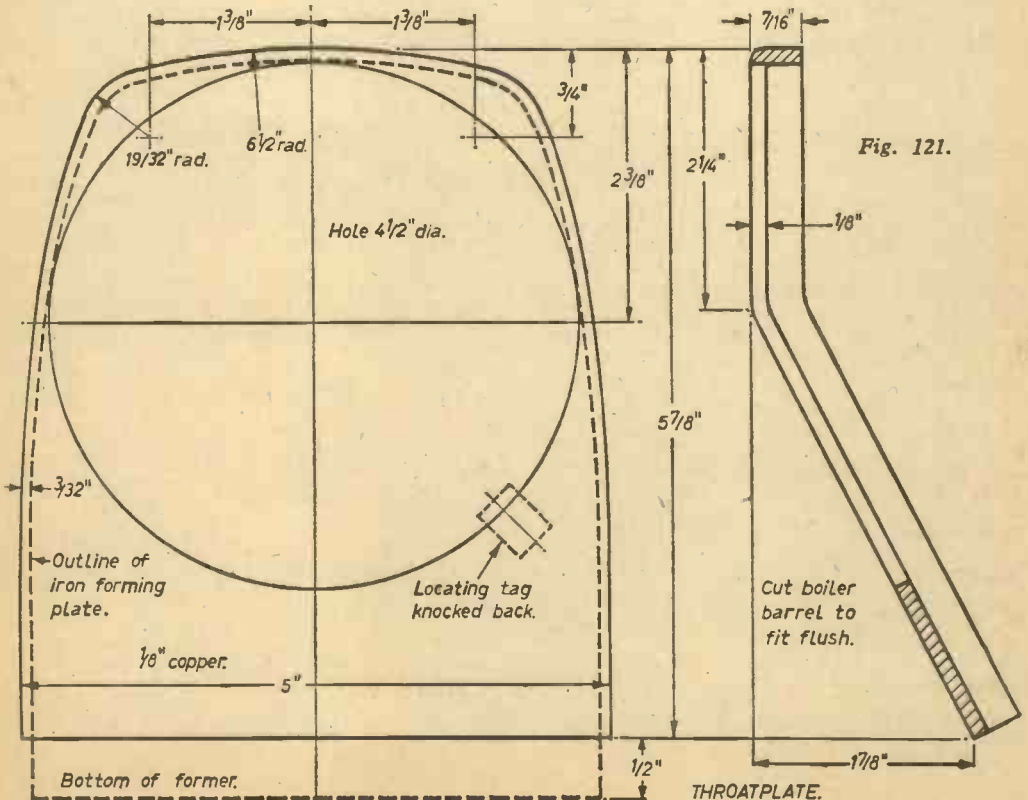

Fig. 121.

or how to see around corners

FIBRE OPTICS

By D. A. Watt

A ONE time laboratory curiosity, the "image-pipe" is rapidly developing into an extremely useful and interesting instrument, and has given rise to a whole new technology—Fibre Optics.

Although the science of fibre optics grew out of the need to see into inaccessible places such as the internals of an intricate casting, or into the stomach of a living person, as we shall see later, this is but one of the many ways in which this remarkable technique can be used.

The basic principle of fibre optics is that most of the light entering one end of a glass rod passes through the rod and out the other end. Whether the rod is straight or twisted does not affect this property. A single rod is known as an image-pipe and in practice several thousand rods of diameters maybe as small as 5 microns (0.0002in.) are bundled together to form a fibrescope. These can be either rigid or flexible assemblies up to 25ft. long.

The quality of the image transmitted by a fibrescope is determined by the number of fibres in the bundle. The photographs printed in this magazine are made up of many closely spaced dots of varying intensity from light grey to black. In the same way the image from the fibrescope is made up of dots of light of varying intensity. The spacing of the dots in these photographs is about 0.008in., which would correspond to a spacing of 200 microns for the fibrescope. The present minimum fibre diameter of 5 microns is more than adequate for most purposes at present.

A fibre conducts light by internal reflection by the same optical mechanism that makes prisms such good reflectors and gives diamonds their exceptional brilliance. If a ray of light passes from one medium (such as air) into a different medium (such as water or glass) having a different refractive index the ray of light is bent. If light rays hit the boundary between the two mediums at oblique angles those striking at less than a certain angle will be reflected back into the first medium as shown in Fig. 1. This angle is determined by the difference in the refractive index of the two materials.

Considering our glass rod image-pipe, Fig. 2, the light entering the end of the tube is mostly reflected internally because of the difference in refractive index between glass and air (1.5 for glass and 1 for air). A light ray entering too obliquely will not be reflected; the angle at which this occurs is called the critical angle, Fig 3.

In a fibrescope the individual fibres will be closely packed with no air jacket and rays will be able to "cross-talk" or pass from one fibre into another. This is prevented by coating the fibre with a thinner layer of glass of lower refractive index. This jacket also provides a protective coating to protect the reflecting boundary from damage.

The refractive indices of the jacket and core must be chosen carefully. The light leaving a fibrescope escapes from the individual fibres at roughly the same angle as the acceptance angle, therefore if the line of sight is less than the minimum exit angle, the image will not be seen. There is a relationship between the indices of refraction of the two materials and the sine of the acceptance angle



The new Ferranti prototype fibre optic faced 3 in. cathode ray tube which was demonstrated for the first time at an Electronics Conversazione held by the Electronics Department of Ferranti Ltd.

Fig. 6.

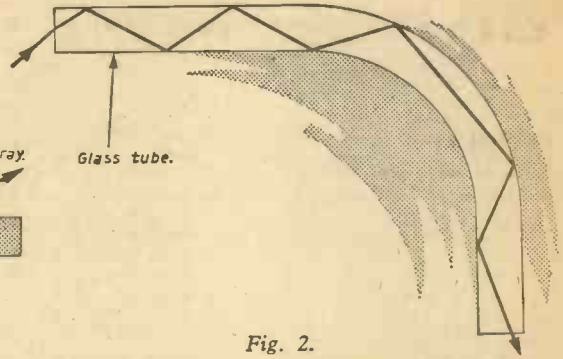
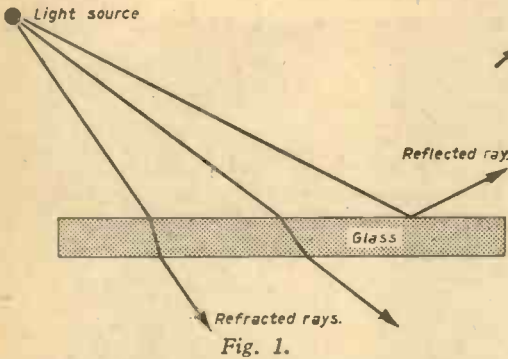

(called the numerical aperture) as shown in the following formula:

$$\text{Numerical aperture (N.A.)} = \sin \alpha$$

$$\text{N.A.} = \sqrt{n_1^2 - n_2^2}$$

where n_1 = refractive index of the core.
 n_2 = refractive index of the jacket.

Theoretically it is possible to have a combination of materials which will give an angle of 90° but angles slightly less are achieved in practice.

There are two types of fibrescope, "coherent" fibrescopes in which the individual fibres are in the same relative position at both ends, and "incoherent" fibrescopes in which the fibres are scrambled. The usefulness of incoherent fibrescopes is not so obvious at first but in fact they provide a means of taking an image apart and putting it together again, a feature which is used in many interesting applications.

They are also useful as "light pipes" for bending light around corners into an inaccessible place. This form of illumination has two distinct advantages over an incandescent lamp on a flexible lead. The light is cold so that an intense source of light with the usual associated heat can be provided, and it can be of far greater brilliance for its size. Incoherent fibres grouped around a coherent fibrescope as shown in Fig 4, provides a convenient light source for a fibrescope.

Early patents on devices using the fibrescope principle were granted as far back as 1927 and the principle itself was probably known for some time before that. The first serious attempts to exploit it were started in 1954 and, as a result of the extensive research effort of the past few years, a few commercial devices are now available.

Now that we have some idea as to how the fibrescope works let us take a look at some of the ways it is being used. The unusual properties of the fibrescope have fired the imagination of many engineers and innumerable applications have been suggested, many of them far from practical.

Considering first the more practical ones, the coherent fibrescope provided a means of doing "impossible" jobs where it was necessary to see around corners. The medical profession were quick to realise their value and among the first useful devices were the Cystoscope and the Duodenoscope. Small fibrescopes have been made to probe the stomach, heart, blood vessels and other organs and a miniature probe in the form of a hypodermic needle has been developed for studying skin tissue and blood cells on living persons. Larger fibrescopes have wide application in industry for looking into awkward places.

By tapering the fibres of a coherent fibrescope the image can be magnified or demagnified, the present limiting ration being 50:1. Although easy to make, these do not have a great practical use.

More activity is at present being directed towards the development of devices for printing

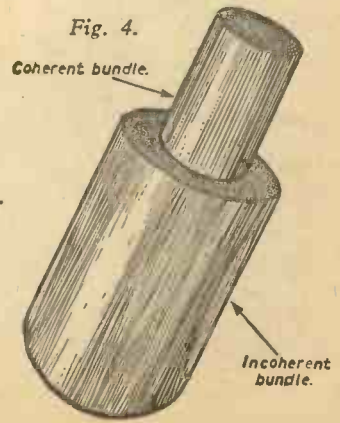
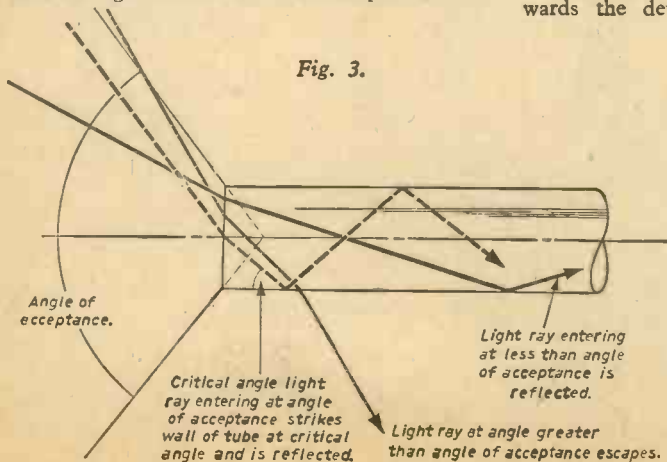

direct from a cathode ray tube. This is done by using a cathode ray tube face made from glass fibre strands of high refractive index bonded together with low refractive index glass to form a glass face mosaic. Fig. 5 shows how with the normal cathode ray tube face some of the light from the image on the phosphorus coated face scatters as it passes through the glass of the tube, and definition is affected. When the light is piped through the glass no scatter occurs and definition does not suffer. This means that prints can be taken direct off the face without the need of lenses. Fig. 6, shows a prototype fibre optic faced 3in. cathode ray tube recently demonstrated by the Electronics Department of Ferranti Ltd. The photograph is reproduced by the courtesy of Ferranti Ltd.

As mentioned previously, incoherent fibrescopes can be used to break up an image and reassemble it. This provides a simple but effective form of coding and decoding. All that is required is two incoherent bundles with exactly similar arrangements of their respective fibres. This is rather difficult to achieve but can be done. Thus equipped the possessor of one bundle can photograph an object or message through his fibrescope and send the photograph off to the person having the other fibrescope, firm in the knowledge that the photograph would be meaningless if it fell into the wrong hands. When viewed in reverse through the fibrescope of the intended recipient, the image would be re-formed and readable.

Another use for incoherent bundles in which the fibres have to be very carefully arranged is in the field of optical scanners. The most efficient form for the pick-up is to have it rotating. Using a fibrescope it is possible to do this. Very much simplified this is done by rearranging the fibres of one end of the fibrescope into a complete circle as shown in Fig. 6. Thus the image at each fibre can be picked up in turn by the rotating pick-up and transmitted to a remote recorder. The recorder stores the images until one complete revolution is completed when all the images can be translated back into the original image. This kind of technique is used in aerial photography and mapping.

One of the more fanciful, but at this stage almost impossible, applications is for colour TV. Three cameras would be set up, giving pictures in red, blue and green respectively. The colour picture would be obtained by combining the output of these three cameras via fibrescopes. Each

dot on the picture would be fed by three fibres, one from each fibrescope.

Undoubtedly this system would work, but the job of threading the individual fibres must be a fibrescope assembler's nightmare!

Although there are many problems yet to be solved, the results so far achieved by fibre optics are encouraging an increasing number of firms to provide funds for development. The next few years should see the introduction of many new devices using these principles.

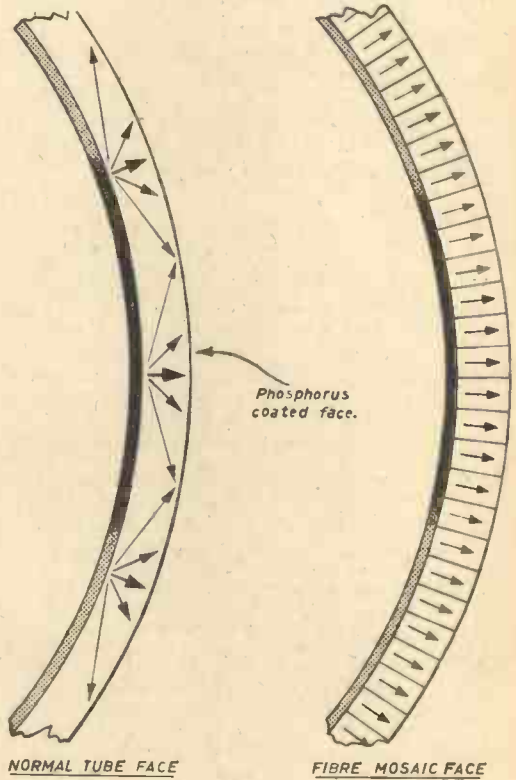
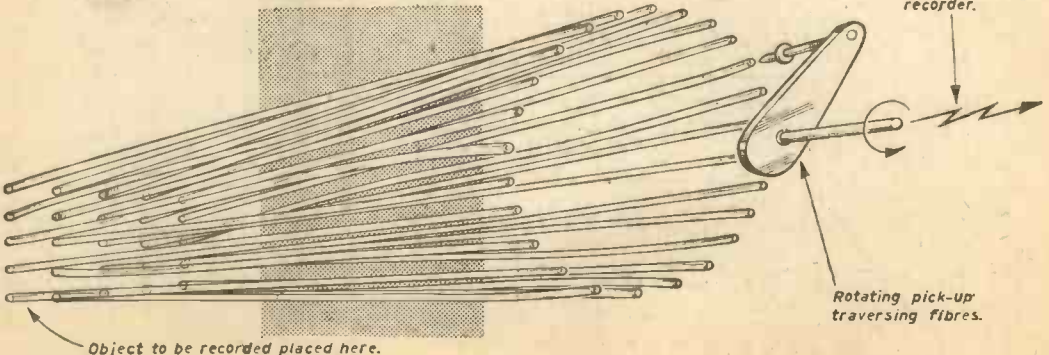

Fig. 5.

Fig. 7.



CHANNEL TUNNEL PROJECT

PREFABRICATED

Described by W. L. Gay

WITHOUT delving into the numerous plans and suggestions for a cross channel link from England to Europe, which has been discussed over the last few decades, the latest idea of a bridge seems so impractical that I have been prompted to put forward a scheme, studied and planned by myself for fourteen years.

I refer to this because there will probably be a few unanswered queries due to space and the brevity of this article, but readers may rest assured that there is no difficulty that may occur to them not already taken into account and a perfectly simple explanation available. Many difficulties come to mind when one is contemplating such a project; cost, time element, human risk involved are perhaps the most important to overcome.

By the simple measure of reducing the time element, the cost of such a "link" would be greatly reduced, danger to human life also a costly contingency, when reduced to nil, also reduces the initial cost.

While endeavouring to describe my plan, I may have to be a little unorthodox because of the unusual design.

As the channel tunnel "Ports" are not contentious, I shall limit my article to that of the actual tunnel, as there are numerous excellent designs for "Ports" that, as long as they can be con-

nected to the proposed tunnel, do not cause congestion of traffic, either will be acceptable. However, my project is a "Prefabricated Tunnel" made on land on each side of the channel, in sections of 300 feet like huge cement and steel pipes are floated and submerged as the "tunnel". That is the simplicity of my plan.

A careful survey of the channel bed will be necessary to decide the most gradual shore lines, level bed and shortest route. Discrepancies can be either levelled off by filling hollows with rocks carried out by hoppers, or, sandbanks levelled by dredging (Fig. 1). While this is being carried out, huge plants are built on either side of the channel, consisting of rail yards, store and workshops, ready mixed concrete machines, and several slipways on which to construct the tunnel sections or units. See sketch.

The metal framework or girders, are manufactured and assembled in small transportable units then transferred to the assembly plant, where the construction of the skeleton of the tunnel section is carried out on several slipways (Fig. 3). When they reach certain stages of production they are "slid" to the next point of assembly and so on, until final launching into the sea.

The "skeleton" or "mattress" will be assembled together with various ducts, cables and pipelines.

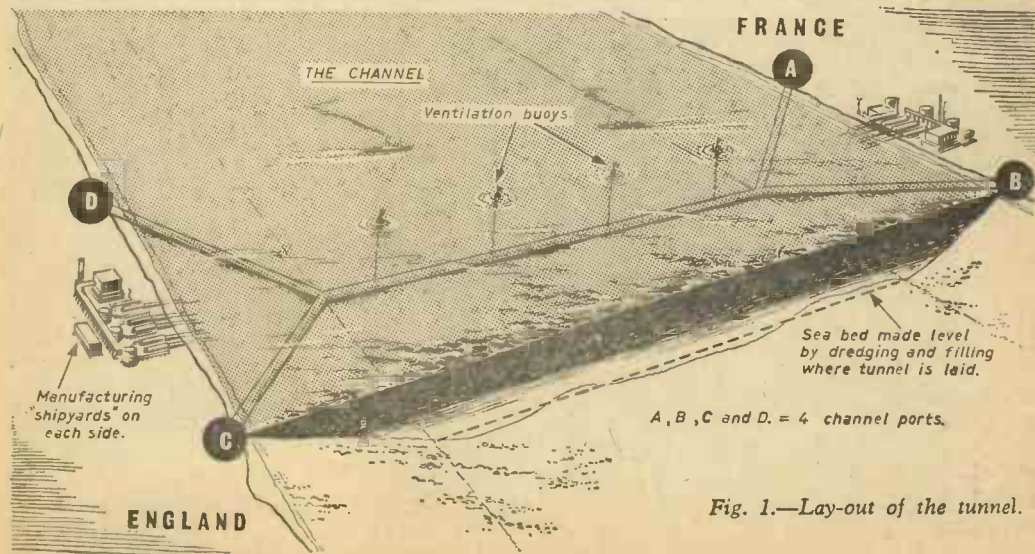

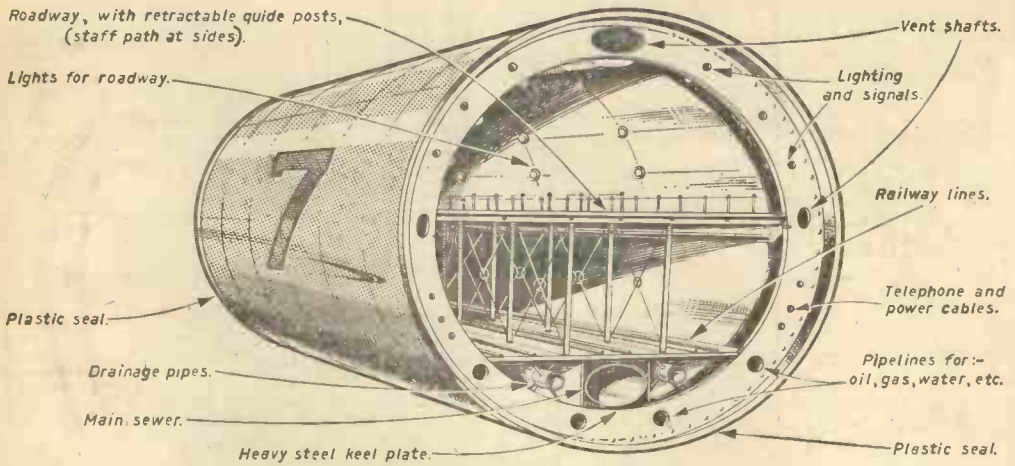
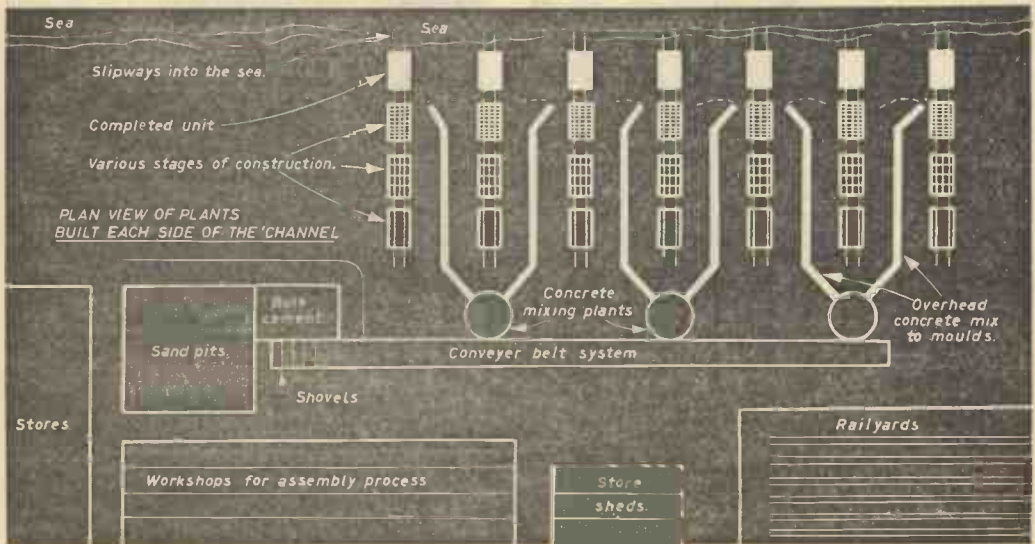

Fig. 2.—Cutaway view of the tunnel.

which will be used later for the conveyance of oil, water, ventilation, gas, etc. (Fig. 2). The unit will be bisected by a girder-like formation, that will eventually separate the tunnel section into two levels, the upper for road transport, the lower for rail. Under the railway line level, will be the drainage and "Rib" or "Keel" of the unit and this will act as the backbone of the tunnel (Fig. 2). When the initial assembly of the ribs or framework is completed, the unit is moved to the next position, where inner lining tiles are keyed to the structure for permanent fixture (incidentally the entire framework has been pre-stressed for maximum strains). Once the tiles are fitted to the framework, the outside of the unit is covered with steel plates to enable a mould to be formed. Another move is made when the unit, ready for the concrete, is "slid"

into the next position, where, from an overhead conveyor system, the special concrete mixture is poured into the mould, filling the cavity between the inner facing tiles and the outside steel plates. Once the concrete is set, the outside plates are removed and the unit moved to the final finishing stage. While the concrete is "curing" the completion of the inside of the section is finished, road surfaces laid consisting of pre-cast blocks bolted to the pre-determined fixtures, thus allowing for repair replacement due to wear and tear. Railway lines are also fitted to shoes located in the lower section (see Fig. 2), the railway lines will be of the overlapped joint principle and, as the temperature variation under water remains constant, the possibility of buckling is negligible, allowing for close tolerances and a vibration free ride is guaranteed.

Fig. 3.—Details of the plants where sections of the tunnel would be manufactured.



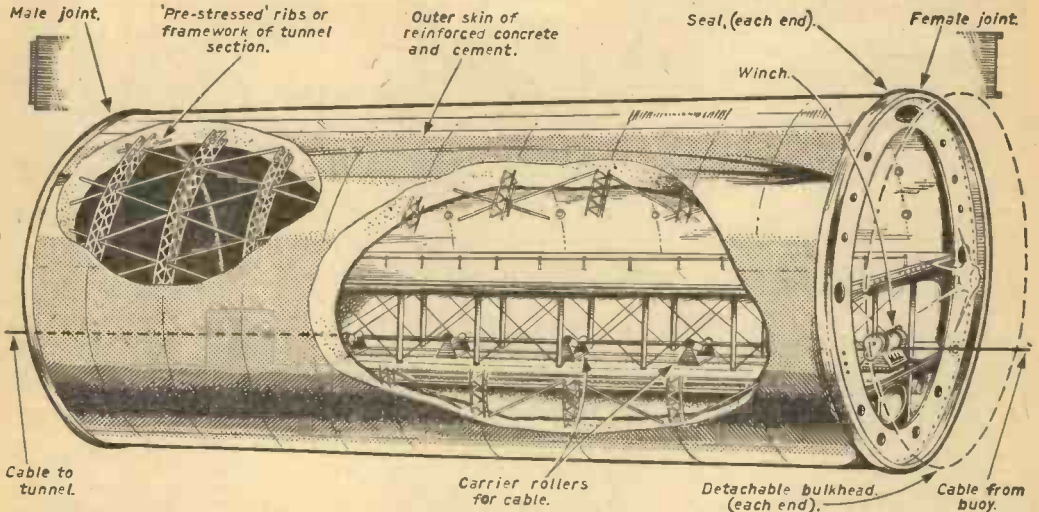

Fig. 4.—Showing the framework of a section of the tunnel. The winch, carrier rollers for cable and bulkhead doors are removed when section is in position.

All electric lights, power lines, cables, telephones, shafts and pipe lines are tested and, once completed, the ends are sealed with detachable bulkheads. The ends of the tunnel section are fitted with a plastic unperishable seal of a male and female design, ensuring a positive water and air tight seal.

Once ready and sealed, the unit is launched into the sea, then towed to the marker buoy or ship situated at the end of the tunnel or to the previously fitted unit, as required (Fig. 5).

For economical reasons and to overcome any expensive point at the centre which would involve under-sea divers, the tunnel is started above water-line on one side and passes underwater until it rises above water on the other side. Tunnel units will be made on both sides and although a greater "tow" will be involved from one side at the start, the situation changes as the tunnel nears the other coast.

The method of connecting the unit to the pre-fitted section is simple and involves no human risk,

trained crews "man" the unit, using the upper level as their headquarters and pass through the bulkhead doors a cable which is complete with power lines. By drawing the cable to a winch, specially fitted to the railway lines, they pass the free end back out of the other bulkhead and refix it to the marker buoy or ship. Once this is done, similar to threading a cord through a large bead, the lower drain level is flooded to lessen the buoyancy of the unit, then by starting the winch driven by power from the power lines, the unit pulls itself under water along the cable (see Fig. 6), until it is finally touching the previously fitted unit. By moving ballast weights from side to side in the new unit until connecting link bolts, large threaded steel bolts are driven through a thin rubber gasket and into the other unit, where nuts are made secure and tightened until a water and air tight seal is obtained at the plastic rings. Once sufficient bolts are tightened to hold the unit in place, the crews dismantle the bulkhead doors separating the units and the process of final fixture is made by other

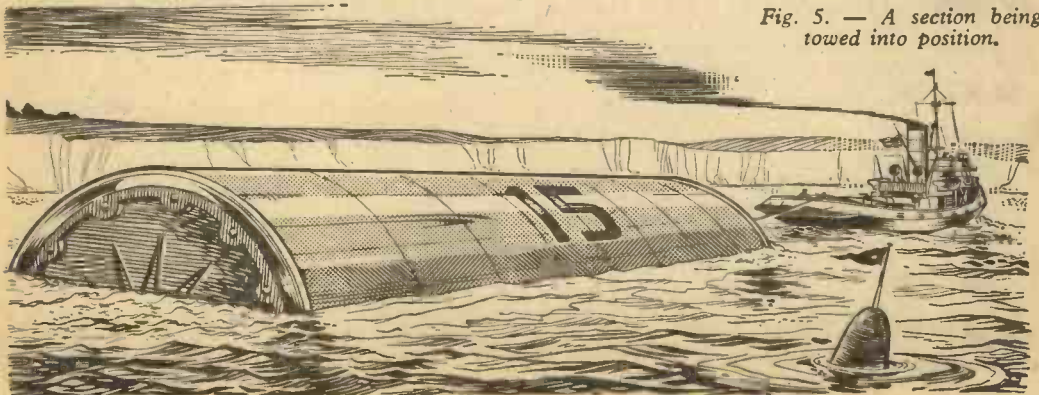

Fig. 5. — A section being towed into position.

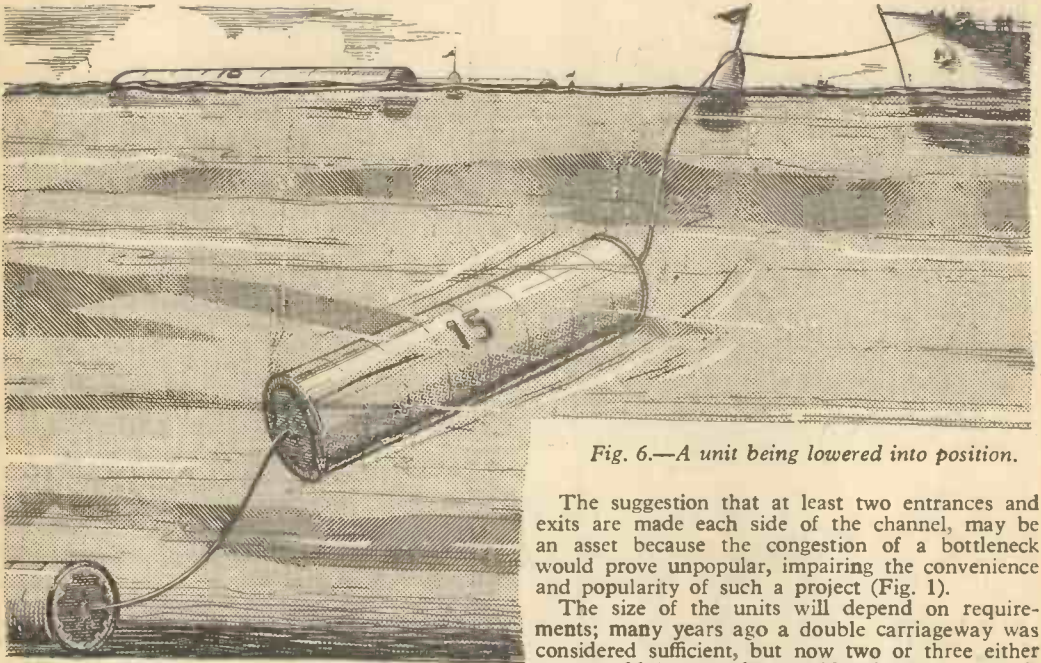

Fig. 6.—A unit being lowered into position.

The suggestion that at least two entrances and exits are made each side of the channel, may be an asset because the congestion of a bottleneck would prove unpopular, impairing the convenience and popularity of such a project (Fig. 1).

The size of the units will depend on requirements; many years ago a double carriageway was considered sufficient, but now two or three either way would have to be considered, but as an additional convenience, the separating barricades or guide posts are made retractable and the widening of the roadway for the busier direction, would be controlled by the mere operating of a switch (Fig. 2). On each side of the main concourse, will be a path for the use of "tunnel personnel" for servicing switch gear, policing traffic or for the removal of obstructing broken down vehicles to await towing from the tunnel.

Ventilation, once a major worry where a deep tunnel was concerned, is simply an inclusion of pre-determined units, where a hatchway is incorporated, to house a ventilation buoy, which is freed to float and allow for pumping foul and fresh air in and out. The speed of this ventilation will be controlled by the installation of a series of "electronic eyes" where the density of smoke will increase or decrease the amount of ventilation required. Smoky vehicles are similarly policed at

(Concluded on page 523)

gangs, while the crews with the bulkhead doors and winches are returned to land by train and/or road. Once the remainder of the steel connection links are tightened and made secure, all other cables, power lines and pipe lines are sealed and connected to one another (Fig. 7), the rail-line link is made and the roadway joint is fitted with standard blocks, thus allowing all services to proceed into the new unit ready for the next section already "pulling" itself on to the end of the cable. Water used for ballast in the unit is pumped out and the entire process repeated until the other side of the channel is reached. Slight deviations in the level of the tunnel can be accounted for by the end of the tunnel section, the connections from the "slope down" to the "level run" and from the "level run" to the "slope up" will be the only places where special angles will be required (Fig. 1) Survey figures should give this "grading" and the numbering of the units will ensure correct location.

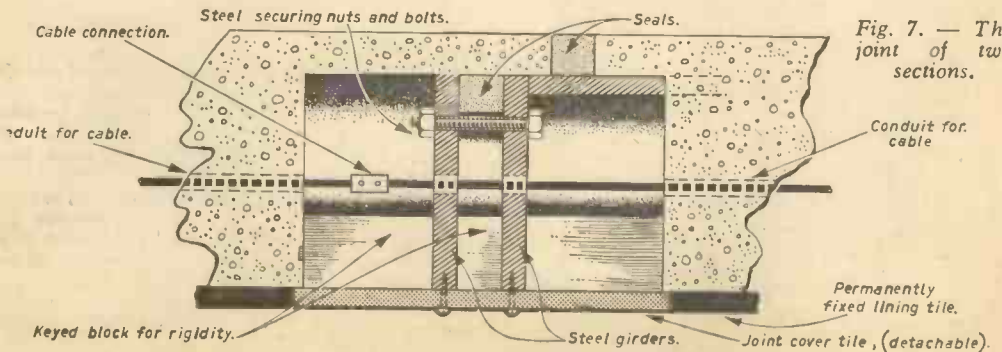
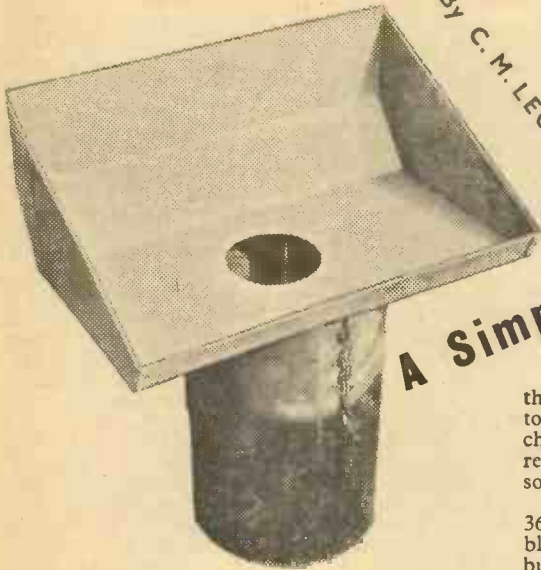

Fig. 7. — The joint of two sections.

By C. M. LEONARD

A Simple BRAZING HEARTH



SMALL brazing or silver soldering jobs, such as model components, can generally be dealt with very well by laying them on a piece of firebrick for heating.

A job like a loco boiler, involving a fair bulk of metal, needs support suitable to its size and weight and provision for holding coke or other packing to concentrate the heat locally. The simple brazing hearth shown was made up with these requirements in mind. It is just about as cheap as possible to make and can be pulled apart instantly for compact stowage.

It is possible to work on either end of a boiler by embedding it in coke in a beheaded oil drum. However, when the boiler requires to be laid down the oil drum shape is no longer very suitable. The drum was retained as part of the complete hearth both to form a stand and because of its useful capacity for holding long, upright jobs.

Any garage will be only too glad to give away an empty five-gallon oil drum, which provides half the structure free. If you have any choice pick

the stoutest one available free from dents. Cut the top out cleanly just inside the rim with a sharp chisel and keep the cut-out disc. Drain out any oil residue and clean out the inside with a paraffin-soaked rag.

The tray top to the hearth is made up from a 36 x 24 in. piece of 18-gauge sheet iron. Cheap black sheet is perfectly suitable; at the time of building only galvanised sheet was available locally, so rather than await new supplies this was used, as can be seen.

The sketch shows how the sheet is marked out and cut to provide two separate end pieces, with the back, bottom and front rim all in one. Assembly is by $\frac{1}{4}$ in. iron rivets. No fancy heads are needed and a serviceable job would result from using cut-down wire nails as rivets. Bend up the riveting flanges on the ends first, then the marked bending lines on the main piece can be adjusted if necessary to give snugly-fitting corners where the ends are fitted. Clamp one end in position with a couple of clamps, drill through both thicknesses every 3 in. or so and rivet up. Treat the second end the same.

The long strip cut from the end of the sheet is cut into three equal lengths. Cut a $\frac{1}{4}$ in.-wide strip out of one edge of each to leave a couple of tabs standing out from the edge. Drill each for a rivet, bend up at right-angles, and then curve the strip to fit closely around the shape of the oil drum inside the open end. These curved pieces are riveted on the underside of the tray to clip it or

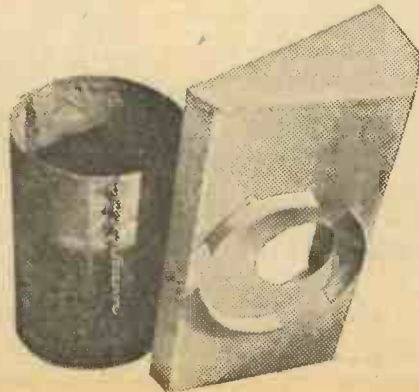
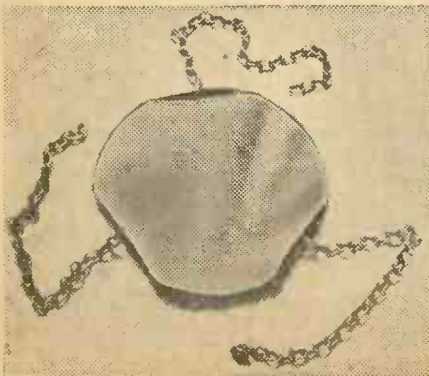

Photo Left—Oil drum top with chains to serve as floor, and two main parts of hearth showing underside of top tray and chains in position in drum

the drum. Space them about equidistant round the circle by eye, riveting the first two tightly straight away. Adjust the position of the third carefully so that when in position the three pieces form a gapped ring, a stiff push fit in the top of the drum.

For working on one end of a loco boiler held upright it is useful to be able to arrange coke packing around the top end, with the rest of the boiler below the level of the hearth. For this purpose a hole is cut in the floor of the hearth about 1½ in. or so larger than the boiler barrel. Cut the hole midway along the floor but slightly nearer the back than the front. This enables the lower front edge to retain enough coke to match the height of the packing at the back.

If some 3 or 4 in. of barrel, say, is required to poke up through the hole into the hearth, that part in the drum below will be much too short to reach the bottom of the drum. This is where the cut-out top comes in. Trim off any sharp, jagged points round the edge, then at three roughly equidistant points round the edge bend up a ¾ in.-wide tab. These serve as attachment points for three short lengths of chain by which the height of the top can be adjusted down in the drum—an adjustable level floor in effect.

At three points round the top edge of the drum make a couple of cuts down about ¾ in. long and some ⅜ in. apart. Bend down the resulting narrow tabs inside and hammer them flat. This forms three vertical slots around the top edge into which the chain can be hooked at any position to give a wide range of possible heights for the floor. The

spare lengths of chain hang down outside. When the top is clipped in position the spaces between the clips under the tray clear the chains, while the tray traps them in the slots, so that there is no possibility of them slipping out during work in the hearth. A yard and a half of cheap iron chain from the local ironmonger will provide three pieces amply long enough. Cut through an end link of each piece, slip the cut link through a hole drilled in each of the three bent-up tabs on the drum top, and rebraze or silver solder the cut link again.

Provide an odd piece of sheet iron to cover the central hole in the tray when it is not required. One way of dealing with a two-stage job which requires the boiler first horizontal and then on end, such as brazing the foundation ring and then the backhead, is to drop the smokebox end of the boiler through a hole in the tray and adjust the height of the floor first so that the firebox is an inch or two above the tray bottom. Remove the boiler and cover the hole with the plate. After dealing with the foundation ring with the boiler coke-packed on its back lift one end of the boiler and push the cover plate aside under the coke, drop the boiler through the hole, and rake the coke back around the end sticking through. This takes so little time that the boiler is still nicely hot for the start of the second stage of work on the backhead.

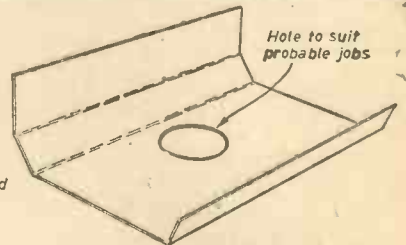
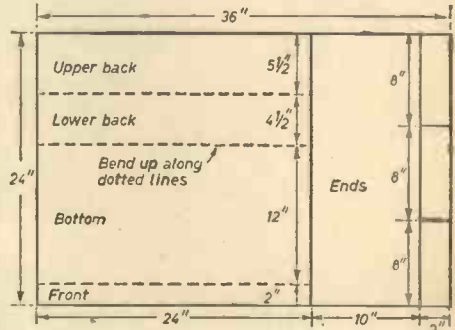
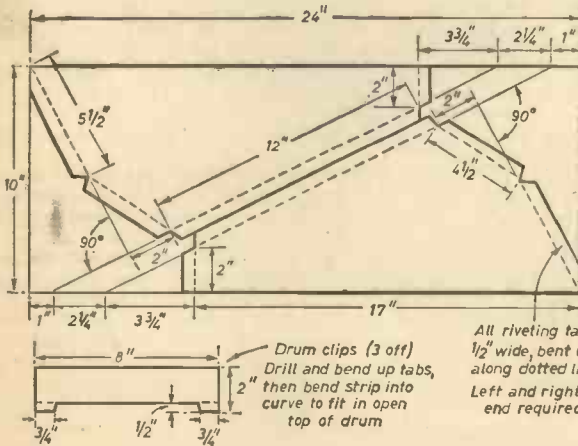

All riveting tabs ½" wide, bent up along dotted lines. Left and right hand end required

Read PRACTICAL MOTORIST the magazine for owner-drivers

IN THE
SEPTEMBER
 ISSUE

(on Sale AUGUST 15)

- Mini gearbox overhaul
- Checking Instruments
- Removing dents
- How to pass the L-test first time

A PACKAWAY DARKROOM



Fig. 1.

By J. H. B. GOULD

WITH the ever-growing popularity of photography as a hobby, more and more people are processing their own prints and enlargements. Unfortunately, it is not always possible to rig a room out as a permanent darkroom; often, the equipment has to be packed away after use. In this regard, the special lighting presents a problem (and also a hazard, if badly rigged). The unit described here has three main advantages: it is self-contained, it does not have to be mounted or suspended from the ceiling or anything else, but stands on the drip tray; also it can be easily unplugged and stowed away in a cupboard after use.

Basically, the unit consists of three parts: (i) a frame; (ii) a main light and (iii) a safelight.

The Frame

This is a simple wooden structure which supports the other parts. It should be light, rigid and stable—this last in spite of its necessarily rather top-heavy arrangement, as shown in Fig. 1.

The Main Light

This saves fumbling in the dark for the wall switch; it also serves as a junction box for the electrical wiring. Two tins are necessary here: one, with a slide-fitting lid, forms the connection box,

while the other, with a press-on cap, serves as a reflector. The first should be 2½ in. or more in diameter and 1 in. to 3 in. depth; the second, 2 in. to 3 in. in diameter and not less than 3 in. long.

It will be necessary to cut away just enough of the wall of the junction-box can and its lid to enable them to fit over the upright of the frame in the manner shown in Fig. 3. Sufficient metal of the wall should be left to form the flanges used in clamping the tin in place. The switched lampholder is fitted to the base of the tin, the plain one to the lid; one of the screws used in this last role is run into the upright to hold the lid in place after assembly.

The second can is used as a reflector for the main light and, for this purpose, a slot is cut in its wall in line with the position of the bulb. In addition, the wall is slit on the opposite side to form a ventilator. A hole is cut in the lid large enough to accept the threaded barrel of the lampholder, on which it is fixed *loosely* by means of a ring nut, a further locking ring being added; this will allow the reflector to be rotated to direct the light. Holes are drilled through the upright to carry the mains cable and earth lead.

(Concluded overleaf and on page 526)

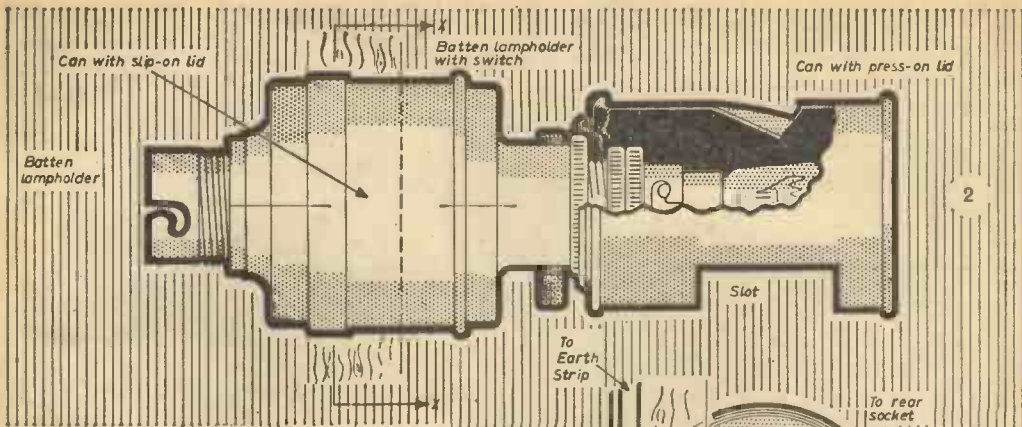
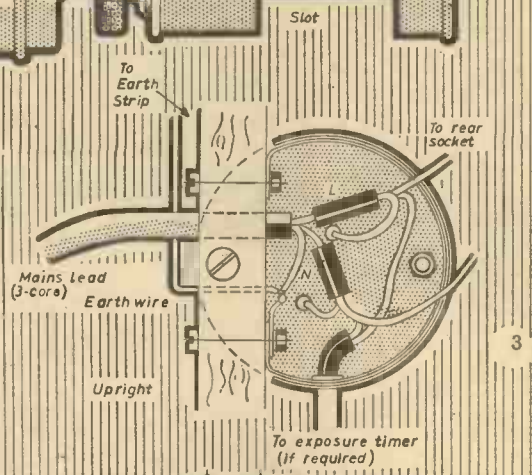

Fig. 2.—Main light.

Fig. 3.—Connection box.

Figs. 4.—Two views of safe light.



2

3

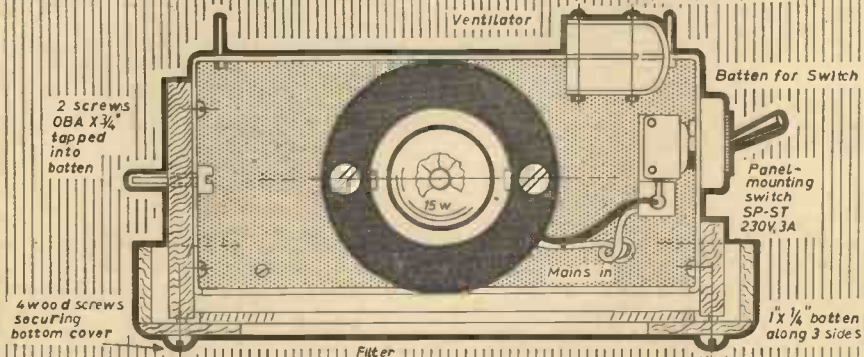

4

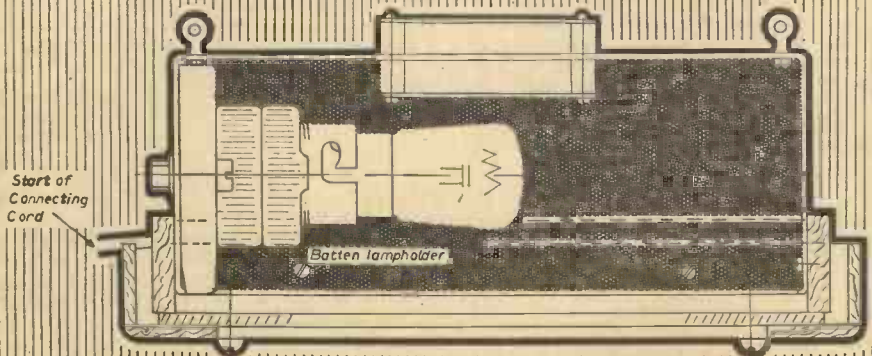

4

"DO-IT-YOURSELF" INSTRUMENTATION

By
D. S. FRASER

TODAY'S trend in manufacturing is toward ever-diminishing tolerances, and a steadily increasing number of critical relationships, between the surfaces of a part or mechanism. This trend is stimulating the growth of electronic methods of measuring dimensions and interpreting the results of such measurement because these have greater accuracy, more flexibility, and offer more advantages in solving today's problems than other methods of gauging.

There are several possible systems which may be used to obtain part dimensions automatically; in fact, any reliable displacement transducer will do the job. As a rule, measurements are never absolute but are based on the comparison of an unknown part against a part of known dimensions which has previously been used to calibrate the system. One widely-used system makes use of an

electro-magnetic gauge head, such as a differential transformer, followed by a high-gain amplifier to expand the signal to usable values.

A system, introduced in the United States by Radio Corporation of America, using an electrostatic gauging principle, has the advantages of freedom from influence by external magnetic fields or magnetised objects, and also has an extremely high voltage output, so that the output signal can be used directly without the need for precision multi-stage amplifiers.

RCA electronic gauging modules have been perfected for concerns who may be interested in "do-it-yourself" instrumentation. They can be used in a number of different combinations to solve even the most complex measurement problems. Each can be supplied individually complete with connector plugs for mounting in a cabinet or in a combination as an integrated system, including a wiring harness and cabinet.

As its gauge head or displacement transducer the RCA system makes use of a variable capacitor which is connected to a modular electronic chassis, the AGMC unit, by means of coaxial cable. The gauge head consists of two steel plates, one of which, the stator, is fixed and the other, the reed, is free to move in relation to the stator. A stylus or gate tip is attached to the reed and passes by a diaphragm seal through a hole in the case.

When the gauge tip is brought into contact with a precisely located part it is deflected in accordance with the dimension of the part, causing the capacity between the reed and the stator to vary proportionately. This change in the gauge head capacity affects tuning in the oscillator load circuit and establishes the voltage applied to the detector.

The detector converts the variable high-frequency AC voltage to a variable DC voltage which is the output of the AGMC unit. A meter in the cathode circuit of the detector is calibrated to read the size of the part being measured. The sensitivity of the AGMC unit is such that full-scale deflection of the gauge head will result in an output voltage change of 20 volts. Standard gauge heads are available with full-scale ranges as small as 0.0005 inches and, as stated, deflecting the stylus

The units shown are top row, left to right: Thyatron; power supply; master gauge control. Bottom row: Difference computer; sum computer.

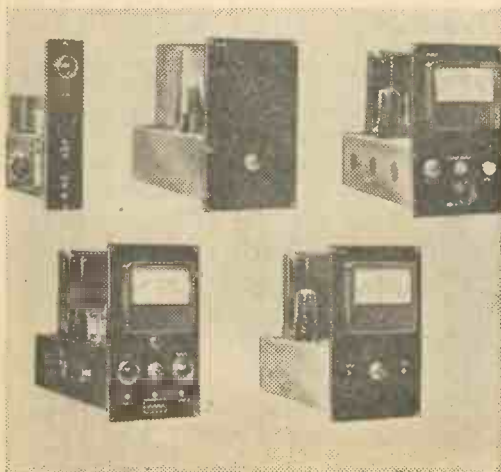

tip this amount will cause an output voltage change from the AGMC of 20 volts. This is great enough to be directly usable and no intermediate amplifiers are required.

This output voltage is used to determine whether or not the dimensions of the part under test are acceptable, and for this purpose it is fed to one or more ATM thyatron units, each of which is set to fire at a specific voltage. Such a chain of thyatron units can be used to determine if a dimension is all right, oversize or undersize. By use of additional thyatrons several sub-divisions or classifications can be made within the "all right" range. On each ATM chassis is a thyatron tube, type RCA-2D21, with COARSE and FINE bias adjustments in the cathode circuit. When the thyatron is fired its plate circuit relay is actuated, and the relay contacts are used to operate signal lights as well as segregating, inking or metal stamping devices to indicate part size.

Difference computers for measuring such dimensions as taper and sum computers which combine individual measurements of two segments to determine overall length are also available.

The differential computer, known as the DC-7, computes the difference between the measurements made by two linear voltage AGMC units. Any tolerance can be set into the circuitry of the DC-7 for deviation from zero in either direction by simple front panel adjustment. It is used for determining taper or any difference of reading of two AGMC gauges.

The DC-7 consists of a meter, used for set-up and to indicate balance (difference) between two linear voltage gauges, a thyatron and relay, as well as signal lights to show O.D. and reject.

Set-up is simple. With both AGMC units in set-up position, and their pointers positioned at "O" (midscale), the set-up button on the DC-7 is pushed and the calibrate screw is turned until the meter indicator shows zero. The high and low limits are then dialled in on the verniers and the unit is ready to operate.

As the two measurements being made vary, the meter indicates half the difference. When this exceeds a predetermined amount the internal thyatron of

the DC-7 fires and actuates the relay, which in turn controls a reject mechanism or a metal inking device. Signal lights also flash to indicate all right or reject. After firing the circuit is reset by pushing the "set-up" button or breaking the thyatron circuit externally by a cam-driven limit switch.

The sum computer, known as the SC-7, is used to resolve the sum of the measurements of two AGMC gauging units into a single answer. Fixturing on many gauging applications involving the determination of three or more related dimensions can be greatly simplified with this SC-7 computer. Typical uses are in checking trunnion crosses and valves. In the former case each arm is measured individually and the sum of the readings indicates total length. In checking valves the distances from the groove to tip are measured individually and added automatically to show overall length.

The two calibration controls and the meter on the SC-7 panel are used to indicate the sum of the outputs of two AGMC linear voltage gauge units. The output voltage of the SC-7 is equal to half the sum of the two input voltages and is fed from one or more thyatron units which control appropriate reject mechanisms. After initial calibration no additional set-up procedure is required.

By combining the electronic modules discussed here with other types, such as memory circuits, it is possible to assemble equipments which can arrive at relatively complex indirect measurements and decisions. Such machines can rival human inspection in performing measurements and will greatly exceed manual operations in production rates and consistent accuracy.

Whether one requires a completely integrated automation system or plans to mechanise individual operations this RCA system offers a most versatile and complete combination of such equipment available from a single source. Typical examples are: a full line of "demand-controlled feeders and orientors; self-compensating grinder controls; high-speed harness testers; a wide variety of multiple dimension gauging and selective segregating systems designed with standard electronic modules for easy expansion and assembly machines."

This photograph shows a typical assembly.

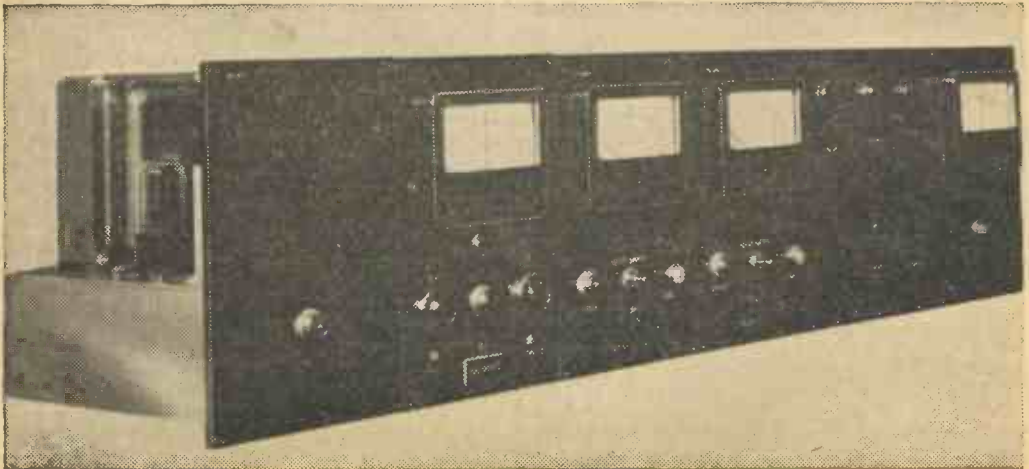

AUTOMATICALLY CONTROLLED MILLING for COMPLICATED PARTS . . .

By A. G. AREND



REFERENCE has already been made to the means of milling complicated parts like propellers directly from drawings without the assistance of masters or magnetic feelers of any kind. What is known as the "electronic eye" scans the drawings and provides the necessary impulses, so that milling proceeds in any direction and angle, and then stops at the required point, and all of which is carried out automatically.

In order to implement the guidance thus afforded by electronic means, it is then necessary to have the milling table movements, as also those of the tool, made to traverse any given direction, longitudinal, cross-traverse, or up-and-down motion, as required. This has also to have the means of changing the speeds of the different electric motors, engaged to actuate these items. Depending upon the nature of the complicated part to be automatically turned out, the number of transmission organs may be quite large, while a relatively great amount of power may be consumed.

Because of the many and variously directed motions of the machine tools, it is accordingly preferable to engage a separate motor for each of these motions. In extreme cases, as many as twelve or more driving motors, each of which is individually controlled, are used for complicated parts. With less complicated parts, it is likewise advantageous to provide separate motors for the spindle-drive and for the feed, inasmuch as this measure also affords a simple solution to the problem of protecting the milling machine against overloads generally. With one of these electrically controlled milling machines, in addition to the normal speed-changing gears, this also involves the provision of a reversing clutch and a change-gear. This means an appreciable simplification as against ordinary constructions as a consequence.

How the Control Functions

With reference to the accompanying diagram, the motor "A" of the spindle-drive is connected to a contactor and reversing switch "C", instead of being equipped with a reversing clutch. For starting and stopping this motor, the drum-type controller "D" is utilised. This device contains the contacts for the pilot currents by which the contactor for the spindle-motor "A", and the feed-motor "B" are operated.

Besides this, the contacts for the main current of the feed-motor, and those for the electro-magnetic reversing clutch "G" for the quick-reverse of the table, are likewise actuated. All table movements are controlled by this latter clutch, which is driven by the feed-motor "B" over a

multi-speed reduction gear. In order that it cannot be started unless the spindle-motor is running, the feed-motor is interlocked with the spindle-motor. Regarding the far-end of the reversing-clutch shaft, this is connected to a change-gear for the different motions of the table, i.e. longitudinal, cross-traverse, and up-and-down. In turn, this change-gear is connected with a special switch "E", which distributes the pilot currents to the requisite limit switches "F", that accords the necessary limitations to feed or quick-traverse motions. Where it happens that automatic quick return of the table has to be provided for, it is advisable, at the end of the working stroke, to brake the motor. It is only necessary to add a special contact to the reversing clutch "G" for the

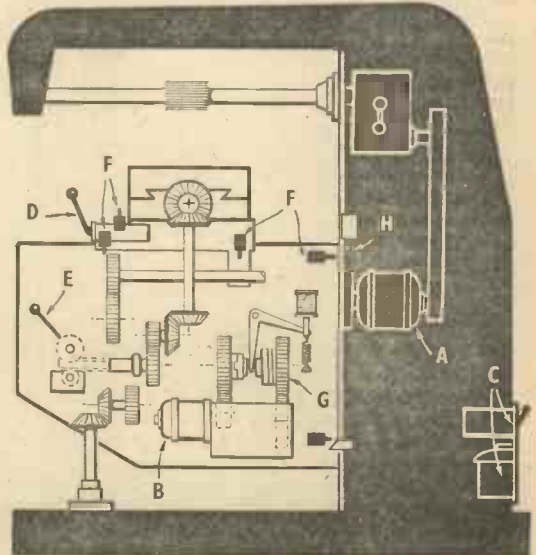

"Automatically Controlled Milling for Complicated Parts." Showing diagrammatically how the milling machine is controlled electrically.

- "A" Motor of spindle drive.
- "B" Feed motor.
- "C" Contactor and reversing switch.
- "D" Main controller.
- "E" Switch for adjusting motion of table.
- "F" Limit switches.
- "G" Reversing clutch.
- "H" Spindle-motor brake.

control of the brake "H", in such circumstances. Without changing the construction of the feed-motor drive, it is possible to provide for automatic quick traverse in either direction, or for intermittent feed, by similar means. The further advantage of providing adequate protection of the machine against overloads is attained by installing separate motors for spindle-drive and feed.

Machine Protection Afforded, Advantages, and Alternatives

Although today it is common practice to provide the motors with protective switches, the question as to whether it is not more important to protect the machine itself appears at times to have been given somewhat scant attention. Compared with the costs of electrical equipment, the first cost of the machine, its renewal, and maintenance costs, are frequently appreciably larger.

Apart from this, the parts of the power transmission are liable to be severely damaged if unduly overloaded, and which relates to the feed-gears and other transmissions on a machine-tool, as well as the tools themselves. In respect of a miller equipped with the control system described in the foregoing notes, the following points have to be observed. As in all cases where a separate motor has been provided, when, for example, the milling cutter has got jammed in the work, it is possible to stop only the feed-motor with the assistance of a suitable electro-magnetic cut-out.

While the cutter can then work itself free, there is no danger of the teeth breaking when the feed is re-engaged. The spindle-drive is stopped by a

special relay only when the overload persists. Added to this, it is also possible to arrange matters in such a way that the feed-motor is not stopped altogether, but made to run at a reduced speed. In this case it is necessary to employ a pole-changing alternating current motor, or a variable-speed direct-current motor. With reference to the relay by which otherwise the feed-motor is cut-out, this is then used for operating an automatic pole-changer, or the regulating resistance of the direct-current motor unit. The high rate of feed is then re-engaged by means of push-buttons, when the cause of the overload has been removed. Amongst the advantages offered by this layout are that accidental interruptions of work are restricted to a minimum of time, while the tools themselves are treated with due care. It might not be amiss to mention that an alternative protective design has been introduced which solves the difficult problem of protecting a drive by several spindles connected to one common motor unit.

All individual spindles are fitted with overload couplings comprising two flanges, and where a spiral spring provides the connection. What force is exerted by this latter item corresponds to the maximum torque to be transmitted, and the two flanges are equipped with contacts. These remain in touch so long as there is no relative angular displacement of one flange against the other, and should an overload occur, the contact is interrupted, and by a relay, the motor is automatically stopped. While this protective design affords an alternative, the former arrangement appears to have been most widely utilised.

SHEET METAL DETAIL FITTING - By Benchman

THE basic method of determining the size of sheet metal fitting is all too often a matter of cutting off a length, making a particular fitting and then cutting off and scrapping the excess material.

The object of this exercise is to provide in an elementary and progressive manner a general knowledge of marking off metal to the correct dimensions before the job is started.

The following method, dealing with a simple bend, is not therefore intended for skilled persons only, but also applicable to Do-It-Yourself enthusiasts.

The main consideration in working sheet metal fittings is to make the correct allowance for "Bending Allowance" and so avoid undue stresses and possible fracture of the metal, resulting from the formation of acute angles.

Since the bending of sheet metal compresses on the inside of the bend and expands on the outside of the bend, a neutral point, the centre (or half the

thickness) of the gauge of the material is taken for the purpose of calculating bending allowance.

Supposing you require a 1in. sheet metal fitting in the form of a right angle bracket made from 16 gauge sheet metal (0.064in.) and assume the radius of the bend is twice the thickness of the material.

First you find the dimensions of the two sides "N" and "O" and then the "Bending Allowance" (B.A.). The sum of these is the total length of material required where "R" is the radius and "G" is the gauge (thickness) of the material.

To find N side

$$N = M - (R + G) = 1\text{in.} - (.128\text{in.} + .064) = 0.808\text{in.}$$

To find O side

$$O = P - (R + G) = 1\text{in.} - (.128\text{in.} + .064\text{in.}) = 0.808\text{in.}$$

$$N = M - (R + G) = 1\text{in.} - (.128\text{in.} + .064\text{in.}) = 0.808\text{in.}$$

To find bending allowance B.A.

$$B.A. = 2\pi(R + \frac{1}{2}G) \times 90/360 = 2 \times 3.1416\text{in.}$$

$$(.128 + .032) \times .25\text{in.} = .251\text{in.}$$

Total length of material

$$= 0.808\text{in.} + 0.808\text{in.} + .251\text{in.} = 1.867\text{in.}$$

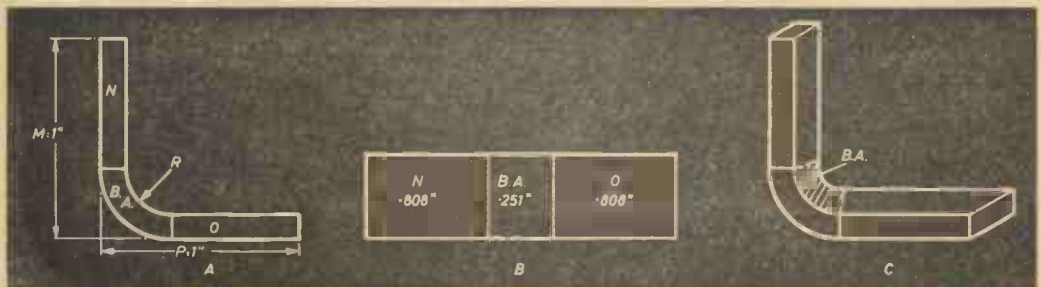

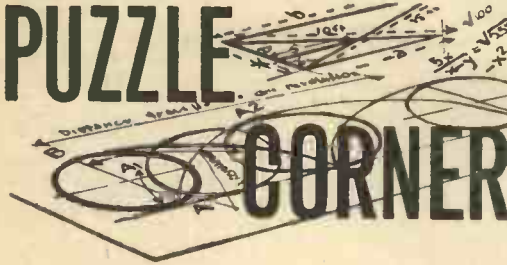

1.—Party Bill

A PARTY of people went out to lunch and their combined bill came to £5 14s. 1d. Assuming that each person paid the same amount and that nobody paid an odd half-penny, how many were there in the party?

2.—The Cyclists

ROBINSON cycles at 10 m.p.h. up hill, 20 m.p.h. down hill and 15 m.p.h. on level road. Jones keeps up a steady pace of 15 m.p.h. If they both cycle from Derby to Nottingham—a rather hilly ride—and back again, which will do the double journey in the shorter time?

3.—The Share Out

A MAN divides a number of pound notes among his sons. To the eldest he gives a pound note and 1/7th of the remainder, to the next son he gives two pound notes and 1/7th of the remainder, to the third three pound notes and 1/7th of the remainder, and so on. If all the sons get the same amount of money, how much does the father distribute and to how many sons?

4.—Fraction

A CERTAIN number can be added to both the numerator and denominator of the fraction $\frac{27}{267}$ so that the result is $\frac{1}{2}$. What is the number?

Answers

1.—£5 14s. 1d. is equal to 1,369 pence and 37 its factor. As this is a prime number there must have been 37 people each paying 3s. 1d.
 2.—Jones will arrive before Robinson for, even were the journey entirely down hill one way it would be up hill the other, and Robinson's average speed, except on the level, is 13½ m.p.h.
 3.—He divides £36 among his six sons.
 4.—The number is 213 which makes the fraction $\frac{240}{480} = \frac{1}{2}$.

Channel Tunnel Project
(Concluded from page 514)

each entrance, where an "eye" will indicate any vehicle exuding too much smoke. Traffic lights, similar to those installed in the "Mersey" tunnel would control branch traffic, if more than one exit or entry port is planned.

At the marker buoy, use of a small ship would be ideal, as would it house the crews of units caught in any sudden bad weather or squalls. Once the unit is under water, the fury of a storm is scarcely felt but the boarding of a unit during a strong gale could present unnecessary risk to human life.

Depending on the size of the "manufacturing plants", the speed with which "connections" are made will vary, but a 24-hour tour of duty is envisaged and completion of the crossing well under two years. While the actual crossing is being made, the installations and building of the channel ports can be completed, even to the connection with the tunnel proper.

In the event of hostilities, the protection of the tunnel would not entail extensive protection, buoyed and anchored boom nets could be hung over the most pregnable parts of the tunnel and with the addition of minefields, attacks from the air or submarines could be nullified.

The natural eddying of currents caused by the presence of such a structure, would eventually cause the project to become silted over with sand and mud. The ventilation buoys can be protected and during peacetime, of course, carry signals for safe ship navigation. Overhauls of such buoys could be carried out by merely pulling in the faulty unit into the hatch, where once pumped dry, technicians can work on comparative "dry land".

I have suggested a multiple series of rail lines for the lower section, anticipating that diesel motive power be used for the engines, thus reducing excessive atmospheric pollution. The possibility of a Hover rail craft could be satisfactorily included, especially for the actual channel crossing, readers may remember the article on this type of transport in a recent publication of *Practical Mechanics*. The cleansing of the tunnel would need attention, but the construction of a special vehicle to wash down the walls, with the help of brushes and modern detergents would be no difficulty, the surface of the tiles used in the lining of the tunnel, being of highly polished nature, would eliminate any cleansing problem.

Readers will note that there is very little man-handling of equipment in this project, all materials are carried direct to the working face and all plant to be re-used is directed back to base. There are no millions of tons of earth, rock and rubble to be "carted" out from a manually dug tunnel, no need for risky earth falls, miners and underground explosives, in fact it is the extremely simple method that makes this project, I have suggested, to be so practical.

Expenditure, as I have already mentioned, although varying with the rising costs, is still considerably less than of any other suggestion and even now stands at £90 million approximately.

The assets of this plan, once the tunnel is complete, are that most of the plant can be dismantled and shipped to other sites where a tunnel is being considered i.e., Gibraltar or where large rivers make bridges impracticable. For near at hand ventures, such units as may be needed, could be made and exported from England or France and shipped or towed to the new site. However, the cost of the tunnel can still be lowered by the disposal of these plants.

NEWNES COMPLETE GAS AND ARC WELDER

Gives you the skill
that normally takes
years to acquire

Written by top experts it provides all the specialised knowledge that would normally take years to gain—this means *success* in your work. It explains the theory, methods and techniques used in repair work and construction, and provides knowledge required for examinations. Whatever the job—whether in general engineering, motor or aircraft industry, railway workshop or shipyard, it will help you. Seize this opportunity to judge its value for yourself—send no money—it's yours on free trial!

2 Volumes in dark blue
moroquette and Cark of 14 Data
Charts

Gas Welding and Cutting: Assembly and operation of equipment. Safety precautions. Weldable metals. Rods and Fluxes. Joints and preparation. Welding sheet steel, cast iron, alloy steels, aluminium, magnesium, copper, etc. Hard facing processes. Hand-cutting and machine cutting. Underwater cutting, Oxygen Lance. Oxy-thermic Drilling, etc. Electric Welding and Cutting: Equipment, transformers, generators. Electrodes. Clothing and accessories. Types of joint. Carbon Arc, Atomic Hydrogen and Inert-Gas Welding. Design of Fabricated work. Stud Welding. Automatic Welding. Testing welds by X-ray and Gamma-ray, etc. Useful tables and data.

Plus Free Postal Advice for 2 years

Send now — No cost, No obligation



OVER 500 PAGES
750 Photos, Drawings, Diagrams & Tables

FREE - "Welding Engineer's Pocket Book"
(Value 7/6)

This helpful 300-page book provides quick-ref. tables and data invaluable in your day-to-day work. It is presented free to every purchaser of the set.



To: George Newnes Ltd., 15-17 Long Acre, London, W.C.2

Please send GAS AND ARC WELDER without obligation to purchase. I will either return the work within 8 days or I will send only 10/- deposit 8 days after delivery, then twelve monthly subscriptions of 10/- until the sum of 130/- has been paid. Cash price in 8 days is £6 5s. 0d.

(Tick box applicable)

The address below is:— My Property Rented unfurnished
Parents' Home Furnished Accommodation Temporary Address
BLOCK LETTERS FOR NAME AND ADDRESS PLEASE

Mr., Mrs., Miss _____

Full Address _____

Occupation _____

Your Signature _____

(Parent signs if you are under 21).

This coupon is invalid if not signed and all questions answered. [GA]567/2

NYLON · P.T.F.E.

ROD, BAR, SHEET,
TUBE, STRIP, WIRE

No quantity too small List on application

BRASS · COPPER
LIGHT ALLOYS

ALUMINIUM · BRONZE

H. ROLLET & CO. LTD.

6 CHESHAM PLACE, LONDON

S.W.1. BELgravia 4300

Also at Liverpool, Leeds, Manchester,
Birmingham

THIS BOOK IS FREE!

"How to get
your G.C.E."
AN AUTHORITY GUIDE

A complete up-to-the-minute guide—all you want to know about G.C.E. How, when and where to apply. Subjects & Syllabuses at all levels. Exemptions, Career Requirements. 'No Pass—No Fee' Home Study Courses... how you can get the G.C.E. and choose your own subjects. Send for this unique book today—FREE! School of Careers, Dept. 160, College House, London, W.8.

"NO PASS-NO FEE!"

SURPLUS BARGAINS

Low Speed Motors. Low Voltage Motors and Gearbox, with Two output shafts giving approx. 4 r.p.m., and 16 r.p.m. at 12 v. DC and 6 r.p.m. and 24 r.p.m. at 24 v. DC. Dimensions approx. 7½" x 5" x 3" overall. Each 25/-, post 1/9.
Telephone Handsets. Two in series with battery give two-way intercom. 35/- pair, post 2/3. Mains Motors from 25/-, post 3/-; Low Voltage Motors from 12/6, post 1/6. Battery Charger Transformers 15v. and 9v., 1½ amp., 16/-, post 1/9; Rectifiers to suit above for 6 and 12v. Charging, 6/6, post 1/-. Send 3d. stamp for illus. list of interesting bargains. Money Back Guarantee.

MILLIGAN'S

2 HARFORD ST., LIVERPOOL, 3

INTRODUCING A NEW PORTASS LATHE

3½" x 16" B.G.S.C. bench lathe complete with faceplate, catchplate and backplate, changewheels, etc., flat or vee drive. Complete satisfaction or remittance refunded in full. Ex-works write:

CHARLES PORTASS & SON

Buttermere Works, Sheffield 8
Est. 1889 Cash or terms

YOUR *Queries* ANSWERED

RULES

Our Panel of Experts will answer your Query only if you comply with the rules given below.

A stamped addressed envelope, a sixpenny crossed postal order and the query coupon from the current issue which appears at the foot of this page, must be enclosed with every letter containing a query. Every query and drawing which is sent

must bear the name and address of the reader. Send your queries to the Editor, PRACTICAL MECHANICS, Geo. Newnes, Ltd., Tower House, Southampton Street, Strand, London, W.C.2.

Filmstrip from Negatives

I WISH to make a 35mm. positive filmstrip from 35mm. negative, for projection and I am at a loss on how to proceed with this project.—R. Richards (Glam.).

THE easiest way to make a filmstrip from negatives is to contact print each one singly on to Kodak positive film. This has the speed of bromide paper and can be handled in a fairly bright red or orange light. Exposure times must be found by experiment.

We have found it convenient to feed the positive film from a full cassette to an empty one, leaving just sufficient between to pass over a 2in. x 2in. slide cover glass. The negative is laid on top of the positive film, with the edges lined up, a clear cover glass placed on top and pressure applied at both edges with bulldog clips. A pencil mark is made where the film leaves the full cassette and this is used as a spacing guide by winding on to the empty cassette until the pencil mark reaches the lip. The result will be a strip of positives with about $\frac{1}{4}$ in. of black spacing between the frames. No continuous light source is necessary for this method.

Ceiling Problem

SEVERAL months ago I painted all the ceilings in our house and now find that they have cracked along the joint lines of the plasterboard. Could you please tell me what causes this cracking and is there any remedy?—S. Spencer (Cheshire).

PLASTER board ceilings invariably crack along the joint lines and very little can be done to obviate the problem unless the joints are properly scrimmed with hessian or linen scrim by the plasterer. Even then, they sometimes crack and subsequent vibration in the house plus normal moisture movement will make most fillings drop out sooner or later. Where cracks are an eyesore, lining the ceiling with paper is about the only satisfactory method of repair.

Oilskin Finish

COULD you please tell me how to treat cloth to obtain an oilskin finish.—F Spencer (Co. Durham).

DISSOLVE 1oz yellow soap in 1½ pints boiling water. Stir in 1 quart of boiled linseed oil. When cold, add $\frac{1}{2}$ pint of goldsize. Rub this mixture into the cloth which should be warmed on a board by ironing immediately prior to application of mixture.

Adapting a Microscope

I OWN a large high power microscope and wish to adapt this instrument from its present form (a medical research type) to a metallurgical microscope. The lighting arrangement at present is, of course, provided by a reflector mounted beneath the slide table. Would it be possible to mount a small electric light on the body suitably reflected inside and downwards thus lighting the specimen from the lens side?—H. Taylor (Lancs.).

A LAMP and condenser would give strong illumination. For the purpose mentioned, lamp and subject may be at twice the condenser focal length from the condenser. E.g., if a 2in. focus condenser were used, the lamp would be 4in. from the condenser, and the condenser would be 4in. from the subject (8in. between lamp and subject). The lamp and condenser would need to be in some kind of ventilated lamphouse or case. An iris may be added to cut off light outside the required area. For even illumination, a flashed opal lamp may be used.

Making a Smoke Screen

COULD you please tell me how to make a "smoke screen" and also how to colour it.—R. E. Fursier (Glos.).

DENSE smoke can be made in a metal canister with limited air supply and containing kerosene-soaked rags. Colouring can be effected by adding barium or strontium nitrates to the combustible mixture, according to colour desired.

Wiring Wall Lamps

I INTEND installing wall lamps in my house, is it correct to bury the P.V.C. three core wire into the plaster, or must conduit be fitted?—F. J. Sullivan (Middx.).

P.V.C.-SHEATHED cable may be embedded in the plaster if there is no risk of mechanical damage, as might occur if nails were driven into the wall. It is, however, preferable to run them through conduit.

Removing Creosote Stains

I HAVE a set of drawings for a model tractor and accidentally spilt creosote on them, can you tell me how to remove these stains?—R. Platt (Lancs.).

NOTHING will remove the basic stain; but you can dissolve the main lot of creosote away by immersing the drawings in trichlorethylene.

SUB-MINIATURE CAMERA

(Concluded from page 499)

An alternative is to mount the camera in line with the wider band, as shown in Fig. 6, which means fixing the camera retaining bands across instead of in line and buckling the unit to the leg. In this position the trouser leg can be drawn up a little and the camera used while sitting.

Since it is not possible to gain access to the rear window which shows the negative numbers, small marks can be put on the winding knob to show the angular distance it must be moved to advance the film by one frame at a time. These films are always well over length and any larger gaps between frames caused by differences in the diameter of the roll as it takes up more film are of no account. In any event, some models are fitted with automatic film winding arrangements.

Inevitably there are variations between brands of sub-miniatures which will require the details given above to be modified slightly. However, the principles remain the same and minor points can be amended to suit individual cases. Some useful accessories for taking and processing sub-miniature negatives will be described in a later article, since this type of photography is likely to become extremely popular in the next few years.

A PACKAWAY DARKROOM

(Concluded from page 517)

The Safelight

This is designed round a 7in. x 5in. diffusing filter suitable for bromide papers. The body can be made from thin sheet aluminium, but it will be a good deal easier to use a ready-made container such as a metal sandwich box or an Oxo tin (as illustrated). The ventilator is made of sheet aluminium or tinsplate, supported on four, shaped battens, the tunnel so formed being painted a matt black (or smoked). The base plate and its skirt can be made from plywood or hardboard and glued together; alternatively, they can be cut and bent from sheet aluminium (18s.w.g.). The completed unit is fixed to the frame by means of two O.B.A. bolts which project from the rear. When in place, the securing nuts should contact the earth strip running along the back of the cross-bar. Finally, the connecting plug is fitted into the socket at the back of the junction box. Three lugs can be fixed to the top of the box, allowing the lamp to be suspended from a ceiling fitting if desired, the plug and cord form of connection makes this possible.

If necessary, the unit can be packed flat for storage or transport by uncoupling the safelight, mainlight reflector and bulb and removing the four screws securing the webs of the frame to the uprights.

"Practical Mechanics" Advice Bureau. **COUPON.**
This coupon is available until August 31st, 1962, and must be attached to all letters containing queries, together with 6d. Postal Order. A stamped addressed envelope must also be enclosed.
Practical Mechanics. August, 1962

An exposure timer can easily be mounted on the frame (as shown in Fig. 1) if so desired, and a lead for this purpose can be taken from the junction box.

COMPONENTS REQUIRED

- 2 batten-mounting lampholders.
 - 1 further... batten-mounting lampholder with switch.
 - 1 adaptor plug.
 - 1 three-pin plug (to suit wall receptacle).
 - 2 15W "pygmy" light bulbs.
 - 1 panel-mounting switch, single-pole, single throw, 230V, 3 Amp.
 - 1 7in. x 5in. darkroom safelight filter, diffused (Ilford S No. 902 or equivalent).
- In addition, 2 round tins and 1 box will be required (see text).

LATHE GADGETS

(Concluded from page 487)

When setting up on the cross-slide, check carefully that the blade is dead square across the centre line of the lathe. Any slight angularity here on a deep cut will have the effect of trying to bend the blade more and more as the depth increases, probably breaking the blade before parting off has been completed. The blade shown is $\frac{3}{8}$ in. thick and $\frac{1}{2}$ in. wide. A wider and thicker blade for use on a bigger lathe would need adjustments to be made where necessary to the dimensions given, the same thing applying to this size blade used on a smaller lathe. The main dimensions affected would be the height of the supporting bolt holes up from the cross-slide and, for a wider blade, the length of the clamp plate studs. For a lathe other than the ML7 it might be as well to check the most suitable position for the holding-down bolt hole before drilling.

OBLIQUE DRILLING GUIDE

(Concluded from page 495)

mark for the front edge of the batten. This mark must be just hidden by the batten when it is glued down. The reason for this pressing forward when marking is that the weight of the drill will press back; if you do not allow for this in setting-up, all the angles of drilling will be slightly more oblique than you intended. Similarly, using your plywood templates, mark for the other three battens. Glue the battens in place, and when set insert the holding-screws.

Your guide is now ready for action. It is convenient to leave the axles floating unsecured, as thus the guide can be readily dismantled and put away without any awkward bits sticking out.

SALES AND WANTS

The pre-paid charge for small advertisements is 9d. per word, with box number 1/6 extra (minimum order 9/-). Advertisements, together with remittance, should be sent to the Advertisement Director, PRACTICAL MECHANICS, Tower House, Southampton Street, London, W.C.2.

PERSONAL

INVENTORUS LIMITED

Our team of consulting experts is available to advise and assist you in all technical and commercial phases of the successful development of your inventions.

Write to:

The Commercial Director
INVENTORUS LIMITED
278/282 High Holborn, W.C.1.

PATENTS

PATENTING SERVICES. Advice qualified Agent. C. L. BROWNE, 114 Greenhayes Avenue, Banstead, Surrey.

MODEL PARTS

"EVENING STAR" in 3 1/2" G.

"Wilwau" is completely up to date with the castings for L.B.S.C.'s fine loco. S.A.E. with enquiries appreciated.
W. K. Waugh, 31 Hillfoot Drive, Bearsden, Nr. Glasgow. Bea 2985

HOBBIES

NEWTONIAN TELESCOPE making 6in., 8 1/2in., 11 1/2in. Glass discs. Grinding its. Aluminised Parabolic Mirrors, Optical flats, Ramsden eye-pieces Barlow lenses. S.A.E. for list. L. J. MAYS, 20 Clover Road, Timperley, Altrincham, Cheshire.

WATCHMAKERS

WATCH PARTS

FOR ALL makes of Watches, Tools, Instructional Books, etc., Special Kits for beginners, send 6d. for "Super Bargain Catalogue." T. G. LOADER, (Dept. B), WATCHMAKERS' MAIL ORDER SERVICE, Milestone Road, Carterton, Oxford.

PLIERS

SQUARE NOSE, SNIPER NOSE, ROUND NOSE or SIDE CUTTERS 12/6 Pair

Send for FREE lists now of Watch Materials, Tools, Bracelets, Straps and Watches to:

J. J. LAWSON
95 Godwin Street, Bradford, 1
Tel. 32075

NEW WATCHES, watch movements, Watchmakers' tools and materials, instructional books, etc at unbeatable prices. Also watch repairs undertaken. Send 1/- for Bumper Bargain Catalogue. THE WATCHMAKERS' SUPPLY COMPANY, "Time House," Carterton, Oxford.

HOME BOAT BUILDING

FULLY PREFABRICATED Kits to assemble a boat at home, for two-berth Cabin Cruisers, fast runabouts, canoes, prams. Enterprise Signet sailing dinghies. Leaflets from: WYVERN BOATS (WESSEX) LTD., Milbourne Port, Sherborne.

BROMLEY BOATS, Kits. Mahogany, Silver Spruce. American Boat plans 3d. list. Southlands Road, Bromley, Kent.

WOODWORKING

ANGLIAN RANGE — Saw Spindles, 10in. R/F Sawbenches, 6in. and 8in. Planers, 6in. Sawplanes and Woodworking Lathes. Send 6d. postage for brochures and price list to the East Anglian Trading Company, 5 Guard-ian Road, Norwich, Norfolk, NOR55A.

PHOTOGRAPHY

PHOTO ENLARGER, Castings and Bellows, 35/- per set, S.A.E. for details. V. J. COTTELL, 84a Chaplin Road, Easton, Bristol 5.

PROJECTORS. Home Assembly Kits, all types and sizes and Stereo from £6/2/6. Fan Base Kit, £37/7/6. Opticals, Screens. S.A.E. MARSHALL SMITH LTD., 64 Norwich Avenue, Bournemouth.

RADIO

RADIO, TELEVISION Service Sheets. All types Valves. S.A.E. list. JOHN GILBERT RADIO, 20 Extension, Shepherd's Bush Market, London W12. SHE 3052.

FOR SALE

ASTRO TELESCOPE making. Standard Ramsden push-in eye-pieces, 1in., 1 1/2in., focus, 35/-; with R.A.S. thread, 42/6 each. S.A.E. list. Object Glasses, Newtonian Mirrors, Diagonal Mounts, Focusing Mounts, Altazimuth Mountings and Tripods for refractors and reflectors. W. BURNETT, 99a, West Street, Boston. Lincs.

NUTS, SCREWS & WASHERS. Mixed parcels of 432 parts 2, 4 & 6 BA Steel in round head, cheese head or countersunk 7/-. Ditto brass 9/-, 6, 8 & 10BA. ditto steel 8/6. Brass 8/6. Also other sizes. Send for free list. Over 140 interesting mixed lots and 3,500 "BOBPAKS" (1/- packs). K. R. WHISTON, Dept. SPM, New Mills, Stockport.

METAL MARKING PUNCHES, sizes 1/16in., 3/32in. or 1/8in. Figures 10/- per set. Letters 30/- per set post free. —THEO ELLIOTT & SON LTD., 8 Eldon Street, Sheffield 1.

FREE — LIQUID Rubber Moulding Guide. Send S.A.E., P.P.S., 53 Foljambe Drive, Dalton, Rotherham.

FOR SALE (continued)

CABINET STANDS for 3 1/4in. Lathes. Leaflet. — TELEMATX PRODUCTS, Kimridge, Thorpe Road, Great Clacton.

OXY-ACETYLENE WELDER. Make your own. Instructions 2/6. DRESE-DEENA, The Harrow Way, Basingstoke Hants.

WASHING MACHINE spares, new and second-hand. J & D ELLISON, Barkhouse Road, Nelson.

BLACKSMITHS PORTABLE FORGES!!! Brand new Government from £5/15/- carriage paid. Thousand bargains, catalogue free. GREENS, 61 Albert Street, Lytham.

NEW BARGAIN LIST of 16 M/M SOUND and SILENT FILMS. Hundreds of titles from as little as 10/- per reel. Colour (sound), titles from 30/- per reel. F.A.E. for list please.

8mm. double-run film. 25ft. lengths fast pan (29° sch) or slow pan (27° sch) not process paid, not spooled, 6/6 each. 16mm. ex-government film manufacture date 1957/58, 300ft. tins containing 6 x 50ft. rolls, 30/- each plus 1/6 post. This film is slow pan and can be successfully reversed. Single rolls of 50ft. ditto 8/- ea. plus 6d. post.

2in. Bi-Convex Glass Condensers, 2/6 each, post 6d. Episcopes from £20 each.

Ex A.M. G45 Gun Camera. 24 volt, 2in. fixed focus lens 50 ft. magazine loading, complete with magazine, new £15.0, ditto used £2. Both post 2/6.

Brand new Kodak (ex Admiralty) 7 x 50 Prismatic Telescopes, focusing, in fitted wooden case with binocular eyepiece, fitted filters, cost over £60/due to another huge purchase lower than ever price £4.10s. each, carriage 5/-.

Brand new (ex A.M.) 12 volt 25 amp. batteries. These are R.A.F. general purpose lead acid accumulators. And are similar in construction to normal car battery. Very suitable for cars and vans, will start any vehicle. Never been filled and in original tropical packing. First charge instructions included cost about £10, only £2.10.0 each, carriage 5/-.

All Metal Projector Stands. Lightweight, fold flat when not in use. Model 1. Height 3ft. Table 20 x 18in. Grade 1 £4. Grade 2 £2.10.0. Both plus 7/6 carr. Model 2. As above but height variable between 2ft. 9in. and 3ft. 3in. Platform 21 x 18in. Grade 1 £5, Grade 2 £3. Both carr. 7/6. All are in good condition, used but paintwork is very good on Grade 1 models.

Ex R.A.F. Aerial Film. 9 1/2in. x 300ft. Pan, £3. 160ft., 35/-, 9 1/2in. x 47ft., 3/-, 24ft., 5/-. Ideal for cutting to smaller sizes. Perfect condition. Post 1/6.

Ex A.M. GGS Mark 3 Recorder Camera, 16mm. made by Specto. Latest model with three shutter speeds, 2 or 10 Lps. blomed 1 1/2in. lens F1.9 with iris to F16, 24 volt 50ft. magazine loading, complete with magazine in original tropical packing, absolutely brand new, only £5, post 2/6. Ditto used £3.10.0, post 2/6.

All goods supplied on 14-day money back guarantee.

R. SANKEY Regal Cinema, ATHERSTONE, WARWICKS. Tel.: Atherstone 2220, 3210.

SITUATIONS VACANT

SKILLED PRACTICAL Engineers and Craftsmen are eligible for associate membership of The Institute of Engineers, Practical, 118 Westwood Park, London SE23. Write for details.

A.M.I., Mech.E., A.M. Brit.I.A.E., City and Guilds, G.C.E., etc., bring high pay and security. "No pass—no fee" terms. Over 95% successes. For details of exams and courses in all branches of Engineering, Building, Electronics, etc., write for 148-page handbook free. B.I.E.T. (Dept. 967B), London W8

EDUCATIONAL

"HOW AND WHY" of Radio and Electronics made easy by a new non-maths practical way. Postal instructions based on hosts of experiments and equipment building carried out at home. New courses bring enjoyment as well as knowledge of this fascinating subject. Free brochure from Dept 12, PM, RADIOSTRUCTOR, Reading.

POSTAL TUITION in Technical Drawing, tracing and blueprint reading. Drawing and Design in wood or metalwork for handicraft Teachers Examinations. Details from O PANSELL, 145 The Crossway, Portchester, Hants.

f's MADE

By repairing Radio and TV Sets as a job or as a spare time business. Our practical course will show you the way. No previous experience is required.

SEND FOR FREE BOOK TODAY!

RADIOSTRUCTOR
Dept. G80 READING, BERKS.

ELECTRICAL

SMALL ELECTRIC CIRCULATING PUMPS

for hot or cold water, fish tanks, ornamental fountains, waterfalls, milk cooling, greenhouse watering, pot washers, etc., comprising 120 watt unshrouded type, shaded pole, A.C. motor, coupled to centrifugal die-cast pump. Output 250 g.p.h. Maximum head 8 feet, 220/250 volts. Silent continuous running. New Price £33.0. Post paid.
H. MIDDLETON, 639 ABBEYDALE RD., SHEFFIELD, 7.

ALL TYPES of Electrical Goods at extremely competitive prices, e.g. 5 amp Twin Cable, 35/-, 100 yards. Lampholders 7/- doz. 5ft. Batters 49/-. Quality and immediate dispatch guaranteed. Request list. JAYLOW SUPPLIES, 93 Fairholt Road, London N16. (Tel.: Stamford Hill 4384).

MISCELLANEOUS

SPRINGS, PRESSWORK. Immediate capacity available. ADWIN SPRING LTD., 33 Elwell Street, West Bromwich. Phone: Tipton 1473.

AQUALUNG AND COMPRESSOR Equipment, Ballraces and Miscellaneous Items. Lists 3d. PRYCE, 157 Malden Road, Cheam, Surrey.

FIX IT. Why scrap it? Repairs to anything mechanical. Parts for obsolete machinery. No job too small. Inventors' models. WELL-WORTH PRODUCTS, Ramsbottom, Bury, Lancs.

The SAVOY

4-TRANSISTOR POCKET RADIO

WITH MOVING COIL SPEAKER
NO SOLDERING NO DRILLING NO AERIAL REQUIRED



4 transistors and two diodes in a 5 stage reflex circuit, push-pull output. Full medium wave. Size 6 1/2" x 3" x 1 1/4". Simple instructions and Assembly Tool provided.

75/- Battery 2/3 P/P 2/9 extra. All parts sold separately

or the SAVOY SUPER-3

with 3 transistors and 2 diodes. **47/-** Battery 1/- P/P 2/- extra
Size 4 1/2" x 2 1/2" x 1 1/4"

SAVOY ELECTRONICS LTD.

15 Malden Lane, Strand, London, WC2 (Back of Adelphi Theatre)

NEW POCKET MANUAL

"PRACTICAL STEAM TRAPPING"

New unique guide to correct selection and installation of steam traps for mains drainage, heating systems, process steam units of all kinds; including best condensate-lifting installations. Concise directions; clear illustrations. Copies free on request to:

SPIRAX-SARCO LTD.

(TECHNICAL DEPT.) Cheltenham, Glos.

FOR PRACTICE OR PLEASURE

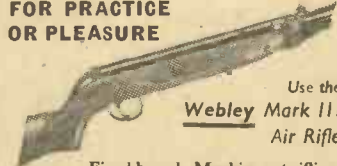

Use the **Webley Mark III** Air Rifle

Fixed barrel. Machine cut rifling. Two models — .22 Sports and .177 Club Target.

Write for descriptive Catalogue.

WEBLEY & SCOTT LTD.
28 PARK LANE, HANDSWORTH BIRMINGHAM, 21

FULL INFORMATION AND OPERATING DATA



Centre, Capstan Turret and Automatic Lathes

NEWNES COMPLETE LATHEWORK

Written and produced to assist the lathe operator to become a highly-skilled craftsman. Subjects include—Differential
2 Volumes and Case of 16 Charts
Free "Turret Lathe Setters' Pocket Book"
2 Years' Free Postal Advice

Yours Free for 7 days

POST COUPON—NO OBLIGATION TO BUY

To: Geo. Newnes Ltd., 15-17 Long Acre, London, W.C.2

Please send *Complete Lathework*. I will return it in 8 days or send 10/- 8 days after delivery then 12 monthly payments of 10/- paying £6/10/- in all. Cash in 8 days £6/5/-.

(Tick ✓ where applicable)

The address below is:—

My Property Rented unfurnished
Parents' Home Furnished Accom.
Temporary Address

BLOCK LETTERS BELOW PLEASE

Mr. _____
Mrs. _____
Miss _____
Address _____

Occupation _____
Signature _____
(Parent signs if you are under 21).

(CL) 568/2
Coupon invalid if all questions not answered

ROGERS 31/33 NELSON ST. SOUTHPORT

- Fibre Washers, 144 Assorted .. . 3/8
- Meter Rectifiers, A.C. to D.C. .. . 3/9
- Sell Tap Screws, 100 Assorted .. . 3/-
- Rectifiers 6 1/2 v. at 6 amps. .. . 18/-
- Winker Units, 6 or 12 volt .. . 8/6
- Motorised Water Pumps .. . 95/-
- Instrument Cases, 12in. x 8in. x 6in. New 7/3
- Telephones, New, Modern .. . 16/-
- Races, Belts, Valves, Pulleys, Pumps, Brass, Steel, Aluminium, etc.

10 PAGE LIST FREE, STAMP PLEASE

THE "ADEPT" BENCH HAND SHAPER
Length of stroke of ram 3 1/2 in.; or No. 2 B.H. model, 6 1/2 in. stroke. Also for Power-drive—extra.

Ask your dealer Manufactured by

The "SUPER-ADEPT" LATHE
1 1/2 in. centres, 8 in. between centres. A good range of accessories is available.

Postage and packing 4/6 (U.K.). The "Adept" 2 1/2 in., 1 1/2 in. B.S.F. 4-jaw independent chuck, reversible jaws.

F. W. PORTASS MACHINE TOOLS LTD.
Adept Works, 141a Nicholson Road, Heeley, Sheffield, 8.

VALTOCK AUTOMATIC ALL PURPOSE BLOWLAMPS

BURN ONLY PURE METHYLATED SPIRIT



The "2000." Ideal for model makers, hobbyists and service engineers for fine delicate work, soft soldering, glass bending, etc.
PRICE 14/7



The "Major." A larger version of the "2000" fitted with flame shield to give large flame; for most big soldering jobs about the house.
PRICE 30/-

The "No. 3." The D.I.Y. man's best friend. Full size, powerful. For paint stripping, heavy soldering and all big plumbing jobs.
PRICE 63/-



Soldering from attachment. Fits the "Major" and "2000". Gives you a soldering iron anywhere—away from electrical supplies.
PRICE 5/-



SLOTGRIP TORSION SCREWDRIVER

Holds screws on the end of the blade

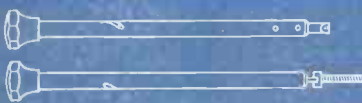

For putting screws in awkward places. Automatic action. Push—it grips. Pull—it's released.
PRICE 5/ 7/6
10" 12/-

See them at your usual suppliers or send for details to:

VALTOCK LTD

REGENCY HOUSE, 1-4 WARWICK STREET,
LONDON, W.1. Telephone: GERrard 1667

GAMAGES

FAMOUS 16" Electric ARC WELDERS!

For joining Ferrous Metals not less than 16 gauge (or 1/16in.) thick, and if necessary, up to 1in. thick by repeat runs after preparations. Robustly constructed throughout. Air cooled. Dimensions approx. 10 x 13 x 8in. Weight approx. 50lb. Incorporates a heavy-duty transformer and is complete with cables, welder's equipment, electrodes and instruments. Will not weld thinner than 1/16in. For 190/2500. single-phase A.C. 10 to 15 amps domestic supply. Runs 16 S.W.G. rods continuously.

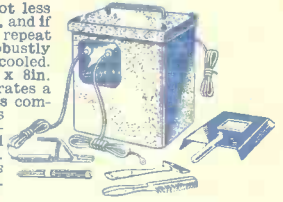

BARGAIN PRICE £15.10.0. or 12 Monthly Payments of 27/3

Part Carr. & pkg. 7/6 in Gt. Britain if outside our extensive van delivery area.

A COMBINED ARC WELDING AND BRAZING MACHINE
New and improved model. Brazes light sheet down to 26 S.W.G.—invaluable for work on car bodies. Even a novice can operate this carbon brazing contact method.
£25 or 12 Monthly 43/9

GAMAGES OFFER

Carr. Paid in G.B.

Sensational Offer! Bright Steel Bolts

at 1/10th Today's Normal Price



All sorts, shapes & sizes. High quality
Hundreds of 2, 4 and 6 BA and 1in. BS7, CSR, Raised, Round and Heads up to approx. 1 1/2in. long. Supplied complete in a strong plastic container 5 x 3 x 3in. with Hinged Type Lid.
GAMAGES PRICE 7/6
Post & pkg. 2/6.

GAMAGES, HOLBORN, LONDON, E.C.1. HOLborn 8484

A JOY TO USE

See it
at your
Tool Shop



Pat. No. 602155.

Cuts through THICK & THIN

Revolutionary in design, robust in construction. Does many jobs an ordinary hacksaw cannot do. Will saw through any thickness without being restricted by the usual hacksaw frame. It's easy and a pleasure to use. An enclosed spring automatically returns the blade after every forward stroke. Blades don't break. No holding pins to get bent or broken. Made for the craftsman—good for a lifetime. **30/9**

FREE Write for illustrated catalogue of complete range of "Leytools"

Leytool

Automatic
HACKSAW

LEYTONSTONE JIG & TOOL CO. LTD.

LEYTOOL WORKS

CROWHURST ROAD, HOLLINGBURY ESTATE, Nr. BRIGHTON
SUSSEX

Also at LEYTON, LONDON

Telephone: BRIGHTON 57011

"EVENING STAR" 2-10-0 CLASS 9

TENDER LOCO FOR 3 1/2-in. G.

DESIGNED BY "L.B.S.C."

Frame steel ...	17/11	Pony King Pin Stay	3/-
Buffer beam angle	2/3	Pump & Rear Frame Stays	8/-
Main horns, hot pressed ...	17/- cet	Pumps & 2 straps	6/-
Main axleboxes ...	18/-	Guide Bar Brackets	6/6 pr.
Bogie wheels ...	4/-	Motion Brackets ...	10/6
Drivers ...	32/-	Brake cylinder stay and brake blocks...	7/6
Cylinder castings (slide or piston valve)	75/-		
Pony Bolster ...	3/-	POSTAGE EXTRA	

A 1/- stamp will bring you a copy of our comprehensive lists with details of blueprints, castings and fittings for many small steam loco's., designed by "L.B.S.C." and other leading designers. Also listed are details of RECOMMENDED workshop equipment (including MYFORD LATHES) all of which is available on the most reasonable OUT OF INCOME TERMS

THE CHOICE OF EXPERIENCE

A. J. REEVES (BIRMINGHAM) LTD

416 MOSELEY ROAD, BIRMINGHAM, 12

Telephone: CALthorpe 2554

Free Guide — SUCCESS IN ENGINEERING

One of the following Courses taken quietly at home in your spare time can be the means of securing substantial well-paid promotion in your present calling, or entry into a more congenial career with better prospects.

ENGINEERING, RADIO, AERO, ETC.

Aero. Draughtsmanship
Jig & Tool Design
Press Tool & Die Design
Sheet Metalwork
Automobile Repairs
Garage Management
Works Mgmt. & Admin.
Practical Foremanship
Ratefixing & Estimating
Time & Motion Study
Engineering Inspection
Metallurgy
Refrigeration
Welding (all branches)
Maintenance Engineering
Steam Engine Technology
I.C. Engine Technology
Diesel Engine Technology
Ordnance Survey Dr'ship

Elec. Draughtsmanship
Machine " "
Automobile " "
Structural " "
R/F Concrete " "
Structural Engineering
Mathematics (all stages)
Radio Technology
Telecommunications
Wiring & Installation
Television
Radio Servicing
Gen. Elec. Engineering
Generators & Motors
Generation & Supply
Aircraft Maintn. Licences
Aerodynamics
Electrical Design
Ordnance Survey Dr'ship

BUILDING AND STRUCTURAL

L.I.O.B.
A.M.I.P.H.E.
Building Construction
Costs & Accounts
Surveying & Levelling
Clerk of Works
Quantity Surveying

A.I.A.S.
A.A.L.P.A.
Builders' Quantities
Carpentry & Joinery
Building Inspector
Building Draughtsmanship
Heating and Ventilating

M.R.S.H.
A.R.I.C.S.

GENERAL, LOCAL GOVERNMENT, ETC.

Gen. Cert of Education
Book-keeping (all stages)
College of Preceptors
Woodwork Teacher
Metalwork Teacher
Housing Manager (A.I.Hsg.)

Common. Prelim. Exam.
A.C.I.S., A.C.C.S.
A.C.W.A. (Costing)
School Attendance Officer
Health Inspector
Civil Service Exams.

BECOME A DRAUGHTSMAN — LEARN AT HOME AND EARN BIG MONEY

Men and Youths urgently wanted for well paid positions as Draughtsmen, Inspectors, etc., in Aero, Jig and Tool, Press Tool, Electrical, Mechanical and other Branches of Engineering. Practical experience is unnecessary for those who are willing to learn—our Guaranteed "Home Study" courses will get you in. Those already engaged in the General Drawing Office should study some specialised Branch such as Jig and Tool or Press Tool Work and so considerably increase their scope and earning capacity.



★ OVER SEVENTY YEARS OF CONTINUOUS SUCCESS ★

NATIONAL INSTITUTE OF ENGINEERING

(In association with CHAMBERS COLLEGE—Founded 1885)

(Dept. 29)

148, HOLBORN, LONDON, E.C.1

SOUTH AFRICA: E.C.S.A., P.O. BOX NO. 8417, JOHANNESBURG
AUSTRALIA: P.O. BOX NO. 4570, MELBOURNE

132-PAGE BOOK FREE!
SEND FOR YOUR COPY

This remarkable FREE GUIDE explains:

- ★ Openings, prospects, salaries, etc., in Draughtsmanship and in all other branches of Engineering and Building.
- ★ How to obtain money-making technical qualifications through special RAPID FULLY-GUARANTEED COURSES.

MANY INTERESTING COURSES TO SELECT FROM!

A.M.I.Mech.E., A.M.I.M.I.,
A.M.Brit.I.R.E., A.M.I.P.E.,
A.M.I.C.E., A.M.I.Struct.E.,
A.M.I.Mun.E., M.R.S.H.,
A.M.I.E.D., A.F.R.Ae.S.,
London B.Sc., Degrees.

Fully guaranteed postal courses for all the above and many other examinations and careers. Fully described in the New Free Guide.



THE ACID TEST OF TUTORIAL EFFICIENCY

SUCCESS—OR NO FEE

We definitely guarantee that if you fail to pass the examination for which you are preparing under our guidance, or if you are not satisfied in every way with our tutorial service—then your Tuition Fee will be returned in full and without question. This is surely the acid test of tutorial efficiency.

If you have ambition you must investigate the Tutorial and Employment services we offer. Founded in 1885, our success record is unapproachable.

ALL TEXTBOOKS ARE SUPPLIED FREE
PROMPT TUTORIAL SERVICE GUARANTEED
NO AGENTS OR TRAVELLERS EMPLOYED

Free Coupon

To: NATIONAL INSTITUTE OF ENGINEERING
(Dept. 29), 148-150, Holborn, London, E.C.1.

Please Forward your Free Guide to

NAME

ADDRESS

My general interest is in: (1) ENGINEERING
(2) AERO (3) RADIO (4) BUILDING
(5) MUNICIPAL WORK

(Place a cross against the branches in which you are interested.)

The subject of examination in which I am especially interested is

To be filled in where you already have a special preference.
(2ld. stamp only required if unsealed envelope is used.)



FOUNDED 1885 - FOREMOST TODAY