

PAIN

MAKING A BAROGRAPH

NEWNES

9^D

PRACTICAL MECHANICS

AUGUST 1945

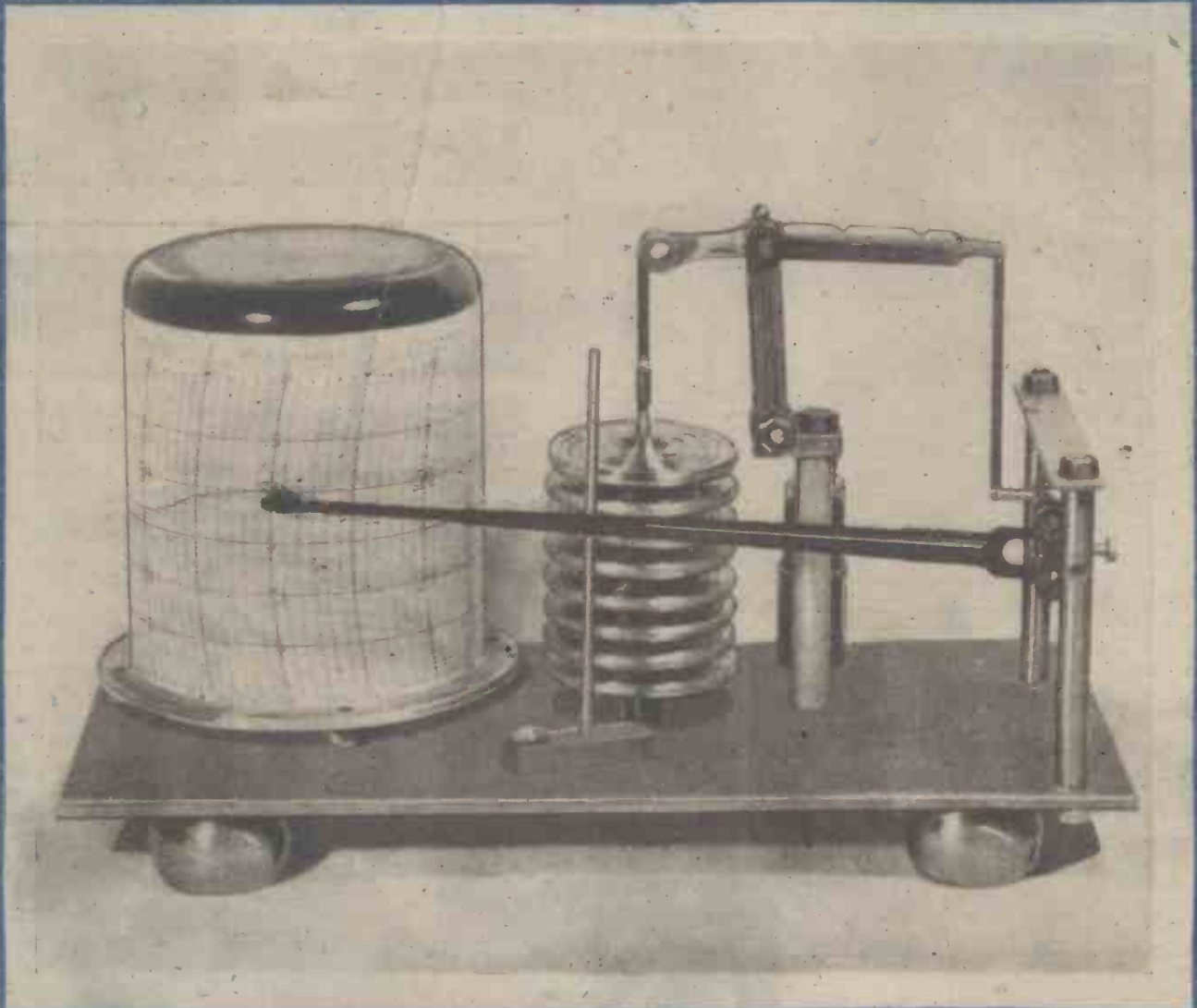

Have YOU Joined the Well-paid Ranks of the TRAINED MEN?

THERE IS ALWAYS A GOOD POSITION FOR THE MAN WITH A SPECIALIZED TRAINING, BUT THERE'S NO WORTH-WHILE PLACE FOR THE UNTRAINED

Ambitious men everywhere have succeeded through I.C.S. Home Study Courses. So also can you. We offer you the benefit of our 54 years' matchless experience as the creative pioneers of postal instruction. Since our establishment in 1891, more than 1,000,000 British men and women have enrolled for I.C.S. Courses.



The man with an I.C.S. Training in any one of the subjects listed below knows it thoroughly, completely, practically. And he knows how to apply it in his everyday work.

Accountancy
Advertising
Aeronautical Engineering
Aero Engine Fitting
Aero Fitting and Rigging
Aeroplane Designing
Air-Conditioning
Architecture
Architectural Drawing
Boilermaking
Book-keeping
Building Construction
Building Contracting
Business Training
Business Management
Carpentry
Chemical Engineering
Civil Engineering
Clerk of Works
Colliery Overman
Colliery Management
Commercial Art
Concrete Engineering
Cotton Manufacturing
Diesel Engineering

Draughtsmanship
(State which branch)
Drawing Office Practice
Electrical Engineering
Engineer in Charge
Eng. Shop Practice
Fire Engineering
Fitting and Turning
Foundry Work
Garage Management
Gas-Power Engineering
Ground Engineer
Heating and Ventilation
Hydraulic Engineering
Joinery
Journalism
Machine Designing
Machine-Tool Work
Marine Engineering
Mechanical Drawing
Mechanical Engineering
Mine Electrician
Mine Fireman
Mine Surveying
Mining Engineering

Motor Engineering
Motor Mechanic
Moulding
Patternmaking
Plastics
Quantity Surveying
Radio Engineering
Radio Servicing
Refrigeration
Salesmanship
Sanitary Engineering
Secretarial Work
Sheet-Metal Work
Steam Engineering
Structural Steelwork
Surveying
(State which branch)
Telegraph Engineering
Telephone Engineering
Templating
Textile Designing
Toolmaking
Welding
Woodworking
Works Engineering

And most of the Technical, Professional, and Matric Exams.

Special terms for members of H.M. Forces and discharged disabled members of H.M. Armed Forces.

If you need technical training, our advice on any matter concerning your work and your career is yours for the asking—free and without obligation. Let us send you full information regarding the subject in which you are specially interested. DON'T DELAY. Make ACTION your watchword.

The successful man DOES to-day what the failure INTENDS doing to-morrow. Write to us TO-DAY

Use this Coupon

INTERNATIONAL CORRESPONDENCE SCHOOLS LTD.

Dept. 95, International Buildings, Kingsway, London, W.C.2.

(Use penny stamp on unsealed envelope)

Please send me particulars of your courses in.....

Name..... Age.....
(USE BLOCK LETTERS)

Address.....



ERSIN MULTICORE SOLDER

contains 3 cores of
non-corrosive Ersin Flux

Radio Experimenters are now able to use "The finest Cored Solder in the World," Ersin Multicore. The three cores of extra active flux ensure speedy soldering and eliminate high resistance of dry joints.

Available from electric and radio shops, ironmongers, etc.

Nominal 1-lb. reels:

13 S.W.G. - 4/10 ea.

16 S.W.G. - 5/3 ea.

Size 2 cartons:

16 S.W.G. - 6d. ea.



MULTICORE SOLDERS LTD. COMMONWEALTH HOUSE,
NEW OXFORD ST., LONDON, W.C.1. Tel: CHAncery 5171/2

MYFORD

Stands for Lathes

Really up-to-date cast iron Stands are available for Myford Lathes. They are sturdy and rigid, and incorporate heavy trays with integral facings designed for each type of Myford bed. Facings, tray undersides and legs are machined to level surfaces.



These Stands can be supplied with or without built-in Motorising Countershaft equipment of special design. This equipment utilizes Vee-rope drive and incorporates a hand lever for tension release; also fine adjustment of tension without resort to spanners.

Vee Headstock Pulleys can be supplied to convert Lathes with flat belt drive.

MYFORD ENGINEERING COMPANY LTD.,
BEESTON, NOTTS.

Phone: 54222/3/4

Good Snapshots are secured by system in developing

Modern sensitized material is so perfectly made and has such a wide range of latitude that you can always be certain of obtaining splendid results if you work systematically.

FOR YOUR NEGATIVES

AZOL

Azol is a concentrated one-solution developer. All you have to do is to add water. With each bottle comes a simple set of Time and Temperature tables for developing plates or films in tanks by daylight, or in dishes in a dark-room. If you use Azol and follow these tables your results will be just right.

FOR YOUR PRINTS

UNIVERSAL

Universal is a concentrated M-Q developer which only needs the addition of water. Used for Gaslight and Broinide prints or for enlargements, it will give you sparkling results. Universal contains two new chemicals—142, for brightening prints and making old paper usable, and 326, which makes for even flowing and does away with airbells.

BOTH OF THESE FINE DEVELOPERS ARE OBTAINABLE AT YOUR DEALERS.

JOHNSON & SONS, MFG. CHEMISTS, LTD.
HENDON, LONDON, N.W.4. ESTABLISHED 1743



Model enthusiasts of all ages to-day 'make do' with their pre-war Bassett-Lowke models; but we promise you that as soon as circumstances allow we shall put into action our plans for making even better scale models that will delight the most exacting. Our staff in London or Manchester would welcome a visit from you and will gladly give assistance on any model matters.

Wartime Stock List (L/12), price 4d., post free.

"Building a 2 1/2 in. gauge Flying Scotsman," fully illustrated. Price 1s.

"How to Build a Traction Engine," illustrated. Price 6d.

"Laying Model Permanent Way," illustrated. Price 3d.

All the above post paid.

BASSETT-LOWKE LTD.

NORTHAMPTON

LONDON: 112, High Holborn, W.C.1.
MANCHESTER: 28, Corporation Street, 4.

THE ALL ELECTRIC HOME OF THE FUTURE

No. 3 THE KITCHEN

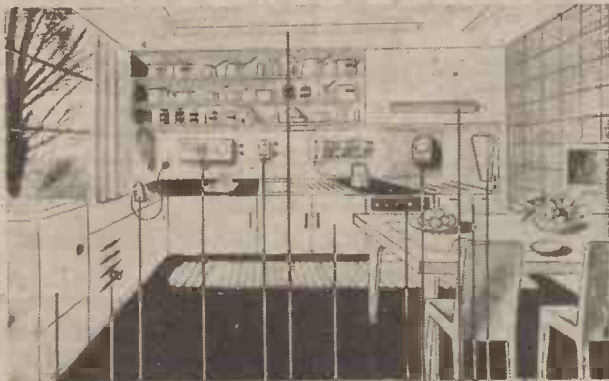

- 1 Electric Refrigerator
- 2 Electric Air Conditioner
- 3 Electric Iron
- 4 Electric Vegetable Peeler and Parser
- 5 Electric Heater
- 6 Fluorescent Lighting
- 7 Electric Dish Washer and Dryer
- 8 Electric Cooker Water Heater and Kettle
- 9 SMITH PRESET CONTROL CLOCK
- 10 Radio Speaker
- 11 Electric Washing Machine
- 12 Electric Scentizer

SMITH ELECTRIC CLOCKS
SMITH'S ENGLISH CLOCKS LTD., CRICKLEWOOD WORKS, LONDON, N.W.3
PLUG IN TO GREENWICH TIME.
Scientific A.B. 30

THIS IS THE VERNIJIGGER

A precision locating instrument

- Simple
- Portable
- Accurate

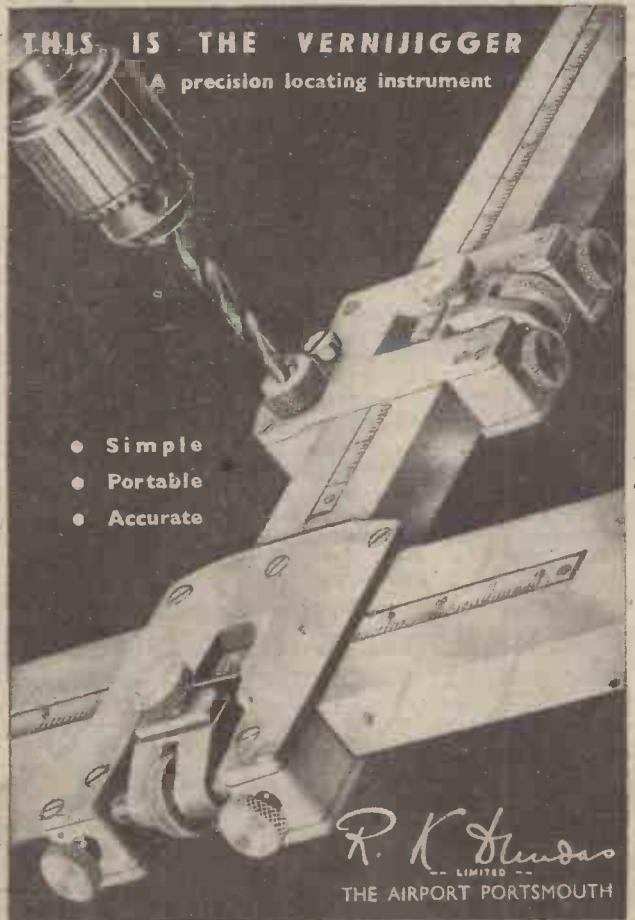

R. K. Hudson
LIMITED
THE AIRPORT PORTSMOUTH

S. TYZACK & SON LTD.

INCORPORATING GEO. ADAMS
"LONDON'S FINEST TOOL SHOPS"

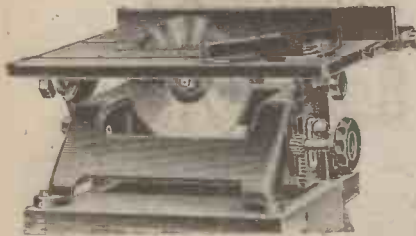

THE NEW "ZYTO" PRECISION BENCH SAW
With Canting and Rise and Fall Table

Rack Feed and Locking Handle. Specially designed for clean and accurate cutting of mitres, angles, etc. Extra long ripping fence, with fine adjustment. Ball-bearing spindle. Clear finish throughout. Table measures 18in. by 14in. Diameter of saw, 10in. Vertical cut, 2 1/2in. Illustrated Leaflet and Price on application.

MOTORISED MODEL, with Motor and Bench Saw

Mounted on one-piece base. Accurately aligned, and complete with Vee belt drive and starter. Illustrated Leaflet and Price on application.

DELIVERY FROM STOCK



THE "ZYTO" COMBINATION HEAD

For Grinding, Polishing, Drilling, Buffing, etc. Heavy construction gunmetal bearings, self centring chucks. Capacity 1 1/2in. Shaft 1 1/2in. x 1in. Height of centres, 6in.

PRICE COMPLETE, 35/-
Calico Mop, 3/- Circular Wire Brush, 5/6, if required.

DELIVERY EX-STOCK

ELECTRIC GRINDERS AND POLISHERS (Double-ended)

1-1 h.p. motors
Complete with Wheels and Polishing Spindle
Full details on request

DELIVERY FROM STOCK

We specialise in Electric Tools
Please Send Us Your Enquiries



S. TYZACK & SON LTD.,

341-345, OLD STREET, LONDON, E.O.1

Telephone: CLE. 4004-5-6



LOG-LOG SLIDE RULE



—priced at 7/6

HARDTMUTH'S meet the needs of the practical mechanic with the range of moderately-priced 'Classic' slide rules. Most popular of all is the 5" log-log rule, illustrated here. Like all 'Classic' slide rules, it is completely accurate, strongly made of seasoned Honduras mahogany, tongued and grooved, and reinforced with flexible stock unaffected by climatic change. The strong, view-free, unbreakable cursor has metal lenses. Inch and centimetre scales on edges.

'Classic' Slide Rule, in strong, pull-off shoulder box with full instructions:

- Series 1—With A, B, C and D Scales—
5" Pocket Model Retail 5/6 each
10" for Desk Use 7/6
- Series 2—With A, B, C, D and Log-Log Scales—
5" Pocket Model 7/6
10" for Desk Use 10/6
- Series 3—For Building and Timber Trade, with Special 3-line Cursor and Explanatory Booklet—
6" Model, with 5" Scales 10/6
- Series 4—With Sine and Tangent Scales—
10" Model 10/6

SOON "KOH-I-NOOR" and "MEPHISTO"—perhaps the two best-known pencils in the world—will be available again.

L. & C. HARDTMUTH (GREAT BRITAIN) LTD.



Temporary Address: 44, Alexandra Road, Epsom, Surrey

OPPORTUNITIES IN PLASTICS

A most informative handbook entitled "OPPORTUNITIES IN PLASTICS" is now available for distribution. This guide discusses in considerable detail the prospect of careers in all branches of the Plastics Industry—knowledge required, salaries, possibilities of promotion, and so on—and explains how you may prepare for these opportunities through our modern home-study courses.

We specialise in Plastics training and our courses are authoritative, up to date and comprehensive. The range of our tuition is wide, covering Elementary Instruction in Basic Subjects, PLASTICS TECHNOLOGY, coaching for the CITY AND GUILDS EXAMINATIONS, and specialised instruction in such specific branches of the industry as:—

Plastics Mould Design, Plastics in the Paint, Varnish and Lacquer Industries, Plastics Costing and Estimating, Plastics for the Aircraft Industry, Plastics for the Electrical Industry, Plastics for the Building Industry, Plastics in Sales Promotion, Plastics in Textiles, Designing in Plastics, Synthetic Rubber Technology, etc.

All courses are conducted under a guarantee of

"SATISFACTION OR REFUND OF FEE"

"OPPORTUNITIES IN PLASTICS" will be sent on request, free and without obligation. The book contains so much useful information and guidance that whatever your interest in Plastics may be, you should make a point of writing for your copy at once.

BRITISH INSTITUTE OF PLASTICS TECHNOLOGY

11, SHAKESPEARE HOUSE,

17, STRATFORD PLACE, LONDON, W.1

Varley ★ 40 YEARS RELIABLE SERVICE TO THE INDUSTRY ★
**POWER CHOKES
TRANSFORMERS
WIRE WOUND RESISTANCES
DELAY SWITCHES**

MADE BY

OLIVER PELL CONTROL LTD
CAMBRIDGE ROW, WOOLWICH, S.E. 18
TELEPHONE: WOOLWICH 1422

YOU MUST KNOW

MATHEMATICS

If you wish to make progress in any branch of engineering, you must know Mathematics. Our specialised method of Home-Study Tuition is a proved success. Hundreds of our students who imagined they could never master Maths have progressed up to the Calculus, and thoroughly enjoyed learning.

Now is the time to increase your knowledge and efficiency, so that you may face the future with courage and confidence.

**T. & C. RADIO COLLEGE,
NORTH RD., PARKSTONE, DORSET**

(Please note new address)

Please send me free details of your Home-Study Courses in Mathematics and Radio.

Name

Address

N. 25

★ Post coupon for free details of our Modern Courses in Mathematics, Radio Reception, Servicing, Transmission, Radio Calculations and Television.

(Post in unsealed envelope—1d. postage.)

Peace will restore
 the pleasures
 of photography with
 still better and
 faster Ilford Selo films

ILFORD SELO
 FILMS



SPRINGS

RILEY
TRADE MARK

by

Riley

ROBERT RILEY LTD.
 MILKSTONE SPRING WORKS, ROCHDALE, LANCS. EST. 1821
 'PHONE: ROCHDALE 2237-8. 'GRAMS: "RILOSPRING."

ON ADMIRALTY, WAR OFFICE and AIR MINISTRY LISTS

CHEMICALS
 REAGENTS, FINE CHEMICALS
SCIENTIFIC APPARATUS

STUDENTS' MATERIALS A SPECIALITY

Write for quotations

CONSOLIDATED INDUSTRIAL RESEARCH
 LABORATORIES, LIMITED,

295, Regents Park Road, Finchley, London, N.3

Precision

HEIGHT GAUGES & VERNIER CALIPERS

Built to B.S.S. accuracy: graduated in 40ths of an inch, vernier headings in 1000ths, or in 1/2 mm. vernier readings in 50ths. Height Gauges: 10 and 18" (English); 25 and 45 cm. (Metric); 10"/25 cm. and 18"/45 cm. (Duplex); Vernier Calipers: 6", 9 and 12" (English); 15, 25 and 30 cm. (Metric) and 6"/15 cm., 9"/25 cm., 12"/30 cm. (Duplex). *6" size also supplied with knife edge jaws, measuring both inside and outside dimensions.

STOCKED BY ALL LEADING TOOL DEALERS.

BRITISH N.S.F. COMPANY LTD.
 KEIGHLEY, YORKS.

London Office: 25 Manchester Square, W.1
 Agents: Stedall Machine Tool Co. 147-155 St. John Street, London, E.C.1. Phone: Clerkenwell 1010 (10 lines)



Tower Tools
 BRITISH MADE

for the
MECHANIC

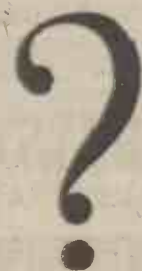

ENGINEERING

OPPORTUNITIES

PREPARE FOR PEACE-TIME COMPETITION

In the more competitive days of peace, technical training will be a vital necessity to the Engineer who wishes to safeguard his position and make advancement. "ENGINEERING OPPORTUNITIES" will show you how to secure this all-important technical training quickly and easily in your spare time. This 100-page book is full of valuable information and explains the simplest way of preparing for recognised Examinations. Among the courses described are :

MECHANICAL ENGINEERING GROUP

A.M.I.Mech.E. City & Guilds General Mechanical Eng. Diesel Engines Draughtsmanship & Trading Works Management Press Tool Work Pattern Making Foundry Practice	Estimating Foremanship Jig & Tool Design Viewing & Inspection Welding Sheet Metal Work Maintenance Eng. Metallurgy Refrigeration
---	--

ELECTRICAL ENGINEERING GROUP

A.M.I.E.E. City & Guilds General Electrical Eng. Alternating Currents Power House Design Traction Mains Eng.	Electricity Supply Electrical Meters Electrical Design Illumination Installations Telegraphy Telephony
--	--

COMMERCIAL ENGINEERING GROUP

A.M.I.P.E. Commercial Eng.	Cost Accounts Languages
-------------------------------	----------------------------

WIRELESS GROUP

A.M.Brit.I.R.E. City & Guilds General Wireless Short-Wave Wireless	Advanced Wireless Radio Servicing Television Talking-Picture Eng.
---	--

CIVIL ENGINEERING GROUP

A.M.I.C.E. Inst. Mun. & Cy. Engineer A.M.A.Struc.E. M.R.San.J. Sanitary Inspector Specifications Structural Design	Road Eng. Hydraulics Municipal Eng. General Civil Eng. Structural Eng. Reinforced Concrete Railway Eng.
--	---

AUTOMOBILE ENGINEERING GROUP

A.M.I.A.E. M.I.M.T. City & Guilds I.A.E. Repair Certificate	General Automobile Eng. Garage Management Electrical Equipment High Speed Diesels
--	--

SURVEYING AND BUILDING GROUP

A.R.I.B.A. F.S.I. A.M.I.H. & V.E. L.I.O.B. F.A.I.	Costing & Valuations Heating & Ventilating Clerk of Works Surveying & Levelling Building (all branches)
---	---

AERONAUTICAL ENGINEERING GROUP

A.F.R.Ae.S. R.A.F. (Maths.) Pilots' Licences Ground Licence	Aero Engines Navigators' Licence Aeroplane Design Meteorology
--	--

UNIVERSITY DEGREES

London Matriculation School Certificate	University Entrance Intermediate B.Sc.
--	---

WE DEFINITELY GUARANTEE

"NO PASS—NO FEE"

If you are earning less than £10 a week you cannot afford to miss reading "ENGINEERING OPPORTUNITIES"; it tells you everything you want to know to make your peace-time future secure; and describes many chances you are now missing. In your own interest we advise you to write for your copy of this enlightening guide to well-paid posts NOW—FREE and without obligation

BRITISH INSTITUTE OF ENGINEERING TECHNOLOGY

410A, SHAKESPEARE HOUSE, 17, STRATFORD PLACE, LONDON, W.1

THE B.I.E.T. IS THE LEADING INSTITUTE OF ITS KIND IN THE WORLD

SUBSCRIPTION RATES

(including postage).

Inland	- - -	10s. 6d. per annum.
Abroad	- - -	10s. per annum.
Canada	- - -	10s. per annum.

Editorial and Advertisement Office: "Practical Mechanics," George Newnes, Ltd.

Tower House, Southampton Street, Strand, W.C.2

'Phone: Temple Bar 4363

Telegrams: Newnes, Rand, London.

Registered at the G.P.O. for transmission by Canadian Magazine Post.

Copyright in all drawings, photographs and articles published in "Practical Mechanics" is specially reserved throughout the countries signatory to the Berne Convention and the U.S.A. Reproductions or imitations of any of these are therefore expressly forbidden.

PRACTICAL MECHANICS

Owing to the paper shortage "The Cyclist," "Practical Motorist," and "Home Movies" are temporarily incorporated.

Editor: F. J. CANN

VOL. XII AUGUST, 1945 No. 143

FAIR COMMENT

BY THE EDITOR

Lessons Well Learnt

THERE are some general lessons to be learnt from the Battle of the Scientists.

Many think that the Germans made a mistake in laying their magnetic mines in penny numbers, giving Britain time to have counter-measures ready before their big campaign the following spring. This, however, was only a small part of their error, because the battle of the magnetic mine had repercussions on the whole position to be taken by science in the British defence organisation. While there were many people who fully realised before the battle that this was going to be a very scientific war, there were many more who had still to learn. The menace of the magnetic mine changed all that almost over-night.

This was surely a new type of war if it introduced weapons which could lie quietly hidden but which would explode if merely approached by a suitable target. Magnetism, which had always been a friend to a sailor, as it gave him a means of navigating his ships, had suddenly turned into a dangerous enemy, not to be fought solely by guns and bravery but by amps. and volts and gauss! Science was in the war.

This lesson of the battle of the magnetic mine was out of all proportion to its technical importance compared with radar, which was a much bigger thing even at that time. The radar battle, if it could by then be called a battle, was surrounded with an enormous wall of secrecy, whereas the menace of the magnetic mine permeated not only everywhere in Service circles, but to the whole British public.

Science and Peace

IT is difficult to recall the atmosphere of those early days in viewing the position now, when science and scientists appear in almost every part of the Admiralty and other Government organisations, far more than they ever penetrated into industry. One of the biggest tasks after the war will be to ensure, as far as possible, that a similar change takes place in circles outside the Services. There are, of course, some industries which are, and have been for a long time, very progressive, but there are still far too many in which the reverse is true. Other Government Departments, whose importance will return with the peace, must also learn to make full use of science in their work.

The lessons of the technical war are just as great for scientists. Men who had never been outside a laboratory learned how to work

in a team with engineers, manufacturers and naval officers. They learned how to make decisions, or how to lay out evidence so that others could make decisions, and they learned how to compromise. They learned to make things happen at a speed unknown to them before, and they drew their satisfaction not so much from the new knowledge that they discovered as from watching the results of the products of their brains at work in the battle of lives in the field. They learned also that specialisation has its weaknesses; that a real appreciation of the fundamentals of science, of its basic laws, its logic and methods of working, is more important than masses of detail. World War II will end with thousands of scientists having quite a new outlook. Will they keep it, and, if so, what will they do?

The answer to this question is plainly before us. This war will give place to another war—a war to win the peace, a war in which the enemies are not nations but unemployment, poverty and all causes of human suffering. Britain and the whole world is looking to science to play its part in the technical battles of peace, just as it has in war. On its record in World War II British science can do it.

Experiments with Explosives

WILL readers please note that we do not undertake to answer queries concerning experiments with explosives and detonating compounds. This is highly dangerous. Very recently there occurred in Manchester the case of a lad of fifteen years of age, a laboratory assistant at the University, who took some sulphur and potassium-chlorate home and ground them together in a mortar. As might have been expected, the compound detonated and the lad was killed. This illustrates the highly dangerous effect of grinding these two otherwise harmless materials together.

Ball Orders

WHILST we are dealing with the matter of queries, may we once again remind readers that our query service is intended to answer questions? It does not undertake to provide illustrated articles, nor to undertake special design work. One reader, the other day, wrote asking whether we could design for him an electric clock, and all of the necessary tools for making it! This is typical of a number of queries we receive, although some do not go quite so far. One reader wanted us to tell how to make a wireless set, whilst another required drawings for a canvas canoe. Such queries are quite outside the scope of a letter.

Search for the Ideal "Flying Wing"

JET-PROPELLED "flying wings"—aero-planes devoid of the normal tail and load-carrying fuselage and vastly more efficient than the best transport planes and bombers of to-day—are envisaged by Sir Frederick Handley Page, head of the pioneer aircraft design and construction company, as the air vehicles of a not distant future.

Successful tailless aircraft should be not only more efficient aerodynamically, offering less "drag" (head resistance) than the orthodox aeroplane, but should solve serious problems arising from the tendency to make aircraft ever more compact and their wings accordingly ever more heavily loaded, involving stronger and heavier wing structures. If, however, the useful load to be carried—crew, passengers, bombs or cargo—can be spread over the span of the wings, the disadvantage of increased weight in the wing structure is minimised. The tailless aircraft, with all its load distributed within the wings, comes into its own.

Numerous difficult problems, particularly of flying control, must be solved before success in this field can be assured. Some of them may be at least partially elucidated through the study of models, a method of technical development adopted by the pioneers of heavier-than-air flight and pursued by enthusiasts ever since. In this belief, Sir Frederick Handley Page has offered £100 in prizes for a competition of tailless model aircraft, to be organised by the Society of Model Aeronautical Engineers.

The contest will take the form of five eliminating contests held in each of the following areas—London, the Midlands, Northern England, Wales and Western England, and Scotland, and a final round for the winners of the eliminating contests at the Handley Page aerodrome, Radlett, Hertfordshire, on September 2nd this year. A prize of £10 will be awarded the entrant of the winning model in each eliminating contest. The winner of the final will receive £50.

Rules and full particulars can be obtained from the secretary of the Society of Model Aeronautical Engineers, 70, Nelson Road, Hornsey, London, N.8.

The Slide Rule Manual

THE Slide Rule Manual, recently published from the offices of this journal at 5s. (by post 5s. 6d.), is a companion work to our "Refresher Course in Mathematics," 8s. 6d. (by post 9s.), and our Vest Pocket Book "Mathematical Tables and Formulae," 3s. 6d. (by post 3s. 9d.).

Making a Barograph

Constructional Details of a Useful Instrument for Home Use

By E. H. JACKSON

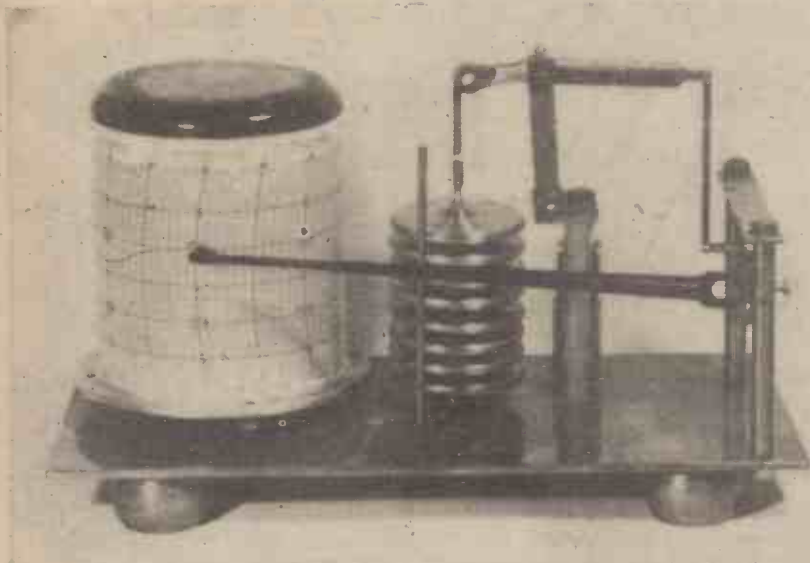

Fig. 1.—General view of the home-made barograph.

THE state of the weather has always been a leading topic of conversation, and at this time of the year when holidays are in full swing it is a cardinal factor. We all welcome the return of the daily weather forecasts, but it is sometimes very useful to have some form of instrument in the home from which we can predict weather conditions in our own particular district. For this purpose there can be nothing more useful and interesting than the Barograph or Recording Barometer. It is superior to the familiar dial barometer since it records the barometric variations hour by hour upon a chart, and we can, from its ever-moving pen, follow the passage of a depression and even anticipate the coming of an anti-cyclone with its fine warm weather.

Such instruments are expensive at the present time costing between £20 and £25, a price which no doubt prohibits their popularity in the average home. Nevertheless, it has been proved by the author that it is well within the bounds of the home mechanic to make a Barograph by doing a little bit of "scrounging" in a motor-car scrap yard where an old dashboard car clock, and a few carburettor levers can be purchased for a few shillings. The only part that need be bought new is the aneroid or capsule stack

costing about £2 10s. It is also cheaper to buy such small items as the recording pen, the recording ink, and the ready printed charts rather than try to make them, since the total cost is only a matter of shillings. A year's supply of charts costs 7s. 6d. from any good class optician, and it is best to buy these first because of the useful data printed along the bottom edge of the chart which will help in the construction of the instrument.

For those readers who are not familiar with the principle of the Barograph, the following brief description is given.

Principle of Operation

The metal capsule

stack is really the heart of the instrument and consists of a series of flexible metal boxes exhausted of air and arranged one above the other in a stack. Variations in atmospheric pressure deflects the corrugated sides of the capsules, thus lengthening or shortening the total stack height in accordance with the barometric pressure.

This movement is only very small being in the region of .030in. per inch rise or fall of the mercury column in a standard barometer. A

system of levers magnifies this small movement approximately thirty times at the pen point. An eight-day clock suitably geared down drives a drum or cylinder one complete revolution in one week. The circumference of the drum is such that a seven-day chart which is ready gummed at one end will just reach once round, and the chart is divided lengthwise into days of the week and hours of the day. The position of the line drawn by the pen upon the chart indicates the barometer reading at any time of the day or night, and it is the peculiar contour and position of this line which gives

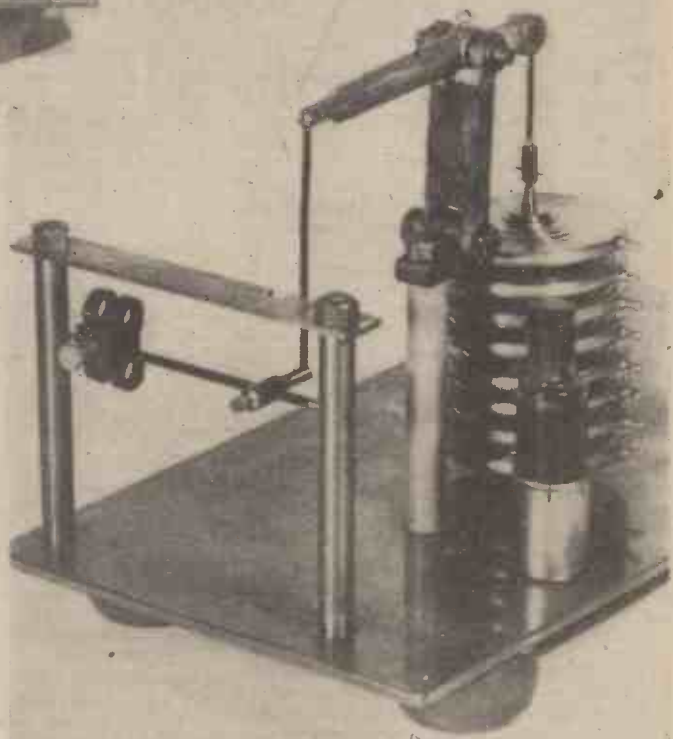

Fig. 2.—Arrangement of lever mechanism showing light clockspring connecting links between capsule stack and top lever, and top lever to pen axle. The alarm clock pivot screws can also be seen. The recording ink bottle is held in a small brass sleeve screwed to the baseplate.

us the weather condition. Thus, a long steady straight line high up on the chart usually indicates settled weather conditions, whereas an undulating line low down on the chart indicates unsettled or stormy weather. A sudden steep drop of the pen will indicate the presence of a deep depression usually accompanied with high wind, and as the pen rises again we know that the depression is passing or filling up. A glance at the chart will show the exact hour when a depression reached its lowest point, and from the rate of rise we can estimate therefrom how soon fair weather may be expected.

Construction Details

It is not proposed to tie down the reader to any fixed dimensions in the construction of this instrument since so much depends upon the type of material which he will be able to improvise for the purpose, but a



Fig. 5.—The chart drum and loose dust cap. The drum is secured to the turntable with the four small tap bolts shown. A shallow recess locates the drum on the turntable.

general outline of its construction together with the illustrations should go a long way to clarify the principal components.

A hole is drilled approximately in the centre of a 10in. x 5in. x 1/4in. brass baseplate large enough to take the threaded end of the capsule stack. Four feet should be either sweated or otherwise secured to the underside of the baseplate which can then be polished to enhance appearance. Three more holes should then be drilled to take the three supporting pillars of the level mechanism. These holes will have to be spaced to suit the type of levers employed, but reference should be made to the pen radius printed at the bottom of the baro-

graph chart. This will most probably be 7.3in. and is in fact the distance from the centre-line of the drum to the centre-line of the two rear pillar holes. These two pillars were made from 5/16in. dia. brass rod turned down at each end and screwed to take 2 B.A. nuts.

The pen axis above the flange of the drum is given on the chart as 1.57in., and this dimension added to the distance from the drum flange top face to the face of the baseplate will give us the height of the pivot screw holes to be drilled and tapped in each pillar. The pivot screws can be obtained from any old alarm clock, and they will be found one in each plate forming the balance wheel bearings.

The pivot screws should be checked for size before the pillars are drilled and tapped and, since the majority of pivot screws are short, it will be necessary to counterbore the pillar nearly half-way through to receive the head of the screw.

A stout knitting needle can be used for the pen axle. Cutting to correct length and carefully grinding the ends to a fine taper point needs a little bit of thinking out, and when the correct length is arrived at it should be trial fitted between the pivot screws which should be adjusted until there is a minimum of end float. The pivoting of the top lever is exactly similar to this except that the axle is much shorter, and the pillar supporting this lever need not be the same design as shown in the illustration. A plain piece of 1/4in. square section

brass bar slotted at the top end to receive the top lever would serve the same purpose. It could be turned down and threaded at the bottom end and secured to the baseplate with a nut on the underside. The ratio of the top lever is roughly 2 : 1 and the dimension from the pivot screw C/L to the C/L of the capsule is 1 5/32in. and from the C/L of the rear connecting link (top) to the C/L of the top lever pivot screw is 2 1/4in.

The short lever connecting the bottom end of the rear link with the pen axle is turned down from a piece of 1/4in. round brass rod. It is secured to the pen axle with a grub screw, and slotted with a fine saw-cut at the other end to receive the rear link (Fig. 2). Actual dimension from C/L of pen axle to C/L of rear connecting link (bottom end) is 1/2in., but exact centres have to be found by experiment to suit the capsule, and it is best to drill a series of small holes in the ends of both the top and bottom levers to allow for adjustment. The pivot pins are made from ordinary sewing needles.

The pen can be purchased complete with detachable "V" type nib and tension spring from the Cambridge Instrument Co., Ltd., and it may be necessary to sweat on a small

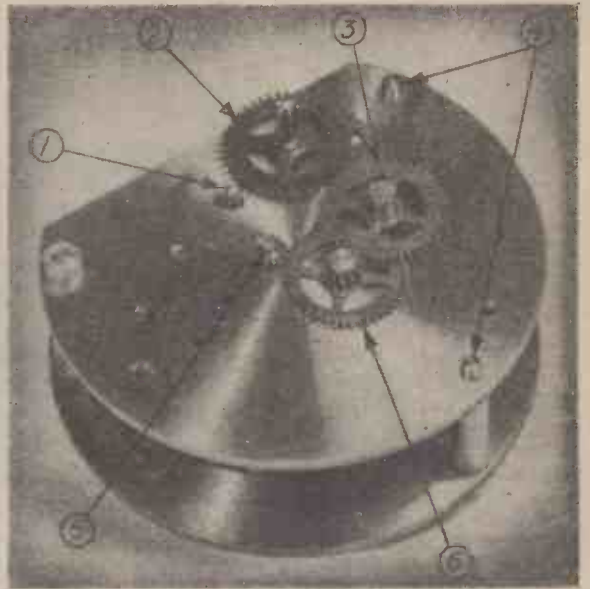

Fig. 4.—General view of Smith's car clock showing modifications to minute and hour wheel positions. 1. Original minute wheel stud. 2. Original hour wheel in new position fitted on long spindle with six-tooth pinion pressed on. 3. Intermediate wheel. 4. Legs 3/4 in. long screwed on to these existing studs to support clock on turntable. 5. Cannon pinion spindle cut short. 6. New position of minute wheel.

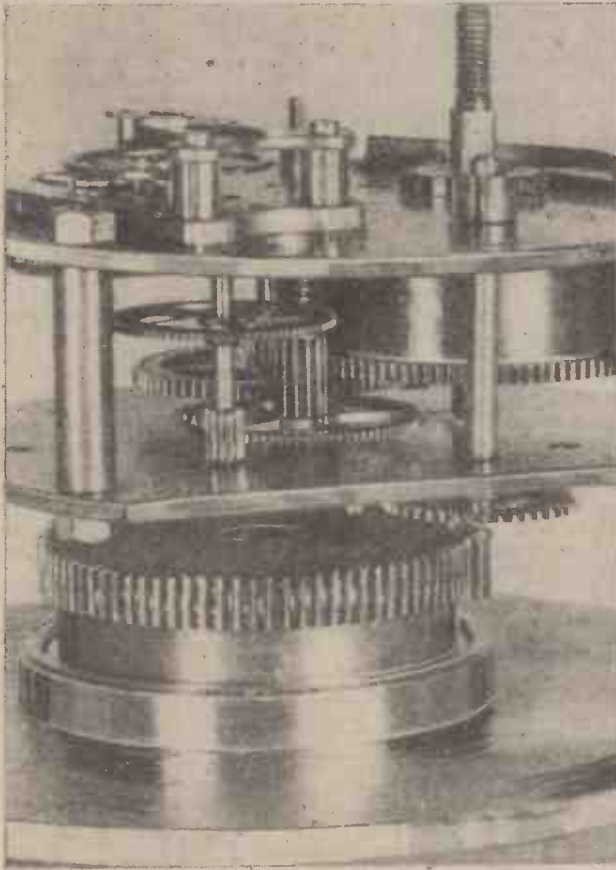
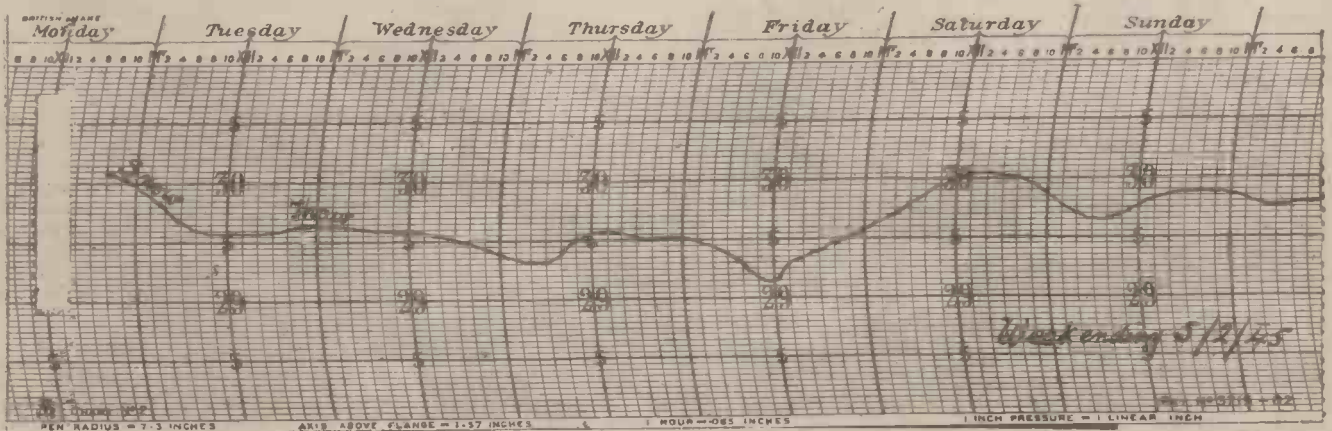

Fig. 3.—Close-up view of drive mechanism showing how the six-tooth pinion driven by the hour wheel meshes with the fixed 84-tooth barrel wheel. Note the long spindle to which the hour wheel is attached held in position with a split collar. One of the ball bearings and part of the turntable can also be seen near the bottom of the picture. Winding of the clock is carried out by fitting a key over the original winder stem when the chart is changed each week-end. (Supporting pillars for the clock cannot be seen on this illustration. See Fig. 6.)



A specimen chart taken from the barograph, showing a weekly recording.

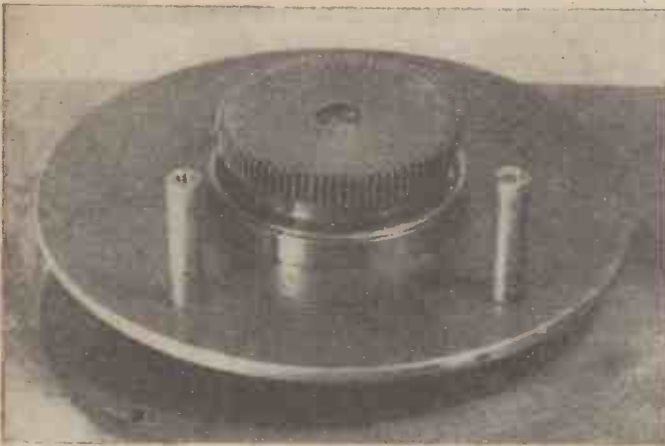

Fig. 6.—General view of the turntable assembly showing the two supporting pillars for the clock.

extension at the nib end (after detaching nib) in order to obtain the required pen radius previously referred to. This all depends on the type of hinge block securing the pen to the pen axle. (See Figs. 1 and 2.)

The Chart Clockwork Mechanism

The driving power for turning the chart drum is provided by an old Smith's eight-day clock as fitted to the dashboard of a 1925 model Morris Cowley car. See that it is in working order before buying from the scrap yard since rough handling may have broken the balance staff. The clock should be taken out of the case and the dial and hands carefully removed. Provided the clock is clean and in working order there is no need to take it to pieces, since it can be used as a complete unit after certain alterations to the minute and hour wheel positions which are on the outside of the clock. Reference to Fig. 4 will show that the minute wheel has been taken off its stud and fitted in a new position. Likewise the hour wheel has been pressed on to a long spindle into which has been fitted a small six-tooth pinion. The long end of the spindle has bearing holes drilled through both plates of the clock in the position shown, and a split brass collar tightly fitted to the tail end keeps it in position endways. An intermediate wheel from almost any old clock is then fitted on to a new stud as shown in order that the drive is transmitted from the minute wheel to the hour wheel. The number of teeth in the intermediate wheel are optional provided it is of the same pitch and that its diameter is about the same as the other two mating wheels.

Chart Drum and Turntable Assembly

The chart drum (Fig. 5) and the clockwork drive are mounted on a small turntable which resembles a large steel washer 3½ in. diameter by ¼ in. thick. The author was perhaps fortunate in finding one about the right size which required very little machining

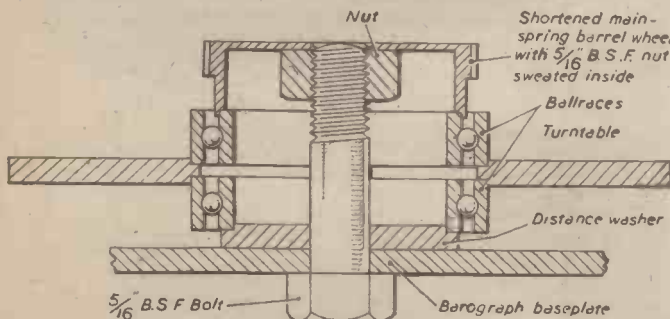

Fig. 7.—General sectional view of the drum turntable assembly showing how the turntable is lightly clamped between two light ball-races.

down. Figs. 6 and 7 show clearly how this large washer is clamped between two light ball bearings. An old mainspring barrel cut down to the required length, forms what might be termed a circular rack around which the clock propels itself. The clock is supported on two brass pillars or legs in such a position that the small six-tooth pinion meshes with the fixed mainspring barrel wheel of 84 teeth. This gives a gear ratio reduction of 14 : 1. Thus 14 revolutions of the hour wheel of the clock make one complete revolution of the drum in exactly seven days.

Mainspring Barrel Wheel

The reader is advised to sort out a mainspring barrel wheel having 84 teeth to start with, then ball bearings should be procured to fit in the manner shown. The turntable washer can be bored out with shallow recesses afterwards to fit the outside diameter of the ball bearings (Fig. 8). A stepped distance washer should be fitted between the barograph baseplate and the bottom ball bearing thick enough to give about ¼ in. clearance between the turntable washer and the baseplate. The whole assembly is clamped together with a 5/16 in. B.S.F. bolt and nut sweated to the inside of the mainspring barrel wheel. The chart drum which sits on the turntable and secured by four 4 B.A. tap bolts was turned down from an old aluminium sleeve found in a scrap yard, but this design need not necessarily be followed. The outside diameter is important, however, and should be 3.460 in. exactly in order that correct time will always be registered on the chart. The dust cover fitting on top of the drum is made from the end cap of a dynamo. But as previously stated, the design of the drum depends on what can be obtained. There is no reason why an old cocoa tin could not be

made to serve the same purpose provided it is the correct diameter. There should be some form of flange at the bottom for the chart to sit on since it is important that the charts are always maintained at the correct height from the baseplate. This flange height can be worked out from the dimension printed along the bottom of the chart, viz., "axis of pen above flange = 1.57 inches.

Pen and Recording Ink

The pen can be made from a length of clock spring tapered down towards the nib end. The thick end could then be sweated on to a small brass pulley with set screw for gripping the pen axle. That used by the author is a ready-made pen which incorporates a tension spring at the wide end of the pen. The detachable nibs are boat shaped and can be bought for a few coppers. It is important that the pen radius 7.3 in. should be kept in mind when fitting the pen, i.e., distance from C/L of pen axle to tip of nib = 7.3 in.

The special recording ink is kept in a little bottle held in a small brass sleeve fixed to the baseplate. The cost is 2s. 6d. per bottle, and it lasts a long time. It is only necessary to replenish the nib about once a fortnight, and care should be taken not to over-fill the pen.

Pen-lifting Bar

A vertical pen lifting bar similar to that shown in the illustration of the finished barograph should be fitted as an additional refinement. This lifts the pen clear of the chart drum when changing the chart each week-end.

A glass case or oval dome to cover the finished instrument is a final refinement that is left to the reader's discretion.

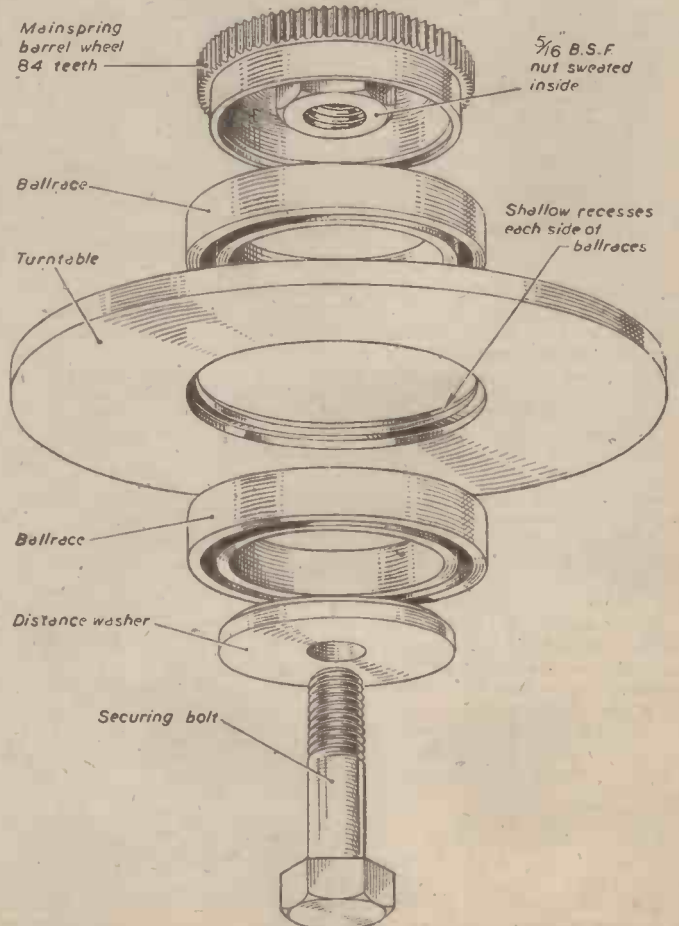

Fig. 8.—Exploded view of the drum turntable assembly.

Recommissioning a Laid-up Car

Some Advice on Taking a Car Out of Storage and Making it Roadworthy Again. Information is Given Regarding the Items which Require Special Attention

By FRANK PRESTON

MANY ex-motorists are now having a completely new experience: that of servicing a car that has been stored for upwards of five years. The experience may be interesting, but it can be rather unpleasant in the absence of advice. The proposition is quite different from that of putting on the road a car which has been stored for one winter, especially if it was put away during the time that the original Pool petrol was in use.

Much depends upon the care that was

exercised when the car was laid up, and those who followed the detailed instructions given in *Practical Motorist* in 1939 and 1940 should not meet many serious difficulties. Those who merely ran the car into the garage, raised it up on bricks and locked the garage door should be very careful that the car is checked over thoroughly before venturing far from home.

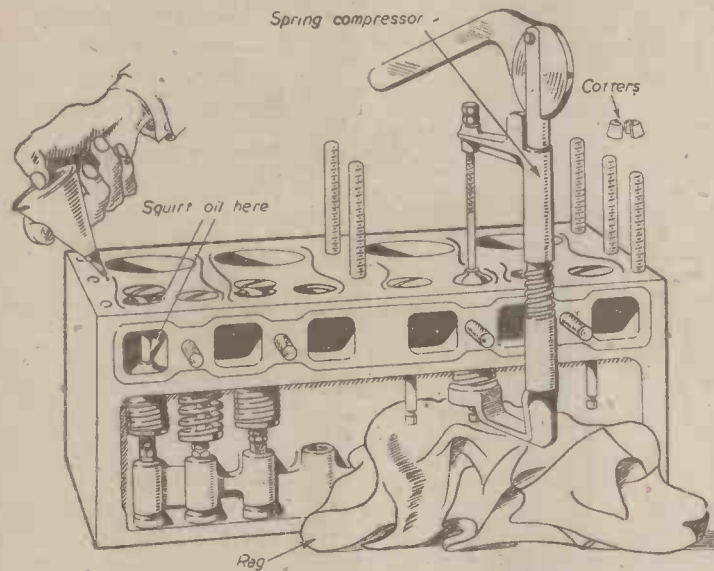

Fig. 2.—This illustration of a partly dismantled four-cylinder side-valve engine shows how stuck valves may be loosened in their guides by injecting penetrating oil round their stems and near the ends of the valve guides. The illustration also shows a valve spring compressed prior to removal of the cotters; the rag is to "collect" any cotters that are dropped.

We will consider the easy case first; where the owner drained the sump and petrol tank, refilled with new oil, poured some Redex or good upper-cylinder lubricant into the cylinders, and turned the engine and transmission over once every few weeks. The same owner would no doubt have removed the battery and arranged for its periodic charging, or have drained it, washed it out with distilled water, allowed it to dry out and then stored it in a dry place.

The first step should be to replace the battery—after charging. In putting petrol into the tank it is a wise plan to "dope" it liberally with upper-cylinder lubricant—say, half a pint to every two gallons of petrol. Petrol can then be drawn into the carburetter

by operating the pump. If an electric pump is fitted it should operate automatically on switching on the ignition. When the pump is of the mechanical type, prime it and the carburetter by using the priming lever fitted to the pump and shown in Fig. 1. While operating the pump depress the float plunger on the carburetter so that free flooding occurs. It is fully justifiable to waste a quarter or even a half-pint of petrol while flooding, because the flow of petrol will tend to clear the valves in the pump and carburetter and to flush the fuel system generally.

Starting the Engine

After waiting for a few minutes for the petrol to evaporate it should be possible to start the engine on the handle. Before attempting this, however, make sure that the crank will turn fairly freely and pour an eggcupful of upper cylinder oil into each cylinder through the plug hole. Turn the crank several times to spread the oil over the cylinder walls. Then start the engine up and allow it to run at a fast idling speed, watching the oil gauge (where fitted) carefully to make sure that the oil is circulating. Allow the engine to run until it is warm—this will take only two or three minutes if the radiator has not yet been filled—and then drain the sump and refill with new oil. After the engine has had time to cool down, fill the radiator. The engine

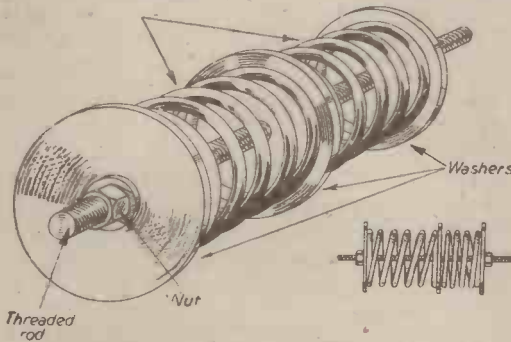

Fig. 3.—How valve springs can be compared by compressing a pair and measuring the compressed lengths of each.

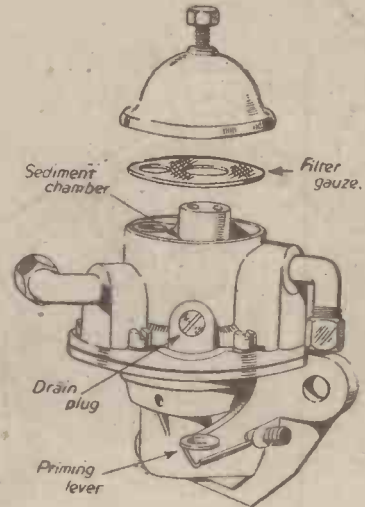

Fig. 1.—A mechanical fuel pump showing how the filter is reached for cleaning, and also the position of the drain plug for the sediment chamber.

should then be in fit condition to be run normally.

With the car still on its "stilts," engage one of the intermediate gears while the engine is running and let in the clutch so that the gearbox and differential are brought into action. Having made sure that those items are in reasonable order, and having checked the oil levels in both, it should be safe to take the car on to the road for a short run. Before getting up any speed check the action of the brakes; it might be too late afterwards! After a run of a few miles, drain the gearbox and axle and fill with the lubricants recommended in the makers' handbook. Then grease all the chassis points and spray the springs with penetrating oil.

If the car is handled carefully for 50 miles or so after that it should be found that little more than routine attentions are required. For example, the dynamo charging rate may be low or erratic, pointing to the need for cleaning the commutator; or the engine may "splutter" occasionally due to dirt or rust from the petrol tank finding its way into the fuel filters. In any case, these filters should be examined and cleaned after the initial run. These points will be dealt with later in this article.

Results of Bad Storage

Unfortunately, there are probably very few cars which will run satisfactorily after the simple and minor attentions described above, for the simple reason that, for one reason or another, the storage was not arranged correctly. Taking the worst case, there will probably be some rusting of the cylinders, exposed (that is, uncovered with oil) parts of the gearbox and rear axle, severe rusting and corrosion of the petrol tank, and corrosion of the valves and valve guides. In addition, the battery will probably be in such a state that either recharging or a new battery will be essential.

Again, it will be logical to start with the engine, and a certain amount of dismantling is advised. Remove the cylinder head and inspect the bores for rusting. It is unlikely that there will be more than a thin film of rust, and this can be removed by rubbing with a muslin cloth soaked in penetrating oil, "Redex," or one of the many high-grade light oils such as "Three-in-One." If the rust cannot be removed in this way, well smear the cylinders with oil, put a fair amount around the piston crowns and turn the crankshaft by means of the starting handle to spread the oil over

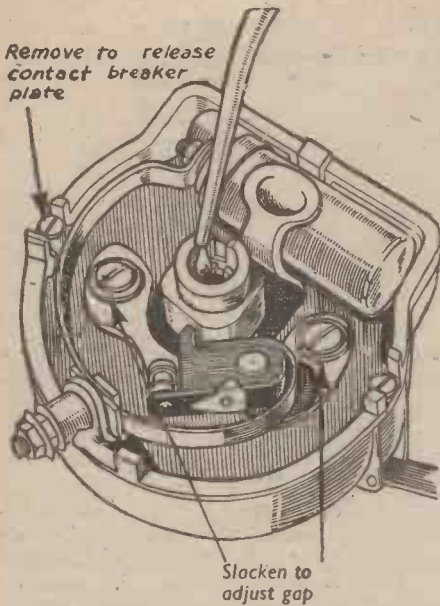

Fig. 4.—Details of a typical contact breaker, showing the points to which attention should be directed.

the cylinder walls. Cover the cylinder block with a clean cloth or newspaper, and give the oil a few hours to soften the rust; then try again.

Valve Corrosion

It may be found that the engine will not turn without applying extreme force—which should be avoided—due to the valves being stuck in their guides. In the case of an o.h.v. engine this can fairly easily be remedied by squirting a fair amount of penetrating or other light oil on the valve stems, removing the springs, and then carefully driving out the valves. With a side-valve engine it is necessary to take off the induction and exhaust manifolds and to squirt oil on to the stems and round the ends of the guides (see Fig. 2). Any valves that stick up and will not seat can be driven down, when the corresponding tappets are at the bottom of their travel, by means of a wooden mallet or a hammer and block of wood. Take care in doing this, or the valve stems might be bent.

After a little patient work on the lines indicated, the valves should gradually free themselves, so that they can be withdrawn. It might in some instances be necessary to place a metal "chock" between the tappet head and valve stem, after removing the spring, in order to raise the valve through its guide.

Once the valves are removed and so placed that there is no doubt as to which was taken from any particular guide, they can be cleaned preparatory to grinding-in. Cleaning will be simplified if the valves are first soaked for an hour or so in penetrating oil or paraffin. The corrosion on the stems and under the heads can be scraped off with a screwdriver or an old knife. After that, the stems may well be cleaned by rubbing them down with a strip of very fine emery cloth, taking care to remove only the surface coating—not the metal.

After thorough cleaning the valves should be ground-in in the usual manner. It is not proposed to explain the method of valve grinding here, since the task is rather apart from that of recommissioning the car.

Valve Springs

It is a good plan to check the valve springs before replacing them. Some may have weakened due to having been kept in a more or less compressed state for a number of years. There is an old and fairly well-known

method of comparing valve springs; that is, by compressing two of them under the same pressure and measuring their lengths. This can be done as shown in Fig. 3 by threading a pair of springs, along with three large washers on a length of screwed rod, and tightening up the end nuts. If any spring has lost its elasticity it should be replaced; alternatively, it might even be thought fit to replace all the springs, especially if they show any signs of rusting.

Ignition Details

After reassembling the engine attention should be turned to the battery and ignition system. It will be assumed that either a new or reconditioned battery has been fitted. Make sure that the connectors are clean and properly tightened up. Smear them with Vaseline after tightening, and then make sure that the earth return to the chassis or scuttle is sound. If the earthing bolt is seen to be rusted it would be wise to remove it and to clean both the bolt and the contact surface of the chassis.

Remove the sparking plugs, and have them cleaned and tested at a garage having a proper sand-blast cleaner and pressure tester. Before replacing the plugs in the cylinder head adjust the gaps to the clearance recommended by the maker of the car. This is important for, whereas 22 thou. is the correct clearance for, say, a Morris, the clearance for some Hillman models is 32 thou., and for certain

centre of the cam. Next set the contact-breaker gap to 12 thou. If the high-tension leads fitted to the distributor show signs of perishing they should be replaced.

See that the connection to the terminal on the side of the distributor is sound, and similarly check the connections to the terminals on the ignition coil.

The Petrol Supply

The fuel system should next receive attention, and it will generally be found that this is one of the most troublesome parts of the car. This is because the original Pool petrol, if allowed to evaporate, left behind a sticky deposit, which affected not only the tank, but also the carburettor and petrol pump. Removal of the petrol tank from the car is to be strongly advised, so that the interior can be inspected and so that the tank can be well flushed with new petrol and penetrating oil.

Drain away the old petrol, and do not even consider putting it back into the tank, for it will cause difficult starting, and perhaps other troubles as well. Keep it for use when

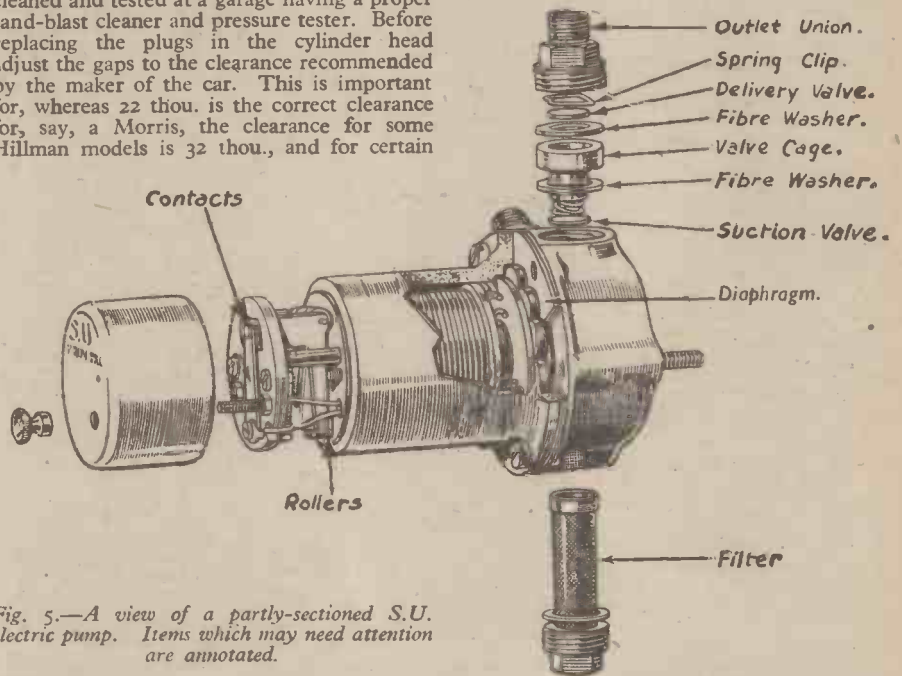

Fig. 5.—A view of a partly-sectioned S.U. electric pump. Items which may need attention are annotated.

Vauxhalls 45 thou.; other makers recommend gaps within these limits.

The distributor cover should be removed and cleaned. In addition, the bakelite plate holding the contact breaker, and shown in Fig. 4, should be removed so that the automatic advance mechanism can be lubricated with engine oil. When this has been suitably lubricated it should be possible to rotate the cam spindle through several degrees in the direction of rotation and, on removing the turning force, the cam should spring back to its original position under the action of the governor springs.

Replace the contact breaker plate, but before fitting the rotor arm apply three drops of light oil to the head of the screw in the

cleaning other parts of the car, such as springs and filters. If the tank is well shaken so that the whole of the interior surface is covered with the petrol-oil mixture, a fair amount of the deposit and rust should be loosened. After swilling round the petrol, leave the tank for a few hours and repeat the process. Finally drain away the mixture used for cleaning; it may be used again if thoroughly filtered.

Fuel Pump

When the tank has been cleaned as well as possible—and after it has been ascertained that the bottom has not rusted to such an extent that it is so thin that it may easily develop a leak—the pump should be cleaned. With an S.U. electric pump the filter can be removed by taking out a brass plug at the bottom of the body part, as shown in Fig. 5. Scrape out any sediment found inside the cylindrical gauze and give the outside a good brushing after soaking the filter in a drop of petrol. It might also be a good plan to remove and clean the valves, which are also shown. The valves are of the flat-disc type, and there is nothing that can go wrong with them unless dirt settles on the seating faces. To remove the valves it is necessary to unscrew the outlet union fitted to the top of the pump body and withdraw the valve cage

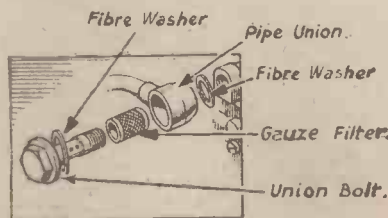

Fig. 6.—The petrol filter for the carburettor is generally fitted in the inlet union.

assembly and the suction valve. These parts can be cleaned in petrol and replaced, taking care that the thick and thin fibre washers are put back in their correct positions above and below the cage.

While dealing with the pump the points of the contact breaker should be cleaned by drawing a strip of thin card between them; while doing this hold the contacts against the faces of the card. Should the contacts be found to be badly pitted and burnt, it would be a sound policy to obtain a reconditioned pump, passing back the old one in exchange.

Having attended to the filter, valves and contacts a rough check can be made of the pump by disconnecting the petrol feed pipe from the carburetter and disconnecting the lead from the pump. Switch on the ignition and hold the connecting tag of the pump lead against its terminal. Petrol should begin to gush from the carburetter feed pipe, the pump continuing to operate as long as the connection to its terminal is maintained.

If the pump does not operate, or if operation is spasmodic, it may mean that the feed pipe from the petrol tank to the pump is blocked or that the pump diaphragm has become hard and stiff. The pipe-line may be cleared, if blocked, by disconnecting it from the pump and blowing down the pipe with the tyre pump. Should the diaphragm have become hard—no doubt due to the action of the old Pool petrol left in the system—the best course is to fit a reconditioned pump. A new diaphragm assembly can be fitted without special tools but this is not an easy matter unless full instructions are to hand, and it may be found that a new diaphragm assembly is not readily obtainable.

Before replacing the pump it will be worth while ascertaining that the diaphragm is not beyond repair. Slacken off the six cheese-head screws which serve to hold the two main parts of the pump together, and loosen the joint between them by moving the solenoid unit up and down. Then switch on the ignition after wedging a match-stick between the two rollers of the contact-breaker assembly and the end plate; this is to hold the contacts together and so ensure that the diaphragm is extended as far as possible. With the diaphragm fully distended in this way, tighten the cheese-head screws. Also make sure that the earthing wire from the terminal on the pump body to the scuttle of the car is making good contact at both of its ends.

The A.C. Pump

Where a mechanical pump is fitted the procedure is different. The filter is in the form of a disc with two holes, and can be removed for cleaning after taking off the domed top of the pump as shown in Fig. 1. There is a recess in the pump body to collect any sediment or dirt rejected by the filter. This should be cleaned out and then flushed with petrol after removing the small drain plug shown in Fig. 1. After cleaning the pump it can be tested, as with the electrical pump, by disconnecting the petrol pipe from the carburetter and seeing that petrol is ejected when the pump is operated. Operation of the pump in this case should be effected by depressing and releasing the priming lever. Failure of the pump will indicate the need for fitting a service replacement. The pump can be removed from the engine by withdrawing the two bolts passing through its mounting flange.

The Carburetter

The carburetter filter should next be cleaned. There is such a wide variety of carburetters in use that specific instructions cannot be given for each type, but in every case the filter is reached after removing the petrol-supply pipe from the carburetter union. One example is illustrated in Fig. 6. It will also be worth while to remove and clean out the float chamber and to see that the needle

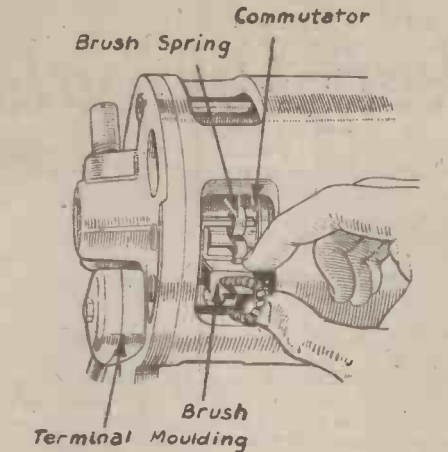

Fig. 7.—The commutator and one of the brushes of a dynamo, as seen after moving the cover clip. A similar layout is used on the starter motor.

valve mounted in the top of the float chamber is free to move up and down. Wash out the chamber and the needle valve assembly with petrol and apply a spot of very light oil to the valve needle.

It may be desirable to see that the carburetter jets are clear, but in doing so it is important that steel wire should not be used. There is generally no harm in using a strand of copper wire provided that undue pressure is not applied and that care is taken that the jet orifice is not enlarged in the slightest degree. Full details of the jet situations and operation cannot be given because of the variety of types. Consequently, before dismantling the carburetter have before you the makers' instructions or, at least, a clear illustration of the particular instrument fitted to your car.

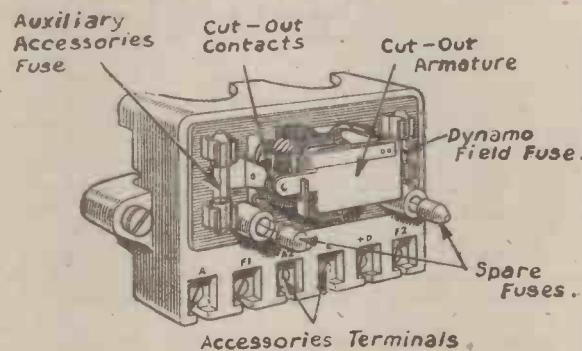

Fig. 8.—A typical distribution box, showing the cut-out and its contacts.

Cleaning the Engine Sump

By this time it should be reasonable to suppose that the engine, ignition system and petrol-supply system are in order. The next step is to drain away any old oil in the sump and to put in flushing oil in such quantity that it reaches the "low" mark on the dipstick. Start the engine and let it run at little more than idling speed for ten minutes, being sure that the radiator is filled with water. Check that the oil is circulating by watching the oil-gauge reading; in the absence of an indication after the engine has run for a few seconds, stop the engine and check over all external oil pipes, looking for any looseness or leakage of oil.

After the engine has run for ten minutes, drain the flushing oil and top up the sump with the correct quantity of oil of the grade recommended by the car makers. As a matter of interest, the flushing oil can be used again at a later date if it is collected through a fine filter. Do not in any circumstances

pour petrol or paraffin in the sump for cleaning purposes.

Flushing Gearbox and Axle

If the engine behaves satisfactorily the gearbox and rear axle can be drained and washed out with paraffin. Then fill to the correct level with new oil to which has been added 12½ per cent. of Redex. The latter special lubricant will help to remove any rust which may have formed and will ensure good "spreading" of the oil over the working surfaces. If rusting is suspected, drive carefully for the first 100 miles and then drain sump, gearbox and axle and refill with the correct lubricants to which Redex has been added.

From this point onward it should be sufficient to give the car the same treatment as one which was stored correctly, except that it may be necessary to repeat the cleansing of the petrol-supply system at 100-mile intervals until all traces of rust and sediment have been removed.

Dynamo and Starter

The commutators of the dynamo and starter motor will require to be cleaned, and it should be ascertained that the dynamo belt is in correct tension. It should not be tight, but should grip the pulleys. This generally means that it should be possible to press in the belt about one inch in the centre of its longest run.

Commutators can be cleaned after moving back the cover clip, by holding a strip of hard felt moistened with petrol against them while the commutator is turned at a moderate speed. If there is any pitting of the commutator, more drastic treatment—with fine emery powder, will be necessary. Unless you have had previous experience of this work it would be wise to entrust the job to an auto-electrician.

See that the carbon brushes slide freely in their guides by raising the pressure springs (see Fig. 7) and moving the brushes backward and forward with the fingers. Any stickiness should be cleared by withdrawing the brush and wiping it over with a cloth dampened with petrol or carbon tetra-chloride (fire-extinguisher fluid). Should any brush be worn down to such an extent that it is not held in close contact with the commutator by its spring, the brush should be replaced.

Failure of the dynamo to charge may indicate that the cut-out contacts, shown in Fig. 8, require to be cleaned. Cleaning can be done in the same way as for the contacts of the electric petrol pump.

By this time the car should be fairly roadworthy, but a close watch should be kept for minor faults over the first few hundred miles. After a little initial running it would be wise to remove the brake drums and dust away from the brakes any rust which may have been rubbed off the insides of the drums. Brake linings and drums should also be wiped over with a cloth soaked in paraffin and then well dried.

**PRACTICAL MECHANICS
HANDBOOK**
By F. J. CAMM
12/6 or by post 13/-
Obtainable from all booksellers or by post from
GEORGE NEWNES, LTD. (Book Dept.),
Tower House, Southampton St., Strand, W.C.2.

Rocket Propulsion

Further Details of U.S. Research : The American Rocket Society and its Affiliates : The United States Rocket Society

By K. W. GATLAND

HAVING covered the work of the American Rocket Society in fair detail; and before going on to review the research of the more recent contemporary U.S. groups, a word about the Society's present-day activities. As might be supposed, war conditions have largely forced the abandonment of any specific technical development programme, and many of the Society's members are engaged on research in the Government laboratories, helping along the rocket's development under the most satisfactory conditions of finance and labour.

Within the Society research is maintained to some extent by theoretical work, occasionally supplemented by small-scale experimentation. It will be readily appreciated that any more extensive practical work carried out by the Society, with its limited resources, would be rather insignificant at the present time, when war sponsored research into reaction propulsion systems is proceeding under conditions which promote large-scale and rapid technical development.

Basis of Wartime Development

The Society's aim throughout its existence has been the encouragement of scientific research and the engineering development of reaction propulsor devices and their application to the problems of transportation and communication, and, in recent times, this has been extended to include the military application of rocket power.

That the American Rocket Society is the most widely renowned group of its kind is no over-statement. In many ways its research has formed the basis for the design of the military rockets which have proved so effective in the hands of the Allied land, air and sea-borne forces, and, in this regard, it should be remembered that while the American group and similar groups throughout the world were struggling along with their researches under most unfavourable conditions of finance, responsible Governments remained apathetic to talk of rockets and reaction flight in general. It is well that so much experimentation had been privately conducted in pre-war years. Had this not been the case the Nazi authorities, quick to realise the rocket's vast possibilities in the work of the free-German *Verin für Raumschiffahrt E.V.*, and whose experiments were commenced years before the outbreak of the war, might well have made the position of the German military forces a far less precarious one.

Affiliate Groups—

There are three rocket groups affiliated to the American Rocket Society, although much of their research is carried out independent of the parent body. Of these, the New York, Westchester Rocket Society, is the most long established, having its foundation in 1936.

In the years prior to its affiliation the group conducted a theoretical study of alighting methods, other than the parachute, suitable for adaption to the rocket projectile. Of the types investigated the gyro-plane type rotor was considered worthy of investigation.

A start was made with the construction of a roft. diameter rotor, and other sizes of

(Continued from page 344, July issue)

varying design were subsequently built and tested in free-flight. These experiments made it clear that the available data concerning the design and theory of the gyro-plane rotor were inadequate for rocket use, and, in consequence, further tests were carried out with the object of determining the effect of dihedral and attack angle changes, as well as wing loading of rotor blades during vertical ascent.

In a report to the American Rocket Society, N. Limber, writer and prominent member of the Westchester Society, has pointed out that when considering efficiency and desirability, the rotor, when compared with the parachute, is somewhat inferior both as regards weight and compactness. In conducting further tests, Mr. Limber says that it is hoped to prove or disprove certain apparent advantages the rotor system may offer, principally decrease in drift, and greater dependability.

Water Cooled Rocket Unit

The group has also designed several liquid-fueled rocket motors. One of these propulsion units, which has reached the construction stage, embodies a in. nozzle constriction, and is one of the largest of its type yet produced by the rocket groups.

The unit, which is built of monel, brass and dural, features a special system permitting the attachment of various liquid oxygen feeding ports. The combustion feed, too, is somewhat unique in that the propellant is first allowed to expand in a mixing chamber, prior to entry into the combustion chamber. Cooling is arranged through the feeding of water from a radial slot, which results in the formation of a protective layer of superheated steam around the inner wall of the firing chamber adjacent to the nozzle "throat."

The Society's more recent investigations have concerned supersonic flow and its effect on the flight efficiency of projectiles.

California Rocket Society

The initial experiments of the affiliate California Rocket Society, like the majority of tests previously described, concerned the powder rocket, its stability and the methods of parachute release. These further trials took place in May, 1941, and again, the powder cartridges were obtained commercially.

A simple beam balance, built by members of the group, served to gain for the experimenters some knowledge of the thrust values of the charges, and this consisted simply of a steel bar, pivoted off-centre, and calibrated by applying various known weights along the free end. During testing, a stop watch was placed close to the thrust indicator and a ciné camera focused on the two instruments.

The initial series of ground trials concerned the standard commercial 8lb. charge with 11/16in. diameter fireclay nozzle, and a first firing recorded a thrust duration of 1.5 seconds. Unfortunately, a fault in the sighting of the camera left the thrust figure uncharted. A second test was made with a rocket charge to which had been fitted a

specially constructed steel nozzle having a length of 2.50in. and a "throat" diameter of 9/16in. When fired, the charge exploded the case after only 0.1 second burning, due, obviously, to the reduced nozzle orifice.

A 3/4in. diameter fireclay nozzle, 2in. in length, featured in the third experiment, but this burned out almost immediately after ignition. A final test was made with an unmodified charge weighing 25oz., of which 12oz. constituted black powder. This fired for an effective period of 2.0 seconds and the scale showed a thrust of 27lb. at maximum combustion. It burned for a further 8 seconds at zero thrust.

Free-flight Research

A month later, experimentation was carried out with powder rockets in free-flight. Each of these was fitted with a parachute, which was packed into a compartment at the nose; the nosing being placed lightly on top. The release action, in this instance, depended upon the "spring" of the parachute's own compression, which acted to throw off the nose cap when the rocket was slowed up at the flight apex.

Several firings were made to test the efficiency of this release method, and quite satisfactory results were achieved; the parachute being ejected at the peak trajectory in almost every instance.

The group later carried out experiments with powder rockets each fitted with a small gyroscope, but due to the very limited burning time of the propulsion charges, the flight results were largely inconclusive.

Conclusion

The firing duration of the 8lb. commercial charge was obviously not adequate for the majority of flight tests. It was further proved inadvisable to modify the standard charge either by the removal of part of the casing, or through the constriction of the nozzle orifice beyond the designed diameter.

Fluid-solid Fueled Rocket Motor

*Unlike the majority of U.S. groups, the California Rocket Society has maintained its technical development programme throughout the war period, and research in the 1943 period concerned the constant-volume rocket motor. Outstanding in this work are several motor developments of a type which employ a liquid-solid propellant, and tests have already shown promise of very high efficiencies in the fully developed version. It is unfortunate that essential details, both as regards design and test results of these units have not been made available for publication.

The Yale Rocket Club is the more recent affiliate group, and its work to date has largely comprised the building and free-flight tests of powder rockets.

The G.A.L.C.I.T. Rocket Research Society

The Guggenheim Aeronautical Laboratory of the California Institute of Technology has established a special section for the development of rocket propulsor systems. In fact, the group's inception dates back to 1936; those chiefly responsible being F. J. Malina and J. Parsons, of the Halifax Powder Company.

During the year of inauguration little of a practical nature was carried out, most of the early work being centred toward gaining a thorough understanding of the subject from the development of known principles and propulsion methods in the light of the more current test results; these, principally due to the American Rocket Society.

In more recent years tests have been conducted of several constant-volume liquid-fueled motors, and also a powder motor, powered by successive impulse.

For the test of such units the group has constructed three proving stands; and the most ambitious of these is shown diagrammatically in Fig. 29. The measurement of thrust reaction in this particular arrangement is achieved through the use of a development of the torsion balance, using heavy feed lines as the torsion member. A lever made up of these tubes supports the motor under test and also extends forward of the torsion member, being balanced by a beam and counterweight. A dial gauge, functioning by an extension on the beam balance, is operated when the thrust of the motor causes rotation about the torsion member.

This system of recording has resulted in the attainment of exceptionally high accuracies; the instruments fitted to the apparatus recording, in addition to the developed thrust, such data as the combustion chamber pressure; propellant feed-line and cylinder pressures; rate of flow of combustibles, and the test duration. The gauges are, of course, ciné photographed throughout the testing period, thereby enabling later study of the results.

Carbon Built, Liquid-fuel Motor

One of the most novel types of several constant-volume rocket motors produced by the G.A.L.C.I.T. is shown in Fig. 30. It is, of course, a liquid propellant motor, and is notable in that all combustion faces are of carbon. In this particular instance, the combustion chamber and nozzle were machined from carbon electrode, and the motor encased tightly within a steel jacket, to which the combustion loads were transmitted. This, consisting simply of a cylindrical liner with plates bolted down firmly at each end.

On test the motor recorded a chamber pressure of 300lb./sq. in. for a period of one minute, and a subsequent examination showed that the nozzle "throat," which originally had a diameter of .136in., suffered only an enlargement of .015in. under the erosion of the exhaust efflux.

Successive Loading Powder Motor

A particularly interesting series of experiments, aimed at the development of a powder rocket motor of the constant-volume type, were conducted by J. W. Parsons, of the G.A.L.C.I.T. Rocket Research Society, and E. S. Forman; the work covering a period of years.

In work of this nature there are, of course, two distinct systems to consider; the slow-burning powder as applied in pyrotechnics, etc., and the rapid burning type demonstrated by Prof. R. H. Goddard. The latter has shown promise of higher efficiencies, and used in conjunction with a suitable motor

and feeding arrangement, it would provide a well controlled and even rate of combustion with a thrust duration effective for periods comparable with the liquid propellant rockets.

The development of an efficient mechanism for the successive injection and firing of small charges is, of course, the principal factor, and many problems are attendant in the design of such apparatus. There must, of necessity, be provided access in the combustion chamber for the entry of the powder charges, and during the individual firings this must be closed, with a gas tight seal. When it is considered that the injecting and sealing action must invariably take place several times a second, the design difficulties can be well appreciated.

The function of this type motor is more in the nature of rapid, individual explosions than a continuous expansion as associated with the more conventional liquid fuel rocket engine. This means that while the heat energy of the powder used is relatively low, the comburant gases are ejected at a considerable velocity, thereby permitting high thermal efficiencies.

Goddard Research

Although Goddard is reputed to have developed an automatic powder motor reloaded by thrust recoil, no performance data has been made available. In the absence of this information, the results of his initial experiments with individual charges are fair indication of the efficiencies attainable. Using a commercial "pistol" powder classified "Infalible" (9.0259 gm. mass) as a single charge

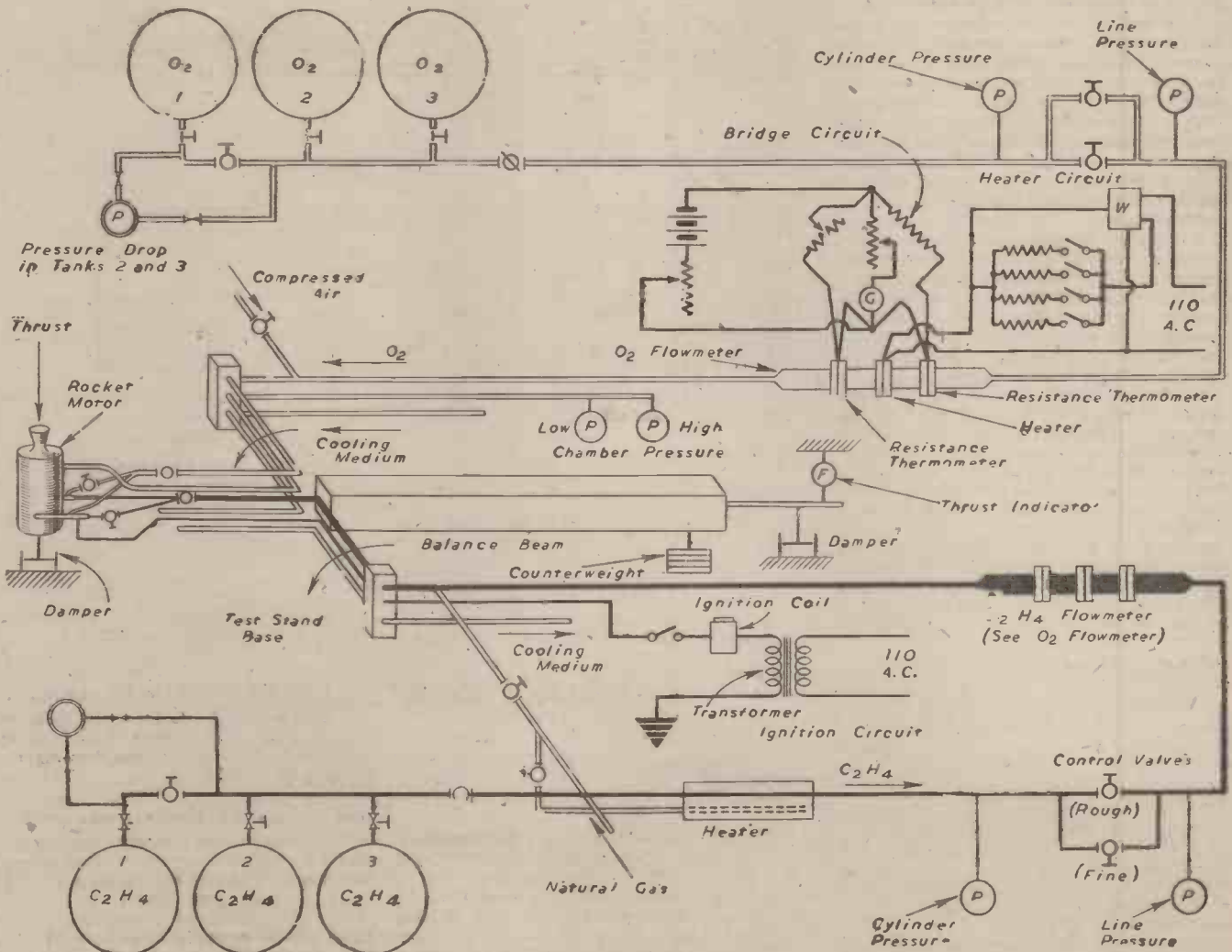

Fig. 29.—Schematic diagram of the G.A.L.C.I.T. rocket motor proving stand (1933).

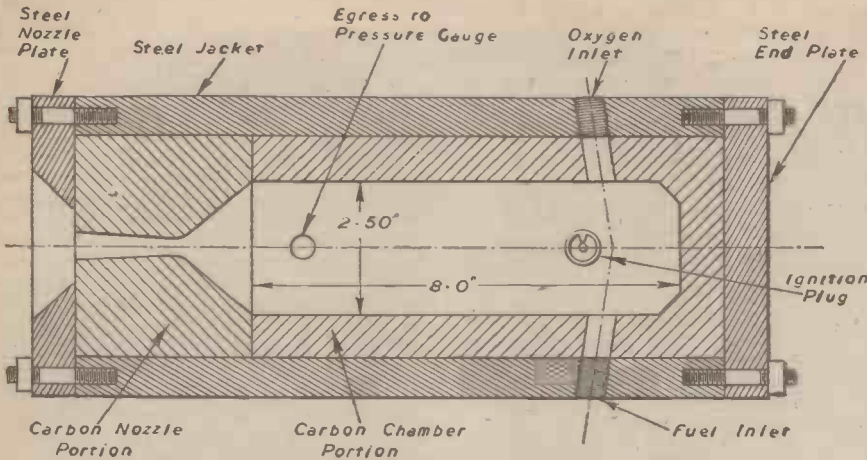

Fig. 30.—Constant-volume rocket motor with firing faces of carbon, produced by the G.A.L.C.I.T. Rocket Research Group, California, U.S.A.

compressed into a small experimental combustion chamber (length of chamber, 2.28 cms.; internal diameter, 2.6 cms.; length of nozzle, 16.29 cms.—de Laval type), proving tests recorded an exhaust velocity of 7,987 ft./sec., and an efficiency of 57.25 per cent. The above figures illustrate the most satisfactory case arising from the use of a well-designed firing chamber, and incorporating an efficient nozzle which permitted optimum expansion of the comburant gases.

More Recent Experiments

The Parsons-Forman preliminary experiments dealt with two single-charge combustion chambers (Fig. 31). These were made in order to gain data of the following all-important factors—(a) The effective exhaust velocity and thermal efficiency of the powder charge rocket obtainable with various powders. (b) The effect of chamber pressure on the thermal efficiency. (c) Methods of varying the chamber pressure. (d) Chamber and nozzle design, and (e) The effect of various methods of ignition and the physical state of the powder.

The original single charge motor, constructed of chrome-molybdenum steel, comprised simply a tube of heavy gauge having a nozzle at one end, and a screwed block at the other. It had a combustion chamber of 1/2 in. diameter and two interchangeable nozzles of 3/16 in. and 1/4 in. diameter "throat" respectively, with a 6 deg. flare angle.

The second motor was similar, though somewhat larger and of increased strength. It had a machined combustion chamber of 1 in. diameter, and a nozzle of 1/2 in. diameter orifice having a flare of 9 1/2 deg. A Ludlum Seminole steel, treated to withstand a tensile stress of 130,000 lb./sq. in., was used throughout.

In the first type, the powder, after its compression in the chamber, was fired by a simple touch fuse, while in the latter model, ignition was performed electrically, and a wad fitted in the "throat" orifice to improve the combustion pressure.

Test Findings

A commercial black powder (Hercules-Lafin and Rand FFG), having a theoretical velocity of 7,900 ft./sec. and nitro-cellulose powder (Hercules "Bullseye" smokeless powder), with a theoretical velocity of 10,600 ft./sec. featured in the testing.

Using these propellants, an exacting series of firings showed that the efficiencies of the test motors compared most favourably with the Goddard single-charge chambers. It was found, too, that an increased jet velocity, and efficiency, resulted from a decreased nozzle diameter, by an increased powder weight, and through the provision of wadding fitted at the nozzle "throat."

These factors, it will be noted, are those which tend to increase the chamber pressure. After repeated firing, using the large chamber, a serious erosion of the nozzle "throat" became apparent, and this resulted in a marked decline of efficiency, and, as might be supposed, considerable fouling was caused by the black powder, which was entirely absent in the use of the smokeless variety. With a well-designed motor, and using a pure fuel compound (nitro-cellulose), ash

high temperatures. The small-grained, rapid-burning smokeless powders are more completely combusted and produce a swifter release of pressure. The duration of combustion, under the prevailing test conditions of smokeless powder, is estimated to lie between 1/5,000 sec. to 1/10,000 sec., which permits kinetic conversion to take place with the minimum heat loss.

More recent work has involved the construction of an automatic injection mechanism, and in addition to providing stand tests, it is hoped to employ this motor for flight research. Participating in this development, the efforts of F. J. Malina and H. S. Taien (both of the G.A.L.C.I.T. Rocket Research Society), Mr. Spade, of the Ludlum Steel Co., and Mr. H. N. Marsh, of the Hercules Powder Co., should not go without mention.

The United States Rocket Society

Although having its formation as recent as 1942, the United States Rocket Society is fast becoming a prominent astronomical body, despite the fact that its present function is purely academic. The group's principal aim during the war years has been the building up of a substantial membership, and this is largely composed of technicians, both of American industry and the armed forces.

Because of war conditions, it has, quite naturally, been found impossible to direct any programme of specific technical development, and in the interim period before practical experimentation is a possibility the coalition

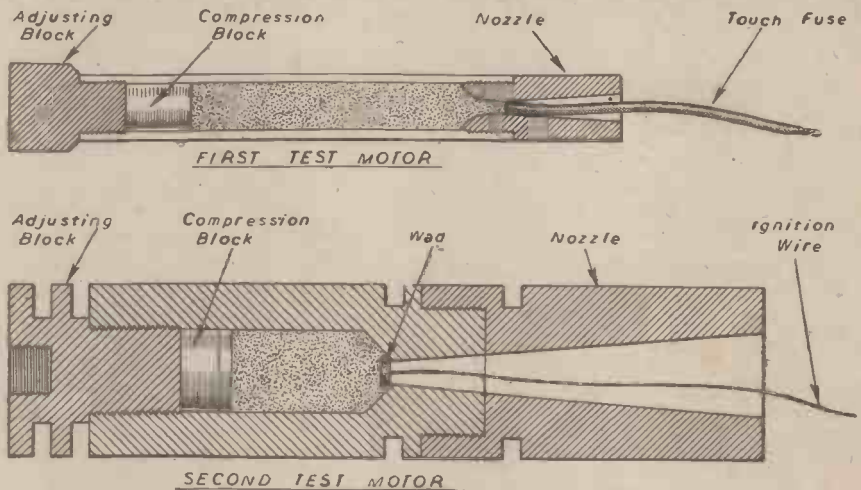

Fig. 31.—Sectional diagram showing the two experimental firing chambers built for the test of "shot" powders (Parsons and Forman, California, U.S.A., 1938).

produced in combustion should only be condensed after the effluent had been ejected from the nozzle.

It is of interest to note that there was no serious heating at any time during the experiments; the motors being only slightly warm to the hand after successive firing. This is accounted to the high speed of gas ejection in that the individual charges did not remain in the chamber for a sufficient period to create

of information and data, the formation of discussion groups, and lecturing, comprises its principal wartime activities.

The founder, Mr. R. L. Farnsworth, has written as a first official work of the Society a review and bibliography, "Rockets—New Trail to Empire." This is a useful reference to the numerous U.S. technical literatures of rocket propulsion, and has undoubtedly done much in the way of publicity for the group.

BOOKS FOR ENGINEERS

- Slide Rule Manual, 5/-, by post 5/6.
- Screw Thread Tables, 5/-, by post 5/3.
- Refresher Course in Mathematics, 8/6, by post 9/-.
- Mathematical Tables and Formulæ (Vest Pocket Book), 3/6, by post 3/9.
- Gears and Gear Cutting, 6/-, by post 6/6.
- Workshop Calculations, Tables and Formulæ, 6/-, by post 6/6.
- Engineer's Manual, 10/6, by post 11/-.
- Practical Mechanics' Handbook, 12/6, by post 13/-.
- Engineer's Pocket Book, 10/6, by post 11/-.

- Motor Car Principles and Practice, 6/-, by post 6/6.
- Wire and Wire Gauges (Vest Pocket Book), 3/6, by post 3/9.
- Dictionary of Metals and Alloys, 10/5, by post 11/-.
- Plant Engineer's Pocket Book, 6/-, by post 6/6.
- Screw Thread Manual, 6/-, by post 6/6.

Published by

GEORGE NEWNES, LTD., TOWER HOUSE, SOUTHAMPTON STREET, STRAND, W.C.2.

Adapting an Epidiascope as a Profile Projector

A Method of Using the Instrument for Checking the Dimensions of Small Component Parts

By D. WILLIAMS, M.Sc., A.Inst.P.

THE checking of the dimensions and shape of small machine parts is often only possible by using a projection microscope or a contour projector. The size and position of the holes in the thin stamping shown in Figure 1 is a typical

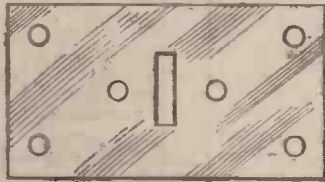

Fig. 1.—A typical example of work which can be conveniently checked in a profile projector.

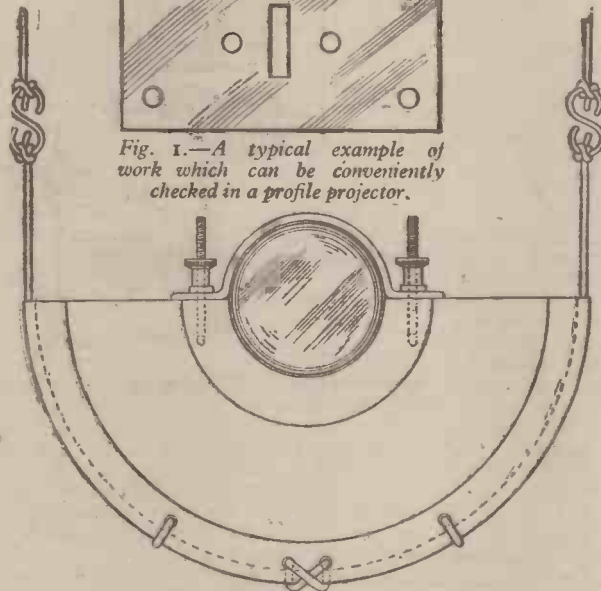

Fig. 3.—The fitting used for clamping to the projection-lens mount.

example of the type of work which can be produced in large numbers, and which may have to be made to small tolerances. If a rapid means of checking is available, quality control can be applied and scrap reduced to a small percentage. The choice of a suitable instrument for this purpose may be largely governed by the size of the work which the instrument can accommodate, and to some extent by cost, delivery time, etc. In some cases it would be found that although a large component can be set up for inspection, only a relatively small section of it can be examined at any one time, and in one factory it was this limitation in an otherwise excellent instrument which led to the adaptation of an Aldis epidiascope as a contour projector. As only the projection lens system was used, the modification described could be applied, not only to other makes of epidiascope, but also to some projection lanterns.

Preliminary Experiments

Removal of the lantern slide holder permitted components of any shape to be mounted in front of the condenser, and an image of the profile was thrown on to a tightly-stretched fabric screen.

Two difficulties were immediately apparent:

- (a) The screen was not rigid enough to permit accurate measurement of the image.

- (b) The projection lens was not perfectly achromatic, resulting in an image having a thin, coloured fringe which made accurate measurement impossible.

As it was intended to measure profiles to an accuracy of at least 0.02 mm., these difficulties could not be overlooked.

Stopping down the projector lens by fitting a cap with a $\frac{1}{4}$ in. diameter hole, produced an image with sharply defined edges without reducing the field of view or cutting down the illumination too much. The reduction in the intensity of the projector beam was actually beneficial, as it reduced glare from the screen and enabled the operator to work for long periods without discomfort.

The Screen

The non-rigid screen supplied with the instrument was not suitable for use when measurements had to be taken. No matter how tightly it was stretched there was always some movement whenever a rule was placed on it. Synthetic wall board, with a hard, smooth surface, painted a matt white, was much better, but had some drawbacks. The operator

taking measurements from the screen had to be careful not to stand in the projector beam and so obscure the image, and in some instances only a contortionist could have achieved this with any degree of comfort. Originally thin, black horizontal and vertical cross lines were marked on the screen for centring purposes, but in practice these were useless, owing to the time taken to position the component on the projector so that the image was in the correct position relative to the lens. Cross lines engraved on a glass plate, which could be moved into any position in front of the screen, were only a theoretical improvement, as the plate could only be held firmly in position for short periods of time before the operator's arm began to get tired, with the result that breakages occurred frequently. Thin white card, ruled with cross lines, whilst not susceptible to breakage, was difficult to keep absolutely flat if it had to cover an image which was at all extensive.

In view of the above disadvantages, a ground glass screen was adopted for use. As will

be seen from Figure 2, it was mounted in a circular frame to enable it to be rotated through 360 degrees, and at the same time being capable of vertical movement controlled by counter weights. The whole framework, mounted on pulleys, running on angle irons fitted to floor and ceiling, permitted horizontal movement at right angles to the projector beam. It was now possible for the operator to stand behind the screen with complete comfort of movement, and to move the screen into any position so that its cross lines could be accurately positioned relative to the image. An additional advantage was that contours could be drawn in pencil on the matt surface for comparison against the image, and could easily be removed or altered by means of a damp cloth, but at the same time would stand considerable fingering during the normal usage of the screen.

A measuring scale drawn on the screen is useful, but if great accuracy is essential, a suitable scale is by no means easy to reproduce on such a surface, and unless the screen is very easy to move, positioning of the scale is rather difficult.

It should be pointed out that the image on the ground glass screen is not quite as easy to measure as that on the ordinary screen, due to the reduction in contrast between the light and dark parts of the image, and also because the measuring scale is not illuminated by the light from the projector. In actual practice, both screens are in use, the ground glass screen being easily moved to one side when not required.

Magnification and Measurements

Before accurate measurements can be made, the exact magnification of the image has to be determined. Fixed positions for both screen and component are essential and the method of mounting the component in

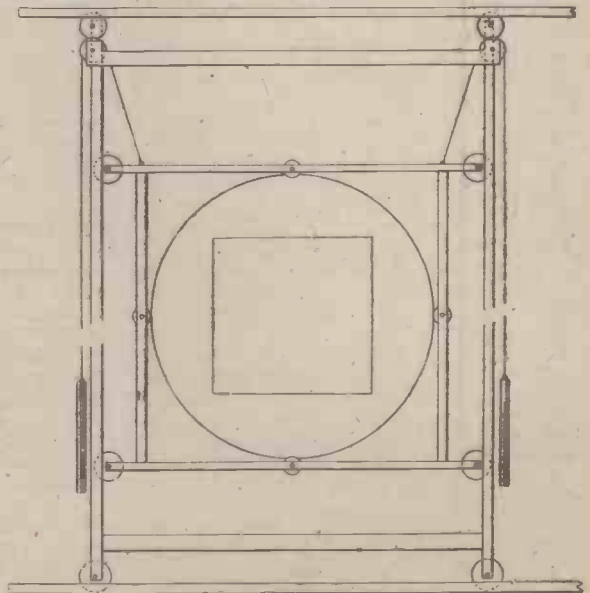

Fig. 2.—Method of mounting the ground glass screen.

front of the condenser lens proved to be too slow and liable to error for speedy routine checking. By inserting the lantern slide holder with a clear lantern slide, thin, flat components could be mounted on the glass plate using plasticine. Alternatively, if the means are available for drilling holes through the glass plate, a spring clip can be riveted to it.

The degree of magnification will depend upon the distance at which the projector can be placed from the screen. For a magnification of 20 times, the projector lens of the Aldis Epidiascope is approximately 13 feet from the screen, and at this distance the intensity of illumination is very good. It is a considerable advantage to set up a projector to give a magnification of 20 or 25 as the provision of a measuring scale is considerably simplified. A scale on white card with a graduation marking of fine black lines is the easiest to use, but unless it can be purchased ready made, it is difficult to make as considerable accuracy is required. When working behind a ground glass screen, a scale made by reducing a large drawing photographically to the correct size can be used, as the scale then consists of fine black lines on clear glass, and if the emulsified side of the photographic plate is placed on the screen there is practically no parallax between the scale and the image. This type of scale can also be made when space limitations necessitate the magnification to some odd number such as 17 times, as the original drawings can easily be reduced photographically to this scale.

Focusing

It is very difficult to focus the image exactly on the white screen which is several feet away and almost impossible if a ground glass screen is used, and even if two operators are available, one at the projector and the other at the screen, sharp focusing, which is essential for exact measuring, is still very difficult. This led to the fitting of a simple remote control focusing device, so that the projector could be adjusted by one operator standing near the screen. The fitting shown in Figure 3 consists of a semi-circular grooved

piece of paxolin clamped to the projection lens mount by means of a semi-circular brass strip held in position by two nuts and bolts. The cord fastened at the centre lies in the groove and is connected to two hooks for easy removal in case the projector lens has to be completely removed at any time. Two other cords fastened to the other ends of the hooks pass over pulleys fixed to the ceiling directly over the projector, and over two more pulleys fixed to the ceiling over the screen. The ends of these two cords hang either in front of the white screen or behind the ground glass screen and are kept tight by small weights fastened to the ends. The general arrangement of projector, cords, and

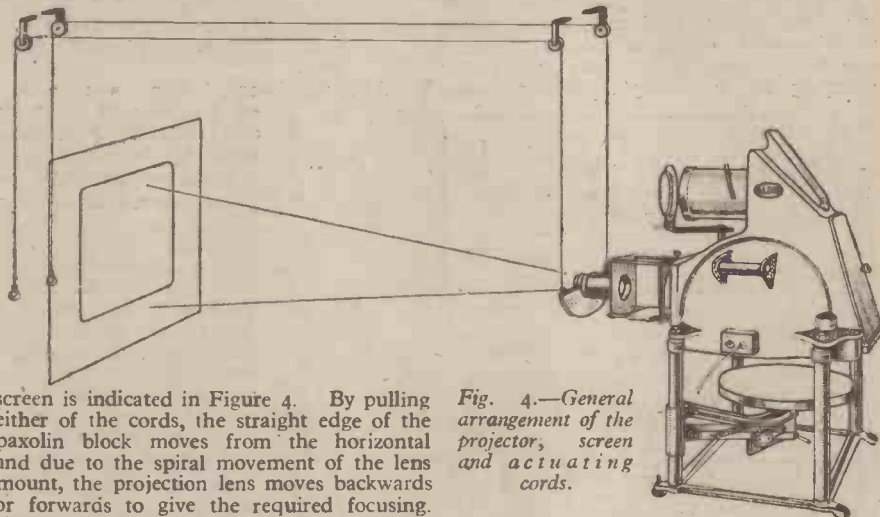

screen is indicated in Figure 4. By pulling either of the cords, the straight edge of the paxolin block moves from the horizontal and due to the spiral movement of the lens mount, the projection lens moves backwards or forwards to give the required focusing. The projector should be roughly focused by hand before clamping the paxolin blocks in position, so that the straight side of the block will be horizontal when the image is in focus and only small movements on each side of this position will be necessary during normal working, thus minimising the strain on the projector.

By fixing to the screen a large convex lens on a movable arm, accuracy of focusing

and measuring can be still further increased, the image and the scale being viewed through the lens in a similar manner to that used for exact focusing of a reflex camera.

Limitations

An Aldis Epidiascope adapted for contour projection as described, has been in use for some considerable time and has proved to be a very useful aid to inspection. It cannot be expected that optically or mechanically it is as good as instruments specially made for the purpose and costing several times its price, but used intelligently it will do a good job of work. Care should be taken initially to determine the extent of spherical aberration present and to limit the

Fig. 4.—General arrangement of the projector, screen and actuating cords.

position of the component in the projector and the size of the screen accordingly. A totally darkened room is not necessary, but is advisable for continuous work. The size of the room is a drawback, but it will probably be found that it can also be very useful as a lecture room for small groups and use can then be made of the instrument as an epidiascope.

Rocket Projector Development

THE following details of the new aircraft weapon were recently released by the Ministry of Aircraft Production:

The original proposal for the development of a rocket-propelled anti-tank weapon was put forward in September, 1941; and, since that date, the R.A.E. has been actively engaged upon the development of the rocket as an aircraft weapon.

The aircraft weapons then available for the attack of tanks were bombs and cannon. The latter, even in the 40mm. calibre, appeared likely to be outmatched by increased and improved armouring, so it was in this field that the aircraft rocket with its enormous penetrating powers had possibilities.

Rocket motors, originally designed by C.P.D. for anti-aircraft use, were immediately available. To these it was proposed to fit armour-piercing heads, similar to those in use with the 25-pdr. gun.

Before air firing could begin many things had to be investigated, such as the effect of the blast and flame on the aircraft, the vulnerability of the rocket to enemy fire, the method of carriage and launching, and the effect of the rockets on the aircraft's performance.

The first R.P. aircraft, a Hurricane, was fitted with experimental projectors by the end of October, 1941, and the first firing of rockets from an aircraft in this country took place on October 25th, 1941, at an

aerodrome on the South Coast. Rounds were fired out to sea with the aircraft picketed on the ground at the edge of the aerodrome. This was satisfactory, and flying trials followed immediately, several rounds being fired successfully from the air without damage to the aircraft.

Ballistic trials took place in November and December, 1941 to obtain fundamental information regarding the scatter and trajectory of the rocket, the method of sighting, the best type and length of projector, the best size of stabilising fin, etc.

Experimental Work

A period of steady development and experimental work followed, as a result of which a rocket projector installation adaptable to any aircraft and suitable for large-scale production was devised. Much ballistic and wind tunnel data were accumulated, and one particularly fruitful investigation was carried out which brought to light the potentialities of the weapon for the attack of targets such as submarines and ships. Concurrently, development of other types of warhead and of practice heads was proceeding.

At about this time the U-boat menace was beginning to assume serious proportions, and attention was therefore turned to a fuller consideration of the possibilities of the R.P. as a counter to this danger.

Coastal Command aircraft equipped with

R.P.s went into operation early in 1943.

With this most pressing problem in hand, attention was again directed to the attack of the smaller land target. The R.P., with its low "muzzle velocity" (it is only a small fraction of that of a cannon shell), its drooping trajectory and its comparatively long time of flight is very sensitive to aircraft flying errors, e.g. incorrect aircraft speed, incorrect angle of dive, sideslip and pilot's errors in range and wind estimation. The need for specialised training for R.P. pilots was well illustrated in September, 1942, when a tactical trial of R.P.s against a moving tank target was arranged. Three Army co-operation pilots who had never before fired R.P.s were posted to R.A.E. for three weeks prior to the date of the trial. They were given intensive training in low flying, range estimation and sighting. In the actual trial against moving tank targets the number of hits (25 per cent.) was much greater than anticipated, and again brought the R.P. weapon into the picture as an anti-tank weapon.

Air Ballistics

Part of the work carried out on the R.P. at the R.A.E. has been concerned with the air ballistics of the weapon. Special ranges have been instituted for this work. On a lonely stretch of the South Coast an air ballistic range has been set up at which, by means of a special photographic technique, the behaviour of the R.P. during its air path can be accurately recorded and analysed.

Garden Woodwork

Construational Details of Three Attractive Seats for the Small Garden

A GARDEN seat, if well made and properly proportioned, usually affords an added attraction in any garden. The three seats described in this article are not difficult to construct, most of the joints used being halving joints. All the parts for two

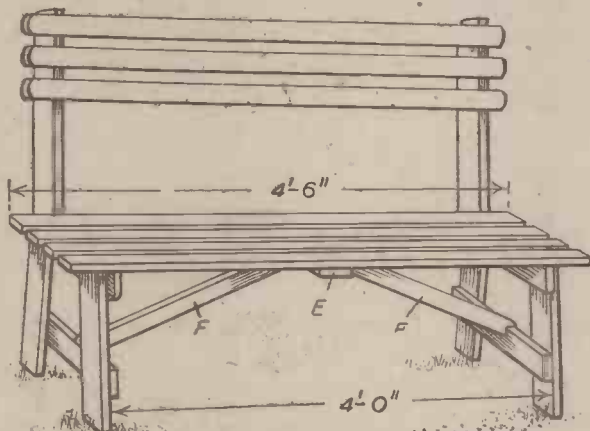

Fig. 1.—A light garden seat which can be constructed of planed deal.

of the seats are simply screwed in place, no cut out joints being required, with the exception of the arm rests for seat No. 3.

The first seat is a straightforward job of light construction, the second of more formal design, and the third a semi-rustic seat, or chair.

For making the seat illustrated in Fig. 1, planed deal 1in. thick can be used throughout. Each back upright can be cut to the shape indicated at A, Fig. 2, from a piece of timber 4in. wide, the stepped part, B, being 1ft. 5in. from the lower end. The two cross-rails C and D are each 1ft. 8in. long, and 2½in. wide, and these are screwed to the back uprights and front legs, on the inside faces, as shown. The front legs are 1ft. 6in. long, which gives the seat a backward slope of 1in. The top rail, C, projects 1in. at the front end, the bottom rail projecting ½in. at both ends.

Seat and Back Battens

After assembling the two ends in this way, the four seat battens can be screwed on.

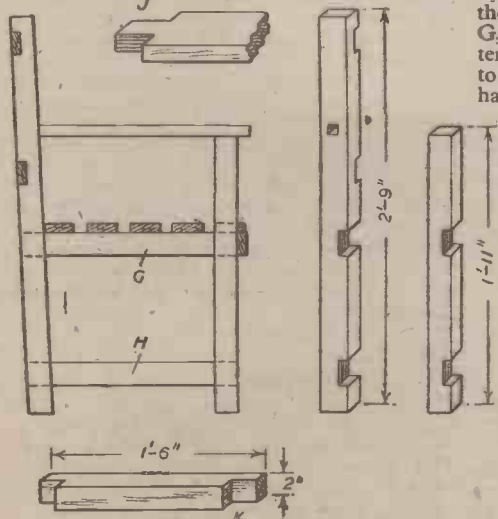

Fig. 4.—End view of seat shown in Fig. 3, and details of uprights and joints.

By "HANDYMAN"

These battens are 3in. wide and 4ft. 6in. long. A cross-batten, E, about 3in. wide, is screwed on underneath the seat battens, across the middle, to give rigidity to the seat.

Two cross-stays F, F, about 2ft. long and 2in. wide, are fitted between the cross-batten and the bottom rails, D, the ends of the stays being notched, as indicated, and then screwed in place.

Three back battens, 4ft. 4in. long and 2½in. wide, are screwed to the sloping back uprights at a distance of 1in. apart.

After well sandpapering the completed seat it can either be treated with varnish stain or given two coats of paint.

A Formal Garden Seat

The seat illustrated in Fig. 3 is intended to be constructed from 2in. by 2in. quartering, pieces of 2in. by 1½in. batten,



Fig. 3.—A garden seat of formal design.

and a few lengths of 2in. by 1in. battens for the seat slats.

The two side supports for the seat can be made first. Saw off two pieces of the quartering, 2ft. 9in. long, for the back uprights, and two pieces 1ft. 11in. long for the front uprights. Place the four pieces together, side by side, and mark the positions of the four slots to take the seat rails, G, and bottom rails, H. With a tenon saw and chisel cut these slots to a depth of ¾in. Two similar slots have also to be cut in the back of the

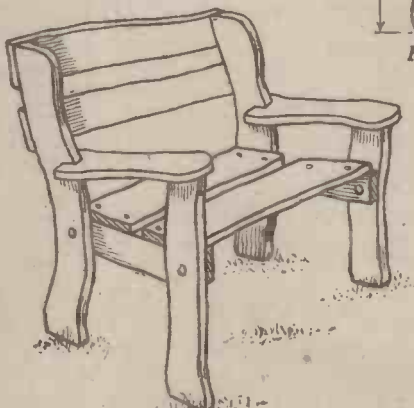

Fig. 5.—A semi-rustic garden chair.

long uprights to take the halved ends of the back rails. These consist of 4ft. lengths of 2in. by 1½in. batten.

The arm rests, which are 1ft. 7in. long, can be cut from a piece of 2in. by 1in. batten. Saw the end of each arm piece, as shown

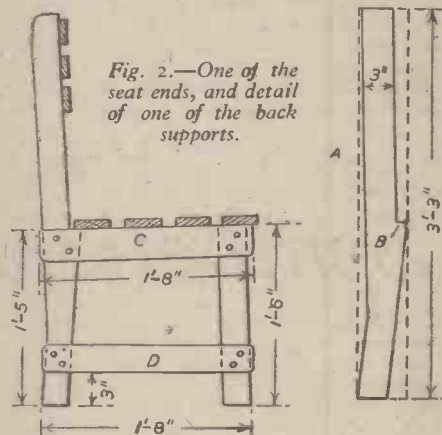

Fig. 2.—One of the seat ends, and detail of one of the back supports.

at J, and cut a square hole in each upright to form a mortise joint.

The seat rails and bottom rails are halved at the ends, as at K, Fig. 4. The dimensions of the bottom rails are given in this illustration, the seat rails being 1in. longer to allow for the required slope of the back uprights. After screwing together the parts forming the sides, the back cross-rails can be screwed in place.

Slats for Seat and Back

For the seat slats, cut five 4ft. lengths of 2in. by 1in. batten and screw the ends to the seat rails so that the slats are equal distances apart. Across the front of the seat, another batten 2in. wide and ¾in. thick can

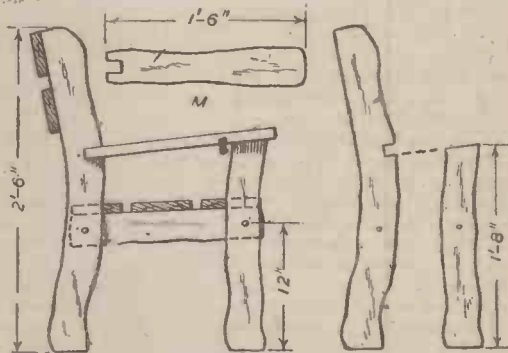

Fig. 6.—Details of the chair shown in Fig. 5.

be screwed on, and the edge of the front seat slat should be flush with this.

The vertical slats between the back cross-rails may be cut from planed wood ¾in. thick, and recesses cut in the cross-rails to receive them, so that the pieces are flush with the back when screwed in place.

This pattern of seat, if painted in white enamel, always looks attractive against the background of a well-trimmed lawn.

Rustic Garden Chair

For making the chair shown in Fig. 5, pieces of rustic wood 1in. thick can be used. Roughly planed rustic wood, with the bark still on the edges, can be purchased at some timber yards, but failing that, ordinary deal

boards can be used, the edges being sawn to an irregular outline with a pad-saw.

The front and back uprights of the chair are roughly 4in. wide, and the seat supports 3in. wide. The two boards forming the back of the chair are 4in. wide, and the seat slats 5in. wide. If only two seat slats are used, as in Fig. 5, they would be 8in. wide.

Front and Back Uprights

Cut the four uprights to the shape and dimensions given in Fig. 6, and in the front edges of the two back pieces cut a slot 1in. wide, to take the slotted ends of the arm-rests. This slot, and the top edge of the front supports are cut at a slight angle to allow the arm rests to slope downwards towards the back.

At a distance of 12in. from the bottom end of the front legs bore a $\frac{3}{8}$ in. hole, and

another hole through each back leg at a distance of 11 $\frac{1}{2}$ in. from the bottom ends. Cut the two seat supports to the dimensions given at L, Fig. 7, and bore $\frac{3}{8}$ in. holes through at a distance of 1 $\frac{1}{2}$ in. from each end. The top edge of these parts should be planed flat so that the ends of the seat slats can be nailed down firmly.

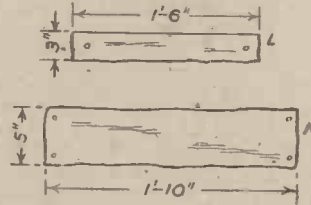

Fig. 7.—Seat support, and seat slat.

Fix the seat supports to the front and back legs with $\frac{3}{8}$ in. galvanised bolts and nuts.

Arm Rests

After shaping the arm rests, as at M, cut out the end slots, and then knock the rests in place. Fix the front ends to the top of the legs with a couple of nails, and drive in a nail to fix the slotted ends of the arm rests to the back uprights. The seat slats are cut to the dimensions given at N, Fig. 7. They are nailed to the seat supports at equal distances apart.

The two boards for forming the back of the chair are 2ft. long and 4in. wide, and are fixed in place with two galvanised nails in each end.

The finished chair can be given a couple of coats of outdoor varnish, or treated with creosote.

Synthetic Training in the R.A.F.

Details of the Rediffusion Trainer, and How it Operates

NOW it can in part be told how the "bomber boys" of the R.A.F. made the grade that enabled them to pinpoint their targets by night, despite all the enemy could do to thwart them.

Half a dozen complete aircrews were put into what are called synthetic trainers, and all of them simultaneously taught their job of finding and hitting their target.

Dummy firing at dummy targets, false messages, atmospheric, night code signs, bad weather, and a host of navigational and technical problems, were simulated on the ground by the ingenious improvisation of the principle behind Rediffusion.

The R.A.F. trainees thus made their mistakes on the ground instead of in the air.

Increase in Navigational Accuracy

One air expert has assessed the overall increase achieved in navigational accuracy by this form of ground training as over 50 per cent., viewed in terms of precision area bombing. In turn, this means no less than that double the bomber force might otherwise have been required to do the same amount of damage.

The synthetic training of bomber crews by a technical device, known as the Rediffusion trainer, is an R.A.F. secret that can now be revealed. The device, which is all British, has been in use since 1940.

Some such apparatus was seen to be necessary to overcome the problem of accustoming air crews in training to the conditions they would meet in operational flying, without having to send them out over an actual target. Throughout the war bomber crews have been trained under the Empire Training Scheme in Canada and in various units in Great Britain and elsewhere, but this training is incomplete without several operational flights over selected targets. Yet it was obviously impracticable to ensure that all trainees flew courses they would have to fly in operations. For one thing, the number of training aircraft required would have been prohibitive, and losses would unavoidably have been severe, apart altogether from the normal wear and tear of engines and aircraft, and the high consumption of petrol. Moreover, particularly in Great Britain, bad weather over long periods would have seriously interfered with the training programme; while in many theatres nearer the scene of operations the presence of large numbers of trainees in the air would have

tended seriously to interfere with the active prosecution of hostilities, and have imposed a considerable strain on flight control personnel. Last, but not least, it would have been difficult to provide sufficient instructors to carry out a training programme on the large scale that would have been necessary.

It was, therefore, seen that while pilots and crews must have adequate flying experience before going into action, the actual training time in the air should be limited to the minimum consistent with efficiency, and involve as small an instructing staff as possible in relation to the crews trained. In other words, the crews had to be taught the "feel" of their controls and learn procedure on the ground, so that by the time they reached the stage when they actually flew as a crew each individual member should have had full experience in the use of the apparatus he had to control in the air. Recourse, therefore, had to be made to "synthetic" methods.

"Synthetic" Aeroplane

Some years before the war, mechanical training devices had been used by the R.A.F.—the Link trainer for training pilots was standard practice—but no attempt had been made at the collective training of crews by similar methods. Shortly after the outbreak of war a scheme for training bomber crews was conceived and put forward to the Air Ministry by Mr. P. Adorjan, technical director of Rediffusion. The idea was that the members of an air crew—pilot, navigator and wireless operator—who had already received individual specialised training in their respective duties, should be brought together in a synthetic aeroplane, and by means of external apparatus controlled by an instructor, allowed to "fly" a course similar to that which they would fly in battle conditions.

The idea was embodied in an apparatus which took the form of a cubicle or, in some cases, the fuselage of a bomber. The prospective navigator, pilot and wireless operator are sent into this and find all the relevant instruments related to navigation as they would be found in a real aeroplane. The dark compartment is connected to the instructor by wire, over which he can send not only all the various messages that might be necessary in "ops," but also reproduce the different kinds of interference which

are liable to take place during a flight. He can give the crews practice in operating procedure, including wireless and celestial navigation, and teach them how to fix their position by these methods. But the great advantage of the apparatus is that the instructor can also reproduce the aural and visual effects the crew would experience on the way to and near their target. Projected cinematograph pictures give them fleeting glimpses of the land or sea below them. Even stars are simulated by means of spots of light, reflected in mirrors! And sound and light effects reproduce the impressions of enemy searchlights, flak and bomb bursts.

Wired Wireless

As the ether must not be jammed by training radio signals, "wired wireless" is adopted for all wireless communication and navigational parts of the Rediffusion trainer. The accuracy in navigation attained is of the same order as that gained in actual practice. Further, in order to get the maximum results with the least number of instructors, five or more bomber crews "fly" the course in each trainer at the same time under the supervision of instructors.

Early in 1940 the Air Ministry decided to proceed with the idea, and from then onwards the maximum amount of help in the development and practical use of the apparatus was given to Rediffusion by the Air Ministry.

The first apparatus was completed and installed at an R.A.F. operational training unit in 1940, during the Battle of Britain. Shortly afterwards hundreds of similar sets of equipment were manufactured and installed in Great Britain. A significant sidelight is that most of this was made in London during the blitz of 1940-41. Thus, the British workers who made the apparatus share the credit with the British brains that conceived and developed it. Equipment was later also produced in Canada, and sets were sent to the Middle East, South Africa, and India.

In this connection, it should be stated that while the idea of the crew trainer was originated by Rediffusion engineers, and all the equipments were manufactured by and most of them installed by them, apparatus made by other firms is incorporated in the trainer. Thus, in most instances, the actual type and make of radio receiver is used that would be employed in the bomber under

flying conditions, and no attempt has been made to replace such apparatus by imitations. Various other firms have also co-operated in the supply of switchgear, instruments and various accessories that make up the complete trainer.

Thousands of Crews Trained

During the past four years, many thousands of crews have been trained in these trainers. Some of the best R.A.F. bomber crews are not ashamed to admit how, in their early days of training in the "Gropes Room," they wandered off their course and lost themselves completely, but by repeated practice were able to reach a stage of efficiency at which they could be sent for their final training in the air. Indeed, crews look back on their training in the "Gropes Room" as the secondary school which has taken them from the preparatory stage and passed them on to the finishing school. In addition to the R.A.F. crews of Bomber Command and Coastal Command, practically all the Allied Air

Forces have been and are using the Rediffusion training method.

Realistic Details

It would be an exaggeration to attribute the whole success of the scheme to the apparatus alone. It was equally due to the enthusiasm and thorough way in which it was used by the R.A.F. training authorities. From "briefing" before the synthetic flights to "reception" after the flights, all details were carried out by them in exactly the same spirit as if it were a most vital operational flight.

The development of other synthetic methods soon followed the success of the Rediffusion apparatus. Even more elaborate devices were subsequently produced among the United Nations, but without robbing the Rediffusion trainer of its proud place as the prototype on which they were based. Synthetic training has been a major factor in the efficient utilisation of man-power and materials by the forces of the United Nations.

Record Flight to India and Back

A SKYMASTER of R.A.F. Transport Command has just made the 9,120 miles flight to Karachi, India, and back in 2 days 8 hours and 11 minutes. Actual flying time was 42 hours 23 minutes—26 hours 8 minutes by day and 16 hours 15 minutes by night, the average speed being approximately 215 m.p.h.

The crew was doubled—enabling each man to have a spell of rest in the aircraft. A stop each way was made at Cairo for refuelling, and there was an eight hours "turn round" at Mauripur airfield (Karachi), but there it was too hot for the crew to sleep.

On the outward run the Skymaster carried 6,000lb. of military supplies and on the return journey 27 Service passengers and 1,755lb. of freight.

Here is the schedule—1st day: depart U.K. 5.44 a.m., arrive Cairo 3.38 p.m., depart Cairo 5.46 p.m. 2nd day: arrive Karachi 4.14 a.m., depart Karachi 1.4 p.m., arrive Cairo 12.18 a.m., depart Cairo 3.7 a.m., arrive U.K. 1.55 p.m.

Aerial view as seen on actual flight projected on large screen by Epidiascope or Cine projector.

Each cubicle represents an aeroplane and has separate radio transmitter and receiver. They receive radio control from instructor exactly as on actual operation.



Regular service radio equipment.

Switches which fire magnesium flashes of varying intensity in front of the cubicles giving effect of near and distant flak explosions searchlights and bomb flashes.

Record of aero engines amplified and relayed to each cubicle.

Map of operation on which position of aeroplane is fixed by crossing of radio beams.

Instructor transmits and receives signals to and from the cubicles in exactly the same way as the ground radio station controls actual flights.

Interior of a Rediffusion trainer as used in the R.A.F. for training bomber pilots.

Masters of Mechanics—105

Charles Babbage

The Story of his Giant Calculating Engine

CHARLES BABBAGE presents a problem to the present-day historian of mechanics. Was he a genius born before his years, a man unable to convince the world of the worth-while nature of his one big invention, or was he just a cantankerous, irritable, and even a commonplace individual afflicted with a one-way mind who, to the end of his days, nursed a grievance over the failure of a much cherished notion on which he had spent a considerable proportion of his life?

The consensus of opinion is that Babbage was a bit of a genius, a man with extraordinary mathematical perceptions and abilities, and that if any blame is to be attached for his failure to make good in respect of the invention of his remarkable calculating engine, as he called it, such blame must be borne, at least to some extent, by the British Treasury officials of the day, who, after subsidising Babbage's invention for a number of years, suddenly lost faith in it and left the luckless inventor more or less financially stranded.

Picturesque Personality

Throughout his life Babbage must have been a somewhat picturesque personality. He had independent means. He made mathematics and mechanics the two main interests of his existence, although he fancied himself as a political reformer, and twice unsuccessfully contested a Parliamentary election.

Towards the end of his days he attained to some public degree of celebrity—or notoriety—by appearing as the sworn and implacable enemy of organ-grinders and street musicians generally. His furious, almost ferocious letters against this human fraternity which appeared in *The Times* in the '60's of the last century nearly brought about a social movement against them.

It is said that so highly strung was Babbage's nervous system that at times the slightest aural disturbance—musical or otherwise—was sufficient to send him into a paroxysm of annoyance and to raise him to the heights of nervous exasperation. Obviously, such a man ought never to have persisted in living in London, as Babbage did for the greater part of his working life. One wonders what he would have thought of the modern mechanical street drill!

Charles Babbage was a Devon man. He was born near Teignmouth in that county on December 26th, 1792, his father being one Benjamin Babbage, of the banking firm of Praed, Mackworth and Babbage.

Bankers in those days were as rich as they are now, so that the youthful Charles Babbage, who was inclined to be delicate, received his first education at a private school.

Captain Marryat

With him in the school was a lad who subsequently became the famous Captain Marryat, the hero of many a schoolboy fiction reader.

The great Captain Marryat was no scholar. He ran away to sea when he was twelve years old, but Charlie Babbage went to other schools, and *did* make good at his studies, so much so that he went to Trinity College, Cambridge, and obtained the degree of B.A. in 1814, and that of M.A. in 1817.

Interest in Mathematics

During his later schooldays, Babbage developed an absorbing interest in mathematics, and particularly in algebra. This interest never left him. Indeed, he designated himself a mathematician first and foremost; his mechanical abilities were to him a secondary consideration.

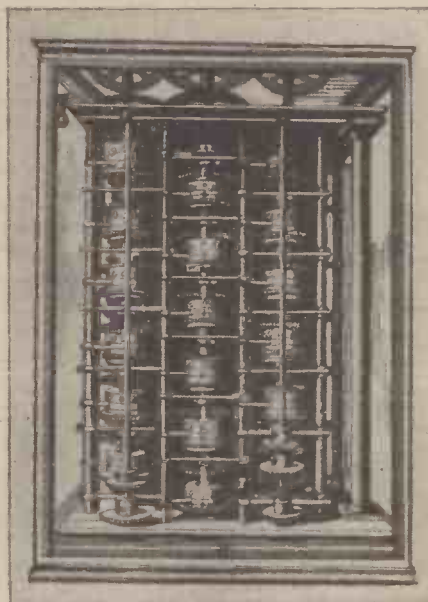

Reproduction from a contemporary drawing of Babbage's first small model of his "Difference Engine."

During his stay at Cambridge, Babbage contributed several mathematical papers to the Royal Society's *Philosophical Transactions*. He became particularly friendly with Sir John Herschel, and with George Peacock, another mathematician who subsequently became the Dean of Ely. Together with them he endeavoured to arouse the English scientific circles from their slavish adherence to the old mathematical forms enunciated by Newton, and to introduce in this country a better knowledge of the more advanced continental systems of mathematical science.



A calculating machine made in 1779 by a German clergyman named Hahn.

He was successful to some extent in this aim, and, no doubt through the influence of Herschel, he was awarded the Fellowship of the Royal Society in 1816, even before he had obtained his M.A. degree at Cambridge.

Babbage, being of independent means, decided after leaving Cambridge to settle in London and to devote his life to the furtherance of mathematical and mechanical science.

In London he entered into the most advanced scientific circles, making mathematical physics, astronomy and mechanics his special studies. In 1820, he played a prominent rôle in the foundation of the London Astronomical Society (now the Royal Astronomical Society) for which he acted as first secretary, becoming the vice-president of the Society four years later.

It was in 1820, also, that he repeated and extended a number of experiments originated by Arago, the French physicist and astronomer, on the magnetisation of rotating discs, as a result of which he announced the discovery of a time factor in the induction of magnetism.

Although Babbage at various times of his life threw out a multitude of mechanical ideas, he carried none of them to a really practical stage. Babbage, perhaps, was the ideal "theoretical" mechanic, the man who is enormously learned in mechanics and its possibilities, but who, for the greater part, is content to leave the practical "donkey-work" of the game to others.

The "Difference Engine"

Yet Charles Babbage, if he had not had a passion for mechanics, could never have conceived the notion of his first calculating machine, or "difference engine," as he sometimes called it. This was a machine which was intended to work out complicated arithmetical problems with the greatest ease and precision. It was termed a "Difference Engine" because its automatic computing methods were based on systems of numerical differences.

The idea of the machine first came to him during his mathematical studies at Cambridge. His idea, however, was by no means the first calculating machine project. Indeed, mechanical calculators had been known on and off for at least a century previously, but they were, in the main, devices with very limited functions, and they were anything but infallible.

As physical and astronomical knowledge progressed, the need for a mechanical means of routine calculation and computation became more and more evident. To construct arithmetical tables "by hand," so to speak, and to work out mathematical data necessary for the tables of the annual *Nautical Almanac* required a prodigious amount of mental labour. And even then the results were never satisfactory. For example, Samuel Smiles, the noted engineering historian, tells us that in a mathematical table worked out for the Board of Longitude by Dr. Hutton, an eminent scientist of his day, forty errors were discovered in a single page selected at random. It was, indeed, more or less tacitly agreed that in large, printed publications of tables, the avoidance of errors was virtually impossible.

Babbage, to test out the principle of his idea of a calculating engine, made a small model of a portion of his proposed machine.

The model was exhibited before, and described in a paper read by its inventor to a meeting of the Astronomical Society in the June of 1822. The model aroused considerable interest and even enthusiasm among members of the Society. Not only did they Oliver Twist-like, "ask for more," but the Society also awarded Babbage its Gold Medal in the following year.

Babbage now found that he had a "following" in the scientific world. His proposals for the building of a large-scale calculating engine of almost fantastic complexity were supported by most of the scientific "Lions" of the day. And when the renowned Sir Humphry Davy, at that time President of the Royal Society, pronounced in favour of the project, the British Govern-

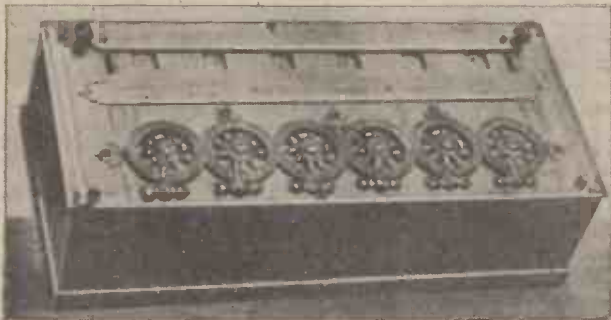

An early adding machine made by Blaise Pascal in the first half of the 18th century.

ment came to Babbage's aid to the tune of a cash payment of £1,500.

The First Failure

Thus encouraged, Babbage set to work at his invention in his own private workshop. For four years he worked at his designs, but after this period had elapsed, Babbage was still in great difficulties with his semi-constructed machine, and his Government grant had completely expended itself.

His next step was to make a sojourn abroad "under medical advice," for his nerves were worsening and he was getting increasingly irritable, even with himself. During this period away from England, Babbage studied continental factories and workshops and, in fact, any process of a mechanical nature which he could come across. A year later he returned to this country and, as a result of his tour, published (in 1832) a volume entitled "On the Economy of Machinery and Manufactures." It was a successful book, and it brought considerable fame to its author.

Now back in England, Babbage returned to the project which had now become his life's interest—the building of his large-scale calculating machine. Fresh financial applications to the British Treasury were necessary at this stage. The Royal Society backed Babbage in his request for funds and so, too, did the Duke of Wellington, who, on behalf of the Government, inspected Babbage's models and plans.

The notion of the Duke of Wellington, the noted victor of Waterloo, acting as a mechanical expert is rather humorous, but Wellington's national credit was almost one hundred per cent. at that time and, in some respects, his opinions were law. The favourable report which he presented on the proposed calculating engine stood Babbage in good stead. Fresh funds were supplied to the inventor at regular and required intervals. Still, however, the projected large-scale calculating engine failed to materialise.

Clement, the Engineer

Babbage blamed it all on to Joseph Clement, the well-known mechanic and

engineer, who he employed to assist him on the practical and mechanical side of the enterprise.

According to a statement made in later years by Babbage, and not long before the latter's death, Clement was recommended to him by the engineer, Sir Isambard Brunel. Clement, at that time, possessed only a small lathe, and his workshop comprised the front room of his house.

Babbage's machine needed a variety of special tools for the construction of its parts, and these Clement himself made for the purpose. As the demands of Babbage's plans increased, Clement had to extend his premises by taking over a space at the rear of his house.

Some idea of the complexity of the Babbage machine may be gained from the fact that the drawings necessary for the calculating part of the machine (as distinct from the figure-printing part of it) covered no less than 400 square feet of paper surface!

Under Babbage's instructions, Clement faithfully acted as draughtsman and working mechanic. But the machine's construction proved to be a painfully slow job.

Babbage v. Clement

Clement, being the better working mechanic of the two, had his own ideas concerning the detail construction of the machine parts. Sometimes these clashed with Babbage's ideas on the same subject, and the result was friction. Babbage became more and more impatient, more and more irritable.

Worst of all, the British Government began to grumble at the continued expense.

Seven years went by. Still no completed calculating machine or engine was forthcoming. The Government had handed out to Babbage about £17,000 of public funds, and the inventor himself had expended some £6,000 of his own private means on it.

To make quicker progress possible, it was determined that Joseph Clement should remove all his engineering tackle and tools to Babbage's own workshops. Clement agreed, but he claimed a higher rate of payment for himself because, he said, working away from his own premises and under the new conditions would not yield him the average rate of profit.

It was through these squabbles that the failure of the whole work was precipitated. Babbage and Clement could just not agree. So Clement ceased work, collected his tools (including the special ones made at Babbage's expense) and calmly carried them back to his own premises.

The Government Backs Out

During another spate of haggling, which resulted from the above action, the Government's official support for the invention was withdrawn. The Treasury payments stopped and the uncompleted calculating engine

remained on Babbage's hands, "a beautiful but unfinished fragment of a great work."

The unfinished engine was subsequently placed in a glass case at King's College, London, in 1842. It was shown at the International Exhibition of 1862. Now, it is in the possession of the South Kensington Museum. To some extent, the engine was copied by a pair of German mechanics, who afterwards occupied twenty years in constructing a smaller machine based on similar principles, and, ironically enough, a similar German-made copy was much later bought by the English Government at a cost of £1,200.

The New Calculating Machine

After the failure of Calculating Engine No. 1 (the "Difference Engine"), Babbage projected an even more complicated machine, an engine which, in the matter of mathematics, was to have an almost human reasoning power. This time the engine was to be operated by sets of perforated cards similar to those used in the Jacquard looms for weaving designs into fabrics.

Again, Babbage subjected his theories to outside scientific examination. A Committee of the British Association convinced itself of the feasibility of Babbage's new project and recorded that the completion of the project would constitute "an epoch in the history of computation equally memorable with that of the introduction of logarithms." At the same time, the Committee protected itself by refusing to advise the completion of the work in view of its great cost.

Unsuccessful

For 37 years of his life Charles Babbage struggled on with his calculating machine. As he grew older it became more and more obvious that he would remain unsuccessful at it. The thing, although brilliantly conceived, was beyond him. Yet he retained his activities to the end, writing about

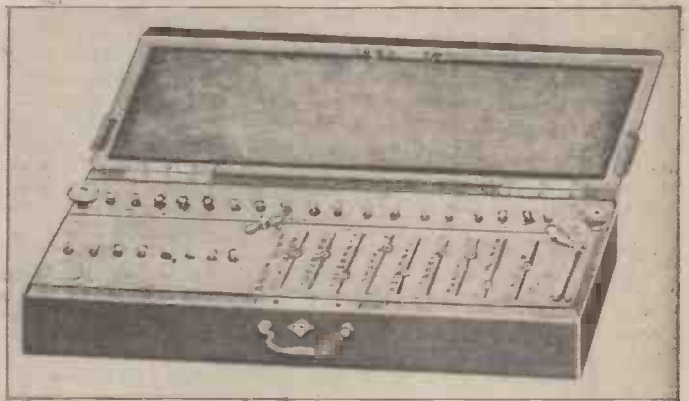

A portable calculating machine invented by Thomas De Colmar, of Paris, and shown at the Great Exhibition, London, in 1851. It was styled an "Arithmometer."

80 publications of one description or another before his powers eventually failed.

Curious Contradictions

In some ways, Babbage's life comprised a most curious set of contradictions. For ten years (1829-39) he was Professor of Mathematics at Cambridge, but he never delivered a single lecture. He was sympathetic, yet irritable. His mechanical gifts were of a high order, yet his main constructional interests were unsuccessful. He was a Fellow of the Royal Society, yet, in 1830, he attacked that Society bitterly and, by so doing, contributed largely to the foundation of the British Association in the following year.

He died on October 18, 1871, remaining to the last a personality which only his intimates could ever correctly fathom.



Fig. 5.—The photo-electric exposure meter in use.

MANY readers will be familiar with the Westinghouse metal rectifier which is used extensively for the rectification of small electric currents for certain wireless sets, H.T. battery eliminators, and trickle chargers, but perhaps few have ever taken the trouble to strip one down to see what it consisted of.

For the benefit of those who have never taken one to pieces, it might be as well to explain briefly that it consists of a series of copper washers coated on one side with cuprous oxide (oxide of copper), and these are placed upon a long insulated bolt together with copper and lead distance washers and fins, as shown in Fig. 1.

When connected up in an A.C. circuit, current will only flow freely through the pile of washers in one direction, i.e., from copper to oxide, and high resistance is set up in the opposite direction. Thus we have a unit which can be readily used for the rectification of A.C. currents when suitably connected up in a circuit.

Principle of Operation

In addition to this peculiar property it has been known for many years that the action of light upon a prepared surface of cuprous oxide on copper will liberate electrons upon the oxide surface in proportion to the amount and character of light falling upon it.

This principle is used for the measurement of light in the majority of photo-electric exposure meters used by many photographers, except that a much more sensitive surface than cuprous oxide is now used, and the instruments can be made very compact.

Cuprous Oxide Washers

Since it is not within the scope of the average home experimenter to prepare one of the highly sensitive photo-electric cells as now used in modern light sensitive meters, the author carried out a number of experiments with the already prepared cuprous oxide washers taken from an old metal rectifier, and it was found that, provided a sufficient number were connected in parallel over a comparatively large area and exposed to light, sufficient current was generated to cause comparative deflections on the needle of a sensitive moving coil measuring instrument.

A Photo-electric Exposure Meter

Constructional Details of a Useful Instrument Constructed from Old Metal Rectifiers

By E. H. JACKSON

The experiment showed that a minimum of one hundred cuprous oxide washers are required to produce a measurable current produced by the reflected light from average photographic subjects, although almost full-scale deflections were obtained with the action of direct sunlight upon the battery of washers.

The reader will find that an average metal rectifier designed for 230-volt A.C. rectification contains about 50 or 60 cuprous oxide coated washers, so in order to make the exposure meter described below, two units shown in Fig. 1 will be required. These can usually be bought for a few shillings from a second-hand junk shop, and they may also be found amongst the redundant parts of many wireless dealers. Many of us will find what we want in the old discarded wireless set of pre-war days, when battery eliminators were very popular.

Constructional Details

The construction of the exposure meter is really very simple, and the exact pattern described here need not necessarily be followed so long as the basic principle is adopted. In brief, all that is necessary is to sandwich a battery of washers between a baseboard covered with copper foil and some form of pick-up grid which will allow the light to reach the oxide surface of the washers. It is advisable to remove surplus cuprous oxide from the back of the washers to ensure good electrical contact with the foil base. It is also advisable that copper foil be used in preference to other metals in order to avoid the possibility of galvanic action which might seriously interfere with the very small currents generated with this type of cell.

Evenly space the washers so that the edges do not touch, since this also can interfere with the final results.

General Layout

Reference to the photograph Fig. 2 will show the layout adopted, which is practically self-explanatory. The washers were arranged on two small baseboards, 50 on each. The copper foil of each base is coupled electrically through a brass hinge in the centre. This arrangement allows baseboards, 5½ in. by 6½ in. to be used, which when folded up can be conveniently carried in the pocket.

Many types of grids were tried for picking up the current generated on the surface of the cuprous oxide, and fairly good results were obtained with perforated zinc firmly

screwed down on the surface. But if optimum currents generated by comparatively dim reflected light are required, the reader is strongly advised to make a celluloid and wire grid as shown in Fig. 3. This method allows the maximum amount of light to reach the cuprous oxide surface of the washers and at the same time picks up stray electrons from almost the entire circumference of each washer.

Two sheets of 1/16 in. thick celluloid, the same size as the baseboards, were used in this instance, and the centres of each washer were carefully marked off 13/16 in. apart. The celluloid was then clamped on the baseboard with the copper foil sandwiched between and drilled with a No. 50 Morse drill. Scratch a small identification mark on the corner of the celluloid, copper foil, and baseboard before drilling, so that these components can be reassembled correctly afterwards, and when the 50 holes have been drilled, remove the celluloid and open out the holes therein with a No. 32 or ¼ in. drill. It is also advisable, although not absolutely necessary, to open out the small holes in the copper foil with a 3/16 in. or ¼ in. hollow punch in order to give clearance for the numerous No. 4. by ¼ in. round-head wood screws which are subsequently used for clamping the washers between the celluloid grid and the foil-lined baseboard.

The "Pick-up" Grid

The wiring of the celluloid to form the "pick-up" grid is illustrated clearly in Fig. 3. A No. 76 drill was used for drilling the eight equidistant holes around each washer screw-hole. It is best to make a small drilling fixture for drilling these small

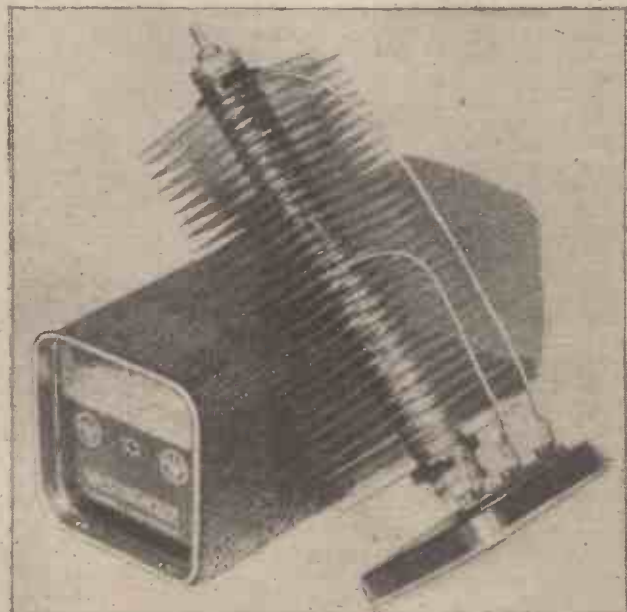

Fig. 1.—A metal rectifier and unit, the cuprous oxide washers of which are used in making the exposure meter described in this article.

wire holes, since marking off is inclined to be rather tedious. A suitable drilling jig is shown in Fig. 4.

No. 36 bare copper wire is threaded through the holes in the manner shown. It was found that approximately an 18in. length of wire was sufficient to cover one complete row of washers. The ends of each row are connected to a common terminal. Care should be taken that the grid wire does not come into contact with the copper foil base, otherwise the complete cell will be short-circuited and will not function.

When the celluloid is completely wired, space out the washers equidistantly, as before described, and carefully place the celluloid on top and fit the screws. Tighten the screws up evenly so that the wire grid is firmly in contact with the cuprous oxide surface of each washer.

After repeating the above operations on the other half baseboard, the sensitive cell portion of the exposure meter is complete.

Measuring Instrument

It only remains to find a measuring instrument sufficiently sensitive to record the light variations.

The author unearthed an old Ferranti battery-testing voltmeter for the purpose, but the reader should not be misled into thinking that such an instrument could be used direct without certain modifications.

Perhaps it might be as well to explain that any good quality moving-coil instrument will do, whether it be calibrated in volts, millivolts, or milliamps, since the majority of such instruments all have a moving coil resistance in the region of 5 to 10 ohms. Shunts or swamping resistances absorb the bulk of the current, while only a small proportion is used through the moving coil in order to give the required scale deflection.

Since the current generated by this photo-electric cell is somewhere in the region of 30 to 60 microamps, it will be realised that the moving coil must be coupled direct to the cell terminals, and all such shunts or swamping resistances which will be found inside the meter when the cover is removed should be disconnected.

Examination of the instrument will show that the moving coil is poised between jewelled bearings, and the current is fed to the moving coil through the hairspring at each end of the coil. Usually the back hairspring is earthed to the frame of the instrument and the front hairspring is connected to an insulated bridge, which also houses the front jewelled bearing. Shunt

coils are to be found connected to these two points, and there is very often another resistance between the terminal in the back of the instrument and one of the hairspring connections. These should be cut out and fresh copper connecting wires sweated on the terminals at the back of the instrument

to be correct, I then know that my camera apertures can be adjusted in accordance with my scale reading at any time, viz.: If next time I take a reading the light value only registers 4 degrees, then I shall set the camera aperture to f.8, which, as most readers will understand, allows twice

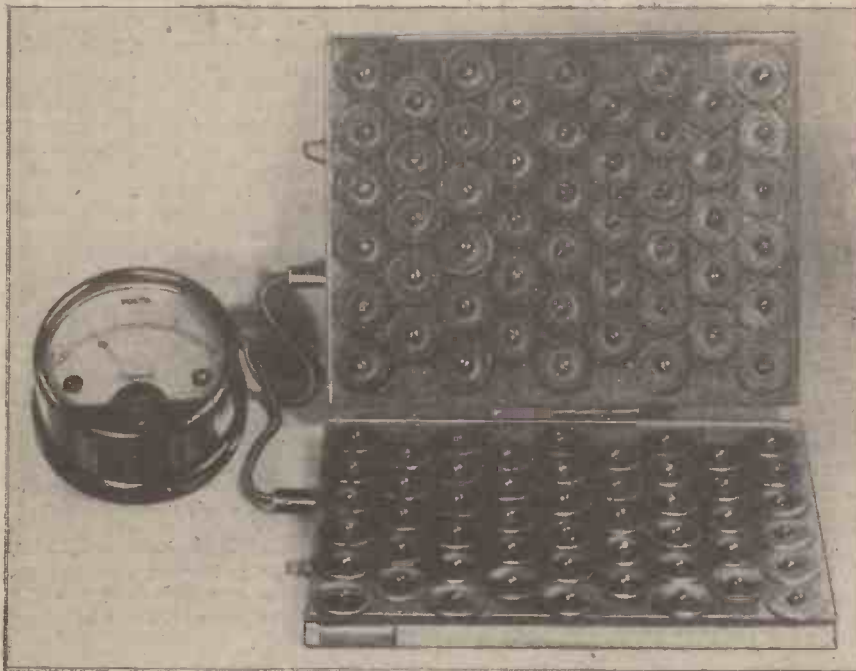

Fig. 2.—The finished exposure meter, showing the layout of the cuprous oxide washers.

and connected to the two hairspring connections.

There is an adjusting arm on the front hairspring which should be eased off so that a minimum tension is maintained when the coil and needle are at a zero position. It may be advisable to mark a fresh zero point on the scale. The whole object of this adjustment is to obtain maximum deflections from the very small currents to be measured.

Having satisfied yourself that the moving-coil is perfectly free and sensitive, the cover can be replaced and the instrument connected up to the cell connections with the positive terminal connected to the grid, and the negative to the copper foil base.

Calibration

The calibrating of the instrument scale in f. numbers to correspond with lens aperture of the camera is an extra refinement which I propose to leave to the reader's own judgment.

My own method of using the exposure meter is to take a reading of the light value facing the subject to be photographed, holding the instrument in the manner shown in Fig. 5. The reading, we will assume for the sake of argument, registers 8 degrees on the scale. Assuming that it is a bright day, I set the camera aperture to f.11 and make an exposure. If the exposure after development is found

as much light through the lens. In other words, once a point on the scale is established through trial and error methods, the rest of the calibration can be calculated from it, and if necessary, the meter scale can be calibrated in f. values to avoid making mistakes. Compensation, of course, has always to be made when films or plates of different speeds are used, but this is usually clearly marked on the packet, and can easily be allowed for.

AEROPLANE HEATING

MANY methods of heating aeroplanes have been devised. The contriver of yet another system asserts that it appears to be the generally accepted practice to utilise the exhaust gases, or air heated by these gases, or a hot part of an aircraft engine. Heated air is led along the interior of the leading edge of the wings to the ailerons, rudder, elevators, etc., to prevent ice formation.

One disadvantage of this method is said to be that, being dependent on the temperature of exhaust gases or the engine, it will fail if the engine fails or is put out of commission. Also there is a possibility of a leakage of gases into the aircraft from the heating system.

The improved device includes at least one chamber into which air is admitted direct from the atmosphere through a controlled inlet, passed through a filter and heated electrically to make its exit by means of one or more outlets to a desired part of the aircraft.

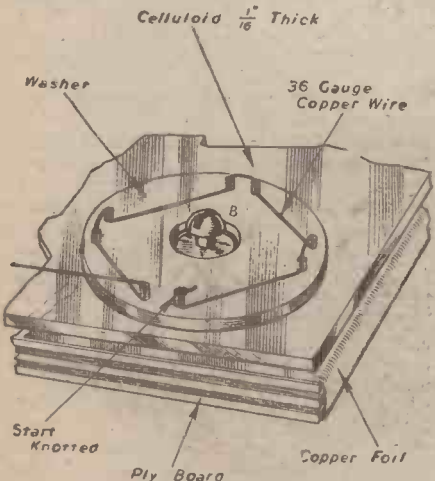

Fig. 3.—Enlarged view of a corner of the celluloid sheet drilled and wired. The wire is threaded through the eight No. 76 drill holes, as shown.

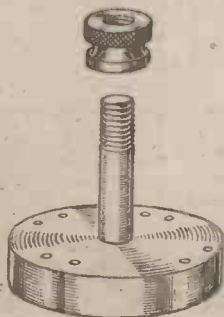

Fig. 4.—Drilling jig for the eight No. 76 wire holes shown in Fig. 3. The centre stud of the jig is pushed through the centre hole "B" and fixed with the knurled nut. The eight guide holes in the jig enable uniform drilling of the many small holes to be accomplished.

Workshop Calculations, Tables and Formulæ

By F. J. CAMM
6/- By Post 6/6

From George Newnes Ltd., Tower House, Southampton Street, London, W.C.2.

High-power Short-circuit Testing-4

Methods of Testing and Recording

By S. STATON

(Continued from page 339, July issue).

IN the three preceding articles we have considered in some detail the subject of the short-circuit testing of circuit breakers under the following headings:

- (1) Service requirements of a circuit breaker.
- (2) Consequent tests necessary in view of these requirements.
- (3) Special equipment and layout of a testing station.

We can now proceed in the light of these considerations to consider how the various tests on a circuit breaker are carried out, and the methods of recording such tests.

Test records are of particular importance to the design engineers. They form a basis for future developments and designs, since they give a picture of the characteristics of a circuit breaker. With many pieces of equipment manufactured in the engineering workshops it is possible to carry out sub-assembly tests, and thus ensure a saving of time and expense when the complete equipment is in its final testing stage. This method of testing is to some extent employed in the testing of circuit breakers.

These tests, to which very brief attention will be paid, are quite part from the actual short-circuit testing of a circuit breaker, but are, nevertheless, essential preliminaries. They consist mainly of the following:

- (1) High voltage pressure test on all bushing insulators.
- (2) High voltage pressure test and megger for insulation resistance on the wooden lifting rods for the contact-carrying assembly. These rods are also given a mechanical pull test to ensure that they are capable of withstanding any tension stresses which may be set up under short-circuit conditions.
- (3) Resistance check of circuit breaker operating coils.
- (4) Volt drop test on all contacts, joints and conductors, etc., inside the circuit breaker.
- (5) Operation tests on complete-assembled circuit breakers.
- (6) High voltage pressure test on complete assembled circuit breaker.

It is not the intention to say anything further about these detail tests, but a few comments will be made on the "operation" test of a circuit breaker immediately prior to short-circuit testing.

Operation Testing

The object of the operation test is to ensure that the closing and tripping coils in conjunction with the operating mechanism are capable of operating the circuit breaker within the prescribed limits of the British Standards Specification. For this test no current is passed through the circuit breaker, as this is unnecessary. The closing coil of the circuit breaker is energised by gradually raising the applied volts until the magnetic force on the plunger inside the coil is sufficient to suck the plunger up, and so actuate the closing mechanism. The value of current at which this occurs is noted and recorded as the "minimum" closing current. This minimum closing value should not exceed 74 per cent. of the normal operating current. The operating current is then gradually raised to 110 per cent. of the normal, the circuit breaker being operated at various intermediate values to ensure that it will operate satisfactorily over the whole of the operating range, which is from 74 per cent. to 110 per cent. of the normal working value. These latter limits apply to the closing of the breaker

only, the tripping is effected by a trip coil, which forces its plunger upwards when energised, this plunger knocks off the toggle catch of the circuit breaker mechanism, thereby causing the latter to collapse, and thus trip out the circuit breaker.

The supply of the trip coil is gradually raised until sufficient force is exerted on the plunger to trip out the breaker as described above. The value of current at which this occurs is recorded as the minimum tripping current, and it must not exceed 50 per cent. of the normal working value.

On the completion of these operation tests the circuit breaker is given a high voltage pressure test at 2½ times the line voltage, plus 2,000 volts, thus, in the case of an 11,000 volt breaker, the high voltage test would be at 27,000 volts.

The circuit breaker is now ready to be handed over for short-circuit testing.

Setting Up for Short-circuit Testing

On receiving a breaker into the testing station the first operation is to clamp it to a suitable flat-topped testing truck. These trucks were described in Article 3. It is then

$$\frac{200 \times 10^6}{3 \times 11,000} = 10,526 \text{ amps.}$$

The tester then refers to the standard current time curves, and notes the value of reactance for 11,000 volts, the reactors are adjusted by the tapings and link board to this value. In choosing this value of reactance from the curves, the tester looks for a curve that has an initial value of current appreciably higher than the particular test value, in order to give a time interval between the commencement of the short circuit and the interruption of same. Thus, in the particular case under consideration he would choose the curve starting at 12 kilo amps.; the required value of current being reached in approximately 0.20 seconds.

This interval allows the D.C. component to fall to the correct value.

Setting of Time by Control Relay

It is now required to set the control relay to trip the circuit breaker at the correct time (the control relay was described in Article 3). To do this, a no-load timing test is carried out to find the time between the instant of energising the circuit breaker trip coil and that of contact separation.

The circuit breaker is closed, and the contacts are connected in series with an

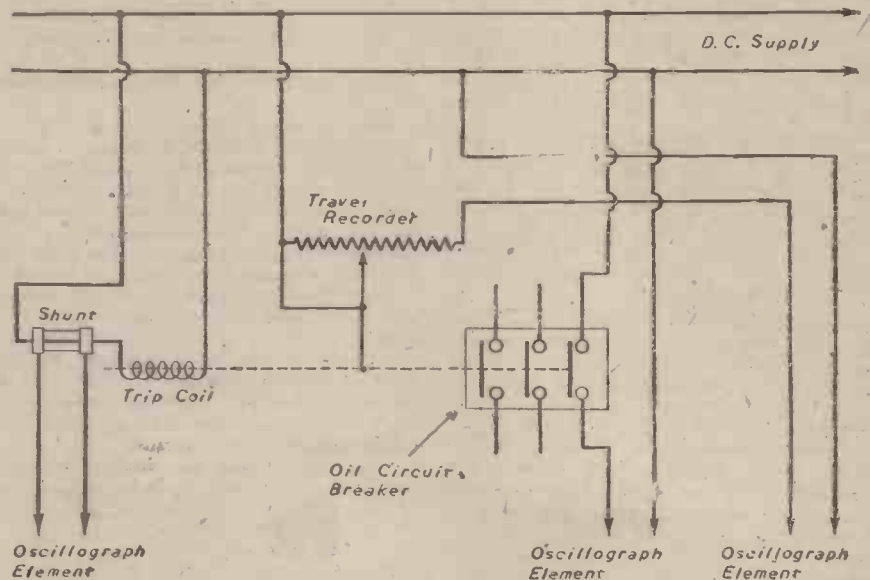

Fig. 7.—Diagram of connections for no-load timing test on circuit breaker.

wheeled to the testing cell and connected up to the station bus bars and recording apparatus.

Current Value

The next thing to set is the value of reactance in the circuit to give the required current value.

It will be recalled (in Article 2) that reactors were employed to give the necessary current values for a given generator voltage, and that a number of "current time" curves for various values of reactance with a given voltage were drawn up. These curves are given in Fig. 5 (June issue). We will consider a three-phase, 11,000 volt, 200 m.v.a. (symmetrical rating) circuit breaker. The current to be broken on test is arrived at as follows:

$$\text{Current} = \frac{\text{m.v.a.} \times 10^6}{\text{Phase factor and rated voltage}}$$

element of the oscillograph to a suitable D.C. supply. The trip coil is connected in series with a shunt to the D.C. supply, and two leads are taken from the shunt to another element of the oscillograph.

The contact travel recorder is connected up to the circuit breaker, oscillograph and D.C. supply, as described in Article 3.

A diagram of connections for this test is shown in Fig. 7. The trip coil is now energised through the oscillograph, and a film taken of the deflection of the connected elements. Such a film is shown in Fig. 8. It will be seen on reference to this that the time interval between the instant of switching on the trip coil current to contacts separate, is 3.5 cycles. Each cycle corresponds to 0.02 second for 50 cycles per second timing wave, and so the actual time is $3.5 \times 0.02 = 0.07$ seconds. Referring back, we saw that the contacts must separate in 0.20 second,

from the commencement of the short circuit. The control relay must, therefore, be set to switch on the trip coil current 0.20—0.07=0.13 seconds after the initiation of the short circuit.

Analysis of No-load Film

All is now ready for the actual short-circuit test, but before considering this, an explanation of the curves in Fig. 8 will be given. There are four traces on the film, and these are as follow :

- (1) Contact separation trace.
- (2) Travel record trace.
- (3) Trip coil current trace.
- (4) 50-cycle timing wave trace.

Contact Separation Trace

The contact separation trace will be seen to be stable for the first four cycles of the test, a step is then shown and the trace becomes stable again until the completion of the test. The initial stable portion of the line is recorded whilst the circuit breaker is closed, and, therefore, current is flowing through the contacts to the oscillograph element, thus causing it to deflect from its zero position. When the circuit breaker is tripped the current ceases to flow and the element returns to the undeflected position where it remains during the remainder of the test.

Travel Trace

This trace commences with a straight line until the contacts begin to move. It then becomes a stepped line until the end of the travel, when it assumes a steady position. At the commencement of the trace, the element is deflected only slightly because all the resistance of the travel recorder sliding resistance is in circuit. When the contacts move downward to open the circuit breaker, the sliding contact of the resistance moves downwards with them, thus cutting out the resistance in circuit with the oscillograph element step by step until the end of the travel. The corresponding increases in current give proportionate deflections of the oscillograph element, thus a stepped line is shown on the film.

There is also a further point to be noted in connection with this trace, the record is actual movement, plotted against a time axis, the slope of the stepped portion is thus a measure of the speed of break or contact movement. In addition to this the change in the slope is an indication or measure of the acceleration. It will be noted that the slope is more acute at the end of the travel, indicating that the speed is greater than at the commencement. The reason for this is, when the circuit breaker is closed, the moving contacts are held in the sockets of the fixed contacts. Considerable friction is thus caused in separating the contacts, resulting in a comparative slowness at the beginning of the movement, as shown on the film.

Trip Coil Trace

This trace commences at zero deflection, on switching on the current it is seen to rise to a maximum and then decrease again for a short period. After this the increase is assumed again until a maximum value has been reached when it continues stable until the end of the test.

The explanation of the shape of this trace is as follows : Circuit breaker trip coils are inducting windings, and since the coil is energised from the D.C. supply the current in the coil increases from the instant of switching according to the law

$$I = \frac{E}{R} \left(1 - e^{-\frac{RT}{L}} \right)$$

where I is the current flowing,
E is the applied volts,

- R is the coil resistance,
- e is the naperian log base = 2.718,
- T is the time in seconds,
- L is the inductance,

reverting to Fig. 8, we see that the current follows this law to a maximum for the first half-cycle after being switched on. At this maximum point the value of the ampere turns is such that sufficient force is exerted on the plunger to attract it up through the trip coil to its topmost position. This causes

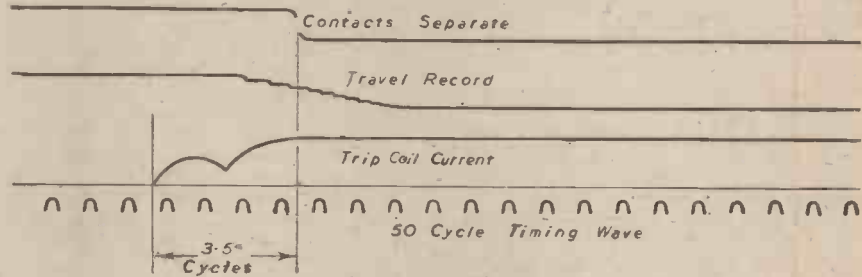

Fig. 8.—No-load film.

an increase in the inductance of the coil and hence a decrease in the value of the current as shown in the next cycle of the trace. When the inductance has become stable again, the current again commences to increase according to the above law, until it attains its maximum steady value. This is then continued to the end of the test.

Timing Wave Trace

This trace is obtained by connecting one of the oscillograph elements to a 50-cycle alternating current supply; in this case the zero or undeflected position of the element falls on the bottom edge of the film, and only the top peaks of each cycle are recorded. The time interval between each successive peak is 0.02 second. This record of a preliminary no-load timing test will give the reader some idea of the speed at which a modern

circuit breaker operates. The average time for tripping being in the order of three or four cycles which, as already noted, equals 0.08 second.

In the next article, the actual short-circuit test will be considered, and typical complete records given, together with an interpretation. (To be continued.)

Automatic Aircraft Navigation

Details of a Remarkable Instrument Used by the R.A.F. for Precision Bombing and Other Purposes

THE methods used by the R.A.F. in finding targets on the darkest, cloudiest nights, in pin-point bombing, and in many navigation feats will one day make a thrilling story. Details have now been released of some of the instruments used which tell the navigator automatically and continuously where he is, and in what direction his aircraft is heading. They represent veritable "landmarks" in the history of air navigation.

Since the earliest days of flying the pilot has used a simple magnetic compass to show the aircraft heading. But this proved completely inadequate for accurate navigation over enemy territory, because it gives the heading only when the aircraft is flying straight, and because in large aircraft not only the pilot but also the navigator, radio operator and bomb aimer have to know where the aircraft is heading to use their complex equipment. A new compass was introduced; it combined the magnetic compass with a gyroscope to give the right reading when the aircraft is turning, climbing or diving. The compass is located in the fuselage of the aircraft, where it is away from bombs or other magnetic sources which could make it inaccurate, and it transmits electrically to compass dials for the pilot, navigator, bomb aimer and radio operator—in fact, for whoever wants to know where the aircraft is heading, and to any equipment, such as the automatic pilot, which must take account of turning of the aircraft.

Distant Reading Compass.

The British Distant Reading Compass—D.R.C. in short—was the first of its kind in use in the world; its value is illustrated by the equivalent compasses since produced in other countries to meet the needs of their own aircraft.

One of the many uses to which it has been put is to provide the navigator automatically

and continuously with information of his position; the tedious calculations hitherto necessary become hopelessly confusing when, as is often the case over enemy territory, the aircraft changes heading, height and speed frequently. The compass is combined with another completely novel device, which measures the distance travelled by the aircraft through the air, to produce an Automatic Position Indicator and show continuously the aircraft's position. The navigator can leave his station, take part in other duties in the aircraft, and when he returns finds his position clocked up on the A.P.I. far more accurately than he would have calculated it himself! When required for special purposes, the aircraft's position is shown by an illuminated arrow, which moves over the map on the navigator's table and the direction of the arrow is the heading of the aircraft.

This instrument has proved a boon, not only in navigation but also in bombing, because it enables the wind strength over the target to be measured with an accuracy hitherto unattainable. These instruments have been conceived and developed by a team of workers at the Royal Aircraft Establishment.

SCREW THREAD TABLES

By F. J. CAMM
(Editor of Practical Engineering)

214 pages; fully indexed and illustrated, and including a section on change-wheel calculations.

5/-, or 5/3 by post from
George Newnes, Ltd., Tower House,
Southampton Street, Strand, London,
W.C.2.

THE WORLD OF MODELS

Some Fine Examples of the Work Done by Luton Model Engineers

By "MOTILUS"

DURING this war, men, whether in the Forces, in factories or on Home Defence, whether full or spare time, have still, in their leisure hours, been drawn together by common interest to form societies in pursuance of their hobbies, a favourite among which appears to be model-making.

I found a striking example of this in Luton this season, when I was present at the annual general meeting of the Model Engineering Section of the Recreation Club attached to Vauxhall Motors works.

There were about 50 members present in the Society's recreational hall—besides visitors from other Luton societies—who had come to hear the speaker, W. J. Bassett-Lowke, M.I.Loco.E., address the meeting on "The Progress of Transport by Water." Luton Vauxhall engineers, through their go-ahead chairman, Mr. S. Gilbert, have heard many famous speakers from the model world, including Mr. J. N. Maskelyne, Mr. Edgar T. Westbury, and others, despite the fact that the society has only been running for two years.

After Mr. Bassett-Lowke's interesting address, members made a close examination of the series of exquisite little waterline model ships, with which the talk was illustrated, and also on show were models by members of the society. These, even in their partly finished state, greatly enhanced the meeting,

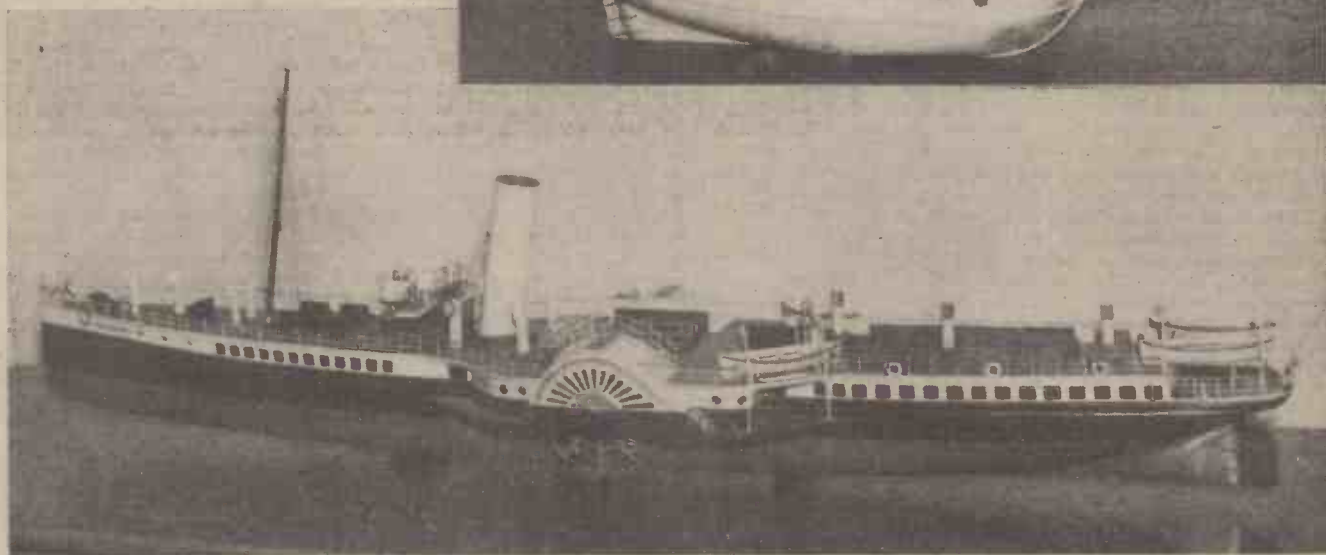
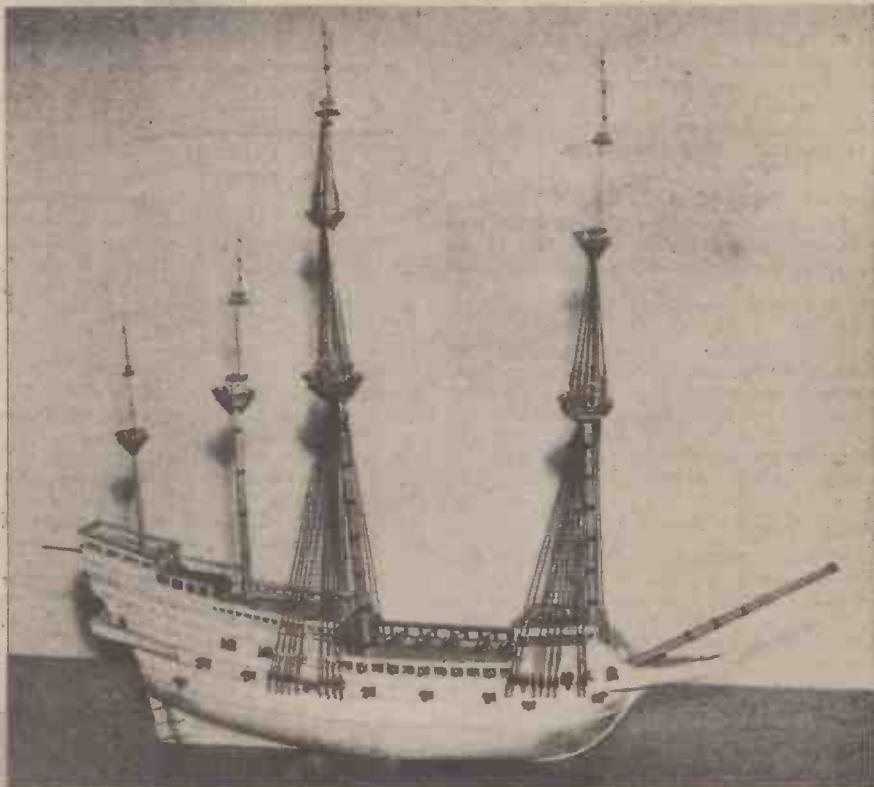

Fig. 1 (Top right).—Elizabethan Galleon "Elizabeth Jonas"— $1/96$ th full size, the work of Mr. E. W. Fraser, "Model Engineer" championship cup winner in 1922. Fig. 2.—A $3/16$ in. to the foot scale model of the cross-Channel pleasure steamer "Balmoral"—made by Mr. A. L. Bratcher, of Harpenden.

(Photographs by courtesy of Vauxhall Motors, Luton).

and showed the makers to be expert craftsmen.

Model Elizabethan Galleon

The first—the work of Mr. E. W. Fraser, was a beautifully detailed model of the Elizabethan galleon *Elizabeth Jonas*— $1/96$ th full size. The original is in the Science Museum, South Kensington, from whence Mr. Fraser obtained the drawings. Model makers will recall the name of E. W. Fraser as the winner of the Championship cup and diploma at the 1922 Model Engineer Exhibition. His prizewinning model was of a Vauxhall car, and this is now in the South Kensington museum.

He commenced work on the scale model of the 16th century galleon *Elizabeth Jonas* before the war, and readers will get an idea of the fine workmanship from Fig. 1, which shows the model as it has progressed to date. Mr. Fraser still has to complete the standing rigging, and all the sails and running rigging—which is no small task!

The hull is carved from pattern makers white pine, the main masts are of yellow pine and the fighting tops of birch. The gratings are made of plastic wood moulded in metal moulds. The housing for the whipstaff is of copper and brass, with wire mesh to represent the diamond-paned windows.

A special feature of the model is the work-

manship of the 70 brass guns, which were made from drawings from the Science Museum. Everything on these tiny weapons moves with a perfect fit and they are beautifully finished. The gun ports are made with copper lids and brass hinges.

The shrouds and ratlines are made of wire, giving a most realistic finish, and the completed model will contain over 2,000 lines. There are still some hundreds of blocks to be made for the running rigging. The little knobs for the masthead tops have been ingeniously made from knitting needles.

The actual dimensions of the *Elizabeth Jonas* herself—rebuilt in 1598—are: Burden, 684 tons; tonnage, 855; breadth, 38ft.;

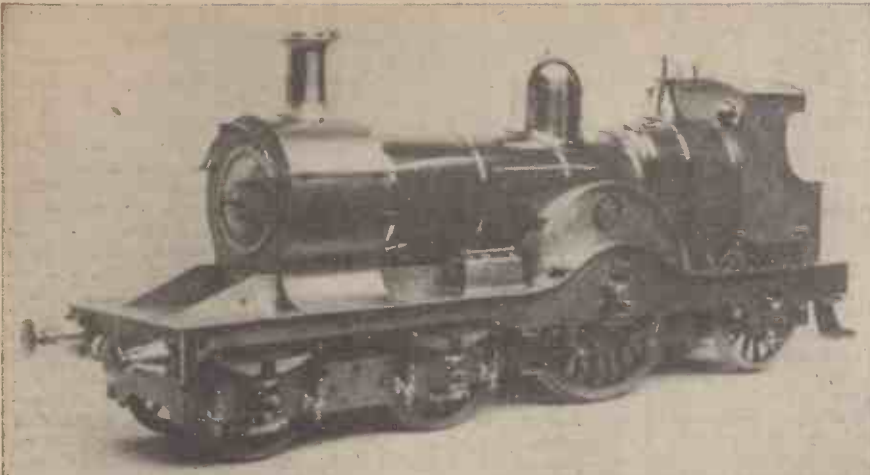

Fig. 5.—A $\frac{1}{4}$ in. to the foot $3\frac{1}{2}$ in. gauge model of the G.W.R. single-driver "Lorna Doone"—the work of Mr. E. W. Fraser.

length of keel, 100ft.; rake forward, 36ft.; rake aft, 6ft.; and depth in hold, 18ft.

Model Paddle Steamer

Another model on view (Fig. 2) was of the well-known pleasure steamer *Balmoral*, which plied from the seaside resorts in the south of England to the French coast in pre-war days. Built to the scale of $\frac{3}{16}$ in. to the foot it is the work of member A. L. Bratcher, of Harpenden. It has been constructed entirely from photographs, and has taken the builder two years of wartime "spare time" to complete. The only "commercial" items on the model are the etched sides of the paddle boxes and the small medallion, photographed from the head of a Queen Victoria penny.

This model is notable as Mr. Bratcher's first attempt. He first planned to run it by steam, but scrapped the steam engine he was making owing to technical difficulties, and decided to drive it by electric power. The model measures $43\frac{1}{2}$ in. by 5 in.; 10 in. over sponsons, and weighs 4 lb. without driving equipment and $7\frac{1}{2}$ lb. complete. Most of the wood used is mahogany, and the wheels are of brass with feathering floats.

The draught is only $1\frac{1}{2}$ in., as the constructor wanted a "scale" hull as near as possible. Consequently the deck fittings and top hamper are of the lightest construction, in order to preserve stability.

The paddle-wheel arches are wood. The ventilators are of .006 in. copper sheet, and all the wooden deck seats are hollowed out

and screwed 2 B.A. The holes in the wooden hull are lightly tapped, and the clear screwed rod tightly screwed in, cut off flush and polished. This has proved a very satisfactory method for small lights.

Scale Model Traction Engine

Third on our list of Luton model makers is Mr. J. Hellewell, a craftsman with over 25 years' experience, and his 1 in. scale Davey Paxman traction engine (Fig. 3) will be a little "gem" when it is completed. At the moment in its half-finished stage it represents 12 months' spare-time work, and is an example of very accurate mechanical modelling.

There are no castings in the model, every-

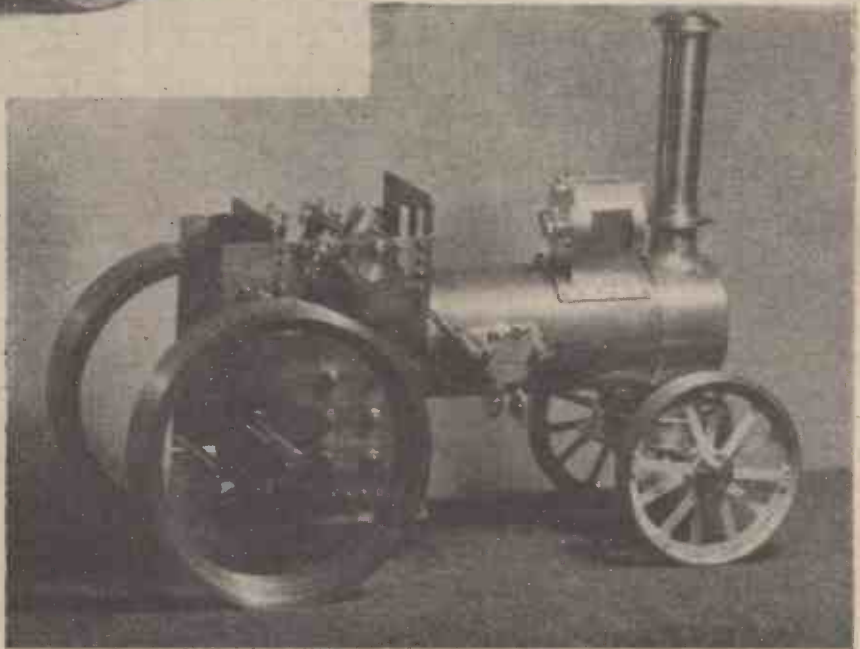

Fig. 3.—Photograph of the unfinished 1 in. scale Davey Paxman traction engine—made by Mr. J. Hellewell.

underneath. Also, now that steam has been abandoned, the funnel is of Bristol board.

The bridge and deck-house is aluminium about $\frac{1}{64}$ in. thick, and all the railings and stanchions from brass wire averaging $\frac{1}{32}$ in. diameter.

An interesting point is the porthole lights. Those in the sponson houses are made from a much-used medium, shoe eyelets, but the others near the waterline are made from lengths of perspex, turned $\frac{3}{16}$ in. diameter

thing being fabricated from the solid. Even the nuts, bolts and screws, of which there are at least 200, in sizes ranging from 10 B.A. to 2 B.A., have been made by the constructor.

The boiler is of copper, with stainless steel fire door. The cylinder, which is steam jacketed, is of bronze alloy with rustless iron liner, and is $\frac{1}{2}$ in. bore by 1 in. stroke. Even the pressure gauge was constructed by Mr. Hellewell.

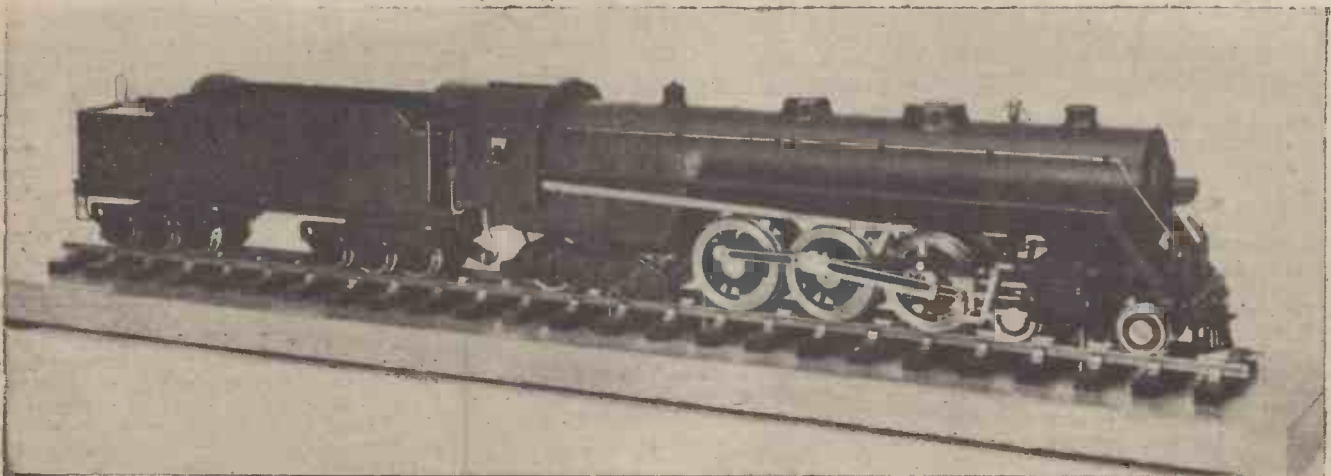

Fig. 4.—An "0" gauge coal-fired New York Central-Hudson type railroad locomotive—also the work of Mr. J. Hellewell.

(Photographs by courtesy of Vauxhall Motors, Luton.)

Among the models he has made during his 25 years' "association" with model-making are a 9.5 mm. optical projector, two petrol engines and a speed-boat engine, and I am also able to give readers an illustration (Fig. 4) of his "o" gauge coal-fired New York Central-Hudson type railroad locomotive—a model any professional company would be proud of.

The engine, which has a coal-fired boiler, brazed throughout and tested to 160lb. per sq. in., was completed in 1934, taking six months of spare-time work. The job was then shelved until about three years ago, when the tender was made. The finish is matt surface black cellulose with bright parts clear lacquered.

Mr. Hellewell has a workshop equipped with a 3 $\frac{1}{2}$ in. Drummond lathe, small hand shaper, drilling machine, grinder, plating bath, and the usual hand tools. His work at Vauxhall Motors is tool designing; Mr. Fraser is a retired experimental shop foreman, and Mr. Bratcher an artist in the Styling Division.

Returning to Mr. Fraser, No. 1 model-maker on our list, and who has been interested in the craft some forty years, I cannot conclude without a reference to his model G.W.R. single driver *Lorna Doone*, which is shown in Fig. 5.

A few years ago Mr. Fraser wanted to

build a model which contained plenty of polished work, and Mr. J. N. Maskelyne advised him to build the *Lorna Doone*, supplying a print from his private collection, and also the necessary drawings. The locomotive is a double-frame model, the original having once been broad gauge and then converted to standard. The cylinders are made from a solid block of duralumin and the pistons of phosphor bronze packed with Palmetto. The slide valves are brass with steel buckles. The motion work is mild steel, case-hardened where necessary, and the boiler is of copper, riveted, sweated and cold-tested to 120lb. per sq. in. The boiler lagging is sheet steel with sheet asbestos under it, and the smoke-box is of sheet steel with door of duralumin, and chimney of mild steel with duralumin base and copper top. The dome is of sheet brass worked up on formers, as also is the safety-valve casing. The cab roof, sides and running boards are of mild steel, and so are the sand boxes. The springs are made from clock springs, and the spring buckles from solid mild steel. The axle boxes are built up and silver soldered, and all frame stretchers and spring hanger brackets are of duralumin.

As to the wheels, the bogies were bought, the drivers cast from Mr. Fraser's pattern by a friendly foundry manager, and the trailers built up by a special method of his

own, which he considers quicker and cleaner than making a pattern and getting castings. Buffers are of stainless steel with casings from solid mild steel. The main feed pump is $\frac{1}{2}$ in. bore and $\frac{1}{2}$ in. stroke, and is driven by an eccentric on the driving wheel.

The model, which is to a scale of $\frac{1}{16}$ in. to the ft. (3 $\frac{1}{16}$ in. gauge), though still unfinished, has been under steam from its own boiler, and the owner assures me it has plenty of power. The final working pressure of the model is to be 70lb. per sq. in. The boiler fittings are all made from gunmetal, and all cock handles are fitted with spiral steel grips of the non-finger-burning variety advocated by Mr. J. C. Crebbin.

To return to my first sentence, this group of progressive model-makers, whom I am told are planning a big exhibition in combination with other Luton model engineering clubs this December, have been brought together by the war to the betterment of their hobby which, as peace becomes apparent, should develop on more and more ambitious lines. One wonders to what extent the excellently equipped apprentice workshop at Vauxhall Motors, with its enthusiastic staff training engineers in all branches of engineering, has helped towards the existence of such high-class model-making as has been described in this contribution on their efforts.

Letters from Readers

"The Phenomenon of Light"

SIR,—May I make an alteration and addition to my letter on "The Phenomenon of Light," which was published in your June issue?

The meaning in the second sentence is not clearly conveyed (the fault is mine), and should read: "... complete darkness over an angle of 180 deg. rearwards to right-angles on each side of the line of motion."

Further consideration has led me to think that travelling at the same speed as that of light would not "freeze" the scene into a fixed sameness, but would still be one of darkness, there being no overtaking wave-forms.

Travelling at a speed less than that of light would, I think, present the scene to the eye as that of red, due to the reduced number of waveforms arriving per second. It is possible that the time sequence would be considerably prolonged.—C. J. WILLIAMSON (Scalloway).

SIR,—May I be allowed to contribute to the correspondence provoked by the article "The Phenomenon of Light" and the letter of R. H. Wallis?

The letter by C. J. Williamson in your June issue, which was submitted as a reply to R. H. Wallis's query, is, I think, itself fallacious in so far as he maintains the relative nature of the speed of light. As was pointed out in the original article, the speed 299,796 kilometres per second (the speed of light) is an absolute speed: it is the same at any place in the universe, and in regard to any piece of matter. Therefore, in the case of Williamson's observer, instead of his seeing "nothing" (by virtue of his receding from the source of light at a speed greater than that of light itself), he would in fact see the whole process of train in station, passengers boarding train, train leaving station in its correct and only time-sequence, regardless of his own motion; the speed of light relative to him still being 299,796 kilometres per second.

The fallacy of the notion of the scene

"freezing" when the observer is moving or receding at same speed as the speed of light is clearly seen when one interprets it as meaning that the speed of light relative to the observer is nought. Indeed, if we take C. J. Williamson's argument to its logical conclusion we see that he in fact endorses that which he set out to deny, namely, R. H. Wallis's theory of the reversal of sequence in time.

What the previous correspondents seem to have overlooked, however, is the fact that the distance and, in the case of the receding observer, the increasing distance of the observer from the observed train is a factor to be reckoned with. This distance would only be of no importance were the speed of light infinite. The time taken by light to travel the distance from train to observer is the sole factor governing the non-simultaneity of "events" and observations. If the observer moves an appreciable distance between the occurrence of "events" the discrepancy will be noticed only in the time taken by light to cover the increased or decreased distance. The sequence of "events" observed will remain unaffected.

I would like, if I may, to end on a rather critical note. The correspondents on this subject (including myself) have been reasoning on purely hypothetical lines; the observer postulated as moving at a greater speed than 299,796 kilometres per second being a scientific impossibility. The speed 299,796 kilometres per second is much more than the speed of light: it is the speed at which lengths contract to zero and mass of matter becomes infinite and thereby ceases to exist.—E. G. NICHOLSON (Northants).

"Practical Mechanics" in the R.A.F.

SIR,—I have never taken the trouble to write to you before, but your editorial in the June issue prompts me to do so this time.

Can I remember the pre-war issues? Yes, easily, for I have every copy from No. 1; and I always spend a pleasant evening when

home on leave looking through back numbers for ideas or articles on various subjects.

I have always found copies of the "P.M.," also its companion issue *Practical Engineering*, in our camp library, but I have mine sent from home and it is read by everyone in the hut.

The most popular articles are undoubtedly the constructional ones, for the lads are very useful with their hands and tools. Toys for the kiddies and articles for the home are always first on the list, after the inevitable cigarette lighter has been made.

Some of them are very good and clean designs and are all well finished. For the home, such things as ashtrays, photo frames, nests of tea-trays, table lamps and table mats are made in a number of designs according to the amount of "scrap" material available. Some very good effects are obtained with the use of aluminium and ebonite, both of which finish well with a high polish.

Model-making is not very popular at the moment, possibly owing to the difficulty in getting household articles and the ability of being able to fulfil some of these needs.

While mentioning model-making, I would like to say how much the articles and photographs by "Motilus" are appreciated. His page is one of the first to be read.

I also find the *Cyclist* supplement very interesting; but what a pity your contributors could not have persuaded the R.A.F. to buy cycles of a decent type, such as they always advocate; instead of these heavy, high-frame uprights with which we are issued.

The quality of them is very poor and they are a constant source of trouble. I'm always pleased to get home and have a trip on my pre-war lightweight sports model.

An unusual slip was noticed in a recent issue (March, I believe), when a view of East and West Looe, in Cornwall, was published with the sun shining from the north.

In conclusion, I think that there are many who are waiting for the "P.M." to get back to its pre-war standard, and all of us in the Forces (and there are many new recruits to the home workshops after their service experiences) will be only too glad to spend a quiet evening in the tool shed or garage.

May I wish "P.M." every success in fulfilling a need for the practical enthusiast.—W. H. VIRGOE (R.A.F.) (Bury St. Edmunds).

Projectiles from Space

Nature's Bombardment of the Earth

By F. J. STIRLING

THE stray "shooting stars" which dash across the heavens every night seldom reach the earth's surface. Twenty miles above our heads they become so completely burnt out by the friction of their headlong flight that they fall silently, gradually and imperceptibly to the ground in the form of a fine, impalpable dust.

As most of us are aware, these so-called shooting stars which career about the skies at night are obviously not stars at all. Imagine them merely as fragmentary lumps of hard metallic and rocky matter, the size, perhaps, of a football and, maybe, often considerably larger, glowing vividly at a height of anything between 20 and 70 miles upwards in the atmosphere, which present to us ground-dwellers the transitory appearance of stars falling earthwards from their celestial moorings.

Technically, a shooting star is called a "meteor." If it succeeds in reaching the

effectively brakes their velocity and, in the majority of instances, entirely destroys them, these visitants from space would constitute VI projectiles indeed, for life on the surface of our planet would hardly be livable if it were subjected to a continuous and uninterrupted hail of high-speed metallic or mineral projectiles such as meteors or shooting stars comprise.

Meteor Velocities

The visible path of a meteor's flight is seldom longer in duration than three seconds.

A few last longer, and many have a shorter appearance, but three seconds is a good average duration for any sizable shooting star. In view of a meteor's fleeting visibility, it is an extraordinarily difficult matter for even a trained astronomical observer to make an estimate of its velocity. Usually, however, it is reckoned that a slow-moving meteor travels at about 7 miles per second, whilst a rapid meteor may touch a velocity of 50 miles per second.

Meteors differ in colour. Some are red, orange or yellow. These are the slower-moving varieties. But there are other meteors which burst with dazzling brilliancy as they fly through the upper regions of the air. These,

the blue or the white meteors, travel the fastest, the friction of their flight through the atmosphere raising them up to white heats.

It seems most likely that the average meteor becomes visible when it is about 80 miles above the earth's surface. Unless this flying lump of rock is of more than average size it burns itself out completely when it arrives at about 20 miles above the earth.

Sometimes a meteor leaves a luminous haze or trail in its wake, a luminescent streak across the sky which lasts for a minute or two after its headlong flight. The cause of this phenomenon is quite unknown, but it is definitely not an optical illusion.

Origin of Meteors

Whence come these strange yet commonplace projectiles from the skies? It seems pretty certain that there exists in space streams or rivers of these flying stones, each stream or meteor river flowing round the sun or round the earth in a highly elliptical path or orbit. Consequently, the earth, at certain regular intervals in its journey round the sun, cuts through these meteor streams, the result being at those times a more intense meteor bombardment of the earth than at other times.

During the month of August meteoric displays may be expected between the tenth and the eleventh day. These meteors contact the earth's atmosphere at a point in a constellation of stars known as *Perseus*. From this fact, these regular August meteors are called the "Perseids." Similarly, the meteors which occur regularly about November 14th are seen originating in the region of the constellation *Leo*. They are thus known as the "Leonids."

The fact that these regularly recurring meteors appear to originate from a mere point in the heavens is due to an illusion of perspective just as is the apparent convergence of a railway track in the far distance. Actually, the paths of the meteors are perfectly parallel and our earth usually cuts directly or obliquely across them.

There are astronomers and scientists who say that the meteor streams which pass around the sun in well-defined orbits are



Halley's Comet, the most famous of these celestial visitors which seem to be so closely associated with meteor production.

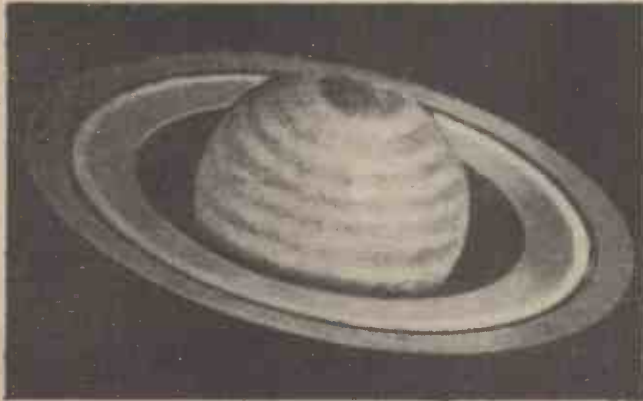

A telescopic view of the planet "Saturn," whose remarkable ring system is composed of innumerable meteors of flying particles encircling the planet.

earth's surface and is large enough to handle, it is then termed a "meteorite."

We might, perhaps, look upon meteors as Nature's VIs. They are projectiles which reach us from space. In this fact lies their tremendous interest from a scientific point of view because they prove to us that our globe, as it steadily and ceaselessly sails along in its appointed orbit round the sun, does not pursue an uninterrupted course. Indeed, Nature is prodigious with her VIs, for a fairly recent estimate made by the astronomical department of Harvard University, U.S.A., suggests that upwards of a hundred billion meteors fling themselves into or are otherwise drawn into the earth's atmosphere every 24 hours. The majority of these meteors are invisible to the naked eye, but they can be witnessed by telescope observers as they dart across the fields of their instruments. These astronomical will-o'-the-wisps must necessarily be very small when they first contact the earth's atmosphere, no greater in size than, say, a paving sett or a cobblestone. Nevertheless, were it not for the fact of the earth's atmosphere which so



A telescopic view of a portion of the moon's surface as seen from an apparent distance of 90 miles. Note the large crater-like formations which are supposed to be due to the impact of large meteorites. They are all similar in formation to "Meteor Crater" in Arizona.

formed from the residues of comets. Other theorists, on the other hand, assign their origin to past explosions of one or more planets, the flying debris having been attracted by the sun and aligned by its gravitational influence into orderly streams. There may be some truth in this suggestion, for it has



Meteor Crater, Arizona, U.S.A. Nearly a mile wide, this enormous crater was caused by the impact of a huge meteorite in prehistoric times.

been proved that the extraordinary rings of the planet Saturn consist of nothing other than a number of encircling meteor streams, the streams being about 50 miles thick. Very probably these rings originate by the past explosion of a satellite or moon of Saturn, the flying particles being gravitationally collected by the parent planet and whirled around its equator, thus providing us with the spectacle of Saturn being surrounded by apparently solid rings.

Quite apart, however, from the regular meteor streams which the earth encounters annually, our globe is the target of countless "stray" meteors which reach it at all times of the night and day. Naturally, we cannot see meteors outside the earth's atmosphere even with the largest telescopes because they are relatively so small and because, being imbued with the deadly cold of outer space, they do not shine by their own light. But the fact that our earth receives daily so enormous a number of these projectiles seems to suggest that the term "empty space" is very much of a misnomer and that, in reality, inter-planetary space is populated by almost inconceivable numbers of rocky lumps and chunks varying in size from the dimensions of a cricket ball to that of a small mountain, all of them hurling themselves in various directions with velocities far exceeding that of a rifle bullet.

Inter-planetary Travel

There is no doubting the fact that such considerations must be thoroughly well taken into account by any future means of inter-planetary travel from the earth, for it is obvious that the impact of myriads of these space projectiles upon any mechanically-powered earth rocket-ship would have the most serious consequences unless special precautions could be devised to minimise their effects.

Meteors which succeed in penetrating the earth's atmosphere and in falling to the ground are known technically as "meteorites." When picked up, the majority of them are roughly globular in shape and are covered with a black, glossy coating, giving them a sort of varnished or enamelled aspect.

In composition, meteorites can be divided into two distinct varieties—mineral and metallic. The mineral meteorites are mostly made up of silicates, through which is diffused iron oxide or iron silicate, whilst the metallic meteorites are composed for the most part of metallic iron contaminated with silicate material.

Iron, therefore, in one form or another,

is a characteristic constituent of all meteorites. So also is nickel, for it is always present in association with the iron. Cobalt is another metal, too, which has been detected in meteorites. So also have magnesium, sodium and potassium.

Some meteorite fragments have been found to contain metallic gold. One or two have shown the presence of diamonds, although in merely microscopic form. Most interesting of all, perhaps, is the fact that a few meteorites have contained carbon together with hydrogen.

To the chemist and to the scientist generally, all meteorites are unique as being the only heavenly bodies which Nature permits us to touch and to handle, to investigate chemically and microscopically. We may view the moon, stars and planets through telescopes, we may calculate their motions with an astonishing degree of accuracy, but, as yet, we have never been able to approach them at close quarters. In the meteorite, however, the scientist has in his own hands a fragment of "sky-stuff" which he is able to examine leisurely and to his heart's content.

Meteorites, as we have seen, have brought to us iron, magnesium, silicates and other common materials of our own earth. They have never, however, contained any unknown substances. It is therefore possible that some time they might do so and that we might discover in a meteorite, if not a new element (for that seems hardly possible), at least an unknown modification of an existing one.

Life on a Meteorite?

Then, again, can a meteorite bring life to our planet? Can it present us with strange seeds of life-forms which, as yet, we know not of? Can the meteorite projectile, after surviving its passage through the earth's atmosphere, bring to us new and terrible diseases of a malignancy yet unknown?

The answer to all such questionings is simply that we do not know. Meteorites, as we have seen, may contain carbon and hydrogen, both of these elements being essential to life as we know it. Perhaps a meteorite may yet bring to our earth an organic material, that is, a substance made up of carbon, hydrogen, oxygen and nitrogen, the four elements of life. If so, then many possibilities will arise before us.

It has been seriously suggested that the original germ of life came to this planet on the back of a meteorite, so to speak, this scientific theory asserting that life on our earth was originally transferred from some other planet by the agency of a space projectile or meteor. The theory has its possibilities, but it is not very probable.

No trace of bacteria has ever been detected upon freshly fallen meteorites. That does not, however, imply that if bacteria do exist in extra-terrestrial regions it would not be possible for a meteor projectile to convey

them to us, for many meteors are porous in inner structure and hosts of living germs could readily store themselves away in even one single microscopic pore provided that the right conditions were present.

Against this suggestion the reader will, no doubt, point to the fact that meteors are heated to incandescence during their flight through the earth's atmosphere and that no life form is capable of withstanding such temperatures. Such is undoubtedly the case, yet, curiously enough, after a meteor has fallen it often rapidly becomes covered with a layer of ice consequent upon the fact that its inner core is at an extremely low temperature.

Space Temperature

We know that a temperature approaching absolute zero (minus 273 deg. C.) reigns in open space. Thus, small bodies travelling through this space will be more or less heatless—that is to say, they will attain a uniform temperature of approximately absolute zero. Now, although a meteor during its passage through the earth's atmosphere becomes heated up to white heat, the velocity of its flight is so rapid that the meteor itself, if it is of any respectable size, has not time to become uniformly heated before it reaches the ground. Thus, although its surface area may have attained glowing incandescence for a few seconds, its inner core still remains many degrees below ordinary zero, thus making possible the characteristic ice formation after the meteor has rested on the earth for a short time.

The question, therefore, seems to be not so much whether it is possible for living bacteria or other minute forms of life to withstand intense heat but, rather, whether these specks of living material will survive after being subjected to intense cold.

The problem, however, has never been decided. No one has yet found bacteria in the pores of a meteorite. Perhaps such life forms may never be discovered therein. But if a meteorite were ever found to be bacteria-



The flash of a large meteor past the telescope camera.

contaminated, such a fact would at once open up the engrossing possibility of strange plant seeds, unknown fungi and germ spores and even the minute origins of malignant diseases yet unknown to us being conveyed to our planet haphazardly by means of a meteor projectile from remote outer space.

Nature's V2s

There is yet another possibility worthy of consideration in relation to the subject of these space projectiles. It is the fact that if we dub as V1 the ordinary meteorites which reach us, Nature has up her sleeve a number of very nasty V2s which she occasionally inflicts upon our earth with somewhat disastrous results.

Nature's V2 is the over-sized meteor, the space projectile which is something of the nature of a flying mountain and which,

occasionally in recorded history, has been proved to hit the earth squarely and forcibly and with serious consequences.

The last recorded of [these natural V-2s fell in the northern wilds of Siberia on June 30th, 1908. It devastated an area of several square miles, trees being completely burnt up and the ground for miles around being pitted with craters, some of them 150ft. in diameter. The sound of the meteorite's impact was recorded at several British meteorological stations, but its exact significance was not realised until later. The impact shock was also registered in Germany.

In Arizona there is the famous Meteor Crater, a huge depression in the earth nearly a mile in diameter and some 600ft. deep. This, in prehistoric ages, was caused by a similar meteorite impact to the Siberia one of relatively recent years, except, of course, that the Arizona impact must have been much more severe. In the latter instance, the huge hurling mass of meteorite material must have buried itself hundreds of feet below the ground, in which position it has been proved still to remain. Many expeditions have been made to Meteor Crater for the purpose of prospecting the buried meteorite, which is accredited with containing large amounts of platinum and gold, but none of them yet has in any way succeeded.

Now, the fact is that it is possible for such enormous masses of material to encounter the earth brings with it the question as to how far it may be possible or likely for our

planet to suffer a major disaster by the impact of a still larger mass of meteorite material.

We have, of course, no possible notion of how much of this "flying mountain" material may be present in interplanetary space, nor have we, as yet, any means of detecting the presence of such dangerous debris. We know that the planet Mars has two revolving moons or satellites, one of which, *Deimos*, is barely 10 miles in diameter. Possibly, therefore, *Deimos* was once a meteor which rushed in to bombard the Martian planet but which was "captured" by the gravitational influence of that planet and made to revolve around it in a permanent orbit.

Flying Mountains

Moreover, there may be, and undoubtedly are, other *Deimoses* in space, although those which we know (constituting the smaller members of the asteroid family of planets) revolve in well-defined orbits. One of these, *Hermes* (discovered in 1937) is, perhaps, not more than a mile or two in diameter, but of all the heavenly bodies, apart from the moon and the meteors which fall to the earth, it is the one which comes the nearest to us, swinging at one point in its orbit to within 400,000 miles of the earth, which is less than twice the moon's distance from us.

Another recently discovered asteroid or planetoid is *Adonis*. Another is *Amor*. *Adonis* seems to have a diameter of less than half a mile. It is literally a flying rock, irregular shaped and it appears to travel

through space merely by turning itself over and over.

Hermes, Amor, Adonis and others of their kin approach the earth, but they never leave their appointed orbits around the sun.

What, however, if one of these miniature planets took it into its head when approaching the earth to make a flying leap at our planet? It would at once constitute a space V-2 *par excellence*. *Adonis, Amor* or *Hermes* might, perchance, consist of solid platinum or gold. Nevertheless, if they happened to hit the earth, great havoc would necessarily be wrought, particularly if the point of impact coincided with a populous region of our globe.

London, Paris or New York, for instance, would fare badly under the impact of even a half-mile-diameter planet, let alone that of a larger-sized projectile. And even if such an unwelcome space visitor buried itself deeply in the bed of the ocean, the result would be felt on all the continents, for a gigantic tidal-wave would at once hurl itself around the earth, bringing destruction and suffering wherever it went.

Fortunately, there seems to be very little chance of our earth being hit by an asteroid broken loose or by a similar sized chunk of extra-terrestrial matter. Yet the possibility remains and it cannot be denied.

Space projectiles, therefore, may bring us new materials, new compounds, perhaps some elementary forms of life, or, as we have just seen, possibly a serious disaster. The chances, however, are quite unpredictable.

Items of Interest

Model Engines from Red Cross Tins

GRANDFATHER clocks which kept accurate time, high-speed cookers, water pumps, stoves and chimneys, suitcases, cupboards, plates, mugs, steam and petrol engines—these are just a few of the things which R.A.F. prisoners of war in Germany made from Red Cross tins.

The tins were so highly prized that when parcels were shared lots would be drawn to decide who should have the tin.

Cooking stoves with forced draught created by belt-driven fans were made which could boil two pints of water in 45 secs.

One airman made a miniature petrol engine, with a tea-cup sized cylinder block, with cooling-fins cast from the melted-down solder of the Red Cross tins. Ignition was by a cam-operated push-rod which struck a flint.

Life-saving Packet for R.A.F.

ONE of the many problems which have confronted British scientists during the war has been of particular interest and importance to R.A.F. pilots and aircrews.

Early in the war, the Royal Air Force was faced with the fact that, with the possibility of much of the air war being fought above water, those airmen who had the misfortune to "ditch" were in danger of dying from thirst while adrift.

Those who crashed far from land were sometimes difficult to locate, and needed a specially large supply of water if they were to survive. In hot climates and tropical waters, fresh water is a greater necessity than food. Many suggestions were tried out during the research which went on in the early days.

Two important considerations, space and weight, had to be borne in mind in producing emergency "desalting" equipment to be carried—first in an aircraft, and then in a small dinghy.

Compact Desalting Apparatus

Eventually, chemists of the Permutit Company, Chiswick, working in association

with the Ministry of Aircraft Production, produced a desalting apparatus in a simple and compact form, suitable even for weak or wounded men's use.

The apparatus is in the form of a box about the size of a half-pound packet of tea. The box is made of transparent plastic, and is used as a drinking vessel.

Inside is a collapsible bag. And all the "ditched" airman has to do is to take out this bag, pour in a quantity of sea water, drop in some cubes, close the bag, and, after a period, squeeze fresh water through a spout at the bottom of the box.

When all the fresh water has been squeezed out, the bag is rinsed in the sea and is then ready to produce another supply. Every part of the apparatus has a safety cord to prevent its loss in rough seas.

The process was devised by British scientists, who passed on the details to the United States. The Americans have now developed a similar apparatus.

Over 20,000 of these boxes have been sent to Eastern Air Command, South East Asia. Each of these, though taking up less space than a pint of water, will produce four and a half pints.

They will be packed into the dinghies carried by all aircraft flying over the sea, several being provided for each member of the crew.



Ranging Hellcats on the flight-deck of one of H.M. escort carriers now serving with the East Indies Fleet. The lift is rising and the flight-deck handling party wait until it is flush with the deck to push the Hellcat into position.

QUERIES and ENQUIRIES

A stamped, addressed envelope, three penny stamps, and the query coupon from the current issue, which appears on back of cover, must be enclosed with every letter containing a query. Every query and drawing which is sent must bear the name and address of the reader. Send your queries to the Editor, PRACTICAL MECHANICS, Geo. Newnes, Ltd., Tower House, Southampton Street, Strand, London, W.C.2.

Crackle Finish

HOW can I make, or from where can I obtain, a small quantity of black crackle paint as used on photographic instruments, etc.? The finish of this gives the impression that the paint has stretched, and dried leaving many tiny ripples.—B. J. Frost (Hitchin).

YOU can obtain the "crackle" effect by making up the following crackle base: aluminium stearate, 25 parts; ethyl acetate, 74 parts; pyroxilin, 1 part.

This "crackle base" is added to ordinary cellulose lacquer in the proportions of approximately 1 part of the "crackle base" to 4 parts of the ordinary lacquer. The resulting lacquer will dry out with a wrinkled surface.

The above ingredients are obtainable from Messrs. A. Boake, Roberts & Co., Ltd., "Ellerslie," Buckhurst Hill, Essex (emergency address), whilst "crackle" and other special types of lacquers can normally be obtained from Messrs. Nobles and Hoare, Ltd., 3, Cromwell Road, London, S.E.1.

Microscope Objectives

WOULD you please explain the following for me? It is a passage from a book:

"A simple microscope with two eye-pieces $\times 6$ and $\times 10$, objectives 2in. , 1in. and $\frac{1}{2}\text{in.}$, and substage condenser."

Also, I have a microscope, and would like to know how I can find out what magnification it is.—G Wright (Wembley).

AN "objective" is the "business end" of a microscope, i.e., the lens or combination of lenses which focuses the light from the object under examination. Its function is to make an image of the object, which image is enlarged by the eyepiece lens. Objectives of 2in. , 1in. and $\frac{1}{2}\text{in.}$ are those particular objectives which give a focused image of the object when they are 2in. , 1in. or $\frac{1}{2}\text{in.}$ away from the object. The nearer the objective is to the object the higher is the degree of magnification given, but the smaller is the area of the object which is covered by the objective lens.

A substage condenser is a lens or a combination of lenses which is fixed under the stage of the microscope, and the function of which is to collect light rays and to focus them accurately on the object under examination. Substage condensers are made adjustable, so that this light focusing can readily be accomplished.

The magnification given by a microscope depends upon the "power" of its objective, on the "power" of the eyepiece and on the distance between the eyepiece and the objective.

To determine approximately the magnifying power of a microscope measure the distance between the object and the centre of the eyepiece. Knowing the focal lengths of both the objective and the eyepiece lens the magnifying power can then be worked out. For instance, if the focal length of the objective is $\frac{1}{2}\text{in.}$, that of the eyepiece lens 1in. , and the distance between the object and the centre of the eyepiece lens is 6in. , then the magnifying power of the microscope will be:

$$\frac{6 \times 6}{\frac{1}{2}} = 72 \text{ times.}$$

The matter is explained in most technical books on the microscope.

Waterproofing Bricks

WILL you kindly advise me on the following matter? I wish to make a waterproof material for sand-lime bricks, similar to that sold as "Prufit" cement waterproofing paste. Can you give me any method or formula of manufacture?—Wm. H. Briggs (Coventry).

A LARGE number of cement and brick waterproofing compositions are nowadays composed mainly of natural rubber latex which has been suitably stabilised in emulsion form by the addition of ammonium compounds, such as ammonium stearate and/or ammonium chloride. We understand that the material you mention is of this nature.

Many of these rubber latex compounds are patented articles, and, in addition, the manipulation and use of the rubber latex is, in not a few instances, subject to patent protection. You can, however, obtain rubber latex for mixing with concrete and similar materials from Revetex Sales Co., Ltd., Upper Thames Street, London, E.C.4. It is merely necessary to mix the cement with the diluted latex and allow the mix to dry out. A waterproof concrete or plaster will then result.

Another mode of waterproofing cement, concrete, plaster, etc., is to mix with the material up to per

cent. of ammonium stearate paste, or, alternatively, to spray a solution of this on to the surface of the finished brickwork or concrete. Ammonium stearate, however, cannot be kept very long in the raw "paste" condition, since it is somewhat unstable.

We would advise you, therefore, to get into touch with the Revetex company (address as above), who will willingly give you all information concerning the use of their rubber latex for waterproofing purposes.

Field Stampings for D.C. Motor

I HAVE an armature which is suitable for D.C. supply. The diameter is $1\frac{1}{2}\text{in.}$ and the length $\frac{3}{4}\text{in.}$. The commutator is $\frac{1}{2}\text{in.}$ diameter and has 22 segments. The shaft is $\frac{3}{16}\text{in.}$ diameter. Total length equals $\frac{3}{4}\text{in.}$. Could you suggest a way in which I could make a suitable stator which I could use for this armature? I require it to drive a small sewing machine.—S. Withington (Birmingham).

THE simplest way of obtaining a field system for your armature would appear to be for you to write to Messrs. Geo. L. Scott and Co., Ltd., Hawarden Bridge Steelworks, Shotton, Chester, to see if they

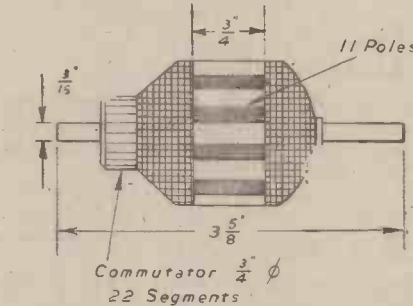
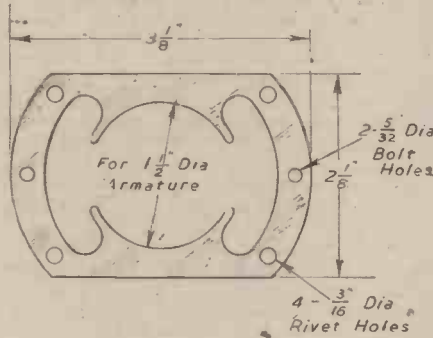

Field stamping and armature for a small D.C. motor. (See reply to S. Withington, B'ham.)

can supply you with some of their S.19 stampings, as shown in the accompanying sketch. Given a fully dimensioned sketch of the field iron system and armature slots, including the air gap clearance between the armature and field poles (which may be measured by means of feeler gauges), and knowing the approximate full load speed desired and the type and voltage of the supply, we could then suggest suitable windings.

Repairing Cine Films

WOULD you please advise me as to the best method of making repairs to cinematograph films which have become torn?—L. Buckley (Manchester).

CINE films which have been torn are readily joined by the application of film cement. Using a sharp knife, scrape the gelatine layer off both contacting surfaces, apply a little of the film cement to each surface, bring them into contact, and apply pressure for an hour or so. An enduring join will then result. You will probably be able to purchase film cement

from Messrs. Flatters and Garnett, Ltd., Oxford Road (opposite the University), Manchester, 13. Alternatively, you can make it yourself by dissolving scrap clear celluloid in a mixture of approximately equal parts of acetone and amyl acetate. These materials may best be obtained by you from Messrs. J. W. Towers and Co., Ltd., Chapel Street (Victoria Bridge end), Salford.

Water Filter: Hot Water System

I SHOULD be obliged if you would give me the following information:

(1) I wish to use water pumped from the river Thames for domestic purposes on a houseboat. The water is comparatively clean, but I should like to construct apparatus for filtration. I believe this can be done by filtration through a bed of sand, with the addition afterwards of chlorine or similar chemicals. Can you tell me if this is correct, what chemical to use, and the correct proportion?

(2) I wish to install a hot water system with an "Ideal" boiler, to supply domestic hot water and radiation. Can you give me information on the size and height of tanks, and water circulation system?

(3) Alternatively, can you recommend any literature or articles on the above subjects?—A. Stephenson (Guildford).

(1) **OBTAIN** a large metal drum of about 20 gallons capacity. Render it scrupulously clean, fit a tap to the lower part, and at the bottom place a 2-in. layer of coarse stones and pebbles. On top of this place succeeding 2- or 3-in. layers of increasingly fine stones, ending up with grit. Above this place a layer of fine sand mixed with 25 per cent. of its weight of coarse charcoal. On top of this place a substantial layer of grit and for the uppermost layer of all, make use of a mixture of grit and small pebbles. The whole of the material used must, of course, have been well washed. The filtering material should fill up the drum to about three-quarters of its capacity.

Water filtered through this medium will be free from all insoluble impurities and from many chemical ones. It will not, however, be free from possible germs. This freedom, however, can be given, as you say, by suitably chlorinating the water. The best way of doing this is to use a small cylinder of chlorine gas (obtainable normally from I.C.I., Ltd., Millbank, London, S.W.1), and by passing a few bubbles of the gas into a large tank of the filtered water. Since, however, small-sized chlorine cylinders are very difficult, and, in fact, almost impossible to obtain nowadays, you may have to use ordinary bleaching powder or chloride of lime as a chlorinating agent, about one thimbleful of fresh bleaching powder being dissolved in every 30 gallons of water. The water so treated should be allowed to stand for six or seven hours before being used.

(2) We are afraid that, within the space of a short reply, we should be quite unable to give you all the details necessary for the successful installation of a complete domestic hot water and radiator system, particularly since you give us no information whatever concerning the conditions under which you propose to construct your hot water system. You might, therefore, care to contact specialist firms who may be able to advise you and to supply you with interesting trade literature. Two such firms are: Messrs. Baker Perkins, Ltd., 7, Collier Street, London, N.1, and Messrs. Charles P. Kinnell & Co., Ltd., 65, Southwark Street, London, S.E.1.

(3) Also, it will be to your advantage to read up a few modern textbooks concerned with heating systems. Some such books are as follows, the prices given in brackets being the publishers' pre-war net retail prices: E. G. Blake, "Practical Hints on the Installation of Heating Apparatus" (2s. 6d.); F. W. Dye, "Heating and Hot Water Work" (9s. 6d.); S. F. Greenland, "Hot Water Service, Design and Pipe Sizing" (12s. 6d.); G. C. Sanford, "Central Heating and Hot Water Supply for Private Houses" (6s.).

Slow-setting Plaster: Sal-ammoniac Solution

I HAVE a standard lamp shade that has been damaged. It is plain parchment with a fancy plaster top and bottom of a pattern similar to that on a birthday iced cake; it appears to have been worked on with a bag and then varnished.

I have some plaster of Paris and have tried this but however thin I mix it, it congeals and begins to set before it can be worked.

Can you tell me how I can mix the plaster or

THE P.M. LIST OF BLUEPRINTS.

The "PRACTICAL MECHANICS" £20 CAR (Designed by F. J. CAMM), 10s. 6d. per set of four sheets.

"PRACTICAL MECHANICS" MASTER BATTERY CLOCK" Blueprints (2 sheets), 2s.

The "PRACTICAL MECHANICS" OUT-BOARD SPEEDBOAT 7s. 6d. per set of three sheets.

A MODEL AUTOGIRO" Full-size blueprint, 1s.

SUPER-DURATION BIPLANE" Full-size blueprint, 1s.

The 1-c.c. TWO-STROKE PETROL ENGINE" Complete set, 5s.

STREAMLINED WAKEFIELD MONOPLANE—2s.

LIGHTWEIGHT DURATION MODEL Full-size blueprint, 2s.

P.M. TRAILER CARAVAN" Complete set, 10s. 6d.

P.M. BATTERY SLAVE CLOCK" 1s.

The above blueprints are obtainable, post free from Messrs. George Newnes, Ltd., Tower House, Southampton Street, Strand, W.C.2.

An * denotes that constructional details are available, free, with the blueprint.

if there is any other kind of medium that would suit?

(2) Can you tell me how much sal-ammoniac crystals is needed per pint of water for Leclanché cells. And will distilled water be suitable for them?—K. Burnett (Romford).

(I) For your purpose, you can delay the setting time of ordinary plaster of Paris by slaking it not with ordinary water, but with water containing white of egg. Use 5 parts white of egg with 95 parts water. Also, if you can, incorporate a small amount of fibrous material in your plaster, such as asbestos fibre, clean hair cuttings, etc. This will give greater strength to the plaster and make it less brittle.

A much slower-setting paste may, for your purpose, be made by slaking calcined magnesite with a solution made by dissolving 40 parts commercial magnesium chloride in 60 parts water. These materials may be obtained from Messrs. Harrington Brothers, Ltd., 4, Oliver's Yard, 53a, City Road, Finsbury, London. This paste, when of the consistency of mortar, takes about 30 hours to dry out and is much harder than plaster of Paris.

(2) The solution of sal-ammoniac (ammonium chloride) used in the Leclanché type of cell should be as strong as possible. This is because by using a strong solution the inner resistance of the cell is lessened and, also, because the strong solution is better able to dissolve the salts which are gradually produced by the action of the cell. Use, therefore, what is termed a saturated solution of sal-ammoniac, that is to say, a solution whose water will dissolve no more of the sal-ammoniac. This is made by taking a given quantity of water and by shaking up with it in a bottle sal-ammoniac. The sal-ammoniac will dissolve. More of it should be added and the process repeated until, at last, no more sal-ammoniac will dissolve. To increase the rapidity of solution, the water should be warm. You need not use distilled water. Ordinary tap water will do.

It is little known that, in an emergency, a strong solution of common salt can be used in a Leclanché cell in place of the sal-ammoniac solution.

Luminous Calcium Sulphide

Can you please answer the following questions: Where can I obtain a small quantity of luminous calcium sulphide, and what would be the price of it?

What is a solvent for calcium sulphide, where can I obtain it and would it destroy its luminescent property?

How long will a good sample of calcium sulphide luminesce if I exposed it for about five seconds, and what period in the dark will render it non-luminescent?—F. Murray (Northampton).

LUMINOUS calcium sulphide can be obtained from any laboratory chemical supply firm, such as Messrs. Harrington Brothers, Ltd., 4, Oliver's Yard, 53a, City Road, Finsbury, London, E.C.1, or Messrs. Baird & Tatlock (London), Ltd., 14-17, St. Cross Street, Hatton Garden, London, E.C.1, or, again, Messrs. W. & J. George and Becker, Ltd., 17-19, Hatton Wall, London, E.C.1. The present price is about 4s. 6d. per oz.

There is no solvent for calcium sulphide. It can be made into a paint by mixing with celluloid varnish, this latter being made by dissolving scrap celluloid in a mixture of approximately equal parts of acetone and amyl (or butyl) acetate, which materials may all be obtained from the above-named sources.

An exposure of five seconds to sunlight will render the calcium sulphide brilliantly luminescent for two or three hours, after which the luminescence will gradually decrease during the ensuing 12 hours.

Several days in the dark are required to render calcium sulphide non-luminescent. In fact, with some samples, several weeks of darkness are required to effect this purpose. Much depends upon the quality of the calcium sulphide, and the above figures must be regarded as being approximate only.

Material for Focal Plane Shutter

(I) I AM making a miniature camera similar to that described in "Practical Mechanics" some time ago, but wish to make my own focal plane shutter. I have worked out all the details, but am in doubt as to what material to use for the roller blinds. I have been told it is a kind of rubberised fabric, but it must be very durable material to stand up to the continual winding and unwinding.

Can you suggest, please, a suitable material, and where it can be obtained?

(2) Can you also tell me how to stick thin leather to aluminium, for covering the body of the camera?—A. Turner (Leicester).

(I) YOUR statement that the material comprising the blind of focal-plane shutters is a rubberised fabric is quite correct, since this appears to be the only kind of dense fabric which will remain flexible and entirely light-proof over long periods. It is hopeless to try to make it yourself, and we are in some doubt as to whether it is at present obtained by the ordinary means. However, Messrs. Jonathan Fallowfield, Ltd., Photographic Dealers, 61-62, Newman Street, London, W.1, will probably be able to inform you whether this material is obtainable. Alternatively, you may desire to apply to actual manufacturers of rubberised fabrics, addresses of which are as under: The Altrincham Rubber Co., Ltd., 2 and 4, Kingsway, Altrincham, Cheshire; Messrs. F. Reddaway and Co., Ltd., Pendleton, Salford, 6, Lancs.; The Greengate and Irwell Rubber Co., Ltd., Greengate, Salford, Lancs.; The India Rubber, Gutta Percha and Telegraph Works Co., Ltd., Silvertown, London, E.16.

(2) A good leather cement is made by mixing equal quantities of raw rubber and bitumen. This must be used warm.

Another cement comprises ordinary celluloid cement mixed with a little powdered naphthalene (mothballs) just sufficient to give it a milky appearance. Celluloid cement can be bought at most paint shops. It can be made by dissolving scrap celluloid in a mixture of approximately equal quantities of acetone and amyl (or butyl) acetate.

A third method of cementing leather to metal is the following:

Dissolve 1 part of tannic acid in 8 parts of water. Make up, separately, a fairly thick glue solution. Spread the warm tannic acid solution on the underside of the leather and the warm glue solution on to the metal. Bring the two surfaces into contact and keep under pressure for some hours. The metal surface should be roughened before applying the glue in order to give the latter a better "key" on to the metal.

Weatherproofing of Overalls

I WISH to weatherproof a suit of canvas overalls for motor-cycling. Can you suggest a rubber base paint that I could make up to brush or spray on to the canvas, or if such a paint or preparation can be obtained from any firm?—J. Jenkins (Stockwell).

THE home waterproofing of overalls is very seldom a successful job. So far as we are aware, there is no rubber-based paint manufactured for this purpose. A bituminous paint would also be more or less unsuitable, as would also a bituminous emulsion. The only method we can suggest in your case is that you dissolve beeswax (1 part) in a mixture of raw linseed oil (8 parts) and genuine turps (2 parts). These quantities are given in parts by weight. This oil is applied sparingly to the outside of the garment four times at intervals of a week. After the final application, the garment is spread out and allowed to remain for 4 to 6 weeks in order to dry out. The drying time may be speeded up by adding a little paint drier to the oil. Very often, however, the oil fluxes with old waterproofing material existing within the fibres of the fabric, the result being a permanently sticky material which never completely dries or hardens. This is the reason why so many attempts at this job fail. We feel we must point this out to you in order that you may not be disappointed if your efforts end in the same result.

Chromatography

I WISH to carry out tests using the chromatography method of analysis. Where could I obtain absorbents such as alumina, magnesia, slaked lime, fuller's earth and zeolite, also solvents ether, chloroform, alcohol, pyridene and acetic acid?—S. W. Allcorn (London, W.).

FOR the best chromatographic results, you should use activated alumina of 100/200 mesh. This is specially manufactured by Messrs. Peter Spence and Co., Ltd., Widnes. It is not very costly material. All the other materials which you mention may be obtained from any firm of laboratory and chemical suppliers. Such firms are: Messrs. Harrington Brothers, Ltd., 4, Oliver's Court, City Road, Finsbury, London; Messrs. Baird and Tatlock (London), Ltd., 14-17, St. Cross Street, London, E.C.1; Messrs. Gallenkamp and Co., Ltd., Technic House, Sun Street, Finsbury Square, London, E.C.2.

We would advise you to inform the supplying firm of your desire to call personally for the required materials, since this will considerably decrease packing and postal charges, which latter are specially high for the conveyance of materials such as ether. Remember, also, that alcohol in the pure state, being dutiable under the Excise laws, is very expensive. A good substitute (non-dutiable) for this is iso-propyl alcohol, which can be obtained from Messrs. A. Boake, Roberts and Co., Ltd., Stratford, London, E.4.

Solidifying Carbon Dioxide

COULD you please answer the following questions:

Is it possible to solidify carbon dioxide in small quantities in the home?

If so, would you kindly give me instructions on how to construct a suitable "unit"?—P. Clarke (Acton).

ORDINARILY speaking, it is impossible to solidify carbon dioxide gas which has been generated in the home laboratory, because the degree of cold necessary is not obtainable by means of the common freezing agents. If, however, you have a cylinder of carbon dioxide gas, you can readily solidify the gas by allowing a swift stream of the gas to flow into a round metal box or other container, in which circumstances the heat absorbed by the quick expansion of the gas will reduce the temperature of the latter to below its freezing point, the result being that a quantity of carbonic "snow" will collect in the box.

The only other method of solidifying carbon dioxide is to pass a slow stream of the gas through a U-tube immersed in liquid air. Liquid air is a commercial commodity costing about 5s. per quart. It is obtainable from most depots of the British Oxygen Company, Wembley, Middlesex.

Boiling Point of Pinene: Catalogues

I WOULD be obliged if you could let me have the following data:

What is the boiling point (in degrees Centigrade) at normal pressure of a pinene?

Is it possible to obtain any of the large bound catalogues of chemical apparatus from any of the large firms, e.g., Gallenkamp, Griffin and Tatlock, Becker, etc.

3. What is the current market price of platinum (in grams)?—M. J. Soula (South Harrow).

PINENE, C.N., boils at 155 deg. C. It is volatile in steam, and hence may be steam-distilled below its normal boiling-point.

The large bound catalogues of chemical and laboratory suppliers are normally only supplied to firms of manufacturers, technical colleges and other large users of apparatus. In some instances, too, the compilers of these catalogues retained the nominal ownership of the compilations and distributed them more or less on a sort of permanent loan. Your chance of obtaining one depends entirely upon the efficiency with which you can persuade one of the firms of laboratory suppliers that you could make good use of a catalogue. There is no harm in your trying, and, very possible, one or more laboratory supply firms might have an old catalogue which they might be willing to let you have gratis.

The price of platinum varies from day to day. Hence, we cannot give you a quotation. However, Messrs. Johnson, Matthey and Co., Ltd., of Hatton Garden, London, E.C.1, will readily give you the information required. Note, however, that the price of platinum is always quoted in ounces (troy), from which its cost in grams may be calculated.

A.C. in a D.C. Motor

I SHALL be obliged if you will answer the following question for me:

Am I right in assuming that, when a D.C. motor is running, D.C. current exists in the field coils, but A.C. exists in the armature coils which is caused through the constant reversal of the current, making an attraction and repulsion on the field core. Is that why armature cores are of laminated iron? Does A.C. occur in D.C. generators?—N. L. Davison (South Shields).

IN reply to your query, you are quite correct; A.C. exists in the armature conductors of D.C. motors, and the core is laminated to reduce eddy currents resulting from the reversal of magnetism in the core, as this alternately passes under poles of opposite magnetic polarity. The field pole shoes are also frequently laminated to reduce eddy currents caused by the magnetic flux jumping from armature slot to slot.

The voltage generated in the armature windings of a D.C. generator is also A.C. This follows from the fact that each conductor alternately comes under the influence of opposite magnetic polarity. As this occurs the commutator segment connected to the conductor passes under the brushes which reverse the connection to the external circuit, so that D.C. only flows out of the brushes.

Transferring Designs on to Cloth

I WANT to "transfer" some original designs on to cloth so that they can be embroidered in silk. Ready-made "transfers" are supplied by various dealers; but I want to transfer my own designs on cloth. How do I do this? What ink or chemical dye can I use to draw the designs on tissue paper which could be transferred on to cloth in the usual way—by ironing on the reverse side? Intervening carbon paper invariably smudges the designs and marks the cloth badly.—Y. D. Gundevia (Mirzapur, India).

THERE are several different types of transfer inks suitable for your purpose, but they are all not easy to make on a small scale, and many of them are apt to give rise to blurred outlines. The following inks will be of interest to you:

- (a) Any ordinary printing ink which has been softened by the addition of turpentine and/or glycerine.
- (b) A thin solution of natural bitumen in turpentine, chloroform, or some other convenient solvent.
- (c) Carnauba wax 3 parts.
Boiled linseed oil 2 "
Caustic soda 0.3 parts.
Pigment Quantity sufficient.
- (d) Gum mastic 30 parts.
Beeswax 10 "
Vaseline 10 "
Colour or pigment Quantity sufficient.

In the instance of this formula, the beeswax should be melted first and the Vaseline worked into it. The mixed beeswax and Vaseline should then be mixed with the molten gum mastic, and finally the pigment should be stirred in. If the resulting ink is too thick, it may be thinned with turpentine.

All the above inks may be used on paper, and may be transferred to fabric by the hot iron method which you describe.

**REVERSING AN A.C. MOTOR
A Correction**

IN the reply to an inquiry under the above heading, which appeared in the June issue, the connections for a double-pole switch were, owing to a draughtsman's error, wrongly indicated: They should, of course, be as follows:

The leads from the ends of the field coils should be taken to the two centre terminals only of the switch, the lead from the top brush in the diagram being connected to the top right-hand terminal and bottom left-hand terminal of the switch. The lead from the bottom brush is connected to the bottom right-hand terminal, and top left-hand terminal.

HIGHSTONE UTILITIES

CRYSTAL SETS



Our latest Model is a REAL RADIO RECEIVER, and is fitted with a PERMANENT CRYSTAL DETECTOR. WHY NOT HAVE A SET IN YOUR OWN ROOM OR AS A STAND-BY? —9/6, post 0d. PERMANENT DETECTORS, 2/6, post 3d.

.0003 Pre-set Condensers 2/-, post 3d. HEADPHONES Reconditioned 9/6, 10/6 & 12/6. New 17/-. Post 6d.

MICROPHONES

Just the thing for impromptu concerts, room to room communication, etc. Bakelite table model, 6/9; Suspension type, 8/6. Post 6d. Super Model on stand, 12/6. Fitting instructions included. Mike buttons, 2/6. Transformers, 6/6. Public Address Transverse current Mike, 37/6, post 1/-.

BUZZERS

No. 2. Square single coil model, 2/6. No. 3. HEAVY DUTY double coil, 4/9, post 3d.

MORSE KEYS

Practise on a regulation size Tapping Key. Our heavy brass model is mounted on a wooden base, has an adjustable gap and nickel contacts. Key is wired to work buzzer or flash lamp by using a 44-volt battery or the transformer described below. BRASS KEY, 6/9. Chromium plated, 7/6. W.O. Model with heavy brass bar and an additional front bracket, 9/6. Chromium plated, 10/6. Junior Key, mounted on a bakelite base, together with a buzzer, 5/-. Should you require a complete outfit, our D.X.2 set consists of a heavy key mounted on a large polished board, 10 1/2 x 7 1/2, together with a buzzer, flash lamp, bulb and holders, with two switches to bring either into circuit. Terminals are also provided for distant sending and receiving, 19/6, post 8d.

BELL TRANSFORMERS



These guaranteed transformers work from any A.C. Mains, giving 3, 5 or 8 volts output at 1 amp., operate bulb, buzzer or bell. Will supply light in bedroom or ladder, etc. PRICE 6/6. POST 5d.

SOLDERING IRONS. Adjustable BH, all parts replaceable and fully guaranteed. 200/250 v., 60 watts, 9/6; 150 watts, 12/6, post 6d.

SEND 1d. S. A. E. FOR LIST B.P. OF USEFUL ELECTRICAL ACCESSORIES. Money refunded if not completely satisfied. Letters only. Please include postage, any excess will be refunded.

HIGHSTONE UTILITIES

55, New Wanstead, London, E.11

CAN YOU PLAY THE PIANO

If you are a music lover, why have you not acquired this enjoyable accomplishment and great social asset? Doubtless because the prospect of practice practice practice! has dismayed and discouraged you. I have enrolled more than 17,500 adult pupils during the War. During 40 years I have taught over 67,750 by post in a third the time, with a quarter the work, at a tenth the expense of the ordinary methods of dull, mechanical wearisome practice, AND I CAN TEACH YOU. Ordinary musical notations only used, no freakish methods, enabling you to read and play at sight any standard musical composition. Send for FREE Book and advice. Say Moderate, Elementary or Beginner.

Mr. H. BECKER, (Dept. 158), 69, Fleet St., E.C.4

"Easily the best soldering fluid obtainable."

This statement by a regular user of "BAKER'S" expresses the general opinion of motor and engineering trades. Sold in 6d., 1/- and 1/6 tins. Also in Bulk.



SIR WM. BURNETT & CO. (CHEMICALS) LTD. Gt. West Rd., Isleworth, Middx. Hounslow O476

"VIBRO-ARC" Engraving Pen

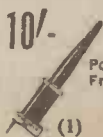

For rapid engraving any metal—hard or soft. Operates from 4-6v. Post Battery or A.C. Transformer.

HOLBOROW, (1) Boroughbridge, Yorks.

LET ME BE YOUR FATHER

You need help and Fatherly advice in difficult times like these. I am in the position to give that to you FREE.



We teach nearly all the Trades and Professions by Post in all parts of the world. The most progressive and most successful Correspondence College in the world.

If you know what you want to study, write for prospectus. If you are undecided, write for my fatherly advice, it is free. Distance makes no difference.

DO ANY OF THESE SUBJECTS INTEREST YOU?

- | | |
|---|--|
| Accountancy Examinations | Matriculation |
| Advertising & Sales Management | Metalurgy |
| Agriculture | Mining, All Subjects |
| A.M.I. Fire E. Examinations | Mining, Electrical Engineering |
| Applied Mechanics | Motor Engineering |
| Army Certificates | Motor Trade |
| Auctioneers and Estate Agents | Municipal and County Engineers |
| Aviation Engineering | Naval Architecture |
| Aviation Wireless | Novel Writing |
| Banking | Pattern Making |
| Blue Prints | Play Writing |
| Boilers | Police, Special Course |
| Book-keeping, Accountancy and Modern Business Methods | Preceptors, College of Press Tool Work |
| B.Sc. (Eng.) | Production Engineering |
| Builders' Quantities | Pumps and Pumping Machinery |
| Building, Architecture and Clerks of Works | Radio Communication |
| Cambridge Senior School Certificate | Radio Service Engineering |
| Civil Engineering | R.A.F. Special Courses |
| Civil Service | Road Making and Maintenance |
| All Commercial Subjects | Salesmanship I.S.M.A. |
| Commercial Art | Sanitation |
| Common Prelim. E.J.E.B. | School Attendance Officer |
| Concrete and Structural Engineering | Secretarial Examinations |
| Draughtsmanship, all Branches | Sheet Metal Work |
| Engineering, all Branches, Subjects and Examinations | Shipbuilding |
| General Education | Shorthand (Pitman's) |
| G.P.O. Eng. Dept. | Short Story Writing |
| Heating and Ventilating | Speaking in Public |
| Industrial Chemistry | Structural Engineering |
| Institute of Housing | Surveying |
| Insurance | Teachers of Handicrafts |
| Journalism | Telephony and Telegraphy |
| Languages | Television |
| Mathematics | Transport Insf. Examinations |

If you do not see your own requirements above, write to us on any subject. Full particulars free.

COUPON. CUT THIS OUT



IF YOU AT-TEND TO THIS NOW IT MAY MAKE A WONDERFUL DIFFERENCE TO YOUR FUTURE.

To Dept. 76, THE BENNETT COLLEGE, LTD., SHEFFIELD

Please send me (free of charge) (Cross out line which does not apply)
 Particulars of.....
 Your private advice about.....

PLEASE WRITE IN BLOCK LETTERS

Name

Address



Add the FINISHING TOUCH

to your models with 'Plasticine,' the famous modelling medium. For nearly half a century 'Plasticine' has been used by modelling enthusiasts the world over, and to them at least, this material of 101 uses is indispensable. Supplies are strictly rationed so make your 'Plasticine' last.

HAR BUTT'S 'Plasticine'

MODEL MAKERS, ENGINEERS, Etc.

We are urgently wanting Passenger Hauling or Goods Hauling Model Locomotives, from 3 1/2 in. gauge to 15 in. gauge, coal fired jobs in good condition, also Track, Wagons, Crocodiles or Coaches for passengers, and anything else suitable. Large or small layouts. Give fullest particulars, photo if possible, and price required. Also the smaller Electric, Steam and Clockwork Layouts. A few of the above are for sale. Stamp with requirements.

BOTTERILLS MODELS, HIGH STREET, CANVEY, ESSEX
 'Phone: Canvey 283.

GIVE THOSE YOU LOVE A Radio You Have Made Yourself.

- The "JB VICTORY FOUR" is:
- Child's play to build.
 - Suitable for work off A.C. or D.C. mains and bang up to date.
 - Portable, it needs no aerial or earth.
 - Ideally suitable for Bedroom, Nursery, Workshop, etc.
 - Guaranteed 6 months and subject during this time to free service.

Complete kit of parts, including valves and all items, even nuts, bolts wire, etc., with full detailed layouts and wiring instructions. 87/117/6. Diagrams, etc., only, 5/-; refunded if complete kit bought later.

V.E.S., Radio House, Ruislip.

You'll be glad you kept on saving when you can again buy an

ADANA

Adana Printing Machines TWICKENHAM, MIDDLESEX

ELECTRADIX

HERE IS A SELECTION OF EXCELLENT ELECTRADIX BARGAINS

CRYSTAL SETS. The famous Wall-nut table model Crystal Set in G.P.O. polished case, variable condenser, tuned tapped A.T.I. semi-perm detector, 42/- . Mark II converted ex W.D. wavemeter type in box with lid, 55/- . Crystal set assembly comprising Condenser, Coil, Detector and Terminals with wiring diagram, 9/6. Catswhisker detectors, 2/6. Spare crystal, 1/- . Semi-perm detectors, 2/6. Spare crystals mounted, 1/6. Aerial wire 7/22 copper cotton covered, 5/- 100ft. Copper indoor aerial wire in 30ft. lengths, 2/- . **WIRE.** Single silk covered magnet wire 28 gauge, 7 1/2 lb.; 30 gauge, 9 1/2 lb.; 32 gauge, 12 1/2 lb. Enamelled and S.C.C. wire, 18 gauge, 3/2 per lb. Twin bell wire, 100 yds. for 12/- . **BELLS.** Large ironclad A.C. 230/150 v. mains bells "Tangent"; 6in. gong, as new, £2.2.0. to tiny Townsend Buzzers at 10/- . **MOTORS.** 115th H.P. D.C. Motors, enclosed, silent, 220 to 250 volts, 1,500 revs., double end 3/4in. shaft. First grade make. Guaranteed, 1/5th H.P., £3 10s. each. All carriage paid England and Wales.



MOTORS. A.C. motors for 200/250 volt mains, new, 1,452 revs., enclosed type, 1/2 H.P. and 1/3 H.P. Quick delivery from limited stock. **MOTOR PUMPS.** We can give immediate delivery of the famous Stuart Turner 12-volt D.C. motor pumps; 120 galls. per hour, 84/- . Same type but for A.C. mains, 110/- . Pumps only; R type twin-piston rotary for 1/2 h.p. motor drive, £3.5.0. Aquarium aerators, £5.

METERS. M.C. Milliammeters, flush panel, 2 1/2in. diameter 0-1 m.a. 100 ohms, bakelite case, new, 5/16. Meter Rectifier 1 m.a., 10/6.

METAL RECTIFIERS for meters, etc.; 5 and 10 m.a., full wave, 8/6; 1 m.a., 10/6.

SUPERSEDERS. H.T. Battery Super-seders for Radio Receivers. 6 volts to 110 v. 15 m.a. The Army, the Navy, and the Air Force use small Rotary Super-seders; a 5 1/2 lb. midget type taking less space than your old H.T. Battery. Last for ever and cost little more than a few months run on H.T. Battery. Size is only 5 1/2in. x 3 1/2in. x 3 1/2in., beautifully made, model finish, ball bearings, etc., and takes small current from your accumulator. Latest model and guaranteed 12 months, £3.15.0 each.

THESE EVER POPULAR

BUTTON MICROPHONES are SOUND TRANSMITTER UNITS. A marvel of acoustic engineering design, as used by G.P.O. For amplification and detection of sound for all purposes.

EVERY BUTTON GUARANTEED

The lin. dia. brass body forms the granule chamber and the diaphragm is thin mica. Needs only a pocket battery 4 1/2 volts and a high-ratio transformer. With special transformer, 7/6. Button only, 2/6. Prices include instruction leaflet.

CORDS. Flexible. 4-way with R.A.F. plug; 1 yard, 1/3 each, or 6 for 5/6, all post free.

BUZZERS, ETC. Light practice buzzers, 3/6. Heavy bakelite L.M., 5/6. All 4 1/2 volts. W36 on wood base, 6 volts, 7/6. A.C. Buzzers for bell-type transformer, 6 volts, 5/- . **BELLS.** A.C. circular type, 6/- . Transformers 230/3-5-8 v., 8/6.

RELAYS. Telephone type No. 6. 2-coil polarised, S.P.C.O., 6 volts, 25 m.a., 3/25 ohms, 8/6. No. 1A S.P. on-off, 2 volts, 40 m.a., 5/- . Relay movements 1,000 ohms, less blade and contact, 2/6.

MIKES. Tannoy and Truvox Hand Mikes for Announcers, Broadcasters and Recorders, multi-cell carbon type, weatherproof with switch in handle. For your sports meeting or dance hall, 21/- . Crystal and M.C. Mikes in stock.

G.P.O. Electric Counters 25/150 volts D.C. 500 ohm coil, counting to 9999, 5/6.

SUNDRIES. H.M.V. Resistors, glass cased, wire ends, 1/2 watt, .01, .025, .05, 11-per set of 3 or 2/6 per doz. Multiple Connection Strips of soldering tags, telephone type, 2/6. G.P.O. Plugs, 2/- .

Please include postage for mail orders.

ELECTRADIX RADIOS

214, Queenstown Road, Battersea, London, S.W.8

Telephone MACaulay 2159

DONT NAIL IT AND SPLIT IT



REPAIR AND CONSTRUCTIONAL PLATES

For Every Purpose

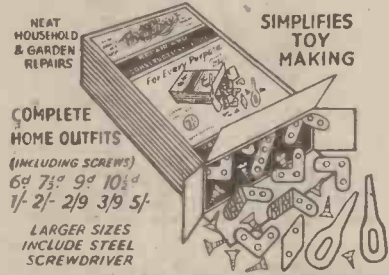

NEAT HOUSEHOLD & GARDEN REPAIRS
SIMPLIFIES TOY MAKING
COMPLETE HOME OUTFITS (INCLUDING SCREWS)
6d 7 1/2 9d 10 1/2
1/- 2/- 2/9 3/9 5/-
LARGER SIZES INCLUDE STEEL SCREWDRIVER

STEEL TOY BUILDING SETS NOW AVAILABLE 12/3 EACH INC. TAX.
BAY MANUFACTURING CO.,
VICTORIA ST., MORECAMBE.
TRADE ENQUIRIES INVITED.

SMALL TOOLS

Drills, Reamers, Lathe Tools, Micrometers, etc.

EVERYTHING FOR THE ENGINEER-MECHANIC

Bench Millers, Lathes, Bench Drills, Electric Motors A.C. and D.C.

Send 4 1/2d. for Lists

NUTTALL'S (LATHES) LIMITED,
MANSFIELD, NOTTS.

Wizard 4-valve Universal Medium Wave and Dorset 3-valve Battery Receiver

Build your own set. Simplicity itself. Both give splendid tone and volume. Very clear point to point wiring instructions, circuit diagram, component layout drawings. British valves. Any components sold separately by us. Your queries answered free S.A.E.

WIZARD circuit, including alternative wiring for 7- and 5-pin valves, 5/- .

DORSET circuit, including additional instructions for tone control and pick-up, 3/6d. No callers.

Write **WELDONA RADIO ACCESSORIES LTD.,**
23, BURLINGTON ROAD, SWANAGE, DORSET

JUBILEE WORM DRIVE HOSE CLIPS



The long-life clip with the ever-tight grip

The Best Known For Radiator Joints, Air, Oil and Water Hose Joints

We guarantee a Tight Joint
L. ROBINSON & Co.
25, London Chambers, GILLINGHAM, KENT

LARGE DEPT. FOR TECHNICAL BOOKS

FOYLES

FOR BOOKS
New and secondhand Books on Engineering and all other subjects.
119-125, Charing X Rd., London, W.C.2
Open 9 a.m.-6 p.m. including Saturday.
Telephone : Gerrard 5660 (16 lines)

MATRICULATION

Brings Success & Security

Whatever your age, you can now study for the all-important Matriculation Examination at home on "NO PASS-NO FEE" terms. "MATRIC" is the accepted passport to all careers, and opens up opportunities which would otherwise be completely closed to you. Ensure the success and security of you and yours through post-war difficulties by writing for our valuable "Guide to Matriculation" immediately—FREE and without obligation. B.T.I. (Dept. 160), 356, Oxford Street, London, W.1.

SHORTHAND

DUTTON'S ONE-WEEK SHORTHAND is used by over 60,000 men and women. Accepted by Services and examining bodies. Test Lesson 3d. Write Dept. P.M., 83, Great Russell St., W.C.1.

IN ONE WEEK

THE USEFULNESS OF PELMANISM

PELMANISM is useful in all the affairs of life. That is its outstanding recommendation to those who wish to make the best of themselves in their occupations, in all their recreations, and in their social and cultural relations.

Every line written in the Pelman Course is directly applicable to some aspect of human life and conduct. The intention of every word in the Course is to make clear to men and women the means by which they can develop their powers to the fullest extent so that they can live more happily and be more successful—so that, on the one hand, they will make and use occasions for profit and advantage and, on the other hand, be at ease in any company. Both conditions are necessary to complete self-respect and a full life.

Remember—Everything you do is preceded by your attitude of mind

Pelmanists are not left to make the applications themselves. An experienced and sympathetic instructional staff shows them, in exact detail, how to apply the principles of Pelmanism to their own circumstances and aspirations. Thus every Pelman Course is an individual Course. Over and over again our correspondents say in effect, "I feel that this Course was prepared for me, and me only." Substantially this is so, for the instructional notes and letters of advice are entirely personal to the individual; they are for him or her only.

Half fees for serving and ex-service members of His Majesty's Forces (Apply for Service Enrolment Form)

The present dominant aim for every man and woman must be to show a courageous, confident, well-equipped mental front. This assured, then all else will be achieved, and the world has no more proven method than Pelmanism to obtain this end.

Your Obligation

To-day there is an obligation upon every man and every woman to make the maximum contribution to the task which the Empire has undertaken. There is a demand for clearness of vision and concentration; there is, above all, a need, such as has never before been felt, for level-headedness and resourcefulness. The Pelman discipline establishes self-confidence, quickens the perception and promotes personal initiative.

Take Up Pelmanism Now

The Pelman Course is fully explained in "The Science of Success." The Course is simple and interesting and takes up very little time. You can enrol on the most convenient terms. The book will be sent you, gratis and post free, on application to-day to:

PELMAN INSTITUTE

(Established over 40 years),
130, Albion House, New Oxford Street, London, W.C.1.

PELMAN (OVERSEAS) INSTITUTES: NEW YORK, 21, North Avenue, New Rochelle. MELBOURNE, 396, Flinders Lane. DURBAN, Natal Bank Chambers (P.O. Box 1489). JOHANNESBURG, P.O. Box 4928, CALCUTTA, 102, Clive Street. DELHI, 10, Alipore Road.

look out!

FOR THE *NEW*
DAYTON
Lightweight
TOURIST
CYCLES

New ideas in design and construction giving extra lightness, easier running and rigidity are outstanding features of the New Dayton Tourist Models which promise to be the sensation of the cycling world.

Look out for future announcements.



For Road and Track

DAYTON

ALL-BRITISH

Cycles



VOL. XIII

AUGUST, 1945

No. 282

Comments of the Month

By F. J. C.

The Appeal to Politicians

As we propose to comment in detail on the pamphlet issued by the C.T.C. entitled "Worse than the Luftwaffe," which represented an appeal to the politicians during the recent election, we are reprinting it here in full, so that readers can digest it and have it before them, when they read our comments on it next month. We do, however, say now, that whilst we support much of the argument, we do not support all of it, and we certainly do not support the attempt to get cyclists to vote for a particular candidate who would support the C.T.C. and would answer satisfactorily the three questions set out at the end of the document. We have before labelled the threat to use the polls to obtain an advantage for a particular section of the community as editorial blackmail. We think the C.T.C. has been ill-advised in adopting this attitude. However, space is not available to criticise the pamphlet in full. This we shall do next month. Here is the pamphlet, printed as received.

"Worse than the Luftwaffe"

"MATTERS of national importance are being widely discussed—with one exception. Little attention is paid to the major national problem of 200,000 accidents a year on British roads.

The killing and maiming of civilians on a bigger scale than the Luftwaffe could achieve is a serious threat to the nation's wellbeing.

That such needless and tragic slaughter should be tolerated is a disgrace to the country whose magnificent wartime achievements amazed the world. Putting the welfare of the whole nation before the private advantage of one section or another, the citizens of Britain recently accomplished the seemingly impossible. A similar determination—"what should be done shall be done"—is needed to end the slaughter on the roads. It is needed to save lives. It is needed to give the nation the benefit of a modern and efficient transport system.

The origin of the present evil cannot be disputed. Since the coming of the motor car, successive governments have failed to provide appropriate facilities for the newer types of road-user. A road system capable of satisfying everybody in the days of cycles and horse-drawn vehicles has proved inadequate for present requirements of transport, travel and recreation.

Heavy motor traffic travelling at high speeds on the present road system, in the presence of other types of traffic, must inevitably lead to a great number of accidents.

Where there is no provision for everybody there will naturally be competition for whatever facilities are available. It is not surprising that the wealthiest and most powerful section of the road-using community—backed by a gigantic industry dependent on its development—should seek to monopolise a great part of the existing road system.

Even if it succeeded, there would still be a high rate of accidents, because the roads are fundamentally unsuitable for fast and heavy traffic.

There is not room on our present roads for everybody. The logical answer is to make room—not by banishing the traffic for which existing roads are quite suitable, but by providing special roads for traffic that cannot safely and efficiently use existing roads.

The struggle for a monopoly of existing roads has led to a demand for cycle paths. Because there is not room for both cyclists and motorists, it is suggested, the cyclists should be removed to overcome the congestion. Though the paths are said to be needed for the safety of the cyclists, it is significant that the demand for them comes from motoring interests and not from the cyclists.

At first glance it might appear that cycle paths are in effect special safety roads for cyclists, and that they would serve a purpose similar to that of special roads for motor traffic. Actually there is little similarity between the provision of special highways for motor vehicles and the segregation of cyclists on separate paths alongside existing roads.

The special motor roads would be designed to facilitate transport. They would be better than existing roads. They would be free from crossings and other obstructive features. In the case of the cycle paths, however, existing advantages would be lost and additional disadvantages would be introduced. Crossings would be increased in number—every side-road and every approach to a house or factory would have to cross the cycle path—and at existing cross-roads there would be greater confusion than at present.

It is in the national interests that facilities should be provided for motor transport to develop in safety. It is equally in the interests of the nation that there should be adequate and safe facilities for other forms of traffic—the unhurried motorist, the cyclist, and the pedestrian.

Attempts to make existing roads serve two incompatible purposes are costing the nation 6,000 lives every year. We need at least a dual road system. There must be simultaneous provision for long-distance transport, for fast road travel, for local traffic, and for recreational travel of all kinds.

To facilitate fast motor transport, special highways must be provided. They should not be intersected at frequent intervals by other roads. They should not be used by pedestrians or cyclists. They should be designed to permit speed with safety.

On the complementary part of the road system—in city streets and rural lanes alike—high speeds should be prevented.

It is not suggested that the ideal road system would completely obviate the possibility of road accidents. There would still

All letters should be addressed to the Editor, "THE CYCLIST," George Newnes, Ltd., Tower House, Southampton Street, Strand, London, W.C.2.

Phone: Temple Bar 4363

Telegrams: Newnes, Rand, London

be road-users who could not or would not behave as circumstances demanded. There would still be the fools who "blind" round the curves of a country lane, who turn to the right without warning, who travel in the dark at a greater speed than their lights justify—and all the other types of "menace" at present met with on the roads.

There will always be accidents of the kind caused by such persons so long as there are road-users who do not realise their obligations or are tempted to ignore them.

Road-users must be trained and the use of the roads must be controlled. Good roadmanship must be taught and enforced as an essential item in good citizenship.

The training of road-users should begin in the schools. It should be supported by the education authorities, the road-users' organisations, the social welfare societies, and the police. It should not, as at present, consist in the lecturing and condemnation of one class of road-user by another.

If the present struggle for a monopoly of the roads were ended by the provision of adequate facilities for all classes, the road-users' organisations would be able to concentrate more of their attention on educating and training the classes they represent. Road-safety congresses and joint committees could become really co-operative and constructive. Manœuvring, attack and defence, of the kind so often seen in present circumstances, would no longer be necessary.

The first road-users' organisation ever to take an interest in road safety and the provision of adequate facilities for road-users was the C.T.C. It is still primarily interested in such subjects. In recent years, however, it has been compelled to devote more and more of its energies to the defence of cyclists against attempts to restrict their pleasures and activities. Nevertheless, it has played a great part in the promotion of good roadmanship among cyclists. It is anxious to do its utmost in that direction.

For the enforcement of decent behaviour on the roads, the existing laws are quite adequate. They are not, however, always applied, or applied with sufficient severity. The lenience of some local magistrates when dealing with offences by road-users has become notorious. It has led to a fairly general belief that such offences are not "serious." The taking of risks on the highway is being condoned. Death and mutilation are dismissed as "the price of progress"—evils that cannot be helped.

They can be helped. They should be helped. And the electors of Britain have a right to ask every political spokesman and every parliamentary candidate to make a clear statement of policy on this matter.

Do you agree that our road-accident figures represent a national evil?

What is your policy on this subject?

Do you support the views set out in the C.T.C. memorandum 'Worse than the Luftwaffe'?"



Scottish Record Broken

BY clocking 2.28.11 for an out-and-home "50," Isobel Adams, Nightingale C.C., beat the Scottish record for that distance for girls by nearly four minutes.

Rotherham Wheeler Decorated

E. HATTERSLEY, Rotherham Wheelers, has been awarded the Military Medal for bravery and devotion to duty during the Italian campaign. He serves with the R.A.O.C.

For Services Rendered

THE B.E.M. has been presented to a well-known Scottish rider, D. McVatish, for his work in connection with shipbuilding in the Clyde.

More Tyres?

PROVISION for a substantial increase in the number of cycle tyres during the next few months is promised by the Dunlop Rubber Company chairman, Sir George Beharrell.

A. B. Marsh, D.F.C.

FLYING OFFICER A. B. MARSH, holder of the National York to Edinburgh tricycle records, who was reported missing many months ago, is now presumed dead. The announcement of his death coincided with the news of the award to him of the D.F.C.

Decorated in Burma

PRE-WAR speedman of the Stretford Wheelers, H. E. Brinslow, who is serving in Burma, has been awarded the Military Medal.

Defence Council Formed

THE latest cyclists' defence council to be formed is in Bedfordshire, with W. Haylock, well-known official, as chairman.

Clubman Killed

A SHORT while before the finish of hostilities in Europe, G. Roberts, Herts and Essex Wheelers, was killed in action.

Highgate Sequence

THE Highgate Cycling Club has successfully concluded the promotion of their 25th Open "100" in the London area. Since its inception in 1921 it has contributed materially to road sport, and keen contests have been fought for the honour of securing premier award.

Promotion for Butterworth

FRANK BUTTERWORTH, who has been in India and Burma for some years past, has been promoted company sergeant-major. He will be remembered as pre-war champion of Manchester Road Club.

Twenty-five Mile Champion

C. CARTWRIGHT, Manchester Clarion, clocked 59 minutes 44 seconds to win the national 25 mile championship. He has previously beaten the hour for the distance, his previous best being 59 minutes 18 seconds.

Chinese at Speed

WHEN the sports meeting run by Messrs. Lever Bros. is held at Bebington Sports Ground in August, a feature of the programme will be a pursuit race confined to Chinese.

London Centre Grass Champion

R. WATERS, South London Road Club, won the National Cyclists' Union (London Centre) half mile grass championship in 1 minute 13½ seconds.

Roads Closed

IT is stated that over 5,000 roads, tracks and paths were closed by the authorities to the public during the war under Defence Regulations. Of these, it is estimated, only 740 have been re-opened.

Travel Ban

THE travel ban between this country and Northern Ireland has been lifted.

Nunhead Wheelers

Resume

THE Nunhead Wheelers C.C. has resumed its touring, racing and social activities.

Good News

HARRY GALLACHER, president of the Zenith Wheelers and appreciated Scottish polo expert, is now back in this country. He was reported killed at Arnheim. The wounds he sustained in that famous action were serious, but, happily, not fatal as previously reported.

at Arnheim. The wounds he sustained in that famous action were serious, but, happily, not fatal as previously reported.

Peden Here

DOUGLAS PEDEN, who won the Southgate "25" some years ago when on a visit from Canada to represent that country in the Olympic Games, is in this country. He will also be recalled as a famous six-day rider at Wembley.

Parker in Action

S. W. PARKER, Ealing C.C. member and holder of several national tricycle records, has joined the Norwich A.B.C. as a second-claim member. In a recent "25" he clocked 1.17.7, a creditable ride for one so long absent from competition. He has been overseas for some years.

Wills's Club Formed

A NEW club has been formed in Bristol: the W. D. and H. O. Wills C.C.

Bristol's Committee

PLANS are afoot for a Bristol Cyclists' Defence Committee. Local clubs and cycling organisations are combining with the trade; and F. Barker, local secretary of the National Association of Cycle Traders, has been elected chairman.

Dale Park Man's Honour

JAMES ELLIOTT, Dale Park C.C., has been awarded the Croix de Guerre with bronze star, for his conduct during the fighting in Normandy. He has been discharged from the Forces, having lost a leg when an armour-piercing shell penetrated the turret of his tank during the early stages of the Normandy campaign.

Taylor Returns

C. TAYLOR, noted partner with H. Birtchnell on tandem rides in pre-war days, has returned to this country from captivity in Germany. He was captured while serving with the Guards at Anzio. This famous Dale Park C.C. combination may yet be seen in action again.

Aberdeen Revival

THE Aberdeen Wheelers have been revived with a progressive road time trial policy, and strong social and club support.

Coventry C.C.'s Loss

ERIC CLEAVER, promising 20-year member of the Coventry C.C., lost his life as the result of a road accident.

Alick Bevan

THREE prizes for a five mile scratch race to be run at Herne Hill at the Polytechnic's meeting in August have been presented by the parents of the late Lt. Alick Bevan, noted pre-war speedster.

Three Wins

RIDING in her first "25," J. Burrows, Romford C.C., made fastest time, with 1.11.33, and secured the first handicap.

J. C. Clague

SERGEANT J. C. CLAGUE, of the Manx Viking Wheelers C.C., who played so large a part in running the massed-start cycle races in the Isle of Man, and who was taken prisoner at Crete over four years ago, has been liberated and is back home again. Clague is "Wayfarer's" nephew.

Road Caution

THERE is a right way and a number of wrong ways of leaving the kerbside on a bicycle. One of the wrong ways is to mount at the left-hand side of the road without bothering to look behind you. Some cyclists unavoidably wobble when they get aboard a bicycle. It is therefore only fair to themselves, and an act of justice to other road-users, if they glance round and make quite sure there is no traffic immediately behind. If there is then the correct policy is to wait. A far worse method of mounting, however, is to adopt the right-hand side of the road for the process, merely because you happen to be there, and then to make your way, through two streams of traffic (light or heavy), to your appointed place on the highway. When you are located on the "wrong" side of the road, it is much better to wheel your bicycle to the other side, and then to mount it there, first looking round for any traffic which may overtake you as soon as you are in motion!

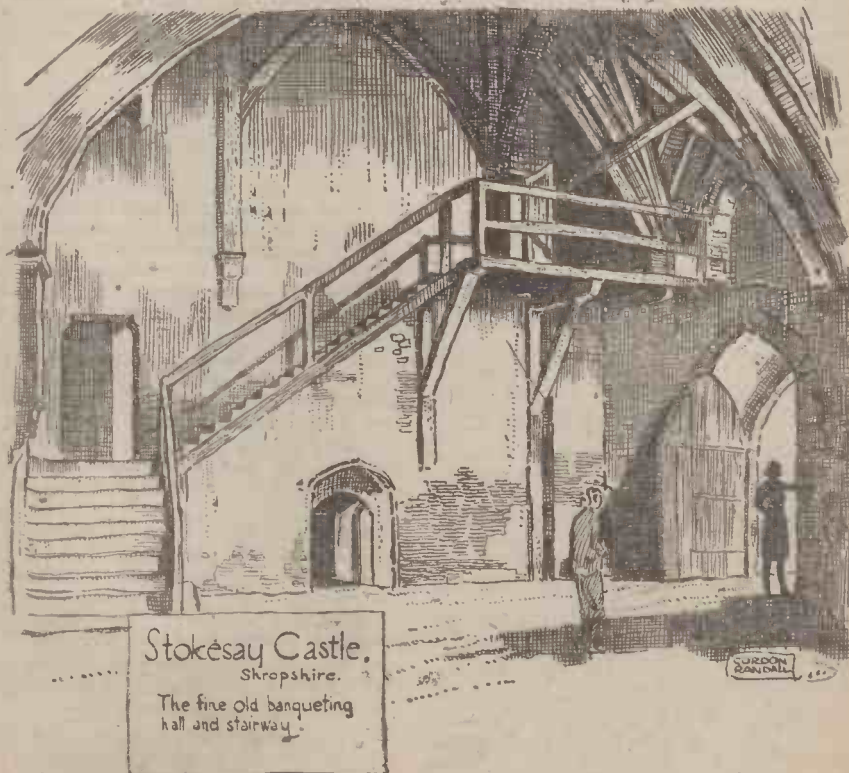

Around the Wheelworld

By ICARUS

The Closing of Roads Illegal

THE National Cyclists Union has many times stated that it is in favour of massed-start racing, provided that the roads are closed. For the information of the N.C.U. and others who may be misled by their attitude may I say that no authority has the power to close roads for the purposes of a cycle race. Even when roads are closed for lawful purposes, statutory notice must be given to the public. The N.C.U., therefore, in sponsoring, through its affiliated clubs, massed-start racing on the roads are running races on exactly the same lines as the B.L.R.C. If it asks to have the roads closed for the purposes of the race it is inviting the Town Clerk concerned to break the law. The N.C.U., in other words, is not entitled to run massed-start racing on the roads under its own rules, which merely permit massed-start racing on closed circuits, and a closed circuit cannot, therefore, be a road. As massed-start racing is quite legal, the N.C.U. can amend its rules so that massed-start racing can take place, as with the B.L.R.C., on roads which are open to the public. In my opinion, it would be wise to do so, although it is unlikely that it will do so, in view of the attitude it has adopted. If past history is any indication it is hardly likely to eat its own words, even when its policy has been proved wrong. The secretary of the B.L.R.C. wrote to the Town Clerk of the Borough of Millport, asking upon what authority he had closed the roads for a recent race "run" under N.C.U. rules. He received the following reply:

Burgh Chambers, Ardrossan.
1st June, 1945.

I am favoured with your letter of 26th ult.

I am afraid there is no Statutory authority for closing public roads in Scotland for the purpose of cycle road racing.

The Town Council take the liberty of closing the roads to be used in the Cycle Race and, as Millport is a coast resort catering for visitors, the public realise that anything that is done to advertise the place or to induce people to come to it is for their benefit and they do not take exception. The object in closing the roads is to endeavour to minimise the risk of accident to the public.

(Signed) ROBERT WOOD,
Town Clerk.

R.R.A. Timekeeper

MR. J. D. DAYMOND has been re-appointed R.R.A. timekeeper for 1945. Cyclists wishing to attack R.R.A. records are recommended to write to him. His address is: 31, Christchurch Hill, Streatham, S.W.2.

The N.C.U. Affiliated Clubs

The following clubs have recently affiliated to the Union:

Poole Wheelers A. and A.C. (this club is actually a revival); Manvers Main C.C.; Norton C.C.; Bromley Road Club (this club is also a revival); Gate C.C. (this is a branch of the Highgate C.C.); Bedlington and District C.C.; Polytechnic Ladies' C.C.; Red Triangle C.C.; St. Christopher's Catholic C.C.; (North-east region).

Road Accidents—May, 1945

ACCIDENTS on the road during May caused the deaths of 125 child pedestrians and child cyclists, an increase of 35 on the previous month. The increase, though partly explained by the longer hours of daylight, may also be connected with the return, following VE-Day, of evacuated children to towns with dense traffic. In the

Metropolitan Police area, child victims numbered 21. This was three times the average for the previous 12 months, although accidents had shown an upward tendency since the end of February.

Total casualties among road users of all ages were 424 deaths, and 9,418 injured. Although deaths were 208 fewer than in May of last year, when traffic was swollen by preparations for D-Day, the proportion of child victims was exceptionally high, half the pedestrians and nearly a third of the cyclists killed being under 15 years of age.

The return of evacuated children, together with the increased number of cars on the road, makes it all the more necessary that parents should discourage young children from playing in the roads and see that on journeys they are accompanied by an older person. It also increases the need for vigilance on the part of drivers, who are asked to be on their guard against children darting into the road.

The following table is an analysis of the number of deaths according to the types of vehicles primarily involved:—

Type of Vehicle.	Number of Deaths.
Service (British, Dominion, and Allied of the three Services)	91
N.F.S.	3
Public Service and Hackney	75
Goods	99
Private Cars	55
Motor Cycles	17
Pedal Cycles	68
Others	16
	424

The term "vehicle primarily involved" means where more than one vehicle was concerned, the vehicle to which the accident appeared to be primarily attributable. In no case does it imply that the driver of the vehicle was culpable.

Britain's "Victory" Cycling Marathon

ENTRY forms for this outstanding feature of 1945 cycle road racing programme are now available. The event is open to all

registered and licenced members of the British League of Racing Cyclists who hold a current Amateur or Independent licence, Senior category. Obtainable from Event Organiser, 24, Disraeli Road, Ealing, London, W.5. The event takes place on August 6th to 10th, 1945, inclusive.

Bicycle "Borrowing"

THE Home Office and the Ministry of War Transport are now considering whether the Road Traffic Act should be amended to make it an offence to take away a bicycle without the owner's consent.

The views of Chief Officers of Police are being obtained and the National Committee on Cycling, who raised the question, have been assured by the Ministry of War Transport that, when all the necessary inquiries have been made, the inclusion of some provision in future legislation will be considered.

I hope that the law will be made sufficiently stringent to permit the imprisonment of those who steal bicycles. Only very few of those who indulge in this particularly low form of felony ever get caught and instead of being charged with theft they are merely charged with borrowing without the owner's consent. There should be no such charge. It should be one of plain theft. As the law stands at present a thief who intends to sell the machine only has to be caught riding the machine to make a plea of borrowing, and the law is thus encouraging cycle thieves. No wonder cycle thefts are on the increase.

"Maillot Jaune" Wanted

A FEATURE of the five-day-stage road race being organised by the British League of Racing Cyclists, starting at Brighton, and finishing at Glasgow (August 6th to 10th, 1945), will be the adoption of the famous "Tour de France" custom of giving the leader of the race the privilege of wearing a yellow jersey. Any reader who may own a yellow road-man's jersey, or can indicate means of supply, is invited to send particulars of loan or purchase to: Event Organiser, 24, Disraeli Road, Ealing, W.5.



The start of the 25 Mile Cycle Race held in the Central Park, Plymouth. The race was started by the Deputy Lord Mayor of the City.

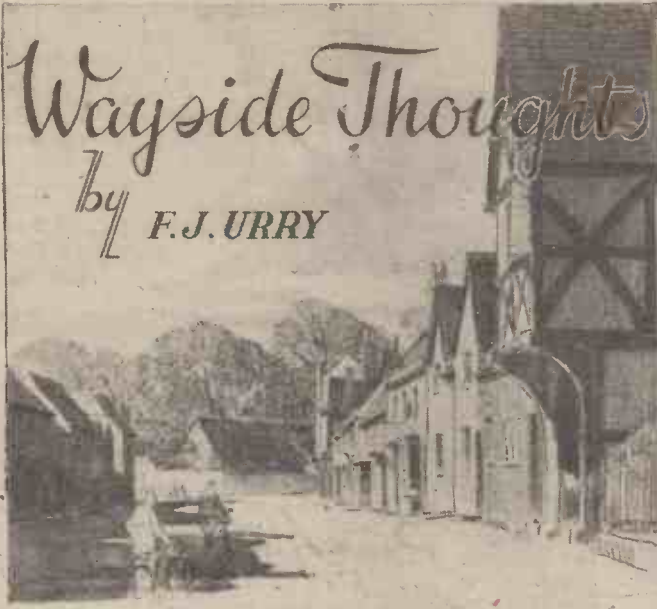

Wayside Thoughts

by F.J. URRY

After Five Years

DURING a recent week-end I had the pleasure of entertaining a couple of Scots lads home on leave—one of them after nearly five years' service abroad. I became acquainted with these boys—less than half my years—during one of my holidays north of the Border, and for some reason or other they liked my company and paid me this visit during their slender leave to renew what is now a firm friendship. That is what cycling does for you as you grow older, for I take it to be a high compliment that young men like my company. Now, I expected—and, indeed, hoped—to receive some first-hand information on the advances and retreats, and the final victory of the North African campaign, for one of my friends had been there all the time, and was only recently back from Italy. But I could not pin the fellow down to the tale of his own adventures; a few photos and a chance remark on a sticky time, and that was all. He wanted to know about cycling. Were the Scotch roads still rideable, and was accommodation yet available, and what was it like without many motors running round? "For," said he, "when this lot is over—and it won't be long now—I've got 56 days' soldier leave with pay coming to me, and you won't find me worrying anyone for a job until that has been spent. Now, make one of the party, and we'll go drumming-up the Highlands and over the passes, and you shall tell the story while I do the cooking." It sounds good to me, but I wonder if the speeds of 28 and 66 would mix so genially as that fireside notion suggests? Anyhow, my young friends chose their mounts from my little stud of bicycles for the morrow, and on that windy day we rode over 50 miles until they were tired, for long absence from the saddle does not make its accommodation the comfortable seating that was almost unnoticed in the days that are gone.

No Weariness

AN old friend of mine recently asked me if I ever get tired of cycling. "If you mean," I said, "do I ever get physically weary, the answer is yes, if I happen to be foot enough to over-reach my fitness—which, believe me, is not very often." Naturally, that condition of weariness has become more liable as I have grown older, but I am wary of it—as, indeed, are most old riders—know how to feed and when to rest, and am content when on tour to cut the miles while there is still pleasure in them. But it seems that wasn't the point of my friend's query. He wanted to know if cycling as an exercise and a means of travel ever palled on me. And the answer as far as I am concerned is definitely no. "But," he insisted, "you often traverse the same roads, and must know the countryside round about your home so thoroughly that there is nothing new to see." How short-sighted such people seem to be. The roads are the same roads, but their furnishings differ from season to season—ah! from day to day—which if you come to think of it, is part of the marvel of our British climate. Riding the long way home the other evening I saw young rabbits up one of my lanes, and near unto an ancient bit of Arden Forest a vixen playing with her three cubs. And overhead was the green canopy of early summer through which the sunlight dropped in flecked gold. Only a few weeks previously I was over the same road with a gale behind me, and all those ancient trees were roaring with organ music, and the rooks were struggling home with their bits of sticks for the mating nest. Why should a man get tired of cycling? He can see things—and hear them—that are so seldom possible to the walker or the motorist, for the rider goes silently and often with surprise as his friend. I don't think I shall ever grow tired of cycling in that sense; I may grow too old—but we won't think of that yet awhile.

The Security of Cycling

A LONG letter is to hand from Burma, most interesting and full of compliments to the pastime. In it my young friend says his companions of the uneasy peace years often told him he was insular and now he says that once he is back in Britain he feels that charge will be more true than ever. The East, he says, is best seen through the magic of the cinema, for two years of the jungle has given him all he needs for the rest of his life. Like so many of the nostalgic letters I receive from the fighting lads, this boy emphasises the peace and security of cycling. That latter adjective is new to me, but apparently it expresses for him a form of travel enjoyment never likely to be beyond his means, and always within the simple scope of his activity. And that is true, though except in the general way I confess not having thought about it in such intimate terms. The pity is that more staid people possessing a love for the countryside do not realise that such regard can and does become a matter of simplicity with the aid of a bicycle. I love cycling because it is simple and grants me the full satisfaction of both my physical and mental qualities to the limits of their extensions, and however short those limits may be there is still nothing in life to match those expressions. That cycling is cheap in the purely material sense of the term is not an argument for its limitation, but for its expansion; for it is only cheap in that one sense, since in every other it is the expression of the highest pleasure in the moral values concerned with outdoor life. It is as well to ponder these things occasionally, to weigh in the scales of the worth-while the gold of simplicity and healthy pleasure against the dross of speed and ostentation that leaves an individual little better than a travelling package with mentality attached. The man who sells his activity for the cushioned seats of speed loses the label of youth; he grows old too quickly.

Well Placed

BIRMINGHAM, where I work and spend a third of my living time, often makes people shudder who only know the city superficially or have merely heard it is in the heart of the Black Country. Every now and then I have the quiet joy of taking the uninitiated a ride amidst our Warwickshire lanes at the spring of the year, and it is delightful to see them begin to understand the land of Shakespeare has not been wholly blackened with the dull monotony of work. Indeed, I am fortunate in my surroundings, and that fact comes home to me in these early days of summer when, taking the long way home, I can enjoy three hours of glorious holiday over five-and-twenty miles of lanes. I can touch the ancient remains of the Forest of Arden in eight miles from the office door, and circling or cutting through those glorious woodlands make a journey ranging from 18 to 32 miles of home returning. Usually, I do not travel these miles for the riding as such, but far more for the vision of the ever-

changing scenes under the green canopies where the distant pool is a jewel in the sunlight, and the road is flecked o'er with a moving pattern of gold. I meet, too, many country people, some of whom have become my friends and invite me to look at their crops, or appraise the pigs grunting over their evening meal. It is all very friendly, and not infrequently quite profitable; but of the joy of it there is no complete telling, for how can a man talk of the refreshment these changes bring to a mind a trifle wearied by the events of the day? That is why I think I am fortunately situated, though another inhabitant of this area may not possess a similar opinion. The reason is that I am a cyclist. I can stop and look and listen and talk, and, being in no hurry to make an anchorage, use the hours of a perfect evening to add a trifling decoration to life.

Lamps and Brakes

I WAS talking to a well-known lamp maker a week or so ago, and he pulled my leg because I didn't like dynamos owing to their non-detachability when not needed, without a considerable amount of trouble. "After the war," he said, "we shall market a dynamo much lighter in weight than a battery front and rear lamp, and fitted with a quick detachment device." Now, that is talking, and if such a model materialises I may yet fall for this muscally functioning form of illumination. As things are the battery lamps will keep me going when the autumn evenings are with us again; but just now I go lampless on my wanderings, for why carry extra weight uselessly? There is another thing I dislike about dynamos of the tyre-operated type, and that is the untidiness of the wires. Why not thread them into a small plastic tube and so lead them to the front and rear lamps? We have quite enough festoons of wire cable in the way of brake leads to want to add any more to the general ensemble. And that reminds me of the promise of several makers of high-class machines, who say they are reverting to the use of inverted levers as part of the architecture of their post-war brake-work. That also is good news for me, for I've ever regretted the disappearance of the inverted lever which gave the rider a nice clean bar, and if the wires were correctly anchored, without sacrificing anything to the strength and reliability of retardation. My 25-years-old Sunbeam has worked under this form of braking, and to-day is as good as ever, except that the moving parts of the actual stirrup need re-bushing, owing to wear.

Will They Do It?

IN a trade contemporary a member of the industry has suggested the formation of a Bicycle Marketing Board for the purpose of giving the bicycle a higher status in the scheme of things. I wonder whether the trade will listen to the sound arguments for the formation of a small virile Board working with the one aim of making cycling more popular as a pastime by making the machine better and better. I am convinced—have been for many years—that public ignorance of cycling in all its many enjoyable phases is colossal, despite all the advertising put out by big and little makers. Naturally, individual firms are out for their own popularity and profit, and cannot afford any other form of crusading. But a Bicycle Board, with the support of the whole industry, can and should strike a novel note in publicity that would reach far beyond the circle of present-day cyclists. Properly handled it could wield great influence, and, in my opinion, be the instrument whereby a larger market would open, not only for the benefit of the makers, but far more so for the users. We have allowed cycling to slump into a form of travel which a man uses because he can't afford anything more expensive. That is wrong; cycling and walking are the only virile forms of travel where a man is a man, and not a parcel to be purveyed, and since cycling has far wider horizons, an easy sitting posture and no foot troubles, it should be the one great form of travel to appeal to the fir of any age, and those who desire to keep fit to any age.



A pretty corner of
GODSTONE SURREY.
The Clayton Arms formerly
the old White Hart Inn—a
great coaching hostelry of the
past.



Cycle tyres in the occupied areas have to stand up to conditions unheard of at home. Over there, as over here, Firestone Tyres are taking the strain.

they use

Firestone

tyres

★ Your help to meet this great demand is vital. Not one ounce of rubber, synthetic or natural, must be wasted. Keep all tyres properly inflated.

Contributions...

No. 6 CYCLE TYRES FOR WAR WORKERS

Tens of thousands of cycle tyres per week were made for war workers and the services.

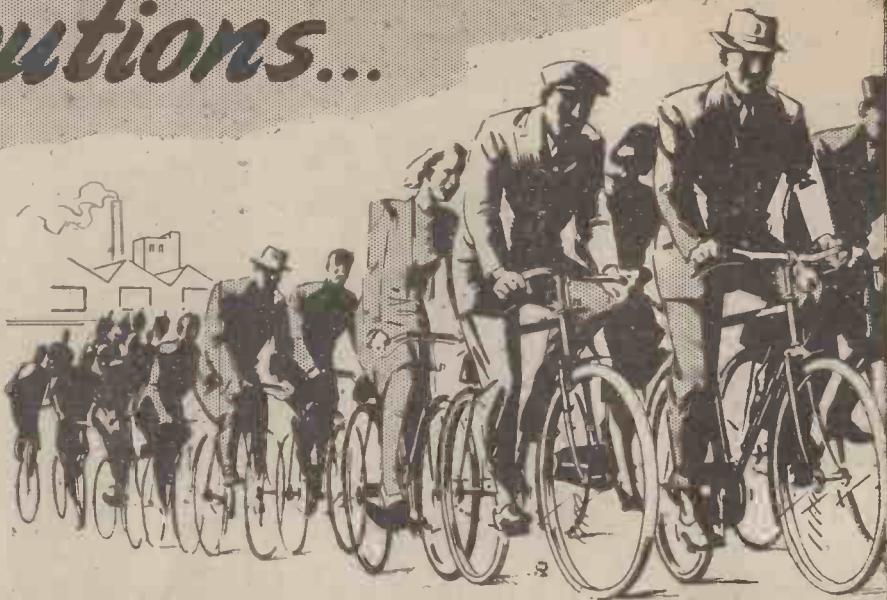

by **DUNLOP**

5H/155



APEX 'SUPERLITE' CELLULOID PUMP 15" 4/-

Thick Celluloid
Beautifully Polished

Light of Weight
but of
robust construction

LASTWEL (Celluloid) 15" 4/-

APEX PRODUCTS

Are in use in every Country In the world.

They are known and appreciated for their reliability ; long service and efficiency in their job of inflating tyres.

War conditions have restricted supplies, and whilst control lasts we are permitted to make only small quantities.

MADE BY

APEX INFLATOR Co. Ltd.
ALDRIDGE ROAD, PERRY BARR,
BIRMINGHAM 22B.

The World Famous BAILEY'S 'SUPER' PUMP 15" 4/- Steel Lined Celluloid Covered

Lining is solid drawn cartridge fashion, the end being solid with the barrel.

Cannot warp nor leak

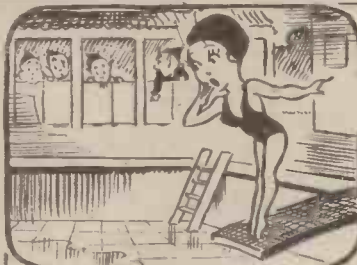

THE "FLUXITE GUINS" AT WORK

"Oh look!" cried OO in dismay.
"No water—it's all run away!"
Sighed OI: "I can see
More FLUXITEing for me,
"The tenth leak I've mended
to-day!"

For all SOLDERING work—you need FLUXITE—the paste flux—with which even dirty metals are soldered and "tinned." For the jointing of lead—without solder; and the "running" of white metal bearings—without "tinning" the bearing. It is suitable for ALL METALS—excepting ALUMINIUM—and can be used with safety on ELECTRICAL and other sensitive apparatus.

With Fluxite joints can be "wiped" successfully that are impossible by any other method.

Used for over 30 years in Government works and by leading engineers and manufacturers. Of all Ironmongers—in tins, 8d., 1/4d. and 2/8. Ask to see the FLUXITE POCKET BLOW LAMP, price 2/6d.

● TO CYCLISTS! Your wheels will NOT keep round and true unless the spokes are tied with fine wire at the crossings AND SOLDERED. This makes a much stronger wheel. It's simple—with FLUXITE—but IMPORTANT.



ALL MECHANICS WILL HAVE

FLUXITE

IT SIMPLIFIES ALL SOLDERING

Write for Book on the ART OF "SOFT" SOLDERING and for Leaflets on CASE-HARDENING STEEL and TEMPERING TOOLS with FLUXITE. Also on "WIPED JOINTS." Price 1d. Each.

FLUXITE LTD., Dept. P.M., Bermondsey Street, S.E.1

CYCLORAMA

By
H. W. ELEY

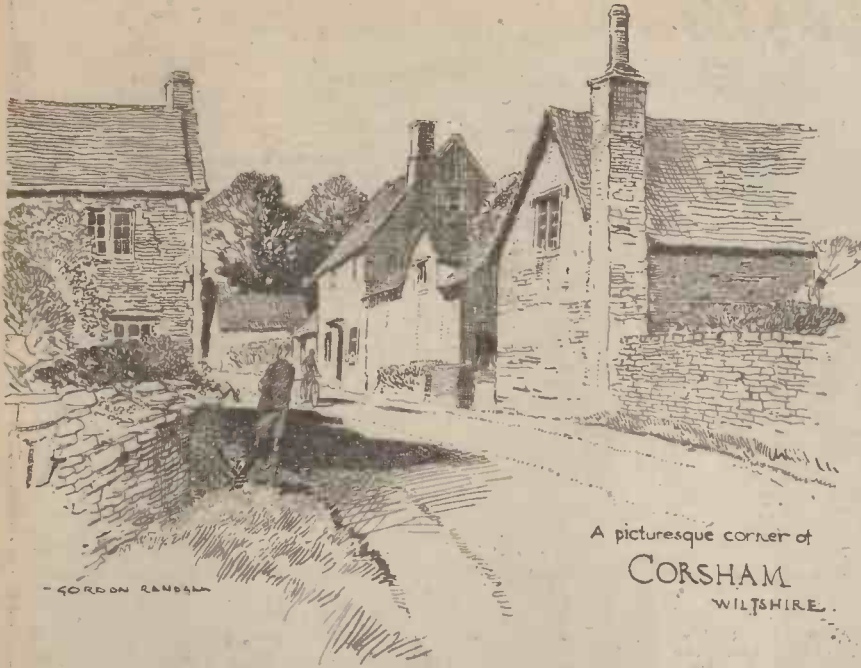

A picturesque corner of
CORSHAM
WILTSHIRE.

Back to "Shows"

THERE is a good deal of discussion going on about the possibility of staging a Cycle Show either this year or next. In talks with dealers and manufacturers I have found that there is a good deal of divergent opinion on the matter, and I imagine that there are many serious difficulties in the way of holding a show this year. Controls and permits have not yet been removed, and the actual work of building stands and fitments would present some real "snags"—possibly only appreciated by those who have to "do the job." And there is the important question of finding a suitable venue; a cycle show to be of real value must be housed in the right place, and some of the "right places" are not now available. I have had a good deal to do with shows of various kinds, and I do not minimise the great difficulties with which the authorities are confronted. And yet, in a sense, the sooner we hold a show, the better for the trade and all those concerned with the future of cycling. At all costs, we have got to keep alive the new enthusiasms created during the war, and a show would focus attention on the bicycle, on the joys of cycling, and indicate to the world that the cycle industry was very much alive.

Brave New World

I LIKE the fresh and optimistic note which characterises so many of the advertisements of the cycle makers these days. There is a fine sense of "looking forward," of firm belief in the future of the industry, of pride in the new models which will, as soon as possible, be on the market. It is often possible to judge an industry by its advertising, and, in the case of the cycle industry, one feels that the coming years are going to show us a vigour, an enthusiasm, and a manufacturing programme which will help enormously in the great task of rebuilding Britain's post-war trade.

Back on the Road

I HAD cycled leisurely to an old inn, feeling the need of a mug of ale, a chat with some of my friends from the fields and farms,

and a quiet smoke. There is a car-park outside the inn, and during recent years it has been a deserted car-park; but not so the other evening; it was more or less full, and as I dismounted from my cycle I suddenly realised what a big difference the return of "basic" was going to mean to the condition of the roads. Once again we cyclists are going to have to be very careful. The highway, where, during the last couple of years or so, we have only been meeting a few fellow wheelers and an odd farm-cart, will now be thronged with cars, with many drivers feeling a bit strange at the wheel, and, maybe, having lost some of their old-time "road-sense." Well, it all means a bit of extra care and caution; let us resolve to obey the rules of the road, let us pledge ourselves to maintain the best traditions of road usage, and all will be well. We can do our part in the great national effort to reduce that tragic list of road fatalities.

Window Display Material

MANY traders have asked me how long it will be before there is an adequate supply of show-sheets, show-cards and other display material. They are all longing for the day when drab windows can be brightened up and colourful displays installed again. Well, it is all connected with that somewhat mysterious body known as "Paper Control"—and I am afraid that the Paper Controller will not say much about the immediate future prospects. But I gather that we shall have to be patient for a good bit longer, and that manufacturers will not, for some time, be able to issue much display material to dealers. We may rest assured that manufacturers, and their advertising staffs, are anxious to resume their full display activities just as soon as possible, for they know that good window displays are "silent salesmen," and a great factor in business building.

At the "Fisherman's Rest"

ANGLERS everywhere are rejoicing, for the coarse fishing season has opened, and once again one may cycle out, with all

the carefully preserved tackle, and spend quiet golden hours by stream or lake or pond. Of course, I know that to the non-angler this business of sitting in a punt or on a bank and watching a float is boredom in excelsis! But if you do happen to be a fisherman, then happy times are ahead. I, for one, like a bit of fishing, and I am hoping to make my usual trip to the Staffordshire village of Alrewas and there fish in the Trent, soliloquise as I wait for the bites, drink ale in the inn close by my "stretch," and ride home in the evening happy and serene in mind. For the frets and fumes of the city, I know of no better antidote than a day's fishing by some quiet meadows, with the gaudy kingfisher flitting across the water like a meteor, and the thrill of landing a fair-sized chub or roach or bream.

Some "Doughboys" Say Good-bye

FOR three years or so a little Warwickshire town I know well has been the home of a pretty large contingent of American soldiers—technical men from New York, from Texas, from Ohio. With the war in Europe over, they are returning to their homes. Some, billeted with us for many months, have become our friends. A few have cycled with me through Warwickshire lanes, have ridden to ancient Tamworth and Lichfield, have lingered in old villages, explored old churches, have supped English ale in our inns. On a farewell ride one of them told me that he will never forget British bicycles—"so light, so 'easy,' so comfortable." It was a tribute I was glad to hear, and it was not by any means an isolated tribute; the "Yanks" have been greatly impressed by our bikes, just as they have been impressed by some of our old villages, our old customs, our ancient heritage of beauty. We say good-bye to them knowing that on many a night in the years to come albums of "snaps" will be scanned in the family circle, and men who lived with us through the war years will tell of some little English "burgh" and the quaint ways of Britishers . . . and the joys of cycling along English lanes.

Rural London

SOME years ago someone wrote a book called "It isn't far from London," and in that book detailed the many rural spots which "modern progress" has left to us almost within sight and sound of the Metropolis. And it is amazing how much good green "country" there is within easy reach of Town. Lately, I have been riding around the lanes of Middlesex . . . that "dormitory" county which Mother London almost threatens to swallow up in her ever-growing expansion. A few minutes' walk from a Tube station, and one may still see truly rural sights, and hear the authentic homely sounds of the countryside. It is but half an hour's journey from Baker Street to Northwood, and there, a week ago, I saw a hare loping across a meadow, heard the pleasant sound of a corn-cutting machine, and watched the merciful "despatch" of many bunnies which had taken refuge in the corn. And in the neighbouring woods I watched with pleasure the antics of the old English red squirrel . . . that lovable little creature which has been almost ousted from our woods and thickets by his American "cousin," the "grey." Yes! within sight of Charing Cross we may still find herds of cows, and see the shy hare dart from her "forme," and feel that Mother Nature clings to her strongholds with incredible tenacity.

Notes of a Highwayman

By Leonard Ellis



The old Yarn Market, Dunster.

Britain's Touring Grounds (9)

ALTHOUGH many new tourists profess to include Somerset in a tour of Devon and Cornwall, the wise ones soon realise that here is a patch of country that is enough in itself. Just a touch of Somerset engenders that urge to go back and see more of it, more than can be seen by trying to absorb the beauties of three or more counties in a single fortnight. The tourist soon finds that Somerset has one charm that is denied to many other counties—it is varied in the extreme. If we care to analyse it, we shall find that there are at least six separate and distinct areas, all of them in many ways quite different. The six may be called the Quantocks, the Mendips, Sedgemoor, the flat eastern area, the seaboard and, last but not least, Exmoor. The Quantocks are lofty wooded hills lying to the north-west of the county town, Taunton, and stretching to within a mile of the sea. In and around will be found many interesting little villages, some with names that cause a smile of amusement, such as Stogumber and Stogursey. Somehow they seem to harmonise with the fanciful picture of the Somerset yokel complete with smock and a broad burr. Narrow lanes and deep coombes are a feature of the district.

Cliffs and Caves

THE Mendips lie to the north-east, and are wilder and bleaker than the Quantocks. Over the summit are many reminders of Roman occupation, and here are some of Britain's finest limestone gorges.

rocky embrace. There is as one can look back and gaze spellbound at the view from the village itself. In spite of all the blatant and repelling invitations to go and see the caves, shut your eyes just once to this irritating display, and do go in. The caves are marvellous.

History and Romance

SEDGEMOOR lies between these two areas, and although many tourists will not care to linger too long there is a distinct charm in the quaint villages with soft-sounding names, the dykes and sedges, and the memories of the battle in 1685, and of Judge Jeffreys. The Polden Hills run right across Sedgemoor almost parallel with the other two ridges, but much lower. Glastonbury, with its glorious old abbey, stands like an island on higher ground right in the middle

Cheddar, of course, is first and foremost; and, in spite of the fact that it is highly commercialised and painfully overrun with day trippers, one cannot deny that the gorge cannot be equalled. When visiting Cheddar it is wise to go down the gorge rather than to climb up. This is in no sense due to the easier travel, but experience shows that the summit of the climb can be an anti-climax. By all means go down and watch the massive awe-inspiring cliffs rise higher and higher on either side until you find yourself enfolded in their no anti-climax at the foot

of the lens; and Wells, farther north, nestles under the lee of the Mendips. To the cyclist-photographer Wells is simply a paradise, as the cathedral, with its tremendous inverted arches, its old clock, its moat and scores of other attractions, just cry aloud to be photographed. The seaboard is not particularly thrilling, although it must be said that Weston, Minehead and Clevedon can show natural beauty that is not to be found in many other "desirable" watering-places. The eastern part of the county has many interesting little towns and villages, some of which make good touring centres. Probably the cream of Somerset lies at its western border, where it shares Exmoor with Devonshire. Here is a touring ground de luxe, with beauty, romance and interest going hand in hand. Here is the country of Lorna Doone and Jan Ridd. Dunster, with its charming main street and quaint old Yarn Market, is a village that is world-famous. Allerford packhorse bridge is said to be the most photographed bridge in the country, and Selworthy is always included in anybody's list of England's six prettiest villages.



Allerford Packhorse Bridge, Somerset.

My Point of View: By "Wayfarer"

Those Good Old Days

SOME bright soul wrote to *The Times* recently to say a word about the price of food and things in the good old days. In April, 1898, he says, he stayed at a small hotel in Switzerland where full board and lodging cost him 2s. 9d. a day, the only extra being coffee, which cost less than 1d. a cup. "Can anybody beat that?" he asked. I think so. Somewhere about the same time I stayed at a cottage in Cheshire where full board and lodging cost 14s. a week—that is 2s. a day. That was the cheapest line I ever struck. And the food was good and plentiful, too.

A Good Sign

IT was interesting to note a recent advertisement in the "Personal" column of one of the newspapers on which my mind feeds. This announced an impending vacancy for the management of a large licensed house on the outskirts of a big city. "A considerable catering business has been carried on, and it is essential that this should be continued. Previous experience in the licensing trade, though desirable, is not essential." Though I, personally, hardly ever patronise licensed premises, it is a good sign when one finds the catering side of the business is given precedence over the beer-drinking aspect.

All the Old Tricks

EXPERIENCE along the road since motor-cars returned early in the shows that our motoring friends have forgotten nothing. They are up to all their old tricks. The popular and genial habit of "shaving" cyclists is still remembered; so is the exasperating idea of turning in and stopping immediately after overtaking a cyclist or two. Boring through continues to be practised, and the penetrating yet out-of-the-way horn has lost nothing of its popularity. As in times past, there is no better example of man's inhumanity to man than as revealed by motorists—and especially, be it noted, by motorists to brother motorists. I feel that, when the scientific gentlemen have discovered what there is in petrol which alters the whole attitude of the most decent individuals, they will have gone a long way in the solution of our road problems.

"Amphibious" Was the Word

QUESTIONS were invited at the end of a talk I gave to a crowded meeting of young people the other evening—a talk dealing with cycling, books, and poetry—and a lad raised a point which made my eyes sparkle. He asked whether I rode a stripped bicycle or an amphibious one. My prompt reply was to the effect that, having very considerable experience as a water-diviner (that is to say, an all-weather cyclist), I rode an amphibious bicycle. I dwelt on the word "amphibious," which seems so suitable for my sort of cycling, in our sort of climate, and I invited my questioner to examine the bicycle which had carried me to the scene of the talk. He did so, and was delighted when I told him to try it. Then, needless to say, the conversation fell on gearing and related subjects, and I had to explain to the youth, and to others who gathered round, why I stick to a low single gear, fixed. However, that aspect of the matter need not be pursued on the present occasion, my concern being only with the blessed word "amphibious," as applied to bicycles.

No "Ought" About It

A FRIEND of mine, just back from a cycle tour of which he gave a brief outline to somebody he knew, was confronted with the assertion that "you ought to have a motor-bike!" His retort to that essentially foolish opinion was that, while he could thus have done the whole of his week's mileage in about a day, the purpose of the holiday would have been lost. He added that he had gone out in search of quiet enjoyment—to spend long days in peace on the road—to see the things at which he looked. His object was not to ascertain how quickly he could travel from the Midlands to the Midlands, via the Mendips, the Quantocks, Exmoor, Land's End, and Dartmoor. So that there was no "ought" about it. It would be just as sensible—if "sensible" is the word to use—to say that the Oxford and Cambridge crews should fit outboard motors to their boats so that they could travel faster, or that football and cricket should be played with electrically-impulsed automata. It certainly is curious that so many people fail to understand that speed is not everything, and that quite a

number of retrograde and mistaken individuals still glory in their physical fitness and like travelling under their own power!

'Ware Trailers

IT seems opportune to say once again that cyclists should always be wary in turning out from the side of the road immediately after they have been overtaken by a motor-car. That motor-car may be hauling a trailer, against which it would be the reverse of pleasant to bump. So make quite sure, before altering course, that the vehicle which has just sped by has no trailer tied to it—and also that there is not another motor-car close on its tail. In other words, obtain visual proof that it is safe to do what you intend doing in the way of varying your course.

Right-hand, Too

EXPERIENCE suggests that the inscription, "Warning. Left-hand drive," which appears on the back of many foreign-built motor-cars, might be applied, suitably altered, to some of our home-built cars with normal right-hand drive!

Where the Nails Come From

ON D-day plus 365 I was walking past a factory where men were at work taking down blackout insignia and anti-sabotage wiring. I observed that it was "raining" nails, and it seemed to be fairly obvious that these were being allowed to lie where they fell, on sidewalk or in roadway. Realising at once what a stack of trouble was being prepared for cyclists (and perhaps for motorists), I set to and picked up 30 of the nails, and then, with many still remaining, another idea struck me. With one hand full of nails, I stalked into the factory, saw somebody in authority, displayed the harvest I had gathered, pointed out that some thoughtless workpeople were providing a very raw deal for cyclists in particular, and obtained a promise that remedial steps would be taken without delay. I had evidence later that the promise was kept.

Quality

A RELATIVE of mine, who has been a prisoner of war in Germany for four years, has just dug out of the pocket of his sports coat (which he has not seen for five years), some pieces of valve tubing. They are in excellent condition. There's quality for you!

A.C. BATTERY CHARGER

For charging car accumulators, either 6 or 12 volt at 1 amp. in enclosed metal case. Input and output flex, lead and ADAPTORS. A thoroughly efficient job. Price 45/-, post paid, 50/- or 12 volt.

BOAT MOTORS, low centre, wound field, high-speed, weight 18oz. Size 5"x11"x2". Well made—No Rubbish. Price 26/-, post paid.

FOR TRICKLE CHARGING CAR CELLS, parts with diagram. Output 1 1/2 amps. for 6v. cells, 30/- set. For 12v. cells, 35/- set.

ELECTRIC ENGRAVERS. Powerful instrument in cylindrical cases, on stand, with spring attachment and switch, suitable for dog collars, identity discs, etc. A.C. Mains Model, 200-240v. 75/- 4-6-volt Battery Model, 55/-.

ECONOMIC ELECTRICCO.,

64, London Road, Twickenham, Middlesex.

Tel.: POPesgrave 1318.

35

FIRST PLACES AND HUNDREDS OF PASSES

In the A.M.I.C.E., A.M.I.M.E., A.M.I.E.E., A.F.R.A.E.S., A.M.I.Chem.E., C. & G., etc. Exams. have been gained by students studying at home with the T.I.G.B. Engineering First Places are your best guide to the most successful Engineering Courses. Write to-day for "The Engineer's Guide to Success" containing the world's widest choice of Engineering Courses—over 200—covering all branches—Mechanical, Electrical, Aeronautical, Wireless, Civil, Chemical, etc. and which alone gives the Regulations governing admission to the Recognised Institutions. The T.I.G.B. guarantees training until successful.

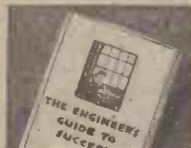

World's best choice of Courses in Engineering

The TECHNOLOGICAL INSTITUTE OF GREAT BRITAIN, 218, Temple Bar House, E.C.4.

Help to Make a Brave New World

It is our duty to contribute towards the building of a better world of international friendship. Join the great band of Esperantists who have pen-friends all over the globe.

Esperanto is the international auxiliary language which has been in use for over fifty years.

A complete correspondence course costs only 5/-, including correction of exercises.

Write for full particulars to BRITISH ESPERANTO ASSOCIATION Inc. (Dept. P.M. 10a), 140, Holland Park Avenue, London, W.11.

SPECIAL LINES

Offered with money-back guarantee. M.W. AERIAL AND H.F. COILS with circuit, Litz grid coils, 5/- per pair. I.F. TRANSFORMERS, first and second. Litz 20/47 wire, iron cores, ceramic trimmers, seamless cans. High Q, 465 KC, 15/- per pair. H.F. MAINS CHOKES, 2/- each. GROUP BOARDS, 20 tags each side, with brackets, 3/6d. each. L.F. CHOKES, 15 h., 270 ohms, 120 m.a. First class job, 7/6d. each. OUTPUT TRANSFORMERS, well made, 3 ratio 60, 90 and 120, 8/6d. ea. Write—

Weldona Radio Accessories, Ltd., 12, Glibbert Road, Swanage, Dorset.

SOLFLUX

SIMPLIFIES SOLDERING

PAINT AND HEAT—JOB'S COMPLETE

Solder applied only where required by means of brush or pad. May be heated by means of solder iron, blow-lamp, open burner, hot plate, oven, etc.

<p>MODEL MAKING ASSEMBLY WORK</p> <p>CYCLE CABLE NIPPLES</p> <p>CAR RADIATORS</p>	<p>SOLDER PAINT & ELECTRICAL SOLDER CREAM (Non-corrosive)</p> <p>2 oz. 4 oz. 1/8 2/9</p> <p>PURE TIN & CREAM (Non-corrosive)</p> <p>2 oz. 4 oz. 2/8 3/6</p>	<p>RADIO AND ELECTRICAL WORK</p> <p>HOUSEHOLD USES</p> <p>TINNING AND REPAIRS TO COOKING UTENSILS, REFRIGERATOR TRAYS, Etc.</p>
--	---	--

SOLFLUX PRODUCTS, 98, ALBION STREET, SOUTHWICK, SUSSEX.

MODEL MAKERS PAMPHLETS

The following carefully illustrated pamphlets are now available at the reduced price of 1/- each. Please enclose stamped and addressed envelope to: HOPKINS, 138, Rodin Road, Loughton, Essex.

- L.670. Details of 1/4 in. spark coil (including condenser, etc.).
- L.673. How to re-make old torch batteries at approx. 1d. each.
- L.671. Details of 4 in. spark coil.
- L.615. How to electroplate at home using simple apparatus.
- L.628. Details of Shocking Coil.
- L.646. Full details of 2- and 6-volt Trickle Chargers (A.C. mains type).
- L.672. Details of 2 in. spark coil.

TAPS AND DIES SMALL TOOLS GARNERS

SHEFFIELD ROAD, BARNSELY Phone: 2866.

B.A. thread screws, one gross useful sizes, 2/6; ditto, nuts, 2/6 gross; assorted gross screws and nuts, 2/6; ditto, brass washers, 1/6 gross; fibre washers, 1/6 gross; assorted soldering tags, 2/- gross; assorted small eyelets and rivets, 1/3 gross. Large stock of screws, etc. State requirements. S.A.E. Rubber-covered stranded copper wire, 14, yard; heavier quality, 14, yd.; very heavy quality, 24, yd.; ideal for aerials, earths, etc. Single cotton-covered tinned copper wire, 25 g., 12 yds., 9d.; 50 yds., 3/-; tinned copper connecting wire, 20ft. coil, 6d.; ditto, rubber-covered, 10ft., 6d.; finest quality push-back wire, 12 yds., 2/3; twin bell wire, 12 yds., 1/9; ditto, heavier quality, 12 yds., 2/3; ditto, flat rubber-covered, 3d. yd.; twin flat, braided electric cable, 6d. yd.; Wood's metal stick, 24 in. by 1/4 in., 1/-; Cotton-covered copper instrument wire, 11b. reels, 18, 20, 22, 24 g., 1/6; 26, 28 g., 1/9; 30, 32 g., 2/-; 34, 36 g., 2/3; silk-covered ditto, 20z. reels, 24, 26, 28 g., 1/6; 30, 32, 34, 36 g., 1/9; 42 g., 2/-; 16 g., double silk-covered, 11b., 5/-; 18 g., enamelled, 11b., 3/6. Sensitive permanent crystal detectors, Tellurium-Zincite combination, complete on base, guaranteed efficient, 2/6; glass tube crystal detectors, complete, 2/-; reliable crystal and cats-whisker, 6d. Reconditioned headphones, complete, 4,000 ohms, 12/6. All postage extra.

POST RADIO SUPPLIES, 33, BOURNE GARDENS, LONDON, E.4.

IDEAS WANTED!

We are open to consider any ideas or patents of practical worth with a view to making and marketing them. Write in confidence to:

Edron Industrial Group, 7 Park Lane, London, W.1

USEFUL BOOKS ON
Travel Journalism, Writing and Photographing your way at home or abroad; Building up an Export Trade; Model-Aircraft Building; Toy-making for every Home. Send stamped and addressed envelope for full particulars.—

USEFUL PUBLICATIONS,
37, Aldwych, London, W.C.2.

ETCHING & ENGRAVING EQUIPMENT

AS SIMPLE TO USE AS A PEN
Will etch on any metal. Quicker than machine engraving. From Dealers or direct. Send for leaflet "E.13."

RUNBAKEN-MANCHESTER-1

Easily made From Our Castings.

J. HALLAM & SON,
Upton, Poole, Dorset.

MINIATURE PETROL ENGINES for Aeroplanes and Speed Boats. Send 3d. for particulars

SILVER PLATING SETS
as supplied to Electroplaters, but in miniature, for small parts, etc., in-structure small sets, 19/- inc. post. Send 2d. stamp for printed folder. Materials for use with Electric Current. permanent Electroplating is carried out. Regret that no materials for Chromium, Nickel, Gold or Copper can be supplied owing to permits being required.

ARGENTA PRODUCTS (D. C.),
40, Harrogate Road, LONDON, E.9.

RATCHET & REVOLUTION COUNTERS

Ask for Leaflet No. 183

Speed up to 6,000 r.p.m.

B. & F. CARTER & Co. Ltd., Bolton 5

LINESIDE FEATURES	"00"	"0"
STAFF HUTS	3/-	3/6 & 4/6
COAL OFFICES	3/9	5/6 & 6/6
WEIGHBRIDGE & OFFICE	7/6	9/6
WATER TOWERS	10/-	22/6
COTTAGES	6/-	9/6
SEATS WITH TIMETABLES	3/6	3/6
BOOKS	by Post	
ABC L.P.T.B.	2/-	2/2d
ABC "IRISH LOCOS"	1/6	1/8d
ABC G.W.R.	1/-	1/6d
ABC WALLETS	1/9	1/11
L.M.S. "TITANS OF TRACK"	1/6	7/8d

TYLOSLEY & HOLBROOK
109, DEANS GATE, MANCHESTER, 3.

FOR SALE NO. 6 BA screws, counter-sunk, cheese-round heads, 1/- per gross. 1/4 in. x 1/4 in. snap-head copper rivets, 1d. per gross. 1/16 in. x 1/4 in. copper rivets, 9d. per gross. 3/16 in. x 3/16 in. copper rivets, 10d. per gross. 1/4 in. bore copper tube, 3d. per ft. 1/4 in. bore brass tube, 3d. per ft. 5 gross of assorted BA screws, 4/- 5 gross of assorted copper rivets, 3/- Casting moulds for metal toys, planes, military, zoo and farm subjects. Lists post free.—W. Roberts (Engineer), Blaen Cwm, Penmachno, Nr. Bettws-y-Coed, N. Wales.

SPARKS' DATA SHEETS

These Data Sheets provide full constructional details, theoretical diagram, component list, and fine full-size black and white prints of Tested and Guaranteed Designs—specially prepared to meet the needs of the amateur and existing conditions.

- LATEST RELEASES**
- MIDGET PORTABLE (No. L.O.P.)** Completely self-contained All-dry battery Three-Valver. Loudspeaker results. Med-wave. Approx. size, 8x6x3 1/2 ins. A fine little set. 2/8
 - MIDGET TWO-VALVER (No. L.O./M.)** All-dry batteries. Med-wave. Powerful 'phone siss. Size 5 1/2 x 5 1/2 x 3 1/2 ins. 8 volts H.T. 2/6
 - RADIO UNIT** A Two-Valver specially designed for use with a Quality Amplifier. H.F. stage plus "Infinite Impedance" Detector. Med-wave. Fine selectivity and quality. Suitable for use with A.C. or D.C. equipment. 2/6
 - 3 WATT A.C. AMPLIFIER (No. L.O./Q.A.B.)** Push-pull Output. Tone and Vol. Controls. Ideal for use with Radio Unit or P.U. 2/6
 - A.C. RADIOGRAM** H.F. Stage. Infinite Impedance Detector. L.F. and Push-pull Output. Med-wave. 8 Watts. Quality reproduction. 3/6
 - THREE-VALVE PUSH-PULL AMPLIFIER (No. 3VA11)** A fine unit for battery operation with P.U., etc. Tone and Vol. Controls. 2/6
- OTHER DATA SHEETS**
- ELECTRIC GUITAR UNITS (3rd Ed.)** 5/-
 - ELECTRONIC ONE-STRING FIDDLE** 3/6
 - A.C./D.C. AMPLIFIER** For use with above. Neg. feed-back. Phase inverter. P.P. Output. 8 Watts. Portable. (No. L.O./Q.A.) 3/6
 - 31 WATT A.C. AMPLIFIER** 2/6
 - TWO-VALVE BATTERY AMPLIFIER** 2/6
 - A.C. QUALITY TWO-VALVE SET (Med-wave)** 2/6
 - COMPACT STRAIGHT THREE (Battery) (M.W.)** 2/-
 - HIGH GAIN CRYSTAL SET (Med-wave)** 1/6
 - SUPER S.W. TWO-VALVER (Battery)** 2/6
 - TRANS CURRENT MICROPHONE** 2/6
 - A.C. CHARGER** 2 and 6 volt 2/6
 - D.C. CHARGER** 2/-
 - SHOCKING COIL** 2/6
 - AUTOMATIC BIAS CIRCUITS (COLOUR CODE: OMB'S LAW)** 1/3 each or 3/3 for the three. All Sets (except the S.W. Two-valver) have full Coil details provided.
- Please include Stamp with Order.
- L. ORMOND-SPARKS (M.),**
9, Phoebeth Road, Brockley, S.E.4.

OLDHAM SOCIETY OF MODEL ENGINEERS

An Exhibition of Models Including Locomotives, Boats, Aeroplanes, Etc.

Will be held at the Oldham Equitable Co-operative Society Premises, King Street, Oldham, in the Educational Dept., Room 2, on Foundry Street on:

- August 11th, 2 p.m. —9.30 p.m.
- August 14th, 2 p.m. —9.30 p.m.
- August 15th, 6.30 p.m. —9.30 p.m.
- August 17th, 6.30 p.m. —9.30 p.m.
- August 18th, 2 p.m. —9.30 p.m.

ADULTS - 6d. Children - 3d.

CHEMISTRY ARE YOU INTERESTED?

Whether you dabble in experiments or pursue a course of serious study you will need our LABORATORY EQUIPMENT.

Send 1d. stamped envelope for PRICE LIST.

BECK
(SCIENTIFIC DEPT. 4), 60, HIGH STREET, STOKE NEWINGTON, LONDON, N.16.
Booklet: "Experiments in Chemistry," 7d. P.O.

INSTRUMENT WIRES, ETC.

Gauge, covering and continuity guaranteed. 14-18-20-22-24-28-30-32-36 mm. enam. 2.9 2.5 3.3 3.8 3.9 4.5 4.3 4.6 4.8 5.4 6.0 per lb. Less than 1-lb. reel 3d. extra. 1-10-5-lbs. reel, 1/- extra. 4- to 8-lbs. reel, 2/9 extra. All reels returnable. Also S.C.C. and D.C.C. wires, and many other interesting Radio and Electronic items. Lists, 1d. stamp. Orders over 20/- post free.

MIDLAND INSTRUMENT CO.,
18, Marlborne Park Road, Birmingham, 17.

Free Guide - "Success in Engineering"

One of the following Courses taken at home in your spare time can definitely be the means of securing substantial promotion in your present calling, or entry into a more congenial career with better prospects.

ENGINEERING, AERO, ETC.

Radio—Aero Engines—Aero Navigation—Aircraft Design—Welding—Aerodynamics—Electrical Engineering—Television—Electric Wiring—Talking Picture Work—Generation and Supply—Works Management—Metallurgy—Refrigeration—Planning, Estimating, Rate-fixing—Time and Motion Study—Aero Inspection—Automobile Engineering—Sheet-metal Work—Engineering Draughtsmanship—Aero Draughtsmanship—Jig and Tool Draughtsmanship—Press Tool and Die Draughtsmanship—Structural or RIF Concrete Draughtsmanship—Sanitary Engineering—R.A.F. AND R.N. PILOTS AND OBSERVERS.

GENERAL

Matriculation—College of Preceptors—Chartered Institute of Secretaries—Aircraft Apprentice—Emergency Commissions (Army).

MUNICIPAL SERVICE

School Attendance Officer—Handicraft Teacher—Registrar—Relieving Officer—Sanitary Inspector—Weights and Measures Inspector—Inst. of Mun. and Cy. Engineers—P.A.S.I.

"PRACTICAL ENGINEERING" said—

We recommend all readers interested in improving their position to apply for a copy of this valuable Book. "Success in Engineering" is not a pamphlet. It is a 132-page book, containing valuable and vital information on all branches of engineering. There are many engaged in engineering who owe their success to The National Institute of Engineering.

The FREE GUIDE explains:

- Openings, prospects, salaries, etc., in Draughtsmanship, Inspection, and opportunities in all other branches of Engineering and Building.
- How to obtain money-making technical qualifications through special RAPID FULLY-GUARANTEED COURSES.

Write now for your copy of this remarkable publication.

A.M.I.E.E., A.M.I.Mech.E.,
A.M.Brit.I.R.E., A.M.I.P.E.,
A.M.I.C.E., A.M.I.Struct.E.,
A.M.I.A.E., A.F.R.Ae.S.,
A.M.I.S.E., M.R.San.I.,
London B.Sc., Degrees.

Fully guaranteed postal courses for all the above and many other examinations. Fully described in the Free Guide.



THE BUILDING BOOM— SECURE YOUR SHARE!

The Free Guide also gives particulars of our extensive range of modern Building and Structural Courses, Building Draughtsmanship; etc. The great post-war Building programme offers unlimited prospects to technically trained men.

BECOME A DRAUGHTSMAN or AERO INSPECTOR AND EARN BIG MONEY

Men and Youths urgently wanted for well paid positions as Draughtsmen, Inspectors, etc., in Aero, Jig and Tool, Press Tool, Electrical, Mechanical and other Branches of Engineering. Practical experience is unnecessary for those who are willing to learn—our Guaranteed "Home Study" courses will get you in. Those already engaged in the General Drawing Office should study some specialised Branch, such as Jig and Tool or Press Tool Work and so considerably increase their scope and earning capacity.



THE ACID TEST OF TUTORIAL EFFICIENCY SUCCESS—OR NO FEE

We definitely guarantee that if you fail to pass the examination for which you are preparing under our guidance, or if you are not satisfied in every way with our tutorial service—then your Tuition Fee will be returned in full and without question. This is surely the acid test of tutorial efficiency.

If you have ambition you must investigate the Tutorial and Employment services we are able to offer. Founded in 1885, our success record is unapproachable.

Why not fill in and post the attached coupon NOW for further details and Free Authoritative Guide to openings in Engineering and Building? This book contains a mine of valuable and exclusive information and may well prove to be the turning point in your career.

PROMPT TUTORIAL SERVICE GUARANTEED.

FREE COUPON

To NATIONAL INSTITUTE OF ENGINEERING
(Dept. 29), 148, Holborn, London, E.C.1.

Please forward your FREE Guide to:

NAME
ADDRESS

My general interest is in: (1) ENGINEERING (Place a cross against the branches in which you are interested.)
(2) AERO (3) RADIO (4) BUILDING
(5) MUNICIPAL WORK

The subject or examination in which I am especially interested is

To be filled in where you already have a special preference.
(Id. stamp only required if unsealed envelope used.)

NATIONAL INSTITUTE OF ENGINEERING

(Dept. 29)

148, HOLBORN, LONDON, E.C.1

OVER SIXTY YEARS OF
CONTINUOUS SUCCESS

SOUTH AFRICAN BRANCH: E.C.S.A. P.O. BOX 8417 JOHANNESBURG

FOUNDED 1885—FOREMOST TODAY—OVER 100,000 SUCCESSSES

Published about the 30th of each month by GEORGE NEWNES, LIMITED, Tower House, Southampton Street, Strand, London, W.C.2 and Printed in England by the Newnes and Pearson Printing Co., Ltd., Exmoor Street, London, W.10. Sole Agents for Australia and New Zealand—Gordon & Gotch, Ltd. Sole Agents for South Africa—Central News Agency, Ltd. Subscription Rates (including postage): Inland, 10s. 6d. per annum. Abroad, 10s. per annum. Canada, 10s. per annum. Registered at the C.P.O. for transmission by Canadian Magazine Post.

CONDITIONS OF SALE AND SUPPLY: This periodical is sold subject to the following conditions, namely, that it shall not, without the written consent of the publishers first given, be lent, re-sold, hired out or otherwise disposed of by way of Trade, except at the full retail price of 9d.; and that it shall not be lent, re-sold, hired out or otherwise disposed of in a mutilated condition or in any unauthorised cover by way of Trade; or affixed to or as part of any publication or advertising, literary or pictorial matter whatsoever.

"Practical Mechanics" Advice Bureau COUPON
This coupon is available until August 30th, 1945, and must be attached to all letters containing queries, together with 3 penny stamps. A stamped address envelope must also be enclosed.
Practical Mechanics, August, 1945.