

AIRCRAFT INSTRUMENTS EXPLAINED

NEWNES

# PRACTICAL MECHANICS

SEPTEMBER 1939

6<sup>d</sup>



# This is NOT an SOS It is NOT an A.R.P. Call It is an Appeal

It is a genuine appeal to all men and women to do just that little bit extra; to make that extra effort which will make the difference between efficiency and stagnation. It is not enough to merely earn a living; we must make the best of whatever abilities we possess. We cannot wait for those abilities to develop themselves unaided; they must be trained.

By becoming efficient in your vocation you can give the best service to your country and to yourself. The more you increase your earning power the better it is for the country, and for yourself personally.

War or no war, earning power always brings its possessor to the front. It is no use waiting for better times. The ideal opportunity never arrives. We have to make the best of existing conditions. Therefore, delay is useless; it is worse, it is harmful.

**YOU CANNOT MAKE MONEY BY SAVING.** If you save 10s. per week for 10 years you have only £260, but if you spend 2s. 6d. per week for 12 or 18 months on a correspondence course, you give your brains a chance to earn thousands of pounds, then there is no need to save. Savings are likely to vanish, but earning capacity is a permanent investment.

## DO ANY OF THESE SUBJECTS INTEREST YOU?

Accountancy Examinations  
Advertising and Sales Management  
Agriculture  
A.M.I. Fire E. Examinations  
Applied Mechanics  
Army Certificates  
Auctioneers and Estate Agents  
Aviation Engineering  
Banking  
Blueprints  
Boilers  
Book-keeping, Accountancy and Modern Business Methods  
B.Sc. (Eng.)  
Building, Architecture, and Clerk of Works  
Builders' Quantities  
Cambridge Senior School Certificate  
Civil Engineering  
Civil Service  
All Commercial Subjects  
Commercial Art  
Concrete and Structural Engineering  
Draughtsmanship. All branches

Engineering, All branches, subjects and examinations  
General Education  
G.P.O. Eng. Dept.  
Heating and Ventilating  
Industrial Chemistry  
Institute of Housing  
Insurance  
Journalism  
Mathematics  
Matriculation  
Metallurgy  
Mining, All subjects  
Mining, Electrical Engineering  
Motor Engineering  
Motor Trade  
Municipal and County Engineer  
Naval Architecture  
Novel Writing  
Pattern Making  
Play Writing  
Police, Special Course  
Preceptors, College of  
Press Tool Work

Pumps and Pumping Machinery  
Radio Communication  
Radio Service Engineering  
Road Making and Maintenance  
Salesmanship, I.S.M.A.  
Sanitation  
School Attendance Officer  
Secretarial Exams.  
Sheet Metal Work  
Shipbuilding  
Shorthand (Pitman's)  
Short-Story Writing  
Speaking in Public  
Structural Engineering  
Surveying  
Teachers of Handicrafts  
Telephony and Telegraphy  
Television  
Transport Inst. Exams.  
Weights and Measures Inspector  
Welding  
Wireless Telegraphy and Telephony  
Works Managers

If you do not see your own requirements above, write to us on any subject. Full particulars free.



## STUDY AT HOME IN YOUR SPARE TIME

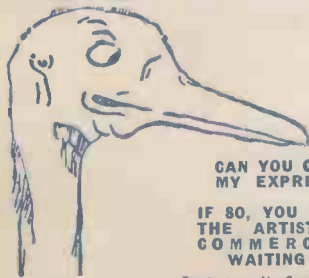

**CAN YOU CHANGE  
MY EXPRESSION?  
IF SO, YOU MAY BE  
THE ARTIST THAT  
COMMERCE IS  
WAITING FOR**

*Jim Duck*  
Just try it for yourself.  
Trace or draw the outline  
and then put in the features

There are hundreds of openings in connection with Humorous Papers, Advertisement Drawing, Posters, Calendars, Catalogues, Textile, Designs, Book Illustrations, etc.

60 per cent. of Commercial Art Work is done by "Free Lance Artists" who do their work at home and sell it to the highest bidders. Many Commercial Artists draw "retaining fees" from various sources, others prefer to work full-time employment or partnership arrangement. We teach you not only how to draw what is wanted, but how to make buyers want what you draw. Many of our students who originally took up Commercial Art as a hobby have since turned it into a full-time paying profession with studio and staff of assistant artists; there is no limit to the possibilities. Let us send full particulars for a FREE TRIAL and details of our course for your inspection. You will be under no obligation whatever.

*Jim Duck* ART DEPT. 76.

## LET ME BE YOUR FATHER

Let me tell you how to make a success of your career.

If your future is undecided or appears unsatisfactory, let us talk it over together. I want to help, and it will cost you nothing to get my help; you will be under no obligation whatever.



## I HAVE HELPED THOUSANDS OF OTHERS

And when I say thousands, I do not exaggerate, as I can produce well over 10,000 unsolicited testimonials from grateful students who, through our Postal Training, have achieved their life's ambition.

*W. Bennett*



Dept. 76, THE BENNETT COLLEGE, SHEFFIELD

EVERY DEPARTMENT IS A  
COMPLETE COLLEGE; EVERY  
STUDENT IS A CLASS TO  
HIMSELF

## JOURNALISM Short-Story, Novel and Play Writing

There's money and pleasure in Journalism and in Story Writing. No apprenticeship, no pupillage, no examinations, no outfit necessary. Writing for newspapers, novels or pictures is not a gift; it is a science that can be acquired by diligent application and proper guidance. It is the most fascinating way of making pastime profitable. Trained ability only is required; we do the training by post. Let us tell you all about it.

DEPARTMENT OF LITERATURE 76

If you attend to this now, it may make a wonderful difference to your future.

### COUPON—

CUT THIS OUT

To Dept. 76, THE BENNETT COLLEGE LTD., SHEFFIELD  
Please send me (free of charge)

Particulars of.....  
Your private advice about  
(Cross out line which does not apply.)

.....  
.....  
.....

PLEASE WRITE IN BLOCK LETTERS

Name.....

Address.....

.....  
.....



# Deciding Factors . . .

The DLP Vice-Screwing Machine should occupy a central position in YOUR workshop.

## Adaptability

The DLP Machine combines the functions of all these tools, without loss of individual efficiency.

## Compactness

## Economy

- Parallel Vice
- Pipe Vice
- Tube, Rod and Strip Bender
- Cable, Rod and Pin Cutter
- Screwing Machine
- Punching Machine
- Cable Stripper
- Flat and Conical Anvils

The space required on your bench is only 12" x 18".

The purchase price is but a fraction of the cost of the separate tools listed above.

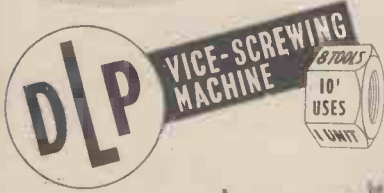

Patent No. 418,829

£5-17-6

Illustrated Folder on Application.



SOLE DISTRIBUTORS FOR THE BRITISH ISLES :

**BUCK & HICKMAN LTD.**

2 WHITECHAPEL RD., LONDON, E.1.

Overseas Enquiries to DeLaPre Components Ltd., Northampton

£52.46

# TRACK PARTS GAUGE "00"

Bond's can now supply Steel Rail and Cast White Metal Chairs for this Gauge.

<b>PRICES</b>			
Steel Rail, sheradised finish	Steel Chairs	...	per 100 1/4
per yd. 1 1/2d., 1/3 doz. yds.	Fishplates	...	per doz. 3d.
Brass Rail	Sleepers, Wooden	...	per 100 8d.
per yd. 3d., 2/3 doz. yds.	Electric Raised Chairs	...	per doz. 8d.
Cast Chairs	Pins	...	3d. packet



**PRICES. Standard Gauge "0" Parts**

Steel Rail, sheradised,	per yd. 2d.	1/8 doz. yds.
Brass Rail	per yd. 4 1/2d.	4/3 doz. yds.
Cast Chairs, slide-on fit	...	per 100 1/2
Electric Raised Chairs	...	per 100 2/-
Fishplates	...	per doz. 3d.
Sleepers, stained correct colour	...	per 100 2/3
Battens, 1/2-in. x 1-in. section	per yd., 2 1/2d., 2/3 doz. yds.	
Pins, approx. 1,000	...	6d. packet
Track Gauge, special, with elec. chair-jig	...	9d. each

All prices-plus postage

## Megow Balsa Flying Kits

Kits for 24in. wing span Flying Models of the STINSON RELIANT, WACO CUSTOM, MONOCOUE, CONSOLIDATED P/30, FAIRCHILD, HAWKER FIGHTER, CURTISS HAWK, RICHMAN AND MERRILL'S VULTEE.

PRICE 2/- Postage 4d.

Large range of smaller kits to make up 12" Flying Models.

PRICE 9d. Postage 3d.



SEND FOR BOND'S 1939 GENERAL CATALOGUE, PRICE 6d.; THIS WILL INTEREST YOU AS ITS 208 PAGES ARE FULL OF PARTS REQUIRED BY THE MODEL MAKER INCLUDING TOOLS AND MATERIALS.

**BOND'S 0' EUSTON ROAD LTD.**

357, EUSTON ROAD, N.W.1

'Phone EUSton 5441-2

Established 1887

# ENGINEERING WORKSHOP PRACTICE

This up-to-date book provides a complete practical course of instruction in every important branch of engineering workshop methods, materials and equipment. It deals with the underlying principles, craftsmanship, machines, tools, measuring processes and machining methods of to-day, and it will prove indispensable to the engineer, draughtsman, mechanic, apprentice and engineering student. Its scope extends from simple hand tools and machines to the latest elaborate machines and methods employed for mass-production purposes.

## SOME OF THE SUBJECTS

Files, Chisels, Scrapers, Shears, Punches, Burnishers, Hand Screw-cutting Tools, Spanners, Vices, Various measuring methods. Verniers, Micrometers, Gauges, Optical Devices, Fluted and Twist Drills. Grinding Angles, Drilling Data, Small and Large Drilling Machines, Electric Drills, Practical Lathework in all its branches, Machining of Metals and Synthetic Materials. Tungsten-carbide and Diamond Tools. Lapping, Honing, Cleaning, Polishing and Rust-protection of various metals. Grinding Operations and Machines, Milling Operations, Cutters and Machines. Planing, Shaping, Slotting and Broaching Operations. Special Machines for Production Purposes. Plate and Bar Machines. Gears and Gear Cutting Methods. Templates, Jigs and Fixtures. Overhauling and Adjusting Machines, Millwright Work. Welding, Brazing and Soldering Metals. Forging Work. Sheet Metal Work. Foundry Work. Patternmaking Practice. Press Work. Engineering Steel and other Metals; their Properties, Testing. Hardening, Tempering and Annealing. Engineers' Drawings. Workshop Calculations, Data, Hints and Recipes.

## THE ILLUSTRATIONS

The book is lavishly illustrated so that the explanations are rendered very clear with examples taken from actual works practice in many instances. There are 24 full-page plates and 877 line and photographic illustrations in the text.

## ENGINEERING POCKET BOOK

In order to make the work even more comprehensive, we have brought out a pocket book, which is supplied free to all purchasers. It contains many useful tables of Screw Threads, Tapers, Angles, Drill Speeds and Sizes, etc.

## A FREE BOOKLET

To the Caxton Publishing Co., Ltd.,  
119 Clun House, Surrey Street,  
London, W.C.2.

Please send me, free of charge, Illustrated Booklet describing "Engineering Workshop Practice."

Name.....

Send this form in unsealed envelope (1/2d. stamp) or a postcard.

Address.....

G.20. ....

# AMBITIOUS ENGINEERS



## HAVE YOU HAD YOUR COPY OF "ENGINEERING OPPORTUNITIES?"

Whatever your age or experience—whether you are one of the "old school," or a youngster who is beginning to realise that in Engineering can be found every possible opportunity for real advancement—you cannot afford to miss reading this highly illuminating guide to the best paid engineering posts.

Our handbook contains, among other intensely interesting matter, details of B.Sc., A.M.I.C.E., A.M.I. Mech. E., A.M.I.E.E., A.M.I.A.E., A.M.I.W.T., A.M.I.R.E., Civil Service, and other important Engineering Examinations; outlines over 200 courses in all branches of Civil, Mechanical, Electrical, Automobile, Radio, Television and Aeronautical Engineering, Building, Government Employment, etc., and explains the unique advantages of our Nationally Organised Employment Department.

WE DEFINITELY GUARANTEE  
"NO PASS-NO FEE"

"ENGINEERING OPPORTUNITIES" is not just a pamphlet—it is a 268 page volume and is the most comprehensive work ever compiled on Successful Engineering Careers. If you are in any way interested in Engineering you must make a point of reading this book without any delay.

Write (or send the coupon) for your copy NOW, while you have the matter in mind. There is absolutely no cost or obligation involved and the book is bound to benefit you.

**BRITISH INSTITUTE OF  
ENGINEERING TECHNOLOGY**

410a, SHAKESPEARE HOUSE,  
17, 18 & 19, STRATFORD PLACE, LONDON, W.1



-----TEAR OFF HERE-----  
**FREE COUPON**

BRITISH INSTITUTE OF  
ENGINEERING TECHNOLOGY,  
410a, Shakespeare House,  
17-19 Stratford Place, W.1.

Please forward, Free of cost or obligation of any kind, your 268-page Handbook. "ENGINEERING OPPORTUNITIES."

Name.....

Address.....

.....

## SUBSCRIPTION RATES

Inland and Abroad 7s. 6d. per annum  
Canada - - 7s. per annum

Editorial and Advertisement Offices: "Practical  
Mechanics," George Newnes Ltd.  
Tower House, Southampton Street, Strand, W.C.2.

Phone: Temple Bar 4363.  
Telegrams: Newnes, Rand, London.

Registered at the G.P.O. for transmission by  
Canadian Magazine Post.

Copyright in all drawings, photographs, and  
articles published in "Practical Mechanics"  
is specifically reserved throughout the  
countries signatory to the Berne Convention  
and the U.S.A. Reproductions or imitations  
of any of these are therefore expressly  
forbidden.

# PRACTICAL MECHANICS

Editor: F. J. CAMM

VOL. VI. SEPTEMBER, 1939. No. 72.

## FAIR COMMENT

### PLANNED RETIREMENT

THE accepted expectation of life is three score years and ten, but that is on the increase, and statistics show that a fair average span between the cradle and the grave is 75 years. The average time spent in mentally equipping oneself for life and laying in a store of knowledge, understanding and intelligence with which to wage life's battle is 16 years. The working life extends for a further 40, leaving approximately 20 years of retirement in which one is free to do the things one really has wanted to do and has been prevented from doing because of work. It is true to say that most men abhor the thought of retirement, particularly those who have led an active life. It is within the knowledge of most of us that some who have retired are miserable individuals, unless they organised in advance of their retirement the leisured years which were to be theirs. Some, indeed, do not live long after retirement, which seems to indicate that it is not work which kills.

Every man at an early age should cultivate one or more hobbies so that when retirement does come he can pursue them with greater vigour, devote more time to them, and thus keep alive his interests. A life without interest is indeed not worth living, and an examination of the cases of those who die soon after retirement indicates that they have not made efforts, prior to putting down the pen or the chisel, to plan their new life.

#### Life a Burden

THUS life becomes a burden, and the dynamic spark of interest in things fails to sustain them. They become a prey to morbid fears, imagine that they are suffering from all the diseases of old age.

A wise individual plans his retirement some years before the event. He builds a workshop and gradually equips it. If he is not of a mechanical turn of mind he lays plans as to the places he will

visit, the fishing expeditions he will undertake; no matter in which direction his interests lie, a little planning will keep fully occupied the greater leisure. Spare time during the active part of one's life seems all too brief, and work-time comes around again, it seems, with monotonous regularity. When work is entirely withdrawn, time can hang heavily on one's hands, unless some interesting occupation can fill it. Hobbies can be pleasurable and profitable, and I know dozens of men who upon attaining the retiring age in the Civil Service or in other jobs, where age decides the time of final departure, and not the degree of activity still retained, have so organised their lives that they have virtually started on fresh careers. Others have turned to practical hobbies, some to quaint ones. Others have taken up the study of languages, have passed examinations, taken degrees, entered other professions, and this they have been able to do with a greater keenness and a more mellow experience than is possible when the heart is young.

#### A Quaint Hobby

THE other day I encountered at an inn a worthy mine host who was once a well-known conjurer. I observed hung around the room a large number of quaint models of prehistoric animals, each of which had been cut from the branches of various trees, and by judicious paring away made to resemble by natural formation weird monsters. Just a bead for an eye, and a touch of red paint for a mouth, and these twigs resembled animals and monsters of the past. The follower of this quaint yet interesting hobby searches the hedges and the trees for queer twig formations which will add to his collection.

Another man I know collects old clocks. Another is enormously interested in the history of the bicycle. A Civil Servant who is 60 visits museums to trace the history of his home town.

Others I know are interested in the history of old inns, collect the title pages of old books, make working models of locomotives. And so whatever your present occupation it is wise to cultivate a hobby distinct from it. The leisured years will not hang so heavily, indeed they will be far more interesting if you do so. You are more fortunate to-day in having so many hobbies from which to select, so many books to help you in those hobbies, and periodicals to bring you the news of them. A hobby will bring you into touch with interesting people, also interested in those hobbies; and thus you enlarge your circle of friends. A hobby is as important to peace of mind as physical culture and regular exercise, good food and sleep are to the body.

#### Why Not Store Air?

IT is somewhat remarkable that whilst elaborate plans are being made in the name of A.R.P., no one seems to have thought of that substance so vital to life—air. We are told to build gas-proof rooms and shelters and to store food. No one has yet suggested that we should store air. It is comparatively simple to do so, for compressor plants can be cheaply purchased and are easily made. Steel bottles in which air can be stored in a comparatively short time are also on the market. I commend the idea to those responsible for A.R.P.

#### Indexes for Volume 6

INDEXES for Volume 6 are now ready, price 7½d. each. Once again I would remind readers that even if they do not have their copies bound, they should keep these annual indexes by them so that they can survey the contents of past issues without having to wade through a large number of them. Postal orders should be sent to the Publisher, George Newnes, Ltd., Tower House, Southampton Street, Strand, London, W.C.2.

# AIRCRAFT INSTRUMENTS EXPLAINED

ANYONE taking a peep for the first-time into the cockpit of an up-to-date long-distance plane or a high-speed bomber might be excused for expressing surprise at the multiplicity of indicating instruments which he would see therein. Yet all such instruments are, in nearly every instance, essential to the well-being and safety of the 'plane, for such guide-instruments provide the pilot not only with auxiliary eyes, but, also, with additional senses. Indeed, much of the training of the present-day pilot for peace or for war is concerned with the meaning and interpretation of his flying instruments. True it is, of course, that a 'plane's instruments are not in all cases infallible guides to safe flying. Nevertheless, a pilot without a reasonably full complement of indicating instruments would be in very



Static tube) being connected to the interior case of the instrument in order to equalise the pressure.

## The Pitot Tube

As the 'plane rushes forward, an air-pressure is set up in the open-ended or Pitot tube, and this pressure is registered on the dial of the instrument, which is calibrated in miles per hour.

An expert pilot, or even a less experienced one flying in good weather does not always require instruments to inform him of the "attitude" or flying angle of his 'plane. In bad weather, however, such attitude-estimating instruments are essential, as is proved by the fact that on several occasions pilots have emerged from clouds or from conditions of bad visibility to find themselves quite unconsciously flying upside down!

## Scientific Guides which Provide the Airman with Auxiliary "Eyes"

much the same position as a ship's navigational officer without his sextant and compass, and, naturally enough, serious and safe flight could not be sustained under such conditions.

### Three Categories

The guide instruments used in a modern aeroplane may be grouped into three main divisions or categories, and it is, indeed, well to memorise these classes, since a clear knowledge of them will enable the amateur student of flying to appreciate more fully the general aim of each instrument in relation to the others.

The guide instruments of a modern 'plane, therefore, are of three classes, viz.:

Flight Instruments.

Navigational Instruments.

Engine Instruments.

Each of these instrument classes may be further sub-divided. Thus, for instance, flight instruments can be classified according as to whether they are instruments of speed estimation, altitude measurement or attitude measurement, the "attitude" of a 'plane being defined as the degree of inclination of any one of its three principle axes.

A 'plane's speed is generally measured by means of its air-speed indicator, of which instrument there are several patterns. Generally, however, the air speed indicator consists of a "pressure head" which is mounted on one of the interplane struts. The pressure head comprises two oppositely placed tubes, one having an open end in

the forward direction of the aeroplane, the other tube being closed at the forwards end, but being pierced with a number of holes in its side. The forwards-open tube (known as the Pitot tube) is connected by means of a pipe line to the diaphragm box of the air-speed indicator dial in the pilot's cockpit, the other tube (known as the

"Attitude" instruments, as we have previously remarked, merely give an indication of the flying "stance" of the 'plane. If an aeroplane banks, that is to say, flies with one wing-tip higher or lower than the other, this inclination is at once registered by one of the attitude-recording instruments. Likewise, any degree of pitch (i.e. of flying with the nose higher or lower than the tail of the machine) is at once detectable. So, too, is "yawing," which is turning to right or to left from a straight path of flight.

### The Cross Level

The majority of flight-attitude instruments operate fundamentally on the well-known spirit-level principle. For instance, the "cross level," which is the instrument for estimating the amount of banking, consists of a curved glass tube sealed at both ends and containing a bubble of air, the movement of which enables the pilot to read off at once any degree of banking which his plane may have got into.

Similarly the "fore-and-aft level" is another spirit-level instrument which gives a correct indication of the degree of pitch or the longitudinal angle of the 'plane.

Both the cross level and the fore-and-aft level suffer from the deficiency of not being able to give true readings unless the 'plane is in fairly steady and straight flight. During a sudden turn, the instruments do not read correctly, neither do they function well under conditions of accelerated motion. A gyroscopic instrument, known as the



A level flight indicator

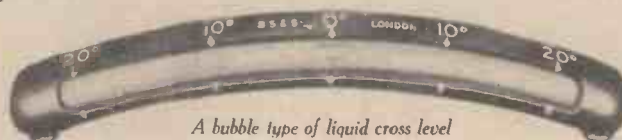

A bubble type of liquid cross level

"Sperry" horizon, however, has been devised to supplant the former instruments. The "Sperry" horizon actually gives a picture of the attitude of the 'plane, for its indicator takes the form of a miniature aeroplane whose inclination coincides with that of the plane in which it is being used.

**Rate of Turn**

It is often very essential for a pilot to know the rate at which his machine is turning. For this purpose, many different rate-of-turn indicators have been used, most of them being of a gyroscopic character and functioning upon the principle of a gyroscope's tending to resist any twisting effect on its axis of spinning. Rate-of-turn indicators are of much use in enabling pilots to maintain a dead straight course at night time or when flying in clouds, since these instruments give a very quick



response to even the slightest turn on the part of the 'plane.

Strange as it may seem, the present-day air pilot has no really satisfactory instrument for informing him of the actual height of his 'plane above ground at any required instant. True it is that many so-called height-indicating instruments—mostly named Altimeters—have been devised, but these one and all operate purely upon the barometric principle whereby a barometer column of mercury, or, in later instruments, a light evacuated box with flexible sides (as in an ordinary "aneroid" barometer) responds to the decrease of atmospheric pressure with increase of height.

**Altimeter Instruments**

Such altimeter instruments, however,

The Sperry directional gyro control units, the dials of which provide continuous visual indications of the course and altitude of the aeroplane whether under automatic or manual control. (Left) Valves for adjusting the mechanism to best working speeds

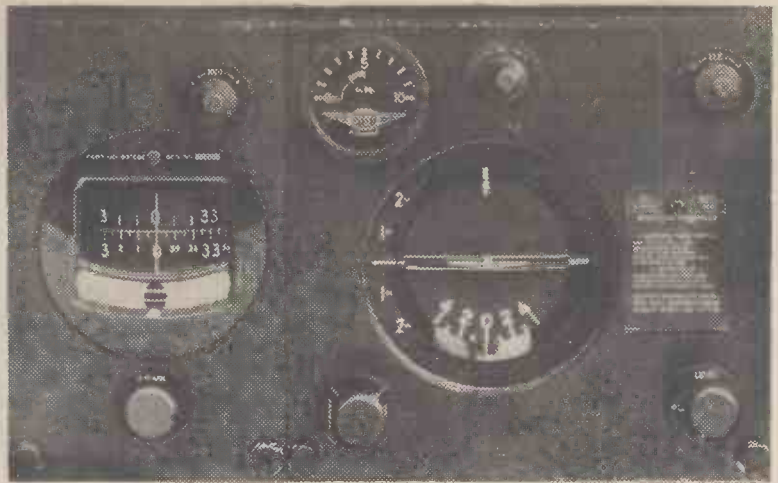

have many failings. In the first place, they do not respond instantly to changes of height. Secondly, they only record the average height at which the 'plane may be flying, and, thirdly, such measurements of height represent height above sea level, not height above land level.

Many attempts have been made to devise an accurate and direct-reading aeroplane height measuring device. One such attempt consisted of sending a train of wireless waves downwards to the earth and by measuring the reflective or "echo" effect, but, owing to the extreme complexity of the matter, this attempt failed. Anyone, therefore who can devise a foolproof direct-reading altimeter for use in modern aircraft can

count upon fame and possibly a reasonable fortune!

**The Statoscope**

Other flying instruments which are sometimes used in up-to-date planes are the "Statoscope" and the rate-of-climb

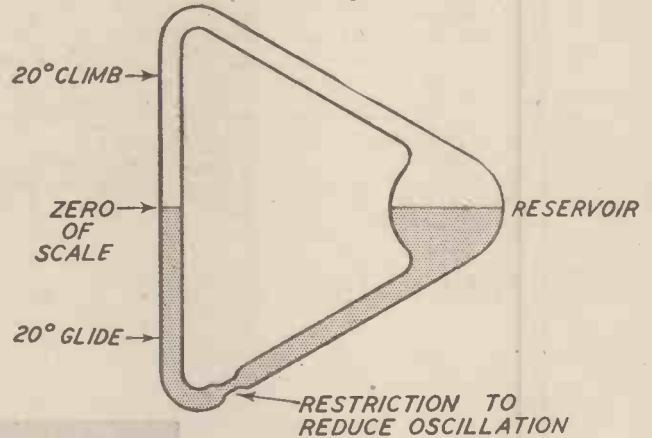

Diagram showing the construction of a fore-and-aft level

indicator. The first-named measures small deviations of the aeroplane from a level course and comprises merely a curved form of spirit level having a bubble in the middle. The rate-of-climb indicator measures the change of height in a given time, and it consists essentially of two air chambers which are connected together by means of a "capillary leak" through which air can flow very slowly. One of these chambers is in communication with the "static" tube of the 'plane's air-speed indicator, mentioned previously, and the rate of climb is measured by estimating the pressure difference between the two air chambers, this being effected by a needle travelling over a dial calibrated in thousands of feet per minute.

**Navigational Instruments**

Coming now to the modern plane's navigational instruments, these are mainly the compass, the directional gyroscope, and other more or less mathematical instruments, such as the sextant, whereby the angle of elevation of the sun or stars can be determined.

It must be remembered that in flying, the ordinary mariners' compass is not the reliable instrument that it is to the seafaring man. The compass, for instance, is rather badly affected by sudden accelerations in the speed of the plane and, also, by sudden turns or other deviations from the straight

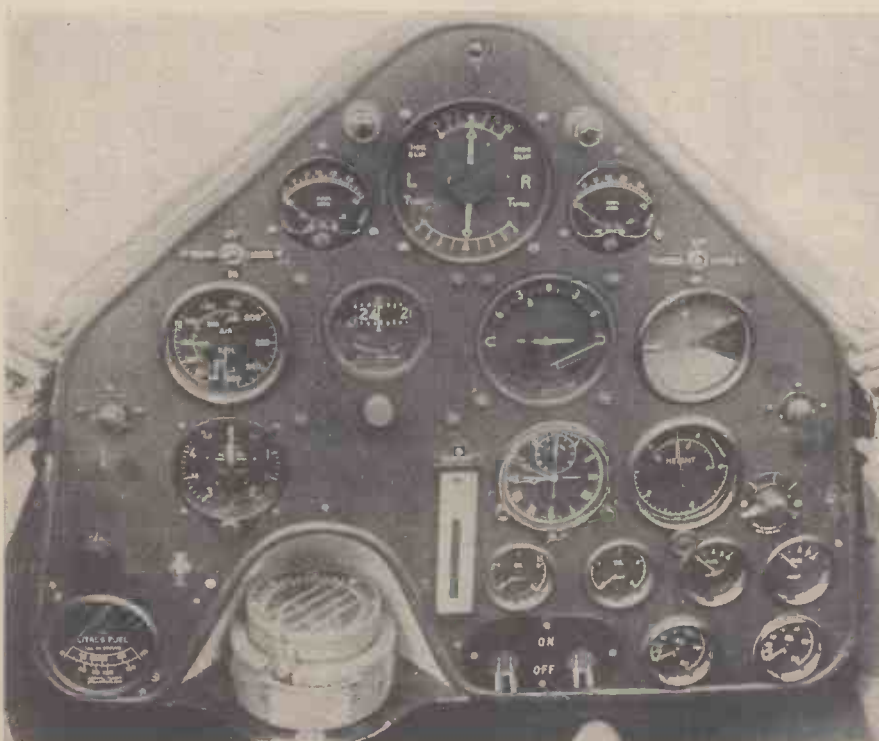

Complete set of instruments on the dashboard of a DH71. The vertical speed indicator is shown at the right-hand end of the centre row of instruments, beside the artificial horizon

and steady path of flight. On account of these facts, therefore, the gyro compass is becoming increasingly used on modern long-distance flights.

Navigational instruments, of course, fall mainly into the domain of the flight observer rather than that of the pilot. Nevertheless, in long-distance flights or during flights across unknown tracts of land, the pilot's eyes must frequently be on his compass or gyroscopic instrument.

**Engine Instruments**

Engine instruments on a modern plane are very numerous, since it is so obviously necessary for the pilot to know precisely what is happening at every vital point in his engine. As is the case with an ultra-efficient car, every aeroplane is equipped with fuel- and oil-indicating instruments, such as its "Flowmeter," or fuel flow indicator, the fuel-feed pressure gauge and the fuel tank gauge for ascertaining the amount of fuel in the tanks. Likewise, in the lubrication system of the engines, there is the oil temperature thermometer and the oil pressure gauge, both of which instruments follow closely the types employed nowadays in ordinary car practice.

All such instruments and gauges, however, have necessarily to be of the highest class and efficiency owing to the very severe (and often very adverse) conditions under which they have to work. For example, the oil pressure gauge of an

Rudder and elevator gyro unit of the Smith Mk IA automatic pilot

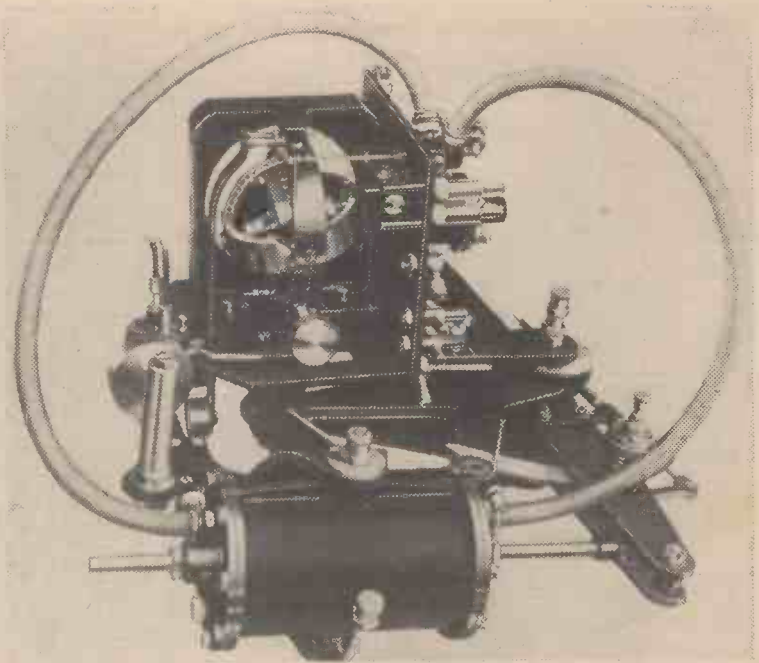

aeroplane has to be made to withstand pressures as much as a hundred per cent. of the normal, owing to the excessive oil

pressures set up when starting the engine from dead cold. Pipe lines connecting the various engine gauges must in all cases be

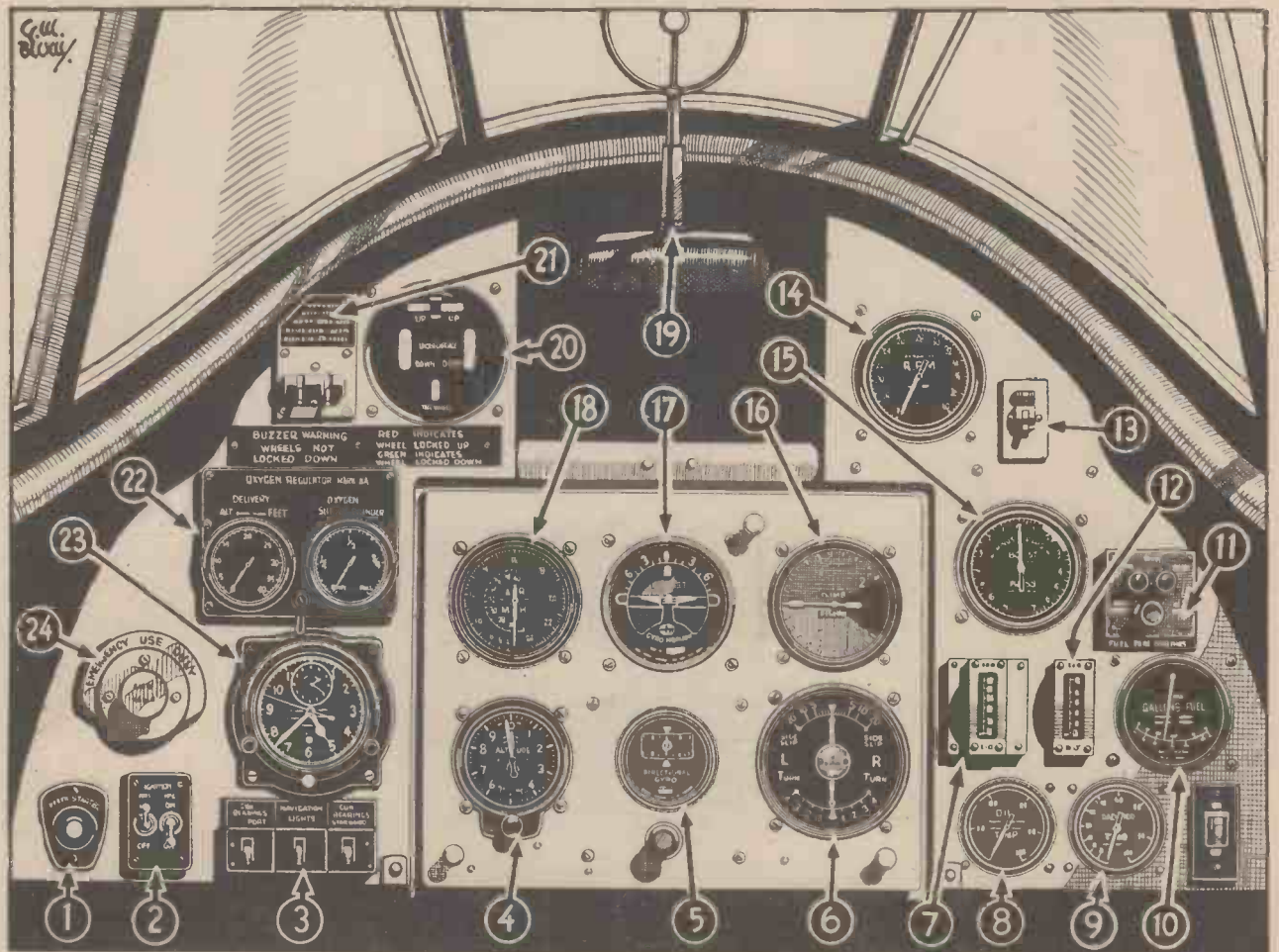

THE DASHBOARD OF A HAWKER HURRICANE FIGHTER.—(1) Engine starter, (2) Ignition switches, (3) Switches for navigation lights and for heating machine-gun bearings at high altitudes, (4) Altimeter, (5) Directional gyro compass, (6) Turn and bank indicator for blind flying, (7) Oil pressure, (8) Oil temperature, (9) Radiator temperature, (10) Fuel indicator, (11) Switches for changing over petrol tanks, (12) Petrol pressure gauge, (13) Switch for illuminating gunsight, (14) Engine revolutions counter, (15) Supercharger pressure gauge, (16) Rate of climb indicator, (17) Artificial horizon for blind flying, (18) Air-speed indicator, (19) Ring gunsight, (20) Retractable undercarriage indicator dial, (21) Undercarriage warning buzzer, (22) Oxygen supply and pressure gauges for high flying, (23) Clock, (24) Emergency extra supercharger switch to give increased speed for a short period



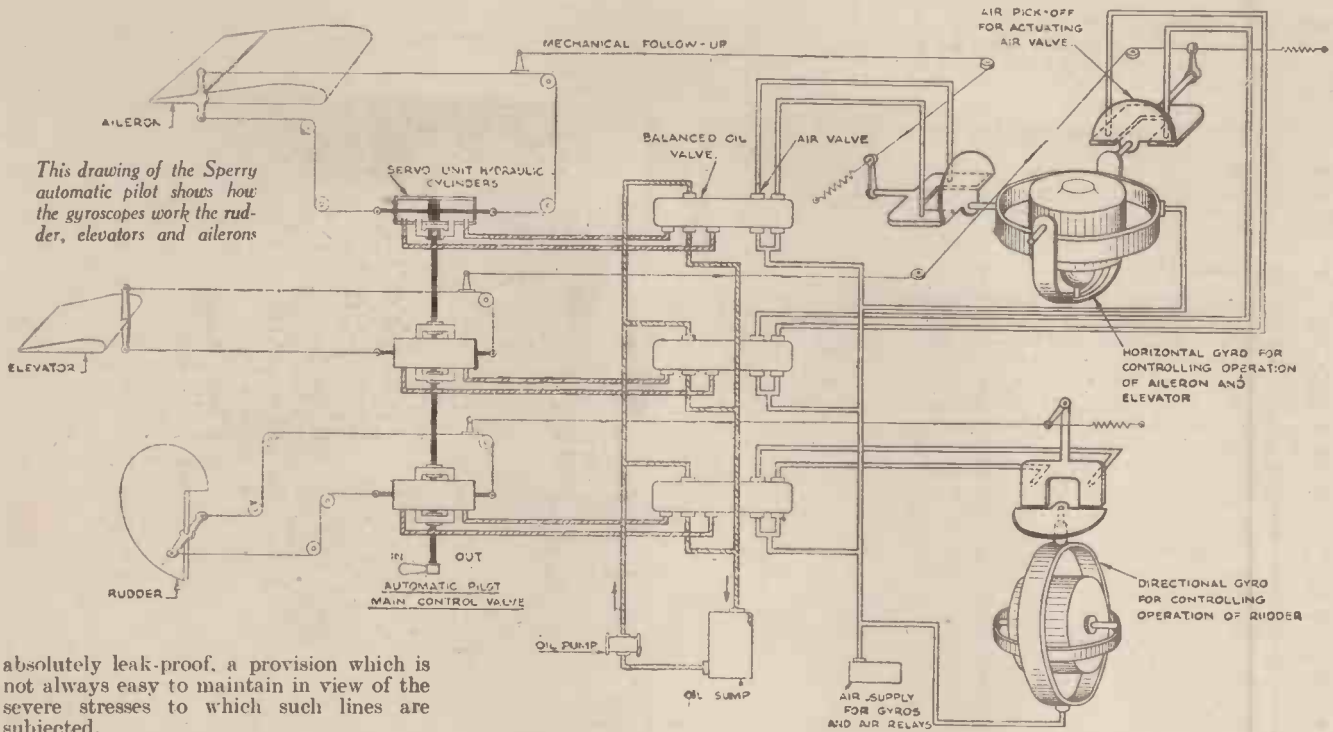

This drawing of the Sperry automatic pilot shows how the gyroscopes work the rudder, elevators and ailerons

absolutely leak-proof, a provision which is not always easy to maintain in view of the severe stresses to which such lines are subjected.

**Electrical Instruments**

Of the various electrical indicating instruments with which the modern aeroplane is equipped we can say but little here. Such instruments comprise merely ammeters, voltmeters and the like, whose purpose it is to give a reading control on the various components of the machine's electrical installation. As such, therefore, they usually do not present many features of novel interest.

Finally, in the category of aeroplane engine instruments come the various "performance indicators," whose function it is to give the pilot a true estimation of his engine's performance.

Of these, perhaps, the most important is the engine speed indicator, sometimes known as the "Tachometer" (from the Greek words, *tachos*, speed, and *metron*, a measure). The tachometer registers the revolutions per minute of the engine crankshaft, and thereby keeps the pilot well informed of the fundamental performance of his power unit.

There are two types of engine-speed indicators—a mechanical and an electrical pattern, the former of which works on the principle of the centrifugal governor which is revolved by means of a flexible shaft drive taken direct from the engine. Such an instrument, therefore, consists merely,

in principle, of a specialised speedometer mechanism.

**The Tachometer**

The electrical engine speed indicator or tachometer, on the other hand, comprises a small generator which is run directly by the engine, and whose produced current actuates a specially calibrated ammeter dial on the fascia board of the 'plane's cockpit.

Auxiliary instruments are often in abundance on a modern 'plane. Such instruments as the radiator water thermometer, the oil tank gauge and the engine sump indicator may, perhaps, be styled "ordinary" ones. More specialised aeroplane indicating instruments are, however, the various wing-temperature thermometers which have been used from time to time, land-sighting devices, and various maximum and minimum thermometers, to say nothing of different patterns of thermostatic heat controls.

**Wireless**

Additionally, of course, every aeroplane carries a full complement of wireless instruments, and frequently direction-finding apparatus as well. Wartime and bombing 'planes take with them their own specialised military instruments, bomb-sights and the like whilst 'planes which are undertaking "out-of-the-ordinary" flights, as, for instance, ultra-high and stratosphere explorations, carry pressure and electrical instruments which are quite unknown on the ordinary forms of flight craft.

Truly, therefore, the modern type of aeroplane, both in peace and in war time, has, probably more than any other single device, emphasised the vital importance of the indicating and the recording instrument, for without its full cargo of these ingenious devices, the flight of an aeroplane through the air would, in these days, constitute a very hazardous journey indeed.

**Land Speed Record**

MR. JOHN COBB, the famous racing motorist, who, last year, was the first man to exceed 350 m.p.h. on the Bonneville Salt Beds, Utah, U.S., only to see Capt. George Eyston exceed this speed 24 hours later with 357 m.p.h., is now in Utah to try and better Eyston's figures. Mr. Cobb has had his turtle-shaped Railton, which he used last year, taken to pieces and rebuilt, and he will attempt to reach a speed of over six miles-a-minute. As this issue goes to press before he makes his attempt. Mr. Cobb may be the new holder of the world's speed record by the time this issue of the magazine is on sale

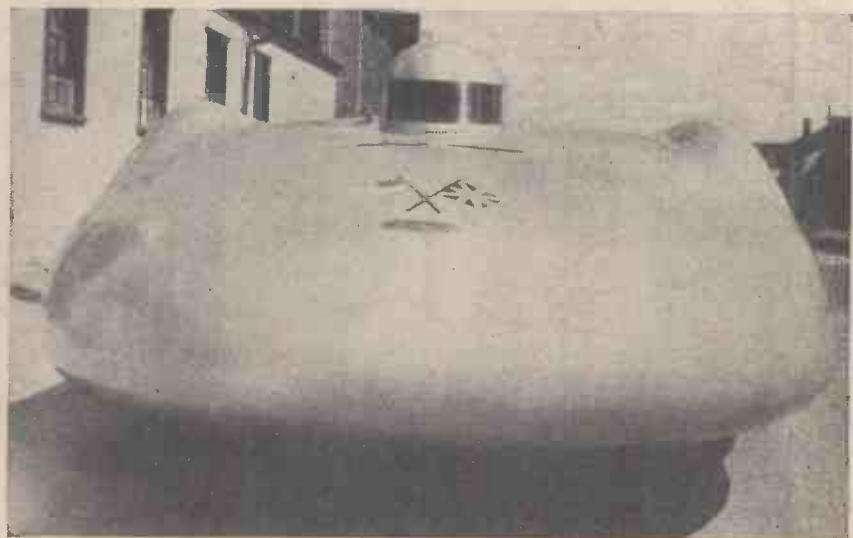

Mr. John Cobb's modified Railton in which he hopes to travel at over six miles a minute

# A MINIATURE POWER-DRIVEN TRAINER CAR



A Trainer Car for Teaching Road Safety and Elementary Engineering To Children

(Left) Children should enjoy their road-safety lessons if they can drive the Atco trainer

thus be easily removed, allowing the chassis to be used as an educational lecturing model.

As the total weight of the whole vehicle is only 150 lb., it would not be a difficult matter to get the chassis on to a raised dais or even a low table, so that pupils would be able to get a better view.

#### Maintenance Manual

To assist in this training the makers have prepared a 66-page manual. It constitutes



(Right) The neat chassis showing the position of the controls. A two-speed gearbox is fitted—one forward and one reverse

A 1 h.p. miniature car is one of the newest devices now being considered by the educational authorities as a means of teaching road safety to children. The fact that the car is power-driven and has the usual controls should enable the child to develop road sense through practical experience. The car is known as the Atco "Junior" Safety-first trainer and costs £35, but is available to local authorities and schools at special rates.

#### Two-Stroke Engine

The main interest to our readers, however, no doubt lies in the specification. The engine is a 98 c.c., 1 h.p., air-cooled Atco-Villiers two-stroke. It is placed immediately over the rear axle with chain drive to the rear wheels. The clutch is of the friction cone type and is foot operated. The gearbox is of the two-speed type—one reverse and one forward speed. The gear lever is centrally placed. The ratios are such as to give adequate power and a maximum speed of between 8 and 10 m.p.h. There is a foot-operated accelerator pedal, with a hand throttle on the steering column.

There is a single brake acting on the rear

axle. It is controlled by a pedal and by an outside handbrake.

#### Adjustable Steering Column

The steering column is adjustable both for length and angle of rake, a desirable feature for making children feel "at home" in the car. Disc wheels are used with 16 in. by 2½ in. Dunlop tyres. The wheels run on roller bearings.

Starting is easy and is by means of a pull-up type handle situated near the floor, and between the driver's and the passenger's seats. The engine runs on petrol, the rear tank having a capacity of 2 pints. Consumption works out at ¾ pint per hour's running.

#### Easily Removable Body

The two-seater body is attached to the chassis by 12 accessible bolts. The body can

a useful text book of elementary motor engineering and of the ethics of driving. A chapter on maintenance and lubrication is also given.

"We have built this car in full faith that it is meeting a real need as a piece of educational equipment," said Mr. J. G. Pugh, managing director of Charles H. Pugh, the makers.

"Whether we welcome it or not, the environment of human beings is becoming more and more mechanical, and children should be taught as early as possible the elementary secrets of mechanical power and the safe control and the use of it.

"Such training is, at least, as popular and vital as Latin, mathematics or physical training, and, furthermore, it would do more than anything else to reduce to a fraction to-day's grim life-toll of the roads in the years to come."

#### Miniature Road Layouts

The "Trainer" is specially suitable, the makers suggest, for use on miniature training-grounds with road crossing signs and beacons.

Grounds of this kind have been recently laid out in a number of schools and by one or two municipalities, and a model "Safety First" training-ground has been built for demonstration purposes at the firm's works at Birmingham.

The use of "trainer cars" in schools will compare with the adoption of "trainer" aircraft which have been for many years a teaching medium in training pupil pilots.

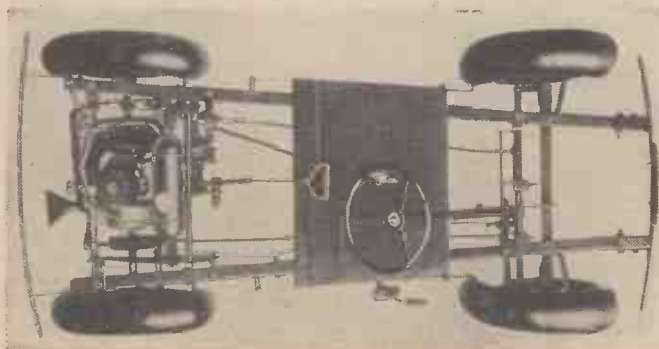

(Left) The engine is mounted over the rear axle. It is a 98-c.c. two-stroke unit. Note the pull-up starter placed centrally near the steering wheel

# A Photo-electric "Areometer"

By Frank W. Britton

## An Instrument which has Several Uses in the Workshop

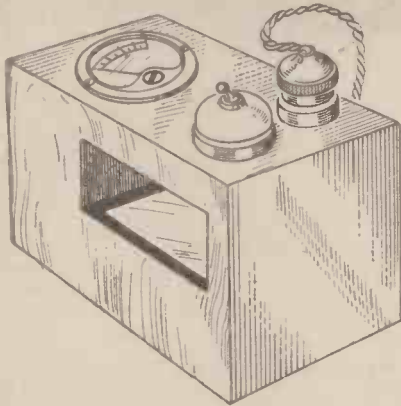

Fig. 1.—The general appearance of the "areometer." The lamp is housed below the aperture

THE uses of an instrument for instantaneously measuring the surface-area of an object will be obvious and the following brief description of such an appliance should present few difficulties to the practical man. It is based on the principle of the photo-electric cell; the type used being that known as the photo-voltaic cell. These latter, by the way, actually generate a small current of electricity by the incidence upon them of light; they are distinct therefore from the gas-filled type in which electrons are released under an applied stress of a constant field voltage. In the case of the photo-voltaic cell the ionisation current or rather, the "work current" is generated photo-chemically in an electrolyte of lead nitrate and accumulates on two electrodes (one of lead, the other of copper oxide). Thus it will be seen that a separate battery is dispensed with.

### The Photo-Voltaic Cell

First of all it will be best to give a few details regarding the construction of the photo-voltaic cell. Here there are certain considerations which are important to bear in mind, especially as regards the size of the apparatus, that is, its accommodation for objects of particular dimensions. Having fixed on the maximum for this factor the limits of the cell as far as its light quantity is concerned will naturally control the size of the electrodes. Another factor is the

candle-power of the lamp used for excitation although this obviously depends on the size of the objects to be measured; but it is rather important that the intensity of the light should be diffused as far as possible in order to cover the entire field occupied by the object—a suitable lens may be used to effect this object if necessary.

The style of the container is the next consideration. It may be of glass, ebonite

necessary to solder wire connections to both electrodes, bringing them through the case and securing with terminals.

### Mounting the Cell

Having made the cell it now remains to mount it in a suitable light-tight box which must be sufficiently large to house (1) the light-source; (2) the object to be measured and (3) the photo-electric cell. For convenience, the best method is to have the whole box arranged horizontally because this allows for a fair sized object. It is here obvious that the surface area of only one face of the object may be measured, it is impossible to determine the total surface area of an irregular solid and therefore the instrument is particularly suitable for small flat objects, for bodies with any depth or thickness the only method of assessing their total surface area is to take the area of each face and to add them together—this is quite satisfactory even though the estimation is only approximate. When the size of the space allotted to the object has been decided, it should be sectioned off by means of a clear glass plate of known surface area. It may be advisable to divide this plate into small squares in order to facilitate the calculation

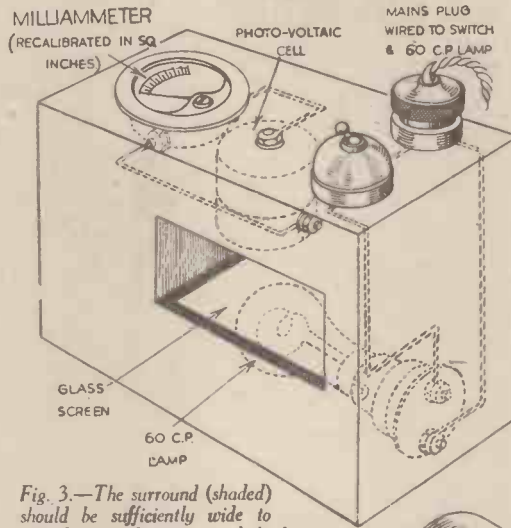

Fig. 3.—The surround (shaded) should be sufficiently wide to exclude as much extraneous light from the lamp as possible. It is inevitable that some light will penetrate from without, therefore a cloth screen should be used round the aperture before the lamp switch is operated

or bakelite, the last being perhaps the most suitable. A round trinket-box or one of the popular bakelite shaving-soap containers is admirable, this must be fitted with a glass cover secured

firmly by means of a ring of rubber ensuring a water-tight joint. A weak solution of lead nitrate in water is placed in the container which also holds a disc of copper coated with copper-oxide, and a ring of lead—the former acting as the negative electrode (cathode) and the latter as the positive or anode. The two electrodes should be spaced fairly closely, about a quarter of an inch apart. It is best to coat the inside of the container and also the back of the electrodes with pitch, but first, of course, it is

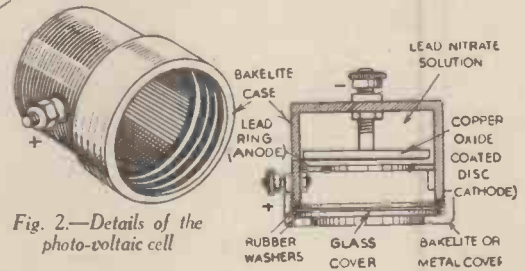

Fig. 2.—Details of the photo-voltaic cell

of areas in calibrating the galvanometer.

### Calibrating the Instrument

When calibrating the instrument it is absolutely necessary to keep to one lamp of fixed candle-power and it is evident that the range of the galvanometer will have to be chosen having regard to this. For all practical purposes a meter reading to a full-scale deflection of ten milliamperes will be suitable. This may seem rather high but the output milliamperage of a photo-voltaic cell such as the one in use is high. As a matter of fact, if a distance of one foot is allowed, four milliamps is possible with a sixty candle-power lamp. Naturally the output increases in proportion to the distance and so, if a distance of six inches is allowed as the space in which the object is placed, a fairly great amount of energy is possible. For the purpose of graduating the instrument a flat piece of opaque material (it may be black paper) is placed

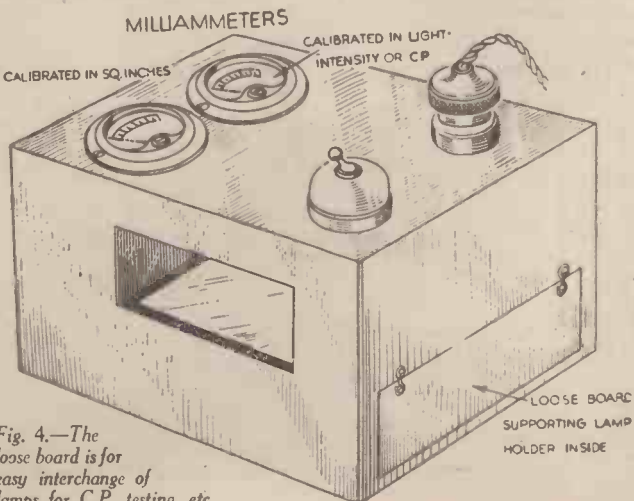

Fig. 4.—The loose board is for easy interchange of lamps for C.P. testing, etc

over the clear glass partition and the lamp switched on. The galvanometer reading being noted carefully. The exact surface area of the object is measured with a rule and dividers—it is best to choose a fairly regular object for this purpose, a square for that matter is best—and the amount of light which this damps out will give a certain reading on the galvo. This reading must now be marked with that particular surface area, it is advisable, however, to take about twelve readings to ensure accuracy. Next, divide the object in two exactly and take the reading for half the surface area; then into four, eight, etc. Checking up carefully after each reading will finally give a fairly accurate reading. But always bear in mind the importance of adhering to the one particular lamp as far as c.p. is concerned and remember that the galvanometer is calibrated specifically for that lamp.

As already mentioned, the overall dimensions of the apparatus will naturally depend on the particular uses to which it is put. It is necessary carefully to plan this beforehand. For instance if the area of one surface of the hand were required to be known a fairly large object-aperture would be necessary—this therefore is a matter entirely at the choice of the experimenter, but for the more usual types of object an instrument of about a cubic foot capacity should be ample.

#### Measuring Light Intensity

Another development of this instrument would be its use for measuring light intensity and also for colour and tone matching. The appliances already on the market make use of the same principle and if the constructor cares to advance along these lines he might incorporate two galvanometers—one for measuring surface area, the other to record the intensity of light transmitted by different coloured filters. This second addition would be invaluable for judging the properties of various coloured glasses used as masks and filters for a multitude of purposes. If the

second galvanometer is calibrated to read direct in terms of candle-power (a matter which is extremely simple and based on the standard lamp already in use) the apparatus furnishes a most useful accessory for the direct measurement of candle-power of any lamp which may be substituted for the standard. But it must be remembered to replace the latter when again resorting to the original purpose of the apparatus.

Should the instrument be required for measuring very minute intensities of light (again departing from the original uses of the appliance) a very sensitive microammeter would have to be substituted for the milliammeter specified above or, alternately, a suitable amplifier could be

that a fairly large space has been left as the aperture in which to place the object to be measured. Should the instrument be intended for flat objects up to an inch in thickness, only about one and a quarter inches would be necessary—a mere slot in other words. Fig. 2 shows the construction of the photo-voltaic cell, while Fig. 3 gives an idea of the interior lay-out of the instrument. The suggestion shown in Fig. 4 is in case the constructor cares to add the second galvanometer for light-intensity and lamp-testing experiments. This is purely optional, however. Fig. 5 is a circuit diagram of an amplifier suitable for use with the cell; in place of the output milliammeter marked G a simple relay

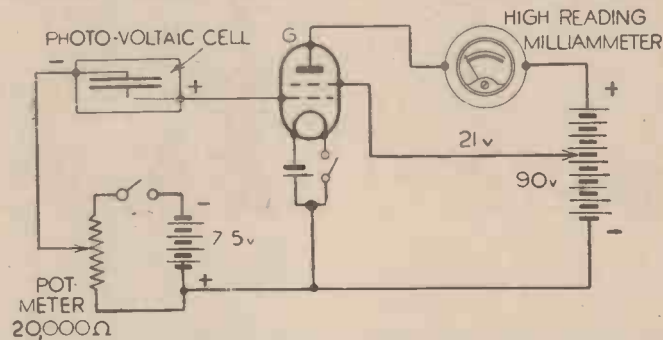

Fig. 5. — Simple circuit for wiring an amplifier to boost up photo-voltaic current

used in series with the meter already in use. A diagram is given showing such an amplifier, the lay-out is sufficiently simple to warrant very little description. A screen-grid valve is used and the photo-voltaic cell is connected in series with a twenty-thousand ohm potentiometer across a grid-bias battery of seven-and-a-half volts. This arrangement is sufficient, too, to operate a relay if one is needed for further experimentation. In this case, the relay would take the place of the second galvanometer inserted in the anode circuit of the valve.

#### Flat Objects

Referring to the diagrams it will be seen

constructed from an ordinary bell mechanism may be inserted. The advantage of this latter measure can be appreciated from this example. Suppose there is a stream of coloured ribbon passing through the aperture, immediately a fault in the colour or even a break occurs, there will be a corresponding variation in the anode circuit of the valve with the consequent operation of the relay. This may be arranged to trip out a control-switch regulating the motor feeding the ribbon. Here is only one use to which such an apparatus may be put, there are no doubt many which will suggest themselves although the original object of the instrument should not be lost sight of.

"Aircraft Design." By C. H. Latimer Needham, M.Sc. (Eng.) Lond., B.Sc., F.R.Ae.S., M.I.A.E. Price 16s. net. 308 pages. 160 illustrations, published by Chapman & Hall, Ltd.

THIS is the second volume by Mr. Latimer Needham, the first volume, recently reviewed in this journal, being entitled "Aerodynamics." This second volume deals with aerostuctures, and it has been written to meet the need for an up-to-date work dealing with the general principles of aircraft design. It would be found useful as a textbook not only to students, but to private constructors of aeroplanes. The author is, of course, experienced in the design, construction, and piloting of aircraft, and also as a lecturer on aeronautics. He has over 20 years' experience upon which to base his writing. It is a most important book, dealing with the general problems of design, the lay-out of aircraft, conditions of loading, aircraft materials, strength of structures, wing structure loads, wing design, fuselage design, tail unit and control surfaces, the undercarriage, design of control system and details, the power unit, float seaplanes and flying-boats, metal construction, the experimental testing of aircraft materials and structure parts, spinning and flutter of aeroplanes, load distribution over tapered and twisted wings, aerofoil characteristics and strength



curves. This is a book which we can thoroughly recommend.

"Auto-Electric Model Railways." By A. Duncan Stubbs. 197 pages. 91 illustrations. Price 3s. 6d. Published by Thomas Nelson & Sons, Ltd.

THIS book is a complete guide to the hobby of model railways, and covers every aspect from the preliminary collection of materials to the final operation of elaborate model railway systems. The eight chapters are: The Choice of Railway Gauge and Materials; The Source of Electrical Energy; Trace Layouts; The Choice of a Control System; Remote Control; Automatic Control; Wiring the Circuit; The Radio Control of Model Boats. The last chapter has been included in view of the fact that many modern elaborate railway systems also include an expanse of water near the track upon which boats may be placed to increase the realism of the entire layout. The book is well illustrated.

"The Evolution of Physics." By Albert Einstein and Leopold Infeld. Published by the Scientific Book Club. 314 pages. Price 2s. 6d. to members.

IN this book the authors have sketched in broad outline the attempts of the human mind to find a connection between the world of ideas, and the world of phenomena. They explain, in simple language, the active forces which compel science to invert ideas corresponding to the reality of our world. The book is divided into four sections dealing respectively with The Rise of the Mechanical View; The Decline of the Mechanical View; Field, Relativity; and Quanta. This interesting volume is well illustrated and there is also an index.

"First Steps in Machine Drawing and Design." By L. A. Johnson, M.I.E.C. Published by Pitt's Popular Publications. 80 pages. Price 1s. 6d.

THIS handbook is intended primarily to assist apprentices and others who are beginning their first study of machine drawing and design. The book is divided into two sections, the first one dealing with Machine Drawing and Design, and Simple Fastenings, the second section covering very fully Materials of Construction. The book is illustrated throughout with clear line drawings, and some useful tables of tangents, sines, etc., are also included.



(Left) The well-known "Kipp's Apparatus," which is used in laboratories for generating hydrogen sulphide gas. (Centre) Scrap copper and strong sulphuric acid are heated in one limb of a bent glass tube. The sulphur dioxide gas which is thereby generated liquefies under pressure in the opposite limb of the tube. (Right) A three-necked "Woulf's bottle," used in the preparation of sulphuryl chloride

# Chemistry for Beginners

## Practical Experiments for the Home Worker

### No. 6. Sulphur and some of its compounds

**T**HE element sulphur has always exerted a peculiar fascination upon mankind, no doubt in consequence of its being belched forth in prodigious amounts by erupting volcanoes and, also, by virtue of the easy manner in which it melts and catches fire with the production of suffocating and characteristic "sulphurous" vapours.

From time immemorial, sulphur has been the "fire-element." Our Saxon forefathers seem to have some knowledge of it, for from their word "bryne," signifying "burning," we derive our present-day common place name for sulphur, to wit *brimstone*, or "burning stone."

Mixtures of pitch and sulphur constituted some of the earliest materials of chemical warfare, such burning masses being hurled into enemy quarters in the course of wars taking place many hundreds of years previous to the Christian era. The direct association of sulphur with warfare was heightened when, in the fourteenth century, this element was found to be an indispensable ingredient of gunpowder, and, naturally enough, our ancestors imparted to this mysterious, easily-combustible material a role which was even an extra-terrestrial one in respect of its supposed assistance in the feeding of those retributive fires of the Underworld which have been held, by poets and theologians alike, to be inextinguishable.

#### Common Substance

To us, however, the element sulphur is a very common and familiar substance. We purchase it cheaply in the form of a fine yellow powder, or "flowers," and also in

the "roll" or "rock" condition. Either of these common forms of sulphur will suffice for the experiments which are to be detailed in these columns, although, perhaps, if anything, the sulphur "flowers" are the most convenient form of the element to experiment with.

Everyone knows what sulphur or "brimstone" is like in appearance. Its characteristic lemon-yellow colour, its slight, clinging smell and the peculiar lambent blue flame with which it burns are all common knowledge. The ordinary commercial "flowers of sulphur" and "roll sulphur" are by no means pure forms of this element, however. There are, indeed, quite a number of different forms of sulphur, of which the best known are Rhombic or "alpha" sulphur, Prismatic or "beta" sulphur, plastic sulphur and amorphous sulphur.

All these varieties of the element sulphur, although quite distinct in properties from one another, are none the less, composed of nothing else but sulphur, just as soot, graphite and diamond, whilst differing widely in properties, are nevertheless inwardly made up of carbon only.

#### "Allotropes"

Quite a number of elements have the power of existing in these widely differing forms, and to these the name *allotropes* (from the Greek *allos*, another; *tropos*, form) is given. Thus rhombic, prismatic and plastic sulphur are all allotropes or "allotropic modifications" of the element sulphur, just as soot, graphite and diamond are allotropes of carbon.

When sulphur is carefully melted, it first

forms a thin liquid. With increasing temperature, however, this liquid thickens up and, also, becomes increasingly dark in colour. At still higher temperatures, the liquid becomes thinner and almost black. Finally, at a temperature of 448°C. the liquid sulphur boils.

If a small basin of liquid sulphur is allowed to cool down until a crust forms on its surface and if, then, the surface crust be immediately broken and the still liquid sulphur underneath poured away, a mass of yellow needle-like crystals will be revealed. These are crystals of "prismatic" sulphur, and the same may be obtained by crystallising sulphur from hot turpentine.

Prismatic sulphur is not stable. In a day or two, the prismatic crystals will fall to powder, the powder consisting of minute crystals of rhombic sulphur, which form of sulphur can be obtained in larger crystals by crystallising sulphur from carbon bisulphide.

By pouring a thin stream of molten sulphur into water, we obtain a most peculiar form of the element known as "plastic sulphur." This is a variety not unsimilar in characteristics to modelling wax or plasticine, for it can be pulled out like soft gum or rubber and easily moulded to any shape between the fingers. Again, however, plastic sulphur is not stable. In the course of a few days, it loses its plasticity and reverts into the stable rhombic form of sulphur.

#### Amorphous Sulphur

The fourth common variety of sulphur—amorphous sulphur—occurs to the extent of about five per cent. in ordinary flowers of sulphur and it is insoluble in carbon

bisulphide. Hence, when flowers of sulphur are dissolved in carbon bisulphide, the insoluble portion remaining is the almost white amorphous sulphur. This milk-white variety of sulphur can be changed into rhombic sulphur simply by heating it to 100C. when, almost immediately, it will turn yellow.

The compounds which are termed "sulphides" contain only sulphur and a metal, and, frequently, they can be made simply by heating sulphur with a metal. For instance, if we heat iron filings with flowers of sulphur in a test tube, the tube contents will glow at red heat, and, on cooling, a greenish-grey compound, *iron sulphide*, will be forthcoming. Thus:—

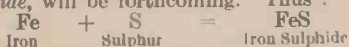

In a similar manner, copper sulphide may be made by heating scrap copper with sulphur.

When a metallic sulphide is acted upon by a mineral acid, such as sulphuric or hydrochloric acid, the well-known " $\text{H}_2\text{S}$ ," or hydrogen sulphide (sulphuretted hydrogen) is evolved. Hydrogen sulphide is a colourless gas which possesses the almost intolerable smell of rotten eggs. In addition to this, it is a fairly poisonous gas, and hence all experiments with it **MUST** be conducted out of doors.

The best way to make hydrogen sulphide is by the action of dilute hydrochloric acid on iron sulphide. A few scraps of iron sulphide are placed in a bottle fitted with a thistle-funnel and a delivery tube. Immediately the acid is poured down the thistle-funnel the evil-smelling gas is copiously disengaged.

#### "Kipp's Apparatus"

Most established laboratories use a "Kipp's apparatus" for generating their supplies of hydrogen sulphide. This consists merely of a central glass chamber in which a supply of iron sulphide is maintained. When the gas-delivery tap or clip is opened, the acid rises and makes contact with the iron sulphide, thereby generating the gas. When the tap is closed, the generated gas forces the acid downwards out of contact with the iron sulphide and thus prevents more of the gas being generated.

Hydrogen sulphide is an inflammable gas. It is also soluble in water, one volume of water dissolving three volumes of the gas.

Despite its highly objectionable odour, hydrogen sulphide is a very much used gas, not only in chemical synthesis but also in consequence of the fact that it is able to precipitate many metals as sulphides from their solutions, an effect which is made much use of in chemical analysis. Thus, silver, arsenic, lead, cadmium, antimony, bismuth, tin, zinc, iron, nickel, cobalt, molybdenum and the sulphides of many other metals may all be precipitated by passing hydrogen sulphide gas into a solution of the respective metallic salt.

Another highly interesting gaseous compound of sulphur is sulphur dioxide,  $\text{SO}_2$ . It is an invisible, pungent-smelling gas which is formed abundantly when sulphur burns in air or oxygen, and it thus possesses the characteristic suffocating smell of "burning sulphur."

The best way to make sulphur dioxide in the laboratory is either to heat scrap copper with concentrated sulphuric acid or else to drop hydrochloric acid on a solution of sodium sulphite (not sulphate).

Sulphur dioxide is very soluble in water and, indeed, it actually combines with it to form sulphurous acid:—

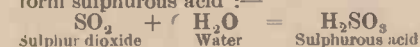

Like chlorine, sulphur dioxide possesses powerful bleaching characteristics due to its absorption of oxygen from the water and the consequent liberation of hydrogen which converts the colouring matter into a colourless form. Thus:—

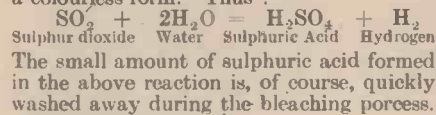

#### A Spectacular Feature

Perhaps, from the point of view of the home chemist, the most spectacular feature of sulphur dioxide is the readiness with which it can be liquefied. At ordinary temperatures it liquefies under a pressure of only a few atmospheres, and such a pressure can be withstood by ordinary glass tubing.

Hence, if we desire to liquify sulphur dioxide, all we have to do is to take a straight piece of glass tubing, seal up one end in a bunsen flame and then introduce a few pieces of scrap copper into that end of the tube. Cover the copper with strong sulphuric acid, then carefully bend the tube in the manner shown in the illustration so that it has two roughly parallel vertical

froth over into the vacant limb of the tube. As the sulphur dioxide gas is disengaged and its internal pressure in the tube increases it will gradually condense to a colourless liquid in the free limb of the tube. By immersing this limb in a mixture of ice and salt for a few minutes, the liquefied sulphur dioxide will be so strongly cooled that it will permit of the sealing-off by a bunsen flame of the limb of the tube containing it, so that the specimen of liquid gas can be retained permanently.

We have already referred to sulphurous acid,  $\text{H}_2\text{SO}_3$ , which is formed in weak solution when sulphur dioxide is dissolved in water. It is from this acid that we derive all the metallic sulphites, such as sodium sulphite. The metallic sulphates come from the well-known sulphuric acid,  $\text{H}_2\text{SO}_4$ , which is, when pure, a colourless, oily, highly-corrosive liquid, commonly known as "oil of vitriol."

#### Sulphuric Acid

Sulphuric acid cannot very well be made in quantity in the ordinary laboratory. Hence, we shall dismiss it with merely the statement that the amateur may, if he so wishes, prepare it simply by dissolving



Crystals of "prismatic" or needle-like sulphur obtained by the method described in this article

limbs. Finally seal off the other end of the tube.

Now clamp the tube securely and very cautiously heat the limb containing the acid and the copper. The heating must not be sufficiently vigorous to cause the acid to

sulphur trioxide,  $\text{SO}_3$ , in water, the trioxide combining with the water to form sulphuric acid, just as sulphur dioxide combines with water to form sulphurous acid. Summarised, these essential reactions may be represented:—

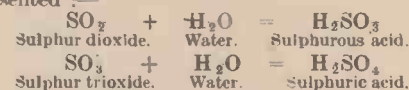

On a large scale, the very important sulphuric acid is now manufactured by passing a mixture of sulphur dioxide and air over heated platinum or vanadium catalysts, which latter cause the  $\text{SO}_2$  and the oxygen of the air to combine together to form  $\text{SO}_3$ —sulphur trioxide. This sulphur trioxide is then merely dissolved in water to form sulphuric acid.

Any reader who wishes to prepare pure sulphur trioxide in the form of silk-white needle-like crystals can do so by distilling strong sulphuric acid with phosphorus pentoxide or by dry-distilling ferric (not ferrous) sulphate.

Another interesting sulphur compound which in these days has attained a position of considerable importance is sulphur monochloride, for by combining this substance with ethylene gas the nowadays well-known and notorious "mustard gas" is manufactured.

Sulphur monochloride,  $\text{S}_2\text{Cl}_2$ , is prepared by acting upon molten sulphur with dry chlorine gas. For this purpose a quantity of sulphur is placed in a flask fitted, as shown in the photograph, with two tubes.

(Continued on page 640)



Making sulphur monochloride. Chlorine gas is passed over molten sulphur in a flask, and the sulphur monochloride which is formed is condensed in a cooled receiver

# A MODERN DUPLICATOR

*A Universal Printing Machine which will Produce any Class of Work from a Simple Typewritten Letter to a Complete Illustrated Catalogue in Colour*

**T**HE Rotaprint is a versatile printing machine which produces perfect typewritten letters with remarkable simplicity. It has a wide range of usefulness and makes the printing of office stationery such as letter heads, invoices, statements, labels, circular letters, illustrated folders, booklets and catalogues as simple an office function as the typing of letters.

letters has innumerable advantages over the old-fashioned duplicator method. It gives a perfect replica of the character of the typewriter without the necessity of stencils, loose type, etc. The Rotaprint metal sheet can be stored for future



(Right) The automatic printing and duplicating machine. (Left) The double inking unit



supplies, as it is a simple matter to erase the date and substitute a new one where necessary.

For the business man it is a simple matter to write a personal letter in his own handwriting to all his customers or potential customers, by writing directly on the metal sheet and printing it on the Rotaprint. These facsimile letters cannot be distinguished from actual handwritten letters.

Art work carried out directly on the metal sheet by pen, pencil, brush or aerograph produces a perfect reproduction and saves

## Photographic Work

Anything which can be photographed—from a simple black and white sketch to a drawing or photograph in full colour—can be imposed on Rotaprint plates by a photo-mechanical process and reproduced on the Rotaprint.

"Dot for dot" negatives can be made

Simply take a Rotaprint metal sheet from the packet supplied by the firm—place it in a standard typewriter and type on it exactly as you would a sheet of paper. Alterations can be made where necessary by erasing with the typewriter rubber. The Rotaprint metal sheet requires no chemical preparation, or washing in warm water and subsequent drying as in other processes, and within one minute of leaving the typewriter the circular letter can be used for printing on the Rotaprint machine.

## Numerous Advantages

This method of producing facsimile



The automatic paper feed

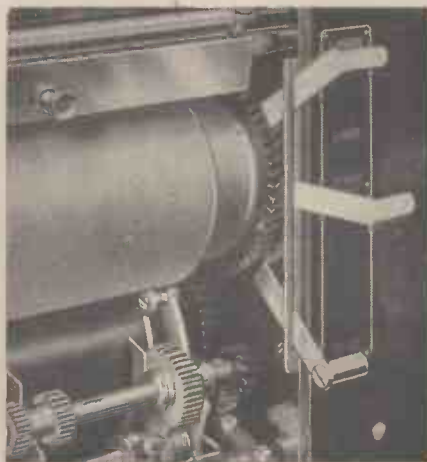

The automatic cut out

the cost of blocks, type setting and process work. No technical knowledge is required for direct image work—if you can draw on paper, you can do the same on the metal sheet and the image you impose on the sheet will give an absolutely faithful reproduction of your subject.



The electric driving motor.

from existing printed matter, illustrated or otherwise, at 1½d. per square inch and transferred to metal plates for four or five shillings, which is about one quarter of the cost of doing the job by any other process.

The Rotaprint machine is backed by the largest and most efficient service and process organisation of its kind. Their works at Queensbury (over 30,000 square feet) the centre of this vast organisation—possess the most up-to-date equipment and they employ more than 250 highly skilled operatives to produce every conceivable type of work and impose it on master sheets for printing on the Rotaprint machine.



## For the Semi-blind

READING and writing and the many pleasures of sight have been regained for the semi-blind through the use of the teleoptic-magnifier, a new type of spectacle lens. This new invention which gives 300 per cent. magnification for distant vision, was described at the recent annual meeting held at Los Angeles by the American Academy of Optometry. A combination of three to five lenses for each

*Barney Connell in his 11-foot submarine which weighs 1,200 lbs., about to make a successful test in the Hudson River. Connell, the owner and builder, navigated the river for about an hour, making half a dozen dives to a depth of several feet. It was the first time he had tested it under salt water. A helper is adjusting the conning tower.*

have been brought back to life according to a claim made by Russian scientists.

That the bacteria must have been alive thousands of years ago is proved by the fact that the soil strata in which the resurrected organisms were discovered also contained the bones of the mammoth rhinoceros, bison, red deer and musk-ox.

## Reclaiming Desert Sands

GRASS is now sprouting on Soviet deserts following the planting of seeds by aeroplane this spring. Moscow considers this a satisfactory method of reclaiming desert sands, and it is being tried in the arid Kara-Kum region.

## Synthetic Rubber

DR. GUSTAV EGLOFF, director of the research laboratories of the Universal Oil Products Company, announces a new process for the manufacture of synthetic rubber from butane gas. This gas is regarded as a waste product in some American oil-fields, as it is so plentiful. It is claimed by the doctor that his product is better and cheaper than the Buna rubber made in Germany. If the synthetic rubber were manufactured in large quantities, he says, the price would be comparable with that of pure Para rubber, while it is said to have greater resistance to acids, heat and alkalis.

"The amount of butane available for conversion into synthetic rubber without the

## "How Fast do Birds Fly?"

IN last month's issue we published an article, under the above heading, in which we gave the approximate speeds of a number of birds when in flight. It is interesting to note that ornithologists at Lanzo, near Turin, have recently carried out experiments to compare the speed of a swallow with that of an aeroplane. The experiments showed that the swallow can fly at 108.5 m.p.h.

The speed was ascertained by taking a mother bird from her nest, fitting an identification disc on her foot and conveying her to a spot estimated as 79 miles away in a direct line. Upon the bird being released she returned to her nest in 43½ minutes.

## Speedometers for Trains

AS a further aid to enable trains to run to schedule over long distances, some of the latest streamlined expresses are being fitted with speedometers.

A railway official says that many people believe that all railway locomotives are fitted with speedometers, but this is not so. Usually the driver keeps to his time with astonishing accuracy as the result of practical experience and without mechanical aid.

## Surgical "Lightning" Knife

DR. GUSTAVUS M. BLECH, of Chicago, announces a new development of the surgical "lightning knife." By use of a high-frequency electric current, the knife, which is a blunt instrument, cuts into tissue and at the same time destroys disease bacteria and stops bleeding by sealing up tiny blood vessels.

The doctor states that he has perfected an electrical knife, which is capable of generating its own current, and weighs only nineteen pounds. It is thus easily transportable.

eye, the teleoptic magnifier looks like a glass cone, is 1 inch long and sufficiently light

# THE MONTH IN SCIENCE AND

to be fitted to ordinary eyeglass frames. It was designed to aid those partially blind from eye nerve disease, a group comprising 15 per cent. of the 200,000 blind people now in the United States.

## 20,000 Years Old

WATER plants, moss, bacteria and other organisms which for 20,000 years have remained buried in the frozen soil of Siberia

use of any other raw material is enormous," declares Dr. Egloff.

"There is a 60 per cent. yield of rubber from butane, so that the oil industry can make 10,000,000,000 lbs. of rubber annually from the butane that is now produced."

## New X-ray Process

DEVELOPMENT of a new X-ray process that will enable every person in the



*A diesel-electric "Automoteur" car. These cars operate between Marseilles and Menton and are run by the P.L.M. railway. Note the semi-streamlined body and driver's "conning tower"*



United States to have a preliminary examination for tuberculosis, heart disease and stomach ulcers, at a cost of no more than ten cents, was revealed by Dr. Linberg, of Decatur, Ill., the inventor, at the annual meeting of the National Tuberculosis Association at Boston, Mass.

The key to the new process is a miniature camera using ordinary 35-mm. film. This "candid camera" photographs an X-ray picture appearing on a sensitive fluoroscopic screen which receives impressions registered by ordinary X-ray examinations. The person being examined stands in a small booth, on one side of which is an X-ray projector and on the other side is the screen. The low cost is made possible by the elimination of the use of regular X-ray films measuring 14 by 17 inches.

## A New Atlantic Plane

THE "Camille Flammarion," a new plane intended for the North Atlantic route, was recently tested out at Marseilles air port. The aeroplane is to undergo further tests when a load of 24 tons will be carried.

## Britain's Tallest Chimney

WHEN the new £6,000,000 Hams Hall power station at Birmingham is completed, it will have the tallest chimney in Britain. The chimney will have 27 feet of foundation, will have a diameter of 22 feet

*J. A. Sams, of the General Electric Works Laboratory, shown with the surface comparator he has developed which is sensitive enough to measure the differences in thickness of a finger print on a piece of smooth glass*



lift for carrying the builders and materials, and this will be extended as the chimney grows. Preston has a chimney 371 feet high, which it claims as the tallest in Britain.

and self-contained dredging unit with a dredging range to a depth of 3,000 feet below the surface of the ocean, which J. C. Williams, a California and Nevada engineer, intends to construct. The deepest gold-digging dredge in the world at present digs at a depth of 126 feet.

# THE WORLD OF INVENTION

round the top, and will be 400 feet above the ground. About 2,000,000 bricks will be used in constructing the chimney, which will cost £26,000 to build. Inside will be an electric

## Small-pox Vaccine

THE head of the Pasteur Institute, in Paris—Dr. Harry Plotz—states that he has discovered a new small-pox vaccine. This new vaccine will eliminate entirely infections sometimes caused by the old serum.

## Bridge to be Moved

THE 47-year-old bridge which spans the Vaal river, at Fourteen Streams, on the boundary of the Cape Province and Transvaal, is shortly to go on a 500-mile journey. The bridge is one of the most famous in South Africa, and it is shortly to be demolished in sections and re-erected across the Kei river, in the Transkeian native territories.

It will be replaced by an entirely new bridge in which 1,530 tons of steelwork will be used.

## Gold-Digging Dredger

WE show on this page an artist's impression of a 9,000-ton self-propelled

## Oil-Engined Car

AN interesting feature of this year's Motor Show, which will be held in the autumn, will be an oil-engined car which will be on exhibition for the first time. It will be an American car, but it will have a British engine. The firm responsible for the engine have tested it for economy and performance in various parts of the world, and an oil-engined car recently completed a 40,000-mile journey without trouble.

It is a six-cylinder engine and advantages claimed for it by the makers are that there is greater fuel economy than with petrol engines, there are no electrical components except starter motor and dynamo, and high speed is now possible. Furthermore, the disadvantages of weight, noise and size have been remedied.

## Anti-Dazzle Device

A SPECIALLY designed instrument, to ensure precise positioning of headlamp bulb filaments in relation to headlamp reflectors, has just been perfected by the Notek non-dazzle headlight engineers.

The new machine, through which every bulb must pass, tests measurements through the whole of the optical axis and by throwing an enlarged picture of the filament on a screen enables both the focal distance and axial displacement to be checked with fine accuracy.

It is claimed by the optical engineers that the qualities of scientific non-dazzle headlamp design are negative unless filament tolerance is very finely limited, and the new machine has been introduced to reject all lamps outside the Company's limit of half a millimetre, or one-third of the normal tolerance.

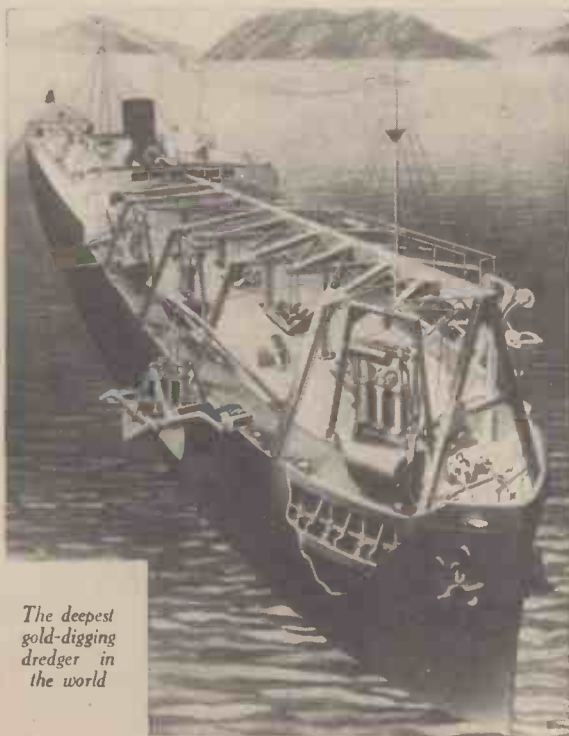

The deepest gold-digging dredger in the world

# MAKING A BANDSAW

## How An Old Motor Cycle can be Converted into a Useful Accessory for a Workshop

**A**T first sight the resemblance of a motor cycle to a bandsaw may appear slight, yet in plain fact it is remarkably close, for they both carry a pair of lightweight wheels, one of which is driven and the other free. The average peripheral

of three-ply, covered with rubber. Cut strips of the thinnest three-ply, feather the ends, and cement and nail these together, using very small tacks with their points riveted over. Drive these tyres on to the rims, and with fine brads nail them to the rope fillings. The rubber tyres are strips of inner tube, joined up and stuck on with rubber solution.

Sandpaper the joints of the latter until they are as nearly flush as is possible. The next stage is the building of a wooden trestle for the firm support of the cycle frame, and the incorporation with this trestle of a wooden upright, on which will be mounted the cycle's front wheel over the back wheel.

### Back-Wheel Support

The back wheel will be supported by the original cycle stand, and the motor by making connections between the foot-rest tubes and the workshop floor.

All the wooden parts, except the trestle legs, may be of hard wood 1 in., thick bolted

together, gripping the top portion of the cycle frame. The upright, or pillar, is similarly made of 4 in. x 1 in. members, which will be 5 ft. 6 in. long, and distanced from each other to take the cycle fork between; that is to say about 4 in. apart.

Between these pillar members the horizontal trestle members are fitted, the trestle leg bolts passing through the whole assembly, and the foot of the pillar being clamped to the floor, like the trestle legs.

### Housing the Front Wheel

The frame, trestle and pillar being now firmly set up, there follows the housing of the front wheel above the back one.

The weight and strains of this front, or upper wheel as it may now be called, are taken by a hardwood bracket of two members 2 ft. 6 in. long, 8 in. wide where they bolt inside the pillar, and 3½ in. wide at their outer ends, where they are connected by a distance piece.

The original front fork is utilized to carry the wheel. A horizontal pivot pin fitted through the head of the fork is carried in slots formed at the back of the pillar. (A. Fig. 1.) Slots, not round bearings, are necessary, because the top wheel has to tilt out of the vertical plane to cause the blade to track correctly.

Not only must it be possible to tilt the top wheel. Its axle must be adjustable vertically for the purpose of tensioning the blade. Both these adjustments can be made by means of the pair of nuts E (Fig. 2) which, travelling on the vertical screwed rods that are fixed in the wooden blocks F, compress the springs D, which, in turn, force upwards the tubular rods B.

The tubular rods can be cut from the stays that supported the pillion carrier. They must be an easy sliding fit in the wooden guide blocks C. The compression springs supporting the rods are of 13 S.W.G. spring wire, and should give an adjustment range of one inch at least.

### Bandsaw Blades

Bandsaw blades are maintained on their wheels by tilting the upper part of the upper wheel backwards. This causes the blade to tend to run backwards also, that is—away from the operator. But the blade is prevented from running off the wheels by the spinners G (see Figs. 1 and 3), which are revolving discs against which the back edge of the blade bears.

The spinners are hard steel discs 2½ in. in diameter, which can be made from slitting saws by grinding off the teeth. They may be mounted on pedal cycle hubs, the hubs

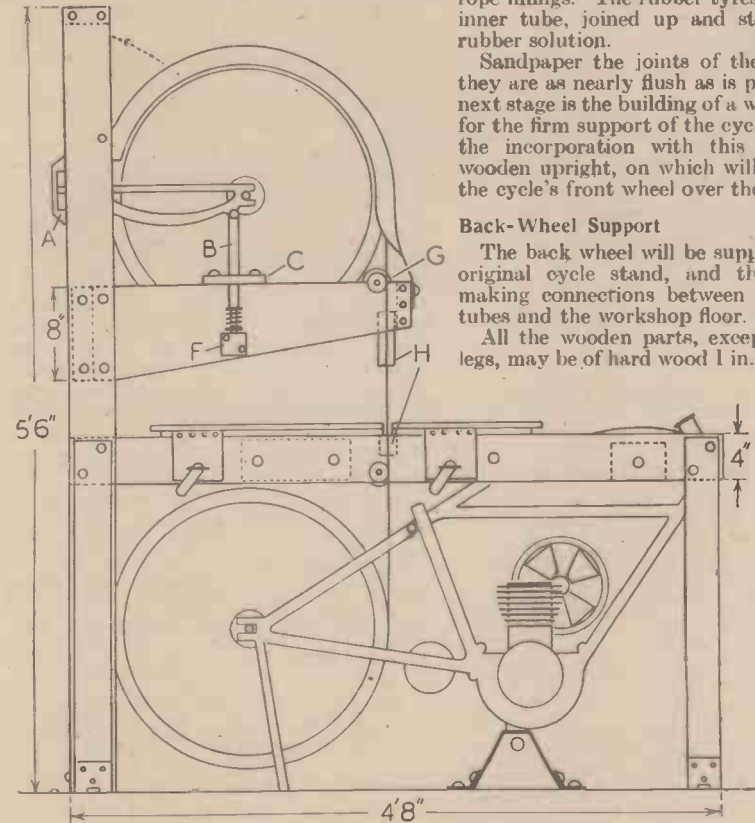

Fig. 1.—Showing the completed bandsaw

speed of these wheels is the same in both cases. While a cycle motor, throttled back, gives all the power required for sawing.

For these reasons a motor cycle that has had its day, but yet provides a workable motor and gearbox, can readily be converted into a bandsaw that is a practical tool and anything but a makeshift. Built as described below, it will saw wood up to a thickness of 5 in., with a cutting speed twenty to thirty times that of a handsaw.

As a first step, strip the frame of everything except the power unit, gearbox and stand. Then take the wheels in hand, as the tyres and tubes have to be replaced by solid, flat treads.

### Filling in the Rims

To fill in the rims some twenty-four feet of old, soft rope will be required for each wheel. It should be rather over 1 in. in circumference. Put one end of the rope through the valve hole, wind it tightly round and round and tuck the far end in under the turns.

To fill the rim dead flush from side to side, go round it with thick string, filling in the gaps between the turns of rope. Then apply varnish liberally, so binding the rope and string together. To complete the wheels for their new duty, they will require flat tyres

together with ½ in. coach bolts. The four trestle legs should be of 3 in. x 3 in. deal, each about 3 ft. long, and clamped to the floor.

For the horizontal member of the trestle cut two pieces of 4 in. x 1 in. hardwood sufficiently long to take between them the steering head at one end, while overlapping the far rim of the back wheel by some 4 in. at the other end. For an average cycle frame they will be about 5 ft. long. With distance pieces between them, these horizon-

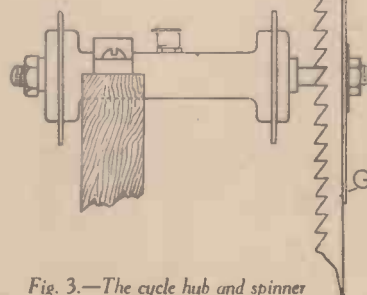

Fig. 3.—The cycle hub and spinner

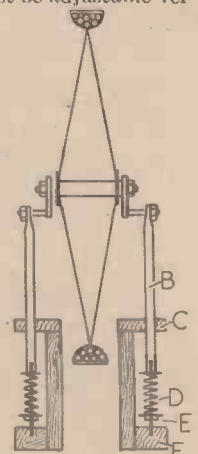

Fig. 2.—A cross-section of the upper wheel

(Continued on page 640)

WORKSHOP PRACTICE

# MAKING DRILLING JIGS

## A Tool useful when Interchangeable Parts are Required

**W**HEN a quantity of small parts have to be drilled for screw or stud holes, and accuracy of position of holes relative to each other is essential, the work is considerably accelerated and dead accuracy and interchangeability ensured if a drilling jig is made for the job.

Some pointers on how to set about the making of such jigs will be useful to readers. The example given will enable the reader to set out and make such jigs for other varied purposes the procedure remaining the same for practically all jobs where the work produced is made from strip metal. Where cast or machined parts having upstanding or other parts are to be drilled the jig will, of course, have to be made so that it can be located on the casting, and each example will no doubt require different treatment.

**An Example**

The piece to be drilled and the complete jig are shown in the drawings. Fig. 1, is the blank to be drilled. Fig. 2, is a top view of the drilling jig and Figs. 3 and 4 are sectional and end views respectively. Fig. 5, is a view of the base plate and separating strips;

proportions may be altered since a  $\frac{1}{8}$  hole (for example) would be better with a bush 3 or even  $3\frac{1}{2}$  times the diameter of the hole, otherwise it will be too thin in the wall to allow of its being driven in tight and yet not closing the hole. Also the smaller the diameter the less hold the bush gets on the plate. For holes over  $\frac{1}{4}$  in. the proportions first stated will be found the



Fig. 1.—The blank to be drilled

best. They will be right for any hole up to  $\frac{3}{8}$  in.

**Making the Jig**

In making the jig the two pieces of steel or iron plate are cut to a size which will leave plenty of length, beyond the end of the piece being drilled, to allow room and clearance for the four screws and two dowels—the former holding the top and bottom of the jig together and the latter acting as locating pins to hold top and

plate (upon which the blank rests) should be the thickness of the blank plus  $\frac{1}{64}$  in.

An essential to truth in jig drilling is that there should be as little exposed part of the drill between the end of the guide bush and the job as possible but there must be enough space to allow of the blank being easily and quickly pushed in between bushes and bottom plate. It is also important because the swarf from the drill should come up to the drill grooves through the bush and not accumulate on the top of the blank.

The distance apart of the two plates is determined by the end strips of steel which are of a width to take  $\frac{3}{8}$  in. screws (larger for larger jigs) and allow plenty of metal each side of the screw. They are carefully draw-filed so as to be of equal height and their upper and under sides dead parallel with each other. This is of great importance. The procedure in making the jig is as follows:

**The Procedure**

The two plates are surfaced dead flat and are placed together with these two flat surfaces in contact with the intervening end strips and clamped with all their edges coinciding. Then the four corner holes are drilled tapping size for the  $\frac{3}{8}$  Whitworth thread. The adjacent sides are marked so that the plates can be placed again in the same relative position. If placed round a half turn the holes may appear to coincide but may, in fact, be so located that while one or two screws screw in a good fit the others are too tight, and draw sideways.

While still clamped together open the holes through the top plate and the intervening end strips to full clearance size of the  $\frac{3}{8}$  in. screws and countersink the holes in the top plate so that the screw heads will sink just below flush with the top surface. Then tap the holes in the bottom plate with a sharp  $\frac{3}{8}$  in. Whitworth tap and clear both ends of the tapped holes

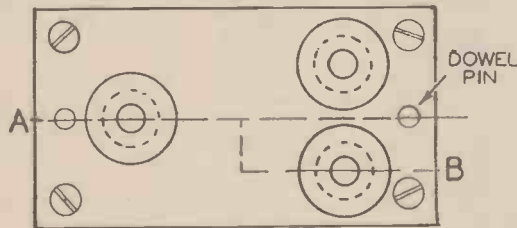

Figs. 2 and 3.—(Left) A top view of the drilling jig. (Right) A sectional view of the jig

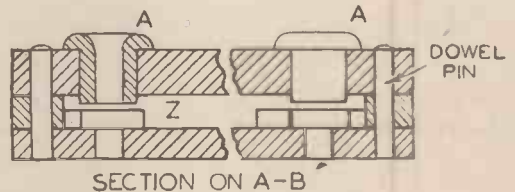

having been removed, and Figs. 6 and 7 are external and sectional views of the hardened bushes much enlarged.

The two plates are made of iron or steel bar. The thickness will depend on the job but the top plate should be of good depth since it has to locate accurately the hardened bushes which guide the drill. Generally, a good rule is to make the top plate of a thickness equal to the diameter of the bush and the bush equal to twice the diameter of the hole to be drilled. This gives a good proportion which can be followed for any jig.

In the case of very small holes these

bottom of the jig in dead and unalterable relation to each other.

The necessity for this is appreciated when it is understood that while the top plate ensures the holes being in correct relation to each other, the bottom plate ensures the piece or blank to be drilled being in such position that the set of holes falls into correct positions upon it.

The space, Z (Fig. 3), between the upper and lower plate will depend on the thickness of the blank to be drilled. It will be seen that the bushes, A, project slightly below the under surface of the top plate and the distance from their ends to the bottom

slightly with a countersink drill so as to prevent any burr on the ends of the holes, caused by the tapping interfering with the close contact of the plates and end strip. Mark at one end punch marks (not in the middle of the end). Single punch marks one end and twin punch marks at the other, so that they can all be re-assembled in correct location with each other. Next carefully drill and reamer, dead square with the surface, the two dowel holes at the centre of each end. These holes go through the top and bottom plates and the separating strips between them at the ends.

**Locating Dowels**

Two silver steel dowels are fitted tightly

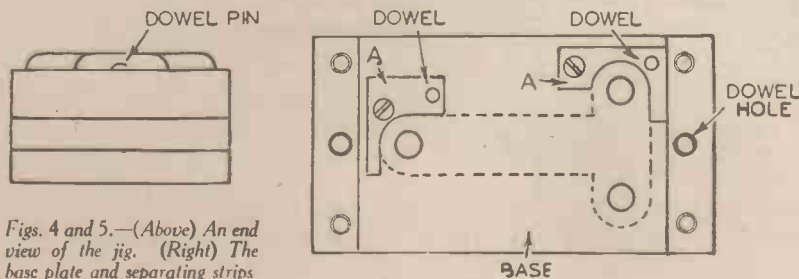

Figs. 4 and 5.—(Above) An end view of the jig. (Right) The base plate and separating strips

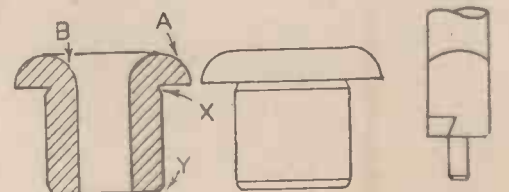

Figs. 6 and 7.—External and sectional views of the hardened bushes

Fig. 8.—Details of a pin cutter

in these holes and when the plates are separated, the dowel pins should be eased from the top plate by pulling emery strip around them till they are a good push fit, so that the dowel pins will stand hard fast in the bottom plate and the end strips but will be a hand push fit in the top plate.

We now take the top plate and, with its underside uppermost, we scribe on it the shape of the blank and mark very accurately with a fine pointed hard scriber the positions of the holes we are arranging the jig to drill. This marking must be very accurate since on it depends the accuracy of the finished job to be done in the jig.

With the plate dead down on a sensitive drill table and with a  $\frac{1}{8}$  in. straight fluted drill, accurately ground and projecting from the drill chuck not more than the thickness of the plate plus  $\frac{1}{8}$  in., we drill the holes required—three of them in this example.

These holes are then opened out with larger drills till we get to the size of the outside of the bush. This operation is best performed by using first a  $\frac{1}{8}$  in. straight flute drill in the  $\frac{1}{8}$  in. hole and then opening out further with the pin cutter shown in Fig. 8, the pilot of this pin cutter being  $\frac{1}{8}$  in. in diameter, bare, so as to fit the holes drilled. The diameter of the cutter will be the diameter of the shank of the drill guiding bushes we are going to fit in the holes and if the pin cutter is properly made and with a pilot just fitting the hole, the holes will all be of dead equal diameter.

#### The Bushes:

We now turn the three bushes of cast steel bar. The section is shown in Fig. 6,

and an outside view in Fig. 7. The cast steel bar is chucked in the lathe and the central hole drilled very carefully with a sharp drill, ground equally each side so as to ensure the hole not being larger than the standard. Some tool makers use special drills slightly under standard—self-made flat drills—and then lap the hole out afterwards—the last operation of all.

Without unchucking the stock round off the front entry as at A B in Fig. 6 and then cut down at the shoulder at X and turn along parallel to the exact size of the hole in the plate. The corner at X is very slightly undercut, as shown, to ensure the bush bedding close down on the plate and not at the corner. The hole in the plate can be very slightly countersunk—very slightly indeed—to effect the same purpose.

Alternatively the entering end of the bush at Y, Fig. 6, is turned very slightly taper, as shown, to allow of easy entry of the bush into the hole without a chance of setting up a burr on the edge of the hole. The bush is then dead hardened by heating red and quenching in water. This will very slightly increase the diameter of the bush and the bush can then be inserted in the plate by entering the slightly tapered end, keeping the bush square with the plate and then pressing it down into position by holding the plate dead flat against one jaw of the vice and, with a brass strip between the head of the bush and the other vice jaw, closing the vice and thus forcing the bush into the hole.

A parallel vice will, of course, be used for this job. Everything must be kept dead square so that the bush and hole are in perfect axial alignment.

#### The Locating Guides

The location of the blank is effected by corner pieces as shown in Fig. 5. These are fitted to a scribed outline of the blank. To get the outline the centres of the four holes are marked by a punch ground parallel and fitting in the bushes in the top plate and with its point ground concentric with its shank in the lathe. Then the outline is set out with dividers from these punch marks and guide pieces of thin steel are cut to shape and laid round an exact pattern of the blank which is located by the holes. The surface of the bottom plate is tinned and the bottom of the guide pieces A A in Fig. 5. These are heated and laid on in contact with the guide blank. The screw hole in each is then drilled tapping size through the guide and into the bottom plate and opened out full screw diameter for the depth of the guide piece and tapped for the screw in the bottom plate. The top is then countersunk to take the screw head and the screw fitted. Then a  $\frac{1}{8}$  in. locating dowel hole is drilled in each.

They can then be unsweated and cleaned and afterwards replaced. This is to ensure that the solder does not stay in the corners and so prevent the blank being pushed up dead in contact with the guides. Finally a drill of the size for each bush is put through the bushes and a hole drilled right through the bottom plate for each hole the jig is designed to drill.

The procedure outlined will be followed, of course, for any shape of blank and any number and position of holes appropriate locating pieces being arranged for each shape.

## REFUELLING A LINER IN MID-AIR

By Refuelling a Plane by this Method it is possible for the Aircraft to carry a Far Greater Load than otherwise.

**S**UCCESSFUL experiments were recently carried out at Southampton to refuel an air-liner in mid-air. The method used in carrying out this difficult feat will be used this year in the new British air-mail service westwards across the North Atlantic. The air-liner in question was the Cabot which recently inaugurated the Atlantic service. The machine used for the refuelling was a camouflaged Harrow bomber, and having taken up their positions as shown in the photograph the two planes flew at a steady 120 m.p.h. 500 ft. from the ground, with the bomber 100 ft. above and slightly to the right of the Cabot.

#### The Connecting Link

From the stern of the liner was trailed a gannet on a line and an ejector system from the tanker flung a projectile, attached to a cable, into the arc of the trailing line. Automatic connection then ensued by means of an ingenious contrivance. The first attempt to link up the two planes failed as they were both executing a turn, but the second attempt proved successful. A hose then descended from the tanker plane until its lower end was secured in the flying-boat, where its attachment for tanking purposes was a simple operation. 200 gallons of petrol was then transferred, but ordinarily the amount would be some 850 gallons, weighing 6,000 lbs., and it could be transferred in less than 10 minutes. The hose was then wound back and the two machines separated.

#### Jettisoning Petrol

A further demonstration was then given of jettisoning petrol in flight. The reason for this was that after the plane had received its overload of petrol and it had to make a

forced landing (a most unlikely occurrence) it could get rid of the petrol before it reached the ground and thus safeguard against fire. The demonstration was successful and 100 gallons of petrol were jettisoned within a few minutes.

It is claimed that by refuelling a liner in mid-air it will be possible for the aircraft to carry a far greater load than would otherwise be possible.

Refuelling by this method is not new, however, as it was used extensively in the United States many years ago and was also demonstrated at the R.A.F. display ten years ago.



The tanker plane flying in position above the air-liner

# WING BUILDING METHODS

The Methods of Wing Construction Dealt With in this Article are those Adopted by Well-known Aero Modellers

**T**HE modern tendency of using scale-wing sections has radically changed the older system of wing construction. Most of the early models were single-surface wings using flat ribs constructed of scantlings steamed to some sort of camber. They functioned very well, but obviously as the under camber was practically equal to the top they were not so efficient as a correct form double-surface wing. Practically all models now use double-surface wings.

Before dealing with methods of construction it is essential to refer to the question of design. Last month I gave details of the various wing sections, and it is important to remember that factors making for efficiency are frequently at variance with factors making for strength.

To take a case in point, a wing tapered in planform is generally admitted to be superior aerodynamically and structurally to one of constant chord. But it is more difficult to construct, and the potential advantage will not be realised unless a fairly high degree of accuracy is achieved.

## A Popular Wing Section

Similarly, RAF32 is a wing-section which enjoys a wide and doubtless well-deserved popularity. But it is not an easy section to reproduce in model sizes, neither is it magical in its effects. In other words, the mere fact that this section is selected for a model will not ensure victory in competition. A very great deal turns on the quality of the construction, and the final adjustment of the model. In fact, one is inclined to attribute the success of many models to these two qualities rather than to the section employed.

It cannot be denied that there is too much talk of efficiency in model wing sections and the fact is often lost sight of that at low model speeds the problem of wing section design is vastly different to full-size practice. The popular Clark Y section, for example, was designed for conditions which do not obtain with a model.

There are many who feel that a deep wing section is necessarily more efficient than a shallow one, whereas a deep wing section is

merely used in full-size practice to accommodate a deep wing spar, thus efficiency is actually sacrificed in order to gain strength.

The methods of wing construction dealt with in this article are those adopted by well-known aero modellers, such as Mr. E. R. Knight who has provided me with details of the methods which he uses. Many of these methods coincide with my own, although the system I used in connection with my competition models and particularly with the Hawker Hurricane competition model vary somewhat.

## A Question of Experiment

It is certainly fitting that modellers should familiarise themselves with various sections, and experiment therewith. But in so doing, their limitations should be borne in mind. In the first place there is the question of "scale effect." The behaviour of a section of the 200-300 miles-an-hour of modern full-scale aircraft is no criterion of what it will do at the 10-15 miles-an-hour of the average model, and most of the

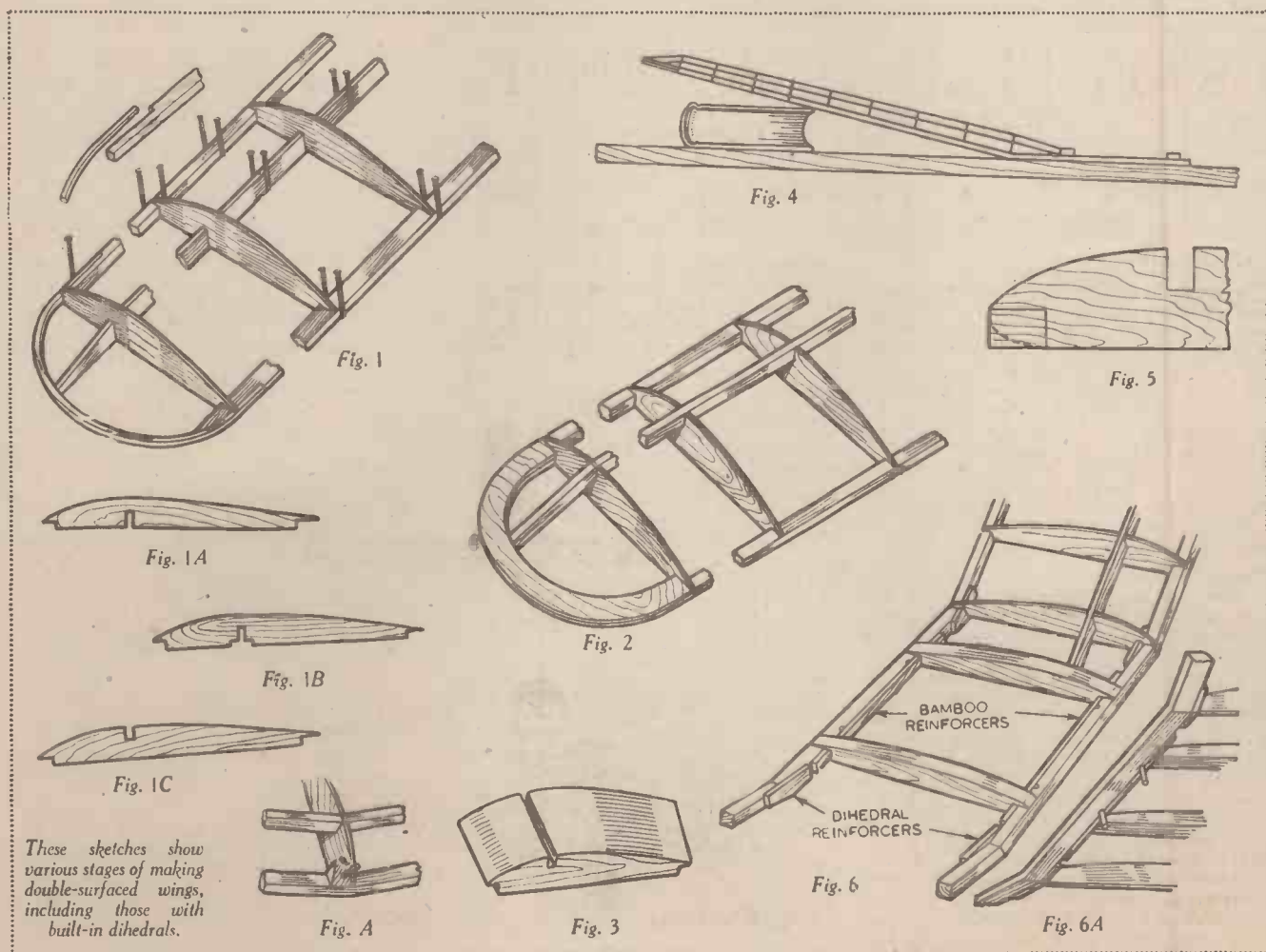

These sketches show various stages of making double-surfaced wings, including those with built-in dihedrals.

data on sections refer to the higher speeds.

Further, however carefully built, the average model conforms to the chosen section only where the ribs come. The inevitable sagging of the covering material between the ribs alters the section completely, whilst weight considerations are against the covering of the entire wing with balsa sheet.

These points have been raised by other writers, but one recalls them to emphasise that there is a very great deal to be said in favour of wings which, while less pretentious aerodynamically are simple to build, cover, and check for the warps which are apt to develop, despite the scarcity of really warm days.

Clark Y is a simple section, and undoubtedly owes a large measure of its popularity to that fact; but it suffers from the disadvantage, slight though it may appear to some, that the leading-edge is not in line with the trailing-edge. The type of wing here to be described approximates very closely to Clark Y, while avoiding this inconvenient factor.

#### For Newcomers

For the benefit of newcomers, it should be explained that the usual method of building a wing is to fasten a full-size plan view to a building-board, preferably a length of pine somewhat larger than the wing, not less than  $\frac{3}{4}$  in. thick, and entirely free from warps. The lengths of wood forming the spars, and the shaped ribs, are fastened in position on the drawing while the balsa cement with which they are joined is drying.

The advantage of the wing-construction to be described is that all spars can be placed flat on the board, likewise the ribs, without the use of any packing-pieces which can so easily vary in size and cause inaccuracies.

When the structure is lifted from the board for the purpose of covering, its accuracy can be checked by sighting the leading-edge from the trailing edge, and noting whether they are parallel or not. While the doped covering is drying, the wing can again be held down flat on the board, and by similar methods any warps which develop can be detected and rectified. In short, the flat lower surface forms a datum which is invaluable at all stages of the wing's career. Thus the prospect of a perfect piece of construction is greatly increased, which will be reflected in its flying performance.

Before someone interjects, "Very nice for playing about, I dare say," let me hasten to add that such a wing is favoured by several of our most successful modellers and has proved sound enough to win for them a place in Great Britain's Wakefield Cup team.

#### A 30-in. Wing Span

To get down to brass tacks, let us take a wing of, say, 30 inches span, intended for a high-wing model. Leading and trailing edges can be of medium-hard balsa,  $\frac{1}{8}$  in. x  $\frac{3}{8}$  in., and these members are first fastened to the plan by pins placed at intervals along each edge. If the wing is tapered, the spars have V-shaped cuts made, are bent as required, and the cuts well cemented. At least one other spar is advisable, and this should be located at a point one-third of the distance across the wing, measured from the leading-edge (see Fig. 1).

It should also be of  $\frac{1}{8}$  in. x  $\frac{3}{8}$  in. balsa, and inexperienced constructors will find it a good plan to place it at the top of the ribs as in Fig. 2. This is not the ideal position from the point of view of structural strength, but will simplify the application of the covering material to the upper surface of the wing.

The ribs (Figs. 1a, 1b and 1c) are cut from  $\frac{3}{8}$  in. balsa sheet, and slots corresponding to the sizes and positions of the three spars must be cut very carefully indeed. The maximum depth of each rib should be about  $\frac{1}{2}$  of the width or chord, and should occur in the region of the middle spar (one-third from the leading-edge). If the wing is of constant chord and camber, one rib should be cut from 1 mm. hard plywood, and used as a template for cutting all the others.

#### A Tapered Wing

A tapered wing is more difficult, but where the ribs are equal distances apart the following will prove helpful. Cut from plywood a template for the smallest and largest ribs. Between them place pieces of balsa sheet, one for each rib, and hold them lightly in a vice. Wrap a piece of glasspaper around a small block of wood, and rub the ribs down to size as though they were a single block of balsa. Cut the slots before separating. (Fig. 3.)

The ribs are now cemented to the leading and trailing edges, but the middle spar is not added until later. There are two ways of forming the wing-tips. Either they are shaped from two thicknesses of  $\frac{1}{8}$ -in. balsa sheet, cemented together with the grain crossing at right angles, and then cemented to the spar ends (Fig. 2), or a piece of  $\frac{1}{8}$  in. x  $\frac{1}{8}$  in. birch can be steamed to shape, cemented to recesses cut in the ends of the leading and trailing spars, and secured with pins until dry. On lifting from the board, the joins can be lashed with silk for greater security. (Fig. 1.)

#### Dihedral Angle

The wing is given its dihedral angle by making V-cuts in leading and trailing spars, holding the flat centre section down with drawing pins, and propping the wing-tips to the required height with books. (Fig. 4). Fill the cuts with cement, and reinforce them with small, shaped pieces of 1-mm. plywood.

Now "dihedral" the middle spar in the same manner, and cement it into place. Note the  $\frac{1}{8}$ -in. diameter bamboo pegs cemented into small balsa blocks, to which are anchored the rubber-bands which couple the wing to the fuselage. (Fig. 2a.)

On lifting from the building-board smooth the sharp edges of the leading and trailing spars with glasspaper and round off the under-side of the leading-edge, as shown, so that the section approximates to Clark Y. (Fig. 5.)

A better wing results from using as a middle spar a length of  $\frac{1}{4}$  in. x  $\frac{1}{8}$  in. balsa, placed on edge, and resting on the building-board with the ribs crossing it. (Figs. 1 and 1a). Even stronger is an inverted T-spar, which can be purchased ready-made, or formed by cementing a length of  $\frac{1}{8}$  in. x  $\frac{1}{8}$  in. balsa on top of a length of  $\frac{1}{4}$  in. x  $\frac{1}{8}$  in. (Fig. 1b). In applying the dihedral, either type must be cut and reinforced with plywood, similarly to the leading and trailing edges.

#### Larger Wings

For larger wings,  $\frac{1}{4}$  in. x  $\frac{1}{8}$  in. can be used for leading and trailing edges,  $\frac{1}{8}$  in. sheet for the ribs,  $\frac{3}{8}$  x  $\frac{3}{8}$  birch for the tips, and  $\frac{3}{8}$  x  $\frac{1}{8}$  for the middle spar. It is advisable to bring the height of the middle spar to within  $\frac{1}{8}$  in. of the top of the ribs, by cutting pieces of  $\frac{1}{8}$  in. sheet to fit between each pair of ribs, and cementing them on top of the middle spar.

With a low-wing model, some modification of the wing-system is, of course, necessary. (See Fig. 6.) The leading and trailing edges are first reinforced with a strip of bamboo, cut to the same depth, and just under  $\frac{1}{8}$  in. thick, which should extend about  $\frac{1}{2}$  in. beyond the fuselage on each side. The dihedral is applied  $\frac{1}{2}$  in. farther on towards the wing-tips, and these points reinforced in the usual way.

#### The Centre Ribs

It is also a good plan to replace the two centre ribs by pieces of  $\frac{1}{4}$  in. x  $\frac{1}{4}$  in. balsa, roughly sanded to a camber, so that when the wing is knocked sideways it tends to pass harmlessly beneath the fuselage instead of fracturing. If the middle spar is located at the top of the ribs it must be cut away between the two centre ribs, to enable the wing to rest firmly beneath the fuselage.

When the middle spar is at the bottom of the ribs, its depth must be reduced between the centre ribs to the depth of the leading and trailing spars. The bamboo attachment pegs can be cemented into holes in the leading and trailing spars, close to the bamboo reinforcement, and beneath the lower longerons. (Fig. 6a.)

The larger types of wing can be improved by sanding the trailing spar to a knife-edge at the rear, before fastening to the building-board. One can occasionally purchase  $\frac{1}{4}$ -in. wide lengths of shaped trailing-edge.

## A GRASS EDGE TRIMMER

THE "Kwickut" grass edge trimmer shown on this page has been designed

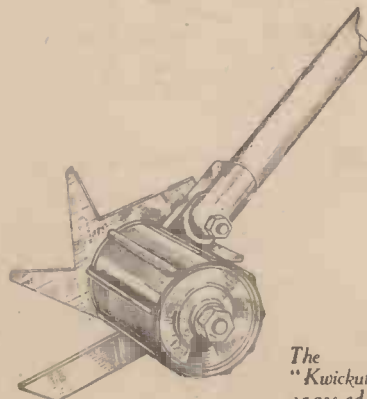

The "Kwickut" grass edge trimmer

to do quickly and neatly what has hitherto been a backaching job with shears. It does in 5 minutes what shears do in 25 minutes! Moreover, owing to the fixed cutting blade being thin and next to the grass, it cuts the overhanging grass between the edge and stone paving. It will trim a grass edge that is level with the flower bed or an edge raised above the bed, no matter what the height.

The construction is such that wear has no effect whatever on the working of the machine and there is nothing to go wrong. An occasional drop of oil on the spindle is all the attention required.

The handle, 4 ft. long, of varnished and polished wood, is fixed in an entirely novel way, cannot split or come loose and is instantly detachable.

The trimmer is finished in an attractive shade of green with a special paint three times as durable as cellulose, and the spindle and nuts are heavily cadmium plated. Its weight is only 2 lb. and it costs 12s. 6d.

# Prepare for Success

One of the following Courses taken at home in your spare time can definitely be the means of securing substantial promotion in your present calling, or entry into a new and more congenial career with far better prospects.

We have helped thousands of others to success. Why not let us do the same for you—you should at least investigate the opportunities we can place within your reach—it will cost you nothing to enquire.

## ENGINEERING

- Inst. of Electrical Engineers, A.M.I.E.E.
- Inst. of Wireless Technology, A.M.I.W.T.
- Inst. of Civil Engineers, A.M.I.C.E.
- Inst. of Structural Engineers, A.M.I.Struct.E.
- Inst. of Builders, L.I.O.B.
- Inst. of Sanitary Engineers, A.M.I.S.E.
- Royal Sanitary Institute, M.R.S.I.
- Inst. of Mechanical Engineers, A.M.I.Mech.E.
- Inst. of Automobile Engineers, A.M.I.A.E.
- Royal Aeronautical Society, A.F.R.Ae.S.
- London B.Sc. Degrees
- Wireless — Telegraphy — Telephony
- Electrical Engineering
- Television—Electric Wiring

- Talking Picture Work
- Works Management
- Building Construction
- Sanitary Engineering
- Sheet Metal Work—Refrigeration
- Motor Engineering
- Engineering Draughtsmanship
- Electrical Draughtsmanship
- Aeronautical Draughtsmanship
- Jig and Tool Draughtsmanship
- Die and Press Tool Draughtsmanship
- Structural Draughtsmanship
- Building Draughtsmanship
- Clerk of Works
- Building Inspection

## MUNICIPAL SERVICE

- School Attendance Officer
- Handicraft Teacher
- Registrar—Relieving Officer
- Sanitary Inspector

- Weights and Measures Inspector
- M. & Cy. Engineers

## GENERAL

- Matriculation—Bookkeeping
- College of Preceptors
- Chartered Institute of Secretaries
- Massage—Institute of Hygiene

## CIVIL SERVICE

- Clerical (age 16-17)
- Executive (age 18-19)
- Tax Inspector (age 21-24)
- Patent Office (age 20-25)
- G.P.O. Engineering (age 18-23)
- Typist (age 16½-25)
- Customs (age 19-21)
- Board of Trade (age 20-25)
- Police College (age 20-26)
- Police Force (under 27)

If you do not see your requirements above, just explain what they are. We are able to advise on all branches of Engineering, Civil Service, Municipal Work, etc.

### Become a Draughtsman—

AND EARN BIG MONEY



Numerous vacancies are now available in Electrical, Mechanical, Structural, Aeronautical and other Branches of Engineering, Building, Civil Service and G.P.O., etc., for men age 17-40. Practical experience is unnecessary for those who are willing to learn—our Guaranteed "Home Study" courses will get you in. Those already engaged in the General Drawing Office should study some specialised Branch such as Jig and Tool or Die and Press Tool Work and so considerably increase their scope and earning capacity.

### THE ACID TEST OF TUTORIAL EFFICIENCY:

SUCCESS — OR NO FEE

We definitely guarantee that if you fail to pass the examination for which you are preparing under our guidance, or if you are not satisfied in every way with our tutorial service—then your Tuition Fee will be returned in full and without question. This is surely the acid test of tutorial efficiency.

If you have ambition you must investigate the service we are able to offer. Founded in 1885, our success record is unapproachable.

Why not fill in and post the attached coupon for further details and free authoritative guide to openings in Engineering, Civil Service or Municipal Work? These books contain a mine of valuable and exclusive information and may well prove to be the turning point in your career.

## NATIONAL INSTITUTE OF ENGINEERING

(Dept. 29)

STAPLE INN BUILDINGS  
LONDON, W.C.1

FIFTY-FOUR YEARS OF  
CONTINUOUS SUCCESS

SOUTH AFRICA BRANCH: E.C.S.A., P.O., BOX 8417, JOHANNESBURG.

### COUPON

To NATIONAL INSTITUTE OF ENGINEERING  
(Dept. 29), Staple Inn Buildings, London, W.C.1.

Please forward your FREE Guide to:—

NAME.....

ADDRESS.....

My general interest is in: **ENGINEERING** (Place a cross against the branch in which you are interested).  
**MUNICIPAL WORK**  
**CIVIL SERVICE**

The subject or examination in which I am especially interested is.....

(To be filled in where you already have a special preference).

Founded 1885 - - - Over 85,000 Successes.

(A stamp only required if unsealed).

SOUTH AFRICA BRANCH E.C.S.A., P.O. BOX 8417, JOHANNESBURG

# —No. 2 Out To-day— AERONAUTICS

The Authoritative Monthly  
Journal of Aviation



Covers the entire field of

SERVICE, TRANSPORT, SPORTING, NATIONAL and INTERNATIONAL TECHNICAL and COMMERCIAL FLYING, THE ROYAL AIR FORCE, THE AIRCRAFT INDUSTRY, THE CIVIL AIR GUARD.

Gives authoritative, indisputable, technical information, facts and figures of new aircraft, with critical reports on performance, latest air-fighting tactics and developments month by month. AERONAUTICS is as Progressive as Flying itself!

Special Contents for September include:

**AERONAUTICAL SCIENCE AND YACHT DESIGN**

By C. R. Fairey

**AIR STRATEGY AND POWER POLITICS**

By Norman Macmillan

**FRENCH AIRCRAFT PRODUCTION**

By R. J. de Marolles

**PROGRESS IN AIRPORT LIGHTING**

By W. Villiers

**NAVIGATION**

By Captain D. C. T. Bennett

**AMERICAN AIRLINES**

By Hubert Broad

**ALUMINIUM IN AIRCRAFT**

By F. R. C. Smith

**BRUSSELS SHOW REVIEW**

Etc. Etc.

SEPT. 1/4 Profusely Illustrated with Photographs & Diagrams  
Of all Newsagents and Bookstalls

## SKYBIRDS

FLYING MODELS

EASY TO BUILD—SATISFACTORY TO FLY  
TWO MOST SUCCESSFUL MODELS  
THE "SPEEDY" AND "STURDY"



High-Wing No. 1 "STURDY"	PRICE EACH <b>6/6</b>	Low-Wing No. 2 "SPEEDY"
30 in.	Span	32 in.
21½ in.	Length	22 in.
2 oz.	Weight	2 oz.
14 ft.	Power (rubber)	15 ft.

**FREE GIFT**

OF A 2/- GLIDER

To all purchasers of "SPEEDY" or "STURDY" up to and including September 20. Send Agent's receipt with application.

**FIRST AND BEST SOLID NON-FLYING**  
1/72nd scale Model Aircraft Construction with every accessory to make the complete Hobby.

SKYBIRDS LATEST MODEL



The Airspeed "OXFORD" price 6/-  
Special Shadow Shading. Paint Outfit, price 1/6

**OUR NEW MILITIA**

The "TWENTY'S" of 1939  
Solid cast scale models in latest battle uniforms. 20 in set, price 2/6



★ The new Skybird Album contains the history of the Skybird League, the Monthly News Bulletin and Price List, all fully illustrated, post free 1/3. Send 1½d. postage for new illustrated price list.

"SKYBIRDS" (Desk P.M.)

3, ALDERMANBURY AVENUE, LONDON, E.C.2

**ENGINEERS' Guide To Success Free!**

For a well-paid post study at home with The T.I.G.B. Write NOW for this great Guide containing world's widest choice of engineering courses—covering all branches—and which alone gives the Regulations for Qualifications such as A.M.Inst.C.E., A.M.I. Mech. E., A.M.I.E.E., C. & G., etc. Training until successful guaranteed.

The Technological Institute of Great Britain  
123, Temple Bar House, London, E.C.4.

(Founded 1917.  
20,000 Successes.)



200 Courses



# VISIBLE AND INVISIBLE INKS

Practical Information concerning a little-known Technology which will interest every Reader

It is not infrequently of great importance to be able to tell the precise variety of ink with which a given specimen of handwriting was written, since, by knowing the type of ink used, one is able to form a pretty shrewd idea as to the age of the writing.

One might be excused for imagining that such a task was one for the practised expert only, but, in actual truth, the task of determining the nature of the ink used in a specimen of handwriting is not a very difficult one, and since there are large

extract. At a later date, copper sulphate was used in their manufacture in place of bichromate of potash. They have an intense blue-black appearance.

*Alizarine Inks.*—One of the first of the "dye" inks. They were made by dissolving indigo in sulphuric acid, and afterwards neutralising the acid.



By holding up a sheet of paper to eye level and glancing along it, the presence of invisible ink writing may nearly always be detected



A specimen of 17th century writing executed in the old-fashioned "iron-gall" ink. It is easily possible to revive faded writing of this nature by adopting the tannin treatment detailed in this article

numbers of amateurs to whom the art of ink analysis will make an especial appeal, it is proposed to set out in this article a straightforward scheme whereby such analysis may be accomplished.

## Different Types

Before proceeding with this scheme, however, it will be necessary for us to have some idea of the different types of inks which have been in use during the past centuries. Briefly, these may be classified into the following groups:—

*Iron Inks.* (Sometimes called "gall inks"): These are the oldest of writing inks and were prepared by adding an iron salt to an extract of galls. They readily acquire a brown or "rust" colour with age.

*Logwood Inks.*—These were manufactured by adding a small amount of bichromate of potash to a logwood

*Aniline Inks.*—A modern type of ink, made from aniline dyes. Copying inks are usually of this type, also.

*Indian Inks.*—These, which have an intense black appearance, are made from finely powdered carbon.

*Printing Inks.*—A large class of inks containing a pigment or colouring matter intimately mixed with a "vehicle" which is usually a mixture of oil, resin and soap.

Now, in order to identify the type of ink with which a given specimen of handwriting has been executed, we need to provide ourselves with four test solutions, viz.:

(1) A solution containing 3 per cent. of oxalic acid.

(2) A solution containing 8 per cent. of photographers' "hypo" and 8 per cent. of ammonia.

(3) A 4 per cent. solution of caustic soda.

(4) A 20 per cent. solution of nitric acid.

It is only necessary to make these solutions up in small quantities, since only a drop or two of each will be required for each analysis.

## Test Solution

In using them, the test solution is taken up on a quill pen or on a sharply-pointed matchstick and the point of the quill or sharpened matchstick is then drawn across one of the ink-written characters. The portion of the character which has been thus brought into contact with the test solution will undergo a colour-change as detailed in the table appearing on page 624, and by noting the particular kind of colour-change, the nature of the ink can be correctly ascertained.

Although one only of the above solutions can be employed for the purpose of analysis, it is best to use at least two or three of the solutions, if only by way of making confirmatory tests.

Incidentally, a separate quill or point must be used for each test solution, and on no account must steel nibs be employed.

Indian inks and printer's inks are not included in the above scheme of analysis, for these are unchangeable, and cannot be removed without severely damaging the paper.

With a little practice, much skill and facility in determining the nature of writing inks will be obtained, and with this it will be more easily possible to estimate the age of a particular piece of ink-writing, remembering that iron inks are the earliest of all, and that after them came the logwood inks, the alizarine inks, and finally the cheap modern aniline inks.

Sometimes it is required entirely to obliterate ink-writing from the surface of the paper, for which purpose an ink-

removing solution is used. There are many of these preparations known, the best of which are tabulated below:—

(a) Chlorine water, or a solution of sodium hypochlorite rendered slightly acid.

(b) A solution of oxalic acid or of ammonium oxalate. Preferably applied hot. This solution is poisonous.

(c) A solution of saltpetre in its own weight of dilute sulphuric acid.

(d) Powdered sulphur and soda mixed in a white small silk bag which is then very gently rubbed over the writing.

One or other of these preparations will succeed in removing any type of ink except Indian or printer's ink. A still more potent ink-eradicator, however, is a solution of potassium permanganate made slightly acid with sulphuric acid. This stains the paper a deep brown, but this coloration is readily removable by immersing the paper afterwards in a solution of sodium sulphite made slightly acid with a few drops of sulphuric acid, or in a solution of sodium metabisulphite.

#### "Obliterating Ink"

A more difficult task which sometimes presents itself is that of removing "obliterating ink," that is to say of removing an ink which has been used, by way of censorship or for some other purpose, to obliterate some underlying writing.

The best way to go about this task is to determine the nature of the obliterating ink by means of the ink tests described above. Then, very cautiously, apply to a portion of the obliterated area a little of one of the above-enumerated ink-eradicators. Although such an ink-eradicator will usually remove the obliterated as well as the obliterating ink, its action will be selective and it will attack the latter ink first, so that, with careful working, sufficient contrast between the two inks will be obtained for the underlying ink to be read clearly.

If, of course, the obliterated characters are in Indian or printer's ink, the obliterating ink can be removed with ease. If, however, the obliterated characters are in ordinary writing ink and the obliterating ink is in Indian or printer's ink, well, one is just too unfortunate, for little can be done in such an instance, since printer's and Indian inks are permanent and ineradicable.

It is not difficult to decipher pencil marks which have been obliterated by any ink other than that of the Indian or printer's variety, for lead pencil consists, for the most part, of graphite, itself an extremely unchangeable material. Care must be taken, however, not to rub pencil marks when they are damp, otherwise bad smudging may occur.

#### Tannic Acid

Sometimes, a handwriting expert finds it necessary to determine whether any portion of the writing of a document has been removed by chemical means. This, fortunately, is easy, for, by brushing over the suspected area of the document a dilute solution of tannic acid, the obliterated ink will often come forth with startling clarity, owing to the combination of the tannin with the invisible residue of the ink which has been left in the fibres of the paper.

Here, therefore, is an excellent means of restoring old and yellow-faded handwriting which may be of sentimental or other value. Merely brush a weak (say, a 2 to 5 per cent.) solution of tannic acid over it, employing a mop of cotton wool or a camel's-hair brush, and the yellow writing will be blackened instantly.

Obliterated inks can often, also, be

brought up by brushing ammonium sulphide over the paper or by exposing the paper to the fumes of ammonia or to hydrogen sulphide gas. Sometimes, too, such obliterated inks may be brought back (in blue or in green, this time) by sponging over the paper a weak solution of potassium ferrocyanide or potassium ferricyanide.

Detection of erasures in pencil is not difficult. All one has to do here is to expose the suspected area of paper to the fumes of iodine, and the erased writing will show up in a darker stain than the rest of the iodine-treated paper.

Coming, now, to the subject of invisible



Treating a hand-written document with ammonium sulphide fumes in order to develop-up any latent secret writing. This test is easily carried out by placing a small quantity of ammonium sulphide at the bottom of a large jamjar, and by inverting another over it, the document being placed in the jars

or "sympathetic" inks, these have been studied for years by many types of individuals, scrupulous and unscrupulous, and it is nowadays a pretty-well recognised fact that there is no invisible ink which can escape detection, once its presence is suspected.

Invisible inks may be divided into two main classes, viz.:—those derived from natural substances, such as wine, saliva, gum, milk, vegetable and fruit juices, and those made from certain chemicals.

The "natural" invisible inks are, for the most part, developed up to visibility merely

by heating the paper almost to charring point. Sometimes when a gum solution has been used as an invisible ink, this is developed by gently breathing on the paper and then by dusting over it cigarette ash or very fine graphite powder.

#### Sympathetic Inks

Chemical invisible or sympathetic inks form a very large class. The best of these are enumerated below:—

(1) Five per cent. solution of cobalt chloride. Developed by heating.

(2) Solution of lead acetate. Developed with ammonium sulphide solution or hydrogen sulphide gas.

(3) Dilute solution of nitric acid. This is made readable by wetting the paper.

(4) Copper chloride solution. Developed by heat.

(5) Copper sulphate solution. Developed by ammonium sulphide.

(6) Rice or starch water. Developed by treatment with weak iodine solution, the hidden characters turning blue.

(7) A solution of ammonium or potassium sulphocyanide. Letters develop up red when brushed over with weak iron chloride solution.

(8) Oxal-molybdc acid. This is made by adding to a boiling solution of molybdc acid an equal quantity of a boiling solution of oxalic acid, and, after cooling, collecting the crystals which form. These, dissolved in water, form the invisible ink. Characters written in this ink become blue when exposed to sunlight or to the light of an electric arc.

Some invisible inks can be developed, bleached and re-developed at will. Of these, is the well-known cobalt chloride ink, whose heat-developed characters disappear on cooling. The lead acetate ink, which is developed in brown characters by the action of ammonium sulphide or hydrogen sulphide gas, can be bleached by wiping it over with strong hydrogen peroxide, after which it can again be re-developed by the sulphide treatment.

#### Re-developable Inks

Another of these re-developable invisible inks consists of water containing 7 per cent. of ammonia and 1 per cent. of raw linseed oil. The paper is slightly moistened before writing with this ink. When the paper is dry, the ink is completely invisible, but every time it is damped, the writing becomes legible.

No invisible ink can be said to be infallibly invisible. Such inks, if they are to escape detection, are best written on rough papers since they tend to show more if the paper be glossy.

Invisible inks can seldom be detected by looking through the paper, but if the latter

(Continued on page 647)

Test Solution	Iron Inks	Alizarine Inks	Logwood & Bichromate Inks	Logwood & Copper Inks	Aniline Inks
Solution No. 1	Disappears	Indigo Blue	Violet	Orange yellow	Unchanged
Solution No. 2	Crimson	Purple	Unchanged	Dark Blue	Smudgy Violet
Solution No. 3	Crimson	Purple	Brown	Smudgy Crimson	Unchanged
Solution No. 4	Disappears	Indigo Blue	Red	Scarlet	Unchanged, but smudges

A simple ink-analysis table for use in conjunction with the four test solutions described in this article. This table only applies to black and blue-black writing inks, and not to coloured inks, which are usually of the aniline variety

# MASTERS OF MECHANICS

No. 48. THE MAN WHO FED THE WORLD

*Cyrus Hall McCormick and  
the Invention of the Reaper*



Cyrus Hall McCormick (1809-1884)



McCormick's early mechanical reaper in use on an American wheat growing farm

**N**EVER was there a truer saying than the old adage which informs us that "Necessity is the Mother of Invention."

Little more than a hundred years ago, agriculture throughout the world was employing the same rules, the same methods and practically the identical implements which it had used in the time of the ancient Egyptians, some five thousand years before the Christian era. But a hundred years ago, the population of the world was growing rapidly. Hence there was arising an increased demand for foodstuffs, of which, naturally enough, wheat and other varieties of grain came first on the list.

And that is why, in the early years of the last century, men, women and even young children toiled from daybreak to nightfall on the vast fertile plains of America's "Middle-West" in an endeavour to garner just a portion of the plentiful crop of golden grain which Nature had so bounteously bestowed upon the American lands. It was, of course, the same in other countries. But in America, owing to the comparatively large-scale farms which had been set up, the task of reaping and gathering the enormous quantities of ripening wheat which faced every farmer and land-owner just a little more than a century ago was a formidable and, indeed, often enough, an entirely unsurmountable one.

## Wheat Wasted

Time and again, the American wheat harvest proved itself to be beyond the powers of even the most determined, experienced and indefatigable New World

farmer to deal with, and so, not unfrequently, despite the calls for more and more wheat which came from the ever-growing American cities and from places overseas as well, cattle were turned out into the golden wheat fields to feed upon the rich grain of the fertile lands.

If only, mused those pioneer large-scale land workers, some mechanical means of cutting down the wheat as it ripened in the fields could be devised, what an enormous burden would be taken off the farmer at the busiest time of his year! What an enormous speeding up in wheat productivity would be accomplished! How, indeed, the non-rural workers of the country would rejoice at the prospect of cheaper grain!

But, alas! the general farming opinion had it in those days, a mechanical reaper which would accomplish the simple act of merely cutting down growing wheat or other grain in a field was impossible. The idea had been tried, they told you, and it had been found to be impracticable of attainment.

## A Rich Man

Thus it was that one Robert McCormick, a prosperous Virginian farmer of Scotch-Irish ancestry, after endeavouring in his own way to construct several wheat-reaping machines, eventually came round to the same contemporary view and viewed with equanimity the spectacle of men, women and children working all day in his fields in a race against time in order to garner as much of the ripened wheat as possible before the rain-storms came along and utterly ruined the heads of the grain,

soddening them and breaking them down completely.

Robert McCormick, perhaps, could afford to view such scenes in a comparatively unperturbed manner, for he was a prosperous man, having, besides his farms, several grist mills, saw mills, a smelting concern and a blacksmith's business.

Cyrus Hall McCormick, his son, who was born on the family farm, Walnut Grove, in Rockbridge County, Virginia, on February 15th, 1809, inherited all the good qualities of his father, including the many-sided mechanical abilities of the latter. As a boy, he helped his father in an attempt to make a reaper which, when pushed bodily into a field of wheat, would cut down the grain. But, as we have seen, McCormick the elder's efforts were all to no effect. The many reapers which he constructed all failed to cut down growing wheat even under the most favourable of conditions, and there is little doubt that eventually McCormick père gave up his reaper-making attempts in disgust.

## Prize Offered

The elder McCormick was by no means the only individual who has recognised the wheat problem and who had attempted to construct a machine which would, in one operation, cut down growing wheat and lay it on one side for binding into sheaves. As far back as 1780 the English Society of Arts, Manufactures and Commerce had offered a prize for the invention of a reaping machine and several patents for such a device had been taken out in England, prominent among which was the invention, in 1800, by Robert Meares of a scissors-like machine mounted on wheels which exerted a slight cutting action when pushed into a field of wheat, and, more especially, the reaping machine of one Henry Ogle (1820), a schoolmaster, which bid fair to become successful but which was abandoned owing to the threats of English farm-labourers who saw in it merely a means of depriving them of their livelihood.

And so, therefore, the agricultural world wagged on, relying for its grain harvest upon the scythe, the sickle and the hand-cutting knife, implements which had been used for that purpose for at least six thousand years.

As the young McCormick grew up, he became more and more fascinated by the notion of a mechanical reaper which would so obviously release the farmer from that species of slavery and drudgery which had been his from the beginning of the world. The fact that McCormick senior had been continually unsuccessful in his attempts to

construct a mechanical reaper in no way discouraged the growing lad. In the intervals of his work on the land and in his father's blacksmith's shop, he had already constructed several useful implements, one of which—a special type of hillside plow—he patented in 1831, just before he made his first successful reaper.

The elder McCormick made his last (and unsuccessful) reaping machine in May, 1831, and, as far as it is possible to ascertain, Cyrus McCormick must have commenced the building of his first (and eminently successful) machine immediately he realised the positive failure of his father's attempt.

#### His First Machine

Between the May and the July of 1831, Cyrus Hall McCormick, then a young man of merely 22, concentrated upon new principles of his own. Knowing nothing of any previous attempts which had been made to build a reaping machine (apart from the efforts of his father), the younger McCormick, in a little log building, which, incidentally, is still standing at the present day, in less than a dozen weeks constructed a reaper which was built upon an entirely new design.

Previous would-be mechanical reaping machines had been *pushed* into a field of corn. Cyrus Hall McCormick's new machine, however, was *drawn* into the wheatfield, the cutting action taking place on one side of the contrivance. McCormick's machine had a reciprocating knife actuated by gears from the main wheel, and it possessed a revolving "reel" which held the grain firmly up against the cutting knife.

The first trial of the machine was made in a small field near Steele's Tavern, Virginia, in the presence of a considerable number of people. The reaper was successful, and, as a result, McCormick subsequently built another one in which he incorporated several minor improvements. With this latter machine, he cut fifty acres of grain on the Walnut Grove farm of his father.

During the next two years, McCormick, the younger, continually gave exhibitions of his new mechanical reaper, the world's first successful implement of this type. In 1834, he patented the device, mainly in consequence of his having seen in a magazine a description of another reaper, the invention of one Obed Hussey, a former sailor, but now a candlestick maker, which claimed to cut grain successfully.

#### Commercial Manufacture

Cyrus Hall McCormick, with the aid of his father and a faithful negro slave, Jo Anderson, who had helped in the building of the first reaper, then commenced the commercial manufacture of his machines in the little log workshop on Walnut Grove Farm, Virginia. But, strangely enough, it was hard to induce local farmers to purchase his machines. Indeed, at the end of ten years Cyrus found that he had only sold seven of them!

Far from being discouraged, however, Cyrus Hall McCormick decided that if American farmers would not come to see his reaper then the reaper must be taken to see them. So mounting his horse, he left the home farm and rode from State to State, preaching the doctrine of the reaper, of the first real invention which had been made since farming began.

Sales then began to look up. In 1843, twenty-nine reapers were sold, and in the following year this figure increased to fifty, all these early machines, of course, being made in the little log shop on Walnut Grove Farm, Virginia.

But now it became clear that a new

manufacturing home must be found for the reaping machines. First of all, therefore McCormick sold a manufacturing licence to a firm at Brockport, New York, and he sent his younger brother, Leander McCormick, to Cincinnati, to look after a similar manufacturing contract in that city.

In 1847, McCormick moved to Chicago, than an almost unknown cluster of rude dwellings huddled together upon a swampy track of land. In Chicago, McCormick found a suitable partner named Gray, and together they built some five hundred reapers for the harvest of 1848. Then Gray sold out to one William B. Ogden, one of the early "founders" of Chicago, and thus the name of the firm was changed to that of "McCormick, Ogden and Co."

#### 1,600 Reapers Sold

No fewer than 1,600 reapers were sold in 1849, but, somehow or other, McCormick and Ogden found that they could not get on together. This resulted in Ogden selling out his interests in the firm to McCormick for 65,000 dollars, Cyrus Hall McCormick thus becoming, at the age of forty years, the sole owner of a very flourishing business.

In 1851, a serious fire took place at the McCormick works in Chicago, making it

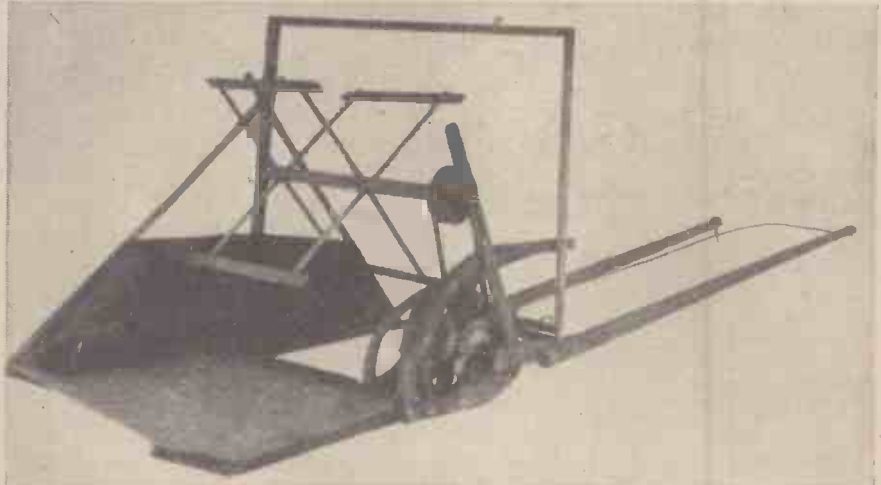

An exact replica of McCormick's first mechanical reaper (1831), which was specially made for the celebration of the centenary of this invention in 1931

necessary to rebuild a large portion of it. This was done in the same year, and so successful became the factory that, in 1856, it had a producing capacity of 40 reapers per day and, in that year, actually sold some 4,000 of them.

Naturally, McCormick was ever improving his machines. Unfortunately for him, however, there were others working in the same field of invention. They infringed his master-patent, but McCormick could obtain little satisfaction against such offences, for, in spite of the fact that he applied for a prolongation of his patent rights, the American courts refused to grant this privilege. Cyrus Hall McCormick, therefore, became patentless, and his invention was open to imitation far and wide.

Despite such facts, however, McCormick still continued to build up a vast and expanding business. Indeed, he showed himself to be not only an ingenious inventor but, also, a veritable Master of Industry and one of the earliest pioneers of works organisation.

#### Built in England

Year by year the power of the McCormick reaper grew. Cyrus Hall McCormick had agents all over the United States. He sent one of his improved reapers to England for

the Crystal Palace "Great Exhibition" of 1851, but, unfortunately, Victorian self-satisfaction was not very much concerned with agricultural machinery at that juncture. "It is a cross between a chariot, a wheelbarrow and a flying-machine," said the London *Times* referring to the McCormick reaper. McCormick, however, made arrangements for his reaper to be built under licence in England and then returned home to America.

As the years passed by McCormick amassed a great fortune as a result of his championship of the reaper and the various other agricultural implements which he brought out subsequently.

One of McCormick's most spectacular productions was his "binder," a machine which not only cut down the growing wheat, but which actually tied it into neat sheaves or bundles which were thrown out at regular intervals at the side of the machine as it progressed along the field.

This constituted the last incursion of Cyrus Hall McCormick into the reaper business, for on May 13th, 1884, he died at his Chicago residence, leaving his son to carry on the business, which still flourishes at the present day as the International Harvester Company, of Chicago.

Nowadays, of course, McCormick's early inventions have been developed out of all recognition.

#### "Power Farming"

On American prairie farms, the present age is one of "power farming." Great tractors farm the land, and perform all the necessary operations of husbandry from the initial ploughing of the soil to the final reaping and even the actual threshing or beating-out of the grain.

The latest of the long line of McCormick reapers actually cuts, cleans, and threshes the grain, filling it automatically into sacks, and dropping the filled and tied sacks into waggons waiting to carry them off the field.

"Such is the modern wonder of "power farming," of the giant American and Canadian industry which feeds half the world on its produce.

Without Cyrus Hall McCormick's fundamental invention, of the mechanical reaper it is clear that the present population of the civilised world could not possibly be supported. McCormick is, indeed, the man who first "fed the world," for upon his first mechanical invention of the reaper have been based all the other automatic implements which have enabled mass-scale farming to come into being.

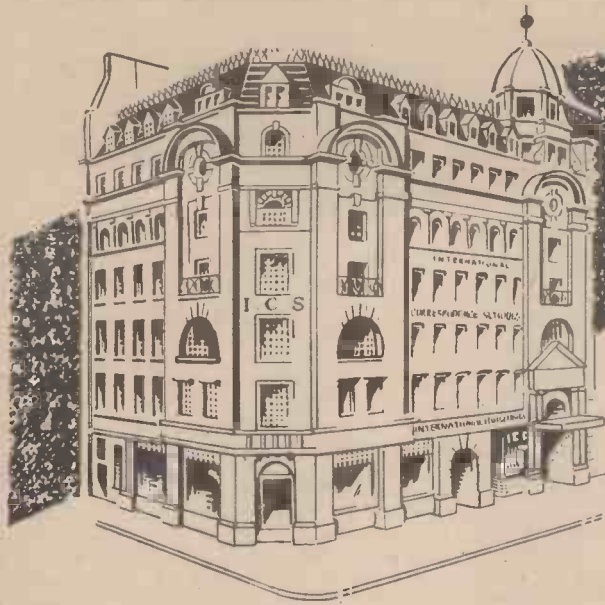

**Your Work -  
AND Your Pay**

The size of your salary is more or less in accordance with the measure of what you know and therefore can do. The more you know, the greater your pay.

Success—progress won by merit—depends on trained ability. Unless you have studied IN YOUR SPARE TIME you have little chance of promotion, for knowledge that comes through everyday work is not enough.

You must know the principles underlying your work and be familiar with the many processes closely related to that work. *The one and only means of obtaining such knowledge is specialized study.*

No man need be without that extra efficiency which adds so much to his income, security, and happiness. He can acquire it on easy terms, by the simple I.C.S. method of teaching by post.

If you are in the early stages of your career and have not yet had a specialized training, you should start to get one without delay. Or perhaps you feel that your knowledge is a little out of date and ought to be modernized. In either case

**The International Correspondence Schools can help you.**

*Our expert advice on any matter concerning your work and your career is yours for the asking—free and without obligation. Let us send you a booklet dealing with the subject in which you are especially interested. It is packed with valuable information.*

The I.C.S. offer instruction in the subjects given below.

Write for Special Booklet to-day or use the Coupon

This is  
**INTERNATIONAL BUILDINGS,  
KINGSWAY, LONDON**

Head Offices of the

**INTERNATIONAL  
CORRESPONDENCE SCHOOLS**

It is the centre from which radiates technical, commercial, and professional instruction that has been of great benefit to tens of thousands of ambitious people.

The I.C.S. is the greatest as well as the largest institution in the Empire devoted to spare-time training. Its prestige is unequalled. Several State Departments have entered into working arrangements with the I.C.S. for the training of men.

More than 1,500 I.C.S. text-books, prepared at International Buildings, are marvels of clearness, accuracy, and practical helpfulness.

There are 80 Instructors at Kingsway, many of them Associates, Members, or Fellows of their respective technical or professional bodies. *All are specialists*, and expert in giving the student *individual attention* throughout his Course of Study.

Among the 400 I.C.S. Courses there is one that can qualify YOU for Promotion and better Pay.

**COUPON FOR FREE BOOKLET**

**INTERNATIONAL CORRESPONDENCE SCHOOLS, LTD. (Dept. 95), International Buildings, Kingsway, London, W.C.2**

Please send me your booklet containing full particulars of the Course of Correspondence Training before which I have marked X. I assume no obligation.

- |   |  |  |   |
|---|--|--|---|
| <input type="checkbox"/> Accountancy              | <input type="checkbox"/> Diesel Engineering        | <input type="checkbox"/> Lettering                       | <input type="checkbox"/> Scientific Management        |
| <input type="checkbox"/> Advertising              | <input type="checkbox"/> Draughtsmanship           | <input type="checkbox"/> Mechanical Drawing              | <input type="checkbox"/> Short-Story Writing          |
| <input type="checkbox"/> Aeronautical Engineering | <input type="checkbox"/> Electrical Engineering    | <input type="checkbox"/> Mechanical Engineering          | <input type="checkbox"/> Steam Engineering            |
| <input type="checkbox"/> Air Conditioning         | <input type="checkbox"/> Engineering Shop Practice | <input type="checkbox"/> Mining Engineering              | <input type="checkbox"/> Surveying                    |
| <input type="checkbox"/> Architecture             | <input type="checkbox"/> Fire Engineering          | <input type="checkbox"/> Motor Engineering               | <input type="checkbox"/> Telephone and Telegraph Eng. |
| <input type="checkbox"/> Boiler Engineering       | <input type="checkbox"/> Garage Management         | <input type="checkbox"/> Pattern-making                  | <input type="checkbox"/> Textiles                     |
| <input type="checkbox"/> Book-keeping             | <input type="checkbox"/> Gas-Power Engineering     | <input type="checkbox"/> Plumbing                        | <input type="checkbox"/> Welding, Gas and Electric    |
| <input type="checkbox"/> Building                 | <input type="checkbox"/> Heating and Ventilation   | <input type="checkbox"/> Radio Engineering and Servicing | <input type="checkbox"/> Wireless Engineering         |
| <input type="checkbox"/> Chemical Engineering     | <input type="checkbox"/> Hydro Electric            | <input type="checkbox"/> Salesmanship                    | <input type="checkbox"/> Woodworking                  |
| <input type="checkbox"/> Civil Engineering        | <input type="checkbox"/> Journalism                | <input type="checkbox"/> Sanitary Engineering            | <input type="checkbox"/> Works Management             |

**EXAMINATIONS**

Technical, Professional, Matriculation, and Civil Service. State the one you wish to pass .....

NOTE.—If your subject is not on the above list, write it here .....

NAME..... Age.....

ADDRESS.....



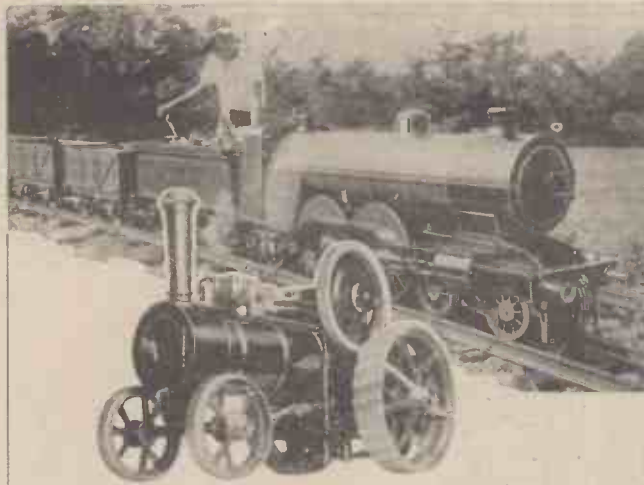

● 160 PAGES FOR 6d.  
● A NEW WONDER VALUE CATALOGUE FOR THE MODEL ENGINEER.

- Write to us now for:— "Steam Locomotives, Stationary Engines and Everything for the Model Engineer" (out September 1st). This comprehensive new Catalogue describes steam engines from gauge "0 to 10½," finished stationary engines, boilers, fittings, etc., outline and detail drawings, railway accessories of every kind, castings for locomotives and stationary engines, raw materials, tools—a veritable model engineer's encyclopaedia in fact! Ask for Section A.B.12. Price 8d. post free. (Catalogue 6d., postage 2d.)
- For gauge "0" only—clockwork electric or steam get G.R.12. Price 3d. post free.
- For the latest developments in "00" gauge, the Twin Train Table Railway, write for T.T.12, 2d. post free.
- See our exhibit at the "Model Engineer" Exhibition, September 7th to 16th.

**BASSETT-LOWKE LTD., NORTHAMPTON**  
London: 112, High Holborn, W.C.1. Manchester: 28, Corporation Street



*Did refused to help Sonny last night  
With his homework; so Sonny said, "Right!"  
I know what helps you,  
When you've homework to do,  
So I'll just go and hide the  
"FLUXITE!"*

See that **FLUXITE** is always by you—in the house—garage—workshop—wherever speedy soldering is needed. Used for 30 years in government works and by leading engineers and manufacturers. Of **Ironmongers**—in tins, 4d., 8d., 1/4 and 2/8. Ask to see the **FLUXITE SMALL-SPACE SOLDERING SET**—compact but substantial—complete with full instructions 7/6. Write for Free Book on the **ART OF "SOFT" SOLDERING** and ask for Leaflet on **CASE-HARDENING STEEL and TEMPERING TOOLS** with **FLUXITE**.

**TO CYCLISTS!** Your wheels will NOT keep round and true unless the spokes are tied with fine wire at the crossings and **SOLDERED**. This makes a much stronger wheel. It's simple—with **FLUXITE**—but **IMPORTANT**.

## THE FLUXITE GUN

is always ready to put Fluxite on the soldering job instantly. A little pressure places the right quantity on the right spot and one charging lasts for ages. Price 1/6, or filled 2/6.

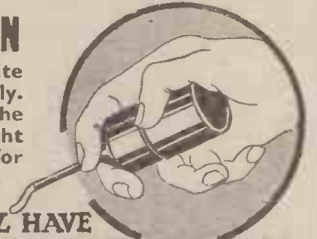

ALL MECHANICS WILL HAVE

# FLUXITE

IT SIMPLIFIES ALL SOLDERING

FLUXITE Ltd., Dept. P.M., Dragon Works, Bermondsey St., S.E.1

*"If your hobby is  
woodwork you'll  
find good use for  
VARNENE"*



Carpenters and Model Makers will find Varnene Oil Varnish Stain an excellent method of obtaining a first-class finish to their woodwork. Its free flow ensures easy and economical application. It stains deeply and dries to a hard, high gloss which will not readily chip or scratch. Use Varnene the finer oil varnish stain and obtain a finish which will make you proud of your work.

Obtainable from Handicraft Stores, Ironmongers, Oilmen, Grocers, etc., in Dark Oak, Walnut, Mahogany, Light Oak, Ebony Black and Clear (Colourless) Varnish.

Tins 6d., 1/- and 1/6

**VARNENE THE FINER**  
**OIL VARNISH STAIN**

Chiswick Products Ltd., London, W.4. VGH/37



**NEW!**

The "Delta" Line of Home Cinema-  
**HAND TURN MODEL . . . . . 25/-**  
**MOTOR MODEL (UNIVERSAL) . . . . . 77/6**

Obtainable from all the leading Stores and Photographic Dealers. If in difficulty write direct for full list to **DELTA (Nottingham) MANUFACTURING CO.** P.M. Dept., 46, HIGH PAVEMENT, NOTTINGHAM.

## CHARGE IT AT HOME

with a "SILEX" Battery Charger. Cheap to run, easy to use. Just Plug-in, fit spades, switch-on, that's all! Prices: 2 v., 1 amp., 12/6; 2 amps., 18/6; 6 v., 1 amp., 15/-; Car Battery models: 6 v., 2 amps., 25/-; 12 v., 30/-; Commercial Charger for 1-14, 2 v. cells, 0-3 ammeter, Low, Medium, High tappings, 50/-. All above are complete, with metal rectifiers and strong steel cases. Larger models quoted for. **SPECIAL! P.M. ARGON VALVE CHARGER** (July, p. 546). Complete kit includes Transformer, Valve, Holder, Ammeter, Resistances, 30", carr. pd. Same complete in strong steel case, plug-in, 37/6. Models suitable for A.C. Mains, 100-250 v., with robust Mains Transformers having a large margin of safety. Send 3d. for **REAL PHOTO** and **FREE TRIAL TERMS**.

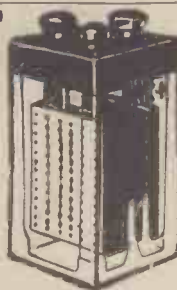

**BRIGHTON RADIO SERVICE**  
34 Middle Street, Brighton

## MYFORD

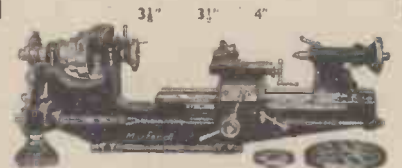

See the new Myford Lathes at the **MODEL ENGINEER EXHIBITION**, London, September 7 to 16

Write for latest Catalogue now **MYFORD ENG. Co., Ltd., Beeston, Nottm.**

## BLUSHING

**FREE** to all sufferers, particulars of a proved home treatment that quickly removes all embarrassment, and permanently cures blushing and flushing of the face and neck. Enclose stamp to pay postage to Mr. M. Temple (Specialist), "Commerce House," 72 Oxford Street, W.1. (Est. 38 years.)

You NEED this **"IMPETUS" MOTOR TOOL** an Electric High Speed hand grinder, file, router, etc., that **SAVES TIME, EFFORT & EXPENSE**. Faster, easier and more accurate. Nothing on the market to touch it at 63/- nett. Send for detailed specification **NOW** and be up to the minute Super model, 85/5/-  
**JOHN P. S. STEEL**  
Clyde Street Mills, Bingley.



## PERFECT USED MODELS

Send 4d. for our Catalogue and Save Money **GEORGES', 11, Friars St., Ipswich**

# Our Busy Inventors

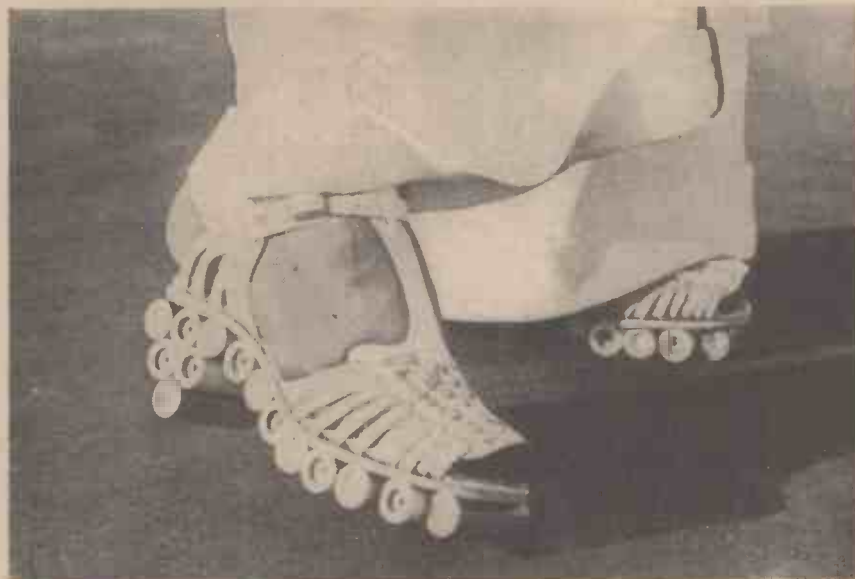

A striking fashion in footwear, the soles of which consist of small rolls, seen at the Italian shoe and leather fair at Vigevano

## To Prevent Snoring

AN inventor residing at San Francisco has applied to the British Patent Office for a patent for an anti-snoring mouthpiece. The object of this invention is to provide a safe remedy, which will not slip nor move out of adjustment during sleep and, therefore, cannot be swallowed.

Snoring generally occurs while the mouth is open. The passage of air through the mouth causes a vibration of the uvula, or soft palate, and of the diaphragm, which, in turn, causes the stertorous respiration commonly known as snoring.

The invention in question comprises a flexible mouthpiece to be worn between the teeth and lips, having a number of small perforations for controlling and diffusing air, and a quantity of larger perforations separated from the air stream zone, for permitting the circulation of saliva and mouth secretions. The mouthpiece is made from a single sheet of material, such as celluloid, preferably transparent. It is narrowed at the top and bottom in order comfortably to fit between the teeth and lips. When applied, owing to the warmth, the material of the mouthpiece softens and conforms to the contour of the mouth. The enlarged ends provide sufficient pressure to hold the device in place. At the same time freedom of movement is allowed to the teeth and gums.

I should not be surprised to learn that, in Hollywood, snoring had been adduced as a reason for divorce. If so, this invention may remove one obstacle to living happily for ever after.

## Adjustable Bed Springs

THE taste of sleepers appears to vary as regards the degree of resilience desirable beneath their recumbent forms. Some folks like a hard-boiled egg, while others prefer a tender one. And so it is with beds.

An easily adjustable bed spring is the subject of a new invention. A lever at the

head of the bed enables the tension on the springs to be increased or decreased to suit the liking of the occupant of the couch. It is asserted that none of the features of fine

The following information is specially supplied to "Practical Mechanics," by Messrs. Hughes & Young (Est. 1829), Patent Agents, of 9 Warwick Court, High Holborn, London, W.C.1, who will be pleased to send readers, mentioning this paper, free of charge, a copy of their handbook, "How to Patent an Invention."

springing is sacrificed owing to the invention.

In double beds there are two springs and two controlling devices, so that each sleeper reclines on the sections of the couch sprung to his wishes. However, in this case, I



The latest idea from Paris are these sun-spectacles which have rims made to represent flowers

## By "Dynamo"

presume the difference in the springs does not produce what is known in mechanics as the incline. Such an inclined plane would convert the couch into a distant relation of a helter-skelter.

## Guide Keys for Typists

IN typewriting by what is known as the "Touch" system, the typist is not allowed to look at the keyboard. But the beginner must naturally learn to position the fingers before commencing to work the machine. Given certain guide keys, the other keys can be instinctively and readily found. However, with keys all of the same construction, it is not possible to distinguish one from another without glancing at the keyboard. While experienced typists have little difficulty in the initial placing of the hand, students are tempted to cast their eyes upon the keyboard, and this hinders their progress.

To deal with such a situation, a keyboard has been formed enabling the typist readily to discover by touch specific guide keys. This avoids the necessity of a sly peep at the keyboard—the besetting sin of the tyro.

According to the new system, the guide keys are recessed thereby differentiating them from the normal keys, which have a plain surface. As a result, the guide keys are easily detected by the tips of the fingers. A further distinction on the keyboard is that the guide keys are made of coloured material. Once started on the right road, the beginner automatically locates the relative keys. At the same time, as regards progress, the typist puts her foot on the accelerator.

## Realism in Toyland

MAKE-BELIEVE is a universal characteristic in the mentality of the child. To add to the happy illusion of toyland, there has been contrived a winding-up device for spring-driving mechanism of toy vehicles. The winding-up device is made as an independent apparatus, with which a toy vehicle can be coupled from time to time. This is in the manner of a petrol station with pumping mechanism. And, in the juvenile mind, it imparts realism to the toy.

## Plucking by Machinery

THE plucking of fowls by hand is a tedious process. When a large number of birds have to be stripped, a mechanical method saves a considerable amount of time and labour. There has recently been patented in the United States a new apparatus for expeditiously divesting edible birds of their plumage. A rotatable frame has stripping means attached to its circular edge. When the frame is gyrated, this stripping means, which is obliquely arranged, speedily renders the fowl a fit candidate for a colony of defunct ornithological nudists.

## Snatchproof Case

BANDITS will receive the shock of their lives, if they attempt to snatch a newly devised case. This invention consists of an

electrified leather bag. Powered by batteries, an electrical shocker, built into the bag and capable of generating a high-tension current, is wired to the handles and to metal strips laid along the exterior of the bag. The device is intended principally for the cases in which bank messengers deliver bonds, stocks and other valuable securities. It is hoped that there is some means to prevent the person carrying the case from being himself more or less electrocuted.

### Wrapped Fuel

COAL-DUST is objected to by the household, who likes his fuel delivered well-screened. However, from the point of view of economy, it is a valuable commodity, although one may demur at paying for it at the rate of large coal. Many years ago coal-dust was compressed into blocks and it is still so used as domestic fuel. This contributes materially to the longevity of the fire on the hearth.

An inventor has now applied to the British Patent Office for the protection of an improvement in relation to coal briquettes. He provides artificial fuel wrapped in a sealed cover, so that the fuel is clean to handle and convenient for use.

The fuel comprises pulverized coal, coke, breeze or anthracite, mixed with oil and a binding material. Moulded under pressure, the resultant cylindrically shaped log is wrapped in a covering of waxed or glacé paper. The ends of the covering being tucked in, the fuel is enclosed practically in an air-tight wrapping. When this log is placed on the fire, the wrapper is not removed. As a consequence, the air-tight covering is heated. This causes immediate carbonisation of the boundary of the log, seals the fuel and prevents the rapid escape of gas and vaporisation of the fuel. The amount of smoke is also minimised. When three or more of these blocks are placed together in an ordinary domestic grate, an agreeably incandescent glow will be created, and the fire will survive for many hours.

### Stained Glass Milk Bottles

Milk bottles will resemble traffic lights, if a recommendation of certain scientists be carried out. These learned gentlemen state that milk in a bottle of the ordinary crystal-glass, exposed in a sunny porch, is liable to have its taste unfavourably affected. They further declare that the most suitable tints for milk bottles are red, yellow and green. The baby's bottle may yet be made of cathedral glass. Perchance, violet rays might be good for the health of the milk supply.

I submitted to my dairyman this idea of glazing milk bottles with plumes borrowed from the rainbow. His criticism—a very natural one—was that coloured glass does not reveal so definitely an imperfectly cleaned bottle as the type at present in use.

### A Tower of Refuge

ONE of the latest things in air raid shelters is a German lady's idea, for which a patent has been applied in this country. The inventress has not emulated the mole and designed a subterranean retreat. Her conception is a bomb- and gas-proof tower which will accommodate a crowd of people who, in the case of emergency, will be able to enter and to leave with great rapidity. Cylindrical in shape with a conical top, this tower has a number of floors, access to which is gained by means of an internal spiral footway adjacent to the

outer wall. Also step-irons may be fixed on the outside of the tower. The refugees, if I may so term the folk who will seek shelter, can occupy the various stories, which may be furnished with seats. Additional accommodation can be provided on the sloping footway, which may be fitted with folding seats.

The tower has a movable top capable of being raised or lowered by means of a screw spindle worked by a handwheel. This lid has a rubber ring which serves as a packing and hermetically closes the tower, so that noxious gases are excluded. There is also an automatic ventilating installation.

Assuming that the walls of this tower of refuge are adamantine, the structure bids fair to prove a cylinder of safety.

### Unobtrusive Lifebuoy

A COMPACT lifebelt, recently devised, has the appearance of an ordinary belt. It can very readily be brought into use as a lifebuoy. The method of inflation consists of sparklet-siphon cartridges. A slight squeeze of the belt buckle inflates the preserver to a buoyancy more than sufficient to float a giant from twelve to sixteen hours in a swimming position.

I understand that hunters and fishermen may wear the belt under their clothing.



The teleoptic-magnifier, a new type of spectacle lens for the semi-blind. It gives 300 per cent. magnification for distant vision. See paragraph on page 614

where it will remain inconspicuous and yet will operate effectively.

### Collision Guard

THE impact of colliding vehicles has occupied a considerable amount of the thought of the inventor. He has studied the subject with a view to eliminate, or at least to reduce, the evil consequences of violent encounters of moving vehicles. For instance, in the last century, the railway waggon was fitted with dead buffers. There was no give and take when there occurred those bumps which are incidental to shunting. Not only was the constitution of impacting waggons undermined, but the contents of the trucks were not improved by the shaking to which they were subjected. Then some inventive genius conceived the idea of a sprung buffer, which prolonged the life of the waggon.

There has been submitted to the British Patent Office a newly devised bumper or collision guard for vehicles, which emanates from the brain of an Egyptian inventor. This contrivance consists of a device combined with shock-absorbing apparatus. And it is characterised by the fact that the shock-absorber farthest remote from the bumper on the front end of the vehicle is arranged to co-act with the ground, to which the severe shock on the bumper is finally imparted. Therefore, long suffering Mother Earth bears the brunt of the bump.

### Make-up for Pictures

THE colouring of photographs, prints and lantern slides requires an implement which will not scratch. It also needs one which is particularly adapted to deal with a glossy surface. A new non-abrasive colouring pencil has been patented in the United States and it is claimed for it that it has the necessary qualifications for picture-tinting. There is a stick of fibrous material capable of absorbing moisture. The stick is impregnated with an aniline dye in absorbed condition and soluble in water. This is capable of penetrating the glossy surface of the object to be coloured. Consequently, the stick may be used after the manner of a brush simply by dipping it in water.

### Aircraft Without Wings

MR. OSCAR VON ASBOTH, a Hungarian engineer, has spent several years in developing a new type of aircraft. It is a helicopter without wings and no airscrew for forward movement. Two sets of rotors, mounted horizontally in the manner of the blades above the fuselage of the autogiro, are driven by the engine which is in the body or fuselage of the machine. These rotors revolve in opposite directions and provide both the lifting and traction forces. The inventor claims that his machine can descend and ascend vertically and hover in the air at any height.

A feature of the machine is that if the engine fails the blades of the rotors will rotate automatically, and enable it to descend at about the same speed as a man with a parachute. The Air Ministry have ordered the Blackburn Aeroplane Co. to build them a small experimental machine.

### POSTAGE STAMPS OF THE WORLD

WHITFIELD KING & CO., of Ipswich, have just issued their 1940 edition of the Standard Catalogue of Postage Stamps of the World. This is a work of reference well known to stamp collectors, which accurately records every issue of the world's postage stamps since 1840, revised and brought up to date and priced according to current market values. Although simplified to the extent of excluding complications in the way of minor varieties, a useful feature is the listing of watermarks upon which the exact identity of many important issues depend. It costs 5s.

### BOND'S NEW CATALOGUE

BOND'S O' EUSTON ROAD, LTD., have just issued their Model and Experimental Engineering Handbook for 1939-40, price 6d. A wide range of models and accessories are listed, including notes on model railways, model boats, etc. A section is devoted to petrol-driven model aeroplanes and petrol engines and also non-flying models. There are 208 pages in this interesting handbook and an eight-page index is included in the back.



# Single-Bladed Airscrews

*This type of Propeller Gives Increased Thrust, much as Reduction of Drag Improves the Lift of a Wing*

CONSIDERABLE interest in the single-bladed airscrew has resulted from the fact that one was fitted to the model which won the Wakefield Cup at Guyancourt, last year. Naturally enough, model enthusiasts are keen to know something of the underlying idea and are wondering to what extent it contributed to America's success.

In common with sundry other devices it would appear to have been "discovered" or "invented," whichever term you prefer, by several persons independently. The writer first heard of it in the form of an article on the Everel full-scale airscrew, appearing in the technical press early in 1937. It was there hailed as something new, and doubtless, from the point of view of full-scale designers, it was new. But it now appears

Having on hand a fractured 9-inch airscrew belonging to a small composite model, I decided to try out the single-blade idea, and soon had evidence of the improved thrust. The ensuing climb was terrific. So was the torque! No less than  $5\frac{1}{2}$  degrees of side thrust were required to deal with it. This was plainly too fierce for utility or comfort, but the substitution of a four-strand motor for the original one of six strands cured the trouble and left the climb and carrying capacity of the model as at the beginning. The question of duration did not, of course, arise with a model of the composite type.

Coming to the matter of applying the single-blade idea to the duration model, doubtless many designers would hesitate to reduce the amount of rubber for fear of

refer again to the pernicious effects of faulty carving, resulting in one blade differing from its fellow. The argument applies with particular force to the question of blade profile, where, on account of the small size, uniformity is none too easy of achievement. The harmful effects of inaccuracy will more readily be recognised if one contemplates the probable behaviour of a model having left- and right-hand wings of differing aerofoil sections.

## Smoother Airflow

Finally, tests with threads placed in the slipstream have clearly indicated that the airflow is smoother behind a single-blade airscrew, and this should be reflected in improved flying qualities.

It may be contended by some that the

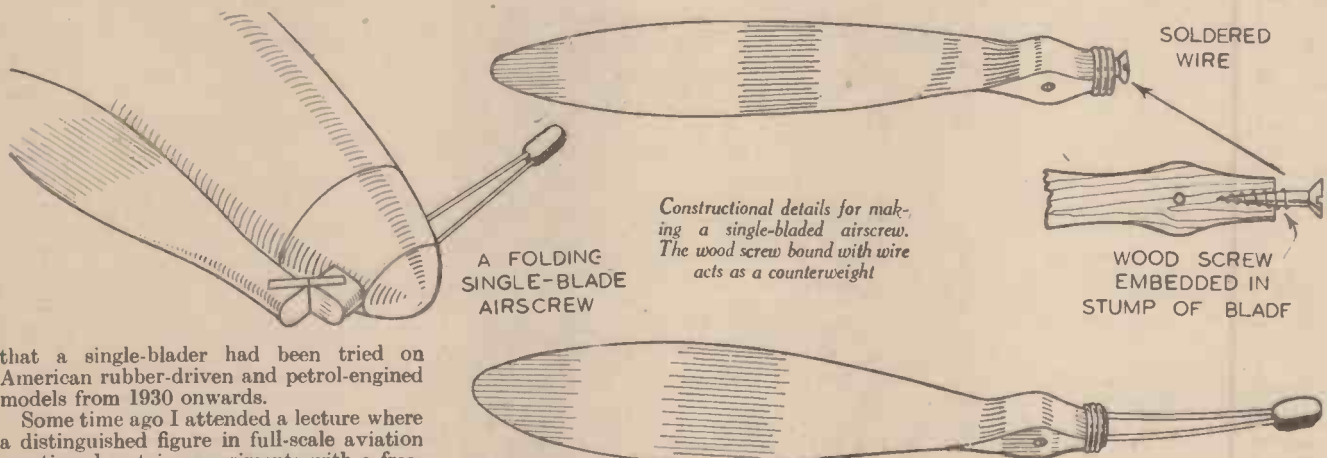

that a single-blader had been tried on American rubber-driven and petrol-engined models from 1930 onwards.

Some time ago I attended a lecture where a distinguished figure in full-scale aviation mentioned certain experiments with a free-wheeling airscrew, and suggested that the idea be applied to models. He was amazed to learn that model designers had used it for years and were now employing folding airscrews. Recently I learned that before the construction of Maia and Mercury began, the composite idea was successfully tried out in model form. Apparently the single-bladed airscrew affords yet another instance of model aviation being ahead of full-scale!

## The Everel Airscrew

The Everel airscrew was claimed to secure increased speed and climb, coupled with complete elimination of vibration. In explanation one has to call into service the modern theory which likens an airscrew to an aeroplane wing. Obviously if the blades differ from one another to even a small extent one will act as a brake upon the other, to the serious detriment of efficiency.

But it is suggested that even when no error exists the blades interfere with one another much as do the wings of a biplane, and that the single-blader corresponds with the monoplane wing, which obviously cannot suffer from interference except where it meets the fuselage. Thus the aerodynamic cleanliness results in increased thrust, much as reduction in drag improves the lift of a wing.

reducing the wind-fighting qualities, and in the case of the Wakefield class, possibly necessitating a heavier structure to bring it up to the minimum stipulated weight.

However, one is not restricted to the improvised type of single-blader, but can adopt the alternative of retaining the usual amount of rubber and reducing the rate of airscrew rotation. As to how best to achieve the latter, to increase the pitch would bring the pitch-angle perilously near the figure where the blade would stall, and would tend to increase the torque, while an increase in diameter is scarcely advisable in view of the fact that this is already frequently 40 per cent. of the wing-span, involving an absurdly stilty undercarriage; also, an increase in tip speed is to be deprecated.

## Increasing Blade Area

There remains the possibility of increasing the blade area, and this would appear to be the best answer to our problem. By way of practical example the 1938 Wakefield winner chose a diameter of 18 inches, and a maximum blade width of  $2\frac{3}{4}$  inches, whereas the usual blade width for an airscrew of this diameter is about  $2\frac{1}{4}$  inches.

Reverting to the subject of single-blade merits, one may perhaps be permitted to

suggested gains are relatively small, and admittedly one cannot produce irrefutable evidence of single-blade superiority. It is early yet to come to any conclusion on the matter, but even though more extensive experience fails to reveal marked superiority there would appear to be no inferiority. Even on this slender basis the single-blader will be held worthwhile by many.

To come to practical considerations, the counter-weight must be securely fastened if it is not to be flung off by centrifugal force, which is very considerable. In the matter of the position of the weight, as frequently happens in model aeronautics, one finds oneself up against opposing considerations. The nearer to the airscrew-boss, the heavier the weight required to balance the blade, while the farther away, the greater the drag.

On the writer's 9-inch airscrew the extremity of the counterweight was  $1\frac{1}{8}$  inches from the driving shaft, and on his 16-inch Wakefield type it was 2 inches away.

The Wakefield winner, in common with a number of American models, had the weight held 3 inches from the centre on two wires of about 20 gauge. With either arrangement the weight is inevitably slightly heavier than the blade it replaces. Incidentally, the single-blade airscrew on the Wakefield winner was of the folding type.



Fig. 1.—(Left) Table lifting. Exposed view showing one of the harnesses in position. Two or more of the sitters wear these harnesses on their wrists and lift the table between them. Fig. 6.—(Centre) "Spirit" manifestations made possible by a lazy tongs arrangement that holds the cloth extended while leaving one of the performer's hands free to work the effects. Fig. 11.—(Right) The artificial hand that taps out messages. As will be seen, the motive power is a simply arranged thread

# Spooky Secrets Fully Explained

How Effects Sometimes Produced by Spiritualists may be Imitated for Theatrical Purposes.

I WANT to make it quite clear that I do not suggest that spiritualist mediums are frauds. Neither do I suggest that the tricks I describe here are used by them to produce their manifestations. The following secrets are described simply as ways in which the kind of effects sometimes produced by spiritualists may be imitated for theatrical purposes.

Table-turning is one of the best known effects of this class, and in Fig. 1 is shown a method by which even a large and heavy table may be made to rise in the air and move about the stage or room with only the finger-tips of the helpers touching it. Of the people seated round the table, two or more are the performer's own assistants. Each of them wears strapped to one or both wrists a metal contrivance such as that shown in Fig. 2. The wide curved part of the fake is padded on the inside and rests along the forearm, while the narrow

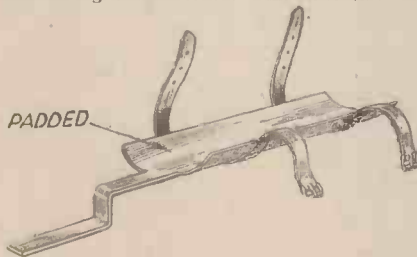

Fig. 2.—The metal contrivance which is strapped to the wrists of the performer's assistant

end reaches to just within the cuff. When the operator takes his place at the table, he slides his hands along the surface and so engages the end of the iron under the edge of the table. By pressing down with

By Norman Hunter  
(The Well-known Conjuror of  
"Maskelyne's Mysteries")

Further Articles on the Secrets of  
Conjuring will appear Regularly  
and Exclusively in this Journal

his fingers on the table he is able to grip the edge of the table against the iron quite firmly. Two persons so equipped, placed opposite each other, can lift, move and manipulate a good-sized table with ease. If a very large table is to be used, four assistants would be needed, one in the centre of each side.

## The Lifting Iron

Fig. 1 shows the tip of the lifting iron engaged under the table edge. It should be noted that in use the irons are masked by the table top and the arms of the operators from the view of the other persons round the table. The audience are prevented from seeing the irons by the fact that the people round the table automatically hamper the view.

For complete success, the effect needs a few rehearsals in order that the operators may work with each other and not in opposition.

## Lifting a Table

A small, light occasional table can be made to cling to the performer's hand by the

method shown in Fig. 3. A small nail with a definite head is driven into the table top near the centre until only a sixteenth of an inch projects. The performer wears a fairly wide ring in one edge of which a slot has been cut, as shown in Fig. 3. Placing his hand flat on the table with the slot in the ring undermost, he slides his hand forward and engages the head of the nail in the slot in the ring. By pressing slightly downwards with his finger-tips he can hold the table firmly against the flat of his hand and carry it about with ease. A cloth, if of thin material, may be thrown over the table and will not prevent the nail head being engaged in the ring. This is a useful addition after presenting the effect without the cloth, as it cancels any suggestion that adhesives or magnets may be the method used.

If a light table is employed, a nail with a very short point can be employed which

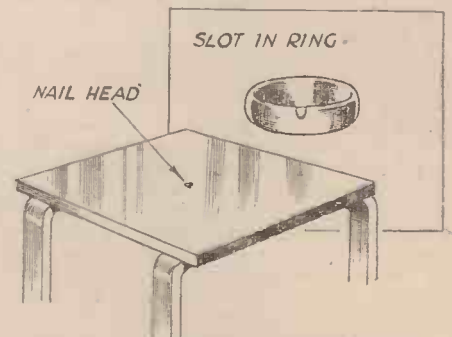

Fig. 3.—A small light occasional table can be made to cling to the performer's hand by the method shown

can be secretly extracted after the trick, allowing the table to be examined. A cane table is excellent for the purpose, being light and offering a surface which does not readily show the nail hole.

**Another Version**

Another table-turning trick suitable for a stage or sideshow is performed with the aid of two threads across the stage. The table in this case must be very light, and it is a good plan to make one from brown paper and cardboard. The legs are formed by rolling paper round a rod, gluing the paper, and sliding it off the rod. The top of the table is a stout cardboard box upside down, with the paper tube legs glued in the four corners. A lid from a slightly larger box, glued over the upturned bottom of the box, and two stretchers of light wood, complete the table. Fig. 4 makes the method of construction clear. Such a table need weigh only a few ounces, yet it will stand firm and small articles can safely be placed upon it. If carefully painted, it cannot be detected from the genuine article at quite close range.

Fig. 5 shows the method of raising the table. Two lengths of black thread are laid across the stage about ten inches apart. A wooden rod is attached to both threads at either end and an assistant stands by each rod in the wings. The table, having been proved to be free of any attachments, is stood over the threads, which are then raised by the two assistants and carry the table steadily up. With a little rehearsal the assistants will be able to make the table perform some quite surprising evolutions in the air.

**Making Bells Ring**

Another type of manifestation consists in causing the bells to ring and articles to move about while they are hidden from

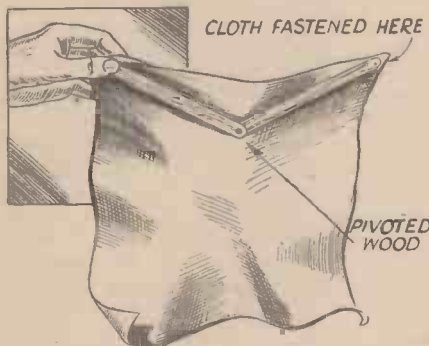

Fig. 7.—As an alternative to Fig. 6, the lazy tongs can be replaced by a pair of strips pivoted together as shown

view by a cloth held in front of them. Fig. 6 shows a simple and practical method of performing such feats. Sewn to the back of the cloth is a lazy tongs arrangement. This may be constructed of strips of metal loosely riveted, or even from thin wood strips. The cloth is fastened to the lazy tongs at several points so that when the tongs are extended they hold the cloth in much the same manner as if both upper corners were being held in the hands. The left hand holds the corner nearest the body and the right hand can now release the cloth and pick up articles on the table. ring bells, turn things upside down, transfer liquid from one glass to another, or perform any other simple feat. The hand is then brought up behind the cloth and the tongs closed, exposing the table once more.

A refinement of the idea is to have

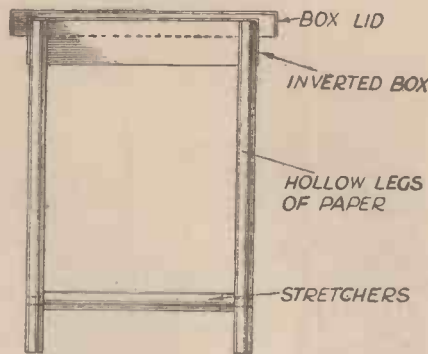

Fig. 4.—A table suitable for the table-turning trick. It is made of brown paper and cardboard and weighs only a few ounces

attached to the outer end of the tongs a dummy set of fingers which can be brought over on top of the tongs when the cloth is extended and counterfeited the performer's hand.

If a still simpler method is required, the lazy tongs can be replaced by a simple pair

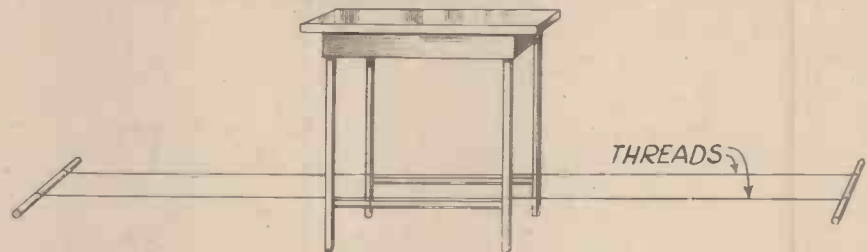

Fig. 5.—The method of raising the table by means of thread. A wooden rod is attached to either end of the thread and an assistant stands by each rod in the wings

of strips pivoted together as shown in Fig. 7. These are attached to the two corners of the cloth and serve to keep it extended. In this method, however, the cloth must be opened and closed quickly to preserve the illusion.

**Rattling a Tambourine**

Fig. 8 shows yet another method of performing such feats as rattling a tambourine behind a cloth. The tambourine is fitted with a fine wire hook and a length of thread is looped from one upper corner of the cloth to the other. The thread is engaged in the hook of the tambourine in the act of laying the cloth over it. The cloth is now held upright in front of the table and

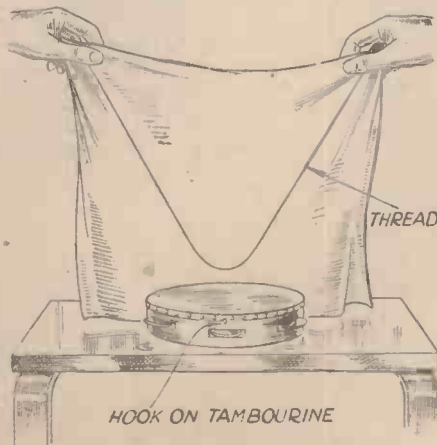

Fig. 8.—Another method of rattling a tambourine behind a cloth. A length of thread is attached to the two upper corners of the cloth and this engages with a hook on the tambourine

the tambourine rattled by jerking the thread with the fingers holding the cloth.

A more elaborate version of this trick consists of having a small cabinet placed on a board or a sheet of glass resting across the backs of two chairs. The cabinet is shown to be quite empty, a bell is placed inside and curtains drawn across the front. Immediately the bell is rung violently and tossed out of the cabinet. Other manifestations follow. An examined slate put into the cabinet quickly becomes covered with writing. Names chosen by the audience are written on paper placed in the cabinet. A selected number of knots are tied in a length of cord while it is in the cabinet. A glass of water is emptied or a newspaper torn to pieces. In nearly every case the articles used are flung out of the cabinet at the conclusion of the effect. Between each trick the curtains are drawn back and the little cabinet is seen to be quite empty.

**Mysterious Cabinet**

This is essentially a stage trick, but it could be performed at a bazaar or fair sideshow just as well as in a theatre. pro-

viding the performance took place in a building and not in a tent. The essence of the secret is that an assistant, usually a young girl, is hidden behind the back of the cabinet where she sits on a ledge. The back of the cabinet is provided with a trap through which she can place her hands and work the various effects.

The presence of a person behind the cabinet is not suspected, because the performer, at the start of the show, lifts the cabinet from a chair and places it on the sheet of glass. Obviously he could not do this without effort in the ordinary way, neither would a sheet of glass, unless it were exceptionally strong, support the weight. To make the trick possible, two wires are attached to the cabinet and pass up into the flies or, in the case of a sideshow, through pulleys in the ceiling and thence across and down to the wings. By means of a simple geared hand winch, an assistant lifts the cabinet while the performer merely guides it to its position. When it is lowered on to the glass the winch is locked so that only a fraction of the weight actually bears on the glass.

**Performing the Trick**

Fig. 9 shows the operation of the trick and Fig. 10 gives an end view of the cabinet in position on the glass. The chair on which the cabinet rests at the rise of the curtain is prepared by having the back spring-hinged. While the cabinet is on the chair the back is bent down but springs back to its normal position when the cabinet is lifted.

The range and variety of manifestations possible with this equipment are practically limited only by the performer's choice. Needless to say, as small and light a person as possible is chosen to work on the cabinet.

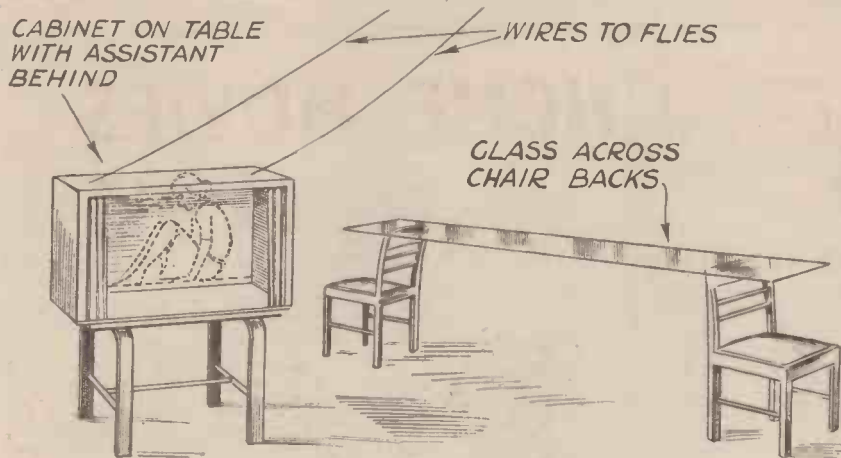

Fig. 9.—Showing the method of working the "mysterious cabinet" trick

### The Tapping Hand

A wax or wooden model of a hand, placed on a table or sheet of glass and caused to tap out answers to questions, is another effective trick. Fig. 11 shows the *modus operandi*. The hand is not prepared, but is constructed so that the wrist is the balance point and normally the finger-tips rest on the table. If the wrist is depressed and released, the fingers will rise and come down with a sharp tap. To effect this movement, a fine thread is stretched across the stage or room at the height of the table top. The hand is put on the table and a concealed assistant, holding one end of the thread, brings it down across the wrist. By pulling the thread he causes the hand to tap, yet at any time the conjurer may bring the hand forward for inspection.

Another method is to have the hand on a tray and carry it, still tapping, round among the audience. The tray is prepared as shown in Fig. 12. There is a space between the top and bottom of the tray in which works a simple lever. When the stud at A is pressed down the stud B rises. The hand in this case is balanced so that the fingers clear the tray, but come down upon it when the wrist is raised a fraction. The hand is placed on the tray with the wrist just over stud B. Slight and imperceptible pressure at A by the thumb as the hands hold the tray causes the hand to tap.

### Thought Reading

Now we come to thought-reading tricks. One of the simplest is to hand out a cigarette case and a packet of ten cigarettes with the request that any number be placed in the case and the case given to an assistant while the conjurer is out of the room. The assistant puts the case on the table, closed. The performer re-enters and tells the number of cigarettes in the case.

The assistant places the case on the table according to a prearranged code. Thus, one to five cigarettes are represented by the case being near one or other of the four corners of the table or in the middle. Six to ten cigarettes are indicated in the same way, but with the case upside down. Care should be taken not to place the case too obviously in one corner or another. In fact, the trick could be worked by placing

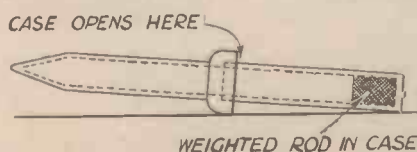

Fig. 13.—When a weighted rod is placed in the case, it will tilt to one side, as shown

the case always in the middle, but with the catch pointing either to one corner or towards the middle of one side.

### Coloured Rods

A metal tube and several coloured wooden rods form another trick of this type.

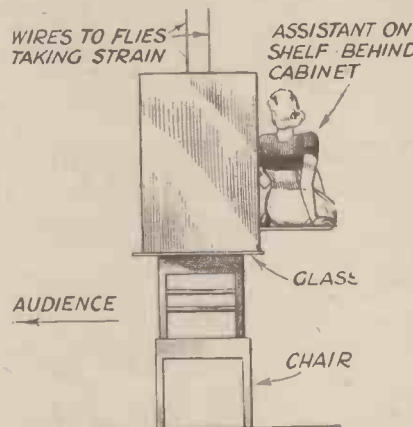

Fig. 10.—An end view of the cabinet in position on the glass

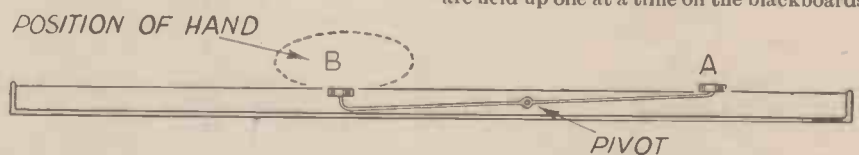

Fig. 12.—Details of the tray for the tapping hand. There is a space between the top and bottom of the tray which works a simple lever. When the stud at A is pressed down, the stud B rises

In the performer's absence, one colour is put into the case and the others hidden. Pretending to read the thoughts of the

audience, the conjurer correctly names the colour in the tube.

This may be done by having three coloured rods. One is weighted at one end, one at the other end, and one is left unweighted. The case and rods are pointed at one end, as shown in Fig. 13. When placed on the table, the case will tip to one end or the other if a weighted rod is inside, but not if the unweighted one is used.

A number of crayons may be given out, one chosen behind the performer's back and handed to him. Still holding the crayon behind his back and in view of the audience, the conjurer tells its colour. This is a simple trick and effective if not performed too often at one show. The conjurer scrapes a morsel of the crayon off with the nail of his forefinger; then, placing his hand to his forehead as if to think hard, he catches a glimpse of the colour. The same trick can be done with pans of water-colour paint, a wetted forefinger bringing off a sample of the colour.

### A Convincing Trick

Finally, here is a very convincing trick in which members of the audience write messages on paper, the messages are burned and the performer's assistant, who has been seated on the stage all the time, looks into a crystal, reads out the messages and replies to them.

To begin with, a separate writing pad is given to each member of the audience to write his message. The pads are prepared with carbon paper stuck to one of the leaves two or three sheets down. The messages when written are thus transferred to another sheet in the pad. The writers themselves tear off the messages they have written and the performer casually hands the pads into the wings. While the genuine messages are being burned, the assistant, off stage, opens up the pads and copies the messages on to blackboards.

### Reading the Crystal

The performer's assistant now takes up the crystal and looks into it. Holding the crystal before his or her face serves to mask the fact that he or she is actually glancing off-stage and reading the messages that are held up one at a time on the blackboards.

## PRACTICAL LEATHERWORK AND OTHER ALLIED CRAFTS

By Fred Jace

This handbook not only deals exhaustively with leatherworking, but other crafts such as Appliqué, Gesso, Raffia, Batik, stencilling and rug-making. It contains 96 pages and 179 photographs and diagrams.

From all Booksellers, 1s. or by post 1s. 2d. from the publishers, George Newnes, Ltd., (Book Dept.), Tower House, Southampton Street, Strand, W.C.2.

A great deal of effect can be got into this mystery if the assistant is a good actor, pretends to have difficulty now and again in making out a word, and comments upon the messages or answers the questions they contain in a way that leaves plenty of room for argument. Sometimes it is not necessary for the assistant to read out the actual message or question. For instance, supposing a member of the audience had written: "Shall I go abroad this year?" The assistant might say: "I get a message from someone who appears to be anxious about a journey of some kind. It may be a journey across the sea. There seems to be every indication that their hopes will be realised, though not necessarily within the year." As will be seen, this does not answer the question at all, but it conveys the fact that the contents of the message are known and gives the impression of a rather profound piece of advice.

**E. GRAY & SON, LTD.,  
GRAYSON & WINFIELD LATHES**

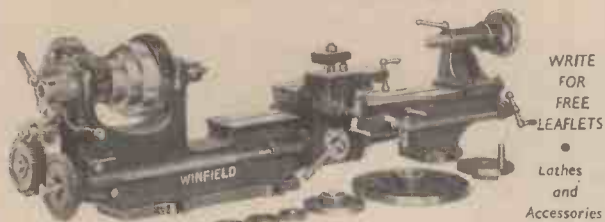

WRITE FOR FREE LEAFLETS  
• Lathes and Accessories

**WINFIELD 3" MODEL "R" £7 15 0**

A really Super Lathe at a reasonable price

Other GRAYSON & WINFIELD 3" MODELS from £4 10 0  
GRAYSON 3 1/2" LATHE £11 0 0

DEPT. "W" CLE 1174  
18-20, CLERKENWELL ROAD, LONDON, E.C.1

**Model Aircraft**

Send 4d. stamp for a copy of this fine Catalogue which describes the world-famous 'CONDOR' MODEL AIRCRAFT and 'NORMAC' ACCESSORIES

NORTHERN MODEL AIRCRAFT Co.  
25, Lower Mosley Street, Manchester, 2



**HOME MOVIES**  
for **9/5**

and 24 more similar monthly payments



Enjoy the evenings at home—showing those holiday films you made—or if you didn't make any get some from our library, we have all the best drama, western, comedy and cartoon films at moderate rates of hire. The Pathe H projector, shown here will give a good flickerless performance. It's the finest projector on the market at anything near the price. It has powerful illumination, and is solidly built, £10 10s. cash. 24 monthly payments of 9s. 5d

GENEROUS EXCHANGE ALLOWANCES

**340-PAGE HANDBOOK 1/- POST FREE**

Shows and describes every make of still and cine apparatus, and contains articles and advice by experts, also has an interesting colour supplement. Send now.

**CITY SALE & EXCHANGE**  
59/60 CHEAPSIDE . LONDON . E.C.2

**STANDS 1 AND 2**

**Model Engineering Exhibition**

SEPTEMBER 7th

Do not miss our display, a large working layout of scale "00" models, not toys, available in parts for home construction. A "00" railway is the perfect home hobby as it embraces many subjects, such as carpentry, metal work, scenic modelling, electricity, etc.

Our new 1940 fully illustrated catalogue will be available, the largest ever printed, exclusively devoted to scale "00" gauge. Send 6d. for your copy; apart from full details of our products it has many useful diagrams and ideas.

THE ORIGINAL SCALE "00" PIONEERS

**HAMBLINGS** 10 CECIL COURT, CHARING CROSS RD., W.C.2. TEL. 4704

FOR ACCURATE WORK AND PERFECT FINISH  
**A "MILNES" LATHE is Essential**

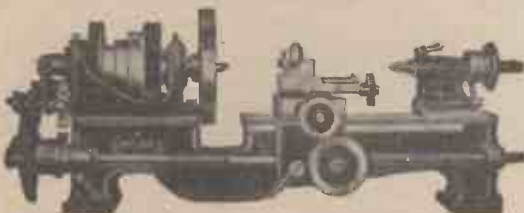

7 in. diameter Centre Lathe

**SELF-CONTAINED ELECTRIC OR COUNTERSHAFT DRIVE**  
Robust construction in every detail with easy means of adjustment ensure a lifetime's efficient service from "MILNES" MACHINES

Send for full lists to: **HENRY MILNES, LIMITED, INGLEBY LATHE WORKS, BRADFORD, YORKSHIRE, ENGLAND**

21st Year

**THE "MODEL ENGINEER" EXHIBITION**

ROYAL HORTICULTURAL HALL,  
Vincent Square, Westminster, S.W.

**SEPTEMBER 7th—16th**

11 a.m. to 9.30 p.m. daily

Sunday excepted

Admission 1s. 3d. (tax included)

A wonder show of Engineering Models of all kinds; Steam Locomotives at work on a 72-ft. passenger-carrying track; working model railways; Steam and Sailing Ship models, Speed-boats and Aeroplanes.

Hundreds of models in competition for the Championship Cups and other prizes.

A splendid trade display of lathes, small machine tools, workshop equipment, and model-making materials.

Exhibits by many of the leading Model Engineering and Railway Clubs.

**EVERY READER OF "PRACTICAL MECHANICS" SHOULD VISIT THE MOST FASCINATING SHOW OF THE YEAR**

# "MOTILUS" PEEPS INTO THE MODEL WORLD



A modified version of the model railway layout which was on view at the Glasgow Empire Exhibition, which is now touring the country

## A New Motor Ship

OVER in Belgium the other week I took the opportunity of looking over the new motor ship *Baudouinville*, built by Messrs. Cockerill of Hoboken. 492 feet long this smart vessel is the largest ship ever built in Belgium. She is approximately 17,000 tons register and now starts on the Congo service of the Maritime Belge.

On my way down to the main saloon, I was interested to see, on the staircase, a unique statue in bronze of the young Prince Baudouin, heir to the Belgian throne, holding in his hands a model of the *Baudouinville*. The thought flashed across my mind that the Prince once had a real working model presented to him of the mail steamer *Prince Baudouin*, built for him by a famous model making firm. It was at the time of 1935 Brussels exhibition, and the



A partly finished model of a 1½-in. scale 4-4-0 George V locomotive

gift was withheld for approximately four months because of the tragic death of his mother, Queen Astrid, in August of that year.

removable deck disclosing the batteries beneath. When Sir Esmond Ovey presented the model to the young prince, it was two or three days before Christmas, and he was disappointed he could not see the boat in motion, but the pond at Laaken was covered in ice. To-day the prince must be just of an age to take an interest in models of every kind. He was only five then!

## Layout on Tour

You remember the popular model railway exhibit at the Empire Exhibition, Glasgow, last year. I was interested to hear that a modified layout of this comprehensive model is now touring the country. It has already been seen at Charing Cross, London, Bentalls of Kingston, the Bristol Trade Exhibition, the Newcastle Trade Exhibition and the Landport Stores at Portsmouth, and at Lewis's in Manchester, and has been received everywhere with acclamation. For those readers interested this railway goes to Lewis's of Liverpool—September 4 to 9, to the same firm at Birmingham, Leeds and Hanley for these respective periods—September 18 to 23, October 2 to 7, October 16 to 21. So if you are in the vicinity don't miss this exhibit.

Model enthusiasts talk of "scale miles"

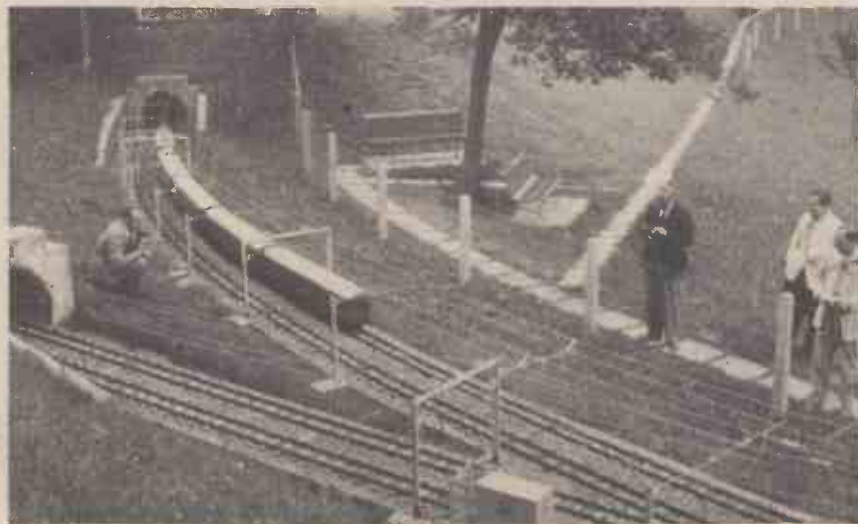

The famous Dietschberg model railway at Lucerne



A 4-6-2 24-in. gauge locomotive

in connection with model railways, but it makes one sit up and think when one is told (like myself!) that each of the trains—the L.M.S. Coronation Scot, the L.N.E.R. Silver Jubilee Express, the G.W.R. Cornish Riviera, and the Southern Belle have done 1,700 actual miles, which mounts up to the heavy total of approximately 75,000 scale miles each. Each mechanism has on an average run 115 miles (approximately 5,000 scale miles) before an overhaul, which has consisted mainly of the renewal of brushes and commutator. The bearings of locomotives and coaches are still the original ones and the gearing also, and for those who are statistically-minded here is a fact: the armature in each locomotive has revolved at least 130,000,000 times! Now work that out! Or what about making a similar record of the workings of *your* railway.

#### Model George V Locomotive

It seems strange to see in a foreign country the familiar outline of the British locomotive, but here in the workshop of the Brast Brothers of Lucerne, are the unmistakable beginnings of a model 1½ in. scale 4-4-0 *George V*. The British pioneers of the iron road are still remembered in a country where the new electric traction now holds sway. The main frames are finished, the boiler mounted, and the wheels ready fixed, and progress should be rapid, as they hope to complete the locomotive by the end of the summer. When I asked who the locomotive was for I was told it was for a private customer whose name at the present time the brothers were not prepared to divulge.

#### A Famous Model Railway

While at Lucerne I made the journey up the mountainside to visit Dipl. Ing. A. Oswald at Dietschiberg. He is the owner of the famous Dietschiberg model railway, which is visited by enthusiasts from all over the continent. The scale is 1:10 and gauge 5-21/32 in., and the total length of the permanent way 450 yards, traversing tunnels, viaducts, etc., on its way, with a layout and elaborate control board, offers great possibilities in railway working. Each locomotive works on 65 volts and is fitted with a transformer. Current is collected by an overhead rail, at a voltage of 250 A.C., which makes it therefore dangerous to touch the live rails. Mr. Oswald's stock on the railway at present consists of a goods train hauled by a 2-4-4-2 locomotive, fitted with two motors: one express train hauled by a

four-motored 2-4-4-2 locomotive, comprising the following vehicles: one luggage van and three coaches 1st and 2nd class. I took a few shots of this railway, one of the finest of its kind I have ever visited, and here is one picture including some of my "companions in camera."



Girls fitting up model coaches for the L.M.S. Coronation Scot

#### A 24-in. Gauge Locomotive

In 1939 the Albert Canal, linking Antwerp and Liège, has been completed and put into service—a gigantic task which has taken 10 years to accomplish at a cost of £14,000,000. This wonderful waterway, 76 miles long,

and capable of accommodating 2,000 ton ocean-going vessels, has been named Albert in honour of great King-Chevalier in whose reign it was begun. The popularity of the late King shows itself in many ways—a memorial to him is to be constructed at the entrance to the Canal. The locomotive in this picture too, is named after him. It is a 4-6-2 24-in. gauge leaving the station at the Liège exhibition for a tour round. Needless to say it is very well patronised and, with its train, forms a very pleasant means of making a preliminary view of the exhibition. I was not able to get many details of the locomotive, but as you will see it is fired by solid fuel.

#### A Motor Boat Engine

I am often asked what is the best steam plant for a metre boat—with a good turn of speed and at the same time easy to handle. You will remember the super motor boat *Streamlinia*, which was described by Mr. F. J. Camm in these pages in 1935. Well the plant illustrated is the latest and most up to date, based on the one used for *Streamlinia*, which over the period of the last two or three years has proved most reliable and speedy. This complete driving unit comprises boiler of brazed copper, complete with safety valve, steam pressure gauge, outer casing, correctly shaped funnel, and is fitted here with the "Eclipse" engine with displacement lubricator and all pipes and unions ready for mounting in the boat. The boiler is 7½ ins. long by 2½ ins. diameter and is fitted with a lamp with spirit feed. The "Eclipse" is double acting with 7/16 bore and 5/8 stroke and is supplied tested under steam at working pressure from 20 to 75 pounds per square inch. Altogether a very suitable outfit for a boat of metre size or thereabouts, available for any type of funnel or funnels.

#### New Lines in Trix

A friend was asking me about the new lines for the Trix trains this season. Well there are many and they are now well in production. Here is a picture showing girls fitting up the coaches for the L.M.S. Coronation Scot, which should be ready by the time this magazine is in print. Another new item on the Trix railway is the production of specially designed scenery, which is suitable for gauge "OO" and gauge "O" lines. This series, produced in conjunction with Messrs. Bassett-Lowke Ltd. and Messrs. Trix Ltd. consists of 1, pastureland with undulating country. 2, sea coast with cliffs. 3, mountains with heather foreground. Each section is the work of the same artist and they are so designed that any of three can be joined to either of the other two without the division being visible.

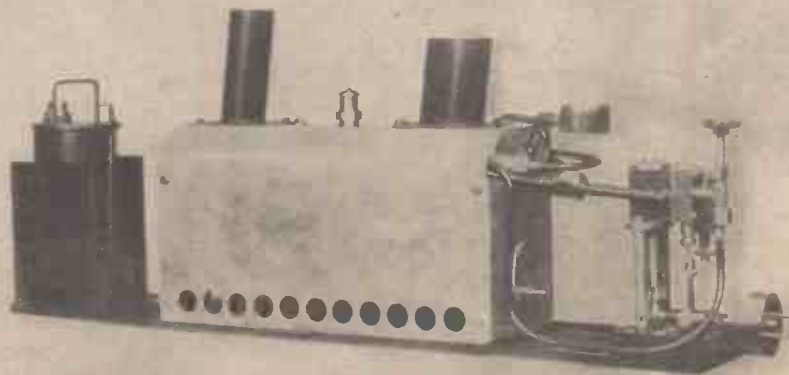

An up-to-date model motor-boat engine

# MODEL AERO TOPICS

Current News from the  
World of Model Aviation

## America Retains the Wakefield Cup

THE International Wakefield Cup Contest which this year was held in America—country of the holder—was held on August 6th. In the result America retains the cup, with Canada second, France third, and Great Britain fourth. The results are as follow:—

1. Dick Korda, U.S.A., 950.2 points.
2. F. Bowers, Canada, 272.66 points.
3. M. Giovanni, France, 217.53 points.
4. R. Copland, Great Britain, 211.3 points.

## The King Peter Cup Contest

THIS contest was held on July 23rd at Fairey's Great West Aerodrome. This year it was for model gliders, and points were awarded according to duration and distance flown. The results are as follows:—

1. France, 25,278.05 points.
2. Great Britain, 24,391.1 points.
3. Germany, 23,974.65 points.
4. Yugoslavia, 22,962.34 points.
5. Holland, 16,959.675 points.
6. Switzerland, 16,328.00 points.
7. Belgium, 5,519.4 points.
8. Denmark, 5,295.575 points.

## Teams

THE French team were certainly the youngest in the field. Switzerland was distinguishable by their skull caps, Yugoslavia was the biggest contingent, together with the Germans and their elaborate equipment, Holland, with models introducing transparent celluloid leading edge, efficient and smart. Belgium and Holland with two representatives only, each having splendid machines fighting a losing cause, as the results of the six best teams being added for final score. Lastly, the British machines generally smaller, but, as results show, up to the standard of the rest. Undoubtedly the German models were the best gliders, certain of them remaining stationary overhead for long periods, but in so doing robbing themselves of the all-important score for distance flown; with duration of 2, 3, and 4 minutes they landed less than a mile from release.

Reception and preliminary details over, examination of models commencing at the Y.M.C.A.

Major Lindsey Lloyd came over in his own 'plane during the afternoon.

Mr. P. A. Gordon in charge of the time-keepers had a very busy time.

There were a lot of preliminary arrangement which had to be made in the direction of enclosures which was delayed owing to the ground being used by full-size aircraft.

Proceedings commenced for the meeting composed of representatives of each team whose job it was to settle points of dispute during the competition should any arise. Flying commenced after a luncheon box had been consumed by the competitors and officials.

The two range-finders were used for the purpose of measuring the distances, as the competitor owed points according to the rules; in this manner one point for one-fifth of a second flown, one point for every metre of distance, the winch-launch method being used.



Launching  
a modern  
glider

Warrant Officer Gutteridge was in charge of the map department, which, when in action, reminded one of the headquarters of an army in the field, and with no less than 8 ft. square being used to locate the positions of landing and calculated distance flown.

A very pleasurable and enjoyable day was passed meeting the competitors, speaking the languages, and holding conversations with so many different foreigners.

## Records Passed

THE S.M.A.E. have passed the following records:—

- Tail-less—A. H. Boys, 1m. 24.5s.  
 Q1P1 Fuselage R.O.G.—R. W. M. Mackenzie, 1m. 54.4s.  
 Q1P1 Fuselage H.L.—F. Howarth, 1m. 51s.  
 Seaplane Biplane (Tank)—J. Marshall, 1m. 24.4s.  
 Seaplane Biplane (Tank)—J. Morris, 2m. 11s.  
 R.O.W. (Tank)—A. D. Piggott, 5m. 55s.  
 Seaplane R.O.W.—J. Marshall, 6m. 24s.  
 Seaplane R.O.W.—C. W. Needham, 7m. 17.7s.  
 Biplane R.O.W.—C. W. Needham, 7m. 17.7s.  
 Seaplane R.O.W.—R. W. M. Mackenzie, 8m. 16.3s.

## Rocket "Record"

AN application was received by the S.M.A.E. for a record of 44 seconds for a rocket model, but it was not passed as the F.A.I. do not recognise this type of model.

## Spoked Wheels

MODEL CRAFT, of 37 Goldsworth Road, Woking, have submitted for test some of their spoked wheels. They are direct spokes made from steel. They have rubber tyres and are made in three sizes, 2 in. at 1s., 1½ in. at 9d., and ¾ in. at 6d. a pair.

## Skybird Competition

A SKYBIRD contest is being organised by Commodore D. W. Bullock, of Club 517, Royal Garage House, Torwood Street, Torquay, Devon. The competition closes on October 31st, and the models eligible are the Skybird Speedy, and Sturdy. The competition is for duration flights, the best average of three. A silver cup will be presented to the winner and Skybird kits value one guinea for the runners-up. Additional prizes will also be awarded. A free gift of a 2s. glider will be made to all purchasers of the Sturdy and Speedy kits up to and including October 30th.

## Farrow Shield Interclub Contest

THE Farrow Shield Interclub decentralised competition takes place on the 17th September, and the Model Engineer No. 2 Cup for speed, a centralised competition, on the 24th September. The competition is for models of the fuselage type rising from the ground unaided. The contest is between affiliated clubs or societies and the best duration of the three leading models of each club counts. The durations added give the number of points scored.





# The Mystery of Magnetism

It is a curious truth that although the existence of that attractive influence which we call magnetism was one of the first scientific facts to be elucidated, we know, at the present day, surprisingly little more about its inner nature than did that great Englishman, William Gilbert, of Colchester, when, in the year 1600, he first published his celebrated treatise on the magnet.

Gilbert's book on magnetism is one of the earliest scientific works in the English language. Therein, its author describes his famous and now classical experiment in which he demonstrated that a magnetised sphere of iron will affect a compass needle just as the earth itself influences that instrument. Hence, reasoned Gilbert in a truly remarkable manner, since the influence which the metallic sphere exerts on the compass must, obviously, come from within the sphere, it would also appear that the earth's influence on the compass is not a thing derived from outer space, but an attraction proceeding inherently from within the earth.

## A Gigantic Spherical Magnet

We know now, of course, that the earth functions as a gigantic spherical magnet, possessing north and south poles, but that fact (which Gilbert, of Colchester, realised full well in 1600) is all that we really do know about the earth's magnetism. Why the earth's magnetic poles are not usually coincident with its polar axis, that is to say, its true north and south poles, and—in particular—why the magnetic poles of our globe undergo a continual year-by-year variation has, for the nearly three-and-a-half centuries since the publication of Gilbert's memorable book, remained a complete and baffling mystery which even the combined resources of modern science have not been able to penetrate.

All we know for certain about the earth's magnetism is that it comes from the earth, and that it is not a mysterious influence thrust on our world from outer space.

The mystery of the earth's magnetism deepens, also, when we reflect upon the fact that if iron, the magnetic metal *par excellence*, exists in vast amounts deep down in the earth's interior, that metal, and also its surroundings, must be in an exceedingly hot condition. We know from experiment, however, that if we take a magnet and heat it strongly it loses its magnetism. Hence it would seem that the earth cannot possess a permanently magnetised core like an enormous sphere of magnetised iron.

## An Opinion

Professor Horace Lamb, the mathematician, of Manchester, used to give it as his opinion that the earth's crust, being a conductor, had minute electrical currents perpetually flowing through it, these currents

decreasing in intensity age by age. On this theory, however, which was at one time put forward to account for the presence of

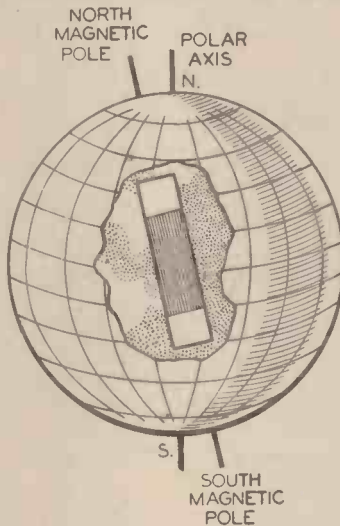

The earth functions as a gigantic spherical magnet possessing north and south poles

magnetism, it would seem obvious that the earth in distant ages must have been very highly electrified, a supposition which rests upon no evidence whatsoever.

## Strange Facts about The Magnetism of the Universe

Professor Larmor, on the other hand, has suggested that the phenomenon of magnetism may, in reality, be due to minute, yet nevertheless continual, circulatory movements of matter throughout the earth's crust, and this is the general theory which,

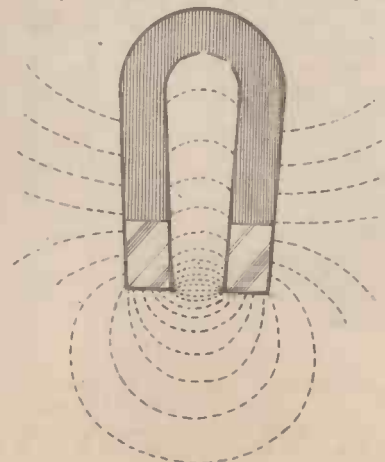

despite its many defections, holds first place in modern times.

Other scientific thinkers have not been slow to suggest that the earth's magnetism may be caused by the earth's movement in space. Such a theory is an attractive one, no doubt, but it fails lamentably owing to the fact that, so far as we have yet been able to ascertain, only one heavenly body possesses this strange attractive property which we call magnetism, that body being our own sun.

It was not until 1908 that the sun's magnetism was first detected by the astronomer, Hale, who observed what is termed the "Zeeman" effect in the solar spectrum.

The Zeeman effect is a well-known one in physics. When a light ray of one definite colour is made to pass through a magnetic field it is split up into other rays. Hale was able to prove that this splitting-up effect took place with some of the sun's rays, and by estimating the extent of the splitting-up effect he was able to form some estimate of the intensity of the sun's magnetic field, which he discovered to be normally about a hundred times as intense as the earth's field of magnetic influence.

## Sun's Magnetic Influence

Hale, however, also found that not only did the sun's magnetic influence vary, but that our luminary is frequently subject to intense magnetic storms, most particularly

in the area of sunspots, these storms sometimes reaching a magnetic intensity as great as ten thousand times that of the earth's magnetic field. Why such effects should take place in or on the sun's surface is, of course, a complete mystery to us,

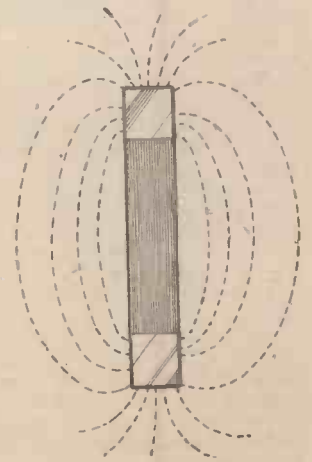

(Left) A horseshoe magnet and (right) a bar magnet, showing the lines of force

although we suspect that the fierce gyrotory and vortex movements of highly-charged matter in the area of the sun's "spots" may fundamentally underlie this tremendous magnetic activity.

Most sunspots could envelope several of our worlds, and if we could live in one of them under our normal conditions it is interesting to realise exactly what we should experience. The intense magnetic field of the vicinity would result in all articles of iron—knives, pins, spades, etc.—cohering together inseparably, so that ordinary civilisation as we know it would be quite impossible.

#### The Other Planets

Apart from the earth, as we have just seen, the sun is the only heavenly body which possesses magnetism—or, rather, it would be better to say, in which magnetism has so far been detected. No doubt the distant stars, which are suns like our own in general structure, are imbued with magnetic properties. Nevertheless, such magnetic fields have never been detected with even the finest of measuring methods.

What is, perhaps, more interesting to us is that none of the planets, other than the earth, seem to be possessed of this strange property of magnetism. The moon, so far as we can possibly tell, has certainly no magnetism. But if our lunar satellite were magnetic some very interesting effects might have made themselves evident. For instance, the moon does not revolve around our earth in a perfectly circular track or orbit. Its path round the earth is elliptical, so that the moon is nearer to the earth at one date every month than at others. Thus, if the moon were magnetic it would produce

on the earth a sort of magnetic tide which would very possibly hinder greatly the wireless and other communications of our world, and produce other unwanted effects. Happily, however, our companion, the moon, seems to be entirely devoid of magnetism, and it is seemingly, also, out of range of the earth's magnetic influence.

Planets having atmospheres, as, for instance, Venus, Mars and Jupiter, if they had magnetic properties, could readily have their fields of force detected by the Zeeman effect, since such planetary atmospheres absorb and modify light rays reflected from them. No such effects, however, have ever been detected by even the most delicate of astronomical observations, and for this reason we infer that the earth alone, of all the sun's family of planets, is magnetic.

We know that, for some mysterious reason, the direction of the earth's magnetic axis varies from year to year, and still further we are aware of the fact that the actual intensity of its magnetism alters strangely from time to time.

Within the last decade, however, a remarkable insight has been given into the character of the earth's magnetism in remote times by a Swiss physicist, M. Mercanton.

The reader will probably be aware of the fact that in the "Blattnerphone" or "talking-tape machine," which is being increasingly employed for sound-recording and reproducing purposes, the sound pulsations are imparted to a roll of metal tape by giving to the tape varying local degrees of magnetism.

Now, in a somewhat similar manner, when volcanic lava containing iron solidifies it becomes partially saturated with

magnetism along the lines of magnetic force in which it happens to lie when on the point of solidification.

Now, Mercanton turned this fact to a very useful purpose. He took pieces of volcanic lava from various parts of the world, carefully cut them up and then determined the intensity and the direction of the magnetism which they contained.

From the results of his purely physical determinations on the magnetism of volcanic rocks, Mercanton deduced the fact that the earth's magnetism has, in past epochs, varied enormously, both in actual intensity and in direction, from its present-day characters. In remote ages it would appear that the earth possessed a very intense magnetic field and that this magnetic influence has gradually dwindled and, indeed, is still diminishing in intensity.

#### A Decaying Influence

On this view, therefore, magnetism is a decaying influence, the present-day relic (so far as our solar system is concerned) of some former mighty force.

Such a viewpoint is, indeed, a perfectly sound one, although it does not bring us any nearer to the actual meaning of magnetism. No doubt, however, far away in the illimitable depths of space, magnetism, even at the present time, exists as a monster and an overwhelming force which, together with other powerful influences, shapes the destinies and, perhaps, even the physical forms of vast worlds which yet we have not glimpsed at.

We on earth have tamed and made use of the giant, magnetism. For all that, however, we still fail lamentably to understand even dimly his real nature.

## CHEMISTRY FOR BEGINNERS

(Continued from page 612)

one for the entry of chlorine gas, and the other for the exit of unchanged chlorine and sulphur monochloride. The sulphur is very gently heated and when it is just molten a slow stream of dry chlorine gas (dried by being passed over calcium chloride) is allowed to flow into the flask. The two elements, chlorine and sulphur, combine directly and with some vigour, and, as a result, fumes of sulphur monochloride will pass out of the flask and will collect as a reddish oil in a cooled receiver.

Pure sulphur monochloride boils at 138-140°C. It is decomposed by water, and hence it fumes strongly in moist air. Owing to its very powerful and rather sickly smell, all experiments with this substance should be conducted out of doors.

Sulphur monochloride readily dissolves sulphur, and for this reason it is much employed for vulcanisation purposes in the rubber industry.

When heated with bromine, sulphur forms a red-brown liquid, sulphur bromide,  $S_2Br_2$ , but the existence of an analogous compound of sulphur with iodine, such as  $S_2I_2$ , is doubtful. There is, however, a gas known as sulphur hexafluoride,  $SF_6$ , formed by the action of fluorine on sulphur, and this is an interesting compound, because, despite the activity of its constituent elements, it is chemically almost inert.

#### A Colourless Liquid

If a mixture of sulphur dioxide and

chlorine be allowed to interact in the presence of sunlight, a colourless fuming liquid known as sulphuryl chloride,  $SO_2Cl_2$ , is formed.

Sulphuryl chloride is best made by passing dry chlorine and dry sulphur dioxide into a three-necked Woulf's bottle similar to the one shown in the photograph on page 611.

Place in the bottle about a quarter of a teaspoonful of camphor (which acts as a catalyst, or a speeder-up of the reaction) and then pass into the bottle from opposite sides slow streams of dry chlorine and dry sulphur dioxide gases. Note that the Woulf's bottle has a vertical length of glass tubing fitted through a cork into its middle "neck," this piece of tubing acting as a safety vent through which the unchanged gases may escape.

The Woulf's bottle into which the reacting gases are passed MUST be allowed to stand in direct sunshine. Otherwise the gases will not combine satisfactorily. In sunshine, however, combination of the gases will take place rapidly with the formation of liquid sulphuryl chloride. When a sufficient amount of this has been collected, it should be placed in a perfectly dry retort and gently distilled, the liquid which distills below 75°C being practically pure sulphuryl chloride. The remaining liquid in the retort can then be put back into the Woulf's bottle and can be used for the preparation of more sulphuryl chloride if required.

Finally, a note on the preparation of one form of colloidal sulphur will be of interest. If sulphur and lime are boiled up in water for half an hour or so, an orange solution consisting of dissolved calcium polysulphides will be formed. If, now, this solution is filtered off and acidified with dilute hydrochloric acid, a cloudy white

precipitate of sulphur will be obtained. This form of sulphur, which is sometimes known as *milk of sulphur*, is, to a large extent, in the colloidal condition, and it will remain in suspension in the liquid without settling, for a very long time.

## MAKING A BANDSAW

(Continued from page 616)

being let into the wooden frame and held there with half-round cycle clips.

In addition to the spinners, and located between them, the blade needs a pair of guides H (Fig. 1). These are blocks of hardwood, slit the thickness of the blade, and well greased. They should be screwed, not nailed, in position, as they must be renewable.

#### A Blade Guard

A mudguard makes a convenient blade guard over the top wheel. It should be pivoted to the upright. The sawing table, of wood, may be two feet square, and held in place simply by G cramps.

It is not necessary to have a strong air blast to cool the engine, but the air round the cylinder must be kept in motion by a fan. If the engine has an outside flywheel this may drive by friction a small perambulator wheel with four brass blades soldered to its spokes. If, however, there is no outside flywheel, the drive can be taken from the main driving chain by a sprocket wheel coupled to a pulley, which may drive a discarded radiator fan.

In conclusion, a suitable blade will be  $\frac{1}{8}$  in. wide, 12 ft. to 13 ft. in circumference, with four teeth per inch.

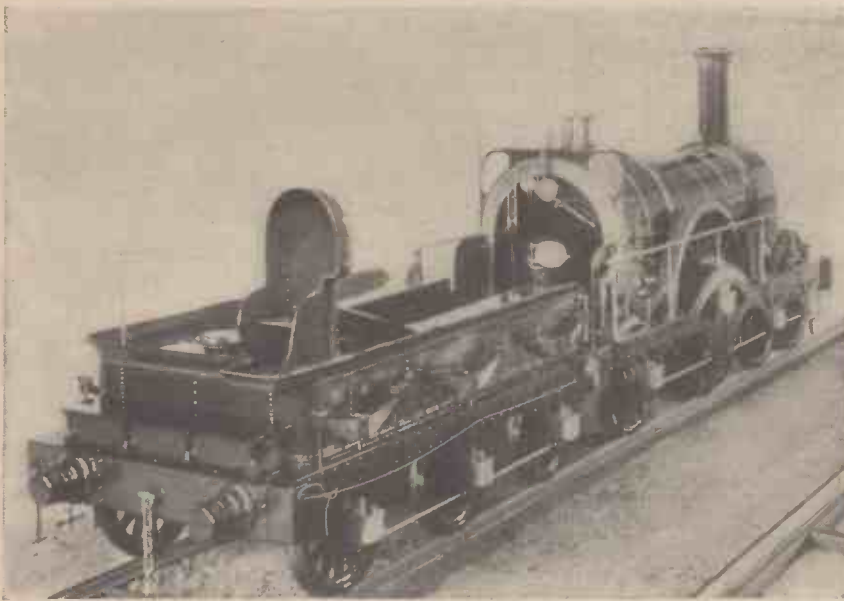

Fig. 20.—A view of the 1-in. scale model of 8-ft. single "Hirondelle"

**The Iron Framed Tender**

I have previously referred to the fact that the *Lord of the Isles* always had attached to it a tender built wholly of iron and this tender is shown in Fig. 22. Here may be seen the difference between the mechanical method of applying the brakes and that where rack and pinion was employed in the sandwich framed tenders. The bell-crank levers on the brake shaft were coupled to long rods which, at their other ends, were attached to the sliding bars carrying the brake blocks.

The porter's shelter was somewhat different from that shown in the last drawings. The actual seat was, for some reason, at a lower level as was also the well for the man's feet. The well and the hooded shelter were two separate units.

I consider that a greater amount of work is involved in modelling this tender than in the sandwich framed type and as regards appearance is not nearly so satisfying. The brake blocks are in both tenders of wood, preferably, in a model, of beech.

**Representing Rivets**

The reader will have noticed that all the plate work of these tenders shows the use

# A Model G.W.R. Broad Gauge Locomotive—Part VI.

By E. W. Twining

IN my last article I gave elevation drawings of the sandwich framed tender and this month I complete the views by a plan, Fig. 21, showing the plating of the top of the water tank and the shape of the coal space. This plating, it must be understood, is that of the prototype tender and will only be of use to the model maker in the event of his building a scale model, but the measurements, which can be taken off by means of the scale, will, of course, be correct for a working model. The top view of the travelling carriage porter's shelter will make clear the form and

arrangement of the plates, which are shown in the side elevations. At the back of the tank will be seen the cover of the water-filling opening. This, in a scale model, would be hinged as indicated, but in a working model, as will be seen shortly, it can very well be made to form the handle of the boiler feed hand pump. This cover, the travelling porter's shelter and all the other details of the tender are clearly shown in the rear end photographs of the right-hand side of the *Hirondelle*, Fig. 20.

of snap headed rivets. The actual insertion of such a tremendous number is out of the question and, moreover, rivets of such small size cannot be purchased. He will probably be already familiar with the idea of representing rivet heads by punching up the plate. It is recommended that either copper or brass be used throughout for the tanks and that the sides, if not the top, are made up of a number of plates, as shown. After the plates are cut to the required sizes, lines should be lightly scribed where riveting is to come, on the inside of the plate. Then make a punch, something

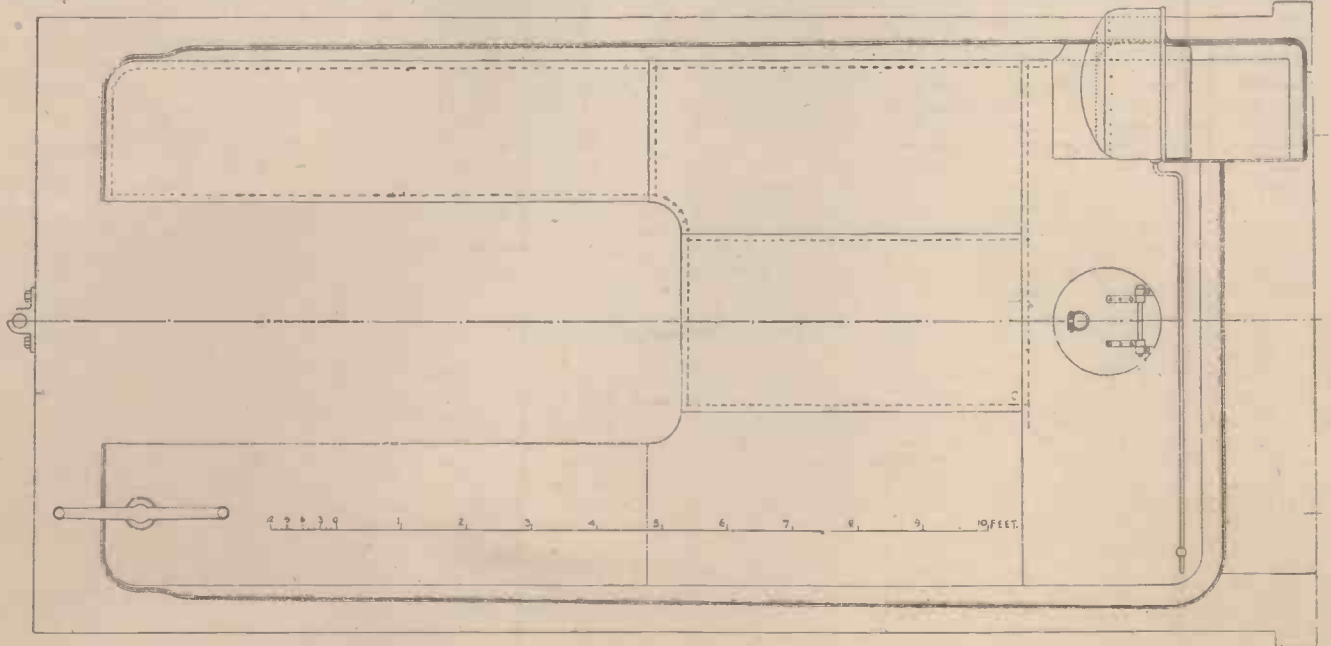
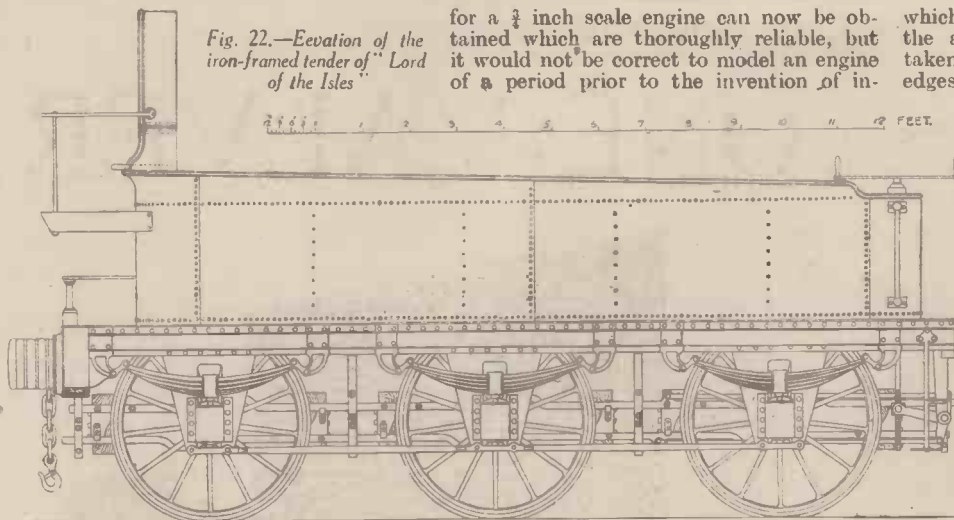

Fig. 21.—A plan of the tender, showing tank, etc.

Fig. 22.—Elevation of the iron-framed tender of "Lord of the Isles"



like a centre punch but with a rounded point, and lay the plate on a block of lead having a fairly true, flat top surface. If the model maker is used to dividing up accurately by eye he may go along on the scribed lines punching downwards through the plate on to the lead without actually sub-dividing, but if there is any doubt of his ability to obtain equal spacing all over it will be best to cross-scribe with a pair of dividers. In commencing to punch try out the effect of the blow delivered by the hammer by lifting the plate and examining the other side. A very little practice will show the amount of force required to give a proper rivet head appearance.

The actual number of spokes should be 13 as I have shown in Fig. 22.

**Boiler Water Feed Arrangement**

In a model locomotive of the size we are now dealing with there should be provided two means of supplying the boiler with water: one a pump in the tender worked by hand and the other a pump on the engine, the latter in operation the whole of the time the engine is working. The tender pump is obviously required for filling the boiler in the first place before getting up steam and for keeping up the water level when the engine is standing. It is true that injectors of a size small enough

for a  $\frac{1}{4}$  inch scale engine can now be obtained which are thoroughly reliable, but it would not be correct to model an engine of a period prior to the invention of in-

jectors which I have drawn in Fig. 20. To make the alteration the pump ram should be taken out, put in the lathe, the knurled edges turned away and new plates soldered above and below. On the top plate will be fitted the hinges and ring. To gain access to the interior of the tank I recommend that the whole of the plate covering the back of the tender be made removable by means of small countersunk screws as shown in Fig. 23, but it will not be necessary to remove this plate for filling the tank with water. The opening through which water can be poured will be of the same diameter as the new top to the pump ram and will be closed by the handle when it is in the down position.

There are on the boiler not far behind the smokebox, one on either side, two check valves. The water delivery pipe from the hand pump in the tender should be led to the left-hand check valve, a union being fitted in the pipe between the engine and tender.

**The Power Pump**

The pump driven by the crosshead should be on the right-hand side. The

jectors and fit it with one of these pieces of apparatus. Moreover, the prototype actually fed its boiler with a pump driven off the crosshead in exactly the same position as that illustrated below.

Dealing first, however, with the hand pump, the arrangement of which is shown

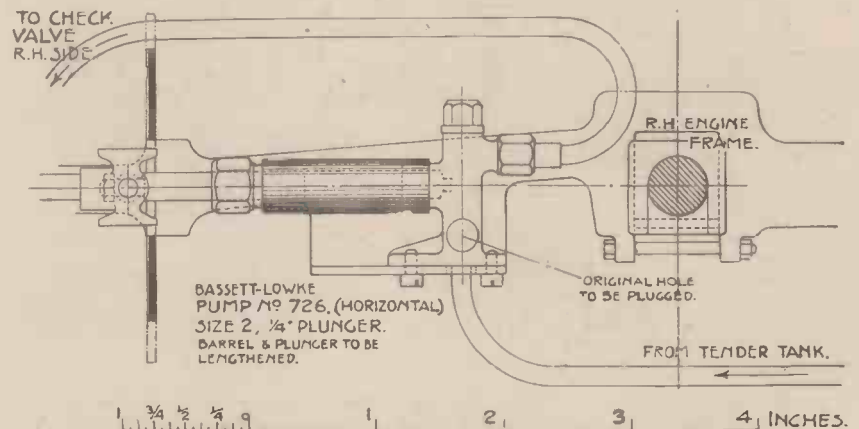

Fig. 24.—Arrangement of the crosshead-driven pump on the engine (right-hand side)

in Fig. 23, I suggest the use of one of Bassett-Lowke's vertical pumps No. 723/5. This has a large turned gunmetal handle, which can readily be converted to represent the form of cover over the water filling hole

arrangement of this is shown in Fig. 24. I think the simplest way to provide this pump will be to buy one of Bassett-Lowke's type No. 726, Horizontal, size No. 2 with a  $\frac{1}{4}$  inch plunger. As made, this pump will be found to have a stroke of only about  $\frac{3}{8}$  inch and it is proposed that it shall be lengthened so as to enable it to have a stroke equal to that of the pistons of the cylinders, from which it is driven, of  $1\frac{1}{2}$  inches. To do this the barrel is sawn across, each part then put in the lathe, turned true and re-joined by means of a piece of brass tube having a length of  $1\frac{1}{8}$  inch. The fact that the pump plunger will not fit this tube is immaterial. There is no packing in the plunger itself, but in the stuffing box around the plunger and there will still be a sufficient length of metal in the stuffing box to keep the ram true. As a matter of fact, a new ram will have to be made of increased length with its outer end shouldered down, threaded and fitted with a nut. This new ram will be made from a piece of  $\frac{1}{4}$  in. brass rod. The gudgeon pin is provided with an eye to receive the end of the pump ram and is clearly shown in Fig. 13 (given previously). Actually, however, it will be the cylinder on the opposite right-hand side which will drive the power pump.

Back Issues containing the five previous articles may still be obtained.

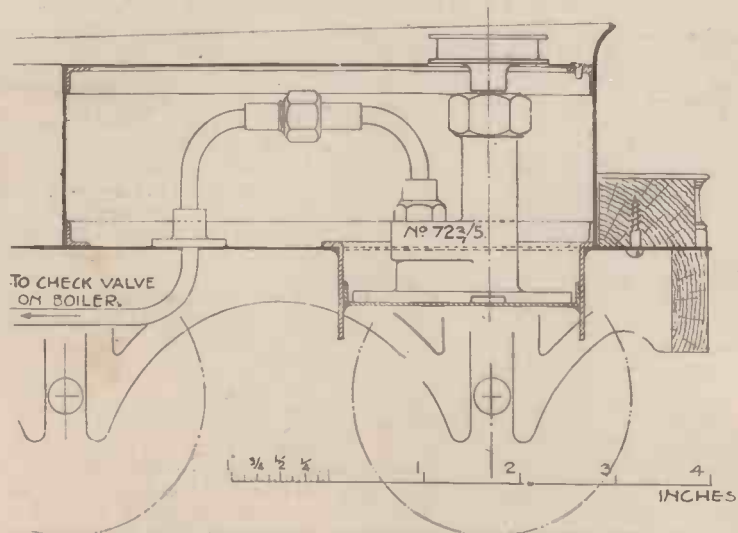
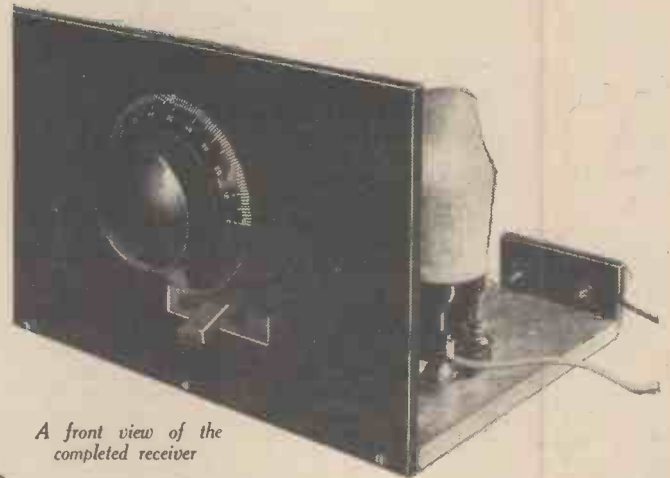
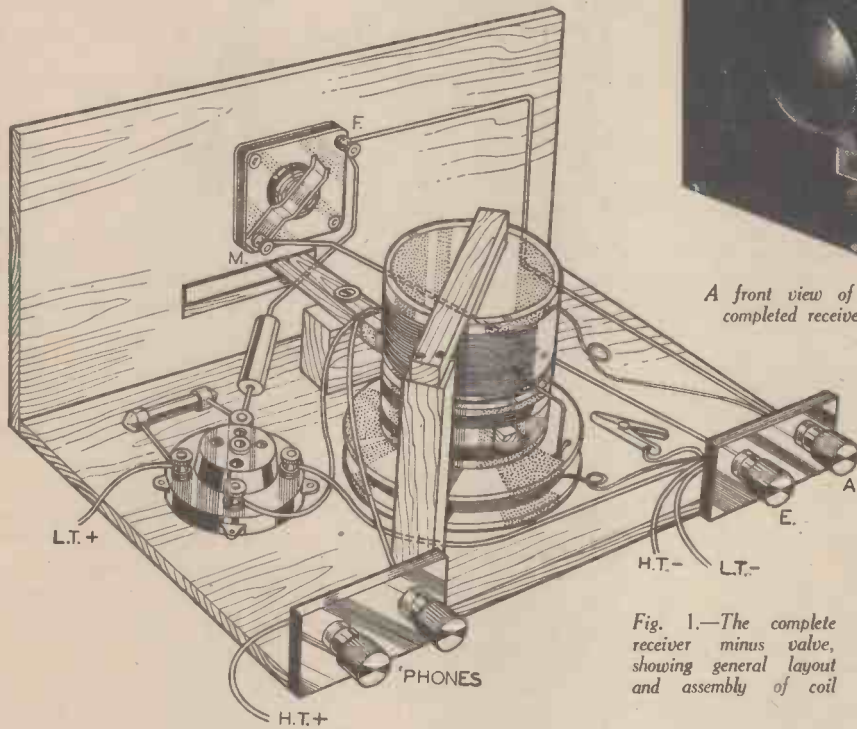

Fig. 23.—Arrangement of hand water pump in tender

"PRACTICAL MECHANICS" WIRELESS SUPPLEMENT

# THE S.S. ONE-VALVER

A Simple but very Efficient Receiver Designed for the Beginner who wishes to Construct his Own Coil



A front view of the completed receiver

receiver to increase sensitivity and selectivity.

This system, in spite of its age, is still very efficient, providing care is taken with the design of the coils, the selection of the valve, and the applied anode voltage. It also saves the cost of a reaction condenser.

**Construction**

A wooden baseboard and panel are used, the sizes in each case being 5½ in. x 8½ in.

The .0005-mfd. tuning condenser, of the solid di-electric type, is mounted a little above the centre of the panel to allow ample room for the reaction control strip which projects through a small slot.

The valve-holder, an ordinary four-pin, baseboard-mounting type, is fixed on the right-hand side of the baseboard, while the coil assembly comes in line with, and to the rear of the tuning condenser.

Two simple terminal or plug-and-socket strips are fixed to the rear edge of the baseboard to enable connections to be made to the aerial and earth and headphones. The grid-leak (2 megohms), can be of the ½-watt type, and the grid condenser (.003 mfd.), an ordinary paper tubular, or whatever type happens to be to hand.

**The Coil**

This component is the vital part, and although its design is such that no difficulty should be experienced with its construction, every attempt must be made to wind the three separate sections as evenly as possible and to make the formers clean, rigid, and secured firmly in the manner described and illustrated. The general assembly is shown in Fig. 4. The bottom coil former, which is fixed to the baseboard with a slight smear of glue or other adhesive, holds the long-wave winding, and this consists of 130 turns of 34 S.W.G. enamelled wire.

Above that is the reaction coil. This is wound on a plain former with 27 turns of 34 S.W.G. enamelled wire. The former is fixed to a narrow wooden strip which, in turn, is pivoted on a small wooden block, so that the coil can be moved over and away from the L.W. coil. The wooden strip must not be screwed too tightly to the

WHEN a receiver is built which employs a coil made by the constructor, a far greater thrill and a feeling of satisfaction is experienced when stations are tuned in, than if a commercial product had been used. Unfortunately, however, it is not always possible to make in the average constructor's den many of the components required for a modern multi-valve receiver. In such instances, it becomes essential to purchase reliable precision-made commercial products, but even so, there is no reason why those parts required for the more simple sets should not be tackled by the enthusiast and, by experiment, modified until the utmost efficiency is obtained. That forms the true pleasure of home construction and should be the key-note of every constructor.

Bearing all this in mind, and the fact that everyone cannot afford to purchase components *ad lib.*, the S.S. One-valver was produced to try and satisfy many demands. The letters S.S. are intended to convey the fact that it is about the *simplest* of the *simple* one-valvers possible to make, consistent with sensitivity and selectivity. From the results obtained under normal conditions, one might also add even another S and call it super.

**The Circuit**

This calls for little comment. It is an orthodox triode arrangement employing the leaky-grid system of rectification. The only feature which might be called unusual in

the light of the average modern circuit is the method of obtaining reaction.

It will be seen in the theoretical circuit, Fig. 2, that the old form of *swinging coil*, or inductive coupling, is used to feed back sufficient high-frequency currents from the anode to the grid circuit to provide the required reaction so essential in this type of

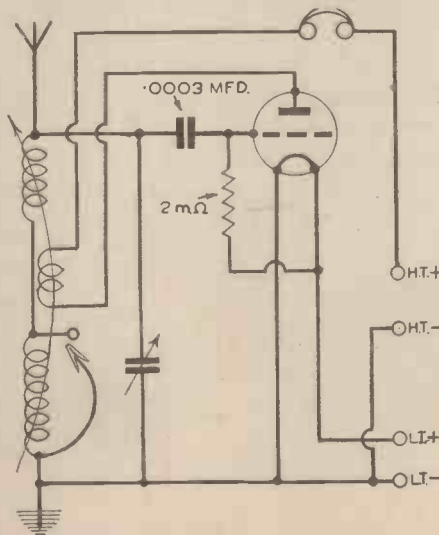

Fig. 2.—The theoretical circuit. An ordinary 2v. H.F. triode will be quite satisfactory

block or else smooth movement will not be possible; it is advisable to place a small washer on each side to provide an even bearing.

The top former carries the medium-wave section, and this consists of 43 turns of 26 S.W.G. enamelled wire, a tapping connection being made at the 12th turn from the upper edge. This is best formed by twisting a small loop in the wire when reaching the specified turn during the actual winding of the coil, removing the enamel coating from the loop with a sharp penknife or a piece of fine sandpaper.

The former is held in position by an upright piece of wood, which is fixed to the baseboard by means of a screw passing up through the base. Take care to ensure that it is firm. Inside the coil former is fastened another strip of wood, by means of adhesive, and this enables the coil to be supported by means of the horizontal strip, which is fixed to the top of the vertical wooden post. A spot of glue will form a firm joint without any risk of damaging the coil or the former.

It is essential to see that the space between the medium and long-wave coils is just sufficient to allow the reaction coil to move freely in between.

**Formers**

These can be made from 2-in. diameter paxoline tubing or ordinary cardboard tubes. If the latter is used, as in the case of the model being described, they should be dried in a gentle heat to remove any trace of moisture and then cut to size with a sharp knife or a fine-toothed saw, the edges being cleaned up afterwards with suitable sandpaper. The medium wave requires a length of 1½ ins., the reaction ¾ in., and the long waves ½ in. The first two are just plain pieces, but the last one has to be fitted with cardboard cheeks. These can be cut from thin, stiff board, their diameter being 2½ ins. Before cutting them out, a circle equal to the diameter of the tube should be drawn (2 ins.), and then the outer, or cutting circle can be marked off. The object of the 2-in. circle is to enable the tube to be stuck to the cheeks in the correct central position. Let the adhesive set hard before attempting to wind the coil.

The start and end of each winding are made fast by boring two fine holes each side of the formers, and threading the wire through them twice.

**Operation**

The batteries required are a 2-volt accumulator and a 60-volt high tension, although if a 120-volt battery is to hand, a slight increase in signal strength can be obtained by applying, say, 70 to 80 volts to the detector.

The tuning is carried out by the variable

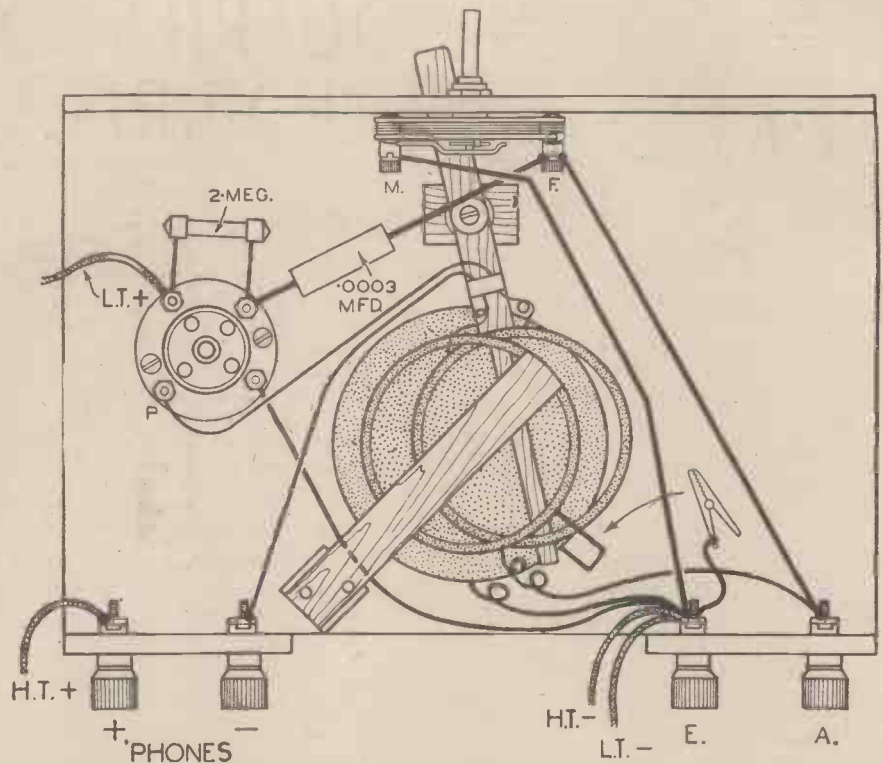

Fig. 3.—All wiring can be followed from this plan view

condenser in the normal manner, but the sensitivity is governed by the position of the reaction coil with relation to the others. Maximum effect is gained when the swinging reaction coil is in between the top and bottom sections, but it must be adjusted to give the loudest signals without any trace of oscillation. The control may seem a little touchy at first, but a little experience with it will soon enable the correct handling to be obtained.

When the long waves are required the clip is removed and left free, while for medium waves it must be clipped on the junction formed by the connection between the end of the medium- and the start of the long-wave windings.

An aerial of medium length should be used. If too long, the damping will stop satisfactory reaction, therefore it is well worth while trying the receiver on an efficient form of indoor aerial. It will be noted that no "extras" are fitted, such as by-pass condensers, H.F. choke, or on-off switch.

Wave-changing is effected by means of the crocodile clip.

**Hotting-up the Circuit**

In certain areas it may be noticed that the selectivity is not sufficient to allow clear separation of all receivable transmis-

sions. The simplest and quickest way of improving such matters is to include between the aerial terminal and the coil tapping point a small condenser, say, one having a value of .0001 mfd. The value is not supercritical, though it will be found that the smaller the capacity the sharper will be the tuning, but the signal strength will decrease correspondingly. It is better, therefore, to use a variable condenser, in which case the maximum value can be in the neighbourhood of .0003 mfd. If a component of this type is used, it can be mounted on the left-hand side of the panel, so that easy control can be obtained. Another way of improving the selectivity is by lowering the aerial tapping point on the medium-wave section down the coil, but as this would mean increasing the total number of turns on the coil, so that it would cover the same wave-range, it is not advisable in this instance. There is no reason, however, why those wishing to progress with their knowledge should not carry out experiments in this direction, making up a separate coil on a longer former for such purposes.

**Dial and Tuning Condenser**

Although a variable condenser of the "solid" dielectric type is specified for the S.S. One-valver, there is no reason why any standard type of air dielectric kind should not be used, provided it has the same capacity, namely, .0005 mfd. On actual test it will, no doubt, be found that a greater efficiency will be obtained with a condenser of the latter kind, but if it is decided to use one, it should be remembered that the coil unit might have to be moved more to the rear of the baseboard. The general appearance of the set will be improved with the fitting of a slow-motion dial, though I would not advise the use of one having station names marked on it, unless one is prepared to experiment with the coils to obtain accurate settings of the dial pointer.

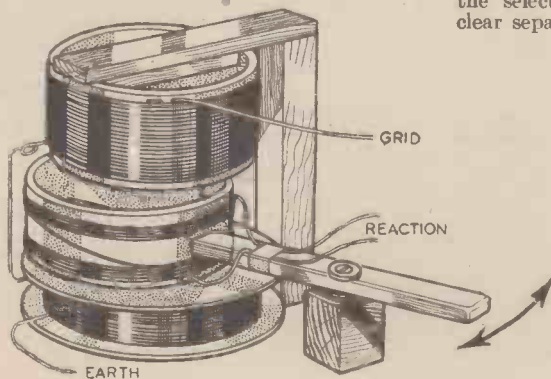

Fig. 4.—The general assembly of the coil unit. The medium wave section is at the top, reaction in the middle, and the L.W. at the bottom. All windings are in the same direction



## QUERIES and ENQUIRIES

A stamped addressed envelope, three penny stamps, and the query coupon from the current issue, which appears on page 111 cover, must be enclosed with every letter containing a query. Every query and drawing which is sent must bear the name and address of the sender. Send your queries to the Editor, PRACTICAL MECHANICS, Geo. Newnes, Ltd., Tower House, Southampton Street, Strand, London, W.C.2.

### TRANSFERRING ENGRAVINGS

"I HAVE made a solution of turpentine and soapy water, but it will only transfer newspaper matter and prints. Can you tell me of a solution capable of transferring engravings?"—T. K. (Co. Sligo).

THERE is no really satisfactory way of transferring engravings since the ink of these illustrations is firmly fixed. You might, however, try using a thick syrup made of soap, turpentine glycerine and a little candle wax. Raw linseed oil may be used instead of turpentine, if required.

### MELTING STEEL

"I HAVE melted iron by means of sulphur applied when iron is red hot. Is there any similar method of melting steel?"—T. L. (Dublin).

RED-HOT iron does not actually melt when brought into contact with sulphur. What happens is that part of the iron actually combines with the sulphur, forming iron sulphide, which results in an erosion of the iron article and gives rise to the belief that it has been locally melted. When steel is made white hot, it will "melt" in a similar way.

### INDOOR SPROUTING OF GRAIN

"CAN you tell me of a nutrient solution necessary for the indoor sprouting of grain, for stock-feeding purposes?"—C. W. (Northallerton).

GRAIN, when spread fairly thinly on a floor in a warm atmosphere should not require any special nutrient medium to cause it to sprout. The grain should be kept warm and damp, and it should be well ventilated. You might try adding sulphate of potash and sulphate of ammonia at the rate of a saltspoonful of each of these salts to the gallon of water. A very weak solution of gelatine containing a pinch of each of the above salts would also suffice, but if this solution is used there will be some danger of the sprouting grain becoming actually mouldy and unfit for any animal consumption.

### COMPRESSING GAS

"WHAT valves are most suitable for compressing gas over 500 lb.? It is essential that they shall not be more than 3/16 in. in diameter. I have tried ball valves without success."—S. C. (Baintree).

BALL valves are useless for the purpose you require. You need a special type of piston valve. Write to the British Oxygen Company, Ltd., Edmonton, London, N., detailing your requirements. This concern specialises in the production of compressor valves and other parts.

### LIQUEFYING AIR

"IS it possible to liquefy air by compression and expansion without raising the pressure above 150 lb. If not, what is the lowest pressure at which it could be accomplished? I enclose a sketch of the apparatus I should use for the experiment."—E. B. (Wembley).

IF air at a pressure of about 120 atmospheres is allowed to emerge from a fine jet and made to sweep over the coil of piping from which it has issued, a very great cooling effect will be obtained and the air will condense to a liquid. Note, however, that the required pressure is 120 atmospheres (i.e.  $120 \times 15 = 1,800$  lbs. per sq. in.). Your suggested pressure of 150 lbs. would not suffice for the liquefaction of air, unless the temperature of the air were very much lowered by outside cooling. Neither would your apparatus suffice for the liquefaction of air, since, so far as we can see, the air would not be allowed to expand continuously.

The above-mentioned British Oxygen Company supplies small air-liquefiers and would, no doubt, be glad to send you particulars of these and, also, to help you in any way with your individual problems.

### MERCURY AND ALUMINIUM

"THE mercury in my home-made barometer had become dusty and dirty. I poured the mercury into an aluminium jug, intending to remove the dust and dirt. Almost immediately at two spots on the inside of the jug which had come in contact with the mercury fine white shreds began to grow. (Elsewhere the mercury had no effect.) They grew to a good length (many inches) dropping off as lengths of about 1 inch were reached. Growth continued until a hole was made in the jug at the two spots. Would you kindly inform me of the cause of this?"—P. P. (South Devon).

YOU have made a very serious mistake, and have not only ruined your aluminium jug by pouring mercury into it, but have, also, probably spoilt your supply of mercury.

Mercury amalgamates (i.e. enters into a condition of mixture) very readily with most metals and with aluminium in particular. The mixture of aluminium and mercury is called "aluminium amalgam." Now, this amalgam oxidises very rapidly and the "growths" which you mention are, in reality, composed of aluminium oxide mixed with a trace of mercury. Such growths, as you yourself have noted, continue until a hole is made in the aluminium vessel.

Since the mercury itself is likely to be contaminated with aluminium, it will not be suitable in this state for barometer use, or, if introduced again into the barometer tube, it will "drag" and leave "tails" of impurity on the glass walls of the tube.

The only real way of purifying mercury which has become contaminated with any other metal is to distil it. This can be effected by distilling the mercury in small quantities at a time from a hard-glass test-tube. The tube may be heated in a hot non-luminous flame and the test-tube

## INFERIORITY COMPLEX GONE FOR EVER

"Can't has slipped out of my Vocabulary," writes a Pelmanist.

"That great handicap, Inferiorty Complex, has gone for ever. 'Can't' has just slipped out of my vocabulary. The Course has broadened my mind more than five years of life could have done. I have been able to distinguish the hollow things of life and—pushing them into the background have discovered what a really wonderful world this is." (E26063).

THIS remarkable letter, received at the Pelman Institute, will carry a message of hope to thousands of readers who are cursed with Diffidence, Shyness, Timidity, Self-Depreciation, Lack of Self-Confidence, Lack of Social Courage, Fear of Failure, Fear of the Future, Fear of Taking Responsibility, Fear of doing something unusual or out of the way. "The Inferiorty Complex" is one of the greatest handicaps that can burden any man or woman to-day.

### Fears Banished and Self-Confidence Developed

Pelmanism eradicates mental defects. Here are a few reports taken at random from the tens of thousands of similar statements:—

"Cured Fear."—"Pelmanism has cured the fear of self and of failure to keep pace with my colleagues." (T.37110).

"Strengthened My Will."—"It has given me a more cheerful outlook, strengthened my Will and helped me to overcome a timid disposition." (M.34208).

"Inferiorty Complex is Dead."—"I have rid myself of all fears of the future. The inferiorty complex is dead." (L.34224).

"Given Me Self-Confidence."—"It has given me Will-Power and Self-Confidence and trained my Imagination." (F.36143).

"Personality Has Developed."—"I have lost nervous fears. I am more self-confident. My personality has developed, and I have gained a lot in knowledge." (T.36007).

Pelmanism trains the senses and brings increased power and energy to your mind. It strengthens your Will-Power. It develops your Personality. It gives you Courage, Initiative, Forcefulness and Determination. It banishes Timidity and drives away Depression and harmful and morbid thoughts. It enables you to adopt a more cheerful and optimistic outlook upon life. And not only does it increase your Efficiency and your Earning-Power, but it enables you to cultivate an appreciation of the finer things of existence.

We have published a book called "The Science of Success" that tells just what Pelmanism does, and gives the experiences of Pelmanists, related by themselves. Write to-day, and by return you will receive a copy of "The Science of Success," free of charge, post paid. Read this book carefully. You will see what men and women in every walk of life say of Pelmanism. You will see that no matter how discouraged, how tired one may be, Pelmanism restores confidence in life, develops self-reliance, and sets one's footsteps definitely on the path to Success. Write or call to-day to:—

Pelman Institute,  
(Established over 40 years)

130, Pelman House, Bloomsbury Street,  
London, W.C.1.

PELMAN (OVERSEAS) INSTITUTES: PARIS, 176 Boulevard Haussmann. NEW YORK, 271 North Avenue, New Rochelle. MELBOURNE, 306 Flinders Lane. JOHANNESBURG, P.O. Box 4928. DURBAN, Natal Bank Chambers (P.O. Box 1489). CALCUTTA, 102 Clive Street, DEHLI, 10 Alipora Road. AMSTERDAM, Damrak 68. JAVA, Malabarweg, Malang.

## ELECTRADIX BARGAINS

**MOTOR BARGAINS** in Midget H.P. Motor for A.C. or D.C. 200/230 volts. 1.10th H.P. D.O.T. type, totally enclosed KB Cover, 2,000 revs., at a price never before offered, 7/6 only. Next larger GM No. 2 type, high speed 1/60th H.P. 4,000 revs. 9/6. Larger still, 1/45th H.P. Model GE, No. 1. 12/6 only, and first rate for model drive or light duty.

**MORSE RECORDING OF WIRELESS SIGNALS.** These well-known service paper tape Inkers record messages on any wavelength at speed. Recorders add enormously to interest. Magnificent British work, mahogany drawer containing tape reel. Such apparatus cost £40. 2/2 to £6 10s. each.

**ELECTRIC SOLDERING IRONS.** Heavy workshop type, 125 watts, 220/230 volts, 6/6.

**3-VALVE (part finished) BATTERY SETS** with oak cabinet ready wired and fitted 2 condensers and engraved panel, 13 x 7 x 6 in., 15/-.  
**PUSH BUTTON TUNING.** 6-way Gang Push, metal cover, 1/6. Multiple Cord, 6d.  
**STATIC CONVERTERS.** A.C. mains to D.C. 40 watts output, steel cased. Output 404 volts, 60/100 m.a. D.C. with valves, 45/-. A.C. mains to D.C. 120 watts at 1 amp, for 220 v. D.C. sets, steel-cased, valves, 50/-.  
**SOUND RECORDING AT HOME** at a reasonable cost. No fancy prices for elaborate gear.

### The FEIGH RECORDER

fits any Gramo, has positive drive by ball-bearing worm gear and rack. The Recording Stylus is tracked across blank at the exact grooving spiral. Price, complete, as illus. with Tone Arm and cutter with real diamond, 37/6. All-metal discs, 3/3 doz.



**CONDENSERS.** Fixed electrolytic 12 + 4 mfd., - 16 mfd. 275 volts, 1/6; 6 + 6 - 12 mfd. 250 volts 1/6; 8 + 8 - 16 mfd. 350 volts, 1/6; 24 + 8 - 32 mfd. 400 volts, 2/6; 8 mfd. 500 volts, 1/6; Mansbridge Paper and Mica, 4 mfd., 3/6; 8 mfd., 5/6; 10 mfd., 7/6; Dubilier Oil for 1,000 volts, 1/8; .005 Mica Trans. 5,000 volts, 2/6; 10,000 volts 5/6; .25 mfd. mica, 4,000 volts 3/6. Oil Condensers, 1 mfd., 3,000 volts, 5/6. Special Condenser Bargain to clear surplus. Western Electric 1 mfd. and 2 mfd., 2d. each, 1/6 doz.; 12/- gross, carriage forward. Ideal for makers of smoothing and filter circuits. Offer open till cleared.

**COIL WINDERS.** Hand drive, bevel friction, 8in. high, 2/6. Iron Pedestal, Brass Wheel, worth 1/6n.  
**COILS.** S.W. plug-in, 1/6. Ribbed formers, 9d. Long-wave and B.C. 2-pin, 1/6. Reaction tuners, 9d. H.F. twin chokes, mains, 9d. Rugby and other coils in stock. All wavelengths in 2-pin, 1/3. S.W. Formers ribbed and slotted, 4d.

**FANFOLS.** Aluminium 16- and 18-gauge one side enamelled. Paxolin and Ebonite, any size, from 24in. x 24in., at low prices.

**VARIABLE CONDENSERS.** .005 mfd. Tekade, 1/3; .0075 Polar Compax, 1/- S.W. Formo, 2/- J.B. Midget, .0001, 1/6; 2-gang variable, .0005, 2/60 3-gang, 3/6.



### SPEAKER MAGNETS (Moving Coil)

Powerful New Steel, Four-claw 4 1/2 lbs., 10 watt M.C. Speaker. Permanent Magnets at manufacturers' price. A great opportunity for 5/-



### DIX-MIPANTA VEST POCKET TESTER

A wonderfully versatile moving-iron multi-range meter for service on A.C. or D.C. jobs. No projecting terminals. THREE ranges of volts: 0-7.5, 0-150, 0-300. Used for MILLIAMPS, reads: 121 m.a. and 75 m.a. Inblack bakelite case. Measures only 2 1/2 in. by 2 1/2 in., with pair of test leads and plugs. "Easit" "N" gives full information, 19/6.

**ELECTRIC DRILL STANDS.** Massive Wolf Geared rise and fall with counterweight. Suitable large or small machines, 7/6, carr. fwd.  
**MORSE PRACTICE SETS.** No. 3, with key buzzer and lamp for sound and visual, line plug, etc., 7/- Sound Type, 1A type key and buzzer, 3/-, Visual Type 2A, key and lamp, 2/-.



**KEYS.** Govt. surplus table Morse Keys, Type KBSL. Polished wood base, massive brass pivot bar, tungsten spring-mounted contacts for quiet working and base lamp for light. A first-class Key for operators. Only 7/6 each.

**TRUE-TWIN CAMERASCOPIES.** 2 lens viewers 1/- post free.  
**SPECIAL CLEARANCE.** Parcels of experimental oddments, coils, magnets, wire chokes, condensers, mikes, switches, terminals, etc. Post free, 10lb., 5/-. Very useful Bargain.

Latest List "N" free on request.

## ELECTRADIX RADIOS

218, UPPER THAMES STREET, LONDON, E.C.4  
 Telephone Central 4611



### PROTRUDING EARS

ORO, a simple remedy, sets them in position immediately. INVISIBLE, comfortable, and harmless, used any time by adults and children. Endorsed by physicians and users as the best method for correcting this disfigurement. Write for free booklet and testimonials to:- M. TRILETY (R189), 45 Matton Garden, London, E.C.1.

provided with a cork through which a small glass delivery tube is passed. The mercury will distil out of the test-tube via the delivery tube and will condense in a cool receiver.

### A PHENOMENON

"I HAVE noticed that if an ordinary candle is lighted in a room full of cigarette smoke, the atmosphere becomes clear within a few minutes. What chemical action takes place?"—L. R. (London, W.11).

NO chemical action takes place in the circumstances you mention, apart, of course, from the chemical process of combustion which occurs during the burning of the candle. We have not previously heard of an ordinary room being cleared of smoke by the simple process of burning a candle in it and, to tell the truth, we feel doubtful as to the accuracy of your statement. If, however, an actual fume-clearing action does take place during the burning of a candle in a room, the effect must be ascribed to convection or circulatory currents in the air caused by the warmth of the candle. Warm air rises and cold air flows in to take its place. Very little heating effects will start such air currents and, once begun, these convection currents will tend to clear a room of smoke.

### RESISTOR FOR DE-FROSTER

"WHAT resistance will I need for the element of a de-froster, working off 12 volts, and what length of wire would be required? What firm could supply the wire?"—D. W. (Glam.).

THE quantity and size of wire required will depend not only on the voltage, but also upon the number of watts the de-froster is designed to consume. The consumption in current is found by dividing the total watts by the voltage, thus a 60-watt de-froster would consume 5 amperes on a 12-volt circuit. "Eureka" wire of No. 20 s.w.g. is suitable for this current, and, having a resistance of 0.661 ohms per yard the 2.4 total ohms necessary would be represented by a length of 3.62 yards. This wire is obtainable from The London Electric Wire Co., Ltd., Playhouse Yard, Golden Lane, E.C.

### CHROMIUM PLATING

"I WISH to chromium plate some small articles. Could you please inform me what voltage and amperage I would need for satisfactory results? Is it possible to utilize the mains (220v. A.C.) in this respect? If so, what equipment would I need?"—L. J. (Richmond).

ALTERNATING current is useless for electro-plating of any description. Direct current at a low voltage and heavy amperage is required. Chromium plating on a small scale is very expensive and the outfit needed will cost far more than sending the articles away to be done. The plating itself is a complicated process as the articles have first to be pickled and made chemically clean, and then heavily coated with nickel before commencing the final chromium process. Chromium if deposited direct on base metals will invariably strip. Messrs. Wm. Canning & Co., Ltd., of Great Hampton Street, Birmingham, publish a special booklet on chromium plating describing the outfit necessary, and we advise you to procure a copy before embarking on such an expensive experiment.

### REWINDING A MOTOR

"I HAVE a 12-volt Lucas windscreen wiper motor and wish to rewind it for use as a 4 to 6 volt boat motor for a 3-ft. model launch. What gauge of wire should be used for the armature and the two field

coils and what are the correct connections? The motor has a three-pole armature."—W. H. P. (Weybridge).

TO convert your 12-volt windscreen wiper motor into a 4 or 6 volt boat motor for driving models, the armature will need winding with as much No. 24 s.w.g. double-silk-covered copper wire as it will hold, and connecting to a 3-part commutator. The finish of each of the three armature coils is joined to the start of the next one, and the junctions taken down to a commutator segment one-third of the circumference in advance. A little adjustment may be necessary to this position, in order to obtain best results, which can be done by twisting the commutator round on the shaft without unsoldering the connections. For the field coils wind with No. 19 s.w.g. d.c.c. copper, and connect in series with the armature. The weights of wire required for field and armature will depend on the actual dimensions of the parts, which have not been stated but probably 2 oz. for the armature, and 6 oz. for the fields will be sufficient.

### METHYLATED SPIRITS

"WHAT are the constituents of methylated spirits?"

"How can I prepare ethyl acetate from acetic acid and methylated spirits?"

"Is chloral hydrate dangerous in any way and how is it prepared?"

"How can I make methyl salicylate?"—J. W. (Edinburgh).

METHYLATED spirit consists of rectified alcohol (ethyl alcohol) to which has been added 10 per cent. of crude methyl alcohol (wood spirit), 1 per cent. of petroleum together with a trace of pyridine, the mixture being "dyed" by the addition of methyl violet.

To prepare ethyl acetate from acetic acid and methylated spirit, fit up a flask provided with a dropping funnel and connected with a Liebig's condenser or some other convenient form of condensing apparatus. A thermometer should also pass through the cork of the flask.

In the flask is placed a mixture of equal volumes of methylated spirit and conc. sulphuric acid, while in the dropping funnel is contained a mixture of equal volumes of methylated spirit and acetic acid. The flask is heated to 140°C and, at that temperature, the mixture of acetic acid and methylated spirit is allowed to drop slowly into the flask from the dropping funnel. Crude ethyl acetate will begin to distil over. When sufficient of the crude ethyl has been obtained, it is shaken with a concentrated solution of common salt containing a little ordinary washing soda. This neutralises the acid which has passed over and causes the pure ethyl acetate to separate out as an oil. This oil is collected and redistilled, whereupon a supply of ethyl acetate of reasonably high purity will be obtained. Perfectly pure ethyl acetate cannot be obtained from methylated spirit.

Chloral hydrate is dangerous in respect of its being a powerful "hypnotic" drug, inducing sleep, coma and even death when taken in sufficient quantity. It is prepared by passing dry chlorine gas into rectified alcohol (or methylated spirit) until the alcohol is saturated with the gas. The process is best carried out in sunlight, and, towards its latter stages, the alcohol should be nearly boiling. In order to saturate the alcohol completely with chlorine, the latter gas will usually have to be passed for two or three days. A crystalline product is formed in the flask. This is, for the most part, chloral alcolate. When it is distilled with conc. sulphuric acid, an oily product,



chloral, distils over. The chloral is converted into crystalline chloral hydrate by treating it with an equal weight of water.

You can make methyl salicylate by distilling a mixture of equal volumes of conc. sulphuric acid and methyl alcohol with one half its weight of salicylic acid. Methyl salicylate boils at a temperature of 224° C.

**CRYSTAL LACQUER**

"I REQUIRE a formula for a good crystal lacquer for brass articles and also one for removing varnish and verdigris from articles of the same metal."—K. G. (Caterham).

"CRYSTAL" finishes on brass and other metal articles are usually obtained by heat-treatment of a synthetic resin lacquer. Write to Bakelite, Ltd., 68 Queen Victoria Street, London, S.W.1 for particulars of the trade varnishes which they supply for this purpose.

A strong hot solution of caustic soda will readily remove varnish and verdigris from brass articles. Immerse the articles in the hot solution for a few minutes. Then wipe or brush away the softened varnish and finally well wash the metal in clean water in order to remove every trace of the soda.

**VISIBLE AND INVISIBLE INKS**  
(Continued from page 624)

has a shiny or smooth surface, the existence of an invisible ink can almost certainly be detected by the simple procedure of holding up the sheet of paper on a level with the eyes and with its edge pointing towards the light. Under these conditions, the "invisible" ink writing will usually be discerned, since it will have dulled the sizing of the paper and, by contrast, will show up "matt" against the surrounding smooth surface of the paper.

Invisible ink messages, for obvious reasons, are seldom transmitted on sheets of paper which are otherwise blank. Often enough, however, they can be detected by cautiously ironing the paper, and then by experimentally treating very small areas with one of the developing chemicals enumerated above, such as, for instance, ammonium sulphide.

Most invisible inks show up when subjected to the drastic procedure of spilling over the paper a quantity of ordinary blue-black writing ink. The spilled ink is left in contact with the paper for about ten seconds, and then instantly washed away by a stream of water. Usually, under these circumstances, the "invisible" characters, no matter in what medium they have been written, will show up clearly, the blue-black writing ink having sunk deeply into the fibre of the paper in these areas.

The very latest method of detecting an invisible ink is more of a physical than a chemical one. It consists of exposing the document in a specially-constructed box to the fumes of a volatile substance, such as iodine, which stains the paper more deeply where the invisible ink has dulled the sizing than in the surrounding areas. The document is then photographed and finally it is exposed to heated air. After a few hours, the stain entirely disappears, and, if desired, the document may then be allowed to continue its journey to its addressee.

**Multi-Model Competition**

In the July and August issues of this journal we gave details of a competition run by Multi-Models in which readers were invited to name a bogie. The sender of the most appropriate name will receive a prize of £5. The closing date has now been extended from August 8 to September 5.

**GRINDING AND POLISHING UNIT**



1/10th H.P., A.C.-D.C., 100 or 250 Volts, 5,000 r.p.m. Fitted with 4in. Mop, 3in. Grinding Wheel, Guard and Tool Rest. Built-in Switch and 4 feet of Flexible Cable. Price £3/9/6

**EASCO** 18 P.M., Brixton Rd., London, S.W.9 Telephone: RELiance 1693

**MAKE MORE MONEY**

£3 to £6 weekly can be earned at home in a wonderful business of your own. No matter where you live you can commence to make money in your spare or whole time. No risk, canvassing or experience required. A wonderful opportunity for anyone wishing to add pounds to their income. Particulars, stamp.

**BALLARD**, York House, 12 Hambrook Road, LONDON, S.E.25.

**3 5/8 in. WINFIELD**  
FOR VALUE AND RELIABILITY

As illustrated £10 - 10 - 0  
or by 12 monthly payments of 18/4  
3 in. B.G.S.C. Lathes from £4 - 10 - 0  
**The Winfield Mfg. Co.** College St. Works  
LONG EATON

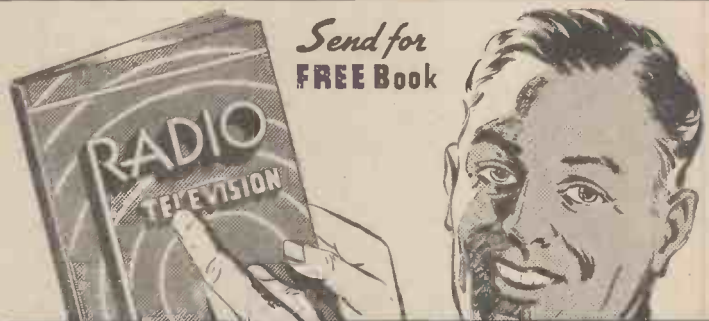

Send for  
**FREE Book**

*Learn* **RADIO**  
**AT HOME**

**FREE**  
—this  
splendid  
equipment

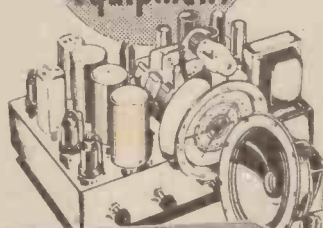

**QUALIFY FOR BIGGER PAY**

You can be trained at home just as National Schools trains students in its large internationally-recognized resident school. During your spare time you can learn these profitable Trades: Radio Service Public Address Broadcasting Sound Recording Communications Television. National's easy-to-learn method brings practical, tested training right to your home, just as it has to thousands of students all over the United States, Canada and overseas countries and provinces. Proven American methods tested for 34 years, 30,000 graduates. You can operate your own radio service business or prepare for a good pay Government job or those positions open to trained men in studios, theatres, shops, laboratories, plants and in many fields. Previous experience unnecessary. Diploma upon graduation.

**EQUIPMENT AND TOOLS FREE**

After enrolling you receive without extra charge complete equipment and tools essential for thorough training — including an All-Wave Superheterodyne Receiver with Cathode Ray Tuning Indicator; Modern AC-DC Multitester; Test Oscillator; Speaker; Headphones and miscellaneous equipment. (This is YOUR opportunity for a successful future. Get National Schools' FREE BOOK of details. Post Coupon TODAY.

**NATIONAL SCHOOLS**

LOS ANGELES, CALIFORNIA, U. S. A.

**MAIL COUPON TODAY FOR FREE BOOK**

Mr. J. A. Rosenkranz, President,  
NATIONAL SCHOOLS, Dept. CGR-9  
4000 S. Figueroa St., Los Angeles, Calif., U.S.A.

Without obligation, please send **FREE BOOK** and complete information

Name \_\_\_\_\_  
Address \_\_\_\_\_  
City \_\_\_\_\_  
Country \_\_\_\_\_

Founded 1905 HOME of America's only resident Trade School offering Home Study Training throughout the world. 75,000 sq. ft. devoted to trade instruction.



Postage to U.S.: Letter 1 1/2d.; post-card 1d.

# BUY, EXCHANGE OR SELL

## An Absorbing Hobby

BUILDING A STUART MODEL IS AN ENROSSING PASTIME, AND THE RESULT A CONTINUOUS PLEASURE



We illustrate:

STUART NO. 10. High Speed Steam Engine. Bore 3/4". Stroke 3/4".

Each set is quite complete—drawings and instructions are included.

If you have a lathe—		
The rough castings - - -	8/6	
If not—		
Fully machined set - - -	18/6	
Ditto, with all holes drilled and tapped - - -	25/-	

This and many other Stuart engines are fully described in the 72-page CATALOGUE No. 3, 6d. post free.

**STUART TURNER LTD. HENLEY - ON - THAMES**

## "WILCO" FOR MOTORS



The motor illustrated is an induction type, geared to run at 47 r.p.m. It is silent and very powerful, cannot be stopped with the hand and operates on 200/250 volt A.C.

Ideal for moving displays, etc. and will not interfere with your radio. Other types can be supplied to run at 3 or 6 r.p.m. for 27/6 each.

Leaflets free or complete Elec. Catalogue of Battery and Mains Motors, Instrument Wire, Morse Sets, etc., 4d., post free.

**1/40 H.P.**  
No. P.M. 24  
Price **32/-**  
Post 6d.

**L. WILKINSON.** 204, Lower Addiscombe Road, Croydon, Surrey



Easily made from our castings 12/6 per set. Complete Engines ready to run from £3.15s.

**HALLAM & SON**  
Upton, Poole, Dorset

**MINIATURE PORTULAN ENGINES** for Aeroplanes and Speed Boats. 1 to 15 c.c. Send 3d. for particulars



The 'ADEPT' LATHE 15/8 in. centres, 6 in. between centres. With compound slide-rest 22/-, or with hand-rest only, 13/9. Screw Tail Stock, 5/6 extra. Post 1/-.

**THE SUPER 'ADEPT', 33/-**  
**F. W. PORTASS,** Sellers Street, SHEFFIELD

## SITUATIONS VACANT

**G.P.O. ENGINEERING DEPT.** (no experience required). Commencing £3/13/0 per week. Age 18-23. Excellent prospects. Free details of Entrance Exam. from B.I.E.T. (Dept. 570), 17-19 Stratford Place, London, W.1.

**DRAUGHTSMEN.** Numerous vacancies available in Electrical, Mechanical, Aeronautical and other Branches of Engineering. Building, G.P.O., etc., for men age 17-40. Exp. unnecessary if willing to learn. Details of openings, salaries, prospects, etc., FREE from N.I.E. (Dept. 372), Staple Inn Buildings, W.C.1.

## TOOLS.

2/9 any lot. Eight lots £1.—Below.  
 3/8" Toolholder with four H.S. Tools.  
 3/8" Adj. Boring Tool with H.S. Tool.  
 1/2" Drill Chuck, taper or straight shank.  
 1/8" to 3/8" Silver Steel, 13 pieces. 13" long.  
 3/8" to 1" Silver Steel, 4 lb., 2" to 4" long.  
 500 Ass. Brass and Steel Screws, etc.  
 100 Steel Hex. Bolts and Nuts, 1/2" to 1".  
 16 H.S. Drills, 1/32" to 5/32".  
 12 Drills, 1/8" to 3/4". Carbon.  
 Set 1" Dies, 1", 3/8", 1/2", 5/8", 3/4", Whit.  
 Ditto, B.S.F. 26 threads of S.A.E.  
 Set 1/2" to 1" Taps, same as Dies. T.S. or P.  
 Slitting Saws, five 1/32" to 1/4" thick, 1" hole.  
 Two dozen Fine and Odd Thread Taps to 3/4".  
 Three dozen Tungsten Hack-Saws to 12".  
 18 Grinding Wheels, 1" to 1" diam.  
 Three H.S. Tap Fluting Cutters, 1 1/2" diam.  
 One dozen Ass. Files, 4" to 12".  
 Six Files, 12" to 16". Note postage terms.  
 Dozen Toolmaker's Needle Files, indispensable.  
 Best Carborundum Wheel, 7" by 1/2" by 3/4" hole.  
 200 Springs to approx. 6" long.  
 Pair each Inside and Out Adj. Spring Calipers, 4", worth 5/-.  
 Four Ass. Carborundum Wheels to 3 1/2" diam., 1/2" hole.  
 Doz. Emery Wheels, 1/8" to 1/2" thick, 1/2" hole.  
 Set Three Bearing Scrapers.  
 0" to 1/2" Adjustable Tap Wrench. Burke.—Below.  
 12 Sets Stocks and Dies, etc., 3/8". Split Dies, cutting 3/32", 1/4", 5/32", 3/8", 7/32", 1/2", 5/8", Whit. or B.S.F. or 0, 1, 2, 3, 4, 5, 6. B.A. Complete with Taper Taps, Adjustable Tap Wrench and Die-Stock, Seven Dies and Taps, usual price of these sets is 12/6, clear while stock lasts at 6/6 per set, extra sets of Taps, Seconds or Plugs, 1/9 set of seven. Burke.  
 Small Taps, 7, 8, 9, 10, 12 B.A.; 1/8" Whit. 6d. each. No dies these sizes. Burke.  
 1" Round Dies, Screwing 1/4", 3/8", 1/2", 5/8", 3/4", Whit., B.S.F.; or Brass 26 Threads; or American Fine. S.A.E. for Yankee Cars, Set of Five Dies 2/9; Four Sets 10/-; Best Quality 1" Die-Stocks, all Steel unbreakable with Hardened adjusting Screws, 1/9 each.—Below.  
 4,000 Taps, same sizes and threads as Dies, 2/9 set, four sets 10/-.—Below.  
 Vee Blocks and Clamps, Starret pattern, accurate, first-class finish, 4/- pair.—Below.  
 £1 orders carriage paid, except abroad.  
**J. BURKE, 30 TRIPPET LANE, SHEFFIELD 1**

**BRAND NEW POWER TOOLS** of quality. 10-inch bandsaws, 54/-; Jigsaws, 22/6; Bench Drills, 11/-; Circular Saws from 25/-; 3-inch S.C. Toolroom Lathes, from £4 5s. New 1-inch chromium plated Micrometers, 12/6; Electric Drills, 37/6; Grinders.—John P. Steel, Bingley.

**GRAYSON'S** Glass-boring Outfits and Tube Cutters avoid risk.—Below.

**DRILLS, Taps, Dies, Files, Chisels and Punches** Best quality at keeneest prices.—Grayson & Company, 300 Campo Lane, Sheffield.

**MYFORD LATHE SPECIALISTS.** Cash or on deposit terms from 10s. monthly. Immediate deliveries anywhere. Nuttalls, 20 Albert Street, Mansfield.

## WATCHMAKING

**WATCH & CLOCK REPAIRERS.** Send 3d. for complete list of material and tools.—Blakiston & Co., Ainsdale, Southport.

## PATENTS

**REGINALD W. BARKER & CO.** (Established 1886), 56 Ludgate Hill, London, E.C.4.—Patent and Trade Mark Booklets Gratis.

## MISCELLANEOUS

**TELESCOPES, MICROSCOPES,** Scientific Instruments, etc. Send for lists. Sale or Exchange.—C. V. Bolton, F.S.M.C., 49a Leigh Road, Leigh, Lancs.

## A.R.P. AND OTHER VENTILATION

Your Dug-out may be Fuggy  
**LESDEX MOTOR BLOWERS** for suction or pressure, 20 cubic feet free air per minute, all aluminium and ensures adequate ventilation.  
 Suitable for blowing and cooling purposes, Porthole or baffle board fixing. Size only 9 in. A.C. or D.C. Mains. Bargain Price **25/-**  
 1/2 H.P. Direct Coupled Sirocco Blowers, A.C. or D.C., 25 ft. air 2 1/2 in. outlet, 50/-.  
 Compressors for Spray Work, hand or motor, cheap.  
**LESLIE DIXON & CO.** 218 Upper Thames Street, E.C.4.

## FREE SERVICE FOR READERS

**READERS** requiring information concerning goods or services advertised in PRACTICAL MECHANICS should give names of Advertisers from whom particulars are desired. Any number of names may be included and we will obtain for you catalogues, lists, and any other information you may be wanting. **THERE IS NO CHARGE FOR THIS SERVICE.**

Readers desiring particulars from a number of Advertisers will, by this method, save time and postage. If any Advertiser stipulates that stamps or postal orders are necessary before samples or catalogue are sent, please enclose the necessary amount with your instructions. You are cordially invited to make full use of this Service.

## ADVERT. SERVICE DEPT., PRACTICAL MECHANICS,

**TOWER HOUSE, SOUTHAMPTON STREET, STRAND, W.C.2**

Please obtain and send to me particulars from the Advertisers in your September issue whose names I give on list attached.

Advertiser | Page No. | Information Required

Attach sheet of paper, with particulars, and your name and address (written in BLOCK letters), with date, to this announcement.

# BUY, EXCHANGE OR SELL

Advertisements are accepted for these columns at 3d. per word (minimum 12 words at 3s.—advertisements of less than 12 words are charged at the minimum rate of 3s.) subject to a discount of 2½% for 6 consecutive monthly insertions or 5% for 12 consecutive monthly insertions. TERMS:—Cash with order. Cheques, Postal Orders, etc., should be made payable to George Newnes, Ltd. The Proprietors reserve the right to refuse or withdraw advertisements at their discretion. All advertisements must be received on or before the 5th of the month preceding date of publication and should be addressed to the Advertisement Manager, "Practical Mechanics," George Newnes Ltd., Tower House, Southampton Street, Strand, W.C.2.

## BATTERY-CHARGING PLANT

**P.M. ARGON CHARGER KIT, 30/-**: Steel-cased complete, plug-in, 37/6 carriage paid. Also Metal Rectifier Chargers. (See display advertisement.) Brighton Radio Service, 34 Middle Street, Brighton.

## BOOKS

**ALL TECHNICAL BOOKS**, including Radio Engineering, Photography, Chemistry, and Mechanics, etc., can now be purchased for as little as 2/6 monthly.—Write a card or call personally for details and lists, from the Technical Department, Phoenix Book Company, Chandos Place, W.C.2.

**THOUSANDS** American, Canadian, English Books, Magazines, Aeroplanes, Boats, Ships, Models, Railways, Engines, Radio, Mechanics, Handicrafts, everything. Samples, 2/6. Catalogues, 3d.—P. M. Final, 15 Nashleigh Hill, Chesham.

## ELECTRICAL

**A.C., D.C. MOTORS**, Grinders, Fans, Drills, Chargers, 1930 interesting lines. List free. Easco Electrical Services, 18pm, Brixton Road, S.W.9.

**AC/DC MOTORS**, 1/12th to 1/8th h.p., from 10/- Stamp particulars.—Brookes, Banners Street, Cradley, Staffs.

use **Bakers' SOLDERING FLUID**

"Easily the Best Soldering Fluid Obtainable." This statement by a regular user of "BAKER'S" expresses the general opinion of the Motor and Engineering Trades.

Sold in 6d., 1/- and 1/6 tins, also in bulk.

*For a quick clean job!*

SIR WM. BURNETT & CO. (CHEMICALS) LIMITED  
GREAT WEST ROAD, ISLEWORTH, MIDDLESEX  
TEL. HOUSLOW 0476

**BRAND NEW ELECTRIC MOTORS**

1 h.p. Totally enclosed ball-bearing double-ended Spindle Single-phase Motor, all voltages. No radio interference. 1,400 r.p.m. Delivery from Stock. An unequalled opportunity. **55/-**. Guaranteed 12 months.

ALSO ¼ h.p. motors 38/6; ½ h.p. 38/6; ¾ h.p. 80/-; 1 h.p. 95/-. Larger sizes to 80 h.p. Send for details. All types Woodworking Machinery: Planers 80/-; Circular Saws 50/-; Bandsaws, 54/-; Wood and Metal Lathes, Drilling Machines, Electric Tools, Rotary, Electric and Hand Pumps. Paint Spray Plants, Guns, Dental Lathes, Air Compressors, Exhaust Fans, Forge Blowers, Petrol and Diesel Engines, etc. Deferred Terms Available.

**JOHN P. S. STEEL** (Dept. P.M.), Clyde Mills, BINGLEY, YORKS.

**OUR ADVICE BUREAU COUPON**

This coupon is available until September 30, 1939, and must be attached to all letters containing queries, together with 3 penny stamps. A stamped addressed envelope must also be enclosed.

**PRACTICAL MECHANICS, SEPT., 1939.**

## CANOE

**BOAT AND CANOE**. Kits from 27/6. All types completed craft. List stamp. Trade.—Metacraft (P), Christchurch, Hants.

## CINEMATOGRAPHY

**ART CINE FILMS**.—Exclusive 9.5 and 16-mm. Free Films to Cine Camera or Projector buyers. All makes. State wants.—P. M. Dane, 64 Stanley Street, Liverpool, 1.

## CLOCK MOVEMENTS

**CLOCK MOVEMENTS**, Timepiece, Strike, Chimes, etc., for mantel, granny, and grandfather cases, also Electric and Recording Movements of every description.—Needham, 25 Stratton Road, Manchester, 16.

## ENGINES

**24-H.P. SCOTT AERO ENGINE**, with Prop, almost new. What offers? — G. Briggs, Springfield Mill, Brook Street, Preston.

## METAL WORK

**MAKE METAL TOYS**. Easy, profitable with "Success" Moulds. List free. Complete trial mould, 1/6.—Lee's, 1 Birkin Avenue, Nottingham.

## MICROSCOPY

**"THE MICROSCOPE AND ENTOMOLOGICAL MONTHLY"**. The premier journal for all students of nature. 1/-, from newsgents, or 1/1 from Microscope, 20/21 Took's Court, London, E.C.4.

**MICROSCOPIC OBJECTS**, unmounted, prepared. Assorted packet, 2/-.—Leng, "Elhanan," Brierley Road, Bourne-mouth.

## MUSICAL INSTRUMENTS

**BAND GUIDE**. Hints on the Bugle, Drum, Flute, Staff Parade formation, etc. Free, post paid.—Potter's (Manufacturers), West Street, London, W.C.2.

## THE WEBLEY SERVICE AIR RIFLE Model

NO LICENSE REQUIRED TO PURCHASE  
Or Use at Home

WRITE FOR DESCRIPTIVE FOLDER

Rooks, Rabbits, Hares, Sparrows and similar vermin can be destroyed by this extremely accurate and powerful Air Rifle ideal for Target Practice.

**CALIBRE 22w177** With Leaf-sight and Peepsight  
**WEBLEY & SCOTT Ltd.** 106, WEAMAN STREET, BIRMINGHAM, 2

## INVENTORS

### VALUABLE GUIDE

General Advice Free. POST FREE 6d.

**CHATWIN & CO.** Est. 1880  
Regd. Patent, Design and Trade Mark Agents for all countries.

253 (D) Gray's Inn Road, London, W.C.1.

## CUT THIS OUT

**Practical Pen Coupon Value 3d.**  
Send five of these coupons with only 3/- (and 2d. stamp) direct to the Fleet Pen Co., 119, Fleet Street, E.C.4. By return you will receive a handsome lever self-filling FLEET S.F. PEN with solid gold nib (fine, medium, or broad), usually 10/6. Fleet price 4/3, or with 5 coupons only 3/-. De Luxe Model. FLEET SELF-FILLER, 2/- extra.



## MODELS

**EVERYTHING FOR** electrical rewinds and repairs. Screws, nuts, and washers for model engineers. Lists free.—Lumen Electric Co., Litherland, Liverpool, 21.

## PATENTS AND INVENTIONS

**HAVE YOU** a sound, practical invention for sale, patented or unpatented? If so, write Chartered Institute of American Inventors, Dept. 10-C, Washington, D.C., U.S.A.

**ADVERTISER** seeks Marketable Inventions. Please send particulars to Box No. 134, c/o PRACTICAL MECHANICS.

## PHOTOGRAPHY

£500 worth, good, cheap Photo Materials, Films, Plates, Cards, Papers, Chemicals, Catalogue and 4 Samples free.—Hackett's Works, July Road, Liverpool, 6.

**DON'T TAKE RISKS**. Good developers mean good results. Our reliable stock developers keep twelve months after mixing. Satisfaction certain to amateurs and professionals. Best developers ever put on the market. Make two pints strong developer. 6d. each. 6 for 2/3, 12 for 4/-. Post free.—Hackett's Works, July Road, Liverpool, 6.

**PHOTOGRAPHIC MATERIALS**. Plates, films, mounts, chemicals, etc. Interesting money-saving lists and samples free. Kindly thoughts. "Kimber's," 105 Queen's Road, Brighton.

## WIRELESS

**CRYSTAL SET KITS**, complete, 3/11, post free. —W. J. Buckle, 63 Avenue Approach, Bury St. Edmunds.

**BECK'S CHEMISTRY**

**SPECIAL OFFER:**  
A Sample Parcel containing many useful pieces of **CHEMICAL APPARATUS 2/6**  
(Carriage Paid)  
Write for full Catalogue, FREE

**BECK** (Scientific Dept. A), 60, High St. Stoke Newington, London, N.16.  
Booklet, "Experiments in Chemistry," 6d. P.O.

## JUBILEE WORM DRIVE HOSE CLIPS

The long-life clip with the ever-tight grip.  
*The Best Known*  
For Radiator Joints, Air, Oil, and Water Hose Joints.



We guarantee a Tight Joint.

Stocked by all Garages and Accessory Dealers

**L. ROBINSON & CO.**  
25 London Chambers, GILLINGHAM, KENT.



# GAMAGES

Send for copies of  
Gamages Tool  
Bargain Leaflets  
for Metalworkers  
and Woodworkers

## 3 in. BACK GEARED, GAP BED, SCREWCUTTING, SLIDING, MILLING and SURFACING LATHE with Compound Slide Rest

GUARANTEED TRUE TO .001 in.

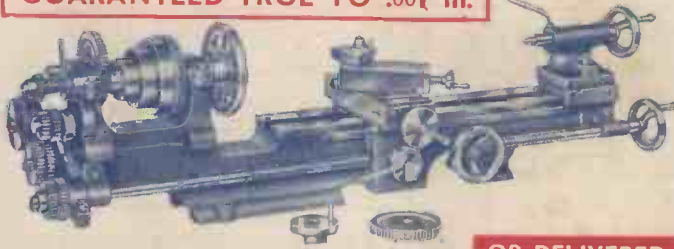

Each lathe is tested for spindle alignment to bed with a test indicator, and is built to the limits of .001 in. alignment of centres. The saddle has machine-cut slots, travels the length of the bed through a square thread lead screw  $\frac{1}{8}$  in. by 10 threads, and is provided with quick action return by hand wheel and rack and pinion. The mandrel is hollow to admit  $\frac{1}{8}$  in. rod and is bored No. 1 morse taper. Mandrel nose is  $\frac{1}{2}$  in. by 12 threads. The tailstock has telescopic steel barrel and is arranged to eject the centre on drawing in the barrel. It can be set over for taper turning. Height of centres 3 in. Swing, over saddle 5 in., over bed 6 in., and over gap 8 in. Distance between centres 20 in. Cone pulleys  $2\frac{1}{2}$  in. 3 in. and  $3\frac{1}{2}$  in. by  $\frac{1}{2}$  in. Length of bed 31 in. Length overall 37 in. Weight 73 lb. Complete with 5 in. face plate, driver plate, 10 change wheels, special apron, £8.17.6 and double clasp nut.

Send for Fully Descriptive Lathe Leaflet

OR DELIVERED ON FIRST OF 12 MONTHLY PAYMENTS OF 16/-

As above; but without quick saddle return, rack and pinion or tailstock setover, and with clutch action on lead screw instead of clasp nuts. £7 10s., or 12 monthly payments of 13/6.

Carriage (Outside Our Extensive Delivery Area)  
3/6 extra on either lathe, England or Wales.

## 5,000 VOLT TRANSFORMERS



Work off ordinary A.C. mains (200/240 volts). Consumption only 10 watts. Ideal for experiments, and suitable for a wide variety of purposes, including Ozone or Neon work.

Vermin traps, etc.  
To-day's value 37/6. Post 0d. **15/-**

## BOXES OF TWELVE ASSORTED FILES



The best and cheapest way to buy Files. British made and excellent quality. Sizes 6 to 12 inches. **12 for 4/6** Post 0d. Also sizes 4 to 8 ins. 12 for 2/11. Post 0d.

## AIR COMPRESSORS

for Paint Spraying, Tyre Inflation, etc.

A heavy duty machine designed for continuous use without overheating. The deeply finned detachable head and cylinder barrel are a feature. Bore, 2 in.; stroke, 2 in.; approx. displacement, 2 cubic feet at 725 r.p.m. Maximum pressure, 120 lb. per square inch. 8 in. diameter flywheel.

Carriage (outside our extensive delivery area) 1/6 England or Wales.

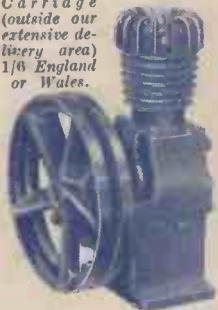

**£4/17/6**

Or Delivered on First of Ten Monthly Payments of **10/6**

$\frac{1}{2}$  h.p. Repulsion Induction Motors to drive same, £5/2/6. Pulley for motor, 5/6.

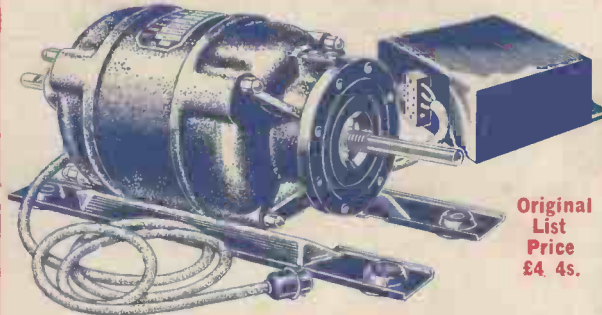

Original List Price £4 4s.

## 1<sup>ST</sup> 250 ONLY! 1.5 h.p. ENGLISH ELECTRIC Co.'s CAPACITOR START MOTORS

Complete and ready to operate. Can be run off ordinary electric light point. Suitable for driving lathes up to 3 in., drilling machines, water pumps for garden fountains, or any type of light machinery. The majority of these motors have been slightly used (some are brand new) but are guaranteed perfect. For A.C., 200-250 volts, 50 cycles. Single phase only. 1,425 r.p.m.

Carriage (outside our extensive delivery area), 1/6 extra, England or Wales.

**25/-**

## HIGH-GRADE ELECTRIC HAND DRILLS

**60/-**

Carriage paid in U.K.

Fitted with genuine Almond  $\frac{1}{4}$ -in. Chuck with key. Ball Bearings. Complete with 10 ft. cab tyre cable. Made for voltages 100/110, 200/220, and 230/250. A.C./D.C. Speed 1,200 r.p.m.

## POLISHING, BORING AND GRINDING HEAD

British made and offered at much below original price. Height 7 in. Total length of spindle, 10 in. Chuck capacity,  $\frac{1}{2}$  in.

Weight 7 lb.



**17/6**

Post 11d. Also available for grinding wheels only, and without chuck and tapered spindle, at same price.

## AIR COMPRESSORS

for Paint Spraying, Tyre Inflation, etc.

A heavy duty machine designed for continuous use without overheating. The deeply finned detachable head and cylinder barrel are a feature. Bore, 2 in.; stroke, 2 in.; approx. displacement, 2 cubic feet at 725 r.p.m. Maximum pressure, 120 lb. per square inch. 8 in. diameter flywheel.

Carriage (outside our extensive delivery area) 1/6 England or Wales.

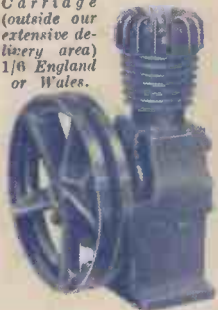

**£4/17/6**

Or Delivered on First of Ten Monthly Payments of **10/6**

$\frac{1}{2}$  h.p. Repulsion Induction Motors to drive same, £5/2/6. Pulley for motor, 5/6.

Suitable for Very Fine Work



## 1 5/8" PLAIN GAP BED LATHE with Compound Slide Rest

Constructed on orthodox lines. Overall length, 12  $\frac{1}{2}$  in. Length of bed, 8 in. Maximum distance between centres, 6  $\frac{1}{2}$  in. Height of centres from gap, 2 in. The nose of the solid mandrel is  $\frac{1}{2}$  in. x 20 threads. Bearings adjustable for wear. Compound slide rest has vee slides with jibs and adjusting screws. Tailstock is of the sliding barrel type, and is held in position by a set screw. Driver plate, 1  $\frac{1}{2}$  in. dia. Cone pulleys, 1  $\frac{1}{2}$  in. x 1  $\frac{1}{2}$  in. dia. for  $\frac{1}{8}$  in. or  $\frac{1}{4}$  in. round belting. Weight, 8 lb. Carriage 1/6 England or Wales. Foot Motor, 18/6. Set of Six Tools, 3/-; Belt, 2/-.

**21/-**

At Pounds Below Original Price

## G.P.O. ROTARY CONVERTERS BY ROTAX

Input 250 volts D.C. Output 160 volts D.C. A finely made machine mounted on rubber in metal box with rubber feet. An unusual opportunity that should not be missed.

Carriage (outside our extensive delivery area) 3/- extra, England and Wales

**17/6**

TO-DAY'S VALUE £12



GAMAGES, HOLBORN, LONDON, E.C.1 Phone your order: HOLBORN 8484 City Branch, 107 Cheapside, E.C.2

Published about the 30th of each month by GEORGE NEWNES, LIMITED, Tower House, Southampton Street, Strand, London, W.C.2, and Printed in England by THE SUN ENGRAVING CO., LTD., London and Watford. Sole Agents for Australia and New Zealand—Gordon & Gotch, Ltd. Sole Agents for South Africa—Central News Agency, Ltd. Subscription Rates: Inland and Abroad, 7s. 6d. per annum; Canada, 7s. per annum. Registered at the G.P.O. for transmission by Canadian Magazine Post.